

## Fundamentals of a Theory of Aether – Part 4: The Mechanical Origin of the Electrostatic Force

Ionel DINU, B.Sc. Physics, M.Sc. Physics, Teacher of Physics QTS

Email : [dynuionel@yahoo.com](mailto:dynuionel@yahoo.com)

LinkedIn : [www.linkedin.com/in/ionel-dinu-74490634](https://www.linkedin.com/in/ionel-dinu-74490634)

(Released : April 8<sup>th</sup> , 2024 ; last update : May 6<sup>th</sup> , 2024)

### *Abstract*

This work is a further development of the theory that explains electrostatic attractions and repulsions by the molecular vibration of objects acting on one another through the liquid aether that fills the vacuum and the interatomic spaces of substances. The 2000-year-old problem of a mechanical explanation of the laws of electrostatics is answered by the behavior of coupled oscillators. The physical origin of the electric field is that of a to-and-fro motion of the aether. Light and radio waves are shown to be longitudinal waves consisting of to-and-fro motions of the aether along the direction of wave propagation, which makes them essentially electric waves. Corroboration with results from previous works leads to the conclusion that the complete nature of light and radio waves is that of electro-gravitational waves. The 100-year-old problems of the photoelectric effect and of the wave-particle duality are solved by uncovering the direct link between voltage and frequency of vibration, by a new interpretation of de Broglie equation, and by advancing the new theory of light propagation in channels.

*Keywords:* aether, electrostatics, coupled oscillators, electric field, radio, wireless, electric wave, light, propagation in channels, matter waves, de Broglie, photoelectric effect, thermionic emission

## I. Introduction

This work claims to solve the 2000-year-old problem of giving a mechanical explanation of the electrostatic force. It is part of a broader project aimed at finding mechanical explanations for all the interactions at-a-distance – gravitational, electrostatic, magnetic –, as well as for the propagation of light through the aether as a longitudinal wave. Explaining electrostatics mechanically has been known historically the most challenging of all the interactions at-a-distance, recognized as such by the scientists of the 19<sup>th</sup> century who were fully immersed in the experimentation and mathematical representation of the phenomena of electrostatics and magnetism, one of whom was William Thomson, Lord Kelvin.

Although he is remembered today as the inventor of the scale of the absolute temperature, William Thomson's main line of work was in the field of electromagnetism. He contributed to the successful transmission of electrical signals through the first transatlantic cable that linked Europe and America. William Thomson was contemporary with the likes of Stokes, Joule, Maxwell and Heaviside, whose works he followed and understood, as he did the works of Faraday and Green, who preceded him. He invented important instruments for the measurement of electrical quantities and was involved in the setting up of the electrical units of measure used today in electricity and magnetism [i1]. His positioning in the midst of the scientific activities, both experimental and theoretical, that took place in the second half of the 19<sup>th</sup> century and contributed to the development of electricity and magnetism makes his opinions and thoughts extremely important.

Relevant to the present work is William Thomson's recognition, in his 1889 address "Ether, Electricity, and Ponderable Matter", of the *necessity of a mechanical theory of electric and magnetic interactions* [i2] :

**1. THE demand for something like a mechanical explanation of electrical phenomena is not new, but it is growing in intensity every year.**

A remarkable thought of William Thomson is his hopelessness that he will ever be able to find a mechanical explanation of the electrostatic phenomena [3] :

**Now, with reference to the electrostatic effect, the hopeless—I must not say "hopeless:" that is too large a word; we are never without hope in science—I was going to use another word, "despair"—well, I feel it desperately difficult; I feel the probability of my seeing the solution of it *is* hopeless.**

---

[i1] British Association for the Advancement of Science, Reports of the Committee on electrical Standards, A record of the history of "absolute units" and of Lord Kelvin's work in connexion with these, Cambridge at the University Press, 1913

[i2] William THOMSON, Mathematical and Physical Papers, Vol iii, Cambridge University Press Warehouse, London, 1890, p484

[i3] William THOMSON, Mathematical and Physical Papers, Vol iii, Cambridge University Press Warehouse, London, 1890, p498

... and again [i4] :

**I have absolutely—not ignored, because I have spoken of it two or three times—but I have left out in the cold, the electrostatic part, the thing we knew first. Our first love was electrostatics. That is absolutely left out in the cold; we do not touch it. We do not get near to explaining the mutual force between two electrified bodies, in any of these illustrations or attempted explanations ;**

The “illustrations or attempted explanations” William Thomson was referring to in the above quote were mostly related to the magnetic effect of the electric current, for which a mechanical explanation has been presented in this series of works titled “Fundamentals of a Theory of Aether” [i5] and [i6]. Although the knowledge of fluid mechanics was relatively well-developed in William Thomson’s time, the fact that the nature of the electric current was not well understood prevented everyone from observing that an electric current in the nature of surface waves along a conductor would generate the required circulation of the aether surrounding the conductor, which aether circulation many thought constituted the magnetic field that the current produced. Perhaps the closest to this theory came the description of the propagation of electricity in a wire as similar to the propagation of sound through an elastic body or by the propagation of motion through a series of ivory balls [i7].

In connection with the magnetic effect of the electric current, it is interesting to mention here William Thomson’s strong belief that, in the interior of a current-carrying solenoid, the aether rotates continuously (or through a definite angle – he could not tell which of these two actually occurred),

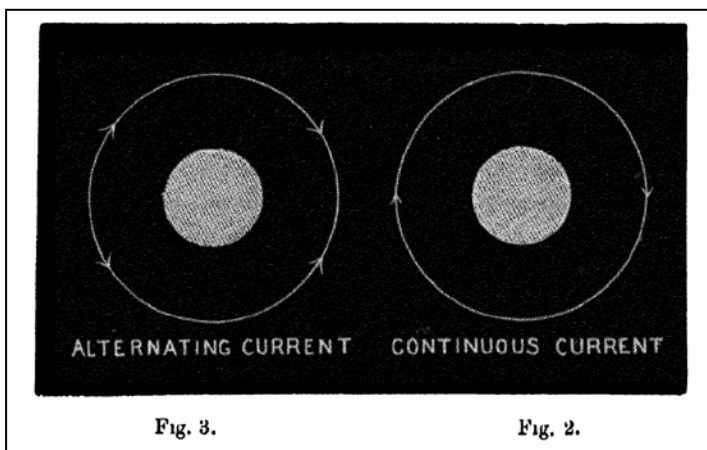

the amount of rotation depending on the strength of the current [i8]. I must note before we look at this quote that I consider quite unreasonable William Thomson’s assumptions that the aether had rotational rigidity and that the electric fluid drags the aether :

“Imagine this (Fig. 2 or Fig. 3) to be the section of an ordinary helix or solenoid with a solid copper core. Imagine a continuous electric current (Fig. 2) or an alternating electric current (Fig. 3) of

[i4] William THOMSON, *Mathematical and Physical Papers*, Vol iii, Cambridge University Press Warehouse, London, 1890, p510

[i5] Ionel DINU, Lori GARDI, *Fundamentals of a Theory of Aether - Part 1*, ResearchGate, August, 2020

[i6] Ionel DINU, *Fundamentals of a Theory of Aether - Part 3*, ResearchGate, December, 2021

[i7] Aug. DE LA RIVE, *A Treatise on Electricity in Theory and Practice*, in three volumes, Vol. II, Longman Brown Green and Longmans, London, 1856, p196,199

[i8] William THOMSON, *Mathematical and Physical Papers*, Vol iii, Cambridge University Press Warehouse, London, 1890, p503,504

of electricity sent through the solenoid, shown in section by the outer circle. Whatever the current of electricity may be, I believe *this* is a reality : *it does pull the ether round* within the solenoid. I do not think this is a dream of electro-magnetic theory ; difficult as the idea is, I believe it to be a reality. Whatever ether is, we move through it - the earth moves through it.

[...]

Somehow or other, however it is, the ether is pulled round, the ether does get a turning motion in the interior of a solenoid ; somehow or other the electric current through the surrounding wire, does give a turning motion to ether in our supposed copper core and in the air between it and the wire through which the current is flowing.

[...]

And now, instead of an alternating current through the helix, take a constant current through it. What can it do ? One thing or the other it does : either a constant current through this helix drags the ether round and round inside, or it drags it round to a certain angle proportionate to the strength of the electric current, and brings it to static equilibrium so turned. It does either one or other of those things.”

I will end this rather historically-scented introduction with the prophesy William Thomson made at the end of his 1889 address on the topic of a mechanical theory of electricity and magnetism [i9], and with my comment that the present work might be the fulfillment of his prophesy :

“And here, I am afraid, I must end by saying that the difficulties are so great in the way of forming anything like a comprehensive theory, that we cannot even imagine a finger-post pointing to a way that can lead us towards the explanation. That is not putting it too strongly. I only say we cannot now imagine it. But this time next year, – this time ten years, – this time one hundred years, – probably it will be just *as* easy as we think it is to understand that glass of water, which seems now so plain and simple. I cannot doubt but that these things, which now seem to us so mysterious, will be no mysteries at all ; that the scales will fall from our eyes ; that we shall learn to look on things in a different way – when that which is now a difficulty will be the only common-sense and intelligible way of looking at the subject.

I ask you to pardon me for leading you up to so impotent a conclusion as that we really know nothing below the surface of this grand subject which constitutes the province of the Institution of Electrical Engineers.”

Is this year, the year 2024, the “this time one hundred years” William Thomson prophesied about in his 1889 address quoted above ? And is the present work, albeit coming 35 years later than prophesied, going to be the one showing how to “look on things in a different way”, “the only common-sense and intelligible way of looking at the subject” of electrostatics ?

I can only hope that what follows will, in William Thomson’s words, make the “scales fall from our eyes”.

---

[i9] William THOMSON, Mathematical and Physical Papers, Vol iii, Cambridge University Press Warehouse, London, 1890, p510,511

## II. The Effluvium and the 2000-year-old problem of explaining electrostatics mechanically

Have you ever wondered how scientists who observed and wrote about electrical phenomena since Plutarch almost 2000 years ago [ii1] have actually attempted to explain what they were seeing? They were all, without exceptions, discussing the *effluvium*, or emanation - a type of fluid the electrical object seemed to emit in all directions. For how else could the electrical object act on another object at a distance away from it?

Of course, this fluid was invisible, but the idea of effluvium was important because it was employed

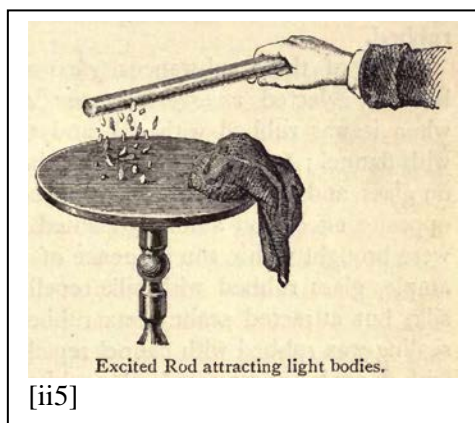

[ii5]

to give a *mechanical* explanation of the attractions that were observed. Initially it was believed that the effluvium displaced the air around the charged object and that the air pressure imbalance thus created forced any nearby object towards the charged object. Later, when the same interactions were observed by Robert Boyle to take place in vacuum, it became clear that it was not the air but the aether that played a role in the observed interactions, since the aether was believed to remain in the space of Torricellian vacuum. Unsurprisingly, the author of the three laws of mechanics, *Isaac Newton*, attempted a *mechanical explanation of the electrostatic attraction* with the help of an elastic fluid emitted by the electrical object [ii1] [ii2] [ii3] [ii4].

As incredible as it may seem, more than one hundred years had to pass between the first scientific investigation of electricity by Gilbert in 1600 and that of *electrostatic repulsion* by Grey and Du Fay in 1733 [ii6]. Thus, it can be said that proper study of the electrostatic repulsion has been overlooked for about sixteen centuries, if we count since the time of Plutarch in the year 100 A.D. [ii1] when people attempted their first explanations of the electrostatic force. Benjamin Franklin, in spite of his extensive researches in electricity, was “perplexed” when he learned that electrostatic repulsion existed between two bodies resinously electrified [ii7]. Electrostatic repulsion was difficult to explain in a science whose name, electricity, entered the English language as “a power to attract straws or light bodies”.

The science of electricity has had a complicated development, and one of the reasons for this complication was Du Fay’s introduction of the idea of *existence of two kinds of electricity* [ii8] to explain *electrostatic repulsion*. It can be said that Du Fay’s introduction of the idea of existence of *two kinds of electricity* almost put an end to the whole effort of finding a mechanical explanation of

---

[ii1] Duane ROLLER, Duane H. D. ROLLER, *The Development of the Concept of Electric Charge*, Harvard University Press, Cambridge, 1954, p3

[ii2] John TYNDALL, *Lesson in Electricity*, D. Appleton and Company, New York, 1895, p3

[ii3] William Snow HARRIS, *Rudimentary Electricity*, 5<sup>th</sup> Ed., London, 1859, p36

[ii4] Park BENJAMIN, *The Age of Electricity, from Amber-Soul to Telephone*, Charles Scribner’s Sons, New York, 1901, p10

[ii5] Thomas P. TREGLOHAN, *Frictional Electricity*, Longmans Green and Co., London, 1886, p3

[ii6] Dionysius LARDNER, *The Cabinet Cyclopaedia, A Manual of Electricity, Magnetism, and Meteorology*, Vol. I, Longman, Brown, Green, and Longmans, John Taylor, London, 1841, p7,12-15

[ii7] Edmund Taylor WHITTAKER, *A history of the theories of aether and electricity : from the age of Descartes to the close of the nineteenth century*, Longmans Green and Co, London, 1910, p47

[ii8] Duane ROLLER, Duane H. D. ROLLER, *The Development of the Concept of Electric Charge*, Harvard University Press, Cambridge, 1954, p44–46

the electrostatic interactions because his view implied that the two kinds of electricity acted on one another at-a-distance. To make matters worse, the concept of effluvium seemed to give contradictory explanations in the case of electrostatic repulsion : for how to explain repulsion between two electrical objects if they both emit, and especially if they both *absorb*, effluvium ?

Effluvium is nevertheless an important concept to return to and reconsider, because it is a *healthy scientific concept*, being derived from a *healthy and legitimate way of scientific reasoning*, something that the experimenters of the past worked so much with in their effort to find a *mechanical explanation of electrostatic interactions*. And effluvium is relevant because it naturally led to the development of the theory advanced in this work - which theory, however, makes no use of effluvium at all. How is this possible ?

Firstly, effluvium is related to the fact that the electrostatic force is a short-range force, unlike the gravitational force which acts through the vast distances of the interplanetary space ; so, although both forces act through the aether, they are not similar because they do not act through the same mechanism. The gravitational force was identified in [ii9] as a buoyancy force in the aether, the aether pressure gradient necessary for its action being produced by the total radiation emitted by a star or a planet. The short-range feature of the electrostatic force is very well captured in the concept of effluvium because the effluvium, as something *emitted* by the charged object, cannot be expected to travel too far through the aether from the object that emitted it.

However, it is not reasonable to admit that the charged object emits effluvium continuously, because this would mean that a charged object is an infinite store of effluvium. It follows then that the effluvium emitted by a charged object must return back to the charged object that emitted it, which is what some investigators in the past actually believed it occurred. And if the effluvium is emitted, then returns back, then it is emitted again, then it returns back again and so on, we have a to-and-fro motion of effluvium that originates at the charged object. If that is the case then, *there is no need for an effluvium at all* since the same function can be assigned to the aether surrounding a charged object : taking a charged object as an object in molecular vibration immersed in aether, it can be seen that the aether will be pushed to-and-fro by the charged object, and this to-and-fro motion will act on another object placed at a distance. Thus, what we call an object with “electric charge” is in fact an object charged with energy of vibration. This naturally leads to the conclusion that what we call the “electric field” surrounding a “charged object” is in fact a to-and-fro motion of the aether produced by the vibrations of that object. We have seen in [ii10] that attractions and repulsions take place between vibrating objects immersed in a liquid, and we will see later how the laws of electrostatics can be explained by the coupling of the vibrating objects acting on one another through the aether.

---

[ii9] Ionel DINU, The Origin of Gravitation, The General Science Journal, January, 2007

[ii10] Ionel DINU, Fundaments of a Theory of Aether - Part 2, ResearchGate, August, 2021

### III. The experimental background of the laws of electrostatics. How the electric charges were invented. A digression into the atomic structure

So what exactly are the electrostatic phenomena that any theory of electrostatics should be able to explain ?

The list of six electrostatic phenomena below [iii1] is the most comprehensive due to the inclusion of the last item, not commonly mentioned in the modern textbooks of physics :

- (i) attraction between a body positively charged and one negatively charged
- (ii) attraction between a body positively charged and one uncharged
- (iii) attraction between a body negatively charged and one uncharged
- (iv) repulsion between two positively charged bodies
- (v) repulsion between two negatively charged bodies
- (vi) attraction that may occur between two bodies that have charges of the same sign, but with the charge on one of them relatively weak.

Let us recall briefly how the artificial concepts of “electric charge” – “positive” and “negative” – have been *invented*. It is best to start with Benjamin Franklin’s theory that explained the charging of a glass rod by rubbing it with a piece of silk : he considered that, through rubbing, the glass rod gained some electric fluid from the piece of silk, which piece of silk was therefore considered to have lost some of its own electric fluid. Since glass gained the electric fluid, it contained more than the normal quantity of electric fluid it had before rubbing, and because of this *excess* of electric fluid it was called by Franklin “charged” “positive”. The silk, since it lost some of its electric fluid, had a *deficit* of electric fluid, and was called “charged” “negative”. *There were no two types of electricity* at this stage of development of the electrical science, there was only the electric fluid that was transferred from one object to another through rubbing, in a way very similar to water that can be transferred from one container to another. “Charge” meant simply “load” – a load of electric fluid in the case of glass and, by extension, a deficit of electric fluid in the case of silk.

The topic of electric fluid was discussed in a previous work of this series [iii2], where it was assigned the name **electrigen**, a place in the Periodic Table of Chemical Elements, the chemical symbol [E], and considered to have no “electric charge” of its own in the sense that “electric charge” is understood today. In fact, the quote below [iii3] clearly shows that the electric fluid *was considered an element also by Franklin himself* [iii4], so the idea of the electric fluid as a distinct chemical element should not appear so unusual to anyone today :

“This observation suggested to Franklin the same hypothesis that (unknown to him) had been propounded a few months previously by Watson : namely, that electricity is an element present in a certain proportion in all matter in its normal condition ; [...].” (underline added)

It is worth noting here Watson’s hypothesis mentioned in the above quote [iii5], according to which

---

[iii1] Duane ROLLER, Duane H. D. ROLLER, The Development of the Concept of Electric Charge, Harvard University Press, Cambridge, 1954, p89

[iii2] Ionel DINU, Lori GARDI, Fundamentals of a Theory of Aether - Part 1, ResearchGate, August, 2020

[iii3] Edmund Taylor WHITTAKER, A history of the theories of aether and electricity : from the age of Descartes to the close of the nineteenth century, Longmans Green and Co, London, 1910, p43

[iii4] Benjamin FRANKLIN, Experiments and observations on electricity, made at Philadelphia in America, London, 1751, p14

[iii5] Edmund Taylor WHITTAKER, A history of the theories of aether and electricity : from the age of Descartes to the close of the nineteenth century, Longmans Green and Co, London, 1910, p42-43

the *electric fluid existed* and was at *the origin of electrical effects* :

"I have shewn, that electricity is the effect of a very subtil and elastic fluid, occupying all bodies [...] ; and that every-where, in its natural state, it is of the same degree of density ; and that glass and other bodies, [...] have the power, by certain known operations, of taking this fluid from one body, and conveying it to another, in a quantity sufficient to be obvious to all our senses ; and that, under certain circumstances, it was possible to render the electricity in some bodies more rare than it naturally is, and, by communicating this to other bodies, to give them an additional quantity, and make their electricity more dense." (underline added)

Another stage in the development of the theory was due to Du Fay's *artificial invention of two types of electric charge* – “vitreous” and “resinous” – [iii6], made with the purpose of explaining the electrostatic repulsion that he was the first to study. It must be stated here that, although Du Fay claimed to “explain” the electrical phenomena he was observing by inventing *two types of electric charge*, his invention explained in fact nothing. The words “vitreous” and “resinous” were chosen by Du Fay because glass (“vitra” in Latin) and sealing-wax (which is made from “resin”, amber belonging to the same class of materials) were the main materials employed in rubbing and obtaining electrical attractions and repulsions : in very simple experiments glass repelled glass, wax repelled wax, whereas glass and wax attracted one another after being rubbed with certain materials. By extension then, all objects that repelled glass after being rubbed with other materials were considered to have glass-like or “vitreous” electricity ; the same procedure was applied to determine the wax-like or “resinous” electricity of other rubbed objects. However, this procedure was actually *inconsistent*, because glass can be made to attract glass if the two are rubbed with different materials, wax can be made to attract wax if the two are rubbed with different materials, and glass can be made to repel wax if the two are rubbed with certain different materials. Even rubbing two identical materials such as two glass plates will result in different electricities on each plate [iii7(a)], and the same is true for two pieces of resin [iii7(b)]. It can be seen that Du Fay's introduction of *two types of electricity* was questionable from the very beginning because **all that happened through rubbing was to create objects that attracted or repelled one another and this is all that a theory of electrostatics was, and still is, supposed to explain**. The *invention of two types of electricity* does not solve the problem of explaining why and how objects repel and attract. In fact, it can be seen at point (vi) in the list of electrostatic phenomena shown at the beginning of this section that there are gradations even among “electricities” of the same type, in that stronger and weaker electricities of the same type can actually attract one another, defeating the very purpose for which two types of electricity were invented.

In the third and last stage of the development of the theory of electricity, Franklin's conception of “positive” charge (or load) due to *excess* of electric fluid in glass was combined with Du Fay's conception of “vitreous” *type of electricity* for the same material, resulting in the ***invention of “positive charge” as a distinct physical entity, which is elevated to the status of a fundamental, irreducible, property of matter in today's physics***. The same happened with the invention of the “negative charge” : the combination of Franklin's “negative” charge due to *deficit* of electric fluid in wax and Du Fay's conception of “resinous” *type of electricity* for the same material resulted in the

---

[iii6] Duane ROLLER, Duane H. D. ROLLER, *The Development of the Concept of Electric Charge*, Harvard University Press, Cambridge, 1954, p44–46

[iii7] (a) Aug. DE LA RIVE, *A Treatise on Electricity in Theory and Practice*, in three volumes, Vol. II, Longman Brown Green and Longmans, London, 1856, p596 ; (b) Rev. Robert MURPHY, *Elementary Principles of the Theories of Electricity, Heat, and Molecular Actions*, Part I On Electricity, Cambridge, London, 1833, p29



***invention of “negative charge” as a distinct physical entity in use today.*** The author of this strange mix of ideas was Robert Symmer, who did not base it on any experimental observations, nor could he have – he put it forward as a personal thought [iii8]. It was Augustin Coulomb who, for some reason, preferred it, promoted it, and tried to bring, unsuccessfully, experimental arguments in its favor.

The strangeness of the coexistence of two opposite types of charges in the same object, which are supposed to attract and cancel one another when the object is “neutral”, is felt by many people when they learn about it for the first time ; these mutually cancelling charges are then supposed to be separable by external forces and be transferred further on other objects through contact. We are asked to believe that they *exist inside the atom of an element*, attracting one another but not annihilating each other, creating tremendous problems for the understanding of the atom, but nevertheless forming the basis for the current model of atomic structure in which a “positive” central part – the atomic nucleus – is surrounded by a “negative” cloud – the electronic shells – inexplicably coexisting as fundamental and separate physical entities, leading to absurdities such as the planetary theory of the atom in which the electron accelerates in its circular motion around the nucleus without emitting radiation (although it is expected to), which absurdities are simply dismissed through Bohr *postulates* proclaiming that the physics happening within the atom is different from the physics happening without it, and thus creating a so-called class of “quantum phenomena” whose common property is to be weird and incomprehensible. Needless to say that I find this situation unacceptable.

It is amazing and ironic to see how some authors in the past described the relationship between the two types of electricity as being the same as “the two elements of common salt – chlorine and sodium – which, when united in certain proportion, produce a neutral salt, whose union is attended not by a destruction of either element, but by a balancing of their chemical activities” [iii9]. This looks like a circular argument, because here the union of chlorine and sodium is used to illustrate two electricities neutralizing each other in a chemically neutral substance, while today’s chemistry uses the doctrine of “positive” and “negative” electric charges to account precisely for the formation of the sodium chloride salt through ionic bonding.

The laws of electrostatics “like charges repel” and “unlike charges attract”, originally introduced by Du Fay for “vitreous” and “resinous” *types of electricity*, were not explained by Du Fay, he just found these attractions and repulsions to occur empirically, i.e. through his experimental observations. After Du Fay, people were forced to assign all electrical objects to one of these two types, “vitreous” or “resinous”, even if, as explained above, the same substance could be made to behave sometimes like a “vitreous” and sometimes like a “resinous” one. Moreover, since the mechanisms of these attractions and repulsions were not explained by Du Fay then, they remain unexplained now in the modern electrical science. No fundamental reason can be given why “positive” (or “vitreous”) charge should repel another “positive” (or “vitreous”) charge.

In an exceptionally well-written textbook on electricity and magnetism [iii10] published at the beginning of the last century, these issues have been correctly highlighted and mentioned to the students of electrostatics, showing that scientists and researchers were aware of these problems until very late in the development of this science. So careful were the authors with the terminology that,

---

[iii8] Duane ROLLER, Duane H. D. ROLLER, *The Development of the Concept of Electric Charge*, Harvard University Press, Cambridge, 1954, p56

[iii9] Frederick GUTHRIE, *Magnetism and Electricity*, William Collins Sons and Co., 1876, p17

[iii10] R. H. JUDE and John SATTERLY, *Senior Magnetism and Electricity*, London, University Tutorial Press, 1911, p93

instead of two types of “electricity”, they employed the term two types of “electrification”.

Coming towards modern era, we observe *the fallacy of positive and negative electricity* perpetuated and enhanced : J. J. Thomson, the discoverer of the electron [iii11], in spite of being well aware of the way in which, and the reason for which, the concepts of positive and negative electricity were developed [iii12], namely to explain electrostatic attractions and repulsions, makes the mistake of assigning to his corpuscule an absolute negative charge, and then tries to explain the action at a distance between electric charges by Faraday’s lines of force in the aether. J. J. Thomson’s explanation fails however, because he cannot explain how an electric charge produces these lines of force, why the lines have different directions for the two types of charge, why the lines are elastic and behave like rubber-bands and, most importantly, because J. J. Thomson makes the fatal mistake of assigning mass to the aether itself, and claiming that the lines of force drag the aether and that this causes the mass of charges and of all matter. The drag is not well explained, nor possible, as it is not clear why it occurs only when the charge accelerates and not also when the charge moves with uniform velocity. Moreover, in my opinion, assigning mass to the aether defeats one of the purposes the aether exists for, which is to *explain the origin of mass* of objects by a hydrodynamical effect due to the *acceleration* of objects in it ; the aether does not have intrinsic mass, it is *the cause and the origin of mass*, but a definite volume of aether *accelerating* through aether can display inertia, so this volume of aether acquires mass only when in, and because of, this state of accelerated motion through the aether.

Retuning to electrostatics, to state again what has been noted once above :

What happens in electrostatic phenomena at the fundamental level is that, through rubbing, mere contact, or other methods, objects are created that attract and repel one another, and this is all that a theory of electrostatics was, *and still is*, supposed to explain.

Since the introduction of *two types of electric charges* (“positive” and “negative”) by Du Fay does not solve the issue of explaining the attractions and repulsions observed in electrostatic phenomena, the present work takes the following approach :

Du Fay’s conjecture for the existence of two types of electricity is dismissed.  
Only one substance is recognized : Franklin’s electric fluid, named in this series of works **electrigen**.  
The electrostatic attractions and repulsions between electrical objects are explained by a two-stage process : (i) *the quantity of electrigen contained in the objects changes by its transfer through rubbing, contact, influence, or other methods* (ii) *this leads to changes in the natural frequency of vibrations of the electrigen in the objects*

It can be said that the theory proposed here is a revival and an expansion of a theory [iii13] [iii14],

---

[iii11] Isobel FALCONER, Corpuscles, Electrons and Cathode Rays: J.J. Thomson and the 'Discovery of the Electron' , BJHS, 1987, 20, p241-276

[iii12] J. J. THOMSON, Electricity and Matter, Charles Scribner’s Sons, New York, 1904, p2

[iii13] S. Tolver PRESTON, Physics of the Ether, London, New York, 1875, p30,31

[iii14] John ANGELL, Elements of Magnetism and Electricity, William Collins Sons and Co., 1877, p72 ; J H PEPPER, Cyclopaedic science simplified, Philadelphia, J. B. Lippincott CO., 1885, p242 ; J L HEILBRON, Robert Symmer and the Two Electricities, ISIS, 1976, p17

contemplated by the scientists of the 19<sup>th</sup> century, which they called “the molecular theory of electricity” or “electricity a mode of movement theory”.

In the theory proposed in this work the concept of *charge* is derived from Franklin’s original idea of deficiency or excess – i.e. less or more *load* – of electrigen in an object. As stated by Watson in the earlier quote, the electrical phenomena themselves are *caused by the electric fluid*, so the term **electrigen** applied to Franklin’s electric fluid is extremely appropriate, since it means “producer of electrical phenomena”, the naming being similar to that used for other elements of the Periodic Table such as **hydrogen** that means “water producer”, **oxygen** that means “acid producer”, **nitrogen** that means “nitrate producer”, a.s.o.

Moreover, electrigen causes electrical phenomena through its vibration, so *electric charge* will imply *electrigen causing attractions and repulsions by its state of vibration*, as only by vibrations can the aether be pushed to-and-fro and a charged object act on another at-a-distance. And, since the electrigen is just one of the chemical elements of the Periodic Table, the other elements of the Periodic Table may also be brought in a state of vibration and cause a to-and-fro motion of the aether around them to act on another element situated at-a-distance. In other words, a charged object will mean : an object that has electrigen in vibration in a normal quantity, in excess or deficit and, in the case of a complete absence of electrigen in an object, charge will imply that it is *other chemical elements in the object that vibrate* and act on the aether with periodic motion.

The problem of attractions and repulsions between charged objects becomes thus one of interactions between objects in molecular vibration made up of different chemical elements in different proportions, including the chemical element electrigen [E]. Electrigen exists in all substances, being the glue that bonds the atoms of elements together chemically in molecules, or physically in liquids and solids, and covers the isolated atom of an element like a film of a certain thickness.

Since the word *atom* was mentioned above, a little digression on this topic is in order here. In the theory advanced in this work, what is currently called “atom of an element” is considered to be in reality made up of *two chemical elements* :

- the nucleus is the real atom of the chemical element, but without a “positive charge” ; the nucleus behaves as if it was charged “positively”, i.e. it produces attractions and repulsions, only when brought in a state of vibration.
- the electronic shells surrounding the nucleus are in fact a layer of electrigen covering the nucleus; there is no attraction between the two, as it is assumed in the current theory of atomic structure where the “positive nucleus” attracts the “negative electrons” ; the electrigen simply covers the nucleus and clings to it due to external aether pressure exerted on the electrigen.

It is not the aim of this work to advance a new theory of atomic structure but, as mentioned in [iii15], the atomic model based on Bohr’s ad-hoc postulates is highly problematic, inconsistent, and relies on the fundamental electrostatic structure derived from DuFay-Symmer-Coulomb’s unnecessary doctrine of the existence of “positive” and “negative” electric charges.

The alternative to this doctrine is the *two chemical elements theory of atom* outlined above, which is more promising since waves of electrigen on the surface of the atom, or just surface waves on the atom itself, can lead to *explaining the atomic line emission spectra in a mechanical way*, which was the original approach scientists took when studying atomic spectra during the *acoustic period*

---

[iii15] Ionel DINU, Fundaments of a Theory of Aether - Part 2, ResearchGate, August, 2021

mentioned in [iii15]. Noteworthy in this respect are the recent works [iii16] [iii17] [iii18], that start from de Broglie's original proposal of two-dimensional stationary electronic wave in an atom and take it to its logical and natural three-dimensional representation, leading to atomic vibration modes with different frequencies, while the shape of the vibrating atom in spherical geometry resembles strikingly the atomic orbitals obtained by quantum mechanics calculations (QM).

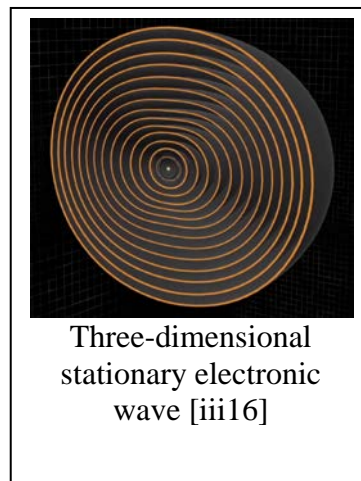
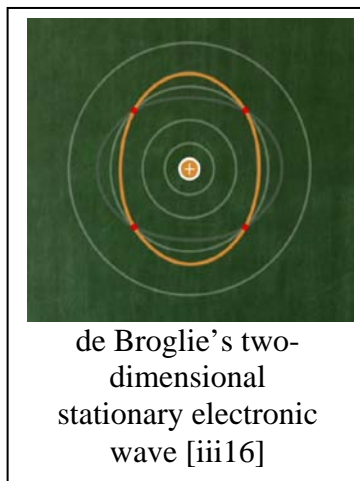
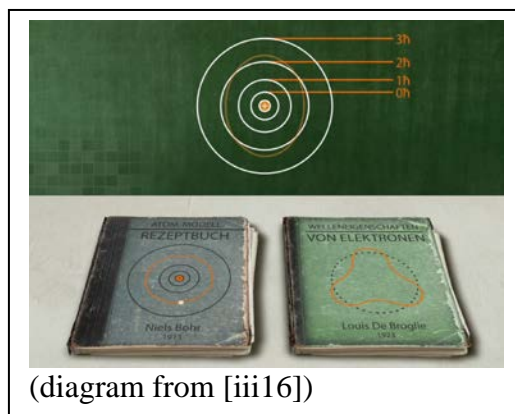

These atomic vibrations, brought about when the atoms of an element are excited through sparks, arcs, or electrical discharges in low-pressure glass tubes, cause the emission of radiations with frequencies corresponding to their respective vibration modes, say ( $f_m$ ) and ( $f_n$ ), in contradiction with Bohr's postulate that the emission of radiation has the frequency ( $f_{mn}$ ) and takes place when one electron jumps between two stationary states corresponding to the atomic orbitals of energy ( $E_m$ ) and ( $E_n$ ) such that :

$$h f_{mn} = E_m - E_n$$

What many modern textbooks on the quantum theory of atom fail to make explicit and clear is that all the frequencies ( $f_m$ ), ( $f_n$ ) and ( $f_{mn}$ ) are observed in the emission spectrum of an element, and are connected through the simple relationship discovered by Walther-Ritz and called *Rydberg-Ritz combination principle* :

$$f_{mn} = f_m - f_n$$

from which it can be seen that,

$$f_m = f_{mn} + f_n$$

As such, the whole line emission spectrum of an element can be considered as a mixture of radiations emitted by the excited atoms of the gas vibrating in different modes and frequencies, and in which higher frequencies are obtained through the principle of heterodyning, proposed by Juliana Mortenson [iii19].

---

[iii16] Malte Ubben and Stefan Heusler, [www.quantumreflections.net](http://www.quantumreflections.net) , Atom 4 The Bohr Model  
 [iii17] Malte Ubben and Stefan Heusler, A haptic model of vibration modes in spherical geometry and its application in atomic physics, nuclear physics and beyond, Eur. J. Phys. 39 (2018) (8pp)  
 [iii18] Malte Ubben and Stefan Heusler, [www.quantumreflections.net](http://www.quantumreflections.net) , Atom 6 Atomic Orbitals  
 [iii19] Juliana Mortenson, Resonance LLC and Forgotten Physics, formerly: Juliana Brooks, Berkshire Laboratories and General Resonance LLC, A Frequency Based Theory of Catalysts, 1999, Spectral Chemistry, 2002, <https://forgottenphysics.com/>

Another notable consequence of the theory proposed here is that, starting from the complete line spectrum of an atom, it is possible to predict the real shape of the atom of an element, since it is the real structure whose vibration produces the radiation, and the possible shape, or shapes, of a vibrating structure can be determined from its normal vibration modes.

On the next three pages I have tried to show through diagrams the *great leap in our understanding of the atom* brought about by the atomic theory proposed in this work, that improves upon [iii16] [iii17] [iii18] through the use of **real** spherical surface waves of electrigen covering the atomic nucleus that act on the aether mechanically to produce radiation, over the currently accepted model of the atom based on quantum mechanical calculations (QM) that use the Schrodinger's **probability** wave equation for a negatively charged electron around a positively charged proton, and presently taught to high-school [iii20, figure below] and to college students [iii21].

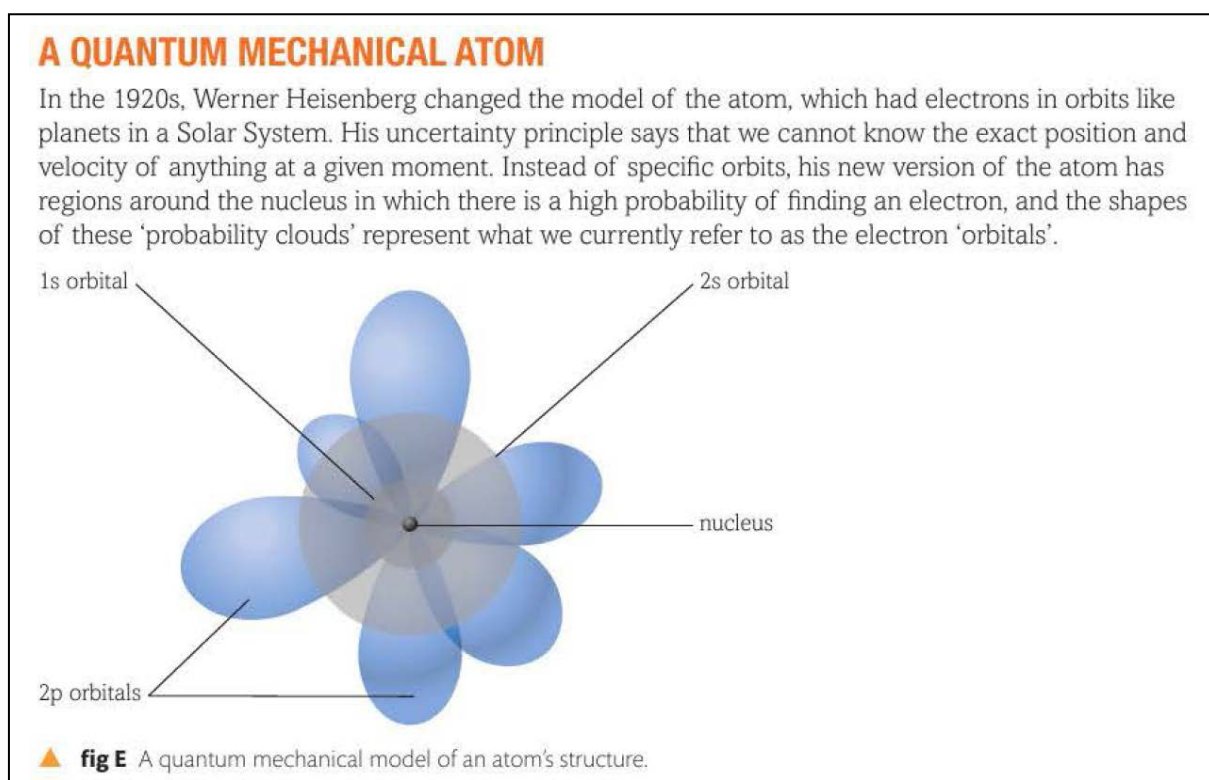

[iii20] Miles HUDSON, Physics, Student Book 1, Pearson Edexcel International AS / A Level, Pearson Education Ltd, London, 2018, p77

[iii21] Hugh D. Young, Roger A. Freedman, A. Lewis Ford, Sears and Zemansky's University Physics with Modern Physics, 15<sup>th</sup> Edition, 2020, p1368-137

(diagrams from [iii21])

Figure 41.5 The Schrödinger equation for the hydrogen atom can be solved most readily by using spherical coordinates.

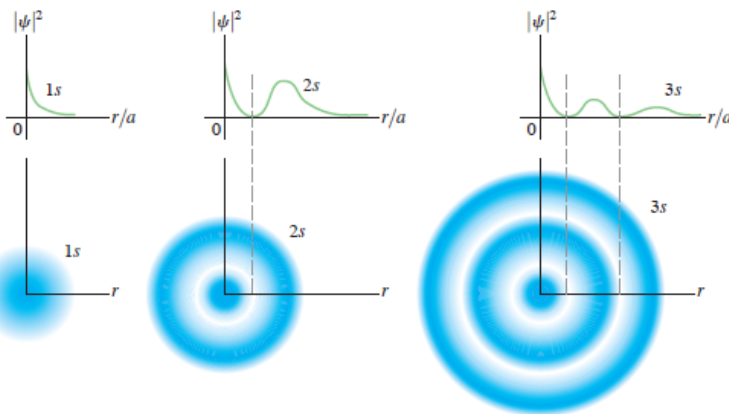
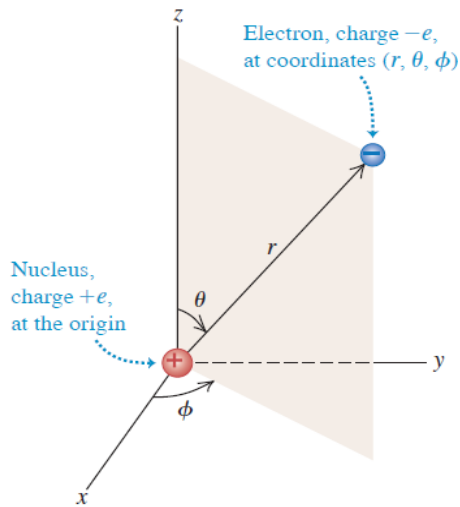
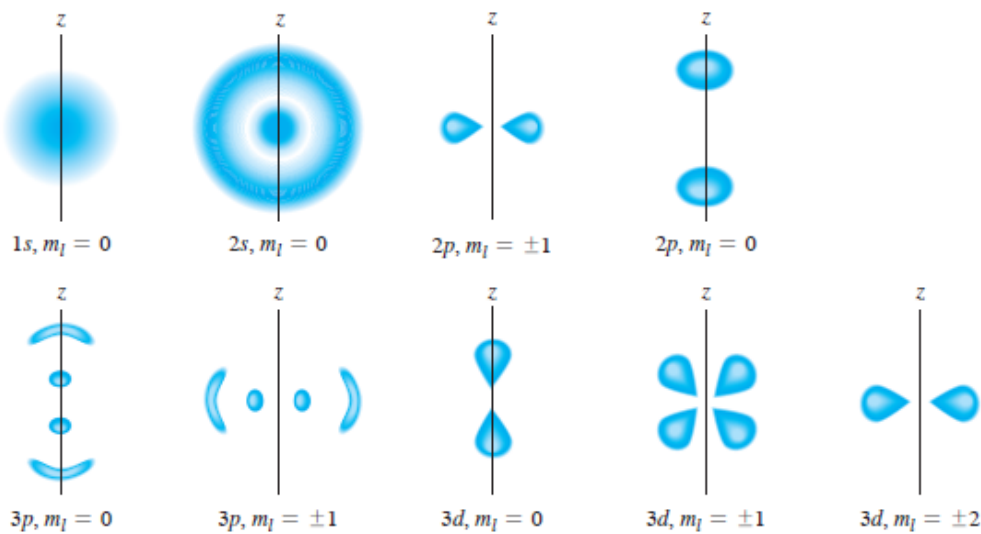
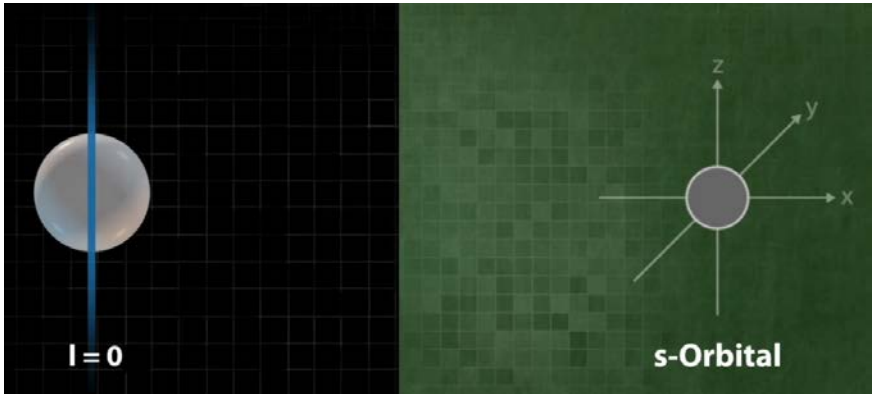

Figure 41.9 Three-dimensional probability distribution functions  $|\psi|^2$  for the spherically symmetric 1s, 2s, and 3s hydrogen-atom wave functions.

Figure 41.10 Cross sections of three-dimensional probability distributions for a few quantum states of the hydrogen atom. They are not to the same scale. Mentally rotate each drawing about the  $z$ -axis to obtain the three-dimensional representation of  $|\psi|^2$ . For example, the  $2p$ ,  $m_l = \pm 1$  probability distribution looks like a fuzzy donut.



(only the diagrams have been reproduced from [iii18], the captions and comments are added to correspond to the theory proposed here)



Electrigen vibration with no nodal lines resemble the s - orbital.  
The atom expands and contracts radially.

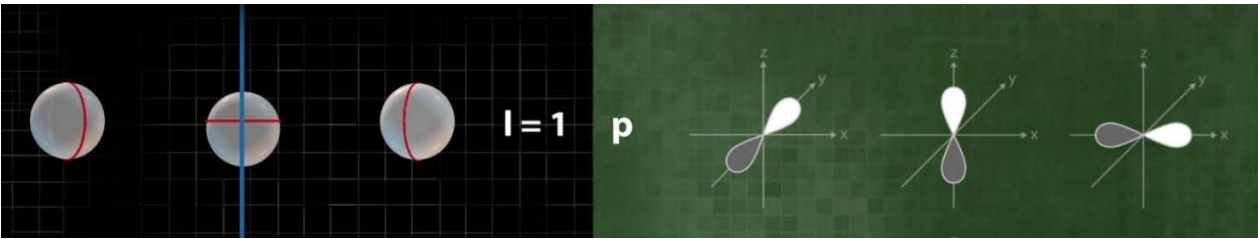

Electrigen vibrations with one nodal line resemble the p - orbitals.  
The atom expands and contracts along three perpendicular directions.

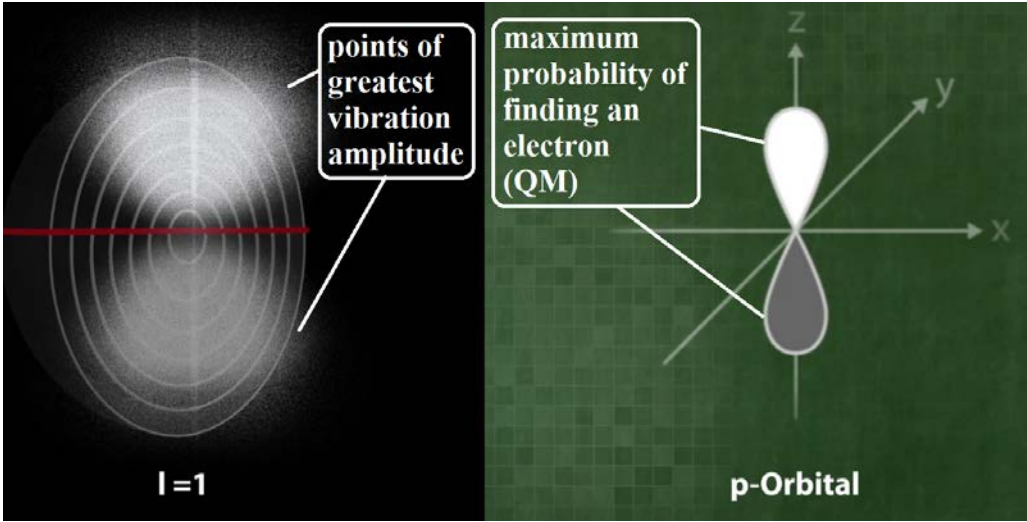

Detail of the electrigen vibration resembling one of the p - orbitals.

“Chemistry does not describe the entire vibration in space, only the location of maximum probability of finding an electron. It corresponds to the points of greatest vibration amplitude.” [iii18]

(only the diagrams have been reproduced from [iii18], the captions and comments are added to correspond to the theory proposed here)

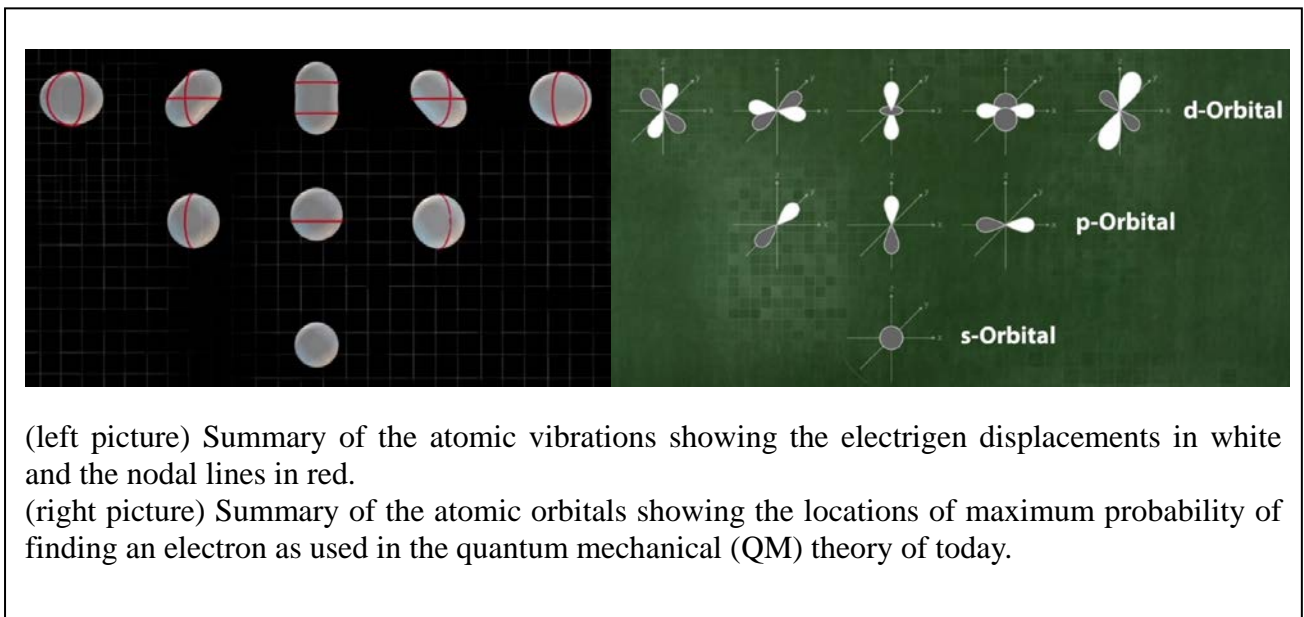
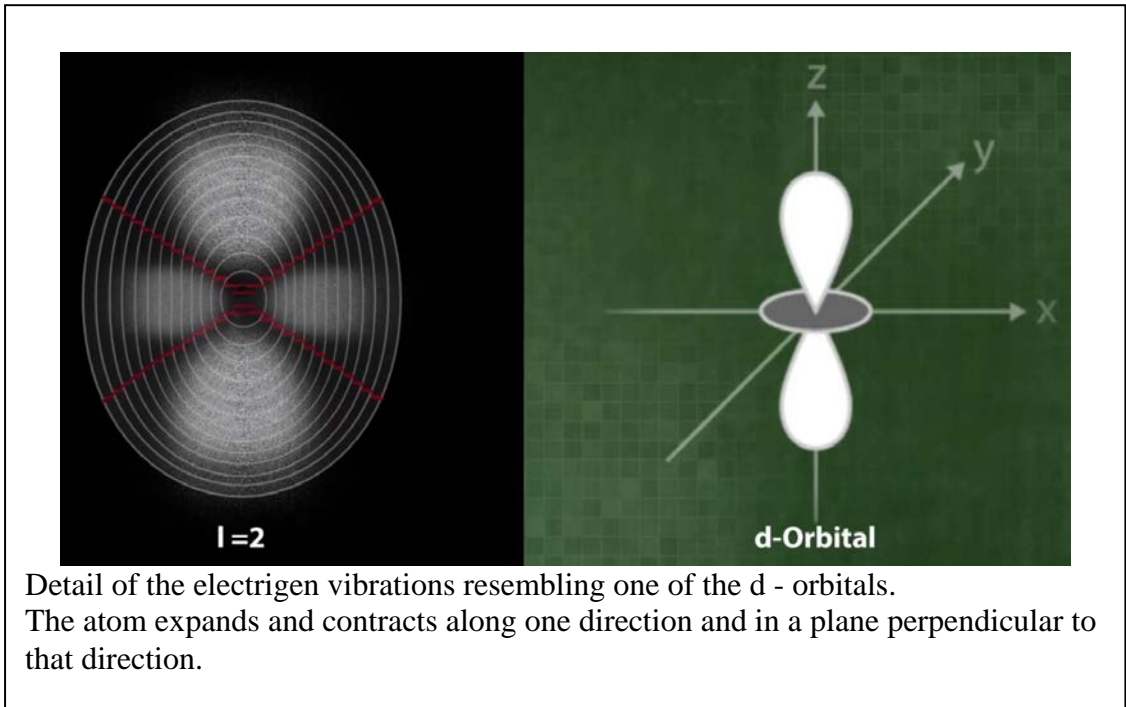



#### IV. The new theory. Explaining the laws of electrostatics by molecular vibration

Returning to the problem of the laws of electrostatics, we have seen in [iv1] that, **for objects of the same size and vibrating with the same frequency**, *attractions or repulsions occur between them depending on the vibrations being in opposite phase or in the same phase respectively*, and this tells us that the way in which an object vibrates with respect to another is fundamental for determining their mutual electrostatic behavior. The figures below are reproduced from page 13 of [iv1] :

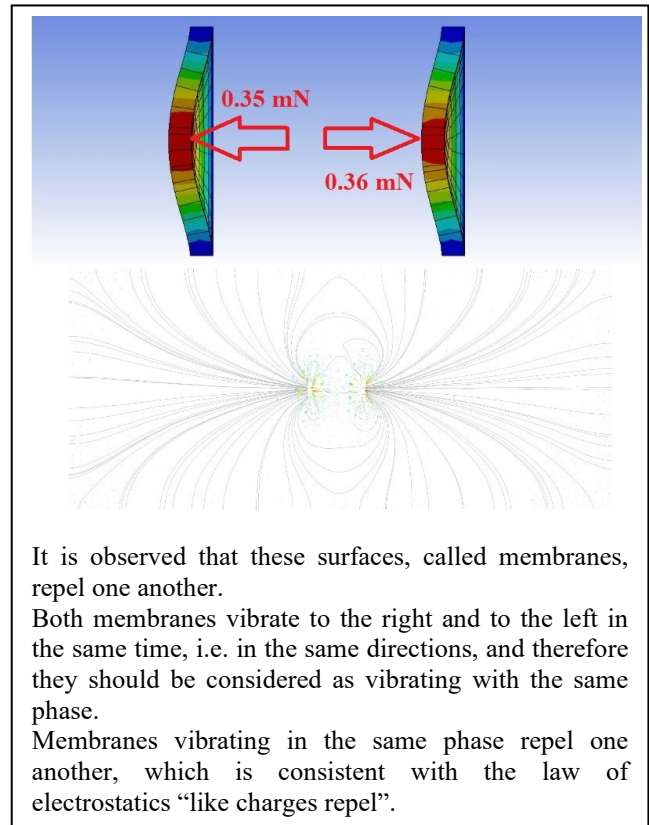
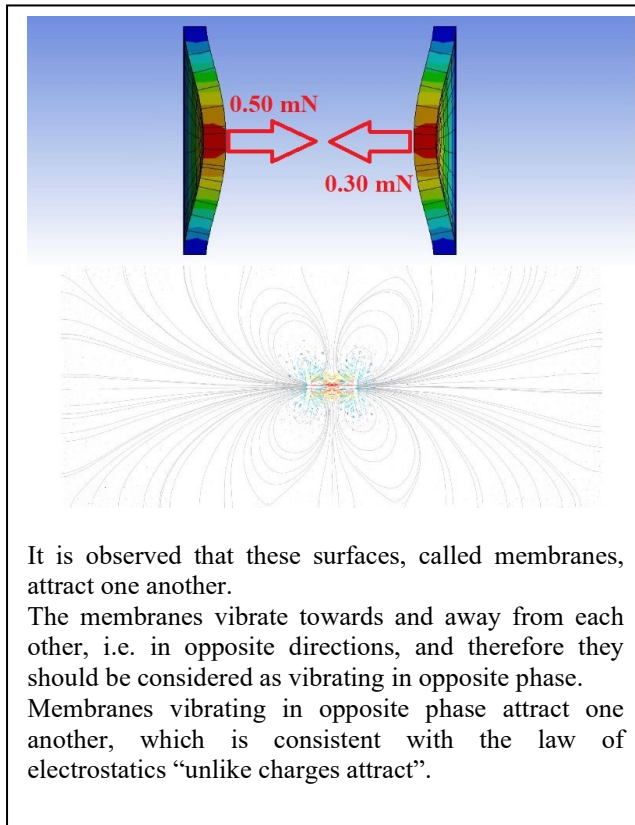

Repulsions and attractions differ considerably in their probability of occurrence : the former happen within very restrictive conditions - only for similar sizes of vibrating objects, same frequency of vibration, same or close phases of vibration ; the latter happen in more varied circumstances - different sizes of objects , different frequencies, any phases - but the phases must be opposite if sizes and frequencies are the same.

We arrive therefore at the important conclusion that, statistically speaking, attractions are encountered in more situations than repulsions, a fact which is supported by experience and by the historical fact discussed in section II, that electrostatic repulsions were studied long after electrostatic attractions. Attractions can be explained by the different sizes of molecules and the different frequencies of their vibration, leading to attractive forces mediated by the aether. Repulsions were initially discovered to take place between a pair of identical objects (such as two glass rods) rubbed with a pair of other identical materials (such as two pieces of silk), and can be explained by the identical sizes of vibrating molecules whose phases of vibration are *initially not correlated, but become correlated* through a **key mechanism proposed here for the first time** :

[iv1] Ionel DINU, Fundamentals of a Theory of Aether - Part 2, ResearchGate, August, 2021

Approaching two energy charged objects to one another leads to an increasingly stronger coupling through the aether between the vibrating molecules of the two objects, which causes the vibrations of the molecules on the two objects to become interlocked, synchronized, and occur in the same phase, resulting in mechanical forces of repulsion between the two objects.

The phenomenon outlined above is called *phase synchronization of coupled oscillators* and is similar to the ones encountered in coupled macroscopic oscillators, such as the synchronization between two pendulum clocks first observed by Huygens [iv2] , or the amazing phase synchronization that occurs between two [iv3] or multiple [iv4] metronomes coupled by sharing the same support.

The pictures below are from [iv3(2)] , where it can be seen that metronomes (in black), initially oscillating in opposite phases, end up oscillating in the same phase due to the **strong** coupling

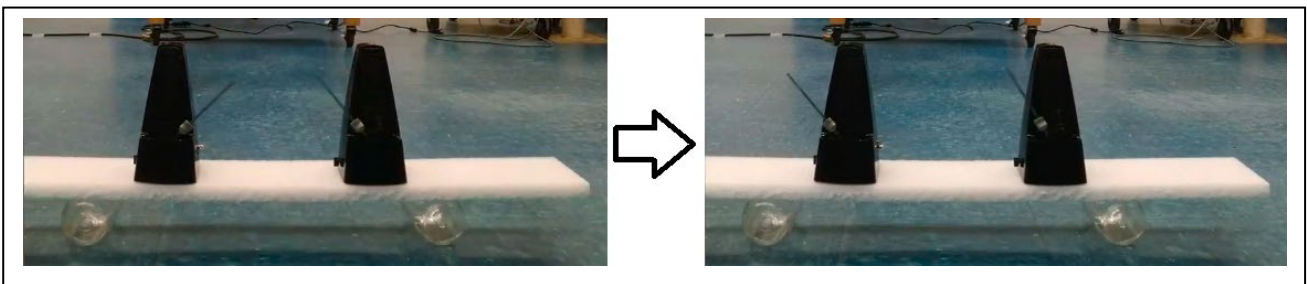

between them caused by the transmission of oscillations through their common support (the white board).

In electrostatic interactions, the two metronomes above represent two molecules on two similarly “charged” objects : the molecules have similar sizes and the same quantity of electrigen, therefore will vibrate with the same natural frequency ; their approachment causes a strong coupling through the aether that transmits their to-and-fro motions, and they will end up vibrating in the same phase and therefore end up repelling one another irrespective of their initial phases of oscillation, that is,

---

[iv2] Allan R. WILLMS, Petko M. KITANOV and William F. LANGFORD, Huygens’ clocks revisited, Royal Society Open Science, 4: 17077, 2017

[iv3] (1) M. FRANCKE, A. POGROMSKY and H. NIJMEIJER, Huygens’ clocks: ‘sympathy’ and resonance, International Journal of Control, 2020, Vol. 93, No. 2, p274-281 ; (2) Synchronization of metronomes , BEZMEN INDUSTRIES , [https://www.youtube.com/watch?v=adho\\_ZGWD\\_s](https://www.youtube.com/watch?v=adho_ZGWD_s)

[iv4] (1) Synchronization of Metronomes, Harvard Natural Sciences Lecture Demonstrations, <https://www.youtube.com/watch?v=Aaxw4zbULMs> ; (2) Spontaneous Synchronization - UCLA Department of Physics & Astronomy, RBfilm, <https://www.youtube.com/watch?v=RFwejbPmIQ> ; (3) Penguin Metronome Synchronization, Jason Harlow, Physics Department, University of Toronto, <https://www.youtube.com/watch?v=jkthqAgIars> ; (4) metronomu douki (32ko), IkeguchiLab, <https://www.youtube.com/watch?v=JWToUATLGzs&t=88s> ; (5) Synchronization of four metronomes on a suspension bridge, Hiroshi Kori, <https://www.youtube.com/watch?v=ZMApCadGSt0> ; (6) metronomu douki (100ko) , IkeguchiLab , <https://www.youtube.com/watch?v=suxu1bmPm2g&t=100s> ; (7) 3A70 10 - Spontaneous Synchronization, UMDemoLab, <https://www.youtube.com/watch?v=8VNzffu914A&t=66s> ; (8) Demo 20207: Metronome Synchronization, Caltech's Feynman Lecture Hall, <https://www.youtube.com/watch?v=O-WLAtBrT2E>

even if their initial phases of oscillation are opposite.

The study of coupled oscillators has been extended to more complex systems, such as biological organisms and collectivities of animals or humans, and interesting mathematical models have been developed, of which one example is the Kuramoto model [iv5].

The theory of two charged objects of similar size repelling each other through phase synchronization of their vibrations due to **strong** coupling through the aether , and of attractions between objects in any other cases, leads to the reformulation of the electrostatic phenomena listed at the beginning of the previous section in terms of molecular vibrations as follows :

	Electrostatics formulation	Molecular vibration formulation
(i)	attraction between a body positively charged and one negatively charged	attraction between a body with deficit of electrigen in vibration and one with surplus of electrigen in vibration
(ii)	attraction between a body positively charged and one uncharged	attraction between a body with deficit of electrigen in vibration and one with electrigen not vibrating at all
(iii)	attraction between a body negatively charged and one uncharged	attraction between a body with surplus of electrigen in vibration and one with electrigen not vibrating at all
(iv)	repulsion between two positively charged bodies	repulsion between two bodies of similar sizes with deficit of electrigen in vibration, where the vibrations are in same phase due to phase synchronization through strong coupling through aether
(v)	repulsion between two negatively charged bodies	repulsion between two bodies of similar sizes with surplus of electrigen in vibration, where the vibrations are in same phase due to phase synchronization through strong coupling through aether
(vi)	attraction that may occur between two bodies that have charges of the same sign, but with the charge on one of them relatively weak	attraction that may occur between two bodies with surplus or deficit of electrigen in vibration, but with the electrigen vibrations different in frequency and amplitude due to different amounts of electrigen surplus or deficit

[iv5] Steven STROGATZ, 2011 Simons Lectures - Steven Strogatz, Coupled Oscillators That Synchronize Themselves, MIT Department of Mathematics, <https://www.youtube.com/watch?v=5zFDMYQ8z8g&t=541s>

Interesting clues on the behavior of matter with excess and deficit of electrigen in a state of vibration can be obtained from the study of discharges of electricity through gases at very low pressure. As can be seen from the picture below [iv6, comments added], the discharge at the positive metallic electrode starts from the surface of the metal, indicating that vibrations there are produced by matter with deficit of electrigen, while at the negative metallic electrode there is a space between the metal surface and the discharge, indicating that there the vibrations are produced by the surplus of electrigen on the negative electrode.

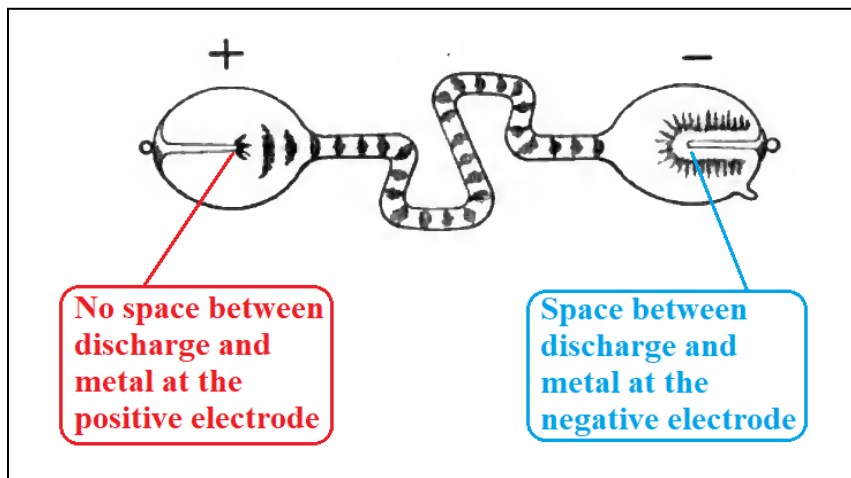

Moreover, in rarefied air, it is observed that a violet light surrounds the negative electrode and a deep red light the positive [iv7], which reveals the true difference between the positive and negative electricity : since violet light has a higher frequency than red, this means that the electrigen acting on the rarefied air and causing it to produce violet light is in a state of vibration of higher frequency than that on the positive electrode causing the air to emit the deep red light. In other words, the negativity of an electrode is given by the frequency of vibration of its electrigen and the lower the frequency the more positive its character is.

A helpful way to visualize the surplus of electrigen on the surface of metals is shown in the picture below, taken from a video made in zero gravity, in the ISS [iv8] : the water on the cloth corresponds to the electrigen and the cloth to the metal itself. A metal with electrigen deficit will then correspond to water trapped within the cloth.

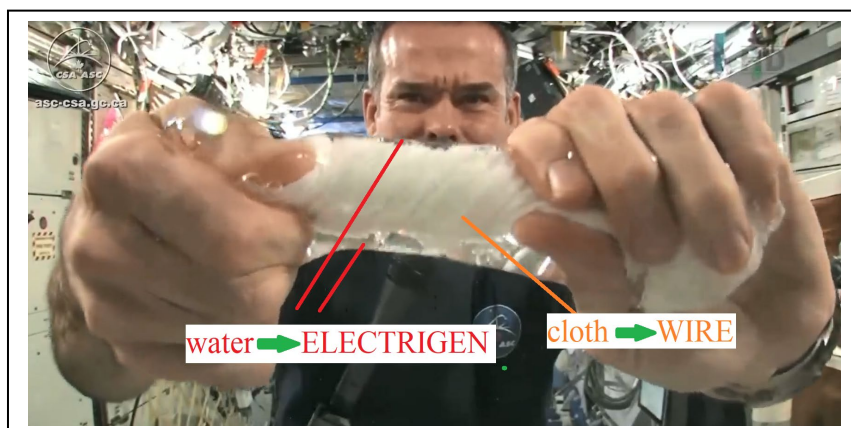

[iv6] T. A. LYONS, A Treatise on the Electromagnetic Phenomena, Vol. I, 1<sup>st</sup> Ed., John Wiley and Sons, New York 1901, p347, fig200

[iv7] Aug. DE LA RIVE, A Treatise on Electricity in Theory and Practice, in three volumes, Vol. II, Longman Brown Green and Longmans, London, 1856, p275

[iv8] Chris HADFIELD, Canadian Space Agency, Wringing

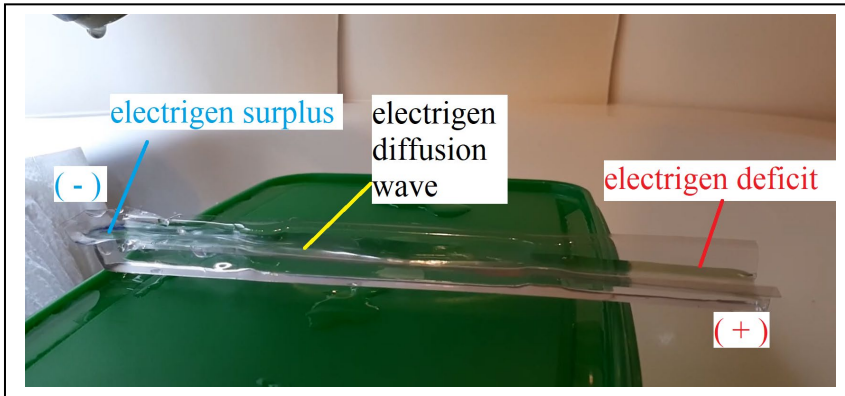

When the electrigen travels along the wire as a diffusion wave it constitutes the direct current, as shown in the picture at the left [iv9], and discussed at length in the Parts 1-3 of this series of articles.

In the remaining part of this section, will be considered examples of electrostatic phenomena and their explanation in terms of molecular vibrations. In order to show the excess or deficit of vibrating electrigen on the surface of an object I will use a representation similar to the *electrical density*, which was defined as the quantity of electricity per unit area at a point on the surface, and called by Poisson *thickness of electrical stratum*. Examples of such representations are shown below, where it is seen that the distribution of electricity on a conductor depends on its form [iv10].

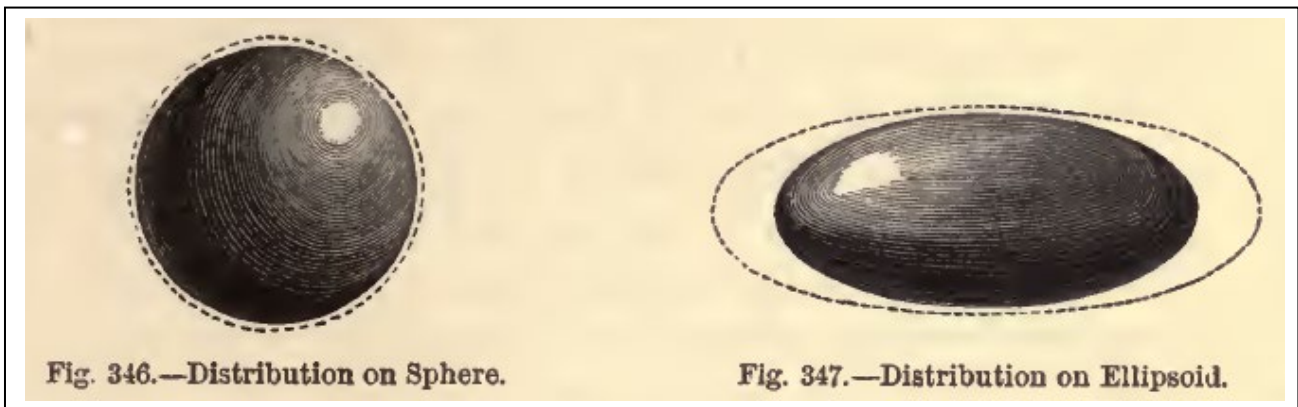

In our case, electrigen excess will be shown as above, with blue coloured lines above the surface of the object, while the deficit will be shown with red coloured lines below the surface of the object, which means that, in this latter case, the atoms of the object at the surface will not be covered by electrigen.

[iv9] Ionel DINU, The ELECTRIC CURRENT in a WIRE , <https://www.youtube.com/watch?v=X-ueR7zkWn8&t=33s>

[iv10] Augustin Privat DESCHANEL, Elementary Treatise on Natural Philosophy, Part III Electricity and Magnetism, 10<sup>th</sup> Ed., D. Appleton and Co., New York, 1891, p568-569

(i) attraction between a body positively charged and one negatively charged

*which in molecular vibration formulation is*

attraction between a body with deficit of electrigen in vibration and one with surplus of electrigen in vibration

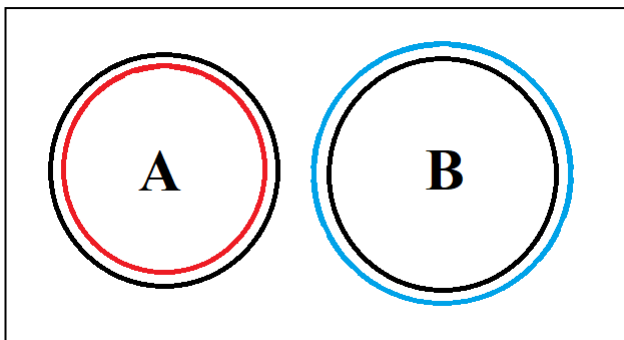

vibrating atoms (black) at the surface of the object (A) interact with vibrating electrigen (blue) on the surface of object (B) ; the sizes of the vibrating objects are different, so attraction occurs irrespective of the frequencies of vibration.

(ii) attraction between a body positively charged and one uncharged

*which in molecular vibration formulation is*

attraction between a body with deficit of electrigen in vibration and one with electrigen not vibrating at all

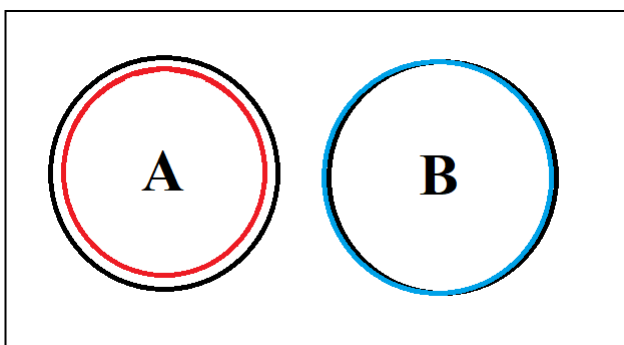

vibrating atoms (black) at the surface of the object (A) interact a with mixture of atoms and electrigen on the surface of object (B) ; the sizes of the vibrating objects are different, so attraction occurs irrespective of the frequencies of vibration.

(iii) attraction between a body negatively charged and one uncharged

*which in molecular vibration formulation is*

attraction between a body with surplus of electrigen in vibration and one with electrigen not vibrating at all

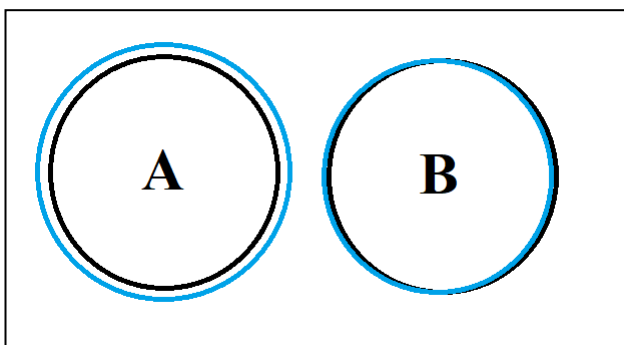

vibrating electrigen (blue) on the surface of the object (A) interacts with a mixture of atoms and electrigen on the surface of object (B) ; the sizes of the vibrating objects are different, so attraction occurs irrespective of the frequencies of vibration.

(iv) repulsion between two positively charged bodies

*which in molecular vibration formulation is*

repulsion between two bodies of similar sizes with deficit of electrigen in vibration, where the vibrations are in same phase due to phase synchronization through strong coupling through aether

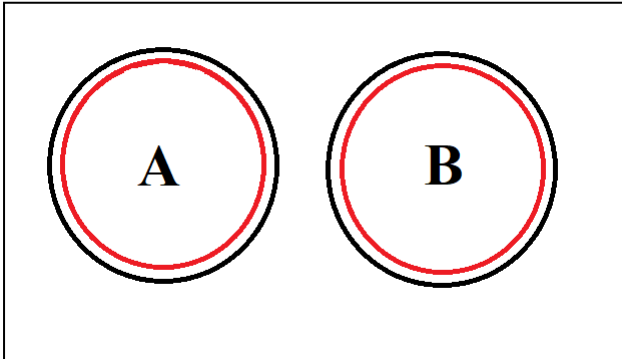

vibrating atoms (black) at the surface of the object (A) interact with vibrating atoms (black) on the surface of object (B) ; the sizes of the vibrating objects are similar because the substances are identical or their molecules have similar sizes, so they vibrate with the same frequencies, phase synchronization occurs, so repulsion occurs irrespective of the initial phases of vibration.

(v) repulsion between two negatively charged bodies

*which in molecular vibration formulation is*

repulsion between two bodies of similar sizes with surplus of electrigen in vibration, where the vibrations are in same phase due to phase synchronization through strong coupling through aether

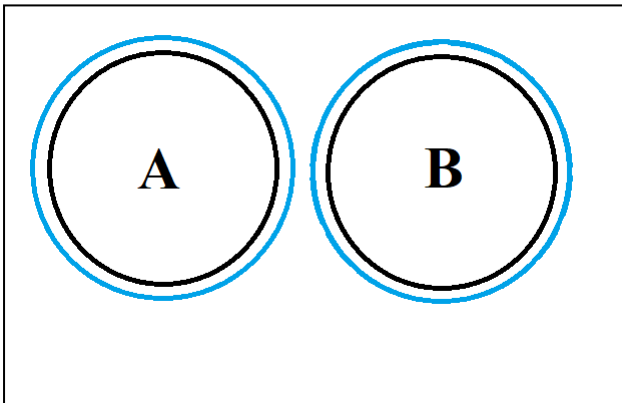

vibrating electrigen (blue) at the surface of the object (A) interacts with vibrating electrigen (blue) on the surface of object (B) ; the thickness of the vibrating electrigen is similar because the substances are identical or their molecules have similar sizes, the electrigen on both objects vibrates with the same frequency, phase synchronization occurs, so repulsion occurs irrespective of the initial phases of vibration.

(vi) attraction that may occur between two bodies that have charges of the same sign, but with the charge on one of them relatively weak

*which in molecular vibration formulation is*

attraction that may occur between two bodies with surplus or deficit of electrigen in vibration, but with the electrigen vibrations different in frequency and amplitude due to different amounts of electrigen surplus or deficit

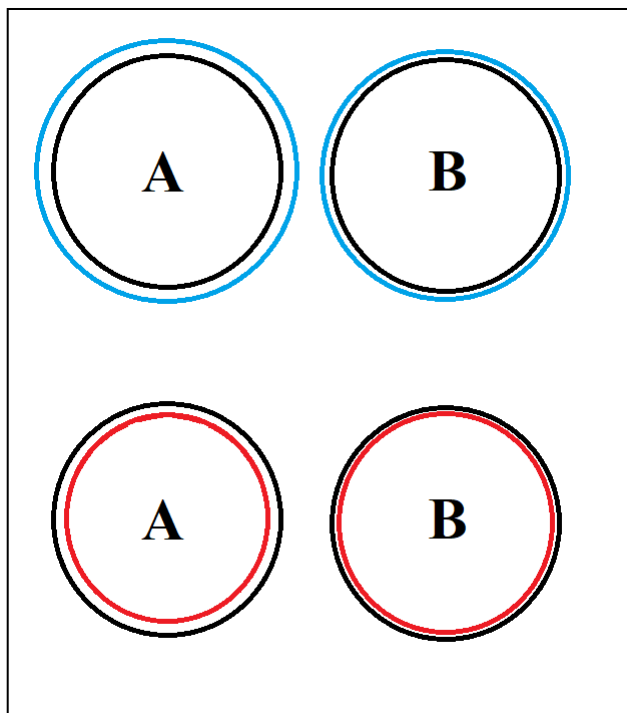

vibrating electrigen (blue) at the surface of the object (A) interacts with vibrating electrigen (blue) on the surface of object (B) ; the thicknesses of the vibrating electrigen is not similar, the electrigen on both objects vibrates with the different frequencies, so attraction occurs.

vibrating atoms (black) at the surface of the object (A) interact with vibrating atoms (black) on the surface of object (B) *and* with the electrigen below the surface of (B); the vibrating atoms of (A) attract the electrigen of (B) since the sizes of the vibrating objects are not similar and vibrate at different frequencies.



## V. General remarks. The motions of the aether. Radio waves and light

Having established that the laws of electrostatics can be explained by the strong coupling through the aether of objects in molecular vibration, a few remarks may be made as to the implications of this theory.

1. Around an object in molecular vibration, the aether is in a to-and fro motion and, since the space around a charged particle is called in today's science "electric field", it follows that the nature of the electric field is that of a to-and-fro motion of the aether. The opposite is also true : a to-and-fro motion of the aether is detected as an electric field no matter in what way it is produced.

2. Since molecular vibrations cause the to-and-fro motion of the aether, electrostatic attractions and repulsions will cease when the "charged object" is at absolute zero of temperature (0[K]).

3. The correspondence between the kinds of aether flow and the physical effects it produces can be summarized in the table below :

Aether motion (flow regime)	Effects
Aether pressure gradient (stationary or in state of laminar flow, compressional)	Gravitational force : an object is pushed in the direction opposite to the aether pressure gradient with a force proportional to the aether pressure gradient produced by a star or a planet and the volume V displaced by the object in the aether
Laminar flow (irrotational, constant U, negligible compression)	No effect on matter : an object continues in a state of rest or of motion with uniform velocity (Newton's 1 <sup>st</sup> Law)
Accelerated flow (irrotational, accelerated, compressional)	Inertia, mass : the aether acts on the accelerating object with a force proportional to the acceleration of the object through the aether and the volume V displaced by the object in the aether (Newton's 2 <sup>nd</sup> Law)
Accelerated flow (turbulent, accelerated, compressional)	Relativistic effects : mass changes with velocity
Vortical, circular flow (rotational, negligible compression)	Magnetic field
To-and-fro motion, near field (irrotational, accelerated, negligible compression)	Electric field
To-and-fro motion, far field (irrotational, accelerated, compressional)	Radio waves, light

4. I have criticized in previous articles Maxwell's theory that light is an electromagnetic wave and I have argued that Hertz did not prove experimentally Maxwell's theory, as it is purported in today's textbooks. I have also argued that, even *within the framework of electromagnetic theory*, the photoelectric effect can be explained as an effect of electromagnetic induction, and so it is unnecessary to invent the notion of light particle or photon. I maintain these criticisms.

However, in the same articles I have advanced alternative theories which have to be reconsidered because of the establishment, in the present series of articles, of the physical natures of the magnetic and electric fields.

Thus, radio waves and light are not electromagnetic waves (as Maxwell and Hertz stated), are not magnetic only (as I attempted to show in my alternative theory, believing that radio waves consist of the magnetic fields produced around the antenna by the high frequency currents surging in the antenna), and are not wakes in the aether (as I have stated elsewhere, believing that the charges - electrons- flowing in a straight wire produce aether wakes around the wire).

Instead, **radio waves and light must be considered electric waves only** because, being longitudinal waves of aether compressions and rarefactions, consist of to-and-fro motions of the aether, and it has been established in this work that the to-and-fro motion of the aether constitutes what we call electric field. In this respect, **the original name of electric waves assigned to radio waves by their first investigators, inventors and authors proves to be exceptionally insightful and accurate.** These original investigators, to be mentioned later, and who have made their discoveries years before Hertz, based their conclusions on experimental observations : they saw that under the actions of the waves they produced in their rooms the objects in the room became electrically charged and produced small sparks, reminiscent of the behavior of objects charged through rubbing.

That radio waves are electric waves only, that light and electricity are “one and the same movement” [v1] consisting in the to-and-fro motion of the aether, can be seen clearly from analyzing how radio waves are produced by a radio antenna, discussed in what follows.

(i) Firstly, it should be clear that at the origin of the waves emitted by a radio antenna is not the high frequency electric current surging in the antenna, as purported in many books of electricity and magnetism, new and old [v2] . This is apparent from the way the magnetic field is produced by an electric current in a conductor (see Parts 1 and 3 of this series), it being inconceivable that the circular motion of aether produced around a wire by the electrigen can change into waves propagating away from the wire when the direct current changes into an alternating current.

(ii) An even stronger argument for the idea that at the origin of the waves emitted by a radio antenna is not the high frequency electric current surging in the antenna is the experimental observation [v3] that a closed oscillating circuit does not radiate if the current of high frequency flowing in it is such that *the current flows in all its parts in the same direction at the same time*, while the same circuit does radiate radio waves into the aether if *the current is made to flow in opposite directions at the same time in different parts of the circuit* and thus *creating loops (antinodes) of potential along the wires of the circuit*. **It turns out therefore that it is critical for the emission of radio waves** to obtain *pulsating antinodes of potential* in an antenna ; and since the pulsating antinodes of potential are created by *pulsating electric charges (electrigen)*, and these impinge on the aether periodically, it follows that the radio waves thus created must necessarily be longitudinal waves of compression and rarefaction of aether, in which the pulsating electric charges act on the aether just like the vibrating paper cone of a loudspeaker acts periodically on the air around it and produces sound waves.

(iii) Very strong support for the argument made above can be found by looking at the factors affecting the emission of radio waves by an antenna, such as voltages and currents in the antenna, the

---

[v1] T. A. LYONS, A Treatise on the Electromagnetic Phenomena, Vol. I, 1<sup>st</sup> Ed., John Wiley and Sons, New York 1901, p542

[v2] Erich HAUSMANN, Swoope's Lessons in Practical Electricity, 17<sup>th</sup> Ed., D. Van Nostrand Co., New York, 1926, p631

[v3] J. A. FLEMING, The Principles of Electric Wave Telegraphy, Longmans, Green, and Co., 1906, p486

height of the antenna, the maximum distance reached by the emitted radio waves, and the radiation pattern of the antenna : all these factors show that the **antenna emits radio waves from its tip where the potential vibrates with maximum amplitude (antinodes) and the current is always zero**, as will be discussed in what follows.

Thus, the antenna emits to the farthest distance when it has a **maximum of electric potential at its tip**, which, very importantly, happens concomitantly with minimum current at its tip and maximum current at its base. As it can be seen in the diagram below, other harmonics are also possible for emission to great distances as long as there is a *potential antinode (maximum amplitude of vibration of the electric charge) at the top end*

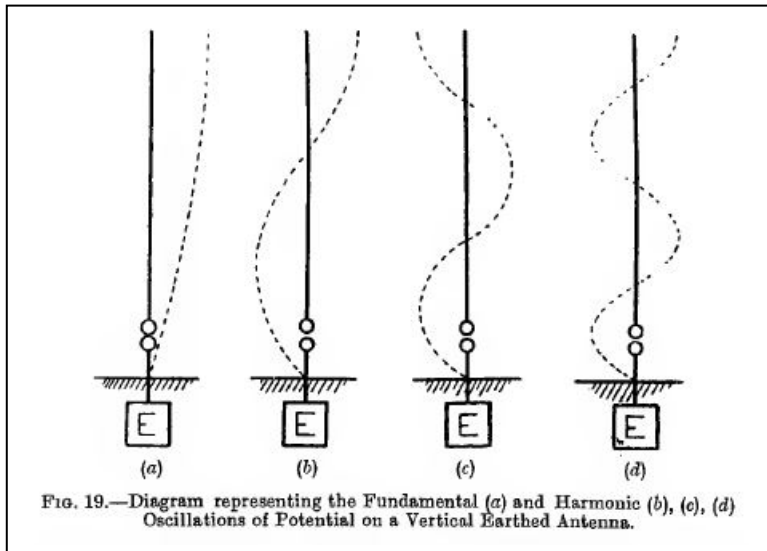

of the electric charge) at the top end [v4] . Marconi discovered in his experiments that the antenna must be *tall and charged to high potential* in order to emit at great distances. His empirical law, that the distance at which signals are received varies as the square of the height of the antenna is proof of this statement [v5]. The pulsating antinodes of potential correspond physically to pulsating electrigen which impinges on the aether periodically, again, very similar to what the vibrating cone does to the air in a loudspeaker. William Preece, the closest of Marconi's collaborators

in the practical demonstrations of wireless transmissions, and most probably Marconi himself, believed that this is indeed the case.

Thus, at the origin of the waves emitted by a radio antenna is the high potential produced at the tip of the antenna, which is contrary to the common belief held today that *at the origin of the radio waves emitted by the antenna is the electric current surging in the antenna*.

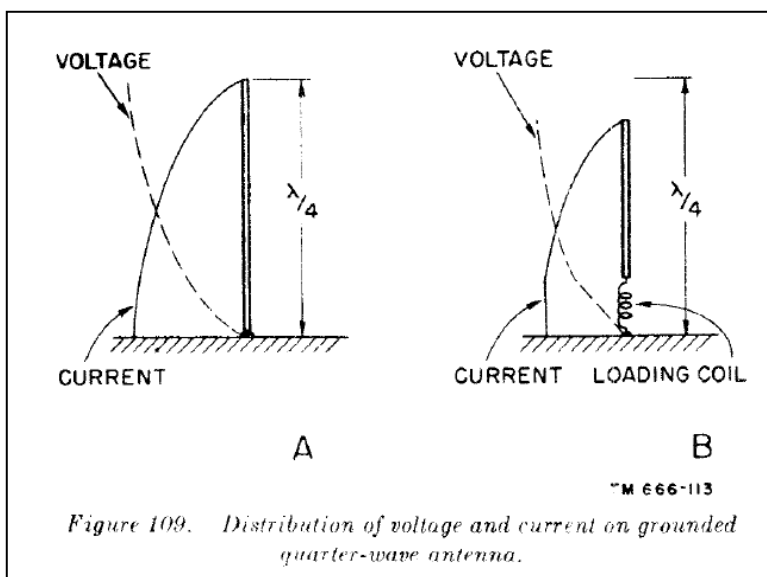

It should be remembered that the antenna emits to the farthest distance when it has a **maximum of electric potential at its tip**, while the maximum current is at its base (see left figure [v5]). If the current in the antenna was at the origin of the radio waves emitted by the antenna, *the height of the antenna would be unimportant* since currents of the same high intensity that flow at the base of a tall antenna could be made to surge at the base of a shorter antenna by attaching a capacity (such as a sphere, plate or cylinder) to its

[v4] J. A. FLEMING, The Principles of Electric Wave Telegraphy, Longmans, Green, and Co., 1906, p271-280

[v5] Department of the Army, Antennas and Radio Propagation, Washington, 1953, p120

end to store the charge. However, as it was discussed above, the antenna has to be *tall and strongly charged at its tip for it to emit at great distances*. This is empirical knowledge hardly-won by Marconi during his numerous field trials.

**Thus, the necessity that a maximum potential variation occur at the tip of the antenna is a strong proof that an antenna emits radio waves from its tip and is also proof for the conception advanced in this work according to which what we call radio waves are longitudinal waves of compressions and rarefactions of the aether.**

For the electrigen that accumulates in great quantities and in very short intervals of time at the tip of the antenna

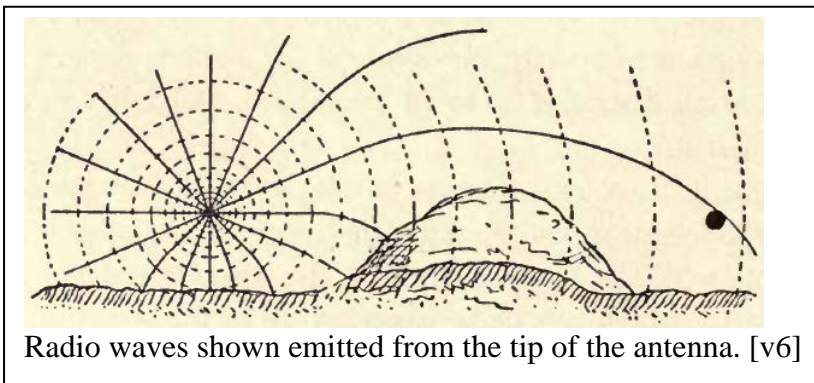

Radio waves shown emitted from the tip of the antenna. [v6]

of the antenna pushes on the aether and creates a compression in the aether. The great excess of electrigen at the tip of the antenna then moves along the antenna into the ground (or into an object of large electrical capacity called balancing capacity), leaving the tip of the antenna with deficit of electrigen, thus creating a rarefaction in the aether. The pulsating electrigen therefore

impinges on the aether at the tip of the antenna periodically, creating longitudinal waves of compressions and rarefactions in the aether, again, very similar to what the vibrating cone does to the air in a loudspeaker.

At the left are two more diagrams from another work [v7], that show radio waves being emitted from the tip of the antenna.

At the left are two more diagrams from another work [v7], that show radio waves being emitted from the tip of the antenna.

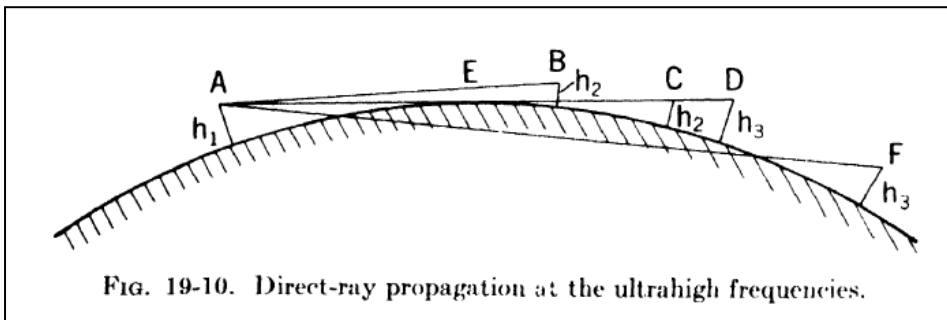

FIG. 19-10. Direct-ray propagation at the ultrahigh frequencies.

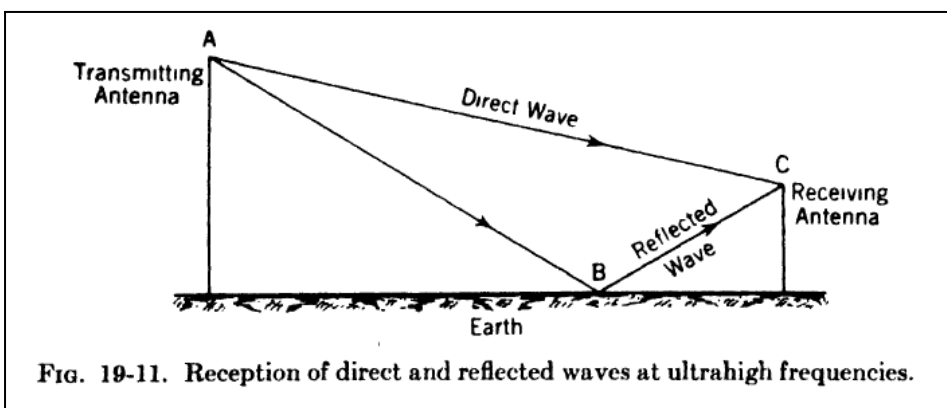

FIG. 19-11. Reception of direct and reflected waves at ultrahigh frequencies.

[v6] J. J. FAHIE, A History of Wireless Telegraphy 1838-1899, William Blackwood and Sons, Edinburgh and London 1899, p214-215

[v7] V. L. EVERITT (editor), Fundamentals of Radio and Electronics, 2<sup>nd</sup> Ed., Constable and Co., London, 1958, p633

The role of the high frequency current in the antenna is therefore to push the electrigen to, and then pull the electrigen from, the tip of the antenna in as great quantity as possible, and this function is the reason why this current was often called *current of high potential* in the works of wireless telegraphy published at the beginning of the 20<sup>th</sup> century. The intensity of the current in the antenna is high also, but its maximum is at the base of the antenna, and this, as discussed above, proves that the current is not directly involved in the emission of radio waves from the antenna – **the emission of radio waves is caused by the high potential the current produces at the tip of the antenna.**

In average size transmitting stations, the maximum potential at the tip of the antenna is in the range of hundreds of kV, in transatlantic size transmitters it is in the order of millions of volts [v8], while the maximum currents are in the hundreds of amperes ; it is obvious that currents of such values, corresponding to a common discharge current through the starter of a car engine, cannot possibly be at the origin of radio waves traveling thousands of kilometers – these waves travel such long distances because of the tremendous *voltage build-up at the tip of the antenna* , corresponding to tremendous *excess and deficit of electrigen at the tip of the antenna*, that causes in turn unimaginably huge compressions and rarefactions in the aether.

Antenna radiation pattern is another feature that supports the theory that the antenna radiation is due to its charging to high voltage and not due to the high currents flowing along it. It is observed that, for a quarter-wavelength antenna, maximum radiation of energy occurs at right angles to the antenna and along the surface of the ground. The antenna emits in *downwards direction from its tip* and the radiation falls off as the vertical angle is increased. These are shown in the figures below [v9].

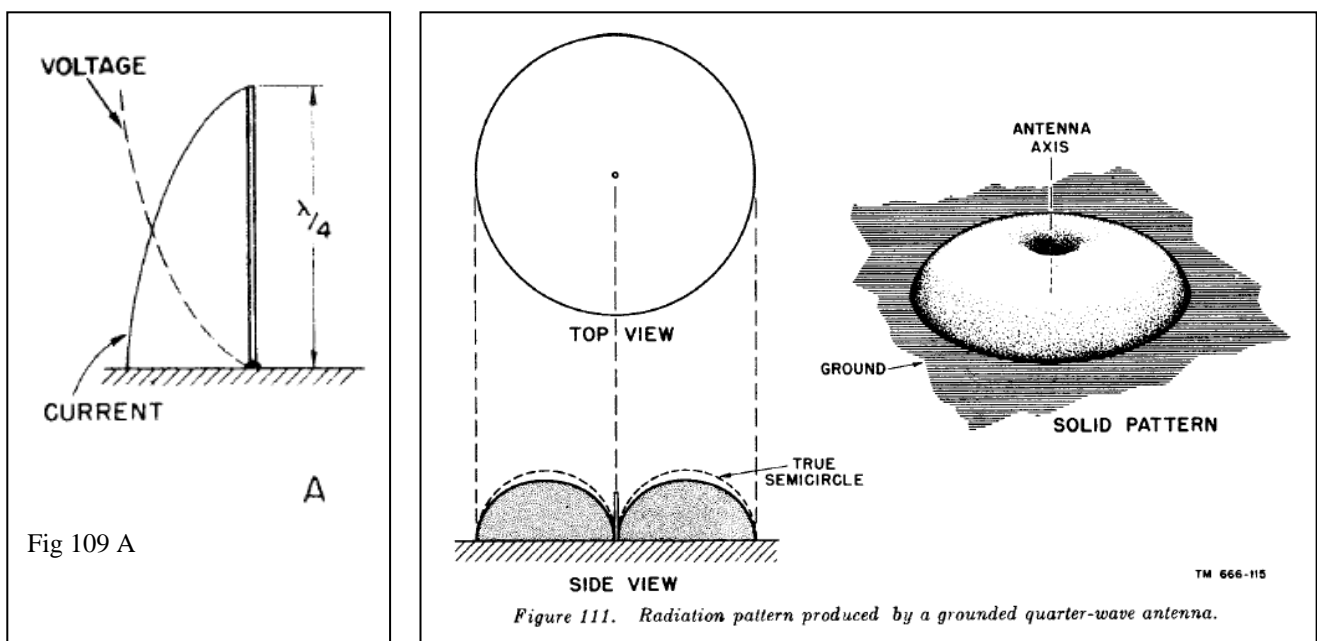

The emission of radiation of the antenna at right angles supports the idea that the emission is caused by electrigen build-up on the surface of the antenna towards its tip, which impinges on the aether surrounding it. The radiation along the surface of the ground can be explained by looking at the *voltage amplitude distribution curve along the antenna* shown in the figure above left, recalling that it corresponds to the density of electrigen on the antenna and, as such, it reproduces with great fidelity *the wavefront of aether compression generated by electrigen in the aether.*

[v8] J. A. FLEMING, The Principles of Electric Wave Telegraphy, Longmans, Green, and Co., 1906, p585

[v9] Department of the Army, Antennas and Radio Propagation, Washington, 1953, p120,121

I have added more such wavefronts on the original figure on the previous page left, and I obtained the figure at the right, where it can be seen that the direction of propagation of the waves emitted by this antenna is indeed downwards from its tip (green arrows).

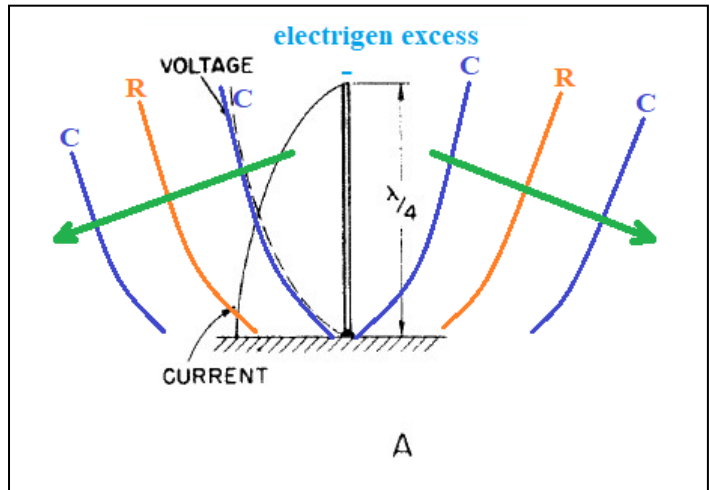

Below are shown the voltage and current distribution for a half-wavelength antenna (center-fed), and its radiation pattern [v10]. It can be seen that there are two sets of waves generated in anti-phase by the voltage distribution along the two arms of the antenna. The two waves interfere and produce maximum of radiation in a direction perpendicular to

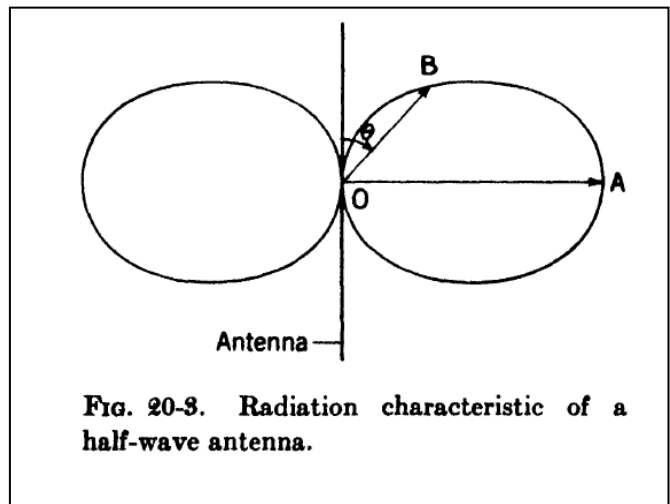
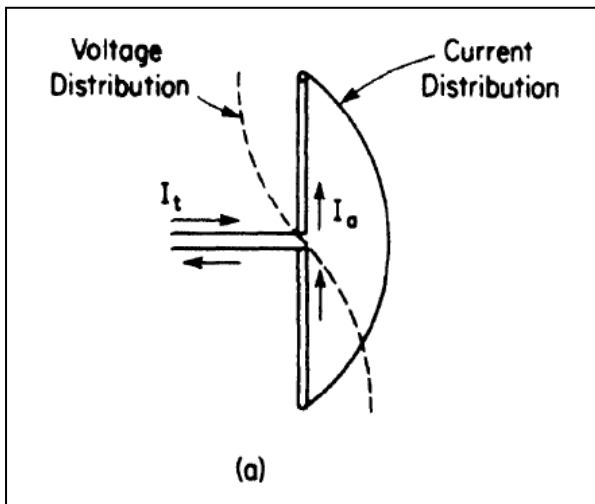
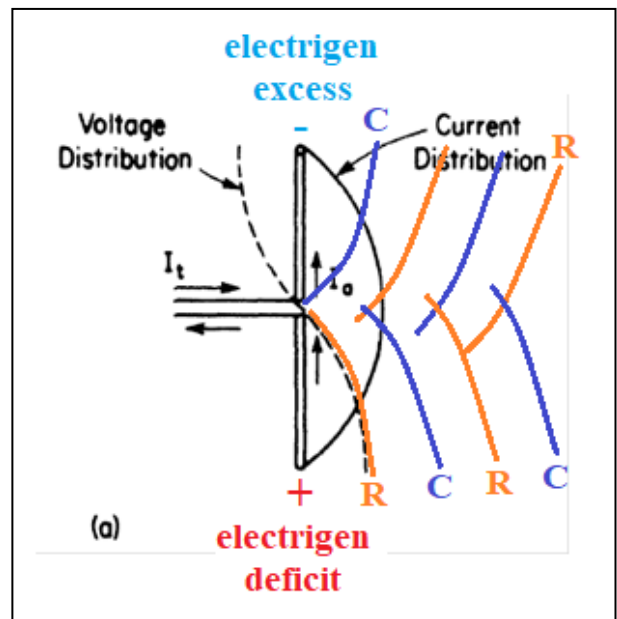

FIG. 20-3. Radiation characteristic of a half-wave antenna.

the antenna. It should be mentioned that, in order to obtain the radiation pattern shown above right, the waves generated by the two arms of the antenna should not be considered spherical and generated strictly from the two tips of the antenna. Instead, the true shapes of the wavefronts should be considered, or else, if a spherical approximation is used, the centres of the spherical waves should be one wavelength apart.

The figure at the right shows the wavefronts of the radio waves produced by the pulsating electrigen along the half-wavelength antenna. It can be seen that the intensity of the resulting wave is along the lines of the radiation pattern shown above.



On the next page I show approximately the correspondence between these wavefronts and those

that exist in the present-day electromagnetic theory. The diagrams showing the wavefronts of this type of antenna were drawn for the first time by Hertz [v11], and have been reproduced since then in books on wireless, radio waves, antenna and electromagnetism by Fleming and Mazzotto [v12], until the modern times by Kraus and Balanis [v13]. The diagram shown below is from an animation that is also inspired from Hertz' original drawing and explanations [v14].

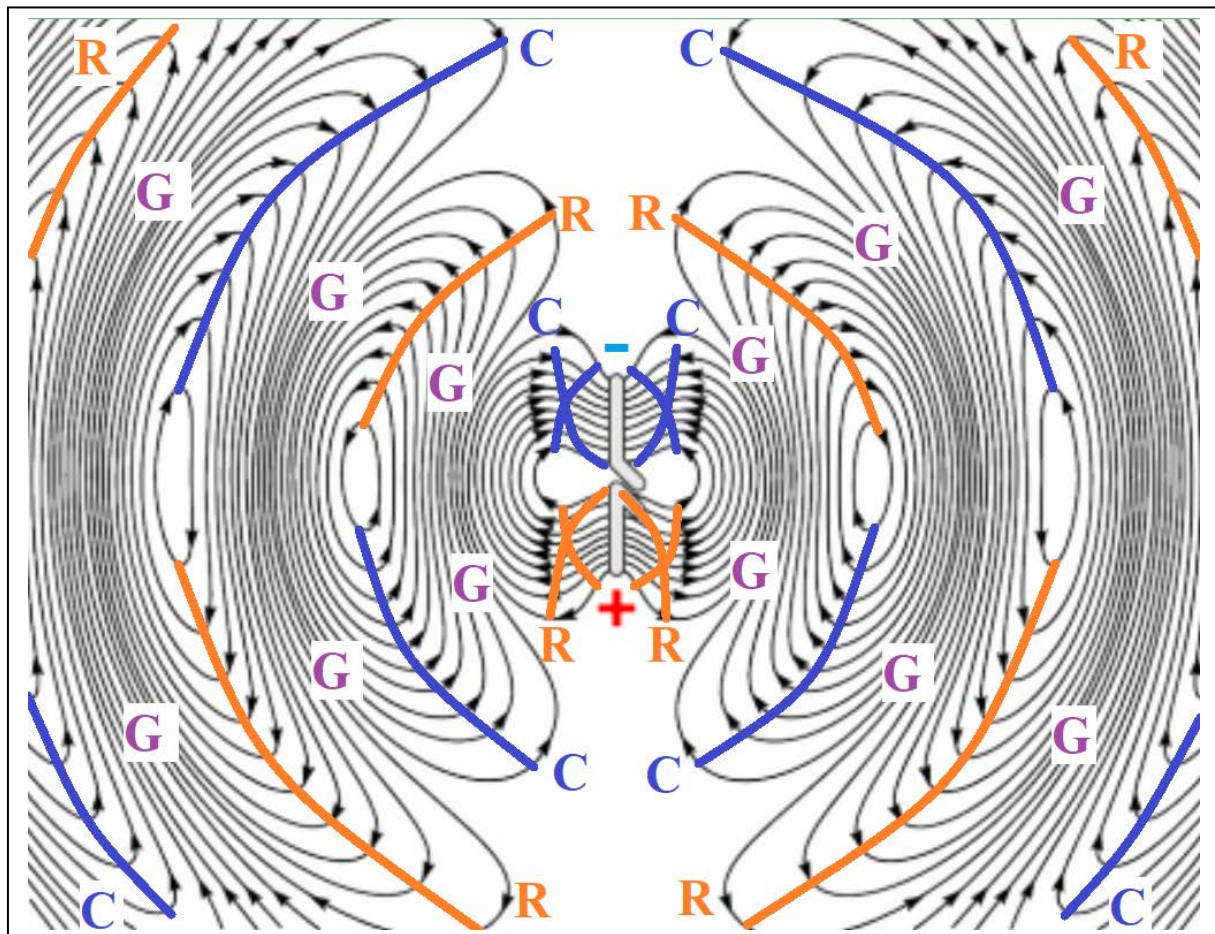

The labels C, R and G correspond to the zones of compression, rarefaction and aether pressure gradient within the wave.

[v11] Heinrich HERTZ, *Electric Waves*, MacMillan and Co., London and New York, 1893, p144-145

[v12] J. A. FLEMING, *The Principles of Electric Wave Telegraphy*, Longmans, Green, and Co., 1906, p352-353 ; Domenico MAZZOTTO, *Wireless Telegraphy and Telephony*, Whittaker and Co., London and New York, 1906, p77

[v13] John D. KRAUS and Keith R. CARVER, *Electromagnetics*, 2<sup>nd</sup> Ed., International Student Edition, 1973, p649 ; John D. KRAUS, *Antennas*, 2<sup>nd</sup> Ed., McGraw-Hill Book Company, 1988, p56-57

[v14] Chetvorno - Own work, CC0, <https://commons.wikimedia.org/w/index.php?curid=41436811>

Below are screenshots from a very interesting video [v15] that proves the theory advanced here, namely that the radio waves are emitted from the points where the amplitude of voltage oscillation is maximum. The antenna used in the experiment is a half-wavelength antenna, and the emission of radiation is according to the *voltage distribution* - and not to the current distribution - along the antenna.

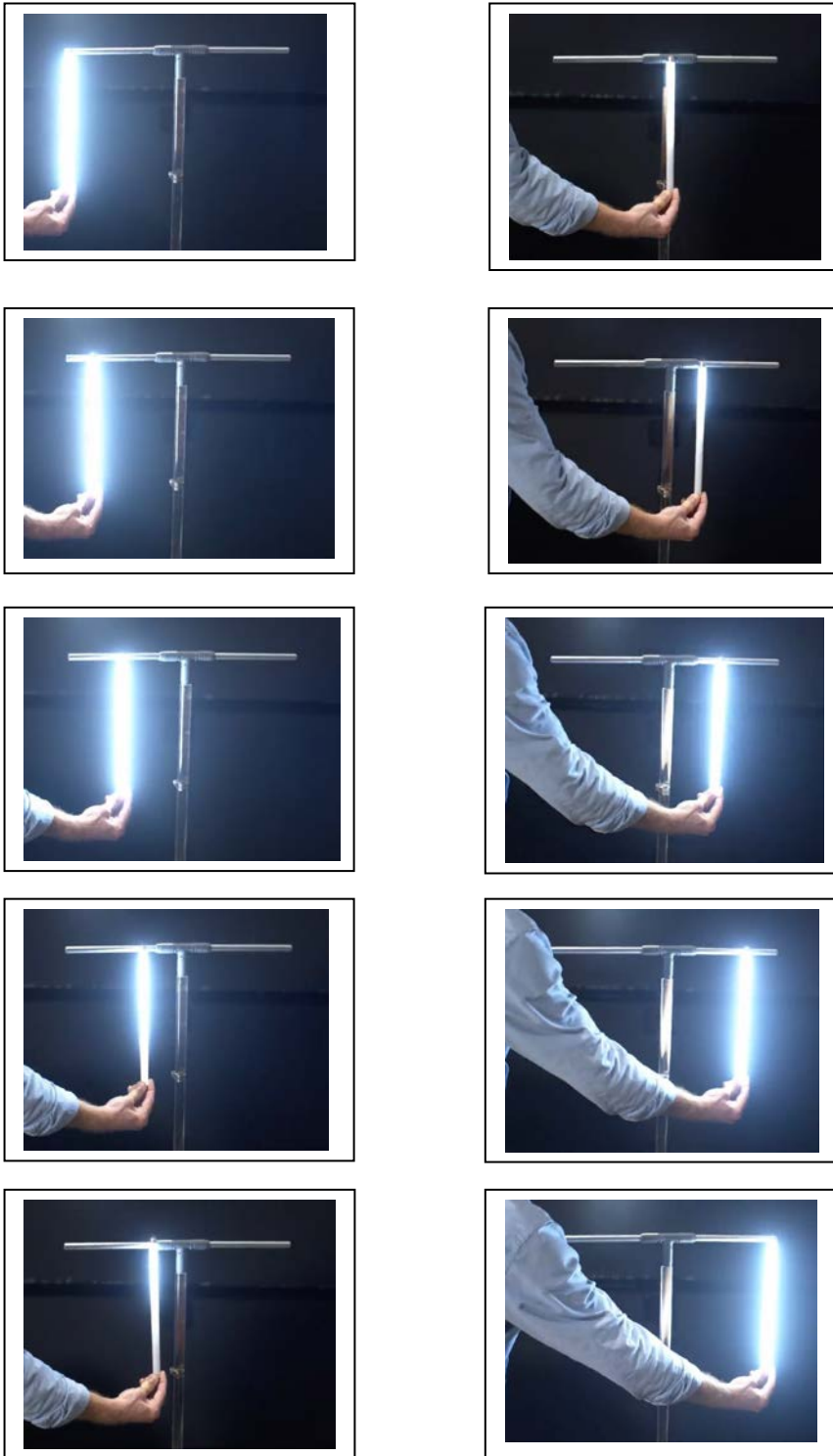

[v15] Radio Wave Properties: Electric and Magnetic Dipole Antennae, Harvard Natural Sciences Lecture Demonstrations, <https://www.youtube.com/watch?v=wUpOlqbHcjI>



In addition to the radiation pattern, the directionality of transmitting and receiving antennas, initially discovered by Marconi *empirically*, proves to be extremely difficult to explain by the electromagnetic wave theory since the electric and magnetic fields are not in such directions as to

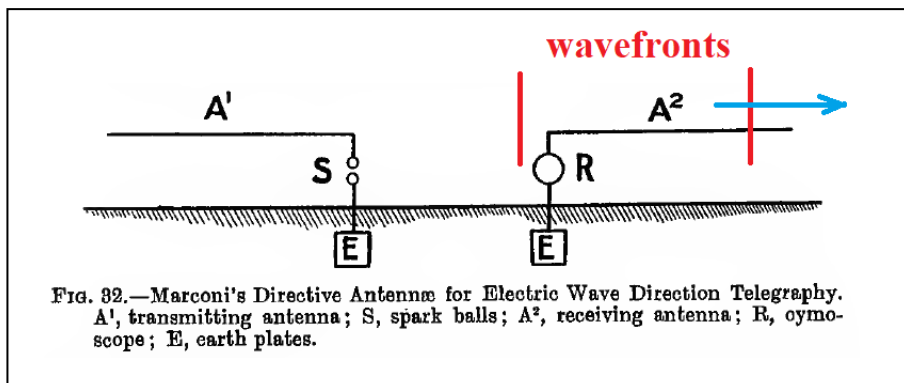

FIG. 32.—Marconi's Directive Antennæ for Electric Wave Direction Telegraphy. A¹, transmitting antenna; S, spark balls; A², receiving antenna; R, cymoscope; E, earth plates.

explain the production of electric currents in the receiving antenna. The longitudinal wave theory explains it by the wavefronts sweeping along the antenna wire and moving the electrigen of the wire periodically along the antenna (see figure at the left [v16]).

The conclusion of this discussion is that the aether movement in the radio wave is a to-and-fro motion and, since this to-and-fro motion of aether was shown in this work to correspond to what we call electrostatic field, it necessarily follows that **radio waves and light are electric waves only**, just as they were initially called by their discoverers before Hertz, by Hertz himself [v17], and by other of his contemporaries. Electric waves have been produced before Hertz (1888) by Elihu Thomson (1886), A.E. Dolbear (1882) [v18] and, most famously, by David Edward Hughes (1879) [v19] [v20]. The latter was also the inventor of the microphone, and his experiments with radio waves were witnessed but sadly downplayed in importance by George Gabriel Stokes [v19]. E. Thomson and D. E. Hughes have stated that, in rooms where the waves were created by powerful discharges, objects close to one another sparked as if they were charged with electricity, and the sparks ceased when the waves were stopped.

Thus, radio waves and light are not magnetic, as can be understood also from the fact that the to-and-fro motion of the aether excludes the existence of rotational motion of aether in the wave. This brings radio waves and light into the same class of longitudinal waves as sound, the difference between the two being only the fluid that constitutes the medium for their propagation: aether for the former, air and other forms of matter for the latter. Moreover, since the aether compressions and rarefactions in a radio wave imply the existence of **aether pressure gradients within the wave**, and we have seen in “The Origin of Gravitation” [v21] that the gravitational force is caused by the aether pressure gradient produced by a star or a planet, it follows that it is more appropriate to say that

light and radio waves are *electro-gravitational waves*

in which **the electric part corresponds to the to-and-fro motion of the aether** along the beam, and

[v16] J. A. FLEMING, The Principles of Electric Wave Telegraphy, Longmans, Green, and Co., 1906, p625

[v17] Heinrich HERTZ, Electric Waves, being Researches on the Propagation of Electric Action with Finite Velocity through Space, London, New York, MacMillan and Co., 1893

[v18] J. J. FAHIE, A History of Wireless Telegraphy, 2<sup>nd</sup> Ed, William Blackwood and Sons, Edinburgh and London 1901, p94-99

[v19] J. J. FAHIE, A History of Wireless Telegraphy, 2<sup>nd</sup> Ed, William Blackwood and Sons, Edinburgh and London 1901, p309

[v20] A. Frederick COLLINS, Wireless Telegraphy, McGraw Publishing Co., New York, 1905, p136

[v21] Ionel DINU, The Origin of Gravitation, The General Science Journal, January, 2007

**the gravitational part corresponds to the aether pressure gradients** that exist within the wave due to aether compressions and rarefactions along the same beam. These aether pressure gradients are time- and space-varying but they can be obtained at fixed regions of space in stationary waves, which is an interesting case to study as it amounts to predicting the possibility of producing gravitational fields from standing radio waves.



The phenomenon is similar to the stationary waves obtained with sound in air, and therefore it predicts also the possibility of manipulating matter gravitationally with the help of radio waves of extremely high intensity, in the same way it is presently manipulated acoustically [v22].

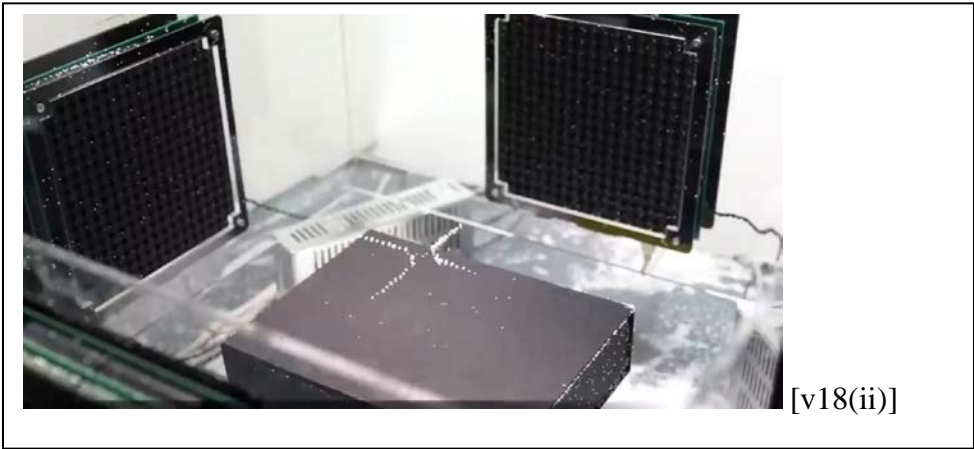

(iv) An interesting experimental finding that supports this theory, in which the movement of the aether is to-and-fro in both the electrostatic field and in light waves, and which therefore supports the

---

[v22] (i) Acoustic levitation, Argonne National Laboratory, <https://www.youtube.com/watch?v=669AcEBpdsY> ; (ii) Acoustic Standing Waves and the Levitation of Small Objects, Harvard Natural Sciences Lecture Demonstrations, <https://www.youtube.com/watch?v=XpNbyfxxkWE> ; (ii) Three-Dimensional Mid-Air Acoustic Manipulation [Acoustic Levitation] (2014-), Yoichi Ochiai, <https://www.youtube.com/watch?v=odJxJRAxdFU&list=PLsSo2-iGT6AojVvE5HsOvifiTcdaKE-1W&index=4> ; Yoichi Ochiai, Takayuki Hoshi, Jun Rekimoto, Three-dimensional Mid-air Acoustic Manipulation by Ultrasonic Phased Arrays, 14 Dec 2013, <https://arxiv.org/abs/1312.4006>

conclusion that light is an electric wave, comes from the fact that *optical and electrical measurements are correlated*.

Thus, for transparent substances, the refractive index ( $n$ ) depends only on their dielectric constant ( $K$ ) [v23] :

$$n = \sqrt{\kappa}$$

The agreement between *electrical and optical* measurements is astonishing for a few substances [v24] , while for others the above relationship is not obeyed ; this should be expected however, as the refractive index is dispersive (dependent on the frequency of light) and the to-and-fro motion of aether is much faster in the light waves than in the electrostatic field. Thus, even for substances that show discrepancies between ( $n$ ) and ( $\sqrt{K}$ ) , the values of ( $n$ ) measured optically and the values of ( $\sqrt{K}$ ) measured electrically approach each other if ( $n$ ) is measured at low frequencies of radiation and ( $K$ ) with high frequency alternating electric fields [v25].

5. The absence of a magnetic field in radio waves and light forces us to dismiss the electro-magnetic theory of light and also to stress again that the explanation of the photoelectric effect as an effect of electromagnetic induction discussed in [v26] was only to show that, *on the basis of electromagnetic theory of light*, it was possible to explain the photoelectric effect without the necessity to postulate the existence of photons. According to the theory presented in this work, both the photoelectric effect and the reception of radio waves in the antenna occur not through electromagnetic induction effects, but through the interaction between the to-and-fro motion of the aether in the incident wave and the electrigen of the irradiated metal or of the wire of the antenna.

While the criticism contained in the work [v27] remains, it will be necessary to modify the interpretation of Hertz's diagram of standing waves in terms not of electromagnetic induction but in terms of longitudinal waves in the aether produced by the emitting oscillating circuit. As such, while I consider Hertz's experiments as still not validating Maxwell's electromagnetic theory, they can be interpreted as showing that what Hertz produced and received were electric waves only, not magnetic waves only as argued my article [v27].

---

[v23] Solomon GARTENHAUS, *Physics Basic Principles, Combined Edition*, 1977, p922,923 ; T. A. LYONS, *A Treatise on the Electromagnetic Phenomena, Vol. I, 1<sup>st</sup> Ed.*, John Wiley and Sons, New York 1901, p542 ; Daniel F. COMSTOCK and Leonard T. TROLAND, *The Nature of Matter and Electricity*, D. Van Nostrand Co., New York, 1917, p160 ; Norman Robert CAMPBELL, *Modern Electrical Theory*, Cambridge, 1907, p37,38 ; Ludwik SILBERSTEIN, *Elements of the Electromagnetic Theory of Light*, Longmans, Green and Co., London, 1918, p3-4

[v24] Richard C. MACLAURIN, *Light*, The Columbia University Press, 1909, p234-235 ; Leonard B. LOEB, *Fundamentals of Electricity and Magnetism, 3<sup>rd</sup> Ed.*, John Wiley and Sons Inc., New York, 1947, p409 ; Adolphe GANOT, *Elements des Physique*, translated by E. Atkinson as *Elementary Treatise on Physics, 18<sup>th</sup> Ed.*, Longmans Green and Co., 1910, p1107-1108

[v25] Alfred DANIELL, *A Textbook of the Principles of Physics, 3<sup>rd</sup> Ed.*, MacMillan and Co., New York, 1895, p744,745 ; E. MASCART and J. JOUBERT, *A Treatise on Electricity and Magnetism, Volume I, General Phenomena and Theory*, Thos. De La Rue and Co., London, 1883, p616-617 ; G. CAREY and Alfred W. PORTER, *Elementary Treatise on Electricity and Magnetism, founded on JOUBERT's "Traite Elementaire D'Electricite"*, 3<sup>rd</sup> Ed., Longmans Green and Co., London, 1909 , p464-466

[v26] Ionel DINU, *Radio Waves – Part III: The Photoelectric Effect*, June, 2013, viXra: 1306.0220

[v27] Ionel DINU, *Radio Waves – Part IV: On the False Electric Waves of Delusional Heinrich Hertz*, ResearchGate, November, 2015

## VI. Helping Millikan explain the photoelectric effect

This section was inspired by Robert Millikan's work "The Electron" [vi1], in which he dedicated a whole chapter to the nature of light and radio waves, discussing the photoelectric effect and the profound complication brought to the wave theory of light by Einstein's corpuscular interpretation of this effect. Having himself verified experimentally Einstein's equation for the photoelectric effect, Millikan discussed at length all the peculiarities of this effect, considered the possible explanations advanced at his time – the aether-string theory of J.J. Thomson, the quantum theory of Einstein, the trigger model – and, *while agreeing with none, could not himself propose a better alternative explanation.*

This topic is important because what Millikan called in the year 1924 "the newest of the problems in physics" [vi1] remains unsolved in the year 2024, a hundred years later, when the high-school students are taught to get used to it and accept it under the name "wave-particle duality" [vi2], only to be told later, in their undergraduate studies [vi3], that "certain experiments will bring out the particulate (particlelike) aspects of the wave, and others its wavelike features". I suggest here that no, experiments don't do that.

It seems to me that Millikan's problem and its solution rest in the clarification of the physical interpretation of the concept of voltage and of the energy of electrons, as well as of the physics of the electron beam itself. As the current interpretations are in wide use today, one can imagine that their reevaluation will have great consequences.

Let us recall that the energy of photo-electrons is measured by their stopping voltage; in a discharge tube or linear accelerator the energy of electrons is measured by the voltage between cathode and anode. Modern science defines voltage as the energy transferred to unit charge. But what does voltage ultimately mean, what is its underlying physical nature? If we remember that the most general formula for voltage is

$$V = \frac{Q}{4\pi\epsilon_0 r}$$

where  $Q$  is the charge generating this voltage, and that charge was considered in this work to be molecular vibration, it is not difficult to see that *to every voltage corresponds a certain frequency of molecular vibration.* There is thus a direct link between voltage and frequency of vibration.

Let us next consider Davisson-Germer experiment with the diffraction of electrons. The figures on the next page are from a very recent textbook of physics for college students [vi4]. It can be seen that the electrons emitted by the hot filament are accelerated through a voltage and formed into an electric current like a beam. Note that nothing is said about this beam, whether it has a structure or it is composed of random arrangement of electrons travelling with energy  $eV$  towards the nickel crystal. However, after scattering from the nickel crystal, a diffraction pattern is observed: the intensity of electric current is greater in certain definite directions, showing constructive interference effects. What is interfering here? The modern conception is that *each* electron travelling in the electric current that forms the beam behaves like a wave, that each wave is somehow spread in all

---

[vi1] Robert Andrews MILLIKAN, The Electron, Its isolation and measurement and the determination of some of its properties, The University of Chicago Press, 2<sup>nd</sup> Ed, 1924, Chapter X The Nature of Radiant Energy, p232

[vi2] Miles HUDSON, Physics, Student Book 1, Pearson Edexcel International AS / A Level, Pearson Education Ltd, London, 2018, p132

[vi3] Solomon GARTENHAUS, Physics Basic Principles, Combined Edition, 1977, p917

[vi4] Hugh D. Young, Roger A. Freedman, A. Lewis Ford, Sears and Zemansky's University Physics with Modern Physics, 15<sup>th</sup> Edition, 2020, p1280-1281

directions after hitting the metal surface, and that these scattered waves then interfere with each other. This interpretation is very hard to accept because it implies that the wave belonging to one

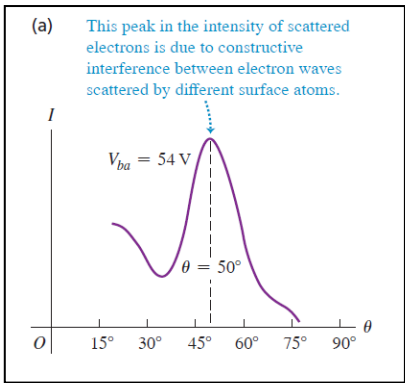
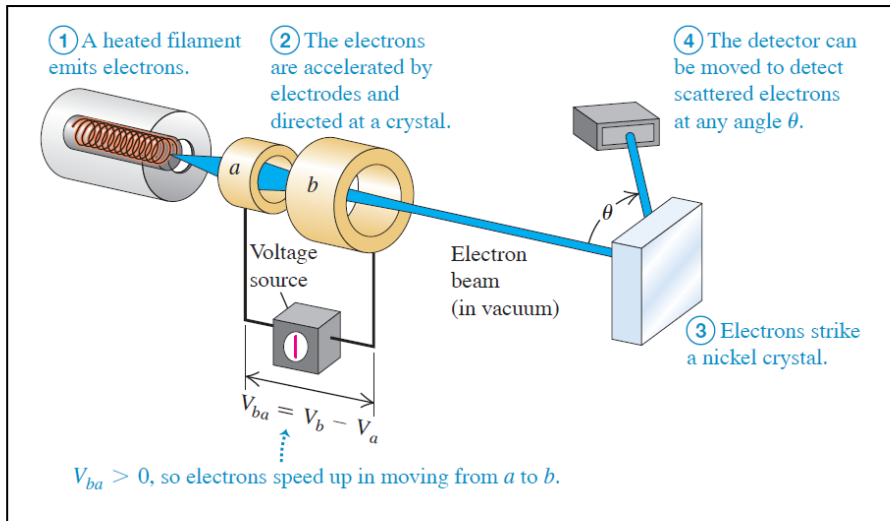

particle (electron) scatters in multiple directions ; but how can the wave associated to *one* particle spread in different directions through scattering ? The impossibility of such an occurrence comes to show how unrealistic is the concept of wave-particle duality mentioned at the beginning of this section.

There is, however, another possible way to look at this experiment. As it was discussed in Parts 1

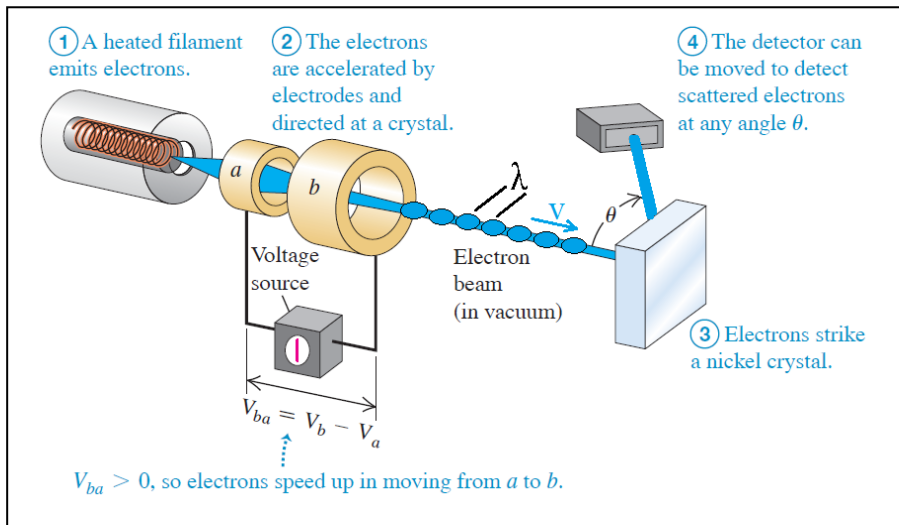

and 3 of this series, an electric current is a diffusion wave of electrigen. Since the electron beam is in essence an electric current, it should not be represented with a *straight line* as in the figure above, but with the *structure of a wave*, as shown in the figure at the left.

The  $\lambda$  shown in the figure is **not the wavelength of one electron in the beam, but the wavelength of the beam as a whole**, considered as a wave, as will be discussed in what follows.

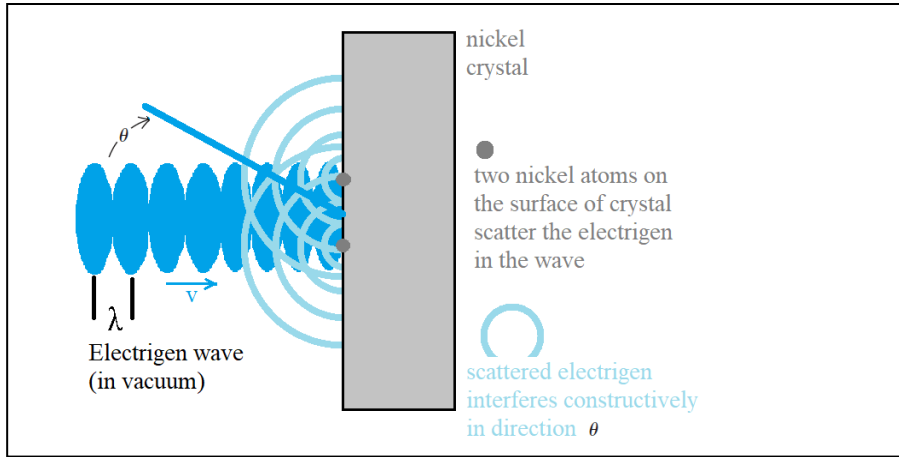

Since every voltage corresponds to a certain frequency of molecular vibration of the accelerating electrodes, the accelerating voltage has the effect of forming the space charge (electrigen) produced by the heated filament through

thermionic emission into a beam composed of a sequence of lumps of electrigen at the frequency (f) corresponding to the value (V) of the accelerating voltage ; in other words, the acceleration of the space charge by the voltage (V) amounts to forming the electrigen into lumps at a frequency (f) that travel one after another at velocity (v).

The beam travelling with velocity (v) and being formed into lumps at the frequency (f) of the accelerating voltage, has a wavelength that satisfies the wave equation

$$v = f \lambda \text{ wherefrom the wavelength is } \lambda = v / f .$$

It can be seen that such a wave can be scattered by the nickel crystal atoms and the electrigen waves resulting from scattering produce the maxima observed in Davisson-Germer experiment.

It is also known that when electrons strike a metallic surface with great energy, radiations (UV, x-rays) are emitted (see figure at the left [vi5]) in a process that has been called inverse photoelectric effect [vi6]. If these radiations are allowed then to strike another metallic target, they produce photoelectrons with maximum energy

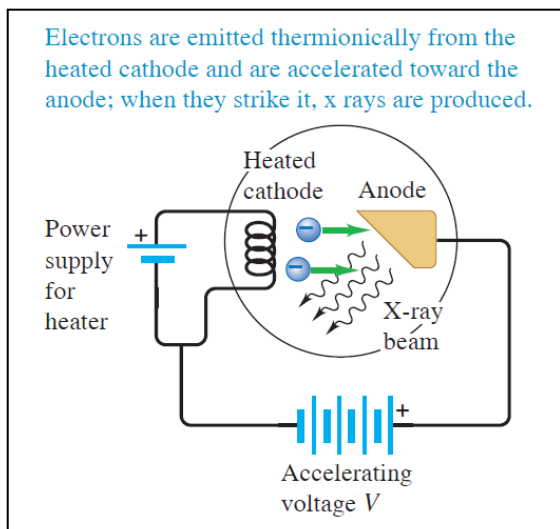

$$h f = e V$$

These experimental facts can be interpreted to show that **the radiations emitted by the metal have frequency (f) because the metal surface is being bombarded by the electron beam at the frequency (f)**. The maximum frequency (f) should not be confused with the characteristic radiations emitted by elements – it is the cut-off frequency of the emitted spectrum and it

is independent of the nature of the metal.

In the figure above therefore, electrons should be shown not as separate particle entities striking the anode chaotically, but as in the figure on the previous page, as a beam of wavelength ( $\lambda$ ), velocity (v) and frequency (f), corresponding to the accelerating voltage (V) so that ( $e V = h f$ ) . It can be easily understood that when a metallic surface is being bombarded by lumps of electrigen at a frequency (f), the electrigen of the metal will start to vibrate at the same frequency (f) as that of the incoming beam and emit radiations in the aether with the same frequency (f). The frequency (f) is the highest possible and lower frequencies are conceivable since discontinuities in the beam will lead to the metal surface being hit by the lumps of electrigen at a lower frequency, causing the electrigen of the metal to vibrate at a lower frequency and so to emit radiation of lower frequency.

Since the frequency of the radiation emitted, and that of the wave of electrons hitting the target are equal

$$\lambda = v / f \text{ and } h f = e V \rightarrow f = eV/h , \text{ so } \lambda = v / (eV/h) , \text{ or } \lambda = h / (eV/v)$$

which is very similar to de Broglie equation  $\lambda = h / p$  .

[vi5] Hugh D. Young, Roger A. Freedman, A. Lewis Ford, Sears and Zemansky's University Physics with Modern Physics, 15<sup>th</sup> Edition, 2020, p1259

[vi6] Robert Andrews MILLIKAN, The Electron, Its isolation and measurement and the determination of some of its properties, The University of Chicago Press, 2<sup>nd</sup> Ed, 1924, Chapter X The Nature of Radiant Energy, p246

The factor  $(eV/v)$  can be rewritten as  $e V = (1/2) m v^2$  wherefrom  $(eV/v) = (1/2) m v = p/2$

from which the wavelength of the electron beam is, according to the theory advanced here,

$$\lambda = h / (p/2) \quad , \quad \text{which is different from de Broglie equation } \lambda = h / p \quad \text{by a factor of 2.}$$

This difference can be due to the low kinetic energy of the beam, for which is applicable the classical expression

$$\text{K.E.} = (1/2) m v^2$$

or, most probably, by the fact that the power supply actually transfers to the beam an energy of

$$e V = (1/2) m v^2 + (1/2) m v^2$$

from which only one half is observed as heating of the metallic target due to the kinetic energy of the electrons while the other half corresponds to the energy spent by the power supply to produce the beam itself. In the case of the photoelectric effect, the energy of the incident radiation is converted into the kinetic energy of the photoelectrons but also spent in the boiling off of electrons from the target (work function)

$$h f = (1/2) m v^2 + \Phi$$

The fact that the emission and absorption of electricity at the surface of a metal are similar to vaporization and condensation of matter [vi7], and that the work done in the photoelectric effect and thermionic emission have the same value [vi8] and correspond to the latent heats of vaporization and condensation of electricity, are in complete accord with the view of electricity as a chemical element in its own right, called electrigen in Part 1 of this series.

From the description of an electron beam and its associated wavelength discussed above, it follows that **the nature of matter waves is in fact that of waves of matter**, by which is meant that beams of atoms or molecules moving with a velocity ( $v$ ) have wave properties simply because the beams themselves are structured in a sequence of higher density lumps following each other with a frequency ( $f$ ) and at a distance ( $\lambda$ ) so that the wave equation ( $v = f \lambda$ ) is obeyed [vi9].

The case of the photoelectric effect can be made in similar terms. When radiation of a certain frequency is incident on the surface of a metal, electrigen will be released from the surface as long as the radiation is able to transfer energy to the electrigen of the metal. This transfer of energy will occur as forced vibrations of the electrigen in the metal caused by the incident radiation, resulting in the “boiling off” of electrigen from the metal surface. The process is very similar to the ultrasound induced vaporization used in ultrasonic vaporizers, if we consider the ultrasound incident on the surface from above the liquid and not acting from within due to a submerged transducer.

As it is well-known, the photoelectric current can be stopped by applying a positive voltage to the metal plate. Thus, when the metal is applied a positive voltage, the metal will have a deficit of electrigen, which means that the layer of electrigen covering the atoms is thinner and can be forced

---

[vi7] O. W. RICHARDSON, The Emission of Electricity from Hot Bodies, 2<sup>nd</sup> Edition, Longmans, Green and Co., London, 1921, p28,153,171,181,183,189

[vi8] C. Guy SUITS and Harold E. WAY (editors), The Collected Works of Irving Langmuir, Volume 3 Thermionic Phenomena, Pergamon Press, 1961, p186 ; C. M. LOVETT, The Work Function in Thermionic and Photoelectric Emission, A Dissertation for the M.Sc. Degree, ProQuest LLC (2016), p7,44

[vi9] Charles F. MEYER, The Diffraction of Light, X-rays and Material Particles, The University of Chicago Press, Chicago, Illinois, 1934, p403-406

to vibrate at the higher frequency corresponding to that voltage ; as the positive voltage is increased, the incident radiation will transfer less and less energy to the electrigen of the metal and force it into vibration of the same frequency and phase, and a stage is reached when it is not possible for the incident radiation to transfer any energy to the electrigen remaining in the metal ; at this point the photoelectric effect stops. Higher radiation frequency will be able to start the photoelectric emission again, because it matches the frequency of vibration of the thinner layer of electrigen layer corresponding to the positive voltage applied to the metal, and is thus able to induce vibration of the same frequency and phase in the electrigen in the metal. It is a phenomenon of resonance in which the frequencies of two vibrating systems match :

$$\text{frequency of radiation} = \text{frequency of electrigen in the metal} \quad \text{or,} \quad h f = e V$$

The so-called work function, missing in the equation above, corresponds to the property of each metal to affect the free vibration of a layer of electrigen of certain thickness. When this is taken into account, the equation becomes

$$h f = e V + \Phi$$

from which it can be seen that every metal produces a different coupling between its electrigen and the radiation incident on it : even without an applied positive voltage, the radiation will not be able to transfer energy to the electrigen of the metal because the metal does not allow the electrigen to vibrate at the same frequency and phase as that of the incident radiation which is a condition for the boiling off of electrigen.

Finally, a new theory of the propagation of radiation is proposed to solve the difficulty that the *spreading-wave theory* brings about in accounting for the ejection of photoelectrons from a metal by very weak radiation obtained from weak sources of radiation, or emitted from strong sources of radiation but weakened by absorption or simply by being situated at great distances from the metal [vi10] [vi11]. It is known that this was the most contentious issue regarding the photoelectric effect because it was very hard to account for the high energy of photoelectrons from the very small energy existing in the incident wave *when the energy of radiation was assumed to be uniformly distributed over its wavefront* - an assumption made in order to explain the decrease in the intensity of radiation with the inverse square of the distance from the source [vi12]. As mentioned in the beginning of this section, a number of solutions were proposed in the past, the one adopted by present-day physics being that advanced by Einstein of particles of light or light quanta which, however, creates the insurmountable problem of wave-particle duality.

The solution to this problem is to admit **that the energy of the radiation is not spread uniformly over the wavefront of the wave**, and that light propagates in channels that look very similar to the discharge channels seen in lightning [vi13] , or to the filaments seen in plasma globes (see photos on the next two pages). This is due to the fact that the aether, being a liquid, can be conceived as having a granular structure, very much like the particles of gas through which these discharges take place. It

---

[vi10] Robert Andrews MILLIKAN, The Electron, Its isolation and measurement and the determination of some of its properties, The University of Chicago Press, 2<sup>nd</sup> Ed, 1924, Chapter X The Nature of Radiant Energy, p251-253

[vi11] Russell McCORMMACH, J. J. Thomson and the Structure of Light, The British Journal for the History of Science, Vol. 3, No. 4 (Dec., 1967), p362-387

[vi12] Daniel F. COMSTOCK and Leonard T. TROLAND, The Nature of Matter and Electricity, D. Van Nostrand Co., New York, 1917, p183,184

[vi13] Philip ATKINSON, Electricity for Everybody, The Century Co., New York, 1907, p(between 48 and 49)



is conceivable then that a source of radiation will produce these kinds of channels through which *the oscillatory to-and-fro aether motions are transmitted*, and not by the uniform distribution of energy over the spherical wavefront assumed to exist in the books of optics and photometry or of general physics [vi14]. Such a channel of propagation of light waves resembles a spark in a discharge gap through which tens of vibrations of very high frequency (millions of hertz) pass and which, with an oscillating circuit connected with the gap, was used in the original spark transmitters of radio waves [vi15].



---

[vi14] John W. T. WALSH, *Photometry*, D. Van Nostrand Co., New York, 1926 , p19 ; Lionel LAURANCE, *general and Practical Optics*, The Orthos Press, London, 1908, p30 ; Archibald Stanley PERCIVAL, *Geometrical Optics*, Longmans, Green and Co., London, 1913, p2-3 ; Joseph VALASEK, *Elements of Optics*, 2nd Ed., McGraw-Hill Book Co., 1932, p10-11 ; W. L. WHITELEY, *General Physics*, 4<sup>th</sup> Ed., University Tutorial Press Ltd., London, 1961, p345-346  
[vi15] J. A. FLEMING, *The Principles of Electric Wave Telegraphy*, Longmans, Green, and Co., 1906, p15, 22-27 ; S. R. BOTTONE, *Wireless Telegraphy and Hertzian Waves*, 4<sup>th</sup> Ed., Whittaker and Co., New York, 1910, p14 ; Raymond Francis YATES and Louis Gerard PACENT, *The Complete Radio Book*, The Century Co., New York, 1922, p62 ; Elmer BUCHER, *Practical Wireless Telegraphy*, Wireless Press Inc., New York, 1917, p83 ; A. Frederick COLLINS, *Wireless Telegraphy*, McGraw Publishing Co., New York, 1905, p37, 47-48, 51-53

The pictures below illustrate the propagation of light in channels away from a source of radiation.



The top photo illustrates a source of great intensity, the middle photo one of lower intensity, and the bottom picture a source of even lower intensity.

The sphere at the centre is the source of radiation. The oscillations of the atoms in the source are transmitted as *longitudinal waves of compression and rarefaction of aether along the channels* shown in lines of blue color.

The blue lines change in time, in locations on the source, in directions and shape, as anyone who has observed a plasma globe can confirm (see video [vi16]). Over time, the whole space around the source will be swept by these channels : the higher the intensity of the source the more rapid the sweeping becomes, and this gives the impression of constant average energy distributed over the surface of a sphere surrounding the source of radiation ; the number of channels crossing unit surface of a sphere enclosing the source decreases with increasing radius of the sphere, thus accounting for the inverse square law of variation of the intensity of light with the distance from the light source. The intensity of light is then equal to the number of channels falling perpendicular to unit area of surface.



In the same time, *light propagation in channels* also accounts for the peculiar finding in the photoelectric effect according to which the energy of photoelectrons does not depend on the intensity of light : this is because the energy of radiation propagates along these channels which, even if changing in shape and locations, remain of a constant cross-section, and when striking the surface of the metal will eject electrons at the point of incidence with the energy corresponding to the frequency of radiation no matter how far the source is. Radiation made weaker by passing it through an absorbing substance results in less number of channels passing through from the source to the target ; the same happens when the source is made weaker or moved farther away : less number of channels hit the target. Conversely, if the intensity of the source is increased by any method, more channels will be produced and reach the target, radiation will hit the surface of the target in more points, and more photoelectrons will be emitted, but their energy will still be that due to the wave propagated in the channel.

It is assumed thus that in the case of a source

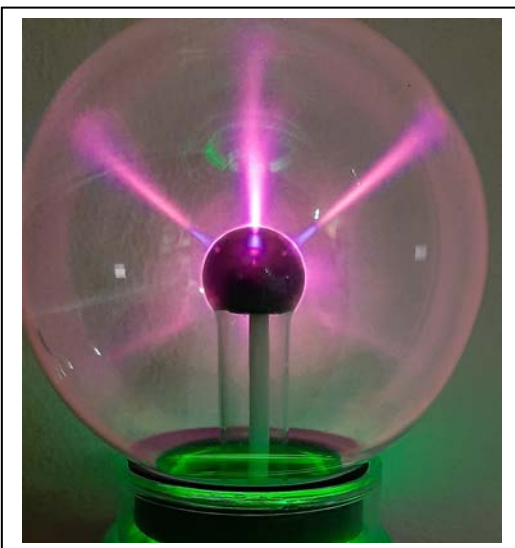

---

[vi16] Ionel DINU, Light propagation in channels, <https://youtu.be/fuUJSVssT3g>

radiating into the aether, the cross-sectional area of a channel remains constant, and the intensity of the source is proportional to the number of channels through which radiation propagates away from the source.

The *theory of light propagation in channels* advanced in this work solves not only the difficulty seen in the photoelectric effect, but also that mentioned by J. J. Thomson in his researches on the ionization of gases by x-rays [vi17] [vi18], in which he observed that only very few molecules of gas were ionized when the radiation passed through the gas. This is in contrast with the expectation that, if x-rays were waves with energy spread uniformly over the whole surface of the wavefront, they would cause ionization in the whole volume of the gas. A staunch opponent of Einstein's idea of "photons" [vi19], J. J. Thomson believed that ordinary optical phenomena are merely average effects [vi20], that the spherical-wave theory was true in an average sense [vi21], and tried to produce a wave theory of light that would explain his observations [vi22]. It can be said the theory of light propagation in channels advanced in this work was inspired by J. J. Thomson's ideas.

Thus, the *theory of light propagation in channels* explains this feature of the ionization of gases by x-rays by the fact that the wave energy travels from the source of x-rays (the anticathode of the discharge tube) in narrow channels which find "here and there", as Millikan put it [vi17], an atom of gas to strike and ionize.

Another issue solved by the theory of light as a longitudinal wave of compressions and rarefactions in the aether is that of Huygens' principle, which is supposed to help us find the wavefront of a wave from its previous geometry. Huygens' principle has been criticized by the present author [vi23] for

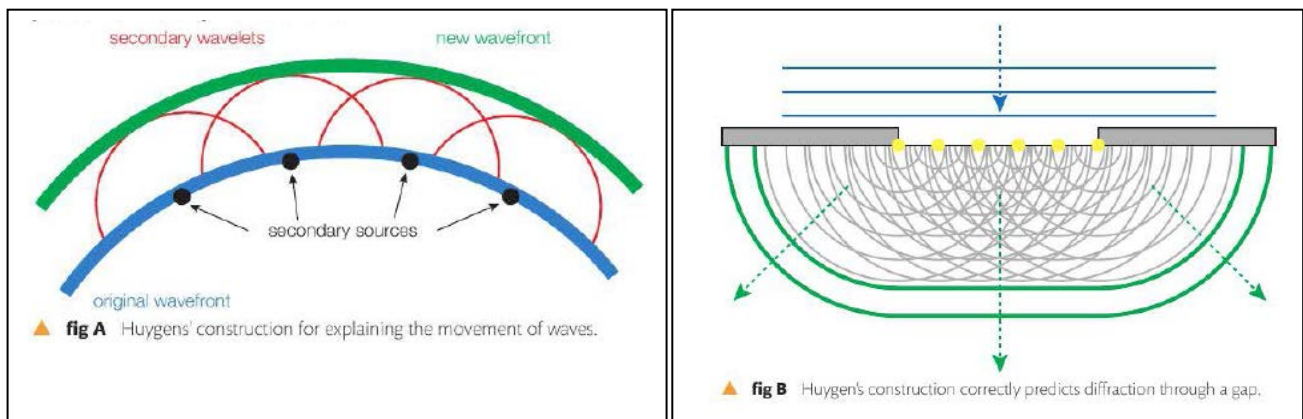

[vi17] Robert Andrews MILLIKAN, *The Electron, Its isolation and measurement and the determination of some of its properties*, The University of Chicago Press, 2<sup>nd</sup> Ed, 1924, Chapter X *The Nature of Radiant Energy*, p235

[vi18] Russell McCORMMACH, *J. J. Thomson and the Structure of Light*, *The British Journal for the History of Science*, Vol. 3, No. 4 (Dec., 1967), p366

[vi19] Russell McCORMMACH, *J. J. Thomson and the Structure of Light*, *The British Journal for the History of Science*, Vol. 3, No. 4 (Dec., 1967), p381,383

[vi20] Russell McCORMMACH, *J. J. Thomson and the Structure of Light*, *The British Journal for the History of Science*, Vol. 3, No. 4 (Dec., 1967), p369

[vi21] Russell McCORMMACH, *J. J. Thomson and the Structure of Light*, *The British Journal for the History of Science*, Vol. 3, No. 4 (Dec., 1967), p376

[vi22] Russell McCORMMACH, *J. J. Thomson and the Structure of Light*, *The British Journal for the History of Science*, Vol. 3, No. 4 (Dec., 1967), all pages

[vi23] Ionel DINU, *Optical Phenomena in the Aether*, *The General Science Journal*, October 3<sup>rd</sup> 2008, p9-15

leading to the construction of wavefronts inconsistent with observations, and also because it completely, and conveniently, overlooks the wavefronts produced in the direction opposite to the propagation of the wave. The pictures on the previous page have been taken from a modern high-school textbook of physics [vi24], and it can be seen clearly in the left picture that the secondary wavelets (in red) are shown incomplete, only those in the forward direction, with no mention of the missing parts in the backward direction, behind the original wavefront (in blue); the diffraction of waves through a gap (right picture) has the same omissions, the wavelets in the gap being drawn incomplete, i.e. only those in the forward direction. It must be remembered that Huygens' principle is supposed to explain the important process of propagation of waves and the formation of the wavefront subsequent to the one to start with. By drawing incomplete "wavelets" it is obvious that this explanation, based on biased and convenient omissions, is not made in a fair way and cannot possibly be an accurate description of what is happening in reality. As such, it can be said that Huygens' principle can be hardly accepted as a true principle of physics. On the other hand, the theory of light propagation in channels advanced in this work explains the propagation of waves in free space by the longitudinal waves of compression and rarefaction in the aether; the explanation of diffraction, interference, polarization, refraction, and even reflection need to be reconsidered on the basis of this new theory and will be discussed in a future work.

It should also be observed that there is no contradiction between the above criticism of Huygens' principle and the *existence* of wavefronts, which have been employed in this work in relation to the emission of radio waves from antennas and of their propagation as longitudinal waves of aether through space. Wavefronts are simply formed through the to-and-fro motion of the aether and there is no need to invent a new principle for the propagation of waves.

There is also no contradiction between admitting the existence of wavefronts in radio waves and the theory of propagation of light and X-rays in channels. This can be understood from the fact that the two types of waves differ significantly due to their modes of production:

- on the one hand, radio waves are emitted by extended sources (antennas) that produce one wavefront of similar dimensions from the whole surface of the antenna through the accumulation of electrigen on its surface ; increasing the potential of the antenna causes the emission of waves to be concentrated towards the tip of the antenna, but still, the dimensions of the emitting source is many-many times the dimensions of an atom

- on the other hand, light and X-rays are emitted by atoms, which are very small sources, emitting radiation through the vibration of electrigen on the surface of each atom that acts on the aether in one given direction only (the direction of electrigen vibration), due to the granular structure of the aether mentioned before ; on the next page is shown again

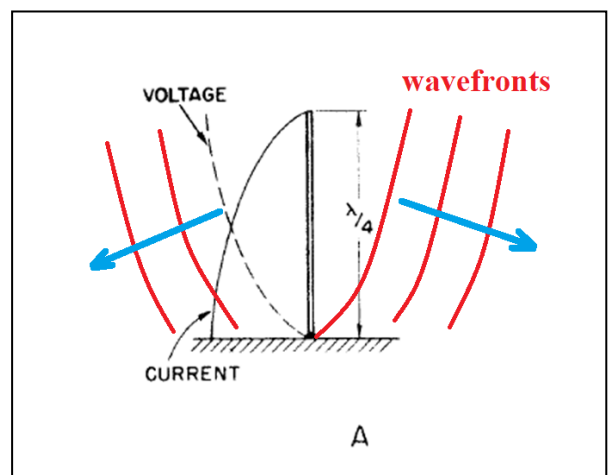

the picture reproduced from [iii18] at p15 of this work to observe the pointed shape of electrigen in vibration, especially in the vibration modes having 2- and 3- nodal lines corresponding to the p- and d- orbitals of quantum mechanical calculations – these pointed shapes strongly indicate the formation of a channel through which aether vibrations propagate in a cross-sectional area of less than that of

---

[vi24] Miles HUDSON, Physics, Student Book 1, Pearson Edexcel International AS / A Level, Pearson Education Ltd, London, 2018, p132

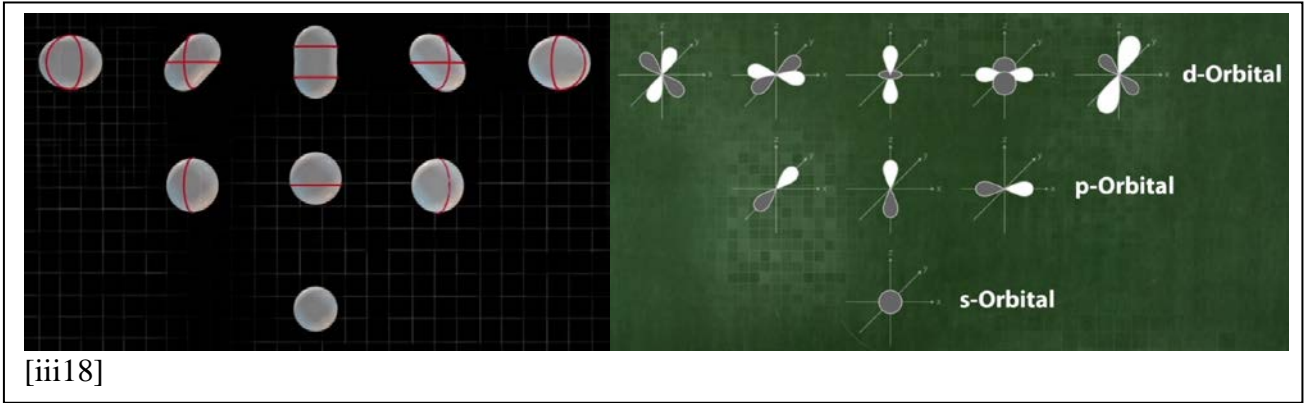

an atom. These very same directed aether vibrations have been mentioned in a previous work [vi25] in relation to the way in which atoms interact electrostatically with each other.

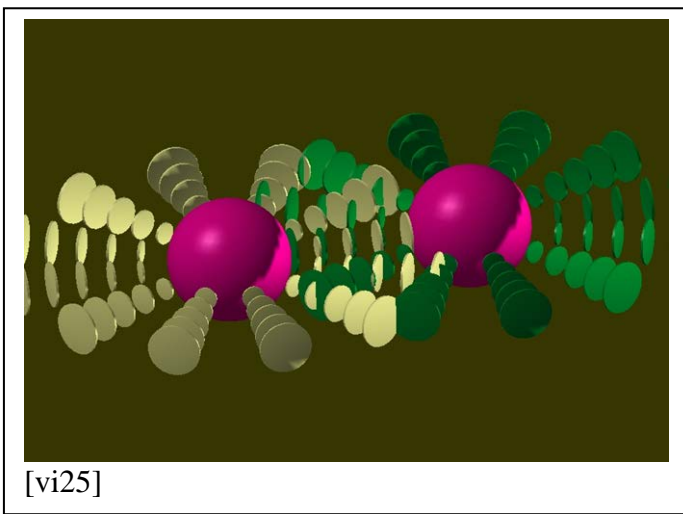

[vi25] Ionel DINU, Rudiments of a Theory of Aether, The General Science Journal, 2020 March, p10-12.