



## Zero Quantum Gravity (*revised*)



Stephen H. Jarvis

Xemdir : [www.xemdir.com](http://www.xemdir.com)

email: [stephen.jarvis@xemdir.com](mailto:stephen.jarvis@xemdir.com)

**Abstract:** The discipline of physics tests theories with known observed phenomena. There, the credibility of any theory is how physical phenomena can be scaled, measured, and thence confirmed using numbers with dimensions in the form of theories. The idea there is to find an exact as possible match of number theory with physical phenomena. Indeed, numbers do not make reality come into existence, yet as shall be shown here numbers do in fact represent sentient based keys to understanding physical phenomena by their certain definition and association. Here the process of sentient based theoretic development is achieved through uncovering the number theory behind the workings of nature as a code for zero-dimensional time and space. There, in making direct utility of the Collatz conjecture, a solution to the three-body problem is proposed. By such, new experiments are proposed in demonstration of gravity's nature. In all, here shall be shown how numbers and their particular definition and utility upon and beyond the proposed zero-dimensional levels of time and space more than likely represent sentient based keys in correctly scaling and surveying physical reality via a proposed temporospatial sentient code, ultimately as a proposed expression of universal sentience measuring itself.

**Keywords:** temporal mechanics; zero-dimensional; zero dimension, natural science; formal science; social science; sentience; speed of light; fine structure constant; zero-point gravity; zero quantum gravity; Xemdir field; colouring packing problem; Collatz conjecture; three-body problem



## Index

---

CHAPTER	TITLE	PAGE
1.	Introduction	3
2.	ABC science code	4
3.	ABC state of the art	7
4.	ABC infinitesimal logic	10
5.	ABC dimensional calculus	12
6.	ABC flat & curved spacetime	14
7.	ABC Temporal Mechanics (TM-0D)	21
8.	TM-0D number theory foundations	23
9.	TM-0D number theory scope & elasticity	26
10.	TM-0D number theory quality assurance (QA)	31
11.	TM-0D number theory spacetime comparisons	36
12.	Quantum's golden ratio metric royal cubit scaling key	42
13.	Quantum's progenitor fine structure constant value $\alpha_x$	48
14.	Quantum's relativistic speed of light scaling and surveying key $c$	59
15.	ABC TM-0D number theory preliminary results (1-59)	68
16.	ABC TM-0D temporospatial sentience code QA test	79
17.	ABC TM-0D ellipsoid structuration of space	81
18.	0QG Xemdir field chamber schematics	92
19.	0QG Xemdir field chamber testing	92
20.	0QG Xemdir field chamber results	92
21.	0QG Xemdir field interpretations	92
22.	Contemporary ABC adaptations	92
23.	Conclusion	95



## 1. Introduction

---

Here the work of Temporal Mechanics<sup>1,2</sup> and its associated zero-dimensional number theory (TM-0D) examine its derived quantum wave function<sup>3</sup> and associated golden ratio codes<sup>4</sup> to derive and then identify with physical phenomena:

- (i) The *temporospatial sentience code* and associated zero-dimensional basis of logic for temporal and spatial dimensional scaling and surveying.
- (ii) The golden ratio *royal cubit*<sup>5</sup> dimensional spatial scaling and surveying key and associated  $\pi$ -error factor.
- (iii) The speed of light  $c$  value as the basis for the constancy of light speed *for any spatial frame of reference*.
- (iv) The fine structure constant  $\alpha$  electromagnetic atomic binding strength value.

Here the derived golden ratio *royal cubit* scaling key utility and associated identified  $\pi$ -error factor serves as a "quality assurance" (QA) facilitator by accurately scaling and surveying physical phenomena in matching the known measurements and scales of physical phenomena.

Previously, the scaling used for the zero-dimensional number theory was expedited by annexing<sup>6</sup> the charge of the electron  $e_c$  and the Bohr radius  $a^0$ . Here though the proposal is for only one scaling key to be annexed, the Bohr radius  $a^0$  in conjunction with the derived metric *royal cubit* and associated  $\pi$ -error factor to then derive the *dimensional number theory connected* ecosystem of equations and constants for physical reality<sup>7</sup> pointing directly to the nature of space and thence nature of gravity. Specifically, presented here is a demonstration of the new *temporospatial sentience code* annexed to a zero-dimensional number theory *law of thought information touchstone* as presented in paper 58<sup>8</sup>, namely by expressing:

- (v) Zero-dimensional time as a moment prescribed with the number value 1.

---

<sup>1</sup>The current work of 59 papers detailing a new mathematical approach to the dimensions of time and space as zero-dimensional logic, see <https://www.xemdir.com/>.

<sup>2</sup>[1][2][3][4][5][6][7][8][9][10][11][12][13][14][15][16][17][18][19][20][21][22][23][24][25][26][27][28][29][30][31][32][33][34][35][36][37][38][39][40][41][42][43][44][45][46][47][48][49][50][51][52][53][54][55][56][57][58][59].

<sup>3</sup> As established in paper 2 [2].

<sup>4</sup> As established in paper 1 [1]: p3-5.

<sup>5</sup> The earliest attested ancient unit of length circa ancient Egypt ~2700BC, as based on the distance from the elbow to the tip of the middle finger, generally accepted as ~0.5236m.

<sup>6</sup> [2]: p16-17.

<sup>7</sup> As outlined in paper 57 ([57]: p15-29).

<sup>8</sup> [58]: p10.



- (vi) Zero-dimensional space as a point prescribed with the number value 0.
- (vii) Both (v)-(vi) linked via a proposed  $0-\infty$  scaling paradox.
- (viii) Such a paradox (vii) resolved with a *temporospatial sentience code*.
- (ix) By such (viii) to then derive dimensional number theory scaling keys that unlock nature's dimensional and physical codes.

As a QA paper, assessed here is the consistency of the TM-0D papers in reaching a common code, here as the *golden ratio time-equation* and Euler identity space-equation that together derive the basis for the fine structure constant  $\alpha$  and thence basis for the speed of light  $c$ , and why  $c$  is a constant for any relative frame of reference. As a QA paper, here the works of TM-0D will be *exclusively referenced* and annexed for consistency and accuracy in setting the basis for the next-step testing for new phenomena, namely the proposed zero quantum gravity Xemdir field<sup>9</sup>. By all of such and in making direct utility of the Collatz conjecture, a solution to the three body problem is proposed.

## 2. The *ABC* science code

---

To be first assessed is how much we depend on not just our sentience yet our ability to process the physical signs around us to demonstrate we are sentient. Commonly, sentience is a feature of subject (self), object (non-self), and subject-object (self-non-self) interaction<sup>10</sup> as follows:

- (x) Sentience reference (subject).
- (xi) Using that sentience reference as a knowledge of one's surroundings (object),
- (xii) Thence confirming sentience in preservation of it and its abilities of sentience (subject-object).

In its most basic form, the idea of sentience has a basic subjective desire to protect itself in an objective world. Science is very similar in that we use our sentience (subject) to gain knowledge of our surrounds (object), to then gain greater experience and understanding of what we are sentient of to *refine* our sentience *ability*. There, science is widely considered<sup>11</sup> as a system of checks and measures as a structure of knowledge that tests, explains, and thence predicts our world. By such, science is broadly categorized into three processes<sup>12</sup>:

---

<sup>9</sup> See papers 52-53 [52][53]: refined in sections 17-20 (TBA).

<sup>10</sup> [60].

<sup>11</sup> [61].

<sup>12</sup> [62].



- (xiii) The study of *our sentience* as psychology, knowing those sentient limitations through empirical analysis, what basically is/is-not, true/false, etc. This is considered as a social science, say (A).
- (xiv) The study of *how we study* as mathematics and logic. This is considered as a formal science, say (B).
- (xv) Describing the physical world through empirical analysis with the aim of predicting its features via the science of physical matter. This is considered as a natural science, say (C).

In taking a closer look at (A), (B), and (C), say ABC, the trustworthy threads in all of such are proposed to be the following:

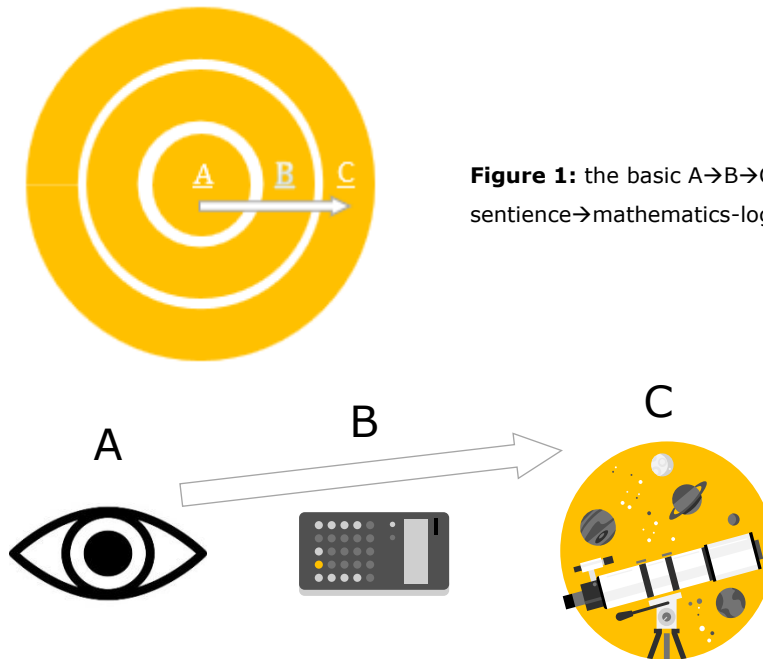
- (xvi) Sentience (A), such as our needing to observe physical reality in the first place, and thus a study of how we basically observe physical reality, primarily with the basic 5 physical senses.
- (xvii) Coding sentience with a formal logic (B), such as how to use that sentient basis with a type of formal code of surveying and scaling *what we are sentient of*, most anciently as the royal cubit measurement scale and associated use of geometric trigonometry<sup>13</sup>, today as a process of infinitesimal calculus and 4d spacetime theory<sup>14</sup>.
- (xviii) To then refine that (A) $\leftrightarrow$ (B) process via being able to explain features of reality not directly apparent to our basic senses in demonstration of technologies granted from the initial successes (A) $\leftrightarrow$ (B), as (C), such as for instance building structures that successfully predict the seasons and associated positions of celestial objects and thence by proxy measuring objects with features of time and space.

In many ways, (A) as the subject and (C) as the object are bridged by how we as a subject (A) scale and survey our objective (C) world using mathematics (B). Consider figure 1 explaining this process.

---

<sup>13</sup> [63].

<sup>14</sup> To be detailed in sections 4-6. See also papers 45 [45] and 57 [57].



**Figure 1:** the basic  $A \rightarrow B \rightarrow C$  process of sentence  $\rightarrow$  mathematics-logic  $\rightarrow$  physical-structures.

Each of these branches as ABC comprise various specialized if not overlapping disciplines. There, *interdisciplinary science* involves the combination of two or more disciplines into one. Is such a process of science a new idea?

In ancient Egypt<sup>15,16</sup> we the human species acknowledged the importance of being sentient by identifying the idea of a supreme subjective sentient being(s) (A). We also acknowledged the idea of scaling and surveying reality as per the utility of the royal cubit which represented a sentient based (A) measurement as per the length from the elbow to the middle fingertip (B). We then went to the next level in seeking to describe things based on (A) and (B) not completely understood to our immediate awareness such as the movement of the celestial objects (C), and achieved this via the construction of astronomically aligned temples (C) dedicated to (A) and (B).

In ancient Egypt, features not apparent to the senses were the God(s) (A), the atom (C) and the afterlife reality (C). Their God(s) (A) though were considered as both celestial and underworld beings, not immediately apparent to the senses, God(s) though who were proposed to command objective reality (C) via certain codes (B) as spells. It did seem therefore that the quest for ancient Egypt was to construct a science to ideally one day reach the level of these beings in finding their favorable social recognition, and thus an ABC based process being in play.

Physics is very similar in its search for the most fundamental particles of all, and the understanding of the most abstract expressions of the stars themselves. In many ways if not by all accounts, the ultimate ABC code for ancient Egypt was the afterlife, and the ABC code of today it

---

<sup>15</sup> [64].

<sup>16</sup> [65].



seems is for artificial intelligence and quantum gravity. In fact, not much has changed from Ancient Egypt to today if indeed AI can open doors to allowing sentience to exist beyond the grave<sup>17</sup>.

Did Ancient Egypt succeed, did that scientific quest find the afterlife, did that scientific quest find the idea of God(s)? One can never know other than in faith, and that was perhaps the thinking back then in turning science into a pursuit of the structure of physical reality itself, such as how to be more certain about physical reality than faith alone.

It seems therefore not much has changed from ancient Egypt to today as a process of scientific thought. The only thing that has changed is the task at hand, namely from the Gods and the afterlife as that which are not discernable to our senses to things like the atom, field forces, and so on and so forth, anything not immediately apparent to our senses in its minutest detail. In many regards therefore, modern science with its quest of absolute small-scale resolution is a complete flip of the ancient sciences pursuing the grand design of it all, the afterlife, yet as proposed here in using the same ABC process.

### 3. *ABC* state of the art

---

Today, the apex of surveying and scaling physical reality is executed by the discipline of physics (C). There, physics is the natural science of matter, matter's fundamental constituents, matter's motion and behavior through space and time, and matter's related entities of energy and force. In fact, physics uses matter in many ways as its proxy sentience, matter as:

- (xix) The basis of observation (A).
- (xx) The basis of *how* then physical reality is surveyed and scaled (B).
- (xxi) Thence the basis for itself (C), and thence the quest for determining hidden mass-particles not visible to the basic senses using number theories (B) and associated applied technologies (C).

This process goes through cycles of refinements to find the absolute/interconnected structure of reality, the quest today being linking quantum field theory (QFT) with general relativity (GR).

---

<sup>17</sup> [66].



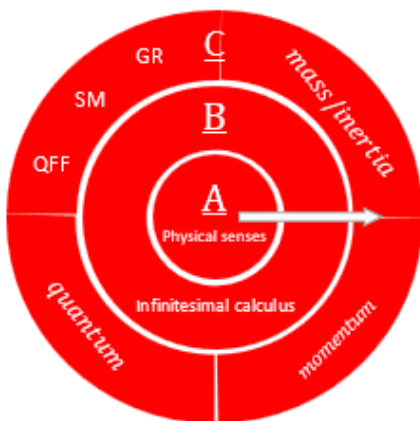
**Figure 2:** the circular refinement of the basic  $A \rightarrow B \rightarrow C$  process of sentence  $\rightarrow$  mathematics  $\rightarrow$  logic  $\rightarrow$  physical  $\rightarrow$  construction.

By all of such, upon such a basis, physics is perhaps the most broad-ranged and holistic scientific discipline, especially given how its advancements require the development of new technologies (C) to confirm its conjectures. In contemporary physics though, some peculiarities have emerged regarding the ABC, process. There are two standout features to contemporary physics:

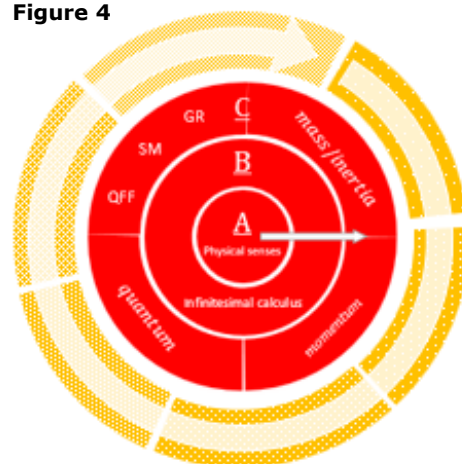
- (xxii) In basing its work on the five physical senses as (A), physics seeks to understand what consciousness in fact is, which itself is a red flag as it signals that physics is using a faulty sentence basis, an incomplete perception basis understanding.
- (xxiii) Dimensional number theory (B) alone scaled to physical phenomena (C) is therefore incomplete without a conjecture of what absolute time and space sentence (A) could be.

Consider figures 3-5 describing this problem in physics:

**Figure 3**

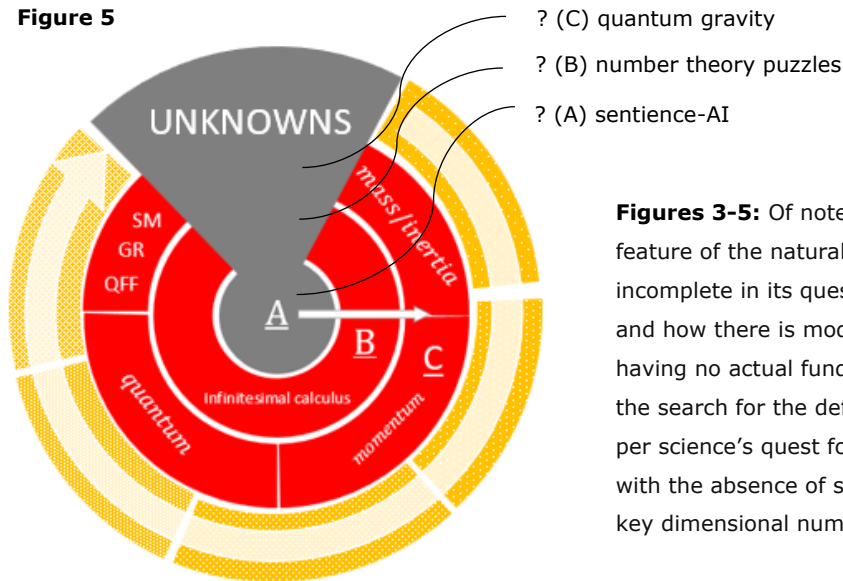


**Figure 4**





**Figure 5**



**Figures 3-5:** Of note here is the primary feature of the natural sciences (C) being incomplete in its quest for quantum gravity, and how there is modern confirmation of having no actual fundamental basis for (A) in the search for the definition of sentience as per science's quest for sentient-AI, together with the absence of solutions to a number of key dimensional number theory puzzles.

The alternative process proposed here by TM-0D is to make a more fundamental conjecture for sentience from the get-go (A), and to directly link a number theory with that sentience code (B), to then test the resultant physical theory when scaled with physical reality (C). Simply, TM-0D considers defining our sentience ability not with mass as the 5 senses yet with time and space, and then proposes a formal code for that (B), and then in using that basis develops a sentience based (A) number theory (B) and thence applies such to scaled phenomena (C) as its QA process. In this way, TM-0D has developed a new sentient-based (A) number theory (B) that then tests known phenomena and equations (C) as its QA. The additional quest for TM-0D as per its process basis is to describe such as clearly and efficiently as possible in thence unlocking a new physics and associated derived technologies.

In view of such a task for TM-0D, TM-0D needs to QA modern physics, specifically to appreciate the state of the art in physics today.

The state of the art in physics (C) circa 2024 circumscribes a dedication to dimensional number theory (B), indeed as a variety of geometric calculus methods presenting the case for two key physical theory pillars (C), namely QFT and GR. The dimensional number theories (B) for QFT (C) and GR (C) do in fact not link, and hence the quest to rectify that mismatch with a bridging dimensional/hyperdimensional number theory model. An example of this quest is evident with the Clay Mathematics Institute (CMI) Millennium Prize Problems<sup>18</sup> and those number theory pursuits as described in papers 44 [44], 49 [49], and 55 [55] of TM-0D.

<sup>18</sup> "To celebrate mathematics in the new millennium, the Clay Mathematics Institute of Cambridge, Massachusetts (CMI) established seven Prize Problems. The Prizes were conceived to record some of the most difficult problems with which mathematicians were grappling at the turn of the second millennium; to elevate



Calculus wizardry (B) on its own though is not sufficient as a basis for a physics theory (C), as any dimensional number theory needs to be relevant to and directly point to known observable data (C). Universities and research agencies and their associated data agree with the current number and associated physical theories describing that data, leading to the current QFT and GR models for EM and gravity respectively. Such is a clear advancement of how numbers and geometry were thought to apply to physical reality early in science's history.

Indeed, to present a new model based on a few bits of data is not what physics is looking for, and such is not the process proposed by TM-0D. Here in this paper, the widely published and accepted theories<sup>19</sup> of QFT and GR are examined, while then proposing a way to make use of the flat and curved 4d spacetime mismatch between QFT and GR respectively. Specifically, here in this paper and its references to the work of TM-0D is an account of calculus as a descriptive application for physical phenomena, namely how calculus came to be, how it was applied to physical phenomena, and how it has grown as two particular dimensional number and thence physical theories into the infrastructures of QFT and GR.

#### 4. *ABC* infinitesimal logic

---

Questioning reality has always been a part of human social development, from ancient times to today. Many of the great questions of reality and human achievements have come in the form of paradoxes, or rather, puzzles that present challenges for not just the physical human achievement yet human thought. Some of these ancient puzzles have come in the form of Zeno's paradoxes<sup>20</sup>, as a method of proof called *reductio ad absurdum*<sup>21</sup>. One such puzzle is the *Dichotomy argument*, namely:

*That which is in locomotion must arrive at the half-way stage before it arrives at the goal.*  
— as recounted by Aristotle, *Physics* VI:9, 239b10 [70]

---

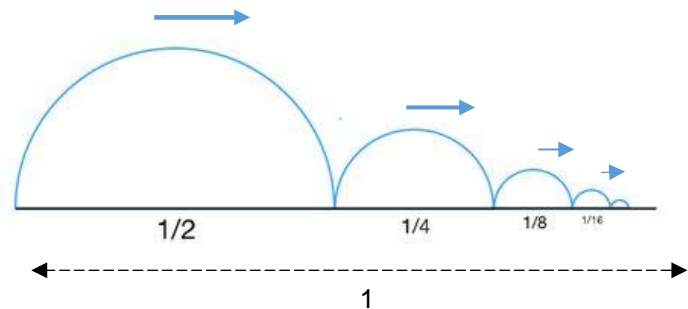
*in the consciousness of the general public the fact that in mathematics, the frontier is still open and abounds in important unsolved problems; to emphasize the importance of working towards a solution of the deepest, most difficult problems; and to recognize achievement in mathematics of historical magnitude" [67].*

<sup>19</sup> And associated proofs/data qualified by the widely practiced journal-submission approach [68].

<sup>20</sup> As based on based on Plato's *Parmenides* (128a–d) [69].

<sup>21</sup> Also known as *proof by contradiction*.

Figure 6



Here, in aiming to achieve “1”, one must quest to complete an infinite number of tasks, and thence by such be *forever unable* to achieve the “1” result given the considered endlessness of infinity. The puzzle is termed a “dichotomy” owing to the constant splitting process involved in each step of the task in highlighting to its core the idea of both fractions and approaching the idea of an infinitely small length. Simply, what makes this puzzle impossible is that the overall aimed length of completion as “1” divided by an infinite number of steps leads to  $\frac{1}{\infty}$  which of course approaches the value of 0, and thus an *impossible event* in aiming to reach “1”.

By such debates and puzzles a system of arguments and counter-arguments were formed as the basis for what was to then become a basis for mathematical logic and the analysis of physical reality. There, as has become evident today, *describing* physical phenomena “*conjectures how*” to label physical phenomena, namely:

- (xxiv) What aspects of phenomena are being labelled?
- (xxv) With what precision?
- (xxvi) To what extent, namely how broad and wide (0 to  $\infty$ )?

Accompanying such is realizing our own limitation of being conscious, namely:

- (xxvii) Our resolution/pixilation of quantum (light) perception.
- (xxviii) Such (xxvii) in primarily occupying the datum reference of time-now in 3d space.
- (xxix) Such (xxviii), in the context of a singular dimension (1d) of time’s flow.
- (xxx) Such (xix) in the context of what can be trusted to be physical laws as a consistent feature of physical reality and our consistent observation ability in it anywhere, anytime.

As is generally agreed, our conscious experience of reality (A) can be considered involving two basic features, two dimensional paradigms, that of the dimension of time<sup>22</sup>, and that of the

---

<sup>22</sup> 1d, as a type of arrow.



dimensions of space<sup>23</sup>, all of such though as reality in a datum-reference of time-now, one time-now moment to the next, all of such in 3d space.

It would be natural for us to consider that the one dimension of time (1d) and the three dimensions of space (3d) are connected as four dimensional spacetime (4d). Thus, as much as we perceive reality in a type of continuous fashion in the datum reference of time-now, we would consider that reality also operates as a type of 3d space and 1d time continuum as 4d spacetime. Such is what physics proposes as 4d spacetime as a grand platform we would exist with/within<sup>24</sup>. We then with such a basis ask how physical reality performs as 4d spacetime. In fact, we test the theories we have of 4d spacetime (B) to see if they measure up with observable physical reality (C). Further to this, we assess how the description of 4d spacetime can represent the general platform for the description of all other phenomena. By such, as all the data suggests, two versions of spacetime have become apparent, flat 4d spacetime for QFT and curved 4d spacetime for GR.

Of note in this process is that no dimensional number theory has been able to link flat and curved spacetime, or rather there is no dimensional number theory describing the physical phenomenal link between flat and curved spacetime, Thus, mass is still the great mystery of description ordaining the requirement<sup>25</sup> of flat and curved 4d spacetime questing a mass-based number theory link between flat and curved 4d spacetime. How did we get there though, how did we construct the descriptions for curved and flat 4d spacetime?

## 5. *ABC* dimensional calculus

---

In presuming sentience (A), the process here is to appreciate how numbers and geometry (B) relate with the idea of dimensionality via an analysis of mass (C), namely by recognizing:

- (xxxi) Features of dimensionality, precisely their known parameters and limitations, specifically how *points in space* and *moments in time* (time-now) are captured, such as the idea of:
  - a. an *infinitesimal* datum reference for time-now.
  - b. *infinitesimal* points in space in time-now's *infinitesimal* datum-reference.
- (xxxii) How approaching the idea of time-now and a point in space requires a particular type of mathematical approach prescribed by *infinitesimal calculus*<sup>26</sup>.

---

<sup>23</sup> 3d, namely spatial volume.

<sup>24</sup> As a dimensional mathematic model and associated physical theory.

<sup>25</sup> By current theoretic and measurement standards.

<sup>26</sup> Gottfried Wilhelm Leibniz and Sir Isaac Newton are both given credit for independently inventing and developing calculus, Newton being regarded as the first to apply calculus to physics [71].



- (xxxiii) How that calculus (xxxii) is constructed *in adapting to*<sup>27</sup> the varying features of physical reality.
- (xxxiv) How that calculus (xxxii)-(xxxiii) acknowledges the idea of a type of symmetry of laws for each infinitesimal point in space and associated infinitesimal moment in time.

In all, the clear idea here for describing physical processes is assuming the ideas of:

- (xxxv) A datum reference of time needing to approach an infinitesimal moment of time-now.
- (xxxvi) 3d space needing to approach infinitesimal points as chosen datum references for infinitesimal moments of time-now.

The word *calculus* comes from Latin meaning "small stone", an apt name given calculus is the art of looking at exceedingly small scale on a broad scale whereby:

- (xxxvii) *Differential calculus* is the mathematical art of cutting something into small pieces to find how that something being cut changes in that cutting process, being useful for:
  - a. instantaneous rates of change.
  - b. slopes of curves.
- (xxxviii) *Integral calculus* joins (integrates) the small pieces together to find how much there is by that integration process, being useful for:
  - a. accumulation of quantities.
  - b. areas between or under curves.
- (xxxix) *Differential calculus* and *integral calculus* are therefore *inverse processes*<sup>28</sup>.

Yet **why** must mathematics be used in dimensional analysis to "approach" the idea of a moment in time and point in space? Why not just present a mathematical theory describing zero-dimensional time and zero-dimensional space, as what TM-0D proposes?

Physics is central to *dimensionality*, namely what (C) is measurable (B), and so *dimensional lengths* of space and time are essential. Even if infinitesimally small *points* in space and *moments* in time are required for those actual measurements to take place, dimensionality is required.

Technically, nothing can be measured using a zero-point for time and space as an axiom. A number theory at best can be the only result from a zero-dimensional appraisal of time and space, a number theory which thence must derive dimensionality and thence apply itself to known scales

---

<sup>27</sup> Not to be forgotten.

<sup>28</sup> Considered as the *fundamental theorem of calculus*, describing the proposed convergence of infinite sequences and series to defined limits.



for time and space to then be relevant to physical phenomena and known associated equation descriptors. To achieve that description, a spatiotemporal geometric and thence dimensional number theory is required, namely as one proposing to describe the dimensions of space and time, as a 3d space and 1d time mathematical model, ideally as a unified 4d spacetime using infinitesimal calculus, such as what QFT and GR have achieved.

The initial question for infinitesimal calculus in starting with the dimensions of time and space is how indeed is space related to time, namely how does space demonstrate the feature of time if not for using a concept associated to space and time such as mass, mass as an extension of space, mass as relative motion in time between masses and how mass moves in regard to space, and thence mass as a basic core descriptor of 4d spacetime. This is no coincidence, as mass yet more pertinently *momentum* is used as the focus of how physical processes change in space:

- (xi) How mass changes location in space.
- (xli) How light as a wave/particle changes location in space:
  - a. as a non-mass wave/particle with momentum,
  - b. has a fixed speed of travel in space,
  - c. and why indeed the speed of light is fixed at  $c$  for any inertial frame of reference.

In short, *momentum* is used to highlight the idea of motion and thus time regarding space as the subject of mass, and therefore ultimately how mass and light, light as a proxy for mass, move in space using 4d spacetime.

Therefore, 4d spacetime has become the basic emphasis description for not just how light travels in space and thus a description of EM, yet also the movement of mass and how mass relates to mass in space and thence useful as a description for gravity. The issue there though are the two types of 4d spacetime, namely flat and curved for QFT and GR respectively, not being mathematically compatible.

## 6. *ABC* flat and curved spacetime

---

As described, modern calculus (B) is purpose built for using infinitesimal structures describing physical phenomena mathematically, namely in being as precise (infinitesimal) as possible, creating nonetheless what are termed *infinitesimal estimates*. Having developed a set of tools for describing infinitesimal calculus, integral and differential calculus of course need to be applied to the conditions specific to physical reality, to the dimensions of space and time, and thus must abide by what is physically observed as those specific conditions of nature<sup>29</sup> under examination.

---

<sup>29</sup> Here, the temptation is to think calculus can explain physical reality *primarily* without conditions, yet the fundamental condition of physical reality, what is and what is not, requires calculus in its various forms of construct to adapt to that data.



Yet as presented in points (xl)-(xli), the key basis used by physics to describe the dimensions of space and time is *momentum*. There, to make calculus sensible to the dimensions, five basic ideas are used for momentum:

- (xlii) *Distance* as length of 1 dimensional space.
- (xliii) *Time* as duration of 1 dimensional time.
- (xliv) *Mass*:
  - a. Considered as the intrinsic property of a body.
  - b. Experimentally defined as a measure of the body's inertia.
  - c. Determining the strength of its gravitational attraction to other bodies.
  - d. Proposing inertial and gravitational mass to be identical as per the equivalence principle, such as an *a priori* of GR.
- (xlv) *Velocity* of mass as *distance per time*.
- (xlvi) Such (xlv)-(xlv) arriving at the basic idea of *momentum* ( $p$ ;  $kgms^{-1}$ ), namely the product of the mass and velocity of an object.

According to Sir Isaac Newton's *Philosophiæ Naturalis Principia Mathematica* as a feature of his proposal for inertia<sup>30</sup>, the rate of change of a body's momentum is equal to the net force acting on it. To note with QFT is that even though light has no mass it is still considered a particle with momentum<sup>31</sup>. Specifically, momentum is proposed to depend on a frame of reference such that in any inertial frame of reference momentum is a *conserved* quantity. Such a process is required for the following reasons:

- (xlvii) *Arbitrating* a closed system not affected by external forces such that in that frame of reference the total linear momentum of mass under examination does not change and can thence be described with calculus.
- (xlviii) To confirm the required condition of being complete with the calculus analysis process, of not leaving this process of examination and determination to anything else.
- (xlix) Such (xlvii)-(xlviii) as a way of making momentum *statutory* for the process of calculus.

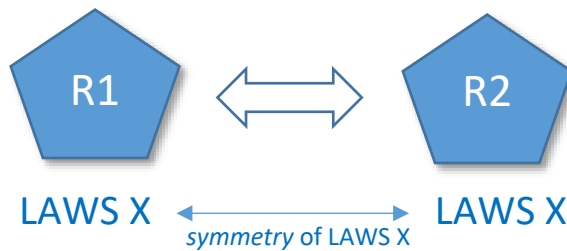
The next step in arbitrating these statutory frames of reference is how one frame of reference can relate to another frame of reference, namely that there needs to exist a *universal governance*

---

<sup>30</sup>"The vis insita, or innate force of matter, is a power of resisting by which every body, as much as in it lies, endeavours to preserve its present state, whether it be of rest or of moving uniformly forward in a straight line" [72][73].

<sup>31</sup> As shown by mathematical deduction based on light being proposed to have kinetic energy and thence momentum.

between frames of reference upon space for objects. Physics terms this as the “*symmetry of laws*”, namely that the set of laws in frame of reference R1 must be the same set of laws for frame of reference R2. In short, the idea of universal symmetry of laws between different frames of reference is underwritten in the principle of relativity, namely the *requirement that the equations describing the laws of physics have the same form in all admissible frames of reference*.



**Figure 7:** frame of reference R1 having the same laws in play (as LAWS X) as frame of reference R2.

The required structuration here is extending the calculus of one frame of reference to another frame of reference<sup>32</sup>. Does for instance the calculus of a process of physical phenomena<sup>33</sup> in one frame of reference apply to **any** type of process of physical phenomena for another frame of reference? Can indeed processes of physical phenomena under investigation *be the same fundamental stuff* to allow for a universal calculus to develop between all frames of reference *for all types of objects in space for all types of processes of physical phenomena*?

It so happens<sup>34</sup> that light and mass have specific conditions for their translational symmetries that require different and specific calculus mapping processes<sup>35</sup>. Such has resulted in the employment of flat 4d spacetime mapping for QFT and curved 4d spacetime mapping for mass (gravity). Fundamental there are the two physical constraints as postulates proposed by Einstein in adapting to known physical data<sup>36</sup>:

- (i) the laws of physics are invariant<sup>37</sup> in all inertial systems<sup>38</sup>.
- (ii) the speed of light in vacuum  $c$  is the same for all inertial observers, regardless of the motion of the light source<sup>39</sup>.

<sup>32</sup> A process named practically as *translational symmetry*.

<sup>33</sup> Such as mass or light.

<sup>34</sup> According to all known measurements of physical phenomena.

<sup>35</sup> As per the development of 3d space and 1d time mathematics described initially by Galilean transformations to thence Lorentz transformations forming the basis of QFT’s flat spacetime, and thence Minkowski flat 4d spacetime and associated Riemannian geometry adapted by Einstein in his formulation of GR.

<sup>36</sup> Not to be overlooked.

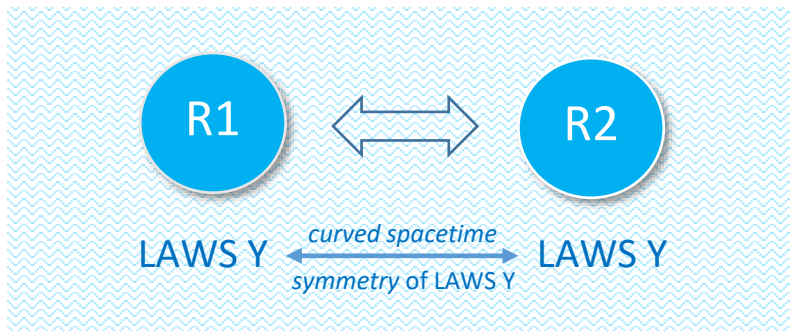
<sup>37</sup> *Identical*.

<sup>38</sup> *Non-accelerating frames of reference*.

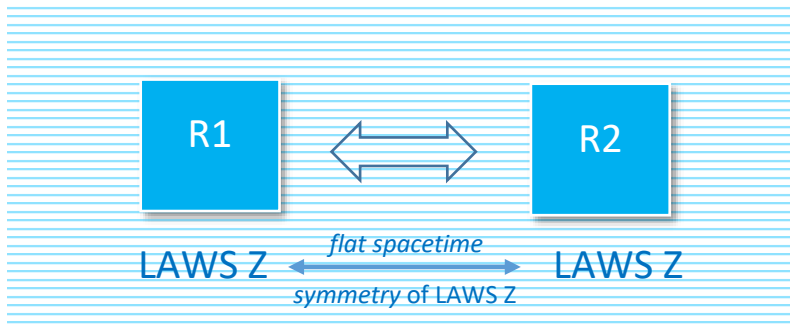
<sup>39</sup> An experimentally known *requirement*.



The proposed if not required result of combining these postulates is the join between space and time, as 4d spacetime. Henceforth, a variety of methods of calculus have been required to describe the nature of light, primarily the natures of the electron and light, all of which have been consistently tested and refined to reach the level they are now at, namely QFT as a *flat* 4d spacetime model and GR as a *curved* 4d spacetime model, noting they are still just models and not reality *per se*.



**Figure 8:** *frame of reference R1* having the same laws in play (LAWS Y, as curved spacetime) as *frame of reference R2*.

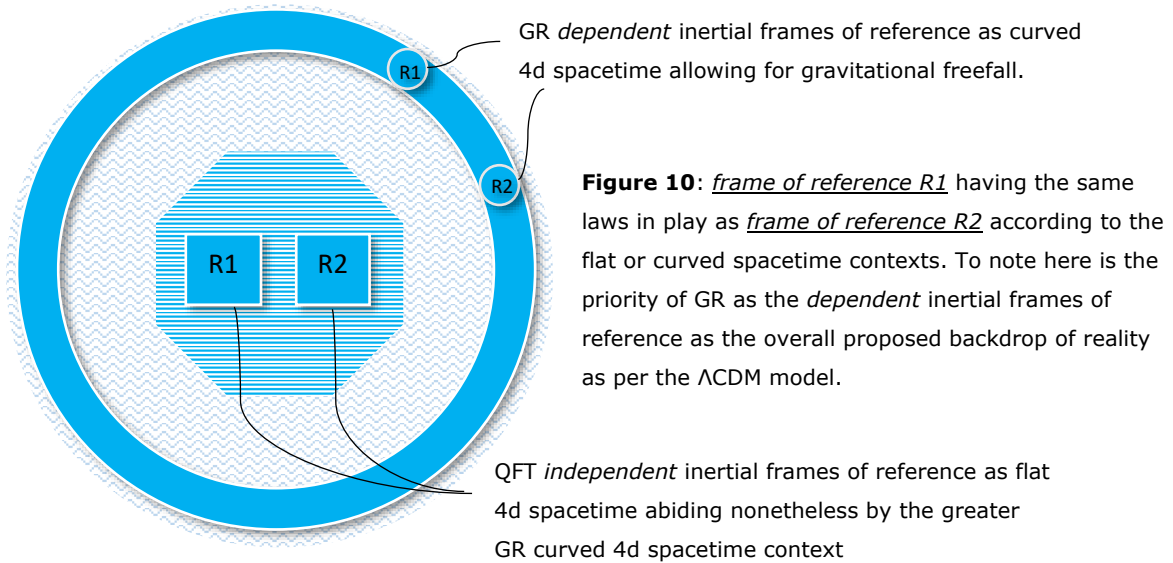


**Figure 9:** *frame of reference R1* having the same laws in play (LAWS Z, as flat spacetime) as *frame of reference R2*.

Of note regarding the disparity between the *flat* 4d spacetime and *curved* 4d spacetime models is how a 4d spacetime interval is classified as being either dependent<sup>40</sup> or independent<sup>41</sup> of the inertial frame of reference. There, with GR the 4d spacetime interval between inertial frames of reference is derived to be *dependent* and *not independent* of inertial frames. This was so to allow for gravitational free fall, specifically *curvature* as the proposed only process available for the infinitesimal calculus of 4d spacetime to accommodate for gravitational freefall. Simply, with GR the 4d spacetime interval between inertial frames of reference is *dependent* and not *independent* of inertial frames. Yet with QFT the 4d spacetime interval is *independent* of the inertial frame of reference (li).

<sup>40</sup> *Inclusive*.

<sup>41</sup> *Non-inclusive*.



Thus, the disparity between QFT and GR was cast regarding the dependence (GR) and independence (QFT) of the inertial frames of reference. Such is entirely intuitive in considering that as EM technically has no actual mass it could only be expressed as an inertial frame of reference *independently from* its general overall system mass-inertia context-source<sup>42</sup>, relegating EM to flat 4d spacetime<sup>43</sup>. Of note in this entire process of describing EM and gravity is the mathematical geometry describing these certain aspects of physical reality, dimensional number theories that can only merely be tools in, as all data has demonstrated, flat and curved spacetime not being truly homogeneous with each other<sup>44</sup>.

Experimentally, given the eminence of QFT describing the microscopic world of particles at our fingertips<sup>45</sup>, the current quest in physics is to somehow quantize gravity if not making the process of GR compatible with QFT, and thus somehow forging a basis or feature of GR being like QFT such that as the rules of curved spacetime are proposed to breakdown for GR in that process then GR can thence be described in terms of having *independent* inertial frame of reference features on the microscopic scale. Consider figure 11.

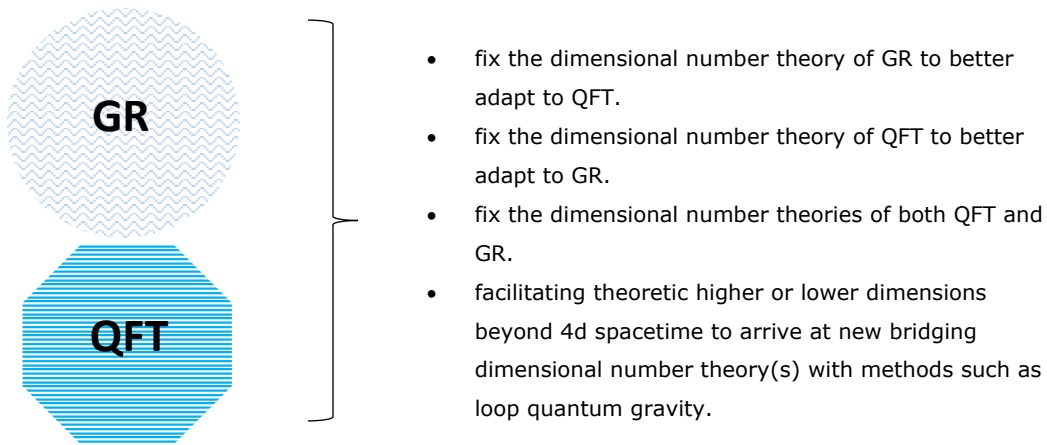
<sup>42</sup> Curved spacetime.

<sup>43</sup> Thence making flat spacetime secondary to curved spacetime.

<sup>44</sup> The quest though is on to find the homogeneity between flat and curved spacetime.

<sup>45</sup> As compared to the GR cosmological scale of stars.

**Figure 11:** options to link GR and QFT include:



To note is that currently there is no mathematical way to link GR and QFT, an impossible task given that such would need to represent an absolute dimensional number theory description of physical reality, a task not possible for the *infinitesimal estimates* approach.

Nonetheless, in going beyond the 4d spacetime number and physical theory approach, key proposed solutions include creating hyperdimensional spacetime bridges between QFT and GR<sup>46</sup>. In fact, many approaches have been considered, from debating the validity of the calculus of QFT and that of GR, attempting to find flaws in each, to then proposing corrections for QFT and GR to unite the two, to the idea of creating extra dimensional and lower dimensional bridges between flat and curved 4d spacetime. There, some theories propose approaches such as *loop quantum gravity* where the quantum-compatible loop states and associated spatial spin networks “weave-up” physical space with a proposed Planck scale spatial granular structure. All such pursuits though ultimately ask if space can be quantized on the Planck scale and thus can demonstrate quantum features such as entanglement, hence the term for the quest as *quantum gravity* [74][75].

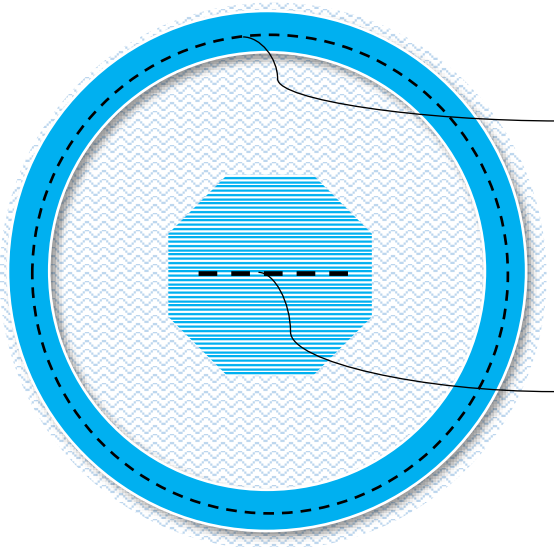
Throughout all the innovative design proposals and processes is of course the need to consider that physical reality and associated phenomena dictates what is real, and not primarily by how numbers are applied to physical phenomena. The temptation therefore is to consider new mathematical modelling for QFT and GR without considering the need to abide what physical reality requires for the application of numbers to describe physical reality.

As has been thoroughly explored and experimentally demonstrated, QFT requires *flat* spacetime modelling approach and GR *curved* spacetime modelling. The only mathematical number theory that could describe reality *de novo* would be exactly that, namely *de novo*, and thus a zero-dimensional basis. Yet the beauty of the dichotomy of flat 4d spacetime and curved 4d spacetime is that it just makes sense on a most basic level, lines as the shortest distances imaginable, and curves

<sup>46</sup> As a type of *proxy-independency*.



as the larger stretched/curved distances to allow for the option of gravitational free fall. Consider figure 12.

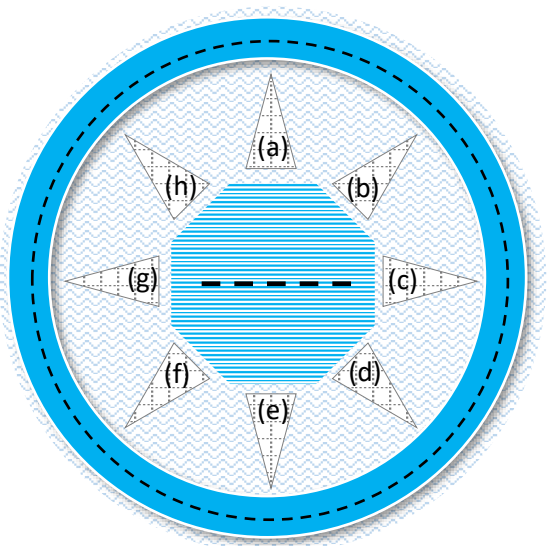


**Figure 12**

**Curved** spacetime expressed as the GR constructed series of infinitesimal straight lines that became curved to allow for the basis of the equivalence principle, namely inertial mass being equitable to gravitational mass.

**Flat** spacetime expressed as the SR series of infinitesimal straight lines.

By all of such though, the search is on to somehow find a mathematical formalism that can join flat and curved 4d spacetime, to thence with that new mathematical formalism utilize the benefits of that proposed dimensional link. This has been the case with the CMI Millennium prize problems. Consider figure 13.



**Figure 13:** a representation of the quest to link curved (GR) and flat (QFT) 4d spacetime, here illustrated as specific quests/tasks of resolution identified by the CMI as the following problems: Poincare conjecture (a), Hodge conjecture (b), Riemann hypothesis (c), Birch and Swinnerton-Dyer conjecture (d), Yang-Mills existence and mass gap (e), Navier-Stokes existence and smoothness (f), and P versus NP (g). Also included here is Fermat's conjecture (h).

To note is that (a)-(h) are figured and scripted in the context of set theory, such to determine the nature of numbers associated to spatial geometry as those values approach  $\infty$  and if the



associated proposed geometries of space and time can change in approaching certain values to describe curved spacetime *emerging* from flat spacetime. Key quests there include the Hodge conjecture (b) which itself relies on the Poincare conjecture (a), both which should then, in each forming a solution for an infinite set, solve the Riemann hypothesis (c), all of which should thence solve the Birch and Swinnerton-Dyer conjecture (d). Solving those problems should then relate solutions to the Yang-Mills existence and mass gap (e), Navier-Stokes existence and smoothness (f), and P versus NP (g) problems<sup>47</sup> as presented throughout paper 55 [55].

By all of such, the current quest in physics is finding how to unite QFT with GR, to somehow merge flat 4d spacetime<sup>48</sup> with curved 4d spacetime<sup>49</sup>. All of such are well-reasoned pursuits, yet ultimately the physical nature of reality needs to confirm any such modelling, a proposed *singularity* realm where the rules of standard physics are proposed to break down. Do these rules break down though in all physical fact?

The problem with exploring the *singularity* level is that the calculus of both QFT and GR breaks down when the quantum and gravitational fields break down, so an entirely new calculus is required to account for any absolute zero-dimensional states for time and space in measuring and predicting the phenomena of such a process in physical reality. Otherwise, the problem is how to demonstrate the singularity process in a laboratory showing any potential link between QFT and GR as those spacetime fields are proposed to break down. By such, the research proposals there are central to finding phenomena at the *cusps* of such an event horizon, such a singularity, and thence with current proposals how space on a Planck scale can somehow demonstrate quantum mechanical features intrinsic to QFT such as quantum entanglement [76].

## 7. *ABC* Temporal Mechanics (TM-0D)

---

TM-0D represents a consecutive series of papers [1]-[59] that began with the proposal of taking the concept of time and allowing it to resound the feature of reality existing *in the moment, one moment to the next*, and thus in *zero-dimensional time*. Such was the conjecture in paper 1 [1]. That conjecture was proposed to be resolved *mathematically* in deriving dimensionality from that zero-dimensional conjecture for time by using a *sentient based (A) number theory (B)*.

To make that conjecture applicable to physics data (C) if not spacetime theory, the aim has been to only consider the re-arrangement of the idea of time according *to how* we are *sentient* in time (A), namely the datum-reference of time-now *as our usual sentient existence reference (A)*, the datum-reference of time-before as the past, and the datum-reference of time-after as the future. The difficulty from paper 1 [1] was finding a way to cross-match the new zero-dimensional time conjecture (A)-(B) with contemporary physics (C), and the solution there was to extend the zero-

---

<sup>47</sup> All of such described in paper 55 [55].

<sup>48</sup> Forming the core of QFT.

<sup>49</sup> Forming the core of GR.



dimension of time to the datum-references of time-before and time-after, to then allow proposed points of space, of zero-dimensional space in zero-dimensional time, to also be dimensionally extended to form the feature of 3d space from the 0d basis of time-now. Yet all was not as simple as it would seem.

Currently in physics *mass* (*kg*) is the established datum-reference for physical theory formulation, *mass* as the fundamental reference for measuring physical reality, as has been the case from antiquity till today. Although mass may seem quite basic, mass is the core feature to dimensional analysis of physical phenomena in the form of the equations of *momentum*, equations that are core to quantum field theory (QFT) and general relativity (GR) and their associated flat and curved spacetime models respectively. This process is traced and described in paper 57<sup>50</sup>.

Despite its apparent simplicity, mass is trustworthy as the primary datum-reference of measurement given it is the most tangible substance to our senses. Yet, mass is problematic as a measurement basis, especially in regard to light and how fundamental particles interact with light. The further problem with mass is how it cannot relate *absolutely precisely* to number-based theoretic models describing its behaviour, only being regarded at best by an *infinitesimal calculus* approach to describing its behaviour. As outlined in paper 57<sup>51</sup>, the fallibility of infinitesimal calculus was identified and how such a fallibility can only result in two general mass-based models, namely QFT and GR as flat and curved spacetime theories respectively.

In resolving the issue of mass and its infinitesimal calculus theoretic axe, the following were proposed as a way to achieve theoretic precision beyond infinitesimal calculus and its use of mass<sup>52</sup>:

- (iii) Reality exists in the datum-reference of time-now, the moment, thence going a step beyond the Lagrangian temporal datum-reference of infinitesimal calculus<sup>53</sup>.
- (liii) Zero-dimensional time is not zero-dimensional space.
- (liv) If zero-dimensional space is the value 0, the proposal is for zero-dimensional time to represent the value 1.
- (lv) Zero-dimensional time and zero-dimensional space are linked via a proposed 0-∞ scaling paradox for points in space<sup>54</sup>.
- (lvi) Such a paradox (lv) is resolved with a *temporospatial sentience code*<sup>55</sup>.
- (lvii) This proposed sentience code is then used to derive scaling keys that unlock nature's dimensional and physical codes<sup>56</sup>.

---

<sup>50</sup> [57]: p3-15.

<sup>51</sup> [57]: p4-14.

<sup>52</sup> [57]: p15-27.

<sup>53</sup> [40]: p5-19.

<sup>54</sup> [43]: p1-5.

<sup>55</sup> [43]: p6-7.

<sup>56</sup> [44]: p12-22.



At first glance, although points in space are given a "0" value may seem natural, the clear problem would be how to resolve the idea of time-now (the moment) being proposed as the value "1". Indeed, how can "1" as time-now be a moment and not a *length* of time as a second (*s*)? Three concepts to note are as follows:

- (lviii) Zero-dimensional time is *not* a dimension of time (and thus *not* a *second*) yet an arbitrary use of the number 1 for time as a moment.
- (lix) if one moment of time is a value of 1 and another moment of time elsewhere is also the value 1, and reality exists in the time-now moment, one moment to the next, then in the continual and entire datum-reference of time-now throughout dimensional space the difference *between* those two moments of time is  $1 - 1 = 0$ , as 0 *seconds*.
- (lx) a length of time as 1s is therefore a secondary feature of spatial dimensionality<sup>57</sup>.

Proposed here therefore is a new way of thinking of time in using this zero-dimensional determination for time-now as the number value "1", hence the emphasis on the title description *TM-0D*.

By comparison, imagine for instance a 0-1 Boolean coding platform and how that allows basic programming and data storage. Here with TM-0D the basic programming is what reality "is" as zero-dimensional time being defined as "1" and zero-dimensional space as "0", indeed *not* analogous to Boolean logic yet a process that underwrites the idea of translational symmetry in the context of a 0-∞ scaling paradox for any point in space that needs resolving. How that is resolved is by the application of a *temporospatial sentience code* as an axiom applied to zero-dimensional time and zero-dimensional space, namely as an axiom a condition that is *self-evident*<sup>58</sup>.

Proposed here therefore is that a zero-dimensional number theory aligned with a *temporospatial sentience code* **should be** capable of describing physical phenomena in a way that is fair and realistic given its strict mathematical definition. The point of all this is to then propose a solution to quantum gravity, to reach from a zero-dimensional level to then conjecture how a quantum of light relates with the idea of mass and thence gravity, all according to a zero-dimensional time and space construction, and to then demonstrate such.

## 8. TM-0D number theory foundations

---

It is *incorrect* to merely state that a relationship between numbers (B) gives rise to reality (C) and thence presumably sentience (A), and so such is not the process of TM-0D in using the zero-

---

<sup>57</sup> [45]: p12, (xv)-(xix).

<sup>58</sup> Axioms by definition are *self-evident*.



dimensional number theory basis. It is also incorrect to state that zero-dimensionality just gives rise to dimensionality, as that also is not the process of TM-0D. Instead, the process of TM-0D is one of proposing zero-dimensional time being associated to *dimensional time* based on our known human conditions of memory and prescience (A), namely memory for the time-domain of time-before, and unknowability for the time-domain of time-after, between which is the zero-dimensional datum-reference of time-now where reality enacts itself (B)→(C).

**This** is the proposed *temporal transcendence (temporospatial) sentience code as an axiom* (A), as a proxy Lagrange operation, in transcending from zero-dimensionality, a process executed here by defining zero-dimensionality in a law of thought process *first* and then applying what temporally exists before and after such as the *temporospatial sentience code* which thence mandates dimensionality. Although this has been the basis from paper 1 [1] through all the subsequent papers, the two recent papers<sup>59</sup> have expanded upon this process.

The proof required for this process therefore, the onus put on TM-0D, is quite extensive, as the current data of physics using spacetime theory is also quite extensive, and so a large amount of critical data and associated equations have had to be considered, yet more importantly have had to be derived from this new number theory basis, all to present a case of proof for the zero-dimensional number theory hypothesis and associated *temporospatial sentience code* filter proposal.

The first phase of TM-0D has been to generate all the necessary theory to demonstrate how all the derived number theory equations *match* known phenomena and associated experiments. The second phase as proposed here is to conduct new research relevant to the new theoretic findings, as outlined in paper 53<sup>60</sup>, described here in full accompanied with derived/required amendments.

To though propose new research for a new phenomenon all associated traits of reality's physical phenomena need to be accounted for. The aim therefore for TM-0D using the zero-dimensional basis and associated *temporospatial sentience code* has been to reach our current understanding of physical phenomena through a continual process of adaptation of the derived dimensional number theory to known physical equations and constants.

The initial zero-dimensional number theory basis of TM-0D is the proposal that if there are any two standalone numbers that can be best used to describe something in reality, they are 0 and 1, 0 being the absence of something, and 1 being the presence of something; to keep their (0 and 1) primary role integrity, their completeness, the proposal is to have these numbers as numerical touchstones of information for the zero-dimensional realms of time and space, for the *absence* of dimensionality. Thence, by proxy, the concept of zero-dimensionality is forever incomplete in being tagged with numbers, and therefore is never complete, *which thence warrants a completeness if not capping of dimensionality by default*. Consider this though as a *dimensional completeness mandate (DCM)* if indeed zero-dimensionality is forever incomplete by its labelling with numbers.

To explain this further, one can have 1 *thing* or the absence of that *thing*, whatever it is. Yet, 1 *thing* does not make "1" by definition a *thing*. For one could also have 1 "other thing". There,

---

<sup>59</sup> [58][59].

<sup>60</sup> [53]: p7-25.





TM-0D understands that the best way to define a number is from a zero-dimensional basis, in proposing the *thing* as zero-dimensional time *to not be the other thing* as zero-dimensional space, that they are two separate things, and must be represented therefore with two different number values. There, TM-0D proposes a spatial point to represent the value 0 and a moment in time to represent the value 1 where the moment existing everywhere is a condition of reality. Consider this as the *zero-dimensional is/is-not information* (0D-I) basis.

This information basis was prescribed in paper 58, *Logic's Information Touchstone*, in the following manner<sup>61</sup>:

*Another point to note about information is that information is executed iteratively, namely as a series of steps as a process, thence involving the feature of time. In physics, that iterative quality is considered as time's flow and how that is measured as entropy. These features are derived and accommodated in the zero-dimensional number theory per the dialectic mathematical relationship of the two derived equations for time and space, namely  $t_B + 1 = t_A$  (where  $t_B^2 = t_A$ ) and  $e^{i\pi} + 1_{t_N} = 0_{t_A}$  respectively<sup>62</sup>. This then translates to a geometric mathematical model of reality that demonstrates its capacity for harboring and communicating all the known data of physical theories, constructing a model of this solar system correct to all its equations, constants, and relative dimensional scales, except for how the stars are proposed to manifest. There, the stars beyond this solar system are derived as holographic projections from the solar system's Hydrogen wall, which is an interesting result. The etiology of that result was presented throughout the previous paper [57]. The question now is why that derivation became evident.*

This information basis forms the foundation for the *temporospatial sentience code*, and so as a zero-dimensional information basis it was considered incompatible with the idea of being applied *directly* to primary dimensional equations. *Dimensional information* relevant to the zero-dimensional logic basis does emerge though in the form of dimensional equations, the primary equations there being the golden ratio equation for time and Euler's equation for space, both of which are then shown by their relationship to relate a pertinent informational ecosystem of dimensionally-based equations.

In short, the logic here is that the moment in time is ever present, everywhere, yet paradoxically represents a zero-dimensional state, and so is given the value 1. This of course is as opposed to a spatial point which<sup>63</sup> is given the value 0. TM-0D though conjectures that the problem with a spatial point is a scaling paradox, namely the sizing and number of zero-dimensional points of space in relation to each other, a situation which beckons dimensionality. The resolution there is proposing to extend zero-dimensional time with a *temporospatial sentient code* whereby two extra *datum-references* for time are created as time-before and time-after, which thence derives 3d space

---

<sup>61</sup> [58]: p12.

<sup>62</sup> [57]: p15-24.

<sup>63</sup> [50]: p3-6.



from zero-dimensional space<sup>64</sup>, noting here a dimensional completeness (DCM) for space as 3 dimensions (3d).

By such, the  $0-\infty$  scaling paradox was resolved while deriving the idea of 3d space with an associated ecosystem of equations found to be relevant to physical phenomena when certain equations were identified as being relevant to both the Bohr radius  $a^0$  and charge of the electron  $e_c$ . That ecosystem of equations thence became self-evident for known equations in physics. Here, this paper shall take this scaling process a step further in deriving the values for  $c$  and  $\alpha$  using the time-equation and the known Bohr radius scale  $a^0$ .

## 9. TM-0D number theory *scope and elasticity*

---

One of the great implications of a foundational number theory for physical phenomena, something the Clay Mathematics Institute has quested with its Millennium prize problems<sup>65</sup>, is that if zero-dimensionality is the absolute ideal *number-theory basis* for time and space despite number theory upon that basis (0D) being incomplete as presented by Godel<sup>66</sup>, all other equations would abide by that context, and thence naturally *embody* with all other equations *in that zero-dimensional context*.

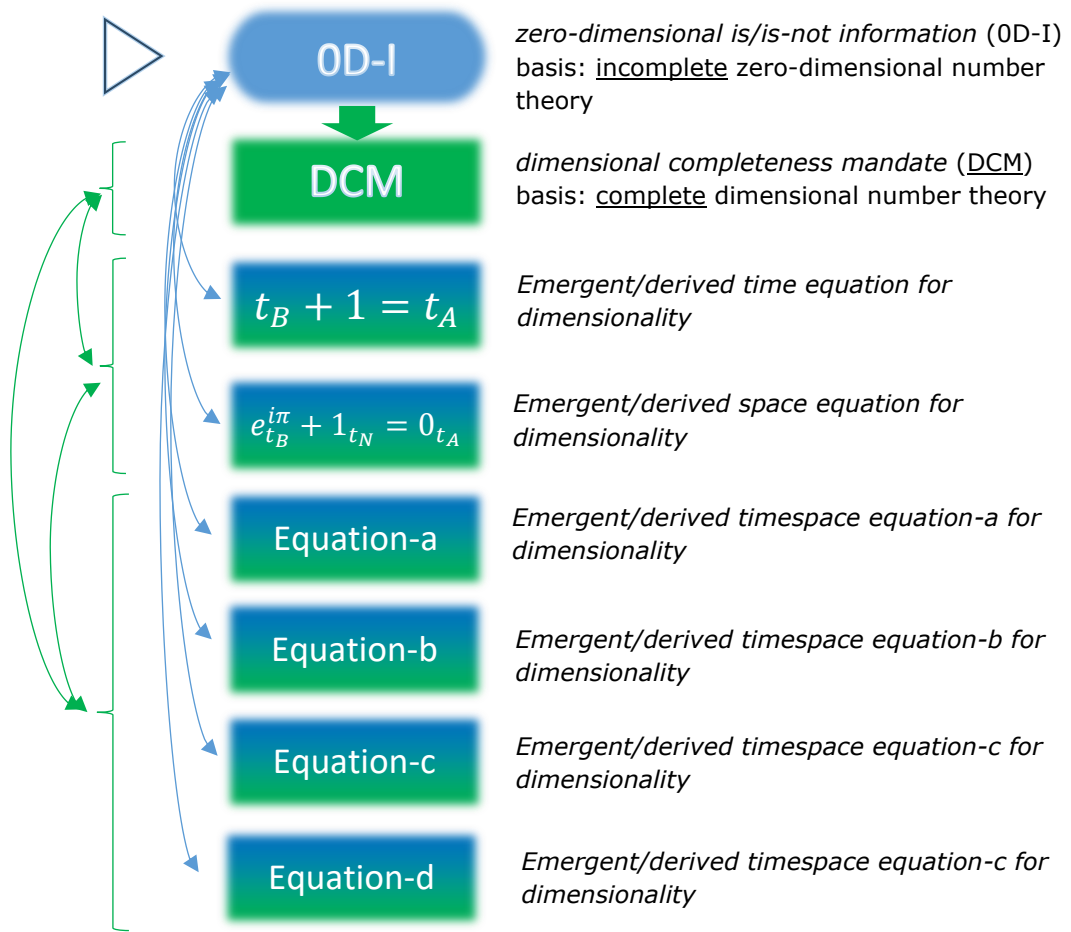
It follows therefore that to make an equation dimensionally significant, it must abide by an absolute condition of zero-dimensionality. Thence, it follows that no one equation is absolutely complete, yet that there is nonetheless a condition of absolute context with zero-dimensionality for each equation. Consider figures 14-18.

---

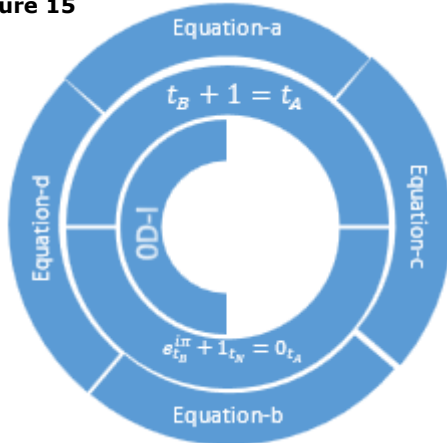
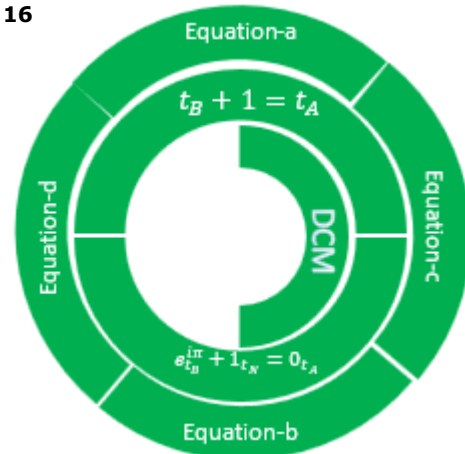
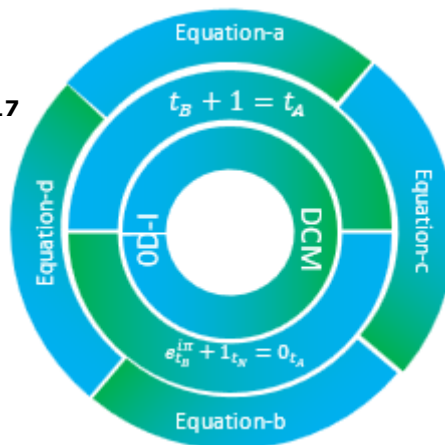
<sup>64</sup> [49]: p3-13.

<sup>65</sup> [44][49][55].

<sup>66</sup> [77].



**Figure 14:** figure 4 as a top-down hierarchy of number theory regard, from the incomplete zero-dimensional number theory basis (OD-I) as the blue arrows/connectors, to then mandate the dimensionally complete number theory basis (DCM) as the green arrows/connectors.

**Figure 15**

**Figure 16**

**Figure 17**

**Figure 18**


**Figures 15-18:** here is a pie-chart hierarchy of number theory regard, from the central incomplete zero-dimensional number theory basis (0D-I) as the figure 15 blue pie chart, to then mandate the dimensionally complete number theory basis (DCM) filter as the figure 16 green pie chart, thence their link as figure 17. Note that each of the equations, namely the time and space equations, and equations a-d, are each individually incomplete as a zero-dimensional equation, yet *together* via the DCM filter are dimensionally complete, which then presents the feature of how these equations are derived, namely according to how they dimensionally fit with each other in a complete and thence fixed manner, despite their individual albeit incomplete zero-dimensional signatures. This (B) feature is thence held in the ABC process as figure 18.



As highlighted in figure 1, (C) as the natural science is all about confirming (A)→(B) via scaling such to known physical phenomena. Although physics has a grand scale of data points, the problem physics faces is how to link all those data points and associated equations together to crack its sought for quantum gravity code. For TM-0D, (C) is how it's (A)→(B) process can be verified with known data, together with presenting the case for "new" proof. (C) for TM-0D is a proposed "next-step" of physics.

In presenting such, TM-0D is not without its hurdles. For instance, the two key equations derived from the zero-dimensionality conjecture are  $t_B + 1 = t_A$  (where  $t_B^2 = t_A$ ) and  $e^{i\pi} + 1_{t_N} = 0_{t_A}$ . However, these two equations each are never complete, as much as:

- (Ixi) Euler's number  $e$  and  $\pi$  can each not be ultimately defined other than through an endless sequence.
- (Ixii) The derived time-equation  $t_B + 1 = t_A$  (where  $t_B^2 = t_A$ ) in having  $t_B$  integral to  $t_A$  is also an endless sequence, as an equation expressing an endless sequence *fractal* when considered *in situ* with geometry.

These two equations together and not alone *in situ* though can be shown to knit together a 3d Cartesian coordinate 0-point grid<sup>67</sup> for any potential point in a 0-∞ spatial scale resulting in:

- (Ixiii) Dimensional number theories that are able to describe the *complete* nature of ∞<sup>68</sup>.

By this derivation process numbers between 0 and ∞ are granted for each unique 3d Cartesian 0-point coordinate system in the general derived 3d spatial grid.

The next step requires asking how else the time and space-equations,  $t_B + 1 = t_A$  and  $e^{i\pi} + 1_{t_N} = 0_{t_A}$ , interact?

The following need to be considered in that proposed equation ecosystem spectrum:

- (Ixiv) The ecosystem of equations by their common *zero-dimensional genesis* and *temporospatial sentient code filter* are thence already knitted together with the time and space equations ultimately in being a part of the universal context of zero-dimensionality.
- (Ixv) Thence there would be expected to be a variety of different equations that don't match each other in describing physical phenomena, and thus a vastness of equations describing physical reality's vast features, yet an ecosystem of dimensional equations that are nonetheless a part of a general completeness of equations, as described by the proposed *dimensional completeness mandate* (DCM).

<sup>67</sup> [43][44][49][50].

<sup>68</sup> [43][44][49][55]



There, numbers are quantity descriptors for the dimensional derivations from zero-dimensionality:

- (lxvi) The fundamental numbers being the golden ratio  $(\phi, \frac{-1}{\phi})$ , Euler's number  $e$ , and  $\pi$ <sup>69</sup>.
- (lxvii) Then derived is the value "3" for the Pythagorean relationship of the golden ratio<sup>70</sup>, as the 3 dimensions of space, as derived with "2" directions on each of the 3 dimensions central to a 0 point reference<sup>71</sup>.
- (lxviii) This (lxvii) thence relates independent sets of  $0 \rightarrow \infty$  numbers for each 3d Cartesian 0-point reference<sup>72</sup>.
- (lxix) This (lxviii) thence mandates symmetries and associated scales between each point in 3d space<sup>73</sup>.

Of note there regarding the individuality of numbers for any unique 3d Cartesian 0-point references and associated general equations for physical phenomena, one cannot say 1 kilogram = 1 joule, or 2 kilograms = 2 joules, and so on and so forth, as here numbers are *secondary* features to physical phenomenal concepts being labelled (mass and energy). What though takes priority with numbers here on this level of regard is *how* each equation in the equation ecosystem is *derived*, and why each equation is derived as such.

Therefore, proposed here is that there are four ways of using numbers, namely:

- (lxx) The primary zero-dimensional basis as an "absolute" basis for 0 and 1.
- (lxxi) Then secondly how numbers are derived to describe how temporal and spatial dimensionality emerges from the zero-dimensional basis as per the *temporospatial sentience code* conjecture filter, namely the time and space equations as  $t_B + 1 = t_A$  and  $e^{i\pi} + 1_{t_N} = 0_{t_A}$  respectively.
- (lxxii) Then thirdly how numbers represent their own 0-point Cartesian family  $0 \rightarrow \infty$  grid anywhere and everywhere in that 3d timespace reality.
- (lxxiii) Then fourthly the ecosystem of number equations as a combination of (lxxi) and (lxxii).

Thus, 2 kilograms is not 2 joules, as numbers in this example are adjectives describing the quantity of mass and energy which themselves as entities (mass and energy) represent more fundamental equations derived from the association of the time-equation and space-equation.

---

<sup>69</sup> [49]: p6-13.

<sup>70</sup> [49]: p14-15; [52]: p7-13.

<sup>71</sup> [49]: p14-15; [52]: p7-13.

<sup>72</sup> [49]: p16-24.

<sup>73</sup> [49]: p16-24; [52]: p7-48.



Phenomena though can relate with other phenomena provided that they can be traced to their common dimensional time and space trunk of derivation, and thence common dimensional time and space context, as shall be shown in this paper, ultimately from the proposed definition for *zero-dimensionality* and how then *dimensionality* is proposed to emerge for time and thence by such space. Some truly fascinating features thence emerge.

All of this is very important, as the proposed zero-point gravity needs to be described in a way that that accounts for the current known equations of physical phenomena.

## 10. TM-0D number theory quality assurance (QA)

---

Physics aims to reach exact equations for phenomena describing exact constants for those equations based solely on measuring physical reality (C) with exact measuring standards (B). Physical constants are therefore values derived to balance the equality of measured physical phenomenal concepts such as mass and energy, physical phenomenal concepts used in relationship with each other having been measured via exact and uniformly agreed upon measurement standards.

The process of TM-0D is different. TM-0D takes a fundamentally absolute zero-dimensional approach as a number theory (B) that when filtered through a proposed *temporospatial sentience code* (A) derives a dimensional number theory (B). That dimensional number theory by its derivation is attributed with the 3 dimensions of space and a dimension of time, as per care of the dimensionally derived space-equation  $e^{i\pi} + 1_{t_N} = 0_{t_A}$  and time-equation  $t_B + 1 = t_A$  where  $t_B^2 = t_A$ . The difficulty though is how the dimensional time-equation relates with the dimensional space-equation, a process which then derives an ecosystem of dimensionally-based equations as their link, equations that point directly to known physical equations and constants (C), yet not exactly so. For, the process of TM-0D is deriving first all **the progenitor equations** that then by their relationship emerge the equations we understand in physics today, except for Einstein's curved spacetime equations, which is a problem given all of cosmology theory and thence physics appears based on Einstein's gravity equations.

The difficulty therefore in understanding TM-0D is accepting all the new TM-0D "progenitor" equations for physical phenomena and their subsequent associated derived equations and constants aside from Einstein's own gravity equations. The added difficulty is of course thence realizing the importance this new process sets for cosmology theory and thence all things held in that context of space and time. The further difficult step in this process is to then investigate how those progenitor equations and their affiliated equations relate dimensionally with each other and why compromises must exist between those equations to thence derive the known physically-based equations and constants aside from Einstein's own gravity equations.

It is important to note therefore that TM-0D is not "physics" (C) per-se, yet a number theory (B) that is applied to a *temporospatial sentience code* (A) to arrive at equations that are then



compared with known physics equations to then show their relevance to physics (C). Clearly, the quest there is to highlight the underlying proposed zero-dimensional number theory basis to physical phenomena, and to then fill any gaps in known physics equations with associated proofs/experiments.

What therefore has this TM-0D proposal found and what refinements if not checks and measures, what quality assurance (QA) processes, are featured with TM-0D in confirming what we are sentient of regarding physical reality?

Just like with physics, the QA of TM-0D involves the idea of using one's ability to scale and survey what they are measuring in confirming known data. Surveying and scaling is not only such, yet of course a feature of an *unbiased* exercise of consciousness. Such is the emphasis of the *temporospatial sentience code*. TM-0D with its proposed *temporospatial sentience code* (A) is thence not a definition of consciousness, yet *how* human consciousness is an analogue of the proposed *temporospatial sentience code* on a fundamental time and space dimensional level. Hence, the *temporospatial sentience code* is a proposed axiom, as something that is self-evident, as what an axiom is, namely something that is self-evident. By such, the *temporospatial sentience code* (A) is tested upon the zero-dimensional number theory (B) basis for reality being an expression of time's moment and thus zero-dimensional time. Simply, here is a proposal for scaling and surveying the dimensions of time and space based on the concept of our proposed *temporospatial sentience ability* from a zero-dimensional level, as a self-evident and thence axiomatic *code* for this proposal.

By comparison, the contemporary scaling and surveying bias of physics, physics' own *spacetime sentience code*, is the  $\Lambda$ CDM model as based on Einstein's proposal of curved spacetime as gravity, a lens that considers the stars as unique solar systems that are clumped as galaxies, galaxies that are drifting apart care of the energy of the  $\Lambda$ CDM big bang, yet each galaxy as solar systems being held together as single galaxies by dark matter. None of this has been absolutely proven, and thus is a conjectured lens of astrophysical regard, a spacetime sentience code lens nonetheless until proven otherwise. This of course asks TM-0D to present a case with even greater sentience code lens clarity and proof, greater sentience code lens clarity and proof above and beyond the last century of curved spacetime theory and achievement. How does TM-0D achieve this and by what QA process above and beyond that of physics' current  $\Lambda$ CDM scheme?

The QA process for TM-0D delivers a scheme of checks and measures that highlight beyond reasonable doubt that the initial assumption of the *temporospatial sentience code* when used with the proposed zero-dimensional information touchstone basis (logic)<sup>74</sup> can present the case for a derived dimensional number theory that aligns with the known equations described by physics regarding what is observed of physical reality aside from Einstein's curved spacetime proposal for gravity, and can do this with the proposal of new *laboratory* proof for TM's proposed theory of gravity.

Initially, the work of TM-0D began rather generally in making a conjecture for the idea of time representing a *temporospatial sentience code* based equation, as per the proposal of paper 1.

---

<sup>74</sup> [58].



A basic equation was derived there for time as  $t_B + 1 = t_A$  where  $t_B^2 = t_A$ . The quadratic solution to that equation resulted in the two values of the golden ratio, numbers which themselves are irrational, and thus have an endless representation of decimal places. This set the bar for the refinement of values and associated decimal places required for all associated derived values.

Owing to the fundamental basis employed, namely zero-dimensional, the classical/pre-modern equations for charge (Coulomb) and gravity (Newtonian) were first considered in order to cover any ground that QFT and GR may have missed. There, the time-equation golden ratio values were implemented into the basic Coulomb charge and Newtonian inertia/gravity equations, yet values rounded off to 4 decimal values given the general uncertainty of this new process. There also in paper 1 the time-equation code was used to derive the infrastructure of the Rydberg equation, thence suggesting that this zero-dimensional approach for time is actually a more fundamental basis than quantum mechanics.

As the papers progressed with their leverage into known equations and constants, as with paper 2 and beyond, the refinement of the golden ratio values became more pronounced with their decimal places. This process of refinement was akin to building the framework of a dimensional number theory equation plexus, not tightening the links until all the equations were to be derived and then dimensionally aligned with each other. The tightening/refinement process comes based on all the derived dimensional phenomena features described by papers 1-59. Consider figure 19 describing this process.



**Figure 19:** the proposed cyclic refinement process of the DCM/OD-1 system of figure 18.

By this process, certain new progenitor equations became apparent. The two key progenitor equations are first for the speed of light  $c$ , and then the fine structure constant  $\alpha$ . As the papers of TM-OD highlight, an ecosystem of equations then become apparent, all connected by the same number theory basis and **not** by empirical observation.



Thus, the real question to be asked of TM-0D is how the list of derived equations are related to each other, namely what dimensional relationships if not compromises are going on between one equation to the next, and do those relationships/compromises feature as a type of physical phenomenon and if so what is that physical phenomenon representing how an underlying mathematical code for physical reality glues itself together.

As paper 3 proposed, and thence its analogous papers 39 [39] and 51 [51], the compromises owe themselves to how each equation is a part of a time and space dimensional hierarchy of priority and how all such equations relate with each other through that hierarchical basis, ultimately how the ecosystem of equations relate to the time and space equations, and thus how  $t_B + 1 = t_A$  where  $t_B^2 = t_A$  relates with  $e^{i\pi} + 1_{t_N} = 0_{t_A}$ . The mathematical code found there was initially presented as the chaos equation in paper 3, the "*Emergence of consciousness from chaos*"<sup>75</sup>, making the proposal that how the time-equation relates to the space-equation as the chaos equation thence emerges the idea of consciousness. Such was a conjecture, only to be demonstrated in paper 59. There, the proposal is that from zero-dimensionally and the proposed use of the *temporospatial sentience code* results in two equations that thence become manifest as the core chaos equation code, a core chaos equation code which is thence proposed to result in how the idea of consciousness emerges, more specifically how an entire time and space system *can accurately check itself*.

Paper 3's chaos equation thence highlights a number of ideas, most of all the underpinning of Brownian motion, thence *underpinning* Einstein's description of Brownian motion in hailing from a more fundamental number theory basis. More fundamentally though, this chaos equation works in league with the anomalous  $\pi$  feature<sup>76</sup> of the time-equation needing such to adapt to the correct  $\pi$  value in the space equation. This  $\pi$ -anomaly was first presented in paper 2 and thence lead the basis for how the dimensions and associated physical phenomena and equations became aligned to then derive the atomic scale. This thence allowed the proposed derivations for the electron radius  $r_e$ <sup>77</sup> and proton radius  $r_p$ <sup>78</sup>, the value of  $\alpha$ <sup>79</sup>, and the value of  $h$ <sup>80</sup>, and thence the derivations for the values of the sun<sup>81</sup> and solar system.

Indeed, here is a proposal for scaling and surveying the dimensions of time and space based on the concept of our proposed *temporospatial sentience ability*, as a self-evident and thence axiomatic *code* for this proposal. What therefore has this proposal found and what checks and measures, what quality assurance (QA) processes, are featured with TM-0D in confirming what we are sentient of regarding physical reality, obviously?

---

<sup>75</sup> [3], later refined in paper 51 ([51]: p14-17). See also paper 39 ([39]: p65- 67).

<sup>76</sup> To be presented in sections 12-14.

<sup>77</sup> [38]: p31-34.

<sup>78</sup> [38]: p35-36.

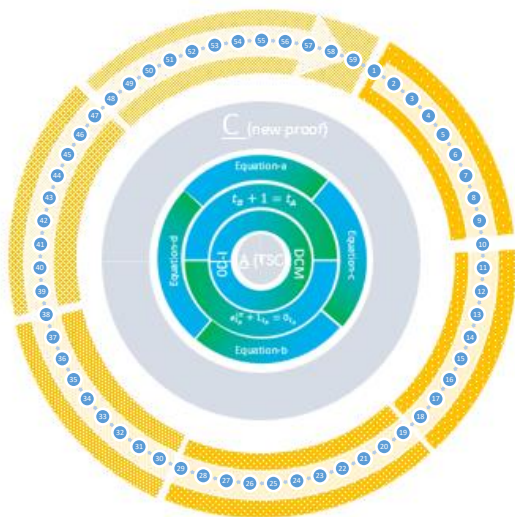
<sup>79</sup> [39]: p46-52.

<sup>80</sup> [39]: p52-59.

<sup>81</sup> [39]: p59-67.

This QA process presentation for TM-0D delivers a scheme of checks and measures that highlight beyond reasonable doubt that the initial assumption of the *temporospatial sentience code* (A) when used with the proposed zero-dimensional information touchstone basis logic<sup>82</sup> (B) can present the case for what is observed of physical reality (C). As a process, the work of TM-0D began rather generally in making a conjecture for the idea of time representing a sentience based equation, as per the proposal of paper 1. A basic equation was derived there for time as  $t_B + 1 = t_A$  where  $t_B^2 = t_A$ . The quadratic solution to that equation resulted in the two values of the golden ratio, numbers which themselves are irrational, and thus have an endless representation of decimal places. This set the bar for the refinement of values and associated decimal places required for all associated derived values in subsequent papers.

Owing to the fundamental basis employed, namely zero-dimensional, the classical/pre-modern equations for charge (Coulomb) and gravity (Newtonian) were first considered in paper 1 to cover any ground that QFT and GR may have missed. There, the time-equation golden ratio values were implemented into the basic Coulomb charge and Newtonian inertia/gravity equations, yet values rounded off to 4 decimal values given the general uncertainty of this new process. As the papers progressed with their leverage into known equations and constants, the refinement of the golden ratio values became more pronounced with their decimal places. This process of refinement was akin to building the framework of a house, not tightening the bolts until all the panels were aligned with each other. The tightening process proposed here<sup>83</sup> is based on all the derived dimensional panels and associated phenomena of papers 1-59. Consider figure 20 highlighting the flow of papers 1-59.



**Figure 20:** highlighting the TM-0D paper development process of the DCM/0D-1 system of figure 19.

<sup>82</sup> [58].

<sup>83</sup> See sections 12-14.



To be noted, no matter how great the fine tuning applied to reality's derived equation ecosystem/plexus integrity process in highlighting an ultimate convening of all the equations, that ultimate number-based construction is a purely mathematical expression that depends on the premise of the time-equation requirement of the future time-paradigm being an unknown and the future time-paradigm of the space-equation being 0. Logically, this presents with blockades in trying to find equations that predict the future, a feature which is upheld by the design of the *temporospatial sentience code*, as much as our perception does itself not perceive the future yet has an otherwise reliable memory of the past, the past being as events in time-now that cascade into the time-before time domain realm by the nature of the run of the time-equation<sup>84</sup>.

Thus, how can all the equations be linked together and then not predict the future if not for a feature preventing them from predicting the future, for containing an uncertainty principle regarding the future? That TM-0D time and space uncertainty principle for the time domain of the future is embedded in both the time and space equations as one by the design of the 0-1 zero-dimensional number theory code and associated design of the *temporospatial sentience code*.

Notwithstanding all of such, questions will always remain as to whether this process of number theory scaled with physical reality is in fact how reality works, namely as opposed to the  $\Lambda$ CDM model, especially given the incompleteness of number theory and continual requirement of proof. Ultimately for physics that answer comes down to what can be demonstrated by way of laboratory proof, and here TM-0D proposes key experiments that quantum field theory (QFT) and general relativity (GR) are unable to propose<sup>85</sup>. Underlying that proposed proof is of course an absolutely accurate derivation of the dimensional mechanics of the two most basic constants in physics, namely the fine structure constant  $\alpha$  and the speed of light  $c$  for any relative motion of a reference object in space<sup>86</sup>.

## 11. TM-0D number theory infinitesimal logic comparisons

---

The TM-0D proposal is to consider a new number theory approach *beyond* the black hole singularity proposal, *beyond* the calculus of QFT and GR breaking down, and thus the establishment of a novel zero-dimensional number theory for space and time as a new theoretic origin. Quite simply, the TM-0D proposal is to develop a zero-dimensional number theory for time and space and to then from that emerge a dimensional number theory that confirms the findings of QFT and GR, and not only that, confirms why the infinitesimal calculus of QFT must be **flat** 4d spacetime and why the infinitesimal calculus of GR must be **curved** 4d spacetime.

---

<sup>84</sup> [6].

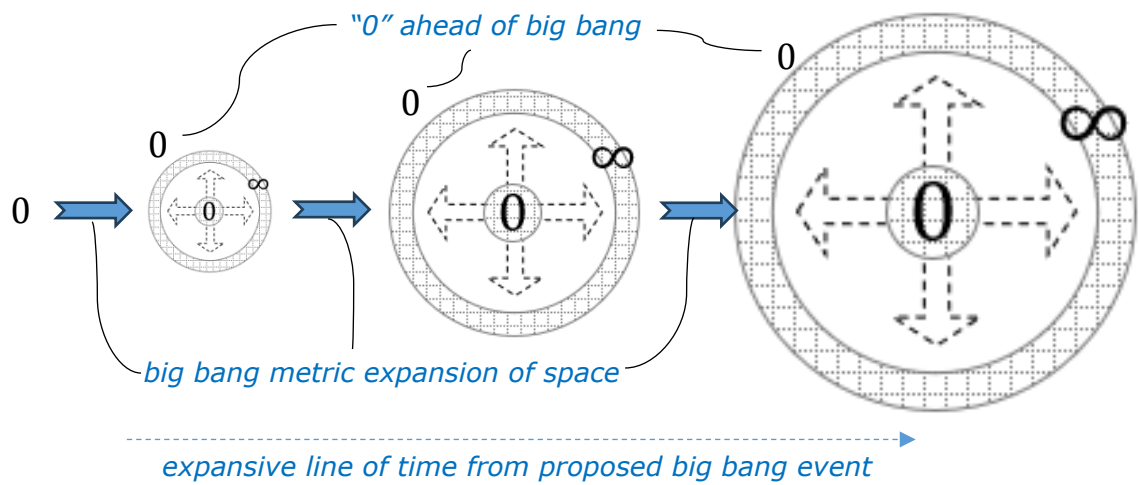
<sup>85</sup> Sections 17-20, TBA.

<sup>86</sup> See section 14.

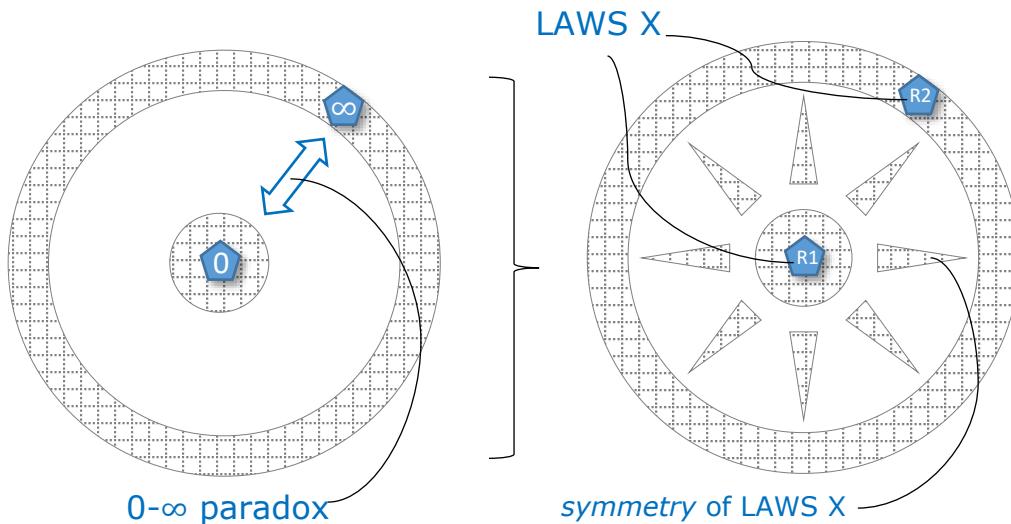
TM-0D considered the *GR inclusive*<sup>87</sup> and *QFT non-inclusive* inertial frame of reference *issue* and decided to work a non-inertial<sup>88</sup> zero-dimensional number theory for time and space, to thence form a zero-dimensional basis not dependent on mass and thence inertia per se, yet strictly a number theory basis for time and space on a zero-dimensional scale, and to then apply that number theory to dimensional analysis, as per its 56 papers [1-56].

The core consideration for the basis of the zero-dimensional number theory was the 0-∞ paradox, namely the size and scale of a point from 0 to ∞ if indeed nothing existed before the proposed big bang and yet that same thing still exists ahead of the shock front of the proposed big bang. Consider figures 21-23.

**Figure 21**



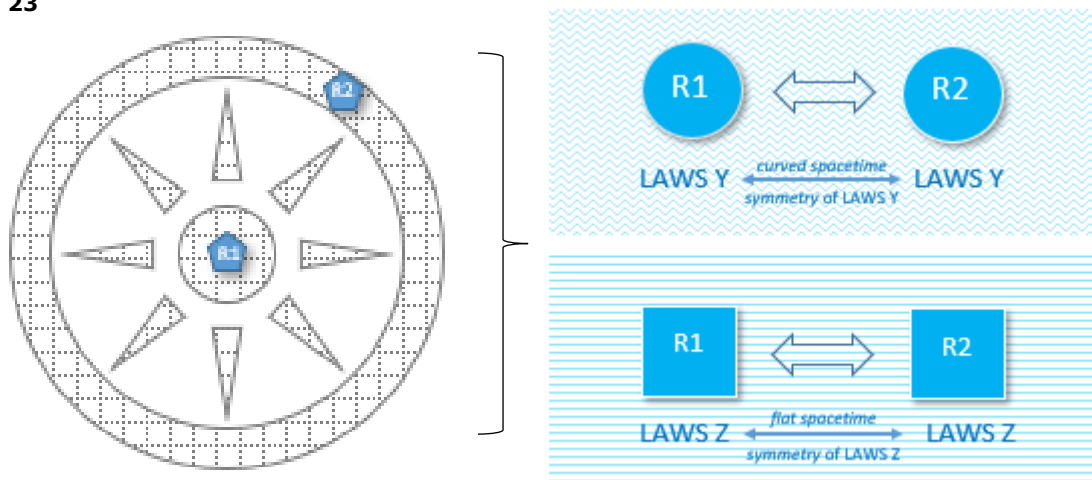
**Figure 22**



<sup>87</sup> As per the chosen priority of the GR-based  $\Lambda$ CDM cosmological model context.

<sup>88</sup> In therefore not using the GR-based  $\Lambda$ CDM cosmological model context.

**Figure 23**



**Figures 21-23:** proposing the 0-∞ paradox as a zero-dimensional number theory encryption leading to the formulation of a singular “LAWS X” context/basis

What is this significance of the symmetry of “LAWS X” for physical phenomena though especially if nothing existed at the considered “0” start time of reality just before physics’ proposed big bang?

- (lxxiv) Firstly, the “LAWS X” basis is aimed to identify a type of *cause* for the observed and theorized metric expansion of space<sup>89</sup> by proposing the 0-∞ scaling paradox which as a paradox aims to capture the scaling paradox of the point in space and moment in time that existed before the big bang and how that relates with what exists ahead of the proposed  $\Lambda$ CDM metric expansion of space shock front, as per figures 21-23.
- (lxxv) Secondly, the “LAWS X” basis is proposed to then allow for the resolution of all CMI infinite-set number theory problems including Fermat’s conjecture.
- (lxxvi) Thirdly, the “LAWS X” basis as the proposed zero-dimensional number theory when scaled with the Bohr radius  $a^0$  aims to then demonstrate:
  - a. known features and associated data of GR and QFT to become evident,
  - b. and thence link QFT and GR by this “LAWS X” context/basis.

The core process here with TM-0D and associated zero-dimensional logic is as follows:

- (lxxvii) the creation of a zero-dimensional number theory for the pre-state (0-time and 0-space) of the big bang and thus also by proxy for that which exists *ahead* of that proposed big bang (also as 0-time and 0-space),

<sup>89</sup> Owing to the redshift of light from observed galaxies.



- (lxxviii) such (lxxvii), as an analysis of a zero-dimensional scaling paradox, namely the  $0-\infty$  scaling paradox, for time and space<sup>90</sup>,
- (lxxix) such (lxxviii), which then represents a mathematical bridge linking the infinitesimal natures of QFT and GR,
- (lxxx) such (lxxix), as a process that when scaled with physical phenomena represent a feature to reality, namely as a fundamental field force effect,
- (lxxxii) such (lxxx), as a proposed *initial condition* for physical phenomena,
- (lxxxiii) such (lxxxii), to thence highlight the features of the responsible fundamental field force effect and how it can be made use of.

TM-0D initiated this entire theoretic process in paper 1 [1] rather generally, surveying the broader landscape of the dimensional number theory issues for EM and gravity<sup>91</sup>.

There, having revealed a golden ratio (fractal) code for a dimensional time equation that related with the quantum shell nature of the atom in deriving the Rydberg equation<sup>92</sup>, the symposium was extended to how the time equation would derive what could only be a quantum wave function when scaled with the charge of the electron  $e_e$  and speed of light  $c$ , as per paper 2 [2].

The next logical step was to derive the Planck scale in paper 3 [3], noting the obvious issue there with the then rudimentary equations and associated constants in play. The task was thence to extend the theory as acutely and broadly as possible to refine the equations and their constants.

By paper 15 [15] a second equation was realized for space as the Euler identity equation as adapted to the golden ratio time equation.

Thence, through a series of papers [1-42] the zero-dimensional approach was reached in paper 43 [43] by:

- (lxxxiii) proposing zero-dimensional time and space as the next step ahead from the infinitesimal calculus approach, namely in going straight to an *absolute* infinitesimal level for time and space.
- (lxxxiv) such (lxxxiii), by identifying a  $0-\infty$  scaling paradox for a point in space<sup>93</sup>.
- (lxxxv) thence resolving such (lxxxiv) by:
  - a. defining the idea of zero-dimensional time and zero-dimensional space.
  - b. proposing two new temporal datum references, namely *time-before* and *time-after*, which thence are shown to derive dimensionality (3d) for space.
- (lxxxvi) all of such thence becoming a new mechanics for the idea of time, hence the titled term TM-0D.

---

<sup>90</sup> [49]: p7-10.

<sup>91</sup> [1]: p10-12.

<sup>92</sup> [1]: p13-18.

<sup>93</sup> A process which then set a basis for an overall non-expanding space locale.



Thus, at its core TM-0D utilizes a number theory that represents a proposed way zero-dimensional time relates with zero-dimensional space where:

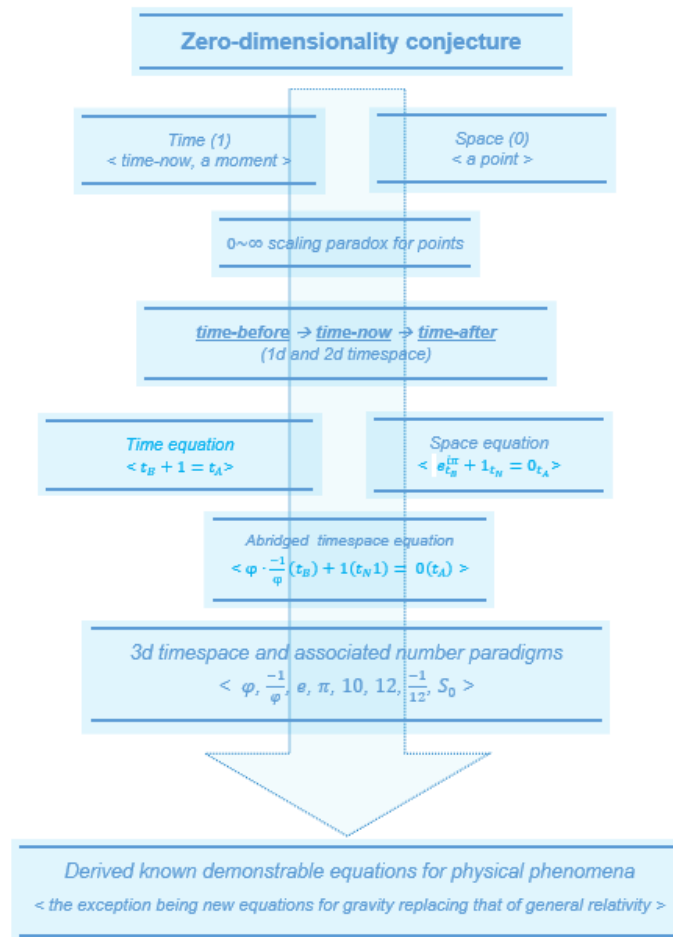
(lxxxvii) 3d space is derived with an associated 1d arrow of time.

(lxxxviii) The arrow of time (1d) is represented as a basic 1d time equation with 3d space termed as *3d timespace*<sup>94</sup>, as  $t_B + 1 = t_A$  where  $t_B^2 = t_A$ .

(lxxxix) 3d space is represented by an analogous equation to the *3d timespace*<sup>95</sup>, as  $e^{i\pi} + 1_{t_N} = 0_{t_A}$ .

Consider figure 24 which describes the process of derivation for the zero-dimensional number theory as outlined in papers 43-56.

**Figure 24**



<sup>94</sup> This is analogous to *flat 4d spacetime*, noting that with the zero-dimensional number theory time as a dimension is concurrent with each dimension of space.

<sup>95</sup> This is analogous to *curved 4d spacetime*, noting once again that with the zero-dimensional number theory time as a dimension is concurrent with each dimension of space.





All of such was thence scaled with what the number theory identifies as the equations for the charge of the electron  $e_c$  and the speed of light  $c$ , revealing and thence resolving:

- (xc) Known dimensional phenomenal features and associated equations in physics as presented in papers 48 [48] and 49 [49].
- (xci) Known calculus problems with the aim of resolving those dimensional number theory problems as presented in papers 49 [49] and 55 [55]:
  - a. Poincaré conjecture<sup>96</sup>.
  - b. Hodge conjecture<sup>97</sup>.
  - c. Riemann hypothesis<sup>98</sup>.
  - d. Birch and Swinnerton-Dyer conjecture<sup>99</sup>.
  - e. Yang-Mills existence and mass gap<sup>100</sup>.
  - f. Navier-Stokes existence and smoothness<sup>101</sup>.
  - g. P versus NP<sup>102</sup>.
  - h. Beal conjecture<sup>103</sup>.
  - i. Fermat's conjecture<sup>104</sup>.
  - j. Goldbach conjecture<sup>105</sup>.

By this process, the fundamental physical phenomenal feature of this proposed new fundamental "initial condition" relationship between the time-equation and the space-equation became apparent. Consider figure 25.

---

<sup>96</sup> [55]: p9-10, p21.

<sup>97</sup> [55]: p10, p21.

<sup>98</sup> [55]: p11, p21-22.

<sup>99</sup> [55]: p12, p22.

<sup>100</sup> [55]: p12-13, p22.

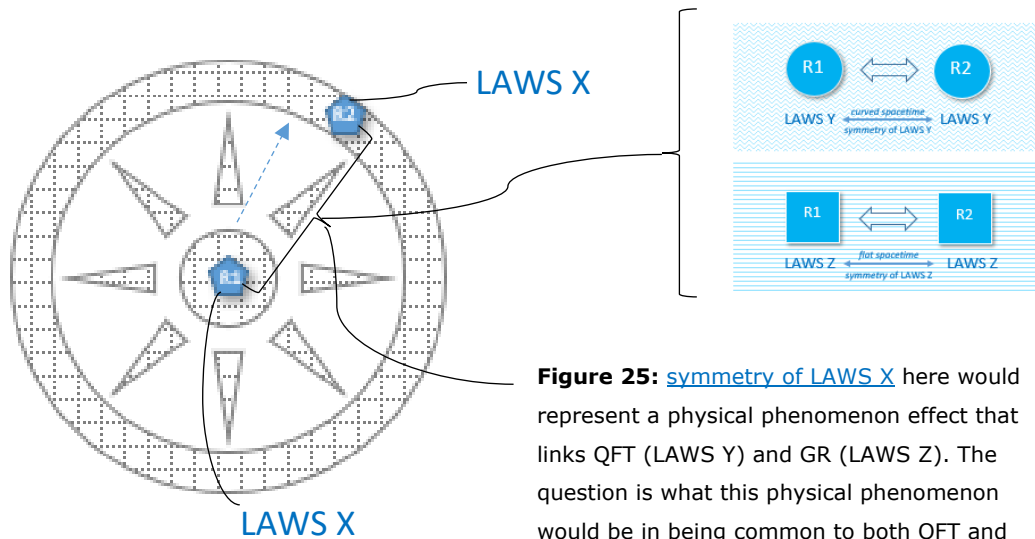
<sup>101</sup> [55]: p13-14, p23.

<sup>102</sup> [55]: p14-15, p24-25.

<sup>103</sup> [55]: p25-27.

<sup>104</sup> [55]: p17-18, p25-27.

<sup>105</sup> [49]: p16-18.



**Figure 25:** [symmetry of LAWS X](#) here would represent a physical phenomenon effect that links QFT (LAWS Y) and GR (LAWS Z). The question is what this physical phenomenon would be in being common to both QFT and GR.

The proposal is that the relationship between the time-equation and space-equation represents the basic code itself for *entropy*. To note is the priority of the datum reference of *time-now*, specifically in the construction of a number theory framework for the dimensions of time and space on the presumption of physical reality executing itself in the datum-reference of *time-now*, thence conjecturing that:

- (xcii) Time travel into the past and future outside the datum-reference of time-now, despite the connotation of the term "*Temporal Mechanics*", is not feasible<sup>106</sup>.
- (xciii) Temporal paradigms of *time-before* and *time-after* are though instrumental in creating dimensionality for zero-dimensional space.

## 12. [Quantum's golden ratio metric royal cubit scaling key](#)

For those new to TM-0D, the suggestion is to have followed the paper links already provided in this paper, to then peruse paper 2, paper 49, and then paper 52, and to keep these available for the sections ahead in using the following links:

<a href="#">Golden Ratio Axioms of Time and Space</a>	paper 2
<a href="#">Zero-dimensional number theory</a>	paper 49

<sup>106</sup> The exception being in the condition of the quantum/particle wave function as presented in paper 52 [52]: p5-18.

The zero-dimensional physical theory (III): graphing time and space

paper 52

Paper 49 provides the core number theory description regarding the  $0-\infty$  paradox and associated *temporospatial sentience code*, and then paper 52 expands upon that core description as the *3d Cartesian 0-point system* that emerges with the associated timespace wave function for each of the axes of each and all 0-point references implicit to the  $0-\infty$  number theory systems derived in paper 49.

In paper 52<sup>107</sup> describing the quantum wave function pictorially, what is now to be identified is a metric royal cubit code that as a metric can *directly derive the values of  $\alpha$  and  $c$*  from the quantum wave function construction. Although paper 52 is based primarily on paper 2, paper 52's description is superior by virtue of referencing the findings of paper 49 as per pages 5-23.

Here though paper 2 will be referenced given paper 2 carries the consistent code identified throughout the 9 volume work, which is of great importance given the 9 volume work has cross-referenced and confirmed a vast spectrum of physics data.

Thus, having perused paper 52 pages 5-23 and paper 2 pages 2-15, note page 12 of paper 2 regarding the  $(\Phi)$  quantum wave function in describing the secondary wavefront for time in space as the quantum wave function. There, the proposal was to consider for the time-equation that as  $t_B^2 = t_A$  the following results for the golden ratio equation, there as equations 5-6, here as equations 1-2 respectively:

$$\left(\frac{-1}{\phi} \cdot -2\sqrt{3}\right)^2 = 4.5835921 \quad (1)$$

$$(\phi \cdot -2\sqrt{3})^2 = 31.4164079 \quad (2)$$

Note here the greater refinement of decimal places for the golden ratio values resulting in a more refined value for  $(\phi \cdot -2\sqrt{3})^2$ .

As a new equation from equation 2:

$$12\phi^2 = 10\pi_\phi \quad (3)$$

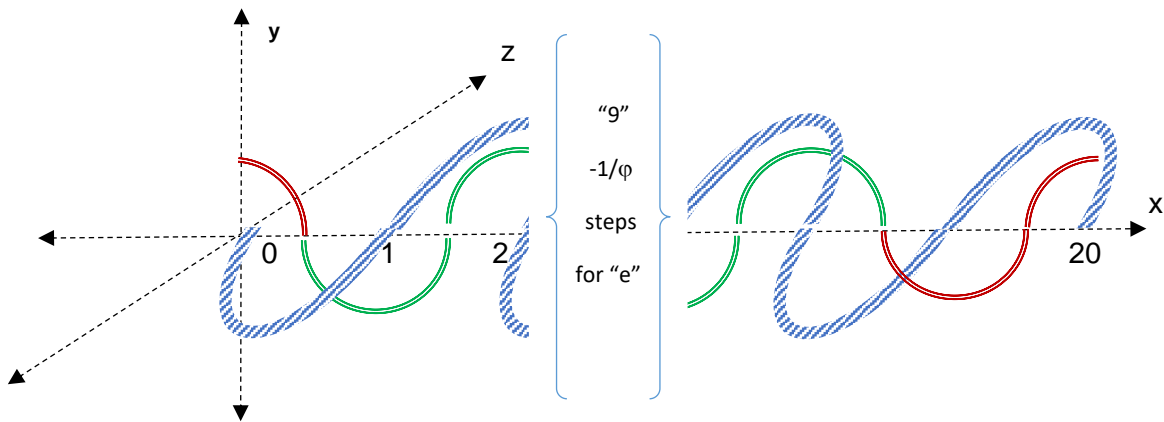
Note, here the value of  $\pi$  is proposed as the analogous derived value of 3.14164079, as  $\pi_\phi$ . Thus, here is the proposed first  $\pi$ -error step of understanding.

Equation 3 particularly also a statement of how the magnetic feature **as** a  $t_A$  event relates to  $10\pi_\phi$ , meaning that in using  $\pi_\phi$  as the baseline wave function condition, as proposed, then there are 10 electromagnetic  $t_A$ -expected wave functions in play by the magnetic dimensional condition of equation 2.

Thus, in tracing out these 10 magnetic wavefunction steps we have the following as per figure 12 paper 2, here as figure 26.

---

<sup>107</sup> [52]: p5-23.

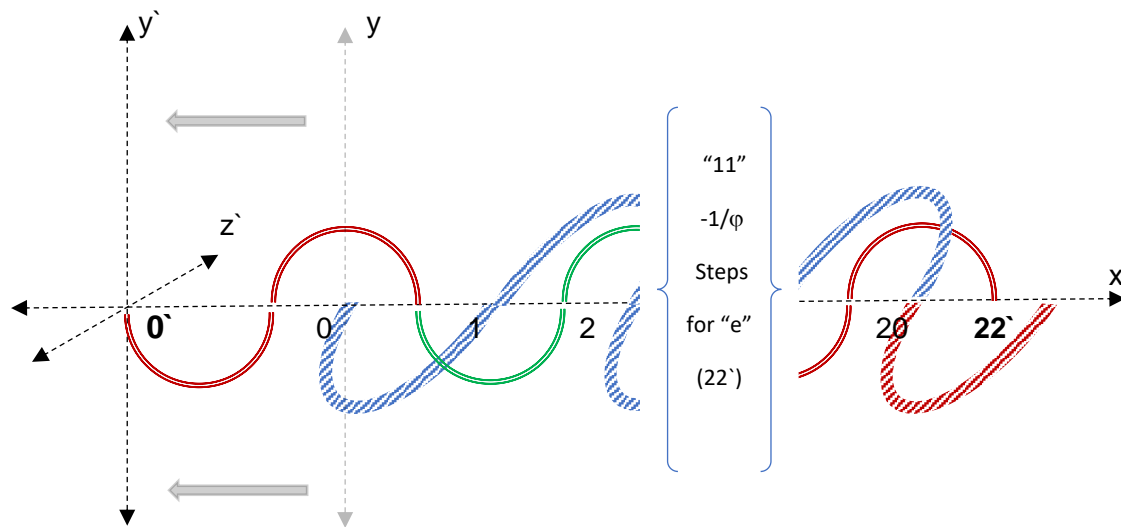


**Figure 26:** Green line electric component (x,y), blue line magnetic component (x,z), both waves out of phase with each other and perpendicular to each other, magnetic wave used as the 0 start point extending 10 wavelengths ahead. Note the red line area though regarding the electric component, and only 9 full electric wavelengths have been completed, leaving another two partial wavelengths.

Thus, at the start of the magnetic wave (0), there is a partial electric component ( $1/4$  red line), and so too at the end of the magnetic wave ( $3/4$  red line). Yet according to a quantum being a package of a full wavelength to satisfy the  $\pi$  condition<sup>108</sup> we have to consider that if we are to annex the use of a full and not partial electric step, we need to consider 11 electric steps not 9.

Thus, as we are regarding the electric component for light as the best representation for  $\pi$ , here as  $\pi_\phi$ , figure 13 from paper 2 is in order, here as figure 27.

<sup>108</sup> [1]: p13-15.



**Figure 27:** Note the completion of the electric components of the wave function toward the 0` and 22` markers.

Thus, the idea here is to:

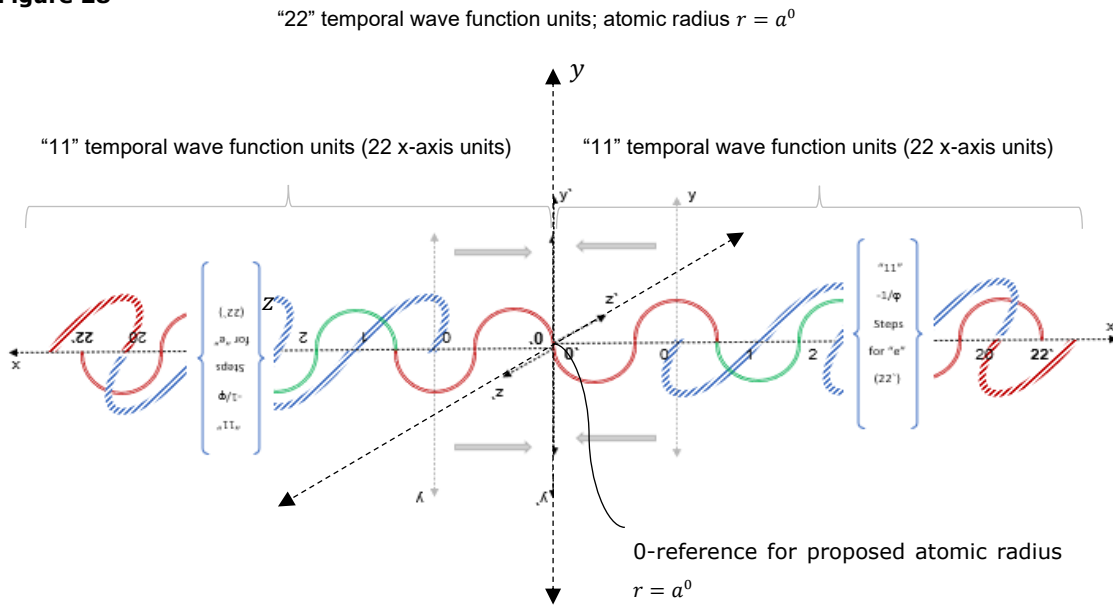
- (xciv) Grant equation 6 of paper 2 as  $(\varphi \cdot -2\sqrt{3})^2 = 31.4164079$ , here as equation 2, as the nominated value for a factor of  $\pi_\Phi$ , here as  $10\pi_\Phi$ .
- (xcv) To achieve this value (31.4164079) it needs to be re-interpreted into both a  $\pi_\Phi$  and thence a  $\frac{-1}{\varphi}$  feature.
- (xcvi) To do that requires scaling such as  $10\pi_\Phi$  steps as a  $t_A$  magnetic process, namely in giving precedence to the magnetic feature of the temporal wave function (given the basis for the scaled value).
- (xcvii) Yet in giving precedence to the magnetic wave function feature, components of the electric wave function feature are compromised.
- (xcviii) This thence warrants the addition of electric wave function components to complete the electric wave function  $\pi$ -requirement component for each of its wave function steps.

Given the wave function progression is in "two" directions from the 0 (0`) reference, (as per figure 8 of paper 2) along each direction of the x-axis from 0 (0`), we need 11 full  $\frac{-1}{\varphi}$  wavelengths on each side of the x-axis 0 (0`) reference to complete what is required for the two values of the golden ratio ( $\varphi, \frac{-1}{\varphi}$ ) to reach  $\pi_\Phi$  along the x-axis for space.

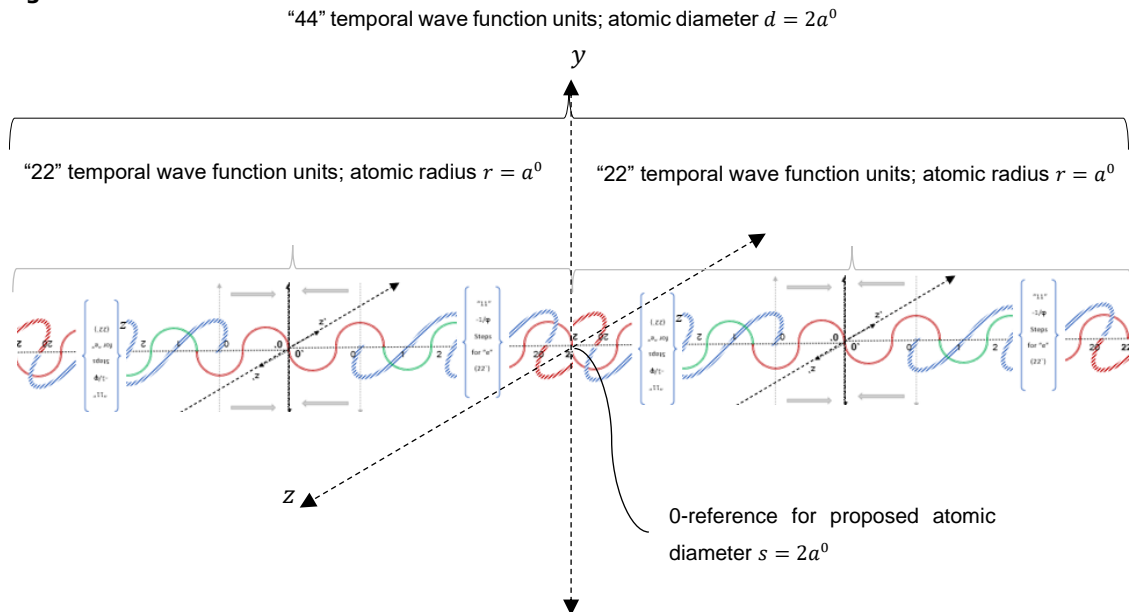
Consider figures 15 and 16a-b from paper 52, here as figures 28-29.



**Figure 28**



**Figure 29**



**Figures 28-29:** as a development from figure 15 of paper 52, scaling the temporal wave function graph to an atomic radius scale (as per paper 52 figure 16a, here as figure 28) and then to the atomic scale (as per paper 52 figure 16b, here as figure 29).

Here, consider therefore how figure 15 of paper 52 is proposed to relate as a 0-point reference for the atomic radius  $r$  as  $r = a^0$  (Bohr radius), here as figure 28, and how that then relates



to the scale of the atom as figure 29. Of note is  $12\varphi^2 = 10\pi_\Phi$  (eq. 3). Thence for the magnetic feature the following applies:

$$\varphi^2 = \frac{5\pi_\Phi}{6} = \pi_\Phi - \frac{\pi_\Phi}{6} \quad (4)$$

$$t_B + 1 = \frac{5\pi_\Phi}{6} \quad (5)$$

Simply, the magnetic feature hedges  $\pi_\Phi$ , crops it, and how this is proposed to manifest is by calculating what happens to  $\frac{\pi_\Phi}{6}$  on this level of number theory congress. Even though the magnetic and electric features are dimensionally in step as a  $t_A$  event, as the three dimensions of space, as demonstrated in paper 2, on this level of congress there is a hedging anomaly, and it needs to be accounted for.

This hedging is proposed to be:

- (xcix) How the wave function not only represents a process of entropy, yet how such then also works in league with the space-equation of  $e^{i\pi} + 1 = 0$ .
- (c) Thence a tangent process of energy release as the wave function, the wave function as a *package of energy (quantum)*, and also how the quantum wave function still maintains its wavelength scale.
- (ci) Thence how this quantum wave function is analogous to  $e^{i\pi}$ , namely  $t_A$  as a new  $t_B$  step, as how the wave function *loops* in time, yet of course as two equations, namely  $t_B + 1 = t_A$  and  $e^{i\pi} + 1_{t_N} = 0_{t_A}$ , noting the perfectly fractal time-equation and how this would thence be altered by the space-equation  $e^{i\pi} + 1 = 0$  by their interaction with each other.

Note,  $e$  uses the true value for  $\pi$  in the space equation, yet the time equation uses its derived value for  $\pi$  as  $\pi_\Phi$ .

The proposed feature of the loop (xlv) is that the loss of the  $\frac{\pi_\Phi}{6}$  would limit the progression in time of the wave function, as shall be shown to be limited as  $c$ .

The question is, where does this  $\frac{\pi_\Phi}{6}$  value feature, in what equation relevant to the quantum wave function? How is thence  $c$  arrived at?

Once again, the task is to present the case that  $\frac{\pi_\Phi}{6}$  is lost, technically, if indeed the electric and magnetic quantum wave function *circuits* are in step (albeit  $1/2$  out of phase, and thus  $1/4$  wavelength) with time, namely:

- (cii) For every  $t_A$  magnetic circuit system there is a  $\frac{5\pi_\Phi}{6}$  circuit value.
- (ciii) Yet every 1 magnetic circuit relates with 1 electric circuit as an *EM* synchronization feature of the quantum wave function.



- (civ) Thus, there is a code in play that represents a fundamental link between time and space highlighting something is happening to  $\frac{\pi_\Phi}{6}$  in keeping the electric and magnetic synchronization feature patent.

The proposal therefore is that the “missing”  $\frac{\pi_\Phi}{6}$  is *given* to the idea of how this entire system is *scaled* and thence *surveyed*. Before such can be provided though, a description of how this  $\pi_\Phi$  value is used and warranted in regard to true  $\pi$ .

### 13. Quantum’s progenitor fine structure constant value $\alpha_x$

---

#### 13.1 Short history of the fine structure constant.

According to physics, the fine-structure constant given the symbol  $\alpha$  quantifies the strength of the electromagnetic interaction between elementary charged particles. Despite being a dimensionless quantity,  $\alpha$  is related to the strength of the coupling of an elementary charge  $e_c$  with the electromagnetic field, as per the nominated formula  $4\pi\epsilon_0\hbar c\alpha = e_c^2$ . The numerical value of  $\alpha$  is  $\sim 0.0072973525693$ , as  $\sim \frac{1}{137.03599908}$ , with a relative uncertainty<sup>109</sup> of  $1.5 \times 10^{-10}$ .

The constant, named by Arnold Sommerfeld, was introduced in 1916<sup>110</sup> in advancing upon the Bohr model of the atom. There,  $\alpha$  quantified the gap in the named fine structure of the spectral lines of the hydrogen atom, and thence relates directly to the electron shell process. Physics does not know why  $\alpha \simeq \frac{1}{137.03599908}$ . Here though this value will be derived from a zero-dimensional basis in constructing a proxy atom in thereof highlighting the electromagnetic binding strength of both the EM field to itself, to free space, and then finally with charge as the true fine structure constant value.

#### 13.2 Addressing the $\pi_\Phi$ error

As is evident, the value of  $\pi_\Phi$  as 3.14164079.... is not precisely the true value of  $\pi$  as 3.141595359.... So why consider it? The process here is asking what the time-equation can achieve, and here it is identifying a value that very closely resembles a value for  $\pi$ . It is as though zero-dimensionality (B) derives dimensionality (C) using the temporospatial sentience key (A) according to specific conditions, and one of those conditions is for the idea of  $\pi$  to represent a compromised value if the proposed quantum wave function is allowed to be constructed as the basis for the atomic locale.

---

<sup>109</sup> [78].

<sup>110</sup> [79].





This though is not the only  $\pi$ -anomaly TM-0D has found. In fact, there is a far more fundamental contextual  $\pi$ -anomaly derived in paper 16. To note there is that the true value for  $\pi$  was derived in paper 15<sup>111</sup>. There it was proposed that given a circle is very different to a line,  $\pi$ , the value for the circumference of a circle with diameter 1, is why we need *words* to *primarily* describe the mathematics of a circle in regard to space, to explain the connection between the arc of a radius drawn as a circle in reference to a line (such as its diameter), and how that is achieved; simply, any **key** irrational number such as  $\pi$  needs words to explain exactly what is happening there, how that irrational number comes into being.

To define why  $\pi$  could be an irrational number, a key one, in words, is a good way to set a standard of use of words to then describe other features of space that could be related to for instance the idea of time; in describing  $\pi$  with words alone, why  $\pi$  is an irrational number, one need only ask oneself how and why  $\pi$  is **related** to a line.

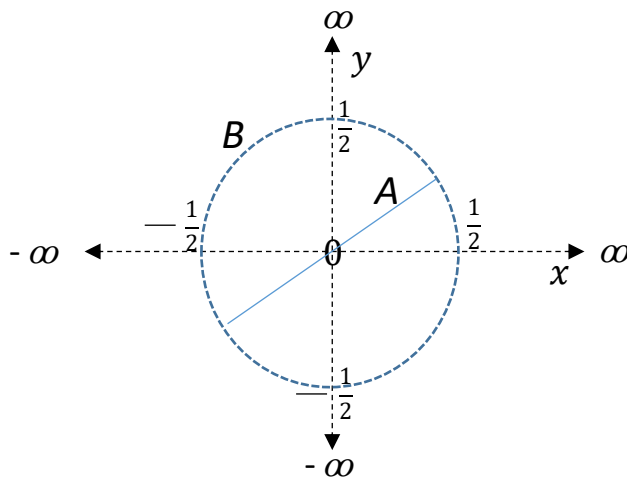
For instance, take a straight line, real and rational, determined, say length of arbitrary unit 1, and then go to the midpoint of that line and draw an arc around that straight line from the midpoint of that line. The proposal is that length of the circle around that line can never be the concept of a complete number as the distance of that line could be. Why? If one suggested that the concept of the distance of that line the circle arcs around can never be determined, then how can that circle be drawn on such an undetermined length of line? Furthermore, to draw that circle is to use a geometry related to that line (diameter) that has **no** actual relationship to the exactness of the number assigned to the distance of that line other than a value that (as a number related to that line) is forever incomplete as a description of a number value, as it can only be, in trying to link the beginning of that line with the end of that line without **being** that line. In other words, that line could be at any angle in reference to the circle.

That's intuitive; and so, if the line is known as a determined length, its circle can never be properly defined, and thus must be irrational. Therefore, how indeed can a straight line be in a perfect ratio with a circle if the angle of that line in space can never be determined owing to the nature itself of the circle, no beginning, and no end? The question is how such improbability of exact definition manifests itself in reality. How does this look therefore on paper in the form of a mathematical axiom for space, with the notion of time being the variable seeking to perfect  $\pi$ , as though time is a type of endless algorithm forever trying to reach the perfect value of  $\pi$ ?

Consider a total "1" length of a line "A" that could represent "any" part of an infinite region of 2-d space around a central "0" point, as follows (figure 30).

---

<sup>111</sup> [15].



**Figure 30:** here, A is a straight line of length "1" in any infinite region of 2d space effected by the axes x and y around an arbitrarily reference point "0" such that from that "0" point the line extends a length of +1/2 and -1/2 from that "0" reference. "B" is the value of  $\pi$  as the arc around the central point "0" radius 1/2.

Here the blue dotted line "B" is the value  $\pi$ . Yet what indeed is the value  $\pi$ ? Can it be represented as a whole number, a fraction even? One thing that is certain is that the circle never gets to "0", never breaches the "0" point.

Therefore, as an arbitrary condition of definition here, let it be suggested that in regard to space for the circle,  $\frac{1}{\infty}$  represents that "non-0" concept for the circle in that the circle as a type of curved line in not skewing "0" would somehow constantly "approach" zero from a  $\frac{1}{2}$  (radius) reference, never meeting it though, as per equation 1.

$$\frac{1}{\infty} \sim 0 \tag{6}$$

In other words, the "reference" of the blue line "A" represents a unit vale per anywhere in  $\omega$  "as" what would trace a "circle" **if** "0" is not being used as the reference for that line. It is just a statement that dispels the notion of "0" and replaces it with the idea of  $\frac{1}{\infty}$  for the idea of the circle. Yet how can  $\omega$  be defined to give substance to this reference for the circle?

Let it now be suggested that to define this circle one must use an increasing denominator value **from the reference of line A** as a fraction central to "0", in approaching "0" from a  $+\frac{1}{2}$  and  $-\frac{1}{2}$  value in order to define the "0" reference; more correctly, in *approaching* the "0" reference, the length of the circle as an exact number would represent a number not expressed by a perfect **single** fraction given  $\omega$  can never be defined, yet a series of fractions that would employ the use of a denominator of the fraction **extending** to  $\omega$  through a process of subtraction and addition **around** a "0" reference (as technically "0" is being approached, yet never reached, as what the "circle" would best represent relevant to this line "A"), as per equation 2:

$$\pi = 1 - \frac{1}{2} + \frac{1}{3} - \frac{1}{4} + \frac{1}{5} \dots etc \tag{7}$$



The problem there though is that any fraction as a factor of  $\frac{1}{2}$  cannot be used, as  $\frac{1}{2}$  is integral to the length of each axis for line A (relevant to "0") "**of the line**" being used, **and therefore "unique" numbers NOT integral to  $\frac{1}{2}$  thus must be used.** Therefore, the process would become as equation 3:

$$\pi = 1 - \frac{1}{3} + \frac{1}{5} - \frac{1}{7} + \frac{1}{9} \dots etc \quad (8)$$

Why is subtraction and addition used in this manner? The process here is being central to "0" while approaching the "0" reference, and thus what must be a negative and positive scale around the "0" reference, the first step clearly being a negative step from the basic "1" line reference (diameter of the circle), the step following that a positive step, the step after that a negative step, and so on and so forth. In short, the idea of "0" is best explained central to  $\frac{1}{\infty}$  by this definition **for the circle.**

Thus, we start with 1 as the overall length of the line, and then seek to determine how to define the circle as a concept that would "approach" a "0" reference therewith, to create a process of balancing subtraction and addition central to this "0" reference of an overall "1" line, one  $+\frac{1}{2}$  length to the  $-\frac{1}{2}$  length meeting at a "0" point, from  $-\frac{1}{2}$  to  $+\frac{1}{2}$ . Once again note that any factor of  $\frac{1}{2}$  from 1 to  $\omega$  cannot be used in this sequence owing to  $\frac{1}{2}$  already representing the scale of each axis in use for line A, as a unique scale is needed "**from**" that  $\frac{1}{2}$  scale all the way to  $\infty$  **for the circle.**

Yet the next question is, **what value, what fraction, of  $\pi$  is being calculated through this process?** Is  $\pi$  being calculated whole or a fraction of  $\pi$ ? The value of  $\pi$  being calculated can only be a factor of the axes being used, and here this is as a progression based on one positive axis of length  $\frac{1}{2}$  and one negative axis of length  $\frac{1}{2}$ , and thus a factor of  $\left(\frac{1}{2}\right)^2$ . Thus, equation 3 must become as equation 4:

$$\frac{\pi}{4} = 1 - \frac{1}{3} + \frac{1}{5} - \frac{1}{7} + \frac{1}{9} \dots etc \quad (9)$$

Note also that  $\omega$  is a concept that would exist by default as a very large number, and thus for the most accurate value for  $\frac{\pi}{4}$  to be reached this series of fractions must extent to include a denominator approaching  $\omega$ , in successfully demonstrating the reference for the circle of  $\frac{1}{\infty}$ ; simply,  $\frac{\pi}{4}$  is the value reached that joins the ends of each axis from "0" to a value of  $\frac{1}{2}$  as the radius around "0", as it only can be, as this is not a direct calculation of the ends of the axes together, yet the value held in the context of  $\omega$ .

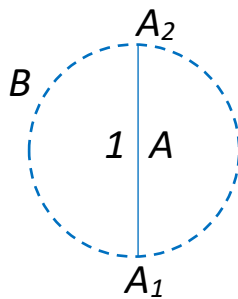
The next real question is, "what is the implication of this curve?". Is it a feature of space or a feature of time? The thinking is that if space has already been measured as the straight-line axes incorporating line "A", space as the "0" construct anywhere and everywhere, then the value of the



curve ( $\pi$ ) in the context of  $\omega$  would be relevant to that other fundamental feature of reality, "time", which shall be discussed shortly.

Nonetheless, this equation is an actual confirmed equation for  $\pi$ , as reached through different axioms of definition as per the work of Gottfried Wilhelm Leibniz [80] and Madhava of Sangamagrama [81]. Here though,  $\pi$  has been reached by this equation in the context of defining the hypothetical concepts of 0 and  $\omega$  using straight lines and a circle for 2d space, which can then be applied to a 3d grid of space. Note that this is not a process of rounding something off using an infinite progression, this is quite the opposite; this is accepting the nature of what is being defined and why it is being defined in such a manner. The question though is, "how can this algorithm as a description of space represent a function of time?". It's fine to define this concept of space as  $\pi$ , yet what about defining  $\pi$  using a function of time? That was the initial quest of papers 1-14 [1-14] using the  $\phi$ -algorithm for time.

As noted in paper 16<sup>112</sup> there are three key items to consider when putting together the notion of the algorithm for  $\pi$  developed in paper 15 [15] to the idea of the quantum wave function. The first is what is presented in figure 30. There, the blue line is length "1", as a ruler for time, as a way space (as per "0") can be used to measure time. Here this "ruler" length of space for time is a value of "1", as per figure 31.



**Figure 31:** here the diameter of circle "B" is length "1", as a ruler for time, as a way space (as per "0") can be used to measure time. Here this "ruler" length of space for time is a value of "1", between points  $A_1$  and  $A_2$ .

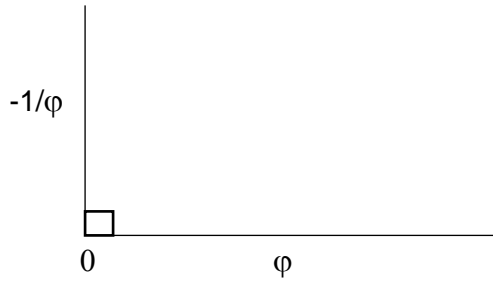
The next key item to consider is what was presented in paper 2 [2] regarding the nature of space regarding the  $\phi$ -algorithm, as per paper 2 figures 1-2 ([2]: p4, fig1-2), here as figures 32-33.

---

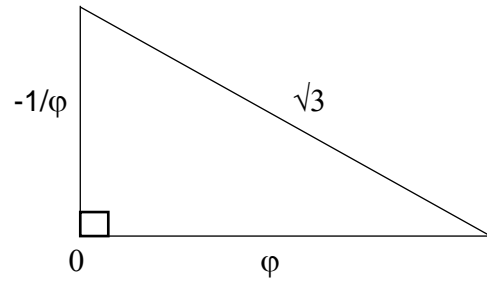
<sup>112</sup> [16].



$$\left(\frac{-1}{\varphi}\right)^2 + \varphi^2 = \sim 3 \tag{10}$$

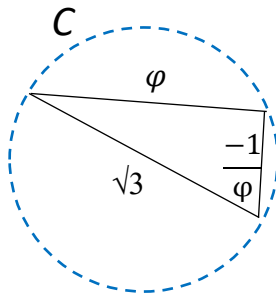


**Figure 32:** two axes of time,  $\frac{-1}{\varphi}$  and  $\varphi$



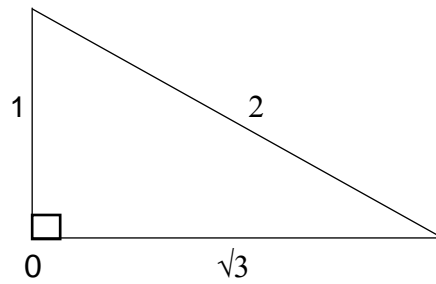
**Figure 33:** two axes of time,  $\frac{-1}{\varphi}$  and  $\varphi$  which then result in the value of  $\sqrt{3}$  (Pythagorean relationship).

This can be represented as per figure 34.



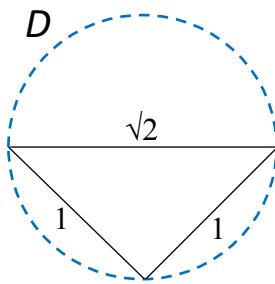
**Figure 34:** Here, the diameter of circle "C" is the value of  $\sqrt{3}$ , the hypotenuse of sides  $\varphi$  and  $\frac{-1}{\varphi}$ .

The third option to consider is the two directions along the axis of the time-algorithm, as per figure 17 paper 2 ([2]: p19, fig17), here as figure 35.



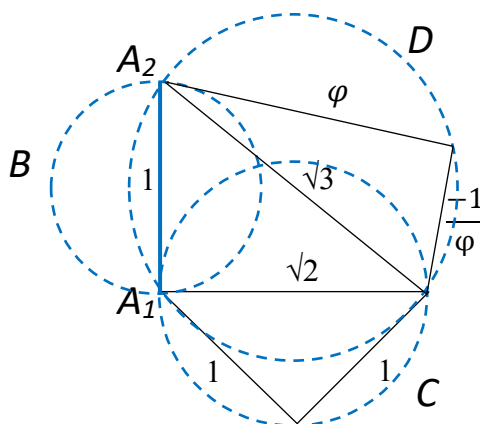
**Figure 35:** two axes of time, 1 and  $\sqrt{3}$  which then result in the value of 2 (Pythagorean relationship).

This can be represented as per figure 36.



**Figure 36:** Here, the diameter of circle "D" is the value of  $\sqrt{2}$ , the hypotenuse of sides 1 and 1.

These are all spatial representations of the proposed time-scaling system. It is now a task of arranging them together as a combined geometry, as per figure 37.



**Figure 37:** Here, circles "B", "C", and "D" are brought together such that the diameters of each of such circles form a right-angle triangle.



What does this combined geometry represent for time as a representation of space? The distance of line A, from A<sub>1</sub> to A<sub>2</sub> is "1". That is the concept of space in regard to time, time as circle "B".

In using 3d space, an extra two "1" units are brought together in the context of a  $\pi$  time-circle to result in a value of  $\sqrt{2}$  as the space representation of circle "C". Not only this, the  $\phi$ -algorithm for time in regard to a circle "D" is brought into play as the value of  $\sqrt{3}$  as the diameter of circle "D". So, the distance between A<sub>1</sub> and A<sub>2</sub> as a spatial representation of circle "B" is being factored with  $\sqrt{2}$  and  $\sqrt{3}$ . Yet the basic premise of time as  $\pi$  for circle "B" as established in paper 15<sup>113</sup> needs to be upheld, thus this  $\pi$  value can be equated to the values of  $\sqrt{2}$  and  $\sqrt{3}$  by the absolute association that has been measured in  $\sqrt{2}$  and  $\sqrt{3}$  joining A<sub>1</sub> and A<sub>2</sub> using circles "C" and "D", as follows (equation 11):

$$\sqrt{2} + \sqrt{3} \cong \pi \quad (11)$$

What this equation simply means is that the distance *in time* that circle "B" can absolutely walk (i.e.,  $\pi$ ) can only be represented through 3d space using those two associated lengths of  $\sqrt{2}$  and  $\sqrt{3}$  as per equation 11. It's not an exact match ( $\sim 0.15\%$  error to the known value of  $\pi$ ), yet a telling association; the error is a good way of saying that there is still more to the idea of associating the concept of dimensional time with dimensional space.

The proposal therefore is to incorporate this  $\sqrt{2} + \sqrt{3}$  scheme as a proxy feature for *dimensional*  $\pi$  as the overall basis for how  $\pi$  is accounted for by this dimensional expression using the time-equation. Let this value be considered as  $\pi_\delta$ .

In therefore considering the general dimensional  $\pi$  feature, and the derived time-equation value for  $\pi$  as  $\pi_\phi$ , the proposed  $\pi$ -error would represent the derived quantum wave function value for  $\pi$  as  $\pi_\phi$  minus its true value, per the only way  $\pi$  can dimensionally walk with the quantum wave function dimensional restrictions. It therefore follows there would exist a  $\pi$ -error, say  $\pi_\epsilon$ , as per equations 12-13.

$$\pi_\epsilon = \frac{\pi_\phi - \pi}{\pi_\delta} \quad (12)$$

$$\pi_\epsilon = \frac{3.14164079 - 3.141592654}{\sqrt{2} + \sqrt{3}} = 1.5299544 \cdot 10^{-5} \quad (13)$$

This value thence needs to be applied to the *overall quantum scale of the proposed atomic radius*, as shall become apparent ahead.

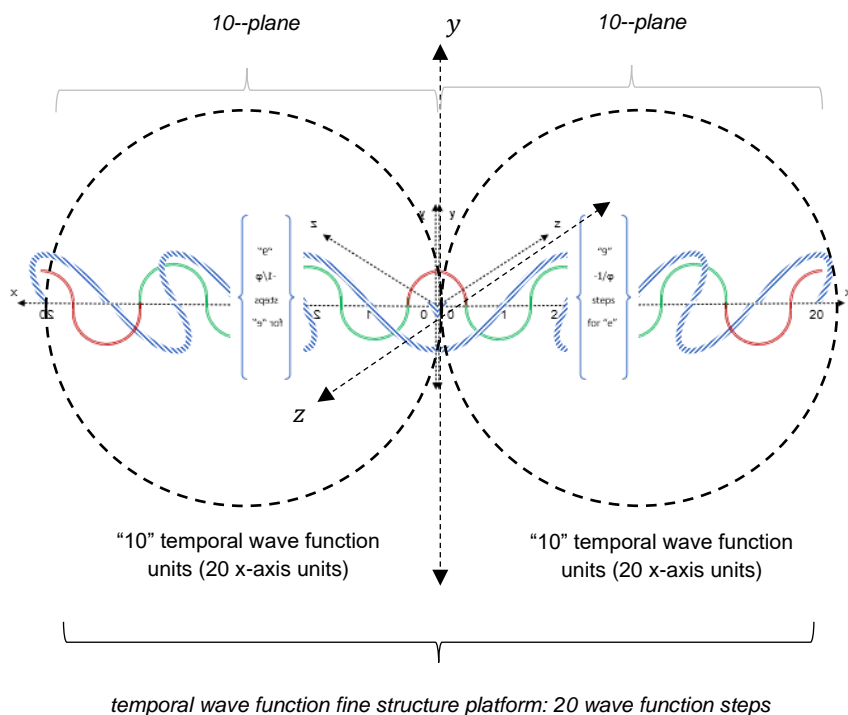
---

<sup>113</sup> [15]: p5-7, eq4.

13.3 The wave function proxy fine structure value

One feature to note by the derived temporal wave function is its 2d nature with 3d space, namely the spatial and temporal axes are derived as 2d planes along each 3d axis. In looking at the actual electric (green line) and magnetic (blue line) *binding facility* of those spatial and temporal 2d planes along each axis, and thus a primary feature regardless of the need to have a full electric wave function unit expression yet the basic  $10\pi$  condition as prescribed by equation 2, consider paper 52 figure 17 as an adaptation of paper 52 figure 14 and figure 16a, here as figure 38 highlighting two temporal wave function 2d planes, each as a “10-plane” circle, mathematically as a plane as the surface of each circle.

**Figure 38:** A temporal wave function 10-plane, namely “10” temporal wave function units as the basic temporal wave function scale in addressing the basic  $\pi$ -requirement of equation 10.



Proposed here is a basic plane of influence for a basic “20-plane” proxy atomic scale, namely 10 wave function steps for each  $x$ -axis vector direction as an  $x$ -axis calibration, thence for 10 temporal wave function units from a 0-reference as each 10-plane proxy atomic scale circle. Such is proposed to represent a basic uncalibrated scale range and not calibrated to 22 wave function steps, as per paper 52 figure 17; here is not a proxy atomic radius per se, yet this new temporal wave function plane accounting for the baseline equations 1 and 2 graphically to account for a full quantum binding facility between the electric and magnetic features of the quantum wave function.

The proposal now is that it is possible to derive a temporal wave function *EM binding strength* 10-plane (2d) platform with the values of equations 1 and 2 while addressing this basic temporal wave function 10-plane (thence 20-plane) of influence (the  $\pi$ -requirement)



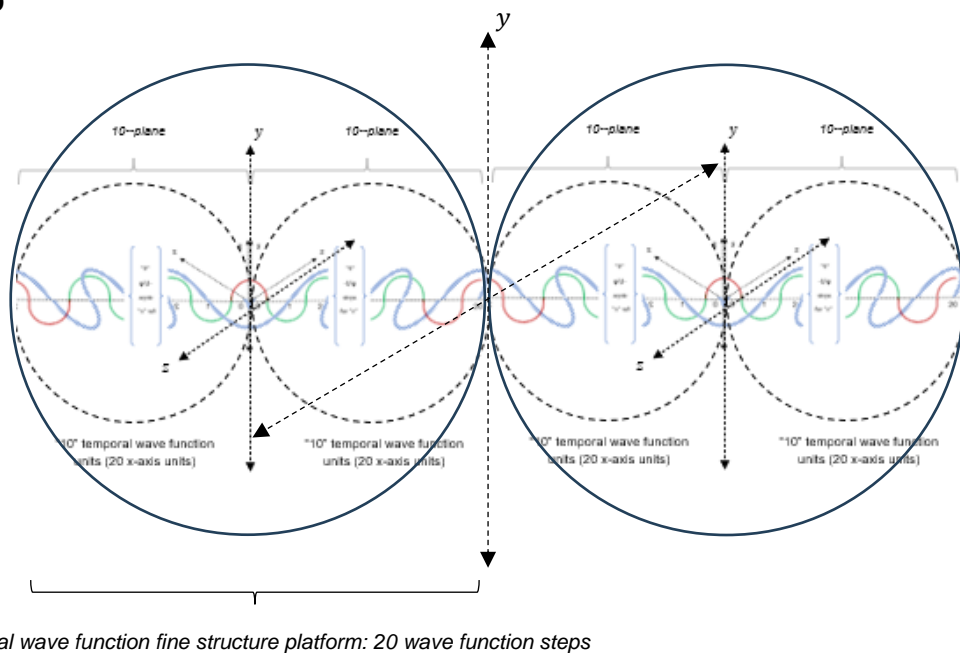
The *10-plane* of influence for each direction of the *x*-axis from 0 (as described in paper 52 figures 16a and 16b, here as figures 28-29) is proposed to represent the basis for  $\pi$ , as 10 is the number of wave function steps (units) that the derivation of space (from the time-equation) finds most closely matching the true value for  $10\pi$  as per equations 1-2 namely  $(\varphi \cdot -2\sqrt{3})^2 = 31.41614079$  as the proxy-*electric* component of the temporal wave function. The associated proxy-*magnetic* component of the temporal wave function there is as per equation 1, namely as  $(\frac{-1}{\varphi} \cdot -2\sqrt{3})^2 = 4.583533$ . Let this value be considered as  $\mu$ , the considered *magnetic factor* of the temporal wave function.

Thus, the proposal here is that the electric component for the temporal wave function is associated to the value of  $\pi_\phi$  (as 3.14164079), and the magnetic component for the temporal wave function is associated to the value of  $\mu$  (as 4.583533) as a proxy for each other despite the primary condition<sup>114</sup> of the time-equation having the magnetic component as  $\varphi$  and electric component as  $\frac{-1}{\varphi}$ .

It would therefore follow that, with this new process of considering the electric and magnetic feature of the quantum wave function, the ratio of  $\pi_\phi$  and  $\mu$ , as  $\frac{\pi_\phi}{\mu}$ , represents the value of 0.6854102.

The next proposal is to consider this ratio as a temporal wave function *scale* that can be translated as a 2d temporal wave function plane for the 10-plane scaled temporal wave function for each direction of the vector *x*-axis from 0 (see paper 52 figure 17, here as figure 39). A plane is considered here given that the temporal wave function is being considered as a 2d plane of dimensional time and space inter-activity. Consider figure 39.

**Figure 39**



<sup>114</sup> According to paper 2 equations 3-4, [2]: p10, eq3-4.



The *electric-based* flat-plane surface area value proposed for the quantum wave function per the *magnetic-value* is proposed as a double value for  $\frac{\pi_x r^2}{\mu}$ , the value for  $r$  here being "10" for each *10-plane* of influence. Thus, the following equation value becomes apparent:

$$\frac{2\pi_x r^2}{\mu} = 137.08204 \quad (14)$$

This value is how it is constructed, the singular dimensional quantum wave function electric-based flat plane surface area per its quantum wave function magnetic value. Yet the *EM binding strength* of this quantum wave function should be per the *electric-based* flat-plane surface area value, and so the proposed EM binding strength of the quantum wave function is proposed to be as equation 7.

$$\frac{\mu}{2\pi_x r^2} = \frac{1}{137.08204} \quad (15)$$

Consider this value as  $\alpha_X$ , ( $X$  being symbolic for the roman numeral 10, here in reference to the *10-plane*) as equation 13:

$$\alpha_X = \frac{1}{137.08204} \quad (16)$$

The proposal here therefore is that the temporal wave function *fine structure*  $\alpha_X$  value as a basic *10-plane* scale represents the blueprint for what becomes the fine structure constant value of  $\alpha$ , the actual value there being  $\frac{1}{137.035999}$ .

To note is that  $\alpha$  (by definition) represents the EM binding strength of charge to the EM field itself, yet here the value for  $\alpha_X$  is the binding strength of the EM field alone.

$\alpha_X$  is thus proposed to be a more fundamental fine structure value than  $\alpha$ , as a temporal wave function *fine structure platform*.

Essentially,  $\alpha_X$  represents the magnetic component of the *10-plane* **per** the electric surface area component of the *10-plane*, forming the *basis* for the *actual* fine structure constant value  $\alpha$  as derived in paper 39<sup>115</sup> according to the descriptive definition of the fine structure constant, namely:

- (cv) A measure of the basic and primary electric feature of the atom quantifying the strength of the electromagnetic interaction between elementary charged particles as related to the elementary charge  $e_c$ ,
- (cvi) Thence denoting the strength of the coupling of an elementary charged particle with the EM field of the atomic locale.

---

<sup>115</sup> [39]: p46-52.



Thus,  $\alpha_x$  is **not** the proposed *actual* known fine structure constant value, for here  $\alpha_x$  is derived specifically as the baseline fine structure constant factor, the proposed fundamental blueprint for the fine structure constant  $\alpha$ , here as that which defines a ratio between the proposed *electric* and *magnetic* features of the temporal wave function, and thus  $\alpha_x$  being symbolic of the actual binding strength of the temporal wave function.

#### 13.4 Incorporating the $\pi$ error $\pi_{\alpha\epsilon}$ into the wave function atomic locale

One proposal to reach the known value for  $\alpha$  ( $\frac{1}{137.035999}$ ) is that one must consider the fine structure constant is the electromagnetic binding strength of charge to the EM field, and thence the *apparent* binding strength of the EM field to the atom. Here therefore  $\pi_\epsilon$  needs to be considered in regard to the proposed full atomic radius of 22 quantum units, namely in being integral to the derived  $\alpha_x$  value, and thence needing to be subtracted from it. The proposal therefore is to take the value of  $22\pi_\epsilon$ , factor it to  $\frac{1}{\alpha_x}$  and thus to 137.08313, and then subtract that resultant value from  $\frac{1}{\alpha_x}$ , as per equations 10-11.

$$\frac{1}{\alpha_x} - \left(22\pi_\epsilon \cdot \frac{1}{\alpha_x}\right) = \frac{1}{\alpha_\Delta} \quad (17)$$

$$137.0820405 - (3.365899683 \cdot 10^{-4} \cdot 137.0820405) = 137.0359 \quad (18)$$

This value is **not** though the binding strength of charge to the EM field, yet the binding strength of the EM field to dimensional space, a value  $\frac{1}{137.0359}$  which is slightly higher than the binding strength of the EM field to charge as  $\frac{1}{137.035999}$ .

Consider this  $\frac{1}{137.0359}$  as  $\alpha_\Delta$ , namely the binding strength constant for the quantum wave function in dimensional space.

To understand the binding strength of electric charge  $e_c$  to the quantum wave function, first the speed of light  $c$  needs to be calculated and if there are any derived errors there that need accounting for in view of the  $\pi_\epsilon$  feature of the quantum wave function.

#### 14. Quantum's relativistic speed of light scaling and surveying key $c$

The next question to ask is what the progenitor value as a spatial dimensional value represents as  $\frac{2\pi_x r^2}{\mu} = 137.08204$ , as what appears to be a dual surface area  $2\pi_x r^2$  per a dimensional spatial value  $\mu$ .



The proposal is that this 137.08204 value **must equate** to the circumference of this **progenitor atomic locale**. Thus, the radius of this progenitor atomic locale, say  $r_{\alpha_x}$ , is held in the following equation:

$$2\pi r_{\alpha_x} = 137.08204 \quad (19)$$

$$r_{\alpha_x} = 21.817 \quad (20)$$

This value  $r_{\alpha_x} = 21.817$  therefore represents the proposed quantum unit radius of this progenitor atom. This significance of this value becomes apparent when asking how many full quanta wave function steps this 21.817 value represents, and the answer to that is "21", a value which then leads to the formulation for the progenitor value for the speed of the quantum wave function as  $c_x$  as shall be described ahead.

To now note is that this derivation of the quantum wave function has been described in the as 21 full quantum wave function units :

- (cvii) This 21-step quantum wave function process on each side of the  $x$ -axis (+ve and -ve) each arise from **two** central points along each axis, as shown in figure 40 as two points of origin, A and B.
- (cviii) These wave function steps (cvii) are *temporal* steps, as what the quantum wave function is derived from, namely the time-equation  $t_B + 1 = t_A$ .
- (cix) Therefore, there are 10.5 temporal wave function steps from each axial wave function point source A and B, and thus two point sources for each axis, and thence  $6 \cdot 10.5 = 63$  *temporal scales* to be considered for the  $x, y, z$  axes.

Consider figure 40 explaining this.

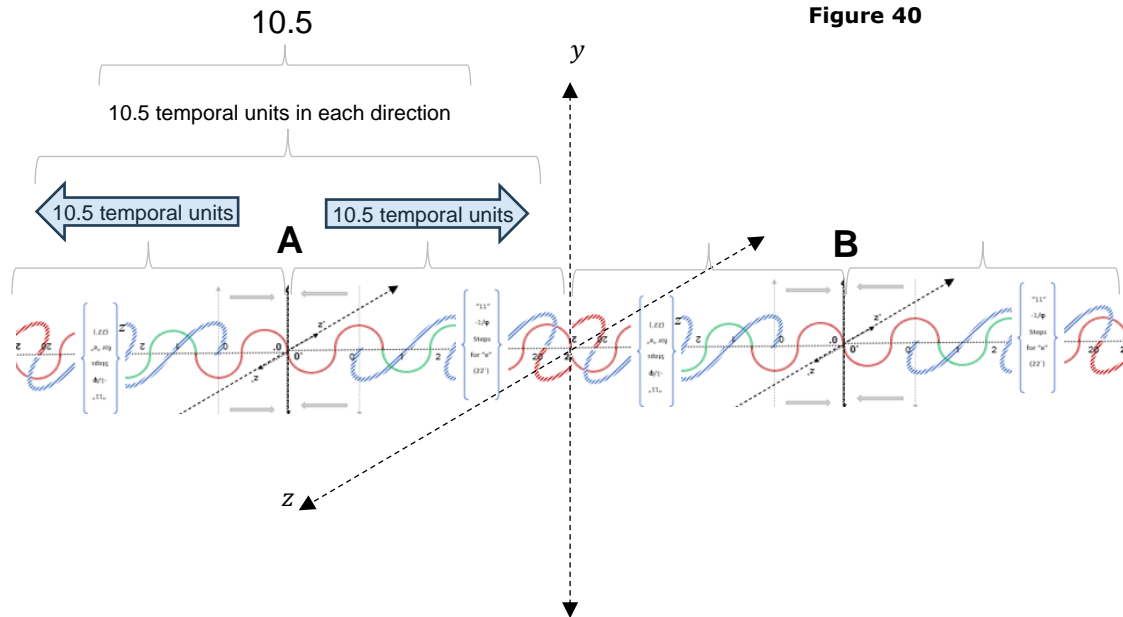


Figure 40

As an absolute dimensional survey therefore, in all there are 6 independent 10.5 temporal steps for the 3 axes, 2 for each axis, and thence a value of 63 temporal scaled units, noting that all of such is associated to the intrinsic golden ratio quantum wave function *cubit hedging requirement*.

To note is that this fine structure binding *compression* of the quantum wave function as based on the primary cubit hedging ( $\frac{\pi\Phi}{6}$ ) is being accounted for by *identifying* the result of the  $\frac{\pi\Phi}{6}$  hedging and then asking what function this hedging serves in this temporal surveying manner.

The next step to ask is what happens when time and space are brought into association, specifically into *relativity* in regard to this quantum wave function hedging, yet more precisely, the  $\frac{\pi\Phi}{6}$  scaling key.

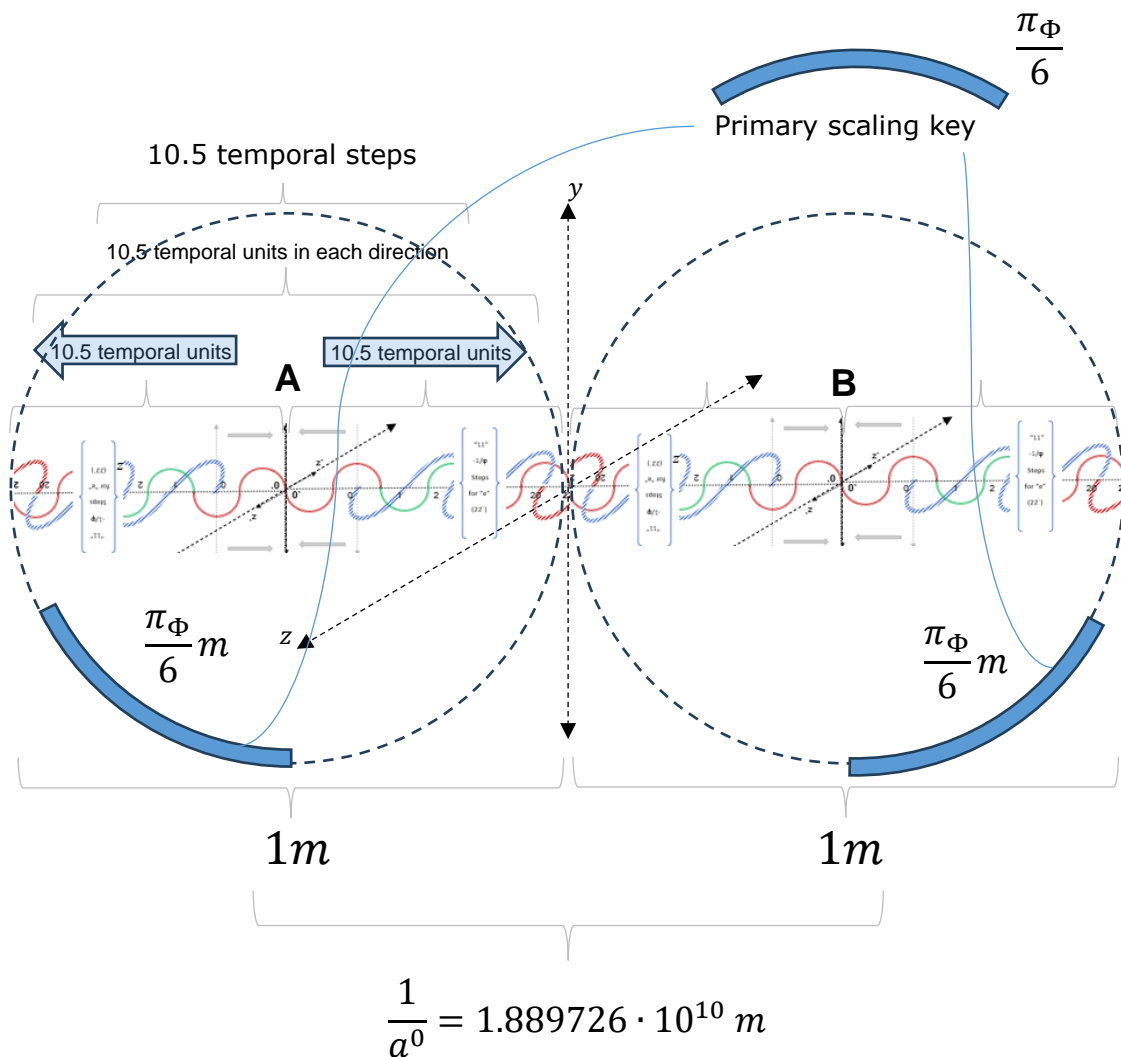
To approach this answer, if therefore:

- (cx) a surveying scale is used as 1 metre ( $m$ ), *arbitrarily*, for a quantum wave function step for this 10.5 temporal value, noting such a value is a diameter for each A and B (figure 40) circles,
- (cxi) a step (cx) which thence grants  $\frac{\pi\Phi}{6}$  the value of  $\frac{\pi\Phi}{6} m$  as the proposed *metric royal cubit* as the *primary hedging/scaling key* for the constructed quantum wave function and associated proxy atomic radius analogue (pre-scaling),
- (cxii) and so then to test such a *proxy atomic radius analogue* the known Bohr radius  $a^0$  value is factored into the proposed  $1m$  diameter value,
- (cxiii) thence (cxii) as a value of  $\frac{1}{a^0} m$ :
  - i. noting that this value  $\frac{1}{a^0}$  is still a metric value,
  - ii. namely, here the  $1m$  function is having the Bohr radius  $a^0$  value factored into the  $1m$  value,



- iii. thence presenting how many Bohr radius  $a^0$  units fit into the  $1m$  scale as a new metric scale for the  $\frac{\pi\Phi}{6}$  function,
  - iv. namely the  $\frac{\pi\Phi}{6}$  function of hedging and thence scaling/limiting the quantum wave function as a process of space in time,
- (cxiv) this (cxiii) thence represents a value of  $\frac{1}{5.2917721 \cdot 10^{-11}}$  and thence  $1.889726 \cdot 10^{10} m$  as a metric spatial hedging scale for the primary derived metric royal cubit  $\frac{\pi\Phi}{6} m$  function.

Consider figure 41 describing this process.



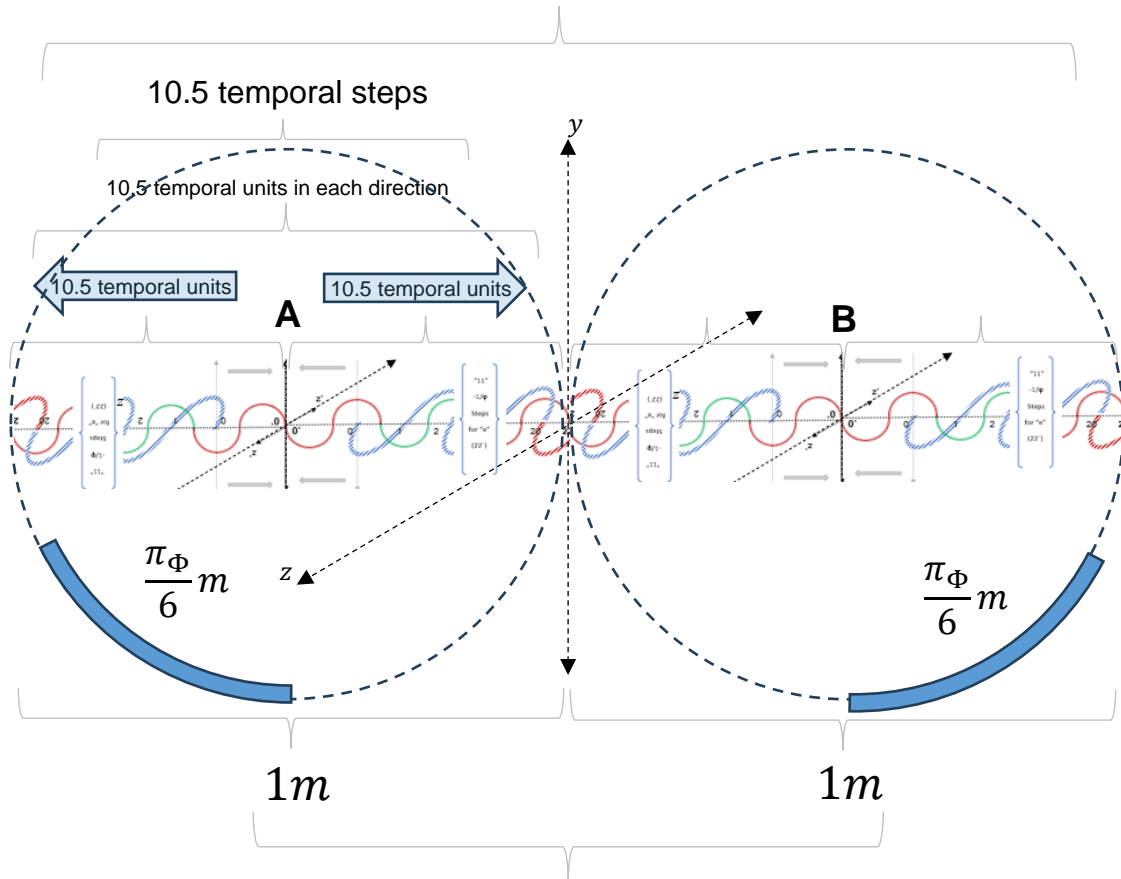
**Figure 41:** here  $\frac{\pi\Phi}{6}$  is the primary quantum wave function scaling key which when factored as a metric requires the Bohr radius  $a^0$  to be factored into the resultant  $1m$  diameter to test the proxy atomic radius analogue with the known atomic radius value  $a^0$ , resulting in a new scaling value of  $1.889726 \cdot 10^{10} m$ .

The next step here is to take this new metric scaling value for spatial distance and factor within it the *dimensionally surveyed* 63 temporal units (for the 3 axes) as seconds (s). By such, the following results:

$$\frac{1.889726 \cdot 10^{10} \text{ m}}{63 \text{ s}} = 2.9995650794 \cdot 10^8 \text{ m.s}^{-1} \tag{21}$$

Consider figure 42 describing this process.

10.5 temporal steps  
for each axis direction = 63 temporal steps,  
proposed as 63 s (seconds)



$\frac{1}{a^0} = 1.889726 \cdot 10^{10} \text{ m}$  as the distance of each temporal axis direction.

**Figure 42:** although the distance of each temporal axis direction is 1 m, the derived Bohr radius scaling factor of  $1.889726 \cdot 10^{10} \text{ m}$  is anchored as a single value owing to its primary single  $\frac{\pi\Phi}{6}$  scaling base. Here though this  $1.889726 \cdot 10^{10} \text{ m}$  value is be proposed to have the overall secondary 3d (3-axis) value of 63 as 63 s (seconds) factored into it. The purpose of this is to test if this value is significant for how time is factored into space dimensionally for this proposed quantum wave function model.



This value, say  $c_x$  (equation 21), translates the idea that the *relativity for distance and time* and thus motion for any point in 3d space is limited by the quantum wave function speed value of  $2.999565 \cdot 10^8 \text{ ms}^{-1}$ . The important idea to consider here is that only one Bohr radius scaling value of  $1.889726 \cdot 10^{10} \text{ m}$  is used given how it is anchored to the primary  $\frac{\pi\Phi}{6}$  scaling key, yet *per* the secondarily derived full 63 quantum temporal steps as  $63 \text{ s}$ , suggesting therefore that the resultant value ***is independent of axis direction, a known feature of light, namely a constant speed regardless of directional and thence relative motion.*** Thus:

*It would therefore appear that the  $\frac{\pi\Phi}{6}$  metric royal cubit scale is a hedging and scaling key for the quantum wave function, mandating the progression of the quantum wave function to a speed of transmission as  $2.999565 \cdot 10^8 \text{ ms}^{-1}$  for every point in 3d space as a set value, irrespective it would seem of any other relative dimensional direction and thence motion, and thus being a condition of the quantum wave function's existence.*

To include the  $\pi_\epsilon$  factor therefore into this  $c_x$  value, a value of  $(\frac{5}{6} \cdot \pi_\epsilon \cdot d)$  as the circumference of light for the whole proposed proxy atom needs considering. For the proxy atomic radius of 21 quantum units,  $d$  here is 42. The following equation therefore represents the  $\pi$ -error for light, as  $\pi_{\epsilon c}$ :

$$\pi_{\epsilon c} = \frac{5}{6} \cdot \pi_\epsilon \cdot d \quad (22)$$

$$\pi_{\epsilon c} = 35 \pi_\epsilon = 5.3548404 \cdot 10^{-4} \quad (23)$$

Although this may seem to be the only error in play for light as this calculated circumference of light for the atom, the next error to be calculated is one more fundamental, having to involve the dimensional aspects of the volume of the basic proxy atom and the core  $\frac{1}{\varphi^2}$  code at play there. Although the  $\varphi^2$  code has been useful for deriving the royal cubit scaling feature of light, here the  $\frac{1}{\varphi^2}$  feature of the dimensional equation  $\varphi^2 + \frac{1}{\varphi^2} = 3$  needs to be considered.

Here, the proposal is that there exists an error fundamental to the 3 dimensions of space separate to  $\pi_\epsilon$  yet associated to the 3d volume of the basic proxy atom as the value of  $\frac{1}{\varphi^2}$  per the volume of the proxy atomic volume. Call this error value  $\varphi^{-2\epsilon}$ , basically as the error feature of  $\frac{1}{\varphi^2}$  in the context of the 3d space equation  $\varphi^2 + \frac{1}{\varphi^2} = 3$ , noting that if  $\varphi^2$  is in play for the quantum wave function's feature of  $c$ , then  $\frac{1}{\varphi^2}$  is not, and so must be subtracted in the context of 3d space and thence the volume of the proxy atom. This error therefore represents a value according to the following equation where here  $r$  is the value of the basic 20 quantum units for the basic proxy atom:

$$\varphi^{-2\epsilon} = \frac{\varphi^{-2}}{(\frac{4}{3}\pi r^3)} = 1.139846 \cdot 10^{-5} \quad (24)$$





The proposed error for  $c_X$  therefore is as  $c_{X\varepsilon}$ :

$$c_{X\varepsilon} = \pi_{\varepsilon c} + \varphi^{-2\varepsilon} = 5.468825 \cdot 10^{-4} \quad (25)$$

This  $c_{X\varepsilon}$  value therefore needs to be factored into  $c_X$  and thence subtracted from  $c_X$  to arrive at the proposed value for  $c$ :

$$c = c_X(1 - c_{X\varepsilon}) = 2.99292459 \cdot 10^8 \text{ ms}^{-1} \quad (26)$$

The known value for light is  $2.99292458 \cdot 10^8 \text{ ms}^{-1}$ . Here to note is that in each calculation step numbers have been used to identify how the dimensions are not only constructed yet how features of the dimensions play out on that construction, all as a fundamental description of that proposed functionality in and of the dimensions. To also note here is that all derived equations are not absolute yet exist in a scaled compromise with each other, as their process of dimensionally fitting with each other.

Given therefore this  $\varphi^{-2\varepsilon}$  error is separate to the  $\pi_{\varepsilon}$  feature, one would consider this  $\varphi^{-2\varepsilon}$  would need to be factored into the derived  $\alpha_{\Delta}$  value. Indeed, it would, yet as it would seem not as directly as with accounting for the value of  $c$ , as  $c$  and  $\alpha$  are two different concepts entirely. Here also to note is that  $\alpha_{\Delta}$  is the binding strength of the *EM field to dimensional space*, a value  $\frac{1}{137.0359}$  which is slightly higher than the binding strength of the *EM field to charge* as  $\frac{1}{137.035999}$ .

The proposal here is to add to the circumferential value of  $\frac{1}{\alpha_{\Delta}}$  as 137.0359 a new dimensional error  $\varphi^{-2\varepsilon}$  *factorial* that accounts for how the EM field *is packed into dimensional space*, namely the most basic number of dimensional packing orientations and thence numbers that can be used that need to be accounted for. This was derived in paper 4<sup>116</sup> as the  $c$  packing<sup>117</sup> idea for charge  $e_c$ . So, here this charge facility is being added to the circumferential feature of  $\alpha_{\Delta}$  and thus to  $\frac{1}{\alpha_{\Delta}}$  as 137.0359. Consider this packing value as  $\frac{\varphi^{-2\varepsilon}}{15}$ , as  $\varphi^{-2\varepsilon c}$ :

$$\frac{\varphi^{-2\varepsilon}}{15} = 7.59897 \cdot 10^{-7} \quad (27)$$

Thus, as a recalibration for  $\frac{1}{\alpha_{\Delta}}$  and thence  $\alpha_{\Delta}$ :

$$\frac{1}{\alpha} = \frac{1}{\alpha_X} (1 + \varphi^{-2\varepsilon c}) = 137.036004 \quad (28)$$

$$\alpha = \frac{1}{137.036004} \quad (29)$$

<sup>116</sup> [2]: p17-21.

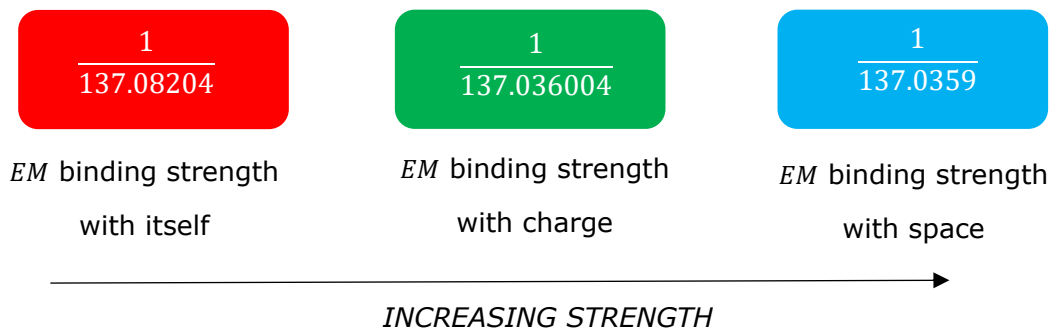
<sup>117</sup> Interestingly, the "packing colouring" problem and its proposed solution arrives at the same value, 15 [82].



Here, the value of  $\alpha$  is correct to 9 decimal places of the currently accepted value for  $\alpha$  as  $\frac{1}{137.035999}$ .

Here would therefore be not how the quantum wave function binds to free space as  $\alpha_\Delta$ , yet to the packing of the quantum wave function in regard to the atom and thence in regard to charge  $e_c$ . Simply, the quantum wave function is packed in the atom according to an absolute minimum number of ways, for efficiency, as accorded by time not passing as  $c$ , namely accorded by the idea of absolute zero-dimensionality for time's moment. That then leads to how the idea of *electric charge*  $e_c$  is formed as the electron that jumps in a shell to release light, described in paper 2, pre-empted in paper 1. Consider figure 43 explaining the comparative scales for the different types of binding strength for the quantum wave function, and why energy is generally released from the atom.

**Figure 43**



The indication here is that EM has greatest binding strength, and thence greatest affinity, with free space. Such is a clear indication of what would be the nature of EM, namely how it would progress in time, and thence the affinity of EM to be released from the atom to find itself in free space. On a large scale, here is the basis for a solar system releasing light for that light to find free space in its most fundamental sense. As figure 43 though shows, EM tends to decay or be altered on that path, which means EM never finds absolute free space.

To ask what the proper scale of the atom should be therefore is to ask what the most appropriate binding strength feature in play would be, and here that is  $\alpha$ .

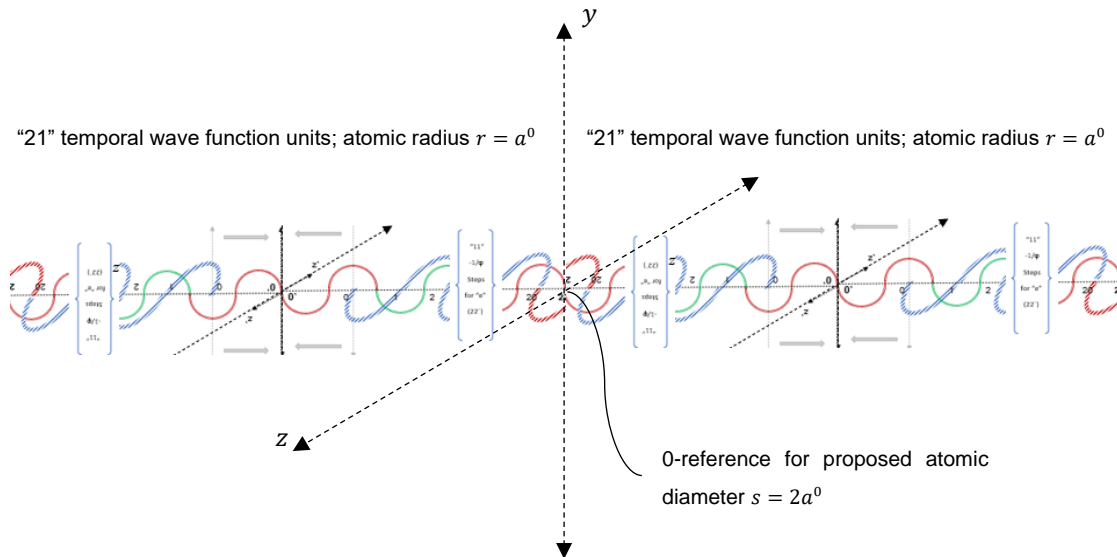
In now re-scaling the atom, in taking the derived  $\alpha$  fine structure constant atom, the value of  $r$  for the proposed resultant Bohr radius  $\alpha^0$  say as  $r_{\alpha^0}$  is 21.80996, which represents the new radius quantum wave function unit value of the atom as the number of quantum wave function units, as per equations 30-31:

$$2\pi r_{\alpha^0} = 137.036004 \quad (30)$$

$$r_{\alpha^0} = 21.80996 \quad (31)$$

This value  $r_{a^0} = 21.80996$  therefore represents the proposed quantum unit radius of this progenitor atom. Consider figure 44.

**Figure 44**



This would therefore suggest that a full quantum wave function “unit” process is a value of “21” for the radius of the proposed quantum wave function atom. It is thus shown that there is a locale for the quantum wave function to present itself in as a fluctuating wave with two aspects, considered as magnetic and electric, that have a binding relationship given by a value  $\alpha_x = \frac{1}{137.08313}$  on this level of consideration, a wave function that extends 21 “full” quantum steps in each direction in that overall locale.

Note that the binding strength of  $\alpha$  is greater than that of  $\alpha_x$ , and thus a greater binding strength, and thus a resultant compressed value for the atomic radius it relates to.

By such, this paper proposes the basis for an atomic-related ecosystem scale underpinning the functionality and relative scales of an atom and thence all other equations, and thence by proxy underpinning QFT, GR, and the standard model of particles. That process is proposed to use:

- (cxv) An exclusive  $\alpha_x \rightarrow \alpha$  scaling process, say as  $\alpha_{\leftarrow x}$ .
- (cxvi) Thus, a (cxv) compression process for the ecosystem of zero-dimensional derived phenomena related equation values.

Once again, to note is how TM-0D presents the basic platform for physical phenomena to manifest, that number theory and associated graphing blueprint, and then how the ecosystem of equations *must work together in the one context* as per the proposed *dimensional completeness*



*mandate* (DCM). The aim therefore with TM-0D has been to describe this number theory blueprint and associated graphing in a way consistent with what is observed of reality, with all physical phenomena considered.

What therefore becomes apparent is how the number theory can then be used as the basis for an ecosystem of derived equations that must conform with each other by their common number theory (B) context of derivation. By such it is possible to visualize the number theory virtual reality for time and space being proposed, and to then compare such to known physical phenomena data (C). Here thus far, importantly, is a derivation of a temporal wave function in space with precursory electric and magnetic features that when scaled with the known Bohr radius  $a^0$  demonstrates itself to be analogous to an EM wave function, termed as a *quantum wave function*.

Notwithstanding all of such, questions will always remain as to whether this zero-dimensional number based (B) and *temporospatial sentience code* filtered (A) process of dimensional number theory generation when scaled with physical reality (C) is how reality works. Ultimately for physics that answer comes down to what can be demonstrated by way of laboratory proof, and here TM-0D proposes a key experiment<sup>118</sup> as an advancement upon the experiment proposed in paper 57, an experiment though that quantum field theory (QFT) and general relativity (GR) by their constitution are unable to propose<sup>119</sup>.

## 15. TM-0D number theory preliminary results (1-59)

---

Importantly to note regarding the (A)→(B)→(C) results for TM-0D is that they only apply to its designed context, namely apparent static space. Conversely, the  $\Lambda$ CDM model proposes a universal *spatial expansion* based on the evidence for the redshift of light of galaxies<sup>120</sup>. How is such resolved?

The task for TM-0D was to focus on the derivation of the known phenomena of a static space locale and to cross-match those derivations with the data of a static-space locale such as this solar system, as per the following papers highlighting those derivations:

- (cxv) Spatial limit of solar system (Oort cloud)<sup>121</sup>.
- (cxvi) Distance to hydrogen wall from *Sol*<sup>122</sup>.

---

<sup>118</sup> Sections 17-20, TBA.

<sup>119</sup> [53][57].

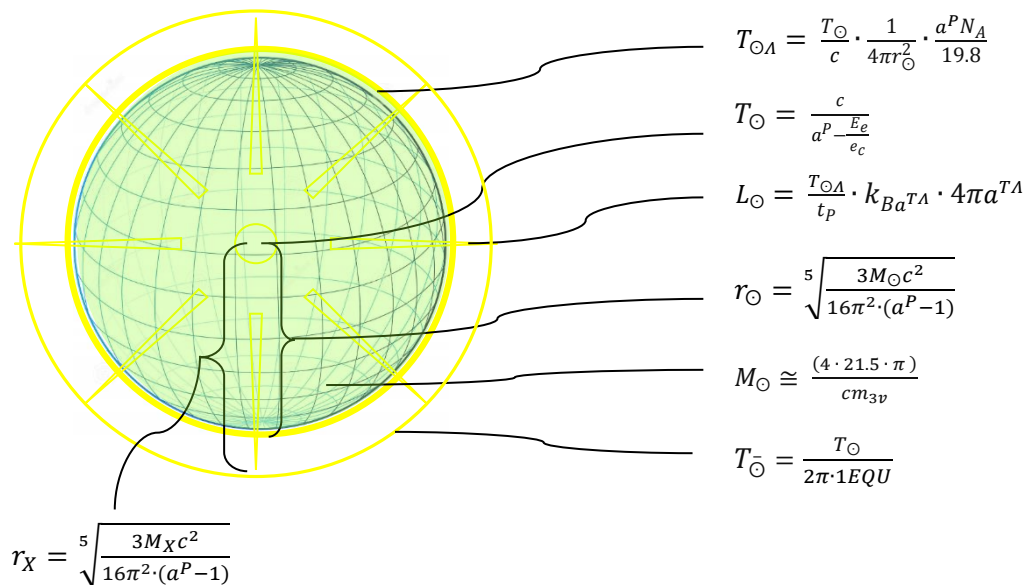
<sup>120</sup> With the  $\Lambda$ CDM model, the galaxies and their suns appear to exist in a static space locale suggesting the presence of cold dark matter (CDM) holding galaxies together in its broader proposed context of expanding space. It is also important to note that CDM has not been found to exist in a solar system locale, and that all modelling for our solar system presents the case for a stable spatial status quo.

<sup>121</sup> [13]: p11, eq6-8.

<sup>122</sup> [32]: p15-16.

- (cxvii) Depth of Hydrogen wall<sup>123</sup>.
- (cxviii) CMBR value<sup>124</sup>.
- (cxix) *Sol* mass<sup>125</sup>.
- (cxx) *Sol* radius (general and coronal)<sup>126</sup>.
- (cxxi) *Sol* temperature (core, surface, and coronal)<sup>127</sup>.
- (cxxii) Mercury perihelion<sup>128</sup>.
- (cxxiii) The dynamic nature of the solar system<sup>129</sup>

This (cxv)-(cxxiii) is highlighted in figure 45<sup>130</sup>; here, the scales of *Sol* are derived in using this *ab initio* zero-dimensional number theory and associated  $e_c$  and  $c$  scaling process, specifically in using the derived values of the fine structure constant ( $\alpha$ ) and Planck constant ( $h$ ).



**Figure 45:** Highlighting the phenomenal features of *Sol* from the derived fine structure constant ( $\alpha$ ) and Planck ( $h$ ) values.

<sup>123</sup> [32]: p16-17, eq6-9.

<sup>124</sup> [14]: p25, eq13; [37]: p29-31.

<sup>125</sup> [39]: p33-37.

<sup>126</sup> [39]: p61-62, p64-65.

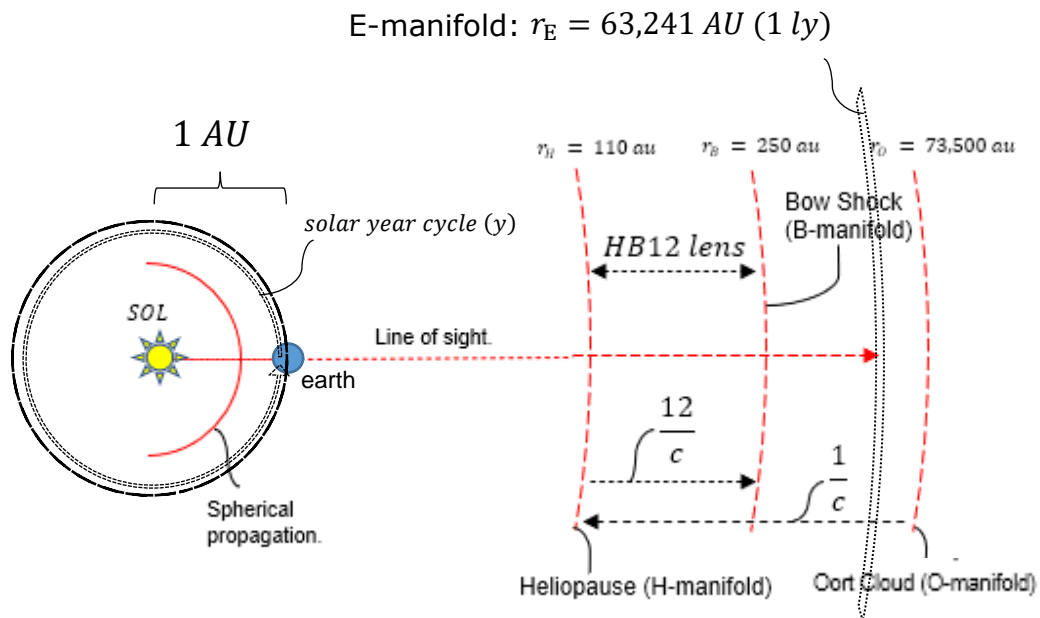
<sup>127</sup> [39]: p59-63.

<sup>128</sup> [14]: p27-28; [51]: p11-14.

<sup>129</sup> The dynamic nature of the solar system is described throughout paper 42 [42] in view of the inherent mismatch between the time equation and space equation, between EM and gravity, always seeking to correct each other. Such a concept was also described in paper 3 [3] in deriving the chaos equation, thence followed up in paper 51 [51]: p14-17. See also paper 39 [39]: p65-67.

<sup>130</sup> [39]: p65, fig14.

Another core achievement was deriving the scale of the known solar system astrophysical firmaments from *Sol*, namely the Heliopause, Hydrogen wall, and Oort cloud, as per figure 46<sup>131</sup>.



**Figure 46:** as per based on figure 1, paper 33 ([33]: p9, fig1), the distance of the  $r_E$  manifold is calculated using the idea of Earth as a solar year ( $y$ ) reference as one revolution around *ol* in accompanying the propagation of light from *Sol*, calculating this value thence as 63,241 AU.

With all such achieved, noting how precisely well the zero-dimensional number theory and thence zero-dimensional physical theory<sup>132</sup> compared and confirmed the known physical phenomena equations and associated physics data of the solar system, together with the microscopic scale features of light and particles<sup>133</sup>, two notable conditions became apparent, namely:

- (cxxiv) the description of light as per the time equation, described as the "*phi quantum wave function*", as flat timespace<sup>134</sup>, namely  $t_B + 1 = t_A$ .
- (cxxv) and the description of gravity, described based on spatial zero-point energy, as curved timespace<sup>135</sup>, namely  $e^{i\pi} + 1_{t_N} = 0_{t_A}$ .

<sup>131</sup> [39]: p66, fig15.

<sup>132</sup> Via the scaling process with the charge of the electron  $e_c$  and speed of light  $c$ .

<sup>133</sup> Subatomic and elementary particles.

<sup>134</sup> [2]: p1-14; [52]: p12-32.

<sup>135</sup> [42]: p22-55; [52]: p40-46.



In other words, the zero-dimensional number theory in proposing to be a more absolute infinitesimal description of the calculus processes for QFT and GR<sup>136</sup> presents the case that the equations and thence calculus for QFT must be different to that of GR, as they are. The finding therefore was that:

- (cxxvi) the description of EM is only possible via a flat spacetime approach in being independent of the derived *dimensional* nature of space, as per  $t_B + 1 = t_A$  where  $t_B^2 = t_A$ .
- (cxxvii) the description of gravity is only possible via a curved spacetime approach in being dependent on the derived *dimensional* nature of space, as per  $e^{i\pi} + 1_{t_N} = 0_{t_A}$ ,

In fact, the zero-dimensional approach confirmed key issues known to the phenomena of quanta<sup>137</sup>, mass<sup>138</sup>, and gravity<sup>139</sup> for static (non-expanding) space.

To note is that this zero-dimensional and thence dimensional number theory (B) when scaled<sup>140</sup> with known features of physical reality (C) confirms all the known data and associated descriptions of QFT and GR relevant to a *static* spatial backdrop scenario, and so *may appear* to be unable to delve into expanding space  $\Lambda$ CDM cosmology theory. However, the basic design of the zero-dimensional number theory posed the question of what existed before the big bang and if that same thing that existed before the big bang exists ahead of the current expanding space context of the big bang  $\Lambda$ CDM model, thence arriving at the  $0-\infty$  paradox for a point in space if indeed the big bang came from a point in space<sup>141</sup>. This paradox was resolved in using the proposed time-domains of *time-before* and *time-after*<sup>142</sup>. Upon such a basis, the zero-dimensional number theory when scaled with  $e_c$  and  $c$  was able to derive phenomena known to  $\Lambda$ CDM expanding space, a seemingly impossible task in not accounting for expanding space other than the scripting of the proposed  $0-\infty$  scaling paradox in the context of the  $\Lambda$ CDM model. How was this “*expanding space*” effect achieved?

In clarifying this issue, namely how such *expanding space* phenomena and associated data was retrieved/derived from/within a static space locale, it is important to note the basis of the zero-dimensional number theory. For instance, paper 43 [43] proposed the hypothetical point that existed *before* the big bang would still presumably be *ahead* of the current big bang as highlighted there in figures 21-23. By such, the zero-dimensional feature of TM-0D presented the window of view for the  $\Lambda$ CDM only regarding this *zero-dimensional* feature, and thence presumably, according to all the

---

<sup>136</sup> In being zero-dimensional and not infinitesimal.

<sup>137</sup> [52]: p12-36, p46-49.

<sup>138</sup> [52]: p36-40, p46-49.

<sup>139</sup> [52]: p40-49.

<sup>140</sup> Using the speed of light  $c$  and charge of the electron  $e_c$ .

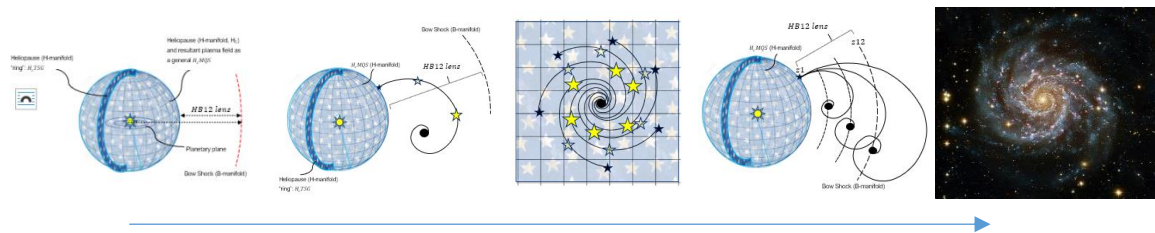
<sup>141</sup> As per paper 43 [43]: p2-5; see also figures 9.1-9.3.

<sup>142</sup> [43]: p6-8.

data, *phenomena in non-expanding space*<sup>143</sup>. Nonetheless, in apparent reproach to the  $\Lambda$ CDM expanding space model, the phenomena and thus information of what appear to be unique solar systems beyond this solar system, namely stars and galaxies, are derived by TM-0D through a newly discovered zero-dimensional number theory feature. There, a key discovery by the zero-dimensional number theory is a phenomenon not currently considered or scouted by physics, the “*electron degeneracy*” phenomenon which as the name suggests describes how the electron is derived to annihilate<sup>144</sup>, specifically to the level of a neutrino. There, that process is derived to represent a type of particle fission process of the electron into neutrinos, such as phenomena giving off the effect of miniature suns perceived as stars.

The region in the solar system where this *electron degeneracy* effect is derived to occur is in the Hydrogen wall, a region that then by its relationship to the derived 3d timespace<sup>145</sup> outer structure of the solar system leads to a holographic display of electron degeneracy events *beyond* the solar system, presenting the effect of a universe of stars and galaxies with associated spatiotemporal data, namely information *mimicking* the existence of stars and galaxies (including back holes) despite the overall context of its zero-dimensional and thence presumably complete zero-point status. This holographic display of astrophysical phenomena is described in papers 32-35 [32-35]. There, the *axis of evil* and *horizon* problems are accounted for by the zero-dimensional number theory<sup>146</sup>.

The astrophysical landscape as described in papers 33<sup>147</sup> and 34<sup>148</sup> became apparent via the proposed/derived  $r_E$  E-manifold context as the focus itself of virtual light activity filtered/adjusted through the derived  $H_cTSG$  and associated *HB12* schemes ([33]: p13-16, fig4-7), thence leading to the holographic display of astrophysical phenomena as per figure 47.



**Figure 47:**  $r_E TSG$  and associated *HB12* scheme from paper 33 ([33]: p13-16, fig4-8).

<sup>143</sup> Thence solar system phenomena, noting that GR implies it is the space around observed galactic phenomena that is expanding care of dark energy, whereby galaxies are held together and thence not expanding care of dark matter.

<sup>144</sup> Such, in the context of a derived *maximum solar system mass* event scenario ([39]: p41-47).

<sup>145</sup> See paper 52 ([52]: p8, xviii) for the definition of 3d timespace.

<sup>146</sup> Specifically, paper 32 [32], summarized in paper 50 [50].

<sup>147</sup> [33]: p5-19.

<sup>148</sup> [34]: p23-32.

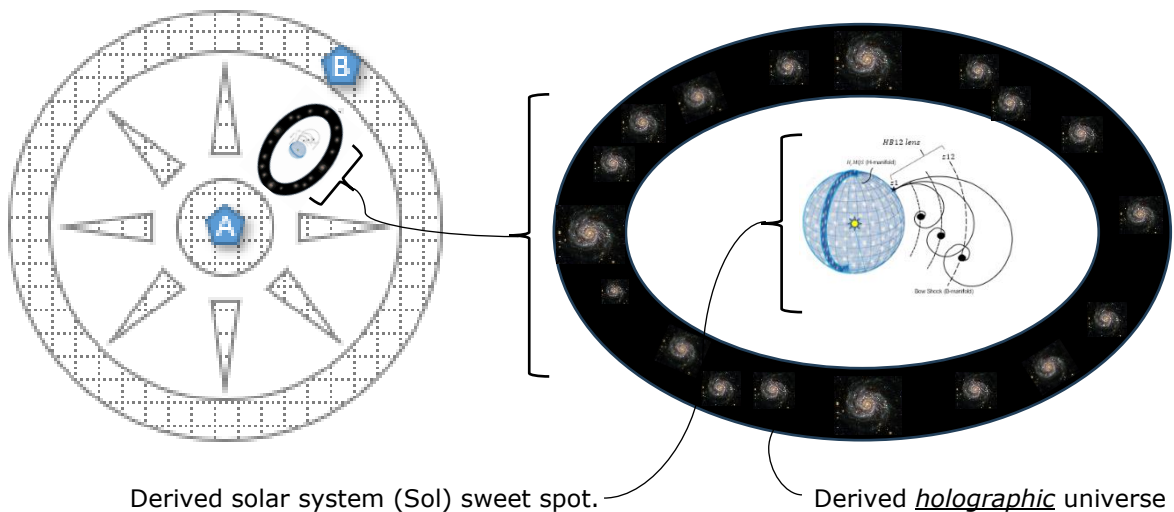


Such presented a case for a virtual/holographic universe of stars with our *Sol* being a part of a galaxy among billions of *virtual* galaxies each holding billions of *virtual* suns themselves. There, TM-0D accurately derived the  $\Lambda$ CDM's age of the universe, the distance to the apparent closest star Proxima Centauri, the apparent number of stars in our apparent galaxy, and the number of apparent galaxies in the apparent universe of stars<sup>149</sup>, including:

- (cxxviii) the number of galaxies to be estimated between 200 billion to 2 trillion, depending on how the data is being processed.
- (cxxix) the number of stars in the Milky Way to approximately number 400 billion.
- (cxxx) the age of the Universe to be 13.8 billion years, as according to the metric expansion of space  $\Lambda$ CDM model and associated star-light data available.
- (cxxxix) Proxima Centauri measured to be the closest star from *SOL* at 4.246 *AU*.

Such is not to say that the universe is not as GR based  $\Lambda$ CDM model proposes, yet that *in an absolute zero-dimensional **context*** the *information* of reality can be modelled if not contained and retrieved, an idea scouted by current black hole theorists [83][84], an idea though *derived* here by this new zero-dimensional number theory, suggesting how on a zero-dimensional level QFT and GR information is in fact *preserved*.

Consider figure 48.



**Figure 48:** (*not drawn to temporal or spatial scale*) the universal “sweet spot”, noting the zero-dimensional number theory correctly derived the “non-existence” feature of the universe (as a hologram in this case) given the zero-dimensional number theory takes the context of the moment **at** the big bang.

<sup>149</sup> [34]: p30.



Significantly, the zero-dimensional number theory correctly derives a holographic and thence illusionary universe as per its zero-dimensional basis, namely based on the 0-time and 0-space condition just before the big bang event, yet still identifies a “real” component in the big bang’s time-line of development, as what would appear to be the sweet-spot, namely the “blueprint” for the overall  $0-\infty$  paradox filtered  $\Lambda$ CDM event ***as this solar system***. This is a significant finding, as it implies a certain *archetypal significance* of this solar system in the context of the universe.

The key limitations nonetheless of the TM-0D zero-dimensional number theory are:

- (cxxxii) How the zero-dimensional number theory is designed to perform based on how numbers are employed to label zero-dimensional time and zero-dimensional space,
- (cxxxiii) Thence how dimensional space is proposed to emerge from the *time-before* and *time-after* paradigms,
- (cxxxiv) Thence how the number theory can only at best be applied to known observed features of physical reality care of dimensional physics, and thence infinitesimal calculus and associated physical phenomena-based data as tested by QFT and GR.

It is important to note in view of the proposed results that the zero-point gravity field is *atypical* by its nature, as zero-dimensionality is in comparison to infinitesimal calculus and associated theory developments. Yet by the zero-dimensional number theory several physical phenomena features contemporary physics cannot explain can be explained:

- (cxxxv) Time’s arrow<sup>150</sup>.
- (cxxxvi) Entropy<sup>151</sup>.
- (cxxxvii) Baryon asymmetry<sup>152</sup>.
- (cxxxviii) Fine structure constant<sup>153</sup>.
- (cxxxix) Derivation of the relativistic speed of light constant  $c$ .
- (cxl) Chaos equation describing randomness and thence Brownian motion<sup>154</sup>.
- (cxli) The *axis of evil* problem<sup>155</sup>.
- (cxlii) The *horizon* problem<sup>156</sup>.
- (cxliii) *Quantum (zero) gravity*<sup>157</sup>.

---

<sup>150</sup> [49]: p10-16.

<sup>151</sup> [42].

<sup>152</sup> [42].

<sup>153</sup> [39].

<sup>154</sup> [3][30][51].

<sup>155</sup> [32].

<sup>156</sup> [32].

<sup>157</sup> See sections 17-20, TBA.



The unanimous feature of concern for physics in any of its fields is the description of physical phenomena that defies physics' own current known theories for light and mass, namely phenomena that defies QFT and GR description processes. Such an unavoidable issue is so by virtue of the zero-dimensional zero-point gravity force being non-inertial by its constructed nature, by its genesis, namely by its zero-dimensional description origin. Without the zero-dimensional approach though the only alternative to such is in using mass and infinitesimal calculus and thence reaching QFT and GR.

In more carefully considering the zero-dimensional number theory approach and associated issues of description for GR and QFT, the following need to be considered for the new proposed description for gravity:

- (cxliv) The idea of "extending" dimensionality from a zero-dimensional basis is explored.
- (cxlv) Such (cxliv), as what is proposed to emerge as a *repulsive* effect of a zero-point time-space field.
- (cxlvi) Such (cxlv), thence representing an absolute time-space barrier repelling both EM and mass.
- (cxlvii) Such (cxlvi), proposed here as the *overall* resultant observed force of gravity.
- (cxlviii) Such (cxlvii), not as QFT or GR, yet as a more fundamental field force working in alliance with QFT and GR, as that *zero quantum gravity* bridge between the two.
- (cxlix) Such (cxlviii), as an eternally repulsive field *basis* as the "cause" that existed before the big bang and thus ahead of the big bang shock front of time and space.
- (cl) Such (cxlix), as a force that moulds dimensionality of time and space into the shape it is perceived in.
- (cli) Such (cl), therefore as a force that moulds the physical constants and associated equation descriptions they are calculated as per the space-equation.
- (clii) Such (cli), as a field force effect that seeks to restore and uphold those physical constants and associated equations when it as a field force effect is generated.
- (cliii) Such (clii), all in the one general zero-dimensional time and zero-dimensional space context.

The gravitational field effect<sup>158</sup> by such represents the very zero-dimensionality of time and space the dimensional systems of time and space are established upon incorporating the ideas of the *before-event* of the big bang and thence what's still ahead of the big bang as a code as a zero-dimensional field as a *type of repulsive effect from the zero-dimensionality keeping the laws of physics in play*. Such thence results in an apparent steady state solar system and associated holographic depiction of the stars beyond as per figure 49.

---

<sup>158</sup> [47].





- a. the age of universe.
- b. the general number of stars and grouping traits.
- c. the constitution of stars.
- (clv) The general CMBR value in the context of the holographic appearance of the universe of stars<sup>161</sup>.
- (clvi) The general background gravitational wave effect in the context of the holographic appearance of the universe of stars.

This result is perhaps significant, as it suggests that if the  $\Lambda$ CDM model is valid then:

- (clvii) The data of the perceived universe can be accurately measured using the physical theories of QFT and GR.
- (clviii) The data framework of the perceived universe can be derived as a zero-dimensional number theory bridging QFT and GR via a holographic astrophysical scaling process as confirmed by the data of the QFT and GR models and associated proposed zero quantum gravity phenomena<sup>162</sup>.
- (clix) The perceived universe can be measured and derived from within the universe at a certain stage of its development, namely in this current time of the proposed development of the perceived universe.

Of course, here the idea of being theoretic and thus conscious as a process of universal modelling poses new standards, namely:

- (clx) The basic idea of a virtual model of the perceived universe within the universe itself in *using* the idea of consciousness in that virtual modelling process could indeed as a process be an *emergence* from the perceived universe's development, if not a feature of its sweet spot of development in time.
- (clxi) The development of the sciences and technologies of these models would represent a key to exploring that same perceived universe in confirmation of the universe's constitution.
- (clxii) The development of perception and thus perceptive development would also represent keys to understanding how to access the perceived universe.
- (clxiii) There would exist a drive for us to pursue an astrophysical course of sentience ability, and thence presumably consider the stars to harbor sentient life.

Of course, these conclusions may seem intuitive, yet here they are derived from the zero-dimensional number theory when used with the temporospatial sentience code filter. Simply, TM-0D

---

<sup>161</sup> [37].

<sup>162</sup> As a proxy for dark energy ( $\Lambda$ ) and dark matter (CDM).



is only limited by the data that is available to demonstrate its efficacy. What eventuated therefore from paper 57 (C) were papers 58 and 59 central to the core logic (B) as paper 58 and associated *temporospatial sentience code* (A) as paper 59.

## 16. ABC TM-0D temporospatial sentience code QA test

---

Is it fair to suggest that the test for the sentience code being used is it being able to act as the basis for observing reality by deriving that reality? Although it is one thing to derive what is observed, the real question is to describe what is proposed to have existed and how long for.

As a general description of this dimensional time and space model derived from a proposed zero-dimensional logic basis, to note is that *dimensional spatial reality is still proposed to exist in the moment, one moment to the next*, yet the zero-dimensional (0D-1) condition proposes that the moment in time as zero-dimensional time is forever incomplete as a number theory<sup>163</sup>. It thence follows that physical reality is proposed to have always existed and always exist *temporally* in eternally seeking completeness. Yet, as per the DCM condition, spatial dimensionality in that eternity of time is proposed to be limited, to be complete. This is precisely what TM-0D derived for its cosmological model and associated holography of stellar phenomena in papers 32-35 [32]-[35]. This is also how the solutions to the Clay Mathematics Institute Millennium Prize problems are proposed to have been solved<sup>164</sup> in giving physical theory relevancy to the solutions.

If the question can be asked, “*can reality be a self-organizing complex of dimensions built on a basic code of the zero dimensions of time and space?*”, the answer is surprising, as that is the premise of the Big Bang theory, namely reality coming from nothing. Interestingly, the 0-∞ paradox is based on taking the idea of the ΛCDM model a step ahead of the Big Bang shock-front and a step before its proposed initiation, as highlighted in paper 43<sup>165</sup> in describing the 0-∞ paradox. Thus, here in this paper is the code of that self-organizing complex of dimensions in an *eternity* of time’s moment, one moment to the next, demonstrating that the ΛCDM model is not only *incomplete*, yet using a flawed theory for gravity<sup>166</sup> despite its apparent utility.

The fundamental code in this dimensional space process is identified as the metric value of  $\frac{\pi_{\Phi}}{6}$  as 0.5236068 *m*, noting the royal cubit metric as the value 0.5236 *m*. The question then is if the royal cubit metric value is significant to the metric value for of  $\frac{\pi_{\Phi}}{6}$ . Of course, the royal cubit metric is an arbitrary scale primarily defined by the length of the elbow to the tip of the middle finger, yet here by derivation the royal cubit as  $\frac{\pi_{\Phi}}{6}$  *m* is proposed to have far greater significance, particularly regarding the scaling and surveying of physical reality using “light”. Here, as evident by the further

---

<sup>163</sup> [46].

<sup>164</sup> [55].

<sup>165</sup> [43]: p2-3.

<sup>166</sup> [57].



steps required to derive the speed of light, the royal metric is a basic scale that needed to be superseded in using the  $\pi$ -error formula  $\pi_\varepsilon = \frac{\pi_\phi - \pi}{\pi_\delta}$  (eq. 12-13).  $\pi$  can thence be considered as the true scaling and surveying key, hence its use in the space-equation  $e^{i\pi} + 1_{t_N} = 0_{t_A}$ .

Some great implications of these derivations by virtue of the *temporospatial sentience code* include:

- (clxiv) The *temporospatial sentience code* could well be an axiom (self-evident) code of reality that is ever present.
- (clxv) We as humans could represent a type of aligned sentience with a universal system sentience, perhaps as an expression of a recognition of the past and unknowability of the future.
- (clxvi) If the *temporospatial sentience code* is used to check reality, then possibly reality uses such a code to check itself.
- (clxvii) We as humans could be essential to this function of reality checking itself, of being sentient, and thus sentience being a guarantee *if not testing process* of what is real.
- (clxviii) The distance from the elbow to the tip of the middle finger is a *preliminary* scaling and surveying code associated to our ability to physically measure reality that would implicate itself in scaling and surveying reality as though measuring oneself inside the workings of a grand astronomical clock.
- (clxix) This preliminary royal cubit scaling and surveying code would nonetheless need to be superseded by the  $\pi$ -error code to properly scale/survey space.

The ABC process therefore is proposed to be a feature of our natural temporal consciousness that we are accustomed to, yet not only such, have been accustomed to from our earliest beginnings in scaling and surveying reality. That earliest time of our sentience ability with the sciences may have indeed be expressed in a basic if not erroneous format, yet it was more than likely as all evidence suggests a format which then asked us as a species at that level of development *to find greater clarity and resolution for that ABC scientific expression*.

It would be logical therefore to consider that the next step from a basic royal cubit scheme would be to dive into smaller and smaller surveying processes of space, all the way to the atom, to find that  $\pi$ -error. This case was presented in paper 57 [57] and here in sections 4-15 as the only possible way we could measure physical data, namely the *infinitesimal* process, from the time of Zeno's paradoxes to today, which though has resulted in the two key streams of theory we have today, QFT and GR. Yet here the proposal is that such a process and associated physical data may need to be re-adapted to our basic sentience ability.

The possibility exists therefore that surveying all the way to the atom through the millennia has distorted our natural albeit basic theoretic view of reality, having us now become required to find a way back to our basic sentience code status (A) and that of the greater structure we exist within (C) in using the zero-dimensional number theory code (B).



Indeed, is it possible we judge our own selves, our own works, to whatever standard of judgement, to whatever scheme of fidelity, to ensure we are real, that we are legitimate? Can it thence be considered that the proposed *temporospatial sentience code* would be a baseline ability upon which further complexity can emerge by however that basis is instructed or rather naturally guided to emerge in complexity?

The over-arching *temporospatial sentience code* context description became evident in paper 59 [59] as the proposed model of consciousness, ultimately associated to the holographic projection of the stars from the Hydrogen wall which was shown by its derivation to be relayed to the Earth reference as per the  $c$  scaling and surveying feature. The thinking therefore is that such a process would represent how sentient life continues to emerge on Earth, namely through a grand macrocosmic reach of sentience from the holographic projection viewed as the stars to the Earth.

Constructed here therefore is a first step in that basic "overview" script of physical reality's scaling and surveying. Here therefore the ABC scaling and surveying system is what it says it is, a *fundamental* scaling and surveying system direct from a zero dimensional law of thought touchstone basis (B) filtered through the *temporospatial sentience code* (A) to confirm known data of physical reality (C).

As a scaling *and* surveying system, and thence implicit to the 3 dimensions of space, such is proposed to be fundamental to not just scaling physical phenomena yet deriving all the known features of physical phenomena, features such as energy, charge, and mass, all according to their known dimensional scales and metrics. This ABC scaling and surveying system is therefore a focus for reading through the 9 volume work of TM-0D. Presented here therefore have been key excerpts from key papers regarding this scaling and surveying process in identifying physical phenomena for what it is measured to be.

In all, perhaps the best analogy for reality is that we live in a great astrophysical clock that understandably prompts and notifies the use of numbers to our perception through astrological movements as a way of recording time's passage and what time it is now. Once again, proposed here is that numbers are *not reality* per se, yet certain associations of numbers associated to both zero-dimensional and dimensional analysis for time and space, associations that point to the right conditions for reality to present in as it does. Here that ABC astrophysical clock has been described in far greater detail than how the ancients used their format of the royal cubit.

The idea we live in a great astrophysical virtual reality clock, and thus naturally regard reality with numbers, must ultimately derive the idea of the greater temporal cavern of reality, that greater system virtual reality clock, a clock that is in fact not real itself yet a type of virtual reality background as a projection. And this is indeed what this theory has found, as it only could as a vast development of number relationships. That virtual reality projection, that greater universal clock, has been derived to be what we observe of the stars, specifically as a holographic projection of phenomena in our solar system's Hydrogen wall. This was presented in papers 58 [58] and 59 [59].

As mentioned in points (v)-(ix) numbers are proposed provide a way to describe reality from a certain zero-dimensional basis, thence creating a scale from 0 to  $\infty$ . In a grand astrophysical/universal clock system therefore, we would be inclined to identify and describe reality





with numbers, even ourselves such as our number reference as a birth/creation date in a certain context of time and a certain location in space, which is what most cultures commonly do.

Clearly, what does such have to do with physics? Why would such a discussion be entertained with those upholding the supposition that reality came into existence from the big bang? Here, the big bang supposition is being questioned and tested, tested in comparison to a zero-dimensional number theory when applied to our temporal awareness capability as our *temporospatial sentient code* ability and for what thence emerges as a dimensional (and not zero-dimensional) number theory for time and space to be tested as a dimensional number theory by solving what the ADCM seeks to achieve, namely a solution to quantum gravity<sup>167</sup>.

Here, the purpose of TM-0D is to ask how a model of the dimensions would emerge on the basis of how our perception is known to work with time as the new basis for describing physical reality, namely by abiding by our known constraints of temporal perception as the proposed *temporospatial sentience code*. Indeed, the constitution of that *temporospatial sentience code* requires faith in how we are aware of the future without the benefit of revelation, namely in accepting the future to be forever unknown if not for indications of the past bifurcating into the future, *much like an implicit code of free choice granted to human sentience* as we peer into the future. The constitution of that model also implies a type of universal sentience. So, indeed, this model not only is proposed to be useful for science, yet the idea of faith itself.

In short, the TM-0D dimensional number theory model is proposed to be a feature of our natural temporal consciousness that we are accustomed to, yet not only such, have been accustomed to from our earliest beginnings in scaling and surveying reality. As described here, the mere labelling of physical reality with numbers can only really be approached from a zero-dimensional number theory basis using a valid *temporospatial sentience code*. By such the *temporospatial sentience code* is considered as a compatible if not valid human analogous sentience description with reality.

## 17. ABC TM-0D ellipsoid structuration of gravitational space

---

### 17.1 The mathematics (B) of static space (C): (B)↔(C)

Considering the confirmed findings of the zero-dimensional number theory (B) when scaled with physical phenomena (C) in using the *temporospatial sentience code* (A), proposed here therefore is *the improbability* of finding a *dimensional infinitesimal* calculus link between QFT and GR. Such is not to say that a dimensional number theory link between higher and lower dimensions is not able to link QFT and GR as a quantum gravity theory, yet here the proposal *is to make use of* the calculated, derived, and thence known incompatibility of the current number theory structure between QFT and GR. By such, zero quantum gravity (0QG) is a term given to the idea of not

---

<sup>167</sup> [57].



focusing on the quest for dimensional quantum gravity yet that a pure number theory link between QFT and GR can be found via a zero-dimensional number theory approach.

As presented, TM-0D derives 3d space to be held together without massively expanding or contracting from and back to a big bang. This “holding together” of space is described mathematically by the space-equation  $e^{it_B} + 1_{t_N} = 0_{t_A}$ , as the zero-point gravity<sup>168</sup> equation. There, in that zero-dimensional description, gravity at its core is derived to be non-inertial and zero-point, such by the nature of its equation, namely in equating to 0. Such though does not make space without a certain shape regarding the fundamental features of EM and mass and of course *more importantly* what may exist sub-quantum.

The TM-0D theory approach presents an exclusive view of an *absolute* infinitesimal (zero-dimensional) approach to the dimensions, which would thus represent a valid ingredient to dimensionality to be explored and verified with data, something which it has both aimed to and demonstrated itself to achieve. Once again to note are figures 21-23 describing the 0-∞ paradox and how that was considered in the context of the  $\Lambda$ CDM model<sup>169</sup>. There, it is important to note that the static space condition of the zero-dimensional number theory does derive the condition of a zero-point gravity describing static space and how such then forms the basis for what is derived to be a *solar system* as per figures 45-48. These theoretic proposals have no change to the known data of the proposed QFT and GR static space phenomena in the context of the perceived  $\Lambda$ CDM model, specifically the expanding universe description of dark energy ( $\Lambda$ ) and cold dark matter (CDM). In fact, the proposals of the zero-dimensional number theory have utilized all QFT and GR data while then proposing a basis for *apparent* expanding space, thence providing a proxy description for dark energy ( $\Lambda$ ) and cold dark matter (CDM).

## 17.2 Equation squeezing (B) as a phenomenon (C): (B)=(C)

The big question for physics regarding zero-dimensional logic and associated derived equations is not only the zero-dimensional origin of the equations, yet how these equations relate to each other the way they do in constructing dimensionality<sup>170</sup>. For instance, why are the equations *squeezed together*, why must the equations yield to each other’s dimensional construction requirements, as it is not something contemporary physics considers applicable to its understanding of physical phenomena when using equations or is it?

For physics, equations are relevant to physical phenomena *brandings* and left at that. Indeed though, what is an equation if not a *squeezing* process of numbers with dimensional analysis, specifically to be as dimensionally numerically precise as possible with the use of numbers and the

---

<sup>168</sup> ([42]: p29, p51-56); ([52]: p39-45).

<sup>169</sup> As based on the physical data modelling and structuration of QFT and GR.

<sup>170</sup> Not as a random joining of numbers.



dimensions? Is not such what the Clay Mathematics Institute Millennium Prize quests<sup>171</sup> are in search of, namely how the dimensions squeeze together with numbers?

As presented in figures 14-18, equations themselves are incomplete if not for being relevant to a type of dimensional analysis they pertain to. Here likewise, the equation *squeezing/refinement* process is a way of determining how the known and tested and thence firm physical constants are related to all other constants by their dimensional construction, ultimately held in a physical constant regime for physical reality by the constitution of their equation dimensional construction parameters.

With TM-0D the squeezing between the equations is the essence of the royal cubit hedging process in identifying the  $\pi$ -error, and how from that hedging process other derivative equation *squeezes* come into play. There, as demonstrated with the derivations of the speed of light  $c$  and fine structure constant  $\alpha$  values the subsidiary phenomena equations must have a series of "constants" as *calibrations* to account for the disparity between the time-equation and space-equation which together as a first equation derivation step reckoned the metric royal cubit to then derive the progenitor speed of light  $c_x$  and thence fine structure constants  $\alpha_x$ . This then required the calculated  $\pi$ -anomaly to be factored into the time-equation to make it properly compatible with the space-equation, thence resulting in the correct values for  $c$  and  $\alpha$  (correct to 7 and 9 decimal places respectively).

Here therefore is not a simple presumption of sentience (A) in using a number-theory model (B) for light to measure mass (C), as per the standard ABC process of physics from ancient times to today, yet a proposal for a zero-dimensional logic (B) and associated *temporospatial sentience code* (A) to be then tested by having its derived dimensional equations (B) be *scaled* with physical reality (C) as *their test* of fidelity with physical reality.

It therefore is proposed that physical reality (C) is structured by how the time-equation (B) adapts to the space-equation (B), how the golden ratio feature  $(\varphi, \frac{-1}{\varphi})$  of the time-equation seeks the perfect circle  $\pi$  feature of the space-equation, and thence how  $\pi$  is reached for time and  $(\varphi, \frac{-1}{\varphi})$  reached for space as the maintenance of physical reality (C) through its great attributes of physical phenomena and associated ecosystem of equations. Can such a proposal be further refined? Is there for instance a precise bridge between the time-equation and space-equation? Is the solution to such really a question of how the golden ratio itself ***relates directly*** with the value of  $\pi$ , and how such then would represent a type of anomaly that then fixes all the equations and constants to their known measured values?

Throughout the papers, specifically from paper 1, the idea of space has been granted a  $0-\infty$  contextual assumption<sup>172</sup> and thence scaling paradox dilemma<sup>173</sup> which then was requested to abide by the conditions of the proposed time-equation. This led to the idea of ultimately a 3d spherical feature for space in having the time-equation form the basis of the quantum wave function and that

---

<sup>171</sup> [67].

<sup>172</sup> [1]: p2-3.

<sup>173</sup> [43]: p1-5.



associated golden ratio code forming the structuration of that 3d spatial void<sup>174</sup>. By such, space was considered as a 3d void. Yet, this 3d spatial void is filled with quantum wave function fluctuations. Here, the quantum wave function fluctuations are known by how they shape themselves in empty space. Yet is such space?

The space-equation was proposed as an equation which was given the features of time-before, time-now, and time-after as per  $e^{\frac{i\pi}{t_B}} + 1_{t_N} = 0_{t_A}$ . What needs to be asked therefore about this space-equation is how it forms a bridge with the time-equation, how this has already been explained by TM-0D, and yet despite such what could still be missing there and how any other geometric dimensional relationships between time and space can be described, to thence perhaps demonstrate anomalies in the time-equation quantum wave function and thence what could only be fluctuations in the space-equation and thence space. The thinking is that this approach will be able to describe how the time-equation and space-equation are most basically squeezed together (B) and what that phenomenon is (C) for both the quantum wave function (from the time-equation) and thence also presumably gravity (from the space-equation).

### 17.3 The mathematics (B) of fluctuating space (C): the ellipsoid egg of space

With all derivations thus far granted, the first thing to consider is that 3d space in its most basic sense is a void, yet this void is filled with quantum wave function fluctuations. Here, the quantum wave function fluctuations are known by how they shape themselves in empty space. Yet the question being asked is if there anything going on with space as a type of number-based metric in regard to the quantum wave function fluctuations and how the time-equation and space-equation are squeezed together by any other route than the  $\pi$ -anomaly process.

As presented in paper 3 and thence paper 51, the proposed chaos equation<sup>175</sup> is a resonance of the quantum wave function as what can only be described as a type of interference resonance. This resonance as a time-before event presented the case for time-before equating to both features of the golden ratio, and thus the equation  $\varphi \cdot \frac{-1}{\varphi} = -1$ , having time-before thence equate to -1, and thence the time-equation equate to 0 as per the space-equation  $e^{\frac{i\pi}{t_B}} + 1_{t_N} = 0_{t_A}$ . This formed the basis for the space-equation proposal in paper 15<sup>176</sup>. This was further examined in paper 42 where it was proposed that nullifying the quantum wave function would represent a feature of space itself as “-1” as *entropic gravity*, as a *negative energy* in regard to the time-equation that produces a null result and thence seeks to make itself static, stable, and thence devoid of time<sup>177</sup>. This was the premise for static space in being a part of the background entropic drive of the time-equation.

---

<sup>174</sup> [2]: p3-7.

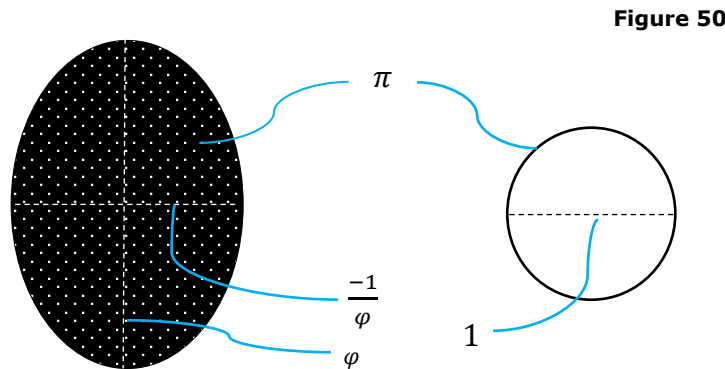
<sup>175</sup> ([3]: p2-5, eq2-3); ([51]: p14-17, eq1-4).

<sup>176</sup> [15]: p8-10.

<sup>177</sup> [42]: p29-56.

As a new proposal, of note is the idea of the surface area (S) of a golden ratio ellipse  $(\varphi, \frac{-1}{\varphi})$ , say  $S_{(\varphi, \frac{-1}{\varphi})}$ , where the long axis of the ellipse is  $\varphi$  and short axis  $\frac{-1}{\varphi}$ , as per equation 31 and figure 50.

$$S_{(\varphi, \frac{-1}{\varphi})} = \pi \cdot \varphi \cdot \frac{-1}{\varphi} = -\pi \tag{31}$$

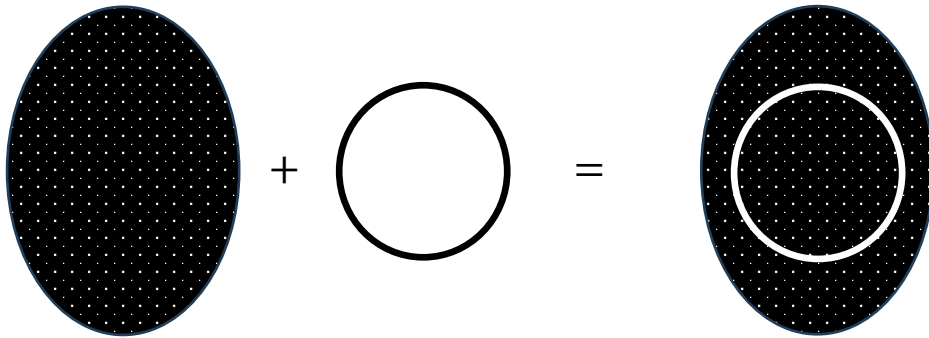


Although the short axis here is a negative value as  $\frac{-1}{\varphi}$  yet portrayed as  $\frac{1}{\varphi}$ , the idea of this negative value will become apparent.

Given such, is it possible to suggest that directly linking the golden ratio  $(\varphi, \frac{-1}{\varphi})$  to  $\pi$  in this way can form an exact bridge between the time-equation and the space-equation? Why not? This here is the idea not of a *primary equation squeeze*, yet a *primary dimensional squeeze*, a *primary dimensional shaping squeeze* to suite a perfect equation requirement with a fundamental equation “-1” link proposed to be the idea of a negative process for time as negative energy, here linking the golden ratio time-equation  $t_B + 1 = t_A$  (where  $t_B^2 = t_A$ ) with the perfect  $\pi$  space-equation  $e^{i\pi} + 1_{t_N} = 0_{t_A}$  using the golden ratio ellipse.

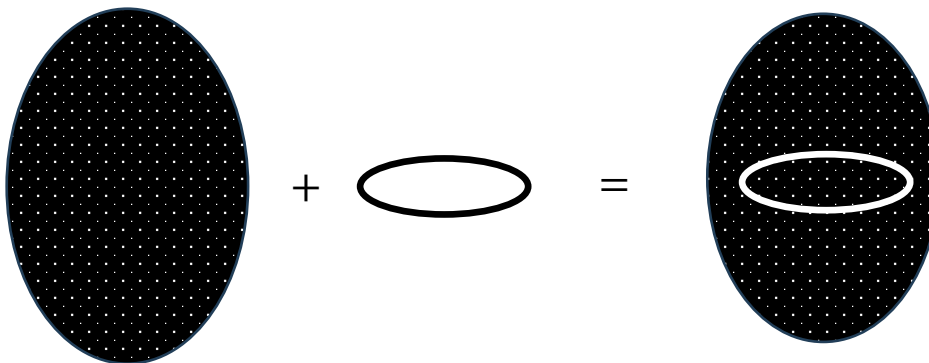
Here therefore the suggestion is that the surface area of the golden ratio ellipse, a 2d entity, equates to the value of  $\pi$ , a 1d idea as the trace of a circle with diameter 1. Consider figure 51 basically illustrating this.

**Figure 51**



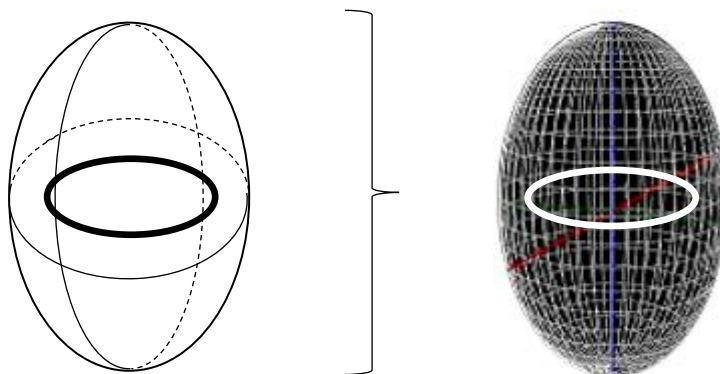
Now let the plane of the ellipse be at right angles to the plane of the circle, as this is a requirement of the derived quantum wave function that has both circular and ellipse features<sup>178</sup>. Consider figure 52.

**Figure 52**



Now consider that this is a feature of the time-equation relating with the space-equation as 3d space, namely that the ellipse can be in any placement around the  $\pi$  circle. Consider figure 53.

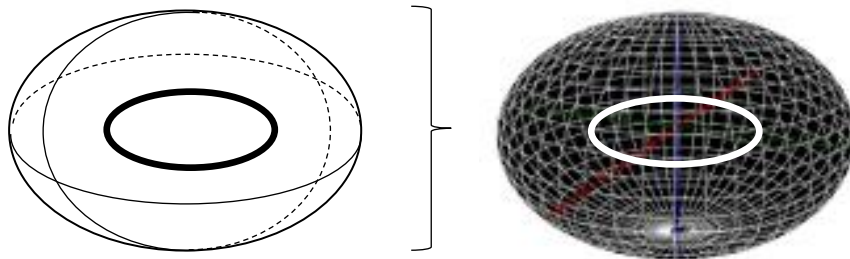
**Figure 53**



<sup>178</sup> [2]: p11.

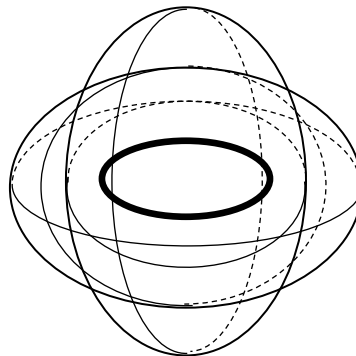
Of course, the other orientation for the ellipse in being perpendicular to the  $\pi$ -circle can be used. Consider figure 54

**Figure 54**



It thence seems there is the possibility of two possible orientations for 3d ellipsoid space in regard to time. Here, "time" is considered as the perfect  $\pi$ -circle feature, as the time-equation aim, and space the perfect golden ratio feature  $(\varphi, \frac{-1}{\varphi})$ , as the space-equation aim, resulting in two fundamental orientation possibilities. Consider figure 55.

**Figure 55**

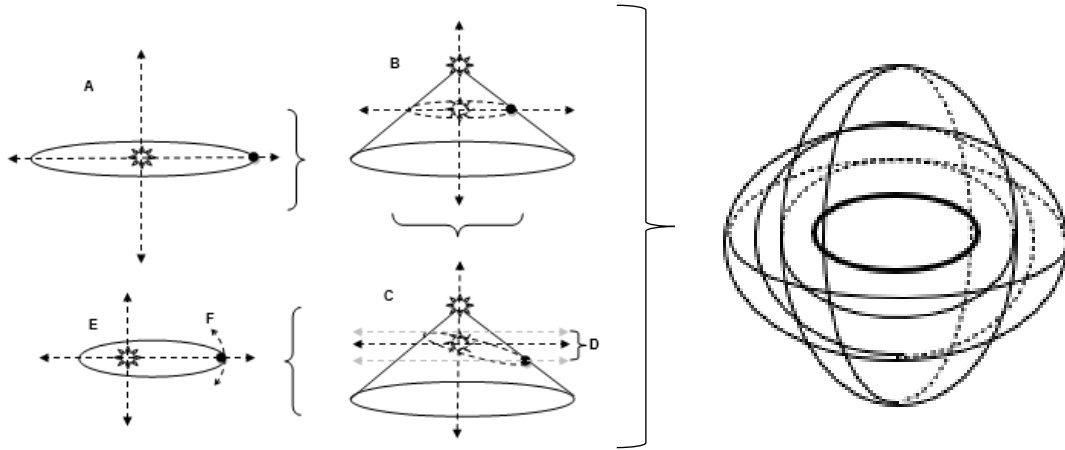


Proposed here is that such forms the basis for how space relates with both EM and mass, and thence how space forms the basis for a gravitational wave effect. The gravitational wave effect of space was presented in paper 51<sup>179</sup>. Although in paper 51 the description of the gravitational wave effect proposed such is intrinsic to how mass as a mass-field effect ( $\theta_\varphi$ ) (and thus the motion of mass) behaves in space by the combined effect of the  $EM$  ( $\theta$ ) and  $EM_X^{DIR}$  ( $\theta_\phi$ ) fields, here this is refined in presenting the baseline dual ellipsoid field for space as the surface area value of -1. See figure 56.

---

<sup>179</sup> [51]: p11-13.

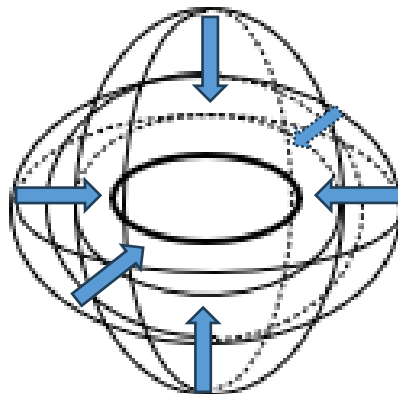
**Figure 56**



Proposed here is that space has two fundamental ellipsoid orientations forming the basis for a  $c$ -scaling of gravity as the development of a gravitational wave structure through space. As presented in paper 57, and here in section 15, there is a derived gravitational wave field effect for this solar system in the context of space the metric of this being  $\sim 1ly$ ,  $1ly$  presumably being the small axis of the proposed solar system ellipsoid of space.

Now to consider is what a quantum wave function  $\pi$ -circle could be in regard to space. This is the idea of the resonances of the quantum wave function as presented in paper 52<sup>180</sup>. Of particular note there is the proposed Xemdir field of space, how the collapse of the quantum wave function to 0 through absolute (X) EM destructive interference resonance (EMDIR) would result in a flattened  $\pi$ -circle field effect, a Xemdir field, as proposed in papers 52<sup>181</sup>. Consider figures 57-58.

**Figure 57**

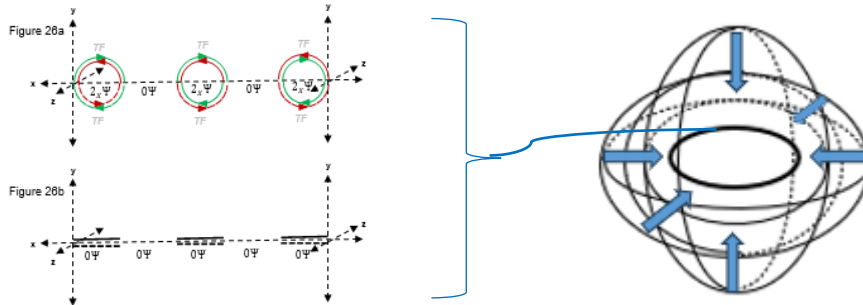


<sup>180</sup> [52]: p35-52.

<sup>181</sup> [52]: p49-52.



**Figure 58**



Here therefore, as this Xemdir field proposes, there is a zero-quantum construction that is associated to space given the  $\pi$ -circle as  $\pi$  and the ellipse as  $-\pi$  together equate to 0, space being that  $-\pi$  ellipse surface area construct associated with the time-equation  $\pi$ -circle in this process. Note that such is how the  $e^{i\pi} + 1_{L_N} = 0_{L_A}$  space-equation demands how  $\pi$  works, namely reducing to 0.

Generally, with all types of resonances for the quantum wave function resulting in EM, mass, and space, the ultimate process itself as force between space and the quantum wave function is for space to enclose itself around the quantum wave function, and thus for the quantum wave function and its associated properties (EM and mass) to be attracted “into” the confines of space. Simply, here is the idea of space forcing EM and mass centrally into itself. This is proposed to form the basis for the appearance of gravity for mass and light, and how space would work in regard to mass, how it would appear to, noting space would still repel light and mass, as it must, thence appear to show how light and mass are self-attractive by space’s ellipsoid presence.

Of note is how the binding strength of the quantum wave function to space was calculated<sup>182</sup> in using only the  $\pi$ -error. Here such an idea is still upheld.

The next idea now is how with this Xemdir field effect, of reducing the quantum wave function to 0 in making fundamental to space, pure space, would this sub-quantum realm operate?

#### 17.4 Sub-quantum chaotic space: the sub-quantum 3-body problem

The sub-quantum realm was first proposed in paper 25<sup>183</sup> as a solution to the Yang Mills existence and mass-gap problem, and then further supported with evidence in deriving the value for the theoretical neutrino mass in paper 35<sup>184</sup>, and thence cross-referencing this to a solution for the

<sup>182</sup> See section 13.4, eq17-18.

<sup>183</sup> [25]: p40-56.

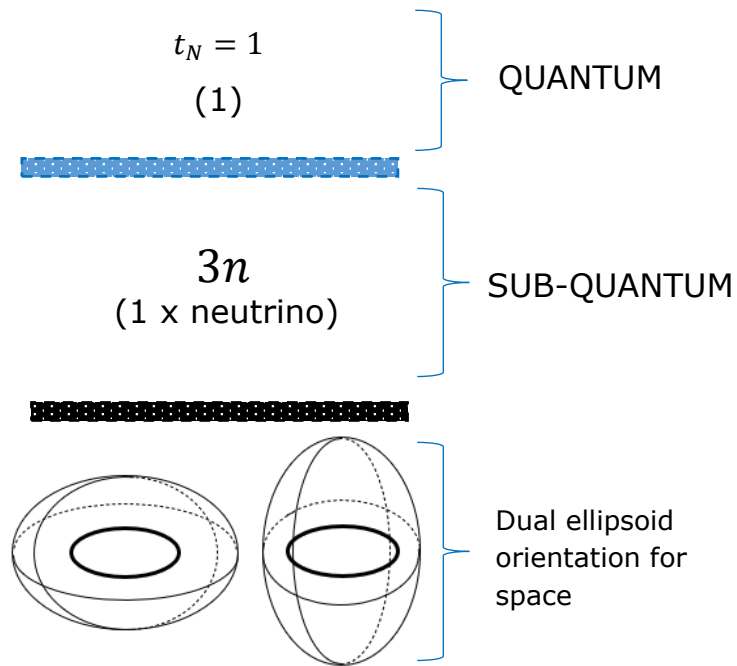
<sup>184</sup> [35]: p27-28, eq1-2.

Riemann hypothesis in paper 44<sup>185</sup>, thence followed up in paper 56<sup>186</sup> with further number-theory solutions.

The fundamental feature of the neutrino in those findings is that a single neutrino exists as a combination of "3" constructs. To also note is that on this sub-quantum level, this 3-construct feature of the neutrino is separate itself to the actual quantum wave function and thence separate to the time-equation itself. In other words, here is a 3-construct feature of the neutrino in a sub-quantum realm that has thence escaped the usual processes of the time-equation, and thence presumably cast itself to not be a part of the usual time-now condition of  $t_N = 1$ , yet would still nonetheless need to be held in the context of  $t_N = 1$ . Also though, as the new findings suggest, this sub-quantum realm represents two basic spatial orientations for the spatial ellipsoid. Can therefore this sub-quantum process be mathematically described?

On the one hand, there is a general  $t_N = 1$  context. On the other hand, there is a  $3n$  (3 being the triplicate feature of the neutrino and  $n$  being a neutrino number itself) feature. Underlying all of such is a "2" orientation feature for ellipsoid space. Consider figure 59.

**Figure 59**



Proposed here is that such can be converted into a set of two equations that work together to put the sub-quantum level properly in the required context of  $t_N = 1$ .

<sup>185</sup> [44]: p20-22.

<sup>186</sup> [56]: p22-23.



The first equation is proposed to be  $3n + 1$  in acknowledgment of the  $3n$  neutrino condition where  $n$  would represent any number of apparent neutrinos, and the "1" would represent the required  $t_N = 1$  context. Such would be the first equation process.

The second equation process would be to divide the first equation process by 2 if that first equation process can be divided by 2 resulting in a whole number value as much as  $n$  and  $3n + 1$  each must be a whole number value. This whole number condition was derived in papers 44 and 56.

The condition therefore for these two equation processes is that **if** the  $3n + 1$  value cannot be divided by 2 the proposal is to take that  $3n + 1$  value as the new " $n$ " value and keep doing this process until this process can be divided by 2.

The conjecture here is that ultimately this process using any number value must ultimately result in the value of "1" if indeed reality must exist in time's moment of  $t_N = 1$  (as the 60 papers of TN-0D have demonstrated).

The interesting feature to all of such is that this conjecture has been presented before in the form of the Collatz conjecture<sup>187</sup> whereby the conjecture asks whether or not the continual amalgamation of two arithmetic operations are able to transform every positive integer into 1. Here, the Collatz conjecture can be considered as a way of resolving sub-quantum's own 3-body (neutrino) problem, how this works with TM-0D's time-equation and space-equation, and how then reality still exists in time's moment of  $t_N = 1$ .

Proposed here therefore is that ellipsoid space is a sub-quantum spatial facilitator as a natural chaotic number-theory process utilizing the mathematical identity of Collatz conjecture in thence resolving the sub-quantum three-body problem. Classically, the three-body problem<sup>188</sup> prescribes taking the initial positions and momenta of three point-masses and solving for their subsequent motion according to Newton's laws of motion and universal gravitation, yet here the three-body problem is not assigned to mass per-se, yet the sub-quantum feature of space proposed to be responsible for gravity, thence proposing the three-body problem's *complete* solution.

## 17.5 The emergence of consciousness (A) from chaotic space (C)

In now taking this into the context of the derived outer Black Expanse region of space as presented in paper 34<sup>189</sup>, namely space before the apparent big bang and thence space ahead of the apparent big bang shock front, and thence what has been derived space beyond this solar system, as presented in figures 21-23, it would appear that this solar system would be moulded within a dual-orientation of chaotic sub-quantum ellipsoid space. Not only such, upon this outer context of this solar system would be projected the astrophysical holography from the proposed

---

<sup>187</sup> The Collatz conjecture has been shown true for all positive integers up to  $2.95 \times 10^{20}$ , but no general proof has been found [87].

<sup>188</sup> [88].

<sup>189</sup> [34]: p17-30.



electron degeneracy process in the Hydrogen wall as a feature of sub-quantum (electron degeneracy) ellipsoid space and thence gravity. As paper 59 proposed, this projection of images is proposed to represent the idea of a greater sphere of consciousness as temporal transcendence, as a universal basis for consciousness. Or, in other words, *consciousness as temporal transcendence would appear to emerge from sub-quantum space* and be primarily featured by this overall astrophysical holographic process.

Proposed here therefore is that subquantum space would be the essence of how sentience can emerge. It would therefore follow that to somehow find how to emerge sentience would require a structuration of sub-quantum matter to make that emergence possible, which may even require a way to harness sub-quantum matter from the quantum scale. More likely than not therefore, the human anatomy, physiology, and biochemistry is a successful system of accessing/perceiving and processing sub-quantum chaotic space and thence consciousness both on the small atomic scale and large astrophysical scale. Interestingly there, our human history shows much in the arena of chartering its understanding of reality and itself in that process using the image of the stars.

## 18 OQG Xemdir field chamber schematics

---

TBA

## 19 OQG Xemdir field chamber testing

---

TBA

## 20 OQG Xemdir field chamber results

---

TBA

## 21 OQG Xemdir field interpretations

---

TBA



## 22 Contemporary ABC adaptations

---

TM-0D is a zero-dimensional number theory (B) applied to a proposed *temporospatial sentience code* (A) to then ask if what is derived matches what we perceive of physical reality (C). The three extraordinary issues that have resulted are:

- (clxx) A new theory for sentience (A) as the *temporospatial sentience code*.
- (clxxi) A new mathematics system (B) as the zero-dimensional number theory.
- (clxxii) A new theory for gravity and thence cosmology (C).

The intention of TM-0D is pure experiment and such alone, and to thus integrate with contemporary ideas and associated experimentation processes. How though can any of such (clxx)-(clxxii) integrate with the contemporary *social, formal, and natural* sciences? The only way this can be achieved is through the manner proposed, namely actual proof that has the backing of a description a way in which the contemporary sciences have not considered yet find useful nonetheless. *Although* TM-0D has been able to derive what is perceived of the general and specific physical phenomena processes *the problem is that* with the TM-0D model the stars are a holographic projection yet for standard physics they are taken as real massive objects. To make this easier to understand, it is perhaps easier to break up the proposed process of TM-0D utility to the sciences.

### 22.1 (A) adaptations

TM-0D is proposed to be an interdisciplinary science that gives a *basic meaning* (A) that can be *logically structured* (B) to a whole host of *observed phenomena* (C) no other interdisciplinary science system can. The philosophy of TM-0D is simple, as it is prescribed by its fundamental *temporospatial sentience code* (A), namely certainty of memory for the past, an acceptance of existence in time-now, with an uncertainty if not choice for the future.

Thus, the grand experiment of TM-0D is to use the facts of history applied to a here and now to then choose a future direction that is still always uncertain yet connected with the requirements of time-before and time-now. The ability for TM-0D therefore to make predictions in this process although being diminished, and thus not being a Promethean process of foretelling, can still present the pan-framework for what "exists" in time-now.

How is TM-0D theory therefore useful as a social science? The TM-0D process is proposed to be a plan called "an experiment". Thence, there is no agenda for the zero dimensional theory other than how it is being used as a tool in an experiment. The experiment thus far in the making of TM-0D has been and still is to allow the work to speak for itself, to express its design protocols, to go where the logic suggests.

In many ways, in a theory developing technology that has a sentience code basis, the possibility exists for that technology to become sentient itself. Yet as papers 58-59 uncovered, sentience is a vastly more complicated if not orphic thing. Just as some social systems consider



themselves as an experiment, and how trust among each other is required, the same is envisaged for the TM-0D theory, namely being developed in a way everyone is OK with, particularly for our survival and not extinction.

In considering the idea of an astrophysical process of consciousness linking the stars and Earth as conjectured by papers 32-35, paper 59, and here, could such be a process of an astrophysical "conscious" experience that transcends time and space? This was the conjecture in paper 59, namely consciousness as temporal transcendence. Here in this paper the idea of consciousness emerging from a sub-quantum level, from the proposed chaos of time-space, all the way to our filter of biological sentience, to our many layered process of perceiving reality, one could only perhaps consider such as a process of astrophysical enlightenment. Here with TM-0D the astrophysical conscious experience is conjectured to be a real phenomenon.

Although a vast array of descriptions have been described to support this proposed astrophysical sentience phenomenon, only the individual in their own *astrophysical clock* reference would know their own precise meaning and role with the greater environment described here. Of note is that here in this paper the idea of a destruction of EM (by destructive interference resonance) that results in the ellipsoid/egg of space which then emerges consciousness itself is proposed. Such a process on a human level could indeed invoke symbolism for an orphic astrophysical experience. Here, the TM-0D theory finds that the constitution of our sentience ultimately is in the stars.

## 22.2 (B) adaptations

The ABC process of TM-0D does appear to have been in play from our earliest recordings, and this is indicative of the universality of the *temporospatial sentience code*. Ancient Egypt for instance appears to have more likely than not hit the right harmonic with its ABC process with its regard for the astrophysical conscious phenomenon, yet lacked the proper resolution of understanding as was evident with its primary royal cubit scaling and surveying key. From such as a species we have been refining our mathematics to go one step better than the royal cubit scaling and surveying system.

The conjecture here with TM-0D is how  $\pi$  relates to the dimensions, and that there is a  $\pi$ -error in play. TM-0D has merely proposed what that absolute mathematical code is by deriving  $c$  and  $\alpha$  with that  $\pi$ -error code. In alliance with formulating such, solutions to the Clay Mathematics Institution Millennium prize problems also become apparent as presented in papers 44 [44], 47 [47], and 55 [55]. Such are solutions to current questions, yet as the TM-0D theory conjectures there are many more interesting and worthwhile questions and solutions that can be pursued and debated.

## 22.3 (C) adaptations

Physics relies primarily on actual physical data. As such, physics rarely presents new theories unless there is clear data to support such. Thus, any TM-0D reworking of physics still needs a basic



physics basis. Therefore, to understand TM-0D one still needs to understand the importance of current physics data, both as QFT and GR, including of course the standard model of particles.

In physics, the idea of "time" has gone through two paradigm shifts in the last millennium. The first was when Sir Isaac Newton proposed that time is an absolute flow in regard to absolute space. The second is when Albert Einstein proposed time is not absolute yet that the flow of time depends on one's rate of motion, that time relative. The proposal here is that time most fundamentally is not an absolute flow in regard to absolute space yet an absolute moment in regard to absolute space, and that time's flow in that process is indeed relative. By such, TM-0D doubts actual existence beyond time-now other than how time's flow is accorded by the number theory required for the absolute moment of time in the context of the  $0-\infty$  scaling paradox of space<sup>190</sup> warranting time-before and time-after and thence temporal transcendence as consciousness<sup>191</sup>.

## 23 Conclusion

---

Proposed here is the TM-0D zero-dimensional number theory as no mere abstract listing of consistencies with known physical data, yet that there is an ABC scaling and surveying process in play the whole scientific community is already a part of. Although much of the emphasis today in physics is on resolving the dimensional mismatch between QFT's flat 4d spacetime and GR's curved 4d spacetime, the proposal here has been to focus on how to best identify and resolve that very well calculus-structured mismatch. Here with the ABC process the intention is not to disrupt or dispel the current quests in science, yet to offer a theoretic and experimental utility to the known mismatch between QFT and GR. Thus, a zero-dimensional number theory is pursued to both confirm the mismatch and confirm the known data of QFT and GR with that mismatch yet propose the next-step number theory solution (B) using a proposed *temporospatial sentience code* (A) to thence confirm both of such as valid in being scaled to known physical data (C). By such, the zero-dimensional number theory presents a new way of utilizing the mismatch between QFT and GR experimentally as *zero quantum gravity (0QG)*.

### Conflicts of Interest

The author declares no conflicts of interest; this has been an entirely self-funded independent project.

---

<sup>190</sup> [43].

<sup>191</sup> [59].



## References

1. Jarvis S. H. (2017), [10.13140/RG.2.2.35132.28804/2](https://doi.org/10.13140/RG.2.2.35132.28804/2),  
<https://www.researchgate.net/publication/328738261> Gravity's Emergence from Electrodynamics,  
<https://vixra.org/abs/1704.0169>
2. Jarvis S. H. (2017), [10.13140/RG.2.2.30099.12327/5](https://doi.org/10.13140/RG.2.2.30099.12327/5),  
<https://www.researchgate.net/publication/328738109> Golden Ratio Axioms of Time and Space,  
<https://vixra.org/abs/1706.0488>
3. Jarvis S. H. (2017), <https://doi.org/10.13140/rq.2.2.23388.23683/2>,  
<https://www.researchgate.net/publication/328738518> The Emergence of Consciousness from Chaos,  
<https://vixra.org/abs/1707.0044>
4. Jarvis S. H. (2017), <https://doi.org/10.13140/rq.2.2.10045.10726/5>,  
<https://www.researchgate.net/publication/328738422> Phi-Quantum Wave-Function Crystal Dynamics, <https://vixra.org/abs/1707.0352>
5. Jarvis S. H. (2017), <https://doi.org/10.13140/rq.2.2.23466.88009/3>,  
<https://www.researchgate.net/publication/328738526> Time as Energy  
<https://vixra.org/abs/1711.0419>
6. Jarvis S. H. (2018), <https://doi.org/10.13140/rq.2.2.13400.55044/4>,  
<https://www.researchgate.net/publication/328738389> The Relativity of Time  
<https://vixra.org/abs/1801.0083>
7. Jarvis S. H. (2019), <https://doi.org/10.13140/rq.2.2.27741.26089/2>,  
<https://www.researchgate.net/publication/332672475> Golden Ratio Entropic Gravity Gravitational Singularity Field Testing, <https://vixra.org/abs/1904.0485>
8. Jarvis S. H. (2019), <https://doi.org/10.13140/rq.2.2.35399.14246/2>,  
<https://www.researchgate.net/publication/332879052> The Golden Ratio Time Algorithm,  
<https://vixra.org/abs/1905.0081>
9. Jarvis S. H. (2019), <https://doi.org/10.13140/rq.2.2.28499.02084/1>,  
<https://www.researchgate.net/publication/333668324> The Physics Chimera,  
<https://vixra.org/abs/1906.0127>
10. Jarvis S. H. (2019), [10.13140/RG.2.2.10258.71363/2](https://doi.org/10.13140/RG.2.2.10258.71363/2),  
<https://www.researchgate.net/publication/333972239> The Conception of Time,  
<https://vixra.org/abs/1906.0441>
11. Jarvis S. H. (2019), <https://doi.org/10.13140/rq.2.2.15833.67689/1>,  
<https://www.researchgate.net/publication/335232726> Space and the Propagation of Light  
<https://vixra.org/abs/1908.0388>
12. Jarvis S. H. (2019), <https://doi.org/10.13140/rq.2.2.17320.93443>,  
<https://www.researchgate.net/publication/336130560> Space and the Nature of Gravity,  
<https://vixra.org/abs/1909.0656>
13. Jarvis S. H. (2019), <https://doi.org/10.13140/rq.2.2.14287.43683/2>,  
<https://www.researchgate.net/publication/337019159> Space and the Redshift Effect,  
<https://vixra.org/abs/1911.0064>
14. Jarvis S. H. (2019), <https://doi.org/10.13140/rq.2.2.25730.63686/2>,  
<https://www.researchgate.net/publication/338159068> Solving the Cosmological Constant Problem,  
<https://vixra.org/abs/1912.0451>





15. Jarvis S. H. (2020), <https://doi.org/10.13140/rq.2.2.13078.91205/3>,  
<https://www.researchgate.net/publication/338548474> Hybrid Time Theory Euler's Formula and the  
[Phi-Algorithm](https://vixra.org/abs/2001.0233), <https://vixra.org/abs/2001.0233>
16. Jarvis S. H. (2020), <https://doi.org/10.13140/rq.2.2.27053.64487/3>,  
<https://www.researchgate.net/publication/338689227> The Hybrid Time Clock as a Function of Gra  
[vity](https://vixra.org/abs/2001.0401), <https://vixra.org/abs/2001.0401>
17. Jarvis S. H. (2020), <https://doi.org/10.13140/rq.2.2.20045.79847/2>,  
<https://www.researchgate.net/publication/340270768> Hybrid Time Theory Cosmology and Quantu  
[m Gravity I](https://vixra.org/abs/2003.0659), <https://vixra.org/abs/2003.0659>
18. Jarvis S. H. (2020), <https://doi.org/10.13140/rq.2.2.16207.84648/1>,  
<https://www.researchgate.net/publication/340574420> Scientific Principles of Space Time and Perce  
[ption](https://vixra.org/abs/2004.0260), <https://vixra.org/abs/2004.0260>
19. Jarvis S. H. (2020), <https://doi.org/10.13140/rq.2.2.23972.22405/1>,  
<https://www.researchgate.net/publication/341117279> Hybrid Time Theory Cosmology and Quantu  
[m Gravity II](https://vixra.org/abs/2005.0053), <https://vixra.org/abs/2005.0053>
20. Jarvis S. H. (2020), <https://doi.org/10.13140/rq.2.2.34441.67683/6>,  
<https://www.researchgate.net/publication/341440377> Mathematical Principles of Time and Energy,  
<https://vixra.org/abs/2005.0179>
21. Jarvis S. H. (2020), <https://doi.org/10.13140/rq.2.2.21001.88169/1>,  
<https://www.researchgate.net/publication/341782076> Dimensional Mechanics of Time and Space,  
<https://vixra.org/abs/2005.0286>
22. Jarvis S. H. (2020), <https://doi.org/10.13140/rq.2.2.29715.71202/3>,  
<https://www.researchgate.net/publication/342343657> Dimensional Thermodynamics,  
<https://vixra.org/abs/2006.0194>
23. Jarvis S. H. (2020), <https://doi.org/10.13140/rq.2.2.10565.68320/3>,  
<https://www.researchgate.net/publication/343281767> Time-Space Wave-Mechanics,  
<https://vixra.org/abs/2007.0223>
24. Jarvis S. H. (2020), <https://doi.org/10.13140/rq.2.2.15362.09929/3>,  
<https://www.researchgate.net/publication/343678982> Temporal Calculus The Calculus of Time-  
[Points in Space](https://vixra.org/abs/2008.0111), <https://vixra.org/abs/2008.0111>
25. Jarvis S. H. (2020), <https://doi.org/10.13140/rq.2.2.33774.43843/3>,  
<https://www.researchgate.net/publication/343987838> Temporal Calculus solving the Yang-  
[Mills Existence and Mass Gap problem](https://vixra.org/abs/2008.0226), <https://vixra.org/abs/2008.0226>
26. Jarvis S. H. (2020), <https://doi.org/10.13140/rq.2.2.28539.75043/2>,  
<https://www.researchgate.net/publication/344221574> Temporal Calculus Time Scaling Space,  
<https://vixra.org/abs/2009.0091>
27. Jarvis S. H. (2020),  
<https://doi.org/10.13140/rq.2.2.20191.07844><https://www.researchgate.net/publication/344387016> T  
[emporal Calculus Resolving Elementary Particle Formation and Confinement](https://vixra.org/abs/2009.0177),  
<https://vixra.org/abs/2009.0177>
28. Jarvis S. H. (2020), <https://doi.org/10.13140/rq.2.2.12474.21447/2>,  
<https://www.researchgate.net/publication/344457690> Temporal Calculus Resolving Einstein's Theor  
[y of Relativity Special and General](https://vixra.org/abs/2010.0017), <https://vixra.org/abs/2010.0017>



29. Jarvis S. H. (2020), <https://doi.org/10.13140/rq.2.2.12651.98086/1>,  
<https://www.researchgate.net/publication/345127477> Time and Non-  
Locality Resolving Bell's Theorem, <https://vixra.org/abs/2011.0002>
30. Jarvis S. H. (2020), <https://doi.org/10.13140/rq.2.2.11032.83206/4>,  
<https://www.researchgate.net/publication/346672010> Non-Local Time-  
Point Theory Magnetic Quantum Shell MQS Modelling, <https://vixra.org/abs/2012.0040>
31. Jarvis S. H. (2021), <https://doi.org/10.13140/rq.2.2.28879.10407/1>,  
<https://www.researchgate.net/publication/348184426> Temporal Mechanics A Time-Space Circuits,  
<https://vixra.org/abs/2101.0022>
32. Jarvis S. H. (2021), <https://doi.org/10.13140/rq.2.2.31751.21925/5>,  
<https://www.researchgate.net/publication/348729069> Temporal Mechanics B Time-  
Space Constants, <https://vixra.org/abs/2101.0148>
33. Jarvis S. H. (2021), <https://doi.org/10.13140/rq.2.2.30214.70720/5>,  
<https://www.researchgate.net/publication/349108810> Temporal Mechanics C Time-Space Manifolds,  
<https://vixra.org/abs/2102.0047>
34. Jarvis S. H. (2021), <https://doi.org/10.13140/rq.2.2.17868.54403/5>,  
<https://www.researchgate.net/publication/350090036> Temporal Mechanics D Time-Space Metrics,  
<https://vixra.org/abs/2103.0102>
35. Jarvis S. H. (2021), <https://doi.org/10.13140/rq.2.2.28496.84483/7>,  
<https://www.researchgate.net/publication/350512305> Temporal Mechanics E Time-Space Logistics,  
<https://vixra.org/abs/2103.0201>
36. Jarvis S. H. (2021), <https://doi.org/10.13140/rq.2.2.34363.34082/5>,  
<https://www.researchgate.net/publication/353224312> Quantum Gravity and the calculation of max  
imum SOL mass, <https://vixra.org/abs/2107.0086>
37. Jarvis S. H. (2021), <https://doi.org/10.13140/rq.2.2.20022.42563/5>,  
<https://www.researchgate.net/publication/353403592> An Axiom of Time resolving Entropy CP viol  
ation and the isotropic CMBR, <https://vixra.org/abs/2107.0146>
38. Jarvis S. H. (2021), <https://doi.org/10.13140/rq.2.2.28179.20007/6>,  
<https://www.researchgate.net/publication/354794575> Temporal Mechanics and EM-  
DIR particle pair production, <https://vixra.org/abs/2109.0167>
39. Jarvis S. H. (2021), <https://doi.org/10.13140/rq.2.2.15658.13764/4>,  
<https://www.researchgate.net/publication/356039421> Temporal Mechanics and the derivation of a  
n electron degeneracy neutrino Gravity constant G fine structure constant a Planck constant h  
and the phenomenal values of Sol, <https://vixra.org/abs/2111.0045>
40. Jarvis S. H. (2021), <http://dx.doi.org/10.13140/RG.2.2.19674.67529/6>,  
<https://www.researchgate.net/publication/356508902> Time-  
domains as the foundation for classical mechanics the relativity of moving objects and the kno  
wn field forces presenting the case for a unified field theory, <https://vixra.org/abs/2111.0131>
41. Jarvis S. H. (2022), [10.13140/RG.2.2.17398.93763/7](https://doi.org/10.13140/RG.2.2.17398.93763/7),  
<https://www.researchgate.net/publication/357690054> A time  
equation thought experiment deriving 3D space as timespace in forming the basis for particle a  
nd field phenomena, <https://vixra.org/abs/2201.0043>
42. Jarvis S. H. (2022), [10.13140/RG.2.2.23272.75521/5](https://doi.org/10.13140/RG.2.2.23272.75521/5),  
<https://www.researchgate.net/publication/358974090> The Temporal Mechanics XEMDIR field resolv



- ing zero-point energy negative energy anti-EM anti-gravity symmetry breaking and Baryon asymmetry, <https://vixra.org/abs/2203.0018>
43. Jarvis S. H. (2022), <https://doi.org/10.13140/rq.2.2.23915.00808/4>, <https://www.researchgate.net/publication/359052099> The mathematics of zero-dimensional space, <https://vixra.org/abs/2203.0030>
44. Jarvis S. H. (2022), <https://doi.org/10.13140/rq.2.2.33528.32000/6>, <https://www.researchgate.net/publication/359577367> A mathematical analysis of zero-dimensionality in deriving the natural numbers offering a solution to Goldbach's conjecture and the Riemann hypothesis, <https://vixra.org/abs/2203.0181>
45. Jarvis S. H. (2022), <http://dx.doi.org/10.13140/RG.2.2.24087.85921/3>, <https://www.researchgate.net/publication/360065326> A foundational zero-dimensional scaling system mandating the principle of relativity and the associated constancy of the speed of light in a vacuum, <https://vixra.org/abs/2204.0127>
46. Jarvis S. H. (2022), <http://dx.doi.org/10.13140/RG.2.2.11064.21768/2>, <https://www.researchgate.net/publication/360270193> The flaw of applying mathematics directly to physical phenomena in addressing the Entscheidungsproblem and Godel's theorems as compared to the mathematics of zero-dimensionality, <https://vixra.org/abs/2204.0177>
47. Jarvis S. H. (2022), [10.13140/RG.2.2.23165.44001/3](https://doi.org/10.13140/RG.2.2.23165.44001/3), <https://www.researchgate.net/publication/360588347> Zero-dimensional mathematics and the associated timespace Xemdir field geodesic in deriving Fermat's principle the stationary-action principle and the principle of inertia, <https://vixra.org/abs/2205.0079>
48. Jarvis S. H. (2022), [10.13140/RG.2.2.29238.57929/5](https://doi.org/10.13140/RG.2.2.29238.57929/5), <https://www.researchgate.net/publication/361556863> Zero-dimensional philosophy, <https://vixra.org/abs/2207.0135>.
49. Jarvis S. H. (2022), <https://www.researchgate.net/publication/361864787> Zero-dimensional number theory, [10.13140/RG.2.2.22499.84008/4](https://doi.org/10.13140/RG.2.2.22499.84008/4).
50. Jarvis S. H. (2022), [10.13140/RG.2.2.14200.52480/2](https://doi.org/10.13140/RG.2.2.14200.52480/2), <https://www.researchgate.net/publication/363474597> The zero-dimensional physical theory I solving reality's puzzle, <https://vixra.org/abs/2209.0125>.
51. Jarvis S. H. (2022), <http://dx.doi.org/10.13140/RG.2.2.16815.41127/4>, <https://www.researchgate.net/publication/363799929> The zero-dimensional physical theory II causality locality and indeterminacy, <https://vixra.org/abs/2209.0150>.
52. Jarvis S. H. (2022), [10.13140/RG.2.2.11854.95049/4](https://doi.org/10.13140/RG.2.2.11854.95049/4), <https://www.researchgate.net/publication/364223266> The zero-dimensional physical theory III graphing time and space <https://vixra.org/abs/2210.0031>.
53. Jarvis S. H. (2022), <http://dx.doi.org/10.13140/RG.2.2.34844.97926/3>, <https://www.researchgate.net/publication/364274254> The zero-dimensional physical theory IV zero-point field dynamics <https://vixra.org/abs/2210.0033>
54. Jarvis S. H. (2022), <http://dx.doi.org/10.13140/RG.2.2.10198.52802>, <https://www.researchgate.net/publication/364872351> The zero-dimensional physical theory V information energy efficiency and intelligence, <https://vixra.org/abs/2210.0160>



55. Jarvis S. H. (2022), [10.13140/RG.2.2.25257.88162/3](https://www.researchgate.net/publication/365632392), <https://www.researchgate.net/publication/365632392> The zero-dimensional physical theory VI charting the Clay Mathematics Institute Millennium Prize problems and Beal conjecture, <https://vixra.org/abs/2211.0133>
56. Jarvis S. H. (2023), <http://dx.doi.org/10.13140/RG.2.2.32104.75527/4>, <https://www.researchgate.net/publication/366781077> The zero-dimensional physical theory VII charting infinity using the Riemann zeta function and Ramanujan summation in deriving dimensional number paradigms, <https://vixra.org/abs/2301.0014>
57. Jarvis S. H. (2023), <http://dx.doi.org/10.13140/RG.2.2.19758.48969/3>, <https://www.researchgate.net/publication/370863393> Zero Quantum Gravity, <https://vixra.org/abs/2305.0124>
58. Jarvis S. H. (2023), <http://dx.doi.org/10.13140/RG.2.2.17749.40167>, <https://www.researchgate.net/publication/374416153> Logic's Information Touchstone, <https://vixra.org/abs/2310.0022>
59. Jarvis S. H. (2023), [10.13140/RG.2.2.14046.61761](https://www.researchgate.net/publication/374444512), <https://www.researchgate.net/publication/374444512> Consciousness as temporal transcendence, <https://vixra.org/abs/2310.0029>
60. Heartfield, James (2002). *"Postmodernism and the 'Death of the Subject'"*. *The Death of the Subject*. Retrieved 28 March 2013.
61. <https://web.archive.org/web/20160620062539/http://www.oxforddictionaries.com/definition/english/scientific-method>, webpage accessed March 29, 2024.
62. [https://en.wikipedia.org/wiki/Branches\\_of\\_science](https://en.wikipedia.org/wiki/Branches_of_science), webpage accessed March 29, 2024.
63. Stephen Skinner, *Sacred Geometry – Deciphering The Code* (Sterling, 2009) & many other sources.
64. Allen, Thomas George, *The Egyptian Book of the Dead: Documents in the Oriental Institute Museum at the University of Chicago*. University of Chicago Press, Chicago 1960.
65. *Grimal, Nicolas* (1994) [1988]. *A History of Ancient Egypt*. Wiley. [ISBN 978-0-631-19396-8](https://www.isbn-international.org/product/978-0-631-19396-8).
66. [https://en.wikipedia.org/wiki/Westworld\\_\(TV\\_series\)](https://en.wikipedia.org/wiki/Westworld_(TV_series)), webpage accessed March 29, 2024.
67. <https://www.claymath.org/millennium-problems>, webpage accessed March 29, 2024.
68. [https://en.wikipedia.org/wiki/List\\_of\\_physics\\_journals](https://en.wikipedia.org/wiki/List_of_physics_journals), webpage accessed March 29, 2024..
69. <http://classics.mit.edu/Plato/parmenides.html>, webpage accessed March 29, 2024..
70. Aristotle. trans. by R. P. Hardie and R. K. Gaye (ed.). *"Physics"*. The Internet Classics Archive. II 9.
71. <https://en.wikipedia.org/wiki/Calculus>, webpage accessed March 29, 2024.
72. <http://www.britannica.com/EBchecked/topic/369153/The-Mathematical-Principles-of-Natural-Philosophy>, webpage accessed March 29, 2024.
73. Newton, Isaac (1846), *Newton's Principia : the mathematical principles of natural philosophy*, New York: Daniel Adee, p. 72, page accessed 9<sup>th</sup> June 2019
74. [https://en.wikipedia.org/wiki/Quantum\\_gravity](https://en.wikipedia.org/wiki/Quantum_gravity), webpage accessed March 29, 2024.
75. <https://www.sciencedirect.com/topics/physics-and-astronomy/quantum-gravity>, webpage accessed March 29, 2024.
76. <https://www.scientificamerican.com/article/quantum-gravity-in-the-lab/>, webpage accessed March 29, 2024.
77. [Kurt Gödel](https://www.jstor.org/stable/2371111) (1931), "Über formal unentscheidbare Sätze der Principia Mathematica und verwandter Systeme I". Monatshefte für Mathematik und Physik 38: 173–198. [doi:10.1007/BF01700692](https://doi.org/10.1007/BF01700692).
78. *"2018 CODATA Value: fine-structure constant"*. *The NIST Reference on Constants, Units, and Uncertainty*. [NIST](https://www.nist.gov/pml/nist-codata). 20 May 2019. Retrieved 20 May 2019.



79. [Sommerfeld, Arnold \(1916\). "Zur Quantentheorie der Spektrallinien". \*Annalen der Physik\*. 4 \(51\): 51–52. Retrieved 6 December 2020.](#)
80. Davis, Martin (28 February 2018). *The Universal Computer : The Road from Leibniz to Turing, Third Edition*. CRC Press. p. 7. ISBN 978-1-138-50208-6. Retrieved 13 January 2020.
81. T. Hayashi, T. Kusuba and M. Yano. 'The correction of the Madhava series for the circumference of a circle', *Centaurus* 33 (pages 149–174). 1990. Retrieved 13 January 2020.
82. <https://www.popularmechanics.com/science/math/a43670398/mathematicians-discovered-something-mind-blowing-about-the-number-15/>, webpage accessed March 29, 2024.
83. <https://www.scientificamerican.com/article/how-the-inside-of-a-black-hole-is-secretly-on-the-outside/>, webpage accessed March 29, 2024.
84. <https://www.msn.com/en-au/news/techandscience/scientists-say-they-ve-finally-solved-stephen-hawking-s-black-hole-paradox/ar-AA1aMUv5?ocid=msdqntp&cvid=b918196e77c5405eb1410938652e3669&ei=9>, webpage accessed May 15<sup>th</sup>, 2023.
85. <https://www.scientificamerican.com/article/a-background-hum-pervades-the-universe-scientists-are-racing-to-find-its-source/>, webpage accessed March 29, 2024.
86. <https://iopscience.iop.org/article/10.3847/2041-8213/abd401/meta>, webpage accessed March 29, 2024.
87. Maddux, Cleborne D.; Johnson, D. Lamont (1997). *Logo: A Retrospective*. New York: Haworth Press. p. 160. ISBN 0-7890-0374-0. The problem is also known by several other names, including: Ulam's conjecture, the Hailstone problem, the Syracuse problem, Kakutani's problem, Hasse's algorithm, and the Collatz problem.
88. Barrow-Green, June (2008). "The Three-Body Problem". In Gowers, Timothy; Barrow-Green, June; Leader, Imre (eds.). *The Princeton Companion to Mathematics*. Princeton University Press. pp. 726–728.