

Critical analysis of Maxwell's "Displacement Current" Hypothesis and "Electromagnetic Waves" Theory

Hongyuan Ye

Yangtze Delta Region Lab of Innovation (Jiashan), China

Abstract: Maxwell's equations introduced "displacement current" theoretical hypothesis, which stated that a changing electric field could induce a changing magnetic field in a vacuum. Furthermore, Maxwell extended Faraday's law of electromagnetic induction from metal circuits to vacuum, and theoretically concluded that a changing magnetic field could induce a changing electric field in a vacuum. Then, Maxwell predicted the existence of "electromagnetic waves" in a vacuum and claimed wireless communication could be achieved by "electromagnetic waves". This study reinterprets Hertz's "electromagnetic waves" verification experiment, and reveals that Hertz's experiment did not prove the existence of "electromagnetic waves", but rather proved that wireless communication was achieved by independent electric field waves. Based on Coulomb's law and mathematical derivation, this paper proves that Maxwell's "displacement current" hypothesis is inconsistent in theory, and directly demonstrates through experiment that the "displacement current" hypothesis is not true, that is, a changing electric field cannot induce a changing magnetic field in a vacuum. In a modern wireless broadcasting system, there are only electric field signals without magnetic field signals. Wireless radio signals are the transmission, propagation, and reception of independent electric field waves in the air. In the application of microwave technology, when a microwave oven is turned off or on, the energy density of the electric field wave and the energy density of the magnetic field wave are not equal, which violates the principle of energy conservation. In EMC engineering testing, a magnetic field probe cannot directly detect magnetic field signals in a changing electric field environment. Based on theoretical analysis and experiments, this study proves that Maxwell's "displacement current" hypothesis is incorrect and denies the existence of "electromagnetic waves," which will have a profound impact on modern scientific discoveries and technological advancement.

Keywords: Maxwell's equations; displacement current; electromagnetic wave; Faraday's law of electromagnetic induction; electric field wave; magnetic field wave; Coulomb's law; wireless broadcasting system; microwave; principle of energy conservation; EMC; .

1. Introduction

In 2004, the British scientific magazine *Physics World* organized an event in which the readers were invited to choose the greatest formula in the history of science. As a result, Maxwell's equations topped the list, overtaking Einstein's mass-energy equation, Newton's second law, the Schrödinger equation, and other equations. Maxwell's equations revealed the common relationship among charge, current, electric fields, and magnetic fields, introduced "displacement current" hypothesis, and proposed the "electromagnetic waves" theory.

The following are Maxwell's equations in integral form.

$$\oiint_S E \cdot ds = \frac{Q}{\epsilon_0} \quad (1-1)$$

$$\oiint_S B \cdot ds = 0 \quad (1-2)$$

$$\oint_L E \cdot dl = - \frac{d\Phi_B}{dt} \quad (1-3)$$

$$\oint_L B \cdot dl = \mu_0 I_{enc} + \mu_0 \epsilon_0 \frac{d\Phi_E}{dt} \quad (1-4)$$

Equation (1-1) is Gauss's law for an electric field. It states that the electric flux passing through a certain closed surface is proportional to the amount of charge Q enclosed by the closed surface, and the coefficient is $1/\epsilon_0$. The electric field is the active field.

Equation (1-2) is Gauss's law for a magnetic field. It states that the magnetic flux passing through a certain closed surface must be equal to 0. Since there is no magnetic monopole in nature, the N pole and the S pole cannot be separated; that is, the magnetic field is a passive field.

Equation (1-3) is Faraday's law of electromagnetic induction. The law states that a magnetic field induces an electric field; that is, the induced electromotive force in a closed coil is proportional to the rate of change of the magnetic flux passing through the cross-section of the coil, and the coefficient is -1 .

Equation (1-4) is the Ampere-Maxwell law. According to Ampere's circuital law, the line integral of the magnetic induction intensity \mathbf{B} along a closed curve L is equal to μ_0 multiplied by the current passing through the closed curve L .

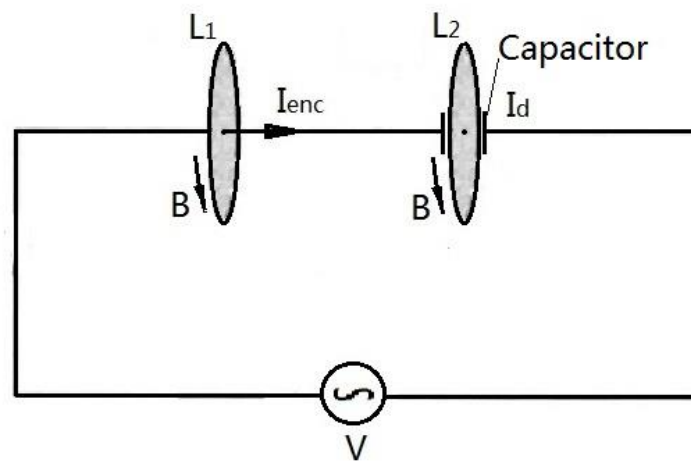

Figure 1.1 Schematic representation of the Ampere-Maxwell law

Figure 1.1 shows a simple circuit containing a capacitor. A conducting current I_{enc} flows through the cross-section of the closed curve L_1 , hence:

$$\oint_{L_1} \mathbf{B} \cdot d\boldsymbol{\ell} = \mu_0 I_{enc} \quad (1-5)$$

The cross-section of the closed curve L_2 is between two plates of the capacitor, and there is no conducting current I_{enc} passing through, but there is an electric field and electric flux between the two plates. Therefore, Maxwell introduced the "displacement current" hypothesis in 1865 and defined the "displacement current" I_d as

$$I_d = \epsilon_0 \frac{d\Phi_E}{dt} \quad (1-6)$$

There is a "displacement current" I_d passing through the cross-section of the closed curve L_2 , then,

$$\oint_{L_2} B \cdot d\ell = \mu_0 \epsilon_0 \frac{d\Phi_E}{dt} \quad (1-7)$$

Maxwell introduced the “displacement current” hypothesis and extended Ampere’s circuital law to the full current law, that is, Ampere-Maxwell law.

$$\oint_L B \cdot d\ell = \mu_0 I_{enc} + \mu_0 \epsilon_0 \frac{d\Phi_E}{dt} \quad (1-4)$$

Ampere-Maxwell law reveals that a magnetic field can be induced by a “displacement current,” that is, by a changing electric field.

According to the Ampere-Maxwell law in Equation (1-4), a changing electric field induces a magnetic field. According to Faraday’s law of electromagnetic induction in Equation (1-3), a changing magnetic field induces an electric field. The electric field and the magnetic field are closely linked and induce each other to form unified “electromagnetic waves”, as shown in Figure 1.2.

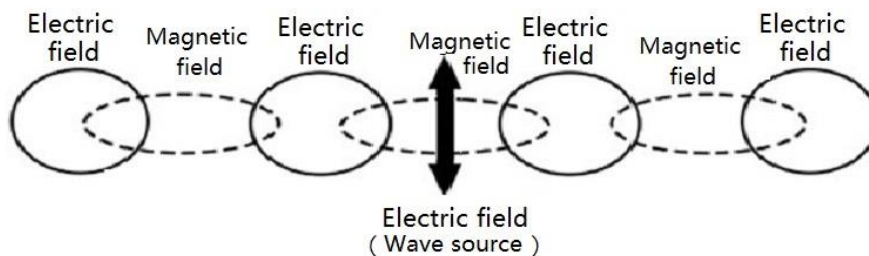

Figure 1.2 Propagation of “electromagnetic waves”

Maxwell introduced the “displacement current” hypothesis in 1865 that theoretically predicted the existence of “electromagnetic waves” and inferred from Maxwell’s equations that light was an “electromagnetic wave”. These ideas were astonishing to scientists throughout the world. The experimental conditions at that time could not prove that a changing electric field induced a magnetic field and a changing magnetic field induced an electric field. The “electromagnetic wave” theory was not accepted by most scientists. Only a few scientists in the world were willing to accept and support this theory, and the German physicist Hertz was one of them.

In 1887, eight years after Maxwell’s death, Hertz experimentally proved the existence of “electromagnetic waves”. The experimental setup is shown in Figure 1.3.

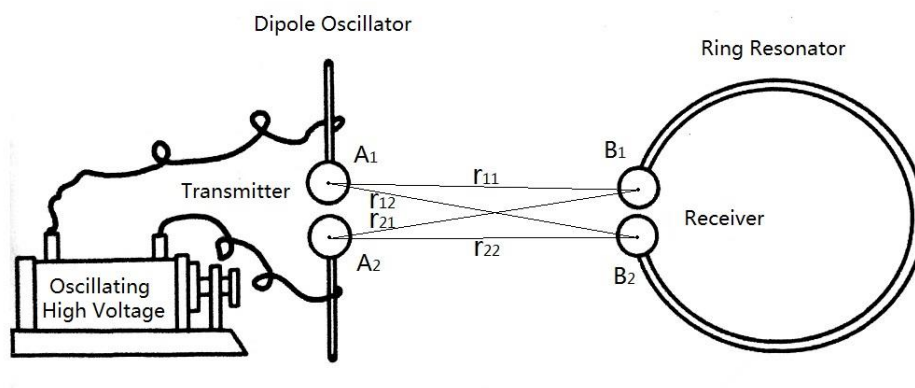

Figure 1.3 Experimental device for the proof of “electromagnetic waves”

The experimental device was very simple and was mainly composed of an “electromagnetic wave” transmitter and receiver. The “electromagnetic wave” transmitter used a dipole oscillator, as shown in Figure 1.3. The transmitter consisted of two metal rods that were equipped with copper balls A_1 and A_2 , and there was a gap between the two copper balls. An oscillating high-voltage electric field was generated between the copper balls A_1 and A_2 , and a dazzling spark was generated to excite an “electromagnetic wave” that propagated outward. The detector used a ring resonator, and the two ends of the ring were also two copper balls B_1 and B_2 with a gap. The Hertz experiment found that when there was a spark bounce in the gap between the two copper balls A_1 and A_2 of the transmitter resonator, there was also a spark bounce in the gap between the two copper balls B_1 and B_2 of the receiver resonator. In this way, Hertz achieved the transmission and reception of “electromagnetic waves” through experiments, which proved the existence of “electromagnetic waves” for the first time.

2. New Interpretation of Hertz’s Experiment

Could a changing electric field genuinely induce a magnetic field? Is the “displacement current” hypothesis true? The experiment in which the German physicist Hertz proved the existence of “electromagnetic waves” in 1887 is reinterpreted below.

Referring to Figure 1.3, powered by the alternating high voltage of the oscillating dipole, the amount of charge $Q_{A1}(t)$ and $Q_{A2}(t)$ on the two brass balls A_1 and A_2 of the emitter oscillator varied periodically with time. Then $Q_{A1}(t)$ and $Q_{A2}(t)$ generated a periodic alternating high voltage between two brass balls A_1 and A_2 , producing a discharge spark. The distances from the brass ball A_1 to the two brass balls B_1 and B_2 of the receiver were r_{11} and r_{12} , respectively, corresponding to their unit vectors \mathbf{r}_{11} and \mathbf{r}_{12} . The distances from brass ball A_2 to brass balls B_1 and B_2 were r_{21} and r_{22} , respectively, and their unit vectors were \mathbf{r}_{21} and \mathbf{r}_{22} .

According to Coulomb's law, the electric field intensity on the brass ball B_1 was

$$E_{B1}(t) = k \left(\frac{Q_{A1}(t_1)}{r_{11}^2} \mathbf{r}_{11} + \frac{Q_{A2}(t_1)}{r_{21}^2} \mathbf{r}_{21} \right) \quad (2-1)$$

The electric field intensity on the brass ball B_2 was

$$E_{B2}(t) = k \left(\frac{Q_{A1}(t_1)}{r_{12}^2} \mathbf{r}_{12} + \frac{Q_{A2}(t_1)}{r_{22}^2} \mathbf{r}_{22} \right) \quad (2-2)$$

Where $k = 1/4\pi\epsilon_0$; $t_1 = t - r_{11}/c$, and c is the velocity of the electric field, which is equal to the speed of light.

The electric field intensities $\mathbf{E}_{B1}(t)$ and $\mathbf{E}_{B2}(t)$ induced charges $Q_{B1}(t)$ and $Q_{B2}(t)$ on the brass balls B_1 and B_2 of the receiver. The charges $Q_{B1}(t)$ and $Q_{B2}(t)$ also varied periodically with time, and their frequencies and charge changes were synchronized with $Q_{A1}(t)$ and $Q_{A2}(t)$. By adjusting the structural parameters, the emitter oscillator and receiver could form resonance. Thus, a sufficient amount of charges $Q_{B1}(t)$ and $Q_{B2}(t)$ could accumulate on the two copper balls B_1 and B_2 of the receiver, and a periodic alternating high voltage could also form between the two copper balls B_1 and B_2 to generate discharge sparks.

In the Hertz experiment in 1887, general knowledge of wireless communication was almost zero. Today, one and a half centuries later, we re-examine the above experiment. In Equations (2-1) and (2-2), there is only a charge and an electric field, and there is no magnetic field. This illustrates the fact that the electric field waves can be generated by the change of the charge at the emitter side, the electric field

waves can propagate independently in a vacuum (air), and the electric field waves can be received independently at the receiver side. The generation, propagation, and reception of electric field waves can be completed independently by the electric field itself without the participation of the magnetic field. **Therefore, Hertz's experiment did not prove the existence of "electromagnetic waves", but rather proved that wireless communication was achieved by independent electric field waves.**

3. "Displacement Current" Hypothesis not Self-consistent in Theory

In the following, we theoretically calculate and analyze the "displacement current" hypothesis. Assuming that the "displacement current" hypothesis is true, as shown in Figure 3.1.

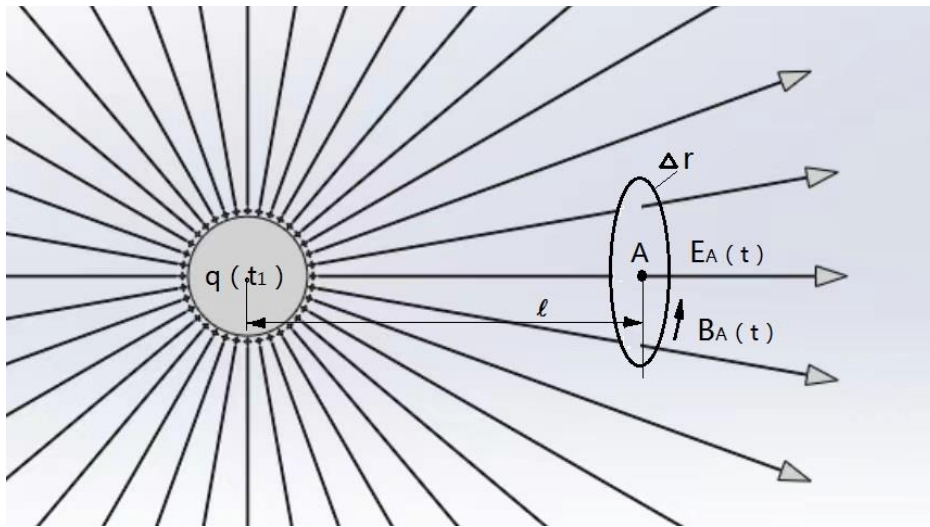

Figure 3.1 Electric and magnetic field waves induced by varying charges

Without losing generality, there is a point charge $q(t_1)$, and the amount of charge $q(t_1)$ changes is a sine function:

$$q(t_1) = q_{\text{Max}} \sin \omega t_1$$

There is a point A in space, and the distance between point A and the point charge is ℓ . Then, the electric field intensity at point A is:

$$E_A(t) = (q_{\text{Max}} \sin \omega t_1) / (4\pi \epsilon_0 \ell^2) \mathbf{n} \quad (3-1)$$

Where $t_1 = t - \ell/c$, the speed of the electric field is equal to the speed of light C, \mathbf{n} is the unit vector, and its direction is from the charge $q(t_1)$ to the point A.

According to Equation (3-1), $E_A(t)$ is a sine function, and the maximum electric field intensity at point A is:

$$E_{A\text{Max}} = q_{\text{Max}} / (4 \pi \epsilon_0 \ell^2) \quad (3-2)$$

To calculate the magnetic induction intensity $B_A(t)$ generated by the changing electric field $E_A(t)$ at point A, a circular cross-section with a radius of Δr is selected at point A, and the circular cross-section is perpendicular to the electric field intensity $E_A(t)$, as shown in Figure 3.1. When Δr is small enough relative to ℓ , it can be approximately considered that the electric field and the magnetic field in the circular cross-section are uniform fields. Then the electric flux of the circular cross-section is:

$$\Phi_{EA}(t) = E_A(t) \pi \Delta r^2$$

$$\Phi_{EA}(t) = (\Delta r^2 q_{Max} \sin \omega t_1) / (4 \epsilon_0 \ell^2)$$

According to Equation (1-6), the corresponding "displacement current" is:

$$\begin{aligned} I_d(t) &= \epsilon_0 d\Phi_{EA}(t) / dt \\ &= \Delta r^2 q_{Max} \omega \cos \omega t_1 / (4 \epsilon_0 \ell^2) \end{aligned}$$

According to Equation (1-7), the magnetic induction intensity $B_A(t)$ is generated by the "displacement current," and there is:

$$\oint_{L_{\Delta r}} \mathbf{B}_A(t) \cdot d\boldsymbol{\ell} = \mu_0 I_d(t)$$

Where $L_{\Delta r}$ is the closed curve of a circle with a radius Δr . Due to Δr is small enough relative to ℓ , it can be considered that the magnetic induction intensity in the circular cross-section is uniform. According to the above equation, there is

$$2\pi \Delta r B_A(t) = \mu_0 q_{Max} \Delta r^2 \omega \cos \omega t_1 / (4 \ell^2)$$

$$\text{Then } B_A(t) = \mu_0 q_{Max} \Delta r \omega \cos \omega t_1 / (8\pi \ell^2) \quad (3-3)$$

According to Equation (3-3), $B_A(t)$ is a cosine function, and the maximum magnetic induction intensity at point A is:

$$B_{AMax} = \mu_0 q_{Max} \Delta r \omega / (8 \pi \ell^2) \quad (3-4)$$

According to Equation (3-2), the maximum electric field intensity E_{AMax} at point A is not related to Δr and ω . But according to Equation (3-4), the maximum magnetic induction intensity B_{AMax} at point A is related to Δr and ω .

In order to intuitively understand the magnetic induction intensity generated by the "displacement current" at point A, letting $q_0=10^{-6}\text{C}$, $\ell=10\text{m}$, $\Delta r=0.001\text{m}$, $f=100\text{MHz}$, $\omega=2\pi f = 200\pi \times 10^6\text{Hz}$. Due to $\Delta r \ll \ell$, according to Equation (3-2), the maximum electric field intensity at point A is:

$$\begin{aligned} E_{Amax} &= q_0 / (4 \pi \epsilon_0 \ell^2) \\ &= 10^{-6} / (4 \times 3.14 \times 8.854 \times 10^{-12} \times 10^2) \text{ v/m} \\ E_{Amax} &= 89.9 \text{ v/m} \end{aligned} \quad (3-5)$$

According to Equation (3-4), the maximum magnetic induction intensity at point A is:

$$\begin{aligned} B_{AMax} &= \mu_0 q_{Max} \Delta r \omega / (8 \pi \ell^2) \\ &= (4 \times 3.14 \times 10^{-7} \times 10^{-6} \times 0.001 \times 2 \times 3.14 \times 100 \times 10^6) / (8 \times 3.14 \times 10^2) \\ B_{AMax} &= 3.14 \times 10^{-10} \text{ (T)} \end{aligned} \quad (3-6)$$

The above calculation results are based on the selected radius of the circular cross-section Δr is 0.001m. If the selected radius of the circular cross-section Δr is 0.002m and Δr is still much smaller than ℓ , Equation (3-4) is still valid. Then, the maximum magnetic induction intensity at point A is:

$$\begin{aligned} B_{AMax} &= \mu_0 q_{Max} \Delta r \omega / (8 \pi \ell^2) \\ &= (4 \times 3.14 \times 10^{-7} \times 10^{-6} \times 0.002 \times 2 \times 3.14 \times 100 \times 10^6) / (8 \times 3.14 \times 10^2) \\ B_{AMax} &= 6.18 \times 10^{-10} \text{ (T)} \end{aligned} \quad (3-7)$$

Comparing the calculation results of Equations (3-6) and (3-7), the maximum magnetic induction intensity at point A is related to the selected radius of circular cross-section, the Δr is different, then the maximum magnetic induction intensity at point A B_{AMax} is different.

And from Equation (3-4), it can be directly obtained that when the selected radius of circular cross-section approaches zero, the maximum magnetic induction intensity B_{AMax} at point A is zero. **Therefore, Maxwell's "displacement current" hypothesis is not self-consistent in theory.**

Furthermore, at point A, a changing electric field induced a changing magnetic field and a changing magnetic field induced a changing electric field. According to Equation (3-5), the maximum electric field intensity at point A is:

$$E_{A\text{max}} = 89.9 \text{ v/m}$$

The maximum energy density of the electric field at point A is:

$$\begin{aligned} P_{EA\text{Max}} &= \epsilon_0 E_{A\text{max}}^2 / 2 \\ &= 8.854 \times 10^{-12} \times 89.9^2 / 2 \\ P_{EA\text{Max}} &= 3.578 \times 10^{-8} \text{ J/m}^3 \end{aligned} \quad (3-8)$$

In accordance with Equation (3-6), the maximum magnetic induction intensity at point A is:

$$B_{A\text{Max}} = 3.14 \times 10^{-10} \text{ T}$$

The maximum energy density of the magnetic field at point A is:

$$\begin{aligned} P_{BA\text{Max}} &= B_{A\text{max}}^2 / (2\mu_0) \\ &= (3.14 \times 10^{-10})^2 / (2 \times 4\pi \times 3.14 \times 10^{-7}) \\ P_{BA\text{Max}} &= 3.92 \times 10^{-12} \text{ J/m}^3 \end{aligned} \quad (3-9)$$

Comparing Equations (3-8) and (3-9), at point A, a changing electric field induced a changing magnetic field, and the energy density of the magnetic field is much less than the energy density of the electric field.

According to Equation (3-4), the maximum magnetic induction intensity $B_{A\text{Max}}$ at point A is proportional to ω . If the frequency $f=100\text{MHz}$ mentioned above is changed to $f=100\text{GHz}$, then the angular frequency $\omega=2\pi f = 200 \pi \times 10^9 \text{ Hz}$. According to Equation (3-4), the maximum magnetic induction intensity at point A is:

$$\begin{aligned} B_{A\text{Max}} &= \mu_0 q_{\text{Max}} \Delta r \omega / (8 \pi \ell^2) \\ &= (4 \times 3.14 \times 10^{-7} \times 10^{-6} \times 0.001 \times 20 \times 3.14 \times 10^9) / (8 \times 3.14 \times 10^2) \\ B_{A\text{Max}} &= 3.14 \times 10^{-7} \text{ T} \end{aligned}$$

Then the maximum energy density of the magnetic field at point A is:

$$\begin{aligned} P_{BA\text{Max}} &= B_{A\text{max}}^2 / (2\mu_0) \\ &= (3.14 \times 10^{-7})^2 / (2 \times 4\pi \times 3.14 \times 10^{-7}) \\ P_{BA\text{Max}} &= 3.92 \times 10^{-6} \text{ J/m}^3 \end{aligned} \quad (3-10)$$

According to Equation (3-2), the maximum electric field intensity at point A is not related to ω , so the maximum energy density of the electric field at point A remains unchanged. Comparing Equations (3-8) and (3-10), if frequency $f=100\text{MHz}$, the energy density of the magnetic field induced by the changing electric field at point A is much lower than the energy density of the electric field, and if frequency $f=100\text{GHz}$, the energy density of the magnetic field induced by the changing electric field at point A is much higher than the energy density of the electric field. **Therefore, based on the principle of energy conservation, Maxwell's "displacement current" hypothesis is also not self-consistent in theory.**

4. Experimental Verification of "Displacement Current" Hypothesis

The Hertz experiment in 1887 did not prove the existence of "electromagnetic waves", and it only proved that wireless communication was achieved independently by electric field waves. Maxwell introduced the "displacement current" hypothesis in 1861. After a century and a half, no experiment has genuinely proved its correctness so far.

Figure 4.1a shows a photograph of the experimental device used by the author to verify the "displacement current" hypothesis, and Figure 4.1b shows a schematic diagram of the experimental device. In the figures, the capacitor C is composed of two round aluminum plates. The radius of the plate is $r_c=100\text{mm}$, and the distance between the two plates is $d_c=60\text{mm}$. A magnetic field induction coil

L_{BE} is set on the side of the gap between the two plates. The radius is $r_{be}=25\text{mm}$, the height is $\text{height}=10\text{mm}$, and the number of turns is $n=1000$. An induction resistor $R_{BE}=300\Omega$ is connected between the two lead wires of the coils L_{BE} . The distance from the center of the induction coils to the center of two plates of capacitor C is $\ell=130\text{mm}$. A closed curve of the induction magnetic field circle L_c is selected with the radius ℓ centered around the capacitor C .

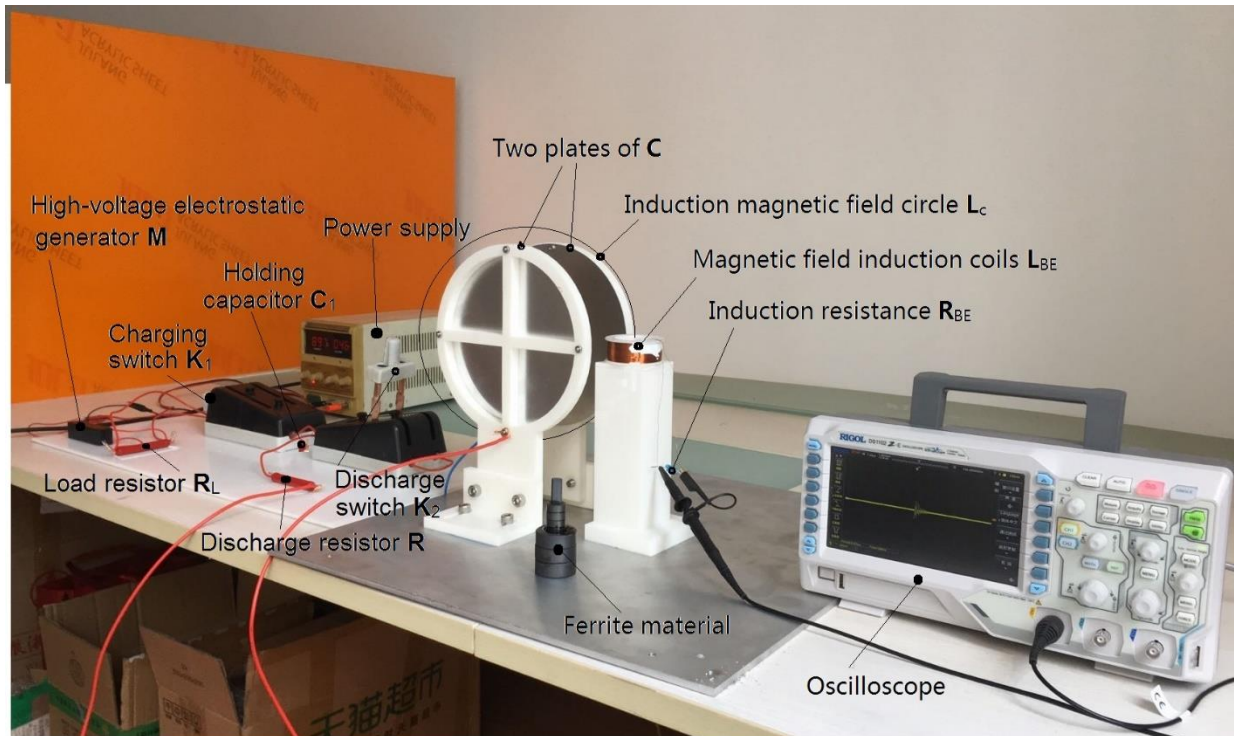

Figure 4.1a Photograph of the experimental device proving the “displacement current” hypothesis

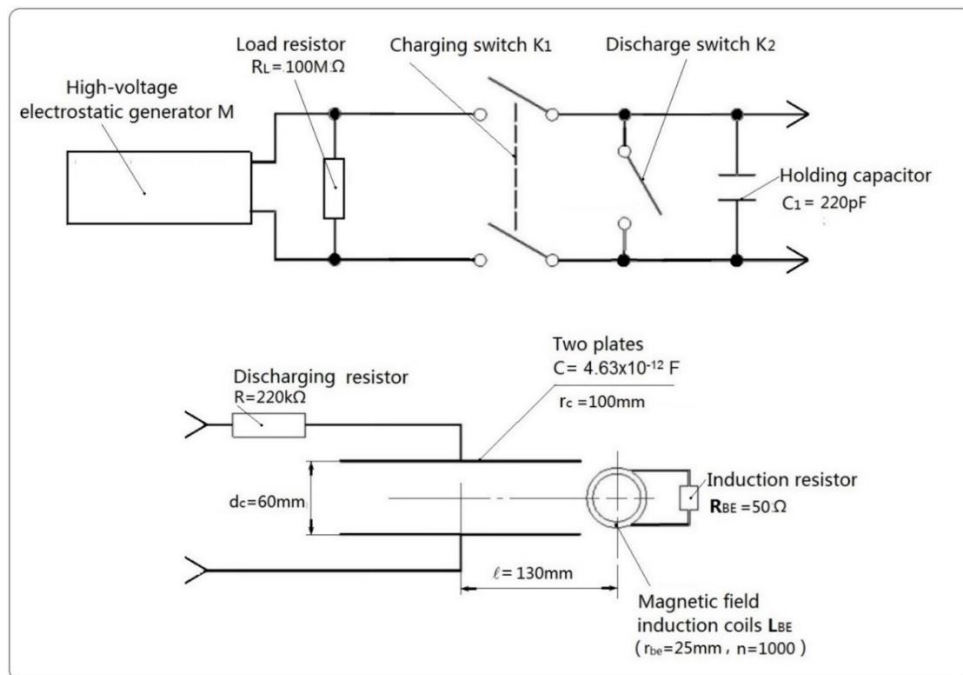

Figure 4.2b Schematic diagram of the experimental device proving the “displacement current” hypothesis

The voltage between the two plates of capacitor C is $V(t)$, the electric field intensity is $E(t)$, and the electric flux is $\Phi_E(t)$. The high-voltage electrostatic generator M generates the high static voltage $V_0=20000$ V. The charging switch K_1 is turned on to charge the capacitor C, and the discharge switch K_2 is turned on to discharge the capacitor C through a resistor R ($R=220k\Omega$). When the capacitor C is discharged, a varying electric field is generated between the two plates of the capacitor. According to Maxwell's "displacement current" hypothesis, a varying magnetic field $B(t)$ is generated along the closed curve L_c . This varying magnetic field induces an electromotive force $V_{BE}(t)$ on the induction coils L_{BE} , which can be detected in the resistor R_{BE} .

The capacitance of the capacitor C is:

$$\begin{aligned} C &= \epsilon_0 \pi r_c^2 / d_c \\ &= 8.85 \times 10^{-12} \times 3.14 \times 0.1^2 / 0.06 \\ &= 4.63 \times 10^{-12} \text{ F} \end{aligned}$$

The time constant is:

$$RC = 220 \times 1000 \times 4.63 \times 10^{-12} = 1.0 \times 10^{-6} \text{ s} = 1.0 \text{ us}$$

The electric flux between the two plates of the capacitor C is:

$$\begin{aligned} \Phi_E(t) &= E(t) \pi r_c^2 \\ &= \pi r_c^2 V(t) / d_c \\ &= 0.523 V(t) \end{aligned}$$

$$\text{Then } d\Phi_E(t) / dt = 0.523 dV(t) / dt \quad (4-1)$$

When the switch K_1 is turned off and the switch K_2 is turned on, the capacitor C is discharged via the resistor R, the voltage $V(t)$ on the two plates of the capacitor decreases exponentially, and there is

$$V(t) = V_0 e^{-t/RC}$$

$$\text{Then } dV(t) / dt = - (V_0 / RC) e^{-t/RC} \quad (4-2)$$

According to Eqs. (4-1) and (4-2), the change rate of the electric flux between the two plates of the capacitor C is obtained:

$$\begin{aligned} d\Phi_E(t) / dt &= - (0.523 V_0 / RC) e^{-t/RC} \\ d\Phi_E(t) / dt &= - 1.046 \times 10^{10} e^{-t/RC} \end{aligned} \quad (4-3)$$

If the "displacement current" hypothesis is true, according to Maxwell's equation (1-4), the following expression is obtained:

$$\oint_{L_c} \mathbf{B}(t) \cdot d\boldsymbol{\ell} = \mu_0 \epsilon_0 \frac{d\Phi_E(t)}{dt}$$

Considering the magnetic induction intensity $B(t)$ passing through induction coils L_{BE} as a uniform magnetic field, the approximate calculation is obtained from Equation above:

$$B(t) (2\pi\ell) = \mu_0 \epsilon_0 d\Phi_E(t) / dt$$

$$\text{Then } B(t) = -1.28 \times 10^{10} \mu_0 \epsilon_0 e^{-t/RC}$$

The magnetic flux of the induction coils L_{BE} and the change rate of the magnetic flux are:

$$\begin{aligned} \Phi_B(t) / dt &= B(t) (\pi r_{be}^2) \\ &= -1.28 \times 10^{10} \times 3.14 \times 0.025^2 \mu_0 \epsilon_0 e^{-t/RC} \\ &= - 2.51 \times 10^7 \mu_0 \epsilon_0 e^{-t/RC} \end{aligned}$$

$$\text{Then } \Phi_B(t) / dt = 2.51 \times 10^{13} \mu_0 \epsilon_0 e^{-t/RC} \quad (4-4)$$

The alternating magnetic flux in Equation (4-4) generates an induced voltage in the induction coils L_{BE} , and according to Maxwell's Equation (1-3), the following expression is obtained:

$$\oint_{L_{BE}} \mathbf{E}_{BE}(t) \cdot d\mathbf{l} = - \frac{d\Phi_B(t)}{dt}$$

The left side of the above equation is the induced voltage of a single turn of the induction coils L_{BE} . Then:

$$\begin{aligned} V_{BE1}(t) &= - d\Phi_B(t) / dt \\ &= - 2.51 \times 10^{13} \mu_0 \epsilon_0 e^{-t/RC} \\ &= - 2.51 \times 10^{13} \times 8.854 \times 4 \times 3.14 \times 10^{-19} e^{-t/RC} \end{aligned}$$

Then $V_{BE1}(t) = -0.000279 e^{-t/RC} \text{ V}$

The positive and negative poles of the magnetic field induction coils L_{BE} are switched, with the number of turns being $n=1000$, so the total induced voltage of L_{BE} is:

$$V_{BE}(t) = 1000 \times 0.000279 e^{-t/RC}$$

Then $V_{BE}(t) = 0.279 e^{-t/RC} \text{ V}$ (4-5)

According to Equation (4-5), the voltage on the induction resistance R_{BE} decreases exponentially. The voltage waveform is shown in Figure 4.2.

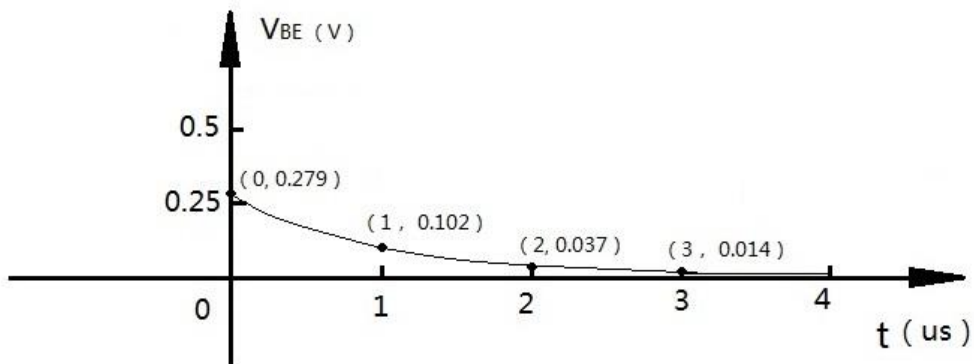

Figure 4.2 Induced voltage waveform calculated based on the "displacement current" hypothesis

As shown in Figure 4.2, $V_{BE} = 0.279 \text{ V}$ at $t=0$; $V_{BE} = 0.102 \text{ V}$ at $t = 1 \mu\text{s}$; $V_{BE} = 0.037 \text{ V}$ at $t=2 \mu\text{s}$; and $V_{BE} = 0.014 \text{ V}$ at $t = 3 \mu\text{s}$.

Figure 4.3 shows the actual voltage waveform obtained with the oscilloscope for the induction resistor R_{BE} . There is no induced voltage waveform calculated according to the "displacement current" hypothesis, as shown in Figure 4.2. **This indicates that when the capacitor C is discharged, the change of the electric flux between the two plates of the capacitor C does not induce a magnetic field as predicted under the "displacement current" hypothesis. Therefore, the above experiment directly proves that the "displacement current" hypothesis is not true.**

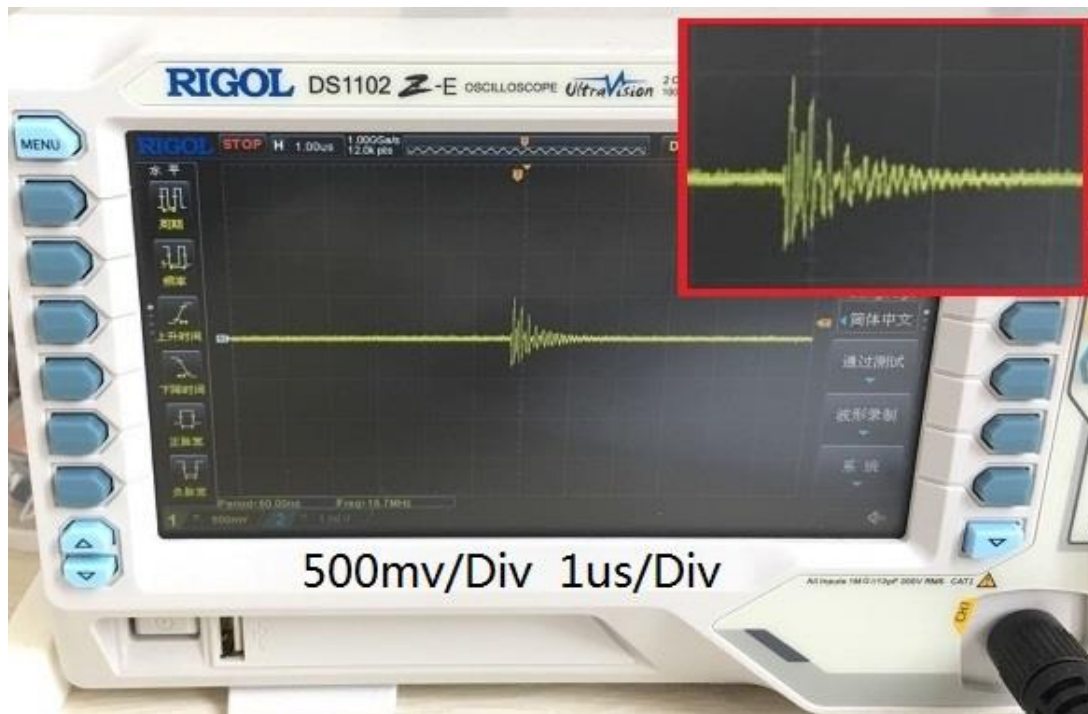

Figure 4.3 Voltage waveform detected by oscilloscope

As shown in Fig. 4.3, the voltage waveform on R_{BE} shows a symmetrical oscillation waveform with a maximum peak value of 0.4 V, and a 1 μ s later, the oscillation waveform has almost decayed to zero. Therefore, we can determine that the oscillation waveform is not caused by the induction of the alternating magnetic field generated by the "displacement current" hypothesis, and the symmetrical oscillation waveform should be the interference signal generated by the electric field when the capacitor C is discharged rapidly.

5. "Electromagnetic Waves" in the Applications of Modern Technology

5.1 "Electromagnetic waves" in a modern wireless broadcasting system

Based on modern wireless broadcasting systems, we will analyze the generation, transmission, propagation, and reception of radio signals below. Figure 5.1 is a block diagram of the structure of a wireless transmitter.

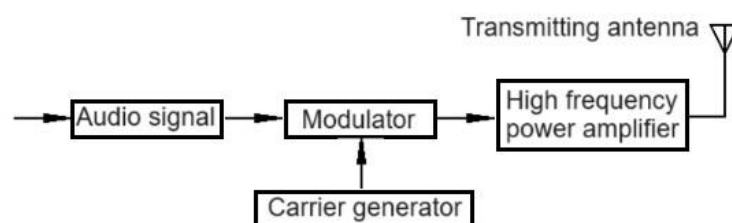

Figure 5.1 Block diagram of a wireless transmitter.

The frequency of the original signal (sound) is relatively low, ranging from 20Hz to 20kHz. The lower frequency signal is unsuitable for transmission. Moreover, due to its low frequency and long wavelength, according to antenna theory, the size of the required transmitting antenna is also larger, so it is actually impossible to directly achieve wireless communication by sound frequency. An effective method to solve

this problem is to use modulation technology. Modulation is the process of loading the transmitted signal onto a high-frequency oscillating signal, amplifying the modulated high-frequency oscillating signal, sending it to the transmitting antenna, and converting it into corresponding wireless high-frequency waves, which are radiated into space. This is the generation and transmission of radio signals.

The receiving process of radio signals is the opposite of the transmitting process. Figure 5.2 is a block diagram of the structure of a radio broadcast receiver.

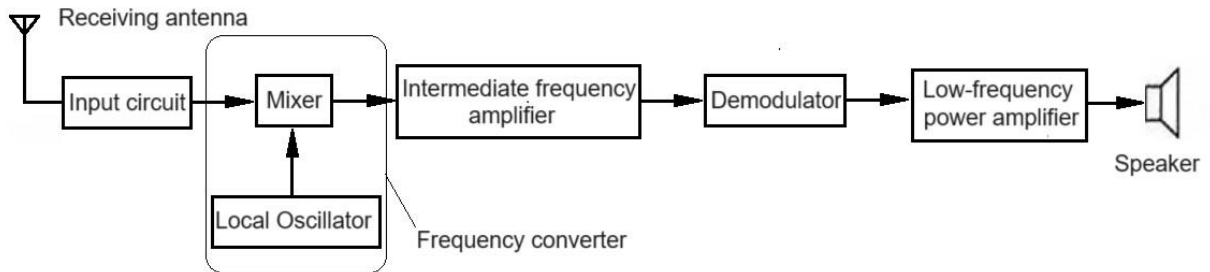

Figure 5.2 Block diagram of a radio broadcast receiver.

A radio receiver mainly includes a receiving antenna, an input circuit, a frequency converter, an intermediate frequency amplifier, a demodulator, a low-frequency power amplifier, and a speaker. First, the high-frequency modulated wireless signal is received by the antenna and frequency-selected by the input circuit. The frequency converter modulates the selected high-frequency modulated signal to an intermediate frequency, which is then amplified by the intermediate frequency amplifier. Then, the demodulator demodulates the original audio signal from the intermediate frequency modulated signal, and the audio signal is converted into sound by power amplification driving the speaker.

Figure 5.3 is a detailed circuit schematic diagram of the receiving and input circuit of an FM radio.

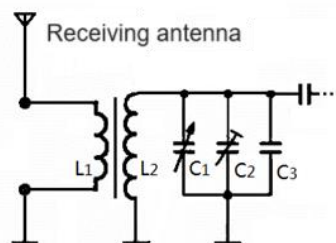

Figure 5.3 Schematic diagram of the receiving and input circuit of an FM radio

The wireless high-frequency electric field wave causes periodic changes in the amount of charge on the receiving antenna. The change in the amount of charge on the receiving antenna excites a weak alternating current signal in the input circuit. The input circuit is an LC resonant circuit, which implements frequency selection for the input signal of the receiving antenna. The capacitor C_1 is a variable capacitor whose capacity can be adjusted. The input circuit amplifies the input signal corresponding to the frequency of L_2C_1 parameters, while suppresses the input signal of other frequencies.

In the above analysis, the antenna and the ground form an open capacitor, there are only electric field waves and no magnetic field waves in the process of transmitting and receiving wireless signals through antennas. In Hertz experimental device of Figure 1.3, with the copper balls A_1 and B_1 stretched up to air and the copper balls A_2 and B_2 pulled down to ground, the copper balls A_1 is the transmitting antenna, and the copper sphere B_1 is the receiving antenna.

Below, an experiment proves that the wireless signal in the wireless broadcasting system is transmitted, propagated, and received by electric field waves in the air. As shown in Figure 5.4a, a stainless steel mesh is laid out on a table and grounded.



5.4a A FM radio on open table

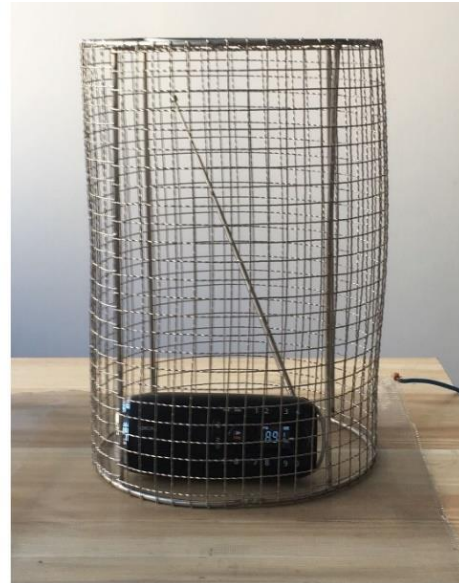

5.4b A FM radio under stainless steel mesh cover

In the experiment, the FM radio is a Philips TAR2808, which is placed on a table covered with a stainless steel mesh. Turn on the radio and select the frequency channel of 89.1MHz, and the speaker plays clear sound. Cover the FM radio with a stainless steel mesh cover (mesh size of 10mm x 10mm), and the speaker of the radio no longer plays clear sound, as shown in Figure 5.4b. This indicates that the wireless radio signals are shielded by the stainless steel mesh cover, and the FM radio cannot receive the wireless radio signals. It is well known that the stainless steel mesh cover can shield the electric field signals, but not the magnetic field signals, so the wireless signals in the wireless broadcasting system only have electric field signals, without magnetic field signals. Wireless radio signals are the transmission, propagation, and reception of individual electric field waves in the air, and magnetic field waves are not required and there are no magnetic field waves within wireless radio signals. Maxell's "electromagnetic waves" do not exist in the real physical world.

Wireless communication is the transmission, propagation, and reception of electric field waves in the air. In wired communication, electrons move slowly in metal wires, typically a few millimeters per hour. Wired communication is also the transmission, propagation, and reception of electric field waves in metal wires. Therefore, wireless communication and wired communication both are the transmission, propagation, and reception of electric field waves.

5.2 "Electromagnetic waves" in high-energy microwave

With a household microwave oven and a simple electromagnetic radiation detector, we can prove whether there are "electromagnetic waves". According to Maxell's "electromagnetic waves" theory, a changing electric field excites a changing magnetic field in the air, and a changing magnetic field excites a changing electric field, and the conversion efficiency between a changing electric field and a changing magnetic field must be 100%. Based on the conservation of energy, the energy density of electric field waves and that of magnetic field waves of electromagnetic radiation must be equal at any point in the air. Microwave oven is a household appliance that uses microwave energy to heat food. A magnetron, which is a core component of microwave oven, can generate high-energy "electromagnetic waves" at frequency of 2.45 GHz.

In the experiment, the electromagnetic radiation detector, which is VC825A from Shengli Instrument, can simultaneously measure the electric field intensity and the magnetic induction intensity. The measurement resolution of electric field intensity is 1V/m, and the resolution of magnetic induction intensity is 0.01 μ T. The detection frequency range covers 5Hz to 3.5GHz. The microwave oven is Galanz G5 (SO) with a rated power of 1000 W, can generate microwave at frequency of 2.45 GHz. The distance between the electromagnetic radiation detector and the microwave oven is set to 500mm.

When the microwave oven is turned off, as shown in Figure 5.5a, the measured electric field intensity $E_0=0\text{V/m}$, and the magnetic induction intensity $B_0=0.00\mu\text{T}$.



Figure 5.5a Microwave oven turned off

Then, the energy density of electric field waves is:

$$P_{E0} = 0 \text{ J/m}^3$$

The energy density of magnetic field waves is:

$$P_{B0} = 0 \text{ J/m}^3$$

When the microwave oven is turned on and working in the "High" mode, as shown in Figure 5.5b, the measured electric field intensity $E_1=0\text{V/m}$, and the magnetic induction intensity $B_1=4.05\mu\text{T}$.



Figure 5.5b Microwave oven turned on

The energy density of electric field waves remains unchanged, and it is:

$$P_{E1} = P_{E0} = 0 \text{ J/m}^3$$

The energy density of magnetic field waves has changed, and it is:

$$P_{B1} = \mathbf{B}_1^2 / (2\mu_0)$$

$$= (4.05 \times 10^{-6})^2 / (2 \times 4\pi \times 10^{-7})$$

$$P_{B1} = 6.53 \times 10^{-6} \text{ J/m}^3$$

In summary, when the microwave oven is turned off or turned on, the energy density of electric field waves and that of magnetic field waves are not equal. Therefore, based on principle of conservation of energy, the experiment above has proven that Maxwell's "electromagnetic waves" theory is not true.

5.3 "Electromagnetic waves" in the application of EMC technology

EMC (Electro Magnetic Compatibility) involves the detection of "electromagnetic waves". The electric field (E field) and magnetic field (H field) are mutually excited and propagated orthogonally. In the application of EMC technology, electromagnetic fields are divided into near-field and far-field. When the distance from the detection point to the radiation source $r \ll \lambda/2\pi$, the electromagnetic field is considered to be a near-field, which is a circuit induction field expressed as capacitance and inductance of the circuit. When the distance from the detection point to the radiation source $r \gg \lambda/2\pi$, the electromagnetic field is considered to be a far-field, which is a radiation field, that is, a changing electric field induces a changing magnetic field, and a changing magnetic field induces a changing electric field. The transition region between the near-field and far-field is called the near-far field transition region. Figure 5.6 shows the relationship between the near-field, far-field, and near-far field transition region in the EMC electromagnetic field.

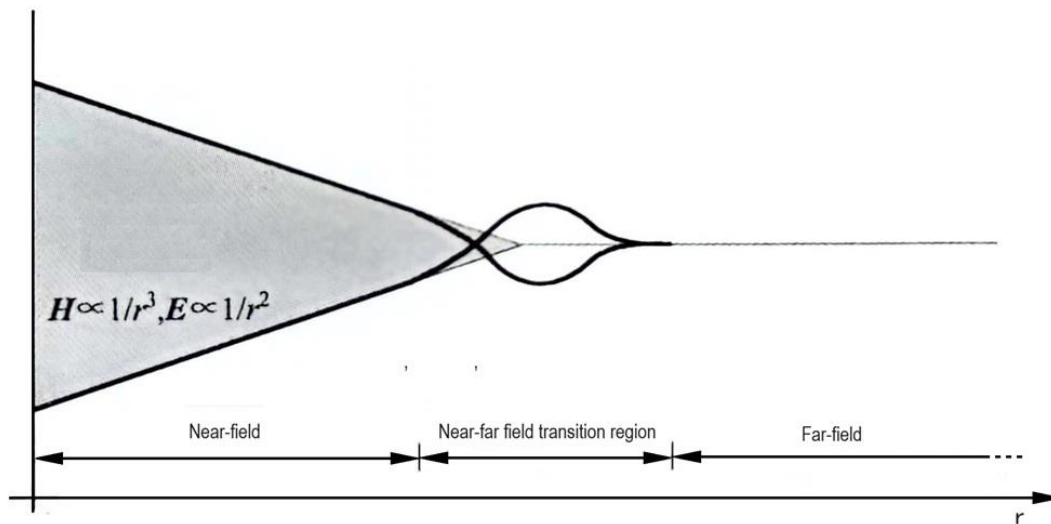

Figure 5.6 The near-field, far-field, and near-far field transition region

In the EMC testing of "electromagnetic waves", the electric field signal and magnetic field signal are measured by an electric field probe and a magnetic field probe, respectively. Figure 5.7a shows the structure of an electric field probe, which is essentially an open capacitor. Figure 5.7b shows the structure of a magnetic field probe, which is a ring-shaped inductor.

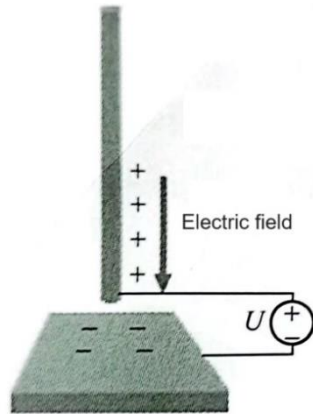

Figure 5.7a An electric field probe

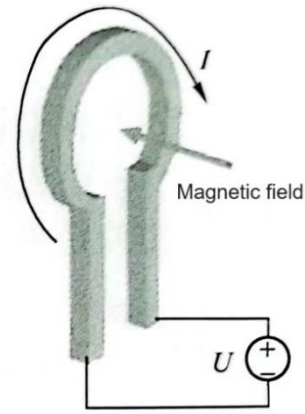

Figure 5.7b A magnetic field probe

In the near field, the electric field signal is generated by the change of charge in the radiating source circuit over time, and its physical principle is the Coulomb's law from Equation (3-1). The magnetic field signal is generated by the conduction current in the radiating source circuit, and its physical principle is the Ampere's circuit law from Equation (1-5). In the near field, the electric field signal and magnetic field signal are measured by the near-field electric field probe and near-field magnetic field probe, respectively. In the far field, according to Maxwell's equation (1-6), the magnetic field signal is generated based on the "displacement current" hypothesis, that is, a changing electric field generates a changing magnetic field. However, in the actual engineering measurement of EMC, the magnetic field probe with Figure 5.7b cannot detect any magnetic field signals. In order to comply with Maxwell's equations, in EMC engineering testing, a standard antenna is used for the measurement of far-field magnetic field signals. We all know that the standard antenna directly measures the value of the electric field signal, and then theoretically converts the measured value of the electric field signal to the magnetic field signal.

In summary, in EMC engineering testing, the existence of "electromagnetic waves" is not really detected. On the contrary, in an environment where the electric field signal changes, the magnetic field probe cannot detect the magnetic field signal, which proves that a changing electric field cannot induce a changing magnetic field, that is, Maxwell's "displacement current" theoretical hypothesis is wrong, and there is no "electromagnetic waves" in the physical world.

6. Conclusion

Maxwell's equations are the greatest scientific accomplishment of physics in the 19th century, which contain a set of four equations. Maxwell introduced the "displacement current" theoretical hypothesis, which stated that a changing electric field could induce a changing magnetic field in a vacuum. Modern physics generally believes that the "displacement current" is the only theoretical hypothesis introduced in Maxwell's electromagnetism equations. In fact, Maxwell's equations also introduced two other theoretical hypotheses.

- 1) From Equation (1-3), Maxwell extended Faraday's law of electromagnetic induction from metal circuits to a vacuum, and theoretically concluded that a changing magnetic field could induce a changing electric field in a vacuum.

2) Maxwell theoretically predicted the existence of "electromagnetic waves" and further predicted the propagation mode of "electromagnetic waves" in a vacuum, as shown in Figure 6.1a.

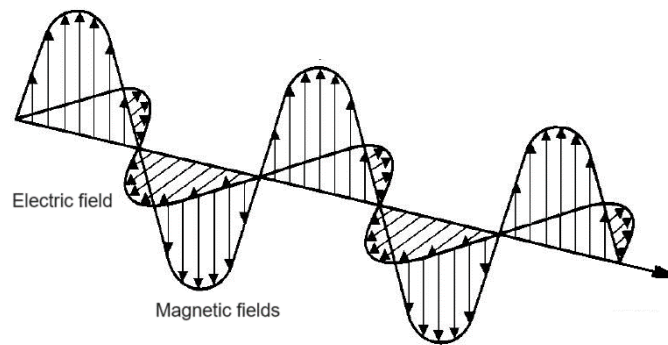

Figure 6.1a Propagation mode of "electromagnetic waves"
(Maxwell theoretically predicted)

Based on physics experiments, the direction of a magnetic field induced by the current in the metal circuit follows the right-hand spiral rule, while the direction of the electric field induced by the changing magnetic field in the metal circuit also follows the right-hand spiral rule and Lenz's law. Therefore, the propagation mode of "electromagnetic waves" should be shown in Figure 6.1b.

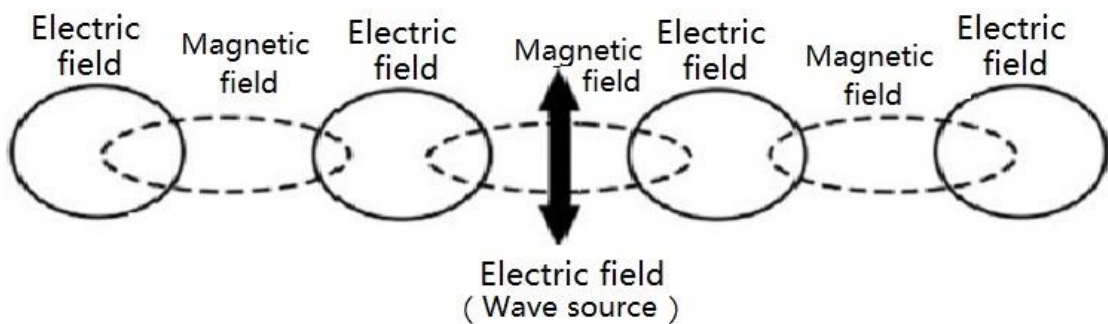

Figure 6.1b Propagation mode of "electromagnetic waves"
(Induction method between electric fields and magnetic fields in metal circuits)

Looking back the history of science, the three theoretical hypotheses introduced in Maxwell's electromagnetic equations have never been verified by physical experiments. This study reinterprets Hertz's "electromagnetic wave" verification experiment, and reveals that Hertz's experiment did not prove the existence of "electromagnetic waves", but rather proved that wireless communication was achieved by independent electric field waves. Based on Coulomb's law and mathematical derivation, this paper proves that Maxwell's "displacement current" hypothesis is inconsistent in theory, and directly demonstrates through experiment that the "displacement current" hypothesis is incorrect, that is, a changing electric field cannot induce a changing magnetic field in a vacuum.

In a modern wireless broadcasting system, there are only electric field signals without magnetic field signals. Wireless radio signals are the transmission, propagation, and reception of independent electric field waves in the air. In the application of microwave technology, when a microwave oven is turned off or on, the energy density of the electric field wave and the energy density of the magnetic field wave are not equal, which violates the principle of energy conservation. In EMC engineering testing, a magnetic field probe cannot directly detect magnetic field signals in a changing electric field environment. Modern wireless communication and microwave technology applications have shown that a changing electric field cannot induce a changing magnetic field in a vacuum. Both wireless and wired communications rely on the transmission, propagation, and reception of independent electric field

waves. Based on theoretical analysis and experiments, this study proves that Maxwell's "displacement current" hypothesis is incorrect and denies the existence of "electromagnetic waves," which will have a profound impact on modern scientific discoveries and technological advancement.

Availability of Data and Materials:

All data generated or analysed during this study are included in this published article and its supplementary information files.

References:

- [1] Hongyuan Ye, Maxwell Equations and Principles of Electromagnetism, e-Print archive, vixra.org/abs/2207.0079, 2022-07-10
- [2] Hongyuan Ye, New Consideration of Electromagnetic Induction - Faraday's Law of Electromagnetic Induction vs. Lorentz's Magnetic Field Force Theorem, e-Print archive, vixra.org/abs/2305.0163, 2023-05-27
- [3] Hongyuan Ye, New Consideration of Electromagnetic Induction - Faraday's Law of Electromagnetic Induction vs. Maxwell's Equation, e-Print archive, [viXra.org/abs/2308.0083](https://vixra.org/abs/2308.0083), 2023-08-13
- [4] Hongyuan Ye, New Research of Electromagnetic Induction, e-Print archive, [viXra.org/abs/2212.0225](https://vixra.org/abs/2212.0225), 2022-12-31
- [5] Michael Faraday, Experimental Researches in Electricity, The Dover Edition, USA, 2004
- [6] Luoyin Wang, Faraday's Experimental Research on Electromagnetism-Analysis According to Faraday's Diary, A Dissertation for Doctor's Degree, University of Science and Technology of China, Hefei 2009
- [7] Liner Fu et al. Fundamentals of Radio, China Labor and Social Security Publishing House, Beijing, 2021
- [8] Junqi Zheng, EMC Electromagnetic Compatibility Design and Case Study, Publishing House of Electronics Industry, 3rd Edition, Beijing, 2018
- [9] Morris H. Shamos, Great Experiments in Physics, 1st Edition, Science Press, Beijing, 1985
- [10] Guo Jin et al., College Physics (Volume 2), 1st Edition, Science Press, Beijing, 2009
- [11] Richard P. Feynman et al., The Feynman Lectures on Physics (Volume 2), The New Millennium Edition, Shanghai Science & Technical Publishers, Shanghai, 2020
- [12] Zhenning Yang, Institute of Physics, Chinese Academy of Sciences, The Origin of Maxwell's Equations and Gauge Theory, <https://mp.weixin.qq.com/s/0FigYVmDEiAFWbfUFEFshw> 2014-12-19
- [13] Maxwell, General Theory of Electromagnetism, 1st Edition, Peking University Press, Beijing, 2010
- [14] David K. Cheng, Field and Wave Electromagnetics, 2nd Edition, Tsinghua University Press, Beijing, 2007