

# Relativity

John Caywood  
 Independent Researcher  
[john\\_caywood@hotmail.com](mailto:john_caywood@hotmail.com)

## Abstract

Lorentz formulas are modified to become Lorentz-Pythagorean circles with half for matter and half for antimatter. History of time passage is different from rate of time passage. Varying rates of time passage for an object accumulate to its history of time passage. Redshift of distant objects is an artifact of the observer being in space rotated with respect to the space wherein the photon was created.

## Keywords

special relativity, general relativity, Lorentz, length contraction, time dilation, red shift

## Contents

Claims of Novelty .....	2
Chapter 2 Introduction .....	3
Definitions.....	3
Mathematical Foundation .....	3
Dimensions.....	4
Chapter 3 Special Relativity .....	4
Time Rate versus Elapsed Time.....	6
Add Antimatter to Special Relativity.....	10
Red Shift and Blue Shift.....	12
Matter vs Antimatter is Indeterminate.....	13
Chapter 4 General Relativity and Equivalence Principle.....	17
Equivalence Principle Regarding Time Rate.....	17
General Relativity.....	18
General Relativity Does Not Depend on Gravity.....	20
Light Cones and Divergent Space.....	21
Simultaneous General Relativity.....	22
General Relativity Done with Graphs.....	24
The Triplets Paradox .....	29
Is Special Relativity Real or an Illusion? .....	35

## Claims of Novelty

- Lorentz time dilation and length contraction equations are written as squares of velocities. Taking the square root of the equations reveal negative velocities which go with positive velocities.
- History of time passage is different from rate of time passage.
- Varying rates of time occur as an object accumulates its elapsed time history.
- Redshift of distant objects is due to time dilation between the observer and the observed space rotated with respect to the space wherein the photon was created.
- There is no age difference in the twin paradox because time dilation is reciprocal between observer and observed. The observed time rates and the accumulated elapsed time return to being the same as the earthbound twin when velocity stops.
- General relativity has nothing to do with distance or gravity. It has to do with separating time rate and elapsed time, which have a reciprocal relationship.
- The Equivalence Principle states that slowing of the time rate of an object is the same, whether it is accelerated by gravity or a mechanical means. This is only true at the quark level, because when a loosely connected system of various components and linkages is accelerated mechanically, each piece of it will have a different acceleration history and thus elapsed time history.

## Chapter 2 Introduction

### Dedication

This work is dedicated to Ginger

### Previous Work

The text and diagrams are substantially the same as my paper posted on the physics archive <https://vixra.org/abs/2209.0057>. The term Sub-quarks are used in that online document. In this paper, the term “Tetrons” is used to emphasize they are a discovery and to avoid usage of a generic term “sub-quarks”. Other authors have published using “subquarks” with different characteristics. The word “tetron” is descriptive because this entity is located at a vertex of a tetrahedral quark. Four tetrons are the four vertices of a quark, as explained in detail later.

### Definitions

#### Stationary Observer

Stationary observer is the same as freefall observer, meaning going in the same frame of reference as an object that has not accelerated in that frame of reference.

#### Elapsed Time and Time Rate

Elapsed time is different from rate of time. An object at a distance from an observer has a history of time passage which has recorded the rate of time passage and distance traveled at that rate.

The Minkowski diagram has a geometrized treatment of time and does not separately record the rate of time passage and the distance traveled at that rate. Rate of time for an observed object slows due to acceleration or gravity, therefore a Minkowski diagram is not a true record of elapsed time for the observed object.

### Mathematical Foundation

This paper does not refer to tensors, which are useful in rotations and boosts in the same coordinate system in the same dimensions. Spacetime mixes space with a single understanding of time, which I believe are necessarily left separate, given the reciprocal relationship of time rate and elapsed time. This paper’s mathematical method uses vectors because they don’t refer to arbitrary coordinates. Unit values are used in equations so empirical constants are not necessary. In particular, vector cross products are used to define values in another dimension.

- The symbol is  $\times$  or  $\times$  or  $\times$  means cross product or vector product or directed area product.
- A new operator  $\underline{\times}$  or  $\underline{\times}$  or  $\underline{\times}$  means the inverse cross product, which amount to division.
- For example,  $\underline{\times} v \times v$  is the directed area product of velocity and velocity.
- The scalar  $v^2/c^2$  can be written as a vector  $(v \times v) \underline{\times} (c \times c)$ .

Cross products preserve the sign of the input vectors. In normal algebra  $(-c) * (+c) = -c^2$ , but the cross-product yields  $(-c \times +c)$  and the resultant sign depends on choosing right- or left-hand rule for vector products.

## Dimensions

Vector cross products can be made in 3 and 7 dimensions. The math basis for cross products in dimensions greater than the three in 3D are, "The orthogonality requirement implies that in  $n$  dimensions, no more than  $n - 1$  vectors can be used."<sup>1</sup> The purpose of this section is to differentiate between primary vectors and cross products that can be made from them. The 6 primary vectors listed below mean 7 dimensions exist and cross products can be made with them.

1. Charge
2. Time
3. Gravity
4. +Spin
5. -Spin (not additive with +Spin)
6. Acceleration

Example vector cross products are:

- Charge X Velocity = Magnetism
- Acceleration X Time = Velocity
- Velocity X Time = Distance
- +Spin X -Spin = Curvature
- Velocity X Velocity = Velocity Area (e.g.,  $v^2$  and  $c^2$ )
- Velocity Area  $\times$  Velocity Area =  $\beta$  (e.g.,  $v^2/c^2 = v^2 \times 1/c^2$ ) where reciprocals are the same units

The +Spin X -Spin in the above list is as follows:

## Chapter 3 Special Relativity

Special Relativity begins with the Lorentz equations of length contraction and time dilation. Time dilation does not depend on who is moving and who is stationary. "Time dilation is reciprocal because moving between two observers is reciprocal"<sup>2</sup>. Only one of the following pairs of statements are true because time rate and elapsed time are reciprocals when relative motion is involved:

- "Rate of time of a moving clock is dilated when measured by a stationary observer.  
AND
- Rate of time of a stationary clock is dilated when measured by a moving observer."  
OR
- "Elapsed time of a moving clock is dilated when measured by a stationary observer.  
AND
- Elapsed time of a stationary clock is dilated when measured by a moving observer."

Length contraction does not depend on who is moving and who is stationary:

"Length contraction affects any geometric quantity related to lengths, so from the perspective of a moving observer, areas and volumes will also appear to shrink along the direction of motion."<sup>3</sup>

---

<sup>1</sup> [Seven-dimensional cross product - Wikipedia](#)

<sup>2</sup> [Reciprocity of Time Dilation \(herongyang.com\)](#)

<sup>3</sup> [Lorentz transformation - Wikipedia](#)

Lorentz Equations

The Lorentz time dilation factor  $\gamma$  is  $1/(1-(v^2/c^2))^{1/2}$

where:

$v$  = the speed of the observed frame

$c$  = the speed of light in a vacuum<sup>4</sup>

The Lorentz equation for length contraction is:

$$L = L_{\text{moving}} / \gamma$$

and the reciprocal equation for time dilation is:

$$t = t_{\text{moving}} \gamma$$

where:

$L$  = length in the frame at rest

$L_{\text{moving}}$  = length in the moving frame

$t$  = rate of time in the frame at rest

$t_{\text{moving}}$  = rate of time in the moving frame

For example, if the velocity of a distant rocket is observed to be half the speed of light:

$$c = 299,792,458 \text{ m/s}$$

$$v/c = 1/2$$

$$v = 149,896,229 \text{ m/s}$$

$$(v/c)^2 = (1/2)^2 = 1/4$$

$$1-(v/c)^2 = 1-1/4 = 3/4$$

$$(1-(v^2/c^2))^{1/2} = (3/4)^{1/2} = 0.866 = 1/\gamma$$

$$\gamma = 1/0.866 = 1.1547$$

$\gamma$  is always  $> 1$

$$L_{\text{moving}}/L = 1/\gamma = 0.866$$

$$t_{\text{moving}}/t = \gamma = 1.1547$$

$$t / t_{\text{moving}} = 1/\gamma = 0.866$$

values verified with [Relativistic Length Contraction Calculator \(thecalculator.co\)](http://thecalculator.co)

Lorentz Equations as a Pythagorean Triangle

Another way of looking at the Lorentz equations is using a Pythagorean triangle:

Following is the Pythagorean formula for length

$$L_{\text{moving}}/L = 1/\gamma$$

$$L_{\text{moving}}/L = (1-(v/c)^2)^{1/2}$$

Square both sides of an equation, which requires both real and imaginary square roots.

$$(L_{\text{moving}}/L)^2 = 1-(v/c)^2$$

$$(L_{\text{moving}}/L)^2 + (v/c)^2 = 1$$

$$(L_{\text{moving}}/L)^2 + (v/c)^2 = 1^2$$

---

<sup>4</sup> [Time dilation - Wikipedia](https://en.wikipedia.org/wiki/Time_dilation)

Following is the formula for time rate

$$t / t_{\text{moving}} = 1/\gamma$$

$$1/\gamma = (1-(v^2/c^2))^{1/2}$$

$$t / t_{\text{moving}} = (1-(v^2/c^2))^{1/2}$$

Square both sides of an equation

$$(t / t_{\text{moving}})^2 = 1-(v^2/c^2)$$

$$(t / t_{\text{moving}})^2 + (v^2/c^2) = 1$$

$$(t / t_{\text{moving}})^2 + (v/c)^2 = 1^2$$

In the below Pythagorean triangle, the  $L_{\text{moving}}/L$  side can be replaced by  $t / t_{\text{moving}}$ . The length contraction value and time dilation value are reciprocal.

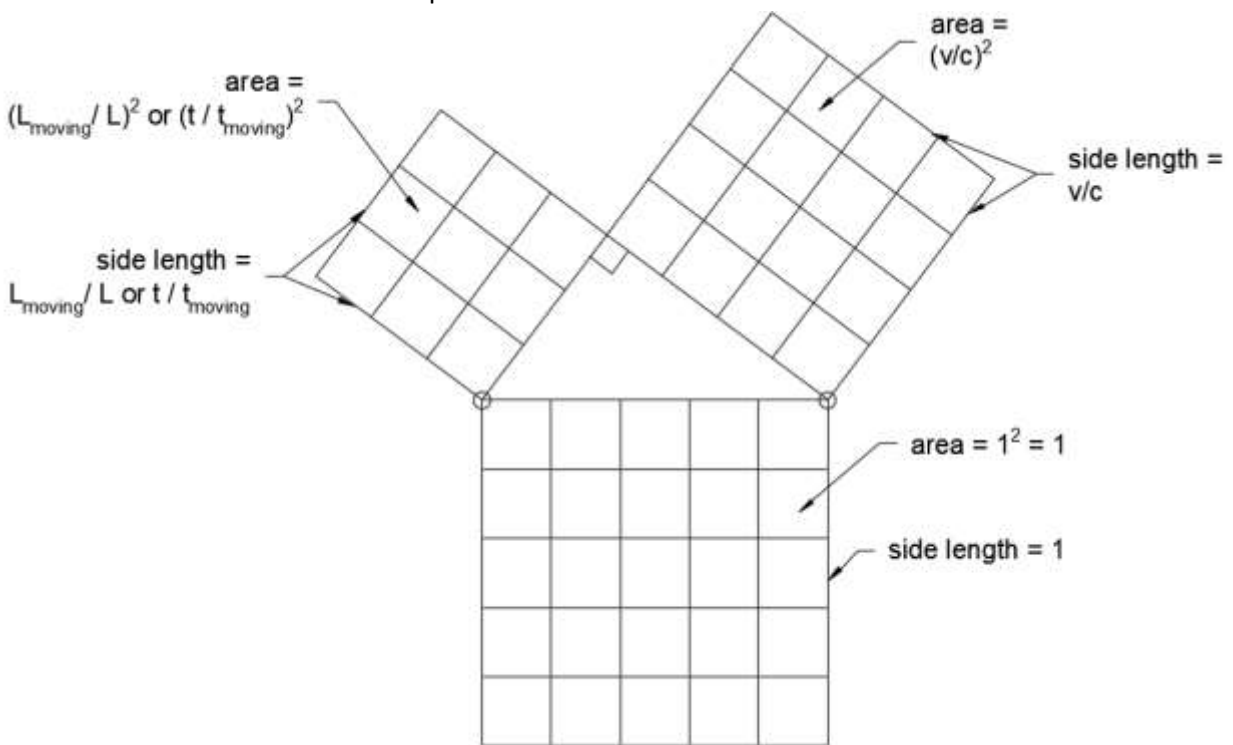

Figure 1 – Lorentz Length Contraction and Time Dilation as a Pythagorean Triangle

~~~~~

### Time Rate versus Elapsed Time

In the diagram below, global time is equivalent to free fall time not affected by gravity. The moving clock's one tick per the global clock's ten ticks is the moving object's time rate. If the moving object changes velocity with respect to the stationary observer, that change is recorded differently in the elapsed global time and the moving object's elapsed time.

The moving object and the stationary observer's recording of their own clocks will be a constant tick rate. Since there is no easy way for the stationary and moving person to read one another's clocks, they

compare the recorded charts when the moving one returns. The moving person's chart reads one tenth of the time elapsed as the stationary person's chart, due to the moving person being time dilated with respect to the stationary person.

The most difficult transition of conceiving time is it has been considered a constant rate of ticking every place forever in the past and forever in the future. Both the time rate and elapsed time vary between two objects, no matter how close together they are. The very distance between two objects guarantees the time rate and elapsed time history can and will be different. The reason is it takes acceleration and velocity for an object to move anywhere. During acceleration the time rate changes and after acceleration the elapsed time is different.

The below diagram illustrates the moving clock's one tick per the global (stationary) clock's ten ticks.

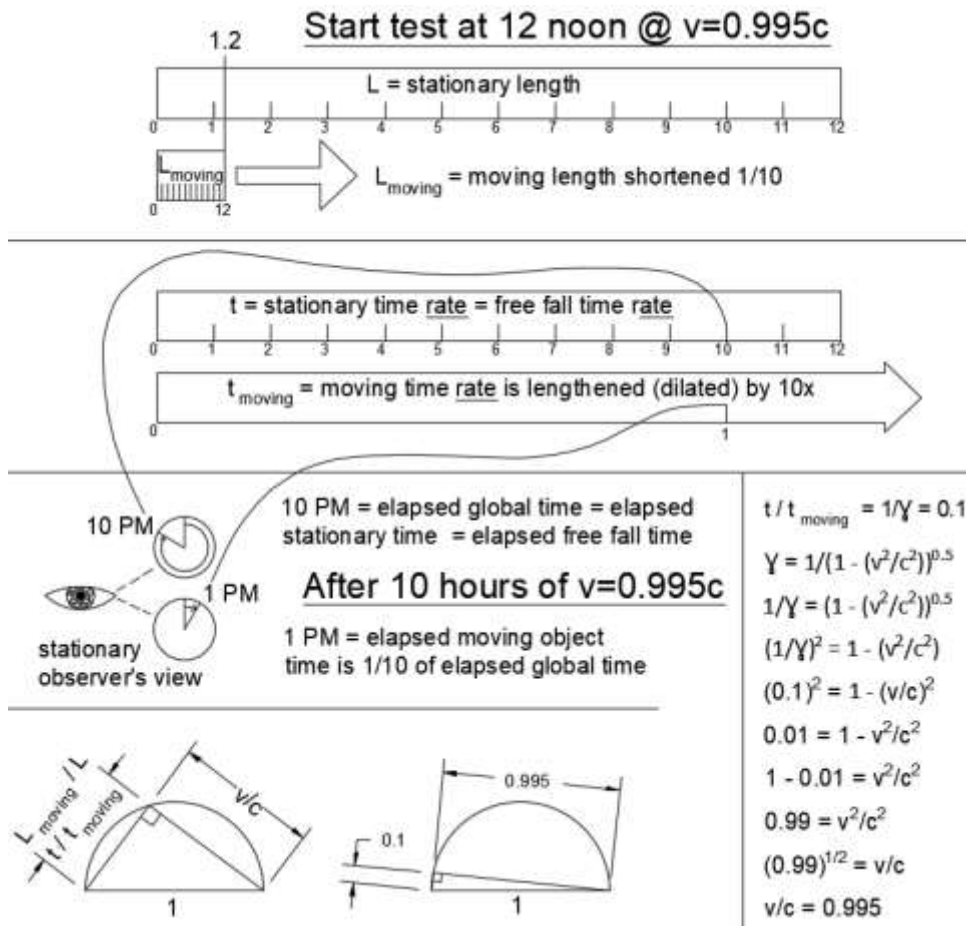

Figure 2 - Time Rate versus Elapsed Time

\*\*\*\*\*

The Twin Clocks in Rockets Paradox

A pair of identical rockets with digital clocks are in a lab, one rocket in the accelerator and one outside. The velocity of the accelerator rocket is increased to nine tenths the speed of light. This causes the

length of that rocket to shorten in the direction of velocity. It also causes that clock to appear to run very slowly. Since time dilation is symmetric, the person in the accelerated rocket looks out at the lab and sees very tall, thin people aging slowly.

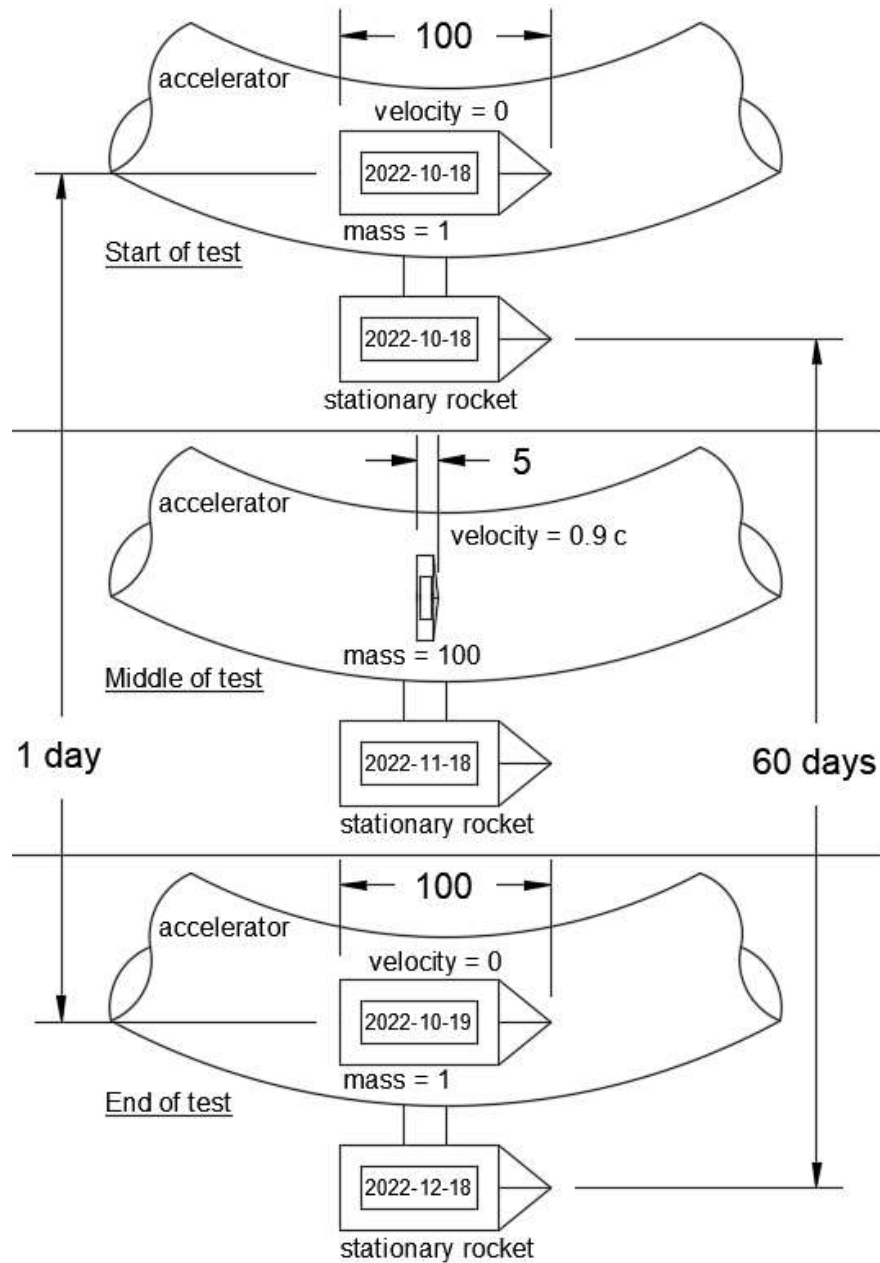

Figure 3 - The Twin Clocks in Rockets Paradox

Time Dilation and Length Contracted Rocket

At the end of the test, the rocket has recovered its original time rate, length and weight, with no evidence of the change remaining. The elapsed time of this event is recorded in the digital clock as being different. That difference is never reconciled. Where did that lost time go? The simplest explanation is the rocket's 3D coordinate system rotated out of plane with the lab's 3D coordinate system.





## Add Antimatter to Special Relativity

Antimatter's existence and motions are the parity, charge, time mirrors of their matter counterparts per Dirac's equation.<sup>5</sup> In the below diagram, there are two Lorentz-Pythagorean triangles inscribed in a circle on both sides of the light speed hypotenuse. Of particular note, the dilations and contractions of antimatter are the reciprocal of those for matter. It could be said the reciprocal nature of time dilation and length contraction has been hidden in the squared velocity of the Lorentz equation since 1904. Time dilation reciprocity in the literature is not completely in lock step.<sup>6 7</sup>

In the below diagram, the matter part of that pair is the triangle above the hypotenuse and the antimatter part of that pair is the triangle below the hypotenuse. Top matter and bottom antimatter triangles are similar shapes but have reciprocal measurements on the left leg of the triangles.

The square roots of  $v^2$  and  $c^2$  are either positive  $+v/+c$  or negative  $-v/-c$ . Matter may be considered to have plus velocity and antimatter to have minus velocity. It could be reasoned that matter and antimatter exist as a congruent pair. For this diagram, it means an object with congruent matter and antimatter may accelerate to a velocity, which will have opposite effects on matter and antimatter's lengths and time rates.

As a congruent matter//antimatter object accelerates, the mass of the matter half will increase as the mass of the antimatter half will decrease. Similarly, the length of the matter half will shorten while the length of the antimatter half will lengthen.

How does a congruent matter//antimatter object both increase mass and decrease mass? How does that object have matter that is shorter and antimatter that is longer? The answer to these questions is the mass has not changed and the length has not contracted because the matter mass is added to the antimatter mass, and likewise the length.

How does a matter//antimatter object accelerating away from a matter//antimatter observer appear? The matter observer will see the matter half will appear red shifted and the antimatter observer will see the antimatter half appear blue shifted.

In the below diagram, using time rate change and length change, reciprocity is illustrated. On the left side, the separate matter and antimatter observers are combined into a congruent matter//antimatter observer. On the right side, the separate matter and antimatter observers are combined into a congruent matter//antimatter object.

The addition of velocity (moving to a distance) induces reciprocal and balancing changes in the viewing frame of reference. A matter observer only sees the matter object and does not see the congruent antimatter object because the cause-effect motions of them are simultaneous and in the same direction.

---

<sup>5</sup> [Dirac equation - Wikipedia](#)

<sup>6</sup> [\[Solved\] Reciprocal Time Dilation in Special Relativity | 9to5Science](#)

<sup>7</sup> [Time dilation - Wikipedia](#)

Lorentz Circle Time and Length Reciprocity

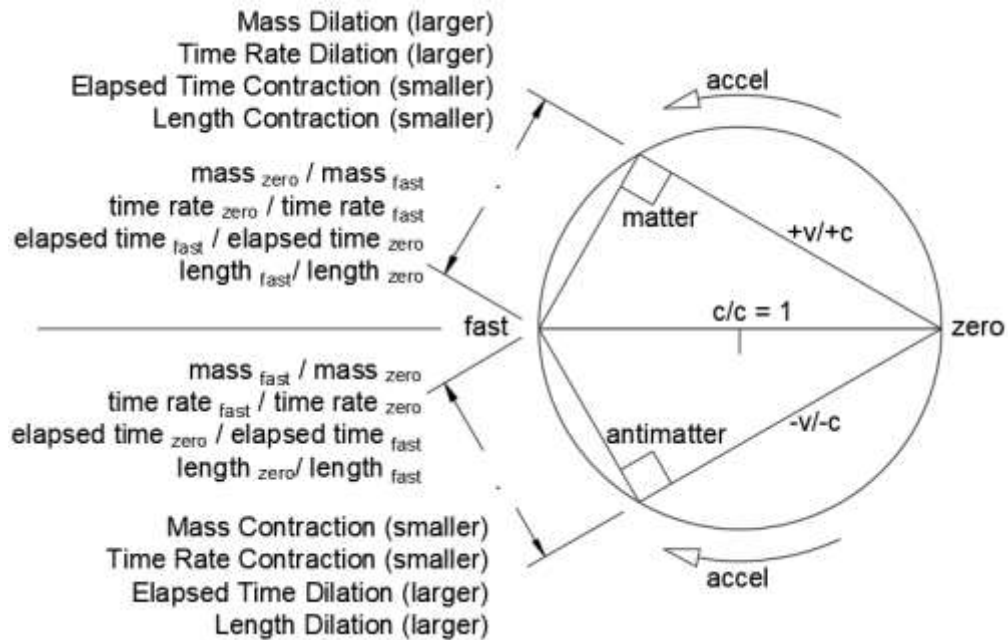

Figure 5 - Reciprocal Time Dilatation and Length Contraction

~~~~~

Multiply Velocity by Time to get Distance

Multiplying the above diagram by time rate obtains distance. The ratios of velocity and distance are the same by similar triangles. As noted in the diagram, the unitless ratios are unchanged. This diagram includes the anti-photon, the components of which will be explained in more detail later. The velocity to move that distance will rotate the moving object's space and time vectors with respect to the unmoving observer. That acceleration to increase from zero velocity to a non-zero velocity will alter forever the elapsed time history of both objects. It doesn't matter which object moves, because the effect is reciprocal.

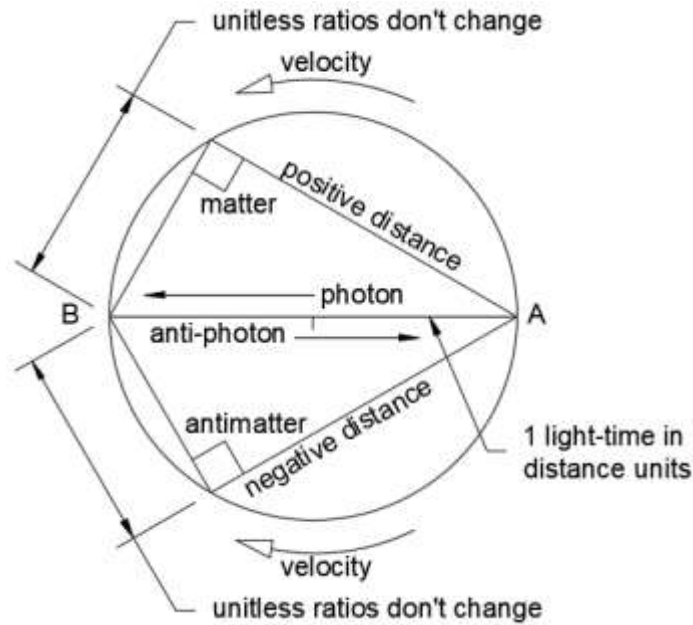

Figure 6 - Reciprocal Distances

~~~~~

### Red Shift and Blue Shift

Light from distant galaxies does not alter its constant speed or the energy carried in its frequency.

- 1) During the observation of distant galaxies, let the frequency of observed light with respect to expected frequency  $f/f_0$  be the length contraction ratio  $L/L_0$
- 2) Let the distance to that distant galaxy be estimated as distance  $d$ , based on an astronomical ladder
- 3) Let  $t$  be the time to travel distance  $d$  at velocity  $c$
- 4) Similarly, the expression  $d/t$  is equal to  $v$ , so for the purpose of evaluating what variable affects  $(L/L_0)$ , only  $v=d/t$  matters since the hypotenuse is always 1
- 5) If a spacecraft goes the distance  $d$  at various velocities, its length contraction as seen by the observer will depend on the total distance it travels and not various length contractions experienced during segments of the journey
- 6) Regardless of the various velocities traveled, the end result depends on total distance and total time
- 7) Similarly, light frequency is length contracted because it is the reciprocal of wavelength, which is a distance
- 8) The light frequency is time dilated, based on the total distance traveled and not on instantaneous velocity. This means wavelength is dilated and takes longer between wave crests passing by a stationary clock's ticking.
- 9) Velocity of light is constant by definition, so distance is what determines the frequency. This is equivalent to saying red shift is not due to velocity, but to distance of the observed light source.

Matter and Antimatter Velocities and Distances

The two Lorentz-Pythagorean circles in the lower part of the following diagram are independent of location of observer. Distance from an observer to an observed object is equivalent to velocity of the observed object.

The telescope image of a distant object is redshifted, which is interpreted as motion away from the observer. If this image were of the antimatter half only, it would appear blue-shifted. This would be interpreted as motion toward the observer. The antimatter half of the matter/antimatter pair is blue-shifted in reverse time, so when the time is factored in, the anti-photons emitted by the antimatter reverse to be viewed as a matching redshift.

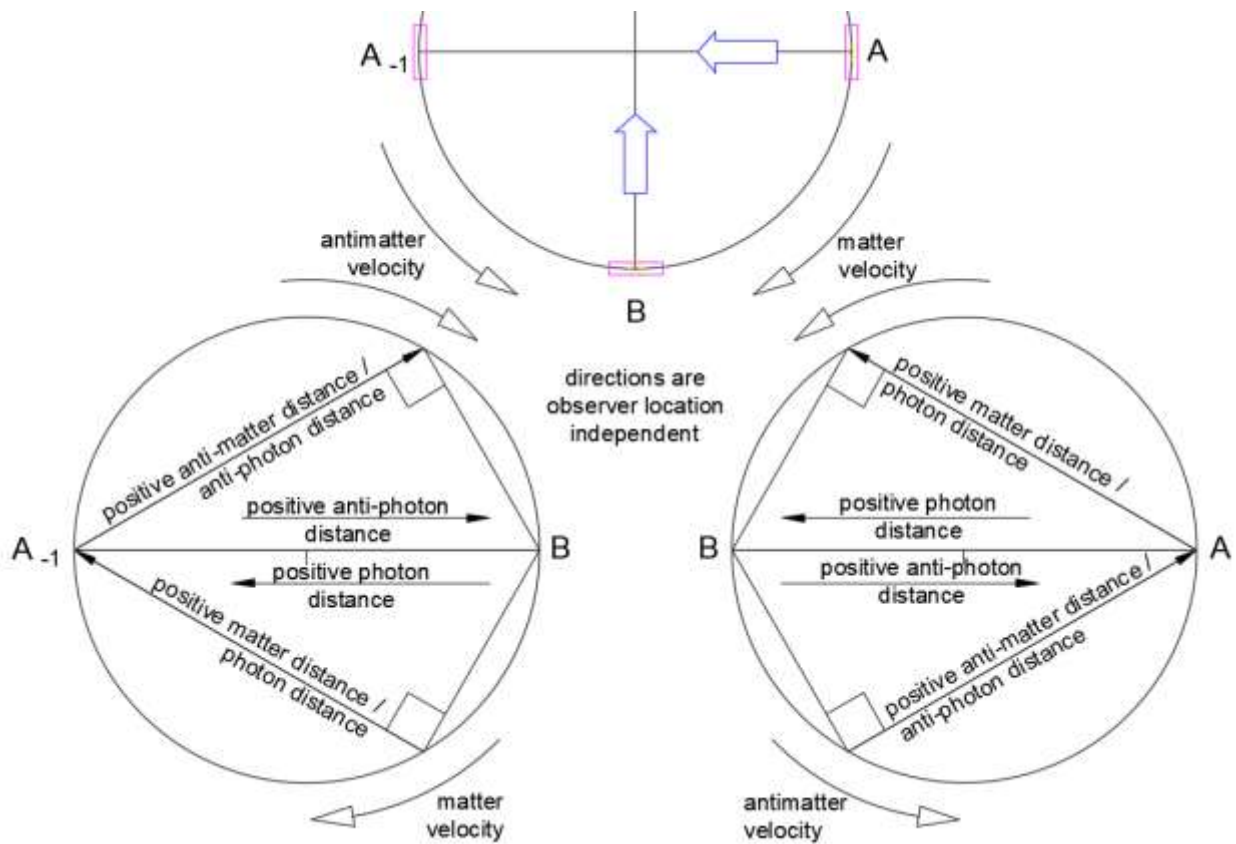

Figure 7 - Matter and Antimatter Velocities and Distances

~~~~~

**Matter vs Antimatter is Indeterminate**

Indeterminate does not mean unknown. It means bi-stable. Stable in both states. If it can be either state, it must be both states. The best way in word to illustrate this dilemma in words is to use Shakespeare's famous quote as follows:

To Be OR Not to Be

This first premise is real matter and imaginary antimatter OR real antimatter and imaginary matter. Matter and antimatter pairs are interdependent and do not exist independently. Congruence in this definition is the real (positive) energy and imaginary (negative) energy exist together, but only one at a time can be seen by an observer. This is somewhat like the mirror anti-universe.<sup>8</sup>

The anti-universe theory as stated in that reference is, "The Big Bang generated a universe–anti-universe pair, our universe flows forward in time, while our mirror counterpart flows backward."

This paper holds universe and anti-universe flow forward in cause-effect time. Matter velocity flows the same direction as cause-effect direction. Antimatter velocity flows backwards from cause-effect velocity. Parity and time reversal restores antimatter’s cause-effect direction to be congruent with matter’s velocity. This is best visualized as a rotation that is consistent with time rotation whether seen by matter using the right-hand rule direction or by antimatter using the left-hand direction.

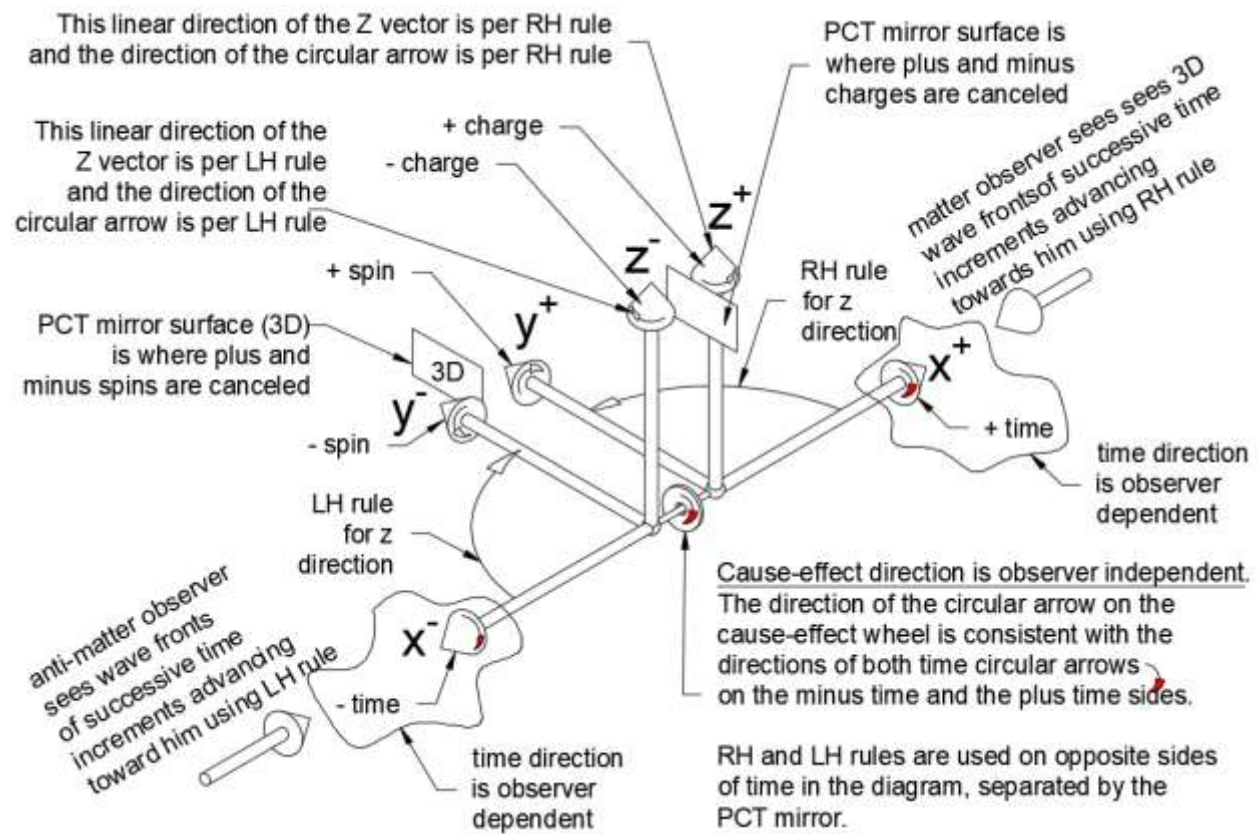

Figure 8 - Time X Spin = Charge

It is necessary to account for the existence of antimatter corollaries to matter in all reactions, to know what is being inverted. It is only necessary to consider matter most of the time. One abstraction of this

<sup>8</sup> [Baryon asymmetry - Wikipedia](#)



notion is the below diagram matter and antimatter being separate in all aspects but interdependent in being mutual PCT mirrors of each other.

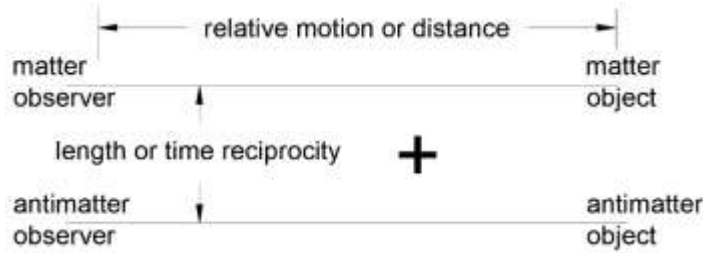

Figure 9 - Parallel Congruent Interdependent Matter/Antimatter

**To Be AND Not to Be**

The second premise is that matter and its antimatter PCT reverse really exist and are not the result of smoke and mirrors. The question, “where this antimatter is”, is diagrammed below as both being congruent with matter and at the opposite side of the universe. Being congruent with is the nested half spheres on the right side and on the opposite side is on the left side.

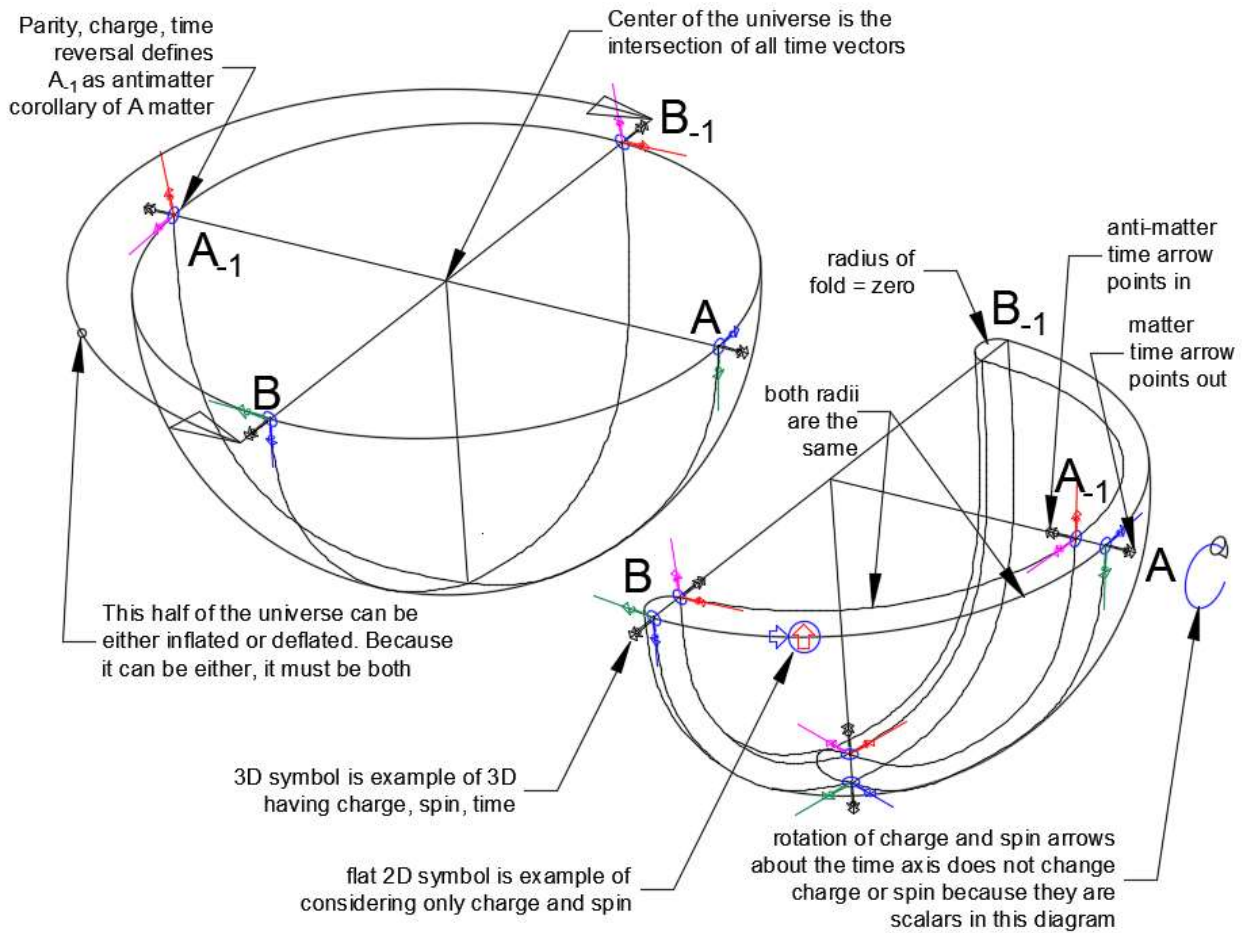

Figure 10 - Spherical vs Two Nested Half Spheres







## General Relativity

The simplest approach to general relativity (GR) is to begin with time dilation. Recall the formula for special relativity's time dilation is:

$$t / t_{\text{moving}} = (1 - (v^2/c^2))^{1/2}$$

$$t = t_{\text{moving}} (1 - (v^2/c^2))^{1/2}$$

$$t_{\text{moving}} = t / (1 - (v^2/c^2))^{1/2}$$

Another important aspect of special relativity is the elapsed time is the reciprocal of time rate, given a constant velocity. For example, the special relativity traveling twin had his time dilated ten times that of his stay-at-home twin. It took the traveling clock ten times as long as the stationary clock during the ten-hour test. The traveling twin and his clock appeared to the stationary twin as moving in slow motion. The traveling twin's clock only passed one hour while the stationary clock passed ten hours.

The traveling twin's time rate was reduced to one tenth of the stationary twin's time rate. As a consequence, during the elapsing time for the 10-hour stationary clock test, the traveling clock's hour hand crawled only from 12 noon to 1 PM. Reciprocal in this case means a dilated time rate, during ten hours of velocity at 0.995c, produced a contracted elapsed time by stationary clock time. Note especially that a dilated time rate produces a reciprocal contracted elapsed time.

### Unit Analysis of General Relativity

In contrast with special relativity, the formula for general relativity's time dilation is:

$$t' = t (1 + \Phi / c^2) \text{ where } \phi (\Phi) = gh$$

and:

$g$  is the acceleration of the traveler during turnaround

$h$  is the distance between traveler and stay-at-home twin<sup>9</sup>

$t$  = stay at home twin elapsed time

$t'$  = traveling twin elapsed time

Substituting and comparing:

$$t' = t (1 + gh / c^2)$$

where the plus symbol means the stay-at-home twin has more time passed than the traveling twin.

Traveler  $t_{\text{moving}} = \text{stay-at-home } t / (1 - (v^2/c^2))^{1/2}$  This equation is special relativity where  $t$  and  $t_{\text{moving}}$  are units of time rate because this is an equation to describe the differential rate of clocks ticking due to velocity at a given moment. The minus symbol means the traveling twin's time rate is less than the stay-at-home twin's time rate.

---

<sup>9</sup> [Twin paradox - Wikipedia](#)

To keep time rate and passage of time separate, different symbols should be used. The importance of differentiating between rate of time and an object’s elapsed time is obvious at this point. If you believe both “t” variables describe the same thing, the meaning is lost. Refer to the Definitions section for a complete description.

Comparing general relativity units where distance & time are identical:

$$t' = t (1 + gh / c^2)$$

$$\text{elapsed time home} = \text{elapsed time travel} (1 + (\text{acceleration} * \text{distance} / (\text{distance}/\text{time})^2)$$

$$\text{elapsed time home} = \text{elapsed time travel} (1 + (\text{distance}/\text{time}^2 * \text{distance}) / (\text{distance}^2/\text{time}^2))$$

$$\text{elapsed time home} = \text{elapsed time travel} (1 + (\text{distance}^2/\text{time}^2) / (\text{distance}^2/\text{time}^2)) \quad \text{Equation 1}$$

$$\text{elapsed time home} = \text{elapsed time travel} (1)$$

Comparing special relativity units where distance & time are identical:

$$t_{\text{moving}} = t / (1 - (v^2/c^2))^{1/2}$$

$$\text{time rate travel} = \text{time rate home} / (1 - (\text{distance}^2/ \text{time}^2) / (\text{distance}^2/\text{time}^2))^{1/2}$$

neglecting the imaginary solution introduced by squaring the equation because velocities are absolute:

$$\text{time rate travel}^2 = \text{time rate home}^2 / (1 - (\text{distance}^2/ \text{time}^2) / (\text{distance}^2/\text{time}^2))$$

$$\text{time rate travel}^2 = \text{time rate home}^2 / (1)$$

Comparing just the interior variables, “g” is acceleration and “h” is distance and “v” is velocity:

- gh units are acceleration\*distance = distance<sup>2</sup>/time<sup>2</sup> per equation 1 above
- v<sup>2</sup> units are distance<sup>2</sup>/time<sup>2</sup>

Einstein evolved general relativity from special relativity. Special relativity has “relative velocity time dilation” and general relativity has “gravitational time dilation”. Relative velocity time dilation is due to observers having different velocities. Gravitational time dilation is due to observers being at different gravitational potentials.<sup>10</sup>

In the example to follow, gravitational time dilation is one case of time dilation due to force at a distance. This example has rocket engine force and then electromagnetic force. Gravity force and electrostatic force could also have been examples. The key understanding is time dilation and length contraction occur due to:

- difference in velocity (SR)
- difference in acceleration with separation by a distance (GR)

Both special and general relativity occur at all velocities, accelerations and distances. High velocity near the speed of light not a prerequisite for relativity. It occurs at even the smallest velocities and smallest accelerations separated by distance.

~~~~~

<sup>10</sup> [Gravitational time dilation - Wikipedia](#)

### General Relativity Does Not Depend on Gravity

The Ruler of Squaresville wants to measure the distance to the Foam Moon and sends an astronaut there, deploying the Ruler of Squaresville on his way and back.

GR equation:  $t' = t (1 + gh / c^2)$

astronaut has velocity = 130

distance from Cube to Moon = 13 cubits

Cube to Moon travel time = 13 cubits / (130 cubits/hour) = 0.1 hour

Ruler expects astronaut back in 0.2 hour = 12 minutes

$g = 10$

$gh = 10 * 13 = 130 \text{ cubits}^2/\text{hour}^2$

there is a discount on the velocity of light today, so  $c^2 = 130 \text{ cubits}^2/\text{hour}^2$

$gh / c^2 = 1 \text{ hour late due to slingshot around the moon}$

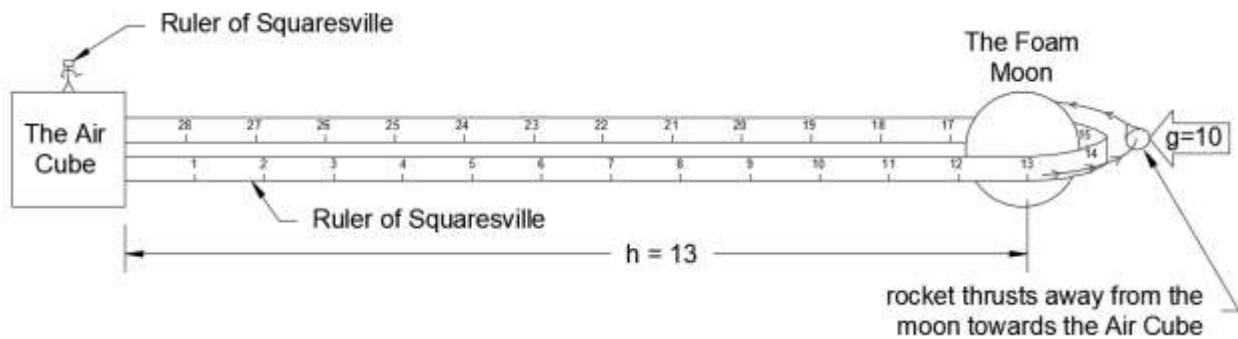

Figure 13 - Return via Rocket Motor

The Ruler of Squaresville is upset the astronaut took so long to return and installed an electromagnet to pull him back home sooner. The electromagnet produces 10g at the moon. Rocket motors are not fired when at the moon. Result is the same. The astronaut is still 1 hour late, because the electromagnet's 10g force exactly replaced the rocket motor's 10g force.

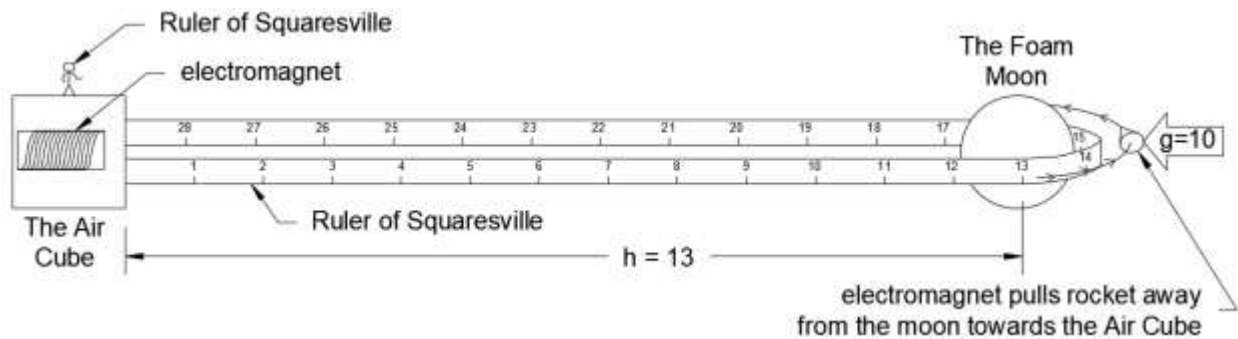

Figure 14 - Return via Electromagnet

~~~~~

## Light Cones and Divergent Space

Recall the previous figure "Observer A's Space Vector Always Points in the Same Direction". In the below diagram, the space grids of "A" and "B" are at right angles to one another. The "A" and "B" time vectors are also at right angles to one another.

Observer "A" cannot see anything at point "B" because time dilation between "A" and "B" has slowed time at "B" to a standstill. "A" sees space at "B" diverged to infinity.

Observer "B" sees time has slowed at "A" to a standstill and diverged "A" space to infinity. There are three ways to understand this:

An observer can only perceive objects as they exist only if their space grid and time vector are parallel. If there is an angle difference, the observer will see a fraction of the object's length less than 1, as determined by length contraction. The observer will see motion slowed to a fraction less than 1, as determined by time dilation. Time dilation means the time to complete an action takes longer, so the speed of occurrence is slower.

This phenomenon is reciprocal, meaning neither A nor B has primacy as being the correct observer. This phenomenon also does not involve velocity. It is due to the spherical curvature of the universe. For observer A, B is the end of the universe because space there has diverged to infinity and time has slowed to zero. This is an example of time dilation and length contraction occur by position.

Time dilation and length contraction also occurs by velocity, as occurs in a particle accelerator. The observer standing beside the accelerator sees a time dilated and length contracted particle. The particle sees a time dilated and length contracted observer.

In the diagram below, the light cones are correct in the sense the time vector is perpendicular to the 3D grid. However, they are incorrect extending outward from the grid - they are concentric circles in the grid.

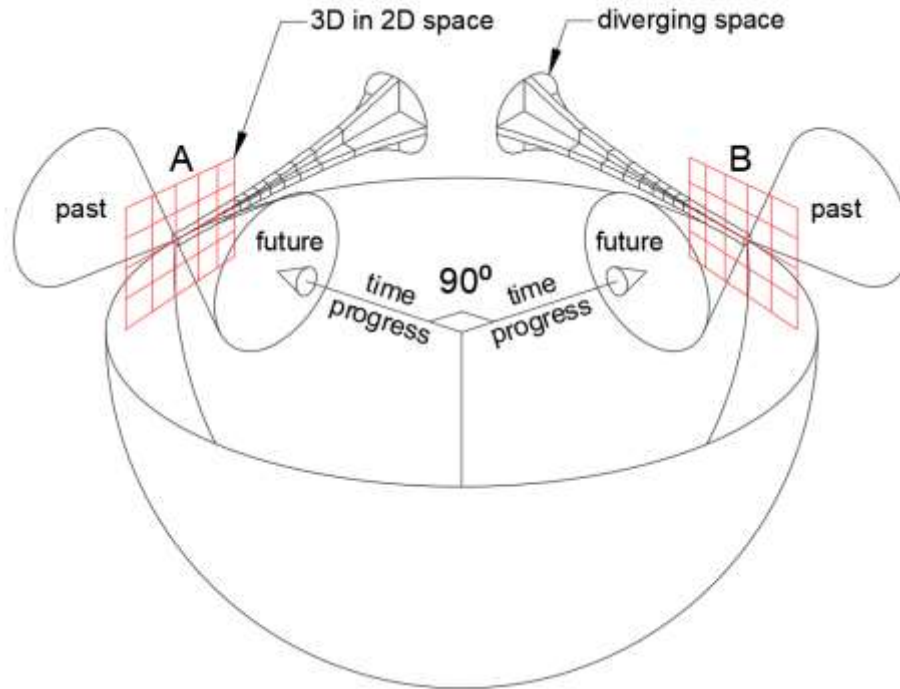

Figure 15 - Light Cones and Divergent Space

~~~~~

### Simultaneous General Relativity

It is illustrative to check general relativity using multiple observers and multiple observed objects.

$g$  = observed object's gravitational effects

$h$  = distance between observer and observed object

Two diagrams below illustrate multiple observers versus multiple attractors, and each diagram has two formulas choices for the object undergoing time dilation:

top diagram is many observers and one observed object:

$$h_1 \text{ is from observer to object: } (t'/t)_i = 1 + g * h_1 / c^2$$

$$h_2 \text{ is from attractor to object: } (t'/t)_i = 1 + g * h_2 / c^2$$

bottom diagram is one observer and many observed objects:

$$h_2 \text{ is from attractor to object: } t'/t = 1 + (\sum_{i=1}^n g_i * h_{2i})/c^2$$

$$h_1 \text{ is from observer to object: } t'/t = 1 + (\sum_{i=1}^n g_i * h_1)/c^2$$

In the first diagram below, there is one attractor affecting one observed object. There are multiple observers. All observers should record the same effects the attractor object has on the observed object. The problem with this experiment is the multiple observers have different relative velocities from the observed object, since they are at various distances from the observed object. The multiple observers also are each measuring their own distance  $h$  to the observed object.

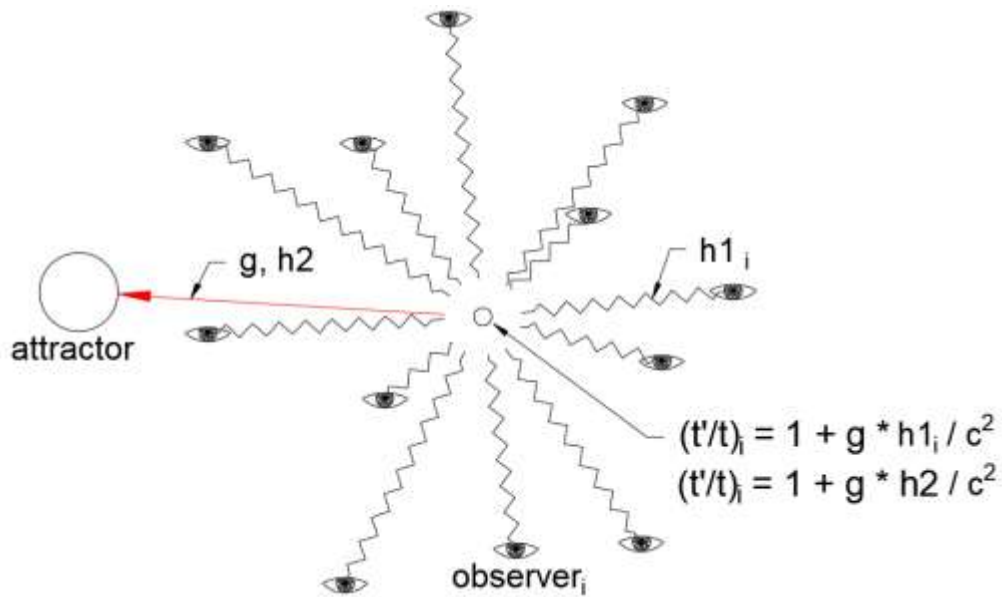

Figure 16 - Many Observers and One Attractor

The many attractors view of GR has one observer viewing a single object being attracted by multiple attractors. This version of GR suffers from the same problem that the distance  $h$ , which should be from the observer to the observed object, has to account for as many distances as there are attractors. This many body problem precludes an exact solution.

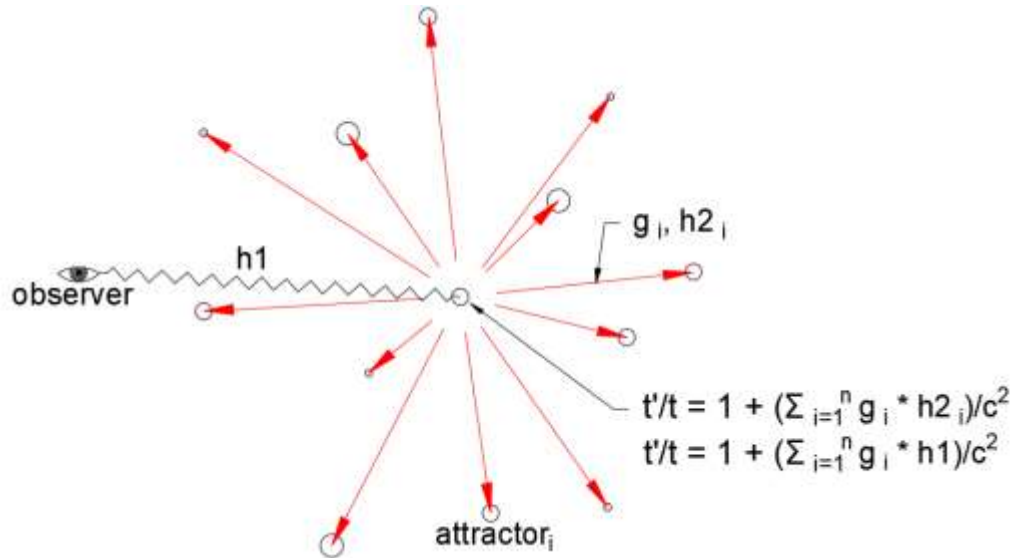

Figure 17 - One Observer and Many Attractors

In general relativity, “ $h$ ” is from observer to object. If “ $h$ ” is from attractor to object, there is no relativity between observer and object, which negates the “ $h2$ ” solutions. Additionally, “ $h2$ ” is not a meaningful variable because “ $g$ ” can be adjusted for different force levels.

The two remaining solutions have “h1”. Does “g” act along the same line as “h1”? In both diagrams, the only condition where “g” acts along the same line as “h1” is when the observer, attractor and object are colinear. This means “h1” is the same as “h2” and the observer must be the attractor.

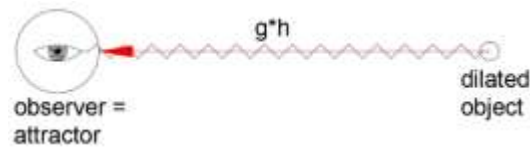

Figure 18 - General Relativity by Equation

All of these problems stem from the origin of GR measuring differential time lapse as in the twin paradox, where one twin goes straight out and returns straight back.

~~~~~

### General Relativity Done with Graphs

The set of graphs below all have global elapsed time as the horizontal scale. The intent is to show the method of determining the global elapsed time for a stationary vs. traveling twin. There is no attempt to be numerically realistic. Traveler’s elapsed time due to acceleration have not been combined in the graphs. A discussion of whether they should be combined follows the graphs.

#### Acceleration

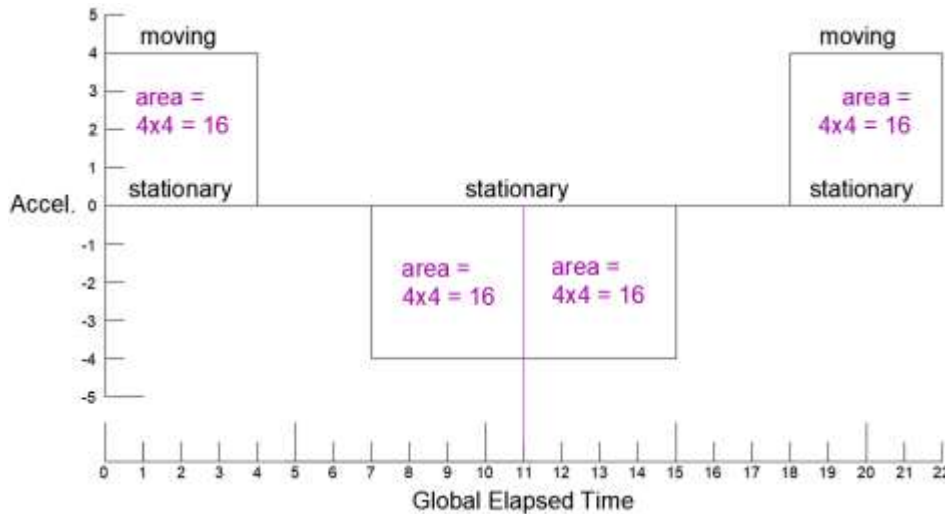

Figure 19 – Acceleration

~~~~~



Time Rate Slowed Due to Acceleration

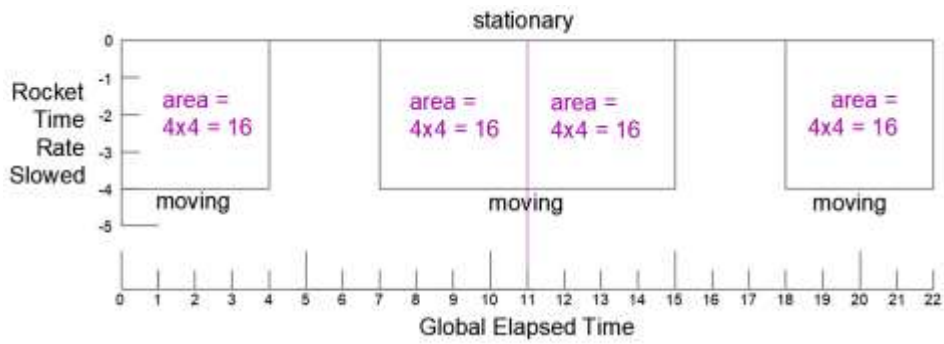

Figure 20 - Time Rate Slowed Due to Acceleration

~~~~~

Velocity

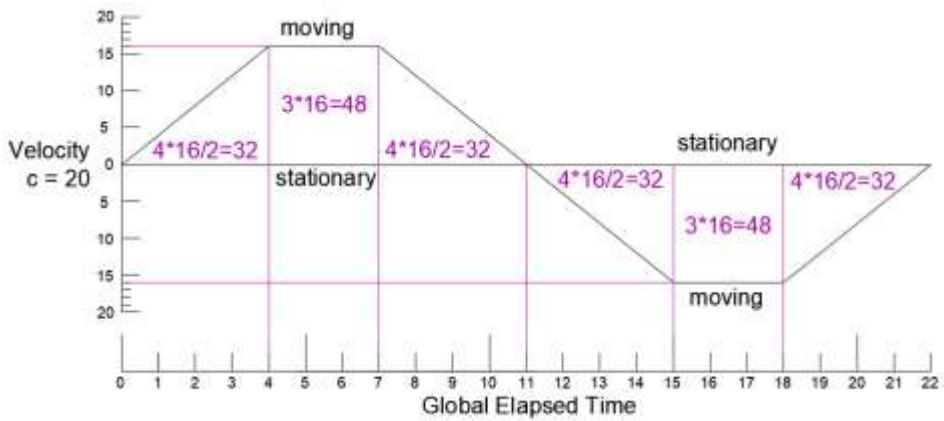

Figure 21 - Velocity

~~~~~

Time Rate Slowed Due to Velocity

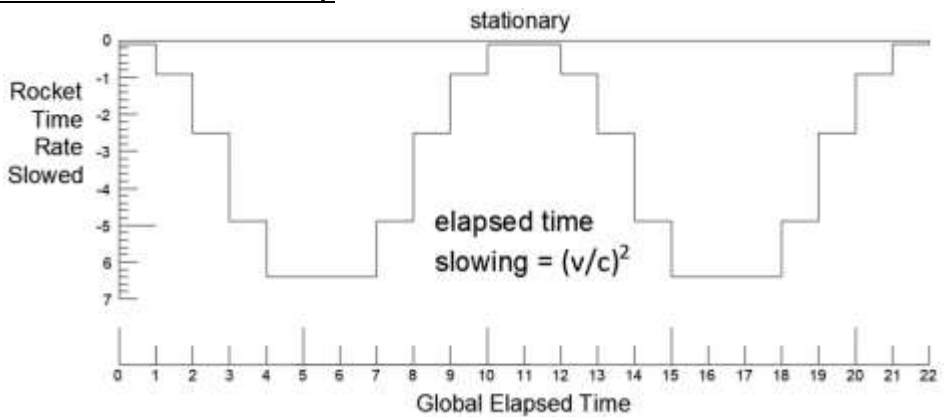

Figure 22 - Time Rate Slowed Due to Velocity

~~~~~

Time Rate Slowed Due to Acceleration and Velocity

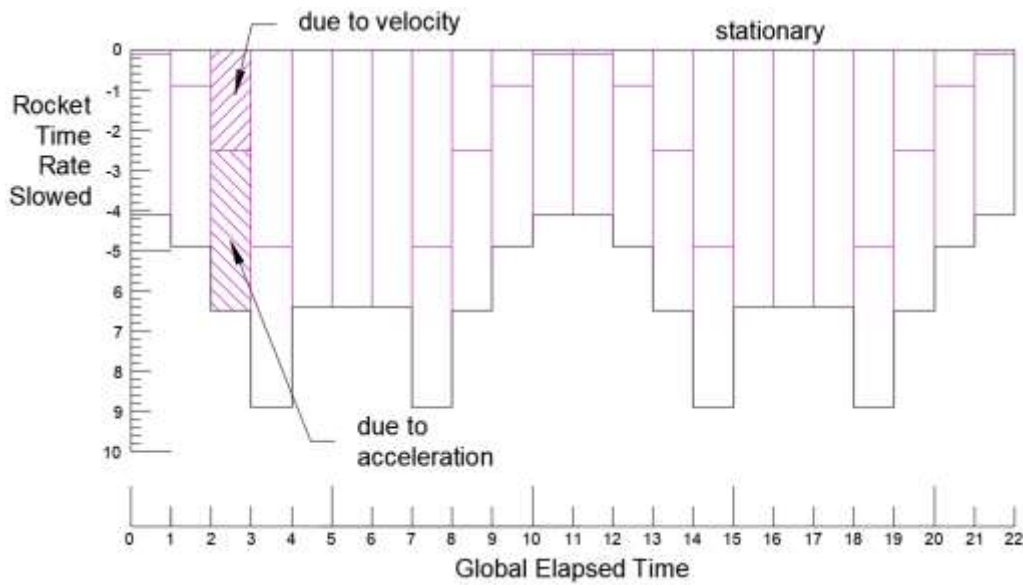

Figure 23 - Time Rate Slowed Due to Acceleration and Velocity

~~~~~

Distance

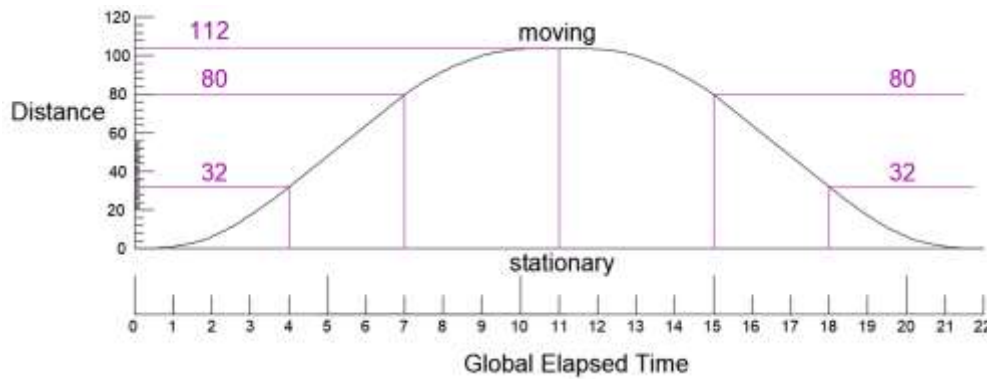

Figure 24 - Distance Traveled

~~~~~



Rocket Elapsed Time Due to Velocity

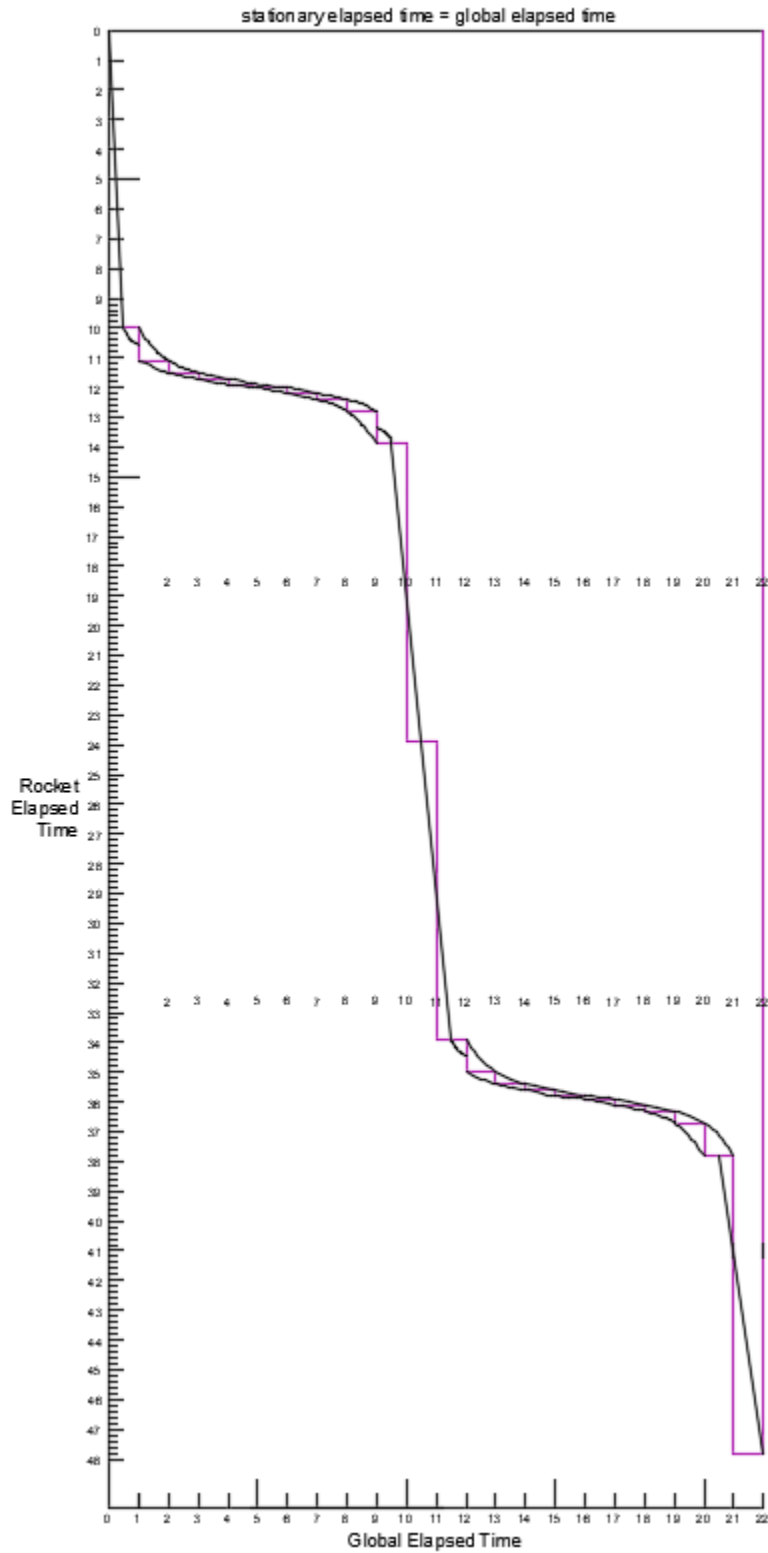

Figure 26 - Rocket Elapsed Time Due to Velocity

~~~~~

*Table of Values Used in Graphs*

|    | A       | B                       | C    | D      | E    | F    | G    | H    | I    | J    | K        | L        | M        | N     | O         | P        |
|----|---------|-------------------------|------|--------|------|------|------|------|------|------|----------|----------|----------|-------|-----------|----------|
| 1  | 1       | Dilated for Accel ratio |      |        |      |      |      |      |      |      |          |          |          |       |           |          |
| 2  | 20      | c                       |      |        |      |      |      |      |      |      |          |          |          |       |           |          |
| 3  | 10      | Mod. for graph          |      |        |      |      |      |      |      |      |          |          |          |       |           |          |
| 4  |         |                         |      |        |      |      |      |      |      |      |          |          |          |       |           |          |
| 5  | Global  |                         |      | Slowed |      |      |      |      |      |      | elapsed  | Slowed   | Slowed   |       | Increment | Total    |
| 6  | Elapsed |                         |      | due to |      | Min  | Max  | Avg  |      |      | time     | due to   | due to   |       | elapsed   | elapsed  |
| 7  | Time    | Accel.                  | Area | Accel. | Area | Vel. | Vel. | Vel. | Area | v/c  | (v/c)**2 | Velocity | Accel. & | Dist. | time due  | time due |
| 8  | 1       | 4                       |      | 4      |      | 0    | 4    | 2    |      | 0.1  | 0.010    | 0.10     | 4.10     |       | 10.000    | 10.0     |
| 9  | 2       | 4                       | 16   | 4      | 16   | 4    | 8    | 6    | 32   | 0.3  | 0.090    | 0.90     | 4.90     |       | 1.111     | 11.1     |
| 10 | 3       | 4                       |      | 4      |      | 8    | 12   | 10   |      | 0.5  | 0.250    | 2.50     | 6.50     |       | 0.400     | 11.5     |
| 11 | 4       | 4                       |      | 4      |      | 12   | 16   | 14   |      | 0.7  | 0.490    | 4.90     | 8.90     | 32    | 0.204     | 11.7     |
| 12 | 5       | 0                       |      | 0      | 0    | 16   | 16   | 16   |      | 0.8  | 0.640    | 6.40     | 6.40     |       | 0.156     | 11.9     |
| 13 | 6       | 0                       | 0    | 0      | 0    | 16   | 16   | 16   | 48   | 0.8  | 0.640    | 6.40     | 6.40     |       | 0.156     | 12.0     |
| 14 | 7       | 0                       |      | 0      |      | 16   | 16   | 16   |      | 0.8  | 0.640    | 6.40     | 6.40     | 80    | 0.156     | 12.2     |
| 15 | 8       | -4                      |      | 4      |      | 16   | 12   | 14   |      | 0.7  | 0.490    | 4.90     | 8.90     |       | 0.204     | 12.4     |
| 16 | 9       | -4                      | -16  | 4      | 16   | 12   | 8    | 10   | 32   | 0.5  | 0.250    | 2.50     | 6.50     |       | 0.400     | 12.8     |
| 17 | 10      | -4                      |      | 4      |      | 8    | 4    | 6    |      | 0.3  | 0.090    | 0.90     | 4.90     |       | 1.111     | 13.9     |
| 18 | 11      | -4                      |      | 4      |      | 4    | 0    | 2    |      | 0.1  | 0.010    | 0.10     | 4.10     | 112   | 10.000    | 23.9     |
| 19 | 12      | -4                      |      | 4      |      | 0    | -4   | -2   |      | -0.1 | 0.010    | 0.10     | 4.10     |       | 10.000    | 33.9     |
| 20 | 13      | -4                      | -16  | 4      | 16   | -4   | -8   | -6   | -32  | -0.3 | 0.090    | 0.90     | 4.90     |       | 1.111     | 35.0     |
| 21 | 14      | -4                      |      | 4      |      | -8   | -12  | -10  |      | -0.5 | 0.250    | 2.50     | 6.50     |       | 0.400     | 35.4     |
| 22 | 15      | -4                      |      | 4      |      | -12  | -16  | -14  |      | -0.7 | 0.490    | 4.90     | 8.90     | 80    | 0.204     | 35.6     |
| 23 | 16      | 0                       |      | 0      |      | -16  | -16  | -16  |      | -0.8 | 0.640    | 6.40     | 6.40     |       | 0.156     | 35.8     |
| 24 | 17      | 0                       | 0    | 0      | 0    | -16  | -16  | -16  | -48  | -0.8 | 0.640    | 6.40     | 6.40     |       | 0.156     | 35.9     |
| 25 | 18      | 0                       |      | 0      |      | -16  | -16  | -16  |      | -0.8 | 0.640    | 6.40     | 6.40     | 32    | 0.156     | 36.1     |
| 26 | 19      | 4                       |      | 4      |      | -16  | -12  | -14  |      | -0.7 | 0.490    | 4.90     | 8.90     |       | 0.204     | 36.3     |
| 27 | 20      | 4                       | 16   | 4      | 16   | -12  | -8   | -10  | -32  | -0.5 | 0.250    | 2.50     | 6.50     |       | 0.400     | 36.7     |
| 28 | 21      | 4                       |      | 4      |      | -8   | -4   | -6   |      | -0.3 | 0.090    | 0.90     | 4.90     |       | 1.111     | 37.8     |
| 29 | 22      | 4                       |      | 4      |      | -4   | 0    | -2   |      | -0.1 | 0.010    | 0.10     | 4.10     | 0     | 10.000    | 47.8     |

*Figure 27 - Values Used in Graphs*

### The Triplets Paradox

The first rocket is launched from a geostationary space station located at a Lagrangian point between the earth and moon where there is no net gravity. The second rocket is launched from a massive planet like Jupiter. A third rocket has been traveling and meets up with the launched rockets. They compare their logs of acceleration, local time rate due to acceleration, velocity, gravity, local time rate due to gravity and local time rate due to both acceleration and gravity. Their logs are as follows. Note that the special relativity elapsed time slowing is not given for the triplets in this paradox.

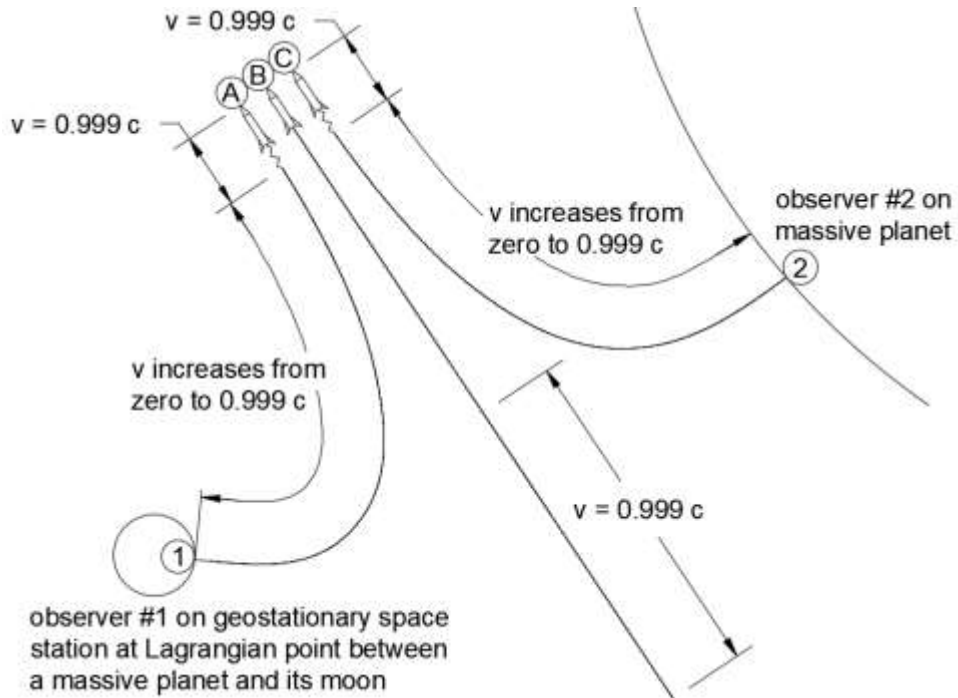

Figure 28 - Example of General Relativity

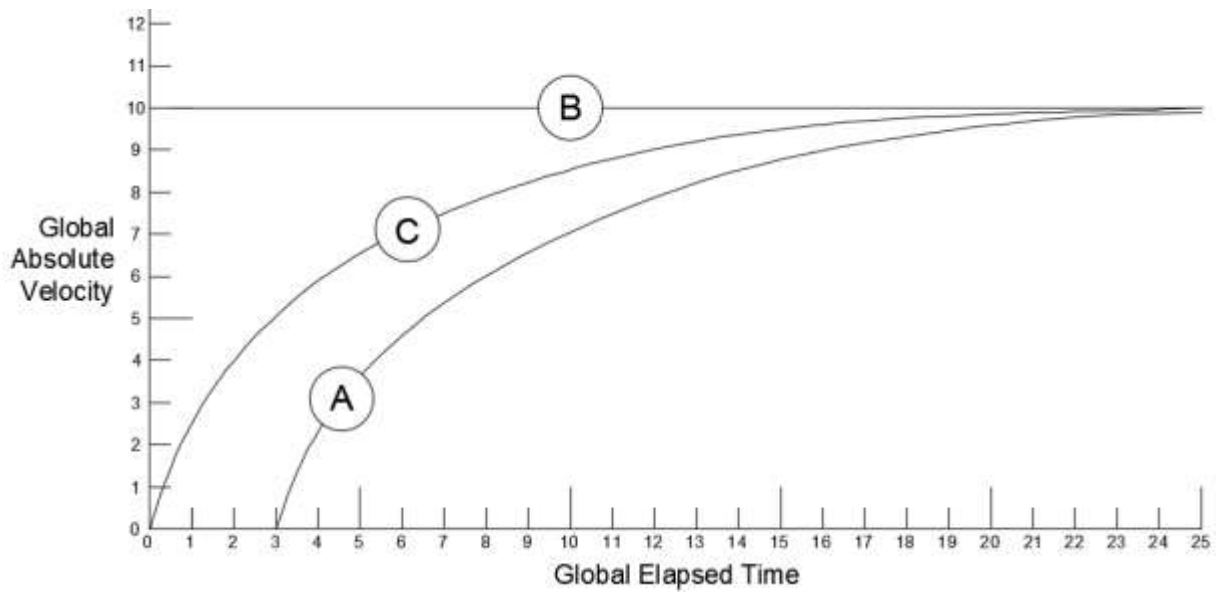

Figure 29 - General Relativity Velocity vs. Time

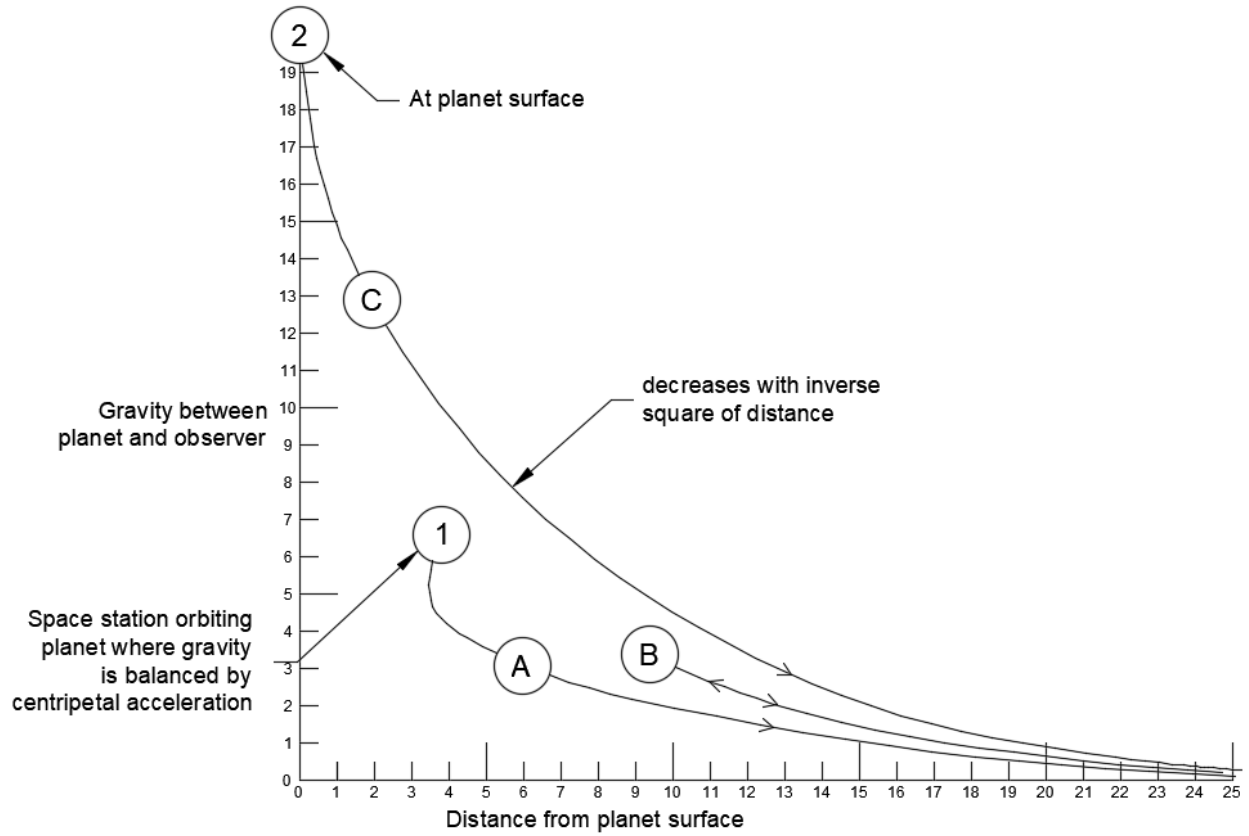

Figure 30 - Gravity Between Planet and Observer

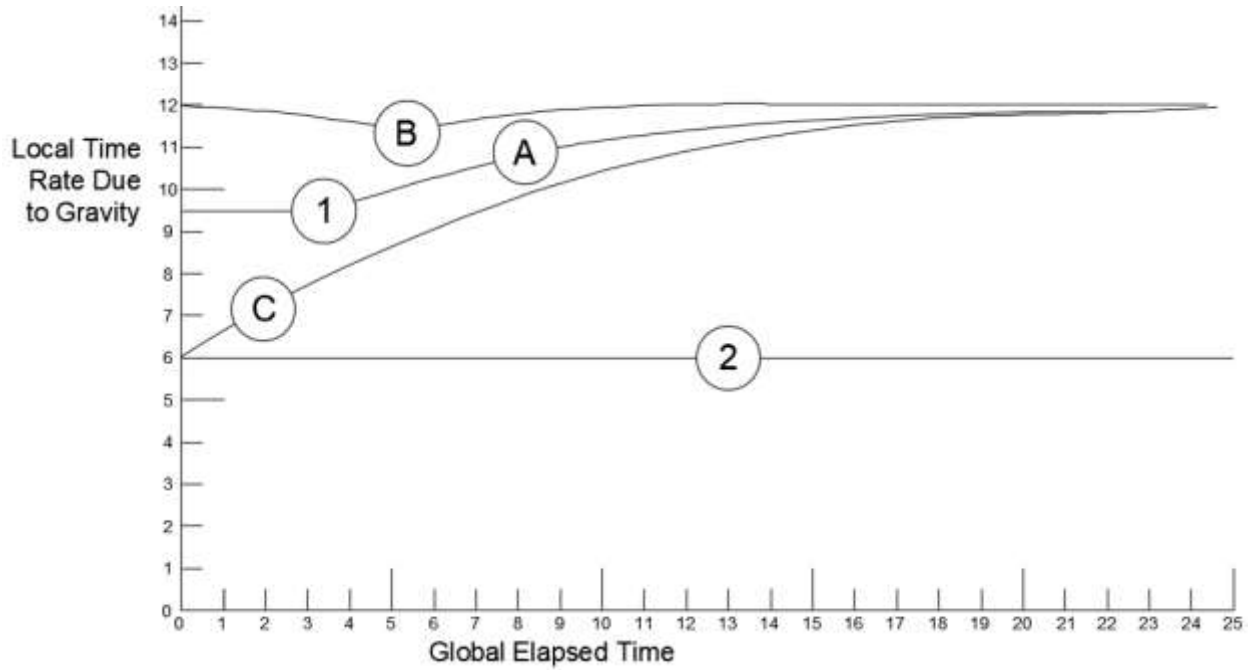

Figure 31 - Local Time Rate Due to Gravity

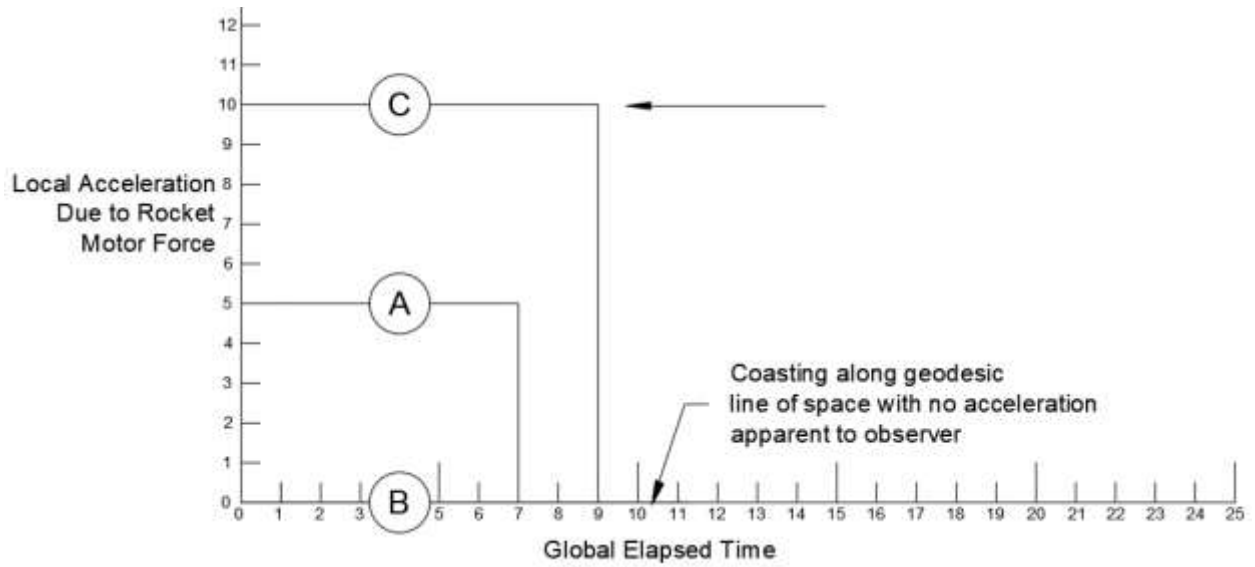

Figure 32 - Local Acceleration Due to Rocket Motor Force

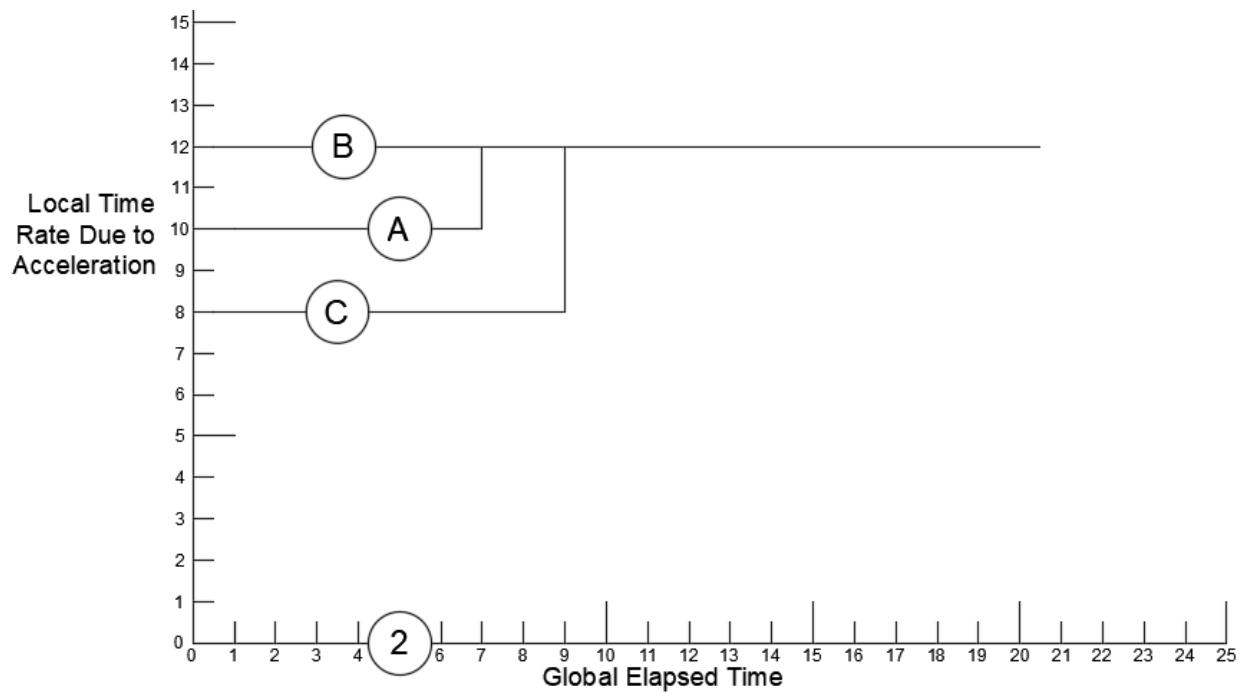

Figure 33 - Local Time Rate Due to Acceleration



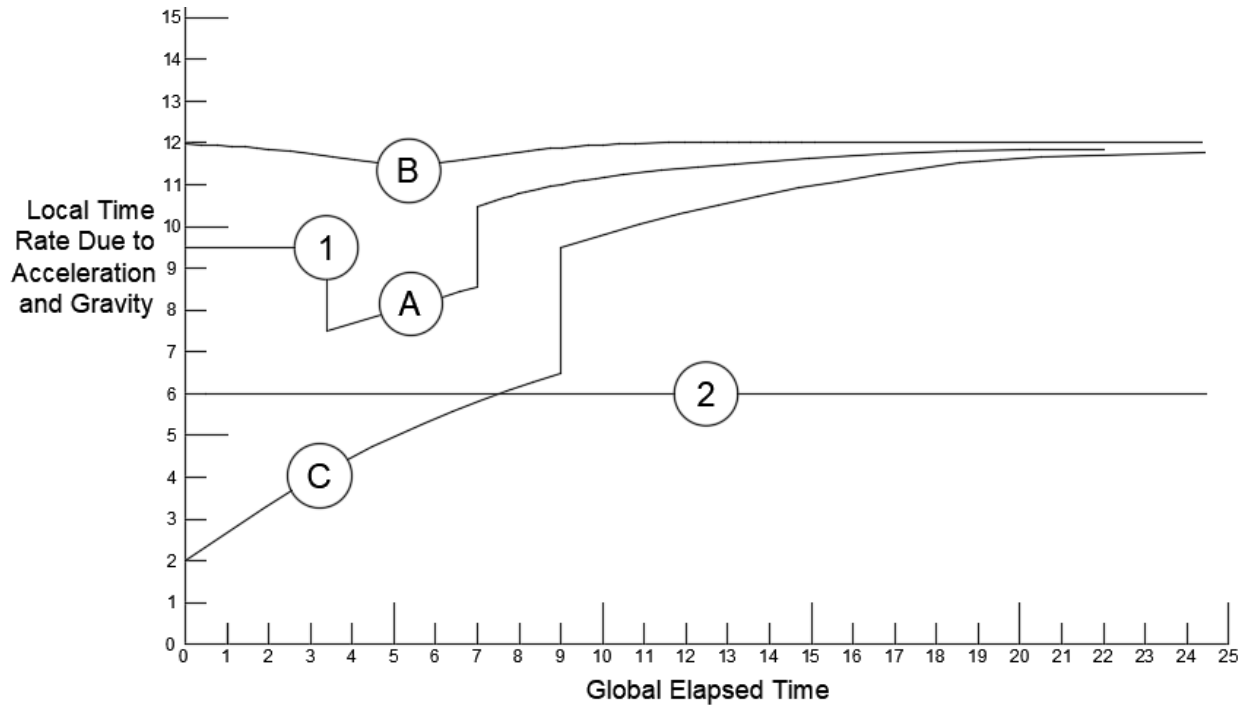

Figure 34 - Local Time Rate Due to Acceleration and Gravity

Question: Is the time dilation formula a time rate formula or an elapsed time formula?

$$t = t_0 / (1 - v^2/c^2)^{1/2}$$

Answer 1: It is an elapsed time formula only if the velocity is constant because it converts from elapsed time for a moving clock vs. stationary clock by observer. Example: rocket B and observer 2 on planet surface.

Answer 2: It is a time rate formula if velocity varies and it is desired to find the small change in moving object's time rate vs. stationary object's time rate.

Time is not dilated by velocity. Time is dilated by acceleration, and retains this dilation when velocity is constant. Time is dilated by gravity, which is acceleration. The legacy version of general relativity is it depends on distance from the observer and acceleration. That does not take into account the situation of a rocket accelerating back and forth a short distance from the observer.

For this oscillating rocket, the history of time passage is retarded with respect to the observer because acceleration slowing time rate is not directional. The historical time passage is not corrected when the rocket oscillates in the opposite direction every other cycle. Every acceleration near the stationary observer has the same effect as if it happened at an extreme distance.

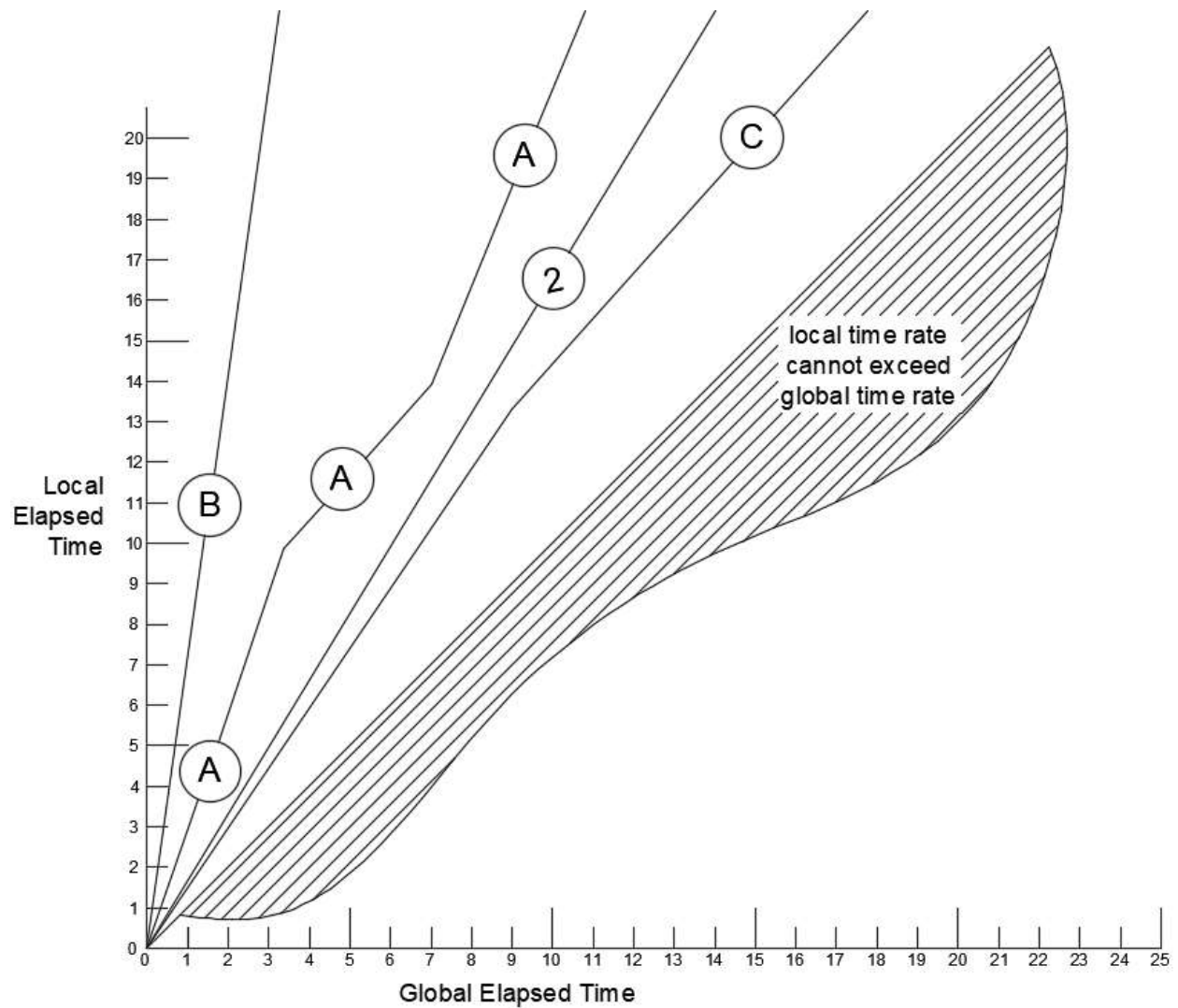

Figure 35 - General Relativity

The conclusion of the “Triplets Paradox” is different elapsed global time among rockets A, B and C. Their global elapsed time can be measured by a relatively stationary observer not on any rocket. The difference is not just observation. The difference is it affects all matter aboard rockets A, B and C.

The Lorentz-Pythagorean circle for matter and antimatter shows velocity effects are reciprocal. The traveling twins and triplets return as the same age as their siblings. The reason is velocity contractions and dilations are not permanent changes. They are changes that undo when the velocity stops and the accelerated matter and antimatter frames of reference rotate back to zero.

## Is Special Relativity Real or an Illusion?

There are two considerations when determining if special relativity is real or an illusion. A short readable history of Einstein's discovery of special and general relativity is at this reference.<sup>11</sup> However, that version omits the Lorentz equations, presumably to not burden the reader with equations.

First question is, "Does cause effect agree with matter or antimatter's length change?". Two atomic clocks at the National Bureau of Standard, one on a table and one on the floor, have elapsed time different after six months of test.<sup>12</sup> How does this different aging of atomic clocks compare to reciprocal time dilation? The answer is that cause-effect agrees with both a matter clock viewed by a matter observer and an antimatter clock viewed by an antimatter observer.

Previously in this paper, it was postulated that the matter observer is congruent with the antimatter observer. Due to the reverse of reverse that antimatter moves, it moves exactly the same as matter. Reverse of reverse means that antimatter's reverse parity direction compared with matter is nullified by antimatter's reverse time direction compared with matter. This allows congruency. Congruent matter and antimatter do not annihilate because they were born joined at the hip, and cannot collide.

The second question is, "Is Einstein's thought experiment correct about special relativity?". Earlier in this paper in section Add Antimatter to Special Relativity, the anti-photon was introduced, which moves congruently with the photon.

A timeless state diagram is also presented later in this paper that illustrates cause-effect as a dimension halfway between matter and antimatter dimensions. When this state diagram is viewed from the right-hand rule matter dimension, cause effect motion occurs the same direction as matter velocity and the opposite direction as antimatter. When viewed from the left-hand rule antimatter dimension, cause effect motion occurs the same direction as antimatter velocity and the opposite direction as matter.

The answer to the second question is the train station and lightning bolt thought experiment is incomplete because it doesn't consider the reverse velocity of the anti-train and the reverse velocity of the anti-photon. Relative velocity of a train with respect to a train station is rooted in the idea the train station is not the moving part of the experiment. Einstein's thought experiment with a train and a train station was a leap forward. A new thought including antimatter and uncertainty needs to replace it.

---

<sup>11</sup> [Gravitational Time Dilation: Why Does Gravity Slow Time? \(scienceabc.com\)](#)

<sup>12</sup> [Einstein's special relativity upheld by atomic clocks | Science News](#)