

# Unified Theory 2

Vladimir Pastushenko

## Introduction.

A single theory is not a theory of everything. These are unified equations for electromagnetic fields (Maxwell) and equations for gravitational fields. These are the unified equations of relativistic dynamics of the Special Theory of Relativity and quantum relativistic dynamics. These are the unified equations of the General Theory of Relativity and quantum gravity.

Keywords: space of matter, quantum gravitation, uniform theory

### Chapters

1. Space-time is a special case of the space of matter
2. General equations of electromagnetic (Maxwell) and gravity mass field.
3. General equations of the Special Theory of Relativity and quantum relativistic dynamics.
4. Scalar bosons.
5. The spectrum of undivided quanta of space-matter.
6. General equations of the General Theory of Relativity and quantum gravity.
7. Dynamics of the Universe.

### 1. Space-time is a special case of the space of matter

Modern physics has a lot of different problems and facts, which go out of the frame of its theoretical views. Theoretical models and fundamental views are contradictory. Mathematics answers the question HOW? physics answers the question WHY? We will look for physical reasons.

It is very important. If (+) a proton charge ( $p^+$ ), in quark ( $p = uud$ ) models is presented by a sum:  $q_p = (u = +\frac{2}{3}) + (u = +\frac{2}{3}) + (d = -\frac{1}{3}) = (+1)$ , fractional charges of quarks, completely the same (+1) charge ( $e^+$ ) of positron does not have any quarks. Such model and view of (+) charge does not correspond to reality. In addition, a proton does not emit an exchange photon in charge interaction with an electron of an atom. The Euclidean axiomatic itself has its own insoluble contradictions. For example,

1. Many point at one point, gives a point again. Is it a point or a set of them, determined by the elements and their relationship?
2. Many lines in one "length without width", gives a line again. Is it a line or a set of them defined similarly?

Euclidean axiomatic does not provide answers to such questions. If in times before our era, these axioms suited everyone, for measuring areas, volumes ..., then in modern research such axioms simply do not work. These ones and many other fundamental contradictions do not have any solutions in theories.

The main characteristic of matter – movement. It is presented by a dynamic space-matter with non-stationary Euclidean space. Straight lines of dynamic ( $\varphi \neq const$ ) beam, do not cross initial line ( $AC \rightarrow \infty$ ) on infinity (Fig. 1.), it means that they are parallel. This means that when moving along the AC line, there is always a space (X-) into which we cannot get.

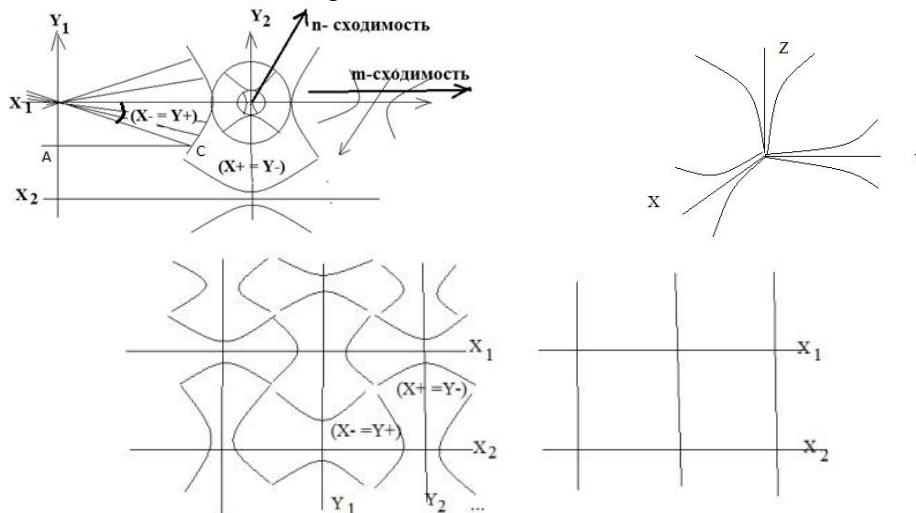

Fig. 1 Dynamic space-matter.

Such dynamic ( $\varphi \neq const$ ) space-matter has its own geometrical facts, as axioms, that do not require any evidence. In two-dimension space, zero angle of parallelism ( $\varphi=0$ ) for (X-) и (Y-) lines, gives Euclidean straight lines. In a maximum case of zero angle of parallelism ( $\varphi = 0$ ) in each axis, a dynamic space-matter

goes into the Euclidean space, as particular case of a dynamic space-matter. It is profound and principal changes of technology of theoretical researches, which form our views about the natural world. As we see, in Euclidean view of space, we do not see everything. Such dynamic ( $\varphi \neq const$ )space-matter has its own geometrical facts, as axioms, that do not require any evidence.

**Axioms of dynamic space-matter**

1. Non-zero, dynamic angle of parallelism, of a beam of parallel lines, determines orthogonal fields  $(X-) \perp (Y-)$  of parallel lines - trajectories, as isotope characteristics of space-matter.
2. Zero angle of parallelism( $\varphi = 0$ ), gives «length without width» with zero or non-zero ( $Y_0$ ) - radius of sphere-point «That does not have parts» in Euclid ( $\varphi \neq 0$ )  $\neq const$  e an axiomatic.
3. A beam of parallel lines with zero angle of parallelism( $\varphi = 0$ ), «equally located to all its points», gives variety of straight lines in one «without width» Euclidean straight line.
4. Inside  $(X-), (Y-)$  and outside  $(X+), (Y+)$  fields of lines-trajectories non-zero( $X_0 \neq 0$ ) or ( $Y_0 \neq 0$ ) of physical sphere-point, form Undivided Region of Localization  $HO\Omega(X \pm)$  or  $HO\Omega(Y \pm)$ of dynamic space-matter.
5. In single fields  $(X- = Y+), (Y- = X+)$  of orthogonal lines-trajectories  $(X-) \perp (Y-)$  there are no two the same sphere-points and lines-trajectories.
6. Sequence of Undivided Regions of Localization  $HO\Omega(X \pm), (Y \pm), (X \pm) \dots$  on radius  $X_0 \neq 0$  or ( $Y_0 \neq 0$ ) of sphere-point on one line-trajectory gives  $(n)$  convergence, and on different trajectories  $(m)$  convergence.

7. To each Undivided Region of Localization  $HO\Omega$  of space-matter corresponds the unit of all its Criterion of Evolution  $(K\Theta)$ , in single  $(X- = Y+), (Y- = X+)$  space-matter on  $(m - n)$ convergences,  $HO\Omega = K\Theta(X- = Y+)K\Theta(Y- = X+) = 1, HO\Omega = K\Theta(m)K\Theta(n) = 1,$

In the system of numbers that are equal by analogy of numbers 1.

8. Fixation of an angle ( $\varphi \neq 0$ )  $= const$  or ( $\varphi = 0$ )a beam of straight parallel lines, space-matter, gives 5<sup>th</sup> postulate of Euclid and an axiom of parallelism.

Any point of fixed lines-trajectories is presented by local basic vectors Rimanov’s space:

$$e_i = \frac{\partial X}{\partial x^i} \mathbf{i} + \frac{\partial Y}{\partial x^i} \mathbf{j} + \frac{\partial Z}{\partial x^i} \mathbf{k}, \quad e^i = \frac{\partial x^i}{\partial X} \mathbf{i} + \frac{\partial x^i}{\partial Y} \mathbf{j} + \frac{\partial x^i}{\partial Z} \mathbf{k},$$

With fundamental tensor  $e_i(x^n) * e_k(x^n) = g_{ik}(x^n)$  and topology  $(x^n = X, Y, Z)$  in Euclidean space. That is, Rimanov’s space is fixed ( $\varphi \neq 0$ )  $= const$  state of dynamic ( $\varphi \neq const$ ) space-matter. Particular case of negative curvature ( $K = -\frac{Y^2}{Y_0} = \frac{(+Y)(-Y)}{Y_0}$ ) (Smirnov b.1, p.186) Rimanov’s space is space of Lobachevski’s geometry (Math encyclopedia b.5, p.439).

These axioms already solve the problems of the Euclidean axiomatic of a set of points at one point “without parts” and a set of lines in one “length without width” of a line.

**Uniform Criteria of Evolution of space-matter.**

All Criteria of Evolution of dynamic space matter, are created

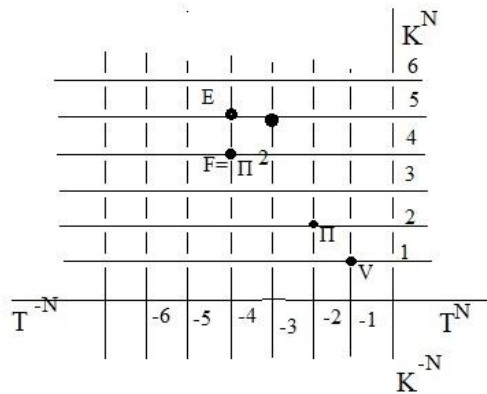

Fig. 1.1. Criteria of Evolution in space-time.

in multidimensional on  $(m-n)$  convergence, space - time, as in multidimensional space of speeds:  $W^N = K^+ T^- N$ . Here for  $(N=1)$ ,  $V = K^+ T^- 1$  speed,  $(W^2 = \Pi)$  potential,  $(\Pi^2 = F)$  force ..., 2- quadrant. Their projection on coordinate  $(T_0)$  or the temporary  $(T)$  space time is given: the  $\Pi K = q$  ( $Y+ = X-$ ) charge in electro ( $Y+ = X-$ ) magnetic fields, or the mass  $\Pi K = m$  ( $X+ = Y-$ ) ingravity ( $X+ = Y-$ ) mass fields, then the density  $\rho = \frac{m}{V} = \frac{\Pi K}{K^3} = \frac{1}{T^2} = v^2$ , this is the square of the frequency, energy of  $(E = \Pi^2 K)$ , impulse  $(p = \Pi^2 T)$ , action  $(\hbar = \Pi^2 K T)$ , etc., uniform space - matter  $HO\Omega = (X+ = Y-) (Y+ = X-) = 1$ . Any equation comes down to these Criteria of Evolution in  $W^N = K^+ T^- N$ , space-time. There are many other Criteria of Evolution in space-

time that we do not use yet. For example, Einstein's energy  $E = mc^2$ , and Planck's energy  $E = \hbar\nu$ , have a direct relationship through mass and frequency, in the form:  $m = \nu^2 V$ , and so on.

**2. Electro (Y+ =X -) magnetic and gravity (X+=Y-) mass fields.**

In uniform (X + = Y-) (Y + = X-) =1, space - matter, remove Maxwell's equations for electro (Y + = X-) magnetic field. In a space angle  $\varphi_X (X-) \neq 0$  of parallelism there is isotropic tension of a stream  $A_n$  a component (Smirnov, b.2, page 234). A full stream of a whirlwind through a secant a surface  $S_1(X-)$  in a look:

$$\iint_{S_1} rot_n A dS_1 = \iint \frac{\partial(A_n / \cos \varphi_X)}{\partial T} dL_1 dT + \iint_{S_1} A_n dS_1$$

$A_n$  Component corresponds to a bunch (X-) of parallel trajectories. It is a tangent along the closed curve  $L_2$

in a surface  $S_2$  where  $S_2 \perp S_1$  and  $L_2 \perp L_1$ . Similarly, the ratio follows:  $\int_{L_2} A_n dL_2 = \iint_{S_2} rot_m \frac{A_n}{\cos \varphi_X} dS_2$

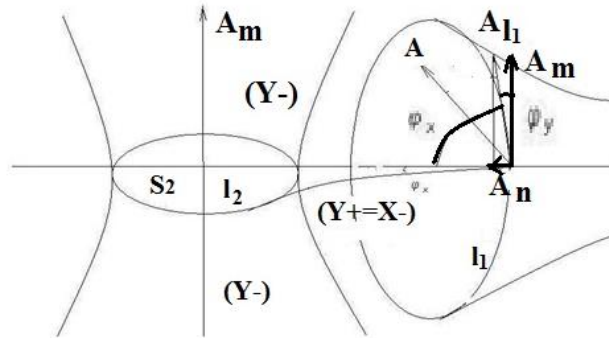

Fig.2. Electro (Y+ =X -) magnetic and gravity (X+=Y-) mass fields.

In a space angle  $\varphi_X (X-) \neq 0$  of parallelism the condition is satisfied

$$\iint_{S_2} rot_m \frac{A_n}{\cos \varphi_X} dS_2 + \iint \frac{\partial A_n}{\partial T} dL_2 dT = 0 = \iint_{S_2} A_m (X-) dS_2$$

In general, there is a system of the equations of dynamics (X - = Y+) of the field.

$$\begin{aligned} \iint_{S_1} rot_n A dS_1 &= \iint \frac{\partial(A_n / \cos \varphi_X)}{\partial T} dL_1 dT + \iint_{S_1} A_n dS_1 \\ \iint_{S_2} rot_m \frac{A_n}{\cos \varphi_X} dS_2 &= -\iint \frac{\partial A_n}{\partial T} dL_2 dT \quad \text{and} \quad \iint_{S_2} A_m dS_2 = 0 \end{aligned}$$

In Euclidean  $\varphi_Y = 0$  axiomatic, accepting tension of a stream vector a component as tension of electric field  $A_n / \cos \varphi_X = E(Y+)$  and an inductive projection for a nonzero corner  $\varphi_X \neq 0$  as induction of magnetic  $B(X-)$  field, we have

$$\begin{aligned} \iint_{S_1} rot_X B(X-) dS_1 &= \iint \frac{\partial E(Y+)}{\partial T} dL_1 dT + \iint_{S_1} E(Y+) dS_1 \\ \iint_{S_2} rot_Y E(Y+) dS_2 &= -\iint \frac{\partial B(X-)}{\partial T} dL_2 dT, \quad \text{in conditions} \quad \iint_{S_2} A_m dS_2 = 0 = \oint_{L_2} B(X-) dL_2. \end{aligned}$$

**Maxwell's equations.**

$$\begin{aligned} c * rot_Y B(X-) &= rot_Y H(X-) = \epsilon_1 \frac{\partial E(Y+)}{\partial T} + \lambda E(Y+); \\ rot_X E(Y+) &= -\mu_1 \frac{\partial H(X-)}{\partial T} = -\frac{\partial B(X-)}{\partial T}; \end{aligned}$$

Induction of vortex magnetic field  $B(X-)$  arises in variation electric  $E(Y+)$  field and vice versa.

For  $L_2$  the ratio, which is not closed, there are ratios  $\int_{L_2} A_n dL_2 = \iint_{S_2} A_m dS_2 \neq 0$  a component. In the conditions of orthogonally  $A_n \perp A_m$  the vector component  $A$ , in nonzero, dynamic ( $\varphi_X \neq const$ ) and ( $\varphi_Y \neq const$ ) corners of parallelism  $A \cos \varphi_Y \perp (A_n = A_m \cos \varphi_X)$ , is dynamics ( $A_m \cos \varphi_X = A_n$ ) components along a contour  $L_2$  in a surface  $S_2$ . Both ratios are presented in the full form.

$$\int_{L_2} A_m \cos \varphi_X dL_2 = \iint_{S_2} \frac{\partial(A_m(X+) * \cos \varphi_X)}{\partial T} dL_2 dT + \iint_{S_2} A_m dS_2$$

The zero streams through  $S_1$  a whirlwind surface ( $rot_n A_m$ ) out of a space angle ( $\varphi_Y \neq const$ ) of parallelism corresponds to conditions

$$\iint_{S_1} rot_n A_m dS_1 + \iint \frac{\partial A_m}{\partial T} dL_1 dT = 0 = \iint_{S_1} A_n(Y-) dS_1$$

In general, the system of the equations of dynamics ( $Y- = X+$ ) of the field is presented in the form:

$$\begin{aligned} \iint_{S_2} rot_m A_m(Y-) dS_2 &= \iint_{S_2} \frac{\partial(A_m(X+) * \cos \varphi_X)}{\partial T} dL_2 dT + \iint_{S_2} A_m dS_2 \\ \iint_{S_1} rot_n A_m(X+) dS_1 &= -\iint \frac{\partial A_m(Y-)}{\partial T} dL_1 dT \quad \iint_{S_1} A_n(Y-) dS_1 = 0 \end{aligned}$$

Entering tension  $G(X+)$  of the field of Strong (Gravitational) Interaction and induction of the mass field by analogy  $M(Y-)$ , we will receive similarly:

$$\begin{aligned} \iint_{S_2} rot_m M(Y-) dS_2 &= \iint \frac{\partial G(X+)}{\partial T} dL_2 dT + \iint_{S_2} G(X+) dS_2 \\ \iint_{S_1} rot_n G(X+) dS_1 &= -\iint \frac{\partial M(Y-)}{\partial T} dL_1 dT, \quad \text{at} \quad \iint_{S_1} A_n(Y-) dS_1 = 0 = \oint_{L_1} M(Y-) dL_1. \end{aligned}$$

Such equations correspond gravity ( $X+ = Y-$ ) to mass fields,

$$\begin{aligned} c * rot_X M(Y-) &= rot_X N(Y-) = \varepsilon_2 * \frac{\partial G(X+)}{\partial T} + \lambda * G(X+) \\ M(Y-) &= \mu_2 * N(Y-); \quad rot_Y G(X+) = -\mu_2 * \frac{\partial N(Y-)}{\partial T} = -\frac{\partial M(Y-)}{\partial T}; \end{aligned}$$

By analogy with Maxwell's equations for electro( $Y+ = X-$ ) magnetic fields. We are talking about the induction of a field of mass  $M(Y-)$  in an alternating  $G'(X+)$  gravitational field, similar to the induction of a magnetic field in an alternating electric field. There are no options here. This is a single mathematical truth of such fields in a single dynamic space-matter. We are talking about the induction of mass fields around moving masses (stars) as well as the induction of magnetic fields around moving charges.

Thus, the rotations  $rot_y B(X-)$  and  $rot_x M(Y-)$  of the trajectories, give the dynamics of  $E'(Y+)$  and  $G'(X+)$  of the electric ( $Y+$ ) and gravitational ( $X+$ ) fields, respectively. And the rotations ( $Y+$ ) of fields around ( $X-$ ) trajectories and ( $X+$ ) fields around ( $Y-$ ) trajectories give dynamics  $rot_x E(Y+) \rightarrow B'(X-)$ , and dynamics  $rot_y G(X+) \rightarrow M'(Y-)$  of mass trajectories.

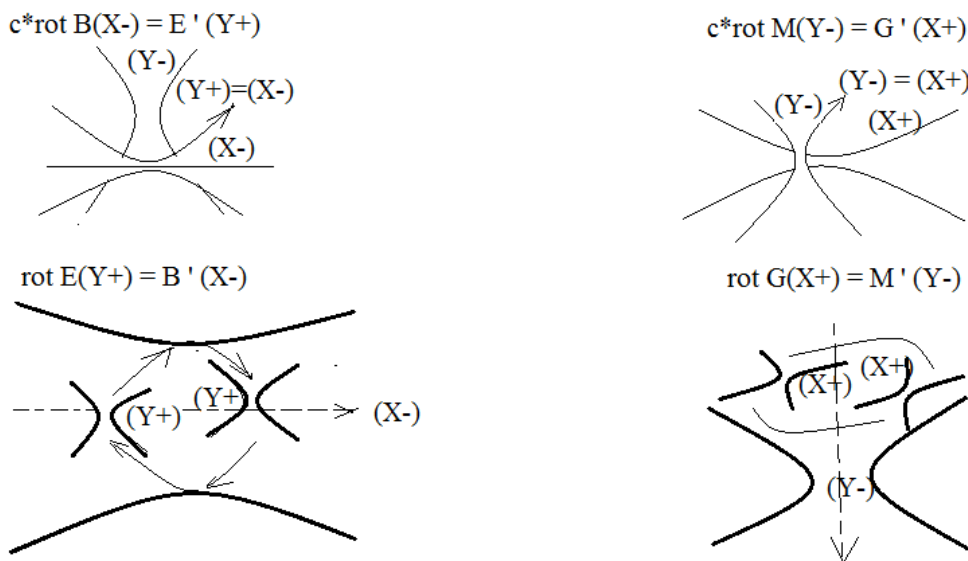

Fig. 2.2-2. Uniform fields of space matter

### 3. General equations of the Special Theory of Relativity and quantum relativistic dynamics.

#### Special Theory of Relativity (STR).

Classical representation:

$$Y^2 \pm (icT)^2 = \left( a^2 = \frac{c^4}{b^2} = const \right) = \bar{Y}^2 \pm (ic\bar{T})^2$$

Circular (+) or hyperbolic (-) uniformly accelerated movement.

$$1). \quad \bar{X} = a_{11}X + a_{12}Y, \quad Y = icT, \quad T = \frac{Y}{ic},$$

$$\bar{X} = a_{11}X + a_{12} \frac{Y}{ic}$$

$$\frac{\bar{Y}}{ic} = a_{21}X + a_{22} \frac{Y}{ic}$$

$$\bar{Y} = a_{21}X + a_{22}Y, \quad \bar{Y} = ic\bar{T},$$

$$2). \quad \bar{X} = a_{11}X + \frac{a_{12}}{ic}Y, \quad a_{11} = b_{11}, \quad \frac{a_{12}}{ic} = ib_{12},$$

$$\bar{Y} = a_{21}icX + a_{22}Y$$

$$a_{21}ic = ib_{21}, \quad a_{22} = b_{22} \cdot a_{22} = b_{22}.$$

$$3). \quad \bar{X} = b_{11}X + ib_{12}Y, \quad \delta_{KT} = 1 \text{ для } K = T,$$

$$\bar{Y} = ib_{21}X + b_{22}Y,$$

$$b_{11}^2 - b_{12}^2 = 1 = b_{22}^2 - b_{21}^2$$

Conditions of orthogonally vector component. In Globally Invariant conditions of the sphere

$$b_{11} = b = b_{22} \quad b_{12}^2 = b_{21}^2 \quad (\pm b_{12})^2 = (\mp b_{21})^2$$

$$b_{12} = -\frac{a_{12}}{c}, \quad b_{21} = a_{21}c \quad b_{12} + b_{21} = 0, \text{ take place:}$$

$$a_{21}c = \frac{a_{12}}{c}, \text{ or for: } c = \frac{\Delta Y}{\Delta T}, \quad \frac{a_{21}\Delta Y}{\Delta T} = \frac{a_{12}\Delta T}{\Delta Y}.$$

4). Further two cases take place.

a). Conditions ( $a_{21} = 0 = a_{12}$ ), nullify projections  $\Delta Y = ic\Delta T$ , dynamic spatially ( $c = \Delta Y / \Delta T$ )

temporary a component of the quantum of a photon, and give GI - Global and Invariant conditions.

b). The reality is that the photon which synchronizes relativistic dynamics has the volume

( $a_{21} \neq 0$ )  $\neq$  ( $a_{12} \neq 0$ ) in space - time. Such reality corresponds to reality of the principle of uncertainty:  $\Delta Y = 0 = (+Y) + (-Y)$ . It is about -

Local Invariance in volume

$$(a_{21} \neq 0) \neq (a_{12} \neq 0).$$

5). Pauli (p. 14): "... it was assumed ..."

$\chi \sqrt{1 - \frac{W^2}{c^2}}$ , or Smirnov (b.3, p. 195): "... we will

put ... ( $b_{12} = ab$ )  $= -b_{21}$  ...". That is, there is no initial reason of such provisions. But already from these provisions, for the unknown reason, according to Smirnov, the mathematical truth follows:

#### Quantum Theory of Relativity (QTR).

The special Theory of Relativity is invalid under conditions:

1). not the uniformly accelerated ( $a^2 \neq const$ ) movement.  
2). Owing to the principle of uncertainty  $\Delta Y = c\Delta T$ , impossibility of fixing of points in space - time, do Lorentz's transformations hopeless.

3) Wave function of quantum is brought to an initial state by input of the calibration field, in the absence of relativistic dynamics, in the process of its dynamics, that is in the absence of quantum relativistic dynamics.

Relativistic dynamics in parallelism coal  $\alpha(X-)$  space quantum trajectories - matters. Instead of X, Y, projections  $K_Y, K_x$ , dynamic radius  $To$ , the dynamic sphere, a tangent to a surface of a dynamic space angle  $\alpha^0(X-) \neq const$ ,

parallelism are considered  $K_Y, K_x, \alpha^0(X-) \neq const$ .

The speech about the material sphere with a nonzero minimum radius  $Y_0 = 1 = ch0$ , and wave function

$$\psi = K_Y - Y_0, \quad Y = K_Y, \quad X = K_X$$

$$\bar{K}_Y = a_{11}K_Y + a_{12}K_X$$

1).  $\bar{K}_X = a_{21}K_Y + a_{22}K_X$  where  $K_X = cT, T = \frac{K_X}{c}$ , time is entered.

$$\bar{K}_Y = a_{11}K_Y + \frac{a_{12}}{c}K_X$$

$$\bar{K}_Y = a_{11}K_Y + \frac{a_{12}}{c}K_X$$

$$\frac{\bar{K}_X}{c} = a_{21}K_Y + \frac{a_{22}}{c}K_X$$

2). or  $\bar{K}_X = a_{21}cK_Y + a_{22}K_X$ .

A). In external GI - it is global - Invariant conditions,

components  $\cos \gamma = \sqrt{(+a_{11})(-a_{11})} = ia_{11}$  give the principle of

uncertainty, with a certain density of probability  $|\psi|^2$  in an experiment, and a matrix of transformations:

$$\bar{K}_Y = ia_{11}K_Y + \left(\frac{a_{12}}{c} = b_{12}\right)K_X$$

$$3). \quad \bar{K}_X = (a_{21}c = b_{21})K_Y + ia_{22}K_X$$

For parallelism corners  $\alpha^0(X-) = 0$ , in GI, such that

$$4). \quad a_{11} = \cos(\alpha^0 = 0^0) = 1 = b, \quad (b=1)K_Y = K_Y$$

$$a_{22} = \cos(\alpha^0 = 0^0) = 1 = b, \quad (b=1)K_X = K_X \text{ conditions take place}$$

$$5). \quad \frac{a_{12}}{(c=1)} = b = a_{21}(c=1), \quad b_{12} = b = b_{21}$$

Period ( $T = 1$ ). In Globally - Invariant conditions

$ia_{11} = ia = ia_{22}$ , the matrix has an appearance

$$6). \quad \bar{K}_Y = ia_{11}K_Y + b_{12}K_X, \quad \text{or } \bar{K}_Y = iabK_Y + bK_X,$$

$$\bar{K}_X = b_{21}K_Y + ia_{22}K_X, \quad \text{or } \bar{K}_X = bK_Y + iabK_X,$$

$$\bar{K}_Y = iabK_Y + bK_X$$

$$\bar{K}_X = bK_Y + iabK_X$$

$$\bar{X} = bX + iabY$$

$$\bar{Y} = -iabX + bY,$$

$$b^2 - a^2b^2 = 1 = -a^2b^2 + b^2, \quad b^2(1 - a^2) = 1,$$

$$b = \frac{1}{\sqrt{1 - a^2}},$$

$$\bar{X} = \frac{X + iaY}{\sqrt{1 - a^2}}, \quad \bar{Y} = \frac{Y - iaX}{\sqrt{1 - a^2}}.$$

6). Substituting reference values  $Y = icT$

$\bar{Y} = ic\bar{T}$ , we will receive:

$$\bar{X} = \frac{X + iaY}{\sqrt{1 - a^2}}, \quad ic\bar{T} = \frac{icT - iaX}{\sqrt{1 - a^2}},$$

$$\bar{T} = \frac{T - \frac{a}{c}X}{\sqrt{1 - a^2}}, \quad a = \frac{W}{c} = \cos \alpha^0,$$

Lorentz's transformations in classical relativistic dynamics

$$\bar{X} = \frac{X - WT}{\sqrt{1 - W^2/c^2}}, \quad \bar{T} = \frac{T - \frac{W}{c^2}X}{\sqrt{1 - W^2/c^2}},$$

$$\bar{W} = \frac{V + W}{1 + VW/c^2}.$$

### **Transition QTR in STR.**

The mathematical truth of transition of the Quantum Theory of Relativity to transformations of the Special Theory of Relativity takes place.

For zero corners of parallelism in Euclidean axiomatic, with speeds smaller velocity

of light  $W_Y < c$ , limit cases of transition of quantum relativistic dynamics vector a component take place

$$a_{22} = (\cos(\alpha^0 = 0) = 1) = a_{11},$$

$$a_{22} = 1, \quad a_{11} = 1, \quad Y = WT,$$

$$(\bar{K}_Y = \bar{Y}) = \frac{(a_{11} = 1)(K_Y = Y) \pm WT}{\sqrt{1 - W^2(X -)/c^2}},$$

$$\bar{Y} = \frac{Y \pm WT}{\sqrt{1 - W^2/c^2}}, \quad \bar{T} = \frac{K_Y/c + (a_{22} = 1)T}{\sqrt{1 - W^2(X -)/c^2}},$$

$$K_Y = K(\cos \alpha^0 = \frac{W}{c}), \quad \bar{T} = \frac{T \pm KW/c^2}{\sqrt{1 - W^2/c^2}},$$

in Lorentz's transformations classical relativistic dynamics.

The same GI a representation form  $K_Y = \psi = Y - Y_0$ , takes place in any multiple  $T \leq \Delta T$ , time point.

7). In the conditions of orthogonally  $\delta_{KT} = 1$ ,  $K = T$ , takes place  $-a^2b^2 + b^2 = 1 = b^2 - a^2b^2$ ,

$$b^2(1 - a^2) = 1, \quad b = \frac{1}{\sqrt{1 - a^2}}.$$

matrix multiplier with conditions:

$$ia_{11} = ia = ia_{22} \quad \text{or} \quad a_{11} = a = a_{22}.$$

B). (LI) already in - Locally - Invariant conditions, relativistic dynamics  $a_{11} \neq a_{22}$ , with external GI conditions, takes place:

$$\bar{K}_Y = b(a_{11}K_Y + K_X)$$

8)  $\bar{K}_X = b(K_Y + a_{22}K_X)$ , where: from  $K_Y = \psi + Y_0$

$$K_X = c(T = \frac{X}{c} = \frac{\hbar}{E}), \quad \text{follows} \quad A_K = b(a_{11}Y_0 + K_X).$$

It is also the decisive moment of relativistic dynamics of quantum of space matter, which is presented in modern

theories by the calibration  $A_K$  field.

$$\psi = \psi_0 \exp(ap \neq const) + A_K$$

9). Under the terms  $a_{22} = \frac{K_X}{cT} = \frac{W}{c} = a = a_{11}$ ,

GI - loudspeakers  $a = a_{22} = a_{11}$ ,  $b = \frac{1}{\sqrt{1 - a^2}} = \frac{1}{\sqrt{1 - W^2/c^2}}$ , the matrix of transformations takes a form:

$$\bar{K}_Y = \frac{a_{11}K_Y + cT}{\sqrt{1 - a_{22}^2}}, \quad \bar{K}_X = \frac{a_{11}K_X + cT}{\sqrt{1 - W^2/c^2}}, \quad c\bar{T} = \frac{K_Y + a_{22}cT}{\sqrt{1 - a_{22}^2}},$$

$$\bar{T} = \frac{K_Y/c + a_{22}T}{\sqrt{1 - W^2/c^2}}, \quad \bar{W}_Y = \frac{\bar{K}_Y}{\bar{T}} = \frac{a_{11}K_Y + cT}{K_Y/c + a_{22}T}, \quad \bar{W}_X = \frac{a_{11}W_Y + c}{a_{22} + W_Y/c},$$

Local Invariance (LI) in conditions  $(a_{22} \neq a_{11}) \neq 1$ ,

in extremely when:  $a_{11} = \frac{W}{c} = \alpha = \frac{1}{137.036}$

$$W = \alpha c \quad ; \quad \alpha = \frac{q^2}{\hbar c}$$

10). Speed limits  $W_Y = c$ , in conditions  $a_{22} = a_{11} \neq 1$ , give

$$\bar{W}_Y = \frac{c(a_{11} + 1)}{(a_{22} + 1)} = c, \quad \text{invariable velocity of light}$$

$\bar{W}_Y = c = W_Y$ , in any system of coordinates.

A deeper conclusion about such quantum relativistic dynamics is that with a constant isotropic Euclidean sphere  $(K_Y)(cT = K_X)$  space-time, in a dynamic  $(\uparrow a_{11} \downarrow)(\downarrow a_{22} \uparrow) = 1$ , space-matter, has place of the dynamics of the ellipsoid  $(\bar{K}_Y)(c\bar{T} = \bar{K}_X)$ . On the contrary, looking at the dynamic ellipsoid of space-time, there is an initial stationary Euclidean sphere inside it.

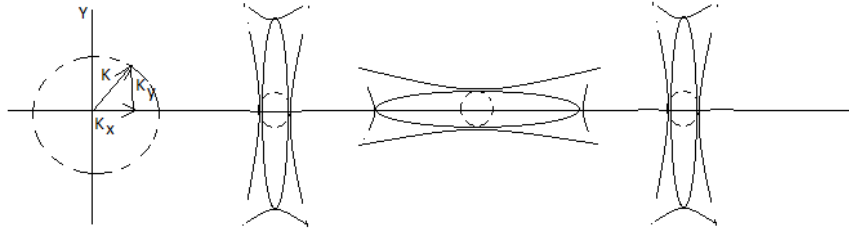

Fig.3. quantum relativistic dynamics of matter space

Such transformations in the angles of parallelism of dynamic space-matter, with induction of relativistic mass, are impossible in the Euclidean axiomatic,  $(a_{11} = 1)(a_{22} = 1) = 1$ . Both theories STR and QTR accept superlight ( $v_i = N \cdot c$ ) space speeds.

$$\overline{W}_Y = \frac{c+Nc}{1+c \cdot Nc/c^2} = c, \quad \overline{W}_Y = \frac{a_{11}Nc+c}{a_{22}+Nc/c} = c, \quad \text{for } a_{11} = a_{22} = 1.$$

#### 4. Scalar bosons.

It is impossible to fix an action of quantum ( $\hbar = \Delta p \Delta \lambda = F \Delta t \Delta \lambda$ ) in space ( $\Delta \lambda$ ) or in time ( $\Delta t$ ). It is connected with zero ( $\varphi \neq const$ ) angle of parallelism (X-) or (Y-) trajectory ( $X \pm$ ) or ( $Y \pm$ ) of quantum of space-matter. There is only certain probability of an action. The transformation of relativistic dynamics of wave ( $\psi$ )- function of quantum field with density of probability ( $|\psi|^2$ ) of interaction in (X+) field (picture 1), corresponds to Globally Invariant  $\psi(X) = e^{-ia}(\overline{\psi})(X)$ , ( $a = const$ ) Lorenz's group. These transformations correspond to turns in the space of circle S, and relativistic-invariant equation of Dirac.

$$i\gamma_\mu \frac{\partial \psi(X)}{\partial x_\mu} - m\psi(X) = 0, \quad \text{and} \quad i\gamma_\mu \frac{\partial \overline{\psi}(X)}{\partial x_\mu} - m\overline{\psi}(X) = 0.$$

Such invariance gives laws of preservation in equations of movement. For transformation of relativistic dynamics in hyperbaric movement.

$$\psi(X) = e^{a(X)}\overline{\psi}(X), \quad ch(aX) = \frac{1}{2}(e^{a(X)} + e^{-a(X)}) \cong e^{a(X)}, \quad a(X) \neq const,$$

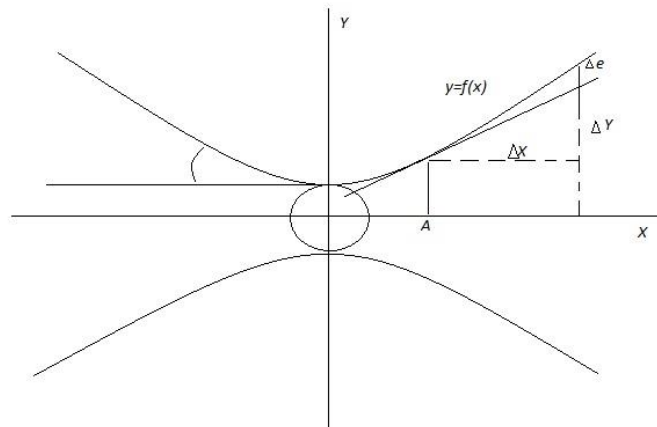
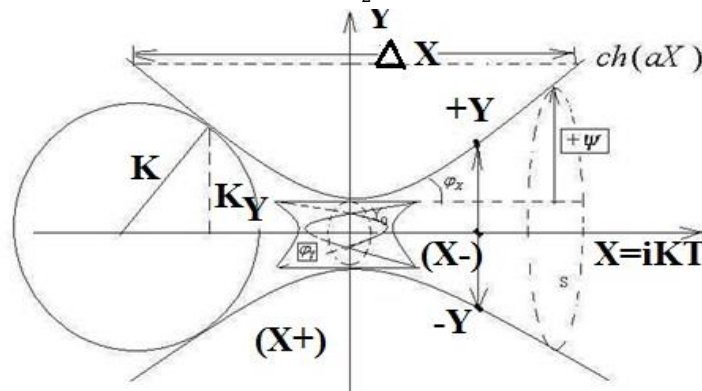

Fig.3. Quantum ( $X \pm$ ) of dynamic space-matter.

$HOI = ch(\frac{X}{Y_0})(X+) \cos(\varphi)(X-) = 1$ ,  $\varphi \neq 90^0$ , at  $\varphi = 0$ ,  $\cos(\varphi) = 1$ , we have:  $ch(\frac{X}{Y_0}) = 1$ ,  $ch(\frac{X=0}{Y_0}) = 1$ , or  $ch(\frac{X}{Y_0 \rightarrow \infty}) = 1$ . The differential of the function  $y = f(x)$  itself is (Mathematical Encyclopedia, v.3, p.327)  $dy = \Delta Y + \Delta \varepsilon$ , (Fig. 3). Only at a fixed point A, the classical representations  $\Delta x = dx$ , are valid;  $\Delta \varepsilon / \Delta x \rightarrow 0$  and



$dy/dx = \Delta Y/\Delta x + \Delta \varepsilon/\Delta x$ ;  $\lim_{\Delta x \rightarrow 0} \Delta Y/\Delta x = y'$ , of the derivative and differential equations in general.  $y'(x) + y(x) + C = 0$ , and  $\frac{\partial y(x)}{\partial x} + y(x) + C = 0$ , are different equations. Outside the fixed point A in the experiment, we have  $\Delta x \neq 0$  and  $0 < |\Delta \varepsilon/\Delta x| < \infty$ , the uncertainty of the dynamics itself  $y = f(x)$  functions "inside" any differential equation. For  $(\pm\psi)$  wave ( $\psi=Y-Y_0$ ) functions, ( $i\psi=\sqrt{(+\psi)(-\psi)}$ ), we will receive the  $i\psi=i\psi$ , transformations  $i\psi e^{ax} e^{i\omega t} = i\psi e^{ax+i\omega t}$ , for  $(X\pm)$ .  $v(X) = v^*(\cos\varphi + i \sin\varphi) = v^* e^{i\varphi}$ .  $iv(X) * \sin\varphi = v\sqrt{(+\sin\varphi)(-\sin\varphi)}$ . Additional component appears in the equation of Dirac.

$$\left[ i\gamma_\mu \frac{\partial \overline{\psi(X)}}{\partial x_\mu} - m\overline{\psi(X)} \right] + i\gamma_\mu \frac{\partial a(X)}{\partial x_\mu} \overline{\psi(X)} = 0$$

Invariance of preservation laws is broken. The calibration fields are imposed for their preservation. They compensate additional component in equation.

$$A_\mu(X) = \bar{A}_\mu(X) + i \frac{\partial a(X)}{\partial x_\mu}, \quad i\gamma_\mu \left[ \frac{\partial}{\partial x_\mu} + iA_\mu(X) \right] \psi(X) - m\psi(X) = 0.$$

Now, substituting the value in such equation  $\psi(X) = e^{a(X)} \overline{\psi(X)}$ ,  $a(X) \neq const$ , of wave function, we will obtain invariant equation of relativistic dynamics.

$$i\gamma_\mu \frac{\partial \psi}{\partial x_\mu} - \gamma_\mu A_\mu(X) \psi - m\psi = i\gamma_\mu \frac{\partial \overline{\psi}}{\partial x_\mu} + i\gamma_\mu \frac{\partial a(X)}{\partial x_\mu} \overline{\psi} - \gamma_\mu \bar{A}_\mu(X) \overline{\psi} - i\gamma_\mu \frac{\partial a(X)}{\partial x_\mu} \overline{\psi} - m\overline{\psi} = 0,$$

$$i\gamma_\mu \frac{\partial \overline{\psi}}{\partial x_\mu} - \gamma_\mu \bar{A}_\mu(X) \overline{\psi} - m\overline{\psi} = 0, \quad \text{or} \quad i\gamma_\mu \left[ \frac{\partial}{\partial x_\mu} + i\bar{A}_\mu(X) \right] \overline{\psi} - m\overline{\psi} = 0$$

This equation is invariant to original equation

$$i\gamma_\mu \left[ \frac{\partial}{\partial x_\mu} + iA_\mu(X) \right] \psi(X) - m\psi(X) = 0,$$

In conditions  $A_\mu(X) = \bar{A}_\mu(X)$ . Presence of scalar boson ( $\sqrt{(+a)(-a)} = ia(\Delta X) \neq 0 = const$ , in the limits of calibration ( $\Delta X \neq 0$ ) field (Fig. 3.). These conditions ( $\frac{\partial a(X)}{\partial x_\mu} \equiv f'(x) = 0$ ) give constant extremes ( $f_{max}$ ) of dynamic  **$f(x) \neq const$**  space-matter in global invariance. And there are no scalar bosons here. Thus, scalar bosons in calibration fields are produced artificially, to address deficiencies of  $A_\mu(X) = \bar{A}_\mu(X) + i \frac{\partial a(X)}{\partial x_\mu}$

Theory of Relativity in quantum fields.

### 5. Spectrum of undivided quantum is of space-matter.

Undivided Regions of localization of quantum's  $(X \pm)$ ,  $(Y \pm)$  of dynamic space-matter correlate with stable quantum's of space-matter. In both cases, these are facts of reality. Stable  $(Y \pm = e)$  electron, radiates stable  $(Y \pm = \gamma)$  photon, and interacts with stable  $(X \pm = p)$  proton and  $(X \pm = \nu_\mu)$ ,  $(X \pm = \nu_e)$  neutrino. In single  $(X=Y+)$ ,  $(X=Y-)$  space-matter they produce first  $OL_1$  Localization region of undivided quantum's on their (m-n) convergences (Fig. 4.).

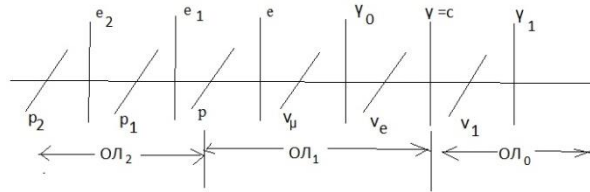

Fig.4. the spectrum of undivided quanta of space-matter.

For preservation of a continuity of single  $(X=Y+)$ ,  $(X=Y-)$  space-matter, photon  $(Y \pm = \gamma_0)$  is introduced, that is equivalent to  $(Y \pm = \gamma)$  photon. It corresponds to analogy of muonic neutrino  $(X \pm = \nu_\mu)$  and electronic  $(X \pm = \nu_e)$  neutrino. In this case, both neutrinos  $(\nu_\mu)$ ,  $(\nu_e)$  and photons  $(\gamma_0)$ ,  $(\gamma)$ , can accelerate as proton or electron till speeds  $(\gamma_1)$ ,  $(\gamma_2, \dots)$ , via the same Lorenz's transformations. If we have standard, outside of any fields, speed of electron  $(W_e = \alpha * c)$ , radiating standard, outside of any field photon  $(V(\gamma) = c)$ , constant  $\alpha = W_e/c = \cos\varphi_\gamma = 1/137,036$  gives by analogy a calculation of speeds  $V(c) = \alpha * V_2(\gamma_2)$  for superlight photons in the view:  $G = 6,67 * 10^{-8}$ .

$$V_2(\gamma_2) = (\alpha^{-1}c), \quad V_4(\gamma_4) = (\alpha^{-2}c), \dots \quad V_i(\gamma_i) = (\alpha^{-N}c),$$

in standard, outside of any fields, conditions. Orbital electron, with an angle of parallelism  $\alpha = W_e/c = \cos\varphi_{MAX}(Y-) = 1/137$ , trajectory, does not radiate photon, as in rectilinear, without acceleration, movement. **This postulate of Bohr, as well as the principle of indeterminacy of space-time and Einstein's principle of equivalence, are the axioms of dynamic space-matter.** Dynamics of mass fields in limits  $(\cos\varphi_{MAX}(X-) = \sqrt{G})$ ,  $(\cos\varphi_{MAX}(Y-) = \alpha = 1/137)$ , of constants of interaction, gives charge isopotential of their masses, that are equal to one.  $m(p) = 938,28 MeV$ ,  $m_e = 0,511 MeV$ ,  $(m_{\nu_\mu} = 0,27 MeV)$ ,



$$\begin{aligned} \left(\frac{X=K_X}{K}\right)^2 (X-) &= \cos^2 \varphi_X = (\sqrt{G})^2 = G, & \left(\frac{Y=K_Y}{K}\right) (Y-) &= \cos \varphi_Y = \alpha = \frac{1}{137,036} \\ m &= \frac{F=\Pi^2}{Y''} = \left[ \frac{\Pi^2 T^2}{Y} = \frac{\Pi}{(Y/K^2)} \right] = \frac{\Pi Y = m_Y}{\left(\frac{Y^2 - G}{K^2 - \frac{1}{2}}\right)}, & \text{where from } 2m_Y &= Gm_X, \\ m &= \frac{F=\Pi^2}{X''} = \left[ \frac{\Pi^2 T^2}{X} = \frac{\Pi}{(X/K^2)} \right] = \frac{\Pi X = m_X}{\left(\frac{X^2 - \alpha^2}{K^2 - \frac{1}{2}}\right)}, & \text{where from } 2m_X &= \alpha^2 m_Y \\ (\alpha/\sqrt{2}) * \Pi K * (\alpha/\sqrt{2}) &= \alpha^2 m(e)/2 = m(\nu_e) = 1,36 * 10^{-5} MeV, & \text{or: } m_X &= \alpha^2 m_Y / 2, \\ \sqrt{G/2} * \Pi K * \sqrt{G/2} &= G * m(p)/2 = m(\gamma_0) = 3.13 * 10^{-5} MeV, & \text{or: } m_Y &= Gm_X / 2 \\ m(\gamma) &= \frac{Gm(\nu_\mu)}{2} = 9,1 * 10^{-9} MeV. \end{aligned}$$

In a single  $(Y\pm = X\mp)$  or  $(Y+ = X-)$ ,  $(Y- = X+)$  space-matter of indivisible structural forms of indivisible quanta  $(Y\pm)$  and  $(X\pm)$ :

$(Y\pm = e^-) = (X- = \nu_e^-)(Y+ = \gamma^+)(X- = \nu_e^-)$  of the electron, where  $\text{НОЛ}(Y\pm) = K\mathcal{E}(Y+)\mathcal{K}\mathcal{E}(Y-)$   
And  $(X\pm = p^+) = (Y- = \gamma_0^+)(X+ = \nu_e^-)(Y- = \gamma_0^+)$  proton, where  $\text{НОЛ}(X\pm) = K\mathcal{E}(X+)\mathcal{K}\mathcal{E}(X-)$ .  
We separate electro  $(Y+ = X-)$  magnetic fields from mass fields  $(Y- = X+)$  in the form:

$$\begin{aligned} (X+)(X+) &= (Y-) \text{ and } \frac{(X+)(X+)}{(Y-)} = 1 = (Y+)(Y-); (Y+ = X-) = \frac{(X+)(X+)}{(Y-)}, \text{ or: } \frac{(X+ = \nu_e^-/2)(\sqrt{2} * G)(X+ = \nu_e^-/2)}{(Y- = \gamma^+)} = q_e(Y+) \\ q_e &= \frac{(m(\nu_e)/2)(\sqrt{2} * G)(m(\nu_e)/2)}{m(\gamma)} = \frac{(1.36 * 10^{-5})^2 * \sqrt{2} * 6,67 * 10^{-8}}{4 * 9,07 * 10^{-9}} = 4,8 * 10^{-10} \text{ ГГЦЕ.} \\ (Y+)(Y+) &= (X-) \text{ и } \frac{(Y+)(Y+)}{(X-)} = 1 = (X+)(X-); (Y+ = X-) = \frac{(Y-)(Y-)}{(X+)}, \text{ или: } \frac{(Y- = \gamma_0^+)(\alpha^2)(Y- = \gamma_0^+)}{(X+ = \nu_e^-)} = q_p(Y+ = X-), \\ q_p &= \frac{(m(\gamma_0^+)/2)(\alpha^2/2)(m(\gamma_0^+)/2)}{m(\nu_e^-)} = \frac{(3,13 * 10^{-5}/2)^2}{2 * 137,036^2 * 1,36 * 10^{-5}} = 4,8 * 10^{-10} \text{ ГГЦЕ.} \end{aligned}$$

These coincidences cannot be random. For a proton wavelength  $\lambda_p = 2,1 * 10^{-14} \text{ см}$ , its frequency  $(\nu_{\gamma_0^+}) = \frac{c}{\lambda_p} = 1,4286 * 10^{24} \text{ Гц}$  is formed by the frequency  $(\gamma_0^+)$  quanta, with mass  $2(m_{\gamma_0^+})c^2 = G\hbar(\nu_{\gamma_0^+})$ .

$1g = 5,62 * 10^{26} \text{ MeV}$ , or:  $(m_{\gamma_0^+}) = \frac{G\hbar(\nu_{\gamma_0^+})}{2c^2} = \frac{6,67 * 10^{-8} * 1,0545 * 10^{-27} * 1,4286 * 10^{24}}{2 * 9 * 10^{20}} = 5,58 * 10^{-32} g = 3,13 * 10^{-5} \text{ MeV}$   
Similarly, for an electron  $\lambda_e = 3,86 * 10^{-11} \text{ см}$ , its frequency  $(\nu_{\nu_e^-}) = \frac{c}{\lambda_e} = 7,77 * 10^{20} \text{ Hz}$ , is formed by the frequency  $(\nu_e^-)$  of a quantum with mass  $2(m_{\nu_e^-})c^2 = \alpha^2 \hbar(\nu_{\nu_e^-})$ , where  $\alpha(Y-) = \frac{1}{137,036}$ , we get:

$$(m_{\nu_e^-}) = \frac{\alpha^2 \hbar(\nu_{\nu_e^-})}{2c^2} = \frac{1 * 1,0545 * 10^{-27} * 7,77 * 10^{20}}{(137,036^2) * 2 * 9 * 10^{20}} = 2,424 * 10^{-32} \text{ г} = 1,36 * 10^{-5} \text{ MeV}, \text{ for the neutrino mass.}$$

The physical fact is the charge isopotential of the proton  $(X- = Y+)e$ , and the electron in the hydrogen atom with the mass ratio  $(p/e \approx 1836)$ . By analogy, we are talking about the charge isopotential  $\nu_\mu(X- = Y+)\gamma_0$ , and  $\nu_e(X- = Y+)\gamma$ , subatoms, with mass ratio  $(\nu_\mu/\gamma_0 \approx 8642)$  and  $(\nu_e/\gamma \approx 1500)$ , respectively. At the same time, subatoms  $(\nu_\mu/\gamma_0)$  are held by the gravitational field of the planets, and subatoms  $(\nu_e/\gamma)$  are held by the gravitational field of stars. This follows from calculations of atomic structures  $(p/e)$ , subatoms of planets  $(p_1/e_1)(p/e)(\nu_\mu/\gamma_0)$  and stars  $(p_2/e_2)(p_1/e_1)(p/e)(\nu_\mu/\gamma_0)(\nu_e/\gamma)$  for:  $e_1 = 2\nu_\mu/\alpha^2 = 10,2 \text{ GeV}$ ,  $e_2 = 2p/\alpha^2 = 35,2 \text{ TeV}$ ,  $\text{НОЛ} = e_1 * 3,13 * \gamma_0 = 1$ , и  $\text{НОЛ} = e_2 * 3,13 * \gamma = 1$ . And also for  $p_1 = 2e/G = 15,3 \text{ TeV}$ , and  $p_1(X- = Y+)e_1$  "heavys atoms" inside the stars themselves. If there are quanta  $(m_X = p_1^-) = \frac{2(m_Y = e^-)}{G} = (15,3 \text{ TeV})$  and  $(m_Y = e_2^-) = \frac{2(m_X = m_p)}{\alpha^2} = (35,24 \text{ TeV})$ , then similarly to the generation by quanta  $(p_1/n_1)$  of the Earth's core of  $(2\alpha p_1^- = 238p^+ = {}^{238}_{92}\text{U})$  uranium nuclei,  $p^+ \approx n$ , followed by decay into a spectrum of atoms, quanta  $p_2^- = \frac{2e_1^-}{G} = 3,06 * 10^5 \text{ TeV}$ , and  $(p_2/n_2)$ ,  $(p_2 \approx n_2)$  cores of the Sun (star), generate cores of the "stellar uranium",  $(2\alpha p_2^- = 290p_1^+ = {}^{290}\text{U}^*)$ , with their exothermic decay into a spectrum of "stellar" atoms  $(p_1^+/e_1^-)$  in the solid surface of a star (Sun) without interactions with ordinary atoms  $(p^+/e^-)$  of hydrogen and the spectrum of atoms. Radiation  $(p_1^+ \rightarrow \nu_\mu^-)$  by the Sun of a muon neutrino, like the emission of  $(e \rightarrow \gamma)$  photons, means the presence on the Sun of such stellar matter  $(p_1^+/e_1^-)$  without interaction with the proton  $(p^+/e^-)$  electron atomic structures of ordinary matter (hydrogen, helium...). These are the calculations and the physically admissible possibilities.

Such coincidences also cannot be accidental. In principle, it is enough to know the constants  $G = 6,674 * 10^{-8}$ ,  $\alpha = 1/137.036$  of the limiting angles and the velocity  $c = 2.993 * 10^{10} \text{ см/с}$  to determine the Planck action constant for unit masses  $(m_0 * m_0 = 1)$  of their charges in the form:

$$\hbar = Gm_0 \frac{\alpha}{c} Gm_0 (1 - 2\alpha)^2 = \frac{(6,674 * 10^{-8})^2 * (1 - 2/(137,036))^2}{137,036 * 2,993 * 10^{10}} = 1.054508 * 10^{-27} \text{ erg} * \text{ s}$$

Or:  $m_0 * m_0 = (K\Xi = m_m)(K\Xi = m_n) = 1$ , in the axioms of dynamic space-matter. Both large and small masses have quantum properties. Example, for the mass of the Sun.

$$\hbar \left( \frac{M_S * c^2}{2} \right) \hbar = 1, \text{ or: } M_S(\alpha\sqrt{2})2v_e = 2 * 10^{33} \left( \frac{\sqrt{2}}{137} \right) * 1,78 * 10^{-27} * 2 * 1,36 * 10^{-5} = 1.$$

This means that such stellar masses  $M_S(\sqrt{2})2 = 2.8 * M_S$  can hold  $v_e$  - neutrinos in their gravitational field. The planets can keep  $e$  - electrons and  $v_\mu$  - neutrinos in their gravitational field.

Similarly, the charge of unit masses is determined:  $m_0 = 1$ , in the form:

$$q = Gm_0\alpha(1 - \alpha)^2 = 6,674 * 10^{-8}(1/137.036) * (1 - 1/137.036)^2 = 4.8 * 10^{-10},$$

And their relations:  $\hbar\alpha c = q^2$ . The model of products of an annihilation of proton and electron corresponds to such calculations. Mass fields ( $Y- = e$ ) ( $X+ = p$ ) of an atom. In addition, the proton does not emit an exchange photon during an electromagnetic, charge interaction with an electron of an atom.

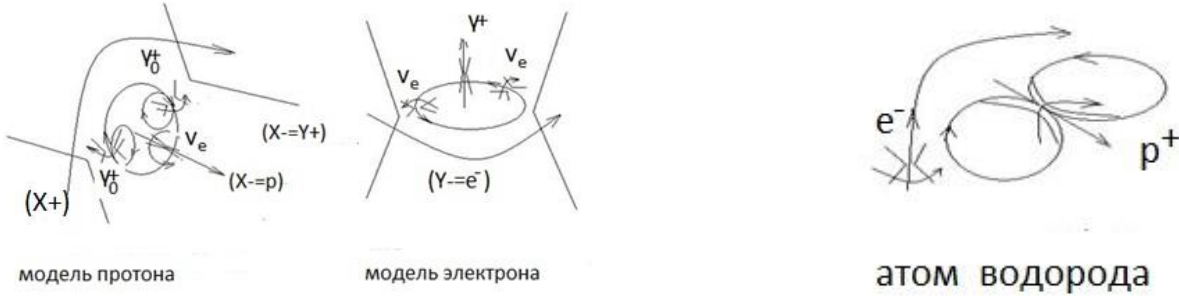

Fig.5. Mass fields of an atom.

Presence of antimatter in a matter of proton or electron is a geometric fact here. In this case, products of annihilation of proton

$$(X\pm = p^+) = (Y- = \gamma_0^+)(X+ = v_e^-)(Y- = \gamma_0^+),$$

And products of annihilation of an electron  $(Y\pm = e^-) = (X- = v_e^-)(Y+ = \gamma^+)(X- = v_e^-)$ ,

By analogy, in single fields of space-matter Bosons of electroweak interaction:

$$\text{НОЛ}(Y) = (Y+ = e^\pm)(X- = v_\mu^\mp) = \frac{2\alpha * (\sqrt{m_e(m_{v_\mu})})}{G} = 81,3 \text{ GeV} = m(W^\pm), \text{ with charge } e^\pm,$$

$$\text{НОЛ}(X) = (X+ = v_\mu^\mp)(Y- = e^\pm) = \frac{\alpha * (\sqrt{(2m_e)m_{v_\mu} \exp 1})}{G} = 94,8 \text{ GeV} = m(Z^0)$$

### New stable particles

On opposite beams of muon antineutrino ( $v_\mu^-$ ) in magnetic fields:

$$\text{НОЛ}(Y \pm = e_1^-) = (X- = v_\mu^-)(Y+ = \gamma_0^+)(X- = v_\mu^-) = \frac{2v_\mu^-}{\alpha^2} = 10,21 \text{ GeV}$$

Unstable, these are known levels of upsilononium.

On opposite beams of positrons ( $e^+$ ), that accelerate in flow of quantum's ( $Y- = \gamma$ ), of photons of «white» laser in a view:

$$\text{НОЛ}(X \pm = p_1^+) = (Y- = e^+)(X+ = v_\mu^-)(Y- = e^+) = \frac{2m_e}{G} = 15,3 \text{ TeV}$$

On opposite beams of antiprotons ( $p^-$ ), takes place:

$$\text{НОЛ}(Y \pm = e_2^-) = (X- = p^-)(Y+ = e^+)(X- = p^-) = \frac{2m_p}{\alpha^2} = 35,24 \text{ TeV}$$

For opposite  $\text{НОЛ}(Y-) = (X+ = p^\pm)(X+ = p^\pm)$ , Mass of quantum is calculated

$$M(Y-) = (X+ = p^\pm)(X+ = p^\pm) = \left( \frac{m_0}{\alpha} = \overline{m}_1 \right) (1 - 2\alpha), \text{ or}$$

$$M(Y-) = \left( \frac{2m_p}{2\alpha} = \frac{m_p}{\alpha} = \overline{m}_1 \right) (1 - 2\alpha) = \frac{0,93828 \text{ GeV}}{(1/137,036)} \left( 1 - \frac{2}{137,036} \right) = 126,7 \text{ GeV},$$

This elementary particle was discovered in collider of CERN.

**PS.** In general models of the atomic spectrum, the quantum model ( $X\pm = {}^4_2\text{He}$ ) of the helium nucleus has the form

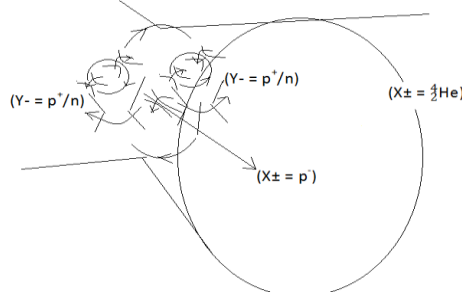
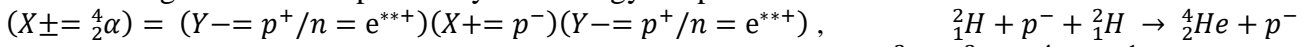

Figure 5.1 Synthesis Model

the structural form of quanta ( $Y- = p^+/n$ ) of strong interaction, structured by the ( $X-$ ) field, in this case either an antineutrino ( $X± = \nu_e^-$ ) or an antiproton ( $X± = p^-$ ). In accordance with the equations of the dynamics of mass fields:  $c * rot_Y M(Y-) = rot_Y N(Y-) = \varepsilon_2 * \frac{\partial G(X+)}{\partial T} + \lambda * G(X+)$ , we are talking about a controlled

( $v_Y * rot_X 2M(Y- = p^+/n) = \varepsilon_2 * \frac{\partial G(X+ = \frac{1}{2}He)}{\partial T}$ ) Thermonuclear reaction:

- 1) Or in inelastic collisions ( $X± = \frac{1}{2}\alpha$ ) = ( $Y- = p^+/n = e^{***}$ )( $X+ = \nu_e^-$ )( $Y- = p^+/n = e^{***}$ ) in the collider, colliding beams of low-energy deuterium nuclei, without primary plasma,
- 2). Or structuring of deuterium plasma by low-energy antiprotons in reactions



Today, a controlled thermonuclear reaction is created in plasma: ( ${}^2_1H + {}^3_1H \rightarrow {}^4_2He + {}^1_0n + 17,6MeV$ ).

They are different cores. In the space-matter ( $Y- = X+$ ) it is ( ${}^2_1H + {}^3_1H$ ) similar to the connection of mass trajectories of the "positron" ( $Y- = p^+/n = e^{***}$ ) or ( $Y- = e^+$ ) and "proton" ( $X+ = {}^3_1H = p^{***}$ ) or ( $X+ = p^+$ ). A proton with a positron, with mutually perpendicular ( $Y- \perp X-$ ) trajectories, is hydrogen, in which everything goes to break the structure, in this case, in the plasma. And only during impacts in high-temperature plasma in the fields ( $X+ = p^+$ ) of Strong Interaction, fields of vortex mass trajectories ( $Y- = p^+/n$ )( $Y- = p^+/n$ ) = ( $X± = \frac{1}{2}He$ ), already a new core, as a stable structure.

More efficient conditions for a controlled thermonuclear reaction are counter flows of deuterium plasma with perpendicular injection of antiproton beams at the point of meeting of plasma flows. The flow of deuterium plasma itself is represented by a controlled flow of ions, as a more stable state of plasma in TOKAMAK. Or inelastic collisions of low-energy deuterium beams, in a chamber with perpendicular lines of force of a strong magnetic field, without primary plasma. The resulting alpha particles heat the water jacket of an already controlled thermonuclear reactor.

- 3) or in inelastic collisions of tritium  ${}^3_1H + p^+ \rightarrow {}^4_2He$ , in colliders with high-energy proton beams, without primary plasma.

**Two grams** of such plasma of synthesized helium is equivalent to 25 tons of gasoline. In all cases, trial experiments are needed on the finished collider.

## 6. General equations of the General Theory of Relativity and quantum gravity.

### 6.1 General Theory of Relativity (GTR) of Einstein in space-matter.

The theory is characterized by tensor of Einstein (G. Korn, T. Korn), it is a math truth of difference of relativistic dynamics of two (1) and (2) points of Rimanov's space, as fixed ( $g_{ik} = const$ ), state of dynamic ( $g_{ik} \neq const$ ), space-matter. (Smirnov V.I. 1974. b.2).

$$R - \frac{1}{2}R_i a_{ji} = \frac{1}{2}grad(U), \quad \text{or} \quad R_{ji} - \frac{1}{2}Rg_{ji} = kT_{ji}, \quad (g_{ji} = const).$$

In this case the matrix of transformations in single units of measure

$$\begin{aligned} R_1 &= a_{11}Y_1 + 0 \\ R_Y &= 0 + a_{YY}Y_Y, \end{aligned} \quad a_{11} = a_{YY} = \sqrt{G}, \quad R^2 = a_{YY}^2 Y_Y^2 = GY_Y^2,$$

$$\text{Gives classical Newton's low} \quad Y_Y^2 = \frac{m^2}{\Pi^2}, \quad R^2 = G \frac{m^2}{\Pi^2}, \quad \text{or} \quad F = G \frac{Mm}{R^2},$$

For relativistic dynamics:

a) in unified Evolution Criteria

$$\begin{aligned} c^2 T^2 - X^2 &= \frac{c_Y^4}{b_Y^2} > 0, \quad b_Y = \frac{F_Y}{M_Y}, \quad c_Y^4 = F_Y, \quad c^2 T^2 - X^2 = \frac{M_Y^2}{F_Y}, \\ F_Y &= \frac{M_Y^2}{c^2 T^2 (1 - W_X^2/c^2)}, \quad c^2 T^2 = R^2 = \frac{R_0^2}{(\cos^2 \varphi_X = G)}, \quad F_Y = G \frac{Mm}{R^2 (1 - W_X^2/c^2)}, \end{aligned}$$

It is relativistic view of Newton's law for mass (Y-) trajectories,

$$\frac{mW^2}{2} = \frac{GMm}{R}, \quad W^2 = \frac{2GM}{R}, \quad \text{or} \quad F_Y = G \frac{Mm}{R^2 (1 - 2GM/Rc^2)}, \quad (1 - 2GM/Rc^2) > 0, \quad (R > \frac{2GM}{c^2}) \neq 0$$

b) in the case of General Theory of Relativity, it is not forbidden to represent the fundamental tensor of Riemannian space (Korn G., Korn T. (1973) pp. 508, 535),  $(g_{ji} = \mathbf{e}_j(x^n) \mathbf{e}_i(x^n))$  local basis vectors  $\mathbf{e}_j(x^n)$  and  $\mathbf{e}_i(x^n)$  in any  $(x^n)$  coordinate system in the form of a vector space of velocities (Korn G., Korn T. p. 504). Then the tensors themselves  $(g_{ji}(1) = \Pi_1)$  and  $(g_{ji}(2) = \Pi_2)$  are represented as gravitational potentials at points 1 and 2. Their difference  $(\Delta g_{ji} = \Delta \Pi)$  in the General equation The Theory of Relativity, gives the tensor of energy - momentum in the unified Criteria of Evolution in the form:

$$\Delta \Pi = \frac{8\pi G}{c^4} \left( T_{ji} = \frac{\Pi^4 K^2}{\Pi^2 T^2} = \frac{\Pi^2 K^2}{T^2} \right) \text{ or: } \Delta \Pi = \Pi_1 - \Pi_2 = \frac{8\pi G}{c^4} \Pi_1^2 \Pi_2, \text{ or: } c^4 = F = \frac{2 \cdot 4\pi R^2 G \Pi_1 \Pi_2}{R^2 \left( 1 - \frac{2G(\Pi_2 R = M)}{R \cdot c^2} \right)}, \text{ where } 4\pi R^2, \text{ is}$$

the surface of the sphere,  $(\Pi_1 R = M_1)$  and  $(\Pi_2 R = M_2)$  in the final form:  $F = \frac{GM_1 M_2}{R^2 \left( 1 - \frac{2G(M)}{Rc^2} \right)}$ , the same relativistic representation of Newton's law as a particular case of the General Theory of Relativity. From these relations it follows only that:  $(1 - 2GM/Rc^2 \neq 0)$ .

c) in the laws of classical physics, the Laplace and Kepler formulas follow from simple relations:

$$\frac{v^2}{R} = \frac{GM}{R^2}, \quad \frac{R^3}{T^2} = \frac{GM}{(2\pi)^2}, \quad \frac{R_1^3}{T_1^2} = \frac{R_2^3}{T_2^2}, \quad \frac{S_1}{t_1} (\omega_1 R_1) = \frac{S_2}{t_2} (\omega_2 R_2), \quad \frac{S_1}{t_1} = \frac{S_2}{t_2}, \quad S_1 t_2 = S_2 t_1, \text{ and } (\omega_1 R_1 = \omega_2 R_2) \text{ in}$$

Kepler's laws. Further,  $v^2 - v_0^2 = 2gh$ , for  $v_0^2 = 0$ ,  $g = \frac{GM}{R^2}$ , the kinetic energy is equal to the potential

one:  $\frac{mv^2}{2} = mgh$ . From  $h = R$  it follows  $v^2 = \frac{2GM}{R}$ . In Einstein's postulates, the speed of light is the limit.

Divide by zero to assume "black holes" with an event horizon equal to the speed of light. The error here is that under the conditions of the "arrow of time" the impossibility of the cause (division by zero in

mathematics) is replaced by the impossible consequence (singularity at the Euclidean point)  $g = \frac{2GM}{(R=0)^2} = \infty$ .

If there is no division by zero, no cause, then there is no singularity or consequence  $(R=0) = \frac{2GM=0}{c^2=const}$ .

If they say that space-time disappears  $(R=0)$  at the "point" of the "black hole" singularity then this is a mistake  $c^2 = (g = \infty)(R=0)$ . Here, the consequences of the singularity, which do not exist, replace the cause, that is, the properties of space-time. This is a conversation about nothing. Here, on the contrary,

$g = \frac{2GM}{(R \neq 0) \rightarrow 0^2} \neq \infty$  the singularity disappears in the properties of the always  $(R \neq 0)$  non-zero sphere-point

of space-time with all its laws with non-zero mass  $(M \neq 0)$ . This is pure mathematics. There are also logically flawless images of the inevitable singularity at the center of the "black hole". But they are based on

misconceptions about Einstein's theory. No evidence, short and to the point. In conformal transformations, when moving towards the boundary of the "black hole", the light cone of events in space-time passes into

the limiting state of the photon light cone. Ordinary space-time disappears. Further, changing the sign of time, it is necessary to move into the superluminal space of velocities (this is the key moment), in which

time and space change places (in space-like space-time). For our space-time (outside the black hole), the time in the black hole changes sign and goes from the future time to the past, and our space-time is absent

$(R=0)$ . If we move to the center of the black hole along any trajectory, then in the future time there will always be a point of zero  $(R=0)$  radius at the center of the sphere, that is, a singularity from which the

photon emerges along a geodesic line. This is also pure mathematics. And the logic here is impeccable. Here we are talking about the inevitable singularity at the center of the "black hole". The error is that Einstein's

Special Relativity allows for a superluminal velocity space  $\overline{W}_V = \frac{c+Nc}{1+c \cdot Nc/c^2} = c$ , and  $v_i = Nc$  which a photon cannot enter. Now let's return to the key point of having a superluminal space of speeds, for such logic. Yes,

a photon cannot get here, but all Einstein's laws work here, but already for the permissible limiting speed  $v_i = Nc$ . The physical vacuum of the Universe, in which the photon moves, also has subspaces into which

the photon cannot get. These are already facts. The observed "black holes" have other causes and properties. But according to this logic, a photon cannot penetrate into the superluminal subspace of a "black hole". A

photon revolves around a black hole. The laws of physics work in this area in the same way as in the physical vacuum. We do not say here that this is a null singularity. The "black hole" cannot absorb the mass,

since this mass, in order to overcome the event horizon, must accelerate to the speed of light  $M \rightarrow 0$ . Even if an atom decays into protons and electrons or electron-positron pairs in Hawking radiation, they cannot reach

the speed of light at the event horizon. Even if the positron was "born" under the Euclidean line, "length without width", the event horizon. This is outside of the Euclidean axiomatics of space-time, outside of

Einstein's postulates. And this means the impossibility of Hawking radiation by "black holes". The observed "black holes" have other causes and properties within the framework of the axioms of dynamic space-matter.

This is beyond the scope of this article.

This means that the space of velocities of mass ( $\sqrt{GW}2(2\pi R)\sqrt{GW} = 2GM$ ) cannot have the speed of light. We obtain for the proton mass ( $M = 1,67 * 10^{-24}g$ ) with the conditional circle ( $2\pi R$ ) of the sphere and the limiting velocity ( $W = c$ ), we have the radius of the proton.

$$R = \frac{GM}{2(2*3.14)c^2} = \frac{6.67*10^{-8}*1.67*10^{-24}}{2*(2*3.14)*9*10^{20}} = 0.98 * 10^{-13}cm.$$

This is the minimal "black hole" that does not emit a photon, with the space of quantum velocities

$(\gamma_0 + v_e + \gamma_0) = p$ , less than the speed of light. And this is proof that the neutrino has a non-zero mass. But the infinities obtained in this way are not found in mathematics or in nature.

It is significant, that gravitational constant ( $a_{11} = a_{YY} = \sqrt{G}$ ), is math truth of maximum ( $a_{11} = a_{YY} = \cos\varphi_{MAX} = \sqrt{G}$ ), angle of parallelism, it is absent ( $k = 8\pi G/c^4$ ) in General Theory of Relativity of Einstein. The second moment is that, there are strict conditions of fixation of potentials ( $g_{ji} = const$ ), with adjustment of them to Euclidean space ( $g_{ii} = 1$ ). Introduction of coefficient in equation ( $\lambda$ ) that is changing energy vacuum,

$$R_{ji} - \frac{1}{2}Rg_{ji} - \frac{1}{2}\lambda g_{ji} = kT_{ji}.$$

This does not change the conditions for its fixation.

### 6.2 General equations of the General Theory of Relativity and quantum gravity.

Elements quantum gravity ( $X + = Y-$ ) a mass field follow from the General Theory of the Relativity. Speech about a difference relativistic dynamics in two (1) and (2) points Riemannian spaces, as to mathematical true tensor Einstein. (G. Korn, T. Korn, c.508). Here  $g_{ik}(1) - g_{ik}(2) \neq 0$ ,  $e_k e_k = 1$ , on conditions  $e_i(X-)$ ,  $e_k(Y-)$ , fundamental tensor  $g_{ik}(x^n) = e_i e_k$  Riemannian spaces in ( $x^n$ ) system of coordinates.

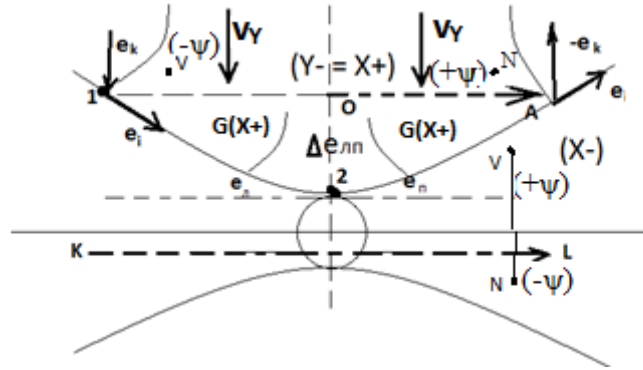

Fig. 6. Quantum gravity ( $X + = Y-$ ) a mass field.

The principle of equivalence of inert and gravitational weight is physical properties gravity ( $X + = Y-$ ) a mass field. This equality of acceleration  $a = v_Y * M(Y-)$  of mass trajectories and acceleration  $g = G(X+)$  of a field of gravitation  $v_Y * M(Y-) = a = g = G(X+)$ , in space of speeds

$$e_i(X-) = e_i(x^n = X, Y, Z) = v_X \left[ \frac{K}{T} \right], \quad e_k(Y-) = e_k(x^n = X, Y, Z) = v_Y \left[ \frac{K}{T} \right]$$

Of local basic vectors. For example, in "the falling" lift acceleration ( $g - a$ ) = 0 is absent, and the weight  $P = m(g - a) = 0$ , is equal to zero.

The point (2) is led by Euclidean to sphere space, where  $(e_i \perp e_k)$  and  $e_i * e_k = 0$ . Therefore in a vicinity of a point (2) it is allocated parallel vectors ( $e_n$ ) and ( $e_n$ ) and we take average value  $\Delta e_{nn} = \frac{1}{2}(e_n + e_n)$ . Accepting ( $e_n = e_k$ ), condition for converting transformations to the Euclidean sphere, ( $x_{2=\pi}^S$ ), and  $g_{ik}(1) - g_{ik}(2) \neq 0$ .  $\Delta e_{nn} = \frac{1}{2}(e_n + e_k) = \frac{1}{2}e_k \left( \frac{e_n}{e_k} + 1 \right)$ , we will receive:

$$g_{ik}(1)(X+) - g_{ik}(2)(X+) = \kappa T_{ik}(Y-),$$

$$g_{ik}(1) - \frac{1}{2}(e_i e_k = g_{ik}) \left( \frac{e_n}{e_k} + 1 \right) (2) = \kappa T_{ik}, \quad \left( \frac{e_n}{e_k} = R \right). \quad (e_n \neq e_k), \quad g_{ik}(x_{2=\pi=k}^S)$$

For ( $e_n = e_k$ ), we have ( $T_{ik} = 0$ ). In the conditions ( $e_n \neq e_n$ ), we are talking about the dynamics of the physical vacuum in fixed angles of parallelism, with different geodesics already dynamic sphere

$(x_n^S \neq x_2^S \neq x_n^S)$  at fixed ( $e_n \neq e_2 \neq e_n = const$ ) points. For dynamic ( $\partial e_n / \partial t \neq 0$ ) angles of parallelism ( $\varphi \neq const$ ) of space-matter, we are talking about acceleration in the sphere (XYZ) of non-stationary Euclidean space. In other words, already the geodesic of the non stationary Euclidean sphere,  $g_{ik}(x_n^S \neq x_2^S \neq x_n^S \neq const)$  changes. We are talking about the acceleration of an already dynamic physical vacuum in its expansion.

From here, the equation of the General Theory of the Relativity in a full kind follows:

$$R_{ik} - \frac{1}{2}Rg_{ik} - \frac{1}{2}g_{ik} = \kappa T_{ik}.$$

What does this equation mean in the classical representation? It all starts with Einstein's postulate about the limiting speed of light ( $c$ ) for mass ( $m$ ) with speed ( $w$ ). This means that:  $(c) \neq (w)$  or  $c^2 \neq w^2$  ;

$$c^2 - w^2 \neq 0; \quad w^2 = \frac{x^2}{t^2}; \quad (c * t)^2 - (x)^2 = const = (c * \bar{t})^2 - (\bar{x})^2.$$

These are the well-known Lorentz transformations in relativistic dynamics. Fundamental here, there is a non-zero difference. Changing the course of time ( $\bar{t}$ ) changes the space ( $\bar{x}$ ), (Smirnov V.I., 1974, vol. 3, part 1, p. 195) with the relativistic correction with a relativistic correction for the mass  $m(Y-)$  trajectory of the quantum field:

$$\frac{w^2}{c^2} = \cos^2 \varphi_{max}(Y -) = \alpha^2 = \left(\frac{1}{137,036}\right)^2 ; \quad c^2 - w^2 = c^2 \left(1 - \frac{w^2}{c^2}\right) = c^2(1 - \alpha^2).$$

For classical transformations of relativistic dynamics:  $\bar{x}_1 = a_{11}c * t_1 - a_{12}x_1$  ;  $c * \bar{t}_1 = a_{21}c * t_1 - a_{22}x_1$  ;  
with transformation matrix:  $a_{ik} = \begin{matrix} a_{11} & a_{12} \\ a_{21} & a_{22} \end{matrix}$ .

In the three-dimensional space-time of the non-zero Euclidean sphere, with a constant geodesic ( $x_1^s = const$ ) curve, there will be four such equations (Smirnov V.I. 1974, vol. 3, part 1, pp. 195-198).

$$\begin{matrix} \bar{x} = a_{11}c * t - a_{12}x - a_{13}y - a_{14}z; & a_{11} & a_{12} & a_{13} & a_{14} \\ \bar{y} = a_{21}c * t - a_{22}x - a_{23}y - a_{24}z & a_{21} & a_{22} & a_{23} & a_{24} \\ \bar{z} = a_{31}c * t - a_{32}x - a_{33}y - a_{34}z & a_{31} & a_{32} & a_{33} & a_{34} \\ c * \bar{t} = a_{41}c * t - a_{42}x - a_{43}y - a_{44}z & a_{41} & a_{42} & a_{43} & a_{44} \end{matrix} \quad \text{with } (a_{ik}) \text{ matrix transformations}$$

in the well-known Lorentz group:  $(x)^2 + (y)^2 + (z)^2 - (c * t)^2 = (\bar{x})^2 + (\bar{y})^2 + (\bar{z})^2 - (c * \bar{t})^2$ . Here it is already possible to substitute numbers and consider the transformations of the relativistic dynamics of the unified Criteria of Evolution: for example: energy  $E = \Pi^2 Y = (m = \Pi Y) * (\Pi = c^2) = m * c^2$ , momentum  $p = \Pi^2 t$ , masses  $m = \Pi Y(X += Y-)$ . Here:  $\Pi = c^2 = gY$ , the acceleration potential ( $g$ ) on the trajectory ( $Y = Y-$ ). Such transformations of relativistic dynamics in an inertial space-time system without acceleration ( $g = 0$ ) in the Euclidean sphere ( $a_{ii} = 1$ ) on Earth are the same as in the Euclidean sphere of space-time of a falling lift in the gravitational field of the Earth itself. Einstein was faced with the task of moving from the space-time of the inertial system in the Euclidean sphere without acceleration on Earth into the space-time of the Euclidean sphere, also without acceleration in an elevator (with mass) falling in the gravitational field. To perform these transformations in relativistic dynamics, Einstein in a mathematical procedure, to the acceleration potential ( $g$ ) on the space-time trajectory ( $Y = Y-$ ) in the inertial frame, added the potential of the gravitational field in the form of the tensor:  $\Pi = w^2 = \frac{Y^2}{t^2} = \frac{(E=\Pi^2 Y)^2}{(p=\Pi^2 t)^2}$ , energy-momentum.

This is a mathematical truth:  $R_{ik} = \frac{1}{2}R(g_{ik} = gY) + \kappa(T_{ik} = \Pi)$ , already Einstein's tensor, in its classical form:  $R_{ik} - \frac{1}{2}Rg_{ik} = \kappa T_{ik}$ . (Korn G., Korn T. (1973), p. 536). Or ( $g_2 = g_1 \pm a$ ) of classical physics. These are additional equations for transformations of relativistic dynamics. Here ( $R_{ik}$ ) are transformations of relativistic dynamics in space-time of a Euclidean sphere, already with a different geodesic curvature ( $x_2^s = const$ ) in a falling elevator in a gravitational field. In other words, the gravitational field ( $\kappa T_{ik} = \Pi$ ) is measured by the curvature of space-time. In other words, the gravitational field is measured by the curvature of space-time. Calculating space-time changes in relativistic dynamics without gravity at point (1):

$\bar{x}_1 = g_{ik}x_1$  ;  $c * \bar{t}_1 = g_{ik}c * t_1$  ; ( $i, k = 1,2,3,4$ ), and changes space-time in relativistic dynamics already with gravity at point (2):  $\bar{x}_2 = g_{ik}x_2$  ;  $c * \bar{t}_2 = g_{ik}c * t_2$  ; we can consider changes in the curvature of the falling geodesic sphere ( $x_2^s = const$ ) in the gravitational field, ( $x^s = X, Y, Z, ct$ ).

$(\bar{x}_2 - \bar{x}_1)^2 = g_{i1}c^2 * (t_2 - t_1)^2 - g_{i2} * (x_2 - x_1)^2 - g_{i3} * (y_2 - y_1)^2 - g_{i4} * (z_2 - z_1)^2 = (kT_{i1})$  ; ( $i=1,2,3,4$ ). Basically, we are dealing with ( $g_{ik}$ )<sup>2</sup> quadratic form ( $g_{ik})(g_{ik} = g_{ir}R_{jkh}^r)$  for the chosen directions ( $e_j e_h = 1$ ) and ( $e_r y^r = 1$ ) transformations of the Riemann-Christoffel tensor (Korn, 1973, p. 535). As you can see, this is a matrix in 5 columns and 4 rows, each of which is an equation of dynamics in a gravitational field, and is solved separately. Or in the general case of a radial representation of a sphere:

Or:  $(\bar{x}_2 - \bar{x}_1)^2 = \Delta x_{21}^2$  ;  $(\bar{t}_2 - \bar{t}_1)^2 = \Delta t_{21}^2$  ; in the form:  $c^2 * \Delta t_{21}^2 - \Delta x_{21}^2 = \frac{\Delta \Pi * \Pi}{g^2}$ . And:

$c^2 * \Delta t^2 \left(1 - \frac{\Delta w^2}{c^2}\right) = \frac{\Delta \Pi * \Pi}{g^2}$  ;  $c^2 \left(1 - \frac{\Delta w^2}{c^2}\right) = \frac{\Delta \Pi * \Pi}{(g^2 * \Delta t^2 = \Pi)} = \Delta \Pi$ . The difference in velocities in orbit is measured

by the eccentricity ( $\varepsilon$ ). Then:  $c^2(1 - \varepsilon^2) = \Delta \Pi$ . Taking the displacement of the perihelion  $\delta \varphi \approx \frac{\Delta A}{A}$ ,

$A \delta \varphi = \Delta A$  ;  $c^2 A \delta \varphi (1 - \varepsilon^2) = (\Delta \Pi * \Delta A \equiv GM)$ , we obtain the well-known Einstein formula:

$\delta \varphi \approx \frac{6\pi GM}{c^2 A(1 - \varepsilon^2)} = 42,98''$ ; for the perihelion of Mercury. In these calculations:



$\delta\varphi \approx \frac{6\pi GM}{c^2 A(1-\varepsilon^2)} = \frac{6 \cdot 3,14 \cdot 6,67 \cdot 10^{-8} \cdot 2 \cdot 10^{33}}{9 \cdot 10^{20} \cdot 5,791 \cdot 10^{12} \cdot 0,958} = 5,03356 \cdot 10^{-7} \text{ rad}$ , ( $1 \text{ rad} = 206264,8''$ ); and  $\delta\varphi = 0,1038''$ , for 1 period of Mercury 88 days, and 100 years on Earth, we get:  $\delta\varphi \cdot \frac{36525}{88} = 43''$ . And in these calculations, the average value of the orbit of Mercury ( $A = 5,791 \cdot 10^{12} \text{ sm}$ ) is taken, which means that we are talking about the rotation of all space-matter around the Sun. This is also a mathematical truth. In this case, the dynamics of vacuum values of space-time ( $\frac{1}{2}g_{ik} = 0$ ) at point (2) is not taken into account ( $e_i \perp e_k$ ). There is no dynamics here. But here it is already possible to substitute numbers and consider the curvature of space-time, with its interpolation into the potential of the space of the velocities of the gravitational field.

**At zero** gravitational potential:  $R_{ik} = \frac{1}{2}R(g_{ik} = gY) + \kappa(T_{ik} = \Pi = 0)$ , the equations of Einstein's General Theory of Relativity, turn into equal equations of Einstein's Special Theory of Relativity, at two different points (laboratories) of Euclidean space, confirming in mathematical truth, the first postulate of Einstein.  $R_{ik} = (R = 1)(g_{ik})$ ;  $\bar{x}_2 = g_{ik}x_1$ ;  $c * \bar{t}_2 = g_{ik}t_1$ ; where (i, k = 1,2,3,4),  $(c * \bar{t})^2 - (\bar{x})^2 = (c * t)^2 - (x)^2$ . **With infinite** gravitational accelerations,  $\Pi = c^2 = (g_2 \rightarrow \infty)(Y_2 \rightarrow 0)$  at a singular point ( $Y_2 \rightarrow 0$ ), for example, a "black hole", in the Einstein equation we are talking about relativistic dynamics:

$$(R_{ik} = (g_2 \rightarrow \infty)(Y_2 \rightarrow 0)) = \frac{1}{2}R(g_{ik} = g_1Y_1) + \kappa(T_{ik} = \Pi = c^2), \quad (g_2) \text{ acceleration at point 2,}$$

$$(c * \bar{t})^2 - (\bar{x})^2 = \frac{c^4}{(g_2 \rightarrow \infty)^2} \rightarrow 0, \text{ and } c * \bar{t}_2 = g_{ik}t_2; \quad \bar{x}_2 = g_{ik}x_2; \quad \text{The Einstein equation itself disappears:}$$

$$(c * \bar{t})^2 - (\bar{x})^2 = 0, \text{ or: } (c * \bar{t})^2 = (\bar{x})^2, \text{ and } (c * \overline{t \rightarrow 0})^2 = (\bar{x} = Y_2 \rightarrow 0)^2$$

This means that there is no such singularity in space-time. There are no "black holes" or singularities in Einstein's equation. All this is in strict mathematical truths. On the other side, the mathematical truth here is that the nonzero difference in relativistic dynamics  $\Delta x_{21}^2$ , in the Einstein equation, is due to the velocities of masses less than the speed of light in the spheres themselves at points 2 and 1, and **outside nonzero Euclidean spheres** with different geodesics ( $x_2^S \neq x_1^S$ ), in the gravity field. There is no speed of masses in the gravitational field equal to the speed of light, ( $1 - \frac{2G(M)}{Rc^2} = 0$ ),  $R(x^S) = \frac{2G(M)}{c^2}$ ,  $c^2 = \frac{2G(M \rightarrow 0)}{(R \rightarrow 0)}$ , ( $R \neq 0$ ), since Einstein's equation itself disappears, along with the singularities in the "black holes". They are not here. The question is closed. In the equations there are only masses of **nonzero** spheres ( $x_2^S \neq x_1^S$ ) as a source of curvature, equal to gravity, and the field of inductive masses (outside the «elevator»), "dark matter". But there are no equations that give "black holes" and singularities. There are no such equations in Einstein's General Theory of Relativity.

The observed "black holes" in space-matter are presented as objects of different energy levels of the physical vacuum. These are objects of stellar (up to  $30,8 * M_{Sun}$ ) masses, interstellar masses (from  $31 * M_{Sun}$  to  $622000 * M_{Sun}$  masses of the Sun), galactic masses (from  $6 * 10^5 M_{Sun}$  to  $10^{10} M_{Sun}$ ), intergalactic masses (from  $10^{10} M_{Sun}$  to  $[10^{13} M_{Sun}]$ ), quasar nuclei (from  $10^{13} M_{Sun}$  to  $10^{17} M_{Sun}$ ) and quasar galaxies to ( $10^{24} M_{Sun}$ ). They have multilevel envelopes of quantum subspaces, into which, for example, a photon cannot enter. This goes beyond Einstein's general theory of relativity, or more precisely, beyond the Euclidean axiomatic of space-time. But there are no infinities or singularities here. They are not in Nature.

Average value of a local basic vector Riemannian spaces ( $\Delta e_{mn}$ ), is defined as a principle of uncertainty of mass ( $Y-$ ) trajectories, but for all length of a wave  $KL = \lambda(X +)$  of a gravitational field. Here accelerations  $G(X +) = v_Y M(Y-)$  of mass trajectories. This uncertainty in the form of a piece ( $2 * OA = 2r$ ), as wave function  $2\psi_Y(Y-)r = \lambda(X +)$  of a mass  $M(Y-)$  trajectory of quantum ( $Y \pm$ ) in  $G(X +)$  the Interaction gravitational field. Here  $2\psi_Y$ , backs ( $\downarrow \uparrow$ ) of a quantum field  $\lambda(X +)$  of gravitation. The projection of a mass ( $Y-$ ) trajectory of quantum, to a circle plane ( $\pi r^2$ ) gives the area of probability ( $\psi_Y$ )<sup>2</sup> of hit of a mass  $M(Y-)$  trajectory of quantum ( $Y \pm$ ), in a quantum  $G(X +)$  gravitational field of mutual ( $Y- = X+$ ) action. In the general case, the points V and N ( $Y-$ ) mass trajectories (Fig. 6) or (V) and (N), ( $X-$ ) charge are identical to each other in the line trajectory of a single beam of parallel straight lines. Each pair of points has its own wave function  $\sqrt{(+\psi)(-\psi)} = i\psi$ , in the interpretation of quantum entanglement. In this view, quantum entanglement is a fact of reality, which follows from the axioms of dynamic space-matter. The entropy of the quantum entanglement of the set gives a potential gradient, but here the Einstein equivalence principle for inert  $v_Y M(Y-) = G(X +)$  and gravitational mass is lost.

These are initial elements quantum  $G(X +) = v_Y M(Y-)$  mass gravity fields. They follow from the equation of the General Theory of the Relativity. We will allocate here dimensions of uniform Criteria of

Evolution of space-matter in a kind. Speed  $v_Y \left[ \frac{K}{T} \right]$ ; potential  $(\Pi = v_Y^2) \left[ \frac{K^2}{T^2} \right]$ ; acceleration  $G(X+) \left[ \frac{K}{T^2} \right]$ ; mass:  $m = \Pi K (Y- = X+)$  fields, and charging:  $q = \Pi K (X- = Y+)$  fields, their density:  $\rho \left[ \frac{\Pi K}{K^3} \right] = \left[ \frac{1}{T^2} \right]$ ; force  $F = \Pi^2$ ; Energy  $\mathcal{E} = \Pi^2 K$ ; an impulse  $P = \Pi^2 T$ ; action  $\hbar = \Pi^2 K T$  and so on. Let us designate  $(\Delta e_{\pi\pi} = 2\psi e_k)$ ,  $T_{ik} = \left( \frac{\mathcal{E}}{P} \right)_i \Delta \left( \frac{\mathcal{E}}{P} \right)_{\pi\pi} = \left( \frac{\mathcal{E}}{P} \right)_i 2\psi \left( \frac{\mathcal{E}}{P} \right)_k = 2\psi T_{ik}$  in a kind tensor energy ( $\mathcal{E}$ ) - (P) - an impulse with wave function ( $\psi$ ). The equation from here follows:

$$R_{ik} - \frac{1}{2} R e_i \Delta e_{\pi\pi} = \kappa \left( \frac{\mathcal{E}}{P} \right)_i \Delta \left( \frac{\mathcal{E}}{P} \right)_{\pi\pi} \quad \text{or} \quad R_{ik}(X+) = 2\psi \left( \frac{1}{2} R e_i e_k(X+) + \kappa T_{ik}(Y-) \right) \quad \text{and}$$

$$R_{ik}(X+) = 2\psi \left( \frac{1}{2} R g_{ik}(X+) + \kappa T_{ik}(Y-) \right).$$

This equation of quantum Gravitational potential with dimension  $\left[ \frac{K^2}{T^2} \right]$  of potential  $(\Pi = v_Y^2)$  and spin( $2\psi$ ). In brackets of this equation, a member of equation of the General Theory of the Relativity in the form of a potential  $\Pi(X+)$  field of gravitation. In field theories (Smirnov, т.2, с.361), acceleration of mass  $(Y-)$  trajectories  $(X+)$  in the field of gravitation of uniform  $(Y-) = (X+)$  space-matter is presented divergence a vector field:

$$\text{div} R_{ik}(Y-) \left[ \frac{K}{T^2} \right] = G(X+) \left[ \frac{K}{T^2} \right], \quad \text{With acceleration } G(X+) \left[ \frac{K}{T^2} \right] \quad \text{and}$$

$$G(X+) \left[ \frac{K}{T^2} \right] = \text{grad}_l \Pi(X+) \left[ \frac{K}{T^2} \right] = \text{grad}_n \Pi(X+) * \cos \varphi_x \left[ \frac{K}{T^2} \right].$$

The parity  $G(X+) = \text{grad}_l \Pi(X+)$  is equivalent  $G_x = \frac{\partial G}{\partial x}$ ;  $G_y = \frac{\partial G}{\partial y}$ ;  $G_z = \frac{\partial G}{\partial z}$  to representation. Here full differential:  $G_x dx + G_y dy + G_z dz = d\Pi$ . It has integrating multiplier of family of surfaces  $\Pi(M) = C_{1,2,3\dots}$ , with a point of M, orthogonal to vector lines of a field of mass  $(Y-)$  trajectories  $(X+)$  in the field of gravitation.

Here  $e_i(Y-) \perp e_k(X-)$ . The quasipotential field from here follows:

$$t_T (G_x dx + G_y dy + G_z dz) = d\Pi \left[ \frac{K^2}{T^2} \right], \quad \text{and} \quad G(X+) = \frac{1}{t_T} \text{grad}_l \Pi(X+) \left[ \frac{K}{T^2} \right].$$

Here  $t_T = n$  for a quasipotential field. Time  $t = nT$ ,  $n$ - is quantity of the periods  $T$  of quantum dynamics.  $n = t_T \neq 0$ . From here follow by quasipotential surfaces of quantum gravitational fields with the period  $T$  and acceleration:  $G(X+) = \frac{\psi}{t_T} \text{grad}_l \Pi(X+) \left[ \frac{K}{T^2} \right]$ .

$$G(X+) \left[ \frac{K}{T^2} \right] = \frac{\psi}{t_T} \left( \text{grad}_n (R g_{ik}) (\cos^2 \varphi_{x_{MAX}} = G) \left[ \frac{K}{T^2} \right] + (\text{grad}_l (T_{ik})) \right).$$

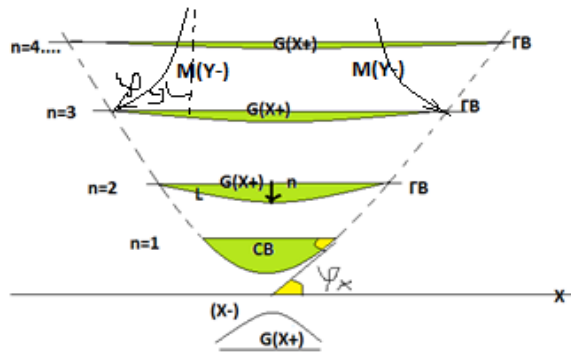

Fig. 7. Quantum gravitational fields.

This chosen direction of a normal fixed in section  $n \perp l$ . In dynamical space-matter, it is a question of dynamics  $\text{rot}_x G(X+) \left[ \frac{K}{T^2} \right]$  of fields on the closed  $\text{rot}_x M(Y-)$  trajectories. Here  $l$  - a line along quasipotential surfaces Riemannian spaces, with normal  $n \perp l$ . The limiting corner of parallelism of mass  $(Y-)$  trajectories  $(X+)$  in the field of gravitation, gives a gravitational

$(\cos^2 \varphi_{(X-)_MAX} = G = 6.67 * 10^{-8})$  constant. Here  $t_T = \frac{t}{T} = n$ , an order of quasi potential surfaces, and

$$(\cos \varphi_{(Y-)_MAX} = \alpha = \frac{1}{137.036}). \quad G(X+) \left[ \frac{K}{T^2} \right] = \frac{\psi * T}{t} (G * \text{grad}_n R g_{ik}(X+) + \alpha * \text{grad}_n T_{ik}(Y-)) \left[ \frac{K}{T^2} \right].$$

This general equation quantum gravity  $(X+ = Y-)$  a mass field already **accelerations**  $\left[ \frac{K}{T^2} \right]$ , and wave  $\psi$ - function, and also  $T$  - the period of dynamics of quantum  $\lambda(X+)$ , with a back  $(\downarrow \uparrow)$ ,  $(2\psi)$ .

Fields of accelerations, as it is known, it already force fields. In addition, this equation differs from the equation of gravitational **potentials** of the General Theory of the Relativity. Let us briefly note the concepts in such approaches.

Next, Einstein tried to carry out a parallel transfer of a vector in a Riemannian space along a geodesic curve  $(x^s)$  from point 1 to point 2, obtaining a quantum of the gravitational field.

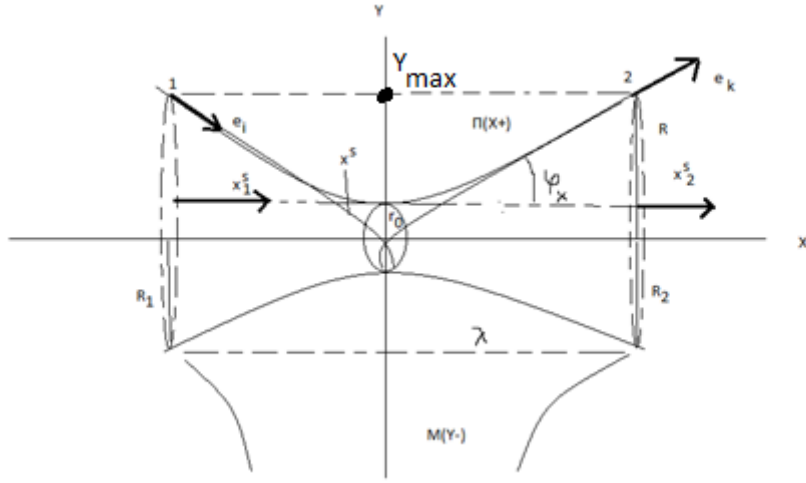

Fig. 7.1 - interpretation of models.

In the mathematical procedures of the Euclidean axiomatic, this is possible only when the vector ( $x_1^s$ ) of point 1 is transferred to exactly the same vector ( $x_2^s$ ), but already point 2, as projections onto the Euclidean space, local basis vectors of the Riemannian space  $e_i(x^s)$  and  $e_k(x^s)$ , ( $x_1^s = x_2^s = \cos\varphi_{X_{max}} = \sqrt{G}$ ), or ( $x_1^s * x_2^s = \sqrt{G}e_i\sqrt{G}e_k = Gg_{ik}(x^s)$ ). At each fixed point of the geodesic curve ( $x^s$ ) in the Euclidean axiomatic of space - matter, the curvature is:  $K = \frac{Y^2}{r_0}$  (V.I. Smirnov, 1974, v.1, p.187), and the ratios:

$$\frac{Y}{r_0} = ch\left(\frac{X}{r_0}\right) = \frac{1}{2}(e^{x/r_0} + e^{-x/r_0}), \text{ and } (X = \frac{\lambda}{2}), \text{ the gravitational potential is equal to:}$$

$$\Pi(X+) = Gg_{ik}\left(1 - \left[\frac{Y}{r_0} = ch\left(\frac{\lambda/2}{r_0}\right)\right]\right) = kT_{ik}. \text{ For: } h = 2\pi(\hbar = \Delta p_Y \Delta x_Y^s), \Delta\lambda = \frac{2\pi\hbar}{\Delta p_Y} \text{ and } ch\left(\frac{\pi\hbar}{\Delta p_Y r_0}\right).$$

Here ( $p_Y$ ) is the momentum of the quantum of the gravitational field. This is how Einstein's idea is realized. By transforming the gravitational potential  $\Pi(X+)$ , you can get options:

a)  $\Pi(X+) = g * x^s = x^s G(X+)$ , relation of relativistic dynamics ( $\frac{Y}{r_0} = R$ ) as rotations of Lorentz transformations in the circle planes ( $R$ ) and  $r_{(0)}$ , and also for  $(\cos\varphi(Y-)_{MAX} = \alpha)$ , and  $Y = \alpha * (Y-)$ , we obtain already quantum gravitational fields of accelerations in the form:

$$Gg_{ik} = G * R * g_{ik} + \alpha T_{ik} \text{ or } G(X+) = G * R * grad_n g_{ik}(X+) + \alpha * grad_n T_{ik}(Y-).$$

b) in Euclidean axiomatic:  $\cos\varphi(Y-)_{min} = 1$ ,  $\cos\varphi(X-)_{min} = 1$ , and:  $Gg_{ik} = R_{ik}$ , we obtain the classical equation of Einstein's general theory of relativity in the form:  $R_{ik} - \frac{1}{2}R * g_{ik} = k * T_{ik}$ .

c) From the standard equation of Einstein's General Theory of Relativity:  $R_{ik} - \frac{1}{2}Rg_{ik} = \frac{8\pi G}{c^4} T_{ik}$ , without dynamics of physical vacuum, in uniform Criteria of Evolution of space-time, the classical Newton's law follows:  $F = \frac{GMm}{R^2}$ . From the difference in gravitational potentials at points (1) and (2) in the form:  $R_{ik} = e_i e_k(1) = U_1$ ;  $\frac{1}{2}Rg_{ik} = e_i e_k(2) = U_2$ , and  $U_1 - U_2 = \Delta U$ . For example, for the Sun and Earth

( $M = 2 * 10^{33}g$ ) and ( $m = 5.97 * 10^{27}g$ ), we get:  $U_1 = \frac{(G=6.67*10^{-8})(M=2*10^{33})}{R=1.496*10^{13}} = 8.917 * 10^{12}$ , gravitational potential at a distance from the Earth and  $U_2 = \frac{(G=6.67*10^{-8})(m=5.97*10^{27})}{R=6.374*10^8} = 6.25 * 10^{11}$ , the potential of the Earth itself. Then: ( $\Delta U = U_1 - U_2 = 8.917 * 10^{12} - 6.25 * 10^{11} = 8.67 * 10^{12}$ ), or ( $\Delta U = 8.29 * 10^{12}$ ), we get:

$$\Delta U = \frac{8\pi G}{(c^4=U^2=F)} (T_{ik} = \frac{(U^2 K)^2}{U^2 T^2} = \frac{U^2(UK=m)^2}{U^2 T^2} = \frac{Mm}{T^2}), \text{ or } \frac{\Delta U}{\sqrt{2}} = \frac{8\pi G Mm}{F T^2}, F = \frac{8\pi G Mm}{(\Delta U/\sqrt{2}) T^2} = \frac{GMm}{(\Delta U * T^2/\sqrt{2})/8\pi},$$

without dark masses. It remains to calculate:  $\frac{\Delta U * T^2}{8\pi\sqrt{2}} = \frac{8.29*10^{12} * (365.25*24*3600=31557600)^2}{8\pi\sqrt{2}} = 2.3 * 10^{26}$ , which

corresponds to the square of the distance ( $R^2 = 2.24 * 10^{26}$ ) from the Earth to the Sun, or  $F = \frac{GMm}{R^2}$ , Newton's law.

d) as well as the conceptual model of loop quantum gravity, already with some reservations. If in the equation of the gravitational potential:  $Gg_{ik}\left(Y_{max} - \left[\frac{Y}{r_0} = ch\left(\frac{\lambda/2}{r_0}\right)\right]\right) = kT_{ik}$ , and the Einsteinium idea of parallel transfer, we represent the transformations of local basis vectors in the spinor field ( $S$ ) of the  $SU(2)$  group as homomorphic group  $SO(3)$ , as well as with the generators of the Lorentz group in the  $SO(1,3)$  space-time of the dynamic sphere, then we obtain: ( $R = x_Y^s$ )  $\rightarrow r_0 \rightarrow (R = x_Y^s)$  transformations. We are talking about the non-stationary Euclidean space of a dynamical hyperboloid in quantum relativistic dynamics (Quantum Theory of Relativity). Or  $g_{ik}(Y_{max} - (Y = r_0 ch(\frac{\lambda/2 > x}{r_0})))$ , and  $Gg_{ik} * S = kT_{ik}$  of the

invariant ( $S^T \epsilon S$ ) with the Minkowski spinor metric:  $\epsilon = \begin{pmatrix} 0 & 1 \\ -1 & 0 \end{pmatrix}$ . For ( $Y = (r_0 = Y_0)$ ) and ( $ch \left( \frac{x=0}{r_0} \right) = 1$ ), these are strict mathematical truths. In fact, this is an additional Bell parameter of probabilistic interaction  $g_{ik}(Y_{max} - (Y = r_0 ch \left( \frac{\lambda/2 > x}{r_0} \right)))$  potentials ( $X_{\pm}$ ) and ( $Y_{\pm}$ ) quanta in experiments, with precise determination of coordinates ( $x$ ). Here, the interaction cross section  $\pi Y_{max}^2 (1 - \psi^2)$  has ( $\psi^2$ ) the probability of wave function interaction. We are talking about the potentials  $\Pi(Y_+)$  of electric or  $\Pi(X_+)$  mass fields. In the interaction of homogeneous potentials ( $\Pi^* \Pi = \Pi^2 = F = dp/dt$ ) an interaction force appears. The Einstein-Podolsky-Rosen paradox consists in measuring the parameters of an entangled particle indirectly, without changing its properties. Particles will be ideally entangled if they are born in the same quantum field with admissible symmetry. To change the properties of an entangled particle, it is necessary to change the "superluminal background" of the physical vacuum, which is allowed by Einstein's formulas. Then, studying (or changing) the influence of the Background Criteria on one particle, we know exactly the dynamics of the second particle, for example, in the interstellar space of a galaxy. There is also an acceptable option when the background for an electron will be a virtual photon, and for a proton a virtual antineutrino. Then, if two electrons (in identical orbits of atoms) are irradiated with entangled photons, we get the same effect. Such radiation can be programmed and change the structure of atoms (molecules) on the planet, but only at the speed of light. Thus, we will obtain a quantum gravitational potential with energy-momentum at each point of the Riemannian space. In technologies of quantum operators for extremals and wave function in quantum dynamics, we obtain a quantum gravitational field within the framework of general relativity. In such a concept there is no principle of equivalence and relativistic dynamics of the physical vacuum with the parameter ( $\lambda$ ) in the Einstein equation. Spinor with scaling generators: ( $R$ )  $\rightarrow$   $r_0 \rightarrow$  ( $R$ ), for

$$Y = r_0 \left( ch \frac{x}{r_0} = \frac{1}{2} (e^{\frac{x}{r_0}} + e^{-\frac{x}{r_0}}) \right), \text{ with scaling parameter } (m), \text{ in the form: } e^{m \begin{pmatrix} 0 & 1 \\ -1 & 0 \end{pmatrix}} = \begin{pmatrix} 0 & e^m \\ -e^m & 0 \end{pmatrix}, \text{ can give}$$

a divergent and convergent spiral in the dynamics ( $x^s$ ) of a geodesic. All this corresponds adequately to the mathematical apparatus (answering the questions HOW) of loop quantum gravity of point gravitational potentials, with an explicit indication of gravitons, but with the indicated shortcomings and the absence of a source of the gravitational field. That is, without answers to the questions WHY.

**For  $n = 1$ ,** (fig. 2) the gravitational field  $G(X_+) \left[ \frac{K}{T^2} \right] = \frac{\psi^* T}{\Delta t} G * grad_n (R g_{ik})(X_+) \left[ \frac{K}{T^2} \right]$  of a source of gravitation is  $G(X_+)$  field SI ( $X_+$ )- Strong Interaction. Quantum dynamics in time  $\Delta t$  within dynamics period  $T$  is represented parity:

$$G(X_+) = \psi * T * G \frac{\partial}{\partial t} grad_n R g_{ik}(X_+)$$

Where  $T = \frac{\hbar}{\epsilon = U^2 \lambda}$ , the period quantum dynamics. The formula for accelerations  $\left[ \frac{K}{T^2} \right]$  SI( $X_+$ ) of a field of Strong Interaction takes a form:

$$G(X_+) \left[ \frac{K}{T^2} \right] = \psi \frac{\hbar}{\Pi^2 \lambda} G \frac{\partial}{\partial t} grad_n R g_{ik}(X_+) \left[ \frac{K}{T^2} \right], \quad grad_n = \frac{\partial}{\partial Y}.$$

Here  $G = 6.67 * 10^{-8}$ ,  $\hbar = \Pi^2 \lambda T$  a stream of quantum energy  $\epsilon = \Pi^2 \lambda = \Delta m c^2$  of a field of inductive weight ( $\Delta m$ ) of exchange quantum ( $Y- = \frac{p}{n}$ ) of Strong Interaction, and also ( $Y- = 2n$ ) nucleons ( $p \approx n$ ) of a atomic nuclei. The inductive weight  $\Delta m(Y- = X_+)$  is represented indissoluble quark models  $\Delta m(Y- = \gamma_0) = u$ , and  $\Delta m(X_+ = \nu_e) = d$  quarks, in ( $X_{\pm} = p^+$ ) = ( $Y- = \gamma_0^+$ )( $X_+ = \nu_e^-$ )( $Y- = \gamma_0^+$ ) the proton model: colored gluon interaction fields ( $X_{\pm} = p^+$ ) = ( $Y_+ = \gamma_0^+$ )( $X_- = \nu_e^-$ )( $Y_+ = \gamma_0^+$ ) quarks In their confinement ( $Y_+)(Y_+) = (X_-)$ , a single space-matter, ( $X_{\pm} = p^+$ ) = ( $u = \gamma_0^+$ )( $d = \nu_e^-$ )( $u = \gamma_0^+$ ), a proton in a given case.

Similarly, the quarks structure ( $Y_{\pm} = n$ ) = ( $X = d$ )( $Y = u$ )( $X = d$ ) = ( $X- = p^+$ )( $Y_+ = e^-$ )( $X- = \nu_e^-$ ), neutron with colored gluon fields ( $X_+)(X_+) = (Y_-)$ , ( $Y_+)(Y_+) = (X_-)$  interactions. This one ( $Y- = X_+$ ) indissoluble space-matter. Decisions of the equations of quantum fields of Strong Interaction, their presence indissoluble quarks models ( $Y- = u$ )( $X_+ = d$ ) of uniform ( $Y- = X_+$ ) space-matter assumes. These are exchange quantum, inductive mass ( $Y- = X_+$ ) field's mesons. Various structures of products of disintegration of elementary particles give various generations ( $Y- = u$ )( $X_+ = d$ ) of quarks, as models. In more complex structures of elementary particles, other quark models appear ( $Y- = c$ ) or ( $Y- = t$ ) as well as ( $X_+ = s$ ) and ( $X_+ = b$ ), in the well-known laws of symmetry.

Each mathematical model that answers the HOW question has its own reasons for internal connections. Lagrangian mechanics can only be applied to systems whose constraints, if any, are all holonomic. In quantum mechanics, where waves are particles with nonholonomic constraints, in the fields of a single space-matter, Lagrange's formalism is impossible, neither in fact, nor by definition. Through

transformations it is always possible to arrive at a different model of a physical fact, but with different reasons and in different connections. Both models are mathematical, but the question is, where is the truth? For example, (+) charge of a proton in quarks and (+) charge of a positron without quarks. This is a fundamental contradiction. Both models work, but the physical reasons are lost. There is no answer to the question WHY so? Quark-gluon fields of the proton, during its annihilation (p+)+(p-), must pass into the quantum fields of photons. But there is no such procedure. The Feynman diagrams work, but the proton does not emit a photon, charged interacting with the electron of the atom. After all, these are the fundamental foundations of all atomic structures, the structure of matter. WHY so - there is no answer. Here we will answer the question WHY a particle has exactly such decay or annihilation products of indivisible quanta. We will proceed from the general representations

$\psi(X) = e^{a(X)}\bar{\psi}(X)$  of the Dirac equation when  $Y = e^{a(X)}(X+)$  the dynamic quantum field

$$(X \pm) = ch\left(\frac{X}{\gamma_0}\right)(X+)cos\varphi(X-) = 1, s\varphi(X-) = \sqrt{G}, \text{ or } (Y \pm) = ch\left(\frac{Y}{X_0}\right)(Y+)cos\varphi(Y-) = 1,$$

$cos\varphi(Y-) = \frac{1}{137.036} = \alpha$ , Where ( $cos\varphi \neq 0$ ) in both cases. In mass fields  $m(Y- = X+)$ , we will take the measured mass and the calculated time ( $T$ ) of particle decay. From the most general representations:

$$m = \frac{\Pi^2}{Y''} = \frac{\Pi^2 T^2}{Y = \exp(z)} = T\Pi\left(\frac{K}{T}\right)\left(\frac{K}{T}\right)\mathcal{F}\exp(-z), \text{ with a unit charge } (X- = Y+) = 1, \text{ and the speed of light } c = 1, \text{ in}$$

the quantum itself, space-matter  $m = T\frac{(\Pi K = q = 1)}{G\alpha}\left(\frac{K}{T} = c = 1\right)\exp(-z)$ ,  $z = \frac{(m_X = \Pi X)}{\Pi = c^2 = 1} = X(MeV)$ , and

$$z = \frac{(m_Y = \Pi Y)}{\Pi = c^2 = 1} = Y(MeV) \text{ in the dynamic, hyperbolic } e^{a(X)} \text{ space of the Dirac equation.}$$

$$\text{For } G = 6,67 * 10^{-8}, \alpha = \frac{1}{137.036}, \nu_\mu = 0,27 MeV, \gamma_0 = 3,13 * 10^{-5} MeV, \nu_e = 1,36 * 10^{-5} MeV, \gamma = 9,1 * 10^{-9} MeV$$

### Mass spectrum in accordance with decay products (annihilation).

**Stable particles** with annihilation products in a single ( $Y\bar{Y} = X\pm$ ) space-matter:

$$(X\pm = p) = (Y- = \gamma_0)(X+ = \nu_e)(Y- = \gamma_0) = \left(\frac{2\gamma_0}{G} - \frac{\nu_e}{\alpha^2}\right) = 938,275 MeV ;$$

$$(Y\pm = e) = (X- = \nu_e)(Y+ = \gamma)(X- = \nu_e) = \left(\frac{2\nu_e}{\alpha^2} - \frac{\gamma\alpha}{2G}\right) = 0,511 MeV ;$$

**Unstable particles** are already in accordance with the products and decay time.  $G\alpha = 4.8673 * 10^{-10}$ ,

$$(Y\pm = \mu) = (X- = \nu_\mu)(Y+ = e)(X- = \nu_e) = \frac{(T=2.176*10^{-6})}{G\alpha}\exp\left(\nu_\mu + e + \frac{\nu_e ch1}{\alpha^2} = 1,1751\right) = 105,66 MeV,$$

Let us denote here and below in the calculations by the underlined font, ( $\underline{\mu} = 1,1751$ ) the exponent  $\exp()$ . It shows the features of the fragmentation of the dynamic field  $\exp(\dots)$  ( $a(X)$ ), in the Dirac equation.

$$(Y\pm = \pi^\pm) = (Y+ = \mu)(X- = \nu_\mu) = \frac{(T=2.76586*10^{-8})}{2G\alpha}\exp(\underline{\mu} + \nu_\mu ch1) = 139,57 MeV, \quad (\underline{\pi^\pm} = 1,59173)$$

$$(X- = \pi^0) = (Y+ = \gamma_0)(Y+ = \gamma_0) = \frac{(T=7.8233*10^{-17})}{G^2\alpha}\exp\left(\frac{2\gamma_0^2}{G\alpha}\right) = 134,98 MeV, \quad (\underline{\pi^0} = 4,025599)$$

$$(X- = \eta^0) = (X+ = \pi^0)(Y-)(X+ = \pi^0)(Y-)(X+ = \pi^0) = \frac{(T=5.172*10^{-19})}{(G\alpha)^2}\exp\left(\frac{3\pi^0}{2} - \frac{\gamma ch2}{G}\right) = 547,853 MeV,$$

$$(X- = \eta^0) = (Y- = \pi^+)(X+ = \pi^0)(Y- = \pi^+) = \frac{(T=5.1*10^{-19})}{\sqrt{2}(G\alpha)^2}\exp\left(2\underline{\pi^\pm} + \frac{\pi^0}{2}\right) = 547,853 MeV,$$

$$(Y\pm = K^+) = (Y+ = \mu)(X- = \nu_\mu) = \frac{(T=1.335*10^{-8})}{G\alpha}\exp 2(\underline{\mu} + \nu_\mu) = 493,67 MeV,$$

$$(Y\pm = K^+) = (Y+ = \pi^+)(X- = \pi^0) = \frac{(T=1.01398*10^{-8})}{G\alpha}\exp\left(\underline{\pi^+} + \frac{\pi^0}{2}\right) = 493,67 MeV. \quad \underline{K^-} = 3,16535$$

$$(Y- = K_S^0) = (X+ = \pi^0)(X+ = \pi^0) = \frac{(T=0,885*10^{-10})}{G\alpha}\exp\left(2\underline{\pi^0} - \frac{\gamma}{G}\right) = 497,67 MeV,$$

$$(X- = K_L^0) = (Y- = \pi^\pm)(X+ = \nu_e)(Y- = e^\mp) = \frac{(T=4,9296*10^{-8})}{G\alpha}\exp\left(\underline{\pi^\pm} + e^\mp + \frac{2\nu_e}{\alpha^2}\right) = 497,67 MeV,$$

$$(X- = K_L^0) = (Y- = \pi^\pm)(X+ = \nu_\mu)(Y- = \mu^\mp) = \frac{(T=5,1713*10^{-8})}{G\alpha}\exp\left(\underline{\pi^\pm} - \frac{\mu^\mp}{2} + 2\nu_\mu\right) = 497,67 MeV,$$

$$(X- = \rho^0) = (Y+ = \pi^+)(Y+ = \pi^+) = \frac{(T=5,02*10^{-24})}{G\alpha}\exp\left(\frac{2\underline{\pi^\pm}}{\sqrt{\alpha}}\left(1 + \frac{1}{2\sqrt{\alpha}}\right)\right) = 775,49 MeV ;$$

$$(X\pm = \rho^+) = (X+ = \pi^0)(Y- = \pi^+) = \frac{(T=6,47566*10^{-24})}{G\alpha}\exp\left(\frac{\pi^0}{\sqrt{\alpha}} - \frac{\pi^+(\sqrt{\alpha}-1)}{2}\right) = 775,4 MeV ;$$

Similarly hadrons

$$(Y\pm = n) = (X- = \nu_e)(Y+ = e)(X- = p) = (T = 878,77)\exp\left(\frac{\nu_e}{\sqrt{G}} + \frac{e}{2} - p\sqrt{G}\right) = 938,57 MeV,$$

$$(X\pm = \Lambda^0) = (X+ = p^+)(Y- = \pi^-) = \frac{(T=2.604*10^{-10})}{G\alpha}\exp\left(ap^+ + \frac{\pi^-}{2}\right) = 1115,68 MeV, \quad \underline{\Lambda^0} = 7,642837$$

$$(Y\pm = \Lambda^0) = (Y+ = n)(X- = \pi^0) = \frac{(T=1.5625*10^{-10})}{G\alpha}\exp\left(an + \frac{\pi^0}{2ch1}\right) = 1115,68 MeV, \quad \underline{\Lambda^0} = 8,153$$

$$(Y- = \Sigma^+) = (X+ = p^+)(X+ = \pi^0) = \frac{(T=8.22*10^{-11})}{G\alpha}\exp\left(ap^+ + \frac{\pi^0}{2}\right) = 1189,37 MeV,$$

$$(X- = \Sigma^+) = (Y+ = n)(Y+ = \pi^+) = \frac{(T=8.1*10^{-11})}{G\alpha ch1}\exp(an + \pi^+) = 1189,37 MeV,$$

$$(X- = \Sigma^-) = (Y+ = n)(Y+ = \pi^-) = \frac{(T=1.25*10^{-10})}{G\alpha}\exp(an + \pi^-) = 1189,37 MeV,$$

$$\begin{aligned}
(X- = \Sigma^0) &= (Y+ = \Lambda^0)(Y+ = \gamma) = \frac{(T=7.4*10^{-20})}{G^2 \alpha * ch1} \exp\left(\frac{\Lambda^0 + \gamma/G}{2}\right) = 1192,64 \text{ MeV}, \quad \underline{\Lambda^0} = 7,642837, \\
(Y\pm = \Xi^0) &= (Y+ = \Lambda^0)(X- = \pi^0) = \frac{(T=2.5984*10^{-10})}{G\alpha} \exp(\Lambda^0 - \pi^0 \sqrt{\alpha}) = 1314,86 \text{ MeV}, \quad \underline{\Lambda^0} = 8,153, \quad \underline{\Xi^0} = 7,809, \\
(X\pm = \Xi^-) &= (X+ = \Lambda^0)(Y- = \pi^-) = \frac{(T=1.3917*10^{-10})}{G\alpha} \exp(\underline{\Lambda^0} + \underline{\pi^-}/2) = 1321,71 \text{ MeV}, \quad \underline{\Lambda^0} = 7,642837, \quad \underline{\Xi^-} = 8,43869, \\
(X- = \Omega^-) &= (Y+ = \Lambda^0)(Y+ = K^-) = \frac{(T=8.018*10^{-11})}{G\alpha} \exp(\underline{\Lambda^0} - \underline{K^-}/2) = 1672,45 \text{ MeV}, \quad \underline{\Lambda^0} = 7,642837, \quad \underline{K^-} = 3,16535 \\
(X- = \Omega^-) &= (Y+ = \Xi^0)(Y+ = \pi^-) = \frac{(T=6.734*10^{-11})}{G\alpha} \exp(\underline{\Xi^0} + \underline{\pi^-}) = 1672,45 \text{ MeV}, \quad \underline{\Xi^0} = 7,809, \\
(Y- = \Omega^-) &= (X+ = \Xi^-)(X+ = \pi^0) = \frac{(T=7.1147*10^{-11})}{G\alpha} \exp(\underline{\Xi^-} + \underline{\pi^0}/ch2) = 1672,45 \text{ MeV}, \quad \underline{\Xi^-} = 8,275,
\end{aligned}$$

There are other methods for calculating the mass spectrum, but this logical construction gives the calculation of the mass spectrum with minimal parameters. The initial parameters here are only decay products. This model is still imperfect, but without the shortcomings and contradictions of the Standard Model.

In other methods of calculating the mass spectrum, we are talking about a different technology of theories themselves, in which Bohr's postulates, the uncertainty principle, the principle of mass equivalence, are presented as axioms of dynamic space-matter. There are other initial concepts and on their basis, other causes and effects in the models. The same mass spectrum is calculated in quantum models. For example, in the quantum relativistic dynamics of the "gauge field", a dynamic mass is formed in the form:  $\bar{W} = \frac{a_{11}W_Y \pm c}{a_{22} \pm W_Y/c}$ ,

at the extreme point,  $(\pm K_Y)^2 = 0 = \frac{\Pi^2}{b^2} - \Pi * \bar{T}^2$ ,  $\Pi_1 = 0$ ,  $\Pi_2 = b^2 * \bar{T}^2$ , with the proper space of

velocities in the Spontaneous Breaking of Symmetry,  $W_Y^2 = \frac{\Pi}{2} = \frac{b^2 * \bar{T}^2}{2}$ , or

$$\bar{W} = \frac{\bar{T}}{\sqrt{2}} \left( \pm b = \frac{\Pi^2 = F_Y}{\bar{m}} \right), \quad \bar{m} * W_Y = \frac{1}{\sqrt{2}} (\pm F_Y \bar{T} = \pm p_Y), \quad \bar{m} * W_Y = \frac{\pm p_Y}{\sqrt{2}}, \quad \bar{m} = \frac{p_Y}{W_Y \sqrt{2}}.$$

For mass  $(Y- = X+)$  fields, under the conditions of Global (GI) and Local Invariance (LI), we obtain:

$$\begin{aligned}
\bar{K}_Y &= (a_{11} = \cos\gamma)_{GI} K \left( ch \frac{X}{Y_0} \cos\varphi_X \right)_{LI} (X+) + K_X (X-), \text{ или} \\
(\Pi \bar{K}_Y = \bar{m}) &= (a_{11} = \cos\gamma)_{GI} \left( \frac{\bar{m} = m_0}{\sqrt{2}} \right) \left( \left( ch \frac{X}{Y_0} = 1 \right) / ch \frac{Y}{X_0} \cos\varphi_X \right)_{LI} (X+ = Y-) + (\Pi K_X = m_0) (X-).
\end{aligned}$$

Symmetries of such mass  $(X+ = Y-)$  trajectories at levels of n- convergence under the conditions  $ch \frac{Y}{X_0} \cos\varphi_X = 1$ , quantum relativistic corrections  $(1 - (\alpha = W/c = 1/137)^2) = (1 + \alpha)(X+)(1 - \alpha)(X-)$  by levels, forming a new and new stage of n- convergence, and in the most general form - dynamic mass:

$$\bar{m} = \left( \left[ \left\{ \frac{m_0}{\sqrt{2}ch2} = \bar{m}_1 \right\} (1 + \alpha) = \bar{m}_2 \right] (1 + \alpha) = \bar{m}_3 \right) (X+) + m_0 (X-).$$

in the quantum field of the Dirac equation, already without the scalar boson. For example,

for:  $m_0 = m_p = 938,279 \text{ MeV}$ ,

$$\bar{m} = \left\{ \frac{m_p}{\sqrt{2}ch2} = \bar{m}_1 \right\} \left( \alpha = \frac{1}{137.036} \right) (X+) + m_p (X-) = 939.57 \text{ MeV} = m_n,$$

$$\bar{m} = \left\{ \frac{m_p}{\sqrt{2}ch2} = (\pi^0) \right\} (X+) + m_n (X-) = (\Lambda^0 = 1115.9 \text{ MeV}), \quad \pi^0 = 176,35 \text{ MeV},$$

$$\bar{m} = \left[ \left\{ \frac{m_p}{\sqrt{2}ch2} = \bar{m}_1 \right\} (1 + \alpha) = \bar{\pi}^0 (1 + \alpha) = \bar{m}_2 = \bar{\pi}^- \right] (X+) + m_p (X-) = (\Lambda^0 = 1115.9 \text{ MeV}), \quad \pi^- = 177,637 \text{ MeV}$$

With relativistic masses of  $\pi$ -mesons, with velocities  $(W = 0,64 * c)$  in quantum relativistic dynamics.

Similarly further:

$$\Sigma^+ (p^+, \pi^0) = \sqrt{2} * \bar{\pi}^0 (1 + \alpha) (X+) + m_p (X-) = 1189,5 (1189,64) \text{ MeV},$$

$$\Sigma^- (n, \pi^-) = \sqrt{2} * \bar{\pi}^- (1 + \alpha ch2) (X+) + m_n (X-) = 1197,68 (1197,3) \text{ MeV},$$

$$\Sigma^0 (\Lambda^0, \gamma) = \sqrt{2} * \bar{\pi}^0 (1 + \alpha)^2 (X+) + m_n (X-) = 1192,6 \text{ MeV}, \quad \Lambda^0 = \Lambda^0 (n, \pi^0),$$

$$\Xi^0 (\pi^0, \Lambda^0 (n, \pi^0)) = [2\bar{\pi}^0 (1 + \alpha)^2 (1 + 2\alpha ch2)] (X+) + m_p (X-) = 1315,8 \text{ MeV} **$$

$$\Xi^- (\pi^-, \Lambda^0 (p, \pi^-)) = [2\bar{\pi}^- (1 + 2\sqrt{2}\alpha ch2)] (X+) + m_p (X-) = 1321,14 \text{ MeV},$$

$$\Omega^- (\Xi^0, \pi^-) (\Xi^-, \pi^0) = \left[ \frac{ch2}{\sqrt{2}} (\bar{\pi}^0 (1 + \alpha)^2) ch1 \right] (X+) + m_p (X-) = 1672,8 \text{ MeV},$$

$$\Lambda_C^+ = \left[ 2 \left( \frac{m_p}{\sqrt{2}} = \bar{\pi}^0 ch2 \right) (1 + \alpha)^2 (X+) + m_p (X-) \right] = [2ch2 (\bar{\pi}^0 (1 + \alpha) = \bar{\pi}^-) (1 + \alpha) (X+) + m_p (X-)] = 2284,6 \text{ MeV}$$

We denote the constant  $(1 + (ch2)^2 (\alpha)^2) = S = 1,10328758$ , the relativistic mass  $(m_0 = 2797,53375 \text{ MeV})$  and

rewrite the formula as:  $\bar{m} = \left( \left( (m_0 S = \bar{m}_1) S = \bar{m}_2 \right) S = \bar{m}_3 \right) S = \bar{m}_4 \right) + \frac{1}{2} m_0 \alpha$ , then

for charmonium levels:

$$\bar{m} = (\bar{m}_1 = 3086,48 \text{ MeV}) + \left( \frac{1}{2} m_0 \alpha = 10,2 \text{ MeV} \right) = 3096,68 \text{ MeV} = j/\psi, \quad (3096,7 \text{ MeV}) \text{ valid},$$

$$\bar{m} = (\bar{m}_2 = 3405,275 \text{ MeV}) + \left( \frac{1}{2} m_0 \alpha = 10,2 \text{ MeV} \right) = 3415,475 \text{ MeV} = \chi_0, \quad (3415 \text{ MeV}),$$

$$\bar{m} = \chi_0 (1 + \alpha * ch2) = 3509,27 \text{ MeV} = \chi_1, \quad (3510 \text{ MeV}),$$



$$\bar{m} = \left( \frac{m_1}{(1+\alpha \cdot ch2)^2} = 2923,74 MeV \right) + (2m_0 \alpha = 40829 MeV) = 2964,6 MeV = \eta_c, \quad (2980 MeV),$$

Similarly, the mass fields ( $Y- = m_e$ ) of the electron,  $\bar{m} = \frac{m_e}{(\cos\varphi = \sqrt{G/2})} = m_0 = 2798.16 MeV$  give:

$$\bar{m} = \frac{2m_0}{(ch2)^3} \left( 1 + \frac{\alpha}{\sqrt{2}} \right) = 105,6 MeV, \text{ muon, and further mesons:}$$

$$\bar{m} = \frac{m_0}{\sqrt{2}(ch2)^2} = 139,78 MeV = \pi^\pm, \quad \bar{m} = \frac{m_0}{\sqrt{2}(ch2)^2} (1 - \sqrt{2} * \alpha * ch2) = 134,3 MeV = \pi^0,$$

$$\bar{m} = \left( \frac{m_0}{4\sqrt{2}} = m_1 \right) * \left( 1 + \frac{\alpha}{\sqrt{2}} \right) = 497,2 MeV = K^0, \quad \bar{m} = (m_1) / \left( 1 + \frac{\alpha}{2\sqrt{2}} \right) = 493,4 MeV = K^\pm,$$

Such a calculation technology, in the conditions ( $X\pm = Y\mp$ ) and ( $\varphi \neq const$ ) dynamic space, in the Euclidean axiomatics ( $\varphi = const$ ) and without ( $X\pm = Y\mp$ ) fields, is impossible in principle. We are talking about a different technology of the theories themselves. Just as it is impossible to represent the quantum relativistic dynamics of the Quantum Theory of Relativity in Euclidean axiomatics ( $\varphi = 0 = const$ ). This is impossible in principle.

The combined equations assume the presence of closed  $rot_x H(X-)$  (vortex) in the shells of magnetic fields ( $X- = p^+$ ) protons in quanta ( $Y- = p/n$ ) and vortex  $rot_y N(Y-)$  mass ( $Y-$ ) trajectories of exchange quanta of mesons, their quark models. These are the fields of strong interaction of nucleons in their electro ( $Y+ = X-$ ) magnetic (charge) and gravitational ( $X+ = Y-$ ) mass interaction. Different structures of decay products of elementary particles give different generations of quarks ( $Y- = u$ )( $X+ = d$ ) as models. Here to quantum ( $Y- = p/n$ ), ( $Y- = 2n$ ) Strong Interaction of nucleons ( $p \approx n$ ) of a core. Since the field density ( $\frac{\partial B(X-)}{\partial T}$ ) of the neutrino trajectory  $\rho(X- = \nu_e)$  is much greater than the field density of the proton trajectory  $\rho(X- = p)$ , then in the quanta of the Strong interaction of nucleons ( $p \approx n$ ) of the nucleus with the neutron decay products

$$(Y\pm = n) = (X = d)(Y = u)(X = d) = (X- = p^+)(Y+ = e^-)(X- = \nu_e^-), \quad \text{and}$$

$$\text{proton annihilation } (X\pm = p^+) = (Y = u)(X = d)(Y = u) = (Y- = \gamma_0^+)(X+ = \nu_e^-)(Y- = \gamma_0^+)$$

the protons are "bound" by the "rigid string" of the vortex magnetic field of the trajectory ( $X- = \nu_e$ ) of the neutrino as the reason for the stability of such quanta of strong interaction in the nuclei of atoms. In this case, we have ( $Y-$ ) = ( $X+$ )( $X+$ ) =  $\cos\varphi_Y * 2p = 2\alpha * p = (Y- = p/n)$  quanta of strong interaction. Hence follows the relation:  $2\alpha * p = \Delta m(Y-)$  = 13,69 MeV. There corresponds the equation:

$$G(X+) = \psi \frac{\hbar\lambda}{\Delta m^2} G \frac{\partial}{\partial t} grad_n R g_{ik}(X+).$$

We have quanta ( $Y- = p/n$ ) of strong interaction in nuclei with a minimum  $\Delta E_N = 6,85 MeV$  and a maximum specific binding energy  $\Delta E_N \approx 8,5 MeV$  or  $\Delta m(Y-) = 17 MeV$ , nucleons kernels. By analogy with the electron bremsstrahlung ( $Y- = e^-$ )  $\rightarrow$  ( $Y- = \gamma^+$ ), X-rays, there is emission of quanta of "dark matter" ( $Y- = \alpha \left[ \left( \frac{p^+}{n} \right) \text{ или } (2n) \right] = e_+^*$ )  $\rightarrow$  ( $Y- = (14 - 17) MeV = \gamma_-^*$ ), with mass ( $Y-$ ) trajectories. They have a charge field ( $Y+$ ) and can react to a magnetic field. We are talking about bremsstrahlung from the nucleus  ${}^2_1H$  of deuterium. Such quanta of "dark matter" are absorbed by quanta ( $Y- = p/n$ ) of the shells of the atomic core. Similar quanta of "dark matter" give the core of planets ( $Y- = 223,36 GeV$ ), stars ( $Y- = 4,3 * 10^6 GeV$ ), "black holes" ( $Y- = 1,5 * 10^7 TeV$ ) and galactic core ( $Y- = 2,48 * 10^{11} TeV$ ).

Unified Maxwell equations for electro ( $Y+ = X-$ ) magnetic fields and gravity ( $X+ = Y-$ ) mass fields of quanta ( $Y- = p/n$ ) and ( $Y- = 2n$ ) Strong Interaction of nucleons of the core,

$c * rot_y B(X-) = \varepsilon_1 \frac{\partial E(Y+)}{\partial T} + \lambda E(Y+);$ $rot_x E(Y+) = -\mu_1 \frac{\partial H(X-)}{\partial T} = -\frac{\partial B(X-)}{\partial T};$	$c * rot_x M(Y-) = \varepsilon_2 * \frac{\partial G(X+)}{\partial T} + \lambda * G(X+)$ $rot_y G(X+) = -\mu_2 * \frac{\partial N(Y-)}{\partial T} = -\frac{\partial M(Y-)}{\partial T};$
---	--

suggest the presence in the nucleus of closed  $rot_y B(X-)$  vortex in shells, magnetic fields and vortex  $rot_x M(Y-)$  mass ( $Y-$ ) trajectories of exchange quanta, as ( $\Delta E = \Delta m(Y-)c^2$ ) nuclear binding energy  $\Delta m = 2\alpha m(p) = \frac{2 * 938,28}{137,036} = 13,694 MeV$ , with the minimum specific binding energy of nucleons of the nucleus  $\Delta E = 6,85 MeV$  mass defect ( $m$ ) in the diagram.

Such quanta ( $Y- = p/n$ ) and ( $Y- = 2n$ ) of the Strong Interaction of the nucleus form structures ( $X\pm$ ) and ( $Y\pm$ ) quanta of the nucleus. At the same time, in the core there is really a general state of the equations of the dynamics of a single ( $X\pm = Y\mp$ ) space-matter.

Let's represent them in the form of kernel models.

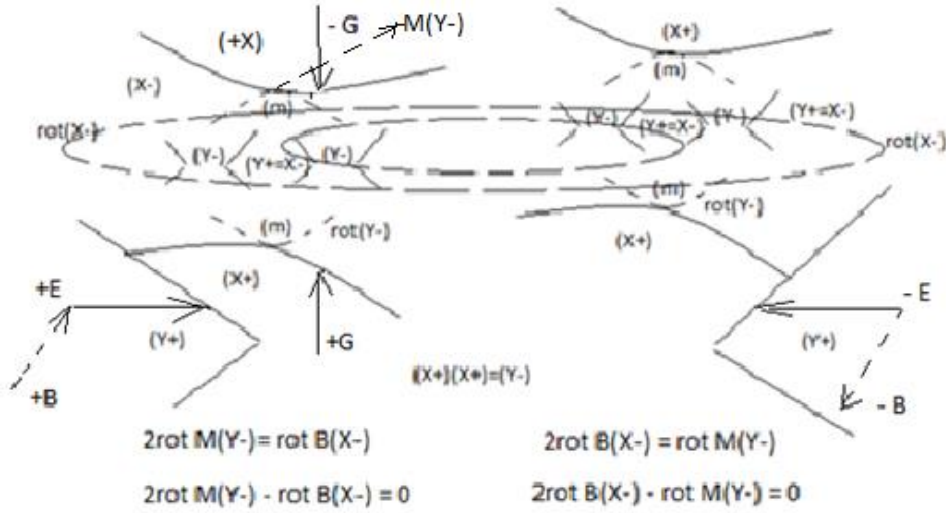

At the same time, in the core there is really a general state of the equations of the dynamics of a single  $(X\pm = Y\mp)$  space-matter. Let us sum these equations for closed vortex  $rot(Y-)$  and  $rot(X-)$  fields in the "standing waves" of the core, without their densities  $\lambda_1 E(Y+)$  and  $\lambda_2 G(X+)$  in the form:

$c * rot_Y B(X-) + c * rot_X M(Y-) = \varepsilon_1 \frac{\partial E(Y+)}{\partial T} + \varepsilon_2 * \frac{\partial G(X+)}{\partial T}$ , and bring these fields to  $(X\pm)$  and  $(Y\pm)$  quanta of the nucleus of the same frequency  $\frac{\partial}{\partial T} = \omega$ , oscillations of all quanta to the structure of the core.

$c * rot_X M(Y-) - \varepsilon_1 \omega E(Y+) = \varepsilon_2 \omega G(X+) - c * rot_Y B(X-) = 0$ , with zero densities outside the vortices. The fact is that "+" to the substance of mass  $(Y- = X+)$  fields corresponds to "-" charge of the electric  $(Y+)$  field  $(Y\pm)$  quanta, and vice versa, for antimatter. The single frequency of oscillations of all quanta in the structure of the core in a single  $(X\pm = Y\mp)$  space-matter has the form:

$$\omega = \frac{c * rot_X M(Y-)}{\varepsilon_1 E(Y+)} = \frac{c * rot_Y B(X-)}{\varepsilon_2 G(X+)} \quad \text{or} \quad \varepsilon_2 G(X+) * c * rot_X M(Y-) = \varepsilon_1 E(Y+) * c * rot_Y B(X-),$$

for gravity  $(X+ = Y-)$  mass fields and electro  $(Y+ = X-)$  magnetic fields of quanta  $(Y- = p/n)$  and  $(Y- = 2n)$  Strong Interaction of nucleons of the core.

The unified  $(X\pm = Y\mp)$  fields for orbital electrons external to the core are added in exactly the same way.  $rot_X E(Y+) + rot_Y G(X+) = \omega B(X-) + \omega M(Y-)$ ,  $rot_Y G(X+) - \omega B(X-) = \omega M(Y-) - rot_X E(Y+) = 0$ ,

$\omega = \frac{rot_Y G(X+)}{B(X-)} = \frac{rot_X E(Y+)}{M(Y-)}$ , or  $rot_Y G(X+) * M(Y-) = rot_X E(Y+) * B(X-)$ , in uniform  $(X\pm = Y\mp)$  fields.

It should be noted that the quantum field wave function has the material essence  $\pm\psi_E \equiv \pm E(Y+)$  electric field strength or  $\pm\psi_B \equiv \pm B(X-)$  magnetic vector field induction. Then  $(\psi_E)^2 \sim (\varepsilon\varepsilon_0 E^2 = \frac{W_E}{V})$  energy density of the electric and  $(\psi_B)^2 \sim (\frac{B^2}{\mu\mu_0} = \frac{W_B}{V})$  magnetic field with total energy density  $\psi^2 = (\psi_E)^2 + (\psi_B)^2$  of the

electromagnetic vector field. Area  $S = \pi r^2 \equiv \psi^2$  the interaction cross section with probability  $\frac{\psi^2}{\psi_{MAX}^2} \leq 1$  has the form  $(i\psi)^2 = (+\psi)(-\psi)$  of the superposition of the wave function of the quantum field. But when fixing the energy, we fix either  $(+\psi)(+\psi) = \psi^2$  or  $(-\psi)(-\psi) = \psi^2$ , always positive  $(\frac{W}{V} = \psi^2) > 0$ , energy density. We are talking about the collapse of the wave function. In this case, we can talk about the electric field  $(+E(Y+))$  of the electron and  $(-E(Y+))$  positron in the superposition of the wave function

$(i\psi)^2 = (+\psi)(-\psi) = -\frac{W}{V} < 0$ , which is what Dirac did. But just such wave functions have  $\pm\psi_G \equiv \pm G(X+)$  quantum gravitational fields and  $\pm\psi_M \equiv \pm M(Y-)$  quanta of the mass field, with exactly the same mathematical representation apparatus. We are talking about the fields of the nucleus or in the cross sections of interactions of mass particles, quantum gravitational  $G(X+) = M(Y-)$  mass fields.

In the general case,  $(Y\pm = \frac{p}{n} = \frac{2}{1}H)$  and  $(X\pm = 2\frac{p}{n} = \frac{4}{2}\alpha)$  of nuclear shells form levels and shells of electrons in the spectrum of atoms. In unified models of decay products of the mass spectrum of elementary particles, in unified fields  $(Y- = X+)$ ,  $(Y+ = X-)$  of space-matter, it is possible to represent the nuclei of the atomic spectrum. Based on the proton and neutron mass calculations:

$(X\pm = p) = (Y- = \nu_e)(X+ = \nu_e)(Y- = \nu_e) = (\frac{2\nu_e}{G} - \frac{\nu_e}{\alpha^2}) = 938,275 MeV$ ,  
 $(Y\pm = n) = (X- = \nu_e)(Y+ = e)(X- = p) = (T = 878,77) \exp(\frac{\nu_e}{\sqrt{G}} + \frac{e}{2} - p\sqrt{G}) = 938,57 MeV$ ,

we are talking about quanta of the Strong Interaction in the structures of the nucleus in the form of models of charged  $(Y\pm = \frac{p}{n}) = (X+ = p) + [(X+ = p)(e)(\nu_e) = n]$  and neutral interactions

$(Y_{\pm} = 2n) = [n = (v_e)(e)(X_{+} = p)] + [n = (X_{+} = p)(e)(v_e)]$ , when the fields  $(X_{+})(X_{+}) = (Y_{-})$  form mass  $(Y_{-})$  trajectories. Such  $(Y_{\pm} = \frac{p}{n})$  and  $(Y_{\pm} = 2n)$  quanta form core structures in a single  $(X_{\pm} = Y_{\mp})$  space-matter, with closed vortex  $(X_{-})$ magnetic fields and  $(Y_{-})$ mass fields. Let us represent the structures of the nucleus in the form of such models of charged  $(Y_{\pm} = \frac{p}{n})$  quanta of the Strong Interaction. For example:

$$(Y_{\pm} = \frac{p}{n} = \frac{2}{1}H), (X_{\pm}) = (Y_{+} = \frac{p}{n})(Y_{+} = \frac{p}{n}) = (X_{-} = \frac{4}{2}\alpha), (Y_{-} = \frac{1}{0}n)(X_{+} = \frac{1}{1}H)(Y_{-} = \frac{1}{0}n) = (X_{\pm} = \frac{3}{1}H),$$

$$(X_{+} = \frac{3}{1}H)(X_{+} = \frac{4}{2}H) = (Y_{-} = \frac{7}{3}Li), \text{ etc. } (X_{-} = \frac{4}{2}\alpha)(Y_{+} = \frac{1}{0}n)(X_{-} = \frac{4}{2}\alpha) = (Y_{-} = \frac{9}{4}Be),$$

$$(X_{+} = \frac{4}{2}\alpha)(Y_{-})(X_{+} = \frac{4}{2}\alpha)(Y_{-})(X_{+} = \frac{4}{2}\alpha) = (X_{+} = \frac{12}{6}C),$$

$$(X_{+} = \frac{4}{2}\alpha)(Y_{-})(X_{+} = \frac{4}{2}\alpha)(Y_{-} = \frac{2}{1}H)(X_{+} = \frac{4}{2}\alpha) = (X_{+} = \frac{14}{7}N).$$

The new structure inside the kernel  $(X_{+} = \frac{4}{2}\alpha)(X_{+} = \frac{4}{2}\alpha) = (\frac{8}{4}Y_{-})$  gives kernels:  $(\frac{8}{4}Y_{+})(\frac{8}{4}Y_{+}) = (X_{-} = \frac{16}{8}O)$ ,  $(Y_{-} = \frac{8}{4}Y_{+})(X_{+} = \frac{3}{1}H)(Y_{-} = \frac{8}{4}Y_{+}) = (X_{\pm} = \frac{19}{9}F)$  and similarly below.

We can say that for the nucleus  $\frac{4}{2}X(N)$  "free"  $(A - 2Z = N)$  neutrons in the form of neutral  $(Y_{\pm} = 2n)$  quanta of the Strong Interaction also form their structures inside the charged structures  $(Y_{\pm} = p/n)$ strong interaction quanta. Charged structures  $(Y_{\pm} = p/n)$  quanta of the Strong Interaction, as a cause, form the structures of the electron shells of atoms. For example: the neutral structure  $(Y_{\pm} = 2n)(Y_{\pm} = 2n) = (X_{\mp} = 4n)$ , is inside the nucleus  $(X_{\pm} = \frac{40}{18}Ar(4n))$  in the form:

$$(X_{\mp} = \frac{12}{6}X)(Y_{\pm} = 2n)(X_{\mp} = \frac{12}{6}X)(Y_{\pm} = 2n)(X_{\mp} = \frac{12}{6}X) = (X_{\pm} = \frac{40}{18}Ar(4n))$$

In such structures, the equations of both the electro  $(Y_{+} = X_{-})$ magnetic field and the equations of the gravitational  $(X_{+} = Y_{-})$  mass field in the form of fields  $(Y_{+})(Y_{+}) = (X_{-})$ and  $(X_{+})(X_{+}) = (Y_{-})$ .

Similarly, further:  $\frac{75}{33}As(9n) = (X_{-} = 4n)(Y_{-} = 1n)(X_{-} = 4n) = (Y_{\pm} = 9n)$ .

Note that in 100% kernel states  $\frac{9}{4}(1n), \frac{19}{9}(1n), \frac{23}{11}(1n), \frac{27}{13}(1n), \frac{31}{15}(1n), \frac{40}{18}(4n), \frac{45}{21}(3n), \frac{51}{23}(5n), \frac{55}{25}(5n), \frac{59}{27}(5n), \frac{75}{33}(9n), \frac{89}{39}(11n), \frac{93}{41}(11n), \frac{103}{45}(13n), \frac{127}{53}(21n), \frac{133}{55}(23n), \frac{139}{57}(25n), \frac{141}{59}(23n), \frac{159}{65}(29n), \frac{165}{67}(31n), \frac{169}{69}(31n), \frac{175}{71}(33n), \frac{181}{73}(35n), \frac{197}{79}(39n), \frac{209}{83}(43n)$ , we obtain the final stable structure of "standing waves" of neutral  $(Y_{\pm} = 2n)$  quanta Strong interaction in the core atom  $\frac{209}{83}Bi(43n)$ .

$$(X_{\mp} = 4n)(Y_{\pm} = 9n)(X_{\mp} = 4n)(Y_{\pm} = 9n)(X_{\mp} = 4n)(Y_{\pm} = 9n)(X_{\mp} = 4n) = (43n) = \frac{209}{83}Bi(43n)$$

inside the structure of charged  $(Y_{\pm} = p/n)$  quanta of the Strong Interaction core, forming the structure of the electron shells of atoms, as a cause.

Such neutral structures are located in the corresponding shells of structures of charged quanta of Strong interaction in self-consistent fields, closed in a figure of eight, a chain of vortex fields. All this corresponds to the equations of dynamics, amenable to modeling, calculations and forecasts.

Saturating these quanta  $(Y_{\pm}), (X_{\pm})$  of nuclear shells with the energy of quanta of "dark matter"

$(Y_{-} = 14 - 17) MeV$ , it is possible to cause "ionization" of nuclear shells. In such artificial radioactivity, it is possible, for example, from the nuclei of atoms  $(_{80}Hg - \frac{2}{1}H)$  or  $(_{81}Tl - \frac{4}{2}He)$  to obtain  $(\frac{197}{79}Au)$  gold. As in the case of a controlled thermonuclear reaction at a collider, a pilot experiment is needed here.

In the most general case, dynamics  $rot_x M(Y_{-})$  of inductive mass fields («the latent weights») is caused by dynamics of a source of gravitation.

$$c * rot_x M(Y_{-}) = \frac{1}{r} G(X_{+}) + \varepsilon_2 \frac{\partial G(X_{+})}{\partial t}.$$

**For  $n \neq 1$** , and  $n = 2, 3, 4 \dots \rightarrow \infty$ , we receive quasipotential  $G(X_{+})$  fields of accelerations  $G(X_{+})$  of a quantum gravitational field, as gravitation source  $\frac{\psi}{t_r} G * grad_n (\frac{1}{2} R g_{ik})(X_{+})$ , with limiting a corner

$(cos^2 \varphi(X_{-})_{MAX} = G)$ , of parallelism of a quantum  $G(X_{+})$  field of Strong Interaction in this case and the period  $T = \frac{\lambda}{c}$  of quantum dynamics. Quasipotential  $G(X_{+})$  fields of a quantum gravitational field of accelerations, on distances  $(c * t = r)$  look like:

$$G(X_{+}) = \frac{\psi * \lambda}{r} \left( G * grad_n \left( \frac{1}{2} R g_{ik} \right) (X_{+}) + \alpha * grad_n (T_{ik})(Y_{-}) \right), \quad r \rightarrow \infty.$$

This equation of a quantum gravitational field **of accelerations**  $G(X_{+}) = v_Y M(Y_{-})$  mass trajectories with a principle of equivalence of inert and gravitational weight. It has a basic difference with the equation of gravitational **potentials** of the General Theory of the Relativity.

Component of a gravitational quasi potential  $G(X_{+}) = v_Y M(Y_{-})$ , field, tensor energy - impulse  $(T_{ik})$  concern inductive mass fields in physical vacuum. In brackets, we have a gradient of potentials gravity  $(X_{+} = Y_{-})$  a mass field.

$$G * grad_n \left( \frac{1}{2} R g_{ik} \right) (X_{+}) + \alpha * grad_n (T_{ik})(Y_{-}) = G * \alpha * grad_{\lambda} \frac{1}{2} \Pi(X_{+} = Y_{-}).$$

$$\text{From here follows. } G(X_{+}) = \frac{\psi(\lambda=1)}{r} * G * \alpha * grad_{\lambda} \left( \frac{1}{2} \Pi(X_{+} = Y_{-}) \right).$$

The general gravitational potential  $\Pi(X+=Y-)$  in a general view includes also potential of a source of gravitation  $(\frac{1}{2}Rg_{ik})(X+)$  and quasi-potential  $(T_{ik})(Y-)$  fields of inductive weights. We write the same equation in other quantum parameters, namely:

$$G(X+) = \frac{\psi^*(Tc=\lambda)}{(t=nT)c} G\alpha \left( \frac{1}{2\lambda} \Pi(X+=Y-) \right), \text{ or } G(X+) = \frac{\psi^*(\frac{1}{T}=v=\frac{\varepsilon}{\hbar})}{nc} G\alpha \left( \frac{1}{2} \Pi \right), \quad G(X+) = \frac{\psi^*\varepsilon}{n\hbar c} G\alpha \left( \frac{1}{2} \Pi \right)$$

Here, the gradient of the total gravity-mass  $\Pi(X+=Y-)$  potential is taken over the entire wavelength  $(\lambda)$ . We are talking about the quantum levels of the mass trajectories of the orbital electrons of the atom, in the form:

$$\hbar = m_e V r. \text{ And further: } \frac{mV^2}{r} = \frac{ke^2}{r^2}. \quad V = \sqrt{\frac{ke^2}{mr}}, \quad (m_e r \sqrt{\frac{ke^2}{r}} = n\hbar), \quad n\hbar = \sqrt{m_e r k e^2}, \quad r = \frac{n^2 \hbar^2}{m_e k e^2}, \text{ for energy,}$$

$$\varepsilon = \frac{ke^2}{r} = \frac{m_e k^2 e^4}{n^2 \hbar^2}, \text{ at radiation, } \Delta\varepsilon = \frac{m_e k^2 e^4}{\hbar^2} \left( \frac{1}{n_1^2} - \frac{1}{n_2^2} \right) = \hbar\nu, \text{ atom.}$$

These are the unified mathematical truths of the unified equations of the unified  $(Y\mp = X\pm)$  space-matter.

### Examples.

For angular speed  $(\omega = \frac{2\pi r}{T} = \frac{1^r}{t}) \left[ \frac{r}{s} \right]$  of inductive mass  $M(Y-)$  trajectories in orbits  $(r)$  round the Sun in its  $G(X+)$  field of gravitation, is rotation this field.

$$rot_y G(X+) = -\mu_2 * \frac{\partial N(Y-)}{\partial t} = -\frac{\partial M(Y-)}{\partial t} \quad \text{or} \quad rot_y G(X+) = \omega M(Y-).$$

For **Mercury**, perihelion  $r_M = 4,6 * 10^{12} \text{ cm}$ , at average rate  $4,736 * 10^6 \text{ cm/c}$  there is a centrifugal acceleration  $a_M = \frac{(v_M)^2}{r_M} = \frac{(4,736 * 10^6)^2}{4,6 * 10^{12}} = 4,876 \text{ cm/s}^2$ . The weight of the Sun  $M_s = 2 * 10^{33} \text{ g}$ , and Sun radius  $r_0 = 7 * 10^{10} \text{ cm}$ , create acceleration  $G(X+)$  a field of gravitation with  $(\psi = 1)$  in a kind.

$$g_M = G(X+) = \frac{1 * (\lambda=1) * G * M_s}{r_M * 2r_0} * \alpha, \quad \text{or} \quad g_M = \frac{6.67 * 10^{-8} * 2 * 10^{33}}{2 * 4,6 * 10^{12} * 7 * 10^{10} * 137} = 1,511 \text{ cm/s}^2.$$

From the relation:  $R_{ik}(X+) = 2\psi \left( \frac{1}{2} Rg_{ik}(X+) + \kappa T_{ik}(Y-) \right)$ , analogue parities in space of accelerations, inductive mass  $M(Y-)$  trajectories round the Sun of the space-matter on average radius  $r_M = 5,8 * 10^{12} \text{ cm}$  in a kind follow.  $a_M(X+) - g_M(X+) = \Delta(Y-) = 4,876 - 1,511 = 3,365 \text{ cm/s}^2$ . From the equation  $(X+=Y-)$  mass gravity fields  $rot_y G(X+) = \omega M(Y-)$ , follows  $\frac{\Delta(Y-)}{\sqrt{2}} = \frac{2\pi r}{T} M(Y-)$ , turn perihelion Mercurial in time  $(T)$ . For  $100 \text{ years} = 6.51 * 10^{14} \text{ s}$ , this turn of mass  $M(Y-)$  trajectories makes  $\frac{\Delta(Y-) * 6.51 * 10^{14}}{r_M * 2\pi \sqrt{2}} (57,3^0) = 42,5''$ . It is about the rotation of all space-matter around the Sun.

For **the Earth**, on distance of an orbit of the Earth and speed of the Earth  $v_3 = 3 * 10^6 \text{ cm/c}$  in an orbit  $r_3 = 1.496 * 10^{13} \text{ cm}$ , centrifugal acceleration is equal

$$a_3 = \frac{(v_3)^2}{r_3} = \frac{(3 * 10^6)^2}{1.496 * 10^{13}} = 0,6 \text{ cm/s}^2.$$

Acceleration  $G(X+)$  a field of gravitation of the Sun  $r_0 = 7 * 10^{10} \text{ cm}$ , with weight  $(M_s)$  and  $(\psi = 1)$ , is available

$$g_3 = G(X+) = \frac{1}{r_3} * G * \frac{M_s}{2r_0} * \alpha = \frac{6.67 * 10^{-8} * 2 * 10^{33}}{2 * 1.496 * 10^{13} * 7 * 10^{10} * 137} = 0.465 \text{ cm/s}^2.$$

Similarly  $a_3(X+) - g_3(X+) = \Delta(Y-) = 0,6 - 0,465 = 0,135 \text{ cm/s}^2$ . From this acceleration of inductive mass  $M(Y-)$  trajectories space-matter round the Sun, turn perihelion orbits of the Earth follows, by analogy and makes  $\frac{\Delta(Y-) * 6.51 * 10^{14}}{r_3 * 2\pi} (57,3^0) = 5,8''$ .

For **Venus**, under the same scheme of calculation, turn perihelion Venus  $r_B = 1.08 * 10^{13} \text{ cm}$ , and speeds  $v_B = 3,5 * 10^6 \text{ cm/s}$ , centrifugal acceleration of Venus in an orbit makes

$$a_B = \frac{(v_B)^2}{r_B} = \frac{(3,5 * 10^6)^2}{1.08 * 10^{13}} = 1,134 \text{ cm/s}^2.$$

Similarly, the acceleration  $G(X+)$  of the solar gravitational field in the orbit of Venus is.

$$g_B = G(X+) = \frac{1}{r_B} * G * \frac{M_s}{2r_0} * \alpha = \frac{6.67 * 10^{-8} * 2 * 10^{33}}{2 * 1.08 * 10^{13} * 7 * 10^{10} * 137} = 0.644 \text{ cm/s}^2.$$

Accelerations of inductive mass  $M(Y-)$  trajectories of space-matter round the Sun,

$$a_B(X+) - g_B(X+) = \Delta(Y-) = 1,134 - 0.644 = 0,49 \text{ cm/s}^2.$$

From here, turn perihelion Venus follows:  $\frac{\Delta(Y-) * 6.51 * 10^{14}}{r_3 * \pi} (57,3^0) = 9,4''$  seconds for 100 years.

Such design values are close to observable values. Essentially that from Einstein's formula for displacement perihelion Mercurial,

$$\delta\varphi \approx \frac{6\pi GM}{c^2 A(1-\varepsilon^2)} = 42,98'', \text{ for 100 years,}$$

$$c^2 A(1-\varepsilon^2) * \delta\varphi \approx 6\pi GM, \quad (c^2 A - c^2 A\varepsilon^2) \delta\varphi \approx 6\pi GM.$$

No reason for this shift is visible, except for the curvature of space from the equation of the General Theory of Relativity. The idea is that the difference in the course of the relativistic time in the orbit causes its rotation and is proportional to the eccentricity. In this case, the slowing down of time ( $\Delta t_{21}^2$ ) in the gravitational ( $X+$ ) field at perihelion gives a relativistic contraction ( $-\Delta x_{21}^2$ ) of the mass ( $Y-$ ) trajectory in the Einstein equation. Formally, this is  $(rot_y G(X+)) = \frac{\Delta G(X+)}{(-\Delta \bar{x}_{21})} = \left(\frac{\partial M(Y-)}{\partial T} = \frac{\Delta M(Y-)}{(\Delta t_{21})}\right)$  is a mathematical truth.

The physical cause is the action of the gravitational  $G(X+)$  field, pushing the planet along a trajectory of mass ( $Y-$ ) as it revolves around the star. We are talking about the presence of inductive mass  $M(Y-)$  fields of space-matter and their rotation around the Sun, as a cause, in accordance with the equations of dynamics. In other words, space-matter itself revolves around the Sun.

For the same reasons, we will consider movement of the Sun round the Galaxy kernel. The initial data. Speed of the Sun in the Galaxy  $v_s = 2,3 * 10^7 \text{ cm/s}$ , weight of a cores of the Galaxy  $M_c = 4,3 * 10^6 * M_s$ ;  $M_G = 4,3 * 10^6 * 2 * 10^{33} (g)$ , distance to the centre of the Galaxy 8,5 кпк or  $r = 2,6 * 10^{22} \text{ cm}$ . Centrifugal acceleration of the Sun in a galactic orbit:

$$a_s = \frac{(v_s)^2}{r} = \frac{(2,3*10^7)^2}{2,6*10^{22}} = 2 * 10^{-8} \text{ cm/s}^2 .$$

Using this technology of calculation, we will estimate core radius of our Galaxy  $r_{\text{я}}$ . In exactly this formula of calculation, we will receive ( $r_{\text{я}}$ ) Core radius of our Galaxy  $g_s = G(X+)$ .

$$a_s = G(X+) = \frac{1}{r} * G * \alpha * \frac{M_c}{2r_c}, \quad \text{whence}$$

$$r_c = \frac{1}{r} * G * \alpha * \frac{M_{\text{я}}}{2a_s} = \frac{6,67*10^{-8}*4,3*10^6*2*10^{33}}{2*137*2,6*10^{22}*2*10^{-8}} = 4 * 10^{15} \text{ cm} \approx 267 \text{ a. e.},$$

1 a. e. =  $r = 1,496 * 10^{13} \text{ cm}$ , or  $1 \text{ pc} = 3 * 10^{18} \text{ cm}$ , , then  $r_{\text{я}} \approx 1,3 * 10^{-3} \text{ pc}$ . Such radius in our Galaxy corresponds to a gradient of all mass fields of a source of gravitation,

$$G(X+) = \frac{\psi(\lambda=1)}{r} * G * \alpha * \text{grad}_{\lambda} \left(\frac{1}{2} \Pi(X+=Y-)\right), \quad \text{with radius } r_c \approx 1,3 * 10^{-3} \text{ pc}.$$

Limits of the measured radius  $r_{0c} \approx 10^{-4} \text{ pc}$  their parity gives a parity of their weights.

$$\frac{r_{0c}}{r_c} * 100\% = \frac{10^{-4}}{1,3*10^{-3}} * 100\% = 7,69 \%.$$

It means that the weight of a kernel of the Galaxy makes 7,69 % the latent mass  $M(Y-)$  fields.

**The parameters of the Moon.** It is well known that in the position of the moon between the sun and the earth, according to Newton's law, the sun attracts the moon 2.2 times stronger than the earth.

For  $M_s = 2 * 10^{33} g$ ,  $m_E = 5,97 * 10^{27} g$ ,  $r_E = 6,371 * 10^8 \text{ cm}$ ,  $m_M = 7,36 * 10^{25} g$ ,

$$r_M = 3,844 * 10^{10} \text{ cm}, \quad G = 6,67 * 10^{-8}, \quad \alpha = 1/137,$$

$$(\Delta A = 1,496 * 10^{13} - r_M = 1,49215 * 10^{13} \text{ cm}),$$

$$F_1 = \frac{GM_s m_M}{(\Delta A)^2} = \frac{6,67*10^{-8}*2*10^{33}*7,36*10^{25}}{(1,49215*10^{13})^2} = 4,41 * 10^{25},$$

$$F_2 = \frac{Gm_E m_M}{(r_M)^2} = \frac{6,67*10^{-8}*5,97*10^{27}*7,36*10^{25}}{(3,844*10^{10})^2} = 1,98 * 10^{25}, \quad (F_1/F_2 = 2,2).$$

The difference in forces  $(F_1 - F_2) = (\Delta F) = (4,41 - 1,98) * 10^{25} = 2,43 * 10^{25}$ , is compensated by the gravity of the ("hidden") mass fields of space around the Earth, with acceleration:

$$g_E(X+) = \frac{\pi}{r_M} * G * \frac{M_E}{r_E} * \alpha = \frac{3,14*\sqrt{2}*6,67*10^{-8}*5,97*10^{27}}{137*3,844*10^{10}*6,371*10^8} = 0,372 \text{ cm/s}^2.$$

The gravitational force of the mass field corresponds within the limits of measurement accuracy.

$$(\Delta F) = m_M * g_E(X+) = 7,36 * 10^{25} * 0,372 = 2,74 * 10^{25}.$$

Thus, decisions of the equations of quantum gravitational fields yield results within the measured.

**Deviation of photons in the gravitational field of the Sun.** The photon "falls" in the gravitational field of the Sun with acceleration:  $g(X+) = \frac{2GM_s}{R_s^2}$ . During the passage of the diameter of the Sun  $t = \frac{2R_s}{c}$ , along the tangent to the sphere of the Sun, the vertical speed of "fall" is:  $v = g * t$ . Photon deflection angle, for  $R_s = 6,963 * 10^{10} \text{ cm}$ , defined as:

$$\varphi = \text{arc sin} \frac{v}{c}, \quad \text{or} \quad \frac{v}{c} = \frac{2GM_s}{R_s^2} * \frac{2R_s}{c} * \frac{1}{c} = \frac{4*6,67*10^{-8}*2*10^{33}}{6,963*10^{10}*(3*10^{10})^2} = 8,515 * 10^{-6},$$

$$\varphi = \text{arc sin}(8,515 * 10^{-6}) = 0,000488^{\circ} = 1,75'' s$$

This angle corresponds to calculations in the equations of Einstein's general theory of relativity. From the same equations, the deceleration of time ( $\Delta t \downarrow$ ) gives an additional acceleration ( $\Delta g \uparrow$ ) in the gravitational field, or centrifugal ( $\Delta a \uparrow$ ) acceleration, with the principle of their ( $\Delta g = \Delta a$ ) equivalence at a constant speed of light  $c = (\Delta g \uparrow)(\Delta t \downarrow)$ . This concerns the passage of time in the orbit of Mercury, calculated by Einstein. In the same way, the course of time of one electron changes in different discrete orbits of the atom, in the

fields of atomic mass. A change in the course of time of an electron in discrete orbits is associated with a change in its frequency ( $\Delta\nu$ ), which in Planck's theory is accompanied by the emission or absorption of a photon ( $\Delta E = \hbar\Delta\nu$ ). And the deeper the "dip" in the ( $X+$ ) field of the Strong and gravitational field near the nucleus, the greater the wavelength and period ( $Y-$ ) of the mass quantum trajectory ( $Y- = e$ ) of an orbital electron in a single ( $X+ = Y-$ ) space-matter, the slower the passage of time. Here we are talking about the discrete dynamics of the course of time in the quantum relativistic dynamics of any quantum of space-time, the physical vacuum near "black holes" is similar.

### 8. Dynamics of the Universe.

Consider the mathematical truths of the dynamics of the chosen Evolution Criteria. In other Criteria, this will be a different view. If ( $R$ ) is the radius of the non-stationary Euclidean space of the sphere of the visible Universe, then from the classical Special Theory of Relativity, where ( $b = \frac{K}{T^2}$ ) acceleration, ( $c^4 = F$ ) force, it follows:  $R^2 - c^2t^2 = \frac{c^4}{b^2} = \bar{R}^2 - c^2\bar{t}^2$ , or  $b^2(R \uparrow)^2 - b^2c^2(t \uparrow)^2 = (c^4 = F)$ , force. In the unified

Criteria, ( $b = \frac{K}{T^2}$ ) ( $R = K$ )  $= \frac{K^2}{T^2} = \Pi$ , we talk about the potential in the velocity space ( $\frac{K}{T} = \bar{e}$ ) vector space in any  $\vec{e}(x^n)$  coordinate system,  $\Pi = g_{ik}(x^n)$ , is the fundamental tensor of the Riemannian space.

$$\Pi_1^2 - \Pi_2^2 = (\Pi_1(X+) - \Pi_2(Y-))(\Pi_1(X-) + \Pi_2(Y+)) = (\Delta\Pi_1(X+ = Y-)) \downarrow (\Delta\Pi_2(X- = Y+)) \uparrow = F$$

This force on the entire radius ( $R = K$ ) of the visible sphere of the single ( $X\pm = Y\mp$ ) space-matter of the Universe, gives (dark) energy ( $U = FK$ ) to the dynamics of the entire Universe.

$$(\Pi_1^2 - \Pi_2^2)K = (\Pi_1 - \Pi_2)K(\Pi_1 + \Pi_2) = (\Delta\Pi_1)(X+ = Y-) \downarrow K(\Delta\Pi_2)(X- = Y+) \uparrow = FK = U$$

What is its nature? At the radius ( $R = K$ ) of the dynamic sphere of the Universe, there is a simultaneous dynamics of a single ( $X\pm = Y\mp$ ) space-matter. Considering the dynamics of potentials in gravity ( $X+ = Y-$ ) mass fields, as is known,  $(\Pi_1 - \Pi_2) = g_{ik}(1) - g_{ik}(2) \neq 0$ , we are talking about the equation «gravity»

$R_{ik} - \frac{1}{2}Rg_{ik} - \frac{1}{2}g_{ik} = kT_{ik}$  of the General Theory of Relativity in any system ( $x^m \neq const$ ) coordinates,

and in various levels of singularity  $OJ_j$ ,  $OJ_i$ , physical vacuum of the entire Universe. The gradient of such ( $\Delta\Pi_1$ ) potential, as is also known, gives the equations of quantum gravity with inductive  $M(Y-)$  (hidden) mass fields in a gravitational field. We are talking about energy-momentum ( $\Delta\Pi_1 \sim T_{ik}$ )  $\downarrow (X+ = Y-)$  of the gravitational ( $X+ = Y-$ ) mass fields of the expanding Universe, with a decrease in density mass ( $Y-$ ) trajectories.

$$\Pi K = \frac{(K_j \rightarrow \infty)^3}{(T_j \rightarrow \infty)^2} = \left( \frac{1}{(T_j \rightarrow \infty)^2} = (\rho_j \rightarrow 0) \downarrow \right) (K_j^3 = V_j \uparrow)(X+ = Y-) = (\rho_j \downarrow V_j \uparrow)(X+ = Y-)$$

$$(R_j) * (R_i = 1,616 * 10^{-33} sm) = 1, \quad (R_j) = 6,2 * 10^{32} sm, \quad (\rho_j \rightarrow 0)$$

On the other hand, the "expansion" of the physical vacuum of the Universe itself is caused by fragmentation ( $\Delta\Pi_2$ )( $X- = Y+$ )  $\uparrow$  of the general ( $X-$ ) field of the Universe, with the formation of new and new quantum ( $\Pi_1 + \Pi_2$ ) potentials, with densities ( $\rho_i(X-) \rightarrow \infty$ ) pushing (in expansion) each other, ( $X-$ ) fields. In the overall picture, in the expanding ( $X-$ ) field of the Universe, mass ( $Y-$ ) trajectories contract into structures.

We are talking about the properties of a dynamic single ( $X\pm = Y\mp$ ) space-matter, in which from:  $\cos\varphi(X-) \cos\varphi(Y-) = 1$ , and  $\lambda_i(X-) \lambda_i(Y-) = 1$ , for velocities  $v_i = const$ , follows the period of dynamics  $T_i(Y-) \rightarrow \infty$ , mass ( $Y-$ ) trajectories of quanta  $\gamma_i(Y-)$  of the physical vacuum at infinite radii

$\lambda_i(Y- = X+) = R_j \rightarrow \infty$ , of the Universe. At the same time, for vanishing densities  $\rho_i(Y-) = \frac{1}{(T_i \rightarrow \infty)^2} \rightarrow 0$ ,

mass trajectories, there exists  $(T_i \rightarrow \infty)(t_i \rightarrow 0) = 1$ , proper ( $t_i \rightarrow 0$ ), vanishing time of the dynamics of the entire Universe. In other words, at infinite radii, the universe disappears in time. On the other hand, in the depths of the physical vacuum  $\lambda_i(X-) \rightarrow 0$ , for speeds  $v_i = const$ , we get the period  $T_i(X-) \rightarrow 0$ , quanta of the physical vacuum, with the densities of its fields  $\rho_i(X-) = \frac{1}{(T_i \rightarrow 0)^2} \rightarrow \infty$ . It is like a "hard bottom" of

the physical vacuum on which we will follow  $(T_i \rightarrow 0)(t_i \rightarrow \infty) = 1$ , infinitely long ( $t_i \rightarrow \infty$ ), in a single ( $X\pm = Y\mp$ ) space-matter. And here the infinity of motion in time reduces to zero ( $R_i = 1,616 * 10^{-33} sm$ )  $\rightarrow 0$ , in space-time, as well as to the disappearance of the Universe in time by  $\lambda_i(Y- = X+) = R_j \rightarrow \infty$ , infinite radii. These are mathematical truths.

#### Representation of model of the mechanism of Higgs in dynamic space matter .

Such mechanism gives a Higgs boson in gravity ( $X+ = Y-$ ) mass fields and bosons ( $W^\pm, Z^0$ ) Electro ( $Y+$ )= $(X-)$  weak interaction. A mechanism essence just the same, as at scalar bosons of the invariant equation of Dirac .

$$i\gamma_\mu \frac{\partial \psi}{\partial x_\mu} - m\psi(X) = 0, \text{ and } i\gamma_\mu \frac{\partial \bar{\psi}}{\partial x_\mu} - m\bar{\psi}(X) = 0, \text{ for } \psi(X) = e^{-ia}\bar{\psi}(X), \text{ transformations}$$



and  $i\gamma_\mu \left[ \frac{\partial}{\partial x_\mu} + iA_\mu(X) \right] \psi(X) - m\psi(X) = 0$ , in conditions  $A_\mu(X) = \bar{A}_\mu(X)$ ,  $A_\mu(X) = \bar{A}_\mu(X) + i \frac{\partial a(X)}{\partial x_\mu}$ , existence of a scalar boson  $(\sqrt{(+a)(-a)} = ia (\Delta X \neq 0) = const$ , within calibration  $(\Delta X \neq 0)$  fields. This scalar boson  $ia(\Delta X \neq 0) = const$ , it is entered into the calibration field artificially, for elimination of shortcomings relativistic dynamics of the Theory of Relativity in quantum fields. Already in it, artificially created scalar field, at Spontaneous Violation of Symmetry the model of the mechanism of Higgs is represented.

Let us consider the principles of such mechanism.

a) In gravity  $(X+ = Y-)$  mass fields. Potential energy of the skalarny field is represented:

$$U(X) = -kx^2 + ax^4, \text{ has extremely in points: } U'(X) = 0, \text{ or } (x_0 = 0), \text{ and } x_{1,2} = \pm \sqrt{\frac{k}{2a}} = \pm L.$$

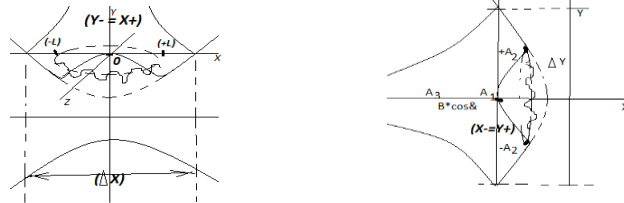

Fig.8. A scalar boson with Higgs's mechanism.

The turn  $(ZX)$  of the plane with points  $(\pm L)$  around an axis  $(Y)$ , is carried out with small fluctuations in points  $(\pm L)$  of balance. With turn:  $\omega = 2\pi(f = \frac{1}{T})$ , around an axis  $(Y)$ , it is harmonious fluctuations of the pruzhny environment:  $(F = kx) = (F = m\omega^2 x)$  which "generates weight"  $(k \equiv m\omega^2)$ ,  $(m)$  analogy of the oscillations of a "scalar" medium and mass. Carrying out replacement of variables at turn around an axis  $(Y)$ , we will receive:  $L + x = \phi$ ,  $x = \phi - L$  and  $(Z = \vartheta)$ . Energy transformation

$$U(x, z) = -k(x^2 + z^2) + a(x^2 + z^2)^2,$$

After groups, it is represented invariant energy  $U(\phi, \vartheta) = \tilde{k} * \phi^2 + 0 * \vartheta + \tilde{U}(\phi, \vartheta)$ , Under the terms of the nonzero mass  $(\tilde{k} \equiv m\omega^2)$ , a scalar boson and a goldstounovsky boson of zero weight. Thus, the scalar boson  $ia(\Delta X) = const$  of the calibration field  $(\Delta X \neq 0)$  finds weight. This is a scalar boson technology, as in the Dirac equation and a simple analogy of the oscillations of a "scalar" medium and mass.

b) In electro  $(Y+ = e =)(X- = \nu)$  magnetic interaction of leptons, in uniform  $(Y+ = X-)$  space matter, just the same mechanism of Higgs of an identification of fields in the conditions of local Invariances scalar Higgs boson, with calibration fields in each point of an equilibrium state

$$(A1 = +L), (A2 = -L), (A3) (Y+) \text{ of the scalar field and } B(X-) \text{ weeding.}$$

Mixing of this calibration field in uniform electro  $Y+ = -X)$  magnetic field in a look:

$$\sqrt{(+A_2)(-A_2)} = iA_2, \text{ bosons } W^\pm = \frac{1}{2}(A_1 + iA_2) \text{ and } Z^0(A_3, B, \cos\theta)$$

Electro  $(Y+ = e =)(X- = \nu)$  weak interaction, which find masses: and  $m_z = \frac{mW}{\cos\theta}$  goldstounovsky boson like a massless photon. Here, emergence of mass fields  $(Y- = X+)$  bosons  $(W^\pm)$ ,  $(Z^0)$  of electroweak interaction in electro magnetic  $(Y+ = e =)(X- = \nu)$  the field, is a limit of Euclidean axiomatics.

In a dynamic space-matter, both theories of both electroweak interaction and the Higgs boson are presented in a unified way in ideas similar to the idea of Spontaneous Symmetry Breaking and the Higgs mechanism, but without a "scalar" environment.

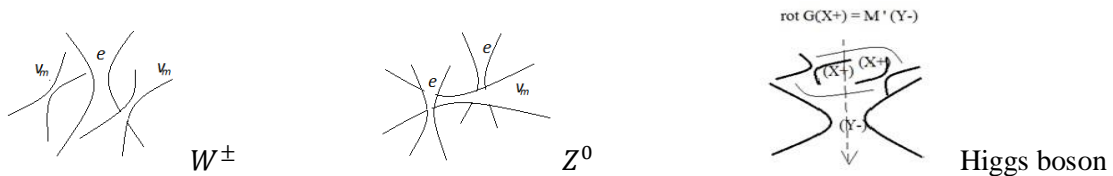

Fig. 8.1.. Electroweak interaction and Higgs boson.

$$\begin{aligned} (Y+ = e^\pm) + 2(X- = \nu_\mu) & & (X+ = \nu_\mu) + 2(Y- = e) & & (X+ = p^+) + (X+ = p^-) = (Y-) \\ W^\pm = \frac{\sqrt{m_e m_\nu \mu * 2\alpha}}{G} = 81.3 GeV, & & Z^0 = \frac{\sqrt{exp1 * (2m_e) m_\nu \mu * \alpha}}{G} = 94.8 GeV & & \frac{2p}{2\alpha} (1 - 2\alpha) = 126,7 GeV \end{aligned}$$

Here is an analogy of the same oscillations in the extremely of the Spontaneous Symmetry Breaking, with the same mass fields. However, mass fields are not born in a scalar field perturbed by vibrations. Mass fields are induced together with electromagnetic dynamics, in accordance with the unified equations of dynamics. Here, the field interaction constants are determined by the limiting angles of parallelism. It is impossible to imagine in the Euclidean axiomatic of the zero angle of parallelism.

**Summary.**

There is no space without matter and there is no matter outside of space. The main property of matter is movement. The paper considers the properties of dynamic space, which have the properties of matter. Dynamic space-matter follows from the properties of the Euclidean axiomatic. The geometric facts of dynamical space determine axioms that do not require proof. In the framework of the axioms of dynamic space, the physical properties of matter are determined. In a unified mathematical truth, Maxwell equations for the electromagnetic field and equations of the dynamics of the gravitational mass field are derived. Already from these equations, inductive mass fields follow, like inductive magnetic fields. These are two mathematical truths and two physical realities. Further. In a single mathematical truth, the equations of the Special Theory of Relativity and the equations of quantum relativistic dynamics are derived. Such equations are impossible in the Euclidean axiomatic. Einstein's tensor is also the mathematical truth of the difference in relativistic dynamics at two points in Riemannian space. The principle of equivalence of inert and gravitational masses is an axiom of the dynamic space of mass trajectories in a gravitational field. The complete equation of the General Theory of Relativity is deduced as the mathematical truth of a dynamic space-matter with elements of quantum gravity. Unlike the Einstein equation, in the complete equation of the General Theory of Relativity, the gravitational constant follows as mathematical truth. The acceleration equations of a quantum gravitational quasi potential field are derived in the framework of field theory. In the framework of this equation, the perihelion of Mercury, the nucleus, and the hidden masses of the Galaxy were calculated. In elementary particle, physics there are unsolvable contradictions. For example, the fractional charge of quarks that form the proton charge and just such a positron charge, but without quarks. In the properties of dynamic space-matter, the proton and electron charges are calculated in a single way. There are limits of applicability of the Euclidean axiomatic, which are determined by the uncertainty principle, the wave function. A scalar field is introduced into the calibration field to maintain relativistic invariance in quantum fields. There is no quantum relativistic dynamics. In turn, the Quantum Theory of Relativity is impossible in the Euclidean axiomatic. Already in an artificially created scalar field, in the model of Spontaneous Symmetry Breaking, the Higgs boson theory and the electroweak interaction theory are being constructed. In both cases, the masses of these bosons are calculated in the framework of a dynamic space-matter without artificially created scalar bosons. In general, Euclidean axiomatic is a special case of a fixed state of dynamic space-matter. This reflects the reality of the properties of dynamic space-matter recorded in experiments. This is the technology of modern theories. In the framework of the axioms of dynamic space-matter, a fundamentally new technology of theories themselves is considered. We cannot just take a line. This is necessarily either (X-) or (Y-) trajectories. And we cannot just take a point ( $r_0 \neq 0$ ), "having no parts" in the Euclidean axiomatic. There are no such objects in Nature.

#### **Literature.**

1. Mathematical encyclopedia, Moscow, "Nauka", 1975
2. (BKF) Berkeley Physics Course. V.4, "Quantum physics", Science, 1986
3. V. Pauli, "Theory of Relativity", Moscow, "Nauka", 1991
4. Landau, Lifshitz, "Theoretical physics. Quantum mechanics", v.3, "Science", 1989
5. P.A. Dirac, "Memories of an Extraordinary Epoch", Moscow, "Nauka", 1990
6. N.F. Nelipa, "Physics of elementary particles. Gauge fields", Moscow, "Higher School", 1985
7. Maurice Klein, "Mathematics. Loss of certainty", Moscow, ed. "Mir", 1984
8. G. Korn, T. Korn, "Handbook of Mathematics", Moscow, "Nauka", 1974
9. A. Naumov, "Physics of the nucleus and elementary particles", "Prosveshchenie", 1984
10. A. Pais, "Scientific activity and life of Albert Einstein", Moscow, "Nauka", 1989.
11. I.S. Shklovsky, "Universe, life, mind", Moscow, "Nauka", 1974
12. T.A. Agekyan, "Stars, galaxies". Moscow. "The science". 1982
13. V. Smirnov, "Course of Higher Mathematics", v.1, p.186. Moscow, "Science". 1965, v.3, part 1, 1967