

Non-Linear Phenomena of the Torsion Field Communication Sessions

Mark Krinker¹, Peng Gao²

Abstract—Torsion field can be used for communication purposes because of the Non-Local phenomena related to the objects which generate this field. Torsion Field Communication, which is Non-Electromagnetic one, is a very different when compared to normal Electromagnetic communication approach. These new properties bring some advantages. This work introduces a series of TFC experiments between Beijing and New York, accomplished by the authors. SEVA instrument was employed as the receiver in New York, and the scalar wave generator, which is based on two resonant Tesla coils, was used as the TF transmitter. As the authors believe, such the conceptions like the non-locality, nonlinearity, quantum entanglement, Field Gyroscope and related to them Synchronicity, all having the common root, are the carriers of this Non-Electromagnetic phenomenon. During these sessions, some accompanying, interesting non-linear phenomena occurred.

I. INTRODUCTION

As the Torsion Field (TF) paradigm was evolving, it naturally came to attempts to employ this phenomenon for a communication [1]. We also can call it a Non-Electromagnetic Communication (Non-EMC) because the carrier of the information has a non-electromagnetic nature.

But even before the work [1], we see some actual examples of Non-EMC phenomena. A brief (but far not complete!) history of their observations includes the following:

In early 1900s, Nikola Tesla was experimenting with two powered caduceus electric coils. He fed the coils with opposite directed alternating currents, so their magnetic fields eliminated each other. He founded that, despite the resulting zero-AC magnetic field, these coils were able to transmit some unknown energy over long distances with no visible attenuation in a range of the experiments[2].

In 1982, Allan Aspect (Orse, France) and coworkers experimented with two correlated photons[3]. There was the spin-to-spin interaction in that experiment, where manipulation with one photon was immediately resulted in a variation of a polarization of its twin, although they moved in opposite directions.

On the other hand, Nature is rich in countless examples of biological Non-EMC. These phenomena manifest

themselves with pretty weak EM fields of communicating objects, comparable to a noise level, which can't support the communication, according to the classical EM conception.

These non-technical natural TFC are not objects of our current consideration, but we understand that they can play a role even in the instrumental Non-EMC.

II. NON-LINEAR NATURE OF TFC. CAUSALITY VS. SYNCHRONICITY?

Here, under TFC, we will understand application of technical TF means for deliberated attempts to link two objects, which results in some *cause and effect* manifestation.

Speaking of the *cause and effect* manifestation, we have to understand that, unlike the classical electromagnetic communication, TFC phenomena don't follow the so called common sense. Multiply experiments with them have convinced us in that. There is other definition of manifestation of the TF phenomena, called *Subtle Fields*, SF, which better corresponds to disagreement between everyday common sense experience and unusual phenomena associated with TF-SF.

Speaking about the divergence between the classical common sense phenomena and TF-SF, we have to classify these SF manifestations as non-linear phenomena. Under the non-linearity, we will understand a wide definition of this term, which includes violations of the cause and effect link. It has to be understood that "*Nature is rich in examples of nonlinear behavior. It turns out that nonlinearity is the rule rather than the exception; the world must be described mathematically by equations that exhibit critical points and novel orders of behavior and cannot always be analyzed or decomposed into simpler forms.*" [4]

In particular, those TF communication sessions, which have been done before, revealed a group of such the non-linear phenomena.

First of all, we have to stress that very fact of addressing - a linkage between a transmitter and receiver doesn't look like that for EM communication. In the EM radio communication, we link them by means of two identical resonant circuits and sources of transmission of electromagnetic waves, accompanied with the cause and effect phenomena. Nothing like that exists in TF-SF communication. There is no an electromagnetic resonance-based linkage/addressing, not to say about the carrier of a different nature. So far, there are no decoders-detectors

¹ Applied PhysTech Research Laboratory, New York, USA;
email:sevatronics@gmail.com

² ENNOVA Health Research Institute;
The Scalar Wave Technology Research Web in China;
email:gpufu@outlook.com

analogical to those in EMC. The information transmitted is single bits, like an alternation of ON-OFF states. Moreover and it's a major: the very the cause and effect principle is violated in TF-SF communication.

Basing on these facts, **our traditional point of view to project major properties of EM communication onto TF-SF one looks pretty naive. We have to find other algorithms of extracting hidden information, taking into account the physical base of this phenomenon. In particular, this specific physical base manifests itself in the very process of the linkage/addressing.**

Unlike the classical EM communication, TFC/Non-EMC can involve an experimenter/operator as an active component of the system. Existence of *PSI-lines* is a best proof of this thesis [5]. A human being can pave a course to the destination in his/her imagination and then successfully follow to the assigned destination along the imaginable line, guided by a simple bio-location indicator in the hands. **The fundamental PSI-lines phenomenon cannot be ignored and any discussion of TFC phenomenon is inadequate without it.**

A similar phenomenon manifests itself in measuring objects with TF instruments, where phenomenon of fading the results was noted: very first result looks pretty contrast, while the following ones look "fading". One of the proposed models explains it in terms of so called informational potential, which implies active participation of the operator in a closed measurement system: object-instrument-experimenter-object in a torsion field feedback loop [6]. At the very beginning, the operator has no information about the object, and his/her informational potential about the object equals zero. Then, as the measurement is in a process, he or she gets the information with the instrument and the informational potential of the operator increases, coming to the consciousness via the instruments and his/her organs. Therefore, the difference of the info-potentials gets less causing the info-current through the instrument to diminish. Fig.1 illustrates this example.

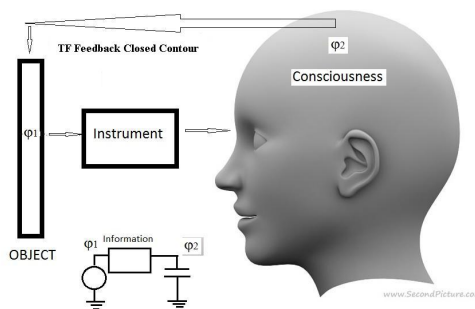

Fig.1. The informational loop: a closed measuring contour, involving the operator. The object and operator have their informational potentials φ_1 and φ_2 . The info-current through the instrument is proportional to their difference. The more is operator's accumulated information, the less is the info-current through the instrument.

The feedback in this contour can be either negative or positive. Moreover, some phase shift of the info-reaction is also possible inside this closed contour. In some cases, these factors can result even in origination of the oscillating process of info-reception, which can explain some cases of alternating contrast of the coming information. Actually, the Transient Processes Theory of automated regulation can be applicable here.

TFC phenomenon has to be considered rather in terms of a four quadrants coordinate system of events, proposed by C. Jung, Fig.2, [4,p.24]. Later, W. Pauli offered his modified version, Fig.3, [ibid]. These approaches are based on a fundamental phenomenon of Synchronicity which, in a simplified presentation, is a meaningful coincidence but, at a deeper look, is a projection of the World of highest metrics onto our 4-dimensional World [4].

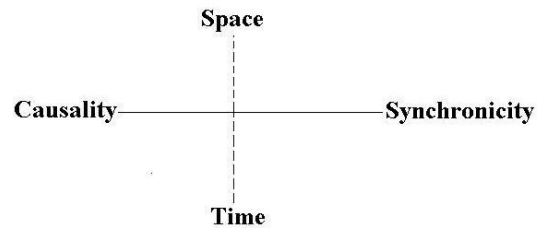

Fig. 2. C. Jung's model explaining a balance of synchronicity and causality

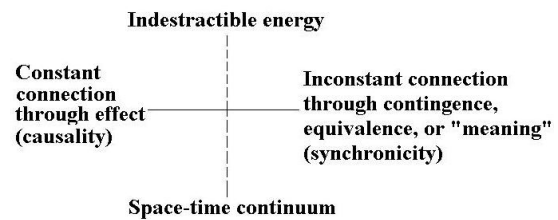

Fig.3. W. Pauli's modified model of Fig.2.

Taking this approach into consideration, we can show extreme positions of Electromagnetic Communication, EMC, and Non-Electromagnetic Communication, Non-EMC, in this coordinate system, Fig.4.

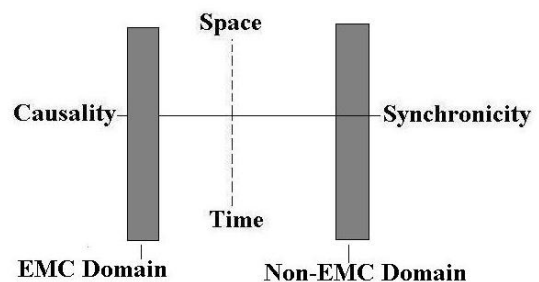

Fig.4. The extreme presentation of positions of classical electromagnetic communication, EMC, and non-electromagnetic one, Non-EMC, in a space of events

Projections of the events in the higher metrics World onto our 4-dimensional World look like chains of strange non-linear phenomena.

The very popular example with habitants of 2-

dimensional world, flatlanders, which experience crossing their flat world with 3-D object, let's say, a sphere, is a good illustration of our encounters with highest metric projections onto our world. First, the flatlander will see the dot, originated from nowhere in his world. Then the dot will be gradually converted into a circle, which then shrinks, converts into the dot and then disappears, Fig.5.

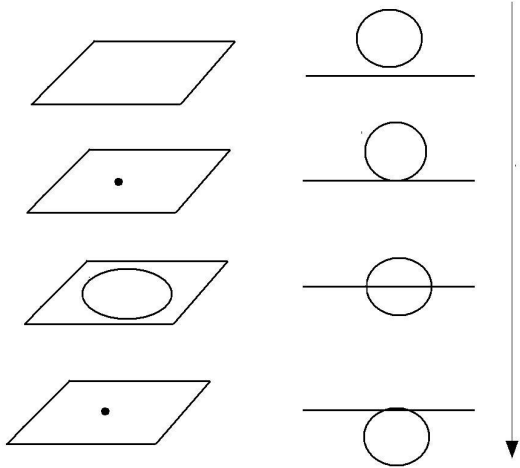

Fig.5. How the “flatlander” sees (left) crossing his 2-dimensional world by 3-D object -the sphere

III. THE COMPLEX NUMBER PRESENTATION OF NON-EMC PHENOMENA.

Fig.4. shows an extreme presentation of Non-EMC phenomenon to stress the synchronicity component. The experience of Non-EMC sessions shows that both the causal and synchronistic components present during real sessions. It can be refined with Fig.6. It's logically to present this mixed phenomenon as a complex number: $c = a + ib$. It's convenient to show this in Fig.6 as a modified version of Fig.4. The Non-EMC domain is much wider than that of EMC. Actually, the causal component of Non-EMC is represented by a real portion a , while the synchronistic one is represented by imaginable ib .

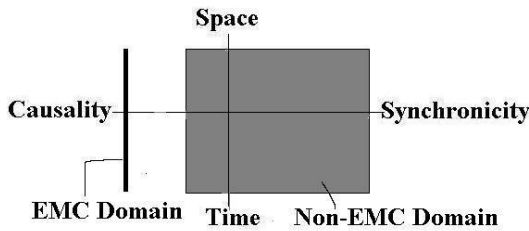

Fig.6. A comparative presentation of EMC and Non-EMC, taking into consideration that Non-EMC still contains some causal component

IV. DECODING NON-EMC MESSAGES.

Actually, our Non-EMC results, represented by the complex numbers, are roots of some polynomials [7]. Same can be said about the dowsing, as a representative of the nonlinear phenomena. Earlier, it was proposed to introduce a complex measure of dowsing results as a

complex number, where its real portion correlates with the instrumental reading, while its imaginable component reflects the subtle effects related to a personality of the operator [8].

Non-EMC belongs to the same level phenomena and the questions of extracting initial information during Non-EMC reception arises. In [7] the following ideological approach was proposed for a wide class of subtle-fields phenomena: to eliminate the imaginable component in Non-EMC experiments, the results have to be multiplied by a complexly conjugated number $(a - ib)$:

$$(a + ib)(a - ib) = a^2 + b^2$$

A major question here is getting the conjugate: $a - ib$. Actually, the conjugate number is a mirror representation of the original number, Fig.7.

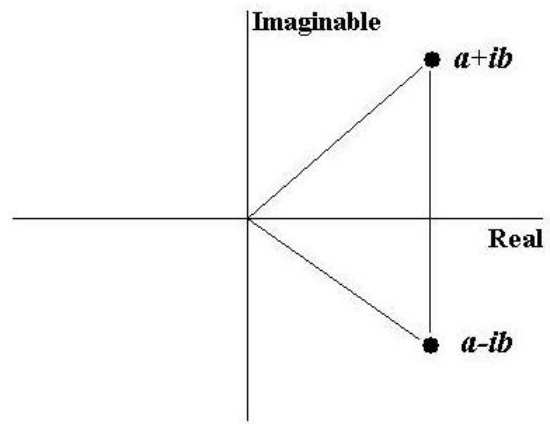

Fig.7. Mirror-like conjugate numbers.

Fig.8 shows an upgraded conception of decoding Non-EMC messages according to [7]. A generalized Non-EMC message, represented as $a + ib$, splits for two channels. In one of them, the $a + ib$ is being converted into its conjugate $a - ib$ in a mirror signal former. Then both are multiplied producing $a^2 + b^2$ as a product. Now we have only real components and the message is shifted leftward, toward the causal portion of Fig.6.

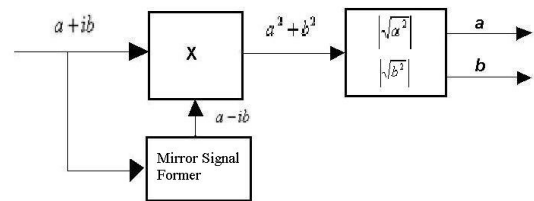

Fig.8. Concept of decoding signals of Non-EM communication

V. ROLE OF DE BROGLIE WAVES IN TFC. RELATION TO THE CAUSALITY-SYNCHRONICITY CONCEPTION

One of non-linear manifestations of TFC is a Temporal Triad Phenomenon [9]. This is a combination of sequent events: a premature reception of TF transmitter signal, conventional reception, correlating with the time, when

TF transmitter was activated, and the lagging reception of the signal after TF transmitter was turned OFF. These phenomena were detailed discussed by one of the author, basing on the interference of de Broglie waves [9].

They are attributed to that the non-linear phenomena are linked to de Broglie's probabilistic waves. The Temporal Triads can be explained in the following way.

Any object manifests itself in the world with its de Broglie wave and the related wave function since the moment the object appears. Let suppose, we have two independent objects, a receiver and a transmitter on a time axis, Fig.9. At the moment "0" they start to interact with each other. Before "0" moment they interact like waves: interference of their wave functions and de Broglie waves like it's shown above. Since the moment "0" they are the whole system with a minimal uncertainty Δt of time and that for Δx of space. Therefore, since this very moment they behave themselves like a particle. However, the experimenters see their interaction as waves before the energizing the transmitter. This is nothing but a signal of interaction of their de Broglie waves, which exist no matter turned the transmitter *on* or *off*. At the "0" moment the direct communication begins, they behave themselves like a particle and the receiver records the signal from the transmitter. After de-energizing the transmitter, they again behave themselves like interfering de Broglie waves and the receiver gets the third signal as a manifestation of interference crest of their mutual wave function.

We have to stress here that the interference fringe of the transmitter and receiver is not a stable picture because of evolution of each of them, which results in variation of λ . However, by this reason, the interference fringes become moving in time, which is very important for our explanation.

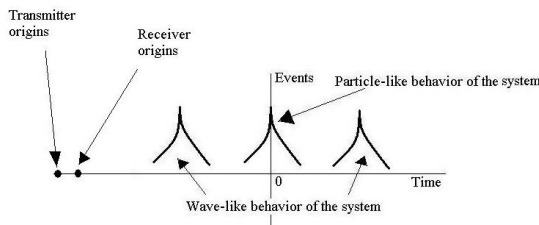

Fig.9. Origination of the Temporal Triad on a base of Corpuscular-Wave Dualism

VI. QUANTUM ENTANGLEMENT AND SPIN-TO-SPIN INTERACTIONS IN NONLINEAR PROCESSES

The Quantum Entanglement, QE, is a considerable component in explanation of discussed phenomena. Question on QE was raised in 1935 in EPR (Einstein-Podolsky-Rosen) thoughtful experiment. A. Aspect's experiment with correlated photons (1982) was one of the dramatic manifestations of QE [3].

QE is not just a prerogative of micro objects. As [10] shows, this behavior can be seen in macroscopic systems.

QE is a very important component of the coming new technology: Torsion Fields/Non-Electromagnetic Communication.

This developing technology uses a pretty unusual technique to connect receiver and transmitter in the non-electromagnetic way: an image-assisted addressing. The very concept of image-assisted addressing was declared in a group of independent works. Dr. A.Y. Smirnov, an author of [11][12], claims he proposed this method back in 1981-1994. Russian independent patents [13][14] of 1999-2000 describe, in details, various features of the related methods. Later, this triggered some modifications of the method, described in [15][16][17][18], but having one invariant feature: a link between the image of the object and the object itself.

In the Second-Physics Group, this image-based approach was employed at the long-distance monitoring of activation of TF generators in Moscow, in February 2010, while the appropriate instrument in New York was linked to said generators with a magnetic digital image of the participants in Moscow, next to the sensor of the instrument, [19]. First Non-EMC session raised a question on a signal-to-noise problem and appropriate non-linear approaches were proposed [20]. Some generalization of the latter sessions can be found in [15].

Participants of such experiments use at least one photographic image; let's say the image of a transmitter located in immediate vicinity of the receiver, next to its sensor. There is a belief that spin-to-spin interaction plays a considerable role in this process due to QE phenomenon between a transmitter and its image, carrying imprinted information about the transmitter. Even remote image of an object still has connections with the original due to spin-to-spin interaction on a base of QE phenomenon.

The great contribution into studying spin-to-spin interaction was done by a Russian scientist A.V. Bobrov, who showed a possibility to record spin-to-spin interaction with electric double layers [21]. Another great achievement of this scientist is that he first discovered a non-electromagnetic component in a laser and light-emitting diodes radiation [22].

When it comes to the shown above, the new class of instruments with clear nonlinear manifestations, relation between the operator and instrument at one side and the object at other side can be explained due to the quantum entanglement.

The pilot Torsion Field Communication sessions, TFC, practiced recently by second-physics.ru group, are a dramatic example of the nonlinear processes.

VII. THE METHODS AND INSTRUMENTS.SOME METHODOLOGICAL REMARKS.

The methodical base of the current long-distance experiments is based on a concept of a Field Gyroscopes, FG, produced by images, as well as the quantum entanglement between associated images. This makes a linkage between transmitters and receivers in the ocean of the surrounding information.

The sessions, which will be shown below, were conducted between the Non-EM-transmitter in Beijing, China, and Non-EM receiver in New York, USA. In New York,

DATAQ DI-149 recorder was employed to record a signal from the receiver. The recorder was connected to an analog output of the receiver to convert the analog signal into USB format, adaptable by the computer. It has to be said that the most sensitive scale of DATAQ DI-149 is 435 mV, while the receiver operated in a range of tens of mV, in some cases. At the same very time, a signal-to-noise ratio plays a role, rather than a physical size of a record on a diagram. Having acceptable the signal-to-noise ratio, it allowed to artificially increase a size of the records either by stretching the diagrams or employing a special digital sampling, like the csv format, which will be shown bellow.

It also has to be stressed one more time here, that Non-EMC has a principal difference with the classical EMC, as it's shown in Fig.6. By this reason, the authors believe that a simple correlation method is not a dominating criterion here. Moreover, a natural discrepancy of computer clocks in Beijing and New York, at least ± 1 min, also contributes in a consideration of the results.

A. Scalar wave generator as the Non-EM-transmitter

The scalar wave generator is standard dual Tesla coil system. In N.Tesla's patent [23], we can see the basic structure of Tesla coil. There are the same parameters in these two Tesla coils. There are large numbers of coils wound in pancake structure in the secondary coil, the center of the secondary coil is connected to a smooth spherical antenna and the end of coil at the outside is connected to ground. There are only few numbers of coils in the primary coil but the diameter of the wire of primary coil is much larger than the diameter of the wire of secondary coil.

N.Tesla wanted to use his Tesla coil system for wireless energy transmission purpose. In his system, the secondary coil was long enough, voltage generated was then high enough, at the same time, the work frequency was also low enough. Then the earth connection of both transmitter coil and receiver coil in Tesla's system can be connected to the Earth. Then the earth between transmitter and receiver can be the conductor. In the history, he transmitted energy over about 26 miles [24].

It's difficult to build an experimental model the same to N.Tesla's for replicating his wireless energy transmission experiment. In fact, if the key point is found, the resonance can be found in any size of coils, no matter how long are the coils. Prof.K.Meyl's work has to be mentioned. He not only proposed scalar wave theory, but also made some experimental kits from the year 2000 to now, which can be used to replicate many Tesla's effects[24].

In this work, the Tesla coil used in scalar wave generator is made on printed circuit board. The advantage of using the printed circuit board to make the coils is that it can ensure the two coils produced by factory are extremely the same.

The secondary coil is printed on the top of the printed circuit board and the total length of the secondary coil is

16 meters. The center of the secondary coil is connected to a series of pillars of brass, and at the end of the series of pillars of brass, a stainless steel ball whose diameter is about 150mm is connected. The outside end of the secondary coil is connected to a ground line, which is the link of the transmitter and receiver. The primary coil is printed under the printed circuit board with wider copper wire. The drive signal should be added to the primary coil of the transmitter in scalar wave generator.

The scalar wave generator consists of two standard pancake coils, one is the transmitter and the other is the receiver. When the two Tesla coils get the true resonance, the scalar wave will be generated. As to the adjustment, we should pay attention to the scalar wave resonance conditions according to Prof. K. Meyl:

- The same frequency;
- The same wave shape, respectively modulation;
- The opposite phase shift[25].

The most important condition is the opposite phase shift between the transmitter coil and the receiver coil. When the three conditions match, the scalar wave will be generated. So the dual Tesla coil system can be also called the Phase-Conjugate-Resonator.

In the previous TFC sessions, researchers usually used the torsion field generator as the transmitter, such as rotating magnetic field, rotating electric field, LED generator and so on. The reason why the scalar wave generator was used in this work is that the nature of scalar wave is torsion field according to Prof. K. Meyl's scalar wave theory and one of author's experimental works [26]. In fact, the Tesla coil used in scalar wave generator is a powerful torsion field generator based on the EM approach.

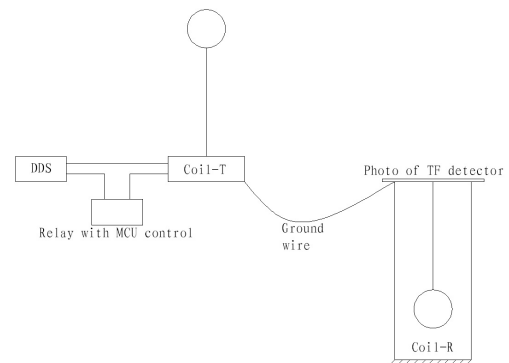

Fig.10. The schematic diagram of configuration on the transmitter side

On the transmitter side, the Non-EM-transmitter contains two same standard pancake Tesla coils, Coil-T and Coil-R. Before experiments, the system should be adjusted to the natural resonance state, whose resonance frequency is 1.57 times higher than the LC resonance state [26]. The signal generator is DDS type, and between the DDS generator and the Coil-T, there is a relay module controlled by MCU, which can turn on or turn off the scalar wave generator automatically. Because of the used cross-

Image method, the photo of torsion field detector should be placed near the transmitter – scalar wave generator. In this work, the sensor part of the photo was usually placed on the center of the pancake coil or on the sphere antenna. The schematic diagram is on Fig.10; and physical diagram is on Fig.11.

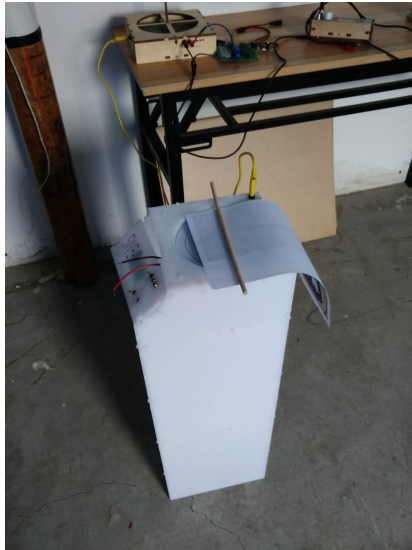

Fig.11. Non-EM transmitter in Beijing

B. SEVA as the Non-EM receiver

Fig.12 shows images of Non-EM receivers SEVA, Spinning Electric Vector Analyzer [27], employed in the experiments. SEVA detects localized spinning electromagnetic fields, Field Gyroscopes. **Despite the electromagnetic/electronic nature of this instrument, it can detect remote non-EM processes. This can be explained due to a mutual TF-EM convertibility.** The Electromagnetic Fields Gyroscopes inherit all the non-linear properties of mechanical gyroscopes known today, yet they bring additional specificities of their field nature.

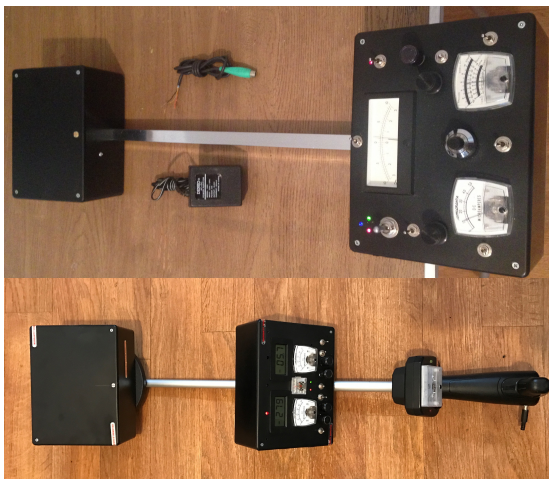

Fig.12. SEVA Instruments employed in the experiment as the Non-EMC receivers

In these sessions, the info-linkage between the transmitter and the receiver was achieved due to a cross-image exchange: the image of the receiver was put on the

transmitter, while the image of the transmitter was put under the receiver SEVA. The schematic diagram of cross-image in this work is shown in Fig.13. The images were put under the instruments few hours before the sessions. Greenwich Mean Time, GMT, was used in these sessions. During the sessions, a Quasi-stationary spinning (QSS) and Non-stationary spinning(NSS) of FG were recorded.

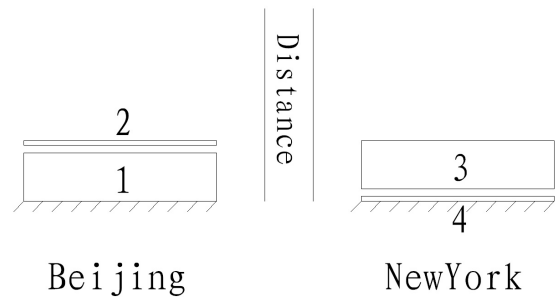

Fig.13. 1.Scalar wave generator on the transmitter side; 2.Photo of torsion field detector-SEVA; 3.Torsion field detector-SEVA on the receiver side; 4.Photo of scalar wave generator

It's very important to mention that Field Gyroscope, registered by SEVA, is a quantum object. Fig.14 show trajectories of the natural spinning vector in vicinity of different objects. The quantum nature of FG manifests itself in its small mass and visible discrete orbits. The images were obtained from a screen of the oscilloscope with SEVA, using band pass filters.

As a quantum objects, FG can demonstrate the Quantum Non-Locality, which can be a physical base of the Non-EM sessions phenomenon.

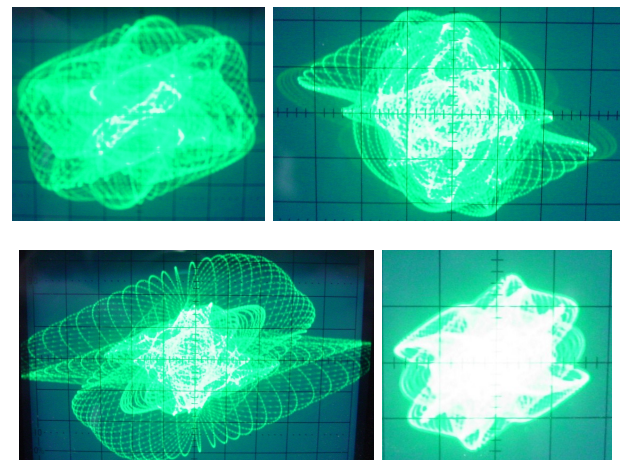

Fig.14. Trajectories of natural EMFG in vicinity of different objects

VIII. EXAMPLES OF THE NON-LINEAR EVENTS IN THE NON-EMC SESSIONS

A. May 17, 2016 Session.



Fig.15. The photo of coil part of scalar wave generator

According to the cross-image method, the photos should be placed near the other side. So on the transmitter side, the sensor part of the photo of SEVA was placed on the center of the coil part of physical scalar wave generator; at the same time, the coil part of the photo of scalar wave generator was placed under the sensor of physical SEVA.

Fig.16 shows a panoramic record of the session. It was decided to conduct the session in the interval between 13:00 – 14:00 GMT. A protocol of the transmission in Beijing was not known in New York in advance. The record was started at 12:16 GMT. In this session, the operator left the laboratory, to reduce a factor of influence of an experimenter on the experiment. At 13:30 GMT, the battery of the SEVA receiver failed. It was partially discharged. However, by the unknown reasons, the QSS record restored itself at 14:04. At 14:41 the experimenter returned to the laboratory and the instrument was turned OFF.

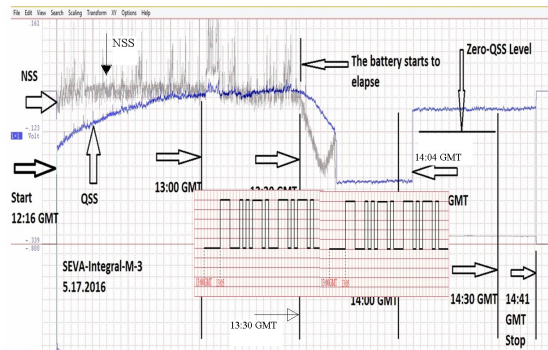

Fig.16. shows a panoramic record of the session with superimposed transmission protocol. The transmission protocol was composed of two identical 17 min sessions having 10 min interval between them.

Fig.17 shows the first part of the original Protocol of the transmission of May 17th 2016.

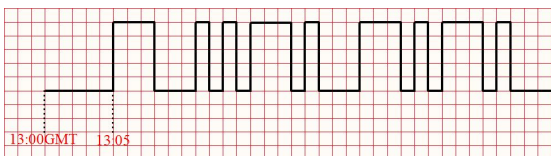

Fig.17. Original protocol of the transmission in Beijing on May 17th 2016.

The encoded mode was Morse code and the protocol on the transmitter side is shown in Fig.17. The meaning of the Morse code is three letters: TFC. In this protocol, one point was one minute long, one line was three minutes long, and the interval between letters was three minutes long. The protocol of Morse code was written into the MCU with C language, who controlled the relay to turn on and off. The promissory time scale was from 13:00GMT to 14:00GMT.

Our first approach was to estimate the results in terms of the classical Cause-and-Effect link. Indeed, we see some spikes of QSS and NSS at 13:02 GMT, by the computer clock in New York. **However, it has to be stressed here that the classical correlation method for transmission and reception is not applicable here in full due to the principal difference between EMC and TFC, shown above.** It has to be taken into consideration that a temporal accuracy of the experiment can be at least ± 2 minutes, due to a routine discrepancy of computer clocks in Beijing and New York. The very first dash in the message lasts 3 minutes and it is visible on the record within mutual accuracy of the computers clocks. We also see some variation of QSS and NSS at further transmission of the dashes and dots. It's also interesting to note, that some recovery of NSS signal at 13:37 coincides with ending of the first portion of the Protocol.

The visible rise of QSS before the transmission is nothing but the *Driving Field Gyroscope up to Speed Phenomenon* [28].

B. May 24th, 2016 Session. The Manifestation of the Synchronicity.

Fig.18 shows a protocol of the transmission in Beijing.

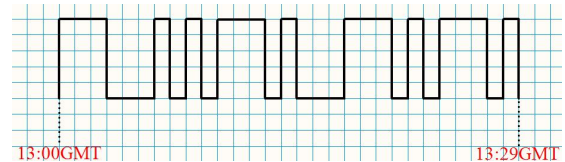

Fig.18. A protocol of May 24th 2016 transmission in Beijing.

It has to be said about the events, preceding this experiment. The experimenter left his home in advance and was walking to the laboratory. While walking, there was an approaching woman speaking with a mobile phone. When they overtook, she said to the phone: China. The experimenter kept walking and, not far away from the laboratory, there was an old lady sitting on a bench. She was exclaiming scrappy pieces of phrases and, when the experimenter was next to her bench, she exclaimed No Way!

The record of the experiment vanished and the phrases, heard before the experiment, together composed a message: “China. No way!” as a prediction of the outcome of the experiment. That was a typical manifestation of the Synchronicity.

The image of the transmitter in Beijing was left under the sensor of SEVA during 30 hours after the experiment.

The experimenter came back to the laboratory next day and decided to record the Phantom signal, which could be imprinted in the image. Then the record was done with no image under the sensor. Fig.19 shows the result. The upper portion shows the record with the image under the sensor, while the lower one is that with no the image. The upper portion reveals clear pulses, especially seen for NSS mode. The record with no image (the lower portion) looks more chaotic.

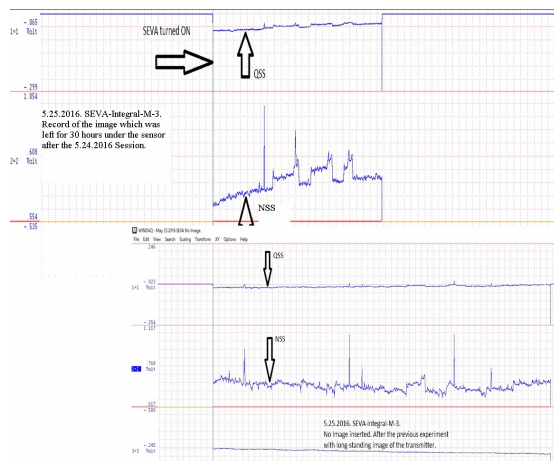

Fig.19. The upper portion- Record of QSS and NSS signals after the image of the transmitter was left for 30 hours under SEVA sensor, the next day after the previous experiment; the lower portion – the record after removal the image.

C. May 29th, 2016 Session

For this session, the configuration was the same to previous one. However, the protocol was different this time. Fig.20 shows the protocol of transmission in Beijing. The meaning of the Morse code is two letters: SW. The promissory time scale was from 14:00GMT to 14:30GMT. This time there were two data packages, and the interval between the two packages was seven minutes long.

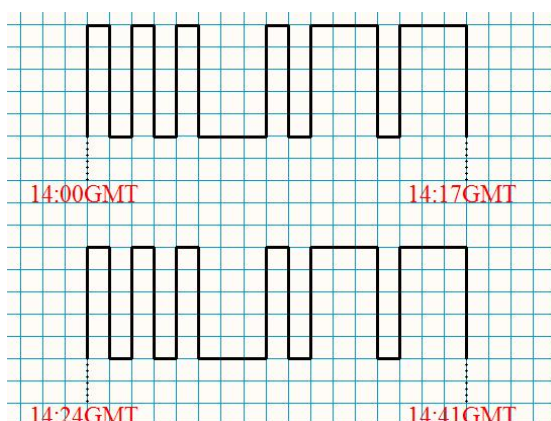

Fig.20. shows the protocol of transmission in Beijing.

Fig.21 shows a panoramic record of the session with the superimposed protocol of transmission.

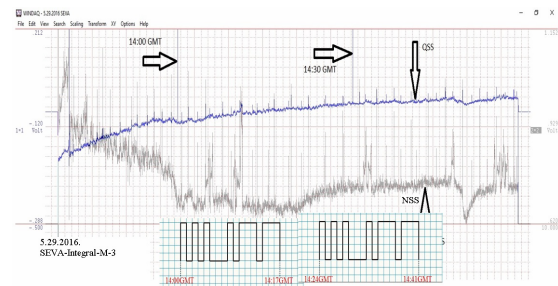

Fig.21. The panoramic record of the session. 14:00 GMT corresponds to the start of the transmission, according to Fig.23

Fig.22 shows computer-processed signals of the experiment in vicinity of 14:00 GMT. The csv format, implemented in DATAQ DI-149 software, was employed. This enables to extract even seemingly weak signals and to represent them in a more contrast way.

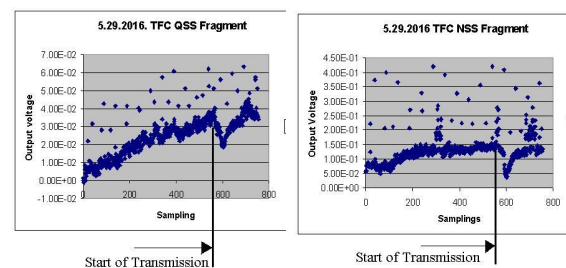

Fig.22. Computer-processed signals in vicinity of 14:00 GMT

In this experiment, it's obviously seen that the start of the transmission in Beijing is accompanied with a variation of the derivative and the level of the signal in New York. There are notable spikes of NSS, which coincide, with the first portion of the Transmission Protocol. Then, there is a plateau and, at 14:21 on New York computer, the NSS starts to grow again. This is pretty corresponds to beginning of the second portion of the Protocol, within a mutual error of the computer clocks in Beijing and New York. We also see the spikes at 14:32 of the computer in New York, what is in a good match with a beginning of the second letter in a second portion of the message. We also see a spike activity, which starts at 14:46 GMT of the computer in New York. This can be related to the end of the transmission and some non-linear aftermath phenomena.

D. June 13th, 2016 Session

Unlike the previous sessions, in this one a partial shielding of the sensor was employed. The sensor was put in a static bag, what partially reduced the field inside.

Fig.23 shows a Protocol of the Transmission in Beijing.

Fig.24 shows a panoramic record of the Session. First, what we see is a smooth character of the record, not like in the previous sessions. However, there are variations of the signal anyway. Fig.25 shows a stretched image of NSS signal, and we see notable oscillations of the signal in vicinity of 14:00 GMT.

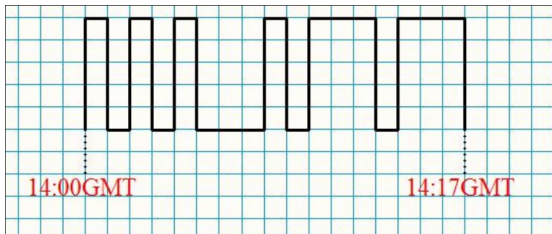

Fig.23. The Transmission Protocol in Beijing, June 13th, 2016

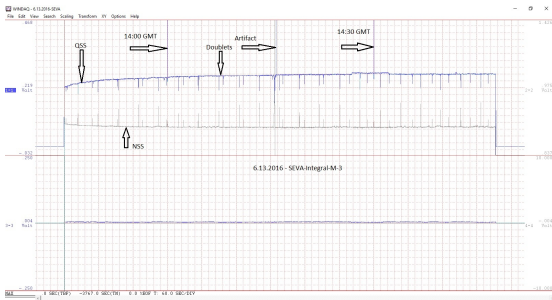

Fig.24. Panoramic record of June 13th 2016 session, where partial shielding of the sensor was employed.

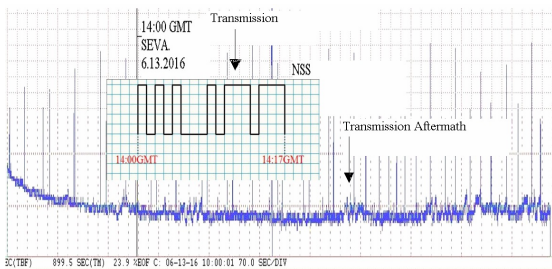

Fig.25. The stretched portion of NSS record of June 13th, 2016. 1 horizontal division = 70 seconds

E. November 28th, 2016 Session

In this session, the configuration changed a lot. On the transmitter side, the high power mode of scalar wave generator was used; the amplifier is about 45 watts. The position of the photo on transmitter side was different too; it is near the sphere antenna this time but not on the coil. The schematic diagram is on Fig.26; and physical diagram is on Fig.27:

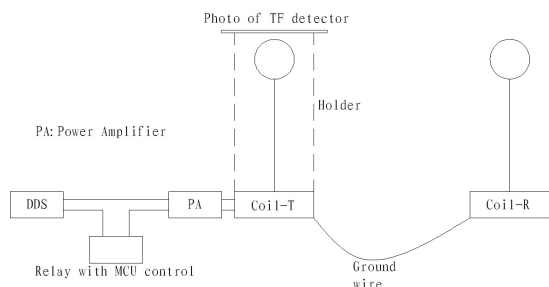

Fig.26. the schematic diagram on transmitter side for November 28th, 2016 Session

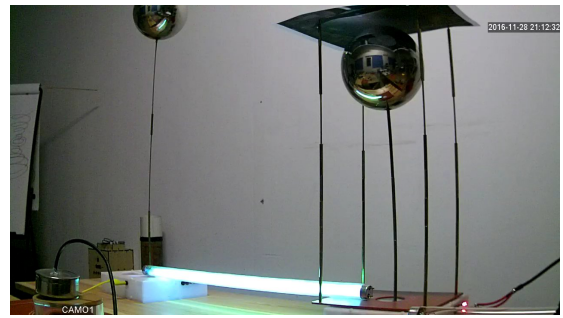

Fig.27. The physical diagram on transmitter side for November 28th, 2016 Session (a state of the transmitter: ON)

Because of the new configuration, the previous photos can't be used for November 28th, 2016 Session any more. So, new photos should be taken for current experiment. The photo of scalar wave generator is in Fig.28 and the photo of the sensor of SEVA is in Fig.29. Because this time, the sphere antenna was used as the efficient area, so the photo of SEVA should be placed on the top of the sphere antenna. In addition, at the same time, the sphere part of the photo of scalar wave generator should be placed under the physical sensor part of the SEVA.

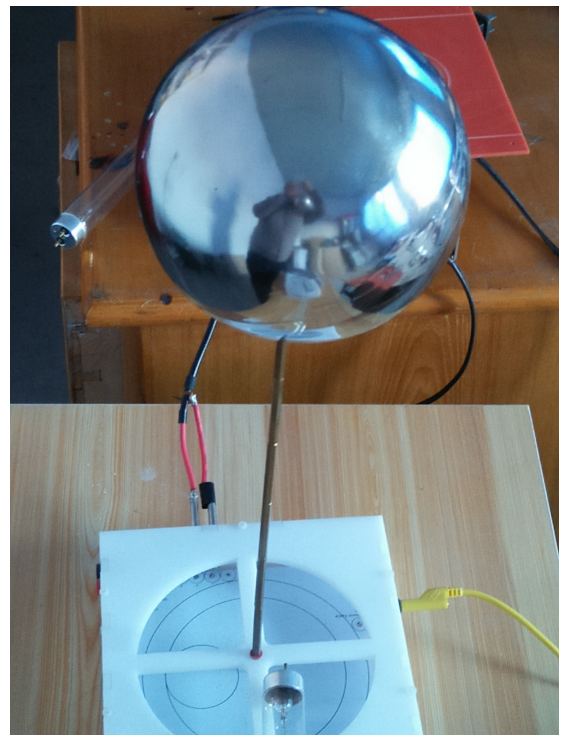

Fig.28. The photo of scalar wave generator for November 28th, 2016 Session

Fig.30 shows the Transmission Protocol in Beijing. It repeats some of the previous ones, but the real time was changed from 14:00 GMT to 13:00 GMT. Therefore, the transmission was started at 13:00 GMT. This time there are two data packages, and the interval between the two packages is seven minutes long.



Fig.29.The photo of the sensor of SEVA for November 28th, 2016 Session

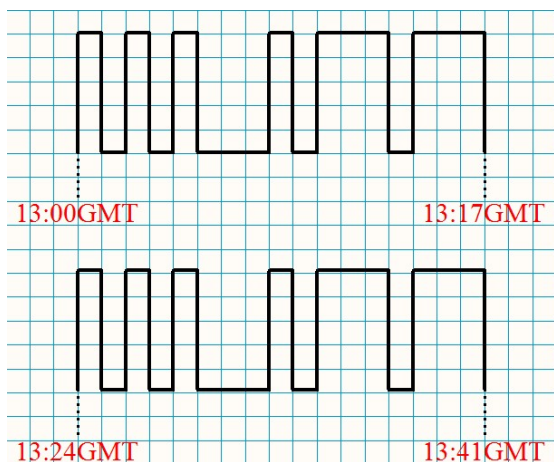

Fig.30. The Transmission Protocol of November 28th 2016.

Fig.31 shows a panoramic record of the experiment, while Fig.32 shows its stretched portion.

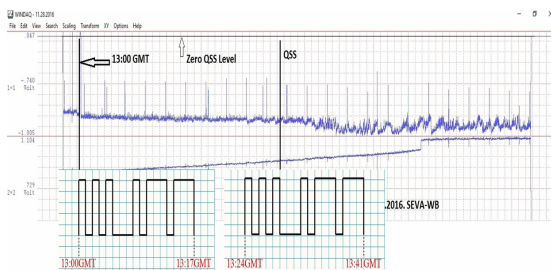

Fig.31.The panoramic record of the experiment, where the transmission was started at 13:00 GMT.

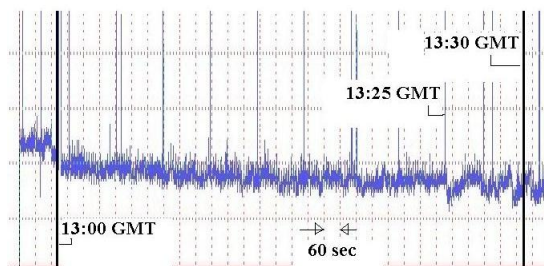

Fig.32.The stretched QSS portion of the November 28th reception. An amplitude of the signal increases as the transmission starts, according to Fig.31.

In this record, we see that variation of QSS starts at 13:33 GMT. It corresponds to the second letter of the second portion of the Protocol. Generally, the record lives an impression that all the reception in New York was delayed in spite of the real transmission in Beijing. Nevertheless, we see some obvious step of QSS at very beginning of the transmission at 13:00. This combination of one correlating fact (13:00 GMT) and the obvious delayed reception looks like a non-linear phenomenon.

It has to be also said that, in this session, a newly made instrument was employed and presence of accumulated Phantoms (remaining spinning field) on its sensor was minimal, therefore.

F. The Spikes

The periodic narrow spikes, seen in all the records, can be a manifestation of Cosmic Shocks – fundamental periodical Space events, which regulate a personal fate of a human being as well as the fate of the Mankind, depending on a choice of a subject – to respond or to react [29]. Their periodicity can count from many millions of years up to hours. The seen spike can be nothing, but the higher harmonics of the Space Shocks.

G. Analysis of the difference between the November 28th, 2016 Session and previous sessions

From the results of SEVA, only the QSS(Quasi-Stationary Spinning) channel of SEVA has reaction for the non-local interaction from the transmitter side for session 5.

Authors believe that the difference is caused by the difference on the transmitter side – the different position of photo of SEVA. It can be seen that the photo of SEVA was placed on the pancake coil of Coil-R in scalar wave generator in previous sessions, but in the November 28th, 2016 Session, the photo of SEVA was placed on the top of sphere antenna of Coil-T in scalar wave generator.

There are some relationships between the November 28th, 2016 Session and one of author's previous work, in which author proved experimentally that the nature of scalar wave was torsion field [26]. The torsion field generated on the top of the sphere antenna of scalar wave generator can rotate a light wooden frame hanging on the top of the sphere antenna. In addition, there is regularity in the movement of wooden frame. Authors believe the regular movement is caused by the generated torsion field, which is a QSS type. So in November 28th, 2016 Session, the photo of torsion field detector was at the same position with the wooden frame in [26], accordingly there was reaction only in the QSS channel of SEVA far away from transmitter side non-locally. On the other hand, from the condition of scalar wave, standing wave structure is formed between Coil-T and Coil-R at right frequency. The structure is stable, if the standing wave was cut into slices through the vertical direction with wave direction, and then in every slice, there is QSS type torsion field with different diameters. Therefore, the photo on the top

of sphere antenna is very thin, just like in a slice. It's the same with the condition impacted by a QSS type torsion field generator.

In the previous three sessions, the photo of SEVA was placed on the coil of Coil-R in scalar wave generator. The coil is pancake type, the standing wave is formed not only in the space between the two sphere antennas, but also along the copper wire on the PCB, which is winded around from outside to center. Therefore, along the wire, there is much torsion field or vortex with different diameters and different directions because of the spiral structure of coil formed. So in the coil area, the torsion field is belong to NSS type. Thus, it can be seen that there is obvious reaction in the NSS channel of SEVA for previous sessions.

IX. CONCLUSION

- In these experiments, we see a combination of events, which coincide with the Transmission Protocol, especially at very beginning of the sessions, as well as a strange behavior of the recorded signals, which violates the cause-and-effect principle. Yet, we encountered strange events of the Synchronicity type, accompanying the experiments (May 17th and 24th experiments). This general behavior is depicted pretty well with Fig. 6, which combines both a conventional behavior of the reception and that related to the Synchronicity. It stimulates a search of more advanced methods of detection of Subtle Field messages, for instance, like that shown in Fig.8, where the Non-EM signal are considered as complex numbers.
- There is a difference between QSS and NSS reception. Non-stationary spinning, NSS, amplitude exceeds that for the Quasi-stationary, QSS one by a simple reason: the QSS process is formed by identical lines of the spectrum, shifted in a phase, while the NSS is formed by all the combinations of the spectral lines of the spectrum. Therefore, the energy of NSS exceeds that for QSS.
May be, because of this reason, some delay effect was noted in some cases for QSS, while for NSS the torsion field detector can react more quickly. The NSS type of torsion field is more suitable for the purpose of TFC.
- The non-stationary spinning, NSS, of the Field Gyroscope includes its precession which, like it takes place for the mechanical gyroscope, can be caused by gravitation. In turn, the gravitation represents local space-time distortions. In this case, the distortions can be caused by coming information which causes the spikes of NSS.
- The fading effect, which is typical for the non-linear phenomena, also was noted in these sessions: first manifestations of the receptions were more contrast than the following ones.
- The result of June 13th 2016 session, where the partial electromagnetic shielding of the sensor was employed and, as a result, the variations of the signal were pretty smooth, unlike other sessions, suggests that the Torsion Fields/Non-Electromagnetic Fields/

Scalar Waves experience a transformation into the Electromagnetic Fields as soon as they encounter a coupling agent/an info linkage/an address sign (a common image and so on). Then EM field is registered by our EM-based instruments.

Moreover, the author believe in that there is no classical propagation process in Non-EMC at all, but rather the instrument extracts the information from the World Hologram, having the coupling agent in its vicinity.

REFERENCES

- [1] A. E. Akimov. Torsion communications of the third millennium. *International Conference: Modern Telecommunication Technologies*, 1995.
- [2] https://en.wikipedia.org/wiki/Bifilar_coil.
- [3] Amit Goswami. *The self-aware universe: How consciousness creates the material world*. Penguin, 1993.
- [4] F David Peat. *Synchronicity: The bridge between matter and mind*. 1987.
- [5] Jeffrey Stuart Keen. Psi-lines, chaos, spirals, magnetism, and entanglement. *NeuroQuantology*, 10(3), 2012.
- [6] M. Krinker. On the fading informational contrast during sequent measurements(in russian). *International Journal of Unconventional Science*, (7(3)):134, 2015.
- [7] M. Krinker. The crisis of the classical metrology at subtle-field interactions research(in russian). *International Journal of Unconventional Science*, (8(3)):76–94, 2015.
- [8] Mark Krinker and Larry Pismenny. *What stands beyond dowsing and feng shui*. New York, 2006.
- [9] Mark Krinker and Aron Goykadosh. Role of de broglie waves on origination of non-linear phenomena in torsion field and spin-to-spin interaction experiments. In *Systems, Applications and Technology Conference (LISAT), 2013 IEEE Long Island*, pages 1–7. IEEE, 2013.
- [10] Juan Maldacena. Black holes and wormholes and the secrets of quantum spacetime. *Scientific American*, 315(5):26, 2016.
- [11] Смирнов, АЮ. Гипотеза о существовании и структуре кода информационных взаимодействий. *Тезисы докладов Первого международного симпозиума «Фундаментальные науки и альтернативная медицина»*, Пуццино, page 85, 1997.
- [12] Смирнов, АЮ. Дальние нелокальные взаимодействия могут определяться торсионными возбуждениями и волнами в виртуальной плазме физического вакуума (гипотезы, концептуальный и качественный анализ). Торсионные поля и информационные взаимодействия–2012: Материалы III-й Международной конференции. *Москва*, pages 15–16, 2012.
- [13] Охатрин А.Ф. Охатрин А.А. Охатрин Ф.А. Ломоносов М.Н. Сизов В.С. Касьянов В.В. Способ Энергоинформационной Связи и Устройство для его Осуществления, 2000. Patent RU 2159009.
- [14] В.Т.Шкатов. Патент РФ 2201133 с приоритетом от 30.09.1999, 1999. Patent RU 2201133.
- [15] Victor Shkatov and Vitaliy Zamsha. Torsion field and interstellar communication, 2015.
- [16] М.Кринкер. К Вопросу Увеличения Отношения Сигнал/Шум в Процессе Торсионной Передачи Информации. In *Conference in Moscow: Torsion Fields and Informational Interactions*, pages 220–222. Second Physics, 2012.
- [17] M. Krinker. Methods and instruments to increase a signal-to-noise ratio in the image-addressing-based torsion field communication. In *Conference in Moscow: Torsion Fields and Informational Interactions*, pages 148–152. Second Physics, 2016.
- [18] В.А. Жигалова. *Эксперименты с Генераторами и Детекторами Торсионного Поля. Сборник Работ*. “Фолиум” Москва, 2014.
- [19] M. Krinker. An attempt of distant monitoring remote objects(in russian). *International Journal of Unconventional Science*, (9(3)):66–69, 2015.

- [20] M. Krinker. On increase of the signal-to-noise ratio in torsion-based sessions of transmitting information(in russian). In *Conference in Moscow: Torsion Fields and Informational Interactions*, pages 220–222. Second Physics, 2012.
- [21] Бобров, Андрей Владимирович. ЯВЛЕНИЕ ИНФОРМАЦИОННОГО ВЗАИМОДЕЙСТВИЯ СПИНОВЫХ ПОЛЕЙ МАТЕРИАЛЬНЫХ ОБЪЕКТОВ В БИОЛОГИИ. In *Труды конференции, Москва*, pages 151–162, 2012.
- [22] А.В. Бобров. Свойства Информационных Полей. In *Конференция: Биополевые Взаимодействия и Медицинские Технологии*, pages 102–106, 2008.
- [23] Nikola Tesla. Apparatus for transmission of electrical energy., May 15 1900. US Patent 649,621.
- [24] Meyl Konstantin. *Documentation (1) on Scalar Wave Technology*. INDEL G mb H Verlagsabteilung.
- [25] Meyl Konstantin. Dna and cell resonance. *INDEL G mb H Verlagsabteilung, Villingen-Schwenningen,(2ndedn), Germany*, 2011.
- [26] Gao Peng. Attempts to detect the torsion field nature of scalar wave generated by dual tesla coil system. In *Torsion fields and information interactions - 2016: Materials of the V-th International Scientific and Practical Conference*, pages 258–270. Second Physics, 2016.
- [27] M Krinker. Spinning electric vector analyzer, seva. theory of operation and experimental test. *Biophysical Method. Scientific Collection*, pages 5–31, 2008.
- [28] M. Krinker. Driving a field gyroscope up to speed by means of external actions. In *Conference in Moscow: Torsion Fields and Informational Interactions*, pages 141–147. Second Physics, 2016.
- [29] Torkom Saraydarian. *Cosmic Shocks*. TSG Enterprises, 1989.