

The human oral-cavity-NA-AC-Hypothalamic axis on the developing of emotional intelligence, creativity and innovation

Dr. Alfred Bennun
Full Professor Emeritus of Biochemistry
Rutgers University

Abstract

7-transmembrane (7TM)-hormonal receptors with by noradrenaline (NA) bind activate adenylate cyclase (AC). The dendrites at the oral-cavity of NA-AC-Hypothalamic (OC-NA-AC-HT) axis have axons across the blood-brain barrier (BBB). Its function is to modulate the hypothalamic-pituitary-adrenal (HTPA) axis and its secretions into the capillary arterioles irrigating the oral cavity. The atrophy of the mammalian olfactory bulb lead humans into motor and re-adaptive brain needs. Thus, an emotional brain develops at human nurturing age. Thus, saliva hormonal communication of infants conditions by dopamine exchanges as behavioral reward. The cAMP response element binding (CREB) protein via stimulatory or inhibitory receptors (Rs and Ri) on G protein phosphorylation could stimulate signaling rewards during stages of neuronal plasticity, allowing mechanisms for conectomas development. Moreover, nurturing as a basal period allows reconfiguration of the structures of the brain itself like to 3 times improvement of the velocity of impulse transmission by axons myelination at important pathways. Infants manifest a functional amygdala and hippocampus when still have an under develop frontal brain. Emotional learning allows to bypass genetic constrains to obtain a self-cognitive level, which links to family and society experience at the unconscious level. Conformational changes release O_2 from the 4 Hemes and $2Mg^{2+}$ during deoxygenation. Mutual exclusion allows the movement of His β_2 143 to the new domain by the confluence of the positive R groups surrounding the single cavity for 2,3-DPG⁵⁻ of the deoxyHb structure. Nascent Mg^{2+} dynamics drive Na^+/K^+ membrane translocation for electrogenic action potential. The H-bonds breakdown and reconstitution involved in the conformational change, showed the energy flow sequence by mutual exclusion in oxy to deoxyHb, blood-plasma to cerebrospinal fluid (CSF) and AC conformational change from hydrophilic to hydrophobic domains. A mechanism by a switch on/off by Mg^{2+} -cAMP coordinative insertion to open DNA in a 3 helix transitory structure with bases pointed externally. Hence, allowing a localized transcription for induce gene and phenotype expression. The initial 16.33 molarity of $(H_2O)_{n=3,4}$ by H-bonds exhaustion retains randomness. The kinetics energy of solvation provides a polarity scale for unidirectional unitary sense circulatory flow for the thermogenic transitions dissipation to exclude organismal entropy. The direct link to oral cavity allows an autonomous emotional human brain. The non-polar sides tends at microtubules to generate a coherence water superposition as dimers $(H_2O \sim OH_2)$, with kinetic energy when reach the oral cavity is exhaled as a 5% vapor.

Introduction

The studies at the Weizmann Institute of Science (1964-65) showed absence of photophosphorylation reversibility in the absence of uncoupled reactants that lead to the emergence of a light-dependent and light-triggered ATPases.

The first resolution by the extraction from the chloroplast membrane of the latter denominated ATP-synthase-ATPase enzyme CF_1 allowed the reconstitution of similar percentage of photophosphorylation and the two ATPase activities.

The study of the affinities of substrate ADP/GDP and ATP/GTP showed similar changes, indicating the three enzymatic activities, have a single active site with differential conformational states [1] [2].

The ATP synthase was dependent of a tight fit within the membrane, containing the electron carrier, allowing the coupling of oxidation-reduction to proton translocation [3]. The latter, mediated by changes in the pKa of a proton acceptor R groups in CF_1 or F_1 , allowing the enzyme to undergo topological changes at its active site, magnifying vectorial transitions.

Thus, electron displacements induce ADP^{3-} to accept a phosphate to form ATP^{4-} . Hence, the mass action of protons favors the endergonic transition from a lower to a higher pH, shown by the Jagendorf's Jump [4].

The chloroplast's studies showing vectorial activities of the ATP synthase ATPase was in apparent contradiction with the principle of microscopic reversibility. The impossibility to differentiate between hot- and cold-molecules allowed a humorous description by Maxwell that such operators should be called *demons*. Figuratively, the principle describes that a single microscopic door allows transit in both senses. However, [5] to evade that incompatibility, were two doors the complementary of the vectorial senses and the door equivalent should be the H-bonds dependent protein structural change during electron transport [6] [7] [8].

An endergonic state of the enzyme will depend on the number and strength of R groups on the membrane enzyme transition from hydrophobic to hydrophilic state, because its hydration changes depend of the tendency of the bipolar water molecules to organize H-bonds. Thus, allows energy conservation at the enzyme protein level by the amphoteric response of the pKa of R-groups in the active site capable to reach equilibrium by synthesis of ATP.

The finding that $\text{CF}_1\text{-ATPase}$ requires Mg^{2+} for binding to the membrane and reconstitution of allotropic properties implicates that vectorial response may depend from both conformational change at the active site coupled to a conformational change displacing the topology of R groups in the membrane from a hydrophilic to hydrophobic conformational domain.

The regulation of metabolism and biological functions in fat cells [9], brain [10][11][12][13] and liver [14] [15] [16] [17] [18], by adenylate cyclase (AC).

Genetic restrictions impose the limits to animal's natural selection, which human control assisted to develop improvement on the species for greater genetic commercial characteristics. The period of nurturing allows to reach hormonal cognitive communication, process like language and family bonds forming individuals diversified to better conform to social pressures.

Hence, the human brain has found a pathway for self-manipulation of its body nutritional

environment. However the progressive linkage to learning to respond to social environment persist outside genetic restrictions as emotional learning, accordingly mediated by the noradrenaline activated AC, with positive feedbacks as dopamine reward secretion for individual achievement and potentiated by participating in competitive activities like sports. Hence, since societies develops tendencies for expansion, differential role for job diversification and instrumentation plus the human learning motivation for inquiring into the unknown and scientific problematic.

The thermodynamics parameters applied to evolution clearly reveals that the frequency of specie's variability is accelerated under stress. Thus, the brain noradrenaline (NA)-AC role in the fight-or-flight [19] response clearly involves requirements for a viable nutritional-territorial environment [20]. Thus, the orientation for evolution of the specie should be to seek and find a fitting environment. Accordingly, all species develop mechanisms to generate phenotypic specialization in the course of evolution. Presently, the model accepted by most biologists including myself corresponds to inherited and transmitted from the genes random contributions from combination of alleles, defining sexual differences, mutations at the DNA level. There is no reason to exclude *Homo sapiens* as well as related cousins from that characterization, which could be expanded under most models of morphological differentiations. Like those favoring survivals that a long time, are conducive to new expressions of adaptability to the territorial medium [21] [22].

The crystallography x-ray analysis by Max Perutz [23] was able to determine the quaternary structure of oxyHb and deoxyHb. The latter showed that the tetramer subunits link to a cavity accommodating a single molecule of 2,3-DPG⁵⁻ by the positivity charged are amino acid residues lining a central pocket. A decrease in pH favors the protonated forms favoring the deoxyHb formation. The two His β_1 and β_2 143 during oxygenation are changed in relative position by the quaternary restructuring topology and move to the two interphase $\beta_2\alpha_1$ and $\alpha_2\beta_1$ to participate in a new domain for 2,3-DPG binding site. Hence, the oxyHb contains duplicated interphases as 2Mg^{2+} -dependent hydrophilic domains mutually exclusive with a single 2,3-DPG-dependent domain within a

tetramer structure of the deoxyHb [24] [25] [26] [27] [28] [29] [30].

Hemoglobin and O_2/Mg^{2+} control of membrane action potential

The crystallography x-ray analysis by Max Perutz [31] was able to determine the quaternary structure of oxyHb and deoxyHb. The latter

showed that the tetramer subunits link to a cavity accommodating a single molecule of 2,3-DPG⁵⁻ by the positivity charged are amino acid residues lining a central pocket. A decrease in pH favors the protonated forms favoring the deoxyHb formation.

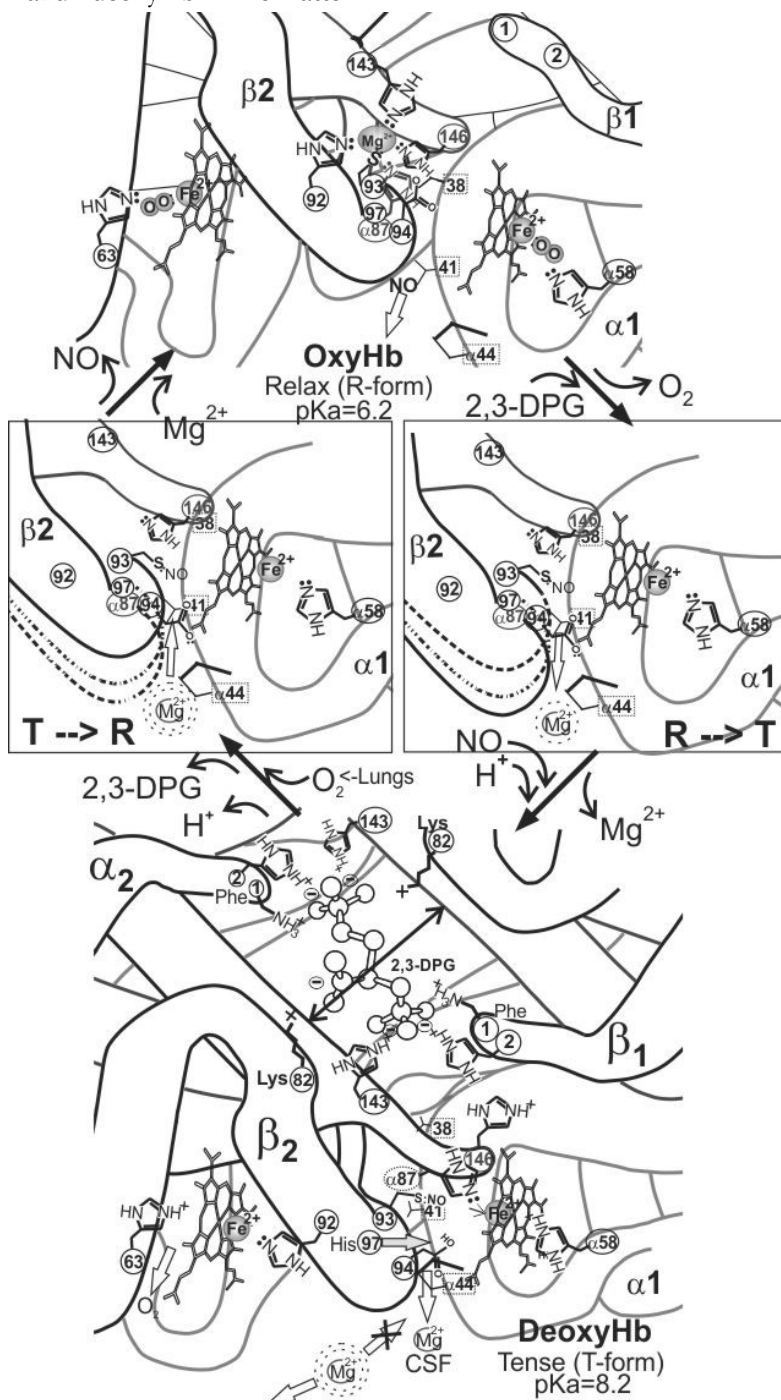

Figure 1: The four Heme oxygenation sites correspond to two dimer interfaces: $\alpha_2\beta_1$ and the illustrated $\beta_2\alpha_1$ coordinated each by Mg^{2+} for negative R group hydration within of oxyHb. This configuration became in mutually exclusive domain with the 2,3-DPG⁵⁻ hydrophobic domain in the tetramer structure of deoxyHb. Thus, at the erythrocyte, Hb release of 4O₂ jointly with the breakdown of 2 coordinated Mg^{2+} (or Mn^{2+} , Zn^{2+}) atoms and its release at tissue level, acting as a carrier for Mg^{2+} released.

Peptide bonds are rigid and fixed in a plane in where two α -carbons, 3.6 Å apart, rotate by angles ϕ (fi) and ψ (psi). The tertiary structure in the 2α and 2β polypeptide chains of Hb bends, twists and folds over and back upon imidazole R-groups. With pKa of 6.5 that at about pH 6 shows two NH bonds that share in a resonance a positive charge. Hence, the hydrophobic state form of the protein by an O₂ induce conformational changes $\alpha_1\beta_1$ dimer to rotate 15° around of other dimer $\alpha_2\beta_2$.

The two His β_1 and β_2 143 during oxygenation are changed in relative position by the quaternary restructuring topology and move to the interphase $\beta_2\alpha_1$ and $\alpha_2\beta_1$ to participate in the disruption of the 2,3-DPG binding site. Hence, the oxyHb contains two ions at the interphases: Mg²⁺-dependent hydrophilic domain, which is mutually exclusive by rotating His β_2 143. This R group the amphoteric or zwitterionic form (can react both as an acid and as a base) changes hydrophilic state to be included in positive R group domain of 2,3-DPG⁵⁻ within the tetramer structure of positive deoxyHb.

The two dimer interfaces: $\alpha_2\beta_1$ and $\beta_2\alpha_1$ link by two Mg²⁺·(H₂O)_n the dynamics of conformational change to an hydrophilic state of the protein, by chelating the R groups His β_2 92, Cys β_2 93 and Asp β_2 94, could attract sequentially the iron in the 4 hemes by His β_2 92, moving away to coordinate Mg²⁺ and coordinate to His α_1 87. The 4 irons within the 4 hemes could does move to the outside surface to interact with the distal β_63 His, increasing Hb affinity for the ligand by forming an H-bond with O₂.

The publications at Rutgers [32] [33] [34] showed conformational allosteric changes, were kinetically depend of hydrophilic configuration to form a coordinative center for Mg²⁺ (or Zn²⁺), operating the dynamics of R groups response to oxygenation.

The events at $\beta_1\alpha_2$ interphase replicate and will not be discussed of the patern show at $\beta_2\alpha_1$ interphase. The Fe ion at the deoxy heme β_2 is attracted by the Mg²⁺ and His β_2 143 (F8) is released and disorganized the 2,3-DPG stability.

The His α_1 87 (E7) moves by Mg²⁺ coordination to interact with the oxy Heme α_1 .

Thus, shows that the mutual exclusion between binding O₂ or 2,3-DPG has synchronized

the motion of R groups responding to oxygenation function.

The importance of this contribution was to show protein dynamics in reference to pressure of O₂ mass action in the orientation of hydrophilic R groups (His, Cys, Asp).

The binding of 2,3-DPG to charged positive R groups lead to hydrophobic state of the protein, with the energy potential in the protein structure in the direction of the spontaneous exergonic dissipative state and therefore the system becomes a potential dissipative thermodynamic path, between hydrophilic oxyHb and hydrophobic deoxyHb.

The dissipative potential functions from the greater atmospheric O₂ pressure to the lower one at the tissue level, became self-organized by Mg²⁺ sequential coordinative from negative residues and the amphoteric histidine. Thus, O₂ pressure creates maximizes potential by Mg²⁺ saturation through bi-, tetra-, hexa-dentate stages, and steadily releases along the differential axis of tissue consumption of O₂ delimited by lower and lower pH (the vertical human posture favors oxygenation of its brain, over that its lower extremities, absent at the quadruple posture of other mammalian).

The model explains sigmoidal binding properties (i.e. positive cooperativity) by the progressive binding by [Mg·(H₂O)₆]²⁺ from two to fourth to six coordinative states with the corresponding number of R groups.

An open system magnifies the function of the mass action of substrate concentration because the product is in a dissipative state and therefore could acquire a lower concentration than predicted from kinetic equilibrium.

Accordingly, at the brain membrane potential transmission of electric signal are potentiated well above that of thermic noises. Thus, because adrenaline could not cross the blood-brain barrier (BBB), the body became restricted to signal stress feedback, capable to turn-off the hypothalamic-pituitary-adrenal (HTPA) axis to persist in exhaustion of metabolic reserves.

This system allows the human brain to be conditioned by achievement related to the euphoric sense of an athletic successful performance, even at the cost of stressful events. The mechanism may involve the conversion of dopamine to noradrenaline (NA) by dopamine β -

monooxygenase, which occurs predominantly inside neurotransmitter vesicles.

Most vertebrate species devote between 2% and 8% of basal metabolism to the brain. In primates, however, the percentage is much higher—in humans it rises to 20–25%, a person uses about 320 calories only to think. Thus, this exceptional energy expenditure leads to autonomous thermogenesis, involved in the daily turnover consuming 450ml of cerebrospinal fluid (CSF), to be released as a 5% of vapor in exhaled air.

The oral cavity (VNO) contains the cell bodies of sensory neurons which have receptors that detect specific non-volatile (liquid) organic compounds which are conveyed to them from the saliva, environment, etc.

Nascent Mg^{2+} compete by attracting water for sizing Na^+/K^+ to allow translocation at the ions gates support of membrane potential

The erythrocyte as a carrier of the kosmotropic Mg^{2+} could function in ionic tendencies to organize the translocation of Na^+/K^+ of an active adenylate

cyclase (AC) in the regulation of the action potential of neurons.

The capture by nascent Mg^{2+} of water from the hydration shells of the less strong ions decreases the sizes of Na^+ and K^+ , fitting both to their gates, allowing across the membrane the sieve effects, which confers specific pattern to the wavelength of the action potential. Noradrenaline (NA) is contained in neuronal junction's vesicles to activate other neurons. NA activated-AC (not to confuse with adrenaline), which is not present in brain are located in the locus-coeruleus system..

The model also proposed to Hb a carrier role for the coordinated Mg^{2+} by oxyHb. Hence, when released O_2 is also released Mg^{2+} . Therefore, there is simultaneous input coupling the delivery O_2 as energy and kosmotropic Mg^{2+} , its hydration shell exchanges the water molecules number to control the hydration sphere of K^+ vs Na^+ . Thus, the latter ion could cross by the modulation of hydrated shell sizes, into corresponding channels to magnify the membrane action potential.

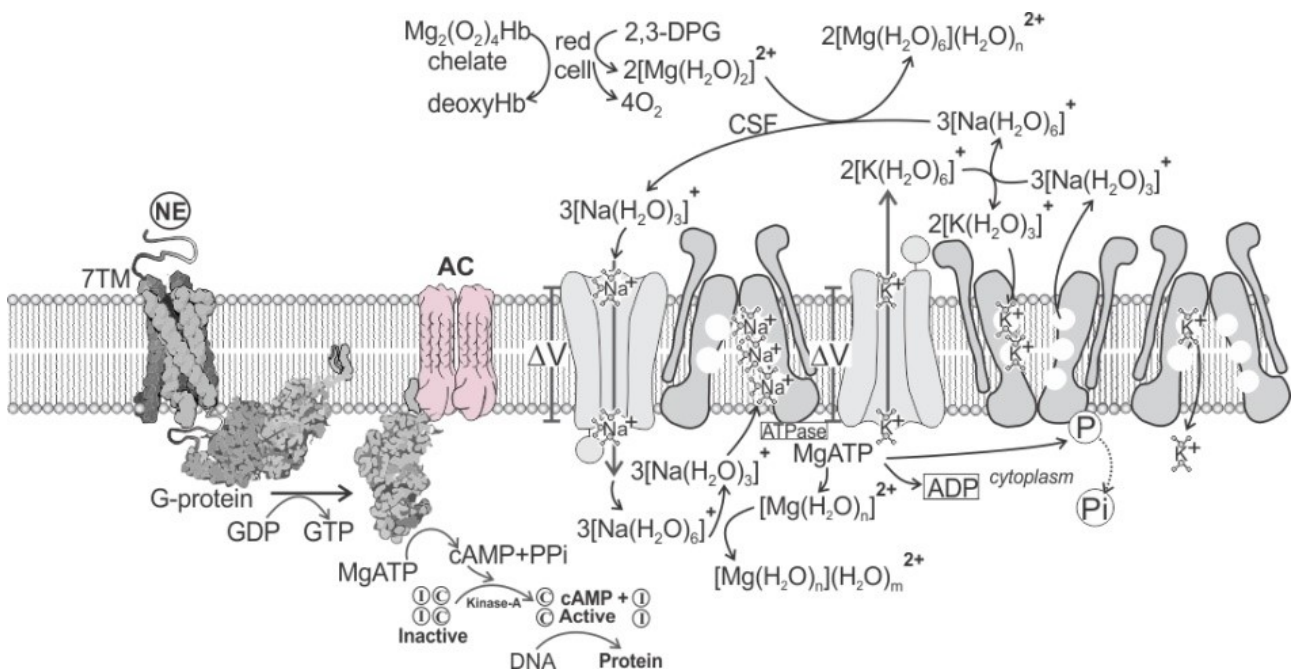

Figure 2: The mutual exclusion between oxyHb vs deoxyHb allows Hb to be a carrier of O_2 plus the hydration shell of nascent Mg^{2+} to tissues and brain demands for electrogenic action potential level. Kosmotropic tend to subtract water from the hydration spheres of proteins, to complete their own. To this group with hexagonal geometry in the first hydric layer $[(6H_2O).Na^+]$ and with octahedral geometry in the first and second hydric layers $(12H_2O).[(6H_2O).Mg^{2+}]$. The Mg^{2+} vs Ca^{2+} can compete in NA-AC by moving as ligands between two domains of the protein.

The $[(3H_2O).Na^+]$ has a smaller size that allows it to access its channel in the Na^+ pump and

subtract H_2O from the $[(6H_2O).K^+]$, cycling the hydric-ionic translocation. The Mg^{2+} is kinetically an

obligatory step for stimulation of NA-dependent AC.

As open system the accumulated mass action of substrate over dissipative product allows to a human brain to maximize neuronal transmission at much clear rate threshold over kinetic energy of temperature.

Adrenaline is coupled to the active site in AC that is coupled to 7TM G protein receptors [35] activated by a GTP cycle [36] [37]. NA is released by the long axons of neurons [38] of the locus-coeruleus into the synaptic junctions for sensorial-integrated perception between many brain areas. The activation of the Na⁺/K⁺-ATPase pump [39] release nascent Mg²⁺, by decreasing [ATP⁺], which has an inhibitory effect on AC.

The energetic contribution of the H-bond is related by hydration of the negative R groups, usually coordinated by a metal (Mg²⁺) which configures a hydrophilic state. The H-bonds breakdown value is about: -5 kcal/mol utilized to configure a conformational change by mutual exclusion changing to a hydrophobic state. This could be cycled as a vectorial function of hydric-ionic translocation, participating into the active site for enzyme state turnover.

In response to the nervous impulse, their hydric and dipolar states can change by dynamics of the H-bonds could manifest discrete states of molecular vibration, at 36.6°C. The brain maintains a steady state in which small changes that last between 200 and 2000 ns do not alter the frequency. Quantum mechanics describes them as wave, phonon.

Glycerol titration displaced 16 H₂O from the ATPase hydration sphere to reach inactivation according to Hill plot used to measure cooperativity of solvation state of the enzyme [40]. Effect that correlates the dynamics of H-bonds with the transition/hydration states that activate ATPase. Mg²⁺ as a chelating loses its hydration shell, so the enzyme when hydrolyzing MgATP⁺ releases Mg²⁺, which tends to complete its hydration state. This Mg²⁺ has the potential to subtract H₂O from the hydration state of [(6H₂O).Na⁺].

The thermodynamics of the brain develops by structuring an autonomous open-system

Science usually supports to investigate many mechanisms to obtain a more general perspective. The evolution could be genetic, phenotypic plasticity, epigenetic development and non-genetic inheritance. The organism themselves, adapt to variation and selectable innovations.

In many animals, the olfactory bulb [41] integrates motor function, which allowed their offspring to reach self-care, in a short time. In the human atrophy of the olfactory bulb leads the loss of newborn baby brain projections and connection to open an emotional-learning-cognitive pathway to maturity.

Thus, for example, the lack of response of the sympathetic motor system, carried by the hypothalamospinal tract, could not become consolidated until the infant [42] learn to walk. Thus, lead to infer that opens a learning period through emotional communication, which allows humans to develop an emotional brain and emotional intelligence. This event has evolved out of genetic restriction, but responds to a pathway introducing self-rewards feedbacks like achievement. Thus, could emanate from competition that human evolution consolidates behavioral coupled to reasoning as an expectation response for emotional reward.

Hence, impulses by emotional support could be can a natural society, boosting the role of creativity. Additionally, could develop plasticity by restructuring important brain connections as the myelination of axons, which improves by about 300% the velocity of the action potential transmission.

The origin of cognition and memory could be attributed to the post-natal, scent-smell communication memory of human infants.

The cffDNA is from the fetal vestige cells by atrophy of the olfactory bulb organ in human and from its remainder an olfactory epithelium [43]. The cfDNA circulating in the maternal blood originates from cells shed from placental trophoblasts microparticles [44], disappears after two hours from delivery.

The activation of Mg²⁺ stimulated adenylate cyclase results in cAMP production, which in the newborn cerebrospinal fluid (CSF) unzipping of the cell-free DNA (cfDNA) and cell-free fetal DNA (cffDNA), for mRNA production in the glial cells of cortical, hippocampal, and spinal cord. The

responses to oxytocin, released from posterior pituitary results in the development of bonding memory.

Prenatal diagnosis targets on the cffDNA analysis show correspondence with the gene responsible for the sex-determining region Y protein (SRY) on the Y chromosome and the DYS14 sequence [45] [46].

Degraded cell-free fetal DNA (cffDNA) fragments [47] released to the blood plasma, could not correspond with a characteristic expression of the genetic DNA in the nuclei, which is transmissible to the progeny. This, will involve duplication of DNA [48] preserved in the neuronal nuclei, from where, according to genetics should have been, transmitted by successive generation. Conditioning could on the other hands implicate anticipatory memory, for appetitive which is present as a reflex. The reflex conditioning response has been described by Pavlov using dog's experimental studies. The human brain could be characterized by reflexive behavior rather than genetically triggered reflexes, which appears to be hormonal configured, generating an emotional intelligence.

Genetic vs environmental experiential learning along the nurturing context of emotional intelligence development

Genes account for between approximately 50% and 70% of the variation in cognition at the population level.

A connectome is a comprehensive map of neural connections in the brain, and may be thought of as its "wiring diagram". An organism's nervous system is made up of neurons which communicate through synapses. A connectome is constructed by tracing the neuron in a nervous system and mapping where neurons are connected through synapses.

During childhood, cognitive abilities dramatically improve to make us who we are: persons capable of multiple academic, social, and professional activities [49].

IQ differences between individuals have been shown to have a large hereditary component. However, it does not mean at groups-level exist evidence for a genetic component between racial groups.

The results suggest a synchrony between gender-related differences in the brain network and behavior [50].

During nurturing conectomas for sex differentiation had been characterized in men by prefrontal to visual cortex and in woman by transversal.

Stronger structural connectivity in motor, sensory, and executive functions matched higher spatial and motor skills in men. In men, there is increased neural connectivity within one hemisphere of the brain. Thus, suggesting that men's brains are structured to facilitate connectivity and coordination between perception and action.

In women, there are stronger neural connections between both cerebral hemispheres, which would facilitate communication between the analytical mind and intuition. In women, the subnets associated with social cognition, attention and memory showed greater connectivity, which was consistent with higher cognitive-social and memory skills in women than in men.

No differences have been found in the size of the corpus callosum or in the white matter, which allows the two sides of the brain to communicate with each other.

Studies of human patterns resulting from interaction of mother-infant separation, as related with decreased glucocorticoid receptor gene methylation of post-traumatic from early life stress.

The oral-cavity-brain axis signaling emotional communication

In the newborn human, the residual structure from evolutionary deletion of the olfactory sense allows a memory unable to coordinate muscles most likely the sympathetic motor pathway has yet to be integrated. This process requires a long period of parental care, before reaching the brain structure of neuronal circuits, capable to support muscular interaction and development through a cognitive visual-hearing language.

The locus coeruleus contains about 6×10^4 NA-AC neurons characterized by their very long axons reaching almost every region. Thus, inputs from saliva at the 7TM receptors of AC, located at the rostral-oral-cavity could cross the blood brain barrier (BBB) [51]. Thus, hormones at the oral cavity could activate the hypothalamic-pituitary-adrenal

(HTPA) axis. Thus, hormonal glands secretion at the arterioles irrigating the oral cavity could represent a near autonomous hormonal signaling control of behavior, through the emotional responses of the oral-cavity-NA-AC-Hypothalamic (OC-NA-AC-HT) axis.

Moreover, the sensorial 7TM hormonal receptor structure of NA activated AC at the locus coeruleus from distant regions, could integrate the five senses (sound, smells, touch, visual and

gustatory regions) into simultaneous multiple perception associated to emotional events.

The auditory cortex processes ear signals. The neuronal network responses for attention, only when the dorsolateral prefrontal cortex and a part of the parietal cortex are simultaneously activated, resulting in acoustic signals constant as more discernible because human ability to integrate the visual perception of lips movement.

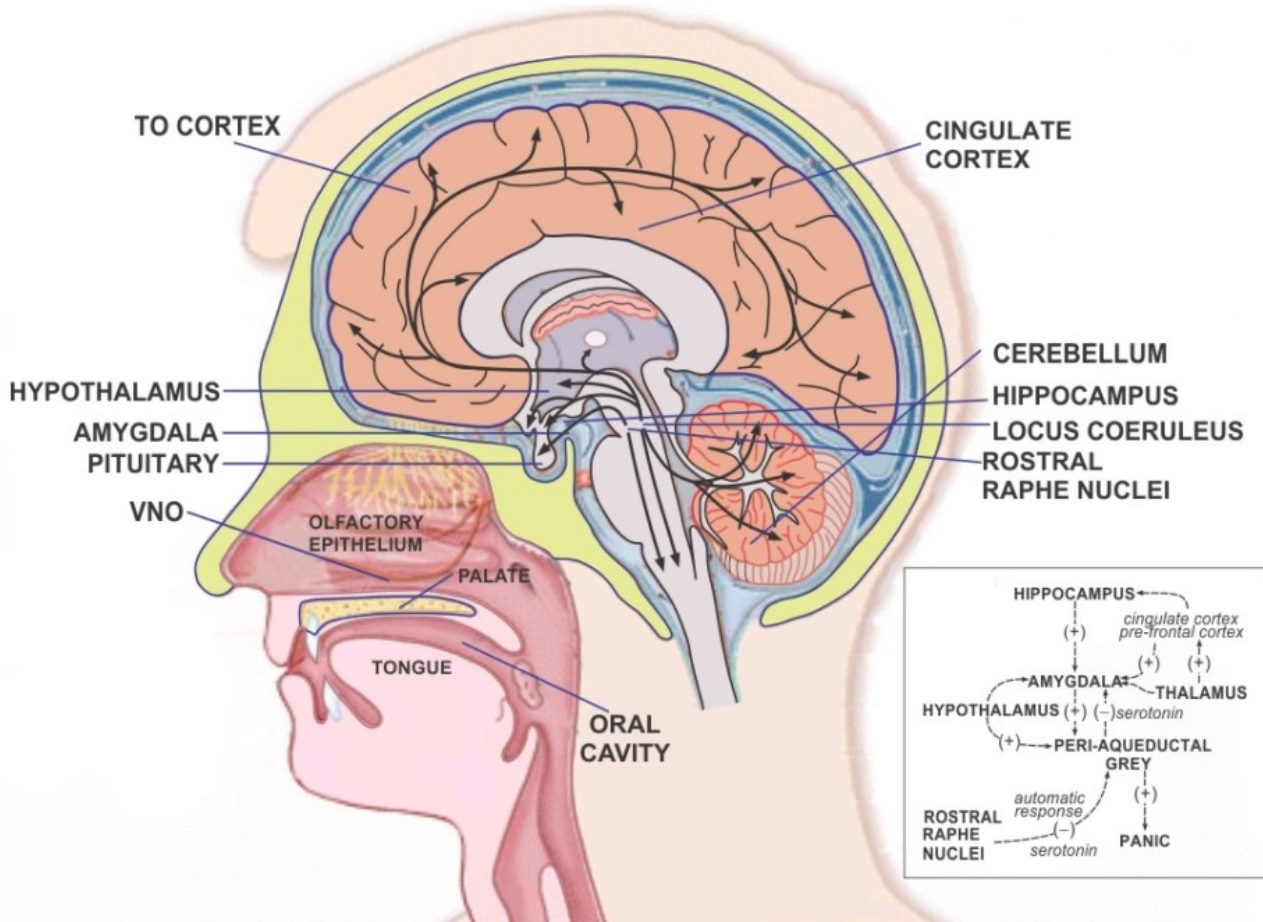

Figure 3: Emotional cognitive connection at the oral-cavity-hypothalamic-NA-AC-brain axis. The hypothalamus (bidirectional) receives projections from sympathetic motor system (carried by the hypothalamospinal tract and they activate the sympathetic motor pathway), from the medial forebrain bundle carried by the mammillothalamic tract. Thus, notable inputs are from the nucleus of the ventrolateral medulla and locus coeruleus.

The implanting of micro-electrodes of low voltage to stimulate the frontal cortex communication knot with the deep brain at the limbic centers related to emotions, memory and learning of the hyperactive depressed patients were calm down. Thus, shows that reason and emotion are link by a crossing turnover. The oral-cavity-hypothalamic-brain axis appears to provide an alternative therapeutic medication to the brain implantation of electrodes. It is suggested a

treatment localized at VNO and/or the surrounding palate areas with stimulatory procedures either: electric discharge or pharmacological access to hormones like oxytocin, dopamine, NA, etc.

Synaptic strengthening is promoted by oxytocin and dopamine for maternal cognitive memory [52].

Oxytocin release into nucleus accumbens shell is also activated by vaginocervical and lactation stimulation.

The paraventricular hypothalamic area is the source of oxytocin input into nucleus accumbens shell, which is signal by dopamine for reward-seeking behaviors.

Adrenaline, oxytocin and dopamine rewards link the emotional responses, coupling with the cognitive reasoning pathways originated at the amygdala and the hippocampus.

Periodic breaks and breathing times at work do the brain good. An important control center (the

prefrontal cortex) sends signals to deeper and older brain regions: the hippocampus and the amygdala, decreasing stress. This interaction favors the transmission of social information, and the development of selective recognition.

The hypothalamic-pituitary-adrenal axis control on the psychosomatic metabolic network

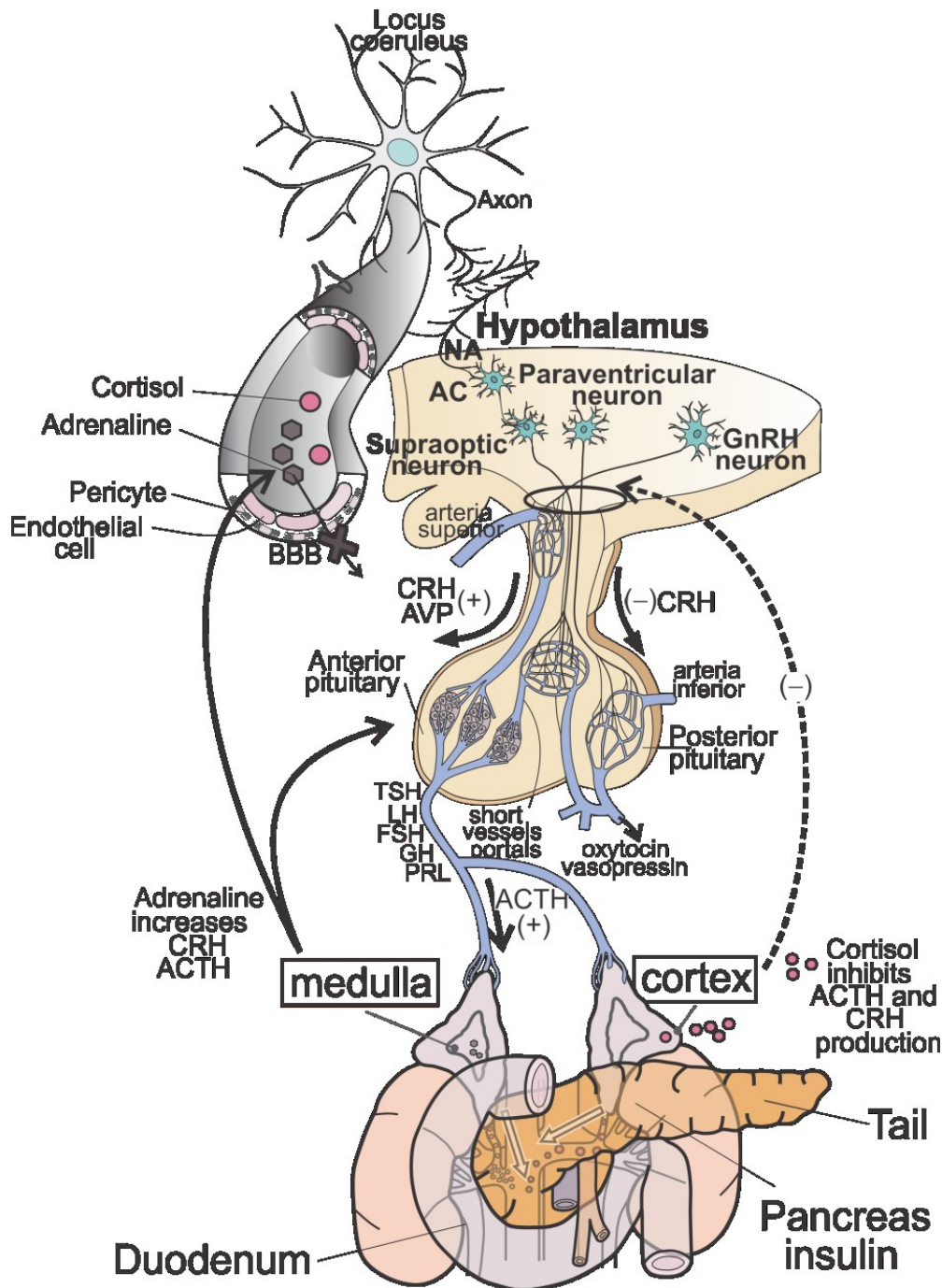

Figure 4: The 7TM hormones receptors at the oral cavity binding NA could activate the hypothalamic-AC with axons oriented to cross the blood-brain barrier (BBB) for impulse activation of the HTPA axis. The brain-NA-AC activity does not respond to adrenaline, which could not cross the BBB. Thus, the adrenaline activated AC of

fat, liver, etc. at tissue level, by not reaching cerebrospinal fluid (CSF) could not exert feedback inhibition over the brain enzyme, and allows cerebral dominance over its metabolic supporting tissue network.

The characterization of the overstimulation of the NA-enzyme AC system (7TM-AC) of the hypothalamic-pituitary-adrenal (HTPA) axis could turn-on the fight-or-flight response [53]. The increment of adrenaline secretion [54], but without entering the cerebrospinal fluid (CSF) [55], shifts body metabolism in the direction of depleting metabolic reserves like fats and cortisol releasing amino acids from proteins to brain itself by control of gluconeogenesis. This mechanism is based in the absence of negative feedback by adrenaline. The latter could not cross the blood-brain barrier (BBB) and therefore have only an incomplete control over the inhibitory signaling, allowing to stop adrenal secretion.

The oral-cavity has a vomeronasal opening at the palate

A metabolic perspective could explain the function and structure thermodynamics advantage of assigning to the brain, unchallenging nutritional control for maximizing its own development.

Thus, a brain pattern of emotional-hormonal control, over metabolic supporting functions, may participate on the psychosomatic bases of the unconscious [56]. Accordingly explain how emotional rewards are granted for human competitions adding a selective control response to the primitive animal fight-or-flight conditioning.

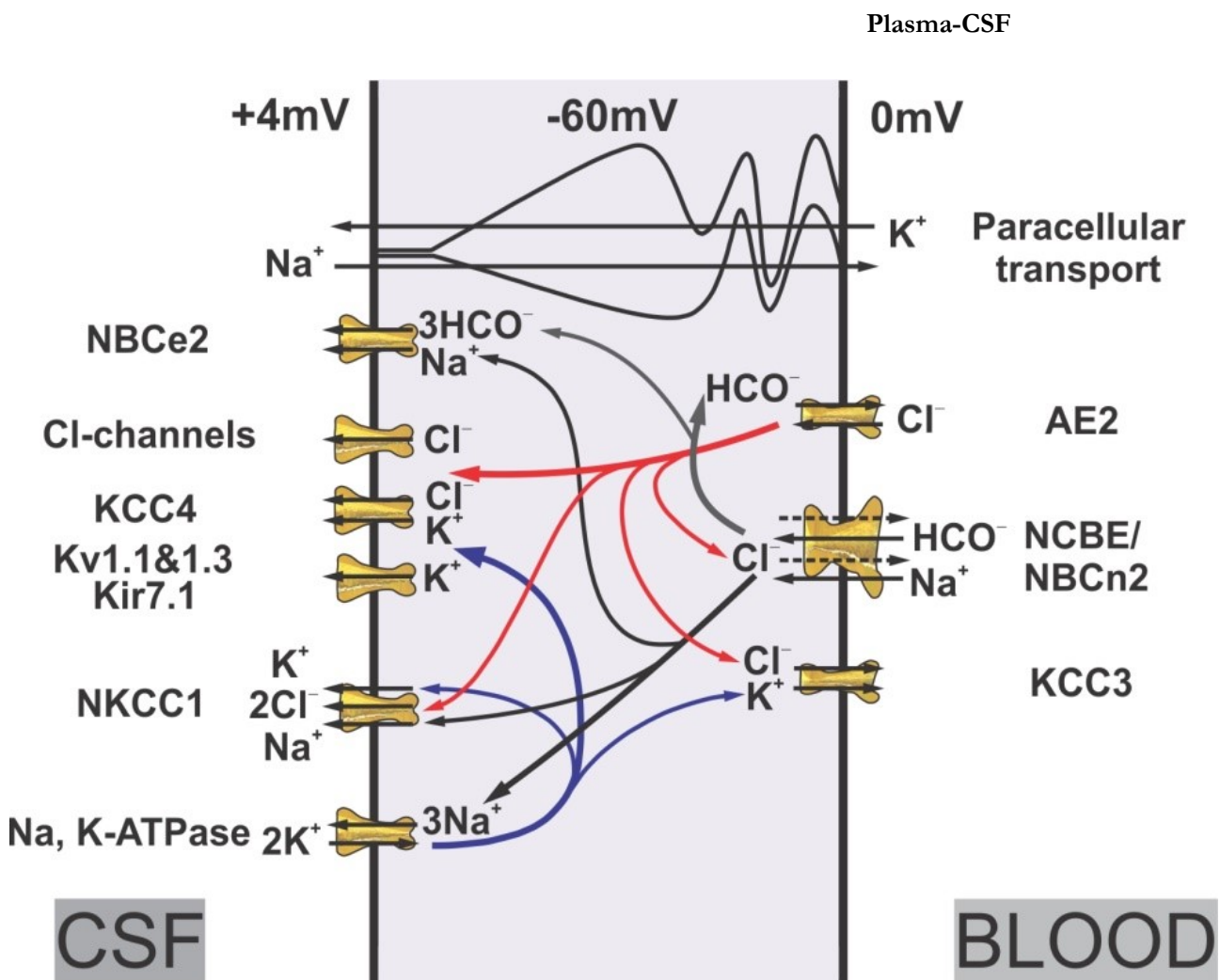

Figure 5: The choroid plexus generation of cerebrospinal fluid (CSF) functions in the mutual exclusive vectorial kinetic according to a potential of hydrophilic-plasma to hydrophobic-CSF flow. Thus, conditions a unilateral sense for entropy release.

The brain of the newborn enjoys a hormonal system development involving about 60% of total calories ingested, which became stabilized at adult age as 25% of total body energy. At maturity the H-bond energy contributions of the enzyme hydration vs dehydration turnovers adds to a thermogenic flow of energy that requires that the brain develops an autonomous cooling system. Thus, at the blood-brain (150ml CSF) barrier are maintained permanently, and 0.3-0.4 ml/min CSF are renovated constantly to generate about 500ml/daily output. The equivalence H-bond contribution is $(H_2O)_{n=3.4}$ for each water cluster configuration about $3.4 \times 5 \text{ kcal/mol} = 17 \text{ kcal/mol}$.

The thermodynamics relationship between structure and function requires an astrocytes network for circulation after breakdown of H-bonds. The water cluster exhausted the H-bonds by the transition of hydrated R groups in proteins in mutual exclusion with the dehydrated ones in oxyHb to deoxyHb, and plasma to CSF. Accordingly the circulation sense continuously depletes of H-bonds energy until, reaching a CSF state that could not allow a liquid state. Thus, allowing the water dimer integration by non-polar superposition of orbitals into conforming kinetic resonance of the individual jointly modify state.

The RARE BiBi mechanism shows a second-order dependence on substrate concentration: Mg^{2+} has to bind first to activate the binding site for MgATP. Hence, the noradrenaline (NA) activated of the hypothalamic tissue is controlled by obligatory ions Mg^{2+} exceeding the substrate concentration. cAMP and calmodulin release of Ca^{2+} determine signaling of the amplitude, phase and period of circadian rhythms [57]. ATP^4 and chelating metabolites decreases CaATP, strongly activating adenylate cyclase (AC) to increment the cAMP-dependent activation of pathways for memory affirmation.

Ca^{2+} releases to activate the glutamate neurotransmission. Serotonin (5-hydroxytryptamine, 5-HT) produced in Raphe nuclei located in the brainstem, could induced Ca^{2+} increase and reduced the cAMP increase, indicating cross-talk between the 5-HT-sensitive Ca^{2+} and cAMP pathways [58]. Ionic equilibrium controlling Ca^{2+} effects for a simultaneous dead-end CaATP [59][60] inhibition of AC and mutual exclusion activation of the α -amino-3-hydroxy-5-methyl-4-isoxazolepropionic acid

(AMPA) receptor, first glutamate receptor ion channel domain.

Turnover, with release of Mg^{2+} from the E as a nascent ion Mg^{2+} acquires a stronger intrinsic charge.

The molecular kinetics synchronization that prevents microscopic reversibility, because could not be conceptually assimilated to the principle of microscopic reversibility requiring a single door, which could allow transit in both senses.

Mutual exclusion between hydrophilic and hydrophobic domains allows vectorial kinetics, which bypasses microscopic reversibility, due to the enzymes turnover has only one sense the hydrophilic changing conformation to the hydrophobic one.

Change conformation turnover of protein is supported by the activation energy of broken H-bonds, from polymeric water in CSF, conversion into waste water. Astrocytes could maintain the H-bond wasted state of water in a liquid phase until their release as vapor to the outside of the system, which is equivalent to entropy dissipation.

Mg-cAMP turn-on/off of switch for CREB function

Mg-cAMP binds to coordinate to both DNA chains by coordination to the negatively oxygen of phosphate groups, on both backbones, connecting the repeated pattern of sugars and on that of Camp.

The phosphoryl groups of the open DNA structure are now facing with their charged oxygen (O^-) to the inside to bind coordinately to Mg^{2+} [61].

The cAMP-Mg-DNA complex acts as a physiological process. The insertion of 3'-5'cyclicAMP of phosphoryl groups by coordination of Mg^{2+} to the negative charged oxygen, to face the hexahydrated Mg^{2+} and allowing the DNA chains to rotate for the purine and pyrimidine groups to face outwards.

The catabolite activator protein (CAP) functions by binding in the presence of the allosteric promoters and enhances the ability of RNA polymerase holoenzyme (RNAP) to bind and initiate transcription [62].

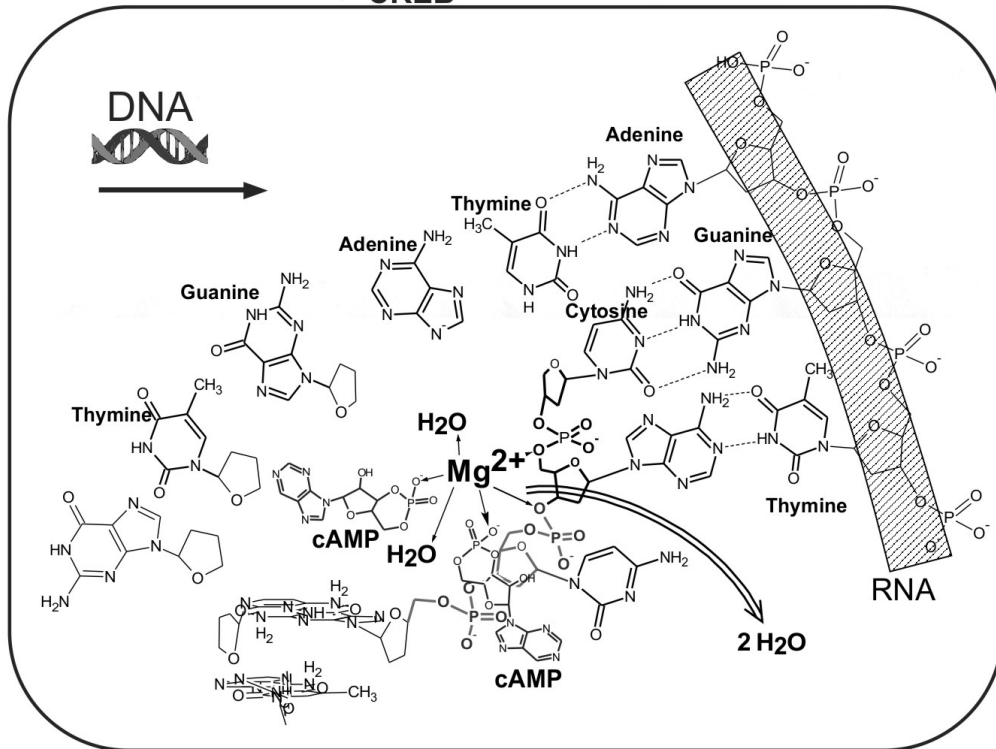
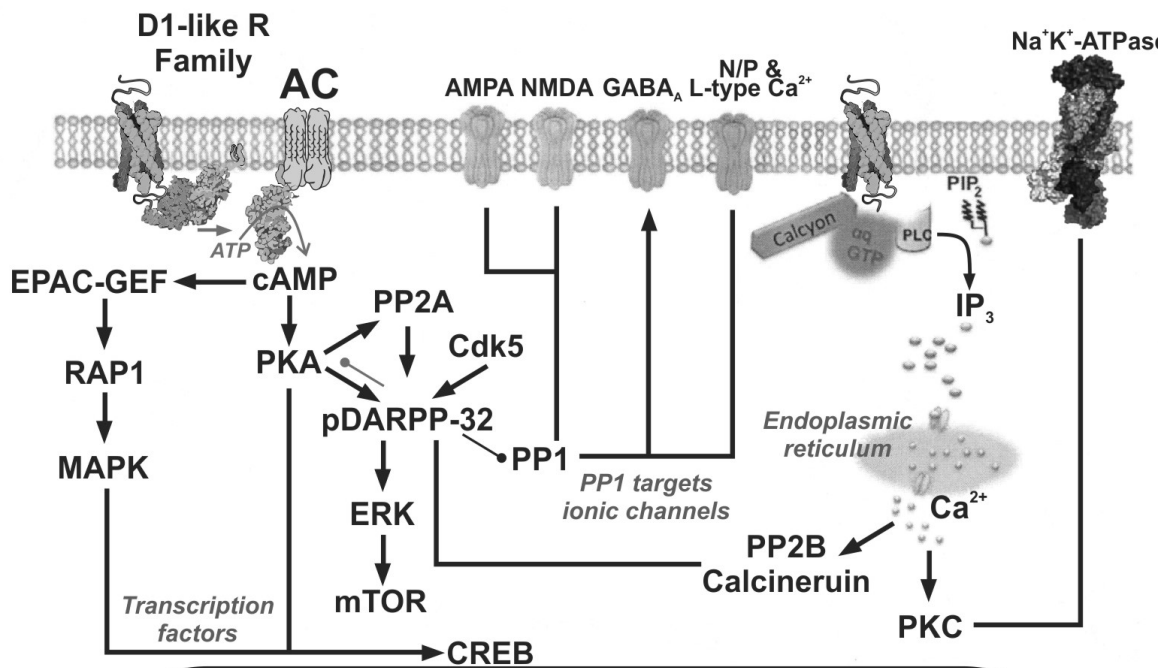

Figure 6: Mg-cAMP inserted in domain of DNA allows a switch-on by Mg^{2+} and -off by Ca^{2+} . A dynamic mechanism to activate gene expression in CREB by inducible gene response to dopamine phosphorylation via G protein coupled receptor. Thus, acting to synthesize brain derived growth factor, a regulator during neuronal development and synaptic plasticity [63]. Thus, producing neurotrophins and nerve growth factor, related of inducible gene expression [64]. The D1-like dopamine (DA) receptors act signaling activatory stage to intracellular pathways. Activation of MAP kinases in neuronal and endocrine cells is critical for cell differentiation and function. This action requires guanine nucleotide exchange factor (GEF)-mediated activation of downstream a host of Ras family small GTPases, which lead to Ras-Raf-MEK-ERK (MAPK/ERK), is a chain of proteins within cell [65] [66] that communicates a signal from a receptor on the surface of the cell to the DNA in the nucleus of the cell.

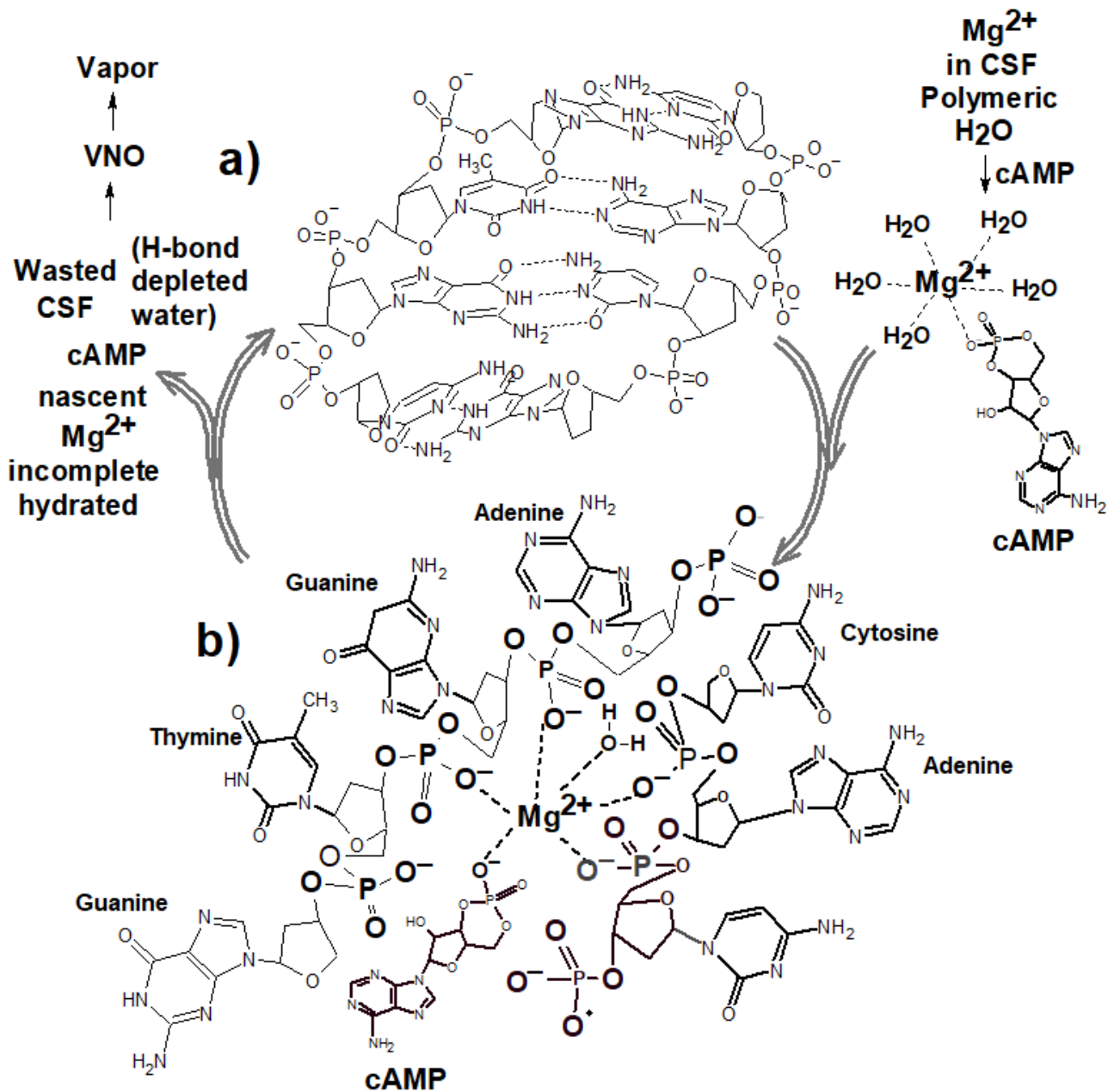

Figure 7. Physiological mechanism for cAMP fitting into the double strands unzipping of nuclear DNA or the transitory structure of cffDNA. The non-physiological treatment technic of heating DNA at 65°C allows the strands separation and transcription used experimentally. a) Base sequence of the two chains attracted to match in a double stranded binary rotational symmetry of DNA. b) cAMP unzipping mechanism opens the double-stranded DNA structure positioning the outside purines and pyrimidines bases to transcription mechanism leading to protein synthesis.

The H-bonds dynamics on folding allowing the peptide bond a resonance stabilized polar and planar structures

Class III adenylyl cyclase membrane-bound mammalian adenylyl cyclase isoforms homologous a 6 transmembrane domain and a 6 membrane segments, follow by C2 cytoplasmic domain.

Adenylyl cyclase is polyphyletic enzyme a 363 amino acid chain. It has catalytic C-terminal

regulatory and N-terminal domains, connected by a linker region.

A peptide with trans configuration manifests repulsion between the δ positions of the pyrrolidine ring of the adjacent amino acid.

All of the information required for a protein to fold into is biologically active conformation is contained in the primary structure.

Two parallel β -pleated sheet with an intervening strand of α helix domains bends on the

surface of globular proteins. This structure offers little steric hindrance to a modification in the direction of the polypeptide chain.

Five-membered ring of proline allows second residue could manifest a reverse turn.

The hydrophobic effect drives protein folding in about 10^{-1} to 10^{-13} s to rotate around the

$C - C_{\alpha}$ and $N - C_{\alpha}$ bonds of the polypeptide backbone.

Domains allow by H-bonds, or ion pair participation, the interaction between distant regions of the polypeptide chain.

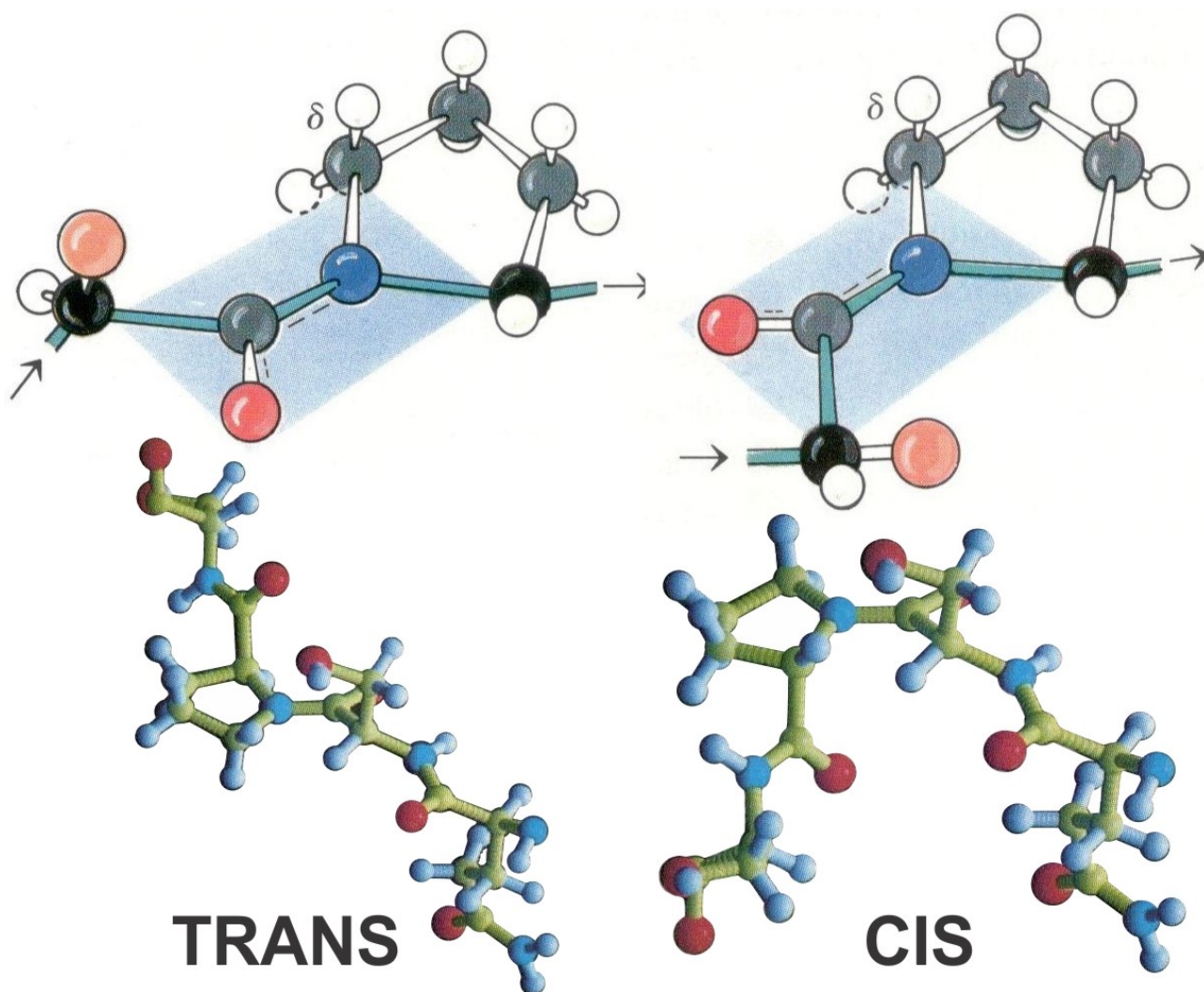

Figure 8: Dynamics of proline allowing sliding between two domains helix-turn-helix changing the correspondence between a hydrophobic vs hydrophilic site.

Mechanism

A vectorial function mechanism may allow a hydrophilic state for Mg^{2+} coordination state to negative R groups precede by mutual exclusion a transit Ca^{2+} coordination to positive R groups. In a subsequent step the switching to a hydrophobic configuration state, could allow an endergonic reaction, closing the adenylate cyclase (AC)-protein into a site configuration, allowing cycling of the ring of the phosphoryl group of AMP to cAMP, by

subtracting water molecules, which could form dimers. Thus, opens the structure by a subsequent Mg^{2+} , obligatory interaction to allow the enzyme configuration to release of the formed complex Mg-cAMP signaling for cAMP response element binding (CREB) function. Thus, allowing turnover between two domains in vectorial precedent for differential state of the hydration, responding to Mg^{2+} transport by coordination to oxy- to deoxy-Hb cycle and Ca^{2+} release by calmodulin for a complete turnover cycle.

AC manifests that C1 and C2 are catalytically inactive, but an obligatory excess of Mg^{2+} over substrate $MgATP$ activates the hydrophilic conversion of $MgATP$ to AMP, and by Ca^{2+} -dependent mutual exclusion of the hydrophilic configuration by stage alignment of C1 and C2, combining a closing state the resulting hydrophobic environment allows the AMP endergonic phosphoryl cycling to cAMP. The system by a second stage of Mg^{2+} release from its coordination within oxyHb returns the C1 to C2 open state releasing Mg -cAMP allowing turnover and detection of enzyme activity.

The water pair hydrophobic structure

The interaction of 2s and 2p orbitals allows a tetrahedral of 104.5° angles from two H atoms of positive charge. An $O-H$ results from the 1s orbit bond overlap with O to form an sp orbital. The H-bond of two water molecules, the partially positive hydrogen atom δ^+ attracts the partially $2\delta^-$ negative charge of one O to the other. The result in a dipole-dipole attraction mediated by the in between H-bonded distance $H-O-H-(OH_2)$ 0.177nm the polarity strength in water 104kcal/mol. The same H covalently to oxygen atom distance of 0.1nm is about 110kcal/mol. An $N-H$ and $C=O-H-N$ as between complementary pairs cytosine attracted to guanine separated by 0.27 to 0.3nm spontaneously attracted to form $H-O$ or $N-O$ by the unshared N or O electrons pairs. The water molecules detached from these intramolecular bonds within a protein become H-bonded between them, in bulk water. The dipolar state can induce transitive dipoles in other close molecules. Liquid state of water clusters show a half-life $10^{-8}s$ to $10^{-11}s$. The average number is $(H_2O)_{n=3,4}$. From liquid to vapor state (heat of vaporization) 0.54kcal/g because a large number of H-bonds have to be broken to reach the vapor [67].

However, heat homeostasis at cerebrospinal fluid (CSF) hydrophobic medium at the pressure present in astrocytes, is able to maintain the release of single molecule of water by H-bonds breakdown and the hydric affinity disappears and allow a little polar state to manifest aggregated by non-polar interactions of $H_2O :: OH_2$, indicating energy

configuration: $(H_2O \sim OH_2)$, between both oxygen atoms. Thus, circulates within the astrocytes network in a metastable state of high oscillatory tension between the oxygen orbitals, between surrounding hydrogen atoms tending to maintain covalent stability. Water dimer is the most widely examined water cluster. The turnaround angle differentiates six different isomers of water dimers. Hereby, RP isomers are illustrated in figure, the potential planar resonance states, orbital-5 $E_{orb} = -15.15eV$ and orbital-9 $E_{orb} = -8.90eV$, with oscillatory potential $\Delta E = -6.25eV$.

Thus, determines several possible states of coherence. Hence, kinetic energy accumulates by resonance amplification. However, in the CSF the absence of O_2 and N_2 allows coherence and their presence in the air induce a randomness decoherence, into the oral cavity, generates the exhaled vapor to the outside, decreasing entropy of the organism and allows brain to operate as an open-system.

Ion pairs can form in the hydrophobic interiors of globular proteins. The free energy of solvation of an ion is so large (about 60kcal/mol) that an isolated charged residue is never found in the hydrophobic interior of a globular protein.

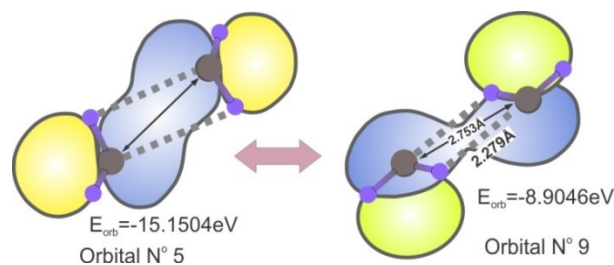

Figure 9: Two oppositely charged ions, however, can form an ion pair. The free energy change for transfer of two oppositely charged residues from water to the monopolar interior of a protein is about -1kcal/mol. When the ion pair forms, the water molecules in the solvation sphere of each ion are released to the bulk. Each ion therefore loses its free energy of solvation, driving their force for ion-pair formation the increase in the entropy of water clusters, during formation of the ion pair.

Discussion

Prigogine modeled life as an open system capable of decreasing entropy. However, his cosmological model was not dissipative but based in

a tendency for mass action equilibrium between enthalpy and entropy.

The Pauli principle exclusion does not allow that two fermions to occupy the same quantum state. Thus, within an atom, the electrons first lodge into an unoccupied lower orbital, a then-on the empty levels up to threshold denominated Fermi distance. Under BCS (Bardeen-Cooper- Schrieffer) model, a within superconductor the electrons could not be treated as individually repulsive particles. Thus, each pair of particles do not behave like fermions, but as bosons another relation between energy and matter, in which pairs of electrons could agglomerate as a Bose-Einstein condensate. The BCS derivate theories assume that in the boson state interactions could be related to the electron spins. The electron is not limited to orbit a proton because also turns around its axis. Accordingly, becomes the movement of atoms became differentiable from of classic physics description as solid, liquid and gases. Furthermore, rotational movement could take only one sense and therefore automatically allows bypassing the microscopic reversibility principle by allowing vectorial dissipative potentials rather than from tendency to only relate to mass-action equilibrium.

Moreover, the rotation sense only limits to one the possible direction, but create two complementary states denominated up and down states. The latter, predicts water pairs by opposite alignment of spins, which could integrate shared orbitals.

Bosons could non-yet been accepted for emergence of entanglement. However, this matter to energy relationship predicts coherence-decoherence states over the whole cosmos. But, if so, the matter could be related to every characteristic of the cosmological level. Thus, a pertinent question: How could relate to the thermodynamics of life and evolution? Does our brain evolved under its thermodynamics parameters, etc.

Cosmological dissipative system far from equilibrium associated to the dissipative Planck's bosons energy [68] based in quantum mechanics as inwardly open thermodynamics. This model meets the challenge implicated in a self-contained universe.

Common knowledge describes a thermodynamics system as open to the sun and

integrated to life dependent of H₂O [69]. The confluence of requirements should be evident in terms that the sun when vaporizes water cluster: (H₂O)_n, separates the molecules integrating the complex.

The result should be lacking H-bonds dissipated from water cluster into wasted water gain in the degree of randomness and the system as a whole pulled by opening the organismal system thanks to entropy release.

The kinetics energy solvation provides a polarity scale for unidirectional unitary sense circulatory flow for the thermogenic transitions dissipation to exclude organismal entropy.

This vapor state when became cooled allows spontaneously establishing of H-bonds resulting in liquid drops, until released from the atmosphere as rain.

Thermodynamically the complete process is cyclic one. A turnover from solar thermogenesis, generating vapor, the kinetic equivalent of entropy (S), which is dissipated by cooling and generates enthalpy (H), an Gibbs free energy: $\Delta G = \Delta H - T\Delta S$.

Thus the potential are the H-bonds chemically reactive with R groups to coordinate Me²⁺, H-bonds are consumed in the water cluster state. Hence, the state of coordinative linked H-bonds became a reactant associated to protein hydrophilic state in turnover through H-bonds breakdown to a less hydrophilic state. Thus, the denominated hydrophobic molecules tend to be nonpolar. A dimer state corresponds to a hydrophobic nonpolar interaction state of water: (H₂O~OH₂).

Hence, a thermodynamics treatment could be applied to energy dependent process with impact on the evolution of living structures and functions, in which the participation of water by H-bonds cyclic breakdown in metabolic function. Thus the total full energy flow does structures open systems that allow to avoid metabolic equilibrium into a dead state. Thus, that as long that life-systems could decreases its entropy, became equivalent to a living state, allows water by decreasing H-bonds to became a carrier of releasing entropy.

The Tasmanian devil (*Sarcophilus harrisii*) has been reported that does not to need drink water, because can obtain from its diet. However, does urine hot liquid. Cool blooded animals do need to

operate a circulatory cycle of hot vs cool liquid transitions to radiate entropy.

Marine species could dissipate heat by conduction into liquid water and release from the evaporation of seas and rivers.

The ancient life species leaving and developing at the environment thermal liquid springs sources, which are rather solar independent do need to release chemical entropy. It is a common believe that the role of cycle thermodynamic in life does not need to be evaluated to establish the dynamics of evolution. Thus, most of the research has been directed to determining the DNA and RNA coding expression.

Hence, mutation and other epigenetic pathways involved in the reconstruction of the human genome is about 44%.

An emotional structuring could be related to 7TM (transmembrane) hormonal receptors like adrenaline at the dendrites of adenylate cyclase (AC) activated by concentration of Mg^{2+} , exceeding that of substrate Mg^{2+} -ATP. A gradient from cycling hydrated vs hydrophobic domains in mutual exclusion of proteins in oxyHb vs deoxyHb and plasma vs cerebrospinal fluid (CSF) structure thermogenesis channeling to reach the oral cavity and allow the release of water dimers that could decoherence into the exhaled vapor state.

An emotional functioning brain develops under nurturing by reward hormonal conditioning by dopamine could be expected from the cAMP release by AC hormonal stimulation. The cAMP response element binding (CREB) protein became phosphorylated via G protein coupled receptors (GPCR) by dopamine signaling. The release of stimulated a brain growth factor (BDNF) a neurotrophin during neuron development became involved in synaptic plasticity. Dysregulation of GPCR signaling has been reported as involved in early stress models, leading to aberrant emotionality.

Conclusions

A model of human brain evolution should take in account the constitutive separation of two integrated parameters: the one for neuronal synapsis and circuits, from that by a multiple wrapped-around astrocytes and their exchanges. The main function of glial cells is the absorption of the generated, thermal-like breaking of H-bonds, from

polymerized water provides the activation energy, coupled for the turnover of structural changes, between hydrophobic and hydrophilic enzyme forms. Thus, increasing rotational and vibrational kinetic activity, on the separated individual H_2O molecules, but maintaining a liquid coherence, during circulation within astrocytes until the lower pressure at the vomeronasal organ (VNO) allows phase conversion to vapor, equivalent to entropy dissipation. The summation of the energy generated by metabolites and H-bond consumption allows the brain thermodynamics to support ratios between metabolite concentrations and the electrogenic action potential in dissipative states, within an open system. Cell-free DNA (cfDNA) from an evolutive disaggregation of the olfactory bulb, are still present as an olfactory epithelium, adapted for sex pheromones and behavioral responses stimulus on adenylate cyclase (AC) for cAMP-dependent unzipping of the DNA. It is a focused process to create neurons differentiated by where the cAMP is inserted, which creates specific neural circuits. Olfactory epithelium may hold the neurons with 7TM receptors for the saliva or pheromones, reaching the oral cavity with their axons crossing the BBB. This allows cffDNA response through cAMP complexing and messenger RNA expression into polypeptide holding a transitory memory during baby rearing, as a psychosomatic molecular carrier of emotional and communication needs of a newborn, which functions to form an unconscious level, which diversifies individual emotional characteristics, approaching a level of animic personalities, which when age allows a conscious level, could offer differentiable roles for social influences that allow the brain self-plasticity such as literacy.

The transposons by scission and insertion along the DNA segments have been reported to represent about 40% of the human genome. The better-fit, involving the variability and selection should be the interplay, between genetic and phenotype modulation. This could represent development plasticity, which functions at Homo sapiens' brain by its signaling for hormonal modulation of the organismal response. The brain itself manages the hormonal system, rewards and inhibition feedbacks, like oxytocin in the course of mother to child hormonal communication. Thus, emotional inputs could be applied not only as a

correlation with behavior, but to the development of emotional intelligence. Thus, promotes the ability to understand, use, and manage your own emotions in positive ways to relieve stress, communicate effectively, empathize with others, product of learning, rather than totally dependent of genetic expression.

References

- [1] Bennun, A. and Avron, M. Light-dependent and light-triggered adenosine triphosphatases in chloroplasts, *Biochimica et Biophysica Acta*, 79, 646-648 (1964).
- [2] Bennun, A. and Avron, M., The relation of the light-dependent and light-triggered adenosine triphosphatases to photophosphorylation, *Biochimica et Biophysica Acta*, 109, 117-127 (1965).
- [3] Bennun, A., Hypothesis for coupling energy transduction with ATP synthesis or ATP hydrolysis, *Nature New Biology*, 233 (35), 5-8 (1971).
- [4] Bennun, A., A model mechanism for coupled phosphorylation, *Proceedings 3rd International Congress on Photosynthesis*, Rehovoth (M. Avron, ed.), , Vol. 2, pp. 1107-1120 (1974), Elsevier Sciences Pub. Co., Amsterdam.
- [5] Bennun A. Interaccion de factor acomplante del cloroplasto con protons y agua. *Recientes Adelantos en Biologia* (página 254) Editores Raul H. Megia y Jaime A. Moguilevsky, simposia Buenos Aires, 1971 (Titration with glycerol allow to determine the number of water molecules involved in the turnover of the active site of CF₁-ATPase).
- [6] Bennun, A. and Bennun, N., Hypothesis for a mechanism of energy transduction. Sigmoidal kinetics of chloroplast's heat-activated ATPase, *Proceedings 2nd International Congress on Photosynthesis Research* (G. Fortí, M. Avron and A. Melardri, eds.), , Vol. 2, 1115-1124, (1972). Dr. W. Junk N.V. Pub., The Hague.
- [7] Bennun, A., The unitary hypothesis on the coupling of energy transduction and its relevance to the modeling of mechanisms, *Annals of the New York Academy of Sciences*, 227, 116-145 (1974).
- [8] Bennun, A., Hypothesis on the role of liganded states of proteins in energy transducing systems, *Biosystems*, 7, 230-244 (1975).
- [9] Harris, R. and Bennun, A., Hormonal control of fat cells adenylate cyclase, *Molecular & Cellular Biochemistry*, 13 (3), 141-146 (1976).
- [10] Brydon-Golz, S. and Bennun, A., Postsynthetic stabilized modification of adenylate cyclase by metabolites, *Biochemical Society Transactions*, 3, 721-724 (1975).
- [11] Brydon-Golz, S., Ohanian, H. and Bennun, A., Effects of noradrenaline on the activation and the stability of brain adenylate cyclase, *Biochem. J.*, 166, 473-483 (1977).
- [12] Ohanian, H., Borhanian, K. and Bennun, A., The effect of manganese on the regulation of brain adenylate cyclase by magnesium and adenosine triphosphate, *Biochemical Society Transactions*, 6, 1179-1182 (1978).
- [13] Ohanian, H., Borhanian, K., De Farias, S. and Bennun, A., A model for the regulation of brain adenylate cyclase by ionic equilibria, *Journal of Bioenergetics and Biomembranes*, 13 (5/6), 317-355 (1981).
- [14] Vicario, P.P., Saperstein, R. and Bennun, A., Role of divalent metals in the activation and regulation of insulin receptor tyrosine kinase, *BioSystems*, 22, 55-56 (1988).
- [15] Vicario, P.P., Saperstein, R. and Bennun, A., Role of divalent metals in the kinetic mechanism of insulin receptor tyrosine kinase, *Archives of Biochemistry Biophysics*, 261 (2), 336-345 (1988).
- [16] Vicario, P.P., Saperstein, R., Katzen, H. and Bennun, A., Metabolic interactions of insulin receptor tyrosine kinase, *Annals of the New York Academy of Sciences*, 529, 92-95 (1988).
- [17] Vicario, P.P., Saperstein, R. and Bennun, A., Role of divalent metals in the kinetic mechanism of insulin receptor tyrosine kinase, *Archives of Biochemistry Biophysics*, 261 (2), 336-345 (1988).
- [18] Vicario, P.P. and Bennun, A., Separate effects of Mg²⁺, MgATP and ATP⁴⁻ on the kinetic mechanism for insulin receptor tyrosine kinase. *Archives of Biochemistry and Biophysics*, 278 (1), 99-105 (1990).
- [19] Bennun A. NA-Overstimulation of the Hypothalamic-Pituitary Adrenal Axis Turns-On the Fight-or Flight Response but Adrenaline Lacks a Negative Feedback which Could Normalize Psychosomatic Dysfunctions. Chapter 2, pp 13-70, (2014) in "Adrenaline: Production, Role in Disease"

and Stress, Effects on the Mind and Body”, Nova Biomedical, Endocrinology Research and Clinical Developments, Book Editor: Bennun A.. ISBN: 978-1-63321-084-4.

[20] Bennun, A., Characterization of the norepinephrine-activation of adenylate cyclase suggest a role in memory affirmation pathways. Overexposure to epinephrine inactivates adenylate cyclase, a casual pathway for stress-pathologies, *BioSystems* 100, 87-93, (2010) Ed: Elsevier.

[21] Bennun A. The noradrenaline-adrenaline-axis of the fight-or-flight exhibits oxytocin and serotonin adaptive responses. *International Journal of Medical and Biological Frontiers*. Volume 21, Issue 4, pages: 387-408 (2015). ISSN: 1081-3829. Nova Publishers.

[22] Bennun A. The psychosomatic separation of noradrenaline at brain and adrenaline at blood is a homeostatic lame axis allowing that the fight-or-flight stressing of metabolic controls could turn-on related diseases. Series: *International Journal of Medical and Biological Frontiers*. Volume 20 Issue 1. Nova Science Publishers. Editors: Andres Costa and Eugenio Villalba. Editorial: Nova Science Publishers, 2014.

[23] Perutz, M. F.. Stereochemistry of cooperative effects in haemoglobin. *Nature*, 228, 726-739 (1970).

[24] Bennun, A., A coupling mechanism to inter-relate regulatory with haem-haem interactions of haemoglobin, *Biomed. Biochim. Acta*, 46 (2/3), 314-319 (1987).

[25] Bennun, A., Needle, N.A. and De Bari, V.A., Infrared spectroscopy of erythrocyte plasma membranes, *Biochemical Society Transactions*, 13, 127-128 (1985).

[26] Bennun, A., Seidler, N. and De Bari, V.A., Divalent metals in the regulation of hemoglobin affinity for oxygen, *Annals of the New York Academy of Sciences*, 463, 76-79 (1986).

[27] De Bari, V.A., Novak, N.A. and Bennun, A., Cyclic nucleotide metabolism in the human erythrocyte, *Clinical Physiology and Biochemistry*, 2, 227-238 (1984).

[28] Bennun, A., Seidler, N. and De Bari, V.A., A model for the regulation of haemoglobin affinity for oxygen, *Biochemical Society Transactions*, 13, 364-366 (1985).

[29] Novembre, P., Nicotra, J., De Bari, V.A., Needle, N.A. and Bennun, A., Erythrocyte transport of cyclic nucleotide, *Annals of the New York Academy of Sciences*, 435, 190-194 (1984).

[30] De Bari, V.A. and Bennun, A., Cyclic GMP in the human erythrocyte. Intracellular levels and transport in normal subjects and chronic hemodialysis patients, *Clinical Biochemistry* 15(4), 219-221 (1982).

[31] Fermi, G. and Perutz, M. F. (1982) In: *Atlas of molecular structures in Biology*, 2 Haemoglobin and Myoglobin D.C., Phillips and Richards F.M. (Eds.) Clarendon Press, Oxford.

[32] Bennun, A., A coupling mechanism to inter-relate regulatory with haem-haem interactions of haemoglobin, *Biomed. Biochim. Acta*, 46 (2/3), 314-319 (1987).

[33] Bennun, A., Seidler, N. and De Bari, V.A., Divalent metals in the regulation of hemoglobin affinity for oxygen, *Annals of the New York Academy of Sciences*, 463, 76-79 (1986).

[34] Vicario, P.P., Saperstein, R. and Bennun, A., Role of divalent metals in the activation and regulation of insulin receptor tyrosine kinase, *BioSystems*, 22, 55-56 (1988).

[35] Ramms DJ, Raimondi F, Arang N, Herberg FW, Taylor SS, Gutkind JS. G α s-Protein Kinase A (PKA) Pathway Signalopathies: The Emerging Genetic Landscape and Therapeutic Potential of Human Diseases Driven by Aberrant G α s-PKA Signaling. *Pharmacol Rev*. 2021 Oct;73(4):155-197. doi: 10.1124/pharmrev.120.000269.

[36] Efeyan A, Zoncu R, Chang S, Gumper I, Snitkin H, Wolfson RL, Kirak O, Sabatini DD, Sabatini DM. Regulation of mTORC1 by the Rag GTPases is necessary for neonatal autophagy and survival. *Nature*. 2013 Jan 31;493(7434):679-83. doi: 10.1038/nature11745. Epub 2012 Dec 23.

[37] Ren M, Zeng J, De Lemos-Chiarandini C, Rosenfeld M, Adesnik M, Sabatini DD. In its active form, the GTP-binding protein rab8 interacts with a stress-activated protein kinase. *Proc Natl Acad Sci U S A*. 1996 May 14;93(10):5151-5. doi: 10.1073/pnas.93.10.5151.

[38] Sanchez-Arias JC, Liu M, Choi CSW, Ebert SN, Brown CE, Swayne LA. Pannexin 1 Regulates Network Ensembles and Dendritic Spine Development in Cortical Neurons. *eNeuro*. 2019

- Jun 6;6(3):ENEURO.0503-18.2019. doi: 10.1523/ENEURO.0503-18.2019. Print 2019 May/June.
- [39] Omori K, Omori K, Morimoto T, Takada T, Akayama M, Yoshimori T, Sabatini DD, Tashiro Y. Expression, localization, and function of an N-terminal half fragment of the rat Na,K-ATPase beta-subunit in HeLa cells. *J Biochem.*, 109(2), 267-75 (1991 Feb).
- [40] Bennun, A. Dynamics of the Hydrophilic to Hydrophobic Proteins and Enzymes Turnover in A. Bennun's Biochemical-Physics Neurotransmission Model for the Glycerol Assay of the Hydration Shell Dynamics on the Hydrophilic Structure of the Active Site of CF1-ATPase" Book Title: *Advances in Chemistry Research* (James C Taylor Editor) in Volume 47 Chapter 5, pages: 165-182. January 2019.
- [41] Manzini I, Schild D, Di Natale C. Principles of odor coding in vertebrates and artificial chemosensory systems. *Physiol Rev.*, 102(1), 61-154 (2022 Jan 1). doi: 10.1152/physrev.00036.2020.
- [42] Schaller BJ, Filis A, Merten HA, Buchfelder M. Premature craniosynostosis--the role of skull base surgery in its correction. A surgical and radiological experience of 172 operated infants/children. *J Craniomaxillofac Surg.*, 40(3), 195-200 (2012 Apr). doi: 10.1016/j.jcms.2011.04.003.
- [43] Schwartz RE, Shokhirev MN, Andrade LR, Gutkind JS, Iglesias-Bartolome R, Shadel GS. Insights into epithelial cell senescence from transcriptome and secretome analysis of human oral keratinocytes. *Aging (Albany NY)*; 13 (4),4747-4777 (2021 Feb 12). doi: 10.18632/aging.202658.
- [44] Smets, E.M.; Visser, A.; Go, A.T.; van Vugt, J.M. and Oudejans, C.B. Novel biomarkers in preeclampsia. *Clin Chim Acta.* 364 (1-2), 22-32 (2006).
- [45] Bustamante-Aragones, A.; Gonzalez-Gonzalez, C.; de Alba, M.R.; Ainse, E. and Ramos, C. Noninvasive prenatal diagnosis using ccfDNA in maternal blood: state of the art. *Expert Review of Molecular Diagnostics.* Informa UK Limited., 10 (2), 197-205 (2010).
- [46] Zimmermann, B.; El-Sheikhah, A.; Nicolaidis, K.; Holzgreve, W. and Hahn, S. Optimized real-time quantitative PCR measurement of male fetal DNA in maternal plasma. *Clin Chem.* 51(9), 1598-604 (2005).
- [47] Bustamante-Aragones, A.; Gonzalez-Gonzalez, C.; De Alba, M.R.; Ainse, E. and Ramos, C. Noninvasive prenatal diagnosis using ccfDNA in maternal blood: state of the art. *Expert Review of Molecular Diagnostics.* Informa UK Limited., 10 (2), 197-205 (2010).
- [48] Moll, J. R.; Acharya, A.; Gal, J.; Mir A. A. and Vinson C.. Magnesium is required for specific DNA binding of the CREB B-ZIP domain. *Nucleic Acids Res.*, 30(5), 1240-6 (2012).
- [49] Sauce, B, Wiedenhoeft, J., Judd, N., Klingberg, T. Change by challenge: A common genetic basis behind childhood cognitive development and cognitive training. *NPJ Sci Learn.*, 6 (1), 16 (2021 Jun 2). doi: 10.1038/s41539-021-00096-6.
- [50] Birkan Tunç, Berkan Solmaz, Drew Parker, Theodore D. Satterthwaite, Mark A. Elliott, Monica E. Calkins, Kosha Ruparel, Raquel E. Gur, Ruben C. Gur, Ragini Verma. Establishing a link between sex-related differences in the structural connectome and behaviour. *Philosophical Transactions of the Royal Society B: Biological Sciences* (2016). DOI: 10.1098/rstb.2015.0111.
- [51] Daneman, R. and Prat, A. The blood-brain barrier. *Cold Spring Harbor Perspectives in Biology.* 7 (1): a020412 (January 2015).
- [52] Numan, M. and Young, L.J. Neural mechanisms of mother-infant bonding and pair bonding: Similarities, differences, and broader implications. *Horm Behav.*, 77:98-112 (2016 Jan). doi: 10.1016/j.yhbeh.2015.05.015.
- [53] Teo, I.; Yeow Chin, K; Stephens, C. and Paget J. (2014). *Drugs in Cardiopulmonary Resuscitation.* Book of Medicine, Endocrine Disorders. Editorial Nova Science Publishers. Editor: Alfred Bennun. Adrenaline: Production, Role in Disease and Stress, Effects on the Mind and Body, pp. 177-212.
- [54] De Souza Cordeiro LM, Elsheikh A, Devisetty N, Morgan DA, Ebert SN, Rahmouni K, Chhabra KH. Hypothalamic MC4R regulates glucose homeostasis through adrenaline-mediated control of glucose reabsorption via renal GLUT2 in mice. *Diabetologia.*, 64 (1), 181-194 (2021 Jan). doi: 10.1007/s00125-020-05289-z.
- [55] Iliff, J. J.; Wang, M.; Liao, Y.; Plogg, B. A.; Peng, W.; Gundersen, G. A.; Benveniste, H.; Vates, G. E.; Deane, R.; Goldman, S. A.; Nagelhus, E. A. and Nedergaard M. A paravascular pathway

facilitates CSF flow through the brain parenchyma and the clearance of interstitial solutes, including amyloid β . *Sci Transl Med.*, 4(147), 147ra111 (2012).

[56] Bennun, A. Quantum State Transition from Liquid to Vapor Water by Physiological Entanglement. *viXra.org > Biochemistry > viXra:2106.0053* <https://vixra.org/abs/2106.0053> (2021-06-08).

[57] O'Neill, J.S. and Reddy, A. B. The essential role of cAMP/Ca²⁺ signalling in mammalian circadian timekeeping. *Biochem Soc Trans.* 40 (1), 44-50 (2012).

[58] Amireault, P. and Dubé, F. Intracellular cAMP and calcium signaling by serotonin in mouse cumulus-oocyte complexes. *Mol Pharmacol.* 68 (6), 1678-87 (2005).

[59] Harris, R.; Cruz, R. and Bennun, A.. The effect of hormones on metal and metal-ATP interactions with fat cell adenylate cyclase. *BioSystems*, 11, 29-46 (1979).

[60] Bennun, A. and Racker, E. Partial resolution of the enzymes catalyzing photophosphorylation IV. Interaction of coupling factor I from chloroplast with components of the chloroplast membrane. *J. Biol. Chem.*, 244, 1325-1331 (1969).

[61] Moll, J. R.; Acharya, A.; Gal, J.; Mir A. A. and Vinson C. Magnesium is required for specific DNA binding of the CREB B-ZIP domain. *Nucleic Acids Res.*, 30 (5), 1240-6 (2012).

[62] Lawson, C. L.; Swigon, D.; Murakami, K. S.; Darst, S. A.; Berman, H.M. and Ebright, R. H.. Catabolite activator protein: DNA binding and transcription activation. *Curr Opin Struct Biol.*, 14(1), 10-20 (2004).

[63] Norgard RJ, Pitarresi JR, Maddipati R, Aiello-Couzo NM, Balli D, Li J, Yamazoe T, Wengyn MD, Millstein ID, Folkert IW, Rosario-Berrios DN, Kim IK, Bassett JB, Payne R, Berry CT, Feng X, Sun K, Gioffi M, Chakraborty P, Jolly MK, Gutkind JS, Lyden D, Freedman BD, Foskett JK, Rustgi AK, Stanger BZ. Calcium signaling induces a partial EMT. *EMBO Rep.*, 22 (9), e51872 (2021 Sep 6). doi: 10.15252/embr.202051872.

[64] Bennun A. The Regenerative Processes Involving the cAMP Unzipping of DNA. The Synthesis of Proteins Integrating Plasticity and Longevity. *Biochemistry Research Trends*. Book

Published by Nova Biomedical, Copyright 2017 by Nova Science Publishers, Inc.

[65] Sabatini DD. In awe of subcellular complexity: 50 years of trespassing boundaries within the cell. *Annu Rev Cell Dev Biol.*, 21:1-33 (2005). doi: 10.1146/annurev.cellbio.21.020904.151711.

[66] Sabatini DD, Louvard D, Adesnik M. Membranes. *Curr Opin Cell Biol.*, 3 (4), 575-9 (1991 Aug). doi: 10.1016/0955-0674(91)90025-t.

[67] Bennun, A. Quantum State Transition from Liquid to Vapor Water by Physiological Entanglement. *viXra.org > Biochemistry > viXra:2106.0053* <https://vixra.org/abs/2106.0053> (2021-06-08).

[68] Bennun, A. and Ledesma, N. The Photon Structure in Interference Processes, Quantum Entanglement and Self-Organized Cosmos. *viXra.org > Relativity and Cosmology > viXra:2109.0214* (2021-09-30).

[69] Bennun, A. The Thermodynamic Inwardly Open System by Locally Decreasing Entropy Originates Life. *viXra.org > Relativity and Cosmology > viXra:2104.0155* <https://vixra.org/abs/2104.0155> (2021-04-25).