

Title: A new perspective on Fatio's Flux

It's Newton, Jim, but not as we know it

Author: Francois Zinserling

(Bachelor of Engineering – University of Pretoria – 1987)

Date: 2021-12

Email: francois@designtech.co.za

ORCID: <https://orcid.org/0000-0001-6166-5717>

LinkedIn: <https://www.linkedin.com/in/francois-zinserling-55173a3a>

ResearchGate: <https://www.researchgate.net/profile/Francois-Zinserling>

Keywords: omnidirectional particle flux, gravitational constant, inertial mass, gravitational mass, flux absorption, Fatio, Le Sage, how gravity works

Introductory video

<https://youtu.be/2dHRsCKG1wc>

(hereby recalling the paper “Mechanics of Gravity”, and all other previous versions of this paper)

Abstract

The vacuum energy is not zero. A conceptual analysis is presented in motivation for space as a dynamic omnidirectional particle flux, to which matter is mostly transparent, from which equations of mass, energy, motion and gravity can be derived.

It is shown through equations that a unit of mass is measured when an object is accelerated in the flux and causes a momentary flux disturbance. Once in motion, if no further external force exists, the mass remains in constant motion in the flux (as per Newton's 1st law and Minkowski's straight worldline).

$E=mc^2$ is derived from relativistic Doppler equations in the flux and proposed as not only a measure of mass, but also a measure of the strength of the local flux that defines the value of mass.

If a fraction of flux is absorbed into any mass, a flux imbalance is formed around the mass, at the speed of light, which can be interpreted as Minkowski's curved worldline or Einstein's curved space. From analysis, the mechanics of gravity emerge. A Newton-like equation is derived from first principles where Newton's apparent 'instant action at a distance' is now understood through interpretations of this hypothesis. As derived here, neither G nor M can be considered universal constants.

The original Fatio/Le Sage's shadow-gravity theories inspired this model, yet it is shown that the numerous troubles that have plagued these theories have been overcome.

This model is compatible with energy absorption in Jovian planets, and predicts a flat rotation curve for motion in a galactic disk without a need for Dark Matter. Loss of mass and Binding Energy is understood.

Through an understanding of the mechanics of this model, a quantum solution of gravity may now be pursued.

Index

Abstract	2
Index.....	3
Introduction.....	5
Introducing the omnipresent, omnidirectional, particle flux.....	6
Omnidirectional flux	6
Absorption	7
Transparency.....	8
The Fatio/Le Sage shadow gravity theory.....	9
Introducing Fatio / Le Sage	9
Porosity of matter.....	10
Superluminal speeds of particles	10
Surface area, or volume, not mass	10
Gravitational shielding.....	10
Speed and Range of gravity, Instant action at a distance,.....	11
Aberration	11
Drag.....	11
Energy: Absorption; Thermodynamic problem;	12
Massive bodies absorb flux, Growing earth.....	12
Coupling to energy.....	12
Particles exit with reduced velocity.....	13
Particles would collide with, and attract each other,	13
Special relativity (SR).....	13
Ultramundane particles, Cosmic radiation, Omnidirectional flux.....	13
Inertial mass as a measure of the flux (observer view).....	15
Discussion of Inertial mass (stationary observer view).....	19
Gravitational mass as a measure of the flux.....	21
The inseparable G and M.....	21
Measurement and Units of G.....	22

Gravitational mass from flux interaction.....	22
Discussion of Gravitational Mass.....	23
Gravity begins from flux absorption, resulting in a flux imbalance around a mass.....	25
Two body gravitational interaction	26
Calculation of Flux absorption	28
Flux absorption.....	29
Energy of Absorbed flux	32
Gravitation ensues from an imbalanced flux absorption.....	33
Conclusion	38
Acknowledgements and affiliations:	39
References:	40
Addendum	44
The flux and gravity in a spiral galaxy disc.....	44
Energy comparisons for Jovian planetary heat.	46
$M + M \leq 2M$. Loss of mass.	47

Introduction

Push-gravity has previously been proposed in many forms; most notably by the publication of Le Sage [1748], which was based on the original idea (non-published) of Fatio [1690]. These, and other 'push-gravity' and 'flow-of-space' or 'shadow-gravity' theories have been met with vehement resistance and thoroughly valid objections by many scientists¹⁻¹¹. With a new outlook on the theory, and greatly inspired by previous work contained within the references, these objections are overcome and dealt with in this document.

Newtonian gravity [1687], with its 'Instant action at a distance' has been superseded by what is now our best current understanding of gravity, given by Einstein's General Relativity (GR) [1916]¹², also described by Wheeler as: 'Space tells mass how to move, and mass tells spacetime how to curve'. Daniel Faccio's representation of 'space is sucked into earth' in his river model¹³, or Einstein's own interpretation of 'earth is accelerating upward like an elevator' both provide usable abstracts.

As Ethan Siegel states, based on GR interpretations¹⁴:

What we perceived as gravity was simply the curvature of space, and the way that matter and energy responded to that curvature as they moved through spacetime. Matter and energy tell spacetime how to curve, and that curved space tells matter and energy how to move.

One can intuitively imagine how curved space could create a path for matter to move, but the above comments still do not explain the how of 'matter bends space', nor how matter couples to space. It is agreed that all matter and energy add to the stress-energy tensor which describes the gravitational field via Einstein's field equations, but descriptively this is not much different from 'mass and energy creates gravity'. Yet the theory (GR) has been thoroughly tested and has proven that its accuracy is renowned¹⁵.

A fully functional mechanistic explanation for the workings of gravity still does not exist. Even the above descriptions of GR do not provide the answer to 'how it works'.

Introducing the omnipresent, omnidirectional, particle flux

Omnidirectional flux

Postulate: The void of space, 'vacuum' contains a dynamic omnidirectional field, a boson flux, which quantum particles have spin=unknown, charge=0, with some 'photon-like' particle and wave qualities. The flux is quantised in particles which couple directly with particles of mass.

Since particle properties have already been attributed to the hypothetical¹⁶ 'graviton', and graviton is proposed as a virtual spin-2 quantum particle that relates to the stress-energy tensor of Einstein's Theory of General Relativity, the flux particles here-in are not considered as gravitons, although the term 'gravitons' as a possible solution is not excluded.

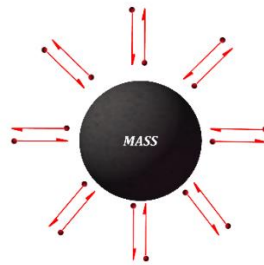

Figure 1: Mass is stable in a balanced omnidirectional flux. If not disturbed by external forces, acceleration = 0.

Consider [Figure 1]. Thought experiment: A composite mass is 'at rest' in an omnidirectional particle flux, with 'at rest' understood as there being no imbalance in the flux from any direction, i.e. the flux energy flow is macroscopically equal from all sides, and no net momentum is imposed on the mass.

Minkowski¹⁷:

With appropriate setting of space and time the substance existing at any worldpoint can always be regarded as being at rest. This axiom means that at every worldpoint the expression

$$c^2 dt^2 - dx^2 - dy^2 - dz^2 \quad \text{Eq1}$$

is always positive, which is equivalent to saying that any velocity v is always smaller than c .

further:

From the beginning we can determine the ratio of the units of length and time in such a way that the natural limit of velocity becomes $c = 1$. If we introduce

$$\sqrt{-1} t = s \tag{Eq2}$$

instead of t , then the quadratic differential expression

$$d\mathcal{T}^2 = -dx^2 - dy^2 - dz^2 - ds^2 \tag{Eq3}$$

becomes completely symmetric in $x; y; z; s$ and this symmetry is carried over to any law that does not contradict the world postulate. Thus the essence of this postulate can be expressed mathematically very concisely in the mystical formula:

$$3 \cdot 10^5 \text{ km} = \sqrt{-1} \text{ seconds} \tag{Eq4}$$

, which defines time as the 4th dimension to 3D space, and the value of the speed of light, c , as fundamental to the whole construct. Time is derived from the fundamental value of c , and a measure of space is derived from the 4-dimensional construct that follows.

In the omnidirectional flux model, the arrow of time always points forward.

In the omnidirectional flux model, a quantum of mass may not be stable in a quantised flux and may appear to have random movements. Kennard¹⁸:

$$\sigma_x \sigma_p \geq \frac{\hbar}{2} \tag{Eq5}$$

The omnidirectional particle flux is a dynamic background, and not to be confused with the static aether theory of Lorentz¹⁹, nor with the corpuscles of the push-gravity theory of Le Sage¹⁻¹¹, although the latter provided much inspiration toward this hypothesis.

Absorption

Postulate: All objects of mass absorb a small fraction of the total flux energy as the flux transitions the mass. Absorbed flux energy is shown to be radiated as heat.

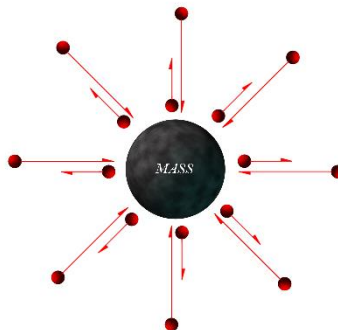

Figure 2: A small fraction of flux is absorbed in mass, resulting in a flux exit energy being reduced from the incident flux.

Consider [Figure 2]. Thought experiment: A small fraction of incident flux is absorbed into mass, creating a symmetric imbalance of flux around the mass. However, a composite mass remains 'at rest' in an omnidirectional particle flux if the net flux energy is equal from all sides. No net momentum is imposed on this mass.

Transparency

Postulate: All objects of mass are transparent to the omnidirectional flux just as clear glass may be transparent to visible light photons. With matter being transparent to the flux, the flux is slowed in mass, and a constant momentum is transferred for the duration of transit of flux. Inertial effects still apply, and a mass will accelerate over time until it achieves this constant momentum.

Masud Mansuripur describes transfer of a constant momentum from a photon in a non-dispersive medium²⁰:

When the pulse first enters the dielectric slab, the positive force of its leading edge accelerates the slab. The acceleration continues until the trailing edge enters, at which point the net force returns to zero. If the mass of the slab is denoted by M – this could include the mass of the Earth, to which the slab is attached – its acquired momentum will be given by the integrated force over the pulse duration, namely, $MV = \frac{1}{4}\epsilon_0(\epsilon - 1)E_0^2 A\Delta T$. [This reduces to $MV = \frac{1}{2}(n^2 - 1)hf/nc$ for a single photon.] So long as the pulse stays within the slab this acquired momentum remains constant. However, as soon as the leading edge of the pulse exits through the slab's rear facet, the trailing edge begins to exert a braking force to slow down the slab's motion. By the time the trailing edge leaves the slab, the motion has come to a halt, and all the momentum initially acquired by the slab has returned to the light pulse

Pfeiffer et al describes transfer of a constant velocity²¹:

...the block accelerates away from the beam source while it is traversed by the leading edge of the beam, then continues to travel away from the source at constant velocity while the beam is turned on. When the beam is turned off, traversal of the trailing edge restores the block to rest

A constant velocity will be imposed on a mass in an imbalanced omnidirectional particle flux. However, it would be a fallacy to assume this entire velocity is transferred instantaneously. Depending on 'beam' strength, by the laws of physics, an inertial mass must still accelerate until it acquires the velocity imposed by the beam.

The Fatio/Le Sage shadow gravity theory

Introducing Fatio / Le Sage

Several valid problems have been identified in Fatio/Le Sage type push-gravity theories (Also known as Le Sage's Shadow Theory)¹⁻¹¹.

Authors attempt a revision of Le Sage, with many successful corrections thereof, and much progress, however not all holistic, and to date these theories have still not been widely accepted. Rosamond Woody and Jana McKenney summarises¹¹:

Although it is not regarded as a viable theory within the mainstream scientific community, there are occasional attempts to re-habilitate the theory outside the mainstream, including those of Radziewskii and Kagalnikova (1960), Shneiderov (1961), Buonomano and Engels (1976), Adamut (1982), Jaakkola (1996), Tom Van Flandern (1999), and Edwards (2007)

A great number of these 'problems' stem from at least some misunderstanding of the original push-gravity theories. As 'shadow-gravity', it is sometimes incorrectly understood that gravity must have a 'light-speed or better' connection between objects of mass and that attraction only ensues when a mutual 'shadow' connection has been established between masses. Conventional definitions of gravity conjure images of 'ropes' or 'strings', or 'loops' or 'gravitons' stretching from one mass to the other. Defining these connections have been troublesome and even more so as is evident from the many failed attempts at explaining push-gravity. This document will show that such a light-shadow-connection is entirely unnecessary.

Almost every gravitational theory currently suffers from the 'speed of gravity' problem (GR excluded). As an example of this, if a particle, a 'graviton', left the sun toward earth for purposes of acting as force-carrier, and attracting the earth when it arrives, the orbital speed of the earth would have moved it out of the particle's path in the ~8 minutes it takes the particle to get there, and the particle will find nothing there to attract. Add to that it must not only be intuitive to interact at the correct location, but also then return to the sun to effect upon it a full 'graviton exchange'. To correct this idea, to thus 'connect' sun and earth, a successful graviton leaving from the sun would need to already know the velocity vector of the earth, which seems unphysical. It was erroneously thought by many that the only way to overcome this problem, was to assign speeds to gravity much greater than the speed of light.

This document no longer suffers from Le Sage's problems, as are briefly discussed below. The problem statements will not be extensively elaborated in this section; please refer to the

references¹⁻¹¹ for exceptional reviews of Le Sage and the many problems associated therewith.

Some of the problems encountered by Fatio and Le Sage have by now been overcome by advances in science, but many have remained unsolved. The issues listed below are now solved and clarified, either in currently established science, or in this document.

Porosity of matter

Problem: Leibniz criticized Fatio's theory for demanding empty space between the particles:

Solution: At the time of the writings of Fatio and Le Sage, little was known about the atom; nucleus and electron, as is known today. This problem can be discounted since atoms are now known to be largely 'empty space'. Furthermore, the premise of this document is that matter is transparent to the omnidirectional flux, like glass is to visible light, and the absorption of flux scales with density. Empty space, although present in 'atoms', is no longer an essential requirement for this hypothesis. Where 'empty space' does become significant, the solution is simply offered with a relation to the density of a volume.

Superluminal speeds of particles

Problem: Corpuscles had to be sufficiently small as to not have a large cross-section with matter. To compensate, and still transfer sufficient momentum upon interaction, particle velocities had to be raised to greater than the speed of light.

Solution: In this document the speed of light is the speed of the flux. The flux interacts with mass through coupling and a fraction of flux is absorbed in mass. The 'sizes' of the flux particles are irrelevant for this hypothesis.

Surface area, or volume, not mass

Problem: Flux interaction will interact on a volume, and it is known that gravity is mass dependent, not volume or surface dependent.

Solution: An easy solution for this problem already exists, which knows mass as volume times density, and that the solution must account for both. This document shows that flux travel through an area, also needs to account for travel at a normal to the area, through the entire mass, which ends in a measure of volume. By accounting for density ρ into equations, volume is converted to mass. It is intuitive that a higher density will receive more interaction with a permeating flux.

Gravitational shielding

Problem: If a mass absorbs flux, it will shield the next mass of some flux, and gravity will be lower on the next mass, and the next mass, and so on.

Solution: Gravitational shielding was perceived to be a big problem for the Fatio/Le Sage theory. However, an understanding of the mechanism of gravity now brings evidence that shielding is real, as flux will be absorbed and reduced through multiple masses, or through very large masses. It can be observed in e.g. non-uniform gravity in spiral galaxy disks, and the behaviour of ocean tides on earth. Shielding is not a problem, but indeed a support of this hypothesis.

Speed and Range of gravity, Instant action at a distance,

Problem: Due to the finite speed of gravity, an object should be attracted to its historic 'visible' location, at a distance $d=ct$. LaPlace calculated that the speed of gravity must be 'at least a hundred million times greater than that of light'. It was not understood how Newton's equations could know 'where the mass is', and how a mass could instantly be attracted over a great distance. It defied the rules of causality and could only be explained by letting the interaction exceed the speed of light.

Solution: With this omnidirectional flux theory, mass absorbs flux and creates an imbalance in flux-in vs flux-out, around every mass. Such imbalance is continuously updated outward at the speed of light and, once in motion, is no longer dependent on its originating mass' position. When another mass encounters the imbalance, the imbalance is *already there*. An action ensues between the mass and the imbalanced flux, creating an impression of an instant interaction between distant masses.

Aberration

Problem: Even if gravity is found to propagate at the speed of light (which it has), there is still a finite time for gravitational interactions to occur. The gravitational attraction must point in the direction of a mass' 'visible' (historic) location, which is not its current position, and this offset will create an unstable angular momentum in the system. Since this is not observed, it is argued that classic gravity must propagate at infinite speed.

Solution: In a static solution no aberration is expected. However, to account for velocity components, a relativistic solution is required. This has been done with both a classic Newton²² and General Relativity²³ solution, with gravitational changes at the speed of light, and it has been found that a velocity component of gravity cancels out the expected aberration. The gravitation vector of a mass in motion points directly at each mass at its current position, and hence no aberration is observed.

Drag

Problem: Gravity through absorption seems to work fine until bodies start moving, then flux particles will 'pile up' on the leading face of a mass and cause noticeable drag, which would

decelerate any moving object of mass. Since a drag is not observed in orbiting bodies, this was considered one of the 'death-blows' to the corpuscle theories.

Solution: In this theory of particle flux, momentum is transferred from particle to mass, but retrieved after transit through the transparent mass. In a balanced flux, even if the mass has 'velocity', there is no net transfer of momentum to or from the flux, and thus there is no net drag effect. In an imbalanced flux, as would be in a gravitational field, a constant momentum is transferred, which does not lead to drag effects.

Energy: Absorption; Thermodynamic problem;

Problem: Given the superluminal speeds of particles mentioned above, most Fatio/Le Sage variations would result in 'blowing up the earth' due to scales of absorbed energy. This has been calculated by Maxwell, Laplace, Poincaré, Feynman and others. It is considered as another 'deathblow' problem.

Solution: This hypothesis agrees that energies of absorbed particles must ultimately be observed as heat. However, it is found that the heat scales relative to the mass sizes, and, for a chosen value of absorption coefficient, may be well within magnitude of known energy limits of e.g., orbiting bodies. See Addendum; Internal heat of Jovian planets are comparable to expected flux absorption energy.

Massive bodies absorb flux, Growing earth

Problem: Omnidirectional flux of corpuscles gets absorbed to create the shadow effect. Where do the corpuscles go? Fatio and Le Sage's corpuscles needed to be absorbed, or somehow discreetly discarded. Some theories suggested a 'growing earth' from these accumulated particles, for which no evidence exists.

Solution: This seems to have been defined as a problem, but it is indeed a part of the solution. Massive bodies must absorb some flux, thereby creating a surrounding flux imbalance. When two or more masses interact, each is affected by the other mass' imbalance, and their respective 'shadows' result in less overall absorption for each mass.

A small fraction of flux is absorbed, clearly defined in this document. All other flux particles that interact would transit a mass with their original energy intact. Flux in transit add to the momentum transferred to the mass, only while in transit. Absorbed flux would exit as e.g., heat, decoupled from gravitation effects.

Coupling to energy

Problem: The question is, 'how does push-gravity attract a particle toward a mass?' This would be the same problem conventional gravitation theories suffer from.

Solution: This problem arises from labelling gravity as an 'attractive' force when it is shown here-in to be because of a 'push' force. Shown here-in, the flux interacts with the mass on a local level, and mass disturbs the flux which disturbance spreads out at the speed of light, where it may interact with another mass. This offers an understanding for Einstein's "mass bends space, and space tells mass how to move". The flux imbalance around a mass is 'curved space'.

Particles exit with reduced velocity

Problems: Corpuscles that are not absorbed may have some scattering or refracting interaction with the mass and will eventually lose velocity, thereby no longer contributing to 'the flux'. Corpuscles with little or no velocity will clog up regions of space.

Solution: The flux particles proposed here-in arrives at 'c' and leaves at 'c' unless it is fully absorbed. Just like visible light through glass. Inside the glass mass traverses at ' $v=c/n$ ', but exits again at 'c'. A flux-particle, in a balanced flux, that has not been absorbed, does not lose any of its energy. A flux-particle that is absorbed loses energy and the mass gains energy. An absorbed particle may partake in transferring momentum to a mass or heating of a mass if the absorption is entirely balanced.

Particles would collide with, and attract each other,

Problem: No matter how small, corpuscles must bounce against each other. An omnidirectional flux of particles that does not annihilate itself is hard to fathom.

Solution: Flux particles are bosons and immune to the effects mentioned.

Special relativity (SR)

Problem: To maintain a shadow, corpuscles must travel at greater than the speed of light. This is considered a major causality problem.

Solution: The speed of light is a universal limit. This document has shown the local flux to abide by the limit, and any relative movement of a mass in a balanced flux immediately creates a relativistic relationship. This model is SR compliant, although general solutions here-in have only been offered for static or low-velocity scenarios. Expanding this model to relativistic cases is a task to be taken and not seen as an insurmountable problem.

Ultramundane particles, Cosmic radiation, Omnidirectional flux

Problem: Fatio/Le Sage proposed a new 'ultramundane corpuscle' as an omnidirectional flux, with origin outside of the universe. Even though Newton was exploring the particle behaviour of light, little was known of photon-like particles. Fatio and Le Sage required particles with mass (corpuscles) to transfer momentum unto mass.

Solution: A boson particle flux overcomes this problem since the particle will only transfer momentum while in transit through a transparent medium, then reclaim its momentum at exit, unless it is absorbed during transit.

The problem of the flux origin has not been overcome and it is not attempted here-in. The (apparently infinite) source of the flux has not been established but has been ruled out as being of origin from known celestial bodies. Proposing a source of the flux is one of many tasks at hand. 'Not knowing' the origin of the flux does not detract from this hypothesis.

Inertial mass as a measure of the flux (observer view)

It is known that the value of an inertial mass can be measured under a change in velocity. Relevant simple classic equations for force $F=m \cdot dv/dt$ or $F=dP/dt$ apply.

For this first exercise, the effects of absorption are considered insignificant. With the mass transparent to a balanced omnidirectional particle flux, the mass has stable (or no relative) motion.

From an observer in (initially) the same reference frame, for a small mass, and ignoring any possible absorption: $\text{Sum}(E_{in}) = \text{Sum}(E_{out})$, where E_i are the energies of the particles that interact with the mass.

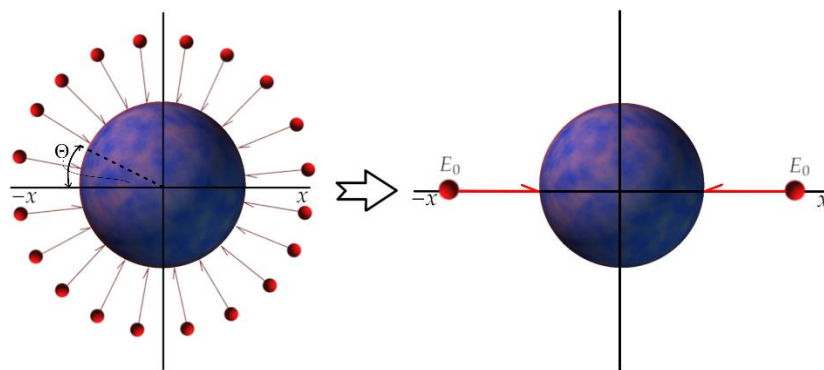

Figure 3: For this exercise, only the x-direction components of all inward particles are summed up, and then represented as +X and -X components.

Consider then, as shown in [Figure 3], only the effect in one dimension (x), where the components of all particles contribute:

$$\vec{E}_0 = \sum_i \vec{E}_i \cos\theta_i \tag{Eq6}$$

Since the vector sum of all particle energies in a balanced flux will equal to zero, the flux is presented as two single simultaneous particles approaching the mass, of equal energy but opposite direction on the +x and -x axes, so that the mass does not gain any momentum from these particles.

The energy vector of each initial particle, before entering the mass, can be represented as:

$$\vec{E}_{01} = h * f_0 \hat{x} \tag{Eq7}$$

and

$$\vec{E}_{02} = -h * f_0 \hat{x} \tag{Eq8}$$

A force F is now applied to the mass m , in direction x . The mass will experience a relativistic change in momentum:

$$\vec{F} = \gamma * m * \frac{dv}{dt} \hat{x} \quad \text{Eq9}$$

$$\gamma = \frac{1}{\sqrt{1 - \frac{v^2}{c^2}}} \quad \text{Eq10}$$

For a mass accelerating from rest, after a single unit of time dt ($dt=1$), the velocity of the mass will be dv , in the $+x$ direction.

At the instant of acceleration of the mass, the two particles $\pm E_0$ in the mass are transformed, so that they appear as particles $E_1 > E_0$ and $E_2 < E_0$ in the mass as shown in [Figure 4]:

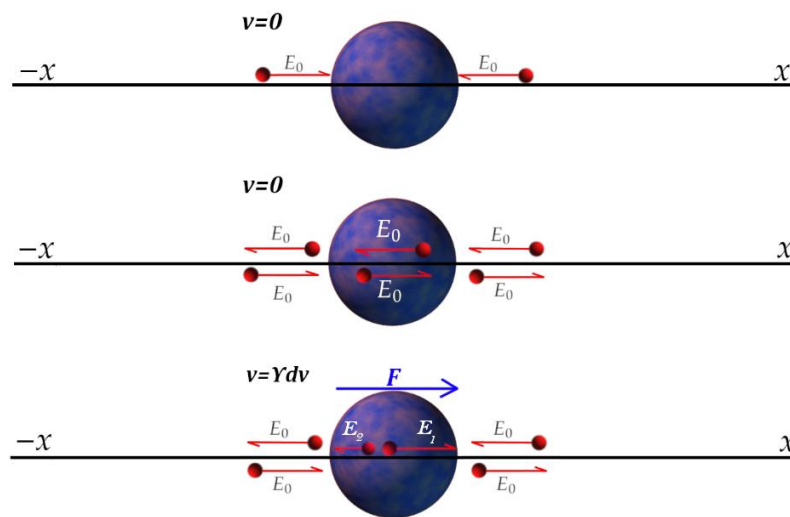

Figure 4: From an observer point of view, the flux particles in the mass are transformed when the mass is accelerated due to an external force. Top picture: the flux is shown around the mass as equal $\pm E_0$. Mid picture: the mass is transparent to the flux and $\pm E_0$ is also within the mass. Bottom picture: The mass is accelerated and the particles within are transformed to E_1 and E_2 , blue-shifted and red-shifted respectively. The surrounding particles remain undisturbed to an external observer. (arrow lengths are not to scale, and represent vector strengths, not particle wavelengths)

From the relativistic Doppler equation^{24,25}, we get the energy of the transformed particles, shown in the bottom of [Figure 4] as E_1 and E_2 :

$$|E_1| = h * f_0 * \sqrt{\frac{c + dv}{c - dv}} \quad \text{Eq11}$$

$$|E_2| = h * f_0 * \sqrt{\frac{c - dv}{c + dv}} \quad \text{Eq12}$$

$$\frac{|E_1| + |E_2|}{|E_0|} = \sqrt{\frac{c + dv}{c - dv}} + \sqrt{\frac{c - dv}{c + dv}} \quad \text{Eq13}$$

$$\frac{|E_1| + |E_2|}{|E_0|} = \frac{2}{\sqrt{1 - \frac{dv^2}{c^2}}} \quad \text{Eq14}$$

$$|E_1| + |E_2| = 2 * \gamma * |E_0| \quad \text{Eq15}$$

Change in energy can be calculated by comparing with the energy of the original particles:

$$|E_1| + |E_2| - 2 * |E_0| = 2 * |E_0| * (\gamma - 1) \quad \text{Eq16}$$

It is known that for a relativistic mass, the change in energy is the kinetic energy gained:

$$|E_k| = (\gamma - 1) * mc^2 \quad \text{Eq17}$$

By setting change in energy of the particles equal to kinetic energy of the mass, a well-known relationship is revealed:

$$2 * |E_0| = mc^2 \quad \text{Eq18}$$

(Note: $2 * E_0 = mc^2$ in this document, because the starting particles each had E_0 energy, which is related to Einstein's derivation²⁶ of $E = mc^2$, since Einstein's choice of starting energy of the photons as $E/2$ each.)

In a different approach the resulting particles indicate the state of motion (dv) of the mass, where $|E_1 + E_2| = |E_1| - |E_2|$ since the particles are in opposite direction:

$$|E_1| - |E_2| = \frac{2 * dv}{c} * \gamma * |E_0| \quad \text{Eq19}$$

Consider for a mass in motion the momentum P can be shown as:

$$P = \frac{|E_1| - |E_2|}{c} = \gamma * m * dv \quad \text{Eq20}$$

From [Eq19] and [Eq20], is revealed:

$$\gamma * m * dv = \frac{2 * dv}{c^2} * \gamma * |E_0| \quad \text{Eq21}$$

And once again:

$$2 * |E_0| = mc^2 \quad \text{Eq22}$$

A next approach takes the total energy of the transformed particles E_1 and E_2 :

$$|E_1| + |E_2| = 2 * |E_0| * (\gamma - 1) + 2 * |E_0| \quad \text{Eq23}$$

Then from [Eq17] and [Eq18] above,

$$|E_k| + mc^2 = |E_1| + |E_2| \quad \text{Eq24}$$

Which is a well-known relationship.

The relation $E^2 = (Pc)^2 + (mc^2)^2$ is shown in terms of the flux particle energies:

$$(|E_1| + |E_2|)^2 = (|E_1| - |E_2|)^2 + (2 * |E_0|)^2 \quad \text{Eq25}$$

From [Eq16] and [Eq19] the particle energies in relation to incident energies are:

$$|E_1| = \gamma * |E_0| \left(1 + \frac{dv}{c}\right) \quad \text{Eq26}$$

and

$$|E_2| = \gamma * |E_0| \left(1 - \frac{dv}{c}\right) \quad \text{Eq27}$$

with a reminder that E_0 , E_1 , E_2 represent sums of x-components of all particles that interact with the mass.

Discussion of Inertial mass (stationary observer view)

The equations above reveal the relations of mass, kinetic energy, momentum, and total energy of a mass interacting with the omnidirectional particle flux, as viewed from a stationary observer. An observer sees the background omnidirectional flux (E_0) undisturbed and sees the particles in transit of the mass disturbed to E_1 and E_2 . Through manipulation of E_1 and E_2 , the momentum [Eq20] and the absorbed kinetic energy [Eq16] can be derived.

Note: $E_1 + E_2 > 2E_0$ because $\gamma > 1$ for all $v < c$ and $E_1 > E_0 > E_2$ is typical in Doppler results.

The premise of $E=mc^2$ is that a photon absorbed into an object of mass, adds to the energy of the object. This is a well-established theory. Here it has been shown that momentum or kinetic energy is gained through absorption of (photon-like) particle energy.

It has been argued in this section that the inertial mass of an object must ensue from particles in transit in the mass; an omnidirectional particle flux to which all mass is transparent will reveal the mass of the object in any direction in which it is accelerated. Inertial mass is apparent for the duration of acceleration (or change in velocity). During acceleration, the flux in the mass is perturbed, as in the E_1, E_2 argument above, in a ratio to the gained energy of the mass.

E_0 represents the prime reference frame for both mass and observer. Also, to be kept in mind is that E_0 is only a linear, one dimensional, representation of an omnidirectional flux. It should be noted that for a larger mass, it is not expected that E_0 would signify a greater energy for each particle, but as shown in [Figure 5], that a larger mass would contain more flux particles in transit, proportional to the volume and density of the mass.

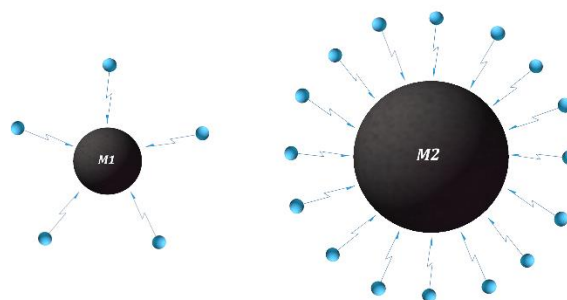

Figure 5: Small mass, fewer flux interactions; large mass, more flux interactions. Not 'bigger' flux for larger mass.

All objects with mass interact with (perturb during acceleration) the flux within itself. It is from interaction with the flux that its mass is defined. If it does not interact, it does not have mass,

e.g., other photon-like particles. If it interacts only a little, it will have low mass, e.g., neutrino or electron.

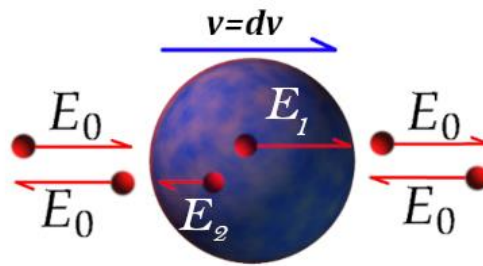

Figure 6: As seen from the viewpoint of an observer: Once the mass is no longer accelerating, new flux particles transiting the mass are consistently perturbed. The net energy in the mass remains constant, and the enveloping flux remains undisturbed. A mass in motion remains in motion unless another force enacts upon it. (Newton's 1st law)

Once acceleration ends, and the mass is in constant motion, the energy of flux particles entering, and exiting, are changed due to the momentum and/or kinetic energy of the mass. No energy is lost, so an observer will continue to see the particles enter as E_0 , transformed inside the mass as E_1 and E_2 , and exit again as E_0 . See [Figure 6].

It is as if the observer sees a 'beam' traversing the mass and attributing a constant velocity to the mass.

The flux does not resist constant motion, and no drag effect will ensue. {Newton's first law, and Minkowski's straight worldline¹⁷} The mass is now in a different reference frame in the flux, relative to an observer that did not accelerate, and from here-on they have a relativistic relationship.

For further consideration later in this document, is that the absorption/transformation of E_1 and E_2 , and subsequent velocity dv , does not happen in 0 time. It happens in a finite time dt , where $dt=1$ instance of time in the exercise above. Seen in an abstract way, dt is the finite time it takes mass (m) to absorb/transform E_1 and E_2 before it can achieve a velocity dv . By extension, the acceleration of a mass (m) under a force (F) is determined by the rate at which mass (m) can absorb/transform energy from a finite supply of flux particles.

Gravitational mass as a measure of the flux

The inseparable G and M

In all direct references to 'G' in this document, the gravitation constant is implied.

NIST²⁸: $G=6.674\ 30 \times 10^{-11} \text{ m}^3 \text{ kg}^{-1} \text{ s}^{-2}$

The Gravitational constant G is prominent in both Newtonian and Einstein's General Relativity equations and presents a measure of the strength of gravitational interactions. See [Figure 7].

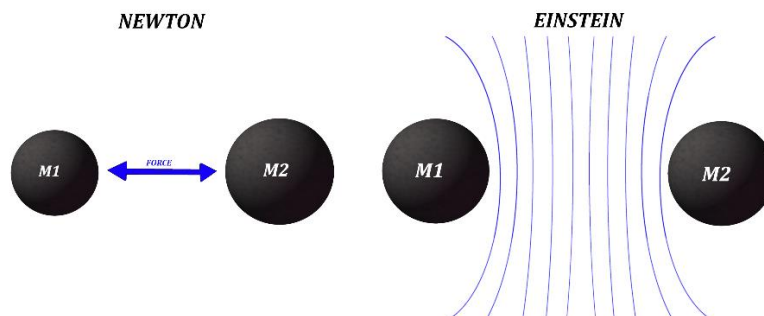

Figure 7: Comparing graphical representations of Newton's 'Action at a distance' to Einstein's 'Curved space'.

Newton:

$$F = \frac{G * M * m}{r^2} \tag{Eq28}$$

, which explains the interaction of one mass with another across a distance 'r', but without a time component.

Einstein:

$$G_{\mu\nu} + \Lambda g_{\mu\nu} = \frac{8\pi G}{c^4} T_{\mu\nu} \tag{Eq29}$$

, which formulates how mass bends space, and how space tells mass to move.

In gravitational calculations encountered above, the values of G (Newton's Gravitational Constant) and M (mass or energy of an object) are inseparable. In Newton's equation $G*M$ is found, with M a measure of mass. In Einstein's equation $G*T_{\mu\nu}$ is present, with $T_{\mu\nu}$ a measure of mass or energy. Even in the equation for bending light $dN = 4GMc^2/r_p$, $G*M$ is still inseparable. Orbital equations require $G*M = v^2/r$, or $G*M=3*\pi*v/P^2$, and gravitational acceleration $g = G*M/r^2$. A few methods of measuring G manage to cancel out mass from the equation²⁹ (although such methods still need to include inertia), but generally these two values are found together as $G*M$ and each equation relies on G being a constant.

Measurement and Units of G

Analysis of the SI units of G above, which can also be shown as 'N*m²/kg²', shows the units as required to balance Newton's (and Einstein's) equation and in Newton's formula would result in a unit of force, measured in Newton. (1 N = 1 kg*m/s²). The combination of units of G, directly reveals the inverse of what Newton's equation does, in that mass (M*m) interacts over the square of distance (r²) but is not otherwise descriptive as to its mechanics.

Acquiring an accurate and reliable measurement value of G has been problematic²⁹⁻³¹, compared to the accuracy obtained for other physics constants. A comprehensive review on the history of measurements of G, and difficulties encountered, is presented by C. Rothleitner and S. Schlamminger²⁹, and also by Junfei Wu et al³⁰.

Gravitational mass from flux interaction

Thought experiment: Consider again, the flux particles E₁ and E₂ in the accelerated mass in the section [Eq15] above.

$$F = \frac{dP}{dt} = \frac{|E_1| - |E_2|}{c \cdot dt} = \gamma * m * \frac{dv}{dt} \quad \text{Eq30}$$

Should the mass be subjected to an external energy of flux, imbalanced as shown in [Eq30], the mass would find itself accelerating, as if a force was subjected onto it. As per Masud and Pfeiffer et al's arguments, the mass will (try to) attain a velocity v from such an imbalanced flux, as if a beam of energy is traversing it.

Mass is transparent to the flux particles, like glass is to visible light, so a constant momentum is transferred while flux particles are within the mass. If a mass were to be placed in a curved Minkowski worldline, an imbalanced flux, the mass absorbs particles unevenly, it gains velocity over time, until it has gained a constant velocity, so it once again finds itself in a 'balanced' flux or straight worldline. In a curved worldline, as would be an object falling into a gravitational field, the magnitude of imbalance increases with each small displacement, resulting in a continuous increase in the velocity imposed.

This mechanism explains an object's gain of kinetic energy while falling into a gravitational field. When the force was applied externally in the inertial mass exercise, the inertial mass gained kinetic energy related to a change in particle energy, where the change in particle energy was equal to the attained kinetic energy of the mass, from [Eq16]:

$$|E_1| + |E_2| - 2 * |E_0| = 2 * |E_0| * (\gamma - 1) \quad \text{Eq31}$$

Shown in [Figure 6], since E₁+E₂ > 2*E₀ by the amount of kinetic energy that was gained, it implies that the mass had absorbed a measure of flux to attain such kinetic energy. When it

is implied that a fraction of E_0 was absorbed, it may be considered that some vector-quantum of flux was absorbed, which added to the momentum component in the +x direction.

If the mass were unable to gain kinetic energy, such as a mass resting against another larger mass, the applied force or absorbed flux would apply a pressure onto the mass as if to attempt to increase its velocity. Since the mass is not moving relative to the imbalanced flux, the pressure would remain constant.

This is in accordance with the equivalence principle^{12,32}, and also with a Minkowski curved worldline¹⁷, where there is similarity between being accelerated by an external force and being in a gravitational field. See [Figure 8].

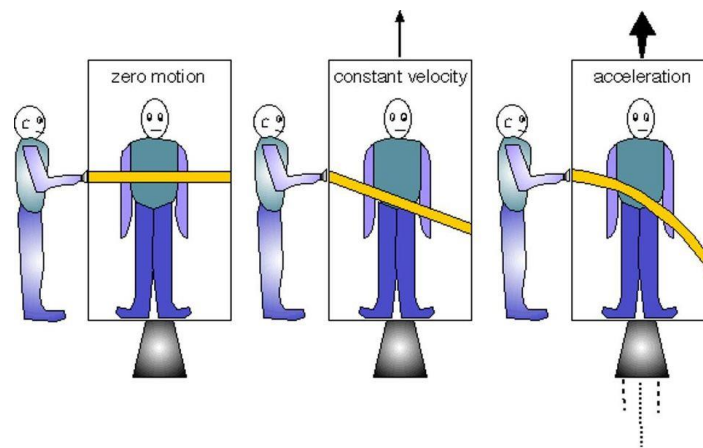

Figure 8: Visualisation of equivalence principle shows acceleration to be similar to being in a gravitational field. Picture credit: Ethan Siegel and Nick Strobel at www.astronomynotes.com

Discussion of Gravitational Mass

Nothing new was delivered in the above section of Gravitational Mass. $E=mc^2$ from the section on Inertial Mass is not a new scientific revelation. It has long been known that photons transfer momentum into mass by Einstein¹² and also by Abrahams and Minkowski²⁰. If a particle is wholly absorbed into a mass, it is as if a force is applied when the particle enters the mass. If the particle remains in the mass, the particle energy and momentum is added to that of the mass.

To describe the mechanics of gravity, what needs to be shown is that an object of mass could create such an imbalance in the omnidirectional particle flux. See [Figure 9].

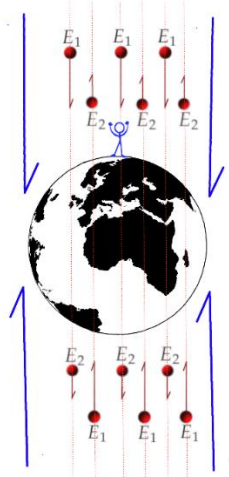

Figure 9: An imbalance in flux above the earth surface, with flux inward greater than a flux outward, results in a net flux inward and, will push a nearby mass down onto earth.

If it can be shown that some flux absorption occurs for objects of mass, such that E_1 (flux in) $>$ E_2 (flux out), then an imbalanced flux field has been formed around such mass. In this equivalent E_1 and E_2 of imbalanced flux, inertial mass and gravitational mass would be unified.

Gravity begins from flux absorption, resulting in a flux imbalance around a mass

As a typical example of flux, calculating the force of the sun's radiation on earth reveals an equation that is proportional to the intensity of the solar radiation. An increased intensity (I) of flux (absorbed) from the sun would increase the force on the earth's surface³³.

$$F = I * \frac{A}{c} \quad \text{Eq32}$$

With: F the force of the radiation on the surface
A the area where the radiation is absorbed
c the speed of light

If gravity were to originate from a flux, then the units of G in Nm²/kg² may be expected to be flux-like, in that G should be an indication of the strength of the flux, and a higher flux would mean a higher G. The units of G do not immediately reveal such a reference.

Reconsider the units of G now represented as:

$$\text{Units of } G = \frac{m}{kg} * \frac{m^2}{s^2} \quad \text{Eq33}$$

, where m/kg is a typical unit of a specific absorption coefficient, and Nm/kg or m²/s² is the unit of a momentum applied per mass (or the velocity-squared of a mass, if simplified). An absorption coefficient may be associated with a flux, and since G is used as a factor to calculate, among other things, force enacted upon mass, it is therefore arguable that G could be associated with a measure of flux, if absorption and velocity can be shown as relevant.

From the solar flux equation [Eq32], an increase in flux is associated with an increase in force. It must immediately be argued that the proposed omnidirectional particle flux of this paper is NOT coming from the sun and other stars, else earth and planets would have felt a definite repulsion from the sun, not an attraction. Since gravity effects appear as a 'pull' and not a 'push', and flux provides a 'push' unto mass, a flux solution for gravity may rather be found by finding attraction from a 'lack of flux'.

Space exists all around, thus flux must necessarily be omnipresent and omnidirectional. Gravity would begin to emerge if there is somehow an imbalance created in the flux, as has been shown above [Eq31]. An imbalanced flux will result in momentum transfer (or gravitation) of mass.

At this point in this discussion, it is not yet intuitive to envision how a mass can enact a net inflow of flux. However, if an omnidirectional flux exists, to which all mass is transparent,

then, if some flux is absorbed in the mass, strength of outgoing flux is reduced. The appearance is of a net 'inflowing' flux. The absorbed component of flux must necessarily be dispersed and cannot be ignored. However, it will be considered to not contribute against the gravitational effect but typically be dissipated as heat.

If it can thus be found that massive objects reduce outgoing flux, by 'consuming' incoming flux, hence creating an imbalance in the flux, a mechanistic description of gravity could begin to form. The measure of gravitational strength 'G' will then be (in part) a measure of the 'flux absorption' into objects of mass.

This document pursues this line of thought and firstly argues that G acts (in part) as an absorption coefficient of the flux.

Two body gravitational interaction

A standard Newton equation for gravitation is:

$$F = \frac{G * m_1 * m_2}{r^2} \quad \text{Eq34}$$

Where it is assumed, G is a constant, and m_1 and m_2 represent the masses of the 2 bodies in the gravitational interaction. The distance between the centres of mass is r , and the force F enacts equally on both masses.

To calculate the acceleration of each mass in the interaction, the equation would be shown as:

$$F = m_1 * a_{m_1} = m_1 * \left(\frac{G * m_2}{r^2}\right) \quad \text{Eq35}$$

With an equal and opposing force toward the other mass, with its own acceleration:

$$F = m_2 * a_{m_2} = m_2 * \left(\frac{G * m_1}{r^2}\right) \quad \text{Eq36}$$

This has been tested to high precision^{34,35}.

With the use of a torsion balance, and various other methods³⁶, the attraction of two masses is used to calculate 'G'. One mass alone is not sufficient to do such a test. At least two objects of mass are required. Measurement of G *must* be considered as a test of gravity between (only) two masses.

It has already been discussed that gravity would be a result of absorption of flux into mass. For a gravitational effect to occur, two masses need to be in 'gravitational sight' of each other. The argument is immediately; if 'G' is in part a measure of absorption, which mass will get the 'G', when the interaction must require both masses to absorb flux, possibly in

unequal measures due to unequal compositions? 'G' must be shared between the two masses in ratio to mass. For the 2 masses, m and M, in the test for the value of G:

$$G = G_m + G_M \quad \text{Eq37}$$

Where G_i are (in part) the absorption vectors for each mass, pointing inward to the mass.

The use of G has until now not been found to be problematic because the combination $M \cdot G$ is always used in calculations. But whereas $M \cdot G$ may be calculated and used correctly, an error in G will result in an error in M.

For this flux gravity theory to bring new predictions though, the masses need their own absorption coefficients. See [Figure 10].

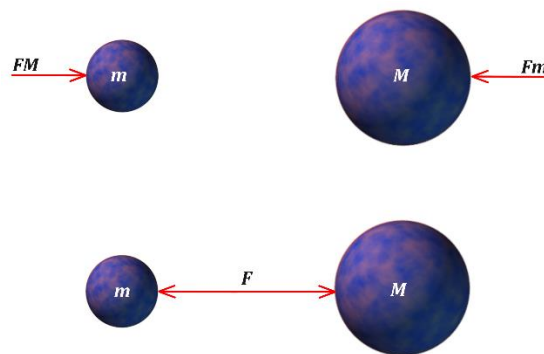

Figure 10: Mass m enacts a force unto mass M, and so also M unto m. It results in a perceived force that enacts on both masses equally. What is perceived as a 'pull force' between masses, is a result of a net push force on each mass.

Where each mass establishes an imbalanced flux field, (note: g_m , g_M are the fields imposed on the opposite mass)

$$g_m = \frac{(G_M * M)}{r^2} \quad \text{Eq38}$$

$$g_M = \frac{(G_m * m)}{r^2} \quad \text{Eq39}$$

which can only be enacted by bringing another mass into measurable range, where each field acts unto the other mass, and the total force results from their combined flux imbalance fields.

Here, a note needs to be inserted to explain the apparent 'instant action at a distance' which ensues from Newton's equation. While the effects of gravity may be compared with the effects of a static field, it has already been established that changes in gravity moves at the speed of light³⁷, yet Newton's equation does not seem to rely on the speed of light. It is as if the mass and its surrounding 'static' field already 'knows' where the other mass is.

Understanding the imbalance created by the absorption of flux, at the speed of light, takes

the mysticism out of this effect. A mass can establish an imbalanced flux field without the nearby presence of another mass. When the other mass approaches, it seems as if there is an instant gravity between the masses. The masses are moving into each other's 'imbalance fields', *which is already there*, hence the instant action. Even where gravitational aberration is expected, where the masses have a relative velocity to each other, it has been shown that aberration is cancelled by velocity components^{22,23}.

(However, the scenario presented here, and Newton's equation, does not yet provide a solution for relativistic masses.)

From [Eq38] and [Eq39] Newton's equation could become:

$$F = F_m + F_M = \frac{(G_M * M)}{r^2} * m + \frac{(G_m * m)}{r^2} * M \quad \text{Eq40}$$

$$F = \frac{(G_m + G_M) * m * M}{r^2} \quad \text{Eq41}$$

, which is noticeably Newton's equations if $G_m + G_M \approx G$, recognised to be a general solution for 2 bodies of similar composition only.

Calculation of Flux absorption

For an omnidirectional particle flux to result in a gravitational 'attraction', a portion of flux must be absorbed in a mass:

$$Flux_{out} = Flux_{in} - Flux_{absorbed} \quad \text{Eq42}$$

Here flux is measured in Gaussian terms, with units of 'number of particles/m²/s', and no reflection or scattering is considered. Momentum transferred by absorbed flux in a balanced flux (after absorption) is considered as negligible.

It has been shown that the gravitational constant 'G' [Eq33] may be associated with the absorption of flux. Here it will be shown that an imbalance in flux (due to absorption by mass) equals a net inward flux potential.

Flux absorption

It is known that absorption of electromagnetic rays, as per example, x-rays³⁸⁻⁴⁰ follows an exponential decay curve as shown in [Figure 11] and [Eq43]:

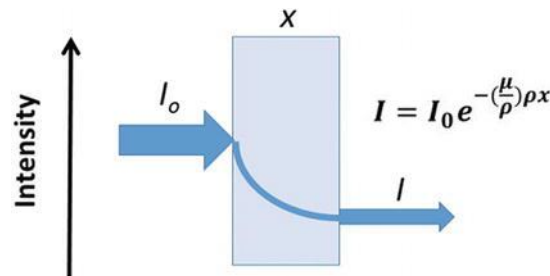

Figure 11: Typical X-Ray absorption curve over a distance x . Picture from: <http://physicsopenlab.org/2018/01/20/x-ray-absorption/>

$$I_{(x)} = I_{0x} * e^{[-(\frac{\mu}{\rho})\rho x]} \quad \text{Eq43}$$

where ρ is the density of the element (g/cm^3), μ is the linear attenuation coefficient, and μ/ρ is the mass attenuation coefficient given in cm^2/g . Note that x-ray absorption is not influenced by the crystal structure of the pigment, but only by the number of atoms/ cm^3 and the thickness of the pigment layer³⁸

From [Eq43], absorbed flux into a mass equals:

$$I_{abs(x)} = I_{0x} - I_{(x)} \quad \text{Eq44}$$

$$I_{abs(x)} = I_{0x}(1 - e^{[-(\frac{\mu}{\rho})\rho x]}) \quad \text{Eq45}$$

, where ρ is the density of the element (kg/m^3), (μ/ρ) is the mass attenuation coefficient given in m^2/kg , I_0 and $I_{abs(x)}$ have units of 'number of particles/ m^2/s '. Again, we consider only the x-components of flux, as was done in [Eq6], so that for any point:

$$\vec{I}_{0x} = \sum_i \vec{I}_{xi} \cos\theta_{xi} \quad \text{Eq46}$$

[Eq45] is a typical result of an integral of an exponential function with boundaries (0 – x); thus, equalling the total linear absorption of flux across a linear distance x , in one axis of x only. See [Figure 12].

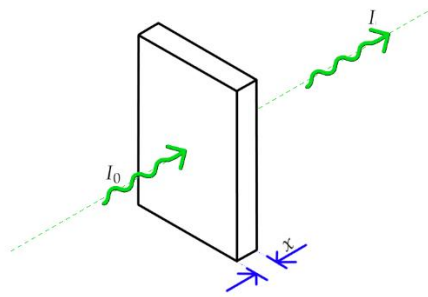

Figure 12: Representation of absorption of a unit of flux through a thickness of 'x'

Since $I_{abs(x)}$ is the absorption of particles per m^2 per second, absorption through a surface area (A), will be the absorption multiplied by area (A), resulting in the total absorption of flux into a cubic volume; through an area $A=Y*Z$, across distance x, resultant $I_{abs(vol)}$ has units of 'number of particles/s'. See [Figure 13].

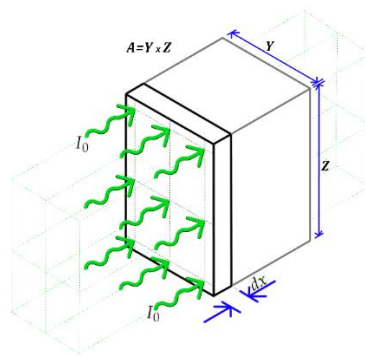

Figure 13: Representing absorption of a measure of flux across an area A, through a distance x

Absorbed flux for the volume can now be calculated:

$$I_{abs(vol_x)} = I_{0x} \left(1 - e^{-\left(\frac{\mu}{\rho}\right)\rho X} \right) * A \quad \text{Eq47}$$

$$I_{abs(vol_x)} = Y * Z * I_{0x} \left(1 - e^{-\left(\frac{\mu}{\rho}\right)\rho X} \right) \quad \text{Eq48}$$

A Taylor expansion for e^{-ax}

$$e^{-\left(\frac{\mu}{\rho}\right)\rho X} = 1 - \left(\frac{\mu}{\rho}\right)\rho X + \frac{\left(\frac{\mu}{\rho}\right)^2 \rho^2 X^2}{2!} - \frac{\left(\frac{\mu}{\rho}\right)^3 \rho^3 X^3}{3!} + \dots \quad \text{Eq49}$$

Which simplifies for small values of $\left(\frac{\mu}{\rho}\right)\rho x$ to:

$$e^{-\left(\frac{\mu}{\rho}\right)\rho X} = 1 - \left(\frac{\mu}{\rho}\right)\rho X \quad \text{Eq50}$$

Simplifying [Eq48]:

$$I_{abs(vol_x)} = Y * Z * I_{0x}(1 - (1 - \mu\rho X)) \quad Eq51$$

$$I_{abs(vol_x)} = \rho * XYZ * \mu I_{0x} \quad Eq52$$

, which XYZ equates to a volume of a cube, and ρ is density, hence $\rho * XYZ = \text{Mass}(M)$.

Compare the above steps for e.g. a sphere, where area $A = \pi r^2$ and length x is the mean path for a particle through a sphere ($x = 4r/3$), then $4/3\pi r^3 \rho = M$ for the sphere. Then it follows:

$$I_{abs(M_x)} = \mu_M I_{0x} * M \quad Eq53$$

Here $I_{abs(M)}$ is in units of 'number of particles per meter per second' (or vector components there-of) from any single direction, I_{0x} have units of 'number of particles/m²/s', and μ is in units of m/kg.

From [Eq53] it is seen that there is a net absorbed flux into the mass (per second). It is postulated that for any mass, total flux absorption, from all directions, is:

$$Flux_{abs(M)} = \mu_M * Flux_{in} * M \quad Eq54$$

, however, it should be noted that a non-uniform, or non-symmetric, shape of mass e.g. a rod, will not have a uniform absorption.

Energy of Absorbed flux

From [Eq53]: I_{ox} (number of particles/m/s) represents a measure of all flux in one direction. Then $I_{ox} * M$ represent the component of flux that interacts with the mass in the x dimension, and $\mu * I_{ox} * M$ represent the portion of that component absorbed into the mass. Refer again to [Figure 3]. The sum of all particles with an x-component, that interacts with mass, was combined to be represented by two particles with energy E_0 , with $I_{ox} * M$ the measure of flux from E_0 .

It was shown from [Eq18] that the flux reveals the relation $2E_0 = mc^2$, whereas $2E_0 = E_{ox}$ is the sum of energies of all +x and -x components of flux into the mass. From [Eq18], the absorbed flux, in units of energy times absorption coefficient:

$$I_{abs} = \mu_M * E(I_0 M) = \mu_M M c^2 \quad Eq55$$

, compare the integral of known gravitational field over surface area of a spherical mass, measured on the surface:

$$I_{abs} = g * A = \frac{GM}{r^2} * 4\pi r^2 \quad Eq56$$

, gives the absorption coefficient μ in terms of 'G':

$$\mu_M = \frac{4\pi G}{c^2} \quad Eq57$$

Define the potential 'g' as:

$$E = g = \frac{\mu_M c^2 M}{4\pi r^2} \quad Eq58$$

Calculate energy for the volume from Einstein's stress-energy, with T^{00} :

$$T^{00} = \frac{1}{2c^2} * \epsilon_0 * E^2 \quad Eq59$$

, $T^{00} * \text{volume}$, with $c=1$ for units:

$$\text{Energy} = \frac{1}{2\mu_M c^2} * \left(\frac{\mu_M c^2 M}{4\pi r^2}\right)^2 * \frac{4\pi r^3}{3} \quad Eq60$$

and an equation for absorbed energy emerges in terms of μ or G

$$E_{abs} = \frac{\mu_M M^2}{24\pi r} * [1c^2] = \frac{GM^2}{6rc^2} * [1c^2] \text{ (Joule)} \quad Eq61$$

*** $1c^2$ where $c^2=1$, to convert tensor units from Joule/ c^2 to Joule.

Absorbed energy is expected to emerge as heat. See Addendum for comparison.

Gravitation ensues from an imbalanced flux absorption

It has been shown in [Eq54] that a fraction of the omnidirectional flux is absorbed into a mass.

Due to absorption of flux into the mass(M), an imbalance of flux (in vs out) is formed around mass (M). This imbalance will be shown to contribute to acceleration of other masses in the vicinity.

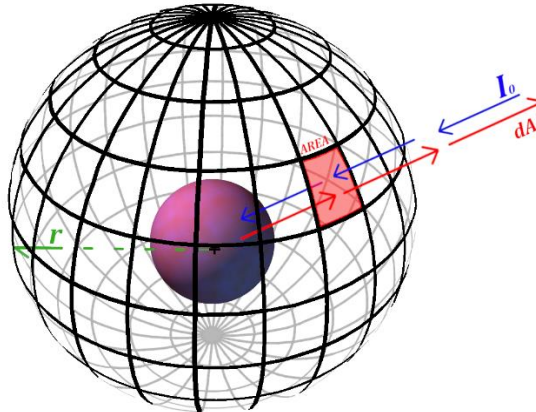

Figure 14: Gaussian sphere depicting measurement of flux at distance (r) through an area (A)

To predict the effect of this interaction over a distance, since the imbalanced flux is a vector field pointing in toward the (centre of) mass(M), invoking a Gaussian sphere, see [Figure 14], to measure the imbalance of flux at a distance (r) from the centre of the mass:

$$E(r) = \frac{\mu_M * E(Flux_{in} * M)}{4\pi r^2} \quad Eq62$$

The above [Eq62] is again E_0 from [Eq18] in one (x) direction only, from the mass, thus potential field strength per unit mass from the mass (M) at a point at distance (r):

$$E_m(r) = \frac{\mu_M * \frac{Mc^2}{2}}{4\pi r^2} \quad Eq63$$

, in units of m/s^2 , or shown in a more familiar form:

$$g(r) = \frac{\mu_M * c^2}{8\pi} * \frac{M}{r^2} \quad Eq64$$

Should another mass (m) be in proximity of (M), (also contributing its own flux-imbalance through absorption), the imbalances in flux will interact on both objects of mass (m) and mass (M), must be added together, with a combined acceleration toward each other, as already discussed in section: [Two body gravitational interaction].

A further contribution to acceleration is that each mass no longer finds itself in a 'balanced flux' as shown in earlier scenarios. Being in an imbalanced flux will also result in an imbalanced absorption, with less absorption between the masses, resulting in a further net 'push' toward each other. This component represents the original Fatio / Le Sage 'shadow-gravity' effect. Many previous authors¹⁻¹¹ have argued that gravitational attraction results from momentum transfer due to secondary absorption within this imbalance. This leads to a thermodynamic energy problem, which had been correctly pointed out a fatal error of the Fatio / Le Sage theory. In this document secondary absorption is considered negligible in a weak gravitational field.

It is rather argued, from [Eq62], representing the imbalanced flux, being now a description of 'curved space' within which any other mass may find itself.

It has further been argued, in [Gravitational mass from flux], that there is also a direct velocity imposed from the net flux imbalance (beam) traversing through, and coupling with, the entire mass, seen as a momentum transfer. While Masud and Pfeiffer et al correctly argue that a constant velocity is imposed on the mass, it cannot naively be accepted that this constant velocity will be achieved instantaneously, or at the passing of just 1 photon, lest there may have been a discovery to overcome inertia! It is thus here-in argued that the imbalanced flux will accelerate a mass, over time, to reach toward the constant velocity that it might impose. For a single photon thus, with hf and n unknown, a mass will be given momentum:

$$mv = \frac{hf}{2c}(n^2 - 1) = \frac{|E_1| - |E_2|}{\gamma c} \quad \text{Eq65}$$

, which arguably this velocity v must also be the escape velocity at any point R, in vicinity of a mass M:

$$v_e = \sqrt{\frac{2GM}{R}} \quad \text{Eq66}$$

, which velocity also determines the time dilation as an effect of the flux imbalance at distance 'R' from a non-rotating sphere.

$$\Delta t = \Delta t' \sqrt{1 - \frac{v_e^2}{c^2}} \quad \text{Eq67}$$

[Eq26] and [Eq27] represented one instance of time ($dt=1$) of acceleration. With an application of a persistent force, E_1 and E_2 would become variable as a function of time. From this, and [Eq20] that confirms $|E_1|-|E_2| = P*c$, it is argued that a mass that finds itself in

an imbalanced flux, will experience a continuous change in momentum, or acceleration, as determined by the relative strengths of E_1 and E_2 , until it achieves velocity v from [Eq66]. Time dilation, as an effect from velocity, is shown to be the time dilation in the imbalanced flux in [Eq67].

Since observation shows this acceleration from one mass to another to continue until impact, it is taken that the imposed velocity has not yet been achieved, due to the inertia of the mass.

Here Petkov⁴¹ and Einstein¹² argue that:

particles falling towards the Earth's surface do not resist their fall

and Petkov goes on to say:

a falling accelerometer reads zero acceleration

because its worldline has been set, and it is merely following its worldline. However, it is rather argued here-in that an accelerometer (seen as e.g. a meter inside a box), requires the box to be accelerated then it (the meter) can measure the acceleration from its own reference because it is attached to the box. In an imbalanced flux field, every atom of the whole box *and* the meter is being accelerated equally, and there will be no reference change from one to the other. For this reason, a swing-jump off a cliff's edge, or a sudden drop from a mild height on a roller-coaster ride, results in a short instant of sensation, as the body is changing from no acceleration to a definite acceleration, and there-after a continuous acceleration brings no sensation anymore because every atom of a body is not sensing any difference in acceleration to another atom. Because the flux pushes on every particle with mass in a body while in a gravitational fall, the body does not have a sensation of falling, and neither does an accelerometer.

From [Eq64] and [Figure 15], choosing spheres as interacting objects: Mass (M) creates an imbalanced flux around itself due to flux absorption. The mass (m) presents itself with a cross-section area ($A = \pi R^2$) through which the imbalanced flux of M will enact an imbalanced absorption, resulting in a push force of m toward M . [This describes one side of the interaction only]

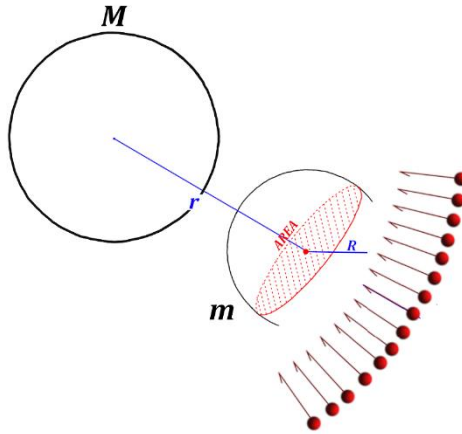

Figure 15: From the vantage point of mass M, mass m presents to it with a cross-section of surface area: $A = \pi R^2$

The mean free path of a particle through a sphere^{42,43} is equal to:

$$L_{eff} = \frac{4R}{3} \quad Eq68$$

For this interaction of flux through the mean free path length, across area (A), from [Figure 15], an imbalanced flux is perceived to exist at (m), caused by (M). Mass (m) has radius R_m , and density ρ_m :

The force on the second mass m, taken from [Eq64], and ignoring the component of secondary absorption:

$$\begin{aligned} F_m &= g(r) * L_{eff(m)} * \rho_m & Eq69 \\ &= \frac{\mu_M * c^2}{8\pi} * \frac{M}{r^2} * \pi R_m^2 * \frac{4R_m}{3} * \rho_m \\ &= \frac{\mu_M * c^2}{8\pi} * \frac{M}{r^2} * \left(\frac{4\pi R_m^3}{3} * \rho_m \right) \\ &= \frac{\mu_M * c^2}{8\pi} * \frac{M}{r^2} * m \end{aligned}$$

There is thus no pull force acting between the masses. The imbalance in flux, caused by absorption into each mass, is enacting a push force directly toward the other mass, which may also be perceived as a 'pulling force' from the other mass.

The force of the imbalanced flux at m, pointing at M, measured in Newton (N) is thus:

$$F_m = \frac{\left(\frac{\mu_M * c^2}{8\pi} \right) * M}{r^2} * m \quad Eq70$$

, while, assuming a uniform (balanced) local surrounding flux, and equivalent mass compositions, the mass m also exerts a force unto mass M:

$$F_M = \frac{(\frac{\mu_m * c^2}{8\pi}) * m}{r^2} * M \quad \text{Eq71}$$

Since the masses will be accelerating toward each other, the perceived total force is the sum of the forces between two masses M and m, which causes the total acceleration toward each other. From [Eq41]:

$$F_{mM} = \frac{(\frac{\mu_M * c^2}{8\pi}) * M * m}{r^2} + \frac{(\frac{\mu_m * c^2}{8\pi}) * m * M}{r^2} \quad \text{Eq72}$$

$$F = \frac{((\frac{\mu_M + \mu_m}{8\pi}) * c^2) * M * m}{r^2} \quad \text{Eq73}$$

, for similar mass types, absorption coefficients of mass m and mass M can be averaged to:

$$\mu_{ave} = \frac{\mu_M + \mu_m}{2} \quad \text{Eq74}$$

, then

	$F = \frac{((\frac{\mu_{ave} * c^2}{4\pi}) * M * m)}{r^2}$	Eq75
--	--	------

, finally [Eq75] reveals gravity because of flux absorption, [Eq76] shows G as a non-constant function of flux absorption for two masses, and [Eq18] has shown mass M variable as a measure of flux strength:

$$G = \frac{(\mu_M + \mu_m) * c^2}{8\pi} = 6.67 * 10^{-11} (\frac{m}{kg} * \frac{m^2}{s^2}) \quad \text{Eq76}$$

, then deduced in [Eq57] and again independently in [Eq75]:

$$\mu_{ave} = \frac{4\pi G}{c^2} = 9.33 * 10^{-27} (\frac{m}{kg}) \quad \text{Eq77}$$

It also becomes evident that Newton's equation is a 2-body approximation for 'low' values of G*M, since the term $e^{-\mu x}$ from [Eq48] does not reappear in the equations above but remains simplified. It also needs to be pointed out that this flux absorption model is based on 'standard' molecular masses, that μ_m likely varies slightly for different molecular materials, and might vary greatly for 'degenerate' masses e.g. bare nuclei, neutron stars or black holes. Necessarily, variations in local flux ($Flux_{in}$), or imbalances in local flux, must cause variations in perceived gravity, as further discussed in the Addendum.

Conclusion

A conceptual analysis has been presented in motivation for space as a dynamic omnidirectional particle flux, to which matter is mostly transparent, from which equations of mass, energy, motion and gravity were derived.

Minkowski space is observed to exist as an omnidirectional flux of 'photon-like' particles, at velocity 'c'. Time as the 4th dimension arises from this premise.

Through interaction with the omnidirectional flux, mass is measured. If a mass is accelerated in a balanced flux, its mass arises as a function of the strength of the local flux. If a mass exists in an imbalanced flux, it is accelerated by the flux until it reaches a constant velocity imposed by the imbalanced flux. Inertial and gravitational mass has been unified.

It has been argued that gravity ensues from of a 'lack of' outgoing flux from a mass. A fraction of flux is absorbed in all mass, which results in a surrounding flux imbalance. In a balanced flux a mass remains at rest (or at constant velocity), but it will be moved by an imbalanced flux. If the imbalance was created by absorption into a mass, effects of gravity are observed. It can be envisaged that a gradient in flux represent Einstein's or Minkowski's 'curved space', as the source of gravity when 2 objects of mass approach.

The absorption coefficient μ , in terms of the gravitational constant G , has been determined by two separate methods. See [Eq57] and [Eq77]. The value of μ is not considered to be a constant.

From the premise of an omnidirectional flux, a mechanistic understanding of gravitation thus arises, which leads to a conclusion that 'G' (universal gravitational constant) is not universal and is not a constant.

The above omnidirectional flux concept not only adheres to Special Relativity but strongly supports it and brings a new understanding of its (SR) workings.

Through our further understanding of the workings there-of, pursuit of this model will inevitably assist to finding a quantum solution for gravity, with G as a measure of local flux, and hopefully also assist to solve the immediate Dark Matter dilemma.

Even with the workings of gravity revealed, knowledge of the existence of an omnidirectional flux must be considered the greatest achievement of this document.

Acknowledgements and affiliations:

The author has no affiliation to any academic institution and has not received sponsorships toward its production.

Special thanks to Ciandri Zinserling, Heinrich Zinserling and Michael Halse for adding value to the model.

George Dishman and Peter Dormehl have contributed greatly by providing critical analysis.

Carmen Brunette, thank you for your love and your continued patience.

References:

1. Sage, G.-L. Le (1784), 'Lucrece Newtonien', Mémoires de l'Académie Royale des Sciences et Belles Lettres de Berlin: 404–432,
2. Andreas Kleinert (2002), Pushing Gravity: New Perspectives on Le Sage's Theory of Gravitation, DOI: 10.1086/376003
3. Hogan, C.J. (1989), 'Mock gravity and cosmic structure', The Astrophysical Journal, 340: 1–10, DOI:10.1086/167981.
4. Edwards, M .R. (2007), 'Photon-Graviton Recycling as Cause of Gravitation' (PDF), Apeiron, 14 (3): 214–233
5. Matthew R. Edwards, (2002), Book: Pushing Gravity: New perspectives on Le Sage's theory of gravitation. Within: Barry Mingst and Paul Stowe, Deriving Newton's Gravitational Law from a Le Sage Mechanism, and: Paul Stowe, Dynamic Effects in Le Sage models
6. WIKI, Website: https://www.wikiwand.com/en/Le_Sage%27s_theory_of_gravitation
7. Barry Mingst and Paul Stowe, 'Deriving Newton's Law from a Le Sage Mechanism', website:
http://www.tuks.nl/pdf/Reference_Material/Paul_Stowe/Stowe_in_PushingGravity.pdf
8. Danilatos, Gerasimos, (2020), Novel quantitative push gravity theory poised for verification, website: <https://doi.org/10.5281/zenodo.3596184>
9. Kevin Brown, Historical Assessments of the Fatio-Lesage Theory, website:
<https://www.mathpages.com/home/kmath209/kmath209.htm>
10. Kevin Brown, Lesage's Shadows, website:
<https://www.mathpages.com/home/kmath131/kmath131.htm>
11. Rosamond Woody, Jana McKenney (2016), Fundamental Concepts and Theories of Gravitational Physics, Book: Chapter 11
12. Einstein, A (1916), The Foundation of the General Theory of Relativity, Annalen Phys. 49, 769-822
13. Daniele Faccio (2013), 'Black Holes, With A Twist' - Inaugural Lecture, website:
https://www.youtube.com/watch?v=YyMYcqXuZ_I
14. Ethan Siegel, 2019, Ask Ethan: How Can A Black Hole's Singularity Spin?, website:
<https://www.forbes.com/sites/startswithabang/2019/04/20/ask-ethan-how-can-a-black-holes-singularity-spin>
15. Clifford M. Will, (2014), The Confrontation between General Relativity and Experiment,
Living Rev. Relativity, 17 (2014), 4, DOI:10.12942/lrr-2014-4, website:
<http://www.livingreviews.org/lrr-2014-4>

16. F. J. Dyson, "Do Gravitons Exist?" (Lecture given at Boston University, 8 Nov. 2005.)
17. Minkowski H. (1908), Space and Time: Minkowski's papers on relativity. Edited by Vesselin Petkov, website: <http://www.minkowskiinstitute.org>
18. Kennard, E. H. (1927), "Zur Quantenmechanik einfacher Bewegungstypen", Zeitschrift für Physik (in German), 44 (4–5): 326–352, doi:10.1007/BF01391200
19. Hendrik Lorentz, (1895), Versuch einer Theorie der electrischen und optischen Erscheinungen in bewegten Körper, translation available on website: https://en.wikisource.org/wiki/Translation:Attempt_of_a_Theory_of_Electrical_and_Optical_Phenomena_in_Moving_Bodies
20. Masud Mansuripur, (2004), Radiation pressure and the linear momentum of the electromagnetic field, website: <https://arxiv.org/ftp/arxiv/papers/1312/1312.3259.pdf>
21. Robert N. C. Pfeifer, Timo A. Nieminen, Norman R. Heckenberg, Halina Rubinsztein-Dunlop, (Oct 2007), Momentum of an electromagnetic wave in dielectric media, website: <https://arxiv.org/abs/0710.0461>
22. Carlip, S. 2000, "Aberration and the speed of gravity", Phys. Lett. A, 267, 81–87, website: <https://arxiv.org/abs/gr-qc/9909087v2>
23. GE Marsh, C. Nissim Sabat, (1999) Physics Letters A 262 (257-260), Website: www.gemarsh.com/wp-content/uploads/SpdGrav-3.pdf
24. Openstax, many contributing authors, (2020), Doppler Effect for Light, educational website: [https://phys.libretexts.org/Bookshelves/University_Physics/Book%3A_University_Physics_\(OpenStax\)/Map%3A_University_Physics_III_-_Optics_and_Modern_Physics_\(OpenStax\)/05%3A_Relativity/5.08%3A_Doppler_Effect_for_Light](https://phys.libretexts.org/Bookshelves/University_Physics/Book%3A_University_Physics_(OpenStax)/Map%3A_University_Physics_III_-_Optics_and_Modern_Physics_(OpenStax)/05%3A_Relativity/5.08%3A_Doppler_Effect_for_Light)
25. Hyperphysics, Moment of Inertia, educational website: <http://hyperphysics.phy-astr.gsu.edu/hbase/mi.html>
26. Einstein, A, 1905, On the Electrodynamics of Moving Bodies, Annalen der Physik, 17, 1905. Reprinted in The Principle of Relativity, Dover Pub.
27. Einstein, Albert; (1907), On the relativity principle and the conclusions drawn from it.
28. NIST, (2014), Newtonian Constant of Gravitation, website: <https://www.nist.gov/system/files/documents/pml/div684/fcdc/Newtonian-Constant-proposal-2.pdf>
29. C. Rothleitner and S. Schlamminger, (2017), Measurements of the Newtonian constant of gravitation, G, website: <https://aip.scitation.org/doi/10.1063/1.4994619>
<https://www.nist.gov/publications/measurements-newtonian-constant-gravitation-g>

30. Junfei Wu et al, (2019), Progress in Precise Measurements of the Gravitational Constant, website:
<https://onlinelibrary.wiley.com/doi/full/10.1002/andp.201900013>
31. Stephan Schlamminger, (date), Why is it so difficult to measure the gravitational constant?, website:
https://tsapps.nist.gov/publication/get_pdf.cfm?pub_id=921014
32. Ethan Siegel, (2020), Ask Ethan: Does The Aether Exist?, website:
<https://www.forbes.com/sites/startswithabang/2020/02/29/ask-ethan-does-the-aether-exist/?sh=475a6dc266ea>
33. OpenStax University Physics, (2020), Momentum and Radiation Pressure, website:
[https://phys.libretexts.org/Bookshelves/University_Physics/Book%3A_University_Physics_\(OpenStax\)/Map%3A_University_Physics_II_-_Thermodynamics_Electricity_and_Magnetism_\(OpenStax\)/16%3A_Electromagnetic_Waves/16.05%3A_Momentum_and_Radiation_Pressure](https://phys.libretexts.org/Bookshelves/University_Physics/Book%3A_University_Physics_(OpenStax)/Map%3A_University_Physics_II_-_Thermodynamics_Electricity_and_Magnetism_(OpenStax)/16%3A_Electromagnetic_Waves/16.05%3A_Momentum_and_Radiation_Pressure)
34. J.Y. Cruz et al, (1991), A Test of Newton's Inverse Square Law of Gravitation Using the 300-m Tower at Erie, Colorado, website:
https://www.researchgate.net/publication/248793354_A_Test_of_Newton's_Inverse_Square_Law_of_Gravitation_Using_the_300-m_Tower_at_Erie_Colorado
35. Jens H Gundlach, (2005), Laboratory tests of gravity, website:
<https://iopscience.iop.org/article/10.1088/1367-2630/7/1/205/pdf>
36. Junfei Wu et al, (2019), Progress in Precise Measurements of the Gravitational Constant, website:
<https://onlinelibrary.wiley.com/doi/full/10.1002/andp.201900013>
37. Abbott et al (2017), Gravitational Waves and Gamma-Rays from a Binary Neutron Star Merger: GW170817 and GRB 170817A, website:
<https://arxiv.org/abs/1710.05834>
38. Arizona State University, (2000), Mechanism for the Absorption of Light, website:
<https://www.asu.edu/courses/phs208/patternsbb/PiN/rdg/mechanism/index.html>
39. Brown University, The Interaction of Light and Matter, website:
https://www.brown.edu/research/labs/mittleman/sites/brown.edu.research.labs.mittleman/files/uploads/lecture08_0.pdf
40. Carl A Carlsson and Gudrun Alm Carlsson, (1996), Basic physics of X-ray imaging, website:
<https://www.diva-portal.org/smash/get/diva2:276160/FULLTEXT02.pdf>
41. Vesselin Petkov. (2012), Book: Inertia and Gravitation, website:
<http://www.minkowskiinstitute.org>

42. Gao, Qiang & Zhang, Yungang & Yu, Jia & Zhang, Zhiguo & Wu, Shaohua & Guo, Wei. (2013). Integrating sphere effective optical path length calibration by gas absorption spectroscopy. Applied Physics B. 114. 10.1007/s00340-013-5521-3, ref 13,16 within, also on website:
https://www.researchgate.net/publication/257402157_Integrating_sphere_effective_optical_path_length_calibration_by_gas_absorption_spectroscopy
43. Hodgkinson, Jane & Masiyano, Dackson & Tatam, Ralph. (2009). Using integrating spheres as absorption cells: Path-length distribution and application of Beer's law. Applied optics. 48. 5748-58. 10.1364/AO.48.005748, also on website:
https://www.researchgate.net/publication/38025272_Using_integrating_spheres_as_absorption_cells_Path-length_distribution_and_application_of_Beer's_law

Addendum

The flux and gravity in a spiral galaxy disc

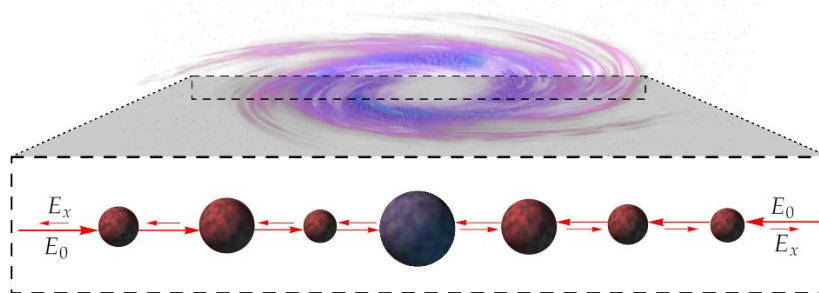

Figure 16: Representation of flux absorption in a spiral galaxy disc, viewed side-on, shows diminishing flux from each side until out the other side.

Consider only the flux in the plane of the disk. [Figure 16] and [Figure 17] show exaggerated flux absorption curves ($I_0 e^{-\mu x}$) into the plane of the disk of a spiral galaxy – edge on. For purposes of illustration the absorption into a central black hole is not distinguished from ‘standard’ absorption.

From the preceding document it has been shown that G is proportional to the strength of the local flux, and that Newton is a general approximation. An exponential curve for G in a galaxy disk is thus predicted, with G_{\max} at +R and -R, pointing inward.

The results below show a stronger incoming flux strength, and a weaker outgoing flux strength, and thus a larger flux imbalance, toward the outer edges of a galaxy disk, which causes increased inward gravitation on the systems in the outer areas of the disk. This may create an impression that there is additional mass (Dark Matter) in the system to cause this increased gravitation.

[Figure 17] Curve1 shows a typical velocity curve expected from observable mass in the disk region. Curve2 and curve3 show exaggerated exponential decay for ‘G’ from $\pm R$ to centre, for display only.

Curve4 shows the component a variable ‘G’ would add(multiply) to the velocity curve, with $c^2/4\pi=1$:

	$v = \sqrt{M} * \sqrt{\frac{1}{r} * (e^{\mu(r-R)} - e^{-\mu(r+R)})}$	Eq78
--	--	------

Curve5(red) = curve4*curve1 shows a flat velocity curve expected in the region of the disk.

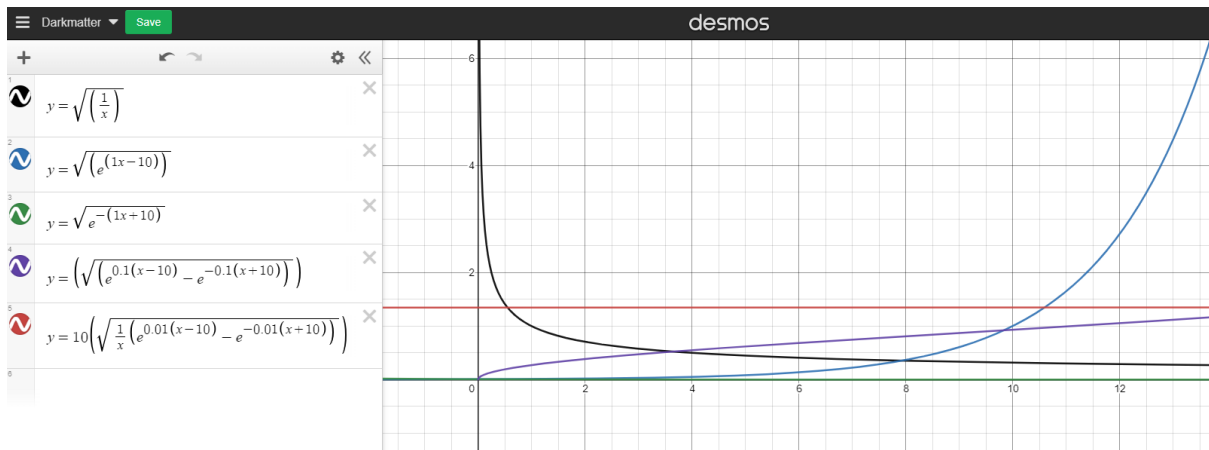

Figure 17: Depiction (merely a representation, exaggerated, not to scale) of absorption into the plane of a spiral galaxy in the region of the disk (curve1 = expected velocity curve from visible mass; curve2 = exaggerated absorption curve of 'G' from +R to centre; curve3 offscreen on -x; curve4 = f(curve2-curve3); curve5 = curve4*curve1 and shows a flat velocity curve in the region of the disk.

Energy comparisons for Jovian planetary heat.

(Note: Speculative) Below is a comparison [Table 1] where all internal heat of earth and Jovian planetary bodies is taken crudely as being totally resultant of flux absorption from [Eq61]. This is not in line with current understanding of the origin of planetary internal heating and needs to be carefully reviewed.

The calculations are presented to define an expected absorption energy, with an upper limit of flux absorption being responsible for all observed Jovian heat.

It is taken that flux absorbed = heat-flow out of mass is a steady-state. Results are not conclusive but may justify further analysis.

Name	E_{mon} Observed Energy(W)	E_{abs} Calculated $\mu\text{M}^2/24\pi r$ (J)	Error= $E_{\text{abs}}/ E_{\text{mon}}/5\pi$
Moon	2.7E12	2.9E13	0.69
Earth	4.4E13	6.9E14	1.00
Neptune	3.0E15	5.2E16	1.10
Jupiter	4.0E17	6.2E18	0.99
Saturn	2.0E17	6.6E17	0.21

Table 1: Energy outflows of Jovian planets are used to determine an upper boundary on μ

(source of energy data: Peter Gallagher <https://www.tcd.ie>)

M + M ≤ 2M. Loss of mass.

Consider again, a single mass (m_0), of normal atomic proportions, such as earth, in a balanced flux I_0 as shown in [Figure 3]. The mass experiences equal flux from +x and -x directions, and its mass is defined as a strength of the flux as described in [Eq18]. Shown again here in [Eq79].

$$2 * |E_0| = m_0 c^2 \quad \text{Eq79}$$

The mass absorbs some flux as shown in [Eq54], resulting in outgoing flux strength less than incident flux. Shown again here in [Eq80].

$$E(r) = \frac{\mu * c^2}{8\pi} * \frac{m_0}{r^2} \quad \text{Eq80}$$

Now let another mass (m_0) of equal atomic proportion, approach on the x-axis, in a similar scenario as was described in the gravitational attraction exercise. The attractive force between the 2 masses arise from an imbalance in flux created by both masses. At this instance the two masses (m_0) and (m_0) no longer find themselves in a balanced flux $2E_0$, but the strength of flux between them is diminished such that each mass finds itself within:

$$|E| = |E_0| + (|E_0| - |E_0| * \frac{\mu}{4\pi r^2}) \quad \text{Eq81}$$

, for μ for earth-like masses from [Eq76]:

$$\mu = \frac{G * 4\pi}{c^2} \quad \text{Eq82}$$

, then the strength of the flux for each earth-like mass around (m_0) becomes:

$$|E| = |E_0| * (2 - \frac{G}{c^2 r^2}) \quad \text{Eq83}$$

, using μ from [Eq76], then the strength of the flux for nuclear masses becomes:

$$|E| = |E_0| * (2 - \frac{\mu}{4\pi r^2}) \quad \text{Eq84}$$

, which in both cases [Eq83] and [Eq84], $|E| < 2|E_0|$, thus $m+m < 2m_0$. Mass has been 'lost' from m_0 in the form of binding energy. This of course only applies to an observer looking at the masses in the x- direction, in the direction as the masses would see each other.

The above [Eq83] is restricted to atomic masses ('normal' mass) as one would find in bindings of chemical compounds with atoms and electrons intact. It is apparent that this loss of mass would be negligible, even when r is reduced to Angstroms scales.

The above argument is invalid though, for extreme densities such as neutron stars or even for nuclei of atoms. Since earth-like atomic masses, with protons, neutrons and electrons, are mostly empty space, it is reasonable to expect a value of μ for bound nuclei at many orders of magnitude higher, since μ is after all a measure of absorption coefficient for a certain density of material. See [Eq43]. For nuclei, [Eq83] cannot be taken as valid, and one must revert to using μ , as shown in [Eq84], where a larger value for μ may signify a significant component of mass lost, such as may occur during nuclear fusion.

When an increased μ for nuclear density is applied to [Eq74], it must be found that the force binding nuclei is calculated to be much stronger than the force of gravity, by the order of $\sim 10^{17}$ times, if one naively replaces μ in [Eq74] with a μ for nuclear density (vs atomic density), and leave the equation unadjusted for quantum effects.

In both cases – molecular and nuclear – mass appears to be lost. This should not be seen as ‘matter is lost’ but rather as ‘flux is lost’. The conclusion must once again be that ‘G’ is not a constant, with G as a measure of absorption, and M as a measure of flux.