



Infinity Put to the Text

Towards a discrete revolution in the
mathematics of the XXI century

Antonio Leon

From different areas of mathematics, such as set theory, geometry, transfinite arithmetic or supertask theory, in this book more than forty arguments are developed about the inconsistency of the hypothesis of the actual infinity in contemporary mathematics. A hypothesis according to which the uncompletable lists, as the list of the natural numbers, exist as completed lists. The inconsistency of this hypothesis would have an enormous impact on physics, forcing us to change the continuum space-time for a discrete model, with indivisible units (atoms) of space and time. The discrete model would be a great simplification of physical theories, including relativity and quantum mechanics. It would also suppose the solution of the old problem of change, posed by the pre-Socratics philosophers twenty-seven centuries ago.

First edition: February 2021.

ISBN 9798709767119

Copyright code SC 210215693261

AGAINST DOGMATISM
AND INTOLERANCE

The author:

Antonio León Sánchez (1948, Antequera, Málaga, Spain). Geologist, specialist in crystallography (solid state physics) and mineralogy (University of Granada). Regular studies in mathematical sciences and postgraduate course in computer science (UNED, Madrid). PhD program in logic and philosophy of science (UNED, Madrid). Retired Professor (Natural Sciences). Independent researcher in the area of the foundation of science. Works published in peer-reviewed scientific journals and as a guest author in a collective publication. In the summer of 2020 he has been included in the Climont's list of the most innovative scientists since the beginning of the XX century [58, p. 1305].

Table of contents

1. Introduction: towards a discrete revolution	7
2. Conventions and symbols	19
3. Three basic principles	27
Introduction	27
Invariance, autonomy and execution	27
4. The Actual Infinity	33
Introduction	33
Actual and potential infinity	35
The Axiom of Infinity	39
Order relations	41
Cardinals and ordinals	44
Sequences	55
Summary	60
5. The Paradoxes of Reflexivity Revisited	65
Introduction	65
Paradoxes or contradictions?	66
6. Paradoxes in Naive Set Theory	73
Paradoxes in naive set theory	73
Cantor and Burali-Forti Paradoxes	75
An extension of Cantor's Paradox	77
7. A rational inconsistency	85
Introduction	85
Discussion	85
8. Inconsistent bubbles	91
Introduction	91
The bubble method	91
Double Bubble Supertask	94
9. Cantor's 1874 argument revisited	97
Introduction	97
Cantor's 1874-argument	97

Rational version of Cantor's 1874-argument	101
A variant of Cantor's 1874 argument	104
10. Cantor versus Cantor	109
Introduction	109
A rational extension of Cantor's 1874 theorem	109
11. Cantor diagonal argument	115
Introduction	115
Theorem of the n th Decimal	115
A rational diagonal argument	117
A final remark	122
12. Rational intervals	125
Introduction	125
A partition a la Cantor	128
A denumerable partition	132
A shrinking rational interval	134
Discussion	136
13. The Power of the Ellipsis	139
Introduction	139
Cantor's 1882 argument	140
Cantor's ternary set	142
Segmentations in the real straight line	144
Final remarks	148
14. An irrational source of rational numbers	151
n -Expofactorial numbers	151
An irrational source of rational numbers	153
Discussion	161
Epilog	162
15. Inconsistency of the Nested Sets	165
A denumerable version of the Nested-Sets Theorem	165
Inconsistency of the nested sets	170
16. On the finiteness of lengths and distances	173
Introduction	173
Euclidean lengths and distances	174
A geometrical supertask	178
17. Spacetime divisibility	181
Introduction	181
Divisibility of real intervals	182
Dividing intervals of space and time	185
Towards a discrete theory of space and time	187
18. Koch's fractal	191
Introduction	191
Conditional Koch's snowflake	194

19. Aleph-null	197
Introduction	197
The smallest transfinite cardinal	198
20. Aleph-null and the power of the continuum	203
Introduction	203
Is Aleph-null a prime number?	203
Aleph-null and the power of the continuum	210
21. Cardinal subtraction	215
Introduction	215
Problems with cardinal subtraction	216
Faticoni argument	219
22. The hypothesis of the continuum	223
Introduction	223
On the brink of the abyss	223
23. Thomson's lamp revisited	227
Introduction	227
Thomson's lamp	229
The counting machine	236
24. Thomson's lamp formalized	239
Introduction	239
Symbols and definitions	239
Discussion	240
Thomson's supertask	242
25. Hilbert's machine	245
Hilbert's Hotel	245
Hilbert machine	246
Hilbert machine contradiction	248
Discussion	250
26. A Disturbing Supertask	253
Introduction	253
The last disk	253
Discussion	255
27. Supertasks sets and boxes	259
Introduction: sets and boxes	259
Emptying sets and boxes	260
The last ball supertask	263
Catching a fallacy	265
28. Zeno Dichotomies	267
Introductory definitions	267
Zeno's Dichotomy II	270
Zeno's Dichotomy I	272
Conclusion	275

29. Infinity and numerical magic	277
Making disappear a number	277
Supertask argument	278
Modus Tollens argument	280
The potential infinity alternative	281
30. An inconsistent table of natural numbers	283
Theorem of the nth Digit	283
d-Modular Rows and d-Exchanges	284
Discussion	286
31. Infinity one by one	287
The unary numeral system	287
The unary table of the natural numbers	289
32. Physics and Supertasks	295
Introduction	295
A Newtonian supertask	295
A relativistic supertask	300
33. A trip through Pi	303
Introduction	303
The decimal expansion of Pi	304
34. Reinterpreting Riemann series theorem	311
Definitions	311
Discussion	312
35. Timetabling the infinite	315
Introduction	315
Recursive definitions	315
A conflicting definition	317
36. Theorem of the Inconsistent Infinity	319
Introduction	319
Two final theorems	319
Appendices, references and alphabetical index _____	
A. The problem of change	323
Introduction	323
Causal changes	323
The problem of change	327
A discrete model: cellular automata	328
B. Infinity and physics	333
Introduction	333
Digital versus analog	335
Relativity: Two interpretation face to face	338

C. Suggestions for a natural theory of sets	343
Introduction	343
A natural definition of set	343
Sets and numbers	347
Finite sets	351
Potentially infinite sets	353
D. Platonism and biology	357
Living beings as extravagant objects	357
Biology and abstract knowledge	358
E. Glossary	363
Bibliographic references	371
Alphabetical index	387

Some of the most interesting pre-Socratic debates had their origin in the cultural precedents developed on the banks of the great rivers of the Near East [202, 24, 207, 176, 222]. But it was the pre-Socratic philosophers, among them Anaximander, Epimenides, Parmenides, or Zeno of Elea, who posed in writing certain problems that remain problems for contemporary philosophy and science. Three of these problems deserve special attention: the problem of change, infinity, and self-reference. The problem of change is undoubtedly the most difficult and significant of the problems posed by man. We were able to raise it, but we have not been able to solve it. And in the end, we have almost forgotten it. The vast majority of humans have not even heard of the problem of change. This book begins by reminding it because its content suggests a new physical and mathematical scenario in which it could be resolved. The new scenario would also imply a profound revolution in science and in our own conception of the physical world.

In spite of its apparent simplicity, no one has been capable of explaining, for instance, how a simple change of position *takes place*. Physics, the science of change, seems to have forgotten its most basic problem. In their turn, some philosophers as Hegel [115, 118, 161, 178, 193, 238] defended that change is an inconsistent notion, while others, as McTaggart, came to the same conclusion as Parmenides [179] on the impossibility of change [160]. Perhaps the (apparent) insolubility of the problem of change has to do with the continuum spacetime framework where all solutions have been tried, a continuum in which space and time can be infinitely divided. For this reason, infinity is involved in the problem of change. And the hegemonic infinitist stream in contemporary

mathematics has its own responsibility in the fact that the problem of change remains an unsolved problem; and a forgotten problem, despite its extraordinary importance: if we do not resolve the problem of change we will not be able to explain the world, because the world is an incessant succession of changes.

Although the relationship is not evident, the difficulties posed by the problem of change could be related to the continuous perception of the physical world that our brain elaborates from discontinuous sequences of images. It takes approximately 0.013 seconds to elaborate one of such images [183], so it can only process a finite number of images per second (less than 77). From this discontinuous sequence of images, however, emerges our continuous perception of the physical world (phi phenomenon [84]), the same as with the projection of the frames of a film. It is reasonable to think that this sensory perception of the natural processes as continuous processes inspired the interpretation of nature in continuous terms. Motion, for example, has always been considered (at least since Aristotle [12, Books III-VI]), and continues to be considered, as a continuous process, not as a discontinuous process. But being a change of position, motion remains unexplained, precisely because it is interpreted as a continuous process. The idea of the continuum is an inheritance from pre-Socratic and classical Greece that could become obsolete if the hypothesis of the actual infinity is inconsistent. It is hard to imagine that motion, clearly perceived as continuous, is actually discontinuous; but possibly it is discontinuous.

Science has been warning us for several centuries that things are not what they seem. Things for a living being are the things that serve it to survive and reproduce. To perceive the intimate physics of the universe is not necessary for life. In consequence, life -natural selection- had not to deal with those issues. The continuous perception of the world is a deception of our brain that has been good for us to survive, but very bad to understand nature: it has not even occurred to us that nature could be discrete, that it could be working in jumps, although at quite more than 77

per second, and more than 77 quadrillion per second. Indeed, as shown in Appendix A, motion, and all changes, could be discrete, discontinuous, which in turn requires for space and time to be of a discrete nature, not infinitely divisible but with indivisible units (atoms of space and time in the terminology of L. Smolin [220]). In this new discrete and finite scenario, the problem of change could find its solution. If the hypothesis of the actual infinity were proved to be inconsistent, that would be the only available scenario to explain the world in consistent terms.

While change is an evident and observable characteristic of our continuously evolving universe, infinity is a theoretical notion of metaphysical origin that became mathematical at the end of the 19th century, and that has no observable relationships with the physical world. We use infinitist mathematics to explain the world, but we have never observed or measured anything infinite. On the contrary, every time the infinities appear in the equations of physics, physicists have to do algebraic juggling to get rid of them. G. Cantor the prince of the mathematical infinity, was an enthusiastic theoplatonist with scarce devotion to experimental sciences and of enormous influence in contemporary mathematics [68, 163]. To illustrate the profound Cantor's theoplatonic convictions, let us recall some of his words:

... in my opinion the absolute reality and legality of the natural numbers is much higher than that of the sensory world. This is so because of a unique and very simple reason, namely, that natural numbers exist in the highest degree of reality, both separately and collectively in their actual infinitude, in the form of eternal ideas in *Intellectus Divinus*. ([163]; reference and (Spanish) text in [91])

... I am only an instrument of a higher power, which will continue to work after me in the same way as it manifested itself thousands of years ago in Euclid and Archimedes ... ([49, pp 104-105])

... I cannot regards them [the atoms] as existent either in concept or in reality no matter how many useful things have up to a certain limit been accomplished by means of this fiction. ([48,

p 78], English translation of [40])

My theory stands as firm as a rock; every arrow directed against it will return quickly to its archer. How do I know this? Because I have studied it from all sides for many years; because I have examined all objections which have ever been made against the infinite numbers; *and above all because I have followed its roots, so to speak, to the first infallible cause of all created things.* [78, p. 283] (the italic is mine).

But neither theoplatonism nor twenty seven centuries of discussions were sufficient to prove (or disprove) the consistency of the basic hypothesis of infinitism: the hypothesis of the actual infinity. A hypothesis according to which the incompletable can exist as completed. For example, the endless list of the natural numbers (the counting numbers) 1, 2, 3, ... would exist as a finished, complete whole, even though there is not a last number completing the list. So complete is that list that it has a precise number of elements: \aleph_0 elements (\aleph_0 , read aleph-null, aleph-naught, or aleph-zero, is the first transfinite cardinal number). The alternative to the hypothesis of the actual infinity is the hypothesis of the potential infinity, which assumes the existence of the endless list of the natural numbers, not as a completed totality but as an endless and always incomplete list; a list that can be arbitrarily extended but that can never be completed (the key distinction between the actual infinity and the potential infinity will be introduced and discussed in Chapter 4).

As it could not be demonstrated or refuted that such incompletable totalities exist as completed totalities, their existence had to be established by law: the Axiom of Infinity of set theories. As will be seen in detail in Chapter 4, the Axiom of Infinity states the existence of an infinite and denumerable set (similar to the set of the natural numbers: 1, 2, 3, ...), assuming that the involved infinity is the actual infinity. Contemporary mathematics are founded on the belief that infinite sets do exist as completed totalities. Some thinkers find it acceptable the completion of incompletable. Some of us do not think so. It is ironic that it has been an es-

entially infinitist theory, set theory, that has finally provided us with the instruments for a productive criticism of the actual infinity hypothesis, beyond the Byzantine nature of the preceding discussions. One of those instruments is the number ω (omega), the smallest of the infinite ordinal numbers. In this book we will make an extensive use of the ω -ordered objects (sets, sequences, lists, tables, procedures, etc.). And it will be proven over and over again that they are inconsistent.

The third conceptual legacy of the Presocratics philosophers, self-reference, is also a debatable notion that has been debated for centuries. In addition to language and meta-language (language on language) we would also have *self-language*, language autonomously speaking about itself. Self-reference paradoxes have been, and continue to be, the source of interminable discussions. One of those paradoxes, the Liar Paradox, (in informal terms: *This sentence is false*) led (via Richard Paradox, as Gödel himself recognized [102, p. 56]), to the celebrated Gödel's first incompleteness theorem. Many logicians consider it as the most important theorem of all times. From the perspective of the natural sciences, this statement often puzzles us. And as expected, the famous theorem also finds support in the Cantorian infinitism [165, p. 116]. In fact, these supports motivated the start of the investigations gathered in this book, although this book does not deal with the motives but with the results of those investigations.

Through self-reference, the theorems of incompleteness limit rational analysis: under a given axiomatic basis *compatible with self-reference*, certain statements can be neither proved nor disproved. Especially if the statement is self-referent, assuming that statements can state about themselves, making use of a rational autonomy that nobody has given them. As if words took on a life of their own, beyond the mind that elaborates them; as if the omelet ate itself. It is significant that some authors try to camouflage self-reference through what could be called self-reference engineering. However, when self-reference appeared in set theory, its use had to be restricted because of the high number of inconsistencies

derived from it. In fact, some well-known inconsistencies of the naive stage of set theory, such as Russell's Paradox of the set of all sets not belonging to themselves, or the universal set itself (the set of all sets), made use of self-reference and were inconsistent (even if they were called paradoxical). It was necessary to impose axiomatic restrictions to eliminate these sets from the set theory scenario: not any predicate can define the elements that belong to a set; not being a member of itself would be an example of an invalid self-referent predicate. Self-reference on demand.

In short, we inherited from Presocratics a promising challenge (the problem of change) and two debatable concepts (the actual infinity and self-reference). With the passage of time we have forgotten the challenge while turning the actual infinity and self-reference into two fundamental and unquestionable pillars of mathematics and logic respectively, both incompetent to solve the problem of change. Infinitism defines the main (and almost unique) stream in contemporary mathematics. Not everyone feels comfortable in the *infinitist paradise* (including authors such as Poincaré, Kronecker or Wittgenstein), although militant criticism is almost non-existent. It is convenient to remember at this point that man tends to be more religious than scientific, and that scientists can also be self-reverent and scarcely self-critical. Putting personal convictions and interests before the objective knowledge of the world is more common than one might expect in the scientific community. There are main streams of scientific thought that are absolutely intolerant of disagreement. Under these conditions, criticizing a long-established foundational hypothesis becomes an almost impossible task. Even so, this book is dedicated to the critique of one of those foundational hypotheses: the hypothesis of the actual infinite.

The consequences of infinitist mathematics on experimental sciences are disastrous because it promotes an analogue, and then continuous, model for the physical world. A model that is clearly in conflict with the discrete nature revealed until now by all physical observations and measurements: ordinary matter, elementary

particles, energy, electric and non-electric charges, seem to be, all of them, discrete entities, discontinuous entities with indivisible minima. The war of physicists against the infinities is also striking. They pay a high price in the form of interminable and tedious calculations for getting rid of them. Whereas, on the other hand, they do not spend a single minute to call into question the formal consistency of the hypothesis of the actual infinity that lays the foundations of infinitist mathematics, at the moment the only formal language available to express their theoretical and experimental analysis of the physical world. Physics, the science of change, the science of the regular succession of events, as Maxwell called it [155, p. 98], is trapped in infinitist mathematics, in the spacetime continuum that makes it impossible to explain change, its great unanswered question.

I am convinced (although my conviction is not *as firm as a rock*) that mathematics needs its own Copernican revolution, the turn from the infinitist continuity (which leads us from pre-Socratic Greece) to the finitist discontinuity discovered by early 20th century physicists (quantum mechanics). A turn that will be forced by the inconsistency of the actual infinity in a world that seems to be consistent in all of its details. That revolution will be more intense than the Scientific Revolution itself. Not only because of its brutal impact on physics, and through physics on the rest of the experimental sciences, but also because it will mean a radical change of paradigm in our understanding of the world and of ourselves. The subject is so relevant that even in this introduction it is worth anticipating its content somewhat, especially because of the stimulus it can give to the reading of the book. It is something similar to discover that the continuous movement we observe on a screen is just an illusion, that the only reality is a discontinuous sequence of images observed at a certain speed (about 24 frames per second). The infinitist continuity represents that illusion, while the finitist discontinuity represents the only reality behind that illusion: the discontinuous sequence of frames. In the case of the physical world, that discontinuity would arise from the existen-

ce of indivisible units of space, maybe of the order of $10^{-105} m^3$ (Planck volume), whose content is updated at the successive indivisible units of time, maybe of the order of $10^{-43}s$ (Planck time), and remains unchanged during each of these tiny units of time. In the Appendices A and B the details are expanded. And in the rest of the book it is shown that this may be the only direction for a consistent knowledge of the physical world.

In any case, the hypothesis of the actual infinity is just a hypothesis, and we have the right and the duty to bring it into question. That is the main objective of this book. A collection of critical arguments on the hypothesis of the actual infinity developed for the last twenty five years. The construction of that criticism was riddled with errors. And it was the endless struggle against those errors that made me understand that the strategy of trial and error is the only viable strategy in this universe, from the formation of galaxies to organic evolution, including the elaboration of scientific theories. Errors are often hidden or simulated. We are educated to be ashamed of errors, but errors are part of the scientific method. And it should be a (positive) part of the professional curriculum of all professions, including scientists. If one paradigm does not work, it is changed for another, and we learn from the mistakes made in the old paradigm. There is no science without errors and corrections. Nor should there be room in science for dogmatism and intolerance. Unfortunately, there is.

It is sure this book still contains errors, which should be a stimulus for a critical reading. I hope it also contains some acceptable conclusions. Most of its chapters are dedicated to the critique of the numerable infinity (the smallest of the infinities, the infinity of the set of the natural numbers) subsumed into the Axiom of Infinity. But also the infinite that legitimizes the sequences of increasing infinities: the sequence of alephs: $\aleph_0, \aleph_1, \aleph_2 \dots$; and the sequence of powers $\aleph_0, 2^{\aleph_0}, 2^{2^{\aleph_0}} \dots$. Thus, to prove the inconsistency of the first infinity implies to invalidate all the others. There is a general agreement in that a contradiction suffices to prove the inconsistency of the hypothesis from which the contradictory re-

sults have been deduced. Except in the case of the hypothesis of the actual infinity. And this is not a joke: in Cantor's words, certain infinities are inconsistent because of their excessive infinitude [40]. An additional reason to deal exclusively with the smallest of them.

Some of the arguments included in this book were published in 2017 [134], as a chapter of the volume edited by F. Pataut in homage to P. Benacerraf, one of the great contemporary authors in the philosophy of mathematics. There, the arguments were summarized, here completely developed and rewritten with the intention of making them accessible to any interested reader. In addition, some other unpublished arguments are included. It is, therefore, an informative book (at least it is not a typical textbook), although certain knowledge (the content of Chapter 4) is necessary. It is also a book of critical research, but without excessive academic requirements. Discussions are rigorous, but without demands for specialized knowledge, which is possible because it is discussed on a basic fundament of mathematics, not on specialized aspects of its development. It is therefore a peculiar text, which aims to disseminate a series of critical reflections on the mathematical infinity. A matter which, as indicated above, transcends mathematics, even science, and announces a pending revolution: the Discreet Revolution.

Chapters 2 and 3 establish the conventions and the basic principles that are followed in the rest of the book. Therefore, it is convenient to read them initially. They are also self-sufficient, requiring no prior knowledge. Chapter 4 contains the basics about the mathematical infinity. It is very advisable for readers without any experience in that field, since it provides the necessary instruments to follow the majority of the discussions developed in the book. For the sake of completeness, the chapter includes some results that might not have been included. Pay attention, above all, to the transfinite numbers \aleph_0 and ω . The rest of the chapters can be read in any order, although they are grouped by the type of argument:

Chapters 5-6: arguments on naif set theory.

Chapters 7-15: axiomatic set theory arguments.

Chapters 16-18: geometry arguments.

Chapters 19-22: transfinite arithmetic arguments.

Chapters 23-32: arguments on supertasks.

Chapters 33-36: synthesis arguments.

Chapters 37-41: appendixes and glossary:

A: The problem of change.

B: Infinity and physics.

C: Suggestions for a natural set theory.

D: Platonism and biology.

E: Glossary.

Evidently, the independence of the chapters imposes an inevitable increase in repetitions, both in text and arguments.

The readers with some experience in the history of the mathematical infinity will surely find the Spanish title of the book (*El fin del infinito*) too pretentious. I think so, too. But I could not avoid its expressive consistency with the content of the book. I believe that the end of infinity will come, but not because it is proved here that it should be so. As Planck said, new ideas break through, not because their detractors are convinced but because they die. Considering that many of them are my age, maybe the announced end is already near.

Note: This book is a revised and updated version (with the exception of most bibliographical references) of previous works (many of them unpublished). Drafts and articles that match partial content in this book are circulating on the Internet outside of my control and without my permission. Many of them contain errors and I do not have the option to correct them. Others have been manipulated. So try to avoid them. I only review those deposited at Academia, General Science, Researchgate and ViXra. Although

they are my originals, I do not review those deposited in ArXiv and PhilSci for years. I take this opportunity to apologize for my lack of activity in scientific social networks. I do not have time anymore to attend to their requirements.

Antonio León Sánchez
Salamanca and Santiago del Collado (Ávila), Spain.
February 2021.

2 CONVENTIONS AND SYMBOLS

P1 To facilitate explanations and discussions, all paragraphs in this book will be consecutively numbered (as this one). They will be referred to by the number that appear at the beginning of each paragraph, preceded by the letter P. For instance, P1 refers to this paragraph, and P2 to next one. For the same reason, all equations will also be consecutively numbered within each chapter, although in this case the numbers will be put in brackets on the right side of each equation:

$$f(i) = a_i \quad (\text{example of equation}) \quad (1)$$

Equations will be referred to by their corresponding numbers in brackets: the above equation would be referred to by (1). As usual, numbers in straight parentheses will indicate bibliographical references. In bibliographic references, the abbreviation p. will be used to indicate page or pages.

P2 Theorems, definitions, corollaries, etc. will be numbered with the same number of the paragraph where they are enunciated. If a theorem is enunciated, for instance, in paragraph P153, it will be referred to as Theorem P153. When more than one statement of the same type are demonstrated in the same paragraph, they will named with the same number plus a distinguishing letter, e.g. P153a, P153b etc. In some cases they will be named by proper names. The symbol “□” will be used to indicate the end of the demonstration of a statement when the demonstration follows the statement. To facilitate reading and minimize errors (related to punctuation) the initial letter of all substantives in the proper

names of theorems, corollaries, definitions, principles, axioms and conclusions will be written in capital letters.

P3 When the same explanation serves to two different alternatives, only one of the alternatives will be explained, adding in parentheses the word, or words, that would have to be changed in the given explanation to be the explanation of the other alternative. For example: If the first (last) item in the list is an even (odd) number, the list begins (ends) with an even (odd) number.

P4 All symbols used in the book are listed at the end of this chapter. The ellipsis, symbolically represented by three dots \dots , will often be used to denote the rest of the elements of a set or sequence that obviously follow the indicated elements. The logical expression “if, and only if” will be written “iff” when convenient. The expression “actual infinity” refers to one of the types of infinity, the other being the potential infinity. Both are introduced and explained in Chapter 4.

P5 Chapter 4 explains the mathematical terms and concepts used in the discussions and arguments developed in the rest of the book. Appendix E includes other mathematical physical and logical concepts that are occasionally used in some chapters of the book, but that are not explained or defined in the book.

P6 It will be inevitable the use of a few number of primitive concepts, i.e. concepts that cannot be defined in terms of other more basic concepts. That is the case, for instance, of point, line or set. The word “collection” will be used in a general sense to refer to sequences, sets, lists, tables, etc.

P7 Most of the collections, mainly sequences and sets, will be ω -ordered (as the sequence 1, 2, 3, \dots of the natural numbers). In a few cases they will be ω^* -ordered (as in the case of the increasing sequence of negative integers $\dots -3, -3, -1$). The sets used in the demonstrations, for example the real interval $(0, 1)$, or the set \mathbb{Q}^+ of the positive rational numbers, will always be the simplest

possible in each occasion.

P8 As usual, to put into a correspondence a set A with another set B means to pair off each element of the A set with an element of the set B . All correspondences will be injective, and in most cases surjective (bijections or one-to-one correspondences). Unless otherwise indicated, the sets \mathbb{N} (natural numbers), \mathbb{Z} (integer numbers), \mathbb{Q} (rational numbers), \mathbb{A} (algebraic numbers) and \mathbb{R} (real numbers), and any of their subsets, will always be considered in their natural order of precedence, that is, ordered by their increasing magnitudes or values. In the case of \mathbb{N} , the natural order of precedence is the ω -order (a case of well-order defined in Chapter 4). In all the other cases, excluding \mathbb{Z} , the order of precedence is a dense order (see P11) that is not a well order.

P9 In most cases, we will use the word “denumerable” to refer to the infinity of the set \mathbb{N} of the natural numbers and to the infinity of any other set or sequence that can be put into a one to one correspondence with \mathbb{N} . The words “enumerable” or “numerable” can also be used with the same meaning. Although the word “countable” is also used to refer to finite or denumerable infinite sets, it will not be used here in order to avoid confusions. Finally, the terms “non-countable” or “non-denumerable” will be used to denote the infinities greater than the denumerable infinity.

P10 Although formally unacceptable, Euclid defined two capital concepts in geometry: the concept of line [117, Definition 2, p. 153] and the concept of straight line [117, Definition 4, p. 153], being the second a particular case of the first; and being both of them currently assumed as primitive, undefinable, concepts. Languages maybe evolving from their most popular use that, unfortunately is not always the most correct one [103]. That could be the reason why in English, *line* and *straight line* came to mean the same thing, and now there is no English word to denote the original Euclidean concept of line, a universal concept that applies to all types of lines. For this reason, in the English edition of this book, the word “line*” will be used to refer to the general geometric

object that Euclid called line. Thus, and still being a primitive concept, a line* (line in Spanish) can be understood as any uni-dimensional continuum of points. Although it is possible to give a formally productive definition of straight line [137], it will not be necessary to do so in this book, so that they can continue to be understood as a particular type of lines whose lengths are the shortest of all possible lines joining any two given points. No matter how redundant, straight lines will always be referred to by “straight lines”. As usual, real and rational lines* and straight lines will be used to denote lines* and straight lines whose points represent respectively densely ordered sets (see P11) of real numbers and of rational numbers.

P11 In all discussions and arguments, time, distances and lengths will be assumed to be Euclidean and represented by real numbers and intervals of real numbers. As usual, a finite interval (a, b) is said finite if its extension $b - a$ is finite, even if the interval is infinitely dense, which means that between any two elements (points, instants, numbers) of the interval, the interval contains infinitely many different elements. This is the case of all intervals of rational and real numbers in their corresponding natural order of precedence. An element inside an interval will be an element of the interval different from its endpoints.

P12 Although supertasks will be introduced in Chapter 23, they will start to be used from the first chapters. A supertask consists of performing an infinite number of actions or tasks (for example counting numbers, or removing balls from a box containing balls) in a finite interval of time, which, unless otherwise indicated, will be the real interval (t_a, t_b) . The successive actions a_1, a_2, a_3, \dots of the infinite sequence of actions $\langle a_i \rangle$ will be supposed to be carried out in the successive instants t_1, t_2, t_3, \dots of a strictly increasing sequence of instants $\langle t_i \rangle$ within the interval (t_a, t_b) , being t_b the limit of the sequence $\langle t_i \rangle$. Every action a_i of $\langle a_i \rangle$ will be assumed to be performed in the precise instant t_i from $\langle t_i \rangle$, and all of them will be instantaneous.

P13 Needless to say, all arguments in this book are of a conceptual nature, even when they make use of material artifacts as machines, boxes, balls and the like, all of which have to be understood as theoretical devices to illustrate the arguments and to facilitate discussions.

P14 The followings symbols and notations will be used in what follows:

MT: Modus Tollens

*: Thomson' lamp on.

o: Thomson's lamp off.

c: Thomson's lamp clicked.

\mathbb{N} : set of the natural numbers in their natural order of precedence.

\mathbb{Z} : set of the integer numbers in their natural order of precedence.

\mathbb{Q} : set of the rational numbers in their natural order of precedence.

\mathbb{Q}^+ : set of the positive rational numbers in their natural order of precedence.

\mathbb{A} : set of the algebraic numbers in their natural order of precedence.

\mathbb{R} : set of the real numbers in their natural order of precedence, and real straight line.

\mathbb{R}^+ : set of the positive real numbers in their natural order of precedence.

\mathbb{R}^3 : Euclidean tridimensional space.

\mathbb{R}^n : Euclidean n-dimensional space.

$|A|$: cardinal of the set A .

\dots : ellipsis.

\in : belongs.

\notin : does not belong.

\subset : subset.

\supset : superset.

$\not\subset$: not subset.

\cup : union of sets.

\cap : intersection of sets.

$P(A)$: power set of the set A (set of all subsets of A).

\aleph_0 : aleph-null, the smallest transfinite cardinal.

2^{\aleph_0} : power of the continuum.

ω : omega, the smallest transfinite ordinal.

$2\omega, 3\omega, \omega_1, \dots$: ordinals greater than ω .

$2^{2^{\aleph_0}}, \aleph_1, \aleph_2, \dots$: cardinals greater than \aleph_0 .

∞ : infinity, the improper real number.

(a, b) : open interval or segment.

$[a, b]$: closed interval or segment.

$(a, b]$: right closed interval or segment.

$[a, b)$: left closed interval or segment.

I_0 : 0-interval, interval whose left endpoint is 0.

$\langle q_n \rangle, \langle q_i \rangle, \dots$: ω -ordered sequence q_1, q_2, q_3, \dots

$\sum_{i=1}^n x_i$: sum of n terms: $x_1 + x_2 + \dots + x_n$.

$\sum_{i=1}^{\infty} x_i$: sum of infinite terms: $x_1 + x_2 + x_3 + \dots$

$\lim_{n \rightarrow \infty} a_n$: limit of the sequence $\langle a_n \rangle$.

$\lim_n a_n$: limit of the sequence $\langle a_n \rangle$.

$\langle D_n(x) \rangle$: ω -ordered sequence of definitions of x .

$D_i(x)$: i th definition of x .

$\langle D_i(x) \rangle_{i=1,2,\dots,n}$: first n definitions of x .

${}^k S_i$: i th element of a collection at the k th definition of the collection.

$|x|$: absolute value of x .

$\min(a, b)$: least of the two values in brackets.

\forall : for all.

\exists : exists.

\Rightarrow : logic inference.

\Leftrightarrow : logic double inference.

iff: if, and only if.

\neg : logic negation.

\vee : logic or.

\wedge : logic and.

\therefore : therefore.

\square : end of a proof.

3 THREE BASIC PRINCIPLES

INTRODUCTION

P15 The Principle of Invariance defined in this chapter is an immediate consequence of the First Law of logic. It is so obvious that it is unnecessary in scientific discussions, except (perhaps) in the discussions on the actual infinity hypothesis. At least this is my opinion after many years of discussions on that matter. Another elementary principle that is implicitly assumed in all conceptual discussions is what we will call here Principle of Autonomy. Basically it states that the logical consistency of an argument does not depend on the actual existence (in material terms) of the intervening objects, as supermachines, indexed balls, perfect lamps and the like, used to illustrate the argument. A third basic principle also assumed in all formal discussions will be explicitly assumed in this book under the name of Principle of Execution, according to which, and as long as they are possible, all possible steps of a demonstration, procedure or definition can be carried out. For the sake of clarity and simplicity and in order to avoid unnecessary discussions, in this book it will be explicitly assumed the Principle of Invariance, the Principle of Autonomy and the Principle of Execution. The next section introduces the three of them.

INVARIANCE, AUTONOMY AND EXECUTION

P16 At least since Aristotle's time, there is a general agreement that all sciences (formal and experimental) have to be built on the basis of the three fundamental laws of logic. [140]:

- Law of Identity.
- Law of Contradiction.
- Law of the Excluded Middle.

In Aristotle words, the first of those laws (the Law of Identity) states:

A thing is what it is, and it is not what it is not.

Or in more abstracts terms:

$$p \Rightarrow p \quad (1)$$

that reads: if p , then p . Where p is any declarative sentence. For example, if I have a book in my hand, then I have a book in my hand; if the number 29 is prime, then the number 29 is prime. Implication (1) is a fundamental tautology whose universal validity is independent of the finite or infinite number of times we make use of it. As we will see, the Principle of Invariance we will introduce here is an immediate consequence of the Law of Identity.

P17 Before introducing the Principle of Invariance, and by way of illustration, let us consider the following sequence of recursive definitions:

Let $\langle q_n \rangle = q_1, q_2, q_3, \dots$ be the sequence of all rational numbers greater than zero and indexed by the successive natural numbers (later in this book it is explained how this type of sequences can be obtained), and let x be a rational variable whose domain (the set in which it takes its numerical values) is the set of the rational numbers greater than zero. Now consider the following sequence $\langle D_n(x) \rangle$ of successive recursive definitions of x :

$$\begin{cases} D_1(x) = q_1 \\ D_i(x) = \min(D_{i-1}(x), q_i); \quad i = 2, 3, 4, \dots \end{cases} \quad (2)$$

where $D_i(x)$ is the i th definition of x , and $\min(D_{i-1}(x), q_i)$ is the smaller of the two numbers in brackets: $D_{i-1}(x)$ and q_i .

The successive definitions $D_i(x)$ compare the current value of x with the successive elements q_i of the sequence of rationals $\langle q_i \rangle$ and defines x as q_i if q_i is less than the current value of x (the value of x each time it is compared).

P18 Once completed the sequence of definitions $\langle D_n(x) \rangle$, it could be impossible to know the current value of x , but at least we can ensure it will continue to be a rational number greater than zero, simply because the domain of x has been defined as the set of the rational numbers greater than zero, and each definition $D_i(x)$ of the sequence $\langle D_n(x) \rangle$ has defined x as a rational number greater than zero.

P19 With $\langle D_n(x) \rangle$ in mind, consider the following:

Principle of Invariance P19. *The completion of any finite or infinite sequence of steps of any argument, procedure, definition or proof, as such a completion, is not a new additional step, and cannot modify neither the properties nor the definitions of the intervening objects.*

P20 It is worth noting that without the Principle of Invariance P19, formal sciences would turn out impossible: any invariant could be arbitrarily modified after completing any procedure, proof, argument or definition composed of a finite or infinite sequence of steps, and in these conditions any thing could be expected after performing the sequence of steps. Or in other words, without the Principle of Invariance P19 we would have to admit the existence of an esoteric source of arbitrary changes incompatible with formal inferences.

P21 The Principle of Invariance P19 implies that completing any finite or infinite sequence of steps of any argument (procedure, definition, proof) means to perform each and every step of the sequence of steps, and only them. So that the completion, as such a completion, is not an additional step, nor does it have consequences on the intervening objects. This obviousness is exactly what the Principle of Invariance P19 states. In our above example, after completing the sequence of definitions $\langle D_n(x) \rangle$, even if we do not know its current value, x will continue to be a rational variable whose domain is the set of the rational numbers greater than zero, and not, for example, a negative number or a red hat.

P22 We will also assume the consistency of an argument does not depend on the actual (physical, material) existence of the objects that intervene in the argument. The consistency of an argument that makes use of, for example, a lamp capable of being turned on and off infinitely many times (Thomson's lamp), does not depend on the actual existence of the lamp but on the logical relationships between the formal objects involved in the argument. Many arguments in this book make use of this type of superlamps or supermachines capable of performing infinitely many actions in a finite time (supertasks). The only purpose of such artifacts is to illustrate the arguments.

P23 We will assume, therefore, the following:

Principle of Autonomy P23.-*The formal consistency of an argument does not depend on the actual, material, existence of the intervening objects, whose formal definitions remain always unaltered.*

It goes without saying this principle is always (implicitly) assumed in infinitist mathematics. It is also assumed in all discussions involving thought experiments. In these cases the formal consistency of the argument does not depend on the possibilities of performing the experiment in practice, but on the logical relationships between the formal elements of the argument the experiment illustrates.

P24 Some arguments will make use of procedures or definitions consisting of a conditional sequence of steps, so that each step of the sequence will be carried out if, and only if, it satisfies a certain condition, otherwise the procedure or definition will end. It will be assumed that all steps satisfying the imposed condition can be carried out. To suppose that it is impossible to carry out a sequence of steps each of whose steps satisfies the imposed condition would imply to assume the impossibility of a possibility, which is a basic contradiction.

P25 In consequence, in this book it is also assumed the following:

Principle of Execution P25.-*While being formally possible, all*

possible steps of a definition, procedure or proof can be carried out in formal terms.

The Principle P25 simple legitimizes the possibility of carrying out all possible steps of any definition, procedure or proof of any argument, simply because they are possible.

P26 Although it may seem unnecessary, in the majority of the arguments developed in the rest of the book, the use of the above principles will be remembered writing them in parentheses whenever they are legitimizing a step or conclusion of that argument.

4 THE ACTUAL INFINITY

INTRODUCTION

P27 This chapter contains the instruments that will be necessary in order to follow the discussions on the mathematical infinity that will be developed in the rest of the book. Many readers will know them, others will need to review them, or to learn them (a basic level of math is sufficient). In any case, and even being known notions, it is always interesting to analyze the way each author introduces and explains them.

P28 Although this book deals exclusively with the actual infinity, references to the potential infinity will be inevitable. This is why it begins by explaining the distinction between the potential infinity and the actual infinity. Once this difference has been explained, the Axiom of Infinity, order relations in sets, infinite cardinals and ordinals, and ω -ordered objects will be introduced. This is all we need to know in order to follow the arguments on the actual infinity hypothesis that will be developed from the next chapter. Most of those arguments will be related to ω , the least infinite ordinal; the ordinal of, for example, the set of the natural numbers:

$$\mathbb{N} = \{1, 2, 3, \dots\} \tag{1}$$

a type of order that will be referred to as ω -order (it is explained in P81).

P29 “Infinite” is a common ‘word we use to refer to the quality of being huge, immense, unbounded etc. In this way, and according to Gauss, the infinite is *a manner of speaking* (C.F. Gauss, Letter to astronomer H.C. Shumacher, 12 July 1831). But the word “infinite” (“infinity”, “the infinite”) has also a precise set theoretical

meaning according to the next:

Definition P29. *A set is said infinite if it can be put into a one to one correspondence with one of its proper subsets*

This is the well known Dedekind's definition of infinite set. It will be discussed in the next Chapter 5. Along with Cantor's work on transfinite numbers, Dedekind's Definition P29 forms part of the foundations of infinitist mathematics, which began to develop at the end of the 19th century. Although the history of mathematical infinity had begun twenty-seven centuries earlier.

P30 Fortunately there is an abundant and excellent literature on the history of infinity (for instance: [251, 152, 210, 26, 199, 60, 142, 164, 168, 131, 132, 1, 169, 166, 57, 239, 15, 198]). The details of that story will not be necessary here, although three of its most relevant protagonists could be remembered as historical references:

- a) Zeno of Elea (490-430 BC), a presocratic philosopher that made use for the first time of the mathematical infinity when defending Parmenides' thesis on the impossibility of change. We know Zeno's work (near forty arguments, including his famous paradoxes against the possibility of change [2, 62]) through his doxographers: Plato, Aristotle, Diogenes Laertius or Simplicius. The infinite in Zeno's arguments is the actual infinity, although obviously Zeno is not doing infinitist mathematics but logical argumentations in which appear infinite collections of points and of instants. Zeno's arguments work properly only if those collections are considered as complete infinite totalities (Zeno's Dichotomies are discussed in Chapter 28).
- b) Aristotle (384-322 BC), one of the most influential thinkers of western culture. He introduced, in a broad sense, the notion of *one to one correspondence* just when trying to solve some of Zeno's paradoxes [12, Books III-VII]. He also introduced the basic distinction between the potential and the actual infinity. A distinction that will be analyzed in the next section.
- c) Georg Cantor (1845-1918), mathematician cofounder, together with R. Dedekind and G. Frege, of set theory at the end of the XIX century. His work on transfinite numbers [47] (cardinals

and ordinals) lays the foundations of modern infinitist mathematics. He inaugurated the so called paradise of the actual infinity, where, according to D. Hilbert, infinitists will inhabit forever [120, p. 170]:

Wherever there is the slightest prospect of fruitful concepts and conclusions, we will carefully track them, cultivate them, support them and make them usable. No one shall be able to drive us out of the paradise that Cantor has created for us.

P31 From Zeno to Aristotle the infinity involved in discussions was usually the actual infinity, although that notion was far from being clearly established before Aristotle. From Aristotle to Cantor, defenders of both types of infinity (actual and potential) existed, although with a certain hegemony of the potential infinity, particularly since the 13th century, once Aristotle was *christianized* by the medieval scholastics. In those preinfinitist times, the same arguments could be used in support of one or of the other infinity (for instance the arguments based on the correspondence between the points of a circle and the points of one of its diameters). But there is not still a theory of the mathematical infinity. The first mathematical theory of infinity appears at the end of the XIX century, being Bolzano, Dedekind and, specially, Cantor its most relevant founders. From Cantor to nowadays the hegemony of the actual infinity has been almost absolute and, in addition, free of serious criticism.

ACTUAL AND POTENTIAL INFINITY

P32 As noted above, the distinction between the actual and the potential infinity is due to Aristotle [12, 11, Books III, VIII]. We will now explain it in modern terms related to set theory. It goes without saying that the only infinity in modern infinitist mathematics, including Dedekind's Definition P29 of infinite set, is the actual infinity.

P33 Consider the list of the natural numbers: 1, 2, 3, . . . According to the hypothesis of the actual infinity that list exists as a *complete totality*, i.e as a totality that contains, all at once, all natural num-

bers. The ellipsis (...) in 1, 2, 3, ... stands for *all* natural numbers. For all. The word “actual” in *actual infinity* means, therefore, that all elements of an infinite collection exist all at once (*in the act*), as a complete totality. Notice also the list of the natural numbers is considered as a complete totality despite the fact that no last number completes the list. To assume the hypothesis of the actual infinity means, then, to assume that it is possible to complete the incompletable, as Aristotle would surely say. [11, p. 291]. Or that the incompletable exists as completed.

P34 To emphasize this sense of completeness, let us consider the task of counting the successive natural numbers 1, 2, 3, ... In agreement with the hypothesis of the actual infinity we could count *all* natural numbers in a finite time, for example in an hour, or in a millisecond:

Count each of the successive natural numbers 1, 2, 3, ... at each of the successive instants t_1, t_2, t_3, \dots of a strictly increasing sequence of instants $\langle t_i \rangle$ within the finite real interval (t_a, t_b) , being t_a and t_b any two instants, and t_b the mathematical limit of the sequence. For instance the classical sequence defined by:

$$t_n = t_a + (t_b - t_a) \frac{2^n - 1}{2^n} \quad (2)$$

As we will have the opportunity to verify in the next chapters, at t_b all natural numbers would have been counted. All (!)

P35 The above task of counting all natural numbers in a finite time, even in less than a second, is an example of supertask. They will be discussed later in this book. Meanwhile note that the fact of pairing the elements of two infinite sequences (in our case the one of natural numbers and the other of instants) does not prove both sequences exist as complete totalities. They could also be potentially infinite, a possibility usually ignored in modern infinitist mathematics.

P36 The alternative to the actual infinity hypothesis is the hypothesis of the potential infinity, which rejects the existence of

complete infinite totalities, and then the possibility to count all natural numbers. From this perspective, the natural numbers result from the *endless* process of counting: it is always possible to count numbers greater than any given number. But it is impossible to complete the process of counting all of them, so that the complete list of all natural numbers makes no sense. The word “potential” in *potential infinity* means, therefore, that the elements of an infinite collection do not exist all at once, but potentially, as possible. The potential infinity is *the unlimited*, as the ordered list of the natural numbers, but only finite collections can be considered as complete totalities, as large as wished but always finite. Contrarily to the actual infinity, the potential infinity assumes the incompletable cannot be completed, cannot exist as completed, precisely because it is incompletable.

P37 In short, the actual infinite hypothesis states that the infinite collections are complete totalities, even if no last element completes the totality, as in the case of the ordered list of the natural numbers. The hypothesis of the potential infinite proposes that the infinite totalities do not exist as complete totalities, the only complete totalities are the finite totalities, though they can be unlimited in the number of their possible elements. From the perspective of the actual infinity it is possible to complete a sequence of steps in which no last step completes the sequence; or even without a first step to start the sequence, as in the case of ω^* -ordered sequences (see P82), for instance, the increasing sequence of negative integers $\dots, -4, -3, -2, -1$. From the perspective of the potential infinite none of those possibilities makes sense. From this perspective the only complete totalities are the finite totalities, as large as wished but always finite. For the potential infinite there is not a last natural number (it is always possible to consider a number greater than any previously considered number), but neither is there the complete collection of all natural numbers.

P38 The potential infinity (the improper or non-genuine infinity as Cantor called it [48, p. 70]) has never deserved the attention of contemporary mathematics. The infinity in Dedekind’s Defini-

tion P29 of infinite set is the actual infinity. The infinitely many elements of an infinite set exist all at once, as a complete totality. Dedekind's Definition P29 is, therefore, based on the violation of the old Euclidean Axiom of the Whole and the Part (the whole is greater than the part) [87]. Set theory has been built on that violation.

P39 The hegemony of the actual infinity in contemporary mathematics is absolute. As absolute as the submission of physics to infinitist mathematics. Some authors proceed as if the existence of complete infinite totalities had been formally demonstrated. Obviously, if that were the case we would not need the Axiom of Infinity to legitimize the existence of such totalities. The actual infinity hypothesis is just a hypothesis.

P40 The three most important "proofs" of the existence of actual infinite totalities (by Bolzano, Dedekind and Cantor) are illustrative of what we could call *naive infinitism*. They also explain why modern infinitist mathematics had finally to establish the existence of actual infinite sets by law, i.e. by means of an axiom (the Axiom of Infinity, which is introduced in the next section).

P41 Bolzano's proof goes as follow (taken from [166, p 112]):

One truth is the proposition that Plato was Greek. Call this p_1 . But then there is another truth p_2 , namely the proposition that p_1 is true [But then there is another truth p_3 , namely the proposition that p_2 is true]. And so *ad infinitum*. Thus the set of truths is infinite.

But the existence of an endless process (p_1 is true, then p_2 is true, then p_3 is true, then . . .) does by no means prove the existence of a final result as a complete totality. At best it proves the existence of an endless (potentially infinite) process. But it does not prove the existence of an actual infinite totality.

P42 Dedekind's proof is similar (taken from [166, p 113]):

Given some arbitrary thought s_1 , there is a separate thought

s_2 , namely that s_1 can be object of thought [there is a separate thought s_3 , namely that s_2 can be object of thought]. And so ad infinitum. Thus the set of thoughts is infinite.

The above comment on Bolzano proof also applies here. Dedekind gave another proof a little more detailed, albeit with the same formal defect, based on his definition of infinite set [70, p. 112].

P43 And finally, Cantor's proof: ([114, p 25], [166, p. 117]):

Each potential infinite presupposes an actual infinity.

or ([46, p. 404] English translation [201, p. 3]):

... in truth the potential infinity has only a borrowed reality, insofar as a potentially infinite concept always points towards a logically prior actually infinite concept whose existence it depends on.

It is now clear why the existence of an actual infinite set had to be finally established by law, that is, by means of an axiom.

THE AXIOM OF INFINITY

P44 Nothing in nature seems to be actually infinite. Until now, all things we have observed and measured are finite. Twenty seven centuries of discussions, on the other hand, were not sufficient to prove (or disprove) the existence of an actual infinity. Infinitists had no other choice but to declare its existence in axiomatic terms by means of the so called Axiom of Infinity, one of the foundational axioms in all modern axiomatic set theories. Set theory is the gateway of the actual infinity in contemporary mathematics.

P45 Since sets will be present in almost all of our arguments, it seems appropriate to make the following consideration on the different ways an element can belong to a set. We usually assume that a particular element belongs or does not belong to a given set, although we could also consider the so called fuzzy sets [248, 76], whose elements have different degrees of membership. In this book, however, we will exclusively deal with complete membership, i.e. with sets whose elements belong completely to their corresponding

sets.

P46 The Axiom of Infinity will be now introduced through three stages of an increasing abstraction. The less formal version of the Axiom of Infinity goes as follows:

$$\textit{There exists an infinite denumerable set} \quad (3)$$

where denumerable (or enumerable) means that it can be put into a one to one correspondence with the set $\mathbb{N} = \{1, 2, 3, \dots\}$ of the natural numbers, and infinite stands for the actual infinity: the elements of that set exist all at once, as a complete totality. Two sets that can be put into a one to one correspondence (said equipotents or equinumerous sets) either both are finite or both are infinite. The second more abstract form of the Axiom of Infinity is the following one:

$$\exists N(0 \in N \wedge \forall x \in N(s(x) \in N)) \quad (4)$$

that reads: there exist a set N [symbols: $\exists N$] such that 0 belongs to N [symbols: $0 \in N$] and for all element x in N [symbols: $\wedge \forall x \in N$] the successor of x , denoted by $s(x)$, also belongs to N [symbols: $s(x) \in N$]. In arithmetical terms we could write:

$$s(0) = 1; s(1) = 2; s(2) = 3; \dots \quad (5)$$

Therefore, the Axiom of Infinity establishes the existence of a set comparable to the set of the natural numbers. And the third still more abstract form of the Axiom of Infinity is:

$$\exists N(\emptyset \in N \wedge \forall x \in N(x \cup \{x\} \in N)) \quad (6)$$

that reads: there exists a set N such that \emptyset (the empty set) belongs to N and for all elements x in N , the element $x \cup \{x\}$ (x and a set whose unique element is x) also belongs to N . Though the existence of an actual infinity can be inferred from both (4) and (6), it would have been better a more explicit declaration that the infinity implicated in the axiom is the actual infinity.

P47 Unnecessary as it may seem, let us recall that an axiom is just an axiom. That is to say, a statement whose veracity is accepted without proofs. A statement that can be accepted or rejected. Although the election will have important consequences on the resulting theory. In the case of the actual infinity hypothesis some relevant authors as L.E.J. Brouwer, C. Hermite, S. Kleene, J. König, L. Kronecker, H. Poincaré, A. Robinson, L. Wittgenstein, o H. Weyl, among others, rejected it, more or less explicitly.

P48 Other thing is the criticism against the actual infinity once set theory was axiomatically established and formally developed. This criticism has been basically non-existent for the last eighty years, and the few attempts carried out were always naive and frequently based on misconceptions of transfinite numbers. Consequently, from now on the word “infinity” will always refer to the actual infinity. And as long as nothing else is said, this actual infinity will also be the denumerable infinity. The potential infinity will always be referred to by “potential infinity”. And the non-denumerable infinity by “non-denumerable infinity”.

ORDER RELATIONS

P49 The most important objects that will be used in the next chapters to discuss on the mathematical infinity will be ordered objects with the same type of order as the set $\mathbb{N} = \{1, 2, 3, \dots\}$ of the natural numbers. The elements of such sets can be indexed by the totality of the natural numbers, and reordered by the order of those natural indexes. It will be necessary, then, to recall the foundations of the order relations in set theory.

P50 G. Cantor introduced the concepts of simply ordered set and well-ordered set in his *Beiträge* (Contributions to the founding of the Theory of Transfinite numbers) [47]. According to Cantor [47, p. 110]:

We call an aggregate [set] M “simply ordered” if a definite “order of precedence” rules over its elements m , so that, of every two elements m_1 and m_2 one takes the “lower” and the other the “higher” rank, and so that, if of three elements m_1, m_2 , and

m_3 , m_1 , say, is of lower rank than m_2 and m_2 is of lower rank than m_3 , then m_1 is of lower rank than m_3 .

And also [47, p. 137]:

We call a simply ordered aggregate F “well-ordered” if its elements f ascend in a definite succession from a lowest f_1 in such a way that:

- I. There is in F an element f_1 which is lowest in rank.
- II. If F' is any part of F and if F has one or many elements of higher rank than all elements of F' , then there is an element f' of F which follows immediately after the totality F' so that no element in rank between f' and F' occur in F .

P51 Modern set theories define the so called *strict order* (that coincides with the above Cantor’s simple order). A relation (symbolically “ $<$ ”) is a *strict order* on a set A if it is:

- a) Irreflexive: $\forall a \in A : a < a$ does not hold.
- b) Asymmetric: if $a < b$ then $b < a$ does not hold.
- c) Transitive: if $a < b$ and $b < c$ then $a < c$.

where $a < b$ means that, under that order relation, a precedes (is a predecessor of) b ; and b succeeds (is a successor of) a . If no other element c exists such that $a < c < b$, then b is the immediate successor of a ; and a is the immediate predecessor of b . If an element has not predecessors it is said the first (least) element of the set; if an element has not successors, it is said the last (greatest) element of the set. A strict order is a *total order* if:

- d) $\forall a, b \in A : \text{either } a < b; \text{ or } b < a$

Finally, a set A will be said *well-ordered* if:

- e) A is totally ordered and every subset of A has a least element.

where the first element of each subset is the predecessor of all its elements in the order relation of A .

P52 Ordered sets define different types of order, so it is important to define what a type of order is:

Definition P52. *Two ordered sets A and B are said to define a type of order if there is a one to one correspondence f between them so that f preserves the order in both sets:*

$$\forall x, y \in A : x < y \Leftrightarrow f(x) < f(y) \quad (7)$$

The sets with the same type of order are classically said *similar* [47, p. 112]. As we will see in the next section, the types of order of the well-ordered sets are the ordinal numbers.

P53 It is now immediate to prove the following:

Theorem P53a. *If an element of a well-ordered set has successors, then it has an immediate successor.*

Proof.-Let m be an element with successors in a well-ordered set X . Let X_{sm} be the subset of X of all successors of m ordered with the same order relation as X . Since X_{sm} is a subset of X , it will have a first element n , and n will be the first successor of m in that order relation. Therefore n is the immediate successor of m in X . \square

Theorem P53b, of the Natural Well-Order. *The set \mathbb{N} of the natural numbers in their natural order of precedence, and any of its subsets with the same type of order, are well-ordered sets.*

Proof.-With the natural order of precedence of the natural numbers (their corresponding increasing magnitudes) any three natural numbers k , m and n satisfies a), b), c) and d) of P51. So, the set \mathbb{N} of the natural numbers is totally ordered. Let A be any subset of \mathbb{N} with the same natural order of precedence and assume it contains the natural number v . Since \mathbb{N} has a first element, the number 1, and each natural number n has an immediate successor $n + 1$ (Peano's Axiom of the Successor [180, p. 1]), the set \mathbb{N} contains a first element 1, the immediate successor of each element less than v , and v itself.

That is, \mathbb{N} contains all elements $1, 2, 3, \dots, v - 1, v \dots$. Therefore, the subset A will also contain a first element: one of elements $1, 2, 3, \dots, v - 1, v$. Hence, the set \mathbb{N} of the natural numbers in their natural order of precedence is a well ordered set. The same argument applies to any subset of \mathbb{N} with the same natural order of precedence of its elements. \square

CARDINALS AND ORDINALS

P54 For the same reason we need axioms and fundamental laws in science (the Aristotelian infinite regress of arguments [10]) we also need primitive concepts in language, i.e. concepts that cannot be defined in terms of other more basic concepts without falling into circular definitions (dictionaries are finite). Most basic mathematical concepts belong to this category: number, point, line, plane, set, and others. Maybe that in some cases the necessary effort to find a formally productive definition has not been made.

P55 There is not a formal definition of number, but we have a good intuitive relationship with the finite numbers, i.e. with the counting numbers $1, 2, 3, \dots$. It is probable that humans (and primates) are endowed with neural networks to deal with numbers [71, 72, 116]. Everyone knows what we mean when we say there are five pencils on the table. Even what we mean when we say that the number of pencils on the table can be increased by adding a new pencil. And that this process is unlimited (potential infinity): It is always possible to add one more pencil (enlarging the table if necessary). Things began to get complicated when it occurred to some people, and to many others the idea seemed fine, that the elements of an unlimited list of numbers exist all at once, as a completed totality (actual infinity). From there, the concept of number began a long process of abstraction and complexification from which emerged a transfinite multitude of numbers increasingly transfinite and increasingly unconnected to our natural intuitive perception of the finite natural numbers, the counting numbers.

P56 In this section we will have to visit the lush tangle (semantic and semiotic) of the transfinite numbers that inhabit the infinitist

paradise inherited from Cantor. Fortunately, it will be a quick visit so that we will not have to get lost in its twisted details. And at the end of the chapter we will be able to return to the numerical sanity, reducing to the maximum the numerical arsenal with which we will face the hypothesis of the actual infinity that fundamentals the Cantorian paradise. If it can be shown that this hypothesis is inconsistent, the infinitist paradise would have to be closed. And we would have to regret having wasted so much time and effort in exploring its endless labyrinths.

P57 Returning to the primitive nature of the concept of number, to say the cardinal of a set is the number of its elements is to say nothing (from a strictly formal perspective). Notwithstanding, everyone knows what we mean when we say the set $\{a, b, c\}$ has three elements, or that its cardinal is three. Even what we mean when we say the cardinal of a denumerable set, as the set \mathbb{N} of the natural numbers, is an infinite number whose symbol (numeral) is “ \aleph_0 ” (that read aleph null, aleph naught, or aleph zero). Although in this case what we mean is not as clear as in the first one (an issue discussed in Chapter 19).

P58) With this formal limitation, we will say the cardinal C of a set X is the number of its elements, a measure of the size of the set independent of the possible ordering of those elements in the set. In symbols $C = |X|$. For obvious reasons, the cardinals of the finite sets are said finite, and the cardinals of the actually infinite sets are said infinite. Although we will not do it here, it can easily be proved that if the cardinal of a set is C , then the number of subsets of that set is just 2^C (including the set itself and the empty set).

P59 The successive finite cardinals $1_c, 2_c, 3_c, 4_c, \dots$ are recursively defined as the cardinals of the successive finite sets of the infinite sequence S of sets defined exclusively in terms of the empty set \emptyset :

$$1_c = |\{ \emptyset \}| \quad (8)$$

$$2_c = |\{ \emptyset, \{ \emptyset \} \}| \quad (9)$$

$$3_c = |\{ \emptyset, \{\emptyset\}, \{\emptyset, \{\emptyset\}\} \}| \quad (10)$$

$$4_c = |\{ \emptyset, \{\emptyset\}, \{\emptyset, \{\emptyset\}\}, \{\emptyset, \{\emptyset\}, \{\emptyset, \{\emptyset\}\}\} \}| \quad (11)$$

$$\dots \quad (12)$$

where the unusual subindex “c” has been provisionally used to emphasize the fact that the finite cardinals are conceptually different from the counting numbers, i.e. from the natural numbers. Note that each set has one more element than the previous one, and that the new element is precisely the set whose unique element is the previous set. This is the abstract way of defining the successive finite cardinals: we recursively define the successive sets of the sequence S and assume each one of those sets has a property called size, or number of elements, or cardinal, and we assign a number and its corresponding symbol (numeral) to that property. For example, the number assigned to that property of the set $\{\emptyset, \{\emptyset\}, \{\emptyset, \{\emptyset\}\}\}$ is 3_c . On the other hand, two sets that can be put into a one to one correspondence have the same cardinal, and they are said to be equipotent.

P60 The sequence S of sets defined by (8)-(12) is infinite. In spite of the fact that each set of the sequence S has one more element than the previous one, and that the sequence is infinite, we will not finally reach a set with infinitely many elements, but a sequence of infinitely many finite sets, each with one more element than the previous, and without a last set completing the sequence. Now then, assume that each time we add a new element to the last defined set of the sequence (8)-(12) we also add one ball to a box initially empty, as the initial empty set of the sequence S . Each time we add a new ball to the box, the box contains the same number of balls as the number of elements of the last set defined by (8)-(12). But, will we finally have a box with a finite number, or with an infinite number of balls? If you think the box will finally contains an infinite number of balls, when the symmetry between both additions get broken? Trivial as it may seems, the question is anything but trivial. We will address it, and many others, in the next chapters.

P61 All the finite sets that can be put into a one to one correspondence with each other have the same finite cardinal; they are equipotent. If instead of pairing off the elements of a finite class of equipotent sets we directly count their elements by means of the natural numbers, we will get a number that coincides with the cardinal number of that class of sets, because the cardinal is the property of that class of sets that represents the amount of elements of each set of that class. So, the above provisional subindex “c” can be remove, and the sequence S of all finite cardinals defined by (8)-(12)) can be written directly as:

$$1 = |\{ \emptyset \}| \quad (13)$$

$$2 = |\{ \emptyset, \{\emptyset\} \}| \quad (14)$$

$$3 = |\{ \emptyset, \{\emptyset\}, \{\emptyset, \{\emptyset\}\} \}| \quad (15)$$

$$4 = |\{ \emptyset, \{\emptyset\}, \{\emptyset, \{\emptyset\}\}, \{\emptyset, \{\emptyset\}, \{\emptyset, \{\emptyset\}\}\} \}| \quad (16)$$

$$\dots \quad (17)$$

and also as:

$$1 = |\{0\}| \quad (18)$$

$$2 = |\{0, 1\}| \quad (19)$$

$$3 = |\{0, 1, 2\}| \quad (20)$$

$$4 = |\{0, 1, 2, 3\}| \quad (21)$$

$$\dots \quad (22)$$

As P62 shows, the set of all finite cardinal numbers and the set of all natural numbers have the same cardinal. For this reason, and although the concept of cardinal number (and cardinality) is broader than that of natural number, in the arguments and discussions developed in the next chapters we will use the set \mathbb{N} of all natural numbers, being the consideration of its elements as a complete totality (actual infinite) versus its consideration as an unlimited and incompletable totality (potential infinity), the great background debate in the rest of the book.

P62 As expected, things are different with the infinite sets, whose cardinality must be established with the aid of an additional assumption: the hypothesis of actual infinity subsumed in the Axiom of Infinity. Although initially this assumption was not considered necessary, as such an assumption: Cantor took for granted the existence of the totality of the finite cardinals. Indeed, in Cantor's own words (italics are mine) [47, pgs. 103-104]:

The first example of a transfinite aggregate is given by the *totality* of finite cardinal numbers v ; we call its cardinal number Aleph-zero and denote it by \aleph_0 ; thus we define

$$\aleph_0 = \{\overline{v}\} \quad (23)$$

where $\{\overline{v}\}$ is Cantor's notation for the cardinal of the set $\{v\}$ of all finite cardinals. According to the notation used in this book (P58), the cardinal of Cantor's set $\{v\}$ of all finite cardinals will be written $|\{v\}|$. Obviously \aleph_0 is an infinite cardinal. Cantor proved it is the smallest cardinal greater than all finite cardinals [47, §6] (chapters 19 and 20 are on \aleph_0).

P63 Let us now prove the following two basic results:

Theorem P63a. *The cardinal of the set \mathbb{N} of the natural numbers is \aleph_0 .*

Proof.-Let f be the one-to-one correspondence between the sets \mathbb{N} of the natural numbers and the set $\{v\}$ of all finite cardinals (whose cardinal is \aleph_0) defined by:

$$f : \mathbb{N} \longleftrightarrow \{v\} : \quad (24)$$

$$f(n) = |\{0, \dots, n-1\}|, \quad \forall n \in \mathbb{N} \quad (25)$$

The bijection f proves that both sets have the same cardinal \aleph_0 . \square

Theorem P63b. *For any natural number, the set of the first n natural numbers in their natural order of precedence is finite.*

Proof.-Let N_n be the set $\{1, 2, \dots, n\}$ of the first n natural numbers in their natural order of precedence. Consider the set $C_n = \{0, 1, \dots, n-1\}$ of the sequence (18)-(22) corresponding

to the definition of the cardinal number n . The one to one correspondence f between N_n and C_n defined according to:

$$N_n \xleftrightarrow{f} C_n \begin{cases} f(1) = 0 \\ f(i) = i - 1, \quad i = 2, 3, \dots, n \end{cases} \quad (26)$$

proves the cardinal of the set N_n of the first n natural numbers is just the finite cardinal number n . \square

P64 All denumerable sets (sets that can be put into a one to one correspondence with the set of all natural numbers) have the same cardinal \aleph_o . While the cardinal of the set \mathbb{N} of the natural numbers is \aleph_o , the cardinal of the set of all subsets of \mathbb{N} , the so called power set of \mathbb{N} and usually denoted by $P(\mathbb{N})$, is not \aleph_o but 2^{\aleph_o} , which is also the cardinal of the set \mathbb{R} of the real numbers. The cardinal of the set $P(P(\mathbb{N}))$ of all subsets of $P(\mathbb{N})$ is not 2^{\aleph_o} but $2^{2^{\aleph_o}}$. The same applies to the set $P(P(P(\mathbb{N})))$ of all subsets of $P(P(\mathbb{N}))$ and son on. We have then an increasing sequence of infinite cardinals (the power sequence):

$$\aleph_o < 2^{\aleph_o} < 2^{2^{\aleph_o}} < 2^{2^{2^{\aleph_o}}} < \dots \quad (27)$$

This book deals exclusively with \aleph_o , except in a small number of arguments in which 2^{\aleph_o} , called power of the continuum, will also be involved.

P65 In common language, an ordinal number (or simply an ordinal) denotes the relative position of an object in a finite list of n objects: first, second, third, . . . n th. So, the ordinal numbers reflect both the size of the list and the relative positions of its elements. The extension of this concept so that it could also be applied to the infinite sets motivated the process of abstraction that finally led to the set theoretical concept of ordinal number, in which it is difficult to recognize its original meaning. Indeed, in set theory the ordinal numbers are classically defined in the following way:

Definition P65. *The ordinals numbers are the types of order of*

the well-ordered sets.

For this reason, two sets A and B are said to have the same ordinal number iff they are well-ordered and there is a bijection f between them that preserves their respective orders (see P52):

$$f : A \longleftrightarrow B : \quad (28)$$

$$\forall x, y \in A : x < y \Leftrightarrow f(x) < f(y) \quad (29)$$

Although they will not be used in this book, there are other more abstract and set theoretical definitions of ordinal numbers, for instance: *an ordinal number is a set which is well-ordered with respect to membership relation (\in) and each of its elements is a subset of the set.*

P66 The elements of any set with a finite number n of elements can only be ordered in a unique way: first, second, third, . . . n th, independently of which element is in fact the first, second, third, . . . n th. Since, according to the Theorem P53a, the set \mathbb{N} of the natural numbers and any of its subsets ordered by their natural order of precedence (increasing magnitudes) are well-ordered, for every natural number n the set of the first n natural numbers defines a type of order, a finite ordinal. Therefore, as in the case of the finite cardinals, those finite ordinals depends only on the finite number of elements of the sets that define them. For this reason, the finite cardinals and the finite ordinals, though conceptually different, share the same properties and are denoted by the same numerals [47, p. 113, 159].

P67 Since we finally identify a type of order (an ordinal, or ordinal number) with a set itself, and any finite set of natural numbers in their natural order of precedence is well-ordered and defines a type of order, the successive finite ordinals 1, 2, 3, . . . can be defined as (the type of order of) the successive finite sets:

$$1 = \{0\} \quad (30)$$

$$2 = \{0, 1\} \quad (31)$$

$$3 = \{0, 1, 2\} \quad (32)$$

$$4 = \{0, 1, 2, 3\} \quad (33)$$

$$5 = \{0, 1, 2, 3, 4\} \quad (34)$$

$$\dots \quad (35)$$

Note that each ordinal n is defined as the well-ordered set of the first $n - 1$ ordinals. According to Cantor's terminology, the finite ordinals are called ordinals of the first class.

P68 It is important to emphasize at this point that for every finite cardinal and every finite ordinal n there exists an immediate successor $n + 1$ (Peano's Axiom of the Successor [180, p. 1]), so that both the set of all finite cardinals and the set of all finite ordinals are infinite sets, which is axiomatically established by the Axiom of Infinity, though in the more abstract and general terms stated in (6). Needless to say that the involved infinity is the actual infinity, even if no explicit declaration establishes that this is the case. Cantor called fundamental series to the infinite sequences of ordinals, whether finite or infinite ordinals.

P69 Things are quite different with the infinite sets. For example, all denumerable sets have the same number of elements, the same cardinal \aleph_0 , but they can be well-ordered in infinitely many different ways, each of which defines a different type of order, i.e. a different infinite ordinal, for example:

$$\{1, 2, 3, \dots\} : \text{Cardinal } \aleph_0. \text{ Ordinal } \omega \quad (36)$$

$$\{2, 3, 4, \dots, 1\} : \text{Cardinal } \aleph_0. \text{ Ordinal } \omega + 1 \quad (37)$$

$$\{3, 4, 5, \dots, 1, 2\} : \text{Cardinal } \aleph_0. \text{ Ordinal } \omega + 2 \quad (38)$$

$$\{1, 3, 5, \dots, 2, 4, 6, \dots\} : \text{Cardinal } \aleph_0. \text{ Ordinal } \omega 2 \quad (39)$$

$$\{3, 5, 7, \dots, 2, 4, 6, \dots, 1\} : \text{Cardinal } \aleph_0. \text{ Ordinal } \omega 2 + 1 \quad (40)$$

$$\{1, 4, 7, \dots, 2, 5, 8, \dots, 3, 6, 9, \dots\} : \text{Cardinal } \aleph_0. \text{ Ordinal } \omega 3 \quad (41)$$

being:

$$\omega < \omega + 1 < \omega + 2 < \dots < \omega 2 < \omega 2 + 1 < \dots < \omega 3 < \dots \quad (42)$$

where $<$ represents the natural order of precedence of the ordinal numbers, the order defined by their corresponding magnitudes, sizes or values (*their natural order according to magnitude*, in Cantor's words [47, p. 111]).

P70 The ordinal numbers of the denumerable sets are called ordinals of the second class. Obviously, all of them are infinite. There are two types of ordinals of the second class [47, p. 169]:

- a) Ordinals of the first kind: ordinals α that have an immediate predecessor α' such that $\alpha = \alpha' + 1$, where 1 is the first finite ordinal. All ordinals of the first kind can then be written in the form $\alpha + n$, being α infinite and n finite.
- b) Ordinals of the second kind: these ordinals are limits of infinite increasing sequences either of finite ordinals or of infinite ordinals of the first kind. For example:

$$\omega = \lim_n(n); \quad n = 1, 2, 3, \dots \quad (43)$$

$$\omega 2 = \lim_n(\omega + n); \quad n = 1, 2, 3, \dots \quad (44)$$

$$\omega 7 = \lim_n(\omega 6 + n); \quad n = 1, 2, 3, \dots \quad (45)$$

P71 Regarding the existence of ordinals of the second class, Cantor proved the following results (rewritten in modern language) [47, p. 158, 160]:

Theorem §14 I. Every infinite sequence of ordinals has a limit, which is the least ordinal that follows in order of magnitude all ordinals of the sequence. [47, p. 158].

Theorem §15 A. The infinite ordinals have a least element ω , the limit of all finite ordinals. [47, p. 160].

Theorem §15 B. If α is any infinite ordinal, the ordinal $\alpha + 1$ is the least ordinal greater than α . [47, p. 161].

Theorem §15 H. Si α is an infinite ordinal, then the set of all ordinals less than α in their order of magnitude is a well ordered set whose ordinal is α . [47, p. 165].

Theorem §15 K. Every infinite ordinal is either the limit of an

infinite sequence of ordinals, or the immediate successor $\alpha + 1$ of another ordinal α . [47, p. 167].

Note that the Theorem §15 B extends Peano's Axiom of the Successor [180, p. 1] to the infinite ordinals; while the Theorem §15 H can also be applied to the finite ordinals.

P72 From Cantor's Theorem §15 H, it immediately follows:

Corollary P72, of Cantor's Theorem §15 A. *If the ordinal of a set is ω , that set has not a last element.*

Proof.- A set X whose ordinal is ω has the same type of order as the set O_ω whose ordinal is ω (Definition 65) and contains all finite ordinals in their natural order of precedence, and only them (Cantor's Theorem §15 H [47, p. 165]). So O_ω cannot have a last element, because that last element could only be the impossible last finite ordinal (Peano's Axiom of the Successor [180, p. 1]). In consequence, X cannot have a last element z either, otherwise, and being f the bijection that preserves the order in X and O_ω , we would have:

$$\forall x \in X : x < z \tag{46}$$

$$\forall f(x) \in O_\omega : f(x) < f(z) \tag{47}$$

and there would be an impossible last element $f(z)$ in O_ω . So X has not a last element. \square

P73 Almost all arguments in this book will be arguments on ω :

- the limit of all finite ordinals.
- the least ordinal after all finite ordinals.
- the least ordinal greater than all finite ordinals.
- the smallest of the infinite ordinals.
- the least ordinal with infinitely many predecessors and no immediate predecessor.

We only need to prove that ω is also the ordinal of the set \mathbb{N} of the

natural numbers in their natural order of precedence. The proof is given in the next P74

P74 The theorem that follows is a trivial result of infinitist mathematics that will be of capital importance in the majority of arguments that will be developed in the next chapters:

Theorem P74, of the ω -order. *The ordinal of the set \mathbb{N} of the natural numbers in their natural order of precedence is ω .*

Proof.-The set \mathbb{N} is well ordered (Theorem P53a). And there is a bijection f between the set \mathbb{N} and the set O_ω of all finite ordinals that preserve their respective orders:

$$f : \mathbb{N} \longleftrightarrow O_\omega \begin{cases} f(n) = \{0, 1, 2, \dots, n-1\}, \quad \forall n \in \mathbb{N} \\ m < n \Leftrightarrow f(m) < f(n) \end{cases} \quad (48)$$

where:

$$\begin{aligned} f(m) < f(n) &\equiv \\ \{0, 1, 2, \dots, m-1\} &< \{0, 1, 2, \dots, m-1, m, \dots, n-1\} \end{aligned} \quad (49)$$

Therefore, O_ω and \mathbb{N} have the same ordinal (Definitions 52 and 65). And according to Cantor's Theorem §15, A [47, p. 160] (see P71), that ordinal is ω . The set \mathbb{N} is, then, ω -ordered.

P75 The ordinals of the second class define a new set: the set of all ordinals whose sets have the same cardinal \aleph_o . The cardinal of this new set is the next aleph: \aleph_1 [47, Theorem §16 F]. In its turn, the set of all ordinals whose sets have the same cardinal \aleph_1 is another set whose cardinal is \aleph_2 . The set of all ordinals whose sets have the same cardinal \aleph_2 is another set whose cardinal is \aleph_3 . And so on. Thus, according to Cantor, there are two increasing sequences of infinite cardinals (the power sequence and the alephs sequence):

$$\aleph_o < 2^{\aleph_o} < 2^{2^{\aleph_o}} < 2^{2^{2^{\aleph_o}}} < \dots \quad (\text{Power sequence}) \quad (50)$$

$$\aleph_o < \aleph_1 < \aleph_2 < \aleph_3 < \dots \quad (\text{Aleph sequence}) \quad (51)$$

The famous hypothesis of the continuum asserts: $\aleph_1 = 2^{\aleph_0}$. The generalized version asserts that, for all i , the i th term of the first sequence is equal to the i th term of the second one. Between 1938 and 1963, it was proved that the hypothesis of the continuum is an undecidable proposition (one that cannot be proved or disproved) within the axiomatic framework of set theory. Fortunately we will not have to address that question in this book, except the short revision of the hypothesis of the continuum that will be carry out in Chapter 22.

SEQUENCES

P76 Assuming that the concepts of set, collection and the like are primitive concepts, the concept of indexed set will be now defined, and after proving two basic results, the concept of sequence will also be defined.

Definition P76a. *A set is said to be indexed by another set, said set of indexes, if there is a bijection between both sets, and all elements of the indexed set are represented by the same symbol plus a symbol different for each element, called subindex, which represents the element of the set of indexes paired with that element by the bijection between the two sets.*

Theorem P76. *If a set is indexed by a well-ordered set of indexes, then the set can be well-ordered by the indexes with the same type of order as the set of indexes.*

Proof.-Let A be a set indexed by a well-ordered set of indexes $I = \{i, j, k, \dots\}$. There is a bijection f between I and A (Definition P76a), so that each element a of A can be written $f(k)_k$, where k is the element of I paired off with the element a of A by the bijection f . Since all indexes are different from one another, any two elements $f(k)_k, f(n)_n$ of A indexed respectively by $k, n \in I$, can also be written a_k, a_n . Let now define a set A' so that being i the first element of I , a_i is also the first element of A' ; and so that every element a_i of A' has as immediate successor the element a_k if, and only if, k is the immediate successor of i in I (Theorem P53a). The set $A' =$

$\{a_i, a_j, a_k, \dots\}$ so defined satisfies:

$$\forall i, k \in I : a_i < a_k \Leftrightarrow i < k \quad (52)$$

$$\left. \begin{array}{l} a_i \in A \Rightarrow i \in I \Rightarrow a_i \in A' \\ a_i \in A' \Rightarrow i \in I \Rightarrow a_i \in A \end{array} \right\} \quad (53)$$

where $<$ is the order of precedence in both sets A' and I . The set A' is totally ordered by $<$, otherwise at least one of the properties a), b), c), d) defined in P51 would not be satisfied by its elements, and according to (52), the same would apply to the elements of I , which is not the case because I is well-ordered. The bijection g between I and A' defined by $g(i) = a_i, \forall i \in I$, and (52) prove both sets have the same ordinal (Definitions P52 and P65). On the other hand, (53) proves A' contains all elements of A , and only them. Therefore, the elements of A can be reordered with the same type of order as the set of indexes I , and the reordered set and the set of indexes have the same ordinal (Definition P65). \square

Corollary P76a. *A set whose elements are indexed by the set of all ordinals in their natural order and precedence and less than a given ordinal α can be well-ordered as set whose ordinal is the given ordinal α*

Proof.-According to Cantor' Theorem §15 H [47, p. 165], the set of all ordinals in their natural order of precedence and less than a given ordinal α is a well-ordered set whose ordinal is α . So, and according to the above Theorem P76, if the elements of a set A are indexed by the set of all ordinals in their natural order of precedence and less than α , then the set A can be ordered as a well-ordered set whose ordinal is α . \square

Definition P76b. *A sequence is a well-ordered set indexed by a well ordered set of ordinals in their natural order of precedence. If the ordinal of the set of indexes is α the sequence is said α -ordered or α -sequence.*

Note that the well order of a sequence is legitimated by the Corollary P76a. It is then clear that a sequence is a particular

type of set, and that not all sets are sequences. Unless other thing indicated, the words “table” and “ordered list” will be used with the meaning of ω -ordered sequence.

Corollary P76b. *An element of a sequence indexed by an ordinal of the second kind cannot have immediate predecessor.*

Proof. An ordinal of the second kind is the limit of an infinite sequence either of finite ordinals, or of ordinals of the first kind [47, p. 167, Theorem §15 K]. So, if an element of a sequence is indexed by an ordinal of the second kind, it cannot have an immediate predecessor because this predecessor would have to be indexed by the impossible last ordinal of an infinite sequence of ordinals for each of whose elements α_v there is a successor ordinal $\alpha_v + 1$ (Peano’s Successor Axiom for finite ordinals and Cantor’s Theorem §15 B for infinite ordinals) [180, p. 1] [47, p. 161]. \square

P77 For the infinite sequences, the set of indices is usually the set of all finite ordinals (ordinals of the first class). For the finite sequences of n elements the set of indexes is the set of the first n finite ordinals. Both sets coincide in their type of order respectively with the set \mathbb{N} of the natural numbers and with the set of the first n natural numbers.

P78 Note that the above Definition P76b extends the definition of sequence that usually appears in mathematical textbooks, so that, in our case, the ordinals that index a sequence can be equal or greater than ω . Although the “extended” sequences will only be used to discuss on the possibility of non-denumerable segmentations (divisions) in the real straight line (Chapter 13), and also to discuss the supposed infinite divisibility of the linear intervals (Chapter 17). Thus, the set of ordinals (indexes) of an ω -ordered sequence is $\{1, 2, 3, \dots\}$, and the elements of the sequence will be written:

$$\langle a_i \rangle = a_1, a_2, a_3, \dots \quad (54)$$

If the set of ordinals of a sequence is, for example, $\{1, 2, 3, \dots, \omega\}$, the corresponding sequence $\langle a_i \rangle$ will be said $(\omega + 1)$ -ordered and

its elements would be:

$$\langle a_i \rangle = a_1, a_2, a_3, \dots a_\omega \quad (55)$$

And the following will not be sequences indexed by that set of indexes:

$$a_1, a_2, a_3, \dots \quad (56)$$

$$a_1, a_2, \dots a_\omega, a_{\omega+1} \quad (57)$$

$$a_\omega, a_2, a_3, a_4, \dots a_1 \quad (58)$$

For simplicity, the word “sequence” will also be used to refer to the ω^* -ordered collections (see P82), even if they are neither well-ordered sets nor true sequences in the sense defined in P76b.

P79 As noted above, most of the theoretical objects we will use here to analyze the formal consistency of the hypothesis of the actual infinity will be well-ordered sets with its corresponding ordinal number. Although the issue that interests us most here is not the ordinal itself but the possibility to consider successively and one by one (one after the other) all elements of the set.

P80 We will finish this instrumental introduction to the mathematical infinity by proving four basic results on well-ordered sets. They will be used occasionally in some of the arguments developed in the rest of the book.

Theorem P80a, of the Indexed Sets. *If a set can be put into a one to one correspondence with the set \mathbb{N} of all natural numbers, then the set can be reordered as an ω -ordered set.*

Proof.-If a set X can be put into a one to one correspondence with the set \mathbb{N} of the natural numbers, then it can be indexed by all elements of this set (Definition P76a). According to the Theorem P74, of the ω -Order, the ordinal of the set \mathbb{N} of the natural numbers is ω . Hence, the elements of X can be reordered by means of their corresponding indexes as an ω -ordered set (Theorem P76). \square

Theorem P80b, of the ω th Term. *If a sequence has an infinite*

ordinal α greater than ω , then the sequence has an ω th term.

Proof.-Let X be a sequence whose ordinal is $\alpha > \omega$. X is indexed by a set O_α of ordinals in their natural order of precedence whose ordinal is α (Definition P76b). According to Cantor's Theorem §15 H [47, p. 165], O_α contains all ordinals less than α , so that it contains the ordinal ω . Therefore, X must contain an ω th term. \square

Theorem P80c, of the Finite Sets. *If a set has a first element, a last element, and each element, except the last, has an immediate successor and, except the first, an immediate predecessor, the set has a finite number of elements.*

Proof.-Let $X = \{a, b, c, \dots v\}$ be a set with a first element a , a last element v and such that every element, except v has an immediate successor and, except a , an immediate predecessor. The immediate successor of a has a finite number of predecessors: 1 predecessor, just the element a . Suppose that, being h any element of X different from a and v , that element h has a finite number n of predecessors. The immediate successor of h has one more predecessor than h , the element h itself. Therefore, it also has a finite number $n + 1$ of predecessors. (Peano's Axiom of the Successor [180, p. 1]). Since the immediate successor of a has a finite number of predecessors, we can inductively conclude that, except a and b , every element of X has a finite number of predecessors. And since a has no predecessors and v has one predecessor more than its immediate predecessor, the number of predecessors of v is also finite (Peano's Axiom of the Successor [180, p. 1]). Therefore, the number of elements of X , which is 1 plus the number of predecessors of its last element v , is finite (Peano's Axiom of the Successor [180, p. 1]). \square

Corollary P80, of the Finite Ordinals. *If a sequence X has a last term and each element has an immediate successor and an immediate predecessor, the sequence has a finite number of elements.*

Proof.-It is an immediate consequence of the Definition P76b and of the Theorem P80 \square

SUMMARY

P81 Obviously this has been only a schematic introduction to Cantor's theory of transfinite numbers [47]. But it is more than we need to know in order to follow the arguments developed in this book. As noted above, we will focus our attention on ω -ordered objects (sets, sequences, tables, lists, etc.), i.e on objects whose elements are ordered in the same way as the natural numbers in their natural order of precedence. Objects as, for instance, the sequence $\langle a_i \rangle = a_1, a_2, a_3, \dots$. This type of ordering (ω -order from now on) is characterized by:

- a) There is a least element a_1 .
- b) Each element a_n has an immediate predecessor a_{n-1} , except the least one a_1 .
- c) Each element a_n has an immediate successor a_{n+1} .
- d) Between any two successive elements a_n, a_{n+1} , no other element exists.
- e) There is not a last element, in spite of which ω -order objects are considered as complete totalities.

P82 Although only very occasionally, we will also deal with ω^* -ordered objects, i.e. objects whose elements are ordered in the same way as the increasing sequence of negative integers $\dots, -3, -2, -1$, which is not well-ordered. In this type of ordering we will use the notation a_{n*} to refer to the last but $n - 1$ element. ω^* -Order is characterized by:

- a) There is a last element a_{1*} .
- b) Each element a_{n*} has an immediate successor $a_{(n-1)*}$, except the last one a_{1*} .
- c) Each element a_{n*} has an immediate predecessor $a_{(n+1)*}$.
- d) Between any two successive elements $a_{(n+1)*}, a_{n*}$ no other element exists.
- e) There is not a first element, in spite of which ω^* -ordered objects are considered as complete totalities.

Evidently, an ω^* -ordered sequence $\langle a_{i^*} \rangle$ defines an ω -ordered sequence $\langle a_i \rangle$ in which every a_i is a_{i^*} . For instance the above sequence $\langle a_{i^*} \rangle$ of increasing negative integers defines the ω -ordered sequence $\langle a_i \rangle$ of decreasing negative integers $-1, -2, -3, \dots$

P83 Consequently, the main protagonists of this book, the ω -ordered objects exhibit:

- **ω -successiveness:** each element a_i has an immediate successor a_{i+1} .
- **ω -discontinuity:** between an element a_i and its immediate successor a_{i+1} no other element exists.
- **ω -asymmetry:** *each element a_i* is preceded by a finite number $i - 1$ of predecessors, and succeeded by an infinite number, \aleph_o , of successors.

It is worth paying attention to the above ω -asymmetry of the ω -ordered objects (note the italics in its definition). No matter how much one advances over the successive terms of an ω -ordered sequence, it is impossible to reach a term with an infinite number of predecessors, despite the fact that the sequence contains an infinite number of terms. This infinite asymmetry makes impossible the existence of elements with an infinite number of predecessors and elements with a finite number of successors. The ω -asymmetry will be one of the most important instruments in the critique of the hypothesis of the actual infinity that will be developed from Chapter 7. As you will see, ω -asymmetry is a relentless detector of infinitist inconsistencies.

P84 In Chapter 28, on Zeno's paradoxes, we will make use of an ω^* -ordered sequence. These sequences exhibit:

- **ω^* -precedence:** each element a_{i^*} has an immediate predecessor $a_{(i+1)^*}$.
- **ω^* -discontinuity:** between an element a_{i^*} and its immediate predecessor $a_{(i+1)^*}$ no other element exists.

- ω^* -**asymmetry**: each element a_{i^*} is preceded by an infinite number, \aleph_o , of predecessors, and succeeded by a finite number $i - 1$ of successors.

P85 Unless otherwise indicated, all sequences are henceforth assumed to be well-ordered objects defined according to the above Definition P76b. In addition, it will be said that a set, or a sequence, is α -ordered to express it is a well-ordered set (or sequence) whose ordinal is α , being α any finite or infinite ordinal, that almost always will be ω .

P86 As noted above, Cantor took it for granted the existence of the set of all finite cardinals in their natural order of precedence (ω -order). Though not explicitly declared as such an assumption, this was the only assumption founding his work on transfinite numbers, in which he proved the existence of other infinite cardinals and ordinals greater respectively than \aleph_o and ω . So, if it were possible to prove that ω -ordered objects are inconsistent, the whole edifice of infinitist mathematics would fall down like a house of cards. This is why most of the following arguments will deal with ω -ordered sets and sequences.

P87 Among other sets, the set \mathbb{Q} of the rational numbers in their natural order of precedence is densely ordered (between two different rationals there are always infinitely many different rationals), but not well ordered. And it is also a denumerable set, as was proved by Cantor[47] [37, p. 123]. Although we will not use it here, Cantor called η to the order type of the set \mathbb{Q} of the rational numbers in their natural order of precedence [47, p. 122-123], and proved that any simply (strictly) ordered set M satisfying:

- (a) $|M| = \aleph_o$.
- (b) M has neither first nor last element.
- (c) M is densely ordered.

is also η -ordered [47, p. 124].

P88 Being \mathbb{Q} denumerable, a one to one correspondence f between between the ω -ordered set of the natural numbers \mathbb{N} and \mathbb{Q} can be established. The bijection f allows to consider *all* elements of \mathbb{Q} one by one, by following the ω -order of \mathbb{N} : $f(1)$, $f(2)$, $f(3)$, \dots . From Chapter 7, this strategy will be used in different demonstrations.

INTRODUCTION

P89 If after pairing each element of a set A with a different element of another set B all elements of B result paired, it is said both sets have the same number of elements (the same cardinality). But if one or more elements of B result unpaired and B is infinite, it is not always allowed to say both sets have a different number of elements, a different cardinality. In this chapter we discuss why it is not.

P90 An injection is a correspondence between the elements of two sets A and B such that each element of A is paired off with a different element of B . If all elements of B are also paired, the injection is said exhaustive or surjective (it is also said a bijection or one to one correspondence); otherwise it is said non-exhaustive, or non-surjective. As we will see, the existence of both exhaustive and non-exhaustive injections between two infinite sets could be indicating they have and have not the same cardinality. Thus, the arbitrary distinction of the exhaustive injections to the detriment of the non-exhaustive ones *could be* concealing a fundamental contradiction in set theory.

P91 Most of the paradoxes related to the actual infinity result from the violation of the Axiom of the Whole and the Part (the assumption that the whole is greater than the part), one of the Common Notions assumed in the First Book of Euclid's *Elements* [87, p 19]. Among the paradoxes resulting from that violation are the so called paradoxes of reflexivity in which the elements of a whole are paired off with the elements of one of its proper parts

[210, 73]. A well-known example of this kind of paradox is Galileo Paradox: the elements of the set of the natural numbers can be paired with the elements of one of its proper subsets, the subset of their squares [98]):

$$f(n) = n^2, \forall n \in \mathbb{N} : 1 \leftrightarrow 1^2, 2 \leftrightarrow 2^2, 3 \leftrightarrow 3^2 \dots \quad (1)$$

Authors as Proclus, J. Filopón, Thabit ibn Qurra al-Harani, R. Grosseteste, G. of Rimini, W. of Ockham etc. found many other examples [210].

P92 The strategy of pairing off the elements of two sets is not just a modern invention. In a certain way, Aristotle used it when trying to solve Zeno's Dichotomy in its two variants [12, 11]. And since then, it has been frequently used by different authors with different level of formalism and different purposes, although, before Dedekind and Cantor, they were never used (including the case of Bolzano [30]) as an instrument to consummate the violation of the old Euclidean axiom. Of course, the existence of a one to one correspondence between two infinite sets does not prove both sets are actually infinite because they could also be potentially infinite.

P93 Things began to change with Dedekind, who stated the definition of infinite set (Definition P29) just on the basis of that violation. Dedekind and Cantor inaugurated the so called paradise of the actual infinity, where exhaustive injections (bijections or one to one correspondences) play a major role.

PARADOXES OR CONTRADICTIONS?

P94 As indicated above, an exhaustive injection of a set A into another set B is a correspondence between the elements of both sets in which each element of A is paired off with a different element of B , and all elements of A and B result paired. When at least one element of the set B results unpaired the injection is said non-exhaustive. Exhaustive and non-exhaustive injections can be used to compare the cardinality of the finite sets. But if the compared sets are infinite, then only exhaustive injections are permitted. An inevitable consequence of assuming that the infinite sets violate,

by definition, the Axiom of the Whole and the Part.

P95 But definitions can also be inconsistent. Specially when the definition is based on the violation of a basic axiom, as is the case of Dedekind's Definition P29 of infinite set. The infinite sets could have been defined inconsistently on the basis of one of the terms of a contradiction: there is an exhaustive injection between a set A and one of its supersets B . The other part of the contradiction would be: there is a non-exhaustive injection between the set and the same superset. No one has ever explained why to have an exhaustive injection with a superset ($|A| = |B|$) and at the same time to have a non-exhaustive injection with the same superset ($|A| < |B|$) is not contradictory. The problem has simply been ignored (justifying it with Dedekind's Definition P29), and set theory has been raised on the basis of that ignorance.

P96 If the notion of set is primitive (undefinable), as it seems to be, then only operational definitions of set could be given. And if sets may have different cardinalities, then an appropriate basic method for comparing cardinalities should be established *before* defining the types of sets that could be defined according to their cardinals, especially if the comparing method has to form part of the definition, as is the case of the Definition P29 of infinite set.

P97 To pair off the elements of two sets is a basic and legitimate method for comparing their respective cardinalities, being unnecessary any other arithmetical or set theoretical operation. It is at this foundational level of set theory where it would have to be discussed if exhaustive and non exhaustive injections are appropriate operations to get conclusions on the cardinality of any two sets. So, this question should be elucidate before trying any definition involving cardinalities, as the definition of infinite set.

P98 It seems reasonable to assume that if after pairing every element of a set A with a different element of a set B , all elements of B result paired, then A and B have the same number of elements. But it seems also reasonable, and for the same elementary

reasons, to assume that if after pairing every element of a set A with a different element of a set B one or more elements of the set B remain unpaired, then A and B do not have the same number of elements. It is worth noting that both exhaustive and non-exhaustive injections make use of *the same basic method of pairing elements*, without carrying out any finite or transfinite arithmetic operation. We are not counting but pairing, we are discussing at the most basic foundational level of set theory.

P99 It should be recalled at this point that the arithmetic peculiarities of transfinite cardinals, as $\aleph_o = \aleph_o + \aleph_o$ and the like (some of them are discussed in Chapter 20), are of all them derived from the hypothetical existence of the infinite sets (Axiom of Infinity), i.e. of sets whose elements can, by definition, be paired with the elements of some of their proper subsets. So, under penalty of circular reasoning, we cannot infer from the deduced existence of those arithmetical peculiarities the existence of just the sets from which those arithmetic peculiarities of infinite cardinals have been deduced (peculiarities that could be used to justify the existence of exhaustive and non exhaustive injections between an infinite set and some of its supersets). This is an unacceptable circular argument. Here, we are simply discussing if the method of pairing the elements of two sets is appropriate to compare their respective cardinalities; and if it is, why non-exhaustive injections are rejected, because that rejection could be concealing a fundamental contradiction.

P100 For example, consider the set \mathbb{N} of the natural numbers, the sets \mathbb{E} and \mathbb{O} of even and odd numbers respectively, and the injection f from \mathbb{E} to \mathbb{N} defined by:

$$f(e) = e; \forall e \in \mathbb{E} \quad (2)$$

The injection f is non-exhaustive since all odd numbers in $\mathbb{O} \subset \mathbb{N}$ remains unpaired. Assume that, consequently, we write:

$$|\mathbb{E}| < |\mathbb{N}| \quad (3)$$

On the other hand, the injection g of \mathbb{E} in \mathbb{N} defined by:

$$g(e) = e/2; \forall e \in \mathbb{E} \quad (4)$$

is exhaustive. Therefore, and according to Dedekind's Definition P29, \mathbb{N} is infinite, and \mathbb{E} has the same cardinality as \mathbb{N} . In consequence:

$$|\mathbb{E}| = |\mathbb{N}| \quad (5)$$

that contradicts (3). In consequence, to say that (5) invalidates (3) because (5) is Dedekind's Definition P29, can be legitimately interpreted as if one term of a contradiction ($|\mathbb{P}| = |\mathbb{N}|$) is used to define a class of objects (the infinite sets), then the other term of the contradiction ($|\mathbb{P}| < |\mathbb{N}|$) is invalidated. We would have finally found the ultimate way to end all contradictions.

P101 Exhaustive and non-exhaustive injections should have the same validity as instruments to compare the cardinalities of the infinite sets just because they use exactly the same comparison method: to pair elements. However, only exhaustive injections can be used with that purpose. But why? Why some pairings are valid while some others are not, if all of them have the same basic legitimacy? The problem here is that the existence of both exhaustive and non-exhaustive injections between two infinite sets could be indicating the existence of an elementary contradiction (that both infinite sets have and have not the same cardinality). In this case the distinction of the exhaustive injections would be the distinction of a term of a contradiction ($|\mathbb{E}| = |\mathbb{N}|$) to the detriment of the other ($|\mathbb{E}| < |\mathbb{N}|$). Or in other words, one term of a contradiction ($|\mathbb{E}| = |\mathbb{N}|$) would be being used to define an object (the infinite sets), while ignoring the other term of the contradiction ($|\mathbb{E}| < |\mathbb{N}|$).

P102 At the very least, the alternative to consider a set as inconsistent because of the existence of both exhaustive and non-exhaustive injections with the elements of the same superset is as legitimate as the alternative to consider it as consistent. Thus,

at the very least, the arbitrary election of the second alternative should be explicitly declared at the foundational level of the theory, which is not the case in current set theories. Current set theories systematically ignore the first alternative. It could be argued that Dedekind's Definition P29 implies to assume the existence of sets for which there exist both exhaustive and non-exhaustive injections with at least one of its supersets. But, for the reason given in P100, a simple definition does not guarantee the defined object is consistent, and then the alternative of the inconsistency has also to be considered. To propose such an alternative is the main objective of this chapter. An alternative that, for all I know, has never been proposed.

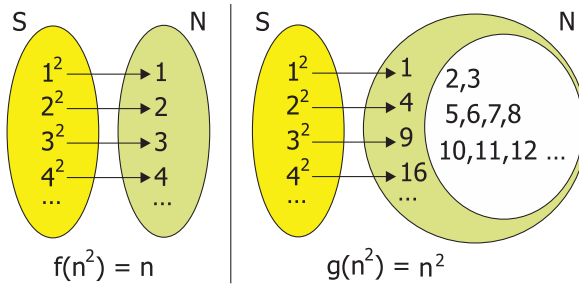

Figure 5.1 – The suspicious power of the ellipsis: the sets S and N have (left) and not have (right) the same number of elements.

P103 Assume, only for a moment, that exhaustive and non exhaustive injections were valid instruments to compare the cardinality of any two sets. In these conditions, let N be an infinite set (Figure 5.1). By definition, there exists a proper subset S of N and an exhaustive injection f from S to N proving both sets have the same number of elements. Consider now the injection g from S to N defined by:

$$g(x) = x, \quad \forall x \in S \quad (6)$$

which evidently is non-exhaustive (the elements of the nonempty set $N-S$ remain unpaired). The injections f and g would be proving that S and N have (f) and not have (g) the same number of elements, i.e. that the infinite sets are inconsistent.

P104 We must therefore decide if exhaustive and non-exhaustive injections do have the same validity as instruments to compare the number of elements of any two sets. If they do, then the actually infinite sets are inconsistent. If they do not, at least one (non-circular, not related to the definition of infinite set) reason should be given to explain why they do not. And, if no reason can be given, then the arbitrary distinction in favor of the exhaustive injections should be declared in an appropriate ad hoc axiom. Until then, the foundation of set theory rests on the basis of one of the terms of a contradiction. Unbelievable as it may seem, the axiomatic foundation of set theory has always ignored this problem.

P105 As could be expected from a theory with such initial foundations, inconsistencies appeared immediately: the set of all ordinals and the set of all cardinals were proved to be inconsistent by Burali-Forti [33] and Cantor respectively. According to Cantor, those sets are inconsistent because of their excessive infinitude (letter to Dedekind quoted in [68, pag. 245], [99, 90]). A set can be infinite but not too infinite. By the appropriate axiomatic restrictions, it was finally stated that some infinite totalities, as the totality of cardinals or the totality of ordinals, do not exist because they lead to contradictions. It can easily be proved, as we will see in the next chapter, that in a set theory without axiomatic restrictions, as Cantor's set theory, each (finite or infinite) set of cardinal C originates nothing less than 2^C inconsistent infinite totalities. Even Riemann's Series Theorem can be reinterpreted as the proof of the existence of another infinitude of inconsistent infinite totalities (Chapter 34)

PARADOXES IN NAIVE SET THEORY

P106 The so-called Cantor Paradox is not a paradox but a true inconsistency, a pair of contradictory results deduced from an infinite set: from the set of all cardinals (or from the universal set, the set of all sets). For this reason, these sets are rejected in modern axiomatic set theories. This chapter demonstrates, however, the existence of an uncountable infinitude of inconsistent infinite sets. It will be proved that, within the framework of the naive set theory, each set with a cardinal number C gives rise to at least 2^C inconsistent infinite sets.

P107 Although Burali-Forti was the first to publish [33] the proof of a paradox related to an infinite set (the set of all ordinals) [32, 99], Cantor was the first to discover one of those paradoxes, now known as Paradox of the Maximum Cardinal, or Cantor Paradox [99, 68, 92], though the discovery was not published. There is no agreement regarding the date Cantor discovered his paradox [99] (the proposed dates range from 1883 [190] to 1896 [106]). There is also no agreement on whether he discovered one paradox or more than one paradox, or even on the precise content of the paradox(es). Fortunately, the goal of this chapter is not to uncover the history of those discoveries. The main objective of this chapter is to prove, within the framework of the naive set theory, the existence of a non-denumerable infinitude of inconsistent infinite sets. Although before developing this objective, it is convenient to recall those first paradoxes in set theory, which were discovered almost at the same time that set theory itself was beginning to develop. And two of the best known of them are Burali-Forti Paradox of the Maximum Ordinal and Cantor Paradox of the Maximum Cardinal.

P108 Burali-Forti Paradox of the Set of All Ordinals and Cantor Paradox of the Set of All Cardinals are both related to the size of the considered totalities, perhaps too big as to be consistent, according to Cantor. At this stage of his life, Cantor followed a direction in set theory more theoplatonic than logic [92], so that an inconsistent totality for him would be a totality that cannot be considered as a (human) set due to its divine nature. Although for other reasons more theological than logical, Cantor was following the same strategy that the axiomatization of set theory would later follow: putting restrictions on the existence of sets.

P109 At the beginning of the development of set theory, the so-called Principle of Comprehension was used indiscriminately to define sets. This principle states that given a condition expressible by a formula $f(x)$, it is possible to form a set with all the elements x that satisfy that formula f , the set $\{x \mid f(x)\}$. Under these conditions it was possible to define sets as the universal set: $\{x \mid x = x\}$. And once the concepts of cardinal and ordinal were defined, the respective sets of all cardinals and all ordinals were also possible. A possibility that, almost immediately, led respectively to Cantor Paradox and to Burali-Forti Paradox.

P110 On the other hand, it is worth noting the euphemism of calling paradox what really is an inconsistency, i.e. a pair of contradictory terms that surely derive from a common precedent hypothesis. From which precedent hypothesis? Perhaps from the only previous hypothesis (explicitly recognized or not) that establishes the existence of Dedekind's infinite sets as complete totalities? Indeed, the simplest explanation of both paradoxes is that they are inconsistencies derived from the hypothesis of the actual infinity, i.e. from assuming the existence of the infinite sets as complete totalities. But no one has dared to analyze this alternative. As is well known, and has just been indicated, the infinitist alternative was to restrict the existence of sets by means of the appropriate axioms, in such a way that the above conflicting sets, and many others, can no longer be considered legal sets.

CANTOR AND BURALI-FORTI PARADOXES

P111 The following is a short version of Cantor Paradox (for a detailed analysis see [99, p. 66-74], [92]): In Cantor's naive set theory, let U be the set of all sets, the so called universal set, and $P(U)$ its power set, the set of all its subsets. Let us denote by $|U|$ and $|P(U)|$ their respective cardinals. Being U the set of *all* sets it must contain all sets and its cardinal must be the maximum cardinal. Then we can write:

$$P(U) \subseteq U \quad (1)$$

$$|P(U)| \leq |U| \quad (2)$$

On the other hand, and according to Cantor's Theorem on the Power Set [43], it holds:

$$|U| < |P(U)| \quad (3)$$

which contradicts (2). Equations (2)-(3) represent Cantor Paradox, which is a true contradiction, i.e. a couple of contradictory conclusions:

$$\text{Cantor Paradox} \begin{cases} |P(U)| \leq |U| \\ |P(U)| > |U| \end{cases} \quad (4)$$

P112 As is well known, Cantor gave no importance to that inconsistency [90] and clinched the argument by assuming the existence of two types of infinite totalities, the consistent and the inconsistent ones [40]. As noted above, in Cantor's opinion the inconsistency of those inconsistent infinite totalities would be due to their excessive infinitude as well as to its divine nature. In fact, we would be in the face of the mother of all infinities, the absolute infinity which, according to Cantor, leads directly to God, being just the divine nature of this absolute infinitude what makes it inconsistent for our poor human minds [40].

P113 Burali-Forti Paradox is similar, although it is deduced from

the set \mathcal{O} of all ordinals. According to the description given in [99] (taken from [63]), the paradox results from the following argument. The set \mathcal{O} of all ordinals is well-ordered, so it has a defined ordinal Ω . Therefore, $\Omega \in \mathcal{O}$. On the other hand, any ordinal $a \in \mathcal{O}$ satisfies:

$$\exists(a + 1) \in \mathcal{O} \tag{5}$$

$$a \leq \Omega \tag{6}$$

$$a < a + 1 \tag{7}$$

and since Ω is an element of \mathcal{O} , it must satisfy (5)-(7). Hence, if we replace a with Ω in (5) we get:

$$\exists(\Omega + 1) \in \mathcal{O} \tag{8}$$

Now by replacing a with $\Omega + 1$ in (6); and a with Ω in (7), we can write:

$$\Omega + 1 \leq \Omega \tag{9}$$

$$\Omega < \Omega + 1 \tag{10}$$

And we come to Burali-Forti Paradox:

$$\text{Burali-Forti Paradox} \begin{cases} \Omega + 1 \leq \Omega \\ \Omega + 1 > \Omega \end{cases} \tag{11}$$

Which is another undoubted contradiction, a new pair of contradictory results.

P114 Finally, we could recall the well-known Russell's Paradox, of the set R of all sets that do not belong to themselves [99]. In this case we will obtain a true paradox, a self-contradictory statement: a part of a statement denies the other part of the statement, and vice versa: it is clear that if R belongs to R , then it does not belong to R ; and if it does not belong to R , then it belongs to R .

P115 The three set theoretical paradoxes we have just recalled have one word in common, the word "all":

- Set of *all* cardinals.
- Set of *all* ordinals.
- Set of *all* sets.
- Set of *all* sets that do not belong to themselves.

where the word “all” refers to the elements of particular infinite totalities, and in order to be able to consider all of its elements, those totalities have to be considered as complete totalities. Totalities whose infinitude is actual, not potential. In the case of finite totalities, the only legitimate totalities according to the alternative hypothesis of the potential infinity, none of the above paradoxes (contradictions) occurs. From the next chapter, it will be shown over and over again that the only consistent totalities are the finite totalities.

P116 In the next section we will see that, within the same framework of the Cantorian set theory, it is possible to extend Cantor's Paradox to other sets much more modest than the set of all sets, or the set of all cardinals. And it will be shown that the number of inconsistent infinite totalities is infinitely greater than the number of consistent ones: each denumerable set gives rise to nothing less than 2^{\aleph_0} inconsistent infinite sets. That is, an uncountable infinity of inconsistent infinite sets. We will always be in doubt about what would have happened with the development of set theory and infinitist mathematics, if that uncountable infinitude of inconsistent infinite sets had been discovered when the theory was beginning its development.

AN EXTENSION OF CANTOR'S PARADOX

P117 To illustrate what could have been but was not, the following discussion will take place within the framework of the Cantorian (naive) set theory. To begin with, let us define two types of disjoint sets:

- a) *Sets relatively disjoint.* Two sets are said relatively disjoint if they have no common element, but at least one element of one of them is part of the definition of at least one element of the other.

- b) *Sets absolutely disjoint.* Two sets are said absolutely disjoint if they have no common element, and no element of any of them is part of the definition of any element of the other.

Consider, for example, the following three sets:

$$A = \{\{a, \{b\}\}, c, d, \{e\}, f\} \quad (12)$$

$$B = \{1, 2, b\} \quad (13)$$

$$C = \{11, 22, 33\} \quad (14)$$

According to the above definitions, A and B are relatively disjoint because they have no common element, but the element b of the set B is part of the definition of the element $\{a, \{b\}\}$ of the set A . On the other hand, A and C are absolutely disjoint because they have no common element and no element of any of them is part of the definition of any element of the other. For the same reason, B and C are also absolutely disjoint.

P118 Consider also the recursive sequence $\langle S_i(X) \rangle$ of the successor sets of a given set X , whose first term is X and whose n th ($n > 1$) term is the set whose elements are the elements of the $(n - 1)$ th term plus a new element which is the set whose unique element is the $(n - 1)$ th term:

$$S_1(X) = X \quad (15)$$

$$S_2(X) = \{X, \{X\}\} \quad (16)$$

$$S_3(X) = \{X, \{X\}, \{X, \{X\}\}\} \quad (17)$$

$$S_4(X) = \{X, \{X\}, \{X, \{X\}\}, \{X, \{X\}, \{X, \{X\}\}\}\} \quad (18)$$

...

If X is the empty set, the above sequence is the well-known sequence used to define the successive finite cardinals and ordinals (see Chapter 4).

P119 Let X be any non empty set; Y any of its subsets; and D_Y the set of all sets absolutely disjoint with the set Y . If Y is the empty set, then D_Y would be the universal set, which is

inconsistent according to (2)-(3). In any other case, it is immediate to prove that D_Y is infinite. In fact, let n be any natural, and then finite, number and assume the cardinal $|D_Y|$ of D_Y satisfies $|D_Y| = n$. Let A be any element of D_Y . Since A is absolutely disjoint with Y , the successor sets $S_1(A), S_2(A) \dots, S_{n+1}(A)$ of the set A are also absolutely disjoint with Y , and they are elements of D_Y . Therefore, the cardinal $|D_Y|$ is greater than any natural number n . In consequence D_Y cannot be finite but infinite.

P120 Consider now the set $P(D_Y)$ of all subsets of D_Y , i.e. the power set of D_Y . The elements of $P(D_Y)$ are all of them subsets of D_Y and therefore sets of sets that are absolutely disjoint with the set Y . Consequently, it holds:

$$\forall A \in P(D_Y) : A \in D_Y \quad (19)$$

And then:

$$P(D_Y) \subseteq D_Y \quad (20)$$

Accordingly, we can write:

$$|P(D_Y)| \leq |D_Y| \quad (21)$$

P121 On the other hand, and in accordance with Cantor's Theorem of the Power Set it holds:

$$|P(D_Y)| > |D_Y| \quad (22)$$

Again a contradiction. But now X is any non empty set, and Y any of its subsets. Therefore, and taking into account that every set of cardinal C has 2^C different subsets, we have proved the following:

Theorem P121, of Cantor Paradox. *In Cantor's set theory, every set whose cardinal is C gives rise to at least 2^C inconsistent infinite sets.*

Each of the sets of that uncountable infinitude of inconsistent infinite sets could only be an absolute and divine infinity, according to Cantor. Or simply a proof of the inconsistency of a concept, the

concept of the actual infinity.

P122 The above argument not only proves the number of inconsistent infinite totalities is infinitely greater than the number of consistent ones, it also suggests the excessive size of the sets could not be the cause of the inconsistency. Consider, for example, the set X of all sets whose elements are exclusively defined by means of the natural number 1:

$$X = \{1, \{1\}, \{1, \{1\}, \{1, \{1\}\}\}, \{\{\{1\}\}\}, \{\{1, \{1\}\}\} \dots \} \quad (23)$$

An argument similar to P119-P121 would immediately prove it is an inconsistent infinite totality, although compared with the universal set (which contains X as a tiny part of its elements) it is an insignificant totality. As a comparative reference, let us remember that, for example, between any two real numbers an uncountable infinitude (2^{\aleph_0}) of other different real numbers do exist. What makes one feel dizzy, as Wittgenstein would surely say [244, p. 110]

P123 Notice that the sets as the set X defined by (23) are inconsistent only when considered from the perspective of the actual infinity, i.e. when considered as *complete* totalities. And recall that from the potential infinite point of view those sets make no sense because from this perspective the only *complete* totalities are the finite totalities, as large as wished but always finite.

P124 Had we known the existence of so many inconsistent infinite sets, and not necessarily as gigantic as the absolute infinity, and perhaps Cantor transfinite set theory would have been received in a different way. Perhaps the very notion of the actual infinity would have been put into question just in set theoretical terms; and perhaps we would have found the way to prove it is an inconsistent notion. But, as we know, this was not the case. The case was the platonic infinitism, increasingly intolerant of disagreement.

P125 The history of the reception of set theory and the way to

deal with its inconsistencies (most of them promoted by the actual infinity hypothesis and by self-reference) is well known. From the beginnings of the XX century a great deal of effort has been carried out to found set theory on a formal basis free of inconsistencies. Although the objective could only be accomplished with the aid of the appropriate axiomatic patching. At least half a dozen of axiomatic set theories have been developed ever since. There are also some contemporary attempts to recover naive set theory [124]. Some hundreds of pages are needed to explain in detail all axiomatic restrictions of contemporary axiomatic set theories. Just the contrary one could expect from the axiomatic foundation of a formal science as set theory.

P126 As noted above, the simplest explanation of Cantor and Burali-Forti inconsistencies is that they are true contradictions derived from the inconsistency of the hypothesis of the actual infinity. The same applies to the set of all sets that are not member of themselves (Russell Paradox). All sets involved in the paradoxes of naive set theory were finally removed from the theory by the opportune axiomatic restrictions. No one dared to suggest the possibility that some of those paradoxes were in fact contradictions derived from the hypothesis of the actual infinity; i.e. from assuming the existence of infinite sets as complete totalities.

P127 What is really true is that Cantor set of *all* cardinals, Burali-Forti set of *all* ordinals, the set of *all* sets, and Russell set of *all* sets that are not members of themselves, are all of them inconsistent totalities when considered from the perspective of the actual infinity hypothesis. Even Turing's famous halting problem is related to the hypothesis of the actual infinity because it also assumes the existence of all pairs programs-inputs as a complete infinite totality [231]. Under the hypothesis of the potential infinity, on the other hand, none of those totalities makes sense because from this perspective only finite totalities can be considered, indefinitely extensible, but always finite.

P128 As indicated above, Cantor Paradox and Burali-Forti Pa-

radox are not paradoxes but inconsistencies, i.e. two couples of contradictory results:

$$\text{Cantor Paradox} \begin{cases} |U| \geq |P(U)| \\ |U| < |P(U)| \end{cases} \quad (24)$$

$$\text{Burali-Forti Paradox} \begin{cases} \Omega + 1 \leq \Omega \\ \Omega + 1 > \Omega \end{cases} \quad (25)$$

Recall that we are discussing within the framework of Cantor's naive set theory, where axiomatic restrictions had not yet been established. In those conditions, the contradictory terms of (24) and (25) can only derive from some previous inconsistent assumption. And the only assumption to get (24) and (25) is the hypothesis of the actual infinity, implicitly assumed by Cantor when he established the existence of the set of all finite cardinals [47, pgs. 103-104] (*italic is mine*):

The first example of a transfinite aggregate is given by the *totality* of finite cardinal numbers v ; we call its cardinal number Aleph-zero and denote it by \aleph_0 [...]

His theoplatonic convictions “as firm as a rock” [78, p.283] prevented him from considering the possibility that his statement about the totality finite cardinals could only be a hypothesis. And much less the possibility that this hypothesis were the cause of the contradiction derived from the set of all cardinals, or from the set of all sets, found by himself.

P129 What is extraordinary about this case is that for more than a century no one has questioned Cantor's claim of the existence of “the totality of the finite cardinal numbers.” No one has seriously considered that Cantor's or Burali-Forti's inconsistencies were consequences of that initial Cantor statement. Instead, it was converted in one of the fundamental axioms of set theory. But if that axiom is finally proved to be inconsistent, it will have set back the progress of humanity for more than a century. Convictions as

firm as a rock could be valid for religions, not for science. Science is the place for hypotheses, errors and corrections, not for dogmas.

P130 In any case (24) and (25) are not paradoxes but true inconsistencies. And tracing their origins, we come to the only hypothesis that supports them: the hypothesis of the actual infinity. But instead of considering the possible inconsistency of that hypothesis, Cantor's successors chose another path: to set the foundation of set theory in such a way that it were possible to avoid all conflicting sets as U , while subsuming the hypothesis the actual infinity into the Axiom of Infinity. By the way, an axiom not sufficiently transparent with respect to that hypothesis. Certainly, it would have been more transparent to explicitly declare the infinity involved in the axiom is the actual infinity, so that the infinite sets exist as complete totalities. Maybe an explicit reference to the completion of incompletable could have motivated the criticism of the actual infinity: completing what cannot be completed does not seem very reasonable. Or maybe human reason is not reasonable enough: The idea that the exotic and incomprehensible adds value to scientific theories has been gaining ground since the last century. Consideration should be given to the possibility that such eccentricities were symptoms of a bad foundation of some areas of science.

7 A RATIONAL INCONSISTENCY

INTRODUCTION

P131 The set \mathbb{Q} of the rational numbers, in their natural order of precedence, is densely ordered: between any two rational numbers infinitely many different rational numbers do exist. But, being denumerable [47, p. 123] [37], \mathbb{Q} can also be reordered by a one to one correspondence with the set \mathbb{N} of the natural numbers, so that between any two successive rational numbers no other rational number does exist. The following argument makes use of this double quality of the rational numbers, and proves for the first time in the book the inconsistency of the actual infinity. Several dozen more proofs will follow.

DISCUSSION

P132 For the sake of simplicity, we will deal with the set \mathbb{Q}^+

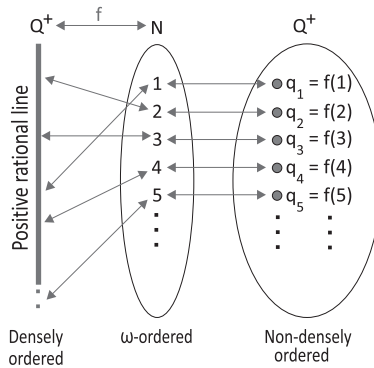

Figure 7.1 – Reordering the positive rational line.

of the positive rational numbers greater than zero, which is also denumerable and densely ordered. Let then f be a one to one correspondence between the set \mathbb{N} of the natural numbers and \mathbb{Q}^+ .

It is evident that f makes it possible to reorder the elements of \mathbb{Q}^+ so that they can be written as $\{q_1, q_2, q_3, \dots\}$, being $q_i = f(i)$, $\forall i \in \mathbb{N}$ (Theorem P80a), which allows to consider successively and one by one, all of them (Figure 7.1).

P133 Let x be a rational variable whose domain is the rational interval $(0, 1)$ and let x_o be any rational number within $(0, 1)$. Consider the following sequence $\langle D_i(x) \rangle$ of recursive definitions of the rational variable x :

$$\begin{cases} D_1(x) = x_o \\ D_i(x) = \min(D_{i-1}(x), |q_i - q_1|), \quad i = 2, 3, 4, \dots \end{cases} \quad (1)$$

where $D_i(x)$ is the i th definition of x ; $|q_i - q_1|$ is the absolute value of $q_i - q_1$; and $\min(D_{i-1}(x), |q_i - q_1|)$ is the smallest (in the natural dense ordering of \mathbb{Q}) of the two values in brackets. So, the successive recursive definitions $\langle D_i(x) \rangle$ define x as $|q_i - q_1|$ if, and only if, $|q_i - q_1|$ is less than $D_{i-1}(x)$; or as $D_{i-1}(x)$ if it is not.

P134 Definitions, procedures and proofs consisting of infinitely many successive steps, as definition (1), are usual in infinitist mathematics (see, for instance, Cantor 1874 argument, or Cantor ternary set, later in this book). Unnecessary as it may seem, we will impose to the successive definitions $\langle D_i(x) \rangle$ the following:

Restriction 134-*Each successive definition $D_i(x)$ will be carried out if, and only if, x results defined as a positive rational number within its domain $(0, 1)$.*

P135 By induction, it is immediate to prove that for each natural number v , the first v successive definitions $\langle D_i(x) \rangle_{i=1,2,\dots,v}$ according to Restriction P134, can be carried out. Evidently $D_1(x)$ can be carried out according to Restriction P134 since $D_1(x) = x_o$, and $x_o \in (0, 1)$. Assume that, being n any natural number, the first n successive definitions $\langle D_i(x) \rangle_{i=1,2,\dots,n}$ can be carried out according to Restriction P134, which means x is defined with a certain value $D_n(x)$ within its domain $(0, 1)$. Since $|q_{n+1} - q_1|$ is a well defined

positive rational number it will be, or not, less than $D_n(x)$. Consequently $D_{n+1}(x)$ defines x as $|q_{n+1} - q_1|$ if this number is less than $D_n(x)$ or as $D_n(x)$ if it is not. In any case $D_{n+1}(x)$ defines x within its domain $(0, 1)$. Therefore, the first $(n + 1)$ successive definitions $\langle D_i(x) \rangle_{i=1,2,\dots,n+1}$ according to Restriction P134 can be carried out. Hence, and according to the Principle of Mathematical Induction, for any natural number v , the first v successive definitions $\langle D_i(x) \rangle_{i=1,2,\dots,v}$ can be carried out according to Restriction P134.

P136 Note that if it were not possible to carry out all possible definitions $\langle D_i(x) \rangle$ in accordance with the Restriction P134, and there being no reason for such an impossibility, we would be faced with the elementary contradiction of an impossible possibility (Principle of Execution P25). The same impossibility would have to apply to any other finite or infinite sequence of possible steps of any other definition, procedure or proof. In such conditions, infinite mathematics would be impossible.

P137 We will begin by proving that once performed all the successive definitions $\langle D_i(x) \rangle$ according to Restriction P134, the rational number $q_1 + x$ is not the smallest rational greater than q_1 . Indeed, whatsoever be the value of x once performed all possible successive definitions $\langle D_i(x) \rangle$ (Principle of Execution P25), the rational number $q_1 + 0,1 \times x$, for instance, is greater than q_1 and less than $q_1 + x$. Notice this argument is a consequence of the natural dense ordering of \mathbb{Q}^+ .

P138 We will prove now, however, that once performed all successive definitions $\langle D_i(x) \rangle$ according to Restriction P134, the rational number $q_1 + x$ is the smallest rational number greater than q_1 . In effect, assume that once performed all successive definitions $\langle D_i(x) \rangle$ according to Restriction P134, the rational number $q_1 + x$ is not the smallest rational greater than q_1 . In such a case there would be a positive rational q_v greater than q_1 and less than $q_1 + x$:

$$q_1 < q_v < q_1 + x \tag{2}$$

and then, by subtracting q_1 to the three members (all of them proper rational numbers) of the above two inequalities, we will have:

$$0 < q_v - q_1 < x \quad (3)$$

which is impossible because:

- a) The index v of q_v is a natural number.
- b) In accordance with P135, it is possible to perform the first v successive definitions $\langle D_i(x) \rangle_{i=1,2,\dots,v}$ according to Restriction P134.
- c) All possible successive definitions $\langle D_i(x) \rangle$ according to Restriction P134 have been carried out (Principle of Execution).
- d) So, at least the first v successive definitions $\langle D_i(x) \rangle_{i=1,2,\dots,v}$ according to Restriction P134 have been carried out.
- e) As a consequence of $D_v(x)$, we can assert that $x \leq q_v - q_1$.
- f) It is then impossible that $x > q_v - q_1$.

In consequence our initial hypothesis must be false and $q_1 + x$ is the smallest rational number greater than q_1 . Notice this amazing conclusion is a legitimate consequence of the reordering of \mathbb{Q}^+ induced by the one to one correspondence f defined in P132. Indeed, it is that correspondence and the hypothesis of the actual infinity what makes it possible to consider in a successive way, and one by one, *all* rational numbers q_i in \mathbb{Q}^+ and then to calculate, one by one, *all* $|q_i - q_1|$.

P139 Once completed the sequence of all definitions $\langle D_i(x) \rangle$ according to Restriction P134, the defined variable x could have been defined an infinite number of times, each with a different value and without a last definition. For this reason it will be impossible to know the current value of x once completed the sequence of definitions $\langle D_i(x) \rangle$ according to Restriction P134. But, in any case, x will continue to be a rational variable properly defined within its domain $(0, 1)$ (Principle of Invariance P19). Thus, indeterminable as its current value may be, x will continue to be a rational va-

riable properly defined within its domain $(0, 1)$. And this is all we need in order to make the above argument conclusive.

P140 Otherwise, if after completing the sequence of definitions $\langle D_i(x) \rangle$ according to Restriction P134, the rational variable x had lost its condition of being a rational variable defined in its domain $(0, 1)$, we would have to admit that the completion of an infinite sequence of successive definitions, as such a completion, has additional and arbitrary effects on the defined object, which goes against the Principle of Invariance P19. But if that were the case, the same *additional arbitrary effects* could be expected from any other definition, procedure or proof consisting of an infinite sequence of successive steps, and then anything could be expected from infinitist mathematics.

P141 We could even timetable the sequence of definitions $\langle D_i(x) \rangle$ by performing each definition $D_i(x)$ at the precise instant t_i of the ω -ordered and strictly increasing sequence of instants $\langle t_n \rangle = t_1, t_2, t_3, \dots$ within the finite interval (t_a, t_b) , whose limit is t_b . In these conditions, x could only lose its condition of rational variable defined within its domain $(0, 1)$ at the precise instant t_b , the first instant *after* having completed the sequence of definitions $\langle D_i(x) \rangle$. In fact, being t_b the limit of $\langle t_n \rangle$ we will have:

$$\forall t \in (t_a, t_b) : \exists v : t_v \leq t < t_{v+1} \quad (4)$$

and then, at every instant t within (t_a, t_b) , x is a well defined rational variable within its rational domain $(0, 1)$.

P142 Therefore, if T is the set of all instants within the interval $(t_a, t_b]$ at which x is a rational variable defined within its domain $(0, 1)$, the complement \bar{T} of T in $(t_a, t_b]$ is just t_b . In consequence only at the precise instant t_b , the first instant *after* having completed the sequence of definitions $\langle D_i(x) \rangle$, could x lose its condition of being a rational variable properly defined within its domain $(0, 1)$.

P143 Thus, we would have to admit not only that the completion, as such a completion, of a sequence of infinitely many successive

definitions, all of them possible, has additional and arbitrary effects on the defined object, but also that those arbitrary effects unexpectedly appear after completing the sequence of definitions. And the same would apply to any other definition, procedure or proof composed of infinitely many successive steps.

P144 We can, therefore, conclude that once performed all definitions $\langle D_i(x) \rangle$ according to Restriction P134, the rational variable x is a rational variable defined within its rational domain $(0, 1)$, whatever its value. And the rational number $q_1 + x$ is, and is not, the least rational number greater than q_1 .

INTRODUCTION

P145 In accordance with the hypothesis of the actual infinity, the infinite sets, including densely ordered sets, exist as complete totalities. A little-discussed consequence of this hypothesis is that a denumerable and densely ordered set can be disordered but cannot be reordered. This chapter discusses the disordering and ordering of denumerable sets, either ω -ordered or densely ordered. The basis of the discussion will be a well-known computer method commonly used for sorting unsorted lists: the bubble method described in the next section. Although the method works with any finite list of any type of numbers either natural, or rational, or irrational, if the list is infinite and denumerable it only works with the natural numbers, not with densely ordered sets as the set of the rational numbers. So that an interval of rational numbers can be disordered but cannot be reordered. These kinds of extravagances are assumed, and even enjoyed, in the infinitist paradise. Although, as will be seen in this chapter, and has already been seen in the previous one, some of those extravagances are inconsistencies derived from the hypothesis of the actual infinity.

THE BUBBLE METHOD

P146 A classic method used in computer science to sort the objects of unordered lists is the bubble method. Its logical basis could not be simpler: each item of the unordered list is compared with the successive items of the list, and it is exchanged with the first of those items that must precede the compared item in the order of the ordered list. The procedure is repeated until exchanges are no

longer necessary. In a symbolic programming language (so symbolic that it's practically English), the algorithm for ordering a list of n disordered elements is written:

```

Switch = true
While Switch
  Switch = False
  For n =1 To List.Length-1
    If List (n) > List (n+1) Then
      temp = List(n)
      List(n) = List (n+1)
      List(n+1) = temp
      Switch = True
    End If
  Next n
End While

```

P147 The bubble method works with any finite list of numbers of any type (or with any list of non-numerical objects whenever they can be ordered according to some criteria), for example with lists of numbers that are disordered with respect to their increasing numerical values. It also works with any infinite and disordered list of natural numbers, although now we should abandon the field of computer science and make use of supertask theory (see Chapter 23).

P148 In effect, let $List(i)$ be a disordered list of natural numbers that includes all natural numbers. To order the list we would have to execute each of the comparisons of the above bubble method in each of the instants of an ω -ordered sequence of instants $\langle t_i \rangle$ in the real interval (t_a, t_b) whose limit is t_b , and repeat the supertask (bubble supertask hereafter) until there are no unordered numbers left (Principle of Execution P25).

P149 Let now f be a one to one correspondence between the ω -ordered set \mathbb{N} of the natural numbers, and the rational interval

$(0, 1)$. The rational numbers in $(0, 1)$ are densely ordered: between any two of them there are infinitely many different rationals. But the bijection f disorders them (from the point of view of their corresponding numerical value) in the sequence $\langle q_i \rangle = q_1, q_2, q_3 \dots$ in which each $f(i) = q_i, \forall i \in \mathbb{N}$ (Theorem P80a). The advantage of this unordered list is that it makes it possible to consider one by one all rational numbers within $(0, 1)$.

P150 The unordered list (in relation to their corresponding numerical values) of rational numbers $\langle q_i \rangle$ has the same number of elements, \aleph_o , as the unordered list of natural numbers $\text{List}(i)$ considered in P148. As in the case of the $\text{List}(i)$, each element of $\langle q_i \rangle$ has a different numeric value, and the different numeric values of each couple of its elements can be compared and swapped according to the bubble method, exactly the same as in the previous case of the natural numbers. Therefore the bubble supertask can be apply to $\langle q_i \rangle$ any finite or infinite number of times.

P151 But while the unordered list of natural numbers $\text{List}(i)$ can be reordered by performing the bubble supertask a finite or infinite number of times, the unordered list of rational numbers $\langle q_i \rangle$ cannot be reordered, no matter the infinite number of times the bubble supertask is applied to its elements. Not only can it not be reordered, but its disorder does not diminish no matter how many times the bubble super task is applied to its elements: between any two of its successive elements q_i, q_{i+1} there are infinite elements that should be between q_i and q_{i+1} , but are not between q_i and q_{i+1} . They will be anywhere else in the list. As in the worst nightmares, no matter how much you try to run, it is not possible to advance in the ordering of the disordered list $\langle q_i \rangle$.

P152 The above impossibility of reordering the list $\langle q_i \rangle$ of rational numbers is a tribute to be paid for assuming that densely ordered sets exist as complete totalities. To some, the inhabitants of the infinitist paradise, it may be an acceptable tribute. For others it is not. And the discrepancy should at least deserve the respect of being considered a discrepancy, which is not currently the case.

The next section proves the discrepancy is quite justified.

DOUBLE BUBBLE SUPERTASK

P153 Consider again the one to one correspondence f between \mathbb{N} and the rational interval $(0, 1)$ which makes it possible, in turn, to consider one by one the elements of that interval:

$$\langle f(i) \rangle = \langle q_i \rangle = q_1, q_2, q_3 \dots \quad (1)$$

Choose at random two elements of $\langle q_i \rangle$. Call x the smallest and b the greatest; consider the rational interval (x, b) , and the following supertask $\langle a_i \rangle$:

At each instant t_i of the sequence $\langle t_i \rangle$ of instants of the real interval (t_a, t_b) whose limit is t_b , execute the task a_i which consist of comparing x with the element q_i of $\langle q_i \rangle$, and make x equal to q_i if, and only if, $q_i \in (x, b)$; i.e. if, and only if, $x < q_i < b$.

P154 Being t_b the limit of $\langle t_i \rangle$, at the instant t_b all actions a_i of the supertask $\langle a_i \rangle$ will have been carried out. Therefore, at the instant t_b the rational number x will have been compared with all the rational numbers in the sequence $\langle q_i \rangle$. With all. And it will have been successively replaced by all those rational numbers that verify the given condition (Principle of Execution P25).

P155 Note that in this supertask it is not even necessary to put conditions on the successive tasks $\langle a_i \rangle$ that must be carried out in the successive instants $\langle t_i \rangle$. The only necessary condition is to have an ω -ordered list of all rational numbers within the rational interval $(0, 1)$, the list $\langle f(i) \rangle$ defined by the bijection f in (1), so that x can be compared, one by one, with the successive elements of that list, and replaced with the compared element each time the compared element is within the rational interval (x, b) .

P156 In P154 it has been proved that at the instant t_b the rational number x has been compared with all the rational numbers $\langle q_i \rangle$ and, in its case, replaced by those q_i that verified $x < q_i < b$.

However, it is also immediate to prove that at the instant t_b the rational x has not been compared with all rationals of $\langle q_i \rangle$. Indeed, at t_b the rational number x will continue to be a rational number, whatever its value (Principle of Invariance P19). And there will still be an infinite number of rationals between x and b , that is, rationals greater than x and less than b . If q_v is one of them, it is clear that x has not been compared with q_v , because in such a case it would have been defined as q_v , which is not the case. So, at the instant t_b the rational x has been and has not been compared with all elements of $\langle q_i \rangle$. And this is a contradiction.

INTRODUCTION

P157 In 1874, 17 years before the publication of his famous diagonal argument, Cantor proved for the first time the set of the real numbers cannot be denumerable. That early Cantor's proof is one of the objectives of this chapter. The other is the analysis of the conditions under which that proof could also be applied to the set of the rational numbers. It will necessary, therefore, to prove such conditions can never be satisfied in order to ensure the impossibility of a contradiction on the cardinality of the set of the rational numbers, which was proved to be numerable by Cantor himself in the same publication [37]. A conflicting rational variant of Cantor's argument is also discussed at the end of the chapter.

CANTOR'S 1874-ARGUMENT

P158 This section explains in detail the first Cantor's proof of the uncountable nature of the set \mathbb{R} of the real numbers, published in the year 1874 in a short paper [37] that also included a proof of the denumerable nature of the set \mathbb{A} of the algebraic numbers and then of the set of the rational numbers \mathbb{Q} , a subset of \mathbb{A} (English edition [36], French edition [41], Spanish edition [50]).

P159 Assume the set \mathbb{R} is denumerable. In such a case, there would be at least one bijection between the ω -ordered set \mathbb{N} of the natural numbers and \mathbb{R} . Let f be any of such bijections. The elements of \mathbb{R} would be reordered by f in the sequence $\langle r_i \rangle$ (Theorem P80a):

$$\langle r_i \rangle = r_1, r_2, r_3, \dots \tag{1}$$

being $r_i = f(i), \forall i \in \mathbb{N}$. Obviously, the sequence $\langle r_i \rangle$ defined by

f would contain all real numbers if \mathbb{R} were actually denumerable, and it would be possible to consider all of them successively and one by one. This *one by one* consideration is the basis of Cantor's proof.

P160 Consider now any real interval (a, b) . Cantor's 1874 argument consists in proving the existence of a real number s in (a, b) which is not in the sequence $\langle r_i \rangle$. The existence of s would prove that $\langle r_i \rangle$ does not contain all real numbers. Therefore, the one to one correspondence f , whatsoever it be, would be impossible. And the initial assumption on the denumerable nature of \mathbb{R} would be false. The proof goes as follows.

P161 Starting from r_1 , find the *first two* elements of $\langle r_i \rangle$ within (a, b) . Denote the smaller of them by a_1 and the greater by b_1 . Define the real interval (a_1, b_1) (see Figure 9.1). Starting from r_1 ,

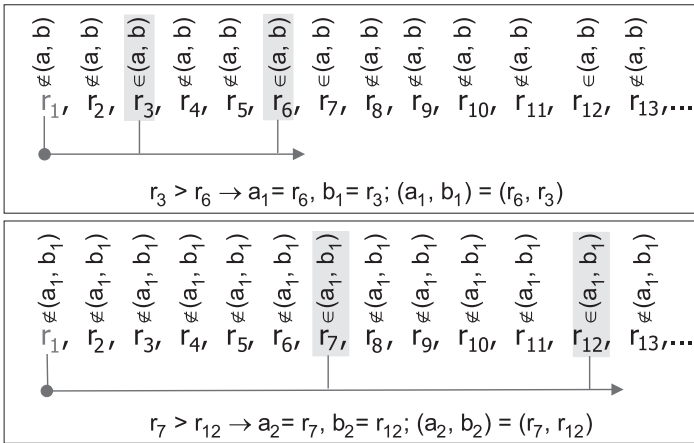

Figure 9.1 – Definition of the first two intervals (a_1, b_1) , (a_2, b_2) .

find the *first two* elements of $\langle r_i \rangle$ within (a_1, b_1) . Denote the smaller of them by a_2 and the greater by b_2 . Define the real interval (a_2, b_2) . Evidently it holds:

$$(a_1, b_1) \supset (a_2, b_2) \tag{2}$$

Starting from r_1 , find the *first two* elements of $\langle r_i \rangle$ within (a_2, b_2) .

Denote the smaller of them by a_3 and the greater by b_3 . Define the real interval (a_3, b_3) . Evidently it holds:

$$(a_1, b_1) \supset (a_2, b_2) \supset (a_3, b_3) \quad (3)$$

The continuation of the above Procedure P161 defines a sequence of real nested intervals (R-intervals):

$$(a_1, b_1) \supset (a_2, b_2) \supset (a_3, b_3) \supset \dots \quad (4)$$

whose left endpoints a_1, a_2, a_3, \dots form a strictly increasing sequence of real numbers, and whose right endpoints b_1, b_2, b_3, \dots form a strictly decreasing sequence also of real numbers, being every element of the first sequence smaller than every element of the second one.

P162 It is important to highlight the fact that an element r_n of $\langle r_i \rangle$ cannot belong to the successive nested real intervals $(a_n, b_n) \supset (a_{n+1}, b_{n+1}) \supset (a_{n+2}, b_{n+2}) \supset \dots$. Indeed, the first time the Procedure P161 considers r_n , a maximum of $n/2$ of those intervals will have been defined. Therefore either r_n is used to define an endpoint of a new real interval $(a_{i < n}, b_{i < n})$, or it does not belong to the last defined interval. In consequence, r_n cannot belong to the successive nested real intervals $(a_n, b_n) \supset (a_{n+1}, b_{n+1}) \supset (a_{n+2}, b_{n+2}) \supset \dots$.

P163 The number of R-intervals will be finite or infinite, and both possibilities have to be considered. Assume in the first place the number of R-intervals is a finite natural number n . In this case, there will be a last R-interval (a_n, b_n) in the sequence of R-intervals, because the successive R-intervals have been indexed by the successive finite natural numbers. This last R-interval will contain, at most, one element r_v of $\langle r_i \rangle$, otherwise it would be possible to define at least a new R-interval (a_{n+1}, b_{n+1}) . Let, therefore, s be any element within (a_n, b_n) , different from r_v , if r_v does exist. Evidently s is a real number within (a, b) which does not belong to the sequence $\langle r_i \rangle$. Consequently, the sequence $\langle r_i \rangle$ does not contain all

real numbers, and the one to one correspondence f is impossible.

P164 Consider now the number of R-intervals is infinite (note this case implies the completion of a procedure of infinitely many successive steps). The sequence $\langle a_i \rangle$ is strictly increasing and upper bounded by any b_i , therefore the limit L_a of $\langle a_i \rangle$ exists. On its part, the sequence $\langle b_i \rangle$ is strictly decreasing and lower bounded by any a_i , in consequence the limit L_b of this sequence also exists. Taking into account that every a_i is less than every b_i it must hold: $L_a \leq L_b$ (Figure 9.2).

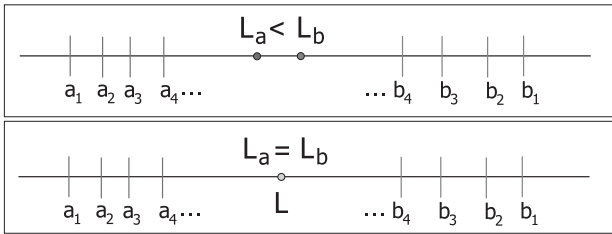

Figure 9.2 – Convergence of $\langle a_i \rangle$ and $\langle b_i \rangle$.

P165 Assume that $L_a < L_b$. In this case, any of the infinitely many elements within the real interval (L_a, L_b) is a real number s within (a, b) which does not belong to the sequence $\langle r_i \rangle$ because, according to P162, if it were an element r_v of $\langle r_i \rangle$ it could not belong to the successive $(a_v, b_v) \supset (a_{v+1}, b_{v+1}) \supset (a_{v+2}, b_{v+2}) \supset \dots$, while s belongs to all of them. Therefore, the one to one correspondence f is impossible.

P166 Finally, assume that $L_a = L_b = L$. It is immediate to prove that L is a real number within (a, b) which is not in $\langle r_i \rangle$. Indeed, assume that L is an element r_v of $\langle r_i \rangle$. According to P162, r_v does not belong to the successive R-intervals $(a_v, b_v) \supset (a_{v+1}, b_{v+1}) \supset (a_{v+2}, b_{v+2}) \supset \dots$, while L belongs to all of them. Therefore, L cannot be r_v . The limit L is a real number in (a, b) which is not in $\langle r_i \rangle$. So, the bijection f is impossible.

P167 According to P159-P166, and being f any supposed bijection between \mathbb{N} and \mathbb{R} , it must be concluded that a bijection (one

to one correspondence) between the set \mathbb{N} of the natural numbers and the set \mathbb{R} of real numbers is impossible. Therefore, \mathbb{R} is not denumerable.

RATIONAL VERSION OF CANTOR'S 1874-ARGUMENT

P168 The argument that follows is identical to the previous one, except in that it applies to the set \mathbb{Q} of the rational numbers.

P169 Assume the set \mathbb{Q} of the rational numbers is denumerable. In such a case, there would be at least one bijection between the ω -ordered set \mathbb{N} of the natural numbers and \mathbb{Q} . Let f be any of such bijections. The elements of \mathbb{Q} would be reordered by f in the sequence $\langle q_i \rangle$:

$$\langle q_i \rangle = q_1, q_2, q_3, \dots \quad (5)$$

being $q_i = f(i), \forall i \in \mathbb{N}$ (Theorem P80a). Obviously, the sequence $\langle q_i \rangle$ defined by f would contain all rational numbers if \mathbb{Q} were actually denumerable, and it would be possible to consider all of them successively and one by one

P170 Consider any real interval (a, b) . Starting from q_1 , find the *first two* elements of $\langle q_i \rangle$ within (a, b) . Denote the smaller of them by a_1 and the greater by b_1 . Define the real interval (a_1, b_1) . Starting from q_1 , find the *first two* elements of $\langle q_i \rangle$ within (a_1, b_1) . Denote the smaller of them by a_2 and the greater by b_2 . Define the real interval (a_2, b_2) . Evidently it holds:

$$(a_1, b_1) \supset (a_2, b_2) \quad (6)$$

Starting from q_1 , find the *first two* elements of $\langle q_i \rangle$ within (a_2, b_2) . Denote the smaller of them by a_3 and the greater by b_3 . Define the real interval (a_3, b_3) . Evidently it holds:

$$(a_1, b_1) \supset (a_2, b_2) \supset (a_3, b_3). \quad (7)$$

P171 The continuation of the above Procedure P170 defines a sequence of real nested intervals (R'-intervals):

$$(a_1, b_1) \supset (a_2, b_2) \supset (a_3, b_3) \supset \dots \quad (8)$$

whose left endpoints a_1, a_2, a_3, \dots form a strictly increasing sequence of rational numbers, and whose right endpoints b_1, b_2, b_3, \dots form a strictly decreasing sequence of rational numbers, being every element of the first sequence smaller than every element of the second one.

P172 It is important to highlight the fact that an element q_n of $\langle q_i \rangle$ cannot belong to the successive nested real intervals $(a_n, b_n) \supset (a_{n+1}, b_{n+1}) \supset (a_{n+2}, b_{n+2}) \supset \dots$. Indeed, the first time the Procedure P170 considers q_n , a maximum of $n/2$ of those intervals will have been defined. Therefore either q_n is used to define an endpoint of a new real interval $(a_{i < n}, b_{i < n})$, or it does not belong to the last defined interval. In consequence, q_n cannot belong to the successive nested real intervals $(a_n, b_n) \supset (a_{n+1}, b_{n+1}) \supset (a_{n+2}, b_{n+2}) \supset \dots$.

P173 The number of R' -intervals will be finite or infinite, and both possibilities have to be considered. Assume in the first place that the number of R' -intervals is a finite natural number n . In this case, there will be a last R' -interval (a_n, b_n) in the sequence of R' -intervals, because the successive R' -intervals have been indexed by the successive finite natural numbers. This last R' -interval will contain, at best, one element q_v of $\langle q_i \rangle$, otherwise it would be possible to define at least one new R -interval (a_{n+1}, b_{n+1}) . Let, therefore, s be any rational number within (a_n, b_n) , different from q_v , if q_v does exist. Evidently s is a rational number within (a, b) which does not belong to the sequence $\langle q_i \rangle$. Consequently, the sequence $\langle q_i \rangle$ does not contain all rational numbers, and the one to one correspondence f is impossible.

P174 Consider now the number of R' -intervals is infinite (note this case implies the completion of a procedure of infinitely many successive steps). The sequence $\langle a_i \rangle$ is strictly increasing and upper bounded by any b_i , therefore the *real* limit L_a of $\langle a_i \rangle$ does exist. On its part, the sequence $\langle b_i \rangle$ is strictly decreasing and lower bounded by any a_i , in consequence the *real* limit L_b of this sequence also exists. Taking into account that every a_i is less than every b_i it must hold: $L_a \leq L_b$, being L_a and L_b two real (rational or irrational)

numbers.

P175 Assume that $L_a < L_b$. In this case, any of the infinitely many rationals within the real interval (L_a, L_b) is a rational number s within (a, b) which does not belong to the sequence $\langle q_i \rangle$, because according to P172, if it were an element q_v of $\langle q_i \rangle$ it could not belong to the successive \mathbb{R} '-intervals $(a_v, b_v) \supset (a_{v+1}, b_{v+1}) \supset (a_{v+2}, b_{v+2}) \supset \dots$, while s belongs to all of them. Therefore $\langle q_i \rangle$ does not contain all rational numbers, and the one to one correspondence f is impossible.

P176 Finally, assume that $L_a = L_b = L$. It is immediate that L is a *real* number within the *real interval* (a, b) which is not in $\langle q_i \rangle$. In fact, if L is irrational then it is clear that it is not in $\langle q_i \rangle$; assume then L is rational, and assume also it is an element q_v of $\langle q_i \rangle$. According to P172, q_v does not belong to the successive \mathbb{R} '-intervals $(a_v, b_v) \supset (a_{v+1}, b_{v+1}) \supset (a_{v+2}, b_{v+2}) \supset \dots$, while L belongs to all of them. Therefore, L cannot be q_v . The limit L is a real number (rational or irrational) in the real interval (a, b) which is not in $\langle q_i \rangle$. Thus, if L were rational then $\langle q_i \rangle$ would not contain all rational numbers, and the one to one correspondence f would be impossible.

P177 We have just proved that, as in Cantor's 1874 argument, the bijection f , which is any assumed bijection between the sets \mathbb{N} and \mathbb{Q} , is impossible in all cases, except that the sequences $\langle a_i \rangle$ and $\langle b_i \rangle$ have a common irrational limit. Thus, except in that case, and for the same reasons as in Cantor's 1874 argument, we would have proved the set \mathbb{Q} of the rational numbers is non-denumerable.

P178 Evidently, If Cantor's 1874-argument could be extended to the rational numbers we would have a contradiction: the set \mathbb{Q} would and would not be denumerable. In consequence, and in order to ensure the impossibility of that contradiction, it must be proved that whatsoever be the rational interval (a, b) and the reordering of $\langle q_i \rangle$, the number of \mathbb{R} '-intervals can never be finite and the sequences of endpoints $\langle a_i \rangle$ and $\langle b_i \rangle$ have always a common *irrational* limit. Until then, the consistency of transfinite set theory will be at

stake. However, 146 years after the publication of Cantor's article, the problem has not even been raised. The following chapter deals with that problem.

A VARIANT OF CANTOR'S 1874 ARGUMENT

P179 The argument that follows is a variant of the above Cantor's first proof of the uncountable nature of the set of the real numbers, though applied to the set of the rational numbers \mathbb{Q} .

P180 Since, according to Cantor, the set \mathbb{Q} of the rational numbers is denumerable we can consider a one to one correspondence f between the ω -ordered set \mathbb{N} of the natural numbers and \mathbb{Q} . Let $\langle q_i \rangle$ be the reordered sequence (Theorem P80a) of rational numbers defined by:

$$f(i) = q_i, \quad \forall i \in \mathbb{N} \quad (9)$$

Obviously $\langle q_i \rangle$ contains all rational numbers, so that it is possible to consider all of them successively and one by one

P181 Let x be a rational variable whose domain is any rational interval (a, b) , and let x_o be any element within (a, b) . Now consider the following sequence of successive recursive definitions $\langle D_i(x) \rangle$ of x :

$$\begin{cases} D_1(x) = x_o \\ D_i(x) = \min \left(\{D_{i-1}(x), q_i\} \cap (a, b) \right), \quad i = 2, 3, 4, \dots \end{cases} \quad (10)$$

where \min stands for the smallest (in the natural order of precedence of \mathbb{Q}) of the two numbers in brackets, or the only number in bracket if $q_i \notin (a, b)$. $\langle D_i(x) \rangle$ compares x with the successive elements of $\langle q_i \rangle$ that belong to (a, b) , and defines x as the compared element each time the compared element is smaller than the current value of x .

P182 Unnecessary as it may seem, we will impose the following restriction to the successive definitions $\langle D_i(x) \rangle$:

Restriction P182.-Each successive definition $D_i(x)$ will be ca-

ried out if, and only if, x results defined as a rational number within its domain (a, b) .

We will prove now that for any natural number v , the first v successive definitions (10) can be carried out according to Restriction P182.

P183 The first definition $D_1(x)$ can be carried out according to Restriction P182 because $D_1(x) = x_o$, and $x_o \in (a, b)$. Assume that, being n any natural number, the first n definitions $\langle D_i(x) \rangle_{i=1,2,\dots,n}$ can be carried according to Restriction P182, so that $D_n(x) \in (a, b)$. Since q_{n+1} is a well defined rational number, we will know if, being in (a, b) , it is less than $D_n(x)$. If this is the case $D_{n+1}(x) = q_{n+1}$; otherwise $D_{n+1}(x) = D_n(x)$. In both cases x results defined within its domain (a, b) . This proves $D_{n+1}(x)$ can also be performed according to Restriction P182. Consequently, for any natural number v , the first v definitions $\langle D_i(x) \rangle_{i=1,2,\dots,v}$ can be carried out according to Restriction P182.

P184 Assume that all definitions $\langle D_i(x) \rangle$ that observe Restriction 182 are carried out (Principle of Execution P25). The value of x once performed all of them, whatsoever be the finite or infinite number of times it has been defined with a different value, will be a rational number within its domain (a, b) just because *it was always defined within its domain (a, b)* . Thus, we can affirm:

Undeterminable as the current value of x may be once performed all definitions $\langle D_i(x) \rangle$ according to Restriction 182, it will be a certain rational number r within its domain (a, b) (Principle of Invariance P19).

P185 Obviously a variable can be properly defined within its domain even if we cannot know its current value. Some infinitists argue, however, that although Restriction 182 applies to each of the infinitely many successive definitions of x , once completed the infinite sequence of those definitions we cannot ensure x continue to be a rational variable defined within its domain (a, b) , despite the fact that each of those definitions defined x as a rational

number within its domain (a, b) . As if the completion of an infinite sequence of definitions had arbitrary additional effects on the defined object, as losing the condition of being a rational variable defined within its domain. Obviously this goes against the Principle of Invariance P19.

P186 The same unknown additional effects on the defined objects could, then, be expected in any other definition, procedure or proof consisting of infinitely many successive steps, in which case infinitist mathematics would have no sense. For instance, in Cantor's 1874 argument if the number of \mathbb{R} -intervals is infinite, and due to those unknown additional effects of the completion on the defined object, we could not ensure these intervals continue to be the real intervals within (a, b) they were defined to be.

P187 Thus, if to complete the infinite sequence of definitions (10) means to perform each and every definition of the sequence, and only them, each of which defines x within its domain (a, b) , and if the completion of the sequence, as such a completion, has not unknown arbitrary effects on x , then, once performed all possible definitions (Principle of Execution P25), x can only be defined as a certain rational number r (whatsoever it be) within its domain (a, b) (Principle of Invariance P19).

P188 Consider the rational interval (a, r) and any element s within (a, r) . It is quite clear that $s \in (a, b)$ and $s < r$. We will prove s cannot belong to $\langle q_i \rangle$. In fact, assume s belongs to $\langle q_i \rangle$. In such a case there will be an element q_v in $\langle q_i \rangle$ such that $q_v = s$, and being s in (a, r) , we will have $q_v \in (a, r)$, and therefore $q_v < r$. But this is impossible because:

- a) The index v of q_v is a natural number.
- b) According to 183, for each natural number v , it is possible to carry out the first v definitions $\langle D_i(x) \rangle_{i=1,2,\dots,v}$ satisfying Restriction P182.
- c) All definitions $\langle D_i(x) \rangle$ satisfying Restriction P182 have been carried out.

- d) At least the first v definitions $\langle D_i(x) \rangle_{i=1,2,\dots,v}$ satisfying Restriction P182 have been carried out (Principle of Execution P25).
- e) $D_v(x) = \min \left(\{D_{v-1}(x), q_v\} \cap (a, b) \right)$ and then $D_v(x) \leq q_v$.
Therefore $r \leq q_v$
- f) It is then impossible that $q_v < r$.

In consequence s cannot be an element of $\langle q_i \rangle$.

P189 The rational number s proves, therefore, the existence of rational numbers within (a, b) that are not in $\langle q_i \rangle$, which in turn proves the falseness of the initial assumption on the denumerable nature of \mathbb{Q} . Now then, taking into account that Cantor proved \mathbb{Q} is denumerable, the final conclusion can only be that \mathbb{Q} is and is not denumerable.

P190 The sequence of definitions $\langle D_i(x) \rangle$ leads to some other contradictory results the reader can easily find. Evidently, contradictory results do not invalidate one another, they simply prove the existence of contradictions (this obviousness is often ignored in the discussions on the actual infinity). If, starting from the same hypothesis, two independent arguments lead to contradictory results they prove the inconsistency of the initial hypothesis. It is quite clear, then, that an argument cannot be refuted by another argument even if this last argument comes to conclusions that contradict the conclusions of the first one. An argument can only be refuted by indicating where and why *that* argument fails. These obviousness are not necessary to be recalled in other areas of discussion, but they do if the area is that of the hypothesis of the actual infinite. Or that of any other hypothesis or axiom used to support a hegemonic stream of scientific thought, as if hegemony were synonymous with truth. Hegemony, almost always hostile to disagreement, takes for granted that its foundational assumptions are indisputable.

INTRODUCTION

P191 Cantor proved in a short paper published in 1874 that the set of the algebraic numbers, and then the set of the rational numbers, are both denumerable. He also proved in the same paper that, on the contrary, the set of the real numbers is non-denumerable. In the previous chapter it was proved that two of the three alternatives of Cantor's proof on the cardinality of the real numbers can be directly applied to the set of the rational numbers. Therefore, to ensure the impossibility of a contradiction on the cardinality of the set of the rational numbers, it is necessary to prove that Cantor's third alternative is the only alternative that can be applied to the set of the rational numbers, which means to prove that for any real interval (a, b) and any bijection f between the set of the natural numbers and the set of the rational numbers, the sequence of real intervals $\langle (a_i, b_i) \rangle$ defined by following Cantor procedure is always infinite, and the sequences of rational numbers $\langle a_i \rangle$ and $\langle b_i \rangle$ of their corresponding rational endpoints have always a common irrational limit. However, 146 years after Cantor's publication, and as far as I know, that need has not even been raised. This chapter reexamines that Cantor's third alternative, proving it can be easily converted in a variant of the second one. Thus, by completing Cantor argument in this way, Cantor's 1874 paper would have proved the set of the rational numbers is and is not denumerable.

A RATIONAL EXTENSION OF CANTOR'S 1874 THEOREM

P192 Assume the set \mathbb{Q} of the rational numbers is denumerable, and let f be any injective function of the set \mathbb{N} of the natural numbers in \mathbb{Q} . Assume also f is a bijection, i.e. a one to one corres-

pondence. The elements of \mathbb{Q} are reordered by f in the sequence $\langle q_i \rangle = q_1, q_2, q_3, \dots$, being $q_i = f(i), \forall i \in \mathbb{N}$ (Theorem P80a), which makes it possible to consider them successively and one by one, as Cantor did in 1874 with the real numbers.

P193 Let (a, b) be any open real interval of \mathbb{R}^+ . Starting from q_1 , and following the order q_1, q_2, q_3, \dots of $\langle q_i \rangle$, find the first two elements of $\langle q_i \rangle$ inside (a, b) . Denote the smaller of them by a_1 and the greater by b_1 . Define the real interval (a_1, b_1) . Starting from q_1 , and following the order q_1, q_2, q_3, \dots of $\langle q_i \rangle$, find the first two elements of $\langle q_i \rangle$ inside (a_1, b_1) . Denote the smaller of them by a_2 and the greater by b_2 . Define the real interval (a_2, b_2) . The continuation of this procedure, that will be referred to as Procedure P193, defines a (finite or infinite) sequence of nested real intervals $S = (a_1, b_1) \supset (a_2, b_2) \supset (a_3, b_3) \supset \dots$ whose left endpoints a_1, a_2, a_3, \dots form a strictly increasing sequence of rational numbers; and whose right endpoints b_1, b_2, b_3, \dots form a strictly decreasing sequence of rational numbers, being every element of the first sequence smaller than every element of the second one.

P194 It is important to highlight the fact that an element q_n of $\langle q_i \rangle$ cannot belong to the successive nested real intervals $(a_n, b_n) \supset (a_{n+1}, b_{n+1}) \supset (a_{n+2}, b_{n+2}) \supset \dots$. Indeed, when the Procedure P193 considers q_n for the first time, a maximum of $n/2$ of those intervals will have been defined. Therefore either q_n is used to define an endpoint of a new real interval $(a_{i < n}, b_{i < n})$, or it does not belong to the last defined interval. In consequence, q_n cannot belong to the successive nested real intervals $(a_n, b_n) \supset (a_{n+1}, b_{n+1}) \supset (a_{n+2}, b_{n+2}) \supset \dots$.

P195 Assume first that S has a finite number n of intervals. In this case, there will be a last interval (a_n, b_n) in S . None of the infinitely many rationals inside (a_n, b_n) , except at most one of them, can be in $\langle q_i \rangle$, otherwise it would be possible to define at least a new real interval (a_{n+1}, b_{n+1}) of S . In this case, therefore, the injective function f of \mathbb{N} in \mathbb{Q} would not be a bijection.

P196 Consider now S is infinite. The sequences $\langle a_i \rangle$ and $\langle b_i \rangle$ are convergent, because $\langle a_i \rangle$ is strictly increasing and upper bounded by any b_i ; and $\langle b_i \rangle$ is strictly decreasing and lower bounded by any a_i . So, their respective limits L_a and L_b exist inside (a, b) , being $L_a \leq L_b$.

P197 If $L_a < L_b$, any of the infinitely many rationals inside the real interval (L_a, L_b) is a rational number s that is not in $\langle q_i \rangle$ because, according to P194, if it were an element q_v of $\langle q_i \rangle$ it could not belong to the successive nested real intervals $(a_v, b_v) \supset (a_{v+1}, b_{v+1}) \supset (a_{v+2}, b_{v+2}) \supset \dots$, while s belongs to all of them. In this case, therefore, the injective function f of \mathbb{N} in \mathbb{Q} would not be a bijection. Up to this point, the above argument coincides basically with Cantor's 1874 argument about the cardinality of the real numbers, except that in this case it has been applied to the rational numbers.

P198 The third alternative in Cantor's 1874 argument is the case $L_a = L_b = L$. Since L is a real number, it will be rational or irrational. If it were rational, it could not be an element q_v of $\langle q_i \rangle$ because, according to P194, q_v cannot belong to the successive nested intervals $(a_v, b_v) \supset (a_{v+1}, b_{v+1}) \supset (a_{v+2}, b_{v+2}) \supset \dots$, while L belongs to all of them. Therefore, if L were rational the real interval (a, b) would contain rational numbers that are not in the sequence $\langle q_i \rangle$, in which case the initial injection f of \mathbb{N} in \mathbb{Q} would not be a one to one correspondence.

P199 We will now examine the case in which L is an irrational number by following a strategy similar to that used in other arguments developed in previous chapters. A strategy, legitimized by the hypothesis of the actual infinity subsumed in the Axiom of Infinity, that allows us to consider infinite collections as complete totalities.

P200 Let x be a rational variable whose initial value is any rational number in the real interval (a, L) , and $\langle t_i \rangle$ a strictly increasing sequence of instants in the real interval (t_a, t_b) whose limit is t_b .

Suppose that at each instant t_n of $\langle t_i \rangle$ the current value of the variable x is compared with the value of the n th element q_n of the sequence of rationals $\langle q_i \rangle$, and it is changed with the value of q_n whenever $x < q_n < L$.

P201 The one to one correspondence g between $\langle t_i \rangle$ and $\langle q_i \rangle$ defined by $g(t_i) = q_i$ proves that, being t_b the limit of $\langle t_i \rangle$, at the instant t_b the variable x will have been compared one by one with all rational numbers of the sequence $\langle q_i \rangle$, and it will have been defined as each of those rationals q_n of $\langle q_i \rangle$ whenever that $x < q_n < L$.

P202 Once completed the sequence of comparisons and redefinitions of the variable x (Principle of Execution P25), we will have a real interval (x, L) . Whatever be the value of the variable x , it will be a rational number (Principle of Invariance P19), and since L is an irrational number it will be $x \neq L$. The real interval (x, L) will therefore contain an infinite number of rational numbers. Let s be one of those rationals. Being $s \in (x, L)$, it must hold $x < s$. It is evident that s does not belong to $\langle q_i \rangle$, because if it were an element q_v of $\langle q_i \rangle$, x would have been compared with q_v and defined as q_v . So we would have $q_v \leq x$, which is impossible if $q_v \in (x, L)$. Thus, in the case of the third alternative of Cantor's 1874 argument, if L is an irrational number, it is also possible to prove that there are elements of (a, b) which are not in $\langle q_i \rangle$.

P203 In agreement with the above three conclusions of the three alternatives of Cantor 1874 argument applied to the rational numbers, the initial injective function f of \mathbb{N} in \mathbb{Q} , that was assumed to be surjective, i.e. a one to one correspondence, cannot be surjective. And being f any injective function of \mathbb{N} in \mathbb{Q} , we must conclude that one to one correspondences between \mathbb{N} and \mathbb{Q} are impossible. Therefore, \mathbb{Q} cannot be denumerable.

P204 For the same reasons as in Cantor's 1874 argument for the real numbers, the above instance for the rational numbers must conclude \mathbb{Q} is not denumerable. Though, on the other hand, and in the same Cantor's 1874 paper [37], Cantor proved \mathbb{Q} (as a subset of

the algebraic numbers) is denumerable. Thus, Cantor would have almost demonstrated the two terms of a contradiction: The set \mathbb{Q} is and is not denumerable. By this contradiction, Cantor would have almost demonstrated that the only hypothesis supporting his transfinite arithmetic is inconsistent. That initial hypothesis is the hypothesis of the actual infinity, the existence of the set “of the totality of the finite cardinals” in Cantor’s words [47, p. 103]. A hypothesis that Cantor did not consider a hypothesis but as an irrefutable fact, given his infinitist convictions “as firm as a rock” [77, p. 283]. Thus, Cantor’s transfinite construction contains the necessary elements for his own self-destruction. Convictions *as firm as a rock* might be good for religion, but not for science. Science should be the place for trial and error; for error and correction.

11 CANTOR DIAGONAL ARGUMENT

INTRODUCTION

P205 This chapter proves a result on the decimal expansion of the rational numbers in the rational open interval $(0, 1)$, which is subsequently used to discuss on a reordering of the rows of a table T that is assumed to contain all rational numbers within $(0, 1)$. A reordering such that the diagonal of the reordered table T could be a rational number from which different rational antidiagonals (elements of $(0, 1)$ that cannot be in T) could be defined. If that were the case, and for the same reason as in Cantor's diagonal argument, the rational open interval $(0, 1)$ would be non-denumerable, and we would have a contradiction in set theory, because Cantor also proved the set of the rational numbers is denumerable.

THEOREM OF THE n TH DECIMAL

P206 Let \mathbb{Q}_{01} be the set of all rational numbers in the rational open interval $(0, 1)$ expressed in decimal notation and completed, in the cases of finitely many decimal digits, with a denumerable infinite number of 0's in the right side of their corresponding decimal expansions (numerical expressions that include all decimal digits of the number). According to the hypothesis of the actual infinity, those decimal expressions exist as complete totalities. Some infinite decimal expressions of rational numbers as, for instance, $0,30000000\dots$ and $0,29999999\dots$ are different when considered as strings of numerals (symbols), although they can also be considered as representing the same number. Here, we are not considering all strings of numerals that represent rational numbers in \mathbb{Q}_{01} but all rational numbers in \mathbb{Q}_{01} each with a unique decimal expression, the one just indicated. On the other hand, and for the reasons

given in P217, the consideration of those double expressions has no consequences on the main argument of this chapter.

P207 Let d be any decimal digit, n any natural number, and q_0 any element of \mathbb{Q}_{01} whose n th decimal digit is just d , for instance:

$$q_0 = 0,11^{(n-1)}1d000\dots \quad (1)$$

From q_0 it is possible to define different sequences of different elements of \mathbb{Q}_{01} , all of them with the same n th decimal digit d . For example the sequence $\langle q_n \rangle$:

$$q_1 = 0,11^{(n-1)}1d1000\dots \quad (2)$$

$$q_2 = 0,11^{(n-1)}1d11000\dots \quad (3)$$

$$q_3 = 0,11^{(n-1)}1d111000\dots \quad (4)$$

$$q_4 = 0,11^{(n-1)}1d1111000\dots \quad (5)$$

$$q_5 = 0,11^{(n-1)}1d11111000\dots \quad (6)$$

...

$$q_i = 0,11^{(n-1)}1d111 \overset{(i)}{\dots} 1000\dots \quad (7)$$

...

The bijection (one to one correspondence) f between the set \mathbb{N} of the natural numbers and $\langle q_n \rangle$ defined by

$$\forall i \in \mathbb{N} : f(i) = q_i \quad (8)$$

proves the following:

Theorem P207, of the n th Decimal.-For any given decimal digit and any given position in the decimal expansion of the elements of \mathbb{Q}_{01} , there exists a denumerable subset of \mathbb{Q}_{01} , each of whose different elements has the same given decimal digit in the same given position of its corresponding decimal expansion.

A RATIONAL DIAGONAL ARGUMENT

P208 Let \mathbb{Q}_{d_n} be the subset of \mathbb{Q}_{01} each of whose elements has the same decimal digit d_n in the same n th position of its decimal expansion. According to the Theorem P207 of the n th Decimal, \mathbb{Q}_{d_n} is denumerable. So, its superset \mathbb{Q}_{01} will be infinite, either denumerable or non-denumerable. Let g be any injective function of \mathbb{N} in \mathbb{Q}_{01} . This function makes it possible to define a table T whose successive rows $r_1, r_2, r_3 \dots$ are just the successive images $g(1), g(2), g(3) \dots$ of the elements of \mathbb{N} in \mathbb{Q}_{01} .

P209 Since the successive rows $\langle r_n \rangle$ of T are indexed by the whole set \mathbb{N} of the natural numbers, T is ω -ordered (Theorem P80a, of the indexed collection). In addition, to assume the existence of the set of all finite natural numbers as a complete infinite totality, as Cantor did in 1883 [47, p. 103-104], means to assume the rows of T also exist as a complete infinite totality. According to this Cantor's assumption (hypothesis of the actual infinity subsumed into the Axiom of Infinity in modern set theories), *every* row r_n of T will be preceded by a finite number, $n - 1$, of rows and succeeded by an infinite number, \aleph_o , of such rows. We will now examine a conflicting consequence of this case of ω -asymmetry.

P210 The diagonal $D = 0.d_{11}d_{22}d_{33} \dots$ of T is a real number within $(0, 1)$ whose n th decimal digit d_{nn} is the n th decimal digit of the n th row r_n of T . As in Cantor's diagonal argument [43], it is possible to define another real number A , said antidiagonal, by replacing each of the infinitely many decimal digits of D with a different decimal digit. By construction A cannot be in T because it differs from each row r_i of T at least in its i th decimal digit. Since A is a real number within $(0, 1)$, it will be either rational or irrational. If it were rational, and for the same reason as in Cantor's diagonal argument, g would not be a one to one correspondence

P211 A row r_i of T will be said n -modular if its n th decimal digit is $n \pmod{10}$. This means that a row is, for instance, 2348-modular if its 2348th decimal digit is 8; or that it is 45390-modular if its 45390th decimal digit is 0. If a row r_n is n -modular (being n in

n -modular the same number as n in r_n) it will be said *d-modular*. For instance, the rows:

$$\begin{aligned}
 r_1 &= 0, 1007647464749943400034577774413 \dots \\
 r_2 &= 0, 220004566777894300000000000000 \dots \\
 r_3 &= 0, 0033333333333333333333333333 \dots \\
 r_7 &= 0, 100100700011111111444444444433333 \dots \\
 r_{20} &= 0, 12345678901234567890111111111111 \dots
 \end{aligned}$$

are all of them d -modular. It is clear that certain rational numbers as $0.\widehat{43}$ or $0.\overline{3353333333}$ cannot be d -modular, whatever be their corresponding rows in T . As will be seen in Chapter 30, these type of numbers pose new problems to the hypothesis of the actual infinity.

P212 Consider now the following permutation \mathbf{D} of the rows $\langle r_n \rangle$ of T :

For each of the successive rows r_i of T :

- If r_i is d -modular then let it unchanged.
- If r_i is not d -modular then exchange it with any following i -modular row $r_{j,j>i}$, provided that at least one of the succeeding rows $r_{j,j>i}$ be i -modular. Otherwise let it unchanged.

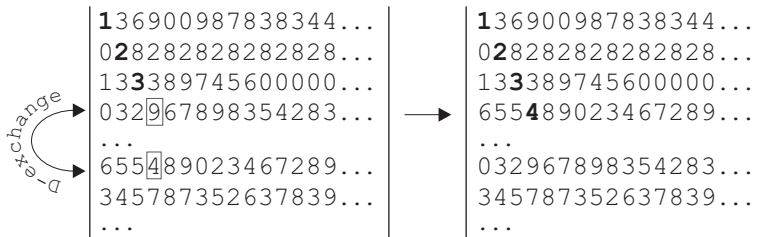

Figure 11.1 – The fourth row of T before being d -exchanged (Left); and after having been d -exchanged (right). Note that only the digits of the decimal expansions are represented, not including the initial 0 or the subsequent decimal separator.

The exchange of a non-d-modular row r_i with a *following i-modular row* will be referred to as *d-exchange* (see Figure 11.1). Thanks to the condition $j > i$ (in $r_{j,j>i}$), once a row r_i has been d-exchanged, it becomes d-modular and will remain d-modular and unaffected by the subsequent d-exchanges. On the other hand, the successive d-exchanges do not change the type of order of T but the rational numbers indexed by the same successive indexes. Or in other words, d-exchanges interchange the content of some couples of rows of T , but not its type of order.

P213 The permutation \mathbf{D} could even be considered as a supertask [188]. Indeed, let $\langle t_n \rangle$ be an ω -ordered sequence of instants within a finite interval of time (t_a, t_b) , being t_b the limit of the sequence. Assume that \mathbf{D} is applied to each row r_i just at the precise instant t_i . The bijection $f(t_i) = r_i$ proves that at t_b the d-exchanges of the permutation \mathbf{D} will have been applied to all rows of T .

P214 It can be proved that all rows of T become d-modular as a consequence of the permutation \mathbf{D} . In effect, assume that a row r_n did not become d-modular as a consequence of the permutation \mathbf{D} . This means that r_n is not d-modular and could not be d-exchanged with a n -modular row $r_{i,i>n}$. Now then, all n -modular rows have the same digit $n(\text{mod } 10)$ in the same n th position of its decimal expansion, and according to the Theorem P207 of the n th Decimal there are infinitely many rational numbers with the same digit in the same position of its decimal expansion, whatever be the digit and the position. Accordingly, since n is finite, the row r_n is preceded by a finite number k ($0 \leq k < n$) of n -modular rows, and succeeded by an infinite number, \aleph_o , of n -modular rows. Any of these infinitely many n -modular rows succeeding r_n had to be d-exchanged with r_n . It is then impossible for r_n not to become d-modular as a consequence of \mathbf{D} . Therefore, each and every row r_n of T becomes d-modular as a consequence of \mathbf{D} .

P215 Let us remark the basic formal structure of the above argument P214 (a simple Modus Tollens). Consider the following two

propositions p_1 and p_2 about the permutation \mathbf{D} :

p_1 : Not all rows of T becomes d-modular because of \mathbf{D} .

p_2 : At least one non-d-modular row r_n of T could not be d-exchanged.

It is quite clear that p_1 implies p_2 : if not all rows of T becomes d-modular because of D , then at least one non-d-modular row r_n of T could not be d-exchanged. Now then, being all natural numbers finite, n is finite; and taking into account the Theorem P207 of the n th Decimal, there is a finite number, k ($0 \leq k < n$), of n -modular rows preceding r_n and an infinite number, \aleph_o , of n -modular rows succeeding r_n , one of which had to be d-exchanged with r_n . In consequence proposition p_2 is false and so will be p_1 . In symbols:

$$p1 \Rightarrow p2 \quad (9)$$

$$\neg p2 \quad (10)$$

$$\therefore \neg p1 \quad (11)$$

P216 The result proved in P214 is a formal consequence of both the Theorem P207 of the n th Decimal and the fact that *every* row r_n of T is always preceded by a finite number, k ($0 \leq k < n$), of n -modular rows and succeeded by an infinite number, \aleph_o , of such n -modular rows (ω -asymmetry). Recall that this ω -asymmetry is an inevitable consequence of assuming, as Cantor did in 1883, the existence of the ω -ordered set \mathbb{N} as a complete infinite totality, a hypothesis subsumed into the Axiom of Infinity.

P217 Let T_d be the table resulting from the permutation \mathbf{D} . Since all of its rows are d-modular, its diagonal D will be the periodic rational number $0.\overline{1234567890}$. It is now immediate to define infinitely many rational antidiagonals from D . Indeed, let us consider periods of ten decimal digits none of which coincide in position with the ten decimal digits of the period $\overline{1234567890}$ of the diagonal D . The number of those periods is 9^{10} . From any two of them, for instance, $q_1 = \overline{0123456789}$ and $q_2 = \overline{0321456789}$, it is possible to define different ω -ordered sequences of rational

antidiagonals $\langle A_n \rangle$, for instance:

$$\forall n \in \mathbb{N} : A_n = 0.q_1 q_1 \overset{(n)}{\dots} q_1 \overline{q_2} \quad (12)$$

whose elements cannot be in T_d for the same reason as in Cantor's diagonal argument. Being periodic rational numbers with a period of nine different digits, the antidiagonals $\langle A_n \rangle$ cannot be redundant decimal expressions of elements of T_d that are not in T_d just because of their redundancy with the decimal expressions that are in fact in T_d . Indeed, these redundant expressions are periodic expressions whose periods have always the same and unique digit: the digit 9. If, on the contrary, those redundant expressions were not considered redundant but representing each of them a different rational number, they would be in T_d , and the same argument above would prove they are different from the antidiagonals $\langle A_n \rangle$. In consequence, and since all those antidiagonals are rational numbers which are not in T_d , we must conclude that the injective function g between \mathbb{N} and \mathbb{Q}_{01} defining T , is not surjective, i.e. it is not a bijection.

P218 Since the injective function g defining T is *any injective function between \mathbb{N} and \mathbb{Q}_{01}* and it cannot be surjective, we must conclude it is impossible to define a bijection between \mathbb{N} and \mathbb{Q}_{01} . Consequently, \mathbb{Q}_{01} is non-denumerable. Although the above inference suffices to conclude that \mathbb{Q}_{01} is non-denumerable, it could be (inappropriately) argued, as against Cantor's diagonal argument, that a new table T' could be defined so that $r'_1 = A$ and $r'_{i+1} = r_i$, $r_i \in T$, $\forall i \in \mathbb{N}$. The new table T' would be denumerable, but through the same diagonal argument, the same conclusion on the impossibility of a bijection between \mathbb{N} and \mathbb{Q}_{01} would be reached. And the same recursive argument could be applied to any table defined in terms of any other previous table and its corresponding antidiagonal, while the new table continue to be denumerable. A bijection between \mathbb{N} and \mathbb{Q}_{01} is impossible. So, \mathbb{Q}_{01} is non-denumerable, and we have a contradiction in set theory because Cantor proved \mathbb{Q} is denumerable [47, p. 123] [37].

P219 the Permutation **D** makes it possible to develop other arguments whose conclusions also point to the inconsistency of the hypothesis of the actual infinity. For instance, it is clear that certain elements of \mathbb{Q}_{01} as, $0.\overline{21}$, $0.\overline{35421}$, $0.\overline{2111111111}$ and many others cannot become d-modular if they were in the table T . This problem will be analyzed in Chapter 30, although for the case of a table of natural numbers.

A FINAL REMARK

P220 As with all discussions on the hypothesis of the actual infinity, the above one is a conceptual discussion unconcerned, as Cantor's diagonal argument, with the physical possibilities of carrying out all the involved operations. The formal inconsistency of a hypothesis does not depend on those possibilities, but on the fact of deducing from it a contradiction (Principle of Autonomy P23). And recall that from an inconsistent hypothesis anything can be deduced, from apparently reasonable assertions to any absurdity. It seems convenient to end by recalling again that an argument cannot be refuted by other different argument simply because it reaches an opposite conclusion. In W. Hodges words [121, p. 4]:

How does anybody get into a state of mind where they persuade themselves that you can criticize an argument by suggesting a different argument which doesn't reach the same conclusion?

This inadmissible strategy is frequently used in the discussions related to the actual infinity hypothesis (and in general in any discussion involving a "main stream" of thought). But to refute an argument means to indicate where and why that argument fails. If two correct arguments based on the same set of hypotheses lead to contradictory conclusions, they are simply proving the existence of a contradiction. And, therefore, the inconsistency of at least one of the assumed hypotheses. In our case, the only hypothesis is the hypothesis of the actual infinity, according to which the infinite sets and sequences exist as complete totalities. The alternative is the hypothesis of the potential infinity, according to which only finite sets and sequences can be considered as *complete totalities*,

unlimited and as large as wished, but always finite if they have to be considered as complete totalities. From this finitist perspective it is not possible to deduce the above contradictions because every row is preceded and succeeded by a finite number of rows.

INTRODUCTION

P221 This chapter contains three arguments on the cardinality of the set \mathbb{Q} of the rational numbers. In the first one, a partition of a real interval of positive real numbers is defined by means of a sequence that contains all positive rational numbers. It is then shown that the partitioned interval contains positive rational numbers that are not in the initial sequence that contains all positive rational numbers. The second argument, which is similar to the first one, deduces a contradiction related to the assumed existence of a denumerable sequence of rational numbers within the real interval $(0, 1]$, being the denumerable nature of the sequence (considered as a complete totality) the only cause of the contradiction. In the third argument, the right endpoint of a rational interval is successively redefined so that each redefinition shortens the length of the interval. The result is a new contradiction related to the cardinality of the set \mathbb{Q} of the rational numbers.

P222 In this and in some other of the following chapters, we will use the concept of partition of a linear (real or rational) interval, which is defined as follows:

Definition P222. *A sequence of adjacent and disjoint intervals $\mathcal{P} = A_1, A_2, \dots, A_n$ is a partition of another interval A if, and only if:*

$$\begin{cases} A = A_1 \cup A_2 \cup \dots \cup A_n \\ A_k \cap A_n = \emptyset, \quad \forall A_k, A_n, n \neq k \in \mathcal{P} \end{cases} \quad (1)$$

For instance:

$$(a, b) = (a, x_1] \cup (x_1, x_2] \cup (x_2, x_3] \cup \dots \cup (x_n, b) \quad (2)$$

is a partition of the interval (a, b) . Note that, as indicated, the intervals of a partition are disjoint (they have no common elements) and adjacent (the right endpoint of any of them coincides with the left endpoint of the next one, if any). A partition is, therefore, a sequence of adjacent and disjoint intervals, so that every interval, except the first one, has an interval disjoint and adjacent to the endpoint of smaller index, which is its immediate predecessor; and, except the last, each interval has an interval disjoint and adjacent to the endpoint of greater index, which is its immediate successor. A consequence of Definition P222 is the following

Corollary P222. *A point belong to a partitioned interval if and only if it is a point of one of the intervals of the partition.*

Proof.-It is an immediate consequence of (1). \square

For the partition to include only one time each point of the partitioned interval, the successive intervals of the partition must be open at the same endpoint and closed at the other, except the first and the last interval of the partition, which can also be open or closed. Any interval can also be considered as a partition of itself of just one element.

P223 Since a partition has a first element, a last element, and each element has an immediate predecessor (except the first) and an immediate successor (except the last), the number of parts in the partition can only be finite (Theorem P80c, of the Finite Sets). On the other hand, it is immediate to prove the following:

Theorem P223.-*If an interval of a partition of a given interval is divided into two adjacent and disjoint intervals, the new two intervals and the remaining ones form a partition of the given interval.*

Proof.-The first (second) of the new intervals has an immediate successor (predecessor): the second (first) of the new intervals. If the partitioned interval is the first (last) interval, then the first (second) of the new intervals will be the new first (last) interval of the partition. In other case, the first (second) of the new interval has an immediate predecessor (successor): the

immediate predecessor (successor) of the partitioned interval. So, the new intervals and the remainder ones define a partition of the given interval (Definition P222). \square

P224 It is possible to consider infinite sequences of numbers $\langle x_i \rangle$ in any real or rational interval (a, b) , and every two of those successive numbers x_i, x_{i+1} define a (sub)interval within (a, b) , for example the open-closed interval $(x_i, x_{i+1}]$. The following concept is then defined, which generalizes the concept of partition:

Definition P224. A segmentation of a given interval in a real or rational line* is a sequence of points within the given interval, so that they define a sequence of disjoint (sub)intervals within the given interval. If the ordinal of the sequence of points is α , the segmentation will be said α -ordered.

P225 Unlike finite partitions, in a ω -segmentation of an interval, for example $(a, b]$, there is not a last part, and the right endpoint b of the ω -segmented interval does not belong to the intervals defined by the ω -segmentation. In this sense, and with those differences with respect to partitions, infinite segmentations of any real or rational intervals can be considered. It is even possible to discuss, as Cantor did in 1882 [38], on the existence of non-denumerable partitions in the continuum. A problem that is analyzed in Chapter 13.

P226 The above Definition P224 of segmentation can be completed by means of the analytic concept of length. In the case of a straight line AB , its length L is given by:

$$L = \sqrt{(a_1 - b_1)^2 + (a_2 - b_2)^2 + (a_3 - b_3)^2} \quad (3)$$

where a_1, a_2, a_3 and b_1, b_2, b_3 are the respective Cartesian coordinates of A and B in the Euclidean space \mathbb{R}^3 . In the case of a continuous line* $f(x)$ the length AB is given by:

$$L = \int_a^b \sqrt{1 + f'(x)} dx \quad (4)$$

In these conditions, to each point x_i within a real interval (a, b) , a real number L_i can be assigned that corresponds to the length of the segment ax_i . Therefore, although the segment (a, b) is densely ordered and non-well-ordered, it is possible to define a set S of points in (a, b) ordered by their strictly increasing (decreasing) lengths with respect to the point a (or b):

$$x_i < x_j \Leftrightarrow ax_i < ax_j, \forall x_i, x_j \in S \quad (5)$$

$$x_i \neq x_j \Leftrightarrow ax_i \neq ax_j, \forall x_i, x_j \in S \quad (6)$$

The above order relation $<$ is a total order because it satisfies a), b) c) and d) of P51. If there is a first element x_1 in S , and S contains all the predecessors of any of its elements but the first, then $<$ is a well order, because any subset S' of S containing, say, x_m , will also contain a first element: one of the elements x_1, \dots, x_m .

A PARTITION A LA CANTOR

P227 As is well known, the set of the rational numbers in their natural order of precedence is densely ordered. So, if a and b are any two different rational numbers such that $a < b$, then the interval (a, b) contains infinitely many different rational numbers, no matter how close a and b are. Or in other words (and contrary to what happens with any natural number in the sequence of the natural numbers 1, 2, 3...), no rational number has an immediate successor in the natural order of precedence of the rational numbers. This trivial property of the rational numbers will be of capital importance in the following argument.

P228 Let f be a one to one correspondence between the set \mathbb{N} of the natural numbers and the denumerable set \mathbb{Q}^+ of all positive rational numbers. Consider the sequence $\langle q_n \rangle$ defined by f (Theorem P80a):

$$\langle q_i \rangle = q_1, q_2, q_3, \dots; q_i = f(i), \forall i \in \mathbb{N} \quad (7)$$

Since f is a one to one correspondence, it is quite clear the sequence $\langle q_n \rangle$ contains all positive rational numbers. Obviously, the ω -order of the indexes of $\langle q_n \rangle$ makes it possible to consider successively and

one by one all elements $q_1, q_2, q_3 \dots$ of \mathbb{Q}^+ , which in turn makes it possible the following Procedure P229.

P229 Let $(a, b]$ be any left open and right closed interval of real numbers. The successive elements $q_1, q_2, q_3 \dots$ of the sequence $\langle q_n \rangle$ defined in (7) will now be used to define a sequence of disjoint and adjacent intervals within $(a, b]$ by means of the following:

Procedure P229.-*Consider successively the elements q_1, q_2, q_3, \dots of $\langle q_n \rangle$. For each successive q_i : If, and only if, q_i belongs to an interval $(x, y]$ previously defined, including the initial $(a, b]$, and q_i is not an endpoint of $(x, y]$, then divide $(x, y]$ into two adjacent and disjoint intervals $(x, q_i]$ and $(q_i, y]$.*

Obviously:

$$(x, y] = (x, q_i] \cup (q_i, y] \quad (8)$$

$$(x, q_i] \cap (q_i, y] = \emptyset \quad (9)$$

As will be shown, we will finally have a sequence S of adjacent and disjoint intervals:

$$S = (a, x_1], (x_1, x_2], (x_2, x_3] \dots \quad (10)$$

where each x_i is a certain element of $\langle q_n \rangle$.

P230 It can easily be proved that for any natural number v , the above Procedure P229 defines a partition of the interval $(a, b]$ with the first v elements of $\langle q_i \rangle$. It is clear that P229 defines a partition of $(a, b]$ with q_1 : either the partition $(a, b]$ if $q_1 \notin (a, b]$, or the partition $(a, q_1](q_1, b]$ if $q_1 \in (a, b]$. Assume that, being n any natural number, P229 defines a partition of $(a, b]$ with the first n elements of $\langle q_i \rangle$. If $q_{n+1} \in (a, b]$, it will belong to an interval of the partition defined by the first n elements of $\langle q_i \rangle$ (Corollary P222), and it will be different from the endpoints of that interval because all rational numbers are different from one another and the endpoints of that interval has been defined by two elements $q_{i < n+1}, q_{j < n+1}$ of $\langle q_i \rangle$. Therefore, in this case P229 divides that interval in two disjoint and adjacent intervals. So, and, according to the Theorem P223,

the Procedure P229 defines a new partition of $(a, b]$ with the $n + 1$ first elements of $\langle q_i \rangle$. Otherwise, if $q_{n+1} \notin (a, b]$ then P229 defines the same partition in $(a, b]$ with the first $n + 1$ elements of $\langle q_i \rangle$ as with the first n elements of $\langle q_i \rangle$. In consequence, for any natural number v , the Procedure P229 defines a partition of the interval $(a, b]$ with the first v elements of $\langle q_i \rangle$.

P231 The following are immediate consequences of the above definition of the Procedure P229:

- a) When considering an element q_i , if q_i is in the interior of an interval $(x, y]$ previously defined, including the initial interval $(a, b]$, then q_i divides that interval into two disjoint and adjacent intervals $(x, q_i]$, $(q_i, y]$ whose union is the previous interval, being q_i the common endpoint of both intervals. Therefore, the two new intervals $(x, q_i]$, $(q_i, y]$ define a partition of the interval $(x, y]$ (Theorem P223).
- b) The successive S intervals are defined two by two, being each new pair of intervals the result of dividing a previously defined interval, including the initial interval $(a, b]$, into two disjoint and adjacent intervals whose union is the previous interval. Consequently, and according to the Theorem P223, the defined intervals at each step of the Procedure P229 form a partition of the initial interval $(a, b]$.
- c) When the Procedure P229 considers the element q_v of $\langle q_n \rangle$, only a finite number, at most $v + 1$, of disjoint and adjacent intervals will have been defined. According to Corollary P222, if $q_v \in (a, b]$ then q_v must belong to one of those intervals, because those intervals form a partition of $(a, b]$.
- d) Each time an element q_v of $\langle q_n \rangle$ divides an interval $(x_i, x_j]$, the endpoints of this interval continue to be endpoints in the new intervals: x_i in $(x_i, q_v]$ and x_j in $(q_v, x_j]$, and the new intervals continue to be densely ordered, otherwise the divided interval would not be densely ordered. The same applies to the intervals $(a, x_i]$ and $(x_k, b]$.
- e) As a consequence of the above four points, once an element q_v

of $\langle q_n \rangle$ has been used to divide an interval into two new intervals, this element q_v will continue to be the common endpoint of two disjoint and adjacent intervals.

- f) As a consequence of P231d, there will always be a first open-closed interval whose left endpoint is a , and a last open-closed interval whose right endpoint is b .

P232 According to P231f, the sequence S defined by the Procedure P229 will necessarily contain a first interval whose left endpoint is a . Let $(a, x]$ be that first interval, where x is a certain element of $\langle q_n \rangle$. Since all real intervals are densely ordered, between a and x infinitely many different rational numbers do exist. Let s be any rational element within the interval $(a, x]$ different from x . As we will see now, s cannot be an element of the sequence $\langle q_n \rangle$.

P233 Assume s is a certain element q_v of $\langle q_n \rangle$. According to P231c, when the Procedure P229 considers q_v only a finite numbers $k \leq v+1$ of disjoint and adjacent intervals will have been defined. Since q_v belongs to (a, x) it will also belong to $(a, b]$, and then to one of the k intervals, say $(x_d, x_h]$, already defined when P229 considers q_v , because those intervals form a partition of $(a, b]$ (Corollary 222). Obviously, q_v cannot be an endpoint of that interval because all rational numbers in $\langle q_i \rangle$ are different, and $(x_d, x_h]$ has been defined before the Procedure P229 considers q_v . So q_v will be used to defined two new intervals $(x_d, q_v]$, $(q_v, x_h]$, and in accord with P231e, it will continue to be the common endpoint of two disjoint and adjacent intervals. So, it is impossible for q_v to be a point in the interior of the first interval $(a, x]$. We must conclude the rational number $s \in (a, x]$ cannot be a member of $\langle q_n \rangle$. A similar argument would prove that the last interval $(y, b]$ of the partition, where y is an element of $\langle q_i \rangle$, also contains infinitely many rational numbers that are not in the sequence $\langle q_i \rangle$. This proves the following:

Conclusion P233.-*The sequence $\langle q_n \rangle$, that contains all positive rational numbers, does not contain all positive rational numbers.*

P234 It is remarkable the fact that, in order to draw the above Conclusion P233, we do not need to know if the Procedure P229 defines a finite or an infinite number of intervals. The conclusion P233 is an inevitable consequence of assuming the set \mathbb{Q}^+ is densely ordered and at the same time denumerable, which allows us to reorder its elements and consider *all of them* successively, one by one.

P235 The above Conclusion P233 is not the only contradiction that can be deduced from the partition defined by the Procedure P229. But its discovery is left to the curiosity of the reader.

A DENUMERABLE PARTITION

P236 Let us now consider the real interval $(0, 1]$ and the set \mathbb{Q}_{01} of all rational numbers in the real interval $(0, 1)$. Since \mathbb{Q}_{01} is denumerable, there is a one to one correspondence f between \mathbb{N} and \mathbb{Q}_{01} which allows to consider one by one the successive elements of \mathbb{Q}_{01} by means of the sequence $\langle q_i \rangle = q_1, q_2, q_3, \dots$ being $q_i = f(i), \forall i \in \mathbb{N}$ (Theorem P80a).

P237 As we will see, a procedure similar to the above one P229 makes it possible to define, in accordance with the Corollary 222 and the Theorem P223, a partition of the real interval $(0, 1]$ by means of the successive rational numbers of the sequence $\langle q_i \rangle$. Since $q_1 \in (0, 1]$, q_1 defines the partition $(0, q_1](q_1, 1]$ of $(0, 1]$. Since $q_2 \in (0, 1]$, q_2 belongs to one of the intervals of the partition defined by q_1 (Corollary 222), for example to $(0, q_1]$, then q_2 define a partition $(0, q_2](q_2, q_1]$ of $(0, q_1]$. And then, q_1 and q_2 define the partition $(0, q_2](q_2, q_1](q_1, 1]$ de $(0, 1]$. For the same reason q_1, q_2 and q_3 define a partition of $(0, 1]$, say $(0, q_2](q_2, q_1](q_1, q_3](q_3, 1]$. It is immediate to demonstrate by induction, or by Modus Tollens, that for every natural number v , the first v rational numbers of $\langle q_i \rangle$ define a partition of the real interval $(0, 1]$.

P238 The inductive proof is as follows. We have just seen that q_1 defines a partition of $(0, 1]$. Assume that, being n any natural number, the first n elements of $\langle q_i \rangle$ define a partition of $(0, 1]$.

According to the Corollary P222, since q_{n+1} belongs to $(0, 1]$, it will belong to an interval, say to $(q_{h < n+1}, q_{j < n+1}]$, of the partition defined by the first n elements of $\langle q_i \rangle$ in $(0, 1]$. Hence, q_{n+1} defines in $(q_h, q_j]$ a partition of two intervals $(q_h, q_{n+1}][q_{n+1}, q_j]$, and since $(q_h, q_j]$ is a part of the partition defined by the first n elements of $\langle q_i \rangle$ in $(0, 1]$, its replacement by the partition $(q_h, q_{n+1}][q_{n+1}, q_j]$ defined by q_{n+1} in $(q_h, q_j]$ continue to be, according to the Theorem 223, a partition of $(0, 1]$. Hence, for each natural number v , the first v rational numbers of $\langle q_i \rangle$ define a partition of the real interval $(0, 1]$.

P239 It will now be proved that all rational numbers of $\langle q_i \rangle$ have been used by the Procedure P237 to define a partition \mathbf{P} of the real interval $(0, 1]$, so that each q_n of $\langle q_i \rangle$ is the common endpoint of two disjoint and adjacent intervals of that partition. Indeed, assume that this is not the case. There will be at least a q_s in $\langle q_i \rangle$ such that q_s is not the common endpoint of two disjoint and adjacent intervals defined by P237. But this is impossible because s is a natural number and it has been proved in P238 that the first s elements of $\langle q_i \rangle$ used by the Procedure P237 define a partition of the real interval $(0, 1]$, with q_s being the common endpoint of two disjoint and adjacent intervals of that partition.

P240 Since $\langle q_i \rangle$ is denumerable and each of its elements is the common endpoint of two adjacent and disjoint intervals of the partition \mathbf{P} defined by $\langle q_i \rangle$ in $(0, 1]$, that partition will consist of an infinite number of parts each of whose successive common endpoints are all of them elements of $\langle q_i \rangle$. This is what the one to one correspondence f between \mathbb{N} and \mathbf{P} defined by $f(n) = (q_h, q_n]$, $\forall n \in \mathbb{N}$ proves. But this is impossible, because the partition \mathbf{P} contains a first element $(0, q_k]$, a last element $(q_r, 1]$, and all the intervals being disjoint and adjacent, each element $(q_h, q_n]$ has an immediate predecessor $(q_p, q_h]$ and an immediate successor $(q_n, q_s]$, so that the partition \mathbf{P} can only contain a finite number of elements (Theorem P80c, of the Finite Sets).

P241 The above contradiction P240 is a consequence of assuming

the existence of a denumerable set, the set \mathbb{Q}_{01} of the rational numbers in the real interval $(0, 1]$, as a complete totality. Indeed it is that set that made it possible the definition of the impossible denumerable partition \mathbf{P} of $(0, 1]$. And since the only property of the set \mathbb{Q}_{01} involved in the definition of \mathbf{P} is the number of its elements considered as a complete totality in which any element has a finite number of predecessors and an infinite number of successors (ω -asymmetry), it must be the cause of the contradiction proved in P240. In which case, and since all denumerable sets can be put into a one to one correspondence with each other, all denumerable sets, including the set of the natural numbers, would be inconsistent when considered as complete totalities, as the hypothesis of the actual infinity considers.

P242 It is time to remember, as was done in P220, that an argument cannot be invalidated because another argument reaches the opposite conclusion. In this case, the conclusion contrary to P240. That is to say, the conclusion that the partition \mathbf{P} defined by the Procedure P237 is not possible because there is not a last element in $\langle q_i \rangle$ to end the definition of the partition \mathbf{P} . But an argument can only be invalidated by indicating where and why that argument fails. If two correct arguments reach two opposite conclusions, they do not invalidate each other; they demonstrate the inconsistency of some common assumption. It happens, however, that the existence of hegemonic streams of thought in the scientific world, mainly in formal sciences, provides its militants with the deep conviction (*as firm as a rock*) that the conclusions of their arguments do in fact invalidate the arguments that reach conclusions contrary to their own. They do not consider the possibility that their stream of thought could be wrong, as if hegemonic and true were the same thing. It seems that the longer and stronger the hegemony of the hegemonic current, the more persistent this unacceptable attitude becomes.

A SHRINKING RATIONAL INTERVAL

P243 Since the set \mathbb{Q}^+ of the rational numbers greater than zero is denumerable, there is a one to one correspondence f between

the set \mathbb{N} of the natural numbers and \mathbb{Q}^+ . Therefore, the sequence $\langle f(i) \rangle = f(1), f(2), f(3), \dots$ contains all rational numbers greater than zero and makes it possible to successively consider all of them, and one by one. Let us now define the concept of 0-interval as any open interval of rational numbers whose left endpoint is the rational number 0 (the argument can immediately be extended to any other rational number). Let $I_o = (0, a)$ be anyone of those 0-intervals and consider the following sequence $\langle D_n(I_o) \rangle$ of recursive definitions of I_o :

$$\begin{cases} D_1(I_o) = I_o \\ D_i(I_o) = D_{i-1}(I_o) \cap (0, f(i)), \quad i = 2, 3, 4, \dots \end{cases} \quad (11)$$

It is clear that $D_i(I_o)$ defines I_o as $(0, f(i))$ if this interval is a 0-subinterval of $D_{i-1}(I_o)$ or as $D_{i-1}(I_o)$ if it is not.

P244 Let us now prove that for each natural number v it is possible to perform the first v definitions $\langle D_i(I_o) \rangle_{i=1,2,\dots,v}$. Indeed, it is quite clear $D_1(I_o) = I_o$ can be carried out. Assume that for any natural number n it is possible to perform the first n definitions $\langle D_i(I_o) \rangle_{i=1,2,\dots,n}$, so that $\langle D_n(I_o) \rangle = (0, x)$ and x is either one of the first n elements of $\langle f(i) \rangle$ or a . Since $f(n+1)$ is a rational number greater than zero it will belong, or not, to $(0, x)$. In the first case I_o can be defined as $(0, f(n+1))$; in the second as $(0, x)$. So the first $n+1$ definitions $\langle D_i(I_o) \rangle_{i=1,2,\dots,n+1}$ can also be carried out. This proves that for any natural number v it is possible to perform the first v definitions $\langle D_i(I_o) \rangle_{i=1,2,\dots,v}$.

P245 Assume now that while the successive definitions $\langle D_n(I_o) \rangle$ can be carried out, they are carried out. Once performed all possible definitions $\langle D_n(I_o) \rangle$ (Principle of Execution P25), the 0-interval I_o will continue to be a 0-interval. Otherwise we would have to accept that the completion of a finite or infinite sequence of definitions, as such a completion, has unexpected arbitrary consequences on the defined object, as losing the quality of being a 0-interval. The same would apply to any other definition, procedure or proof consisting of infinitely many successive steps, in whose case infi-

nitist mathematics would no longer make sense (Principle of Invariance P19). We then conclude that once performed all possible definitions $D_i(I_o)$ of I_o , and indeterminable as it may be its right endpoint z , I_o will be a certain 0-interval $(0, z)$. And this is all we need to know in order to continue our argument.

P246 Let s be any element within $(0, z)$. Obviously, s is a rational number different from 0 and z , but it cannot be an element of the sequence $\langle q_n \rangle$. Indeed, assume s is a certain element q_v of $\langle q_n \rangle$. Since $q_v \in (0, z)$, this would imply $D_v(I_o)$ has not been carried out because $D_v(I_o)$ would have defined I_o as $(0, q_v)$ and then it would be impossible that $q_v \in (0, z)$ because $(0, z)$ is the interval that results from completing all definitions (11). But, on the other hand, v is a natural number and, in agreement with P244, the first v definitions $\langle D_i(I_o) \rangle_{i=1,2,\dots,v}$ have been carried out. This proves our assumption on s is false. Consequently s is not a member of $\langle q_n \rangle$. The problem is that, being \mathbb{Q}^+ a denumerable set, $\langle q_n \rangle$ contains all rational numbers greater than zero. We must conclude $\langle q_n \rangle$ contains and does not contain all rational numbers greater than zero.

DISCUSSION

P247 Cantor's *Beiträge* (English translation [47]), published in 1895 and 1897 (Part I, [44] and Part II, [45] respectively) contains the fundamentals of the theory of infinite cardinals and ordinal numbers. Epigraph 6 of the first article begins by assuming the existence of the set of all finite cardinals as a complete totality. Although rather than as an explicit assumption it was introduced as an example of *transfinite aggregate* whose existence as a complete totality Cantor took for granted. This implicit assumption (equivalent to our modern Axiom of Infinity) is the only assumption in Cantor's theory on transfinite numbers. From it, Cantor successfully derived the existence of increasing infinite ordinals (Theorems §15 A-K) and cardinals (Theorems §16 D-F). The consistency of Cantor theory rests, therefore, on the consistency of that unique foundational assumption (although it was not included as a foundational hypothesis, but rather as an obvious and

unquestionable truth).

P248 In 1874 Cantor proved for the first time the set of the real numbers is not denumerable [37, 36, 41, 50]. Two of the three final alternatives of Cantor's proof can also be applied to the set of the rational numbers. In consequence, it is necessary to prove the third alternative is the only alternative that can be applied to the set of the rational numbers. Otherwise that set would and would not be denumerable. Until now, and as far as I know, this problem has not even been raised. Chapter 10 of this book dealt with that problem and proved that the third alternative of Cantor's proof can be easily converted in a variant of the second one, which implies the set \mathbb{Q} of rational numbers is non-denumerable.

P249 Some years after, from 1879 to 1882, Cantor published an article, divided into four parts, on linear sets of points [39, 42]. In the third part, he proved a theorem according to which, a continuum of points can only be divided into a denumerable number of disjoint and continuous subsets. In the next chapter, the alternative of a non-denumerable infinitude of adjacent and disjoint set of intervals in the real straight line will be discussed, together with the inconsistencies related to that alternative.

P250 In 1891 Cantor proved for the second time that the set of the real numbers (in their binary expression) is not denumerable, now by his celebrated diagonal method, an impeccable Modus Tollens [43]. Cantor antidiagonal is the binary expression of a real number in the real interval $(0, 1)$, and being real it will be either rational or irrational. If it were rational we would have the same problem as with Cantor's 1874 argument. So, it should be *formally proved* that no permutation of the \aleph_0 rows of Cantor's table yields a rational diagonal (rational antidiagonals are immediately derived from rational diagonals). Chapter 11 analyzed this problem, demonstrating the existence of rational antidiagonals.

P251 On the other hand, the above three arguments on real and rational intervals have demonstrated three contradictions related

to the cardinality of the set of the rational numbers. According to the first and third of those arguments, there would be sets of rational numbers that are denumerable and non-denumerable. According to the second of these arguments, there would be denumerable sets of rational numbers that define denumerable partitions that cannot be denumerable. Therefore, and according to P247, the supposed existence of the infinite sets as complete totalities would be inconsistent, because that hypothesis is the only one necessary for the construction of the mentioned three arguments of this chapter.

INTRODUCTION

P252 The set of the real numbers was proved to be non-denumerable by Cantor's 1874 argument and Cantor's diagonal argument (in the second case for the binary representation of the real numbers). Although the diagonal argument has been contested, I think both arguments are well founded and in fact they prove the set of the real numbers cannot be denumerable. Both arguments, however, could also be applied to the set \mathbb{Q} of the rational numbers (see Chapters 9 10 y 11). If that were the case, we would be in the face of a fundamental contradiction: the set \mathbb{Q} would and would not be denumerable. And the cause of that contradiction could only be the hypothesis of the actual infinity subsumed into the Axiom of Infinity, the only hypothesis behind both Cantor's arguments.

P253 Therefore, the Axiom of Infinity will be in question until it be proved the impossibility of applying both Cantor's arguments to the set of the rational numbers. Notice this is a fact, not a more or less debatable hypothesis. For over a century no one (within the hegemonic infinitism) has noticed it is, in effect, necessary to prove that impossibility in order to guaranty the consistency of the Axiom of Infinity. This is also a fact. And a shocking one, taking into account the high number of scholars who have examined both arguments, particularly the diagonal argument.

P254 As we will see in this chapter, there is a third source of inconsistencies related to the cardinality of the set \mathbb{Q} of the rational numbers. In this case the inconsistencies come from a result proved by Cantor according to which a continuum of points can only

be divided into, at most, a denumerable infinitude of continuous disjoint subsets. After analyzing Cantor's argument, this chapter will prove the opposite conclusion, i.e. that non-denumerable segmentations in the real straight line are possible. This result not only contradicts Cantor's, but also has the side effect of a new contradiction regarding the cardinality of the set of the rational numbers.

P255 Before beginning, let us recall that a partition (see P222) in the real straight line is any finite sequence of disjoint and adjacent segments of the real straight line whose union is a segment of the real straight line. For example, the sequence $\langle (x_i, x_{i+1}] \rangle$ of real segments is a partition in the real straight line if:

$$(x_1, x_2] \cup (x_2, x_3] \cup (x_3, x_4] \cup \cdots \cup (x_{n-1}, x_n] = (x_1, x_n] \quad (1)$$

$$\forall i \leq j : (x_i, x_{i+1}] \cap (x_{j+1}, x_{j+2}] = \emptyset \quad (2)$$

Remember also that segmentations of infinitely many parts can also be defined in the real straight line, for instance ω -ordered segmentations (see P224). We could even consider the possibility of non-denumerable sets of disjoint segments (intervals) in the continuum of the real straight line, of in any other continuum of points, whether linear, or bi-dimensional, or n-dimensional.

CANTOR'S 1882 ARGUMENT

P256 In a letter to R. Dedekind, dated on January 5, 1874, Cantor wrote:[68, p. 54]

Is it possible to map uniquely a surface (suppose a square including its boundaries) onto a line (suppose a straight line including its endpoints) so that to each point of the surface one point of the line and reciprocally to each point of the line one point of the surface correspond?

Cantor comment the question to other friends, which found it absurd because of the (apparent) impossibility of reducing two variables to only one [68, p. 54].

P257 Notwithstanding, in 1879 Cantor had found a way to prove that an affirmative answer to his question was possible. Including the general case of mapping any n -dimensional continuum of points onto the real interval $(0, 1)$. The key of the proof was the decimal infinite expansions of the real numbers within $(0, 1)$. He wrote to Dedekind asking for his opinion on the proof:

What I have communicated to you recently is so unexpected, so new to myself, that I cannot, as it were, achieve a certain peace of mind until I have obtained from you, my dear friend, a decision as to whether it is correct. Until you give me your approval, I can only say: *je le vois, mais je ne le crois pas* [I see it but I don't believe it].

Dedekind discovered a flaw in Cantor's proof, but Cantor was able to fix it quickly. Since then it is possible, indeed, to affirm that a segment of a straight line of a Planck's length has the same number of points as the entire three-dimensional universe we inhabit (or any other imaginable n -dimensional universe). Obviously, thanks to the ellipsis ...

P258 Between 1879 and 1882 Cantor published a work on infinite sets of points divided into four parts [39]. In the third of those parts, published in 1882 [38], Cantor used a one to one correspondence between the points of an infinite n -dimensional space and an n -dimensional figure of a finite volume, to prove that in an n -dimensional infinite space there cannot exist a non-numerable partition of disjoint and continuous parts, i.e. continuums that at most have their boundaries in common. P259 summarizes Cantor's argument.

P259 In modern language and notation, Cantor's 1882 argument goes as follows [38, p. 366-367]. Let \mathbb{R}^n be a continuous n -dimensional space infinite in all directions. Let $\langle A_\alpha \rangle$ be any infinite set of continuous subsets of \mathbb{R}^n that are disjoint with one another, sharing at most their boundaries. Let S^n be a continuous n -dimensional hyper-sphere of a finite hyper-radius equal to 1. A one to one correspondence f between \mathbb{R}^n and S^n can be established. The set

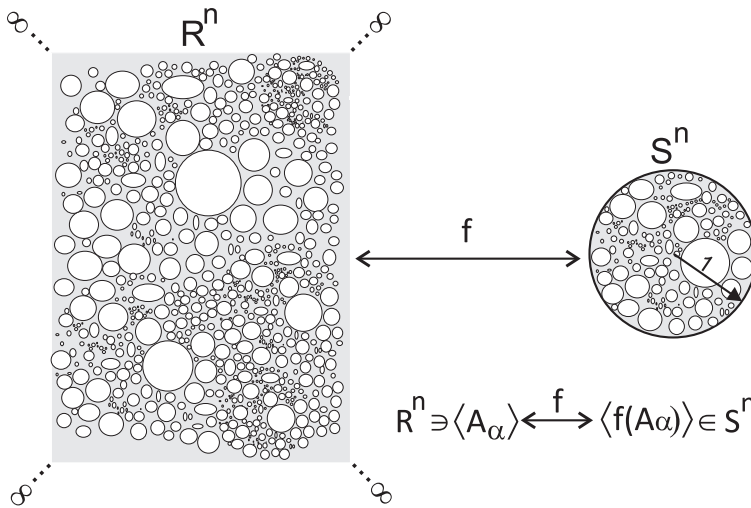

Figure 13.1 – A bi-dimensional representation of Cantor’s 1882 argument on the impossibility of a non-denumerable partition of a continuum of points.

$\langle f(A_\alpha) \rangle$ of subsets of S^n is a replica of the set $\langle A_\alpha \rangle$ of subsets of \mathbb{R}^n , although within the finite hyper-sphere S^n . Therefore, if $\langle f(A_\alpha) \rangle$ were numerable, so will be $\langle A_\alpha \rangle$; and vice versa (Figure 13.1). Now then, being n and the hyper-radius of S^n finite, the volume V of S^n is also finite. Hence, the number of subsets $f(A_i)$ whose volume is greater than any given finite number v can only be finite because all of them are within a finite volume V . In consequence, Cantor infers that the infinitude of $\langle f(A_\alpha) \rangle$, and then that of $\langle A_\alpha \rangle$, can only be denumerable. In the next section of this chapter it will be proved, however, the opposite conclusion.

CANTOR’S TERNARY SET

P260 Cantor’s ternary set (also known as Cantor dust) is a well known mathematical object usually introduced in first courses of calculus, mathematical analysis or fractal geometry [151]. The definition of Cantor ternary set is an appropriate example of a procedure with infinitely many successive steps that, in addition, resembles the Procedure P264 (see P264) we will make use of in the next argument, at least in the sense that both procedures define a

non-denumerable set. Indeed, and as will be seen later, the Procedure P264 allows to define a non-denumerable set, in this case of disjoint and adjacent segments in the real straight line, with the only aid of the elements of the real interval $(0, 1)$.

P261 But let's now recall the way Cantor's dust can be constructed. Consider the closed real interval $[0, 1]$. If we remove or delete the open middle third $(1/3, 2/3)$ of this interval we will get two closed intervals

$$[0, 1/3], [2/3, 1] \quad (3)$$

If we now remove the open middle third of each of these intervals, $(1/9, 2/9)$ and $(7/9, 8/9)$, we will get four closed intervals:

$$[0, 1/9], [2/9, 1/3], [2/3, 7/9], [8/9, 1] \quad (4)$$

If we now remove the open middle third of each of these four intervals we will get eight closed intervals, whose open middle third can be removed again, and so on. By continuing this procedure ad infinitum we will get Cantor ternary set (Figure 13.2).



Figura 13.2 – The first six steps of the sequence of infinitely many steps that define Cantor ternary set.

P262 Before beginning our discussion it seems convenient to recall the above procedure of infinitely many successive steps is considered as a complete totality of steps whose final result is a completely defined set: Cantor ternary set. Although this set can also be defined in other non-constructive terms, infinitist mathematicians believe the infinitely many steps of its construction can in fact be (theoretically) carried out (Principle of Execution P25). Even in

the Cantorian definition of the ternary set Z , it is assumed as a *totality* of real numbers: the set of *all* real numbers satisfying:

$$Z = \frac{c_1}{3} + \frac{c_2}{3^2} + \frac{c_3}{3^3} + \cdots + \frac{c_v}{3^v} + \cdots \quad (5)$$

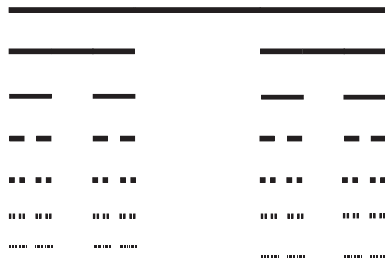
where c can take, at will, any of the two integer values 0 or 2.

SEGMENTATIONS IN THE REAL STRAIGHT LINE

P263 In the next argument, and to avoid unnecessary discussions, we will use standard mathematical notation in the place of computer science notation, though this last would be simpler. Let us consider two identical sets $A = B = (0, 1)$ of real numbers, and two identical sets I and J of indexes with the same cardinal 2^{\aleph_0} as $(0, 1)$. The elements of I and of J will be referred to a, b, c, d, e, \dots . Since A, B, I and J have the same cardinal, the elements of I (and the elements of J) can be put into a one to one correspondence with the elements of A and with the elements of B . Therefore, the elements of A and the elements of B can be indexed (Definition P76a) by the elements of I as $r_a, r_b, r_c, r_d, \dots$

P264 Consider the real variables u and v , whose initial values are: $u = v = 0$, and the Procedure P264 which consists in repeating the same biconditional step until one of the conditions is satisfied:

Step:

If $A = \emptyset$, or $I = \emptyset$ then end. Else:

 Select any element k of J

$I = J - \{k\}$

$J = I$

 Select any element of B and index it as r_k

$A = B - \{r_k\}$

$B = A$

If $u + r_k$ is not a proper real number then end. Else:

$v = u + r_k$

$(x_k, y_k] = (u, v]$

$S_k = \{(x_k, y_k]\}$

$u = v$

Next step

P265 Each step of the Procedure P264 consists in removing any element k from I (via the intermediate set of indexes J) in order to index and remove from A any of its elements r_k (via the intermediate set B), which is then used to define a new left open and right closed segment $(x_k, y_k]$ of real numbers whose left endpoint x_k is the current value of u and whose right endpoint y_k is $u + r_k$. The set S_k is then defined as a singleton whose only element is the segment just defined. Finally u is redefined as $u + r_k$ in order to define the left open endpoint of the next segment that, consequently, will be disjoint and adjacent to the one just defined. Since the sum of two proper real numbers, as u and r_k , is always a proper real number, the Procedure P264 empties I , J , A , and B (Principle of Execution P25).

P266 We now define the following set S of all segments of the real straight line defined by the above Procedure P264.

$$\begin{aligned} S &= \bigcup_{\alpha} S_{\alpha} = \bigcup_{\alpha} \{(x_{\alpha}, y_{\alpha}]\} = \\ &= \{(x_k, y_k], (x_h, y_h], (x_c, y_c], (x_n, y_n], \dots\}, \quad (\text{where } x_k = 0) \end{aligned} \quad (6)$$

whose elements are adjacent and disjoint since $x_h = y_k$; $x_c = y_h$; $x_n = y_c \dots$. Therefore, we will have:

$$\forall h, s : h \neq s \Rightarrow (x_h, y_h] \cap (x_s, y_s] = \emptyset \quad (7)$$

$$\forall h, s : y_h = x_s \Rightarrow (x_h, y_h] \cup (x_s, y_s] = (x_h, y_s] \quad (8)$$

being $(x_h, y_h]$ and $(x_s, y_s]$ adjacent and disjoint. In accordance with their definition, and taking into account each element of $(0, 1)$ is different from each other, the segments of the set S also satisfy:

$$\forall \{(x_h, y_h], (x_s, y_s)\} \subset S \begin{cases} y_h - x_h = r_h \in (0, 1) \\ y_s - x_s = r_s \in (0, 1) \\ r_h \neq r_s \end{cases} \quad (9)$$

which, on the other hand, means each segment of S has a different

extension greater than zero.

P267 Each segment $(x_h, y_h]$ of S defines the real number $y_h - x_h = r_h$ within the real segment $(0, 1)$, that obviously is the same real number r_h used to define the extension of $(x_h, y_h]$, and only the extension of $(x_h, y_h]$ because it was removed from A once defined $(x_h, y_h]$. Thus, it is immediate to define a one to one correspondence between S and $(0, 1)$. Indeed, consider the correspondence f between S and $(0, 1)$ defined by:

$$f : S \leftrightarrow (0, 1) \quad (10)$$

$$f((x_h, y_h)) = y_h - x_h = r_h, \quad \forall (x_h, y_h) \in S \quad (11)$$

Since, according to the definition of the Procedure P264, each $y_h - x_h$ is a different element of $(0, 1)$, and taking into account (9), the correspondence f is an injective function (injection). It is also surjective (exhaustive), otherwise we would have found two proper real numbers u and r_k (see the above definition of the Procedure P264) whose sum is not a proper real number, which is impossible because the set of the real numbers is closed with respect to addition. In consequence f is a one to one correspondence (bijection). Therefore the set S of real segments and the real segment $(0, 1)$ have the same cardinality: 2^{\aleph_0} .

P268 Obviously, this conclusion contradicts Cantor's on the same subject, which has been summarized in P256-P259. Since both arguments are built on the basis of a common hypothesis, the hypothesis of actual infinity, it must be that hypothesis that causes the contradiction.

P269 Apart from the above Cantor's 1882 argument P256-P259, (usually ignored in the secondary literature for this purpose) the impossible existence of non-denumerable sets of disjoint segments (intervals) in the real line is usually justified in the following way. Assume that it were possible such a non-denumerable set S of

disjoint segments in the real straight line:

$$(x_a, y_a](x_b, y_b](x_c, y_c] \dots, \quad (12)$$

$$x_b = y_a, x_c = y_b, \dots \quad (13)$$

Being each $(x_\alpha, y_\alpha]$ a real segment, it contains infinitely many rational numbers. And being:

$$(x_p, y_p] \cap (x_u, y_u] = \emptyset, \quad \forall (x_p, y_p], (x_u, y_u] \in S; \quad p \neq u : \quad (14)$$

we could pick out a rational number q_h within each segment $(x_h, y_h]$ of S and we will finally have a non-denumerable sequence of different rational numbers, which is impossible because the set of the rational numbers was proved to be denumerable [37], [47, p. 123].

P270 As we have just seen, the above justification rest on a previous infinitist result, namely that the set \mathbb{Q} of the rational numbers is denumerable, a result that had been previously proved by Cantor [37], [47, p. 123]. Therefore, it is not an independent proof in the sense that it does not prove the impossibility to define a non-countable set of disjoint segments in the real straight line (as is the case of Cantor's 1882 argument P256-P259), it simple asserts that such a set would be in conflict with the countable cardinality of the set of the rational numbers previously proved by Cantor.

P271 On the other hand, and according to the argument P263-P267, the above Procedure P264 defines a non-denumerable set of disjoints segments in the real line. In these conditions, we could pick out any rational number q_h within each segment $(x_h, y_h]$ of the set S (any real segment contains an infinite subset of rational numbers) and we would have a non-denumerable set of rational numbers $\{q_k, q_h, q_c, \dots\}$. Consequently, and taking into account the set of the rational numbers \mathbb{Q} was also proved to be denumerable ([37], [47, p. 123]), we have a new contradiction regarding the cardinality of \mathbb{Q} .

P272 For the third time, when completing an uncompleted Can-

tor's argument, we have found a fundamental contradiction involving the cardinality of the set \mathbb{Q} of the rational numbers. As in the precedent cases, this new contradiction points towards the inconsistency of the hypothesis of the actual infinity subsumed into the Axiom of Infinity. It is in fact this axiom that legitimizes the existence of the infinite sets as complete totalities, and then the completeness of procedures of infinitely many steps as the Procedure P264 that defines the sequence of segments S , from which the above contradiction has been drawn.

FINAL REMARKS

P273 Evidently, the claim that it is actually impossible to complete in physical terms any infinite computation, as the above Procedure P264, has no effect on the argument, mainly for the following two reasons:

- a) As most of the infinitist arguments, the argument P263-P267 is also a conceptual discussion unrelated to the physical world. The formal consistency of the actual infinity hypothesis does not depend upon the actual possibilities of performing this or that procedure, but on the existence of contradictions formally deduced from that hypothesis. When formally proved, contradictory results in formal systems depend exclusively on the consistency of their foundational assumptions, regardless of the possibility of actually performing the finitely or infinitely many steps involved in the corresponding arguments (Principle of Autonomy P23).
- b) Infinitist mathematics takes it for granted the completion of all definitions and procedures composed of infinitely many steps (Principle of Execution P25) and consider the resulting objects as complete infinite totalities, as in the introductory example of Cantor ternary set. Argument P263-P267 cannot be a (convenient) exception.

P274 As will have been observed, the use of the ellipsis in the arguments about the mathematical infinity is practically unavoidable. It is convenient to remember that all those arguments can

also be developed under the hypothesis of the potential infinity. Although with a very significant difference: in the case of the potential infinity we cannot consider as complete a sequence of steps ending in an ellipsis. From the perspective of the potential infinity, ellipses always end in complete finite totalities. Although the totality is unlimited in the number of the possible elements that can still be included in the totality. In the case of the potential infinity, infinite totalities do not exist. For this reason, none of the contradictions that we have deduced up to this point (and none of those that we will continue to deduce) under the hypothesis of actual infinity appear under the hypothesis of potential infinity.

n-EXPOFACTORIAL NUMBERS

P275 This chapter introduces the expofactorial and the *n*-expofactorial numbers, as well as the method of the successive decimal expansions by means of which it is possible to define a different rational number from the infinite decimal expansion of each irrational number within the real interval $(0, 1)$. In such a case, there would be as many rational as irrational numbers within $(0, 1)$. Evidently, this conclusion goes against other well known results on the cardinality of the set \mathbb{Q} of the rational numbers.

P276 Although the method of the successive decimal expansions we will make use of in the next section works with natural numbers of any size, we will use natural numbers unimaginably large: the *n*-expofactorials numbers defined in P279.

P277 The first time I considered the expofactorial of the natural numbers (expofactorials for short), I didn't know they have already been defined by C. A. Pickover ([181] cited in [241]) with the name of *superfactorials* and the symbols $n\$,$ the same name and symbols used by Sloane and Plouffe to define $n\$ = \prod_{k=1}^n k!$ [241]. That said, I will retain my original notation and name. The expofactorial of a natural number $n,$ written $n^!$ (note the factorial symbol “!” appears as exponent), is the factorial $n!$ raised to a power tower of order $n!$ of the same exponent $n!$:

$$n^! = n!^{n!^{n!^{n!^{n!}}}}$$

Or in Knuth's notation:

$$n! = n! \uparrow\uparrow (1 + n!) \tag{1}$$

P278 These numbers growth so rapidly that while the expofactorial of 2 (in symbols $2^!$) is 16, the expofactorial of 3 (in symbols $3^!$) is practically incalculable even with the aid of the most powerful computers:

$$\begin{aligned} 3^! &= 6^{6^{6^{6^{6^6}}} \\ &= 6^{6^{6^{6^{6^{46656}}} \\ &= 6^{6^{6^{6^{265911977215322677968248940438791859490534220026992430066043278949707355\dots}}} \end{aligned}$$

where the incomplete exponent of the last equation (second step of the calculation by the online calculator Big Number Calculator) has nothing less than 36306 digits, a string of figures over seven meters long, 11 pages, if each figure is 5 mm. And there still remains four steps to go. Indeed, the expofactorial of any natural number greater than 2 is so large that it is practically incalculable (it is not an anodyne power of ten but a precise sequence of different figures).

P279 Expofactorials are insignificant compared with n-expofactorials, recursively defined from expofactorials as follows: the 2-expofactorial of a natural number n , denoted by $n^{!2}$, is the expofactorial $n^!$ raised to a power tower of order $n^!$ of the same exponent $n^!$; the 3-expofactorial of n , denoted by $n^{!3}$, is the 2-expofactorial of n raised to a power tower of order $n^{!2}$ of the same exponent $n^{!2}$; the 4-expofactorial of n , denoted by $n^{!4}$, is the 3-expofactorial of n raised to a power tower of order $n^{!3}$ of the same exponent $n^{!3}$; and so on:

$$\begin{aligned} n^{!2} &= n^{! \left(\begin{matrix} n^! \\ \cdot \\ \cdot \\ \cdot \end{matrix} \right)} & n^{!3} &= n^{!2 \left(\begin{matrix} n^{!2} \\ \cdot \\ \cdot \\ \cdot \end{matrix} \right)} & n^{!4} &= n^{!3 \left(\begin{matrix} n^{!3} \\ \cdot \\ \cdot \\ \cdot \end{matrix} \right)} & \dots \end{aligned}$$

Or in Knuth's notation:

$$n^{!2} = n^{!} \uparrow\uparrow (1 + n^{!}) \quad (2)$$

$$n^{!3} = n^{!2} \uparrow\uparrow (1 + n^{!2}) \quad (3)$$

$$n^{!4} = n^{!3} \uparrow\uparrow (1 + n^{!3}) \quad (4)$$

$$n^{!5} = n^{!4} \uparrow\uparrow (1 + n^{!4}) \quad (5)$$

...

The *grandeur* of, for example, $9^{!9}$ (9-expofactorial of 9) is far beyond human imagination. Three standard arithmetic symbols, just $9^{!9}$, is all we need to define a *finite* number so large that the standard writing of its precise sequence of figures would surely be a string of numerals of a length millions of times greater than the diameter of the visible universe. If we use the hexadecimal numeral system, $F^{!F}$ would be inconceivable greater.

P280 The discussion that follows makes use of the 9-expofactorial of 9. For simplicity, it will be denoted by the letter “h” (for huge). So, in what follows “h” will stand for $9^{!9}$.

AN IRRATIONAL SOURCE OF RATIONAL NUMBERS

P281 The real numbers within the interval $(0, 1)$ with an infinite decimal expansion are arithmetically defined as:

$$r = 0.d_1d_2d_3\dots \quad (6)$$

$$= d_1 \times 10^{-1} + d_2 \times 10^{-2} + d_3 \times 10^{-3} + \dots \quad (7)$$

where the sequence of decimals digits $d_1d_2d_3\dots$ is ω -ordered, as the set \mathbb{N} of the natural numbers 1, 2, 3, ... that indexes them (Theorem P80a, of the Indexed Sets).

P282 In accordance with the hypothesis of the actual infinity, subsumed into the Axiom of Infinity, the infinite decimal expansion $0.d_1d_2d_3d_4\dots$ of any real number (with an infinite decimal expansion) within the real interval $(0, 1)$ does exist as a complete ω -ordered totality: it has a first decimal digit (decimal hereafter), d_1 , and each decimal d_n (except d_1) has an *immediate predecessor*

sor d_{n-1} and an *immediate successor* d_{n+1} , so that no last decimal exists (ω -successiveness), and where immediate predecessor (successor) means that no other decimal exists between any two successive decimals d_n, d_{n+1} (ω -discontinuity). In addition, each decimal digit d_n is preceded by a finite number $n - 1$ of decimal digits and followed by an infinite number, \aleph_ω , of such decimal digits (ω -asymmetry). Since the argument that follows deals exclusively with ω -ordered infinities, from now on, and for simplicity, they will be referred to simply as infinities.

P283 A point to note is that ω , the ordinal of the ω -ordered sequences, is *the smallest infinite ordinal*. Therefore, if r and s are two real numbers within the real interval $(0, 1)$ and they coincide in their first successive ω decimals, then both numbers are identical. On the contrary, and taking into account that every ordinal less than ω is finite, if r and s are different then they can only coincide in a finite number of their first successive decimals.

P284 Let \mathbb{N} be the ω -ordered set of the natural numbers, h the 9-expofactorial of 9 (in symbols $9^{!9}$), and m_α any element of the set M_I of the irrational numbers within the real interval $(0, 1)$. The exclusive decimal expansion of m_α :

$$m_\alpha = 0.d_1d_2d_3\dots \tag{8}$$

defines the following ω -ordered sequence $\langle q_{\alpha,nh} \rangle$ of rational numbers:

$$q_{\alpha,h} = 0.d_1d_2\dots d_h \tag{9}$$

$$q_{\alpha,2h} = 0.d_1d_2\dots d_h d_{h+1}\dots d_{2h} \tag{10}$$

$$q_{\alpha,3h} = 0.d_1d_2\dots d_h d_{h+1}\dots d_{2h} d_{2h+1}\dots d_{3h} \tag{11}$$

...

$$q_{\alpha,nh} = 0.d_1d_2\dots d_h d_{h+1}\dots d_{2h} d_{2h+1}\dots d_{3h} d_{3h+1}\dots d_{nh} \tag{12}$$

...

being $q_{\alpha,nh}$ (for every n in \mathbb{N}) the rational number within $(0, 1)$

whose finite decimal expansion $0.d_1d_2 \dots d_{nh}$ coincides with the first nh decimals of m_α . For this reason, m_α will be said the *source* of the sequence $\langle q_{\alpha,nh} \rangle$, and α will appear as a part of the subindex of each $q_{\alpha,nh}$. The rational $q_{\alpha,(n+1)h}$ will be said the h -expansion of the rational $q_{\alpha,nh}$ because $q_{\alpha,nh}$ is expanded with the next h successive decimals (starting from d_{nh+1}) of the source m_α in order to define $q_{\alpha,(n+1)h}$. Don't forget the unimaginable grandeur of $h = 9!^9$.

P285 From the perspective of the actual infinity hypothesis, the result of defining the infinitely many natural numbers by adding to the first natural number (the number 1) infinitely many successive times one unit ($1+1=2$; $2+1=3$; $3+1=4$; \dots), is a set of infinitely many increasing finite numbers, without ever reaching an infinite number (the recursive definition of the natural numbers in set theoretical terms leads to the same conclusion). Or in other words, infinitists defend that by adding to a first unit an infinite number of successive units we never reach an number of infinite size but infinitely many finite numbers, each one unit greater than its immediate predecessor. The same will happen if instead of one unit we add any finite number of units. Even h units.

P286 Consequently, and being h a natural number, the result of defining the infinitely many elements of $\langle q_{\alpha,nh} \rangle$ by adding infinitely many successive times h new decimals to the decimal expansion of $q_{\alpha,h}$, yields infinitely many decimal expansions, explosively increasing but always finite: $nh \in \mathbb{N}$ for each $n \in \mathbb{N}$ because the semiring $(\mathbb{N}, +, *)$ is closed with respect to addition and multiplication. Therefore, all of those decimal expansions $\langle q_{\alpha,nh} \rangle$ will be rational numbers.

P287 This infinitist consequence will be essential for the next argument since it legitimates the existence of the *infinitely many* rational numbers in $\langle q_{\alpha,nh} \rangle$, all of them with *finitely many decimals*, nh for each n in \mathbb{N} . In the same way \mathbb{N} contains infinitely many finite natural numbers, each of them one unit greater than its immediate predecessor, $\langle q_{\alpha,nh} \rangle$ contains infinitely many ratio-

nal numbers with a finite decimal expansion, each with h decimals more than its immediate predecessor. This is, in fact, infinitist orthodoxy.

P288 Let P be the set of *all* pairs $(m_\alpha, q_{\alpha,h})$ whose first component is a different element m_α of the set M_I of the irrational numbers in $(0, 1)$, and whose second component is the rational number $q_{\alpha,h}$ within $(0, 1)$ defined by the first h successive decimals d_1, d_2, \dots, d_h of m_α :

$$(m_\alpha, q_{\alpha,h}) \in P \Leftrightarrow \begin{cases} m_\alpha = 0.d_1d_2\dots d_h d_{h+1}\dots \in M_I \\ q_{\alpha,h} = 0.d_1d_2\dots d_h \end{cases} \quad (13)$$

Although the first element m_α of each pair is a different irrational number, the second one $q_{\alpha,h}$ will be repeated a certain number of times in the different pairs of P . Thus, P contains all irrational numbers within $(0, 1)$ as the first element of each of its couples of numbers, the second element of each couple being the rational number whose h digits are the first h digits of its irrational partner.

P289 Notice that if there are not irrational numbers in $(0, 1)$ with the same first h decimals, then the second element of each pair of P would be a different rational number. In these conditions the discussion that follows would be unnecessary: there would be as many rationals as irrationals within $(0, 1)$. We will assume this is not the case and, as a consequence, that P contains couples of irrationals/rationals whose rational components have the same h decimal digits.

P290 Let then $q_{\alpha,h}$ be any of the repeated rationals in P , and let P_α be the subset of P of all pairs $(m_\varphi, q_{\varphi,h})$ whose second rational component $q_{\varphi,h}$ coincides with $q_{\alpha,h}$:

$$P_\alpha = \{(m_\varphi, q_{\varphi,h}) \mid (m_\varphi, q_{\varphi,h}) \in P \wedge q_{\varphi,h} = q_{\alpha,h}\} \quad (14)$$

For simplicity, the repeated rational numbers in P_α will be called P-repetitions.

P291 By definition, the irrational numbers of all pairs of P_α are irrational numbers within $(0, 1)$ with the same first h decimals. Obviously, some of these numbers will also have the first $2h$ decimals and some will not (change, for instance, any decimal $d_{(h+i)0 < i \leq h}$ in any irrational in $(0, 1)$ and you will get an irrational with the same first h decimals but not with the same $2h$ decimals). Of the first ones, some will have the first $3h$ decimals and some will not. And so on.

P292 In accord with P291, if we replace each repeated rational in P_α with its h -expansion, the number of P-repetitions will decrease. And if we replace the remaining repeated rationals with their corresponding h -expansions, the number of P-repetitions will decrease again. And so on. The problem is that after each of these replacements, (h -replacement of P_α hereafter) we would have a new set, and after a sequence of h -replacements we would have a sequence of sets $P'_\alpha, P''_\alpha \dots$ and we could not demonstrate if the repeated rationals disappear or not (see Chapter 15). To avoid this problem we will have to redefine the set P_α after each h -replacement.

P293 Each pair $(m_\varphi, q_{\varphi, h})$ of P_α defines a sequence $\langle q_{\varphi, nh} \rangle$ of rational numbers similar to the sequence $\langle q_{\alpha, nh} \rangle$ defined in P284, except in that the source is now the irrational number m_φ in the place of m_α . The assumed actual existence, all at once, of the infinitely many decimals of the ω -ordered decimal expansion of any irrational number in $(0, 1)$ as a complete totality, legitimates the definitions of the sets P, P_α , as well as the sequences $\langle q_{\varphi, nh} \rangle$, all of them as complete totalities.

P294 Let A be any set of pairs of numbers (a, b) whose first component a is a different irrational number within the real interval $(0, 1)$ and whose second component b is a rational number within the same real interval $(0, 1)$. Let us define the following two set operators:

- 1) $D(A) =$ set of all pairs of A whose rational components are

different, not repeated.

- 2) $R(A)$ = set of all pairs of A whose rational components are repeated.

Evidently:

$$A = D(A) \cup R(A) \quad (15)$$

$$D(A) \cap R(A) = \emptyset \quad (16)$$

P295 Consider now the following sequence of (re)definitions of the set P_α :

$$n = 1, 2, 3, \dots$$

$$\left\{ \begin{array}{l} \text{If } R(P_\alpha) = \emptyset \text{ Then End. Else:} \\ P_\alpha^d = D(P_\alpha) \\ P_\alpha^r = \{(m_\varphi, q_{\varphi, (n+1)h}) \mid (m_\varphi, q_{\varphi, nh}) \in R(P_\alpha)\} \\ P_\alpha = P_\alpha^d \cup P_\alpha^r \end{array} \right. \quad (17)$$

In each definition (17) of the set P_α , its repeated rationals are replaced with their corresponding h-expansions. In agreement with P291, in each h-replacement the number of repeated rationals in P_α decreases. We will now prove that, by successive h-replacements, it is possible to replace each repeated rational in P_α with a different rational within the interval $(0, 1)$.

P296 Let us assume that while $R(P_\alpha) \neq \emptyset$ and P_α can be h-replaced, it is h-replaced in accordance with (17). Once all possible h-replacements have been carried out (Principle of Execution P25), there will be two exhaustive and mutually exclusive alternatives regarding $R(P_\alpha)$ (the subset of P_α of all pairs with repeated rationals):

- 1.- $R(P_\alpha)$ is not empty.
- 2.- $R(P_\alpha)$ is empty.

Consider the first alternative: $R(P_\alpha)$ is not empty. We know that

for each element $(m_\lambda, q_{\lambda, v_h})$ in $R(P_\alpha)$ there is an ω -ordered sequence $\langle q_{\lambda, nh} \rangle$ of rationals with a finite decimal expansion. So that each $(m_\lambda, q_{\lambda, v_h})$ in $R(P_\alpha)$ can be replaced with its h-expansion $(m_\lambda, q_{\lambda, (v+1)h})$. Consequently a new h-replacement of P_α is possible, which contradicts the fact that, being $R(P_\alpha) \neq \emptyset$, all possible h-replacements of P_α have been carried out. Therefore, and by Modus Tollens, the first alternative is false and then, once performed all possible h-replacements of P_α the set $R(P_\alpha)$ is empty.

P297 Note that the argument P296 has nothing to do with constructive reasonings based on the successively performed h-replacements. It is a simple Modus Tollens: once performed all possible h-replacements (Principle of Execution P25), the hypothesis that $R(P_\alpha)$ is not empty leads to the contradictory conclusion that not all possible h-replacements have been carried out. That hypothesis must be, therefore, false.

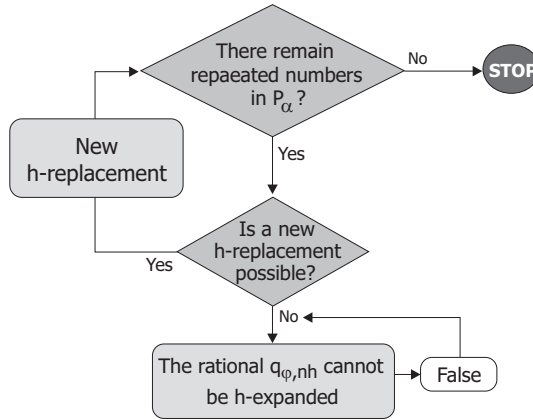

Figure 14.1 – The consequences of being a complete sequence without a last element completing the sequence.

P298 As Figure 14.1 illustrates, the argument P296 takes advantage of the fact that, in accord with the hypothesis of the actual infinity, ω -ordered sequences do exist as complete totalities in which *each element* has finitely many predecessors and infinitely many successors (ω -asymmetry). This assumption, makes it possible to

ensure that while P_α contains P-repetitions, i.e. while $R(P_\alpha)$ is not empty, the repeated rational numbers can be replaced with their corresponding successive h-expansions by means of successive h-replacements of P_α . And that this sequence of h-replacements can *actually be completed* because of the *actual completeness* of each infinite sequence $\langle q_{\varphi,nh} \rangle$ and to the Principle of Execution P25. Consequently, only when P_α no longer contains P-repetitions, i.e. when $R(P_\alpha)$ is empty, it will be possible to ensure that all possible h-replacements have been carried out (under penalty of contradiction).

P299 By contrast, from the potential infinity perspective the existence of completed infinite totalities without a last element that completes them, makes no sense. Thus, from this perspective we are not legitimated to consider the completion of the sequence of h-replacements if this sequence is potentially infinite.

P300 Once removed all P-repetitions, the resulting numbers can only be rational numbers with a finite decimal expansion since all elements of all sequences $\langle q_{\varphi,nh} \rangle$ are rational numbers with a finite decimal expansion, for the same reason that each of the infinitely many natural numbers is a finite number one unit greater than its immediate predecessor.

P301 In accordance with the Definition P290 of P_α , the rational numbers resulting from the removal of all P-repetitions cannot be repeated in the set $P - P_\alpha$ because all rational numbers in this last set differ from the rationals of P_α in at least one of their first h decimals.

P302 The above argument P290-P301 can be applied to any other repeated rational in the set P of all pairs $(m_\alpha, q_{\alpha,nh})$. In consequence, all repeated rationals can be replaced with a different rational number derived from the decimal expansion of the first irrational component of the pair. In these conditions each pair of P will be formed by a different irrational number m_α and a different rational number q_α . The one to one correspondence f defined by

$f(m_\alpha) = q_\alpha$ would be proving the set of the rational numbers in $(0, 1)$ and the set of irrational numbers in $(0, 1)$ have the same cardinality.

DISCUSSION

P303 The hypothesis of the actual infinity subsumed into the Axiom of Infinity legitimizes the following line of reasoning on which argument P288-P302 is grounded:

- 303-1. The infinitely many decimals of the decimal expansion of any irrational number within $(0, 1)$ do exist as an actual complete totality.
- 303-2. The infinite decimal expansions of the irrational numbers in $(0, 1)$ are ω -ordered, being ω the smallest infinite ordinal.
- 303-3. Two different irrational numbers in $(0, 1)$ can only coincide in a finite number of their first successive decimals.
- 303-4. The infinitely many h-expansions $\langle q_{\varphi, nh} \rangle$ defined from the decimal expansion of each irrational m_φ in the real interval $(0, 1)$ do exist as an actual complete totality.
- 303-5. Each of the infinitely many h-expansions of $\langle q_{\varphi, nh} \rangle$ is a rational number with finitely many decimals: nh for each n in \mathbb{N} .
- 303-6. In accordance with 303-4 and 303-5, the repeated rationals of P_α can be successively replaced with their corresponding successive rational h-expansions any finite or infinite number of times.
- 303-7. In these conditions, and by Modus Tollens P296, all P-repetitions can be removed from P_α , and then from P , so that each pair will finally be composed of a different irrational and a different rational derived from its irrational partner.
- 303-8. Consequently each irrational number within $(0, 1)$ defines a different rational number within the same interval.

P304 Conclusion P3038 contradicts other well known results on the cardinality of the set of the rational numbers.

P305 To define rational numbers, and ω -ordered sequences of rational numbers, from the decimal expansion of the irrational numbers leads to some other contradictory results we have not dealt with here.

EPILOG

P306 As it has been repeatedly said, from the perspective of the actual infinity hypothesis, the infinitely many decimals of a real number with an infinite decimal expansion do exist as a complete ω -ordered totality. In consequence, to consider that a real number *does exist* as the complete totality of its infinitely many decimals, means to consider that number is either a mind-independent entity, or an unverifiable assumption, because human mind cannot embrace the actual infinity (we can not even imagine finite numbers as $9!^9$, which are minuscule compared with the actual infinitude of for instance \aleph_0). Thus, from the infinitist perspective, all irrational numbers would be (platonic) mind-independent entities.

P307 From the hypothesis of the potential infinity, however, an irrational number is not a mind-independent entity formed by a complete ω -ordered sequence of decimals that exist all at once and by themselves. From this hypothesis, irrational numbers result from endless calculations that cannot be replaced with a division between two integers, although at each stage of the calculation the number coincides with a rational number of finitely many decimals. In this sense the irrational numbers are also definable as (potentially infinite) sequences of rational numbers, and therefore as sequences of proportions between two integer numbers.

P308 In the case of the rational numbers the calculations can be replaced with a division between two integers, which is not necessarily endless. In its turn, integer numbers would result from the endless process of counting. Naturally, the existence of endless processes of counting and calculations does not necessarily mean

the existence of their corresponding finished results as complete totalities, as is assumed from the infinitist point of view.

P309 We must decide which of the two alternatives is the most appropriate to found a theory of numbers. And the election is not irrelevant: we need mathematics to explain the physical world. Think, for example, of the problems posed by the actual infinity in certain areas of physics, as quantum electrodynamics (*renormalization*) or quantum gravity [221]. Or the assumed dense ordering of the *continuum* spacetime (founded on the assumed uncountable cardinality 2^{\aleph_0} of the real numbers) versus the discontinuous nature of ordinary matter, electric charge or energy. Some of these problems are discussed in Appendix B.

15 INCONSISTENCY OF THE NESTED SETS

A DENUMERABLE VERSION OF THE NESTED-SETS THEOREM

P310 Let $A = \{a_1, a_2, a_3, \dots\}$ be any ω -ordered set and consider the following recursive definition:

$$\begin{cases} A_1 = A - \{a_1\} \\ A_i = A_{i-1} - \{a_i\}; \quad i = 2, 3, 4, \dots \end{cases} \quad (1)$$

that yields the ω -ordered sequence $S = \langle A_n \rangle$ of nested sets $A_1 \supset A_2 \supset A_3 \supset \dots$, being each set $A_n = \{a_{n+1}, a_{n+2}, a_{n+3}, \dots\}$ a denumerable proper subset of all its predecessors, as well as a superset of all of its successors. Note that, in order to define the numerable sequence of numerable sets $\langle A_i \rangle$, the possibility of removing one by one all elements of A is assumed, even if there is not a last element to be removed.



Figura 15.1 – Venn diagram of the Empty Intersection Theorem: All sets are nested and, being denumerable, each of them occupies a concentric area greater than zero. However the common concentric area is null.

P311 The following theorem is a denumerable version of the so called Nested Sets Theorem (the original version, also called Cantor’s Intersection Theorem, deals with compact sets, and the conclusion is exactly the contrary, i.e. that the intersection is nonempty [138, p. 98-99]).

Theorem P311, of the empty intersection.-*The sequence S of sets $\langle A_n \rangle$ defined in P310 satisfies:*

$$\bigcap_i A_i = \emptyset \tag{2}$$

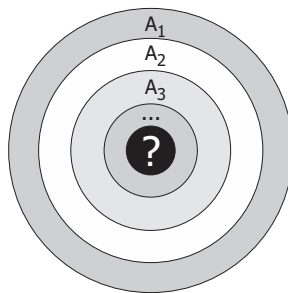
Proof.-If an element a_k would belong to the intersection then only a finite number (equal or less than k) of sets would have been defined by (1), since a_k does not belong to $A_k, A_{k+1}, A_{k+2}, \dots$

P312 The Empty Intersection Theorem is a trivial result in modern infinitist mathematics. It simply states the sets $\langle A_n \rangle$ have no common element. As far as I know, the consequences of the fact that *each set A_i* is a denumerable proper subset of *all* its predecessors have never been examined. This chapter discusses some of those consequences.



Figura 15.2 – Removing, one by one, the balls of a box that contains \aleph_0 balls.

P313 Before starting the main discussion that will take place in the next section, let us examine an elementary *physical* version of the Empty Intersection Theorem. Let BX be a box containing a denumerable collection $\langle b_i \rangle$ of balls indexed as b_1, b_2, b_3, \dots ,

and let $\langle t_n \rangle$ be a strictly increasing ω -ordered sequence of instants within the real interval (t_a, t_b) whose limit is t_b . Now consider the following supertask: at each instant t_i remove from the box the ball b_i , and only the ball b_i . The one to one correspondence f between $\langle t_i \rangle$ and $\langle b_i \rangle$ defined by $f(t_i) = b_i, \forall t_i \in \langle t_i \rangle$ proves that at t_b all balls will have been removed from BX .

P314 In accordance with the way of removing the balls, one by one and in such a way that between the removal of a ball b_n and the removal of the next one b_{n+1} an interval of time $t_{n+1} - t_n$ greater than zero always elapses, it could be expected that just before completing the removal of all balls from the box, the box will contain ... 5, 4, 3, 2, 1 balls. Nothing further from the (infinitist) truth: before it is empty, the box will never contain a finite number n of balls, whatever n , simply because those n balls would be the impossible last n balls of an ω -ordered collection of indexed balls; and the successive instants at which the successive balls were successively removed from the box would be the impossible last n instants of an ω -ordered sequence of instants.

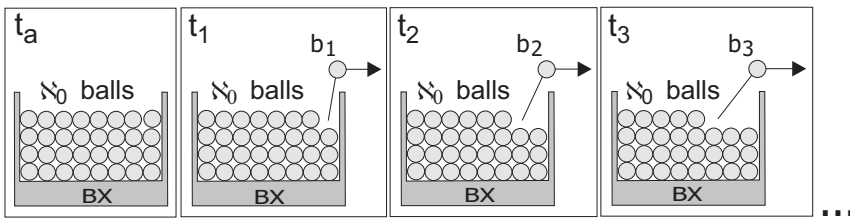
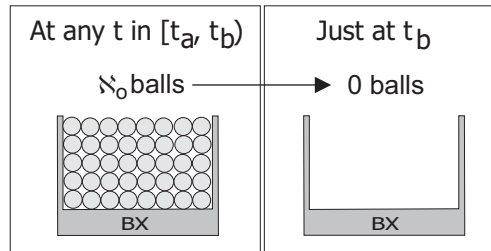

Figure 15.3 – The Aleph-zero or zero dichotomy

P315 Let $f(t)$ be the number of balls within the box at any instant t in $[t_a, t_b]$, i.e. the number of balls to be removed at the precise instant t . As a consequence of ω -order, we will have the following inevitable dichotomy:

$$\forall t \in [t_a, t_b] : f(t) = \begin{cases} \aleph_0 & \text{if } t \in [t_a, t_b) \\ 0 & \text{if } t = t_b \end{cases} \quad (3)$$

Otherwise, if for a t in $[t_a, t_b)$ it holds $f(t) = n$, being n any natural number, then there would exist the impossible last n terms of an ω -ordered sequence.

P316 Taking into account the one to one correspondence $f(t_i) = b_i$, all balls $\langle b_n \rangle$ are removed *one by one* from the box BX , one after the other and in such a way that an interval of time $\Delta_i t = t_{i+1} - t_i$ greater than zero always elapses between the removal of two successive balls $b_i, b_{i+1}, \forall i \in \mathbb{N}$. But according to the above \aleph_o or 0 dichotomy (3), this is impossible because the number of balls to be removed from the box has to change *directly* from \aleph_o to 0 (without intermediate finite states at which only a finite number of balls remain to be removed), and this is only possible by removing simultaneously \aleph_o balls.

P317 The box BX plays the role of the set A and the successive removals of the balls from BX represent the successive steps of the recursive definition (1). Since the successive elements a_1, a_2, a_3, \dots of A are successively removed in order to define the successive terms A_1, A_2, A_2, \dots of the sequence S , we could write:

$$A_i = \{\phi_1, \phi_2, \dots, \phi_i, a_{i+1}, a_{i+2}, \dots\} \quad (4)$$

where $\phi_1, \phi_2, \dots, \phi_i$ simply indicate the successive elements a_1, a_2, \dots, a_i , of A that have been successively removed in order to define the successive sets A_1, A_2, \dots, A_i , of the sequence S .

P318 As in the case of the box BX , and for the same reasons, if we focus our attention on the number of elements that remain unmarked in (4) as the recursive definition (1) progresses, then we will immediately come to the conclusion that that number can only take two values: \aleph_o and 0.

P319 The \aleph_o or 0 dichotomy implies the number of unmarked elements in (4) changes directly from \aleph_o to 0, and this is only possible by marking \aleph_o elements at once, i.e. by defining simultaneously \aleph_o sets of the sequence S , which evidently is not compatible with the

recursiveness of that definition, in the same way that to remove simultaneously \aleph_0 balls from the box is not compatible with the successiveness of the removals.

P320 There is, however, a significant difference between taking away the balls from BX and the recursive definition (1): while the box BX is always the same box BX as the balls are successively removed from it (which makes it evident the fallacy of the removal), the set A originates a sequence of sets: starting from A_1 , each set A_i originates a new set A_{i+1} when the element a_{i+1} is removed from it in order to define the next term of the sequence. Thus, A dissolves in a complete infinite sequence of sets without a last set completing the sequence, which conceals the fallacy of removing one by one all elements of a collection without ever resting ... 3, 2, 1 elements to be removed.

P321 Faced with the evidence of the fact that by removing one by one the infinitely many balls within the box BX you will inevitably get a box BX that will successively contain ... , 5, 4, 3, 2, 1, 0 balls, some infinitists claim that you cannot remove one by one the balls from that box because there is not a last ball to be removed. You can remove one by one the elements of a set to define a numerable sequence of sets, such as the above sequence $\langle A_i \rangle$, even if there is no last element to be removed, but you cannot remove one by one the infinitely many balls of a box because there is not a last ball to be removed from the box. What to think of a formal theory that allows to remove elements from a set, but not balls from a box because this would call the theory into question? If that theory assumes the hypothesis of the actual infinity, it is assuming that all elements of an infinite collection exist as a complete totality, with or without a last element. And if all elements of the collections are removed from the collection, the result can only be the empty set, otherwise not all elements of the collection would have been removed from the collection. Be the collection a denumerable set or a box that contains infinitely many balls. In consequence, if a bijection as the above one proves that all elements of a collection have been removed from the collection at a certain instant, at

that instant the resulting collection can only be the empty set. Not accepting this conclusion means accepting that after removing all elements from a collection, not all elements of the collection have been removed from the collection. And if the elements of the collection are removed one by one, and all are removed, it is difficult to explain that the container, be it a box or a set, never contains a finite number of elements not yet removed.

INCONSISTENCY OF THE NESTED SETS

P322 The above discussion of the Empty Intersection Theorem suggests that this theorem is not as trivial as it seems. It, in fact, motivates the short discussion that follows, whose main objective is to put into question the formal consistency of the actual infinity hypothesis. It seems convenient at this point to recall that Cantor took it for granted the existence of the set of all finite cardinals as a complete infinite totality (a hypothesis now subsumed into the modern Axiom of Infinity), and that from that initial assumption he successfully derived the infinite sequence of the transfinite ordinals of the second class, the smallest of which is ω [47, p. 167, Theorem §15 K]. Thus, any result affecting the formal consistency of ω will affect the whole sequence of transfinite ordinals of the second class as well as the formal consistency of the actual infinity hypothesis. Let us just begin by assuming the Axiom of Infinity and then the existence of ω -ordered sets and ω -ordered sequences as complete infinite totalities.

P323 Consider again the above sequence of sets $S = A_1, A_2, A_3, \dots$. From S , define the sequence S^* of sets by successively adding to S^* (that is initially empty) the successive sets A_1, A_2, A_3, \dots , of S if, and only if, $\bigcap_{i=1}^n A_i \neq \emptyset$:

$$n = 1, 2, 3, \dots : \text{ add } A_n \text{ to } S^* \text{ iff } n = 1 \text{ or } \bigcap_{i=1}^{i=n} A_i \neq \emptyset \quad (5)$$

P324 As in previous arguments in this book, it could easily be proved by induction or by Modus Tollens that for any natural number v the first v successive additions (5) can be carried out.

The inductive proof is as follows. According to (5) the set A_1 can be added to S^* . Suppose that for any natural number n it is possible to add to S^* the first n sets A_1, A_2, \dots, A_n of the sequence S . We will have:

$$A_1 \cap A_2 \cap \dots \cap A_n = A_n \neq \emptyset \quad (6)$$

Since $A_{n+1} = \{a_{n+2}, a_{n+2}, a_{n+2}, \dots\}$ is a denumerable subset of A_n we can write:

$$A_1 \cap A_2 \cap \dots \cap A_n \cap A_{n+1} = A_{n+1} \neq \emptyset \quad (7)$$

Hence, A_{n+1} can also be added to S^* , which proves that for every natural number v it is possible to add the first v elements of S to S^* . And then, for any natural number v , the first v successive additions (5) can be carried out.

P325 Assume that while the successive additions (5) can be carried out they are carried out. Once all possible successive additions (5) have been carried out (Principle of Execution P25), the sequence S^* will be formed by a certain (finite or infinite) number of sets that by addition have a nonempty intersection. Let, therefore, a_v be any element of that intersection. Evidently it holds: $a_v \notin A_v$. In consequence, A_v is not a member of the sequence S^* .

P326 It is immediate to prove, however, A_v is a member of S^* :

- a) The subindex v in A_v is a natural number.
- b) According to P324, for each natural number v the first v successive additions (5) can be carried out.
- c) All possible successive additions (5) have been carried out.
- d) The first v successive additions (5) have been carried out (Principle of Execution P25).
- e) The v th addition (5) adds A_v to S^* because:

$$A_1 \cap A_2 \cap \dots \cap A_v = A_v \neq \emptyset \quad (8)$$

- f) In consequence A_v is a member of S^* .

P327 We have, therefore, derived a contradiction from our initial assumption: the set A_v is and is not in the sequence S^* .

P328 The alternative to the above contradiction is another contradiction even more elemental: after having performed all possible successive additions (5) in accordance with the Principle of Execution P25, not all possible successive additions (5) have been performed.

P329 It could also be argued that S^* is defined infinitely many times and that although each and every addition (5) defines S^* as a sequence of sets whose intersection is nonempty, the completion of the sequence of successive additions (5) converts S^* into a sequence of sets whose intersection is empty. As if the completion of an ω -ordered sequence of additions, as such a completion, had additional arbitrary consequences on the defined object. The same arbitrary consequences could be expected in any other procedure or proof consisting of an ω -ordered sequence of steps. In those conditions any thing could be expected in infinitist mathematics because the Principle of Invariance P19 could be violated.

P330 Moreover, by timetabling the sequence of additions (5) so that each n th step takes place at the precise instant t_n of a strictly increasing sequence of instants $\langle t_i \rangle$ within (t_a, t_b) whose limit is t_b , it could easily be proved that only at t_b , once completed the sequence of additions (5), could S^* become a sequence of sets whose intersection is empty. This would confirm, on the one hand that the completion of an ω -ordered sequence of additions, as such a completion, has additional arbitrary effects on the resulting object; and on the other that those arbitrary effects takes place at the instant t_b , the first instant after completing the sequence S^* of additions; an instant in which no step of the addition is carried out; an instant when nothing happens that can justify the empty intersection of the sequence of sets S^* defined by (5).

INTRODUCTION

P331 This chapter makes use of a few number of basic concepts of Euclidean geometry. Some of them, as point, line* or straight line, are primitive concepts while other, as segment or distance, can be defined in formally productive terms [137]. It is assumed all of them are well known to the reader.

P332 Recall that an ω -segmentation of a line* AB is a well-ordered set of points $\langle x_i \rangle$ such that each $x_{i,i>1}$ is the immediate successor of x_{i-1} (see details in P224). The ω -ordered sequence $\langle x_n \rangle$ of points within the real straight line interval $(0, 1)$ defined by:

$$x_n = \frac{(2^n - 1)}{2^n}; \quad n = 1, 2, 3, \dots \quad (1)$$

is an example of ω -segmentation of a finite straight line segment. Each pair of successive points x_n, x_{n+1} defines a part (interval or segment) of the ω -segmentation. The successive parts are disjoint and adjacent, so that the right endpoint of any of them coincides with the left endpoint of the following one:

$$(x_1, x_2](x_2, x_3](x_3, x_4] \dots \quad (2)$$

P333 As is well known, at least since the 18th century, ω -segmentations (then called simply divisions) of finite line* segments are only possible if the successive adjacent and disjoint parts of the ω -segmentation are of a decreasing length, otherwise the length of the line* would have to be infinite [23]. This inevitable restriction originates a huge asymmetry in the segmentation. Indeed, whatever be the length of the ω -segmented line* AB , and whatever be

the ω -segmentation, all of its parts, except a finite number of them, will necessarily lie within a final segment CB arbitrarily small, so small that it will always be smaller than any considered interval.

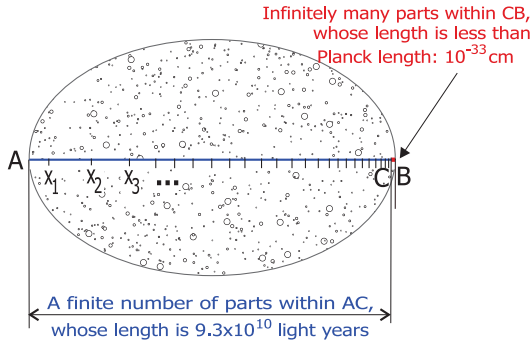

Figure 16.1 – Spatial ω -asymmetry in the ω -segmentation of a line* AB whose length is the diameter of the visible universe.

P334 To illustrate the magnitude of the infinite asymmetry of ω -asymmetry, consider an ω -segmentation of a straight line segment AB whose length is $9,3 \times 10^{10}$ light years, the assumed diameter of the visible universe. Whatever be the ω -segmentation of this enormous segment all its infinitely many parts, except a finite number of them, will inevitably lie within a final segment CB inconceivable less than, for instance, Planck length ($\sim 10^{-33}$ cm). There is no way to define a less asymmetric ω -segmentation, the smallest of the infinite segmentations (Figure 16.1). Thus, ω -segmentations are infinitely asymmetrical. And being ω the smallest infinite ordinal, any transfinite segmentation has to contain at least one ω -ordered segmentation (Theorem P80b, of the ω th Term). As the next section shows, the unaesthetic consequence of the above asymmetry becomes a little more controversial if the segments of the segmentations are not of a decreasing length.

EUCLIDEAN LENGTHS AND DISTANCES

P335 In what follows, only lines* that do not intersect with themselves will be considered. A line* whose endpoints are A and B

will be denoted by AB . The same notation AB will be used to represent the length of the line* and the distance from A to B if AB is a straight line. Both, length and distance will be real numbers. In these conditions, it is possible to prove, among many others, the following results on lines*, lengths and distances.

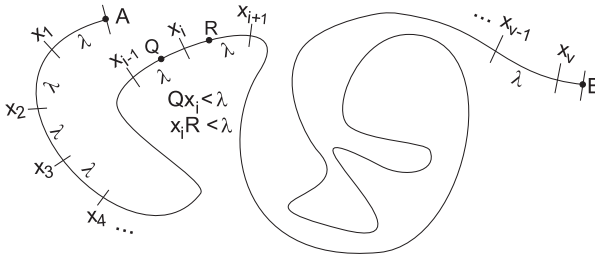

Figure 16.2 – Any line* with two endpoints has a finite length.

Theorem P335, of the Finite Segments.—*In the Euclidean space \mathbb{R}^3 , any line* with two endpoints has a finite length.*

Proof.—(Figure 16.2) Let AB be any line* in the Euclidean space \mathbb{R}^3 , and λ any finite length less than AB . Take in AB a point x_1 such that $Ax_1 = \lambda$. If $x_1B > \lambda$, take in x_1B a point x_2 such that $x_1x_2 = \lambda$. If $x_2B > \lambda$, take in x_2B a point x_3 such that $x_2x_3 = \lambda$. The continuation of this procedure can only end at a point x_v such that $x_vB \leq \lambda$. Hence, the set X has a first element x_1 and a last element x_v . In addition, for any point $x_i, 1 < i < v$ of X , a point Q of Ax_i and a point R of x_iB such that $Qx_i < \lambda, x_iR < \lambda$ can only belong respectively to the adjacent and disjoint segments $x_{i-1}x_i$ and x_ix_{i+1} , otherwise there would be points of X defining segments of length less than λ , which is not the case. In consequence, each $x_i, 1 < i < v$ of X has an immediate predecessor and an immediate successor. Therefore, the set X is finite (Theorem P80c of the Finite Sets), and the same holds for the set S of the successive segments defined by the two points A and B and the v points of the set X : $Ax_1, x_1x_2, x_2x_3, \dots, x_vB$. And being finite the sum of any finite number of finite lengths, AB has a finite length. \square

Corollary P335a, of the Closed Lines.—*In the Euclidean space \mathbb{R}^3 , any closed line* has a finite length.*

Proof.-(Figure 16.3) Let L be any closed line* in the Euclidean

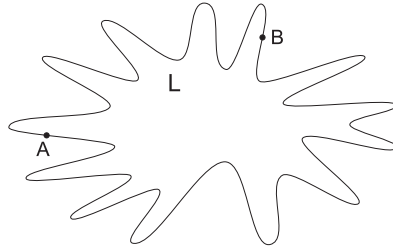

Figure 16.3 – All closed lines* have a finite length in the Euclidean space.

space \mathbb{R}^3 , and A and B any two of its points. A and B define in L , and in the same direction of rotation, two adjacent segments AB and BA whose lengths sum the length of the whole line* L . According to the Theorem P335 of the Finite Segments, AB and BA have a finite length. So, L has also a finite length. \square

Corollary P335b, of the Finite Distances.-*In the Euclidean space \mathbb{R}^3 the distance between any two of its points is always finite.*

Proof.-Let A and B be any two points in the Euclidean space \mathbb{R}^3 . Join them by a straight line AB . In accordance with the Theorem P335 of the Finite Segments, AB has a finite length. So, the distance from A to B , which is the length of the straight line AB , is finite. \square

Corollary P335c, of the Finite Polygons.-*A polygon can only have a finite number of sides and a finite perimeter.*

Proof.-(Figure 16.4) In a polygon, each side has a clockwise

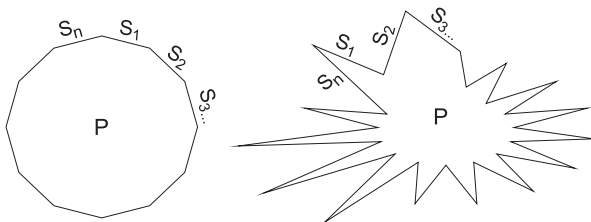

Figure 16.4 – A polygon can only have a finite number of sides and a finite perimeter.

adjacent side (its immediate successor side) and a counterclockwise adjacent side (its immediate predecessor side). Let P be any polygon. Index any of its sides as S_1 and the sides adjacent to S_1 clockwise as S_2, S_3, \dots . The side S_n adjacent to S_1 in the counterclockwise direction can only be the last indexed side. Therefore, P has a first and a last side, and each side has an immediate successor and an immediate predecessor. Consequently, it has a finite number of sides (Theorem P80c of the Finite Sets). And its perimeter will be finite (Theorem P335, of the Finite Segments). \square

Corollary P335d, of the Circumferences.-*The length of the circumference of a circle, its radius, its diameter, and its area can only be finite.*

Proof.-It is an immediate consequence of the corollaries P335a and P335b. \square

Corollary P335e, of the Infinite Lines 1.-*In the Euclidean space \mathbb{R}^3 it is impossible to join any two of its points by a line* of infinite length.*

Proof.-(Figure 16.5) Let A and B be any two points of \mathbb{R}^3 . Join



Figura 16.5 – Two points of the Euclidean space can only be joined by a line* of finite length.

them by any line* AB . The length AB will always be finite (Theorem P335, of the Finite Segments). \square

Corollary P335f, of the Infinite Lines 2.-*In the Euclidean space \mathbb{R}^3 lines* of infinite length are inconsistent.*

Proof.-(Figure 16.6) Let L be any line* in the Euclidean space \mathbb{R}^3 , and P any of its points. P divides L into two lines* L_1 and L_2 , in opposite directions. According to the Theorem P335 of

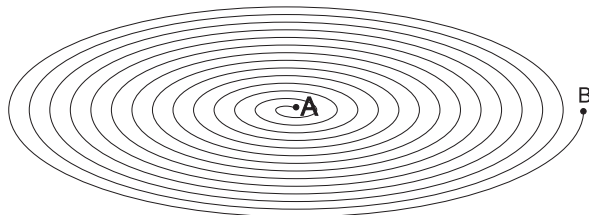
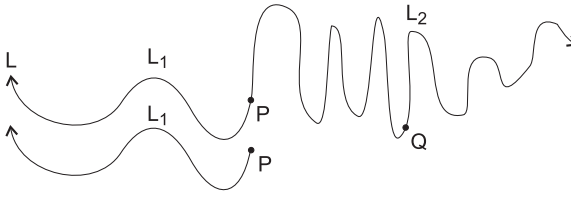

Figure 16.6 – In the Euclidean space all lines* have a finite length.

the Finite Segments, no point Q of L_1 exists such that the segment PQ has an infinite length. In consequence, if all points Q of L_1 such that PQ has a finite length are removed from L_1 the result is an empty set of points. Therefore, L_1 can only have a finite length, except that an empty set of points can have an infinite in length, which is not the case. For the same reason, L_2 has also a finite length. Consequently, L has a finite length. \square

Infinitism rejects the above proof of the Corollary P335f by arguing that even if no point Q of L_1 defines a finite segment PQ , the line* L_1 has an infinite length because it does not have an end (see P321).

A GEOMETRICAL SUPERTASK

P336 As just indicated, Chapter 15 discussed the (inappropriate) objection of infinitism to arguments similar to the proof of the above Corollary P335f. This section adds another proof of that corollary unrelated to the proof given in P335.

P337 Let r be a straight line and c a circle of a finite diameter d whose center is placed on a point x_a of r . Assume that, in the direction from x_a to the right, the straight line r has an infinite length. And let $\langle t_n \rangle = t_1, t_2, t_3 \dots$ be an ω -ordered and strictly increasing sequence of instants within the finite interval of time (t_a, t_b) , whose limit is t_b . Assume that at each instant t_i of $\langle t_n \rangle$, and only at each instant t_i of $\langle t_n \rangle$, the circle c is translated along the straight line r in the same direction from left to right and by a distance equal to its diameter d , so that its center is placed on a

point x_i of the straight line r (Figure 16.7). Obviously, this is a supertask (see Chapter 23), a thought experiment independent of the physical possibilities to be carried out in practice the successive translations.

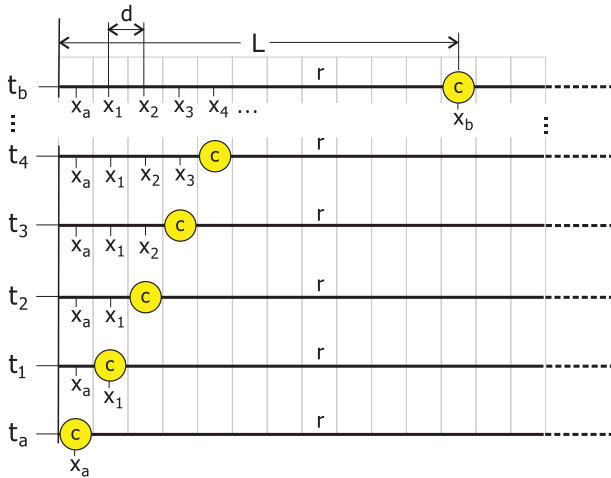

Figure 16.7 – Translating a circle along an infinite straight line

P338 At t_b the circle c will have been translated infinitely many times in the same direction and by the same finite distance d along the straight line r . So, at t_b , and wherever it is, the circle c will continue to be a circle of a diameter d whose center will be a certain point x_b of r (Principle of Invariance P19).

P339 We can consider, therefore, two points of the straight line r : the center x_a of c at the instant t_a and the center x_b of c at instant t_b , after having been translated infinitely many times along the straight line r . According to the Theorem P335 of the Finite Segments, the length L of the segment x_ax_b will be finite. And being d and L two finite numbers, the number $n = L/d$ is also finite.

P340 So, at t_b , and after having been translated an infinite number of times, the circle c has only been translated a finite number n

of times. This contradiction proves the inconsistency of the initial assumption on the infinite length of r .

P341 The above argument can be applied to any type of line* and figure (replacing distance by length in the successive translations). We must therefore conclude that all distances, lines and figures we can consider within a given space will always be finite, which suggests that space itself is finite in all of its dimensions, otherwise it would be hard to explain the impossibility of lines* with an infinite length.

INTRODUCTION

P342 In Chapter 16 it was proved that in the Euclidean space \mathbb{R}^3 any line* with two endpoints can only be divided into a finite number of parts of equal finite length. As a consequence, it was also proved that in the same Euclidean space the distance between any two of its points is always finite, and that all lines, whether open or closed, have a finite length. This chapter discusses the possibility of dividing any finite interval (of space or time) into an infinite number of parts of decreasing lengths (durations), which is the only way in which a finite length (duration) can presumably be divided into infinitely many parts. This would be the Aristotelian infinity by division [12, Books 3 and 6], and the result of the discussion is also the inconsistency of such infinite divisions.

P343 Dividing an interval (a, b) into a given (finite or infinite) number of parts is to define a sequence of adjacent and disjoint parts such that:

$$(a, b) = (a, x_1)[x_1, x_2][x_2, x_3] \dots [x_n, b) \quad (1)$$

$$(a, b) = (a, y_1)[y_1, y_2)[y_2, y_3) \dots \quad (2)$$

In the first case, equation (1), the division is finite (Theorem P80c, of the Finite Sets). It would be a partition of the interval (see P222). In the second, equation (2), the division would be infinite, without a last interval. It would be an ω -ordered segmentation (see P224). In such a case, the sequence of points $\langle x_i \rangle$ defining the ω -segmentation will also be ω -ordered, and its limit will be the right endpoint b of the interval (a, b) .

P344 In the case of the ω -ordered segmentations of an open interval (a, b) , the limit of the increasing (decreasing) sequence of points defining the partition is the right endpoint b (left endpoint a) of the interval. We know that between each of the points of the sequence and its limit there is always the same infinite number \aleph_o of points of the sequence (ω -asymmetry). Moreover, although the successive points approach their limit, none of them reach it. The limit point is not a point of the sequence.

P345 Recall that, according to the definitions given in P222-P224, the collection of intervals:

$$[x_1, x_2][x_2, x_3][x_3, x_4) \dots [x_\omega, x_{\omega+1}) \quad (3)$$

is not a partition because the left endpoint x_ω of the last interval is not common to any other interval. It is also not a ω -segmentation because its ordinal is $\omega + 1$. Therefore it is a $(\omega + 1)$ -segmentation. An example of ω -segmentation would be:

$$[x_1, x_2)[x_2, x_3)[x_3, x_4) \dots \quad (4)$$

DIVISIBILITY OF REAL INTERVALS

P346 In P236-P241 of Chapter12 a real interval (the real interval $(0, 1]$) was divided into an infinite sequence of parts with a first and a last part, each part (except the first) having an immediate predecessor and an immediate successor (except the last). Of course, that division is impossible (Corollary P80, of the Finite Ordinals). The impossible partition was made possible by a denumerable collection of points considered as a complete totality. And since the only property of the collection of points used to define that impossible partition was its supposed denumerability, it was concluded that denumerable collections of points, and in general denumerable sets are inconsistent objects when considered as complete totalities, which is the way they are considered under the hypothesis of the actual infinite.

P347 A proof independent of P236-P241 about the inconsistency

of the ω -segmentations of any real interval (a, b) will now be given. Let $\langle x_i \rangle$ be an ω -ordered sequence of points in the real interval (a, b) , which defines an ω -segmentation of (a, b) :

$$(a, x_1][x_1, x_2][x_2, x_3][x_3, x_4] \dots \quad (5)$$

If the point x_1 is removed from $\langle x_i \rangle$, the remaining points continue to define an ω -segmentation of (a, b) :

$$(a, x_2][x_2, x_3][x_3, x_4][x_4, x_5] \dots \quad (6)$$

If the point x_2 is also removed from $\langle x_i \rangle$, the remaining points continue to define an ω -segmentation of (a, b) :

$$(a, x_3][x_3, x_4][x_4, x_5][x_5, x_6] \dots \quad (7)$$

If the point x_3 is also removed from $\langle x_i \rangle$ the remaining points continue to define an ω -segmentation of (a, b) :

$$(a, x_4][x_4, x_5][x_5, x_6][x_6, x_7] \dots \quad (8)$$

It is immediate to prove that for any natural number v it is possible to remove from $\langle x_i \rangle$ the first v elements of $\langle x_i \rangle$ so that the remaining points of $\langle x_i \rangle$ continue to define an ω -segmentation of (a, b) . It has been just proved that this is what happens when the first element x_1 is removed from $\langle x_i \rangle$. Suppose that, with n being any natural number, this is also what happens when the first n elements of $\langle x_i \rangle$ are removed from $\langle x_i \rangle$. We will have the ω -segmentation of (a, b) :

$$(a, x_{n+1}][x_{n+1}, x_{n+2}][x_{n+2}, x_{n+3}][x_{n+3}, x_{n+4}] \dots \quad (9)$$

Therefore, if the $(n + 1)$ th term is also removed from $\langle x_i \rangle$, we will also have an ω -segmentation of (a, b) :

$$(a, x_{n+2}][x_{n+2}, x_{n+3}][x_{n+3}, x_{n+4}][x_{n+4}, x_{n+5}] \dots \quad (10)$$

So, for every natural number v it is possible to remove from $\langle x_i \rangle$

its first v elements, and the remaining elements continue to define an ω -segmentation of (a, b) .

P348 Suppose that all points that can be removed from $\langle x_i \rangle$ while the remaining ones define an ω -segmentation of (a, b) , are removed from $\langle x_i \rangle$ (Principle of Execution P25). With respect to the number of non-removed points, we will have the following two exhaustive and mutually exclusive alternatives:

p1: All elements of $\langle x_i \rangle$ are removed from $\langle x_i \rangle$.

p2: Not all elements of $\langle x_i \rangle$ are removed from $\langle x_i \rangle$.

Consider also the proposition:

p3: At least one element x_s of $\langle x_i \rangle$ was not removed from $\langle x_i \rangle$.

It is clear that $p2 \Rightarrow p3$, because if not all elements of $\langle x_i \rangle$ have been removed from $\langle x_i \rangle$, at least one element x_s of $\langle x_i \rangle$ has not been removed from $\langle x_i \rangle$. But this is impossible because s is a natural number and, according to the inductive argument P347, for all natural numbers s it is possible to remove from $\langle x_i \rangle$ its first s elements, and the remaining ones define an ω -segmentation of (a, b) . So, it holds:

$$p2 \Rightarrow p3 \quad (11)$$

$$\neg p3 \quad (12)$$

$$\therefore \neg p2 \quad (13)$$

Hence, the proposition $p2$ is false, and $p1$ must be true. Consequently, all elements of $\langle x_i \rangle$ can be removed and still have an ω -segmentation of (a, b)

P349 The problem is that if all points are removed from the sequence $\langle x_i \rangle$, the result can only be an empty set of points. This absurdity is a consequence of the actual infinity hypothesis, according to which all points of $\langle x_i \rangle$ exist as a complete and ω -asymmetric totality, whose elements can be considered successively and one by one. The hypothesis of the potential infinity does not lead to the above absurdity, because from this perspective (a, b) can only be

divided into a finite number of parts, which can be increased by adding new points, but always having a finite number of parts.

P350 It has just been proved that it is possible to remove all points from the sequence of points that defines an ω -segmentation of any real interval (a, b) and still have an ω -segmentation of (a, b) . But if all points of a sequence of points are removed from the sequence, the resulting set can only be the empty set. So the absurdity that the empty set of points defines an ω -segmentation of any real interval (a, b) has just been demonstrated. Which allows us to prove the following:

Theorem P350, of the Divisibility.-*The division of a real interval into an infinite number of parts is inconsistent.*

Proof.-According to P348, ω -segmentations are inconsistent. Since, according to P82, every ω^* -ordered sequence $\langle x_{i^*}^* \rangle$ defines the ω -ordered sequence $\langle x_i \rangle$, ω^* -segmentations are also inconsistent. And since every α -segmentation whose ordinal α is greater than ω contains an ω -segmentation (Theorem P80b, of the ω th Term), every α -segmentation is inconsistent. In addition, any non-denumerable segmentation would include infinitely many numerable segmentations, all of them inconsistent. Therefore, the division of a real interval into a numerable or non-numerable infinite number of parts is inconsistent. \square

DIVIDING INTERVALS OF SPACE AND TIME

P351 Supertask theory will be used in this section to confirm Theorem P350. As is well known, space in physics and geometry, and time in physics, are constructions based on the continuum of the real numbers. Let, then, (a, b) be any space interval and (t_a, t_b) any time interval, both open, finite and parts of \mathbb{R} . Let also $\langle x_i \rangle$ and $\langle t_i \rangle$ be two ω -ordered sequences, the first one of points within the interval (a, b) and the second of instants in the interval (t_a, t_b) , being b the limit of the sequence $\langle x_i \rangle$, and t_b the limit of the sequence $\langle t_i \rangle$.

P352 According to the hypothesis of the actual infinity subsumed

into the Axiom of Infinity, the infinitely many elements of the sequence $\langle x_i \rangle$ exist all at once, as a complete totality. And the same applies to the infinitely many elements of $\langle t_i \rangle$. We can, then, consider one by one the successive elements of $\langle x_i \rangle$ and of $\langle t_i \rangle$. And on that consideration will be based the argument that follows. Indeed, let us consider the following procedure P352:

Procedure P352. *At each of the successive instants of $\langle t_i \rangle$ mark each of the successive points of $\langle x_i \rangle$, so that each point x_i is marked at t_i , and only at t_i .*

P353 Let us now prove the following two theorems

Theorem P353a *At instant t_b all instants of $\langle t_i \rangle$ have passed and all points of $\langle x_i \rangle$ have been marked.*

Proof.-Being t_b the limit of the sequence $\langle t_i \rangle$, the instant t_b is the first instant after all instants of the sequence $\langle t_i \rangle$. Therefore, at t_b all instants of $\langle t_i \rangle$ have passed. On the other hand, the one to one correspondence f between $\langle x_i \rangle$ and $\langle t_i \rangle$ defined by $x_i = f(t_i)$ proves that at t_b all points of $\langle x_i \rangle$ have been marked. \square

Theorem P353b *At instant t_b not all instants of $\langle t_i \rangle$ have passed, and not all points of $\langle x_i \rangle$ have been marked*

Proof.-Let T be the set of all instants within the interval (t_a, t_b) at which only a finite number of instants of the sequence $\langle t_i \rangle$ have passed. And let \bar{T} be the complement set of T with respect to (t_a, t_b) . It must hold: $\bar{T} \neq \emptyset$, otherwise there would be at least one t in \bar{T} and then in (t_a, t_b) at which an infinite number of instants of $\langle t_i \rangle$ have passed, which is impossible because being t_b the limit of $\langle t_i \rangle$, it holds:

$$\forall t \in (t_a, t_b), \exists v \in \mathbb{N} : t_v < t < t_{v+1} \quad (14)$$

so that at instant t only a finite number v of instants of the sequence $\langle t_i \rangle$ have passed. In consequence, and being t any instant of (t_a, t_b) , the set of instants of the interval (t_a, t_b) at which an infinite number of instants of the sequence $\langle t_i \rangle$ have

passed is the empty set. And since t_b is the first instant after all instants of the interval (t_a, t_b) , at the instant t_b not all instants of the sequence $\langle t_i \rangle$ have passed, nor all points of the sequence $\langle x_i \rangle$ have been marked. \square

P354 The contradiction between the theorems P353a and P353b confirms the Theorem P350 on the inconsistency of dividing a real interval into a denumerable infinitude of parts. Since the continuum of the real numbers is the usual model for space and time, we can generalize the above conclusions in the form of the following:

Theorem P354 *A finite interval of space, or time, cannot be divided into a numerable or non-numerable infinite number of parts.*

And if it is not possible to divide a finite interval of space, or of time, into an infinite number of parts, it seems reasonable to consider the possibility of the existence of indivisible minimal units of space and time.

TOWARDS A DISCRETE THEORY OF SPACE AND TIME

P355 The concepts of point, line, straight line, plane, and angle (and a few more) remain primitive concepts in contemporary geometries, whether Euclidean or non-Euclidean. Although for the last three of them formally productive definitions can be given [137]. Contemporary geometries are also continuous geometries: between any two points of any line* there is always the same number of points: 2^{\aleph_0} (the power of the continuum). The same number of points that also exist in any two-dimensional surface and in any three-dimensional solid. A line* of one trillionth of a millimeter, for example, has the same number of points as the whole known three-dimensional universe, exactly 2^{\aleph_0} points.

P356 Although they are continuous geometries, all objects in Euclidean and non-Euclidean geometries are made up of points, which are indivisible units. From this perspective, these geometries could be considered as discrete, discontinuous. The problem

is that points, whatever they are (if they are anything at all), have no extension. Length is a property of lines, not of points. When two points are joined by a line, the length emerges as a property of the line. Lines can have very different lengths, from ultra-microscopic to intergalactic, although they all have the same number of points. Thus, it could be inferred that the lengths of lines have nothing to do with the number of their corresponding points, although lines have only points, and points, as such points, do not have intrinsic properties. Points only have relative positions in arbitrary reference frames.

P357 Being made up of 2^{\aleph_0} points, any line* contains an uncountable infinity of ω -ordered sequences of points, each of which defines a ω -segmentation in the line* or in any interval of the line. According to the Theorem P354, all of them are inconsistent. Consequently, lines, as objects formed by a continuum of points, are inconsistent objects. Since every two-dimensional surface and every three-dimensional solid is made up of the same uncountable infinitude of points, exactly 2^{\aleph_0} points, they all are inconsistent objects. And for the same reason, it can be said that the Euclidean space \mathbb{R}^3 , as defined by a three-dimensional continuum of points, is also inconsistent. A conclusion that is confirmed by the contradictions analyzed in Chapter 13 in relation to the existence of uncountable partitions in the n -dimensional spaces and in the real line.

P358 In this chapter and the previous one, it has been proved that:

- a) A line with two endpoints can only be divided into a finite number of parts with the same finite length.
- b) The (Euclidean) distance between two points is always finite.
- c) The length of a (closed or open) line* is always finite.
- d) lines* of infinite length are inconsistent.
- e) The division of a finite interval of space (time) into an infinite number of parts of a decreasing length (duration) is inconsistent.

- f) lines*, as a continuum of points, are inconsistent.
- g) Two-dimensional and three-dimensional continuums of points are inconsistent.

Therefore, it seems reasonable to propose the consideration of a discrete geometry in substitution of the geometries based on continuums of points. Although discrete geometries already exist, they exist for particular purposes, for example the combinatorial analysis of the relationships between geometric elements [25], or the development of computational algorithms for the representation of geometric objects [74, 54]. There are even general discrete geometries, whether or not related to quantum gravity [19, 95, 97, 173], but not independent of infinitist mathematics. This chapter points to a discrete geometry that has nothing to do with the existing discrete geometries, and that it will surely require the development of a discrete and finitist mathematics, free from the inconsistencies caused by the hypothesis of the actual infinity. The discrete and finite nature of space and time will surely bring about an unprecedented revolution in mathematics and physics (see Appendices A and B).

P359 In certain discrete geometries, such as the geometries of CALMs (see Appendix A), the hypotenuse of the right triangles has the same number of indivisible units of space (geons) as the largest of the legs. The factor that converts between discrete hypotenuses and continuous hypotenuses has the same form as the relativistic factor γ of Lorentz transformation. The special theory of relativity could then be interpreted in terms of a discrete geometry, and the interpretation would be compatible with the experimental support of special relativity, a theory of the space-time continuum. Furthermore, the oddities of relativity could be explained and simplified in the new framework of a discrete geometry.

INTRODUCTION

P360 Koch's fractal, or Koch's curve, was described for the first time by Helge von Koch in 1904 [236, 237], before the concept of fractal were formalized and popularized in the last half of the XX century, particularly by Benoit Mandelbrot [150, 151]. There are some variants of Koch's fractal, of which we will use the closed-line* version known as Koch's snowflake.

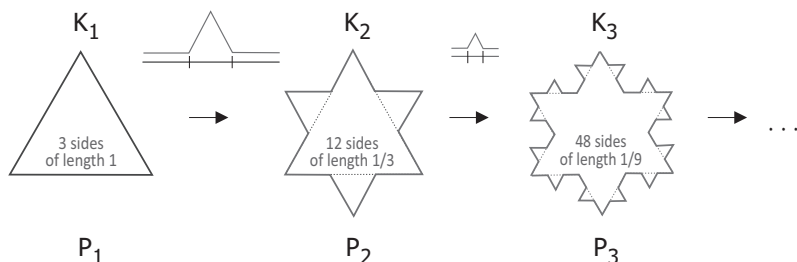

Figure 18.1 – The first three steps of the construction of Koch's snowflake (the original curve described by Koch was constructed on only one of the sides of the triangle). Notice that at each step the number of sides increases by a factor of 4 while their length decrease by a factor of 3.

P361 As Figure 18.1 illustrates, the first step P_1 in the construction of Koch's snowflake is a closed line* K_1 of three straight sides of the same length (an equilateral triangle). In the second step P_2 , the central third of each side is replaced by two identical straight segments of the same length as the replaced one and so that they form an angle of 60° outward. The result is a new closed line* K_2 . In the third step P_3 , the central third of each side is replaced by two identical straight segments of the same length as the replaced one and so that they form an angle of 60° outward. The result is a

new closed line* K_3 . By continuing this procedure (KP hereafter) ad infinitum we would “finally get” Koch’s snowflake \mathcal{K} .

P362 Notice each step P_i of KP originates a closed line* K_i composed of a certain number of sides (that will be referred to as iS), being all of them straight segments of the same length. Notice also that each iS is adjacent to other two iS : the one in the clockwise direction and the other in the anticlockwise direction. For the sake of clarity, we will also say that each side iS has an immediate successor (its adjacent segment in the clockwise direction) and an immediate predecessor (its adjacent segment in the anticlockwise direction). The successive lines* $\langle K_n \rangle$ are discrete in the sense that they are composed of a certain finite number of identical parts (the sides iS) that are adjacent and discontinuous to each other.

P363 For obvious reasons, the words “*and so ad infinitum*” (or the inevitable ellipsis “...”) are omnipresent in infinitist mathematics. Although they not always lead to satisfactory results. As we will see, this is the case of the above introduction to Koch’s fractals, which is the usual way Koch’s fractals are introduced in text books and secondary literature on the subject. In fact the reader could come to the conclusion that by continuing this process ad infinitum one finally reaches Koch’s curve \mathcal{K} . Nothing is further from the truth.

P364 The successive lines* K_1, K_2, K_3, \dots defined by KP form an ω -ordered sequence $\langle K_n \rangle$ whose limit is Koch’s curve \mathcal{K} . Therefore you can never reach \mathcal{K} through the successive terms of the sequence $\langle K_n \rangle$ because the limit \mathcal{K} does not have an immediate predecessor in the sequence $\langle K_n \rangle$ (Corollary P72). Recall ω -asymmetry: *each term* of $\langle K_n \rangle$ has a finite number of predecessors and an infinite number of successors.

P365 Thus, although some metric characteristics of the lines* $\langle K_n \rangle$ approaches to the corresponding metric characteristics of \mathcal{K} as much as you wish, the number of terms between any K_n and \mathcal{K} is always the same: \aleph_0 . So, from the point of view of the number

of terms of the sequence, it is impossible to approach to \mathcal{K} , to get close of \mathcal{K} . Similarly, if you go back from \mathcal{K} towards the element of $\langle K_n \rangle$, you will always come to a term separated from \mathcal{K} by infinitely many other terms of the sequence. Backward steps will always be steps over infinitely many terms of the sequence. From the limit of an ω -ordered sequence, backward jumps are always over an infinite number of terms of that sequence (ω -asymmetry).

P366 In consequence, the above expression: “by continuing this procedure (KP) ad infinitum we will finally get Koch’s fractal \mathcal{K} ” is erroneous. By continuing that procedure you will never get \mathcal{K} . Koch’s curve \mathcal{K} can only be defined as the limit of the sequence of lines* $\langle K_n \rangle$ defined by KP. Moreover, some significant characteristics of the lines* $\langle K_n \rangle$, as their discreteness, could not be present in \mathcal{K} . The limit of a sequence is independent of the terms of the sequences of which it is a limit.

P367 It is clear on the other hand that as KP progresses:

- a) The length L_n of the successive lines* K_n increases with n :

$$L_n = L_1 \left(\frac{4}{3} \right)^{n-1} \quad (1)$$

where L_1 is the length of K_1 in a certain metric (as the euclidean metric of \mathbb{R}^2).

- b) The number N_n of sides of the successive K_n increases with n :

$$N_n = 3 \times 4^{n-1} \quad (2)$$

- c) The length l_n of the sides nS of the successive K_n decreases with n :

$$l_n = L_1 \left(\frac{1}{3} \right)^{n-1} \quad (3)$$

P368 In the limit we will have:

$$\lim_{n \rightarrow \infty} L_n = \lim_{n \rightarrow \infty} L_1 \times \left(\frac{4}{3}\right)^{n-1} = \infty \quad (4)$$

$$\lim_{n \rightarrow \infty} N_n = \lim_{n \rightarrow \infty} 3 \times 4^{n-1} = \infty \quad (5)$$

$$\lim_{n \rightarrow \infty} l_n = \lim_{n \rightarrow \infty} L_1 \times \left(\frac{1}{3}\right)^{n-1} = 0 \quad (6)$$

P369 Koch's snowflake \mathcal{K} is the limit approached by the successive terms of $\langle K_n \rangle$. Therefore, and in accordance with the above limits, \mathcal{K} will have an infinite length and infinitely many sides of length 0 (both in the same metric as L_n and l_n), which could be interpreted as not having sides anyway. To prove other features of Koch snowflake is not so immediate (see for instance [232]). We know it is a closed continuous, although nowhere differentiable, function whose fractal dimension D is:

$$D = \frac{\log 4}{\log 3} = 1,261859507 \quad (7)$$

P370 If \mathcal{K} were a closed line* of infinite length, it would be an inconsistent line* according to the Corollary of the Closed Lines proved in Chapter 16. In the last section of this chapter we will develop another argument on the sequence of closed lines* $\langle K_n \rangle$ whose conclusion points to the same inconsistency.

CONDITIONAL KOCH'S SNOWFLAKE

P371 Let us impose the following restriction to the above procedure KP:

Restriction P371.—*Each step P_i of KP will be carried out if, and only if, the resulting line* K_i is a closed line* composed of $3 \times 4^{i-1}$ sides iS of identical length greater than zero, and so that each side has an immediate successor and an immediate predecessor.*

P372 Let us now prove that for every natural number v the first v steps $\langle P_i \rangle_{i=1,2,\dots,v}$ of KP can be carried out without violating Restriction P371. It is quite clear that the equilateral triangle of P_1 satisfies all requirements of the Restriction P371. Now, and being n any natural number, assume the first n steps $\langle P_i \rangle_{i=1,2,\dots,n}$ can be carried out without violating Restriction P371. The resulting closed line* K_n will consist of $3 \times 4^{n-1}$ sides nS each with a length $L_1/3^{n-1} > 0$. It is then possible to replace the central third of each side nS with two straight segments of length $L_1/3^n > 0$ forming an angle of 60° outwards. The resulting line* is a closed line* K_{n+1} with 3×4^n sides ${}^{n+1}S$ of length $L_1/3^n > 0$ and each new side has an immediate predecessor and an immediate successor. So it satisfies Restriction P371v. Thus the first $n + 1$ steps $\langle P_i \rangle_{i=1,2,\dots,n+1}$ of KP could also be carried out without violating Restriction P371. This proves that for any natural number v the first v steps $\langle P_i \rangle_{i=1,2,\dots,v}$ of KP can be carried out without violating Restriction P371.

P373 Assume now that while the successive steps P_i of KP can be carried out, they are carried out (Principle of Execution P25). Let \mathcal{K}' be the resulting line*. It is immediate to prove the following two theorems:

Theorem P373a, of Koch a.-*The number of sides of \mathcal{K}' is finite.*

Prof.-Let r be the number of sides of \mathcal{K}' . We can index the sides of \mathcal{K}' by indexing any one of them as the first side S_1 and the successive adjacent sides in the clockwise sense as $S_2, S_3, S_4 \dots$. The side S_r adjacent to S_1 in the anticlockwise sense can only be the last (indexed) side of \mathcal{K}' . In addition, each side of \mathcal{K}' has an immediate successor and an immediate predecessor. So, the number of sides of \mathcal{K}' is finite (Theorem P80c of the Finite Set). \square

Theorem P373b, of Koch b.-*The number of sides of \mathcal{K}' is not finite.*

Prof.-Assume the number of sides of \mathcal{K}' is finite. It will be a certain natural number n . From the inequality:

$$n < 3 \times 4^{n-1} \tag{8}$$

and taking into account the number of sides nS of K_n is $3 \times 4^{n-1}$ we immediately deduce that the n th step P_n of KP has not been carried out, which is impossible according to P372. \square

P374 As always, the above contradiction between Koch a and Koch b theorems can only be a consequence of the hypothesis of the actual infinity, of the hypothesis that infinite sets do exist as complete totalities. This is in fact the only hypothesis in the above conditional construction of \mathcal{K}' . From the perspective of the potential infinity, on the other hand, that contradiction never appears because the number of sides of \mathcal{K}' is always finite, as greater as you wish but always finite.

INTRODUCTION

P375 To name an object we only need to invent an arbitrary term (word(s) or symbol(s)) to denote the object. But to name an object is not the same as to define the object in terms of other previously defined objects. In this last case, we would also have to define those previously defined objects in terms of other previously defined objects, and these last objects in terms of other previously defined objects, and so on and on. We would finally fall into a potentially infinite regression of definitions.

P376 For this reason we are forced to accept primitive concepts we use without having been previously defined. Most basic concepts in both formal and experimental sciences belong to this category: number, set, space, point, time, mass, etc. In some cases, as with the concept of mass or number, operational definitions are available. In other cases (set, point, instant, etc.) not even that.

P377 For the same reason as in the case of primitive concepts, we also need axioms (formal sciences) and fundamental laws (experimental sciences). Although in this case to avoid an infinite regression of arguments. While axioms may be arbitrary, most of the fundamental laws of experimental sciences are inductive conclusions derived from experimental observations and measurements.

P378 Euclid's Elements is perhaps the first axiomatic system in the history of Mathematics. Notwithstanding, the history of mathematics until the beginning of the XX century is full of works no so formalized as it could be expected. This is the case of Cantor's foundational works on transfinite numbers, his famous *Beiträ-*

ge [44, 45] (English translation [47]). Cantor made no assumption about the existence of infinite sets, he simply took it for granted the existence of transfinite aggregates (transfinite sets). In particular, the existence of the “aggregate [set] of all finite cardinals” (natural numbers), whose cardinal is Aleph-null. The next section discusses some inconveniences of Cantor definition of the first transfinite cardinal.

THE SMALLEST TRANSFINITE CARDINAL

P379 ‘Contributions to the founding of the theory of Transfinite numbers (Beiträge zur Begründung der transfiniten Mengenlehre) is the most important Cantor’s work on the foundation of transfinite arithmetic. It resumes and refines most of his previous works on sets and transfinite cardinals and ordinals published since 1870. Beiträge’s Section 6 begins as follows [47, p. 103-104]:

Aggregates with finite cardinal numbers are called “finite aggregates,” all other we will call “transfinite aggregates” and their cardinal numbers “transfinite cardinal numbers.” The first example of a transfinite aggregate is given by the totality of finite cardinal numbers ν ; we call its cardinal number “Aleph zero” and denote it by \aleph_o ; thus we define:

$$\aleph_o = \{\overline{\nu}\} \tag{1}$$

It is then clear that Cantor defined \aleph_o as the cardinal of the set of *all* finite cardinals. In modern notation it can be written:

$$\aleph_o = |\{1, 2, 3, \dots\}| = |\mathbb{N}| \tag{2}$$

P380 Next, Cantor proved that \aleph_o is not a finite cardinal [47, §6]. For this he proved that $\aleph_o = \aleph_o + 1$, while for every finite cardinal n it holds $n \neq n + 1$. So, \aleph_o cannot be a finite cardinal. As could not be otherwise, the proof that $\aleph_o = \aleph_o + 1$ is based on a one to one correspondence. In effect, consider the sets:

$$\mathbb{N} = \{1, 2, 3, \dots\} \quad (\text{Cardinal } \aleph_o) \tag{3}$$

$$A = \mathbb{N} \cup \{0,333\} \quad (\text{Cardinal } \aleph_o + 1) \tag{4}$$

The one to one correspondence f between \mathbb{N} and A defined by:

$$f(1) = 0,333 \quad (5)$$

$$f(i + 1) = i, \quad \forall i \in \mathbb{N} \quad (6)$$

proves that both sets are equipotent (equivalent), and then that $\aleph_o = \aleph_o + 1$. Obviously, $n \neq n + 1$ because all finite sets satisfy the Euclidean Axiom of the Whole and the Part. And $\aleph_o = \aleph_o + 1$ because transfinite sets violate, by definition, that Euclidean axiom.

P381 Cantor also proved [47, §6] that:

a) \aleph_o is greater than all finite cardinals.

Cantor's Proof: Every finite cardinal is the cardinal of a set that is a proper part of the set of all finite cardinals and that part is not equivalent to the set of all finite cardinals.

b) \aleph_o is the smallest transfinite cardinal number.

Cantor's Proof: On the one hand, every transfinite set has proper parts of cardinal \aleph_o , and of the other if a set has cardinal \aleph_o any of its transfinite parts has also the cardinal number \aleph_o .

Thus, these properties of \aleph_o are formal consequences of its definition as the cardinal of the set of all finite cardinals. They are not part of the definition of \aleph_o .

P382 We will now examine in which way, if any, the definition of \aleph_o is related to the operational definition of finite cardinals. Finite cardinals may be operationally defined in different ways, for instance by recursive definitions (see Chapter 4), as the following one:

$$1 = |\{\emptyset\}| \quad (7)$$

$$2 = |\{\emptyset, \{\emptyset\}\}| \quad (8)$$

$$3 = |\{\emptyset, \{\emptyset\}, \{\emptyset, \{\emptyset\}\}| \quad (9)$$

$$4 = |\{\emptyset, \{\emptyset\}, \{\emptyset, \{\emptyset\}\}, \{\emptyset, \{\emptyset\}, \{\emptyset, \{\emptyset\}\}\}| \quad (10)$$

...

or even:

$$1 = |\{0\}| \tag{11}$$

$$2 = |\{0, 1\}| \tag{12}$$

$$3 = |\{0, 1, 2\}| \tag{13}$$

$$4 = |\{0, 1, 2, 4\}| \tag{14}$$

...

P383 The sequence of the above recursive definitions, and many similar others, is considered as a complete sequence that originates the complete totality of the natural numbers in agreement with the hypothesis of the actual infinity. Notwithstanding, and in spite of the fact that it consists of infinitely many steps and each step defines a number greater than its immediate predecessor, no infinite number is reached. According to infinitism, it yields an infinite sequence of finite numbers, each one unit greater than its immediate predecessor, but always finite. As could not be otherwise, \aleph_o cannot be recursively defined from the sequence of finite cardinals, \aleph_o is unrelated to this operational sequence.

P384 Being the smallest infinite cardinal greater than all finite cardinals, \aleph_o could be considered as the limit of the strictly increasing sequence of the finite cardinals. But while the distance between the successive terms of a convergent sequence and its limit always decreases, in the case of \aleph_o that distance is either undefined or always the same (just \aleph_o). Chapter 21 discusses the subtraction of cardinals and the singularities of that operation when there are infinite cardinals involved.

P385 It is easy to see that the successive natural numbers do not approach \aleph_o as the successive terms of a convergent sequence to their limit do. Let n_1 and n_2 be two natural numbers such that $n_1 < n_2$, being $n_2 - n_1 = a$. Suppose the successive natural numbers approach \aleph_o . We would have:

$$\aleph_o - n_2 < \aleph_o - n_1 \tag{15}$$

$$\aleph_o < \aleph_o - n_1 + n_2 \tag{16}$$

$$\aleph_o < \aleph_o + a \quad (17)$$

which is not the case. Thus, whether or not finite cardinals can be subtracted from \aleph_o , the successive natural numbers do not approach to \aleph_o . Therefore, \aleph_o is not the limit of the strictly increasing sequence of the natural numbers. It is the smallest of the infinite cardinals greater than all finite cardinals, but it is not their limit.

P386 We lack of a formal definition of number. But we know what we mean when we say the set $A = \{a, b, c, d, e\}$ has five elements: we can count them; we can consider them successively; we dispose of operational instruments to identify them. But none of those operational instrument is applicable to the case of \aleph_o . Therefore, we must assume not only that the set of all finite cardinals does exist as a complete totality, but also that this set has a precise cardinal number, were number, in this case, is a primitive notion unrelated to any of the operative definitions available for the concept of number.

P387 On the other hand, Cantor's definition of \aleph_o could be equivalent to a circular definition. In effect, assuming the cardinal of the union of two disjoint sets is the sum of their respective cardinals we will have:

$$\aleph_o = |\{1, 2, 3, \dots\}| \quad (18)$$

$$= |\{1\} \cup \{2\} \cup \{3\} \cup \dots| \quad (19)$$

$$= |\{1\}| + |\{2\}| + |\{3\}| + \dots \quad (20)$$

$$= 1 + 1 + 1 + \dots \quad (21)$$

and the last sum is defined only if we know the number of summands, and that number is just the number being defined by the sum.

P388 Let us consider again Cantor original definition of \aleph_o :

$$\aleph_o = |\{1, 2, 3, \dots\}| \quad (22)$$

and let us call *defining set* to the set $\{1, 2, 3, \dots\}$ used to define the cardinal \aleph_o . Consider also the following conditioned supertask: at each of the successive instants t_n of the ω -ordered sequence of instants $\langle t_n \rangle$ within the finite real interval $[t_a, t_b)$ and whose limit is t_b , take away the first element of the defining set of \aleph_o if, and only if, the resulting set remains a defining set of \aleph_o :

$$\begin{aligned} t_1 &: \text{defining set } \{2, 3, 4, \dots\} : \aleph_o = |\{2, 3, 4, \dots\}| \\ t_2 &: \text{Defining set } \{3, 4, 5, \dots\} : \aleph_o = |\{3, 4, 5, \dots\}| \\ t_3 &: \text{Defining set } \{4, 5, 6, \dots\} : \aleph_o = |\{4, 5, 6, \dots\}| \\ &\dots \end{aligned}$$

Let v be any finite cardinal and assume that at t_b , once completed the supertask, we have:

$$t_b : \aleph_o = |\{v, v + 1, v + 2, \dots\}| \quad (23)$$

Since

$$\aleph_o = |\{v + 1, v + 2, v + 3, \dots\}| \quad (24)$$

the number v had to be removed from the defining set at the instant t_v . So definition (23) is impossible for any finite number v . We would have to conclude that, at t_b , definition (23) is impossible for every finite cardinal v . In these conditions we can only have:

$$t_b : \aleph_o = |\emptyset| = 0 \quad (25)$$

INTRODUCTION

P389 This chapter will be concerned with the transfinite cardinals \aleph_o and 2^{\aleph_o} , as well as with the elements of the ω -ordered set of the natural numbers $\mathbb{N} = \{1, 2, 3, \dots\}$. It will also make use of the basic arithmetic operations between finite and infinite cardinals introduced by Cantor in his foundational work on transfinite numbers [47]. Operations that continue to be applicable in modern infinitist mathematics.

P390 Once assumed the existence of the set \mathbb{N} of all finite cardinals (natural numbers) as a complete totality (in modern terms: the actual infinity hypothesis subsumed in the Axiom of Infinity), Cantor defined \aleph_o as its cardinal. He then proved \aleph_o is the smallest infinite cardinal greater than all finite cardinals [47, §6].

P391 Arithmetic operations of infinitely many operands are usual in infinitist arithmetic. So, not only the operands but also the number of arithmetic operations can be of any finite or infinite size. In what follows, and for reasons of clarity, we will index the successive operands of the arithmetic operations even when non strictly necessary.

IS ALEPH-NUL A PRIME NUMBER?

P392 Axiomatic set theories (for instance ZFC-axiomatic) legitimize the possibility to dissociate any finite or infinite set into two or more disjoint sets. For example, the set \mathbb{N} of the natural numbers can be written as:

$$\mathbb{N} = \{1, 2, 3, \dots\} = \{1\} \cup \{2, 3, 4, \dots\} = \{1\} \cup \{2\} \cup \{3, 4, 5 \dots\} \dots$$

Thus, if $|X|$ denotes the cardinal of a set X , and taking into account the cardinal of the union of two disjoint sets is the sum of the cardinal of each set, we will have:

$$\aleph_o = |\{1, 2, 3, \dots\}| \quad (1)$$

$$= |\{1\} \cup \{2, 3, 4, \dots\}| \quad (2)$$

$$= |\{1\}| + |\{2, 3, 4, \dots\}| \quad (3)$$

$$= 1_1 + |\{2, 3, 4, \dots\}| \quad (4)$$

where the natural number 1 is written as 1_1 to indicate it stands for the cardinal of the set $\{1\}$ whose unique element is the natural number 1; the same will apply to the successive cardinals $1_2, 1_3, 1_4 \dots$ of the successive singletons (sets with a unique element) $\{2\}, \{3\}, \{4\}, \dots$. Recall that Cantor used equation (4) to prove \aleph_o is not a natural number (see Chapter 19 on Aleph-null).

P393 By successive dissociations (S-dissociations from now on) of \mathbb{N} we will obtain:

$$\aleph_o = |\{1, 2, 3, \dots\}| \quad (5)$$

$$= |\{1\} \cup \{2, 3, 4, \dots\}| \quad (6)$$

$$= |\{1\}| + |\{2, 3, 4, \dots\}| \quad (7)$$

$$= 1_1 + |\{2, 3, 4, \dots\}| \quad (8)$$

$$= 1_1 + |\{2\} \cup \{3, 4, 5, \dots\}| \quad (9)$$

$$= 1_1 + |\{2\}| + |\{3, 4, 5, \dots\}| \quad (10)$$

$$= 1_1 + 1_2 + |\{3, 4, 5, \dots\}| \quad (11)$$

$$= 1_1 + 1_2 + |\{3\} \cup \{4, 5, 6, \dots\}| \quad (12)$$

$$= 1_1 + 1_2 + |\{3\}| + |\{4, 5, 6, \dots\}| \quad (13)$$

$$= 1_1 + 1_2 + 1_3 + |\{4, 5, 6, \dots\}| \quad (14)$$

...

It is worth noting that a S-dissociation simply dissociates a set into two disjoint sets, so that the cardinal of the original set is the sum of the cardinals of the resulting two sets.

P394 Infinitist mathematics assumes that procedures of infinitely many steps as the above S-dissociation can in fact be carried out. On the other hand, it can easily be proved, by induction or by Modus Tollens (MT), that for each natural number v it is possible to perform the first v successive S-dissociations.

P395 The MT proof goes as follows: Assume it is false that for every natural number v the first v successive S-dissociations can be carried out. If that were the case, there would exist at least a natural number $n \leq v$ such that it is impossible to perform the n th S-dissociations. That is to say, there would exist at least a natural number n such that:

$$\aleph_o = 1_1 + 1_2 + \cdots + 1_{n-1} + |\{n, n+1, n+2, \dots\}| \quad (15)$$

and $\{n, n+1, n+2, \dots\}$ can no longer be S-dissociated. But this is false because:

$$\aleph_o = 1_1 + 1_2 + \cdots + 1_{n-1} + |\{n, n+1, n+2, \dots\}| \quad (16)$$

$$= 1_1 + 1_2 + \cdots + 1_{n-1} + |\{n\} \cup \{n+1, n+2, n+3, \dots\}| \quad (17)$$

$$= 1_1 + 1_2 + \cdots + 1_{n-1} + |\{n\}| + |\{n+1, n+2, n+3, \dots\}| \quad (18)$$

$$= 1_1 + 1_2 + \cdots + 1_{n-1} + 1_n + |\{n+1, n+2, n+3, \dots\}| \quad (19)$$

Our initial assumption must therefore be false, and then we can assert that for every natural number v the first v successive S-dissociations can be carried out.

P396 The inductive proof is as follows:

- a) It is quite clear the first S-dissociation can be carried out because:

$$\aleph_o = |\{1, 2, 3, \dots\}| \quad (20)$$

$$= |\{1\} \cup \{2, 3, 4, \dots\}| \quad (21)$$

$$= |\{1\}| + |\{2, 3, 4, \dots\}| \quad (22)$$

$$= 1_1 + |\{2, 3, 4, \dots\}| \quad (23)$$

b) Assume that, being n any natural number, the first n successive S-dissociations can be carried out. We would have:

$$\aleph_o = 1_1 + 1_2 + \dots + 1_n + |\{n + 1, n + 2, n + 3, \dots\}| \quad (24)$$

and then we can write:

$$\aleph_o = 1_1 + 1_2 + \dots + 1_n + |\{n + 1\} \cup \{n + 2, n + 3, \dots\}| \quad (25)$$

$$= 1_1 + 1_2 + \dots + 1_n + |\{n + 1\}| + |\{n + 2, n + 3, \dots\}| \quad (26)$$

$$= 1_1 + 1_2 + \dots + 1_n + 1_{n+1} + |\{n + 2, n + 3, \dots\}| \quad (27)$$

which means the first $n + 1$ successive S-dissociations can also be carried out.

We have then proved the first S-dissociation can be carried out and if, for any n in \mathbb{N} , the first n successive S-dissociations can be carried out, then the first $n + 1$ successive S-dissociations can also be carried out. This proves that for any v in \mathbb{N} the first v successive S-dissociations can be carried out.

P397 Assume now that while the successive S-dissociations can be carried out, they are carried out. Once performed all possible successive S-dissociations (Principle of Execution P25) we would have one of the following two exhaustive and mutually exclusive alternatives:

$$\aleph_o = 1_1 + 1_2 + \dots + 1_v + |\{v + 1, v + 2, v + 3, \dots\}| \quad (28)$$

$$\aleph_o = 1_1 + 1_2 + 1_3 + \dots \quad (29)$$

where v is a certain natural number. Since $v + 1$ is also a natural number, the first alternative must be false according to P395 and P396. Notice this is not a question of indeterminacy but of impossibility: the set of natural numbers for which the first alternative is true is the empty set, while if v were indeterminate there

would exist a nonempty set of possible solutions. Consequently, once performed all possible successive S-dissociations (Principle of Execution P25) we will have:

$$\aleph_o = 1_1 + 1_2 + 1_3 + \dots \quad (30)$$

Let $S = \{1_1, 1_2, 1_3, \dots\}$ be the set of all summands of the sum (30). The one to one correspondence f between \mathbb{N} and S defined by $f(i) = 1_i$, proves that the successive elements of the set S can be indexed by the totality of the successive natural numbers. Hence, that set is ω -ordered (Theorem P80a, of the Indexed Sets). Therefore, the set S defines the ω -ordered sequence $\langle 1_i \rangle$, being each 1_i of $\langle 1_i \rangle$ the cardinal $|\{i\}|$, which is equal to 1.

P398 According to (30), and taking into account the associativity of cardinals addition and the fact that, as Cantor himself proved [47, p. 94-97, §4], $a^x \times a^y = a^{x+y}$ being a , x and y any three finite or infinite cardinals, we can write:

$$2^{\aleph_o} = 2^{1_1+1_2+1_3+\dots} \quad (31)$$

$$= 2^{1_1+(1_2+1_3+\dots)} \quad (32)$$

$$= 2^{1_1} \times 2^{1_2+1_3+1_4+\dots} \quad (33)$$

where each 1_i represent the cardinal of the singleton $\{i\}$, which is 1.

P399 The successive power dissociations of 2^{\aleph_o} (P-dissociations hereafter) would be:

$$2^{\aleph_o} = 2^{1_1+1_2+1_3+\dots} \quad (34)$$

$$= 2^{1_1+(1_2+1_3+\dots)} \quad (35)$$

$$= 2^{1_1} \times 2^{1_2+1_3+1_4+\dots} \quad (36)$$

$$= 2^{1_1} \times 2^{1_2+(1_3+1_4+\dots)} \quad (37)$$

$$= 2^{1_1} \times 2^{1_2} \times 2^{1_3+1_4+1_5+\dots} \quad (38)$$

$$= 2^{1_1} \times 2^{1_2} \times 2^{1_3+(1_4+1_5+\dots)} \quad (39)$$

$$= 2^{1_1} \times 2^{1_2} \times 2^{1_3} \times 2^{1_4+1_5+1_6+\dots} \quad (40)$$

$$= 2^{1_1} \times 2^{1_2} \times 2^{1_3} \times 2^{1_4+(1_5+1_6+\dots)} \quad (41)$$

...

Notice a P-dissociation is a simple application of the associative property of addition and of a standard property of the product of powers.

P400 Let us prove by MT (an inductive proof is also possible) that for every natural number v the first v successive P-dissociations can be carried out. Assume it is false that for every natural number v the first v successive P-dissociations can be carried out. In such a case there would exist at least a natural number $n \leq v$ such that:

$$2^{\aleph_o} = 2^{1_1} \times 2^{1_2} \times \dots \times 2^{1_{n-1}} \times 2^{1_n+1_{n+1}+1_{n+2}+\dots} \quad (42)$$

and $2^{1_n+1_{n+1}+1_{n+2}+\dots}$ cannot be P-dissociated. But this false because:

$$2^{\aleph_o} = 2^{1_1} \times 2^{1_2} \times \dots \times 2^{1_{n-1}} \times 2^{1_n+1_{n+1}+1_{n+2}+\dots} \quad (43)$$

$$= 2^{1_1} \times 2^{1_2} \times \dots \times 2^{1_{n-1}} \times 2^{1_n+(1_{n+1}+1_{n+2}+\dots)} \quad (44)$$

$$= 2^{1_1} \times 2^{1_2} \times \dots \times 2^{1_{n-1}} \times 2^{1_n} \times 2^{1_{n+1}+1_{n+2}+1_{n+3}+\dots} \quad (45)$$

Therefore our initial assumption must be false and we can assert that for every natural number v the first v successive P-dissociations can be carried out.

P401 Assume that while the successive P-dissociations can be carried out, they are carried out. Once performed all possible successive P-dissociations (Principle of Execution P25) we will have one of the following two exhaustive and mutually exclusive alternatives:

$$2^{\aleph_o} = 2^{1_1} \times 2^{1_2} \times \dots \times 2^{1_{v-1}} \times 2^{1_v+1_{v+1}+1_{n+3}+\dots} \quad (46)$$

$$2^{\aleph_o} = 2^{1_1} \times 2^{1_2} \times 2^{1_3} \times \dots \quad (47)$$

where v is a certain natural number. According to P400, and being v a natural number, the first alternative must be false. Notice again this is not a question of indeterminacy but of impossibility: the set of natural numbers for which the first alternative is true is the empty set, while if v were indeterminate there would exist a nonempty set of possible solutions. Consequently, once performed all possible successive P-dissociations (Principle of Execution P25) we will have:

$$2^{\aleph_o} = 2^{1^1} \times 2^{1^2} \times 2^{1^3} \times \dots \tag{48}$$

Let $F = \{2^{1^1}, 2^{1^2}, 2^{1^3} \dots\}$ be the set of all factors of the product (48). The one to one correspondence g between \mathbb{N} and F defined by $g(i) = 2^{1^i}, \forall i \in \mathbb{N}$, proves that the successive elements of the set F can be indexed by the totality of the successive natural numbers. Hence, that set is ω -ordered (Theorem P80a, of the Indexed Sets). So then, the set F defines the ω -ordered sequence $\langle 2_i^{1^i} \rangle$, being each $2_i^{1^i}$ of $\langle 2_i^{1^i} \rangle$ an indexed factor equal to 2.

P402 Equation (48) is taken for granted and, as Cantor did, it can be immediately derived from Cantor's definition of cardinal exponentiation [47, §4].

P403 An immediate consequence of (48) is that \aleph_o cannot be expressed by a product of finite cardinals greater than 1. In fact, if the number of factors is finite the product will also be finite. If the number of factors is infinite the product will be equal or greater than 2^{\aleph_o} , which in turn is greater than \aleph_o (Cantor Theorem of the Power Set [43]). Thus, as in the case of prime numbers, \aleph_o must always form part of its own factorizations:

$$\aleph_o = 1 \times 2 \times \dots \times n \times \aleph_o \tag{49}$$

$$= 3 \times 333 \times 3333 \times \aleph_o \times \aleph_o \tag{50}$$

$$= 10^{3456789} \times \aleph_o^{123234346543598923693492984120423456789} \tag{51}$$

$$= \aleph_o^{9^{19}} \times \aleph_o^{9^{19}} \times \aleph_o^{9^{19}} \times (\dots) \times \aleph_o^{9^{19}} \tag{52}$$

etc.

ALEPH-NULL AND THE POWER OF THE CONTINUUM

P404 Let us write the first factor 2^{1^1} in (48) as $1_1 + 1_2$. We will have:

$$2^{\aleph_0} = (1_1 + 1_2) \times 2^{1^2} \times 2^{1^3} \times 2^{1^4} \times \dots \quad (53)$$

P405 Taking into account the associativity of cardinal multiplication as well as the distributive property of cardinal multiplication over cardinal addition, we can successively duplicate the number of summands in the first factor of (53) by multiplying it by the successive second factors of (53), and splitting each product $1_i \times 2^{1^j}$ as $1_{2i-1} + 1_{2i}$:

$$2^{\aleph_0} = (1_1 + 1_2) \times 2^{1^2} \times 2^{1^3} \times 2^{1^4} \times \dots \quad (54)$$

$$= [(1_1 + 1_2) \times 2^{1^2}] \times 2^{1^3} \times 2^{1^4} \times \dots \quad (55)$$

$$= (1_1 + 1_2 + 1_3 + 1_4) \times 2^{1^3} \times 2^{1^4} \times 2^{1^5} \times \dots \quad (56)$$

$$= [(1_1 + 1_2 + 1_3 + 1_4) \times 2^{1^3}] \times 2^{1^4} \times 2^{1^5} \times \dots \quad (57)$$

$$= (1_1 + 1_2 + \dots + 1_8) \times 2^{1^4} \times 2^{1^5} \times 2^{1^6} \times \dots \quad (58)$$

$$= [(1_1 + 1_2 + \dots + 1_8) \times 2^{1^4}] \times 2^{1^5} \times 2^{1^6} \times \dots \quad (59)$$

$$= (1_1 + 1_2 + \dots + 1_{16}) \times 2^{1^5} \times 2^{1^6} \times 2^{1^7} \times \dots \quad (60)$$

$$= [(1_1 + 1_2 + \dots + 1_{16}) \times 2^{1^5}] \times 2^{1^6} \times 2^{1^7} \times \dots \quad (61)$$

$$= (1_1 + 1_2 + \dots + 1_{32}) \times 2^{1^6} \times 2^{1^7} \times 2^{1^8} \times \dots \quad (62)$$

...

These successive duplications of the first factor of (53) will be referred to as F-duplications. It is clear that in each new F-duplication the number of summands of the first factor is doubled, so that if the previous sum has been multiplied by 2^{1^n} , the indexes i of the successive new summands verify:

$$1 \leq i \leq 2^n \quad (63)$$

In accordance with P401, the sequence of the successive factors of the successive F-duplications is the ω -ordered sequence of factors

$\langle 2_i^{1_i} \rangle$. In consequence, only an ω -ordered sequence of successive F-duplications could be carried out, and in each of them the index i of the corresponding factor 2^{1_i} that doubles the summands, is a natural number i . Therefore, and according to (63), the successive summands of the successive duplications will be indexed by the successive natural numbers.

P406 Let us prove, by MT (an inductive proof is also possible), that for every natural number v the first v successive F-duplications can be carried out. For this, assume it is false that for every natural number v the first v successive F-duplications can be carried out. There would exist at least a natural number $n \leq v$ such that it is impossible to perform the n th F-duplication. That is to say, there would exist at least a natural number n such that:

$$2^{\aleph_0} = (1_1 + 1_2 + \dots + 1_{2^{n-1}}) \times (2^{1_n} \times 2^{1_{n+1}} \times 2^{1_{n+2}} \times \dots) \quad (64)$$

cannot be F-duplicated. It is immediate to prove this is false because:

$$2^{\aleph_0} = (1_1 + 1_2 + \dots + 1_{2^{n-1}}) \times (2^{1_n} \times 2^{1_{n+1}} \times 2^{1_{n+2}} \times \dots) \quad (65)$$

$$= (1_1 + 1_2 + \dots + 1_{2^{n-1}}) \times (2^{1_n}) \times (2^{1_{n+1}} \times 2^{1_{n+2}} \times \dots) \quad (66)$$

$$= [(1_1 + 1_2 + \dots + 1_{2^{n-1}}) \times 2^{1_n}] \times 2^{1_{n+1}} \times 2^{1_{n+2}} \times \dots \quad (67)$$

$$= (1_1 + 1_2 + \dots + 1_{2^n}) \times (2^{1_{n+1}} \times 2^{1_{n+2}} \times 2^{1_{n+3}} \times \dots) \quad (68)$$

Our initial assumption is, then, false. Therefore, for every natural number v the first v successive F-duplications can be carried out.

P407 Assume now that while the successive F-duplications can be carried out (Principle of Execution P25), they are carried out. Once performed all possible successive F-duplications we would have one of the following two exhaustive and mutually exclusive alternatives:

$$2^{\aleph_0} = (1_1 + 1_2 + \dots + 1_{2^{v-1}}) \times (2^{1_v} \times 2^{1_{v+1}} \times 2^{1_{v+2}} \times \dots) \quad (69)$$

$$2^{\aleph_0} = 1_1 + 1_2 + 1_3 + \dots \quad (70)$$

where v is a certain natural number. Being v a natural number, the first alternative must be false according to P406. Once again, this is not a question of indeterminacy but of impossibility: the set of natural numbers for which the first alternative is true is the empty set, while if v were indeterminable there would exist a nonempty set of possible solutions. Consequently, once performed all possible successive F-duplications (Principle of Execution P25) we will have:

$$2^{\aleph_0} = 1_1 + 1_2 + 1_3 + \dots \quad (71)$$

P408 The sequence of summands $\langle 1_i \rangle$ (71) must be ω -ordered, otherwise, and considering that ω is the least infinite ordinal, that sequence would contain at least a term indexed by ω (Theorem P80b, of the ω th Term), which could only have been originated in a previous duplication of the ω -ordered sequence of F-duplications, in which the duplication factor would have to be an element 2^{1_v} of the ω -ordered sequence of factors $\langle 2^{1_i} \rangle$, and the resulting summands would be indexed by the successive indexes i satisfying $1 \leq i \leq 2^v$ (63), all of them finite. It is then impossible the existence of such an ω th term.

P409 Taking into account (71) and (30) we can write:

$$2^{\aleph_0} = 2^{1_1} \times 2^{1_2} \times 2^{1_3} \times \dots = 1_1 + 1_2 + 1_3 + \dots = \aleph_0 \quad (72)$$

On the other hand, \aleph_0 is the cardinal of the set \mathbb{N} while 2^{\aleph_0} is the cardinal of its power set $P(\mathbb{N})$. And according to Cantor's Theorem of the Power Set [43], it must hold:

$$\aleph_0 < 2^{\aleph_0} \quad (73)$$

which contradicts (72)

P410 It seems convenient to recall that the above argument P404-P409 is exclusively based on well established definitions, operations and properties of transfinite arithmetics. It simply takes advantage of a consequence of the hypothesis of the actual infinity: the exis-

tence of ω -ordered sequences as complete totalities, in spite of the fact that no last element completes them. The argument is, therefore, a formal consequence of assuming the *completion of incomplete*. This infinitist assumption makes it possible to complete any definition or procedure composed of an ω -ordered sequence of steps in which no last step completes the sequence.

INTRODUCTION

P411 Contrary to what happens with transfinite ordinals, the subtraction of cardinals in transfinite arithmetics is not always defined, not even permitted. Notwithstanding, some indirect definitions and results on the subtraction involving transfinite cardinals have been given [212, p. 161-173]. For instance, in ZFC (in some cases without the aid of the Axiom of Choice) the following results, among others, can be proved:

- If a and b are two cardinals, we will say that $a - b$ exists if there is one, and only one, cardinal c so that $a = b + c$. We then write: $c = a - b$ (Tarski-Bernstein Theorem).
- If a is an infinite cardinal and b a (finite or infinite) cardinal then there exists a third cardinal c such that:

$$b + c = a \Leftrightarrow b \leq a \tag{1}$$

If $b = a$ then c can take infinitely many values ($\aleph_o + n = \aleph_o$ and the like). If not, we will have $c = a$.

- If a is an infinite cardinal and $\aleph_o \leq a$ then $2^a - a = 2^a$ (Tarski-Sierpinski Theorem).
- If a and b are two cardinals and $a - b$ does exist, then for any other cardinal c , the difference $(c + a) - b$ also exists and is equal to $c + (a - b)$

But, in general, specially if the involved cardinals are alephs, we cannot write things as:

$$a - c = b \tag{2}$$

$$a - a = 0 \tag{3}$$

P412 We have just seen some examples in which subtracting transfinite cardinals is permitted, in the last section of this chapter we will see an example in which it is not. Thus, the status of the subtraction of cardinals in transfinite arithmetic is really peculiar. Although it seems reasonable to declare undefined the subtraction of two cardinals when nothing can be said on the result of the subtraction, what about the subtraction of two cardinals when it leads to a contradiction? To be defined or undefined could be reasonable, but to be defined, or undefined, or inconsistent, depending on the case, is unusual from a formal point of view. How on Earth can be consistent an arithmetic operation that in some cases leads to contradictions without having previously determined which are those cases and why they are inconsistent?

P413 At the foundational level of set theory, we will now analyze the reasons for which transfinite subtraction have to be prohibited in most cases. Obviously, at this foundational level of discussion we can only establish correspondences between sets. To make use of transfinite arithmetic would inevitably lead to circular arguments because transfinite arithmetic derives from the foundational definitions and assumptions we will concerned with. As we will see, those reasons are immediate consequences of the foundational definition of the infinite sets, which, as we know, is based on the violation of Axiom of the Whole and the Part. In effect, the subtraction of finite cardinals (all of which observe the old Euclidian axiom) pose no problem, the problem of cardinal subtraction only appears when at least one of the operands is infinite. And as has just been indicated, sometimes it appears and sometimes it does not, without being able to establish the precise reasons why it does or does not appear.

PROBLEMS WITH CARDINAL SUBTRACTION

P414 If A and B are any two finite sets such that $|B| \leq |A|$ and f is an injective function from B to A , we will have:

$$(A - f(B)) \cap f(B) = \emptyset \tag{4}$$

$$A = (A - f(B)) \cup f(B) \tag{5}$$

$$|A| = |A - f(B)| + |f(B)| \tag{6}$$

$$|A| = |A - f(B)| + |B| \tag{7}$$

So, it could be expected that the subtraction of the cardinals $|A|$ and $|B|$ were something similar to:

$$|A| - |B| = |A - f(B)| \tag{8}$$

because, being B and $f(B)$ equipotent, $A - f(B)$ is the set that results by taking away (subtracting) from A as many elements as $|B|$. It could be proved that definition (8) always works with finite cardinals.

P415 As we will now see, in the case of the infinite sets, and due to the violation of the Axiom of the Whole and the Parts, the definition (8) of cardinal subtraction does not work. In fact, let $A = \{a_1, a_2, a_3, \dots\}$ and $B = \{b_1, b_2, b_3, \dots\}$ be any two denumerable and ω -ordered sets. Consider the following injective functions from B to A :

$$\forall i \in \mathbb{N} \begin{cases} f(b_i) = a_i \\ g(b_i) = a_{i+n}, \forall n \in \mathbb{N} \\ h(b_i) = a_{2i} \end{cases} \tag{9}$$

where n is any natural number. We would have:

$$|A| - |B| = |A - f(B)| = |\emptyset| = 0 \tag{10}$$

$$|A| - |B| = |A - g(B)| = |\{a_1, a_2, \dots, a_n\}| = n, \forall n \in \mathbb{N} \tag{11}$$

$$|A| - |B| = |A - h(B)| = |\{a_1, a_3, a_5, \dots\}| = \aleph_o \tag{12}$$

Thus, the subtraction of the same two infinite cardinals $|A|$ and $|B|$ yields infinitely many different results, depending on the particular way of pairing the elements of both sets: the elements of B can be paired either with the elements of A (f , for instance) or with the elements of a proper part of A (g or h), as if the part and the whole were the same thing.

P416 We could even prove a set theoretical version of Riemann's Series Theorem: If A and B are any two ω -ordered sets then the subtraction of their respective cardinals $|A|$ and $|B|$ can be made equal to any given natural number or to \aleph_0 . Indeed, let $A = \{a_1, a_2, a_3, \dots\}$ and $B = \{b_1, b_2, b_3, \dots\}$ be any two ω -ordered sets and n any natural number. Consider now the injections f and g of B in A defined by:

$$f(b_i) = a_{n+i}, \quad \forall b_i \in B \quad (13)$$

$$g(b_i) = a_{2i}, \quad \forall b_i \in B \quad (14)$$

It can be written:

$$f(B) = \{a_{n+1}, a_{n+2}, a_{n+3}, \dots\} \quad (15)$$

$$A - f(B) = \{a_1, a_2, \dots, a_n\} \quad (16)$$

$$|A| - |B| = |A - f(B)| = |\{a_1, a_2, \dots, a_n\}| = n, \quad \forall n \in \mathbb{N} \quad (17)$$

$$g(B) = \{a_2, a_4, a_6, \dots\} \quad (18)$$

$$A - g(B) = \{a_1, a_3, a_5, \dots\} \quad (19)$$

$$|A| - |B| = |A - g(B)| = |\{a_1, a_3, a_5, \dots\}| = \aleph_0 \quad (20)$$

P417 As in the case of Riemann's Series Theorem, that will be reinterpreted in Chapter 34, the above conclusion can also be reinterpreted as a contradiction derived from the formal foundations of set theory. In effect, let us denote by:

D: Dedekind's definition of infinite set.

A: Axiom of Infinity.

H_0 : Two sets have the same number of elements if they can be put into a one to one correspondence.

In accord with P416 we can write:

$$D \wedge A \wedge H_0 \Rightarrow (|A| - |B| = n) \wedge (|A| - |B| \neq n) \quad (21)$$

which has all the hallmarks of a contradiction.

P418 The possibility to get the same result when operating on different operands (as is the case of the transfinite cardinals addition, multiplication or exponentiation) may be admissible. But the possibility to get infinitely many different results when operating exactly on the same two operands (as the above case of cardinal subtraction) is more debatable. However, the second possibility is a consequence of the first one. In fact, if we accept that:

$$b + c = a \quad (22)$$

$$b + d = a \quad (23)$$

$$b + e = a \quad (24)$$

...

then we should also accept that:

$$b - a = c \quad (25)$$

$$b - a = d \quad (26)$$

$$b - a = e \quad (27)$$

...

The preferred solution to this problem has been, notwithstanding, the (more or less explicit) ignorance of cardinal subtraction.

FATICONI ARGUMENT

P419 In [88, pgs. 150-151], we can read the following argument on the impossibility of subtracting infinite cardinals (by the way, a typical argument on this issue):

H_1 : Assume we can define the subtraction $\aleph_o - \aleph_o$ (as the opposite of the addition) so that:

$$\aleph_o - \aleph_o = 0 \quad (28)$$

We would have:

$$1 + \aleph_o = \aleph_o \quad (29)$$

$$1 + (\aleph_o - \aleph_o) = \aleph_o - \aleph_o \quad (30)$$

$$1 + 0 = 0 \quad (31)$$

$$1 = 0 \quad (32)$$

In consequence H_1 is impossible.

P420 As it could not be otherwise, Faticoni's argument is grounded on the same basic definitions and assumptions of modern axiomatic set theories. It could be, therefore, completed as follows:

D: a set is actually infinite if there exists a one to one correspondence between the set and one of its proper subsets.

A: there exist an actual infinite set (Axiom of Infinity).

H_0 : two sets have the same number of elements if they can be put into a one to one correspondence.

H_1 : assume we can define the subtraction $\aleph_o - \aleph_o$ (as the opposite of the addition) so that:

$$\aleph_o - \aleph_o = 0 \quad (33)$$

We would have:

$$1 + \aleph_o = \aleph_o \quad (34)$$

$$1 + (\aleph_o - \aleph_o) = \aleph_o - \aleph_o \quad (35)$$

$$1 + 0 = 0 \quad (36)$$

$$1 = 0 \quad (37)$$

In consequence H_1 is impossible.

Notice that *D* and *A* state the existence of a set that violates the Euclidean Axiom of the Whole and the Parts [87]. It is now evident that absurdity (37) could also be caused by the inconsistency of *D* and *A*, i.e. we could write:

$$D \wedge A \wedge H_0 \wedge H_1 \Rightarrow (1 = 0) \quad (38)$$

P421 Perhaps cardinal subtraction is an impossible operation. Let us then consider the possibility of taking away balls from a box that contains balls. Let BX be a box containing a denumerable collection of black balls. Now add to BX a denumerable collection of white balls. At this moment BX will contain \aleph_0 black ball plus \aleph_0 white balls, i.e. \aleph_0 balls ($\aleph_0 + \aleph_0 = \aleph_0$). Now take away from BX all white balls, i.e. remove \aleph_0 balls from a box that contains \aleph_0 balls. The result will be a box that contains \aleph_0 balls (all black balls). Finally remove all black balls, i.e. remove \aleph_0 balls from a box that contains \aleph_0 balls. The result now is a box that contains no balls. Thus, by removing \aleph_0 balls from a box that contains \aleph_0 balls, we can get either a box that contains \aleph_0 balls or a box that contains no balls, a conclusion that is in agreement with P418.



Figura 21.1 – Adding and removing balls from a box

INTRODUCTION

P422 In the year 1900, at the second International Congress of Mathematics held in Paris, David Hilbert gave a lecture in which he proposed a list of 23 unsolved mathematical problems as a challenge for the mathematicians of the new century. The first of those problems was the so called problem of the continuum, that had been posed some years before by G. Cantor. The problem in question consists in proving (or disproving) the equality:

$$2^{\aleph_0} = \aleph_1 \tag{1}$$

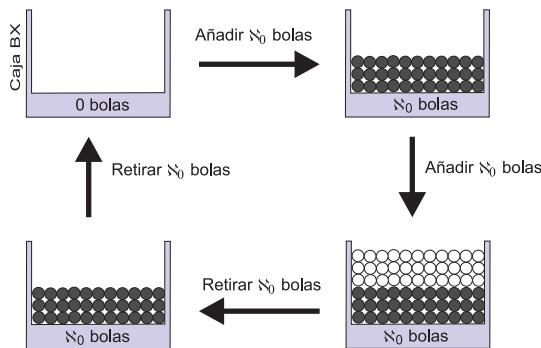
where 2^{\aleph_0} is the cardinal of the set of the real numbers (the continuum) and \aleph_1 is the cardinal of the set of all ordinals of the second class [47, p. 173, Theorem §16 F] (in modern terms, \aleph_1 is the cardinal of the set ω_1 (also denoted by Ω) of all countable ordinals).

P423 For over thirty years the problem was much discussed, until it was finally demonstrated the impossibility to prove or disprove the hypothesis of the continuum (1) within the current framework of axiomatic set theories, assuming they are consistent theories. Recall the Axiom of Infinity is one of the axiomatic fundamentals of all current axiomatic theories.

ON THE BRINK OF THE ABYSS

P424 At the third International Congress of Mathematics, now held in Heidelberg in the year 1904, Julius König, a physician and mathematician at the University of Budapest, read an article in

which he proved the power of the continuum 2^{\aleph_0} cannot be an aleph and that the continuum could never be a well-ordered set. These conclusions were incompatible with one of the most firm infinitist Cantor's convictions: that every infinite cardinal is a member of his list of alephs.

P425 The paper presented by König proved that if \aleph_μ is the supremum of a sequence of cardinals, it holds:

$$\aleph_\mu^{\aleph_0} > \aleph_\mu \quad (2)$$

If the power of the continuum 2^{\aleph_0} is an aleph, for instance \aleph_β , the supremum of the sequence $\aleph_\beta, \aleph_{\beta+1}, \aleph_{\beta+2}, \dots$ is $\aleph_{\beta+\omega}$, and it holds:

$$\aleph_{\beta+\omega}^{\aleph_0} > \aleph_{\beta+\omega} \quad (3)$$

Making then use of an earlier theorem proved by Felix Bernstein in his doctoral thesis: :

$$\aleph_\alpha^{\aleph_0} = \aleph_\alpha \times 2^{\aleph_0}, \text{ for all ordinal } \alpha \quad (4)$$

it could be written:

$$\aleph_{\beta+\omega}^{\aleph_0} = \aleph_{\beta+\omega} \times 2^{\aleph_0} \quad (5)$$

$$= \aleph_{\beta+\omega} \times \aleph_\beta \quad (6)$$

$$= \aleph_{\beta+\omega} \quad (7)$$

which contradicts (3).

P426 The news spread beyond the Third International Mathematics Congress and the scientific community itself. The international press made the discovery of König public with great headlines. Cantor, shocked and enraged by the humiliation, did not accept König's results, although he found no fault in his demonstration. He was convinced that God would not allow his possible mistakes to be revealed in that way [68, pgs. 247-250].

P427 Immediately afterwards, Ernst Zermelo proved that Berns-

tein's theorem was not valid for all ordinals; not for those who have no immediate predecessor, as was the case of the ordinal used by König. It seems that before Zermelo, Felix Hausdorff had discovered Bernstein's failure. Hausdorff wrote to Bernstein informing him of the discovery of the ruling, but Bernstein never replied [83]. König ended up withdrawing his argument. But the infinitists understood the importance of solving the continuum problem in order to avoid new shocks related to the actual infinity hypothesis that is the basis of infinitist mathematics.

P428 In the year 1938 K. Gödel proved that the falsity of the hypothesis of the continuum (equation 1) cannot be deduced from the axioms of set theory [101]. In 1963 P. J. Cohen proved the complementary result, i.e. that its veracity cannot be deduced either from the axioms of set theory [59]. The hypothesis of the continuum is, therefore, undecidable in the axiomatic framework of set theory.

P429 As it with all undecidable propositions, the hypothesis of the continuum is undecidable within a particular axiomatic scenario. In other scenarios, the proposition could be demonstrable or refutable. Remember the Axiom of Infinity (questioned in this book), is one of the axioms of that particular scenario in which the hypothesis of the continuum is undecidable.

P430 In the preceding pages of this book some contradictory results involving the Axiom of Infinity have been proved (and some other will be demonstrated in the remainder ones). If that were the case, it would also have been proved that:

$$2^{\aleph_0} = \aleph_1 \tag{8}$$

and that:

$$2^{\aleph_0} \neq \aleph_1 \tag{9}$$

since once proved a contradiction in a formal system, any other contradiction can also be proved.

P431 According to Cohen and Gödel, the hypothesis of the continuum cannot be proved or disproved within the framework of current axiomatic set theories (as ZFC). According to the pages of this book the hypothesis of the actual infinity subsumed into the Axiom of Infinity would be an inconsistent hypothesis. A conclusion that dynamites the entire building of infinitist mathematics, including its famous hypothesis of the continuum.

INTRODUCTION

P432 To perform an ω -supertask (supertask hereafter) means to perform an ω -ordered sequence of actions (tasks) in a finite interval of time. Supertasks are useful theoretical devices for the philosophy of mathematics, particularly for the discussions on certain problems related to infinity [230, 31, 56, 188, 18, 242, 188]. Although their physical possibilities and implications have also been discussed [182, 184, 188, 203, 111, 113, 112, 184, 185, 186, 82, 187, 175, 6, 7, 189, 242, 123, 80, 81, 175, 79, 213]. In this book all supertasks will be conceptual.



Figura 23.1 – God performing Gregory's supertask.

P433 Probably Gregory of Rimini was the first to propose how a supertask could be accomplished ([166], p. 53):

If God can endlessly add a cubic foot to a stone -which He can- then He can create an infinitely big stone. For He need only add one cubic foot at some time, another half an hour later, another a quarter of an hour later than that, and so on *ad infinitum*.

He would then have before Him an infinite stone at the end of the hour.

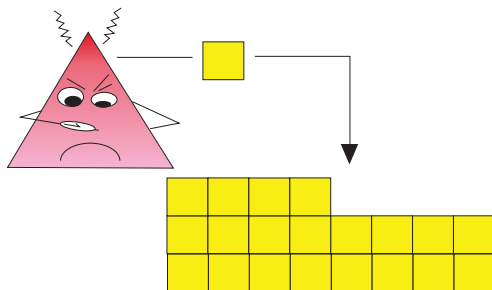
But the term “*supertask*” was introduced by J. F. Thomson in his seminal paper of 1954 [230]. Thomson’s paper was motivated by Black’s argument [28] on the impossibility to perform infinitely many successive actions and by the discussions of Black’s argument by R. Taylor [229] and J. Watling [240]. In his paper Thomson tried to prove the impossibility of supertasks. Thomson argument was, in turn, criticized in another seminal paper, in this case by P. Benacerraf [17]. Benacerraf’s successful criticism finally motivated the foundation of a new infinitist theory independent of set theory: supertask theory.

P434 The basic idea of Benacerraf’s criticism of Thomson’s argument is the impossibility to derive formal conclusions on the final state of the supermachine that performs the supertask from the sequence of states the machine traverses as a consequence of performing the supertask. Although Benacerraf’s criticism of Thomson’s lamp argument is well founded (see below), it is far from being complete. As we will see here, it is possible to consider a new line of argument, which Benacerraf only incidentally considered, based on the formal definition of the lamp. That line of argument leads to a contradiction that put into question the formal consistency of the ω -order involved in supertasks.

P435 In fact, if the world continues to be the same world it was before the execution of a supertask, and one is still allowed to think in rational terms in the same framework of the laws of logic, then Thomson’s argument can be reoriented towards the formal definition of the machine that performs the supertask. A definition that is assumed to be independent of the number of performed tasks with that machine, and then a definition that holds before, during and after performing the supertask, whenever the completion of a supertask, as such a completion, does not arbitrarily change a legitimate definition previously established (Principles of Invariance P19 and of Autonomy P23).

P436 The possibilities to perform an uncountable infinitude of actions were examined, and ruled out, by P. Clark and S. Read [56]. Supertasks have also been considered from the perspective of nonstandard analysis [159, 158, 4, 145], although the possibilities to perform a *hypertask* along a hyperreal interval of time have not been discussed, despite the fact that finite hyperreal intervals can be divided into hypercountably many successive infinitesimal intervals (hyperfinite partitions) [226, 104, 127, 119], etc. But most of the supertasks are ω -supertasks, i.e. ω -ordered sequences of actions performed in a finite (or perceived as finite) interval of time.

THOMSON'S LAMP

P437 As Thomson did in 1954 ([230], p. 5), in the following discussion we will make use of one of those:

... reading-lamps that have a button in the base. If the lamp is *off* and you press the button the lamp goes *on*, and if the lamp is *on* and you press the button the lamp goes *off*.



Figura 23.2 – Thomson's lamp has two, and only two, states: *off* and *on*. The state of Thomson's lamp changes if, and only if, its button is pressed.

Let us complete Thomson's definition by explicitly declaring the following conditions regarding the (theoretical) functioning of the lamp:

- a) Thomson's lamp has two, and only two, states: *on* and *off*.
- b) The state of the lamp (*on/off*) changes if, and only if, its button is pressed down.
- c) Each change of state takes place at a precise and definite instant.

- d) The pressing down (clicking) of the button and the corresponding lamp change of state are both instantaneous and simultaneous events.
- e) Thomson's lamp remains unaltered after performing any finite or infinite number of clickings.

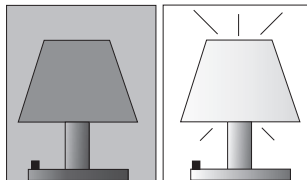
P438 Assume now the button of Thomson's lamp is clicked at each of the infinitely many successive instants t_i , and only at them, of a strictly increasing and ω -ordered sequence of instants $\langle t_n \rangle$ defined within a finite interval of time (t_a, t_b) , being t_b the limit of the sequence $\langle t_n \rangle$. In these conditions, at the instant t_b the button of the lamp will have undergone an ω -ordered sequence $\langle c_n \rangle$ of clicks (each click c_i performed at the precise instant t_i) and, consequently, the state of the lamp will have changed an ω -ordered infinitude of times. Or in other words, at t_b Thomson's supertask will have been completed. Don't forget this is a purely conceptual argument, so that we are not concerned here with the physical details.

P439 Thomson tried to derive a contradiction from his supertask by speculating on the final state of the lamp at the instant t_b in terms of the sequence of switchings completed along the supertask ([230], p. 5):

[The lamp] cannot be *on*, because I did not ever turn it *on* without at once turning it *off*. It cannot be *off*, because I did in the first place turn it *on*, and thereafter I never turned *off* without at once turning it *on*. But the lamp must be either *on* or *off*. This is a contradiction.

P440 It is worth noting, as we have just seen, that Thomson based his argument on the sequence of actions carried out on the lamp: it was never turned on without turning it off after, and viceversa. What Thomson tried to do is to derive the final state of the lamp, the state of the lamp at t_b , from the successive changes of state the lamp underwent during the supertask: The reason why the lamp cannot be *on* is because it was always turned *off* after turning it *on*. And for the same reason it cannot be *off* either. This way of arguing was severely criticized by Benacerraf

P441 Benacerraf argued against Thomson's argument as follows ([17], p. 768):

The only reasons Thomson gives for supposing that his lamp will not be *off* at t_b are ones which hold only for times *before* t_b . The explanation is quite simply that Thomson's instructions do not cover the state of the lamp at t_b , although they do tell us what will be its state at every instant *between* t_a and t_b (including t_a). Certainly, the lamp must be *on* or *off* (provided that it hasn't gone up in a metaphysical puff of smoke in the interval), but nothing we are told implies which it is to be. The arguments to the effect that it can't be either just have no bearing on the case. To suppose that they *do* is to suppose that a description of the physical state of the lamp at t_b (with respect to the property of being *on* or *off*) is a *logical* consequence of a description of its state (with respect to the same property) at times prior to t_b . [t_a and t_b appears respectively as t_0 and t_1 in Benacerraf's paper].

P442 In short, according to Benacerraf, the problem posed by Thomson is not sufficiently described since no constraint have been placed on what happens at t_b [3]. But the only constraint on what happens at t_b is that Thomson's lamp continue to be Thomson's lamp. Or in other words, that the execution of a supertask does not change the formal definitions of the involved theoretical artifacts (Principle of Invariance P19). As we will see, the state of Thomson's lamp at t_b is not "a *logical consequence of a description of its state (with respect to the same property) at times prior to t_b* ", it is a logical consequence of remaining a Thomson's lamp after performing Thomson's supertask (Principle of Invariance). And this is pertinent to the case. It will be the key of the next argumentation.

P443 Consider the instant t_b , the limit of the sequence $\langle t_n \rangle$ of instants at which the successive clicks $\langle c_n \rangle$ have been performed. That instant is, therefore, the first instant *after completing* the sequence of switchings. The first instant at which the button of the lamp is no longer clicked. Let now S_b be the state of the lamp

at instant t_b . Being the state of a Thomson's lamp, it can only be either *on* or *off*. And this conclusion has nothing to do with the number of previously performed switchings. The lamp will be either *on* or *off* because, being a Thomson's lamp, it has only two states: *on* and *off*, and it is not affected by the number of times it has been turned on and off (Principle of Invariance P19). Therefore the state S_b of the lamp at the instant t_b can only be either on or off, regardless of the number of times it has been turned on or off.

P444 Some infinitist claim, however, that at t_b , after performing Thomson's supertask, the lamp could be in any unknown state, even in an exotic one. But a lamp that can be in an unknown state is not a Thomson's lamp: the only possible states of a Thomson's lamp are *on* and *off*. No other alternative is possible *without arbitrarily violating* the formal legitimate definition of Thomson's lamp. And we presume no formal theory is authorized to violate arbitrarily a formal definition, nor, obviously to change, in the same arbitrary terms, the nature of the world (Principle of invariance). It goes without saying that if that were the case any thing could be expected from that theory, because the case could be applied to any other argument.

P445 Others claim the state S_b is the consequence of completing the ω -ordered sequence of clicks $\langle c_n \rangle$, since that sequence, and only that sequence, has been carried out. But if to complete the sequence of clicks $\langle c_n \rangle$ means to perform each and every of the infinitely many clicks c_1, c_2, c_3, \dots of $\langle c_n \rangle$, and only them, then we have a problem. The problem that no click c_i of $\langle c_n \rangle$ originates S_b . None. Indeed, if c_v is any element of $\langle c_n \rangle$ it cannot originates S_b because in such a case the button would have been clicked only a finite number v of times. That is to say, if we remove from $\langle c_n \rangle$ all clicks that do not originate S_b , then all of them would be removed. Or in other, set theoretical, words, if from the set of performed clicks $\langle c_i \rangle$ we remove all clicks that do not originate S_b , all clicks would be removed and we would get the empty set (see P321). It is not, therefore, a question of indeterminacy but of impossibility: no click of the sequence $\langle c_i \rangle$ originates S_b . None.

P446 In those conditions, how can it be claimed that the completion of the sequence of clicks $\langle c_n \rangle$, *none* of whose elements originates S_b , originates just S_b ? Is the completion of the sequence an additional click different from all elements of $\langle c_n \rangle$? If that were the case the sequence of performed clicks would be $(\omega + 1)$ -ordered in the place of ω -ordered, but ω -supertasks are ω -ordered sequences not $(\omega + 1)$ -ordered sequences.

P447 At this point some infinitists claim the lamp could be at S_b by reasons unknown. But, once again, that claim violates the definition of the lamp: the state of a Thomson's lamp changes exclusively by pressing down its button, by clicking its button. So a lamp that changes its state by reasons unknown is not, by definition, a Thomson's lamp (Principles of Invariance P19 and of Autonomy P23).

P448 It makes no sense to argue about the last term of an ω -ordered sequence because such a last term does not exist. By contrast, it is always possible to argue about the limit of an ω -ordered sequence, whenever that limit exists, because it is a well defined object, though it is not an element of the sequence. Similarly, whilst it makes no sense to argue about the last instant at which the button of Thomson's lamp is clicked, the instant t_b is plenty of meaning: it is limit of the sequence of instants at which the successive switchings are carried out. It is the first instant after completing the sequence of switchings. It is the first instant at which the button of the lamp is no longer clicked. It is the first instant after all instant of (t_a, t_b) .

P449 And the relevant question on the state S_b is: at which instant Thomson's lamp becomes S_b ? It is immediate to prove that instant can only be the precise instant t_b . We know the state of the lamp is S_b at instant t_b , but assume there exist an instant t within (t_a, t_b) at which the lamp becomes S_b . Since t_b is the limit of the sequence $\langle t_n \rangle$, we will have:

$$\exists v : t_v \leq t < t_{v+1} \tag{1}$$

which means that at t only a finite number v of clicks have been carried out, and then that infinitely many clickings still remain to be carried out. Therefore, no instant t exists in (t_a, t_b) at which the lamp becomes S_b . None. The precise instant at which the lamp becomes S_b is not within the interval (t_a, t_b) . Therefore, the state S_b can only originate at the first instant after all instants of (t_a, t_b) . And that instant is just t_b , because the state of the lamp in t_b is the state S_b .

P450 But at t_b the button of the lamp is not clicked. At t_b nothing happens that can cause a change in the state of the lamp. Consequently, the state S_b , which according to P448 can only originate at the instant t_b , cannot originate at the instant t_b . The state S_b is, therefore, an impossible state. It is the consequence of assuming that it is possible to complete an incompletable sequence of actions, incompletable because there is not a final element to complete the sequence.

P451 The fact that the elements of two incompletable sequences can be paired off by a one to one correspondence, as in the case of the above sequences of clicks and of instants, does not prove both sequences exist as complete infinite totalities: they could also be potentially infinite. The possibility of pairing off the elements of two impossible totalities does not make them possible

P452 At this point, all that one can expect from infinitists is to be declared incompetent to understand the meaning of the sentence: "*the state of the lamp at t_b is the result of completing the ω -ordered sequence $\langle c_n \rangle$ of clicks, a result that manifests for the first time just at t_b* ". But, wait a moment, is not S_b the result of a pressing down the button of the lamp? Do not forget that Thomson's lamp can only change its state if, and only if, its button is clicked. And that both events, the clicking and the corresponding lamp change of state, are instantaneous and simultaneous by definition. Furthermore, the lamp is not altered by pressing its button any finite or infinite number of times. So, if S_b appears for the first time at the precise instant t_b and at t_b the button of the lamp is

not clicked, then S_b is impossible.

P453 In short, S_b must of necessity be originated just at the instant t_b , otherwise only a finite number of clicks would have been performed, according to [P448-P449]. But, on the other hand, it cannot be originated at t_b because:

- 1.- The state of the lamp changes only by clicking its button.
- 2.- The clicking of the button and the corresponding lamp change of state are instantaneous and simultaneous events that takes place at a definite and precise instant.
- 3.- Being the clicking of the button and the corresponding lamp change of state instantaneous and simultaneous events, and being the state S_b originated at the precise instant t_b , the button must be clicked at that precise instant t_b .
- 4.- But at t_b the button of the lamp is not clicked.

Therefore, it has to be concluded that the state S_b originates and does not originate at the instant t_b . Or what is the same, in the instant t_b the button of the lamp is pressed and it is not pressed. And this is a contradiction.

P454 S_b could only be, therefore, the impossible last state of an ω -ordered sequence of states in which no last state exists. The imprint of an inconsistency. The consequence of assuming the hypothesis of the actual infinity from which derives the existence of ω -ordered sequences as *complete totalities*, in spite of the fact that no last element completes them. The state S_b forces the actual infinity to leave a trace of its existence and what it leaves is an inconsistency.

P455 Thomson's lamp is a theoretical device intentionally invented to facilitate a formal discussion on the actual infinity hypothesis that legitimizes the existence of ω -ordered sequences as complete totalities [45], [47, p. 160, Theorem §15 A]. Supertasks are an example of such sequences, and contradiction [P453] clearly indicates the hypothesis on which they are founded is inconsistent.

THE COUNTING MACHINE

P456 The Counting Machine (*CM*) we will examine in this section poses a problem similar to the one posed by Thomson's lamp we have just examined. As its name suggests, *CM* counts natural numbers, and it does it by counting the successive numbers 1, 2, 3... at each of the successive instants $t_1, t_2, t_3 \dots$ of the above sequence $\langle t_n \rangle$. *CM* counts each number n at the precise instants t_n . In addition, the machine has a red LED **L** that turns *on* if, and only if, the machine counts an even number; and the LED turns *off* if, and only if, the machine counts an odd number, and so that the counting of the number and the change of state of **L** are simultaneous and instantaneous events. Obviously, **L** is a perfect LED that never fails.

P457 The one to one correspondence f between $\langle i \rangle$ and $\langle t_i \rangle$

$$f : \langle t_i \rangle \mapsto \mathbb{N} \quad (2)$$

$$f(t_n) = n, \quad \forall t_n \in \langle t_i \rangle \quad (3)$$

proves that at t_b our machine will have counted all natural numbers. All. The conclusions on the state of **L** at t_b will not be deduced from its successive states while performing the supertask of counting all natural numbers, as Thomson did with his lamp, otherwise Benacerraf's criticism would be inevitable. They will be deduced from the fact that the LED of *CM* has two, and only two, states, *on* and *off*, so that no other alternative exist. Thus, if after performing the supertask, *CM* continues to be the same counting machine it was before beginning the supertask, i.e. if performing a supertask does not arbitrarily violate a legitimate formal definition, as that of *CM*, then its LED **L** can only be either *on* or *off*, simply because, according to its legitimate definition, **L** can only be either *on* or *off*, and it will always be either *on* or *off*, independently of the number of times it has been turned *on* and *off*.

P458 Assume then that at t_b the red LED of *CM* is *on* (a similar argument would apply if it were *off*). One of the following two

exhaustive and mutually exclusive alternatives must be true:

- a) The red LED **L** is *on* because *CM* counted a last even number that left it *on*.
- b) The red LED **L** is *on* because of any other reason.

The first alternative is impossible if *all* natural numbers have been in fact counted: each even number has an immediate odd successor and then there is not a last natural number, neither even nor odd. The second alternative would imply the formal definition of *CM* has been arbitrarily violated: its red LED **L** turns *on* if, and only if, the machine counts an even number, which excludes the possibility of being turned *on* by any other reason (Principle of Invariance P19).

P459 Since the same argument applies if **L** is *off* at t_b , we must conclude that if the ω -ordered list of the natural numbers exists as a complete infinite totality, then, once completed the supertask of counting all of them, **L** can be neither *on* nor *off*; though, by definition, it will be either *on* or *off*. The alternative to this contradiction is the arbitrary violation of a legitimate definition with the only purpose to justify that **L** can change its state by reasons different from the reason defined as the unique reason why **L** can change its state: if, and only if, *CM* counts a natural number, being both events simultaneous and instantaneous. But assuming the arbitrary violation of a definition when convenient means any thing can be proved. So this alternative is formally unacceptable.

P460 Notice again that, as in the case of Thomson's lamp, the above contradiction on the state of **L** at t_b has not been drawn from its successive states while performing the supertask, but from the fact of being a LED with two definite, precise and unique states: *on* and *off*, and so that it turns *on* if, and only if, *CM* counts an even number; and it turns *off* if, and only if, *CM* counts an odd number. Thus, as in the case of Thomson's lamp, *CM* definition forces the actual infinity to leave a track of its existence through the state of **L** at t_b , and what it leaves is an inconsistency. By

contrast, from the hypothesis of the potential infinity, only finite totalities of numbers can be counted, as large as wished but always finite, and depending of the parity of the last counted number, \mathbf{L} will be either *on* or *off*, in agreement with the definition of CM .

INTRODUCTION

P461 The discussions on Thomson's lamp analyzed in the precedent chapter can be formalized (at least up to a certain point) by introducing a simple symbolic notation that allows to define the lamp and its functioning in abstract terms. The symbolic definition can then be used to develop formulas that represent the laws of functioning of Thomson's lamp. Being independent of the number of times the lamp is turned *on/off*, these laws represent the universal attributes and the universal behaviour of a Thomson's lamp. As we will see, some of those laws are not compatible with the assumption that a Thomson's lamp can be switched infinitely many times during a finite interval of time. It will be proved that to perform Thomson's supertask implies the violation of at least one of the laws that define the functioning of the lamp, a law that is independent of the number of times the lamp is turned *on* and *off*. This conclusion will prove that, as its author defended, Thomson's supertask is inconsistent.

SYMBOLS AND DEFINITIONS

P462 The symbols “*” and “o” will be used to represent the lamp is *on* and *off* respectively. The clicks will be represented with the letter “c”. We will also use standard symbols of logic and mathematics. So, being TL Thomson's lamp, we will write:

$$\text{TL is } on \text{ at instant } t: *[t] \tag{1}$$

$$\text{TL is } off \text{ at instant } t: o[t] \tag{2}$$

$$\text{TL is } on \text{ along the interval } (t_a, t_b): *(t_a, t_b) \tag{3}$$

$$\text{TL is } off \text{ along the interval } (t_a, t_b): o(t_a, t_b) \tag{4}$$

Click at instant t , being TL *on*: $c\{[t], *\}$ (5)

Click at instant t , being TL *off*: $c\{[t], o\}$ (6)

Click at least one time in (t_a, t_b) , being TL *on*: $c\{(t_a, t_b), *\}$ (7)

Click at least one time in (t_a, t_b) , being TL *off*: $c\{(t_a, t_b), o\}$ (8)

TL is not cliciked since t_b : $\neg c\{[t_b, \infty)\}$ (9)

Note the expressions “Being *on* at instant t ” and “Being *off* at instant t ”, and recall that in the spacetime continuum no instant has an immediate preceding (or succeeding) instant: between any two instants, however close they may be, there are another 2^{\aleph_0} instants, the same number of instants as in the entire history of the universe (≈ 13800 millions years)

P463 We can now formalize the definition of Thomson’s lamp by means of the following four axioms:

$$\text{Thomson's lamp} \quad \begin{cases} c\{[t], o\} \Rightarrow *[t] \\ c\{[t], *\} \Rightarrow o[t] \\ *[t] \vee o[t] \\ \neg(*[t] \wedge o[t]) \end{cases} \quad (10)$$

P464 Some basic laws of Thomson’s lamp can now be immediately deduced, for example:

$$c\{(t_a, t_b), o\} \Rightarrow \exists t \in (t_a, t_b) : *[t] \quad (11)$$

$$c\{(t_a, t_b), *\} \Rightarrow \neg *(t_a, t_b) \quad (12)$$

$$o[t_b] \Rightarrow \neg *[t_b, \infty) \quad (13)$$

$$*[t_a, t_b] \Rightarrow \neg c\{(t_a, t_b)\} \quad (14)$$

$$c\{[t], o\} \Rightarrow \neg o\{[t, \infty)\} \quad (15)$$

$$\text{etc.} \quad (16)$$

DISCUSSION

P465 This section proves the following two laws of Thomson’s lamp:

$$\text{BT1: } c\{(-\infty, t_b), *\} \wedge *[t_b, \infty) \Rightarrow \exists t \leq t_b : c\{[t], o\} \wedge \neg c\{(t, \infty), *\}$$

BT2: $c\{(-\infty, t_b), o\} \wedge o[t_b, \infty) \Rightarrow \exists t \leq t_b : c\{[t, *] \wedge \neg c\{(t, \infty), o\}$

The first law (BT1) reads: if the lamp's button has been clicked at least once within the interval $(-\infty, t_b)$, the lamp being previously *on*, and the lamp stays *on* from t_b , then there is an instant t equal or prior to t_b such that the button is clicked at t , the lamp being previously *off*, and the button is no longer clicked from t . The second law (BT2) reads equal except we must replace *on* with *off* and vice versa.

P466 BT1 is proved as follow (BT2 would be proved in a similar way). Assume that:

$$\neg \exists t \leq t_b : c\{[t, o\} \quad (17)$$

We can write:

$$\neg c\{(-\infty, t_b], o\} \quad (18)$$

Taking into account the antecedent of BT1 we have:

$$c\{(-\infty, t_b), *\} \Rightarrow \exists t < t_b : c\{[t, *\} \quad (19)$$

and then:

$$o[t] \quad (20)$$

From (18) and (20), and taking into account that $t < t_b$ we deduce:

$$o[t_b] \quad (21)$$

and then:

$$\neg * [t_b, \infty) \quad (22)$$

which goes against the second term of the antecedent of BT1. Therefore if that antecedent is true then assumption (17) is false.

P467 Assume now that it holds:

$$\neg \exists t \leq t_b : \neg c\{(t, \infty), *\} \quad (23)$$

In other words, suppose that there is no instant before or equal to t_b such that, being the lamp *on*, no click has ever been performed from that instant onwards. We will have:

$$c\{[t_b, \infty), *\} \quad (24)$$

which goes against the second term $*[t_b, \infty)$ of BT1 antecedent. Consequently, if this antecedent is true then assumption (23) must be false.

P468 The falsehood of assumptions (17) and (23) proves BT1. It is worth noting that BT1 is not derived from the successively performed clicks but from the laws defining Thomson's lamp. Thus, if we assume the Principle of Invariance P19, BT1 must always hold: before, during and after the performing of any finite or infinite sequence of clicks.

THOMSON'S SUPERTASK

P469 Let $\langle c_n \rangle$ be the ω -ordered sequence of clicks of Thomson's supertask, being each click c_i performed at the precise instant t_i of the strictly increasing and ω -ordered sequence of instants $\langle t_n \rangle$ within (t_a, t_b) and whose limit is t_b . According to its definition, Thomson's lamp has two, and only two, states: *on* and *off*. So, it can only be either of or *off*, independently of the number of times it has been clicked. Assume, then, the state S_b of the lamp at t_b is *on* (a similar argument could be developed if it were *off* though making use of BT2 in the place of BT1). In these conditions the antecedent of BT1 would be true: the lamp has been clicked at least once along the interval (∞, t_b) being the lamp *on*, and it is *on* from t_b . Therefore, the consequent of BT1 must also be true. We will now prove, however, it is not.

P470 Indeed, on the one hand, if $t < t_b$, and being t_b the limit of the sequence $\langle t_n \rangle$, there would exist a t_v in the sequence $\langle t_n \rangle$ such that $t_v \leq t < t_{v+1}$, so that at t only a finite number v of clicks would have been performed. On the other hand, the instant t cannot be the limit t_b either, because at t_b the button of the lamp has not been clicked. Consequently, t cannot be an element

of $(t_a, t_b]$. Therefore, to perform Thomson's supertask implies the violation of BT1, which goes against the Principle of Invariance P19. Hence, Thomson's supertask is inconsistent.

HILBERT'S HOTEL

P471 In the next discussion we will make use of a supermachine inspired by the emblematic Hilbert's Hotel. But before beginning, let us relate some of the prodigious, and suspicious, abilities of the illustrious Hotel.



Figura 25.1 – The power of the ellipsis: An infinitist way of making money.

P472 Its director, for example, has discovered a fantastic way of getting rich: he demands one euro to R_1 (the guest of the room 1); R_1 recovers his euro by demanding one euro to R_2 (the guest of the room 2); R_2 recovers his euro by demanding one euro to R_3 (the guest of the room 3); and so on. Finally all guests recover his euro, because there is not a last guest losing his money. Our crafty director then demands a second euro to R_1 which recovers again his euro by demanding one euro to R_2 , which recovers again his euro by demanding one euro to R_3 , and so on and on. Thousands of euros coming from the (infinitist) nothingness to the pocket of the fortunate director.

P473 Hilbert's Hotel is even capable of violating the laws of thermodynamics by making it possible the functioning of a perpetuum mobile: in fact we would only have to power the appropriate machine with the calories obtained from the successive rooms of the prodigious hotel in the same way its director gets the euros.

P474 Incredible as it may seem, infinitists justify all those absurd pathologies, and many others, in behalf of the *peculiarities* of the actual infinity. They prefer to assume any pathological behaviour of the world before examining the consistency of the pathogene. In the next discussion, however, we will come to a contradiction that cannot be easily justified by the picturesque nature of the actual infinity.

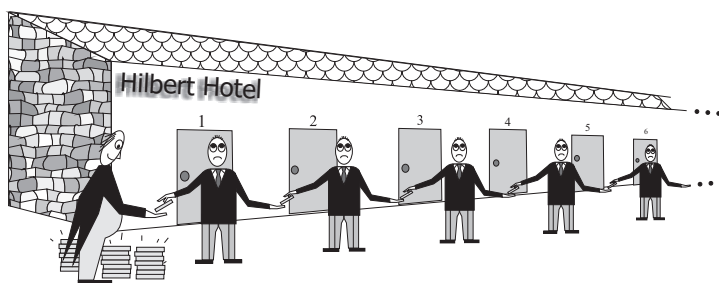
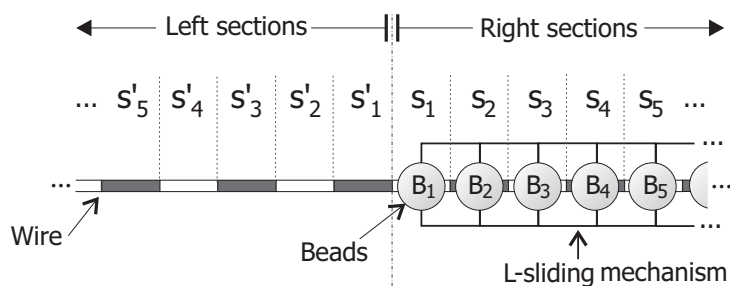

Figure 25.2 – Hilbert's machine just before performing the first L-sliding.

HILBERT MACHINE

P475 In the following conceptual discussion we will make use of a theoretical device, inspired by the emblematic Hilbert Hotel, that will be referred to as *Hilbert machine*, composed of the following elements (see Figure 25.2):

- a) An infinite horizontal wire divided into two infinite parts, the left and the right side:
 - 1) The right side in turn is divided into an ω -ordered sequence of disjoint and adjacent sections $\langle S_i \rangle$ of equal length indexed from left to right as S_1, S_2, S_3, \dots . They will be referred to as right sections.

- 2) The left side is also divided into an ω -ordered sequence of disjoint and adjacent sections $\langle S'_i \rangle$ of equal length, the same length as the right sections, and indexed now from right to left as \dots, S'_3, S'_2, S'_1 ; being S'_1 adjacent to S_1 . They will be referred to as left sections.
- b) An ω -ordered sequence of indexed beads $\langle b_n \rangle$ strung on the wire, so that they can slide on the wire as the beads of an abacus, being the center of each bead b_i initially placed on the center of the right section S_i .
- c) All beads are mechanically linked by a sliding mechanism that slides simultaneously all beads the same distance along the wire.
- d) The sliding mechanism is adjusted in such a way that it slides simultaneously each bead exactly one, and only one, section to the left (L-sliding).

P476 Obviously, Hilbert's machine is a theoretical artifact, and its functioning is a simple thought experiment that illustrates a formal argument to test ω -order, the type of order of the well-ordered set \mathbb{N} of the natural numbers, whose ordinal number is ω , the least transfinite ordinal [47, p. 160, Theorem §15 A]. This is not, therefore, a discussion on the physical restrictions and consequences of performing a particular sequence of physical actions.

P477 Since the sections $\langle S'_i \rangle$ of the left side of the wire are ω -ordered, each section S'_n has an immediate successor section S'_{n+1} just on its left (ω -successiveness). In accord with the hypothesis of the actual infinity all those infinitely many left sections exist as a complete totality in spite of the fact that there is not a last section completing the sequence. The same applies to the right sections $\langle S_i \rangle$.

P478 We will assume Hilbert's machine always works according to the following:

Restriction P478.-*An L-sliding will be carried out if, and only if, after being performed all beads remain strung on the wire.*

Otherwise, the L-sliding will be undone so that every bead recover its previous position and then the machine stops.

P479 Let us begin by proving that for each $v \in \mathbb{N}$ the first v L-slidings can be carried out according to Restriction P478. Assume this assertion is not true. There will be a natural number $n \leq v$ such that it is impossible to perform the n th L-sliding according to Restriction P478. But this is impossible because whatsoever be the left section occupied by b_1 just before performing the n th L-sliding, there always be a left section contiguous to that section, otherwise b_1 would be in the impossible last left section (ω -successiveness). So, b_1 can L-slide to that contiguous left section, and every ball $b_{i,i>1}$ can move to the section previously occupied by b_{i-1} . Therefore, the n th L-sliding can be carried out according to Restriction P478. Consequently our assumption is not true, and for each $v \in \mathbb{N}$ it is possible to carry out the first v L-slidings according to Restriction P478.

P480 The following inductive argument leads to the same conclusion as the previous one P479 (Modus Tollens). It is clear that the first L-sliding can be performed: b_1 slides to S'_1 and every $b_{i,i>1}$ to the section previously occupied by b_{i-1} . Suppose that, for any natural number n , the first n L-slidings can be carried out. Since each L-sliding moves each ball one section to the left, all balls will have been moved n sections to the left, so that b_1 will be in the left section S'_n , since S'_n is n sections to the left of the S_1 , the section initially occupied by b_1 . And since S'_n has an adjacent left section S'_{n+1} (ω -successiveness), b_1 can slide to S'_{n+1} and each $b_{i,i>1}$ to the section previously occupied by b_{i-1} . So, if for any n the first n L-slidings can be carried out, the first $n + 1$ L-slidings can also be carried out. And since the first L-sliding can be carried out, we conclude that for any $v \in \mathbb{N}$ the first v L-slidings can be carried out.

HILBERT MACHINE CONTRADICTION

P481 Assume that while the successive L-slidings can be carried out, they are carried out (Principle of Execution P25). It is imme-

diate to prove the following:

Theorem P481a.-*Once performed all possible L-slidings all balls remain strung on the wire.*

Proof.-It is an immediate consequence of Restriction P478: if an L-sliding removes a bead from the wire, that L-sliding would be undone and the machine stops with every ball strung on the wire in the section occupied just before that L-sliding. In addition, since an L-sliding simultaneously moves each ball one section, and only one section, to the left, and the first ball to the left of all balls is b_1 , it had to be b_1 , and only b_1 , the ball that came out of the wire by one L-sliding. Otherwise, if the first n balls were simultaneously removed from the wire by one L-sliding, then each ball $b_{i>1}$ would have been moved i sections to the left by one L-sliding, which is impossible. In consequence, if b_1 is removed from the wire, b_2 would have to be in the impossible last section of an ω -ordered collection $\langle S'_i \rangle$ of sections. So, once all possible L-slides have been done, all the balls remain strung on the wire. \square

Theorem P481b.-*Once performed all possible L-slidings no bead remains strung on the wire.*

Proof.-Let b_v be any bead and assume that once performed all possible L-slidings (Principle of Execution P25) it is strung on the right section S_k . It must be $k < v$ because all L-slidings are towards the left, the direction towards which the indexes of $\langle S_i \rangle$ decrease. Since b_v was initially placed on S_v only a finite number $v - k$ of L-slidings would have been performed, and then it would not have been possible to perform the the first $v - k + 1$ L-slidings, which goes against P479 and P480, because $v - k + 1$ is a natural number. A similar reasoning can be applied if b_v were finally strung on a left section S'_n , being now the number of performed L-slidings exactly $v + n - 1$ and then it would not have been possible to perform the first $v + n$ L-slidings, which also goes against P479 and P480, because $v + n$ is also a natural number. Thus, since b_v is any bead, if all possible L-slidings have been performed, then no bead remains strung on the wire. Note this is not a question of

indeterminacy but of impossibility: the set of possible sections any ball b_v could be finally occupying is the empty set. \square

P482 It is remarkable the fact that in the demonstration P481 of Hilbert's contradiction it has only been assumed that, under the hypothesis of the actual infinity, all possible L-slidings have been performed (Principle of Execution P25). The reader can easily prove a corollary of the Theorem P481b: all balls stop being inserted in the wire at the same instant, an instant at which L-slidings are no longer performed.

DISCUSSION

P483 Let us compare the functioning of the above Hilbert machine (H_ω from now on) with the functioning of a finite version of the machine (symbolically H_n). This finite machine has a finite number n of both right and left sections (Figure 25.3). A finite sequence of n beads are initially strung on the right side of the wire, the center of each bead b_i placed on the center of the right section S_i . It is immediate to prove that H_n can only perform n L-slidings because not having a left section S'_{n+1} , Restriction P478 will stop the machine with each left section S'_i occupied by the bead b_{n-i+1} and all right sections empty, and this is all. No contradiction is derived from the functioning of H_n . Thus for any natural number n , the corresponding machine H_n is a consistent theoretical artifact. Only the infinite Hilbert's machine H_ω is inconsistent.

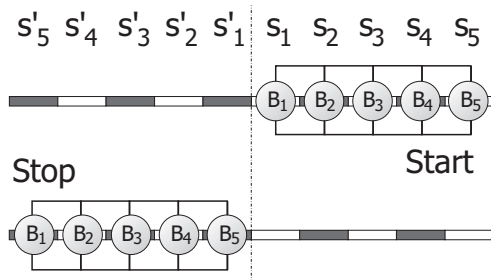

Figure 25.3 – A finite machine of five sections.

P484 What contradiction P481a-P481b proves is not the inconsistent functioning of a supermachine. What it proves is the inconsistency of ω -order itself (Principle of Autonomy P23) because of ω -successiveness. Perhaps we should not be surprised by this conclusion. After all, an ω -ordered sequence is one which is both complete (as the actual infinity requires) and incompletable (there is not a last element that completes the sequence). On the other hand, and as Cantor proved [47, p. 160, Theorem §15 A], ω -order is an inevitable consequence of assuming the existence of infinite sets as complete totalities. An existence axiomatically stated in our days by the Axiom of Infinity, in all axiomatic set theories including its most popular versions as ZFC [227, 225]. It is, therefore, that axiom the ultimate cause of contradiction P481a-P481b.

INTRODUCTION

P485 This chapter examines the consistency of ω -order by means of a supertask that works as a sort of trap for the assumed existence of ω -ordered collections, which are simultaneously complete (as is required by the Actual infinity) and incompletable (because no last element completes them). Cantor himself proved [47, P. 160, Teorema §15 A], that ω -order is a formal consequence of assuming the existence of denumerable sets as complete totalities. Although it is hardly recognized, to be ω -ordered means to be both complete and incompletable. In fact, the Axiom of Infinity states the existence of complete denumerable totalities, the most simple of which are ω -ordered, i.e. with a first element and such that each element has an immediate successor. Consequently, there is not a last element that completes ω -ordered totalities. To be complete and incompletable is a modest eccentricity in the highly eccentric infinite paradise of our days, but its simplicity is just an advantage if we are interested in examining the formal consistency of ω -order. In addition, ω is the first transfinite ordinal, the one on which all successive transfinite ordinals are built up. This magnifies the interest of its formal analysis, because if the basis of the construction is inconsistent, all constructions built on that basis will also be inconsistent. The short discussion that follows is based on a supertask conceived to put into question just the ability of being complete and incompletable that characterizes ω -order.

THE LAST DISK

P486 Consider a hollow cylinder C and an ω -ordered collection of identical disks $\langle d_i \rangle$ such that each disk d_i fits exactly within

the cylinder (Figure 26.1). Let a_1 be the action of placing the disc d_1 completely inside the cylinder C , and let $a_{i>1}$ be the action of replacing the disk d_{i-1} inside the cylinder by its immediate successor the disk d_i , which is accomplished by placing d_i completely within the cylinder. Consider the ω -ordered sequence of actions $\langle a_i \rangle$ and assume that each action a_i is carried out at the instant t_i , being t_i an element of the ω -ordered sequence of instants $\langle t_i \rangle$ in the real interval (t_a, t_b) such that t_b is the limit of $\langle t_i \rangle$. Let S_ω be the supertask of performing the ω -ordered sequence of actions $\langle a_i \rangle$

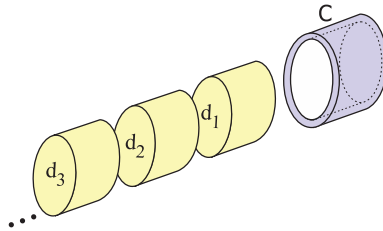

Figure 26.1 – The hollow cylinder C and the ω -ordered collection of discs $\langle d_i \rangle$.

P487 Let us impose to S_ω the following:

Restriction P487.—Each action a_i of $\langle a_i \rangle$ will be carried out if, and only if, it leaves the cylinder completely occupied by the disc d_i .

P488 It is immediate to prove that all actions $\langle a_i \rangle$ observe restriction P487: in fact it is clear that a_1 observes restriction P487 because it leaves the cylinder completely occupied by the disk d_1 . Assume the first n actions observe Restriction P487. It is quite clear that a_{n+1} also observes Restriction P487: it leaves the cylinder completely occupied by the disk d_{n+1} because, by definition, it consists just in placing d_{n+1} completely inside the cylinder. Consequently all actions $\langle a_i \rangle$ observe restriction P487.

P489 Consider now the one to one correspondence f between $\langle t_i \rangle$ and $\langle a_i \rangle$ defined by $f(t_i) = a_i$. Since t_b is the limit of $\langle t_i \rangle$ (the first

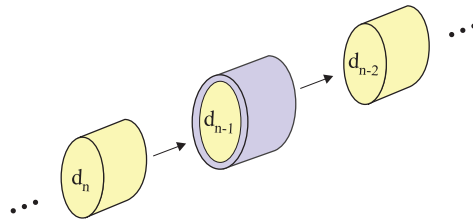

Figure 26.2 – The action a_n of supertask S_ω about to be carried out.

instant after all instants of $\langle t_i \rangle$, at t_b all actions $\langle a_i \rangle$ will have been carried out (Principle of Execution P25), and supertask S_ω will have been completed.

DISCUSSION

P490 With respect to the possibilities of being occupied by the disks $\langle d_i \rangle$, the cylinder C can exhibit one, and only one, of the following three alternative states:

1. Empty, occupied by no disk.
2. Partially or completely occupied by one disk.
3. Partially or completely occupied by two disks.

According to the way the successive actions $\langle a_i \rangle$ are carried out, the third state is impossible because each action $a_{i,i>1}$ consists in removing from the cylinder C the disk d_{i-1} by introducing the disk d_i completely inside C . So, once performed the infinitely many actions $\langle a_i \rangle$ of the supertask S_ω , the cylinder C can only be either empty or (partially or completely) occupied by one disk of the collection $\langle d_i \rangle$.

P491 At instant t_b the cylinder C cannot be occupied by a disk d_v , whatsoever it be, because in such a case only a finite number v of disks would have been introduced inside the cylinder and the supertask S_ω would not have been completed. In consequence, at t_b once the supertask S_ω has been completed, C must be empty.

P492 The problem is: how C becomes empty if none of the performed actions leaves it empty? Infinitists claim that although, in

fact, no particular action a_i leaves the cylinder empty, the completion of all of them does it. The Principle of Invariance P19 adequately answers this claim. But, in addition, another type of answer will be given in the discussion that follows.

P493 There are two alternatives regarding the completion of the ω -ordered sequence of actions $\langle a_i \rangle$ of the supertask S_ω :

- a) The completion is an additional $(\omega+1)$ -th action.
- b) The completion is not an additional $(\omega+1)$ -th action. It simply consists in performing each one of the infinitely many actions $\langle a_i \rangle$, and only them.

P494 Let us examine the first alternative (which obviously goes against the Principle of Invariance P19). The supposed $(\omega+1)$ -th action can only occur at t_b because, being t_b the limit of $\langle t_i \rangle$, for any instant t prior to t_b there is an instant t_v of $\langle t_i \rangle$ such that $t < t_v$ and there still remain infinitely many actions $a_v, a_{v+1}, a_{v+2} \dots$ of $\langle a_i \rangle$ to be performed. Whatever be the instant we consider, if it is prior to t_b , there will remain infinitely many actions to be performed and only a finite number of them will have been carried out. Therefore, the assumed $(\omega + 1)$ -th action must occur at the precise instant t_b . In consequence, at t_b the cylinder has to be occupied by a disk, otherwise, if the cylinder were empty at t_b , the supposed $(\omega+1)$ -th action, which occur at t_b and consists just in leaving the cylinder empty, would not be the cause of leaving the cylinder empty as it is assumed to be, because it is already empty. We will have, therefore, a disk d_v inside the cylinder at t_b . And, for the reasons given in P491, this is impossible if S_ω has been completed: the disk d_v within the cylinder would be proving that only a finite number v of actions would have been carried out. Thus, the first alternative is impossible.

P495 We will examine, then, the second alternative. According to it, the cylinder becomes empty as a consequence of having completed the countably many actions a_1, a_2, a_3, \dots and only them. Thus, either the successive actions have an accumulative effect capable

of leaving finally the cylinder empty, or the completion has a sort of sudden final effect on the cylinder as a consequence of which it results empty. We can rule out this last possibility for exactly the same reasons we have ruled out the above $(\omega+1)$ -th additional action: that additional action would have to take place at t_b , and then at t_b there would be a disk d_v inside the cylinder proving that at t_b only a finite number v of actions would have been performed. The only possibility is, therefore, that the cylinder C becomes empty as a consequence of a certain accumulative effect of the successively performed actions.

P496 Let v_i be the volume inside the cylinder which is not occupied by the disk d_i once d_i is placed inside the cylinder by the action a_i , i.e. the empty volume inside C once d_i has been placed in C . According to the above definition of a_i we will have:

$$v_i = 0, \quad \forall i \in \mathbb{N} \quad (1)$$

Let us then define the series $\langle s_i \rangle$ as:

$$s_i = v_1 + v_2 + \cdots + v_i, \quad \forall i \in \mathbb{N} \quad (2)$$

The i th term s_i of this series represents, therefore, the empty volume inside the cylinder once performed the firsts i actions of $\langle a_i \rangle$. Evidently we will have:

$$s_i = 0, \quad \forall i \in \mathbb{N} \quad (3)$$

$\langle s_i \rangle$ is therefore a series of constant terms. Thus it can be written:

$$\lim_{i \rightarrow \infty} s_i = \sum_1^{\infty} v_i = 0 \quad (4)$$

Therefore, once completed the ω -ordered sequence of actions $\langle a_i \rangle$, and having each a_i left an empty volume $v_i = 0$ inside the cylinder, the resulting empty volume inside the cylinder is also null. The cylinder C cannot, therefore, results empty as a consequence of an accumulative effect of the successively performed actions a_i .

Therefore, the completion of the ω -ordered sequence of actions $\langle a_i \rangle$ does not leave the cylinder empty.

P497 In consequence, it must be concluded that supertask S_ω leads to a contradiction: the completion of $\langle a_i \rangle$ leaves and does not leave the cylinder empty of disks.

P498 We will consider now the finite versions of S_ω . For this let n be any natural number and $\langle d_i \rangle_{i=1,2,\dots,n}$ the finite collection of the first n disks of $\langle d_i \rangle$. As in the case of S_ω , let a_1 be the action of placing the disc d_1 inside the cylinder C , and let $a_{i,i>1}$ be the action of replacing the disk d_{i-1} of $\langle d_i \rangle$ within C with its immediate successor the disk d_i at the instant t_i . Let n be the task of performing the finite sequence of actions $\langle a_i \rangle_{1,2,\dots,n}$. It is immediate to prove that at t_n all these actions will have been performed and the cylinder will finally contain the last disk d_n placed within it. No contradiction arises here. And this holds for every natural number: S_n is consistent for every $n \in \mathbb{N}$. Only S_ω is inconsistent. But the only difference between S_ω and $S_n, \forall n \in \mathbb{N}$ is just the ω -order of S_ω . The contradiction with S_ω can only derive from this type of infinite ordering, and then from the Axiom of Infinity, of which it is a formal consequence. Thus, the argument above is not on the impossibility of a particular supertask, but on the inconsistency of ω -order. Being complete and incompletable could be, after all, a formal inconsistency rather than an eccentricity of the first transfinite ordinal.

INTRODUCTION: SETS AND BOXES

P499 From the platonic point of view (the dominant perspective in contemporary mathematics), all attempts to define the concept of set have been circular, so that it is now considered a primitive notion, a concept that cannot be defined in terms of other more basic concepts.

P500 From a non-platonic point of view, however, it is possible to define the notion of set as a mental construct. For instance, Charles Dogson (better known as Lewis Carroll) proposed the following concept [51, p. 31]:

Classification, or the formation of Classes, is a Mental Process, in which we imagine that we have put together, in a group, certain Things. Such a group is called a Class.

Carroll's notion of class leads immediately to the following definition:

A set is a theoretical object that results from a mental process of grouping arbitrary objects previously defined.

It could be proved this definition is not compatible with self-reference, one of the main sources of inconsistency in naive (Cantorian) set theory. But this type of non-platonic definitions are ignored in contemporary mathematics. Some of them will be introduced in Appendix C.

P501 We could imagine a set as a sort of box that contains objects. And while the number of objects is finite the comparison will always be consistent. But when the number of objects is infinite

some significant differences appear between sets and boxes. As we will see in this chapter the consideration of an infinite set as a box that contains infinitely many objects leads to contradictions.

EMPTYING SETS AND BOXES

P502 Consider a box BX containing an ω -ordered collection $\langle b_i \rangle$ of identical balls indexed as b_1, b_2, b_3, \dots . And consider also an ω -ordered set $B = \{b_1, b_2, b_3, \dots\}$ whose elements are also a denumerable collection of identical balls indexed as b_1, b_2, b_3, \dots .

P503 From the set B let us define the following ω -ordered sequence of sets $\langle B_n \rangle$:

$$\begin{cases} B_1 = B - \{b_1\} \\ B_i = B_{i-1} - \{b_i\}, \quad i = 2, 3, 4, \dots \end{cases} \quad (1)$$

$\langle B_n \rangle$ is, therefore, the sequence of nested sets:

$$B_1 \supset B_2 \supset B_3 \supset \dots \quad (2)$$

each of whose members $B_n = \{b_{n+1}, b_{n+2}, b_{n+3}, \dots\}$ is a denumerable set.

P504 Let now (t_a, t_b) be a finite interval of time and $\langle t_n \rangle$ an ω -ordered and strictly increasing sequence of instants within (t_a, t_b) whose limit is t_b . Assume that at each instant t_i of $\langle t_n \rangle$ the ball b_i is removed from the box BX . Let $BX(t_i)$ be the state of the box (the remaining collection of balls within the box) at the instant t_i , just the instant at which the ball b_i has been removed from the box. The successive states $\langle BX(t_i) \rangle$ of the box BX can be symbolically expressed in a form similar to (1):

$$\begin{cases} BX(t_1) = BX(t_a) - b_1 \\ BX(t_i) = BX(t_{i-1}) - b_i, \quad i = 2, 3, 4, \dots \end{cases} \quad (3)$$

P505 The one to one correspondence $f(t_i) = b_i$ proves that at

t_b all balls will have been removed from the box, and BX will be empty. By comparing (1) with (3) we will have:

$$BX(t_i) = B_i, \forall i \in \mathbb{N} \quad (4)$$

P506 There is, however, a fundamental difference between the sequence of sets $\langle B_n \rangle$ and the sequence of states $\langle BX(t_i) \rangle$ of the box BX : in each of the successive states $BX(t_i)$ defined by (3), the box BX is always the same box BX , while the successive sets B_i defined by the successive definitions (1) are different from one another. As a consequence we will have a final empty box BX but not a final empty set. How is this possible? Why and when the symmetry between both sequences of definitions (sets and boxes) get broken?

P507 On the other hand, and regarding the sequence of states $\langle BX(t_i) \rangle$ of the box BX defined by (3), it is worth noting that at *each* instant t in (t_a, t_b) the box BX contains \aleph_o balls, whereas at t_b it is empty. In fact, since t_b is the limit of the sequence $\langle t_n \rangle$, we will have:

$$\forall t \in (t_a, t_b) : \exists v : t_v \leq t < t_{v+1} \quad (5)$$

Therefore, at t only the first v balls b_1, b_2, \dots, b_v have been removed from BX , and BX still contains infinitely many balls $b_{v+1}, b_{v+2}, b_{v+3}, \dots$. So then, at each instant t within (t_a, t_b) the box BX contains \aleph_o balls. Or in other words, if T is the set of all instants of the interval of time (t_a, t_b) at which the box BX contains \aleph_o balls, the complement \overline{T} of T in $(t_a, t_b]$ can only be the singleton $\{t_b\}$.

P508 In these conditions, the only way for the box BX to become empty at t_b would be by removing simultaneously infinitely many balls just at t_b . How is this possible if at t_b no ball is removed from the box? How is this possible if all balls have been removed *one by one*, and with an interval of time greater than zero between any two successive removals? How is it possible that, in those conditions, and for any natural number n , the box *never* contains $n \dots, 3, 2,$

1 balls? And recall we are not subtracting cardinals (Chapter 21) but removing one by one the balls from a box that contains balls (see P321).

P509 Let us go a step further in this discussion. Consider the following sequence of definitions of the sets X and Y by means of the above ω -ordered sequence of sets $\langle B_n \rangle$:

$$i = 1, 2, 3, \dots \begin{cases} B_i \neq \emptyset \Rightarrow X = B_i \\ Y = B_2 \end{cases} \quad (6)$$

While the sequence of definitions (6) of the set Y poses no problem and we will finally have $Y = B_2$, the successive definitions (6) of the set X poses the following problem: Definitions (6) can only leave X defined as the empty set, otherwise only a finite number of definitions would have been performed, because any element b_n in X would be proving the n th redefinition (that defines X as $\{b_{n+1}, b_{n+2}, b_{n+3}, \dots\}$) would not have been carried out. The problem is that no definition (6) defines X as the empty set, simple because all sets B_i of $\langle B_n \rangle$ are denumerable. All.

P510 An interesting variant of the above argument is the following one. Let $A_1 = \{a_1, a_2, a_3, \dots\}$ be a denumerable set and consider the following sequence of definitions of the set B :

$$i = 1, 2, 3, \dots : \text{iff } |A_i| > 1 \text{ then } \begin{cases} A_{i+1} = A_i - \{a_i\} \\ A_i = A_{i+1} \\ B = A_i \end{cases} \quad (7)$$

According to (7), B is defined as A_i if, and only if, the cardinal of A_i is equal or greater than 1. Therefore, (7) can only define B as a singleton $\{a_\nu\}$. But this is impossible because, having being successively defined according to the ω -order of the successive indexes $1, 2, 3, \dots$, the index ν of a_ν could only be an impossible last natural number.

THE LAST BALL SUPERTASK

P511 The above set theoretical argument P510 can be reanalyzed by means of a conditional supertask S_{bx} . Indeed, consider again the same above box BX with the same collection of indexed balls $\langle b_n \rangle$, and the same sequence of instants $\langle t_n \rangle$ within (t_a, t_b) . Let the conditional supertask S_{bx} be defined according to:

At each precise instant t_i of $\langle t_n \rangle$, remove from BX the ball b_i if, and only if, the box BX contains at least two balls.

Note, the successive balls are removed from BX *one by one*, one after the other, and in such a way that a time greater than zero always elapses between two successive removals: $\Delta t = t_{i+1} - t_i > 0, \forall i \in \mathbb{N}$. And note also the balls are successively removed from BX according to the ω -order of their respective indexes $1, 2, 3, \dots$

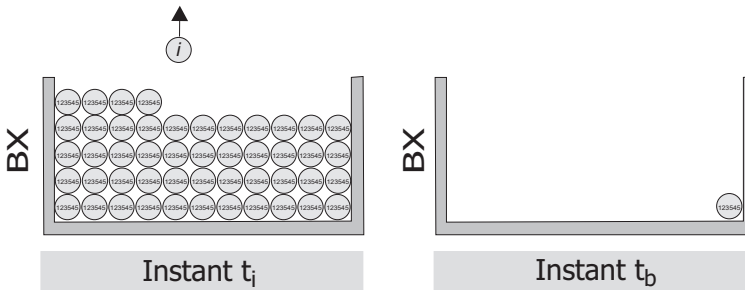

Figure 27.1 – The last ball supertask S_{bx} : remove from BX the ball b_i at t_i if, and only if, BX contains at least two balls.

P512 The one to one correspondence f between $\langle t_n \rangle$ and $\langle b_n \rangle$ defined by $f(t_i) = b_i$ proves that, being t_b the limit of $\langle t_n \rangle$, at t_b the supertask S_{bx} has been completed. Indeed, for all $i \in \mathbb{N}$, it is always possible to remove from BX the ball b_i at the instant t_i iff BX contains at least two balls. But, on the other hand, the completion of S_{bx} is impossible because it can only left one ball within BX , and that ball could only be a ball indexed by an impossible last natural number. S_{bx} leads, then, to a contradiction: it can, and cannot, be completed.

P513 Consider now the following variant S'_{bx} of S_{bx} :

At each successive instant t_i of $\langle t_n \rangle$ remove from BX any ball b_k .

In this case, it is immediate to prove that at t_b the supertask S'_{bx} has been completed, leaving one ball b_p within BX , where the index p is any natural number (in the place of the impossible last natural number of S_{bx}). That BX contains the unique ball b_p is, in fact, a possible result for S'_{bx} . Therefore, in this sense S'_{bx} is not contradictory.

P514 In consequence, we must conclude that it is possible, and it is not possible, to remove from BX one by one all balls but one of $\langle b_n \rangle$, depending on the order they are removed: if they are removed at random, the removal is possible; if they are removed following the ω -ordered sequence of their respective indexes, the removal is impossible. It is hard to accept that, being it possible a random removal, the removal is impossible if the balls are removed by following the ω -order of their respective indexes.

P515 The supertask S'_{bx} poses an additional problem related to the instant at which it takes place the removal of the last ball that leaves BX with only one ball. Indeed, let t be any instant within the finite interval of time (t_a, t_b) . Being t_b the limit of the sequence $\langle t_n \rangle$, it holds:

$$\exists t_v \in \langle t_n \rangle : t_v < t < t_{v+1} \quad (8)$$

So that, at t only a finite number v of balls have been removed from BX . Consequently, if T is the set of all instants of (t_a, t_b) at which BX contains infinitely many balls, then the complement \bar{T} of T in (t_a, t_b) can only be the singleton $\{t_b\}$. Hence, the last removal that left BX with only one ball inside it, could only take place at t_b , just the first instant at which no removal takes place; and that removal had to remove from BX infinitely many balls at once, which obviously goes against the own definition of the supertask S'_{bx} .

P516 As in previous chapters of this book, the above contradictory results deduced from the supertasks S_{bx} and S'_{bx} point to the same

suspicious hypothesis: the hypothesis of the actual infinity; the belief that an infinite list exist as a complete totality without a last element completing the list; the believing that it is possible to complete the incompletable, as Aristotle would surely say [11, p. 291]. A hypothesis, on the other hand, subsumed into the Axiom of Infinity founding infinitist mathematics, the main, and *almost* unique, stream in contemporary mathematics.

CATCHING A FALLACY

P517 Consider again the collection of indexed balls $\langle b_n \rangle$. We can consider a denumerable set B whose elements are the collection of balls $\langle b_n \rangle$. We can also consider a box BX that contains all of them. But could we consider a hollow cylinder AB , with the same diameter as the balls, that contains the same collection of balls $\langle b_n \rangle$? Obviously, in this case the balls could only be aligned in straight line, one after the other, just as the sequence of the natural numbers $1, 2, 3, \dots$. Naturally, both the box and the cylinder would have to have infinite sizes, but the existence of such objects can be assumed without that assumption affecting the arguments that such containers illustrate (Principle of Autonomy P23).

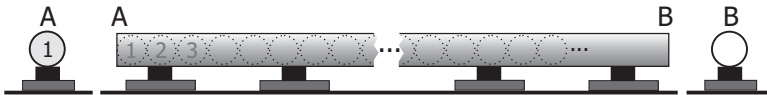

Figure 27.2 – The hollow cylinder AB containing the collection of balls $\langle b_n \rangle$ as a complete totality. The cylinder appears occupied when observed from its end A with the ball b_1 at sight. But it appears empty when observed from its end B , otherwise we would be observing the impossible last ball of an ω -ordered collection of balls.

P518 From the point of view of the hypothesis of the actual infinity, the answer to the question posed in P517 can only be negative: the cylinder AB would appear occupied when observed from its end A with the ball b_1 at sight, and empty when observed from its end B , otherwise the impossible last ball of an ω -ordered sequence of balls (the collection $\langle b_n \rangle$) would be at sight.

P519 In consequence, while we can consider the set B of the ω -

ordered collection of balls $\langle b_n \rangle$, and the box BX with the ω -ordered collection of balls $\langle b_n \rangle$ inside it, we cannot consider the hollow cylinder AB with the same ω -ordered collection of balls $\langle b_n \rangle$ inside it. Or in other more general words, the possibility to consider an ω -ordered collection of objects inside a container depends on the shape of the container. Some shapes, as the hollow cylinder AB , cannot be permitted under penalty of inconsistency.

P520 Ridiculous as it may seem, axiomatic set theories should face the above inconsistency [P519]. They would have to include a new axiom restricting the shapes of the containers capable of containing ω -ordered sequences of objects. For example, the hollow cylinder above would have to be declared inconsistent as a container of the balls $\langle b_i \rangle$.

P521 Or, alternatively, the hollow cylinder AB could be considered a trap to catch a fallacy: the fallacy of completing the incomplete; the fallacy of the existence of ω -ordered lists of elements as complete totalities without a last element completing the lists.

INTRODUCTORY DEFINITIONS

P522 This chapter introduces a formalized version of Zeno's Dichotomy in its two variants (here referred to as Dichotomy I and II) based on the successiveness and discontinuity of ω -order (Dichotomy I) and of ω^* -order (Dichotomy II). Each of these formalized versions leads to a contradiction pointing to the inconsistency of the hypothesis of the actual infinity (the existence of the '*totality of finite cardinal numbers*', in Cantor's words [47, p. 103]) from which the first transfinite ordinal number ω is deduced [47, p. 160, Theorem §15 A].

P523 In the second half of the XX century, several solutions to some of Zeno's paradoxes were proposed with the aid of Cantor's transfinite arithmetic, topology, measure theory and, more recently, internal set theory (a branch of non-standard analysis) [109, 110, 249, 111, 113, 112, 159, 158]. It is also worth noting the solutions proposed by P. Lynds [143, 144] within classical and quantum mechanics frameworks. Some of these solutions, however, have been contested. And in most cases, the proposed solutions do not explain where Zeno's arguments fail. Moreover, some of the proposed solutions gave rise to a new collection of problems so exciting as Zeno's paradoxes [177, 4, 188, 203, 126, 213]. In the discussion that follows I propose a new way to discuss Zeno's Dichotomies based on the notion of ω -order, the type of order of the well-ordered sets whose ordinal number is ω , the least transfinite ordinal [47, p. 160, Theorem §15 A]. The set \mathbb{N} of the natural numbers is an example of ω -ordered set.

P524 A sequence $\langle a_i \rangle$ indexed by the ω -ordered set \mathbb{N} of the natu-

ral numbers is also ω -ordered by the relation of precedence of their indexes (Theorem P80a, of the Indexed Sets), which can be the same, or not, as their natural precedence, if any. As is well known, in an ω -ordered sequence there is a first element but not a last one, and each element has an immediate successor and an immediate predecessor, except the first one, which has no predecessor. So, assuming the set of the natural numbers exist as a complete infinite totality (hypothesis of the actual infinity subsumed into the Axiom of Infinity) means that any ω -ordered sequence can also exist as a complete infinite totality, despite the fact that no last element completes the sequence.

P525 An ω^* -ordered sequence is one in which there exists a last element but not a first one, and each element has an immediate predecessor and an immediate successor, except the last one that has no successor. Since there is not a first element these sequences are non-well-ordered. From the same infinitist perspective, ω^* -ordered sequences are also complete infinite totalities, in spite of the fact that there is not a first element to begin with. The *increasing* sequence of negative integers, $\mathbb{Z}^* = \dots, -3, -2, -1$, is an example of ω^* -ordered sequence.



Figura 28.1 – Z^* -points and Z -points.

P526 That said, let us consider a point particle P moving through the X axis (of a Cartesian coordinate system) from the point -1 to the point 2 at a constant finite velocity v (Figure 28.1). Assume P is in the point 0 just at the precise instant t_0 . At instant $t_1 = t_0 + 1/v$ it will be exactly in the point 1 . Consider now the following ω^* -ordered sequence of Z^* -points $\langle z_i^* \rangle$ within the real interval $(0, 1)$,

defined by [234]

$$z_{n*}^* = \frac{1}{2^n}, \forall n \in \mathbb{N} \tag{1}$$

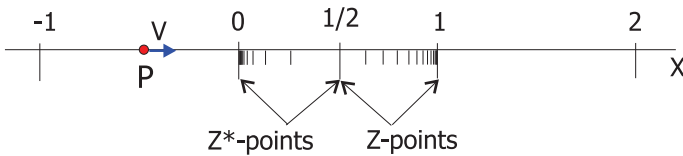
where z_{n*}^* stands for the last but $n - 1$ element of the ω^* -ordered sequence $\langle z_i^* \rangle$ of Z^* -points. Consider also the sequence of Z -points $\langle z_i \rangle$ within the real interval $(0, 1)$ defined by:

$$z_n = \frac{2^n - 1}{2^n}, \forall n \in \mathbb{N} \tag{2}$$

P527 Although the points of the X axis are densely ordered (between any two of its points infinitely many other points do exist), Z^* -points and Z -points are not. Between any two successive Z^* -points $z_{(n+1)*}^*$, z_{n*}^* there is no other Z^* -point (ω^* -discontinuity), and a distance greater than zero $z_{n*}^* - z_{(n+1)*}^* > 0$ always exists. Because of ω^* -discontinuity, Z^* -points can only be traversed (by a point object as P) in a successive way, one at a time, one after the other, and in such a way that between any two successive Z^* -points, a distance greater than zero $z_{n*}^* - z_{(n+1)*}^* > 0$ must always be traversed. The traversal will take a time greater than zero if it is traversed at a finite velocity. The same applies to Z -points, which exhibit ω -discontinuity.

P528 As P passes over the points of the closed real interval $[0, 1]$ of the X axis, it must traverse the successive Z^* -points and the successive Z -points. It makes no sense to wonder about the instant at which P begins to traverse the successive Z^* -points because there is not a first Z^* -point to be traversed. The same can be said on the instant at which P ends to traverse the Z -points, in this case because there is not a last Z -point to be traversed. For this reason, we will focus our attention on the number of Z^* -points P has already traversed and on the number of Z -points it must still traverse at any instant t within the closed real interval $[t_o, t_1]$.

P529 In this sense, and being t any instant within $[t_o, t_1]$, let $Z^*(t)$ be the number of Z^* -points P has traversed just at instant t . And let $Z(t)$ be the number of Z -points to be traversed by P at the

instant t . The discussion that follows examines the evolution of $Z^*(t)$ and $Z(t)$ as P moves from the point 0 to the point 1. Both discussions are formalized versions of Zeno's Dichotomy II and I respectively. See, for instance, [34, 35, 235, 203, 126, 239, 62, 157].

P530 The strategy of pairing off the Z^* -points (or the Z -points) with the successive instants of a strictly increasing infinite sequence of instants was firstly used (in a broad sense) by Aristotle [12, Books-III-VI] when trying to solve Zeno's dichotomies. Although Aristotle ended up by rejecting his original strategy, it is still the preferred one to discuss on both paradoxes. As we will see, however, the discontinuity and separation of Z^* -points and Z -points leads to a conflicting conclusion.

ZENO'S DICHOTOMY II

P531 Let us begin by analyzing the way P passes over the Z^* -points. Since the sequence of Z^* -points is ω^* -ordered, its first point does not exist, and consequently its first n points, for any finite number n , do not exist either. Thus, and taking into account that P is in the point 0 at t_0 and in the point 1 at t_1 , it holds:

$$\forall t \in [t_0, t_1] \begin{cases} t = t_0 : & Z^*(t) = 0 \\ t > t_0 : & Z^*(t) = \aleph_o \end{cases} \quad (3)$$

According to (3), no instant t exists within $[t_0, t_1]$ at which $Z^*(t) = n$, whatever be the finite number n , otherwise there would exist the impossible first n elements of an ω^* -ordered sequence. Notice $Z^*(t)$ is well defined in the whole interval $[t_0, t_1]$. Thus, equation (3) represents a dichotomy, ω^* -dichotomy: $Z^*(t)$ can only take two values along the whole closed interval $[t_0, t_1]$: 0 and \aleph_o .

P532 In agreement with P531 and regarding the number of traversed Z^* -points, P can only have two successive states: the state $P^*(0)$ at which it has traversed zero Z^* -points, and the state $P^*(\aleph_o)$ at which it has traversed aleph-null Z^* -points. The number of traversed Z^* -points change directly from zero to \aleph_o (ω^* -dichotomy), without finite intermediate states at which P has tra-

versed only a finite number of Z^* -points.

P533 Taking into account the ω^* -discontinuity of Z^* -points and the fact that between any two successive Z^* -points a distance greater than zero always exists, to traverse two successive Z^* -points $z_{(n+1)^*}^*, z_{n^*}^*$, whatsoever they be, means to traverse a distance greater than zero:

$$z_{n^*}^* - z_{(n+1)^*}^* > 0, \forall n \in \mathbb{N} \tag{4}$$

In consequence, to traverse \aleph_o of such successive Z^* -points in the same direction means to traverse a distance greater than zero. And to traverse a distance greater than zero at the finite velocity v of P means the traversal has to last a time greater than zero.

P534 Although it is impossible to calculate neither the exact duration of the transition $P^*(0) \rightarrow P^*(\aleph_o)$ nor the distance P must traverse while performing such a transition (there is neither a first instant nor a first point at which the transition begins), we have proved in P533 that, indeterminable as they might be, that duration and that distance must be greater than zero. It will now be proved they cannot be greater than zero.

P535 Let d be any real number greater than zero and consider the real interval $(0, d)$. According to the ω^* -dichotomy (533), at any point x within $(0, d)$ our point-particle P have already traversed aleph-null Z^* -points. In consequence the distance P must traverse while performing the transition $P^*(0) \rightarrow P^*(\aleph_o)$ is less than d . And since d is any real number greater than zero, we must conclude the distance P must traverse while performing the transition $P^*(0) \rightarrow P^*(\aleph_o)$ is less than any real number greater than zero.

P536 So then, according to P533, the distance P must traverse while performing the transition $P^*(0) \rightarrow P^*(\aleph_o)$ is greater than zero. And according to P535 that distance must be less than any number greater than zero. But there is no real number greater than zero and less than any real number greater than zero. So, it is impossible for the distance P must traverse while performing

the transition $P^*(0) \rightarrow P^*(\aleph_o)$ to be greater than zero. The same conclusion, and for the same reasons, applies to the time elapsed while performing the transition $P^*(0) \rightarrow P^*(\aleph_o)$.

P537 In line with P533 and P535, the point particle P needs to traverse a distance greater than zero for a time greater than zero to perform the transition $P^*(0) \rightarrow P^*(\aleph_o)$, but neither that distance nor that time can be greater than zero. Note this is not a question of indeterminacy but of impossibility. If it were a question of indeterminacy there would exist a nonempty set of possible solutions, although we could not determine which of them is the correct one. In our case the set of possible solutions is the empty set, because the set of the real numbers greater than zero and less than any real number greater than zero is the empty set.

P538 In short:

- A) According to the actual infinity hypothesis, the transition $P^*(0) \rightarrow P^*(\aleph_o)$ takes place.
- B) The transition $P^*(0) \rightarrow P^*(\aleph_o)$ can only take place along a distance and a time greater than zero, because of the ω^* -discontinuity and to the distance greater than zero that P must traverse at its finite velocity v .
- C) The transition $P^*(0) \rightarrow P^*(\aleph_o)$ cannot take place along a distance and a time greater than zero, because of the ω^* -dichotomy, and because no real number greater than zero is less than all real numbers greater than zero.
- D) Zeno's Dichotomy II is, therefore, a contradiction derived from ω^* -order.

ZENO'S DICHOTOMY I

P539 We will now examine the way P traverses the Z-points between the point 0 and the point 1. Being $Z(t)$ the number of Z-points to be traversed by P at the precise instant t in $[t_0, t_1]$, that number can only take two values: \aleph_o and 0. In fact, assume that at any instant t within $[t_0, t_1]$ the number of Z-points to be traversed by P is a finite number $n > 0$. This would imply the

impossible existence of the last n points of an ω -ordered sequence of points. Thus, we have a new dichotomy:

$$\forall t \in [t_0, t_1] \begin{cases} t < t_1 : Z(t) = \aleph_o \\ t = t_1 : Z(t) = 0 \end{cases} \quad (5)$$

Therefore, no instant t exists at which $Z(t) = n$, whatever be the finite number n . Notice $Z(t)$ is well defined in the whole interval $[t_0, t_1]$. Thus, equation (5) expresses a new dichotomy, ω -dichotomy: $Z(t)$ can only take two values: \aleph_o and 0.

P540 In accord with P539 and regarding the number of Z-points to be traversed, P can only have two successive states: the state $P(\aleph_o)$ at which that number is \aleph_o , and the state $P(0)$ at which that number is 0. The number of Z-points to be traversed by P decreases directly from \aleph_o to 0, without finite intermediate states at which it has to traverse only a finite number of Z-points.

P541 Taking into account the ω -discontinuity of Z-points and the fact that between any two successive Z-points a distance greater than zero always exists, to traverse two successive Z-points, whatsoever they be, means to traverse a distance greater than zero:

$$z_{n+1} - z_n > 0, \forall n \in \mathbb{N} \quad (6)$$

In consequence, to traverse \aleph_o of such successive Z-points in the same direction means to traverse a distance greater than zero. And to traverse a distance greater than zero at the finite velocity v of P means the traversal has to last a time greater than zero.

P542 Although it is impossible to calculate neither the exact duration of the transition $P(\aleph_o) \rightarrow P(0)$ nor the distance P must traverse while performing such a transition (there is neither a last instant nor a last point at which the transition ends), we have proved in P541 that, indeterminable as they might be, that duration and that distance must be greater than zero. It will now be proved

they cannot be greater than zero.

P543 Let τ be any real number greater than zero, and consider the real interval $(0, \tau)$. According to the ω -dichotomy (5), for any instant t within $(0, \tau)$ the number of Z-points that P must still traverse at the instant $t_1 - t$ is \aleph_o . In consequence, the time P needs to perform the transition $P(\aleph_o) \rightarrow P(0)$ is less than τ . And since τ is any real number greater than zero, we must conclude the time P needs to perform the transition $P(\aleph_o) \rightarrow P(0)$ is less than any real number greater than zero.

P544 So then, according to P541, the time P needs to perform the transition $P(\aleph_o) \rightarrow P(0)$ is greater than zero. And according to P543 that time must be less than any real number greater than zero. But there is no real number greater than zero and less than any real number greater than zero. So, it is impossible for the transition $P(\aleph_o) \rightarrow P(0)$ to last a time greater than zero. The same conclusion, and for the same reasons, applies to the distance P must traverse while performing the transition $P(\aleph_o) \rightarrow P(0)$.

P545 In line with P541 and P543, P needs to traverse a distance greater than zero for a time greater than zero to perform the transition $P(\aleph_o) \rightarrow P(0)$, but neither that distance nor that time can be greater than zero. Note this is not a question of indeterminacy but of impossibility. If it were a question of indeterminacy there would exist a nonempty set of possible solutions, although we could not determine which of them is the correct one. In our case the set of possible solutions is the empty set because the set of real numbers greater than zero and less than any real number greater than zero is, in fact, the empty set.

P546 In short:

- A) According to the actual infinity hypothesis, the transition $P(\aleph_o) \rightarrow P(0)$ takes place.
- B) The transition $P(\aleph_o) \rightarrow P(0)$ can only take place along a distance and a time greater than zero, because of the ω -discontinuity and of the distance greater than zero P must

traverse at its finite velocity v .

- C) The transition $P(\aleph_o) \rightarrow P(0)$ cannot take place along a distance and a time greater than zero because of the ω -dichotomy, and because no real number greater than zero is less than all real numbers greater than zero.
- D) Zeno's Dichotomy I is, therefore, a contradiction derived from ω -order.

CONCLUSION

P547 According to the hypothesis of the actual infinity, the set of Z-points and the set of Z^* -points do exist as complete totalities. Therefore the transitions $P^*(0) \rightarrow P^*(\aleph_o)$ and $P(\aleph_o) \rightarrow P(0)$ take place while P moves from the point 0 to the point 1. Now then, the transitions $P^*(0) \rightarrow P^*(\aleph_o)$ and $P(\aleph_o) \rightarrow P(0)$ can only take place along a distance and a time greater than zero. The problem is that they cannot take place along a distance and a time greater than zero because that time and that distance is less than any real number greater than zero, and no real number greater than zero and less than any real number greater than zero do exist.

P548 The above contradictions are direct consequences of assuming that ω -ordered and ω^* -ordered sets, as the sets of Z-points and of Z^* -points, exist as complete infinite totalities, which in turn is a consequence of assuming the existence of all finite natural numbers as a complete totality [47, p. 103-104], which is the hypothesis of the actual infinity subsumed into the Axiom of Infinity in modern set theories. An hypothesis that, consequently, should be put to the test.

MAKING DISAPPEAR A NUMBER

P549 As we will see in this chapter, it is possible to make disappear a number from a list of numbers if the list is ω -ordered, and the number in question successively exchanges its current position in the list with the number in the next position in the list, while a number in the next position in the list exists to exchange its position. This absurdity is an inevitable consequence of assuming that ω -ordered lists exist as complete totalities, even without a last element completing the corresponding list. It will also be proved these conflicting disappearances do not happen in potentially infinite lists.

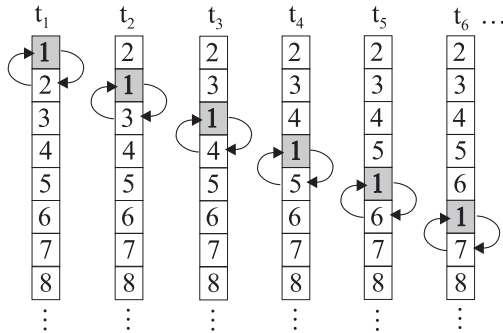

Figurea 29.1 – $\langle E_{1,i} \rangle$ exchanges through the ω -ordered list of the natural numbers.

P550 Consider the ω -ordered list of all natural numbers: $\mathbb{N} = 1, 2, 3, \dots$, and let $\langle r_i \rangle$ be the ω -ordered sequence of the rows of a table T such that $r_i = i, \forall i \in \mathbb{N}$. Assume now we exchange the number 1 with the number 2; and then the number 1 with the

number 3; and then the number 1 with the number 4; and so on (Figure 29.1). In symbols:

$$E_{1,n} \begin{cases} r_n = n + 1 \\ r_{n+1} = 1 \end{cases} \quad n = 1, 2, 3, \dots \quad (1)$$

where $E_{1,n}$ represents the exchange between the number 1 in the row r_n of T and the number $n + 1$ in the row r_{n+1} of T . The purpose of the next discussion is to examine the destination of the number 1 once all possible exchanges $\langle E_{1,i} \rangle$ defined by (1) have been carried out (Principle of Execution P25).

P551 It is immediate to prove that for each natural number v the first v exchanges $\langle E_{1,i} \rangle_{i=1,2,\dots,v}$ can be carried out. In fact, it is clear $E_{1,1}$ can be carried out because it places the number 1 in r_2 and the number 2 in r_1 . Assume that, being n any natural number, the first n exchanges $\langle E_{1,i} \rangle_{i=1,2,\dots,n}$ can be performed. Once performed, the number 1 will be placed in r_{n+1} and the number $n+1$ in r_n . Consequently, $E_{1,n+1}$ can also be performed because it places 1 in r_{n+2} and the number $n + 2$ in r_{n+1} . Thus, $E_{1,1}$ can be performed, and if for any natural number n the first n exchanges $\langle E_{1,i} \rangle_{i=1,2,\dots,n}$ can be performed, then the first $\langle E_{1,i} \rangle_{i=1,2,\dots,(n+1)}$ exchanges can also be performed. This inductive reasoning proves that for each natural number v the first v exchanges $\langle E_{1,i} \rangle_{i=1,\dots,v}$ can be carried out. We will examine the consequences of this conclusion in the following two sections by means of two independent arguments

SUPERTASK ARGUMENT

P552 Supertask theory assumes the possibility to perform infinitely many actions in a finite interval of time (see [188] for background details and Chapters 23 and 17 of this book). The short discussion that follows analyzes this assumption by mean of a supertask whose successive tasks consist just in performing the successive exchanges $\langle E_{1,i} \rangle$ defined by (1). As a consequence of those successive exchanges, the number 1, originally placed in the first row of T , will be successively placed in the 2nd, 3rd, 4th... row of T .

P553 Let $\langle t_n \rangle$ be a strictly increasing and ω -ordered sequence of instants within the real interval (t_a, t_b) whose limit is t_b . Assume each possible exchange $E_{1,i}$ is performed at the precise instants t_i of $\langle t_n \rangle$. Being t_b the limit of $\langle t_i \rangle$, the one to one correspondence between $\langle t_i \rangle$ and $\langle E_{1,i} \rangle$ defined by $f(t_i) = E_{1,i}$, proves that at the instant t_b all possible exchanges $\langle E_{1,i} \rangle$ will have been carried out (Principle of Execution P25). The problem is: in which row will be placed the number 1 at t_b ?

P554 Let r_v be any row of T . Since $E_{1,v}$ places the number 1 in the row r_{v+1} , if the number 1 were in the row r_v then the first v exchanges $\langle E_{1,i} \rangle_{i=1,2,\dots,v}$ would not have been carried out, which according to P551 is impossible. Thus, and being, r_v any row of T , we must conclude that at the instant t_b the number 1 has disappeared from the table. While all numbers greater than 1 remain in T , each number $n > 1$ in r_{n-1} , the number 1 has magically disappeared from T .

P555 It is worth noting the conclusion on the disappearance of the number 1 has not been deduced from the successively performed exchanges $\langle E_{1,i} \rangle$. We have simply proved that once all possible exchanges $\langle E_{1,i} \rangle$ have been carried out (Principle of Execution P25), the number 1 cannot be in any row of T , otherwise it would have to be in a certain row r_v , whatsoever it be, and then the first v exchanges $\langle E_{1,i} \rangle_{i=1,2,\dots,v}$ would not have been carried out, which goes against P551.

P556 And note again, the above conclusion is not a question of indeterminacy regarding the row of T occupied by the number 1 once all possible exchanges $\langle E_{1,i} \rangle$ have been carried out, it is a question of an actual disappearance: once all possible exchanges $\langle E_{1,i} \rangle$ have been carried out (Principle of Execution P25), the set of possible rows of T where the number 1 could be is just the empty set. In line with other arguments in this book, it is immediate the number 1 disappear from T just at t_b , an instant at which the number 1 is no longer exchanged. This is, in fact, infinitist magic. The problem is that magic is not compatible with formal sciences.

MODUS TOLLENS ARGUMENT

P557 Consider the following two propositions regarding the execution of all possible exchanges $\langle E_{1,i} \rangle$:

p: Once performed all possible exchanges $\langle E_{1,i} \rangle$, the number 1 remains in T .

q: Once performed all possible exchanges $\langle E_{1,i} \rangle$, the number 1 is in a certain row r_v of T .

It is quite clear that $p \Rightarrow q$ because if once performed all possible exchanges $\langle E_{1,i} \rangle$ the number 1 remains in T , then it must be in one of its rows r_v , whatever it be.

P558 We will prove now q is false. Let r_v be any row of T . If once performed all possible exchanges $\langle E_{1,i} \rangle$ the number 1 is in r_v then $E_{1,v}$ has not been carried out. But this is false because:

- 1) The index v in $E_{1,v}$ is a natural number.
- 2) According to P551, for each natural number v , it is possible to carry out the first v exchanges $\langle E_{1,i} \rangle_{i=1,2\dots v}$.
- 3) All possible exchanges $\langle E_{1,i} \rangle$ have been carried out.
- 4) At least the first v exchanges $\langle E_{1,i} \rangle_{i=1,2\dots v}(1)$ have been carried out.
- 5) $E_{1,v}$ placed the number 1 in r_{v+1} .

In consequence the number 1 is not in r_v . Therefore, and being r_v any row, we must conclude q is false.

P559 Therefore, we can write:

$$p \Rightarrow q \quad (2)$$

$$\neg q \quad (3)$$

$$\therefore \neg p \quad (4)$$

which means that once performed all possible exchanges $\langle E_{1,i} \rangle$ (Principle of Execution P25), the number 1 is no longer in the table T .

P560 Evidently, the above arguments on the disappearance of the number 1 could be applied to any other number of T . Moreover, it could be applied simultaneously to any number of numbers of T . For example, all odd (or even) numbers can disappear simultaneously from T by a sequence of exchanges similar to the above one. The reader will certainly be able to define it.

THE POTENTIAL INFINITY ALTERNATIVE

P561 We will end this chapter by analyzing the problem of $\langle E_{1,i} \rangle$ exchanges from the point of view of the potential infinity. From this point of view only finite totalities make sense, as large as wished but always finite. Consider, then, any finite number n and the table T_n of the first n natural numbers. $\langle E_{1,i} \rangle$ will be now defined by:

$$E_{1,i} \begin{cases} r_i = i + 1 \\ r_{i+1} = 1 \end{cases} \quad i = 1, 2, 3, \dots, n - 1 \quad (5)$$

and then, only a finite number $n - 1$ of exchanges $\langle E_{1,i} \rangle_{i=1,2,\dots,(n-1)}$ can be carried out, at the end of which the number 1 will be placed in the last row r_n of T_n .

P562 Thus, for any given natural number n the exchanges (5) in T_n are consistent. Only when they take place in the assumed complete lists T of all natural numbers they become inconsistent. In symbols:

$$E_{1,i} \begin{cases} r_i = i + 1 \\ r_{i+1} = 1 \end{cases} \quad i = 1, 2, 3, \dots, n - 1 \quad (6)$$

is consistent for all $n \in \mathbb{N}$, while:

$$E_{1,i} \begin{cases} r_i = i + 1 \\ r_{i+1} = 1 \end{cases} \quad i = 1, 2, 3, \dots \quad (7)$$

is inconsistent.

THEOREM OF THE NTH DIGIT

P563 This chapter proves the existence of a class of natural numbers that can be used to reorder the rows of a table that contains all natural numbers in such a way that all of its rows become a particular type of row. The existence of such a reordering contradicts the fact that infinitely many rows of the table can never become such a particular type of row. The corresponding proofs are so elementary and simple that only foundational elements of set theory can be involved in the contradiction.

P564 Let \mathbb{N} be the ω -ordered set of all natural numbers and expressed in the decimal numeral system. It is immediate to prove the following:

Theorem P564, of the nth Digit.-*For any given digit and any given position in the numerical expression of the elements of the set \mathbb{N} , there is at least a denumerable subset of \mathbb{N} , each of whose elements has the same given digit in the same given position of its numerical expression.*

Proof.-Let d be any digit (numeral, figure or cipher) of the decimal numeral system, m any natural number, and n any element of \mathbb{N} whose m th digit is just d , for instance $n = 1^{(m-1)}\mathbf{1d}$. From n it is possible to define different sequences of different elements of \mathbb{N} , all of them with the same digit d in the same m th position of its numerical expression. For example the sequence $\langle n_i \rangle$:

$$n_1 = 1^{(m-1)}\mathbf{1d1} \tag{1}$$

$$n_2 = 1^{(m-1)}\mathbf{1d11} \tag{2}$$

$$n_3 = 1^{(m-1)}1\mathbf{d}111 \quad (3)$$

$$n_4 = 1^{(m-1)}1\mathbf{d}1111 \quad (4)$$

...

The one to one correspondence f between the ω -ordered set \mathbb{N} and $\langle n_i \rangle$ defined by $f(i) = n_i$, $\forall i \in \mathbb{N}$, proves $\langle n_i \rangle$ is denumerable. \square

D-MODULAR ROWS AND D-EXCHANGES

P565 Let T be a table whose successive rows $\langle r_i \rangle$ are the successive elements $\langle i \rangle$ of \mathbb{N} . A row r_i of T will be said n -modular iff it has at least n digits and its n th digit is $n(\text{mod } 10)$. This means that a row is, for instance, 6767-modular if its 6767th digit is 7; or that it is 3333330-modular if its 3333330th digit is 0. If a row r_n is n -modular (being n in n -modular the same number as n in r_n) it will be said d-modular. Consider now the following permutation **D** of the rows $\langle r_i \rangle$ of T . For each successive row r_i of T :

- If r_i is d-modular then let it unchanged.
- If r_i is not d-modular then exchange it with any following i -modular row $r_{j,j>i}$, provided that at least one of the rows $r_{j,j>i}$ succeeding r_i be i -modular. Otherwise let it unchanged.

where to exchange two rows r_i and r_j means to interchange their respective numerical contents, i.e to place the number in r_j in r_i , and the number in r_i in r_j . The exchange of a non-d-modular row r_i with a following i -modular row $r_{j,j>i}$ will be referred to as d-exchange. Thanks to the condition $j > i$ (in $r_{j,j>i}$), once a row r_i has been d-exchanged, it becomes d-modular and will remain d-modular and unaffected by the subsequent d-exchanges.

P566 Regarding the possibility of being i -modular, it is immediate to prove the following:

Theorem P566, of the non- i -Modular Numbers *There is an infinite number of natural numbers, each one of whose successive digits c_i is different from $i(\text{mod } 10)$.*

Proof Consider, for instance, the sequence $\langle s_i \rangle$:

$$s_1 = 21 \tag{5}$$

$$s_2 = 2121 \tag{6}$$

$$s_3 = 212121 \tag{7}$$

$$s_4 = 21212121 \tag{8}$$

...

The one to one correspondence f between \mathbb{N} and $\langle s_i \rangle$ defined by $f(i) = s_i$ proves it is denumerable. And it is impossible for each of its elements to have a i th digit d_i equal to $i \pmod{10}$.

□

P567 Though procedures and proofs of infinitely many steps are accepted and usual in infinitist mathematics, \mathbf{D} could even be considered as an ω -ordered supertask [230, 134]. Indeed, let $\langle t_n \rangle$ be an ω -ordered and convergent sequence of instants within a finite interval of time (t_a, t_b) , being t_b the limit of the sequence. Assume that \mathbf{D} is applied to each row r_i just at the precise instant t_i . The bijection $f(t_i) = r_i$ proves that at t_b the permutation \mathbf{D} will have been applied to every row of T .

P568 Let then T_d the table resulting from applying \mathbf{D} to T . It is immediate to prove that:

Theorem P568a All rows of T_d are d -modular.

Proof.-Assume there is in T_d a row r_n that is not d -modular. This implies r_n is not n -modular and could not be d -exchanged with a succeeding n -modular row. Since n is finite and all n -modular rows have the same digit $n \pmod{10}$ in the same n th position of its numerical expression, r_n will be preceded by at most a finite number $n - 1$ of n -modular rows and succeeded by an infinite number of n -modular rows (Theorem P564 of the n th Digit), one of which had to be exchanged with r_n . So, it is impossible for the row r_n of T_d not to be d -modular. □

Theorem P568b Not all rows of T_d are d -modular.

Proof.-Let n be any of the natural numbers none of whose i th digit is $i(\text{mod } 10)$ (Theorem P566). Since permutation \mathbf{D} does not remove rows from T , the number n will be a row r_v of T_d . But r_v cannot be d -modular, otherwise the v th digit of n would be $v(\text{mod } 10)$, which is not the case. \square

DISCUSSION

P569 The elementariness and simplicity of the above argument suggest that its contradictory conclusions could only be solved by refining some of the foundational elements of set theory, such as the hypothesis of the actual infinity subsumed into the Axiom of Infinity. Indeed, it is that hypothesis that legitimizes the existence of any infinite collection as a complete totality, even not having a last element completing the collection [134], as is the case of the above ω -ordered list T of *all* natural numbers. It is also that hypothesis that makes it possible the Theorem P564, of the n th Digit, and then that each row r_n of T be preceded by a finite number of n -modular rows and succeeded by an infinite number of such n -modular rows, which in turn makes it possible the above argument. An argument that would be impossible, for instance, under the hypothesis of the potential infinity.

THE UNARY NUMERAL SYSTEM

P570 A numeral is not a number but the symbol we use to represent a number. Thus, the numeral “5” is the symbol for the number 5 in the usual decimal numeral system. Perhaps the most primitive way to represent numbers [245] is what we now call the unary numeral system (UNS). As its name suggests, only one numeral is needed to represent any natural number. Here we will use the numeral “1”. The successive natural numbers will then be written as: 1, 11, 111, 1111, 11111, 111111, ...

P571 Although, for obvious reasons, the UNS is not the most appropriate for complex arithmetic calculations, it is the system that best represents the essential nature of the natural numbers: each natural number is exactly one unit greater than its immediate predecessor, and then the unary expression of each natural number has exactly one numeral more than the unary expression of its immediate predecessor. In addition, the UNS suggests a recursive arithmetic definition of the natural numbers: starting from the first of them, the number 1, add one unit to define the next one.

P572 The result of defining the successive natural numbers (all of them finite) by adding one unit to the first natural number, and then to the successive numbers resulting from each of the infinitely many successive additions, is not an infinite number but an infinitude of finite numbers, each one unit greater than its immediate predecessor. In conformity with the hypothesis of the actual infinity, all these infinitely many finite natural numbers exist as a complete totality. Or in terms of the UNS, according to the infinitist orthodoxy it is possible to define infinitely many finite strings of

1s, each with one numeral 1 more than its immediate predecessor, without ever reaching a string with infinitely many 1s. On this belief is axiomatically founded the infinitist paradise. The Axiom of Infinity say, basically, the same: $\exists N(\emptyset \in N \wedge \forall x \in N(x \cup \{x\} \in N))$ (Chapter 4).

P573 Let us put to the test the above hypothesis on the existence of an actual infinitude of finite numbers, each one unit greater than its immediate predecessor. For this, consider a special unary writing machine (UWM) capable of writing horizontal strings of 1s of any finite length. Now let UWM work according to the following conditions:

On an empty tape, and at each of the successive instants t_i , and only at them, of an ω -ordered sequence of instants $\langle t_i \rangle$ in the real interval (t_a, t_b) whose limit is t_b , UWM writes a first numeral 1, or a numeral 1 on the right side of the last numeral 1 written by UWM. At instant t_b , UWM writes nothing and stops.

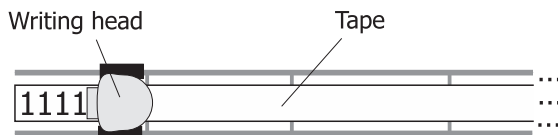

Figure 31.1 – The unary writing machine on the point of writing the fifth numeral, i.e. the number 5 in the unary numeral system.

P574 From the supposed existence of the sequence of the natural numbers as a complete totality (hypothesis of the actual infinity subsumed into the Axiom of Infinity) and from the functioning of UWM, the following two theorems are immediately deduced:

Theorem P574a: *At t_b , the string S_1 written by UWM is finite.*

Proof.-Let t be any instant in the interval (t_a, t_b) . It holds: $\exists v \in \mathbb{N} : t_v < t < t_{v+1}$. Therefore, at the instant t , the string S_1 has a finite number v of 1s. So then, and being t any instant of (t_a, t_b) , the string S_1 is finite in the whole interval (t_a, t_b) .

Alternatively, if T is the set of all instants of (t_a, t_b) at which UWM has written only a finite string of 1s, the complementary set \bar{T} of T in (t_a, t_b) is the empty set. And considering that at t_b no numeral is written, S_1 can only be finite. \square

Theorem P574b : *At t_b , the string S_1 written by UWM is not finite.*

*Proof*n.-Let n be any natural number. If S_1 were a finite string of n numerals 1, UME would not have written the corresponding numeral 1 at each of the successive instants $t_{n+1}, t_{n+2}, t_{n+2} \dots$ of $\langle t_i \rangle$, what is not the case. So then, at t_b the string S_1 is not finite. \square

P575 Again a contradiction, and behind it the same cause: the actual infinity hypothesis. The belief that the infinite collections exist as complete totalities.

THE UNARY TABLE OF THE NATURAL NUMBERS

P576 Consider now the following ω -ordered table U of the natural numbers written in the UNS:

Row r_1 : 1	(1)
Row r_2 : 11	(2)
Row r_3 : 111	(3)
Row r_4 : 1111	(4)
Row r_5 : 11111	(5)
...	(6)

The n th row of U , symbolically r_n , corresponds to the unary representation of the natural number n , which consists of a string of exactly n numerals “1”. According to the hypothesis of the actual infinity, the infinitely many rows of U , one for each natural number, do exist all at once, as a complete totality.

P577 The number of rows of U is the same as the number of the natural numbers, i.e. \aleph_o , the cardinal of the set of the natural

numbers. According to the infinitist orthodoxy, \aleph_o is the smallest infinite cardinal, the smallest number greater than all finite natural numbers (see Chapters 4 and 19 on the actual infinity and aleph null respectively).

P578 The first column of U has \aleph_o elements, one for each row, one for each natural number. Since each element of this column belongs to a *different row* and no other column has more elements than this first column (it could easily be proved that each column of U has \aleph_o elements), we can say this first column defines the number of rows of U , in the sense that the first element of each row is a different element of this first column, and then a one to one correspondence f between the rows $\langle r_i \rangle$ of U and the elements $\langle c_{1i} \rangle$ of its first column can be defined:

$$f(r_i) = c_{1i}, \forall r_i \in T \quad (7)$$

However, while the number of rows of U is completely defined by the number of 1s of its first column, the number of its columns is highly problematic, as we will immediately see.

P579 Being each row r_n composed of exactly n numerals “1”, and being each of those numerals an element of a different column, that row ensures the existence of at least n columns in U . It is in this sense that we will say that r_n defines exactly n columns:

$$r_1 = 1 \quad (r_1 \text{ defines 1 column}) \quad (8)$$

$$r_2 = 11 \quad (r_2 \text{ defines 2 columns}) \quad (9)$$

$$r_3 = 111 \quad (r_3 \text{ defines 3 columns}) \quad (10)$$

$$r_4 = 1111 \quad (r_4 \text{ defines 4 columns}) \quad (11)$$

$$\dots \quad (12)$$

$$r_n = 111 \dots 111 \quad (r_n \text{ defines } n \text{ columns}) \quad (13)$$

$$\dots \quad (14)$$

P580 Let's begin by proving the number of columns of the table U

cannot be finite. In effect, let n be any natural number. U cannot have n columns because in that case the number $n + 1$ would not belong to the table: the unary representation of that number is a string of $n + 1$ numerals “1” and then a row of U that defines $n + 1$ columns. Thus, whatsoever be the finite number n , U cannot have n columns.

P581 And now we will prove the number of columns of U cannot be infinite either. Since each row is the unary expression of a natural number and all natural numbers are finite, each row r_n consists of a finite string of n numerals “1”. So, every row of U defines a finite number of columns. Or in other words, since no natural number is infinite, no row defines infinitely many columns. But if no row defines an infinite number of columns, U cannot have an infinite number of columns, unless the number of its columns is defined not by one row but by a certain number of rows. We will examine now this possibility.

P582 Assume the infinite number of columns (C from now on) of the table U is not defined by a particular row but by a group of rows, even by the whole table. Evidently, if a group of rows (or the whole table) is needed in order to define C , then at least two rows of the group will contribute together to the definition of C . Where contribute together means that *each row* defines certain columns that the other does not and vice versa.

P583 Let r_k and r_n be any two of those contributing rows. If r_k and r_n contribute together to define C , then r_k will define certain columns that r_n does not, and vice versa. Otherwise only one of them would be necessary in order to define C .

P584 Now then, since k and n are natural numbers we will have either $k < n$ or $k > n$. Assume $k < n$, in this case r_k defines the firsts k columns of U and r_n the firsts n columns of U . In consequence, although r_n defines $(n - k)$ columns that r_k does not, all columns defined by r_k are also defined by r_n . This proves the impossibility that any two different rows of a group of rows (inclu-

ding the whole table) *contribute together* to define C . Therefore, the number of rows of U cannot be infinite.

P585 And things can get worse with respect to the definition of C . In effect, let $\langle t_n \rangle$ be any ω -ordered strictly increasing sequence of instants within the real interval (t_a, t_b) whose limit is t_b and consider the following conditional supertask:

Supertask P585.—*At each instant t_i of $\langle t_n \rangle$ remove from U the row r_i if, and only if, the remaining rows define the same number of columns of U as if r_i were not removed. Otherwise end the supertask.*

P586 In any case, at the instant t_b supertask P585 would have been performed and we will have the following two mutually exclusive alternatives:

- 1) At t_b not all rows have been removed.
- 2) At t_b all rows have been removed.

In accord with the first alternative, and taking into account the successive way the rows have been removed, there will be a first row r_n that was not removed because its removal would have changed the number of columns of U . But this is impossible because all columns defined by r_n are also defined by the next row r_{n+1} . The first alternative is then false. We must therefore conclude the second alternative is true, which means U has the same number of columns as an empty table! A new consequence of being complete and incompletable as the list of the natural numbers is assumed to be from the perspective of the actual infinity hypothesis.

P587 While, in accordance with the hypothesis of the actual infinity subsumed into the Axiom of Infinity, U is a complete and well defined totality composed of infinitely many rows, the argument [P580-P585] proves the number of its columns cannot be finite or infinite. Consequently, the unary table U of *all* natural numbers is inconsistent. An inconsistency that does not arise on the hypothesis of the potential infinity: for any natural number n , the unary

table U_n of the first n natural numbers has exactly n rows and n columns.

INTRODUCTION

P588 In the last years of the 20th century and the first years of the 21st, the arguments on supertasks have been extended to the physical world. And not only to explore the possibilities that supertasks could actually be carried out in the physical world, but also, and inversely, to discover new characteristics of the physical world from supertasks. As expected, the supposed practical execution of supertasks would impose on the physical world an anomalous and implausible phenomenology never observed before. But infinitism is willing to accept any anomalous phenomenology before questioning the formal consistency of the actual infinity hypothesis involved in such anomalies. In this chapter two supertasks are analyzed, the one in the framework of classical mechanics and the other in that of special relativity. The first is the emblematic “beautiful supertask”. The second proposes to solve the Goldbach conjecture by analyzing one by one all even natural numbers taking advantage of the relativistic dilation of time.

A NEWTONIAN SUPERTASK

P589 In 1996 J. P. Laraudogoitia published a short article entitled *A beautiful Supertask. Example of Indeterminism in Classical Mechanics*, a paradigm of the class of supertasks in which physical laws get involved [184]. The physical foundation of the beautiful supertask (BS hereafter) is the elastic collision. As it is well known, classical mechanics states that in this kind of collisions the linear momentum (the product of mass and velocity: $m \times v$) and the kinetic energy (half the product of mass and the square of velocity: $1/2 \times m \times v^2$) are conserved. If an object of mass m moving with

a uniform velocity v meets another object at rest and with the same mass m , both objects are said to collide elastically if after the collision the object that was at rest inherits the motion from the one that was moving and the one that was moving inherits the rest state from the one that was at rest. There is therefore an exchange of roles in elastic collisions. This simple mechanical basis is the fundament of BS. Only that instead of one elastic collision there will be an ω -ordered sequence of elastic collisions. Although the ω -order does not appear in the original argument.

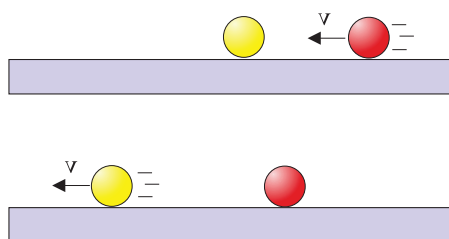

Figure 32.1 – Elastic collision of two particles: the linear momentum and the kinetic energy are preserved (in the case represented the two particles have the same mass).

P590 Let us consider, as Laraudogoitia did, an ω -ordered set of point particles $\langle p_i \rangle$, all of them with the same mass m , each particle p_i at rest at the point $x_i = 1/2^i$ of an ω -ordered sequence of points $\langle x_i \rangle$ of the X axis of a coordinate system in \mathbb{R}^3 . The set of particles $\langle p_i \rangle$ is completed with another additional point particle, p_o , to the right of the previous ones and with the same mass m as them, but in this case moving along the common straight line X to the left with a uniform velocity v parallel to X (Figure 32.2). Naturally, the above set of particles (L system from now on) could not exist in our physical universe if they were elementary particles of ordinary matter because the known universe has a finite number of such particles, in the order of 2×10^{80} .

P591 Suppose that p_o collides elastically with p_1 at the instant t_1 . As a consequence of this elastic collision, p_o remains at rest at the point x_1 and p_1 inherits the rectilinear and uniform motion of

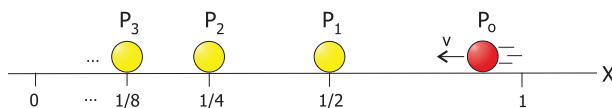

Figure 32.2 – The beautiful supertask about to begin.

p_0 , moving then to the left with the velocity v inherited from p_0 . Now it will be p_1 that ends up suffering an elastic collision with p_2 . As a consequence of this new collision, p_1 remains at rest in x_2 while p_2 inherits the motion of p_1 . The motion of p_2 towards p_3 ends up in a new elastic collision as a consequence of which p_2 remains at rest in x_3 and p_3 inherits the motion of p_2 . It is obvious how this story continues: each particle p_i at rest in x_i inherits the motion of its predecessor p_{i-1} , which in turn inherits the rest state of p_i in x_i . Thus, each p_i particle moves from its original position x_i to the next one x_{i+1} . Although we will not do it here, it is easy to calculate the instant t_i in which the particle p_i collides with its neighbor p_{i+1} . It is also easy to calculate the first instant t_b at which all particles have already collided ($t_b = 1/2v$). Supertask BS is the infinite sequence of elastic collisions just described.

P592 Before beginning the discussion on BS , a minor problem will be addressed related to the fact that while the sequences $\langle p_i \rangle$ and $\langle x_i \rangle$ are ω -ordered by their corresponding sequences of indexes: the natural number in their natural order of precedence (Theorem P80a, of the Indexed Sets), the points of the real straight line X are densely ordered. Indeed, BS assumes that each particle p_i is at rest at the point x_i where it collides with the moving particle p_{i-1} , its immediate predecessor in $\langle p_i \rangle$. Now then, the collision cannot take place in the point x_i , otherwise both particles would be in the same point x_i at the same instant t_i , and this would not be an elastic collision but a physical interpenetration. The problem here is that the real line is densely ordered, so that between any two different points infinitely many other different points do exist. There is not a point x in X immediately preceding the point x_i where p_i is placed. That is to say, there is no point x in the X axis occupied by the particle p_{i-1} at the instant t_i at which it collides

with p_i . Or in other more general terms: there is no couple of points (x_i, x) in the X axis at which the couple of point particles (p_i, p_{i-1}) can collide, because whatsoever be x , infinitely many different points exist between x and x_i , which makes impossible for the two point particles to collide. In these conditions, two point particles can interpenetrate each other but not elastically collide. The continuum of the real line is not the right scenario for an elastic collision of two point particles.

P593 Going back to BS , at the instant t_b , once BS has been completed, the particle p_o will be at rest in x_1 and each particle p_i of $\langle p_i \rangle$ will be at rest in x_{i+1} . And since there is not a last particle in the ω -ordered system of particles L , there will not be a last collision either, or a last particle moving indefinitely to the left. At the instant t_b , all particles of the system L of particles will be at rest. And since there is not a last particle inheriting the linear momentum and the kinetic energy of the initial particle p_o , then either the basic laws of physics are violated (conservation of energy and linear momentum), or it is necessary to appeal to an *ad hoc* energy dissipation that justifies the ω -order causing this mechanical anomaly. Naturally, in a finite system of particles the story would end without the need for anomalous dissipations, with the last particle on the left moving indefinitely to the left with the velocity v inherited from the particle p_o through $p_{n-1}, p_{n-2} \dots, p_1$. And this holds for any finite number n of particles. Only when the number of particles is infinite appears the anomalous dissipation of momentum and kinetic energy.

P594 The supertask BS has an epilogue based on the symmetry with respect to time of Newton laws of mechanics: it would be possible that a system of particles like the previous one, being at rest all its particles, spontaneously self-excite so that each particle in the position x_{i+1} moves to the position x_i and the particle p_o initiates a motion of uniform velocity v parallel to the axis X and from left to right. This would be the self-excited supertask SS .

P595 The publication of BS was followed by a certain discussion

and by other similar publications [184, 185, 186, 82, 5, 187, 175, 6, 7, 189, etc.]. But it was not even considered the possibility that the anomalous dissipation and self-excitation were the product of the inconsistency of the ω -order (and therefore of the actual infinity) involved in the sequence $\langle p_i \rangle$: the infinitely many particles of $\langle p_i \rangle$ exist as a complete totality despite the fact that no last particle completes the sequence. There is no physical reason for the anomalous dissipation that must follow *BS*. The only reason is to avoid the infinitist catastrophe that would imply the existence of a last particle in the ω -ordered sequence of particles $\langle p_i \rangle$; the existence of a last inheritor of the linear momentum and the kinetic energy of p_o . It is the non-existence of a last particle in a ω -ordered system of particles that imposes the anomalous dissipation. Either anomalous dissipation or inconsistency of the ω -order. Infinitism does not hesitate to choose the dissipation of energy, however anomalous it may be. Which naturally complicates in an unnecessary way the understanding of the world.

P596 Let us consider again the system L of particles, but now with p_o moving along the negative side of the X axis, towards the particles $\langle p_i \rangle$ placed as before. Let us suppose that p_o moves in this case from left to right with the same uniform velocity v as before, although in the opposite direction, and in such a way that it is at the point $x = -1$ of the X axis at the instant t^* . At the instant $t_1 = t^* + 1/v$ it will be in the point 0, the origin O of the X axis, to the point of encountering the particles $\langle p_i \rangle$.

P597 But the encounter will never take place. If the elastic collision of p_o with some particle of $\langle p_i \rangle$ would take place, the particle p_o would remain stopped at a certain point x_v of $(0, 1/2)$, since at the point 0 there is no particle of $\langle p_i \rangle$ (0 is the limit of the sequence $\langle x_i \rangle$, not a point of the sequence). Taking into account that between the point 0 and the point x_v , whatever be x_v , there are infinitely many points of $\langle x_i \rangle$ in each of which there is a particle of $\langle p_i \rangle$, the particle p_o had to be stopped before x_v . Therefore, the moving particle p_o cannot be stopped at any point x_v , whatever it is, because it would have to be stopped before that x_v . An una-

voidable consequence of the ω -asymmetry: every point x_v of $\langle x_i \rangle$ and every particle p_v of $\langle p_i \rangle$ has a finite number v of predecessors and an infinite number \aleph_o of successors. So, there is not a last point of $\langle x_i \rangle$ or a last particle of $\langle p_i \rangle$. And since the only point of $(0, 1/2)$ before all points of $\langle x_i \rangle$ is the point 0, and no particle of $\langle p_i \rangle$ is placed in the point 0, the particle p_o would pass through all particles of $\langle p_i \rangle$ without colliding with any of them, which is impossible because all of them are particles with a mass greater than zero, and all of them are placed in the trajectory of p_o . This would be the ghostly supertask *GS*.

P598 *HS* and its formal sequels *SS* and *GS* would be proving the inconsistency of ω -order, and then the inconsistency of the hypothesis of the actual infinity from which that ω -order is deduced [47, p. 158, Theorem §14 I].

A RELATIVISTIC SUPERTASK

P599 The first physical requirement of a supertask is the infinite divisibility of time: an infinite number of successive instants are necessary in order to execute the successive tasks of a supertask. We know that matter, energy, and electric and non-electric charges are discrete, quantified, and not infinitely divisible. With respect to space-time we do not have the same certainty. It would be more aesthetic if it were also discrete, at least because of its intimate relationships with the rest of the physical entities, which are. However, the dominant idea throughout the 20th century has been that of a space-time continuum, a legacy of the pre-Socratic world.

P600 Since the 1920s there has been some interest in discussing discrete and finite options for space and time (see for example [27, 61, 94, 162, 129, 96, 19, 200, 20]). These options have become increasingly important as serious alternatives to the continuum. Thus, for example, the development of string theory and loop quantum gravity, two important approaches to quantum gravity, require certain doses of finiteness: the scale of strings is supposed to be close to the Planck scale [209], and, in turn, loop quantum gravity uses a quantum spacetime [219, 220].

P601 Although many infinitist believe supertasks are conceptually possible, they do not believe they were possible from the point of view of their practical execution. Especially if they involve extreme physical situations as would be the case of infinite speeds, durations and trajectories [110, 112]. This requirement is a serious drawback to the physical reality of supertasks. A solution is to draw on the theory of relativity. If the time corresponds to that of a mobile observer relative to the supertask reference frame, then the mobile observer may perceive a finite time in performing the supertask even though the duration of the supertask is infinite relative to its proper reference frame [81]. In this type of supertasks, known as *bifurcated supertasks* [81, 80, 149] two reference systems intervene in which time flows in a very different way, so it would be possible to match finite time intervals in one of them with infinite intervals in the other. This situation could occur in certain spatial-temporal conditions (Malament-Hogarth spaces [123]) such as those that occur around the singularity of a black hole.

P602 It would be possible, then, to arrange two research teams so that one of them would accelerate to close enough to the speed of light while keeping the other team always in its event horizon, so that both teams can communicate. Time would pass in a very different way in both frames, a finite interval in the accelerated team's frame would be equivalent to an infinite interval in the other, here the scientific team would have to be replaced from generation to generation, but the successive teams could dedicate their time, for example, to analyze one by one the successive even numbers and check, for example, Goldbach's conjecture (to check if every even number greater than 2 is the sum of two prime numbers). If, when exploring the list of even numbers, they find an exception, they would communicate it to other team, so that this team would know in a finite time the solution of Goldbach's conjecture: if they receive a signal before the expected time, the conjecture would be false. But if the conjecture is true, the research team would have to analyze the complete sequence of the even numbers, and in these conditions the supertask could only be of an infinite duration

P603 In the reference frame of a bifurcated supertask of an assumed infinite duration, the interval of time would be an interval of the real straight line with two endpoints: the instant in which the supertask begins, and the first instant after completing the supertask. The length of that interval can only be finite (Theorem P335, of the Finite Segments). And if in that finite interval of time infinitely many tasks have to be performed, the division of the interval into infinite parts, defined by the duration of each task, is also inconsistent (Theorem P354).

INTRODUCTION

P604 The number Pi (π) does not need presentation. Almost everyone knows it is the ratio of the circumference to the diameter of any circle. . . and many other things. It is the most ubiquitous of all numbers, π appears in an interminable list of mathematical and physical formula (see [172] for a short and pleasant introduction).

P605 Pi is an irrational and transcendent number, i.e. a non algebraic number that transcends algebraic methods, in Euler words (cited in [172, p. 59]). In consequence its decimal expansion is infinite and the only way to know its successive digits is to calculate them by means of appropriate algorithms. From an infinitist point of view, however, the infinitely many digits of π exist, all at once, as a finished and complete totality. From that (theo)platonian point of view, π exists by itself independently of the human mind. This is not the point of view of this book.

P606 Chapter 14 ended by recalling that the existence of endless calculations does not implies the existence of the corresponding finished results. For instance, if we divide 1 by 3 we get a rational number with an endless decimal expansion:

$$\frac{1}{3} = 0,33333333333333333333333333333333 \dots \quad (1)$$

and it is worth asking whether this decimal expansion exists as a complete and finished totality (actual infinity) or as an unlimited sequence of digits, as large as you wish but always finite (potential infinity).

P607 In the case of π the algorithms are a little more complicated, for instance Ramanujan's algorithm:

$$\frac{1}{\pi} = \frac{2\sqrt{2}}{9801} \sum_{n=0}^{\infty} \frac{(4n)!(1103 + 26390n)}{(n!)^4 396^{4n}} \quad (2)$$

Or Chudnovsky's algorithm [55]:

$$\frac{1}{\pi} = 12 \sum_{n=0}^{\infty} \frac{(-1)^n (6n)!(13591406 + 54514034n)}{(n!)^3 (3n)!(640320^3)^{n+1/2}} \quad (3)$$

The last one has served to calculate the first 12.1 trillions digits of π in October 2013 [246]. Fantastic as they may seem, these decimal expansions are minuscule: written in ordinary text (5 mm per digit) would occupy a distance equal to 0.033 the distance from the Earth to the Sun. Written in the same ordinary text, a decimal expansion of $9^{!9}$ decimals (see Chapter XXX) would be a string of digits millions of times greater than the diameter of the observable universe (93000 millions of light-years). And $9^{!9}$ is ridiculous compared with, for instance $10^{!100}$, which in turn is ridiculous compared with $100^{!1000}$ etc.

P608 However, infinitist mathematics assumes the infinitely many decimals of π (and of any other number with an infinite decimal expansion) do exist as a complete totality, as an ω -ordered sequence of digits in which every digit is preceded by a finite number of digits and succeeded by an infinite number of digits, being \aleph_0 the cardinal of the set of all those digits. We will see now that assumption could lead to a contradiction.

THE DECIMAL EXPANSION OF PI

P609 Consider the expression of π in the decimal numeral system:

$$\pi = 3,141592653589793238462643383279502884\dots \quad (4)$$

Its decimal expansion .141592653... is an ω -ordered sequence of digits whose ordinal is ω , the smallest of the transfinite ordinals.

This sequence has a first digit, in this case the digit 1, but not a last digit, and each digit has an immediate successor and an immediate predecessor (except the first of them). In consequence each digit is preceded by a finite number of digits and succeeded by an infinite numbers of digits (ω -asymmetry)

P610 Let $\langle p_n \rangle$ be the sequence defined by the decimal expansion of π so that the i th term p_i of $\langle p_n \rangle$ is just the i th digit of the decimal expansion of π :

$$p_1 = 1; p_2 = 4; p_3 = 1; p_4 = 5; p_5 = 9; p_6 = 2; \dots \quad (5)$$

Let C be the set $\{0, 1, 2, 3, 4, 5, 6, 7, 8, 9\}$ of all digits of the decimal numeral system, and let x be a variable whose domain is the set C .

P611 Now let us consider the following sequence $\langle D_n(x) \rangle$ of definitions of x :

$$D_i(x) = p_i, p_i \in \langle p_n \rangle; i = 1, 2, 3, \dots \quad (6)$$

subjected to the following:

Restriction P611.-Each i th definition $D_i(x)$ of the sequence of definitions $\langle D_n(x) \rangle$ will be carried out if, and only if, x results defined within its domain C .

Notice that the sequences $\langle p_n \rangle$ and $\langle D_n(x) \rangle$ are indexed by the natural numbers. So, they are ω -ordered (Theorem P80a, of the Indexed Sets). And notice also the successive definitions $D_i(x)$ are carried out successively, following the natural ω -order of the indexes $i = 1, 2, 3, \dots$.

P612 Let us now prove the following:

Theorem P612.-For each natural number v it is possible to perform the first v definitions $\langle D_n(x) \rangle_{i=1,2,\dots,v}$.

Proof.-Assume that there is a natural number v for which it is impossible to perform the first v definitions $\langle D_n(x) \rangle_{i=1,2,\dots,v}$.

There will be a first natural number $k \leq v$ for which it is impossible to carry out $D_k(x)$. Now then, according to (6) we have:

$$D_k(x) = p_k \quad (7)$$

where p_k is the k th digit of the decimal expansion of π , i.e. one of the elements of the set C of all digits of the decimal numeral system. Consequently, $D_k(x)$ defines x as an element of its domain C , and according to Restriction 611 it can be performed. Therefore it is impossible that $D_k(x)$ cannot be performed. So, for each natural number v it is possible to perform the first v definitions $\langle D_n(x) \rangle_{i=1,2,\dots,v}$. \square

An inductive proof would also be immediate.

P613 The Principle of Invariance P19, the Principle of Execution P25 and ω -order allow us to prove the following two theorems.

Theorem P613a. - *Once performed all possible definitions $D_i(x)$ of the sequence of definitions $\langle D_n(x) \rangle$, and only them, x is defined as an element of C*

Proof.-Since each and every definition $D_i(x)$ of $\langle D_n(x) \rangle$ defines x as a decimal digit p_i of the decimal expansion of π , and each digit of that expansion is an element of C we must conclude that each and every definition $D_i(x)$ of $\langle D_n(x) \rangle$ defines x as an element of its domain C . So, and according to Principle of Invariance P19, once performed all possible definitions $D_i(x)$ of $\langle D_n(x) \rangle$ (Principle of Execution P25), and only them, x will be defined as an element of C , whatsoever it be. \square

Theorem P613b. - *Once performed all possible definitions $D_i(x)$ of the sequence of definitions $\langle D_n(x) \rangle$, and only them, x is not defined as an element of C .*

Proof.-Let C_h be any element of C and assume that once performed all possible definitions of the sequence $\langle D_n(x) \rangle$ (Principle of Execution P25), and only them, we have $x = C_h$. At least one definition $D_i(x)$ will define x as C_h . Let $D_k(x) = C_h \in C$ be any one of such definitions. $D_k(x)$ does not leave x defined

as C_h , in the sense that all definitions that follow $D_k(x)$ define x also as C_h . If that were the case the number π would be rational: $\pi = 3,1415\dots C_h C_h C_h \dots$. Therefore, none of the definitions that define x as C_h leave x defined as C_h , for any $C_h \in C$. And since the completion of the sequence of definitions $\langle D_n(x) \rangle$ is not an additional definition (Principle of Invariance P19) and C_h is any element of C , we must conclude that once performed all possible definitions of the sequence of definitions $\langle D_n(x) \rangle$, and only them, x is not defined as an element of C . \square

P614 Notice the conclusion on the value of x once performed all possible definitions $\langle D_n(x) \rangle$ (Principle of Execution P25) and only them, is not a question of indeterminacy but of impossibility: the set of possible solutions is the empty set.

P615 The hypothesis of the actual infinity legitimizes the existence of ω -ordered lists as complete totalities without a last element completing the lists. The decimal expansion of π is one of those lists, and the above contradiction a simple consequence of assuming its existence as a finished and complete totality.

P616 Things are quite different from the potential infinity perspective, simply because from this perspective only finite totalities make sense. The existence of never-ending procedures as that of counting, or that of dividing 1 by 3, or π algorithms, explain the existence of endless sequences of results. But we cannot affirm that these endless sequences of results exist as ended totalities. We cannot affirm that it is possible to complete the incompletable. That possibility can only be axiomatically established.

P617 In the end, the only common property of all integer numbers is that each one of them (n) is one unit greater than its immediate predecessor ($n - 1$). As an ultimate cause, all properties of the rational numbers come from this universal property of the integer numbers: each rational number corresponds to a ratio (n_1/n_2) of two integer numbers (n_1 and n_2). Algorithms more complex than

simple a proportion originate irrational numbers like π . Although every finite decimal expression of an irrational number corresponds to a rational number, that is to say, to a proportion of two integer numbers.

P618 Some properties of the real numbers can be amazing (for some more than others) and their corresponding relations with the aforementioned universal property of the integer numbers are far from being evident. But all rational (and irrational?) numbers are built on the sole basis of that universal attribute of integer numbers, and therefore that sole basis must be the ultimate cause of all of their properties.

P619 In the case of the real numbers it must also be considered the existence of endless calculation algorithms that tend towards a limit without ever reaching the limit, as is the case, for the sake of illustration, of the well known Gregory-Leibniz series:

$$1 - \frac{1}{3} + \frac{1}{5} - \frac{1}{7} + \frac{1}{9} - \frac{1}{11} + \dots = \frac{\pi}{4} \quad (8)$$

According to the potential infinity hypothesis you can go as far as you wish through those series, but you can never complete the trip. According to the actual infinity hypothesis you can do it.

P620 In both cases, the actual and the potential infinity, the series and the limits of the series are two different things. According to the actual infinity hypothesis you can write:

$$\sum_{n=0}^{\infty} \frac{(-1)^n}{2n+1} = \frac{\pi}{4} \quad (9)$$

assuming that the infinitely many summands of the series do exist all at once as a complete totality, and that you can sum all of them, being the result of the sum the limit of the series. On the

contrary, from the potential infinity perspective we must write:

$$\sum_{n=0}^{\rightarrow} \frac{(-1)^n}{2n+1} \rightarrow \frac{\pi}{4} \quad (10)$$

which means we can approach the limit as much as we wish but we will never reach the limit, and the existence of all summands of the series as a complete totality makes no sense.

DEFINITIONS

P621 Riemann's Series Theorem states that it is possible to reorder the summands of a conditionally convergent series in such a way that it converges to any desired number or to (positive or negative) infinity. As we will see in this chapter, the theorem only applies if infinitely many terms are involved in the rearrangement. In those conditions, to converge and not converge to a given number could be reinterpreted as a contradiction derived from the inconsistency of the actual infinity.

P622 A series $\sum_{i=0}^{\infty} a_i$ is conditionally convergent if it is convergent but not absolutely convergent. Or in other terms if, and only if:

- a) The series converges to a finite number L :

$$\lim_{n \rightarrow \infty} \sum_{i=0}^{\infty} a_i = L \quad (1)$$

- b) The series of its positive (negative) terms diverges to positive (negative) infinite.

$$\lim_{n \rightarrow \infty} \sum_{i=0}^{\infty} |a_i| = \infty \quad (2)$$

P623 Riemann's Series Theorem states that by the appropriate rearrangement of its terms, any conditionally convergent series can be made converge to any given finite number or to infinity.

DISCUSSION

P624 We will exclusively deal with conditionally convergent series of real numbers that may converge to infinity or to different finite numbers by rearrangements based on the application of the associative, commutative and distributive properties of the elementary arithmetic operations in the field of the real numbers.

P625 Let $S = \sum_{i=1}^{\infty} a_i$ be any conditionally convergent series; v any natural number; and $S_{v,O}$ the sum of the first v summands of S ordered in a certain way denoted by O . Let us apply one time one of the properties associative, commutative or distributive to the summands of $S_{v,O}$ so that we get a new ordering O_1 of the initial summands. Being S_{v,O_1} the new sum, it will hold $S_{v,O_1} = S_{v,O}$, otherwise the applied property would not be satisfied in the field of the real numbers, which is not the case. Assume that for any natural number n it is possible to apply n successive times the properties associative, commutative and distributive to the summands of $S_{v,O}$ to get a new ordering O_n of the initial summands and so that, being S_{v,O_n} the new sum, it holds: $S_{v,O_n} = S_{v,O}$. The properties associative, commutative or distributive can be applied one time again to the summands of S_{v,O_n} to get a new ordering O_{n+1} of them, and so that $S_{v,O_{n+1}} = S_{v,O_n}$, otherwise the applied property would not be satisfied in the field of the real numbers, which is not the case.

P626 From the above inductive argument P625, we conclude that for any finite natural number n it is possible to apply n times the properties associative, commutative and distributive to the summands of $S_{v,o}$ to get n different arrangements of the summands while their sum is always the same.

P627 It holds, then, the following:

Theorem of the Consistent Reordering.-*For any natural number v , the sum of first v terms of any conditionally convergent series is always the same, irrespective of the rearrangement of the involved summands.*

We can therefore assert that only when the number of summands

is infinite the result of the sum depends on the rearrangement of the summands. Therefore, it is the assumed actual infinite number of summands that made it possible Riemann's conclusion.

P628 According to Riemann series theorem, if S is any conditionally convergent series and r any real number, the sum of its infinitely many terms is and is not equal to r , depending on the order the terms of the series are summed. This is the type of result one can expect if the hypothesis of the actual infinity were inconsistent. Riemann's Series Theorem could, therefore, be reinterpreted as a proof of the inconsistency of the actual infinity hypothesis. And that possibility, as legitimate as any other, should be explicitly declared in the statement of the theorem.

INTRODUCTION

P629 Mathematics is not usually concerned with the way the infinitely many successive steps of, for instance, an ω -ordered sequence of recursive definitions could be carried out. It simply assumes they are carried out in their complete totalities (Principle of Execution P25). But the finitely or infinitely many successive steps of any definition, procedure or proof could easily be timetabled by any sequence of instants of the same ordinality as the sequence of steps, and a one to one correspondence between both sequences. Evidently, the correspondence between instants and steps has no effect on the result of the timetabled definition or procedure. It simply states the successive instants at which each of its successive steps could be performed. We will examine here the difference between defining a sequence of infinitely many different objects without a last object completing the sequence, and redefining infinitely many times the same object.

RECURSIVE DEFINITIONS

P630 Let $\langle a_n \rangle$ be any ω -ordered sequence a_1, a_2, a_3, \dots and consider the following ω -ordered sequence of recursive definitions:

$$\begin{cases} A_1 = \{a_1\} \\ A_i = A_{i-1} \cup \{a_i\}, \quad i = 2, 3, 4, \dots \end{cases} \quad (1)$$

The result of the sequence of definitions (1) is assumed to be an ω -ordered sequence $\langle A_n \rangle$ of nested sets:

$$A_1 \subset A_2 \subset A_3 \subset \dots \quad (2)$$

which, according to the hypothesis of the actual infinity, exists as a complete totality. Obviously, this implies to assume the infinitely many successive steps of (1) have been completed. Notice that, being a recursive definition, it is not possible to define all sets $\langle A_n \rangle$ at once. The sets of the sequence $\langle A_n \rangle$ have to be defined one by one, one after the other. Simply because, except the first one, each set is defined in terms of the previous one. Recursive definitions indexed by well-ordered sets, as the ω -ordered set \mathbb{N} of the natural numbers, do have ω -ordinality (Theorem P80a, of the Indexed Sets).

P631 Let now (t_a, t_b) be any finite interval of time and let $\langle t_n \rangle$ be an ω -ordered and strictly increasing sequence of instants within (t_a, t_b) whose limit is t_b , as is the case of, for example, the classical sequence defined by:

$$t_n = t_a + (t_b - t_a) \times \frac{2^n - 1}{2^n} \quad (3)$$

Definition (3) assumes time is infinitely divisible, what may, or may not, be the case in the physical world. This is not, however, an impediment to infinitist formal theories because they could be assumed to be developed in a conceptual universe in which time is arbitrarily defined as infinitely divisible (Principle of Autonomy P23).

P632 The sequence of definitions (1) can be timetabled by the sequence $\langle t_n \rangle$ in an elementary way: by assuming that each n th definition takes places at the precise instant t_n . The one to one correspondence f defined by:

$$f : \langle t_i \rangle \leftrightarrow \langle A_i \rangle \quad (4)$$

$$f(t_i) = A_i, \forall i \in \mathbb{N} \quad (5)$$

proves that at t_b we will have the same ω -ordered totality $\langle A_n \rangle$ defined in (1). Notice each successive step of definition (1) defines a new set, and we will finally have a sequence of infinitely many

sets without a last set completing the sequence.

A CONFLICTING DEFINITION

P633 Timetabling mathematical definitions composed of infinitely many steps reveals some significant insufficiencies on the assumed completeness of the involved ω -ordered totalities. We will now examine one of them.

P634 Let x and y be two natural variables (whose domain is the set of the natural numbers) initially defined as $x = 1, y = 1$. And consider the following ω -ordered sequences of definitions of both variables, $\langle D_n(x) \rangle$ and $\langle D_n(y) \rangle$:

$$\text{At each successive instant } t_n \text{ of } \langle t_n \rangle \begin{cases} D_n(y) = 1 \\ D_n(x) = n \end{cases} \quad (6)$$

where n in t_n is the same as in $D_n(x) = n$. Evidently y is always defined with the same value 1, while at each successive instant t_n , x is defined with a different value, just the index n of t_n . Since t_b is the limit of $\langle t_n \rangle$, at t_b the sequences $\langle D_n(x) \rangle$ and $\langle D_n(y) \rangle$ will have been completed. Thus, t_b is the first instant at which the variables x and y are no longer redefined.

P635 In the first place, it will be proved that x and y remain well defined along the whole interval $[t_a, t_b)$. In fact, let t be any instant within $[t_a, t_b)$. Evidently, it holds $t_a \leq t < t_b$. So, if $t_a \leq t < t_2$ we will have $x = 1; y = 1$. And if $t_1 < t$, there will be an index v such that $t_v \leq t < t_{v+1}$ because $\langle t_n \rangle$ is an ω -ordered and strictly increasing sequence whose limit is t_b . In this case, we will have $x = v; y = 1$. This proves that both variables remain well defined along the whole interval $[t_a, t_b)$.

P636 Since x and y remain well defined along the whole interval $[t_a, t_b)$ and no other definition takes place neither at t_b nor after t_b , we can conclude both variables remain well defined in the whole closed interval $[t_a, t_b]$.

P637 It is immediate to prove, however, that x is not defined at t_b . Although it was always defined as a natural number, its current value at t_b cannot be a natural number, otherwise, and taking into account that it was successively defined as the successive natural numbers, that number would be the impossible last natural number or, alternatively, only a finite number of definitions would have been carried out. Notice this is not a question of indeterminacy but of impossibility: no natural number v exists such that the value of x at t_b could be v . None. After infinitely many correct definitions it becomes non-defined just at the precise instant t_b . The problem is that nothing happens at t_b that can let x non-defined.

P638 In agreement with P636 and P637, we must conclude that, as a consequence of having been defined infinitely many successive times, at t_b the variable x is and is not defined. A new contradiction deduced from the same hypothesis of the actual infinity.

INTRODUCTION

P639 This book has mainly dealt with ω -ordered collections (sets and different types of sequences, tables, procedures and definitions). From the infinitist point of view, those collections exist as ordered complete totalities, as the ordered list of the natural numbers. According to the infinitist orthodoxy these collections exist as complete totalities even if no last element completes the corresponding collection. In the precedent chapters, and from the perspectives of set theory, transfinite arithmetics, geometry, and supermachines-supertasks, we have examined some of the consequences of assuming the infinite collections exist as complete totalities.

P640 Supermachines and supertasks have provided us with a new instrument for the analysis of the actual infinity hypothesis: time. On the one hand, timetabling an ω -ordered sequence of steps, or of actions, of any kind, does not change the result of the sequence or alter the formal consistency of the corresponding definitions, proofs or procedures. And on the other, it provides a new way to examine the consequences of completing the incompletable, most of the times forcing the actual infinity to leave a track of its assumed existence. And, as we have seen in this book, what it leaves are inconsistencies. The last theorem of the next section summarizes all those formal conflicts.

TWO FINAL THEOREMS

P641 Along this book the words “action” and “task” have been used in the broadest sense to refer to the successive actions performed

in the successive steps or stages of different procedures, proofs, arguments, definitions and supertasks. Basically, only ω -ordered sequences were considered, and they were assumed to be carried out at the successive instants of a strictly increasing sequence of instants within a finite interval of time whose right endpoint is the limit of the sequence.

P642 We will end this book by considering the same sequence of actions we begin with: the counting of the successive natural numbers. It is the most simple and at the same time the most significant sequence of actions because the sequence of the natural numbers was used by Cantor to define the first transfinite cardinal \aleph_0 [47, pgs. 103-104] and the first transfinite ordinal ω [47, p. 115].

P643 In agreement with the hypothesis of the actual infinity, the ω -Ordered sequence $\langle n \rangle$ of the natural numbers do exist as a complete totality in spite of the fact that no last number completes the sequence. And the same can be said of any other ω -ordered sequence whatsoever. This is precisely the hypothesis, the completion of incomplete, that this book has been discussing.

P644 The following two theorems summarize the results of such a discussion. As we will immediately see, what is proved by the first theorem is a contradiction, of which only the hypothesis of the actual infinity subsumed into the Axiom of Infinity, may be responsible, as the second of those theorems proves.

P645 Once the hypothesis of the actual infinite has been assumed (and therefore the existence of infinite collections as complete totalities, even if there is not a last element to complete the collection), it is possible to prove the following two theorems:

Theorem P645a, of the Inconsistent Completion. *-If the successive natural numbers 1, 2, 3, ... of the ω -ordered sequence $\langle n \rangle$ of the natural numbers are counted at the successive instants t_1, t_2, t_3, \dots of an ω -ordered sequence of instants $\langle t_n \rangle$ within the finite interval of time (t_a, t_b) whose limit is t_b , then at the precise instant t_b all natural numbers have and have not*

been counted.

Proof.-Since the sequence $\langle n \rangle$ of the natural numbers and the sequence $\langle t_n \rangle$ of instants are both ω -ordered, it is immediate that a one to one correspondence $f(n) = t_n$ between $\langle n \rangle$ and $\langle t_n \rangle$ does exist, being t_n just the precise instant at which the number n is counted. Since t_b is the limit of the sequence $\langle t_n \rangle$, the instant t_b is posterior to all instants of the sequence $\langle t_n \rangle$. Consequently, at the precise instant t_b all natural numbers of the sequence $\langle n \rangle$ have already been counted, each n at the precise instant t_n , always prior to t_b . So, at the precise instant t_b all natural numbers have been counted (Principle of Execution P25).

Let now A be the set of all instants of (t_a, t_b) at which the counting of the successive natural numbers is not completed, and B the set of all instants of (t_a, t_b) at which the counting of the successive natural numbers is already completed. Taking into account that t_b is the limit of $\langle t_n \rangle$, we can write:

$$\forall t \in (t_a, t_b) : \exists t_v \in \langle t_n \rangle : t_v < t < t_{v+1} \quad (1)$$

so that at t , for any t in (t_a, t_b) , only a finite number v of natural numbers, $1, 2, 3, \dots, v$, have been counted and infinitely many of them, $v+1, v+2, v+3, \dots$, remain still to be counted. So, at t the counting of the successive natural numbers is not completed. Consequently we can write:

$$\forall t \in (t_a, t_b) : t \in A; t \notin B \quad (2)$$

And then:

$$(t_a, t_b) \subset A \quad (3)$$

$$(t_a, t_b) \cap B = \emptyset \quad (4)$$

Therefore no instant t of the interval (t_a, t_b) exists such that at t the counting of the successive natural numbers is completed. None. As equation (4) indicates, this is not a question of indeterminacy but of impossibility. So, and being t_b the first

instant after all instants of the interval (t_a, t_b) , at the precise instant t_b not all natural numbers have been counted. \square

Theorem P645b, of the Inconsistent Infinity.-*The hypothesis of the actual infinity, which asserts the existence of the set of the natural numbers as a complete totality, is inconsistent*

Proof.-Let k be any natural number and consider the sequence $S_k = 1, 2, 3, \dots k$ of the first k natural numbers of $\langle n \rangle$, and the sequence T_k of the first k instants $t_1, t_2, \dots t_k$ of the ω -ordered sequence of instants $\langle t_n \rangle$ within (t_a, t_b) whose limit is t_b . Assume each number i of S_k is counted at the precise instant t_i of T_k . The counting will end at t_k when counting the last number k . So, for any natural number k the counting of the first k natural numbers poses no problem, and no contradiction arises. Only when the sequence of natural numbers is considered as a complete totality, as the hypothesis of the actual infinity subsumed into the Axiom of Infinity requires, the contradiction of the Theorem P645 of the Inconsistent Completion, appears. We must therefore conclude this contradiction is a formal consequence of the hypothesis of the actual infinity. \square

Apéndice A.

The problem of change

INTRODUCTION

P646 Change is the most pervasive characteristic of our continuously evolving universe. And it is also the most difficult logical problem that man has ever faced (for a general background see [170, 206], and for the particular view of H. Bergson see [21, 22]). So difficult that it continues unresolved for over 27 centuries. Change could even be an inconsistent process, as it has been claimed at least from pre-Socratic times. An not only by pre-Socratic authors as Parmenides or Zeno of Elea, modern authors as J.E. McTaggart also defended the inconsistency of change [160]. If that were the case, it would be impossible to explain the physical world, whose most distinctive feature is just its state of continuous change. It is therefore surprising how little interest contemporary physics (the science of change) takes in the problem of change. Especially because if a solution is found, all physical theories would have to be adapted to it. In this sense, the discussion that follows proves that change is inconsistent in the spacetime continuum, but it could find a solution in certain discrete spacetimes similar to those used in cellular automata, where, in addition, all oddities of relativity and quantum physics could be explained. Rarities that surely appear because of the insistence of physics to explain the physical world by means of inappropriate mathematics, the same one that makes it impossible to solve the problem of change.

CAUSAL CHANGES

P647 For the sake of simplicity, and in order to avoid unnecessary complications, we will discuss here the problem of causal changes in physical objects. So, if O is one of those physical objects, we

will say O changes causally from the state S_a to the state S_b if there exist a set of (physical) laws L such that, under the same conditions C , and as a consequence of those laws and conditions, the state of O is S_a at the instant t_a and S_b at an ulterior instant t_b . In symbols:

$$S_a \mapsto S_b : L(S_a, C, t_a) = (S_b, t_b) \quad (1)$$

Since we will only deal with causal changes defined according to (1), from now on they will be referred to simply as changes.

P648 The change $S_a \mapsto S_b$ can be direct, without intermediate states. In such a case, it will be referred to as *canonical* change. It can also be the result of an ordered sequence of canonical changes:

$$\langle S_a \mapsto S_b \rangle : S_a \mapsto S_1 \mapsto S_2 \mapsto \cdots \mapsto S_v \mapsto S_b \quad (2)$$

Notice that every element S_n of $\{S_i\}$ must have an immediate predecessor S_{n-1} (except the first of them S_1) so that S_n can be causally derived from S_{n-1} :

$$\forall S_{n>1} : L(S_{n-1}, C_{n-1}, t_{n-1}) = (S_n, t_n) \quad (3)$$

The objective of our discussion will exclusively be the analysis of the canonical changes, be them or not forming part of a sequence of canonical changes. But first it will be necessary to rule out the possibility that causal changes can occur in densely ordered sequences of changes, a possibility that is difficult to imagine but that must be considered.

P649 Indeed, some infinitists claim that a change could also be the result of completing a densely ordered sequence of non canonical changes: one in which between any two changes infinitely many other changes do occur (it is hard to explain in physical terms what on earth a densely ordered sequence of changes could really be). For this reason, and before discussing the problem of canonical change (the classical problem of change) we will prove the impossibility for a change to occur as a consequence of completing a densely ordered

sequence of changes. Recall that the infinitude of a densely ordered sequence may be numerable, as in the case of the rational numbers (whose cardinal is \aleph_0), or non-denumerable as in the case of the real numbers and the case of the spacetime continuum (whose cardinal is 2^{\aleph_0}). It is in that spacetime continuum that all physical changes are supposed to occur.

P650 In the first place, it is quite clear that in a densely ordered sequence of changes no change can be canonical. In fact, if $\langle S_a \mapsto S_b \rangle$ is a densely ordered sequence of changes and S_λ is any element of the sequence then it is impossible that S_λ results from a canonical change of an immediate predecessor S_μ , simply because in a densely ordered sequence no element has an immediate predecessor. Therefore, S_μ cannot immediately precede S_λ and then the canonical change:

$$L(S_\mu, C_\mu, t_\mu) = (S_\lambda, t_\lambda) \quad (4)$$

is impossible, for all $S_\lambda \in [S_a, S_b]$.

P651 Assume $S_a \mapsto S_b$ takes place through a densely ordered sequence of non canonical changes $\langle S_a \mapsto S_b \rangle$. The state S_b results, therefore, from the completion of a densely ordered sequence of changes. Thus, the state of our object O will be S_a at a certain instant t_a , and S_b at another posterior instant t_b . In those conditions, let $f(t)$, for each t in $[t_a, t_b]$, be the number of those changes that still have to be performed at the instant t in order to reach S_b . It is immediate that $f(t)$ cannot take a finite value n , otherwise there would exist the impossible lasts n changes of a densely ordered sequence of changes. In consequence, there is no instant within $[t_a, t_b]$ at which only a finite number of changes remain to be performed in order to reach S_b . We are not facing an indeterminacy, but an impossibility: the set of instants in which only a finite number of changes remain to take place is the empty set. Therefore, infinitely many changes would have to occur instantaneously just at t_b .

P652 We will now prove that instantaneous changes (of a null duration) are impossible in a spacetime continuum. As we will see, the reason for that impossibility is that if t is any instant of a densely ordered sequence of instants then t has neither immediate predecessor $p(t)$ nor immediate successor $s(t)$, so that between t and $s(t)$ (or between $p(t)$ and t) there is no time at all. As will be seen next in this appendix, if time exists in indivisible units (chronons), then time passes through each chronon, and between two successive chronons no time passes. The natural numbers reflect this situation: between two successive natural numbers there is no other natural number. The opposite occurs with the real numbers modeling the spacetime continuum: between any two of them infinitely many other different real numbers do exist (dense order).

P653 Assume that in our physical object O an instantaneous change $S_i \mapsto S_j$ takes place at a certain instant t of the spacetime continuum. The change would be instantaneous if the state of O were S_i at the instant t and S_j at an hypothetical immediate successor $s(t)$ of t , being null the time elapsed between t and $s(t)$. But in the spacetime continuum this is impossible because t does not have an immediate successor $s(t)$, so that between any two different instants of the spacetime continuum *a time greater than zero always passes*. So S_i and S_j could only be two simultaneous states in whose case it would be inconsistent to establish a chronological order of precedence between both states, so that none of them can be the cause of the other. Instantaneous changes are therefore impossible in the space-time continuum.

P654 According to P651, in a densely ordered sequence of changes, instantaneous changes have to occur. And according to P653 instantaneous changes are impossible in the spacetime continuum. Thus, densely ordered sequences of changes are impossible in the spacetime continuum.

P655 To propose the coexistence of S_a and S_b at a certain instant as a solution to the problem of change $S_a \mapsto S_b$ means to pose the problem of that change in terms of the change $S_a \mapsto (S_a S_b)$,

where $(S_a S_b)$ stands for that supposed coexistence of states. And the same would apply to the changes $S_a \mapsto (S_a(S_a S_b))$, $S_a \mapsto (S_a(S_a(S_a S_b)))$, etc.

THE PROBLEM OF CHANGE

P656 Consider any canonical change $S_a \mapsto S_b$ of any physical object O . We will begin by proving that change must be instantaneous, i.e. of a null duration. In fact, assume its duration is $t > 0$, being t any positive real number. For every t' in the real interval $(0, t)$, the state of our object O will be either S_a or S_b . If it were S_a then the change would not yet have begun and its duration would be less than t . If it were S_b then the change would have already finished and its duration would also be less than t . But O must be in one of those two states because $S_a \mapsto S_b$ is a canonical change. Consequently, the duration of the canonical change $S_a \mapsto S_b$ is less than any real number greater than zero. And being zero the only real number less than any real number greater than zero, the canonical change $S_a \mapsto S_b$ can only have a null duration, i.e. it can only be instantaneous.

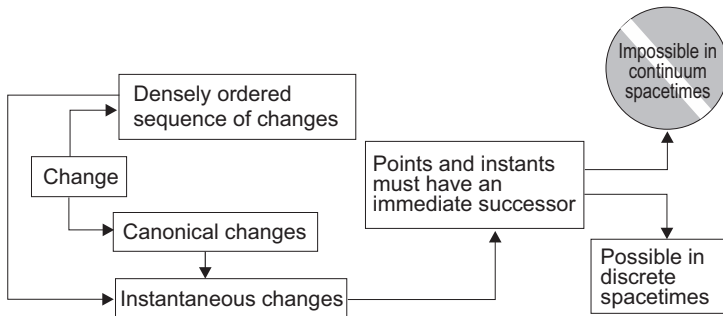

Figure A.1 – The problem of change.

P657 So far we have proved that (see Figure A.1):

- a) According to P653, instantaneous changes are impossible in the spacetime continuum.
- b) According to P654, causal changes cannot take place through a densely ordered sequence of changes.

- c) According to P656, canonical changes take place instantaneously.

In consequence, it holds the following:

Theorem P657, of Change.-*Change is impossible in the space-time continuum.*

P658 Being change a pervasive process in our current universe, the Theorem of Change could be indicating that the spacetime continuum is not the most appropriate representation of space and time. Space and time could, in fact, be of a discrete nature, with indivisible minimum units. In the next section we will analyze the possibility that change may occur in discrete spacetimes.

A DISCRETE MODEL: CELLULAR AUTOMATA

P659 Cellular automata like models (CALM) provide a new interesting perspective to analyze the way the universe could be evolving. In particular it provides a discrete space-time in which a new analysis of the incomprehensible oddities of contemporary physics, including change, would be possible. As we will see in the next short discussion, twenty seven centuries after it was posed, the old problem of change could find a first consistent solution in the discrete spacetime of CALMs.



Figura A.2 – Discrete versus continuum space.

P660 In CALMs, space is exclusively composed of indivisible minimum units: geons. Time is also composed of a sequence of succes-

sive minimum indivisible units: chronons. No extension exists between a geon and its immediate successor in any spatial direction. Similarly, no time elapses between a chronon and its immediate successor. Each geon can exhibit different states, each defined by a certain set of variables. The states of all geons change simultaneously at each successive chronon in accordance with the laws driving the evolution of the automaton. Once changed, the state of each geon remains unchanged for a chronon. In what follows we will assume this is the case, although in the place of one chronon, the state of each geon could also remain unchanged for a certain (natural) numbers of chronons.

P661 Let $u, v, c, \dots z$ be the set of variables defining the state of each geon of a certain CALM A . Let us represent the n th state of each geon σ_i by $\sigma_i(u_{i,n}, v_{i,n}, \dots z_{i,n})$, where $u_{i,n}, v_{i,n} \dots z_{i,n}$ are the particular values of the state variables of σ_1 at the n th chronon. Let finally L be the set of laws driving the evolution of the automaton, including the laws that relate the different state variables to each other. L determines the way each geon σ_i changes from a chronon to the next one taking into account the state of σ_i as well as the state of any other geon with which it interacts, which may include all geons. All these current states define the conditions C_i under which the laws L determine the state of each geon in the next chronon, that is, the laws that determine the change that each geon undergoes in each successive chronon.

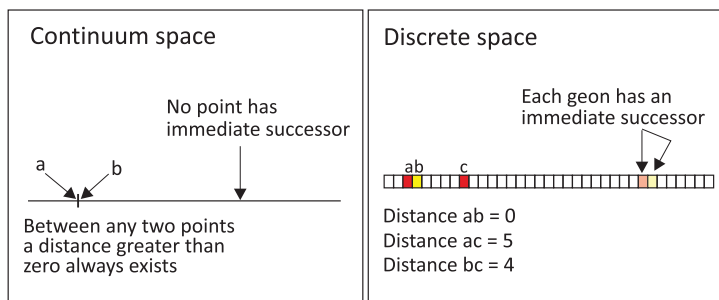
P662 The automaton engine changes the state of every geon at each chronon and maintains it just for one chronon. Thus we can write for each particular geon σ_i :

$$\begin{aligned}
 L(\sigma_i(u_{i,n} \dots, z_{i,n}), C_n, \tau_n) &= (\sigma_i(u_{i,n+1} \dots, z_{i,n+1}), \tau_{n+1}) \\
 L(\sigma_i(u_{i,n+1} \dots, z_{i,n+1}), C_{n+1}, \tau_{n+1}) &= (\sigma_i(u_{i,n+2} \dots, z_{i,n+2}), \tau_{n+2}) \\
 L(\sigma_i(u_{i,n+2} \dots, z_{i,n+2}), C_{n+2}, \tau_{n+2}) &= (\sigma_i(i, u_{n+3} \dots, z_{i,n+3}), \tau_{n+3}) \\
 L(\sigma_i(u_{i,n+3} \dots, z_{i,n+3}), C_{n+3}, \tau_{n+3}) &= (\sigma_i(u_{i,n+4} \dots, z_{i,n+4}), \tau_{n+4}) \\
 \dots &
 \end{aligned}$$

Certain sets of geons could remain grouped with the same con-

figuration through the successive chronons. They could be said CALM's objects.

P663 It is significant that the operation of a CALM is similar to that of a computer: its internal clock defines the indivisible units of time in which all operations and updates occur. And remember that computers are man-made machines capable of simulating physical phenomena.

P664 Being both space and time discrete, each chronon τ_n has an immediate predecessor τ_{n-1} and an immediate successor τ_{n+1} , so that no other chronon elapses neither between τ_{n-1} and τ_n nor between τ_n and τ_{n+1} . Or in other words: no time passes between any two successive chronons. This simple characteristic of CALMs suffices to solve the logic problem of change because discrete spacetime allows instantaneous changes: the state A_n at chronon τ_n changes to A_{n+1} at the next chronon τ_{n+1} , being null the time elapsed between τ_n and τ_{n+1} . It could be said that all geons of a CALM are updated simultaneously at each chronon. The same could be said of the instants and points of the spacetime continuum, with the difference that in the continuum there is an uncountable infinity of instants and points and none of them has an immediate successor, which makes change impossible.

P665 Do not forget that our sensory perception of the world is absolutely continuous. This is why we are used to think in terms of a spacetime continuum. So far, our only way of thinking. All our models of the physical world have assumed the physical world is a continuous world. It is then almost inevitable to extrapolate this way of thinking to the new discrete paradigm, which obviously would be catastrophic. To think in (physical) discrete terms will surely require a long process of reeducation.

P666 An electron, for instance, could be in the state S_1 at a certain instant t_1 and in the state S_2 at other posterior instant t_2 , without ever being in any intermediate state between S_1 and S_2 (quantum jump). It is therefore a canonical change. In the space-

time continuum the interval (t_1, t_2) must always be greater than zero and during that time the electron cannot be at S_1 or at S_2 . Therefore, it must cease to exist for a time greater than zero. It must disappear at t_1 and reappear at t_2 . In the digital spacetime of a CALM all we have to do is to consider two successive chronons, τ_1 and τ_2 . At τ_1 our electron would be in the state S_1 , and at τ_2 in the state S_2 (Figure A.3).

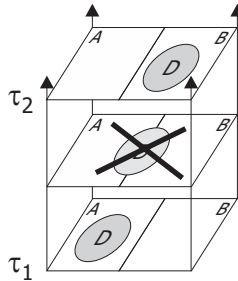

Figure A.3 – In the discrete spacetime of a CALM, an object D changes from A to B without passing between A and B (think, for instance in a quantum jump of an electron).

P667 By way of example, assume that:

- The universe has $2,66 \times 10^{185}$ geons.
- The universe contains 10^{80} elementary particles.
- Each particle is defined by p variables
- Each particle is, somehow, present in each geon.

Let U be a tridimensional CALM of $2,66 \times 10^{185}$ geons in which the state of each geon is defined by $p \times 10^{80}$ state variables. If it were possible to simulate U , perhaps we would observe the self-organizing and evolution of an object similar to our universe.

P668 U would be incomparable less complex than, for instance, any matrix of infinite elements (which are usual in mathematics and theoretical physics). We could model the universe, provided we know the basic laws that make it evolve. In this circumstances, to simulate does not means to reproduce the exact history

of the universe: recursive interactions between geons and the resulting non-linear dynamics open the door of unexpectedness and creativity, as in the case of the terrestrial biosphere.

P669 In any case, and as noted in P668, we could theorize on U , we could use it as a theoretical reference to grasp the essence, magnitude and possibilities of real universes. Colossal as it may seem, U would be a finite object and then composed of a number of elements incomparably less than the number of points (2^{\aleph_0}) a simple interval of, say, one trillionth of a millimeter of the continuous space. In addition, while the points of the space continuum are abstract artifacts devoid of intrinsic physical attributes, each element of U would be plenty of physical meaning.

P670 To conclude this appendix, let us imagine we build a very advanced computer game in which its characters evolve until they become aware of their own intelligence. When trying to explain their digital universe, they would surely have the same type of problems we have when trying to explain the incessant changes we observe in our physical world.

Apéndice B.

Infinity and physics

INTRODUCTION

P671 Mathematics has been essentially Platonic throughout its history. And it continues to be essentially Platonic. Although other more naturalistic alternatives could also be considered [147]. Contemporary neurosciences have made it clear that our brain, and therefore all our logical abilities, grow and develop through our own actions and experiences with the physical world. So, despite dominant Platonism, mathematics also has its roots in the natural world.

P672 Everything we know of the universe suggests that it is a dynamic system consistent with the laws driving its evolution. No contradictions or arbitrariness have ever been discovered. Mathematics is also consistent a system, in this case with the group of axioms underlying each of its branches. But the consistency of a theory does not guarantee that it is an appropriate theory to explain the physical world. The recognized role of mathematics in explaining the physical world (Quine and Putnam's Principle of Indispensability) should be relativized by the role of mathematics in developing inappropriate theories for the same purpose. If the hypothesis of the actual infinite were inconsistent, mathematics would have been directing the explanation of the world in a wrong direction, the direction of the pre-Socratic continuum. They would be responsible for a considerable delay in the knowledge of the world. Naturally not the mathematics as such, those responsible would be the mathematicians who maintain and impose the hegemony of their thought and their hostility to disagreement

P673 This appendix suggests a discrete alternative to the conti-

nuous paradigm, until now the only paradigm in which all theories that claim to explain the physical world have been developed. A paradigm surely inspired by our sensory perception of the world. We perceive all material objects and all physical processes in an essentially continuous way. In particular, motion (the most ubiquitous and common of all natural processes) is sensory perceived as a continuous process, and all theories on motion, at least since Aristotle [12, Book 3], consider it is in fact a continuous process.

P674 But recall that motion in a film is also perceived as a continuous process, although it is a simple consequence of viewing a discontinuous sequence of images. Human visual system is also based on this phenomenon (phi phenomenon): each perceived image needs a neuro-processing time greater than zero so that we can only perceive discontinuous sequences of images of the natural processes, though our brain makes them appear as continuous processes. As we will see in this appendix, the physical world could also be explained in similar discrete terms. And, what is more interesting, these discrete explanations are much more simple than their corresponding continuous (classical) alternatives.

P675 For the last two centuries, the evidence of the facts revealed by modern science has clearly proved that the physical worlds, at least in what refers to ordinary matter, energy and the different types of charges, is essentially discontinuous, discrete. On the contrary, space and time are still considered as continuous entities (infinitely divisible) by the majority of contemporary scientists.

P676 Things are beginning to change also on this issue, and the number of contemporary physicists that believe spacetime must be of a certain granular nature is quickly increasing. In Martin Rees' words [192, p 12]:

Space can't be indefinitely divided. The details are still mysterious, but most physicists suspect that there is some kind of granularity on a scale of 10^{-33} cm [Planck's length].

P677 The hypothesis of the actual infinity is closely involved in this discussion. Needless to say that if it were an inconsistent hypothesis, we would be forced to replace our current analog paradigm with a digital model of nature in which space and time could only be of a discrete nature, with indivisible minima (Theorem P354). In the next two sections we will discuss some aspects of this change of paradigm.

DIGITAL VERSUS ANALOG

P678 The continuum is infinitely divisible: between any two real numbers (points, instants) there always exist other 2^{\aleph_0} different real numbers (points, instants). And what is more important, all those real numbers do exist all at once, as a complete totality. As a consequence, a straight line segment of a Planck length ($\approx 10^{-33} \text{ cm}$) has the same number of points as the whole tri-dimensional universe. Consequently, we would have to admit such a minuscule linear segment would create and destroy the same number of virtual quantum particles as the whole universe, provided that virtual quantum particles are created in the points of the physical space, as it assumed to be the case. Nonetheless, that continuum is considered an appropriate model for the physical space and time. We will now discuss some consequences of this assumption.

P679 Infinitist mathematics has been practically the only mathematics since the beginning of the 20th century, although illustrious dissidents as Poincaré or Wittgenstein were never absent. In consequence, physics is made of this infinitist mathematics: the mathematics founded on the belief that the infinite sets do exist as complete totalities (hypothesis subsumed into the Axiom of Infinity); on the believing that the list of the natural numbers exists as a complete totality in spite of the fact the no last number completes the list; on the believing, in short, that it is possible to *complete* the *incompletable*.

P680 But, contrarily to mathematics, physics theories must be experimentally tested. And experimental physics is always finitist: all observations and measurements can only yield a finite (and indeed

very small) number of digits. An experimental precision of twenty decimals is considered a formidable result, and in fact it is formidable. But for infinitist mathematics it is a ridiculous number of decimals compared, for instance, with a number with 9^{19} decimals (Chapter 14 defines n-expofactorials numbers as 9^{19}). Imagine, on the other hand, a physical constant with 9^{19} decimals, its representation in standard text, at five millimeters per digit, would occupy a line millions of times longer than the diameter of the visible universe. Those physical constants would be rather grotesque. And so would be the universe if those monstrous numbers were necessary to explain its working and evolution. A finite number of decimals, i.e. a simple proportion of two integer numbers, should suffice. I suspect W. Ockham would had come to the same conclusion.

P681 A common method for solving physical problems by means of infinitist mathematics (differential and integral calculus, for instance) consists in trying first a discrete solution in order to make discreteness tends to zero and find there (in the continuum scenario) the correct solution. This was the method M. Planck was using to solve the so called ultraviolet catastrophe, an apparently unsolvable problems in those days, at the beginning of the XX century. Surprisingly enough, the correct solution appeared much more before discreteness vanishes in the infinitist scenario of the continuum. What we now call Planck constant gave the correct solution at the particular value of $6,626068 \times 10^{-34} \text{ m}^2 \text{ Kg s}^{-1}$.

P682 Although Planck's discrete solution to the ultraviolet catastrophe was initially taken as provisional, it immediately led to the birth of quantum mechanics, the most successful science ever developed by man. But quantum mechanics, the science of discreteness par excellence, the science where indivisible minima play a fundamental role, is also made of infinitist mathematics, the mathematics of the continuum where indivisible minima make no sense. This incompatibility is surely the cause of another apparently unsolvable problem: the incompatibility between quantum mechanics and the general theory of relativity. In S. Majid words [148, p 73]:

The continuum assumption on space and time seems then to be the root of our problems in quantum gravity.

P683 Although Planck scale was initially conceived to provide a universal metric reference independent of our arbitrary elections for mass, length and time units, it finally served to discover the limits beyond which the physical laws make no longer sense. But if the laws of physics lose their meaning at Planck's scale, then the continuum turns out to be absolutely useless to physics.

P684 And not only useless. When infinity appears in their equations, physicists are forced to remove it from them because of the unsolvable problems it invariably leads to. A removal that usually requires a lot of hard and tedious work, as in the case of renormalization in quantum electrodynamics. Not all physical theories are renormalizable, for instance if photons had rest mass, minuscule as it may be, then quantum electrodynamics (a part of the Standard Model of Particles) would lose its gauge symmetry and would become non-renormalizable. So, the hypothesis of the actual infinity finally imposes severe restrictions to the physical theories, restrictions that are physically significant. Moreover, a theory explaining the general treatment of singularities (appearance of infinities) would be necessary: in which cases, and why, they should be, or not, eliminated.

P685 Physicists never question the formal consistency of the actual infinity, as if that consistence were a proved fact. Evidently that is not the case, otherwise the Axiom of Infinity would be unnecessary. The hypothesis of the actual infinity, the belief that the infinite sets exist as complete totalities, is just a hypothesis. Brouwer, Poincaré or Wittgenstein, among others, rejected it. What is really surprising here is that while we spend a lot of time and money to liberate physical equations from the infinities, no effort is made in order to examine the possibilities to liberate mathematics from the actual infinity.

P686 If there is a physical theory compromised with the actual

infinity, that theory is the theory of relativity, whose special section (special relativity) is a theory on the spacetime continuum. The next section reproduces, slightly modified, a chapter of [135] which is devoted to the confrontation between the analog (classical) and the digital interpretation of relativity.

RELATIVITY: TWO INTERPRETATION FACE TO FACE

P687 We will now confront some singular aspects of the theory of relativity from the point of view of its classical (analog) interpretation and from the point of view of the discrete (digital) alternative. In this last interpretation both space and time are assumed to be of a discrete nature, with indivisible minima of space (geons) and of time (chronons).

P688 The most outstanding characteristic of the digital alternative is its compatibility with all relativistic observations and measurements. Which could be explained because it simply replaces the spacetime continuum of relativity by a discrete model in which there also exists a maximum insurmountable speed, though in this case not as an axiomatic principle but as an inevitable consequence of the existence of indivisible minima of space (geons) and time (chronons). Indeed, if nothing is smaller than a geon, and nothing can last less than a chronon, then there would be a maximum speed of one geon per chronon (to move through more than one geon for one chronon would mean that a geon could be traversed in less than one chronon).

P689 Other relativistic problems, as the impossibility to observe and measure absolute velocities, are resolved by considering the preinertial nature of photons (an object is preinertial if it inherits the relative velocity vector of the reference frame where it is set into motion). Thus, preinertia and a digital model of spacetime is all we need to explain in physical terms all the enigmas and oddities derived from the theory of relativity.

P690 The most notable consequence of discrete space-time is that its indivisible units, geons and chronons, would be real physical

objects rather than theoretical entelechies devoid of physical meaning, as is the case with points and instants in the spacetime continuum of relativistic physics. In the discrete alternative, space and time would be actual physical objects in their own right. The relative character of space-time in the theory of special relativity, and the theory itself, could be interpreted as provisional and inevitable solutions forced by the attempt to explain the discontinuous world by means of inappropriate continuous mathematics. It will be worthwhile, then, to confront both alternatives, classical (CA) and discrete (DA).

P691 CA is founded on the spacetime continuum: between any two of its points there are other 2^{\aleph_0} different points. In this continuum all spacetime regions do have the same number of points, so that a linear interval of, for instance, Planck length, has the same number of points as the whole 3-dimensional universe. In the place of abstract points, DA assumes the existence of indivisible (atomic) pieces of space (geons) and time (chronons). In this model, regions of different extensions do have different number of geons (chronons), and the whole universe would have a finite number of such geons, perhaps in the order of 10^{185} if they were of a Planck volume.

P692 Lorentz factor γ is capital in the transformation of the same name that in CA serves to convert between measurements carried out in different inertial reference frames (see P359). In DA, the same factor would be used to convert between continuous and discontinuous measurements. This makes experimental compatibility of both versions possible, with the advantage that typical CA rarities do not appear in DA.

P693 The formal consistency of CA depends on an external mathematical hypothesis: the hypothesis of the actual infinity, which, on the other hand, could be inconsistent (for the reasons given in this book, that could be the case). The formal consistency of DA does not depend on any external mathematical hypothesis. The consistency of a physical theory should not depend upon the con-

sistency of an abstract external axiom, as is the case of the Axiom of Infinity.

P694 The points of the spacetime continuum are primitive abstract objects without physical meaning, in spite of which physicists are forced to deal with mass points, charge points, etc. Points are not experimentally testable. Chronons and geons are plenty of physical meaning since they are indivisible physical pieces (atoms) of space and time. In addition, they could be experimentally testable (there is an increasing number of researches trying to detect the spacetime granularity).

P695 The spacetime continuum is not (consistently) compatible with change (see Appendix A). Discrete spacetimes are (consistently) compatible with change. Recall that change is the most pervasive characteristic of the Universe. And the great problem forgotten by physics, the science of change

P696 The existence of a maximum insurmountable velocity is an axiomatic requirement in CA (Second Principle of relativity). In DA, the existence of a maximum insurmountable velocity is a natural consequence of the existence of indivisible minima of both space and time. In DA the Second Principle of relativity is not necessary.

P697 The impossibility of absolute motion is a formal (axiomatic) consequence of the First Principle of relativity in CA. Absolute motion through the fabric of geons is possible in DA. The impossibility to detect absolute motion in DA is a physical consequence of preinertia, including the preinertia of photons.

P698 In CA, the inclination of the relative trajectory of a photon (vertical in the rest frame of its emitting source) can only be explained in axiomatic terms (First and Second Principles of relativity). In DA, that inclination is physically explained by photon preinertia.

P699 In CA, the universality of the physical laws needs to make reference to abstract reference frames. In DA, that reference is not necessary, although it may be convenient

P700 In CA, the two principles of the special relativity are necessary. DA needs no particular principle, once assumed the universality of all natural laws as a fundamental principle for all sciences.

P701 In CA, gravity is explained in geometrical terms. No *physical reason* has ever been given to explain why matter has the ability to curve an abstract continuum of points, completely devoid of physical meaning. DA offers the possibility of a physical explanation of gravity and other general relativity phenomena:

On the one hand, an object would be a particular set of geons defined by the values of a certain number of state variables. On the other, the values of the state variables of the surrounding geons would be somehow modified by the object. This modification and the periodic and synchronized way of functioning of certain discrete models, as CALMs (Cellular Automata Like Models, see Appendix A), could suffice to build a physical theory of gravity. Entanglement and synchronicity could also be explained in the same physical terms (See Section on cellular automata in Appendix A).

P702 In CA, light bends thanks to the gravitational curvature of spacetime. In DA, a simple attractive force, in the sense given in P701, between preinertial objects could account for the gravitational bending of light, without having to deform neither space nor time. An explanation much more simple and physical.

P703 For all the above reasons, it seems reasonable to begin to consider the possibility of a new digital paradigm, for both mathematics and physics.

Apéndice C.

Suggestions for a natural theory of sets

INTRODUCTION

P704 The contemporary foundation of set theory seems excessively tortuous and complex, probably for the following three reasons:

- a) The platonic scenario where it has been formally founded and developed, an scenario in which sets are considered as platonic objects whose existence is mind independent.
- b) The hypothesis of the actual infinity subsumed into the Axiom of Infinity according to which the infinite sets exist as complete totalities.
- c) The restrictions necessary to avoid the inconsistencies derived from self-reference and from certain excessively infinite sets.

This appendix suggests another foundational alternative far away from the platonic scenario: the natural scenario of mind intentional activities. The discussion that follows is in fact founded on a natural (non platonic) definition of set. It also introduces the concept of incompletable sequences, via the successor set. Uncompletable sequences of successor sets are then used to define the incompletable sequence of finite cardinals and then the concept of potentially infinite set.

A NATURAL DEFINITION OF SET

P705 We will assume here that sets and natural numbers are elementary theoretical objects that result from our intentional mental activity. Therefore they are not objects that exist by themselves and with which we have the ability to contact. They are mental constructs that do not exist beyond the mind that construct them.

P706 Perhaps the most basic mind intentional process is to consider any object or group of objects, i.e. to focus our attention on them. There are, in turn, two basic ways to consider objects, either successively or simultaneously. The first leads to the concept of natural number; the second to the concept of set.

P707 When we consider successively different objects we are in a certain way counting them. A natural number is a sort of measure of the amount of successively considered objects. On the other hand, if we consider simultaneously different objects we are grouping them into a totality that is a new object different from each of the considered objects. Accordingly, let us propose the following natural definition of set based on a suggestion by Lewis Carroll [51, p. 31]:

Definition P707.-*A set is the theoretical object that results from a mental grouping of arbitrary objects previously defined.*

The physical world is plenty of natural groups of objects, for example the set of the stars of a galaxy, or the set of all ions of a particular pyrite crystal. The human mind has the ability to recognize these natural groups, but it has also the ability to define many other arbitrary groups which may include abstract and imaginary objects.

P708 Obviously, the definition given in [P707] is constructive: it only indicates the way sets are constructed: by mental groupings of arbitrary objects previously defined. Being constructive, it is not a circular semantic definition. Sets are defined as theoretical objects because human mind can only construct theoretical objects. Furthermore, Definition P707 requires the previous definitions (either by enumeration or by comprehension) of the objects that will be grouped. This seems a reasonable requirement, otherwise we would not know what we are grouping, what we are defining.

P709 On the other hand, that simple requirement (to be defined before to be grouped) invalidates self-referring sets. In fact, accor-

ding to it, a set cannot belong to itself because it does not exist as an element that may be grouped until the set has been defined. Paradoxes as those of Cantor (set of all cardinals), Burali-Forti (set of all ordinals) and Russell (set of all sets that do not belong to themselves) are immediately ruled out because their corresponding sets do not satisfy Definition P707.

P710 Let us now compare the above constructive definition of set with the following two platonic attempts due to G. Cantor, although the first of them suggests a non-platonic definition that is reminiscent of Definition 707:

- a) By a 'manifold' or 'aggregate' I generally understand every multiplicity which can be thought of as one, i.e. any totality of definite elements which by means of a law can be bound up into a whole, and I believe that in this I am defining something which is related to the Platonic eidos or idea ([48, page 93]).
- b) By an 'aggregate' (Menge) we are to understand any collection into a whole M of definite and separate objects m of our intuition or our thought. ([44, p. 481], [47, p. 85])

P711 Since multiplicity, totality and collection are synonymous of set both definitions are circular. Circularity could not be avoided in all subsequent attempts to define the notion of platonic set, and it was finally declared as undefinable, i.e. as a primitive concept that cannot be defined in terms of other more basic concepts. The impossibility to define platonic sets probably indicates that sets are not the platonic objects they were assumed to be, but products of our intentional mind activity.

P712 Fortunately, most of the symbols, conventions and operations of classic axiomatic set theories can be preserved in non platonic set theories. Particularly the notions of membership, subset, empty set, union, intersection, correspondences and the like. By contrast, most of the axioms needed in platonic set theories become unnecessary in non-platonic scenarios.

P713 As we will see in this appendix, one of the most significant notions in a constructive set theory is that of *successor set*, which follows immediately from Definition P707. Indeed, it is immediate to prove the following:

Theorem P713, of the Successor Set.-*Each set A defines a new set, its successor set $s(A)$, whose elements are the elements of A , plus a new element which is the set whose unique element is the set A itself.*

Proof.-Once defined a set A , for instance $A = \{a, b, c\}$, we will have at our disposal a new object, the set A , and according to Definition P707, we can group it with any other arbitrary elements previously defined. For instance with the elements a, b, c just used to define A . So we can define a new set $S(A)$ as:

$$s(A) = A \cup \{ \{A\} \} = \{a, b, c, \{A\}\} \quad (1)$$

$s(A)$ is said the successor set of the set A . \square

As we will see the concept of successor may be used to define, also in constructive terms, the successive natural numbers.

P714 By *incompletable* we mean here something that not only is incomplete but also that cannot be completed. In line with this idea, we will define the notion of *incompletable sequence* as:

Definition P714.-*An incompletable sequence is one whose elements can never be considered as a complete totality, in the sense that it is always possible to increase the sequence of considered elements by considering new elements still non-considered.*

P715 The notion of successor set allows to define an incompletable sequence of sets. Indeed, consider the successive successor sets of an initial set A :

$$A, s(A), s(s(A)), s(s(s(A))) \dots s(s(s(\dots(A)\dots))) \quad (2)$$

that can be compactly written:

$$A, s^1(A), s^2(A), s^3(A), \dots s^n(A) \quad (3)$$

Assume we get a final set X :

$$X = s^n(A) \quad (4)$$

whose successor set cannot be defined. Whatsoever be the set X , it will be a well defined object and then, according to Definition P707, we can group it with any arbitrary elements previously defined, including the elements of X , to form a new set. So we can define:

$$s(X) = X \cup \{ \{X\} \} = s^{n+1}(A) \quad (5)$$

Consequently it is false that the successor set of X cannot be defined. Thus the sequence of successive successor sets of A is in fact incompletable because we can always increase the sequence of already considered successor sets by considering a new element, namely the successor set of the last successor set just defined. We can therefore assert the following:

Theorem P715, of the Sequence of Successors.-*The sequence of the successor sets of any set is incompletable.*

SETS AND NUMBERS

P716 Although several constructive and formal attempts to define the concept of number have been carried out, this concept could in fact be primitive, non-definable in terms of other more basic concepts. In any case we can assume that two sets have the same *number* of elements, the same cardinal, if they can be put into a one to one correspondence. All sets that can be put into a one to one correspondence among each other define a class of sets, and then a number: the cardinal of all sets of that class. The cardinal of a set A is usually denoted by $|A|$, although there are other representations such as $\text{Card}(A)$, \overline{A} or $n(A)$.

P717 To count the elements of a set A means finally to consider successively each one of its elements. We could define a number (name, numeral and properties) each time we consider a new element of A as an indication of the quantity of the considered elements, as an indication of the size of the set. Though in this context

number, quantity and size are semantically indistinguishable and then the attempt of definition is also circular. After all, perhaps only operative definitions of the concept of number are possible. P719 introduces one of them.

P718 One of the best known incomplete sequence of successor sets is the following one based on the notion of *empty set* \emptyset , a set without elements defined because of its great utility (the same as with the number zero):

$$\emptyset = \text{empty set.} \quad (6)$$

$$s^1(\emptyset) = \emptyset \cup \{\emptyset\} = \{\emptyset\} \quad (7)$$

$$s^2(\emptyset) = \{\emptyset\} \cup \{\{\emptyset\}\} = \{\emptyset, \{\emptyset\}\} \quad (8)$$

$$s^3(\emptyset) = \{\emptyset, \{\emptyset\}\} \cup \{\{\emptyset, \{\emptyset\}\}\} = \{\emptyset, \{\emptyset\}, \{\emptyset, \{\emptyset\}\}\} \quad (9)$$

...

P719 We call finite cardinals, or natural numbers, just to the cardinals of the above successive sets (Von Neumann definition of 1923 [174]):

$$0 = |\emptyset| \quad (10)$$

$$1 = |\{\emptyset\}| = 0 + 1 \quad (11)$$

$$2 = |\{\emptyset, \{\emptyset\}\}| = 1 + 1 \quad (12)$$

$$3 = |\{\emptyset, \{\emptyset\}, \{\emptyset, \{\emptyset\}\}| = 2 + 1 \quad (13)$$

$$4 = |\{\emptyset, \{\emptyset\}, \{\emptyset, \{\emptyset\}\}, \{\emptyset, \{\emptyset\}, \{\emptyset, \{\emptyset\}\}\}| = 3 + 1 \quad (14)$$

...

where we write +1 to indicate a new element has been added to the precedent set in order to define the new set and its corresponding new finite cardinal. The above sequence of the finite cardinals can also be written as:

$$0 = |\emptyset| \quad (15)$$

$$1 = |\{0\}| \quad (16)$$

$$2 = |\{0, 1\}| \quad (17)$$

$$3 = |\{0, 1, 2\}| \quad (18)$$

$$4 = |\{0, 1, 2, 3\}| \quad (19)$$

$$5 = |\{0, 1, 2, 3, 4\}| \quad (20)$$

$$\dots \quad (21)$$

Note each cardinal n is recursively defined in terms of the previously defined $n - 1$, except the first of them.

P720 Notice also the above definition of the successive finite cardinals, which we identify here with the successive natural numbers, is only an operational definition. Ultimately we lack of an appropriate definition of number. So, to say the cardinal of a set is the number of its elements is to say nothing from a strictly formal point of view. But we need to define the cardinal of a set as the number of its elements even if the concept of number is not properly defined but accepted as a primitive concept that admits operational definitions.

P721 According to P714, the above sequence (15)-(21) is incomplete so that no last finite cardinal exists. In fact, whatsoever be the finite cardinal n we consider, we will have:

$$n = |\{\emptyset, s^1(\emptyset), s^2(\emptyset), \dots, s^{n-1}(\emptyset)\}| \quad (22)$$

and since the sequence of successor sets is incomplete in accord with P715, the successor set of $s^{n-1}(\emptyset)$ does exist, and then we can write:

$$s^n(\emptyset) = s^{n-1}(\emptyset) \cup \{s^{n-1}(\emptyset)\} \quad (23)$$

$$= \{\emptyset, s^1(\emptyset), s^2(\emptyset), \dots, s^{n-1}(\emptyset), s^n(\emptyset)\} \quad (24)$$

In accordance with (15)-(21) the set $s^n(\emptyset)$ defines the finite cardinal $n + 1$:

$$|s^n(\emptyset)| = |\{\emptyset, s^1(\emptyset), s^2(\emptyset), \dots, s^n(\emptyset)\}| \quad (25)$$

$$= |\{0, 1, 2, \dots, n\}| = n + 1 \quad (26)$$

We can therefore assert that being n a finite cardinal (a natural number) of the incompletable sequence (15)-(21), $n + 1$ is also a finite cardinal or natural number of the incompletable sequence (15)-(21). Thus, we can write:

Theorem P721, of the sequence of cardinals.-*If n is a finite natural number, and then the cardinal of a member of the incompletable sequence of the successor sets of the empty set, then $n + 1$ is also a finite natural number and then the cardinal of a set of the same incompletable sequence.*

P722 It is worth noting this constructive way of defining natural numbers, ultimately based on the Definition P707, does not pose any problem of existence. This is so because we are not trying to define the set of the natural numbers as a complete mind-independent totality, but as an incompletable and operational sequence of successive terms recursively defined: each number is defined from the previous one.

P723 Since all sets of the same cardinality are equipotent we can say that a natural number n is the immediate successor of another natural number m (or that m is the immediate predecessor of n) if n is the cardinal of the successor set of any set of cardinal m . Or in other words, if $n = m + 1$. Evidently if n is the immediate successor of m then it is also a successor (though not immediate) of all predecessors of m . As we saw in Chapter 4, the natural order of precedence of the natural numbers is a total order, which is also a well-order.

P724 Let us now consider the set \mathbb{N}_n of the first n natural numbers:

$$\mathbb{N}_n = \{1, 2, 3, \dots, n\} \quad (27)$$

We will prove the following:

Theorem P724.-*The cardinal of the set N_n of the firsts n natural numbers is just n .*

Proof.-By definition, n is the cardinal of the set:

$$A = \{\emptyset, s^1(\emptyset), s^2(\emptyset), \dots, s^{n-1}(\emptyset)\} \quad (28)$$

Let f be a function from N_n to A defined as:

$$\begin{cases} f(1) = \emptyset \\ f(i) = s^{i-1}(\emptyset), \quad i = 2, 3, 4, \dots, n \end{cases} \quad (29)$$

It is clear that f is a one to one correspondence. Therefore N_n and A are equipotent, i.e. the cardinal of N_n is n . \square

P725 As a consequence of the recursive way they are defined, the elements of N_n exhibit a type of ordering we will call *natural order* and denote by n -order, whose main characteristics are:

- a) There is a first element: the only one without predecessors (1).
- b) There is a last element: the only one without successors (n).
- c) Each given element k has an immediate successor $k + 1$, except the last one.
- d) Each given element has k an immediate predecessor $k - 1$, except the first one.

where immediate successor (predecessor) of a given element means that there is no other element between the given element and its immediate successor (predecessor). Note that n -order is the same as ω -order except that in ω -order there is not a last element. Thus, ω -ordered sets are complete totalities (as the actual infinity requires) although no last element completes them. Evidently, this is not the case of n -ordered sets, all of which have a last element.

FINITE SETS

P726 As is well known, the hypothesis of the actual infinity subsumed into the Axiom of Infinity states the existence of a set equipotent with the set of all finite cardinals (and then with that of the natural numbers) considered as a complete totality, as if the above sequence (6)-(9) could in fact be actually completed.

P727 By contrast, in a non-platonic theory of sets that sequence is incomplete and then cannot be considered as a complete totality. That sequence is an example of potentially infinite object. In the next section we will introduce them in a form a little more detailed. In this one we will focus our attention on finite sets. To begin with, consider the following elementary definition based on the above sequences of successor sets and finite cardinals:

Definition P727.-*A set is finite if, and only if, it has a finite cardinal.*

P728 The above theorems and definitions allow to prove the following results on the finite sets:

Theorem P728a.- *Every finite set can be n -ordered.*

Proof.-Let A be any finite set. According to Definition P727, there will be a finite cardinal n such as $|A| = n$. Being A equipotent with all sets of the same cardinality it will equipotent to the n -ordered set \mathbb{N}_n of the first n finite cardinals whose cardinal is n in accord with P724. So, a one to one correspondence f exists between \mathbb{N}_n and A . Accordingly, we can write:

$$A^* = \{f(1), f(2), f(3), \dots, f(n)\} \quad (30)$$

which is the n -ordered version of the set A , because if i precedes j in \mathbb{N} , then $f(i)$ precedes $f(j)$ in this reordering of A .
□

Theorem P728b.-*If A is a finite set of cardinal n then its successor set $S(A) = A \cup \{\{A\}\}$ is a finite set of cardinal $n + 1$.*

Proof.-Since the cardinal of the set A is n and, according to [P724], the cardinal of N_n is also n there will be a one to one correspondence f between A and the set $N_n = \{1, 2, 3, \dots, n\}$. The one to one correspondence g defined by:

$$g : A \cup \{\{A\}\} \mapsto \{1, 2, \dots, n, n + 1\} \begin{cases} \forall a \in A : g(a) = f(a) \\ g(\{A\}) = n + 1 \end{cases} \quad (31)$$

proves $S(A)$ is a finite set whose cardinal is $n + 1$. \square

Theorem P728c.-If A is a finite set and b an element which does not belong to A then the set $A \cup \{b\}$ is also finite.

Proof.-Let f be a correspondence between the sets $A \cup \{b\}$ and $s(A)$ defined by:

$$f : A \cup \{b\} \mapsto S(A) \begin{cases} f(a) = a, \forall a \in A \\ f(b) = \{A\} \end{cases} \quad (32)$$

Evidently f is a bijection between $A \cup \{b\}$ and $s(A)$. So these sets have the same cardinality. Let n be the cardinal of A , according to the Theorem P728b, the cardinal of $s(A)$ is the finite cardinal $n + 1$. Thus the cardinal of $A \cup \{b\}$ is also $n + 1$. Consequently $A \cup \{b\}$ is a finite set. \square

Theorem P728d.-If A and B are any two finite sets then the set $A \cup B$ is also finite.

Proof.-Being B finite it can be n -ordered (Theorem P728a) and its elements can be represented as b_1, b_2, \dots, b_k . According to the Theorem P728c, the successive sets:

$$A \cup \{b_1\} \quad (33)$$

$$A \cup \{b_1\} \cup \{b_2\} \quad (34)$$

\vdots

$$A \cup \{b_1\} \cup \{b_2\} \cdots \cup \{b_k\} = A \cup B \quad (35)$$

are all them finite. \square

POTENTIALLY INFINITE SETS

P729 As far as I know, potentially infinite sets have never deserved the attention of mathematicians. Probably because set theories are infinitist theories founded and developed by infinitists that assume the hypothesis of the actual infinity.

P730 From the above constructive perspective we can only consider the ability of our minds to perform endless (incompletable) process as that of counting or defining in recursive terms. The objects resulting from those incompletable processes could be used to define sets in the sense of Definition P707.

P731 But those sets could never be considered as complete totalities, as in the case of finite sets. Those incompletable totalities would represent the set theoretical version of the potential infinity introduced by Aristotle twenty four centuries ago [12, Book VIII].

P732 Potentially infinite sets can be immediately defined in terms of finite sets.

Definition P732: *A set is potentially infinite if, and only if, it is not finite.*

P733 The following theorems are immediate consequences of the above definition.

Theorem P733a.-*Potentially infinite sets do not have finite cardinals.*

Proof.-It is an immediate consequence of Definitions P727 and P732. \square

Theorem P733b.-*The set \mathbb{N} of finite cardinals is potentially infinite.*

Proof.-Let us assume that \mathbb{N} is finite. According to Definition P727 it will have a finite cardinal n , which is also the cardinal of the $(n - 1)$ th successive successor set of $\{\emptyset\}$ in (6)-(9). According to [P721] this sequence is incompletable so that the n th term, and then the finite cardinal $n + 1$, also exists. Therefore n is not the cardinal of \mathbb{N} . This proves that no finite cardinal n can be the cardinal of \mathbb{N} . Therefore \mathbb{N} is not finite, and then it is potentially infinite according to Definition P732. \square

Theorem P733c.-*If X is a potentially infinite set and A any of its finite subsets then the set $X - A$ is also potentially infinite.*

Proof.-Evidently we will have:

$$X = A \cup (X - A) \quad (36)$$

So if $X - A$ were finite then, according to the Theorem P728d, the set X would also be finite. Consequently $X - A$ must be potentially infinite. \square

Theorem P733d.-*If X is a potentially infinite set and A any of its proper finite subsets, then X contains elements which are not in A .*

Proof.-According to Definition 727, A has a finite number n of elements. Therefore, X must contain elements which are not in A , otherwise X would also have a finite cardinal n and would be a finite set, which is not the case. \square

Theorem P733e.-*If X is a potentially infinite sets and A any of its proper finite subsets, then A is a proper subset of at least another finite subset of X .*

Proof.-Let A be a finite subset of a potentially infinite set X , and b an element of X that does not belong to A (Theorem P733d). Since A is finite, the set $B = A \cup \{b\}$ is also finite (Theorem P728c). And it holds: $A \subset B \subset X$. \square

Apéndice D.

Platonism and biology

LIVING BEINGS AS EXTRAVAGANT OBJECTS

P734 In 1973 Dobzhansky published a celebrated paper whose title summarizes modern biological thought [75]:

Nothing in Biology Makes Sense Except in the Light of Evolution.

I think it would have been more appropriate to write *reproduction* in the place of *evolution* because, on the one hand, evolution is powered by reproduction; and on the other because only reproduction can account for the extravagances of living beings. Of course, evolution is a natural process and denying it is so absurd as denying photosynthesis or glycolysis. Other thing is its theoretical explanation. As any scientific theory, the theory of organic evolution remains unfinished and currently opened to numerous discussions. See for instance [218, 29, 223, 195, 205, 153, 85, 194, 53, 105, 204, 52].

P735 Living beings are, in fact, extravagant objects, i.e. objects with properties that cannot be deduced exclusively from the physical laws. To have red feathers, or yellow feathers, or to move by jumping, or to be devoured by the female in exchange for copulating with it, are examples (and the list would be interminable) of properties that cannot be derived exclusively from the physical laws but from the peculiar competitive and reproductive history of each organism. Thus, living beings are subjected to a biological law that dominates over all physical laws, the Law of Reproduction: *reproduce as you might*.

P736 The informational nature of living beings [136] and the law of reproduction make it possible the fixation of arbitrary extrava-

gances. The success in reproducing depends upon certain characteristics of living beings that frequently have nothing to do with the efficient accomplishment of the physical laws but with arbitrary preferences such as singing, or dancing, or having brilliant colors.

P737 Although, on the other hand, to achieve reproduction is previously necessary to be alive, which in turn requires a lot of functional abilities related to the particular ecological niche each living being occupies. But this is in fact secondary: adapted and efficient as an organism may be, if it does not reproduce, all its physical excellence will be immediately removed from the biosphere. The Law of Reproduction opens the door to innovations in living beings, and then almost anything can be expected.

BIOLOGY AND ABSTRACT KNOWLEDGE

P738 Living beings are topically viewed as systems efficiently adapted to their environment. No attention is usually paid to their extravagant nature, although being extravagant is a very remarkable feature. We, living beings, are the only (known) extravagant objects in the Universe. By the way, those extravagances could only be the result of a capricious evolution, not of an *intelligent design* as creationists defend. Capricious evolution restricted by the physical laws governing the world.

P739 One of the latest extravagances appeared in the biosphere is the consciousness exhibited by, at least, most of the human beings. Surely, that sensation of individual subjectivity is responsible for some peculiar ways of interpreting the world, as platonic essentialism, the belief that ideas and abstract concepts do exist independently of the mind that elaborate them.

P740 Animals do have the ability to compose abstract representations of their environment, particularly of all those objects and processes involved in their survival and reproduction. A leopard, for instance, has in its brain the (abstract) idea of gazelle, it knows what to do with a gazelle (as is well known by gazelles), whatsoever be the *particular* gazelle it encounters with. The abstract idea

of gazelle, and of any other thing, is elaborated in the brain by means of different components (the so called atoms of knowledge) that not only serve to form the idea of gazelle but of many other abstract ideas.

P741 And not only ideas, sensorial perceptions are also elaborated, by similar processes, in atomic and abstract terms [250, 167] which surely also serves to organisms to filter the irrelevant details of the highly variable and useless information coming from the physical world, and thus to identify with sufficient security the (biologically) significant objects and process that form part of their ecological niches.



Figura D.1 – The dog '*knows*' the logic of the physical world; the ball does not.

P742 To have the ability of composing abstract representations of the world is indispensable for animals in order to survive and reproduce, And a mistake in this affair may cost them the higher of the prices. A ball rolling down towards a precipice will not stop to avoid falling down; but the dog running behind it, will try to stop as soon as it perceives the precipice; dogs *know* gravity and its consequences. Animals interact with their surroundings and need to know its singularities, its peculiar ways of being and evolving, i.e. its physical logic, and even its mathematical logic: primates and humans could dispose of neural networks to deal with numbers [71, 72, 116].

P743 Animals need abstract representations of the physical world, and that is not a minor detail (the maintenance and continuous

functioning of this internal representation of the world consumes up to 80 % of the total energy consumed by a human brain [191].) It must be an efficient and precise representation, if not animal life would be impossible. It is through their own actions and experiences, including imitation and innovation [128, 100, 196, 243] that they develop their neurobiological representation of the world in symbolic and abstract terms. The cortex behavior depends on the neuronal circuits developed through the history of stimuli each individual receives [86, 133]. It is then clear that abstract knowledge built on individual actions and experiences is indispensable for animal life.

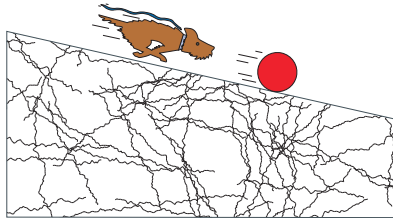
P744 Perception and cognition are constructive neuronal processes in which elementary units of abstract knowledge are involved. The processes take place in different brain areas, as we are now beginning to know with certain detail [197, 65, 217, 66, 130, 67, 211]. This way of functioning seems incompatible with platonic essentialism. Accordingly, concepts and ideas seem to be brain elaborations rather than transcendent entities we have the ability to connect with. Through our personal cognitive actions and experiences (that, in addition, have a transpersonal cumulative potential through cultural heritage and cultural networks) we have ended up by developing that great cognitive system we call science.

P745 The consciousness of ideas and the ability of recursive thinking (perhaps an exclusive ability of humans [64, 116]) could have promoted the raising and persistence of platonic essentialism. But that way of thinking is simply incompatible with both evolutionary biology [156] and neurobiology. It seems reasonable that Plato were platonic in Plato times, but it is certainly surprising the persistence of that old way of thinking in the community of contemporary mathematicians. Though, as could be expected, a certain level of disagreement on this affair also exists [146, 139, 147, 14]. It is remarkable the fact that many non platonic authors, such as Wittgenstein, were against both the actual infinity and self-reference [154], two capital concepts in the history of platonic mathematics.

Eso está basado en sus creencias platónicas.

P746 The reader may come to his own conclusions on the consequences the above biological criticism of platonic essentialism could have on self-reference and the actual infinity. Although, evidently, he can also maintain that he does not know through neural networks and persists in his platonic beliefs. But for those of us who believe in the organic nature of our brains and in its abilities to perceive and know modeled through more than 3600 millions years of implacable organic evolution, Platonism has no longer sense. The actual infinity and self-reference could lose all their meaning away from their platonic scenario

P747 In my opinion, the actual infinity hypothesis is not only useless in order to explain the physical world, it is also annoying in certain disciplines as quantum gravity and quantum electrodynamics (renormalization [93, 125, 142, 247, 208, 221, 9]). Physics [214, 216] and even mathematics [171, 215] could go without it. Except transfinite arithmetic and other related areas, most of contemporary mathematics are compatible with the potential infinity, including key concepts as those of limit or integral. Experimental sciences as chemistry, biology and geology have never been related to it. The potential infinity would suffice. Some contemporary cosmological theories, as the theory of multiverse [69] or the theory of cyclic universe [224], make use of infinity in a rather imprecise way. Even the number of distinguishable sites in the universe could be finite [122]. Matter, energy, and electric charge seem to be discrete entities with indivisible minima; space and time could also be of the same discrete nature, as is being suggested from some areas of contemporary physics [107, 108, 233, 89, 219, 13, 220, 8, 148, 228, 16, 141, 16, 228].

P748 Beyond Planck's scale nature seems to lose all its physical sense. As the actual infinity, the spacetime continuum could also be inconsistent. The reader can finally imagine the enormous simplification of mathematics and physics once liberated from the platonic burden of the actual infinity and self-reference. Perhaps we should give Ockham razor a chance.

Apéndice E.

Glossary

Axiom.-A statement whose truthfulness is accepted without proof as the basis for inference arguments.

Axiom of Choice.-See ZFC.

Circular definition.-Invalid definition because the term defined is used in its own definition.

Compact set.-A set of real numbers A it is said compact, if each sequence of elements of A has a subsequence that converges to one element of A .

Complement set.-Being A a proper subset of B , the set $B - A$ of all elements of B not in A is said the complement of A with respect to B , denoted by \overline{A} , or by A' .

Correspondences between sets.-To establish a correspondence between two sets A and B is somehow matching their elements, or part of them. If all elements of A are matched, the correspondence is an application; if, in addition, each element of A is matched with a different element of B , the application is said an injective function or injective application; if in a function all elements of B are matched, the function is called bijective, surjective or exhaustive or a one-to-one correspondence; a function in which not all elements of B are matched is said non-surjective, or non-exhaustive.

Distance between two points.-Length of the straight line between the two points. If the Euclidean coordinates of both points

are (x_1, y_1, z_1) and (x_2, y_2, z_2) , the Euclidean distance is given by

$$d = \sqrt{(x_2 - x_1)^2 + (y_2 - y_1)^2 + (z_2 - z_1)^2} \quad (1)$$

Empty Set.-A set without elements whose cardinal is 0, and whose symbol is \emptyset .

Euclidean.-Geometries built on the basis of the 5 Euclidean postulates (or on their corresponding modern versions). The existence of a single parallel through a given point to a given straight line is assumed. The Euclidean distance between two points in a Euclidean space is the length of the straight line joining them.

Euclidean Axiom of the Whole and the Part.-The whole is greater than any of its proper parts (parts different from the whole).

Euclidean space.-Cartesian geometric space (with a coordinate system, for example three-dimensional with three coordinate axes X , Y and Z) which satisfies Euclid's axioms and in which the distance between two points of coordinate (x_1, y_1, z_1) and (x_2, y_2, z_2) is defined by (1).

Fractal.-Geometric object whose structure is the same on any scale that is represented or observed. They are the objects of study of fractal geometry.

Function.-A relation between the elements of two sets, called domain and image, which associates a single element of the image with each element of the domain. The function is real (rational) if the domain is the set of real (rational) numbers.

Fundamental laws of logic

First Law (Principle of Identity): $A = A$ (A is what it is, and A is not what it is not).

Second Law (Law of Contradiction): A and non- A is not possible.

Third Law (Principle of the Excluded Middle): either A or non-A; no third alternative.

Fuzzy set.-A set that may contain elements that belong only partially to it.

Gauge theories.-Quantum field theories developed to explain the fundamental interactions between elementary particles.

Gödel Theorem (First Theorem of Incompleteness).-In every formal system there exist true statements that cannot be proved.

Hilbert's Hotel.-A (conceptual) hotel with infinite single rooms, which being completely occupied by one guest in each room, can admit infinite new guests who will stay individually, each one in a room. To do this, each of the former guests changes its room according to the following criteria: if a guest occupies the room R_n , it is changed to the room R_{2n+1} . That way, all rooms with an even number become free. In those infinite rooms that have been left empty, the infinite new guests will be accommodated.

Hyper-real numbers.-An axiomatic extension of the real numbers that include infinitesimals and infinite numbers.

Infimum.-See sequence.

Injective function.-See correspondences between sets.

Image of an element.-The image of an element of one set in another set, through an injective correspondence of the first set in the second one, is the element of the second set paired with the element of the first set.

Internal or closed operation.-An operation, for example addition or multiplication, between the elements of a set is internal or closed if the result is always an element of the set.

Internal Set Theory.-Axiomatic set theory that expands ZFC to include part of the non-standard analysis.

Interval.-Set of points or numbers x defined by two points or numbers a and b called **endpoints** of the interval that verify $a < b$. It is denoted by $[a, b]$ if both ends are included (**closed** interval); or by (a, b) if they are not included (**open** interval); if only one of the ends is included, they are called **half-open**, or **half-closed**, or open on the left and closed on the right $(a, b]$, and vice versa $[a, b)$.

Knuth notation.-A simplified way of expressing numbers raised to an exponent, or to a tower of exponents of the same exponent. For example 9^{9^9} is written $9 \uparrow\uparrow 3$.

Limit of a sequence.-A real number L is the limit of a sequence $\langle a_i \rangle$ of real numbers if for every real number $\epsilon > 0$ there is a natural number k such that for every natural number $n > k$ it holds $|L - a_n| < \epsilon$. In symbols:

$$\lim_{n \rightarrow \infty} = L \Rightarrow \forall \epsilon > 0 : \exists n \in \mathbb{N} : |L - a_n| < \epsilon, \forall n > k \quad (2)$$

Mathematical induction.-A method for demonstrating that all elements of a collection, such as the set of the natural numbers, satisfy a given property P : it must be proved that the first element a_1 of the collection satisfies P and that if any element a_n of the collection satisfies P , then the next element a_{n+1} also satisfies P .

Measure theory.-A branch of mathematics that studies measurable sets and functions. Of interest in geometry, analysis and statistic.

Metric.-A symmetric binary function d defined for a given set A , which is non-negative and satisfies:

$$d(x, y) + d(y, z) \geq d(x, z), \forall x, y, z \in A \quad (3)$$

being $d(x, y) = 0$ iff $x = y$. It is usually referred to as *distance*.

Modus Tollens.-A basic rule of logical inference: If the consequence of a true logical inference is false, then the antecedent of

the inference is also false:

$$p \Rightarrow q \quad (4)$$

$$\neg q \quad (5)$$

$$\frac{\quad}{\therefore \neg p} \quad (6)$$

Nested sets (intervals).-A sequence of sets (intervals) such that each of them is a proper subset (superset) of its immediate successor.

Non-standard analysis.-A branch of mathematical analysis, in which infinitesimal numbers are introduced in an axiomatic way: non-null numbers (called hyper-reals) whose absolute value (independent of the sign) is smaller than any standard real number.

One to one correspondence (bijection).-There is a one-to-one correspondence between a set A and another set B if each element of A can be paired off with a different element of the set B , and all elements of A and B result paired.

Peano's axioms.-Peano's axioms are statements about the natural numbers that (as any axiom) are accepted without demonstration. They are the following:

- 1) 1 is a natural number.
- 2) If n is a natural number, $n + 1$ is also a natural number called the successor of n
- 3) 1 is not a successor of other natural number.
- 4) If two natural numbers have different successors, then they are different natural numbers.
- 5) If a set contains the number 1 and the successor of each element in that set, then that set contains all natural numbers.

Permutation.-Each of the different reorderings of an ordered list of elements.

Perpetuum mobile.-A hypothetical machine that would be able to continue working forever, after an initial impulse, without the

need for additional external power. Its existence would violate the second law of thermodynamics, which is why it is considered an impossible object.

Proper subset.-A set A is a proper subset of another set B if all elements of A are elements of B , but not all elements of B are elements of A . The set B is said a superset of the set A .

Proper part.-Part of a whole that does not contain all elements of the whole.

Quantum chromodynamics.-Study of the properties of the strong nuclear interaction from a quantum point of view.

Quantum electrodynamics.-Study of the properties of the electromagnetic interaction from a quantum point of view.

Recursive definition.-A first definition of an element followed by a finite or infinite sequence of new definitions in which each new definition the element is defined in terms of the previous definition.

Renormalization.-Calculation procedures used to eliminate the infinities from equations

Richard paradox.-Assume there exists the indexed list of all arithmetic properties of the natural numbers: to be even, odd, prime, multiple of 5, etc. An additional property would be that of being richardian: a number is said richardian if it doesn't meet the property it indexes; and non-Richardic if he does. Let's assume that the property of being a Richardian is indexed by the number k , $k =$ be richardian. It is easy to see that if the number k is richardian, then it is not richardian; and that if k isn't richardian, then it's richardian.

Standard model of particles.-Theory that describes and classifies all elementary particles, and describes the electromagnetic, weak nuclear and strong nuclear interactions.

Segment of a given line.-A line* whose points and endpoints belong all of them to the given line.

Sequence.-A sequence is an ordered set of elements a_1, a_2, a_3, \dots , usually denoted by $\langle a_i \rangle$. The elements (also called terms) that precede a given element are called predecessors of that element. And those that follow it are called successors. If between two terms of a sequence there are no other terms of the sequence, one of them is the **immediate predecessor** of the other; and the other the **immediate successor** to the one. A sequence is **strictly increasing (decreasing)** if each of its elements is greater (smaller) than its immediate predecessor. An element that is not part of a sequence and is greater (smaller) than all elements of the sequence is called the **upper (lower) bound** of the sequence. The lower of the upper bounds is called the **least upper bound or supremum** of the sequence. The highest of the lower bounds is called the **greatest lower bound or infimum** of the sequence. A sequence with a limit is said **convergent**, and their terms are said to converge to that limit because they are getting closer and closer to it, although they never reach it. Non-convergent sequences are said to be **divergent**.

Superset.-See proper subset.

Supertask.-Execution of an infinite number of tasks, or actions, within a finite interval of time.

Supremum.-See sequence.

Surjective function or bijection.-See correspondences between sets.

Tautology.-A statement that is always true. For example: either the number 1177 is a prime number or the number 1177 is not a prime number.

Topology.-Branch of mathematics that studies the properties of geometric objects that remain constant under transformations such

as stretching, torsion and deformation. It generalizes the concepts of continuity and limit.

Venn diagram.-A diagram in which mathematical sets are represented by overlapping circles.

ZFC.-Standard axiomatic set theory (Zermelo-Fraenkel) that includes the Axiom of choice: of any family of disjointed sets it is possible to define a set with one element from each set of the family.

Bibliographic references

- [1] Amir D. Aczell, *The Mystery of the Aleph: Mathematics, the Kabbalah and the Search for Infinity*, Pockets Books, New York, 2000.
- [2] Antonio Alegre Gorri, *Estudios sobre los presocráticos*, Anthropos, Barcelona, 1985.
- [3] L. V. Allis and T. Koetsierx, *On Some Paradoxes of the infinite*, British Journal for the Philosophy of Science **46** (1991), 235 – 47.
- [4] Joseph S. Alper and Mark Bridger, *Mathematics, Models and Zeno's Paradoxes*, Synthese **110** (1997), 143 – 166.
- [5] ———, *Newtonian Supertasks. A Critical Analysis*, Synthese **114(2)** (1998), 355 – 369.
- [6] ———, *On the Dynamics of Perez Laraudogotia's Supertask*, Synthese **119** (1999), 325 – 337.
- [7] Joseph S. Alper, Mark Bridger, John Earman, and John D. Norton, *What is a Newtonian System? The Failure of Energy Conservation and Determinism in Supertasks*, Synthese **124** (2000), 281 – 293.
- [8] Jan Ambjorn, Jerzy Jurkiewicz, and Renate Loll, *El universo cuántico autoorganizado*, Investigación y Ciencia **384** (2008), 20–27.
- [9] Charis Anastopoulos, *Particle or Wave. The evolution of the concept of matter in modern physics*, Princeton University Press, New Jersey, 2008.
- [10] Aristotle, *Prior and Posterior Analytics*, Clarendon Press, Oxford, 1949.
- [11] Aristóteles, *Metafísica*, Espasa Calpe, Madrid, 1995.
- [12] ———, *Física*, Gredos, Madrid, 1998.
- [13] John Baez, *The Quantum of Area?*, Nature **421** (2003), 702 – 703.
- [14] Mark Balaguer, *Platonism and Anti-platonism in Mathematics*, Oxford University Press, New York, 2001.
- [15] John D. Barrow, *The Infinite Book*, Vintage Books(Random House), New York, 2006.

- [16] Jacob D. Bekenstein, *La información en un universo holográfico*, Investigación y Ciencia **325** (2003), 36–43.
- [17] Paul Benacerraf, *Tasks, Super-tasks, and Modern Eleatics*, J. Philos. **LIX** (1962), no. 24, 765–784.
- [18] Paul Benacerraf and H. Putnam, *Introduction*, Philosophy of Mathematics: Selected Readings (Cambridge) (P. Benacerraf and H. Putnam, eds.), Cambridge University Press, 1964, pp. 1–27.
- [19] Jean Paul Van Bendegem, *In defense of discrete space and time*, Logique et Analyse **38** (1997), 150–152.
- [20] _____, *Finitism in Geometry*, Stanford Encyclopaedia of Philosophy (E. N. Zalta, ed.), Stanford University, URL = <http://plato.stanford.edu>, 2002.
- [21] Henri Bergson, *Creative Evolution*, Dover Publications Inc., New York, 1998.
- [22] Henri Bergson, *The Cinematographic View of Becoming*, Zeno's Paradoxes (Wesley C. Salmon, ed.), Hackett Publishing Company, Inc, Indianapolis/Cambridge, 2001, pp. 59 – 66.
- [23] George Berkeley, *A Treatise Concerning the Principles of Human Knowledge*, Renaissance Editions, <http://darkwing.uoregon.edu/~bear/berkeley>, 2004.
- [24] Alberto Bernabé, *Introducción y notas*, Fragmentos presocráticos (Alberto Bernabé, ed.), Alianza, Madrid, 1988.
- [25] Károly Bezdek, *Classical topics in discrete geometry*, Springer., New York, 2010.
- [26] Joël Biard, *Logique et physique de l'infini au Xive siècle*, Infini des mathématiciens, infini des philosophes (Fran çoise Monnoyeur, ed.), Berlin, Paris, 1992.
- [27] Erwin Biser, *Discrete Real Space*, J. Philos. **38** (1941), 518 – 524.
- [28] M. Black, *Achilles and the Tortoise*, Analysis **XI** (1950 - 51), 91 – 101.
- [29] Ernest Boesiger, *Teorías evolucionistas posteriores a Lamrck y Darwin*, Estudios sobre la filosofía de la biología (Francisco J. Ayala and Theodosius Dobzhansky, eds.), Ariel, 1983, pp. 45–74.
- [30] Bernard Bolzano, *Paradoxien des Unendlichen*, B. van Rootselaar, Hamburg, 1975.
- [31] David Bostock, *Aristotle, Zeno, and the potential Infinite*, Proceedings of the Aristotelian Society **73** (1972), 37 – 51.
- [32] R. Bunn, *Los desarrollos en la fundamentación de la matemática desde 1870 a 1910*, Del cálculo a la teoría de conjuntos, 1630-1910. Una introducción histórica (I. Grattan-Guinness, ed.), Alianza, Madrid, 1984, pp. 283–327.

- [33] Cesare Burali-Forti, *Una questione sui numeri transfiniti*, Rendiconti del Circolo Matematico di Palermo **11** (1897), 154–164.
- [34] Florian Cajori, *The History of Zeno's Arguments on Motion*, American Mathematical Monthly **XXII** (1915), 1–6, 38–47, 77–82, 109–115, 143–149, 179,–186, 215–220, 253–258, 292–297, <http://www.matedu.cinvestav.mx/librosydocelec/Cajori.pdf>.
- [35] _____, *The Purpose of Zeno's Arguments on Motion*, Isis **III** (1920-21), 7–20.
- [36] Georg Cantor, *On a property of the class of all real algebraic numbers*, Crelle's Journal for Mathematics **77** (1874), 258–262, Translated by C.P.Grant.
- [37] _____, *Über eine eigenschaft des inbegriffes aller reellen algebraischen zahlen*, Journal für die reine und angewandte Mathematik **77** (1874), 258–262.
- [38] Georg Cantor, *Recueil d'articles*, ch. Fondaments d'une theorie general des ensembles, pp. 381–408, BnF Gallica, 1879-1889.
- [39] _____, *Recueil d'articles*, ch. Sur les ensembles infinis et linéaires des points I-IV, pp. 349–380, BnF Gallica, 1879-1889.
- [40] Georg Cantor, *Grundlagen einer allgemeinen Mannichfaltigkeitslehre*, Mathematischen Annalen **21** (1883), 545 – 591.
- [41] _____, *Sur une propriété du système de tous les nombres algébriques réels*, Acta Mathematica **2** (1883), 305–310, Translated by P. Appell, reviewed and corrected by G. Cantor.
- [42] _____, *Über verschiedene Theoreme asu der Theorie der Punktmengen in einem n-fach ausgedehnten stetigen Raume Gn*, Acta Mathematica **7** (1885), 105–124.
- [43] _____, *Über Eine elementare frage der mannigfaltigkeitslehre*, Jahresbericht der Deutschen Mathematiker Vereinigung **1** (1891), 75–78.
- [44] _____, *Beiträge zur Begründung der transfiniten Mengenlehre*, Mathematische Annalen **XLVI** (1895), 481 – 512.
- [45] _____, *Beiträge zur Begründung der transfiniten Mengenlehre*, Mathematische Annalen **XLIX** (1897), 207 – 246.
- [46] _____, *Gesammelte Abhandlungen*, Verlag von Julius Springer, Berlin, 1932.
- [47] _____, *Contributions to the founding of the theory of transfinite numbers*, Dover, New York, 1955.
- [48] _____, *Foundations of a General Theory of Manifolds*, The Theoretical Journal of the National Caucus of Labor Committees **9** (1976), no. 1-2, 69 – 96.

- [49] ———, *On The Theory of the Transfinite. Correspondence of Georg Cantor and J. B: Cardinal Franzelin*, *Fidelio* **III** (1994), no. 3, 97 – 110.
- [50] ———, *Sobre una propiedad de la colección de todos los números reales algebraicos*, *Fundamentos para una teoría general de conjuntos. Escritos y correspondencia selecta* (José Ferreirós, ed.), *Crítica*, Madrid, 2006, pp. 179–183.
- [51] Lewis Carroll, *El juego de la Lógica*, 6 ed., Alianza, Madrid, 1982.
- [52] Sean B. Carroll, Benjamin Proud'home, and Nicolas Gompel, *La regulación de la evolución*, *Investigación y Ciencia* **382** (2008), 24–31.
- [53] Carlos Castrodeza, *Los límites de la historia natural. Hacia una nueva biología del conocimiento*, Akal, Madrid, 2003.
- [54] Li M. Chen, *Digital and discrete geometry*, Springer, New York, 2014.
- [55] David V. Chudnovsky and Gregory V. Chudnovsky, *The computation of classical constants*, *Proc. Natl. Acad. Sci. U.S.A.* **86** (21) (1989), 8178–8182.
- [56] P. Clark and S. Read, *Hypertasks*, *Synthese* **61** (1984), 387 – 390.
- [57] Brian Clegg, *A Brief History of Infinity. The Quest to Think the Unthinkable*, Constable and Robinson Ltd, London, 2003.
- [58] Jean de Climont, *The worldwide list of alternative theories and critics*, Editions d'Assailly, 2021.
- [59] Paul J. Cohen, *The independence of the Continuum Hypothesis*, *Proceedings of the National Academy of Sciences* **50** (1963), 1143 – 1148.
- [60] Jonas Cohn, *Histoire de l'infini. Le problème de l'infini dans la pensée occidentale jusqu'à Kant*, Leséditions du CERF, Paris, 1994.
- [61] H. R. Coish, *Elementary particles in a finite world geometry*, *Phys. Rev.* **114** (1959), 383 – 388.
- [62] Giorgio Colli, *Zenón de Elea*, Sexto Piso, Madrid, 2006.
- [63] Irving M. Copi, *The burali-forti paradox*, *Philosophy of Science* **25** (1958), no. 4, 281–286.
- [64] Michael C. Corballis, *Pensamiento recursivo*, *Mente y Cerebro* **27** (2007), 78–87.
- [65] Antonio Damasio, *Creación cerebral de la mente*, *Investigación y Ciencia* (2000), 66–71.
- [66] Antonio Damasio, *El error de Descartes*, *Crítica*, Barcelona, 2003.
- [67] ———, *Y el cerebro creó al hombre*, Destino, Barcelona, 2010.
- [68] Josep W. Dauben, *Georg Cantor. His mathematics and Philosophy of the Infinite*, Princeton University Press, Princeton, N. J., 1990.

- [69] P. C. W. Davies, *Multiverse Cosmological Models*, Mod. Phys. Lett. A **19** (2004), 727–743.
- [70] Richard Dedekind, *Qué son y para qué sirven los números (was sind Und was sollen die Zahlen(1888))*, Alianza, Madrid, 1998.
- [71] Stanislas Dehaene, Nicolas Molko and Laurent Cohen, and Anna J. Wilson, *Arithmetic and the Brain*, Curr. Opin. Neurobiol. **14** (2004), 218–224.
- [72] Stanislas Dehane, *Bases biológicas de la aritmética elemental*, Mente y Cerebro **25** (2007), 62–67.
- [73] Jean-Paul Delahaye, *El carácter paradójico del Infinito*, Investigación y Ciencia (Scientific American) **Temas: Ideas del infinito** (2001), no. 23, 36 – 44.
- [74] Satyan L. Devadoss and Joseph O’Rourke, *Discrete and computational geometry*, Princeton University Press, Princeton and Oxford, 2011.
- [75] Theodosius Dobzhansky, *Nothing in biology makes sense except in the light of evolution*, American Biology Teacher **35** (1973), 125–129.
- [76] Didier Dubois and Henri Prade, *Fuzzy Sets and Systems*, Academic Press, New York, 1988.
- [77] W. Dunham, *Journey through Genius: The Great Theorems of Mathematics*, Wiley, New York, 1990.
- [78] William Dunham, *Journey through genius. the great theorems of mathematics*, John John Wiley and Sons, New York, 1990.
- [79] John Earman, *Determinism: What We Have Learned and What We Still Don’t Know*, Freedom and Determinism (Michael O’Rourke and David Shier, eds.), MIT Press, Cambridge, 2004, pp. 21–46.
- [80] John Earman and John D. Norton, *Forever is a Day: Supertasks in Pitowsky and Malament-hogarth Spacetimes*, Philosophy of Science **60** (1993), no. 1, 22–42.
- [81] ———, *Infinite Pains: The Trouble with Supertasks*, Paul Benacerraf: The Philosopher and His Critics (S. Stich, ed.), Blackwell, New York, 1996.
- [82] ———, *Comments on Laraudogoitia’s ‘classical Particle Dynamics, Indeterminism and a Supertask’*, The British Journal for the Philosophy of Science **49** (1998), no. 1, 122 – 133.
- [83] Heinz-Dieter Ebbinghaus, *Zermelo and the heidelberg congress 1904*, Historia Mathematica (2007).
- [84] V. Ekroll, F. Faul, and J. Golz, *Classification of apparent motion percepts based on temporal factors*, Journal of Vision **8** (2008), no. 4, 1–22.
- [85] Niles Eldredge, *Síntesis inacabada. Jerarquías biológicas y pensamiento evolutivo moderno*, Fondo de Cultura Económica, Mexico, 1997.

- [86] Michael J. Hawrylycz et al., *An Anatomically Comprehensive Atlas of the Adult Human Brain Transcriptome*, *Nature* **489** (2012), 391–399.
- [87] Euclides, *Elementos*, Gredos, Madrid, 2000.
- [88] Theodore G. Faticoni, *The mathematics of infinity: A guide to great ideas*, John Wiley and Sons, Hoboken, New Jersey, July 2006.
- [89] José L. Fernández Barbón, *Geometría no conmutativa y espaciotiempo cuántico.*, *Investigación y Ciencia* (2005), no. 342, 60–69.
- [90] José Ferreirós, *El nacimiento de la teoría de conjuntos*, Universidad Autónoma de Madrid, Madrid, 1993.
- [91] ———, *Matemáticas y platonismo(s)*, *Gaceta de la Real Sociedad Matemática Española* **2** (1999), no. 3, 446–473.
- [92] ———, *Fundamentos para una teoría general de conjuntos*, 1 ed., *Clásicos de la ciencia y la tecnología*, ch. Introducción, pp. 9–78, Editorial Crítica, Barcelona, 2006.
- [93] Richard Feynman, *Superstrings: A Theory of Everything?*, *Superstrings: A Theory of Everything?* (Paul Davis and Julian Brown, eds.), Cambridge University Press, Cambridge, 1988.
- [94] D. Finkelstein and E. Rodríguez, *Quantum time-space and gravity*, *Quantum Concepts in Space and Time* (R. Penrose and C. J. Isham, eds.), Oxford University Press, Oxford, 1986, pp. 247 – 254.
- [95] Fabrizio Fiore, Luciano Burderi, Tiziana Di Salvo, Marco Feroci, Claudio Labanti, Michelle R. Lavagna, and Simone Pirrotta, *HERMES: a swarm of nano-satellites for high energy astrophysics and fundamental physics*, *Space Telescopes and Instrumentation 2018: Ultraviolet to Gamma Ray* (Jan-Willem A. den Herder, Shouleh Nikzad, and Kazuhiro Nakazawa, eds.), vol. 10699, International Society for Optics and Photonics, SPIE, 2018.
- [96] P. Forrest, *Is Space-time Discrete or Continuous?*, *Synthese* **103** (1995), 327 – 354.
- [97] Laurent Freidel and Etera R. Livine, *Bubble networks: framed discrete geometry for quantum gravity*, *General Relativity and Gravitation* **51** (2018), no. 1, 9.
- [98] Galileo Galilei, *Consideraciones y demostraciones matemáticas sobre dos nuevas ciencias*, Editora Nacional, Madrid, 1981.
- [99] Alejandro R. Garcíadiego Dantan, *Bertrand Russell y los orígenes de las paradojas de la teoría de conjuntos*, Alianza, Madrid, 1992.
- [100] Valeria Gazzola, Lisa Aziz-Zadieh, and Christian Keysers, *Empathy and the Somatotopic Auditory Mirror System in Humans*, *Curr. Biol.* **19** (2006), 1824–1829.

- [101] Kurt Gödel, *The consistency of the Axiom of Choice and the Generalized Continuum Hypothesis*, Proceedings of the National Academy of Sciences **24** (1938), 556 – 557.
- [102] Kurt Gödel, *Obras Completas*, ch. Sobre sentencias formalmente indecidibles de Principia Mathematica y sistemas afines, pp. 53–87, Alianza, Madrid, 1989.
- [103] James Gleick, *The information*, Fourth Estate, London, 2012.
- [104] Robert Goldblatt, *Lectures on the Hyperreals: An Introduction to Non-standard Analysis*, Springer-Verlag, New York, 1998.
- [105] Stephen Jay Gould, *Acabo de llegar: el final de un principio en la historia natural*, Crítica, Barcelona, 2003.
- [106] I. Grattan-Guinness, *Are there paradoxes of the set of all sets?*, International Journal of Mathematical Education, Science and Technology **12** (1981), 9–18.
- [107] Brian Greene, *El universo elegante*, Editorial Crítica, Barcelona, 2001.
- [108] ———, *The Fabric of the Cosmos. Space, Time, and the Texture of Reality*, Alfred A. Knopf, New York, 2004.
- [109] Adolf Grünbaum, *Modern Science and Refutation of the Paradoxes of Zeno*, The Scientific Monthly **LXXXI** (1955), 234–239.
- [110] ———, *Modern Science and Zeno's Paradoxes*, George Allen And Unwin Ltd, London, 1967.
- [111] ———, *Modern Science and Refutation of the Paradoxes of Zeno*, Zeno's Paradoxes (Wesley C. Salmon, ed.), Hackett Publishing Company, Inc, Indianapolis/Cambridge, 2001, pp. 164 – 175.
- [112] ———, *Modern Science and Zeno's Paradoxes of Motion*, Zeno's Paradoxes (Wesley C. Salmon, ed.), Hackett Publishing Company, Inc, Indianapolis/Cambridge, 2001, pp. 200 – 250.
- [113] ———, *Zeno's Metrical Paradox of Extension*, Zeno's Paradoxes (Wesley C. Salmon, ed.), Hackett Publishing Company, Inc, Indianapolis/Cambridge, 2001, pp. 176 – 199.
- [114] Michael Hallet, *Cantorian Set Theory and Limitation of Size*, Oxford University Press, 1984.
- [115] Charles Hamblin, *Starting and Stopping*, The Monist **53** (1969), 410 – 425.
- [116] Marc D. Hauser, *Mentes animales*, El nuevo humanismo y las fronteras de la ciencia (John Brockman, ed.), Kairós, Barcelona, 2007, pp. 113–136.
- [117] Thomas Heath, *The Thirteen Books of Euclid's Elements*, second ed., vol. I, Dover Publications Inc, New York, 1956.

- [118] Georg Wilhelm Frederich Hegel, *Lógica*, Folio, Barcelona, 2003.
- [119] James M. Henle and Eugene M. Kleinberg, *Infinitesimal Calculus*, Dover Publications Inc., Mineola, New York, 2003.
- [120] David Hilbert, *Über das unendliche*, *Mathematische Annalen* **95** (1926), no. 1, 161–190.
- [121] Wilfrid Hodges, *An Editor Recalls some Hopeless Papers*, *The Bulletin of Symbolic Logic* **4** (1998), no. 1, 1–16.
- [122] Craig J. Hogan, *El libro del Big Bang*, Alianza, Madrid, 2005.
- [123] M. L. Hogarth, *Does General Relativity Allow an Observer to view an Eternity in a Finite Time?*, *Foundations of Physics Letters* **5** (1992), 173 – 181.
- [124] M. Randall Holmes, *Alternative Axiomatic Set Theories*, *The Stanford Encyclopedia of Philosophy* (Edward N. Zalta, ed.), Stanford University, 2007.
- [125] Gerard't Hooft, *Partículas elementales*, Crítica, Barcelona, 1991.
- [126] Nick Huggett, *Zeno's Paradoxes*, *The Stanford Encyclopaedia of Philosophy* (Summer 2004 Edition) (Edward N. Zalta(ed.), ed.), Stanford University, <http://plato.stanford.edu/archives/sum2004/entries/paradox-zeno/>, 2004.
- [127] H. Jerome Keisler, *Elementary Calculus. An Infinitesimal Approach*, second ed., Author, <http://www.wisc.edu/keisler/keislercalc.pdf>, September 2002.
- [128] Evelyne Kohler, Christian Keysers, Alessandra Ulmitá, Leonardo Fogassi, Vittorio Gallese, and Giacomo Rizzolati, *Hearing Sounds, Understanding Actions: Action Representation in Mirror Neurons*, *Science* **297** (2002), 846–848.
- [129] H. Kragh and B. Carazza, *From Time Atoms to Space-time Quantization: the Idea of Discrete Time, ca 1925-1936*, *Studies in History and Philosophy of Science* **25** (1994), 437 – 462.
- [130] Dharshan Kumara, Jennifer J. Summerfield, Demis Hassabis, and Eleanor A. Maguire, *Tracking the Emergence of Conceptual Knowledge during Human Decision Making*, *Neuron* **63** (2009), 889–901.
- [131] Shaughan Lavine, *Understanding the Infinite*, Harvard University Press, Cambridge MA, 1998.
- [132] Marc Lchièze-Rey, *L'infini. De la philosophie à l'astrophysique*, Hatier, Paris, 1999.
- [133] Ed Leind and Mike Hawrylycz, *The genetic geography of the brain*, *Sci. Amer.* (2014), 71–77.

- [134] Antonio León and Ana C. León, *Supertasks, Physics and the Axiom of Infinity*, Truth, Objects, Infinity. New Perspectives on the Philosophy of Paul Benacerraf. (Fabrice Pataut, ed.), Springer, Switzerland, 2017, pp. 223–259.
- [135] Antonio Leon, *Digital relativity*, Next publication.
- [136] ———, *Living beings as informed systems: towards a physical theory of information*, Journal of Biological Systems **4** (1996), no. 4, 565 – 584.
- [137] ———, *Proving unproved euclidean propositions on a new foundational basis*, International Journal of Scientific Research in Mathematical and Statistical Sciences **7** (2020), no. 3, 61–81.
- [138] Enrique Linés, *Principios de Análisis Matemático*, Reverté, Barcelona, 1991.
- [139] Bernard Linsky and Edward N. Zalta, *Naturalized Platonism vs Platonized Naturalism*, J. Philos. **XCII/10** (1995), 525–555.
- [140] John Losee, *Introducción histórica a la filosofía de la ciencia*, Alianza, Madrid, 1987.
- [141] Seth Loyd and Y. Jack Ng, *Computación en agujeros negros*, Investigación y Ciencia (Scientific American) (2005), no. 340, 59 – 67.
- [142] Jean Pierre Luminet and Marc Lachièze-Rey, *La physique et l’infini*, Flammarion, Paris, 1994.
- [143] Peter Lynds, *Time and Classical and Quantum Mechanics: Indeterminacy vs. Discontinuity*, Foundations of Physics Letters **16** (2003), 343 – 355.
- [144] Peter Lynds, *Zeno’s Paradoxes: A Timely Solution*, philsci-archives (2003), 1 – 9, <http://philsci-archives.pitt.edu/archive/00001197>.
- [145] William I. Maclaughlin, *Thomson’s Lamp is Dysfunctional*, Synthese **116** (1998), no. 3, 281 – 301.
- [146] Penelope Maddy, *Perception and Mathematical Intuition*, The Philosophical Review **89** (1980), 163–196.
- [147] ———, *Naturalism in Mathematics*, Oxford University Press, New York, 1997.
- [148] Shahn Majid, *Quantum space time and physical reality*, On Space and Time (Shahn Majid, ed.), Cambridge University Press, New York, 2008, pp. 56–140.
- [149] John Byron Manchack, *On the Possibility of Supertasks in General Relativity*, Philsci-Archive (2009), 1–18, <http://philsci-archives.pitt.edu/archive/00005020>.
- [150] B. Mandelbrot, *The fractal geometry of nature*, W. H. Freeman, 1982.

- [151] Benôit Mandelbrot, *Los objetos fractales. Forma, azar y dimensiones*, Tusquets, Barcelona, 1987.
- [152] Eli Maor, *To Infinity and Beyond. A Cultural History of the Infinite*, Pinceton University Press, Princeton, New Jersey, 1991.
- [153] Lynn Margulis, *Teoría de la simbiosis: las células como comunidades microbianas*, Evolución ambiental (Lynn Margulis and Lorraine Olendzenski, eds.), Alianza, Madrid, 1996, pp. 157–182.
- [154] Mathieu Marion, *Wittgenstein, finitism and the foundations of mathematics*, Clarendon Press Oxford, Oxford, 1998.
- [155] James Clerk Maxwell, *Materia y movimiento*, Crítica, Barcelona, 2006.
- [156] Ernst Mayr, *The Growth of Biological Thought*, Harvard University Press, Cambirdge MA, 1982.
- [157] Joseph Mazur, *The Motion Paradox*, Dutton, 2007.
- [158] William I. McLaughlin, *Una resolución de las paradojas de Zenón*, Investigación y Ciencia (Scientific American) (1995), no. 220, 62 – 68.
- [159] William I. McLaughlin and Silvia L. Miller, *An Epistemological Use of non-standard Analysis to Answer Zeno's Objections Against Motion*, Synthese **92** (1992), no. 3, 371 – 384.
- [160] J. E. McTaggart, *The unreality of time*, Mind **17** (1908), 457 – 474.
- [161] Brian Medlin, *The Origin of Motion*, Mind **72** (1963), 155 – 175.
- [162] A. Meessen, *Is it logically possible to generalize physics through space-time quantization?*, Philosophie der Naturwissenschaften. Akten des 13 Internationalen Wittgenstein Symposium (P. Weingartner and G. Schurz, eds.), Hölder-Pichler-Tempsky, Vienna, 1989, pp. 19 – 47.
- [163] H. Meschkowski, *Georg Cantor. Leben, Werk und Wirkung*, Bibliographisches Institut, Mannheim, 1983.
- [164] Andreas W. Moore, *Breve historia del infinito*, Investigación y Ciencia (Scientific American) (1995), no. 225, 54 – 59.
- [165] ———, *A brief history of infinity*, Scientific American **272** (1995), no. 4, 112–116.
- [166] ———, *The Infinite*, Routledge, New York, 2001.
- [167] Francisco Mora, *Cómo funciona el cerebro*, Alianza, Madrid, 2007.
- [168] Richard Morris, *Achilles in the Quantum Universe*, Henry Holt and Company, New York, 1997.
- [169] ———, *La historia definitiva del infinito*, Ediciones B S.A., 2000.
- [170] Chris Mortensen, *Change*, Stanford Encyclopaedia of Philosophy (E. N. Zalta, ed.), Stanford University, URL = <http://plato.stanford.edu>, 2020.

- [171] Jan Mycielski, *Analysis without actual Infinite*, The Journal of Symbolic Logic **46** (1981), no. 3, 625 – 633.
- [172] Joaquín Navarro, *Los secretos del número π ¿por qué es imposible la cuadratura del círculo?*, RBA Editores, 2014.
- [173] Alexander I. Nesterov and Héctor Mata, *How nonassociative geometry describes a discrete spacetime*, Frontiers in Physics **7** (2019), no. 32, 1–18.
- [174] John Von Neumann, *On the introduction of transfinite numbers*, From Frege to Gödel. A sourcebook in mathematical logic 1879-1931 (Jean Van Heijenoort, ed.), Harvard University Press, 2011, pp. 346–354.
- [175] John D. Norton, *A Quantum Mechanical Supertask*, Found. Phys. **29** (1999), no. 8, 1265 – 1302.
- [176] Javier Ordoñez, Victor Navarro, and José Manuel Sánchez Ron, *Historia de la Ciencia*, Espasa Calpe, Madrid, 2004.
- [177] Alba Papa-Grimaldi, *Why mathematical solutions of Zeno’s paradoxes miss the point: Zeno’s one and many relation and Parmenides prohibition*, The Review of Metaphysics **50** (1996), 299–314.
- [178] Derek Parfit, *Reasons and Persons*, The Clarendon Press, Oxford, 1984.
- [179] Parménides, *Acerca de la naturaleza*, De Tales a Demócrito. Fragmentos presocráticos (Alberto Bernabé, ed.), Alianza, Madrid, 1988, pp. 159 – 167.
- [180] Giuseppe Peano, *Arithmetices principia. nova methodo exposita*, Libreria Bocca, Roma, 1889.
- [181] Clifford A. Pickover, *Keys to Infinity*, Wiley, New York, 1995.
- [182] I. Pitowsky, *The Physical Church Thesis and Physical Computational Complexity*, Iyyun: The Jerusalem Philosophical Quarterly **39** (1990), 81 –99.
- [183] Mary Potter, Carl Hagmann, and Emily McCourt, *Banana or fruit? Detection and recognition across categorical levels in RSVP*, Psychonomic Bulletin and Review **22** (2015), no. 2, 578–585.
- [184] Jon Pérez Laraudogoitia, *A Beautiful Supertask*, Mind **105** (1996), 49–54.
- [185] _____, *Classical Particle Dynamics, Indeterminism and a Supertask*, British Journal for the Philosophy of Science **48** (1997), no. 1, 49 – 54.
- [186] _____, *Infinity Machines and Creation Ex Nihilo*, Synthese **115** (1998), 259 – 265.
- [187] _____, *Why Dynamical Self-excitation is Possible*, Synthese **119** (1999), no. 3, 313 – 323.

- [188] ———, *Supertasks*, The Stanford Encyclopaedia of Philosophy (E. N. Zalta, ed.), Stanford University, URL = <http://plato.stanford.edu>, 2001.
- [189] Jon Pérez Laraudogoitia, Mark Bridger, and Joseph S. Alper, *Two Ways of Looking at a Newtonian Supertask*, *Synthese* **131** (2002), no. 2, 157 – 171.
- [190] W. Purkert, *Cantor's view on the foundations of mathematics*, The history of modern mathematics (D. Rowe and J. McCleary, eds.), Academic Press, New York, 1989, pp. 49–64.
- [191] Marcus E. Raichle, *The Brain's Dark Energy*, *Science* **319** (2006), 1249–1250.
- [192] Martin Rees, *Just Six Numbers. The deep forces that shape the universe*, Phoenix. Orion Books Ltd., London, 2000.
- [193] Nicholas Rescher, *Process Philosophy*, Stanford Encyclopedia of Philosophy (Edward N. Zalta, ed.), Stanford University, URL = <http://plato.stanford.edu>, 2002.
- [194] Robert J. Richards, *El significado de la evolución. La construcción morfológica y la reconstrucción ideológica de la teoría de Darwin*, Alianza, Madrid, 1998.
- [195] Mark Ridley, *La evolución y sus problemas*, Pirámide, Madrid, 1985.
- [196] Giacomo Rizzolati, Leonardo Fogassi, and Vittorio Gallese, *Neuronas espejo*, *Investigación y Ciencia* **364** (2007), 14–21.
- [197] Adina L. Roskies, *The Binding problem*, *Neuron* **24** (1999), 7–9.
- [198] Francesc Rossell i Pujols, *El infinito*, EMSE EDAPP, Barcelona, 2019.
- [199] Brian Rotman, *The Ghost in Turing Machine*, Stanford University Press, Stanford, 1993.
- [200] Carlo Rovelli, *Quantum spacetime: What do we know?*, Physics meets Philosophy at the Plank scale (Craig Callender and Nick Huggett, eds.), Cambridge University Press, Cambridge, 2001, pp. 101 – 122.
- [201] Rudy Rucker, *Infinity and the Mind*, Princeton University Press, Princeton, 1995.
- [202] Bertrand Russell, *Historia de la Filosofía Occidental*, Espasa Calpe, Madrid, 1997.
- [203] Wesley C. Salmon, *Introduction, Zeno's Paradoxes* (Wesley C. Salmon, ed.), Hackett Publishing Company, Inc, Indianapolis, Cambridge, 2001, pp. 5 – 44.
- [204] Javier Sampedro, *Deconstruyendo a Darwin*, Crítica, 2007.
- [205] Máximo Sandín, *Lamarck y los mensajeros. La función de los virus en la evolución*, Istmo, Madrid, 1995.

- [206] Steven Savitt, *Being and Becoming in Modern Physics*, The Stanford Encyclopedia of Philosophy (Edward N. Zalta, ed.), The Stanford Encyclopedia of Philosophy, 2008.
- [207] Erwin Schrödinger, *La naturaleza y los griegos*, Tusquets, Barcelona, 1996.
- [208] Bruce A. Schumm, *Deep Down Things. The Breathtaking Beauty of Particle Physics*, The Johns Hopkins University Press, Baltimore, 2004.
- [209] John H. Schwarz, *Introduction to superstring theory*, arXiv:hep-ex/0008017 (2000), 1–44.
- [210] Jan Sebestik, *La paradoxe de la réflexivité des ensembles infinis: Leibniz, Goldbach, Bolzano.*, Infini des mathématiciens, infini des philosophes (Françoise Monnoyeur, ed.), Belin, Paris, 1992, pp. 175–191.
- [211] Sebastian Seung, *Connectome. How the brain's wiring makes us who we are*, Houghton Mifflin Harcourt, New York, 2012.
- [212] Waclaw Sierpinski, *Cardinal and ordinal numbers*, PWN-Polish Scientific Publishers, Warszawa, 1965.
- [213] Z. K. Silagadze, *Zeno meets modern science*, Philsci-archieve (2005), 1–40.
- [214] Hourya Sinaceur, *Le fini et l'infini*, Infini des mathématiciens, infini des philosophes (Françoise Monnoyeur, ed.), Belin, Paris, 1992.
- [215] ———, *¿existen los números infinitos?*, Mundo Científico (La Recherche) **Extra: El Universo de los números** (2001), 24 – 31.
- [216] Hourya Sinaceur and J. M. Salanski (eds.), *Le labyrinthe du continu*, Springer-Verlag, Berlin, 1992.
- [217] Wolf Singer, *Consciousness and the Binding Problem*, Ann. N.Y. Acad. Sci. **929** (2001), 123–146.
- [218] J. Maynard Smith, D. Bohm, M. Green, and C. H. Waddington, *El status del neodarwinismo*, Hacia una Biología Teórica (C. H. Waddington, ed.), Alianza, Madrid, 1976, pp. 295 – 324.
- [219] Lee Smolin, *Three roads to quantum gravity. A new understanding of space, time and the universe*, Phoenix, London, 2003.
- [220] Lee Smolin, *Átomos del espacio y del tiempo*, Investigación y Ciencia (2004), no. 330, 58 – 67.
- [221] ———, *The trouble with physics*, Allen Lane. Penguin Books, London, 2007.
- [222] Carlos Solís and Luis Sellés, *Historia de la ciencia*, Espasa Calpe, Madrid, 2005.
- [223] Steven M. Stanley, *El nuevo cómputo de la evolución*, Siglo XXI, Madrid, 1986.

- [224] Paul Steinhardt, *El universo cíclico*, El nuevo humanismo y las fronteras de la ciencia (John Brockman, ed.), Kairós, Barcelona, 2008, pp. 363–379.
- [225] Robert R. Stoll, *Set Theory and Logic*, Dover, New York, 1979.
- [226] K. D. Stroyan, *Foundations of Infinitesimal Calculus*, Academic Press, Inc, New York, 1997.
- [227] Patrick Suppes, *Axiomatic Set Theory*, Dover, New York, 1972.
- [228] Leonard Susskind, *Los agujeros negros y la paradoja de la información*, Investigación y Ciencia (Scientific American) (1997), no. 249, 12 – 18.
- [229] Richard Taylor, *Mr. Black on Temporal Paradoxes*, Analysis **12** (1951 - 52), 38 – 44.
- [230] James F. Thomson, *Tasks and Supertasks*, Analysis **15** (1954), 1–13.
- [231] Alan M. Turing, *On Computability Numbers, With an Application to the Entscheidungsproblem*, Proc. London Math. Soc. Series 2 **43** (1937), 230 – 265.
- [232] Sime Ungar, *The Koch curve: A geometrical proof*, Am. Math. Mon. **114**, **1** (2007), 61–66.
- [233] Gabriele Veneziano, *El universo antes de la Gran Explosión*, Investigación y Ciencia (Scientific American) (2004), no. 334, 58 – 67.
- [234] Gregory Vlastos, *Zeno's Race Course*, Journal of the History of Philosophy **IV** (1966), 95–108.
- [235] ———, *Zeno of Elea*, The Encyclopaedia of Philosophy (Paul Edwards, ed.), McMillan and Free Press, New York, 1967.
- [236] Helge von Koch, *Sur une courbe continue sans tangente, obtenue par une construction géométrique élémentaire*, Arkiv for Matematik **1** (1904), 681–704.
- [237] ———, *Une méthode géométrique élémentaire pour l'étude de certaines questions de la théorie des courbes planes*, Acta Mathematica **30** (1906), 145–174.
- [238] G. H. Von Wright, *Time, Change and Contradiction*, Cambridge University Press, Cambridge, 1968.
- [239] David Foster Wallace, *Everything and more. A compact history of infinity*, Orion Books Ltd., London, 2005.
- [240] John Watling, *The sum of an infinite series*, Analysis **13** (1952 - 53), 39 – 46.
- [241] Eric W. Weistein, *Superfactorial*, Eric Weistein World of Mathematics, Wolfram Research Inc., <http://mathworld.wolfram.com>, 2009.

- [242] H. Weyl, *Philosophy of Mathematics and Natural Sciences*, Princeton University Press, Princeton, 1949.
- [243] Klaus Wilhelm, *La cultura entre los primates*, *Mente y Cerebro* **29** (2008), 66–71.
- [244] Ludwig Wittgenstein, *Observaciones sobre los fundamentos de la matemática*, Alianza Universidad, Madrid, 1987.
- [245] Stephen Wolfram, *Mathematical Notation: Past and Future*. <http://www.stephenwolfram.com/publications>, Wolfram Media Inc, 2010 (English).
- [246] Alexander J. Yee and Shigeru Kondo, *12.1 Trillions Digits of Pi*, www.numberworld.org, 2013.
- [247] F. J. Ynduráin, *Electrones, neutrinos y quarks*, Crítica, Barcelona, 2001.
- [248] Lofty A. Zadeh, *Fuzzy Sets*, *Information and Control* **8(3)** (1965), 338–353.
- [249] Mark Zangari, *Zeno, Zero and Indeterminate Forms: Instants in the Logic of Motion*, *Australasian Journal of Philosophy* **72** (1994), 187–204.
- [250] Semir Zeki, *Una visión del cerebro*, Ariel, Barcelona, 1995.
- [251] Paolo Zellini, *Breve storia dell'infinito*, Adelphi Edizioni, Milano, 1980.

Alphabetical index

0-Intervals, 135

α -Ordered sequence, 62

A denumerable partition, 132

A grotesque universe, 336

A shrinking rational interval, 134

A shrinking rational interval , 134–136

A suspicious difference, 169

A trip through π , 305–307

Absolute infinity, 75

Absolutely disjoint sets, 77

Actual and potential infinity, 35–39

Actual infinity, 35, 80, 308

Aleph-null \aleph_0 , 45, 48, 82

 And the power of the continuum, 210–212

 As a prime number, 203–209

 Circular definition, 201

 Defining sets, 201

 Definition, 198

 First transfinite cardinal, 320

 Greater than all finite cardinals, 199

 Is not a natural number, 198

 Natural numbers do not approach, 200

 Not the limit of the natural numbers, 200

 Properties, 199

 The first transfinite cardinal, 290

 The least transfinite cardinal, 199

Aleph-null or zero dichotomy, 167

Algebraic numbers, 97

Animals and abstract knowledge, 358, 359

Antidiagonal, 137

Argument of the rational intervals, 128–131

Aristotle, 8, 27, 34–36, 66, 265, 270, 334, 354

 Aristotle and one to one correspondences, 66, 270

Atoms, 9

Axiom

 Axiom, 363

 of Choice, 363, 370

 of Infinity, 10, 14, 33, 38–40, 68, 83, 117, 120, 136, 139, 148, 153, 161, 170,
 203, 220, 223, 225, 226, 251, 253, 258, 265, 268, 275, 286, 288, 292,
 320, 322, 335, 337, 340, 343, 351

- of the Whole and the Part, 65, 67, 199, 216
- Axiomatic set theories, 81

- Benacerraf criticism of Thomson's lamp, 231
- Benacerraf, P., 15, 228, 236
- Bergson, H., 323
- Bernstein theorem, 224
- Bernstein, F., 224
- Bijection, 367
- Black, M., 228
- Bolzano, B.P.J.N., 35, 38, 66
 - Actual infinity proof, 38
- Brouwer, L., 337
- Brouwer, L.E.J., 41
- Bubble method, 91
- Burali-Forti Paradox, 71, 73, 81, 345

- CALMs, 341
- Cantor Paradox, 75, 81
- Cantor, G., 9, 34, 35, 37, 66, 97, 109, 117, 137, 147, 203, 207, 209, 223, 224, 267, 320
 - \aleph_0 is the smallest infinite cardinal, 203
 - 1874 argument, 86, 97–101, 139
 - 1882 argument, 140–142
 - Cantor antidiagonal, 117
 - Actual infinity proof, 39
 - Antidiagonal, 117
 - Beiträge, 136, 197
 - Cantor dust, 142
 - Cantor Paradox, 73, 345
 - Definition of set, 345
 - Diagonal argument, 117, 137, 139
 - Foundational works, 197
 - Infinity and God, 75
 - Intersection Theorem, 166
 - Naive set theory, 77
 - Order relations
 - Simply ordered aggregates, 41
 - well-ordered aggregates, 42
 - Paradox of the Maximum Cardinal, 71, 75
 - Power Set Theorem, 75, 209, 212
 - Ternary Set, 86, 142
 - The smallest infinite cardinal, 48
 - Theorem 16-F, 54
 - Theorem §14, I, 52
 - Theorem §15 A, 52, 267
 - Theorem §15 B, 52
 - Theorem §15 H, 52
 - Theorem §15 K, 52
 - Theorems §15 A-K, 136
 - Theorems §16 D-F, 136
 - Totality of finite cardinals, 47
- Cardinal numbers, 45, 347
- Cardinal of a set, 45

- Cardinal subtraction theorems, 215
- Cardinality, 65
- Carroll, L., 259, 344
- Cellular Automata Like Models, CALMs, 328
- Change
 - Canonical changes, 324
 - Causal changes, 323
 - Change in CALMs, 330
 - Impossible in the spacetime continuum, 327–328
 - Instantaneous changes, 326
 - Impossible in the spacetime continuum, 326
 - Instantaneous changes in CALMs, 330
 - The problem of change, 7, 323
- Chronons, 338
- Chudnovsky's algorithm, 304
- Circular definition, 363
- Clark, P., 229
- Class, definition by L. Carroll, 259
- Cohen, P., 225
- Complete totalities, 37
- Conditionally convergent series, 311
- Consistent and inconsistent infinite totalities, 75
- Construction of a rational antidiagonal, 121
- Construction of a rational diagonal, 120
- Construction of Cantor Ternary Set, 143
- Continuous perception, 8
- Continuum hypothesis, 55
- Continuum spacetime, 326
- Contradiction
 - of the decimal expansion of π , 306
 - of the denumerable partitions, 133
 - of the double bouble, 94
 - of the i-modular rows, 285
 - of the two variables, 317
 - of the unary writing machine, 288
- Corollary
 - of the Circumferences, 177
 - of the Closed Lines, 175
 - of the discrete spacetime, 187
 - of the Finite Distances, 176
 - of the Finite Ordinals, 59, 182
 - of the Finite Polygons, 176
 - of the Infinite Lines 1, 177
 - of the Infinite Lines 2, 177
- Countable, 21
- Counting Machine, 236

- d-Exchanges, 119
- d-Modular Permutation, 118
- d-Modular rows, 118, 284
- Dedekind, J.W.R., 34, 35, 37, 66, 141
 - Actual infinity proof, 38
 - Definition of infinite set, 34, 35, 38, 66, 70
- Dedimal expansion of π , 304

Definition

- Incompletable sequence, 346
- Indexed set, 55
 - of \aleph_α , 198
 - of finite set, 352
 - of infinite set (Dedekind), 34
 - of potentially infinite set, 354
 - of Set (natural), 344
 - of type of order, 43
- Ordinal numbers, 49
- Partition, 125
- Segmentation, 127
- Sequence, 56, 125
- Set of indexes, 55
- Type of order, 43
- Deformation of a space made of points, 341
- Dense ordering of the rational numbers, 128
- Densely ordered sequence of changes, 324
- Denumerable, 21
- Differences between set and boxes with infinitely many elements, 261
- Diogenes Laertius, 34
- Discontinuity of Z -points and Z^* -points, 269
- Discrete nature, 12
- Discrete Revolution, 15
- Discrete spacetime, 9
- Discrete spacetime: chronons, 328
- Discrete spacetime: geons, 328
- P-Dissociations of powers, 207
- S-Dissociations of denumerable sets, 204
- Dividing space and time intervals, 185–187
- Dobzhansky, T., 357
- Dogson, C., 259
- F-Duplications of an infinite product, 210

- η -Order, 62
- Elastic collision, 295
- Ellipsis, 148
- Empty Intersection Theorem, 166
- Empty set, 364
- Emptying sets and boxes, 260
- Entanglement and synchronicity, 341
- Enumerable, 21
- Errors, 14
- Euclid, 65
- Euclid's Elements, 65, 197
- Euclidean Axiom of the Whole and the Part, 38, 364
- Euclidean distance, 363
- Euclidean geometries, 364
- Euclidean space, 364
- Euclidean time and distance, 22
- Euler, L., 303
- d-Exchanges, 119
- Exhaustive injection, 66
- Exhaustive, surjective or bijective injection, 65

- h-Expansions of rational numbers, 154
- n-Expofactorial numbers, 152
- Expofactorial numbers, 151
- Extension of Cantor paradox, 78–80

- Faticoni argument, 219
- Filopon, 66
- Finite Hilbert machine, 250
- Finite ordinals, 50
- Finite sets
 - Definition, 352
 - Theorems, 352–353
- Finitist physics, 335
- Fractal, 364
- Frege, G., 34
- Function, 364
- Fundamental laws, 197
- Fundamental laws of logic, 364
- Fuzzy sets, 39

- Galileo Inconsistency, 70
- Galileo Paradox, 66
- Gauge symmetry, 337
- Gauge theories, 365
- Gauss, C.F., 33
- Geons, 338
- Goldbach Conjecture, 295, 301
- Gregory-Leibniz series, 308
- Grosseteste, R., 66
- Grotesque physical constants, 336
- Grotesque universal constants, 336
- Gödel, K., 225
- Gödel First Incompleteness Theorem, 11, 365

- Hausdorff, F., 225
- Hegel, H.W.F., 7
- Hegemony of the actual infinity, 35, 38
- Hegemony of the potential infinity, 35
- Hermite, C., 41
- Hilbert Hotel, 245, 365
 - A way of getting rich, 245
 - A way of violating physical laws, 246
- Hilbert machine
 - Argument, 247–251
 - Contradiction, 248, 250
 - Definition, 246
 - Restriction, 247
- Hilbert, D., 35, 223
 - List of 23 unsolved problems, 223
- History of infinity, 34
- Hodges, W., 122
- Hyper-real numbers, 365
- Hypothesis of the actual infinity, 8–11, 13–15, 27, 33, 35, 36, 38, 41, 58, 74, 81–83, 113, 118, 122, 139, 148, 153, 155, 159, 161, 162, 170, 184, 196,

- 200, 203, 212, 225, 226, 235, 247, 265, 267, 268, 272, 274, 275, 286–289, 292, 295, 300, 307, 308, 313, 316, 318–320, 322, 335, 337, 339, 343, 351, 353, 361
- Hypothesis of the continuum, 223
- Hypothesis of the continuum: current status, 226
- Hypothesis of the potential infinity, 10, 148

- Image of an element, 365
- Impossibility of absolute motion, 340
- Incompatibility between quantum mechanics and general relativity, 336
- Incompletable sequences, 346
- Inconsistency of the ω -segmentations, 182
- Inconsistent denumerable sets, 134, 182
- Inconsistent lines* of infinite length, 179
- Inductive arguments
 - A denumerable partition, 132
 - Exchange of numbers, 278
 - Hilbert machine, 248
 - Koch snowflake, 195
 - Nested set inconsistency, 170
 - Rational partition, 129
 - Redefinitions of a rational 0-interval, 135
 - Riemann finite reorderings, 312
 - S-Dissociations, 205
 - The last disk, 254
 - The next rational, 86
- Infimum, 365
- Infinite decimal expansions, 153
- Infinite regress, 44
- Infinitist magic, 265–266
- Infinitist orthodoxy, 155
- Infinitist paradise, 12, 288
- Infinity by division, 181
- Injective correspondences, 65
- Injective function, 65, 365
- Internal or closed operation, 365
- Internal Set Theory, 365
- Interval, 366

- Kinetic energy, 295
- Kleene, S., 41
- Knuth notation, 152, 366
- Koch Theorem a, 195
- Koch Theorem b, 195
- Koch's argument, 194–196
- Koch's curve, 191
- Koch's fractal, 191
- Koch's snowflake, 191
 - And the potential infinity, 196
 - Conditional construction, 194
 - Construction, 191
 - Contradiction, 195
 - Discreteness, 192
 - Fractal dimension, 194

- General properties, 194
- Immediate successor and immediate predecessor, 192
- Length of the sides, 193
- Length of the successive lines*, 193
- Lines, 192
- Number of lines*, 193
- ω -asymmetry, 193
- Sides, 192
- Koch, H.V., 191
- Kronecker, L., 12, 41
- König, J., 41, 223

- Laraudogoitia, J.P., 295
- Law of Reproduction, 357
- Laws of logic
 - Law of Contradiction, 364
 - Principle of Identity, 364
 - Principle of the Excluded Middle, 365
- Liar Paradox, 11
- Limit of a sequence, 366
- Linear momentum, 295
- Living beings as extravagant objects, 357
- Living beings as informational systems, 357
- Lorentz transformation, 339
- Lynds, P., 267

- Majid, S., 336
- Malament-Hogarth spaces, 301
- Mandelbrot, B., 191
- Mathematical induction, 366
- Maximum insurmountable speed, 338
- Maximum velocity, 340
- Maxwell, C., 13
- McTaggart, J.M.E., 7, 323
- Measure theory, 366
- Medieval scholastics, 35
- Metaphor of the dog and the ball, 359
- Metric, 366
- d-Modular Permutation, 118
- d-Modular rows, 118, 284
- n-Modular rows, 117, 284
- Modus Tollens, 366
- Modus Tollens arguments
 - Cantor diagonal, 137
 - Exchanging numbers, 280
 - F-Duplications, 211
 - h-Replacements, 159
 - Hilbert machine, 248
 - P-Dissociations, 208
 - Permutation **D**, 119
 - S-dissociations, 205
 - The decimal expansion of π , 305
- Motion as a continuous process, 334

- Naive infinitism, 38

- Naive set theory, 81
- Natural definition of set, 344
- Natural order, 351
- Natural order versus ω -order, 351
- Nested intervals, 99
- Nested Set Inconsistency, 170–172
- Nested sets (intervals), 367
- Nested Sets Theorem, 166
- John Von Neumann definition of the natural numbers, 348
- Next rational argument, 86–88
- Non-countable, 21
- Non-denumerable, 21
- Non-denumerable infinity, 41
- Non-exhaustive injection, 65
- Non-Platonic definition of set, 259
- Non-standard analysis, 367
- Number as a primitive concept, 347
- Number of elementary particles in the universe, 296
- Numerable, 21
- Numerable infinity, 14
- Numeral of a number, 287

- α -Ordered sequence, 62
- ω The first infinite ordinal, 52
- ω , the first transfinite ordinal, 11, 161, 174, 212, 247, 253, 267
- ω -Asymmetry, 61, 117, 134, 173
- ω -Dichotomy, 273
- ω -Discontinuity, 61
- ω -Order, 21, 33, 60, 62, 63, 128, 167, 228, 247, 251, 253, 258, 262–264, 267, 296, 298–300, 305, 306, 351
- ω -Ordered objects, 11, 20, 24, 33, 60–63, 89, 92, 97, 101, 104, 119, 120, 153, 154, 157, 159, 161, 162, 165, 167, 168, 170, 172–174, 178, 181, 182, 192, 193, 202, 203, 208, 211–213, 217, 218, 227, 229, 230, 232–235, 237, 242, 246, 247, 249, 251, 253, 254, 256–258, 260, 262, 264–268, 273, 275, 277, 279, 283–286, 288, 289, 292, 296–299, 304, 305, 307, 315–317, 319–321, 351
- ω -Ordered partitions, 182
- ω -Ordered segmentations, 173
- ω -Sucesividad, 61
- ω^* -Ordered, objects, 20
- ω^* -Asymmetry, 61
- ω^* -Dichotomy, 270
- ω^* -Discontinuity, 61
- ω^* -Discontinuity, 269
- ω^* -Order, 267
- ω^* -Ordered objects, 37, 60, 61, 268–270, 275
- ω^* -Precedence, 61
- Ockham razor, 336, 361
- Ockham, W. of, 66
- One to one correspondence, 34, 367
- Operational definition, 197
- Operational definition of finite cardinals, 199
- Operational definition of the natural numbers, 199
- Ordinal η , 62

- Ordinal number, 49
- P-repetitions, 156
- Pairing rationals with irrationals, 156–161
- Paradise of the actual infinity, 35, 66
- Paradoxes of reflexivity, 65–71
- Parmenides, 7, 34, 323
- Partition a la Cantor, 129
- Partition of an interval, 140
- Partitions
 - Corollary, 126
 - In a line, 125
 - ω -Partitions, 174
 - of an interval, 125
 - of the real straight line, 144–146
- Peano's Axiom of the Successor, 44, 51, 53, 57
- Peano's Axioms, 367
- Permutation, 367
- Perpetuum mobile, 246, 367
- Phi phenomenon, 8, 334
- Physical version of the Empty Intersection Theorem, 166
- Physics, the science of change, 13
- Pi, π , 303
- Pickover, C.A., 151
- Planck constant, 336
- Planck length, 174, 334, 335, 339
- Planck scale, 300, 337, 361
- Planck time, 14
- Planck volume, 14
- Planck, M., 16, 336
- Plato, 34, 360
- non-Platonic conceptions of numbers, 162
- Platonic conception of numbers, 162
- Platonic essentialism, 358, 360, 361
- Platonic sets, 259
- Platonism, 10
- Platonism and biology, 360
- Poincaré, H., 12, 41, 335, 337
- Points: a primitive concept, 340
- Potential infinity, 33, 36, 37, 41, 80, 81, 122, 160, 162, 196, 238, 281, 286, 292, 303, 307–309, 354
- Potential infinity hypothesis, 361
- Potentially infinite sets, 354–355
- Power of the continuum, 49
- Pre-Socratic Greece, 13
- Preinertia, 338
- Preinertia of photons, 340
- Primitive concepts, 44, 197
- Principle of Autonomy, 27, 30, 122, 148, 228, 251, 316
- Principle of Comprehension, 74
- Principle of Execution, 27, 30, 87, 88, 92, 105–107, 112, 135, 144, 145, 148, 158–160, 171, 172, 184, 195, 206, 208, 211, 212, 248–250, 255, 278–280, 306, 307, 315, 321
- Principle of Indispensability, 333

- Principle of Invariance, 27–29, 88, 89, 105, 106, 136, 172, 179, 228, 231, 232, 237, 242, 243, 306, 307
 - Necessity, 29
- Problem of the continuum, 223
- Proclus, 66
- Proofs of the actual infinity, 38, 39
- Proper part, 368
- Proper subset, 368
- Properties of order relations
 - Asymmetric, 42
 - Irreflexive, 42
 - Transitive, 42

- Quantum chromodynamics, 368
- Quantum electrodynamics, 368
- Quantum mechanics, 336
- Quantum mechanics, 13
- Quine and Putnam's Principle of Indispensability, 333

- Ramanujan's algorithm, 304
- Rational anti-diagonals, 115
- Rational extension of Cantor 1874 argument, 101–104
- Rational numbers
 - First contradiction, 107
 - Second contradiction, 112
 - Third contradiction, 121
 - Fourth contradiction, 131
 - Fifth contradiction, 136
 - Sixth contradiction, 147
 - Seventh contradiction, 162
- Rational numbers are and are not denumerable, 107, 110–113, 121, 147, 161
- Rational sequences from irrational numbers, 154
- Rational variation of Cantor 1874 argument, 104–107
- Read, S., 229
- Recursive definition of the natural numbers, 155, 287
- Recursive definitions, 28, 86, 165, 200, 315, 368
- Recursive sequence of successor sets, 78
- Rees, M., 334
- Regression of arguments, 197
- Regression of definitions, 197
- Reinterpretation of Faticoni argument, 220
- Reinterpretation of Riemann series theorem, 313
- Relatively disjoint sets, 77
- Relativistic factor γ , 339
- Renormalization, 163, 337, 368
- Richard Paradox, 11, 368
- Riemann Series Theorem, 71, 311
- Rimini, G. of, 66, 227
- Robinson, A., 41
- Russell Paradox, 12, 81, 345

- Sbtraction of infinite cardinals, 217
- Scientific method, 14
- Scientific Revolution, 13

- Second Principle of relativity, 340
- Segment of a given line*, 369
- Segmentations
 - α -Segmentations, 127
 - Definition, 127
 - ω -Ordered, 173
 - ω -Segmentations, 127, 173
- Self-reference, 81, 343
- Self-reference paradoxes, 11
- Sensory perception of space and time, 334
- Sequence
 - Convergent, 369
 - Definition, 369
 - Immediate predecessor, 369
 - Immediate successor, 369
 - Infimum, 369
 - Lower bound, 369
 - Non-convergent, 369
 - of infinite cardinals, 49
 - of successor sets, 346
 - Predecessors, 369
 - Strictly decreasing, 369
 - Strictly increasing, 369
 - Successors, 369
 - Supremum, 369
 - Upper bound, 369
- Series and limits, 308
- Set theoretical version of Riemann series theorem, 218
- Sets
 - Absolutely disjoint, 77
 - Axiomatic ZFC, 370
 - Cantor Ternary Set, 142
 - Cardinal, 45
 - Circular definition, 345
 - Compact set, 363
 - Complement set, 363
 - Correspondences
 - Application, 363
 - Bijjective function, 363
 - Definition, 363
 - Injective function, 363
 - Surjective function, 363
 - Densely ordered, 62, 85
 - η -ordered, 62
 - Equipotent, 46, 199, 217, 350–352
 - Finite sets
 - Properties, 352–353
 - Fuzzy set, 365
 - Non-platonic definition, 259
 - of Burali-Forti of all ordinals, 81
 - of Cantor of all cardinals, 81
 - of Russell, 81
 - Operators, 157
 - Power set of \mathbb{N} , 49

- Redefinitions, 262
- Relatively disjoint, 77
- Self-referring sets, 344
- Similar sets, 43
- Strict order, 42
- Total order, 42
- Universal set, 12
- Well ordered, 42
- Well-ordered, 49
- Sets and boxes, 259
- Shumacher, H.C., 33
- Simplicius, 34
- Singularities, 337
- Smolin, L., 9
- Solutions to Zeno's paradoxes, 267
- Spacetime continuum, 13
- Spacetime continuum, 163, 240, 300, 323, 325, 328, 330, 338–340, 361
- Spacetime granularity, 334
- Spatial ω -asymmetry, 174
- Special theory of relativity, 338
- Standard Model of Particles, 337
- Standard model of particles, 368
- Subtraction of finite cardinals, 216, 217
- Successor set, 346
- Superfactorial numbers, 151
- Superset, 369
- Supertasks, 22, 228, 369
 - A beautiful supertask, 296–297
 - And non standard analysis, 229
 - And the uncountable infinity, 229
 - Bifurcated, 301
 - Concept, 227
 - Counting all natural numbers, 36
 - Defining \aleph_0 , 202
 - Emptying boxes, 260
 - Exchanging numbers, 278
 - Ghostly supertask, 299
 - Gregory supertask, 227
 - Infinite intervals of time, 302
 - Mechanical anomalies, 298
 - ω -Supertasks, 229
 - of d-exchanges, 119
 - of the bubble, 92, 93
 - of the double bubble, 94
 - of the last ball, variation, 263
 - of Thomson, 230
 - Removing balls from a box, 167
 - Removing rows from a table, 292
 - Self-exited supertask, 298
 - the counting machine, 236
 - the last ball, 263
 - the last disk, 253–255
 - the moving circle, 178
 - Thomson's lamp supertask, 230

- Thomson's supertask, 242
- Timetabling definitions, 89
- Supremum, 369
- Surjective function or bijection, 369

- Tarski-Bernstein theorem, 215
- Tarski-Sierpinski theorem, 215
- Tautology, 369
- Taylor, R., 228
- Thabit ibn Qurra al-Harani, 66
- The set of natural numbers is ω -ordered, 54
- The set of natural numbers is well-ordered, 44
- Theory of relativity, 338
- Theorem
 - Koch a, 195
 - Koch b, 195
 - of Cantor Intersection, 166
 - of Cantor's Paradox, 79
 - of Change, 328
 - of Riemann Series, 311
 - of Tarski-Bernstein, 215
 - of Tarski-Sierpinski, 215
 - of the ω -order, 54
 - of the ω th Term, 174, 212
 - of the n th Decimal, 116
 - of the n th Digit, 283
 - of the Finite Ordinals, 177
 - of the Finite Reorderings, 312
 - of the Finite Segments, 175
 - of the Finite Sets, 59, 126, 133, 175, 181, 195
 - of the first class, 51
 - of the Inconsistent Completion, 320
 - of the Inconsistent Infinity, 322
 - of the Indexed Sets, 58, 153, 206, 209, 268, 305, 316
 - of the Natural Well-Order, 43
 - of the Nested Sets, 166
 - of the non-i-Modular Numbers, 284
 - ω th Term, 58
 - of the second class, 52
 - of the Sequence of Cardinals, 350
 - of the Sequence of Successors, 347
 - of the Successor Set, 346
 - Riemann Series, 71, 311
- Thomson Lamp, 229, 239
 - Axioms, 240
 - Benacerraf criticism, 231
 - BT1 and BT2 laws, 240
 - Derived laws, 240
 - Final state, 231–235
 - Formal definition, 240
 - Formalized discussion, 240–243
 - Symbols, 239
 - Thomson argument, 230
 - Working, 229

- Thomson, J.F., 228–230
- Timetabling a recursive definition, 316
- Timetabling procedures of infinitely many steps, 315
- Topology, 369
- Total order, 42
- Transfinite cardinals, 47–49
 - Increasing sequences, 54
- Transfinite ordinals, 49–62
 - of the First kind, 52
 - of the Second kind, 52
- Turing halting problem, 81
- Type of order, 43

- U-CALM, 331
- Ultimate arithmetical causes, 307
- Ultraviolet catastrophe, 336
- Unary numeral system, 287
- Unary table of the natural numbers, 289
- Unary Writing Machine, 288
- Universal set, 75

- Venn diagram, 165, 370

- War against infinities, 13
- Watling, J., 228
- Well-ordered sets of natural numbers, 44
- Weyl, H., 41
- Wittgenstein, L., 12, 41, 80, 335, 337, 360

- Z-points and Z^* -points, 268
- Zeno Dichotomy I, 272–275
- Zeno Dichotomy II, 270–272
- Zeno of Elea, 34, 267, 270, 323
- Zeno paradoxes, 34
- Zermelo, E., 224
- ZFC, 226, 370