

Earth in the Expanding Universe: A Dualistic Approach to Determine Their Physical Parameters Based on a Combined Einstein Gravity Field Equation Using the Hubble Law

Tibor Endre Nagy

University of Debrecen, Kenézy Gyula University Hospital, Department of Pulmonology, 2-26 Béla Bartók str., 4031 Debrecen, Hungary

E-mail: nagytibore@hotmail.com

Abstract

If rapid motion is added in the form of redshift to the Earth as a result of expansion of space which in turn complements the notion of an expanding universe, the information may be used to calculate both distances and time periods. When an accelerated system and gravitational field exist together at the same time, a 'short evolving distance' pointing towards the origin of the universe can be calculated. From this value, knowledge of the entire plane angle and the deviating angle of a light beam grazing the surface of the Earth renders it possible to determine enormous distances by utilizing the rules of trigonometry. This 'long evolving distance' in the range of the radius of the universe can be converted into 'evolving time' by dividing it by the speed of light. The geometric relationship between the two distances can realize from a physical point of view through a light velocity expansion of space when the Hubble constant is $71.1887 \text{ km} \cdot \text{s}^{-1} \cdot \text{Mpc}^{-1}$. Based upon this chronology, the universe may have been formed 13.7355 billion years ago (taking into account the gravitational refractive index when $H_0 = 75.85 \text{ km/s/Mpc}$ and $H_0 = 66.81 \text{ km/s/Mpc}$, the lower limit is 12.1 billion years and the upper limit is 15.58 billion years). Utilizing the inverse ratio of the angles, the size of the Earth equates to what is known.

Keywords: cosmological parameters, high redshift galaxies, Earth, gravitation, general relativity, Euclidean geometry, Hubble constant

1. Introduction

In this paper I have sought to answer the question as to whether cosmological parameters may be determined by transforming the redshift of the expanding universe surrounding the Earth. By employing Einstein's formulae in conjunction with the Earth's parameters, is it possible to achieve similar results to previous astronomical observations? Can a distance projected at the speed of light, which defines the radius of the universe, be paralleled with the physical manifestations of a universe expanding at the speed of light? Do these simplifications allow for a better understanding of the processes taking place in the universe?

In accordance with the notion of an expanding universe (Hubble 1929) whereby every galaxy is receding from every other, it is possible to calculate the point in the past when the universe was created (Lemaitre 1931). Consequentially, the same dynamic applies to the Milky Way, the Earth included. If motion due to the rapid expansion of space is applied to the Earth in our galaxy, compared to other galaxies, the planet along with its gravitation field forms a three-dimensional expanding sphere (Nagy 2015). This situation results in a beam of light passing the Earth's gravitational field being propagated in a persistent homogeneous figure of $g = 9.8 \text{ m/s}^2$, the recognition of which creates new opportunities for defining various physical parameters. It is therefore possible, utilizing these means, to calculate when the universe was created. By employing the theory of General Relativity (Einstein 1916) and the rules of Euclidean geometry an alternative dating method might well be designed.

2. Determining the radius of the universe from the aspect of the high redshift Milky Way Galaxy, including the Earth, in the expanding cosmos

Since there also exists time shift behind redshift (Einstein 1911) it is possible to calculate the exact point in time due to the rapid expansion of space in a manner to estimate the time interval involved by invoking the basic laws of physics. Alterations in either the acceleration or the gravitational fields (or

both together) result in changes regarding the frequency of light. This shift of the spectrum line to a lower frequency is demonstrated by Einstein's original formula (Einstein 1911):

$$\nu = \nu_0 \left(1 + \frac{\Phi}{c^2} \right), \quad (1)$$

where, ν is the altered frequency, ν_0 is the initial frequency, c is the speed of light and Φ is the gravitation potential difference.

The gravitational potential difference (Φ) is equal to the product of free fall acceleration (g) and the distance (h) between two points of different gravitational potentials: $\Phi=g \cdot h$ (Einstein 1911). Therefore:

$$\nu = \nu_0 \left(1 + \frac{g \cdot h}{c^2} \right). \quad (2)$$

If the same extent of a light beam's redshift measured at farther galaxies (Hubble 1929) is equated to the acceleration of the Earth (as a component of our galaxy) the above formula may also be applied. (Ignoring the rotation of the Solar System compared to the center of the Milky Way Galaxy $v \approx 2.2 \cdot 10^5$ m/s/ and the orbiting of the Earth around the Sun $v \approx 3 \cdot 10^4$ m/s/ in this situation). In this manner, a distance (h) can be calculated pointing towards the origin of the universe. This 'short evolving distance' ($h_{\text{past present}}$) from a physical point of view is:

$$h_{\text{past present}} = \frac{\nu - \nu_0}{\nu_0} \cdot \frac{c^2}{g_{\text{Earth standard}}}, \quad (3)$$

where $h_{\text{past present}}$ is the unknown distance between two points of a gravitational field, $(\nu - \nu_0)/\nu_0 = 3.141592653$ is the redshift of the Earth as a component of the highly redshifted Milky Way Galaxy, c is the speed of light ($2.99792458 \cdot 10^8$ m·s⁻¹) (CODATA 2010) and g is the standard gravity of the Earth (9.80665 m·s⁻²) (Dunford 2012).

Numerically:

$$h_{\text{past present}} = 3.141592653 \cdot \frac{8.987551787 \cdot 10^{16} \text{ m}^2 \cdot \text{s}^{-2}}{9.80665 \text{ m} \cdot \text{s}^{-2}} = 2.879191841 \cdot 10^{16} \text{ m}. \quad (4)$$

{This distance value is created in 1g gravity. However, propagated in gravity-free space (c), the light runs $9.46 \cdot 10^{15}$ meters in a tropical/solar year $/3.1556926 \cdot 10^7$ s/:

$$x = c \cdot t = 2.99792458 \cdot 10^8 \cdot \text{m} \cdot \text{s}^{-1} \cdot 3.1556926 \cdot 10^7 \text{ s} = 9.460528412 \cdot 10^{15} \text{ m}. \quad (4.a)$$

Multiplied it by π , it is $2.9721126558 \cdot 10^{16}$ m. The proportion of distance of light propagating in 1g gravity (Eq.4) and non-gravity space (Eq.4.a) is: 0.968735769 or vice versa 1.032273228.

This 'short evolving distance' ($h_{\text{past present}}$) is expressed in time ($T_{h \text{ past present}}$):

$$T_{h \text{ past present}} = \frac{h_{\text{past present}}}{c} = \frac{2.879191841 \cdot 10^{16} \text{ m}}{2.99792458 \cdot 10^8 \text{ m} \cdot \text{s}^{-1}} = 0.960395021 \cdot 10^8 \text{ s}. \quad (4.b)$$

This 'short evolving time' divided by π is the following: $3.0570323 \cdot 10^7$ s. Since one tropical/solar year is $3.1556926 \cdot 10^7$ s, theirs rate also equates to 0.968735769 or vice versa 1.03227323. However, since the light in this case propagates in 1g gravity, i.e., slower (c_0), the ratio of the two distances or times can be considered as the gravitational refractive index (n_g) of the two media with respect to light (see

section 2.4). With this correction, the resulting time interval coincides with the Earth's orbit around the Sun.}

This distance (Eq.4) depends on both the spectrum line shift ratio, which matches the motion of the Earth, and the gravity of the Earth (Fig.1.a). The 'short evolving distance' ($h_{\text{past present}}$) can be given mathematically or geometrically by the ratio of the entire plane angle (2π) and the deviation angle (α) of a light beam passing near the Earth's surface caused by the gravitational field: $h/\alpha=H/2\pi$ (Herrmann 1990). With the ratio calculated from the known 'short evolving distance' (h) and the two known angles (α , 2π) an enormous unknown distance can be calculated, which might be termed the 'long evolving distance' ($H_{\text{past present}} = H_{\text{universe}}$) (Fig.1.b).

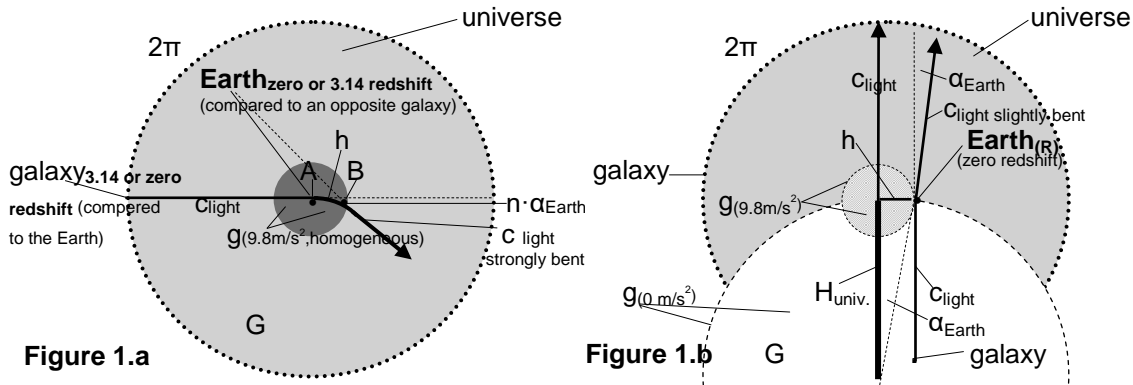

Figure 1. Dualistic Earth (in terms of movement) The relationship between the entire plane angle ($2\cdot\pi$) and the deviation angle of a light beam (c) coming from the galaxy on the left grazing the Earth (α_{Earth}) is illustrated above. (The expanding universe is represented as a light gray circle and the Earth in the center as a black dot.) If the same beam passes through the gravitational field of the Earth ($g = 9.8\text{m}\cdot\text{s}^{-2}$) while the Earth is in motion ($n\cdot\alpha$) (Fig.1.a) or is comparatively static (α) (Fig.1.b), then the degrees of change in the properties of light (e.g. deflection) are different. In the left hand figure, compared to the opposite galaxy (with a redshift of 3.14 for example) the Earth moves away from A to B with the same velocity, together with the light beam in its g , along their contact distance h . This relative one-dimensional movement of the galaxy and the Earth in three dimensions forms a sphere with the radius of h (the dark gray circle) around the planet. All observable redshifts from every direction of the cosmos are transformed into this spherical region due to this principle. As a consequence of the Earth's movement with various redshifts, this sphere also contains a homogeneous gravitational field with a value of $9.8\text{ m}\cdot\text{s}^{-2}$. During the generation of the contact distance ($h = n\cdot R_{\text{Earth}}$) there will exist a concentric relationship between the increasing radius of the universe and the size of the Earth. From this data (h , $2\cdot\pi$ and α), based on Euclidean geometry, the size of the universe (H) (right hand figure) in the case of the inverse ratio of angles ($\alpha/2\cdot\pi^{-1}$) as well as the Earth's radius (R_{Earth}) can be determined symmetrically. (The striped circle in Fig.1.b) occupies the same space as in Fig.1.a).

When compared to light passing through non-gravitational space (c) in the universe, the Earth cannot move at the speed of light as it would not then be possible for it to pass by and the conditions outlined in Figure 1.a could not exist. The Earth, as illustrated in Figure 1.a, cannot move at a speed greater than the speed of a light beam passing through its gravitational field (c_0). For these two reasons a distinction should be made between the propagation of light in the gravitational field (c_0) and the non-gravitational space (c) in the cosmos (see section 2.4). Consequently, the cosmos or the space in it can only expand at a speed of c_0 , as demonstrated in Equation 23; for this simple reason the stars are still visible. Conversely, if it were possible for space to expand faster than the speed of light the stars would no longer be visible.

The deviation angle of a light beam (α) passing near to a celestial body's surface (in this case that of the Earth) is, according to Einstein's formula (Einstein 1911):

$$\alpha_{\text{Earth}} = \frac{2 \cdot G \cdot M_{\text{Earth}}}{c^2 \cdot R_{\text{Earth}}} \quad (5)$$

Numerically:

$$\alpha_{Earth} = \frac{2 \cdot 6.673848 \cdot 10^{-11} m^3 \cdot kg^{-1} \cdot s^{-2} \cdot 5.97219 \cdot 10^{24} kg}{8.987551787 \cdot 10^{16} m^2 \cdot s^{-2} \cdot 6.371005 \cdot 10^6 m} = 1.392164551076 \cdot 10^{-9}. \quad (6)$$

Thus, a miniscule deflection angle of α_{Earth} of any light beam passing by the Earth should be multiplied by the enormous value of $2\pi \cdot \alpha^{-1}$ ($4.513249028 \cdot 10^9$) to create a complete angle of $2 \cdot \pi$.

Therefore, by conjoining two Einstein equations (Eq.2 and Eq.5) by employing $2\pi/\alpha$:

$$H_{universe\ present} = h_{Earth} \cdot \frac{2 \cdot \pi}{\alpha_{Earth}} = \frac{v - v_0}{v_0} \cdot \frac{c^4}{g_{Earth\ stand}} \cdot \frac{\pi \cdot R_{Earth\ mean}}{G \cdot M_{Earth}}. \quad (7)$$

Where $H_{universe}$ is the radius of the universe, $(v-v_0)/v_0 = 3.141592653$ is the redshift of the Earth (as a component of the highly redshifted Milky Way Galaxy), c is the speed of light ($2.99792458 \cdot 10^8 m \cdot s^{-1}$), π is the ratio of a circle's circumference to its diameter (3.141592653), G is the gravitational constant ($6.673848 \cdot 10^{-11} m^3 \cdot kg^{-1} \cdot s^{-2}$) (CODATA 2010), R is the volumetric mean radius of the Earth ($6.371005 \cdot 10^6 m$), g is the standard gravity of the Earth ($9.80665 m \cdot s^{-2}$) and M is the mass of the Earth ($5.97219 \cdot 10^{24} kg$) (Dunford 2012).

When considering the large redshift $((v-v_0)/v_0 = 3.141592)$ which may be measured from stars farther away, the 'long evolving distance' ($H_{past\ present}$) equals $12.99 \cdot 10^{25} m$, the radius of the universe:

$$H_{universe\ present} = 3.141592653 \cdot \frac{80.77608713 \cdot 10^{32} m^4 \cdot s^{-4} \cdot 3.141592653 \cdot 6.371005 \cdot 10^6 m}{9.80665 m \cdot s^{-2} \cdot 6.673848 \cdot 10^{-11} m^3 \cdot kg^{-1} \cdot s^{-2} \cdot 5.97219 \cdot 10^{24} kg}. \quad (8)$$

According to them, the concrete result is as follows:

$$H_{universe\ present} = 12.994509779 \cdot 10^{25} m. \quad (8.a)$$

Which, in time ($T_{universe} = H_{universe}/c$) is $4.3345010 \cdot 10^{17} s$. Since one tropical/solar year is $3.1556926 \cdot 10^7 s$ (Convert Units), this equates to 13.7355010 billion years (≈ 13.7355 billion years) according to our present knowledge (Bennett et al. 2013).

2.1. Proofing of distance definitions employing angle functions

For verification purposes, as shown in Figure 1.b:

$$tg\alpha_{Earth} = \frac{a}{b} = \frac{h}{H_{universe\ present}}. \quad (9)$$

Derived from this the radius of the universe ($H_{universe\ present}$) is:

$$H_{universe\ present} = \frac{h}{tg\alpha_{Earth}} = \frac{h}{\frac{2 \cdot G \cdot M_{Earth}}{c^2 \cdot R_{Earth}}} = \frac{h \cdot c^2 \cdot R_{Earth}}{2 \cdot G \cdot M_{Earth}} = 2.068139858 \cdot 10^{25} m. \quad (10)$$

The result multiplied by $2 \cdot \pi$: $12.994506 \cdot 10^{25} m$, which is equal to the previous equation (Eq.8).

2.2. Determination of the Hubble constant in light velocity expansion of space

In the geometric representation in Figure 1 and the algebraic relationship expressed in Equation 7, the increase in the value of $h_{\text{past present}}$ in the ratio of angles to the value of $H_{\text{past present}}$ in the physical aspect can be achieved through the expansion of space. This distance projection occurs instantly mathematically, but in the shortest possible time physically due to the speed of light. Similarly, the speed of light must be taken into account when interpreting information from various astronomical events. In consideration of this fact, let the expansion of the universe at the speed of light ($v_{\text{at } c}$) stand as the starting point in this model. This approach reduces the number of uncertainties in describing the physical laws of nature. Since the laws of nature allow for nothing faster than the speed of light to exist, no rate of inflation can exceed it, which fact is supported by the comparatively trivial observation that galaxies would be invisible were they to be moving faster than the speed of light.

In a universe expanding at the speed of light, the Hubble constant ($H_{0 \text{ at } c}$) (Eq.13) stands steady in relation to both short and long evolving distances. Using the $2\pi/\alpha$ ratio the contact distance (h) is projected forward to the radius of the universe (H), which can be interpreted geometrically as in Figure 1.b. However, in determining the value of h (Eq.3), which can be explained from a physical point of view, the expansion of the universe should not have the speed of light as light must be able to pass by the Earth (Fig.1.a). Both cases relate to the difference between the propagation of light along the distance h in a homogeneous field of gravity ($g = 9.8 \text{ m/s}^2$) from A to B (dark gray circle in Fig.1.a) and the area in a space without gravity ($g = 0 \text{ m}\cdot\text{s}^{-2}$) from h to H (white circle in Fig.1.b). The light velocity constant according to Einstein's equation ($c = c_0 \cdot \sqrt{1 + \Phi \cdot c^{-2}}$) may be maintained with the introduction of time dilation (Einstein 1911). Accordingly, an accessory acceleration/deceleration or inflation/deflation will appear between the two media; thus, the stable value of the 3.14 redshift can also change positively or negatively, modifying the radius of the cosmos.

The relationship between the light velocity expansion of the cosmos ($v = c$ or c_0) and the value obtained for the radius of the universe ($H_{\text{universe present}}$), as in Equation 7, is created by the Hubble constant ($v = H_0 \cdot d$). Based on the two known factors of velocity and distance, the Hubble constant

$$H_{0 \text{ at } c} = \frac{v_{\text{at } c}}{H_{\text{universe present}}} \quad (11)$$

($H_{0 \text{ at } c}$) is:

Where, the cosmic radius ($H_{\text{universe present}}$) determined by Einstein's equations is equal to d in the Hubble equation.

Since 1 mega parsec (Mpc) is $3.08567758 \cdot 10^{22} \text{ m}$, the radius of the universe (Eq.7 and Eq.8) in Mpc

$$H_{\text{universe present Mpc}} = \frac{12.994509779 \cdot 10^{25} \text{ m}}{3.08567758 \cdot 10^{22} \text{ m}} \cdot \text{Mpc} = 4.211233819 \cdot 10^3 \text{ Mpc} \quad (12)$$

is:

Ergo, the exact value of the Hubble constant ($H_{0 \text{ at } c}$) at light velocity expansion ($v = c$) is as follows:

$$H_{0 \text{ at } c} = \frac{2.99792458 \cdot 10^5 \text{ km}\cdot\text{s}^{-1}}{4.211233819 \cdot 10^3 \text{ Mpc}} = 71.188746786 \text{ km}\cdot\text{s}^{-1} \cdot \text{Mpc}^{-1} \quad (13)$$

2.3 Quasi-stability of the maximum redshift (3.14)

For further verification, the distance or radius of the universe ($H_{\text{universe present}}$) apparently depends on the redshift $/(v-v_0)/v_0/$ if the rest ($H_{0 \text{ at } c}$, c) is constant. Its value should not exceed 3.14 because then the universe's expansion velocity (v) would exceed the light velocity (c):

$$v_{\text{at } c} = H_{0 \text{ at } c} \cdot H_{\text{univ. pres. Mpc}} = H_{0 \text{ at } c} \cdot h \cdot \frac{2 \cdot \pi}{\alpha} \cdot \frac{1}{3.08567758 \cdot 10^{22}} \quad (14)$$

This is detailed:

$$v_{at\ c} = H_{0\ at\ c} \cdot \frac{v - v_0}{v_0} \cdot \frac{c^2}{g_{Earth}} \cdot \frac{\pi \cdot c^2 \cdot R_{Earth}}{G \cdot M_{Earth}} \cdot \frac{1}{3.08567758 \cdot 10^{22}} \quad (14.a)$$

This is, numerically:

$$v_{at\ c} = H_{0at\ c} \cdot H_{univ.pr.Mpc} = 71.188746786 \frac{km}{s \cdot Mpc} \cdot 4.211233819 \cdot 10^3 Mpc = 2.99792458 \cdot 10^5 \frac{km}{s} \quad (15)$$

Maintaining the idea of a universe expanding at the speed of light on the left hand side of Equation 14 the redshift cannot be reduced, because then the speed of light would also decrease. In order for the spatial expansion of the speed of light to remain unchanged while the redshift decreases, the parameters of the Earth would have to change. If the redshift decreases (for example by $\alpha/2 \cdot \pi^{-1}$) then the Earth's radius must increase ($2 \cdot \pi/\alpha$):

$$v_{at\ c} = H_{0\ at\ c} \cdot H_{univ.pres.Mpc} = H_{0\ at\ c} \cdot \frac{\alpha}{2 \cdot \pi} \cdot \frac{v - v_0}{v_0} \cdot \frac{c^2}{g_{Earth}} \cdot \frac{\pi \cdot c^2 \cdot \frac{2 \cdot \pi}{\alpha} \cdot R_{Earth}}{G \cdot M_{Earth}} \cdot \frac{1}{3.08567758 \cdot 10^{22}}, \quad (16)$$

or the value of g should decrease (by $\alpha/2 \cdot \pi^{-1}$):

$$v_{at\ c} = H_{0\ at\ c} \cdot H_{univ.pres.Mpc} = H_{0\ at\ c} \cdot \frac{\alpha}{2 \cdot \pi} \cdot \frac{v - v_0}{v_0} \cdot \frac{c^2}{\frac{\alpha}{2 \cdot \pi} \cdot g_{Earth}} \cdot \frac{\pi \cdot c^2 \cdot R_{Earth}}{G \cdot M_{Earth}} \cdot \frac{1}{3.08567758 \cdot 10^{22}} \quad (17)$$

An increase in the Earth's radius ($2 \cdot \pi/\alpha$) and a decrease in its surface gravity ($\alpha/2 \cdot \pi^{-1}$) results in a decrease in density:

$$v_{at\ c} = H_{0\ at\ c} \cdot H_{univ.pres.Mpc} = H_{0\ at\ c} \cdot \frac{\alpha}{2 \cdot \pi} \cdot \frac{\alpha}{2 \cdot \pi} \cdot \frac{v - v_0}{v_0} \cdot \frac{c^2}{\frac{\alpha}{2 \cdot \pi} \cdot g_{Earth}} \cdot \frac{\pi \cdot c^2 \cdot \frac{2 \cdot \pi}{\alpha} \cdot R_{Earth}}{G \cdot M_{Earth}} \cdot \frac{1}{3.08567 \cdot 10^{22}} \quad (18)$$

This applies only to a beam of light running parallel to the Earth, but at a very long distance in limited g, which can be explained by returning to the point of Earth's creation when the accretion process began. However, during the period since then up until the present, with gravitational contraction producing an increase in density its radius has decreased, as a consequence of which its surface gravity has become what it is today (1g).

In terms of the correlation between the redshift reduction and the Earth's radius, the Earth's radius increased by $2\pi/\alpha$ to $h_{past\ present}$. The redshift reduced by the square of the $\alpha/2\pi$ ratio increases the size of the Earth (R_{Earth}) to the radius of the universe ($H_{universe\ present}$).

Similarly to Equation 18 (without changing the value of g), the distance increase is as follows:

$$v_{at\ c} = H_{0\ at\ c} \cdot H_{u.pr.Mpc} = H_{0\ at\ c} \cdot \left(\frac{\alpha}{2 \cdot \pi}\right)^2 \cdot \frac{v - v_0}{v_0} \cdot \frac{c^2}{g_{Earth}} \cdot \frac{\pi \cdot c^2 \cdot \left(\frac{2 \cdot \pi}{\alpha}\right)^2 \cdot R_{Earth\ mean}}{G \cdot M_{Earth}} \cdot \frac{1}{3.0856 \cdot 10^{22}} \quad (18.a)$$

Highlighting the relationship between the redshift and the radius of the Earth from the equation:

$$H_{univ.pres.} = \left(\frac{2 \cdot \pi}{\alpha}\right)^2 \cdot R_{Earth} = \left(\frac{6.2831853071}{1.392164551 \cdot 10^{-9}}\right)^2 \cdot 6.371005 \cdot 10^6 m = 12.9773656 \cdot 10^{25} m \quad (18.b)$$

This is essentially the value of Equation 7, which is the radius of the universe. Any further reduction in redshift ($\alpha/2\pi^{-1}$) (Eq.18.a) will no longer result in an increase in the cosmic radius; it is eliminated due to time dilation.

2.4 Propagation of light in gravity and non-gravitational space in an increasing number of dimensions

As has already been established (see Figures 1.a and 1.b), the ratio of the speed of light traveling through the Earth's gravitational field to the velocity of light propagating through gravity-free space is clearly definable. What this article refers to as the '*absolute gravitational refractive index*' for the two media is: $n_{g9.8,g0}$ and $n_{g0,g9.8}$. When light spreads in gravity compared to light in non-gravity space, it is as follows: $n_{g9.8,g0} = c/c_0 = 1.0322732$; but in non-gravitational space compared to light in gravity it is: $n_{g0,g9.8} = c_0/c = 0.9687358$. This means that light in the Earth's gravitational field spreads more slowly (c_0) than in gravity-free space (c).

The degree of deformation of space-time in this model also can be expressed by the gravitational refractive index. The ratio obtained gives you the upper and lower limits of the age of the cosmos by multiplying or dividing the average radius of the universe. However, this distance is only true for one dimension. As the number of dimensions increases, the proportion of gravity refractive indices also increases. By comparing the two factors, one can only determine the final value of the actual age of the cosmos. This gravitational refractive index time interval, further enhanced by dimensions, is called the '*dimensional gravity refractive index age*'. Although the radius of the universe can be represented in three dimensions in the form of a sphere, it is still one-dimensional by Equation 7. It thus only partially reflects the structure of the four-dimensional space-time. Therefore, it is necessary to construct a cube-shaped body in order to obtain the inherent distance and time that corresponds to the wishes of the four-dimensional space. This is possible by introducing the gravitational refractive index, which can be applied to the entire universe.

The speed of light is determined by the distance and time dimension inherent in the structure of space-time (different mass density media). Light behaves differently in its individual components, in close interaction with its surroundings, when it changes phase and exits gravity into gravity-free space, or vice-versa; it is therefore necessary to separate its constituent elements, which can be characterized by other refractive indices. What might be termed '*relative gravitational refractive indices*' ($n_{g9.8,g0distance}$ and $n_{g9.8,g0time}$) can express their relationship to the velocity elements of distance and time ($h_{in\ g=9.8}, T_{in\ g=9.8}$).

2.4 a

In one dimensional space, when light exits gravity and propagates into a non-gravitational space its relative gravitational refractive index ($n_{g9.8,g0distance}$) with respect to distance is as follows:

$$n_{g9.8,g0distance} = \frac{c}{c_0} = \frac{h_{in\ g=0}}{h_{in\ g=9.8}} = \frac{T_{in\ g=0}}{T_{in\ g=9.8}} = \frac{2.97211265581 \cdot 10^{16} m}{365.24218967\ day} = \frac{h_{in\ g=0}}{h_{in\ g=9.8}} = \frac{2.97211265581 \cdot 10^{16} m}{2.879191841 \cdot 10^{16} m} = \frac{T_{in\ g=0}}{365.24218967\ day} = 1.0322732 . \quad (19)$$

With respect to distance (Eq.4), in gravity distance contraction occurs ($h_{in\ g=9.8} < h_{in\ g=0}$), which compensates for the decrease in the speed of light (c_0).

By dividing the path of light propagating in gravity by its path in gravity-free space, the ratio of the two (the first division about the distance dimension) can be plotted on a number line. The absolute value of the ratio can be taken from the point corresponding to 1. Taking the value of 1 as point A and the value of 1.0322732 as point B, we obtain a segment on the number line. If this segment is considered as a distance or a time dimension, a derived one-dimensional section is obtained. From this, with the increase in the number of Euclidean space dimensions (E^0, E^1, E^2, E^3), a plane and then a cube can be produced. The fourth dimension (E^4) corresponds to the four-dimensional analogue of the cube. Point A corresponding to the point of 1 has a zero dimension (E^0). Dividing the two distance values (Eq.19) we can get from point A to point B, which represents a one-dimensional section (E^1). The

absolute value between points A and B (1.0322732) divided by the ratio of time intervals between points B and D (0.96873) produces a parallel line segment with end points C and D to create a square. This corresponds geometrically to the displacement perpendicular to the numerical line (x-axis) described above along the z-axis of a Cartesian coordinate system. (Fig.2.a). The value (1.065588) between B and D (which is the square of the value between points A and B) divided by the square of the ratio of the time intervals (0.93845), out of two dimensions (E^2 , ABCD), correspondingly a cube (E^3 , ABCD - EFGH, $1.065588/0.96873 = 1.0999$) or its four-dimensional analogue (E^4 ; ABCDEFGH - JKLMNOPQ; $1.065588/0.93845 = 1.128931$) is then obtainable. This third division in the 3-dimensional representation corresponds geometrically to the offset to the y-axis of the Cartesian coordinate system (Fig.2.b).

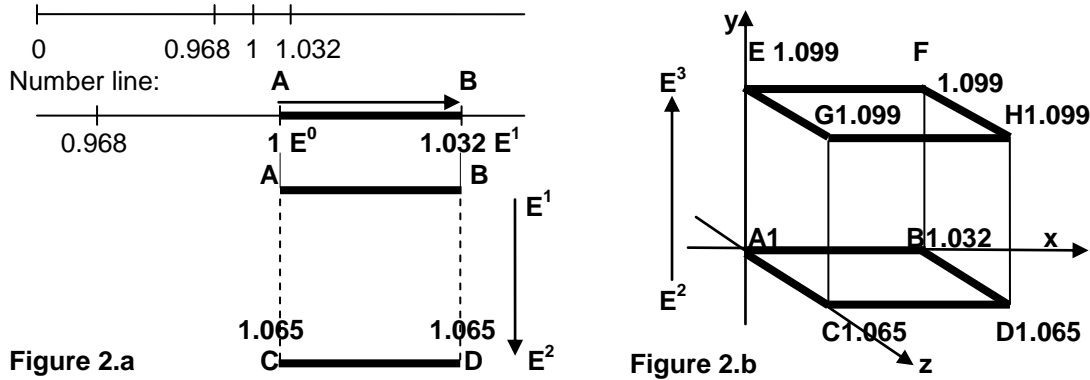

Figure 2. The structure of four-dimensional space-time (E^4) build up to three dimensions (E^3) relative to a gravitational refractive index value greater than 1. The number lines are plotted along an x, y, z coordinate system where the x axis is to the right, the z axis is to the front and the y axis is upward, in the direction of increasing numeric values. (The representation of zero on the numeric line indicates only the direction of the change in ratios.) As a result, the data determined by algebraic calculations is transformed into a spatial geometry and the curvature of space-time can be geometricized. Although the increasing curvature of space-time is consumed and lost in the structure, since it is a ratio of the dimension of a curved to a non-curved distance, the geometric shape shown is also considered to be curved. Since even the initial first dimension is curved by n_g , the resulting four-dimensional shape through 2-D and 3-D can also be curved by n_g . The use of a refractive index alone provides only an imaginary frame for spatial appearance, as it can be curved hyperbolically or spherically depending on the degree of gravity (and mass).

In addition, the structure of the four-dimensional cube can be eliminated by multiplying the ratio of time intervals ($n_{g9.8, g0time} = 0.96873$) (Eq.19.a). Specifically, multiplying the derivative four-dimensional cube or its value (1.128931) by 0.96873 four times will reduce it gradually (E^4 , E^2 , E^1 , E^0). In this way positive changes are annihilated by negative changes $1/1.128931 \cdot (0.96873)^4 = 1/$. The geometric representation of the data obtained by the introduction of the gravitational refractive index only reinterprets the real physical properties of the universe. With this conversion, the essential elements of the cosmos do not change, but at the same time illustrate and explain the variability of the astronomical data obtained.

By dividing the time interval of light's propagation in gravity (by running h) by the time interval of light propagation in non-gravity (the first division about the time dimension) produces a one-dimensional line segment, which is the ratio of the two and is actually a time dimension (in relation to the orbit of the Earth). Taking into account the case of one dimensional space, when light exits from gravity into non-gravity space the refractive index with respect to time ($n_{g9.8, g0time}$) is as follows:

$$n_{g9.8, g0time} = \frac{c}{c'} = \frac{T_{in\ g=0}}{h_{in\ g=0}} = \frac{2.97211265581 \cdot 10^{16} m}{365.24218967\ day} = \frac{T_{in\ g=9.8}}{T_{in\ g=0}} = \frac{353.8231828\ day}{365.24218967\ day} = 0.9687357945. \quad (19.a)$$

However, with respect to time ($n_{g9.8,g0time}$) it is found that time dilation occurs ($T_{in\ g=0} > T_{in\ g=9.8}$) which compensates for the increase in the speed of light (c). The refractive index for the distance ($n_{g9.8,g0distance}$) traveled by light multiplied by the refractive index for the time ($n_{g9.8,g0time}$) it takes for the light to travel is equal to the value of the speed of light (c).

$$n_{g9.8,g0distance} \cdot n_{g9.8,g0time} = \frac{c}{c_0} \cdot \frac{c}{c'} = 1.0322732 \cdot 0.9687357945 = 1. \quad (19.b)$$

The apparent change in light velocity (c_0 and c') is eliminated when it exits the two components of the light into the gravitational field while the velocity of light remains constant; in this case, the two different numeric values representing a segment of a one-dimensional line coincide.

Accordingly, dividing the refractive index for time or distance defined in one dimension produces a two-dimensional surface corresponding to the numerical value geometrically. Ergo, the two different numerical values representing a segment of a one-dimensional line will be parallel to each other; in this manner, the numerical data can be transferred to the space-time structure. The size of the line segment between points A and B should correspond to the absolute value of the refractive index. By dividing (the second division about distance and time) the numeric value representing the line segment, it is then shifted to points C and D to form a square. The ratio of refractive indices for distance and time exceeds the value in Formula 19:

$$\frac{n_{g9.8,g0distance}}{n_{g9.8,g0time}} = \frac{\frac{c}{c_0}}{\frac{c}{c'}} = \frac{c'}{c_0} = \frac{1.0322732}{0.9687357945} = 1.065587961. \quad (19.c)$$

However, in two-dimensions, when light exits from gravity into space that is free of gravity the ratio of refractive indices for time and distance (the second division about time and distance) exceeds the value in Formula 19:

$$\frac{n_{g9.8,g0time}}{n_{g9.8,g0distance}} = \frac{\frac{c}{c'}}{\frac{c}{c_0}} = \frac{c_0}{c'} = \frac{0.9687357945}{1.0322732} = 0.9384490401. \quad (19.d)$$

Furthermore, taking into account three-dimensional space, when light exits from gravity into gravity free space the ratio of the three refractive indices is:

$$\frac{\frac{n_{g9.8,g0distance}}{n_{g9.8,g0time}}}{1} = \frac{\frac{c}{c_0}}{\left(\frac{c}{c'}\right)^2} = \frac{c}{c'} \cdot \frac{c}{c'} = \frac{c_0}{\left(\frac{c}{c'}\right)^2} = \frac{1.0322732}{(0.9687357945)^2} = 1.0999779. \quad (19.e)$$

By dividing the numeric value representing the line segment one more time (the third /sub/ division is about distance and time), ABCD is shifted to points EFGH to form a cube. As regards three-dimensional space, when light propagates from gravity into gravity free space the following option of the ratio of the three refractive indices is:

$$\frac{\frac{n_{g9.8,g0distance}}{n_{g9.8,g0time}}}{1} = \frac{1}{n_{g9.8,g0time}} = \frac{1}{\frac{c}{c'}} = \frac{1}{0.9687357945} = 1.0322732. \quad (19.f)$$

Finally, when taking into account the fourth dimension of space (the third division), when light propagates from gravity into gravity free space the ratio of the four refractive indices (Eq.19.c and

$$\frac{n_{g_{9.8},g_{0}time}}{n_{g_{9.8},g_{0}distance}} = \frac{\frac{\frac{c}{c_0}}{\frac{c'}{c}}}{\frac{\frac{c_0}{c'}}{c_0}} = \frac{c_0}{c'} = \frac{c'^2}{c_0^2} = \frac{1.0322732}{0.9687357945} = \frac{1.065587961}{0.9384490401} = 1.1354777036. \quad (19.g)$$

Eq.19.d) in a mirror image division of the fractional line is:

The opposite ratio on the bases of Eq.19.d and Eq.19.c in a mirror image division of the fractional line is:

$$\frac{n_{g_{9.8},g_{0}distance}}{n_{g_{9.8},g_{0}time}} = \frac{\frac{\frac{c'}{c}}{\frac{c_0}{c'}}}{\frac{\frac{c_0}{c}}{c_0}} = \frac{c_0}{c'} = \frac{c'^2}{c_0^2} = \frac{1.0322732}{1.065587961} = \frac{0.9384490401}{1.065587961} = 0.8806860162. \quad (19.h)$$

By dividing the numeric value representing the line segment one more time, the third division, ABCD - EFGH is shifted to points ABCDEFGH - IJKLMNOP to form the four dimensional analogue of the cube. In contrast to the above, for a four-story fracture in a non-mirror image division the fracture can be simplified as follows:

$$\frac{n_{g_{9.8},g_{0}time}}{n_{g_{9.8},g_{0}distance}} = \frac{\frac{\frac{c}{c'}}{\frac{c_0}{c}}}{\frac{\frac{c_0}{c'}}{c_0}} = \frac{c_0}{c'} = 1. \quad (19.i)$$

$$\frac{n_{g_{9.8},g_{0}distance}}{n_{g_{9.8},g_{0}time}} = \frac{\frac{\frac{c'}{c}}{\frac{c_0}{c'}}}{\frac{\frac{c_0}{c}}{c_0}} = \frac{c_0}{c'} = 1. \quad (19.j)$$

By dividing Equations 20.g and 20.h and their variations, the value of the four refractive indices can no longer be physically increased (except for Equations 20.l and 20.m). The value has reached the maximum that can be physically interpreted since the number of dimensions has reached the four dimensions of space that exist in the universe, that is, the Einsteinian four-dimensional space-time continuum.

2.4 b

In the opposite case (see 2.4.a) the ratio of light velocity of the gravity-free space (c) and of the Earth's gravitation field (c₀) is: n_{g₀,g_{9.8}} = c₀/c = 0.9687357945. In this case, it is assumed that the light in non-gravity space (c) is slightly faster than in the 1g gravitational field (c₀). In terms of distance, this means that the distance defined in non-g is longer than in g (h_{in g=0} > h_{in g=9.8}). Accordingly, in one-dimension (the first division about the distance dimension) the relative refractive index for distance (n_{g_{9.8},g₀distance}) is as follows:

$$n_{g_{9.8},g_{0}distance} = \frac{c_0}{c} = \frac{\frac{h_{in g=9.8}}{T_{in g=0}}}{\frac{h_{in g=0}}{T_{in g=0}}} = \frac{2.879191841 \cdot 10^{16} m}{365.24218967 day} = \frac{h_{in g=9.8}}{h_{in g=0}} = \frac{2.879191841 \cdot 10^{16} m}{2.97211265581 \cdot 10^{16} m} = 0.9687357945. \quad (20)$$

This increase in distance is due to the onset of time dilation ($T_{in\ g=0} > T_{in\ g=9.8}$). As a consequence, in one-dimension, the relative refractive index for the time ($n_{g0,g9.8time}$) (the first division about it) is as follows:

$$n_{g0,g9.8time} = \frac{c'}{c} = \frac{\frac{h_{in\ g=0}}{T_{in\ g=9.8}}}{\frac{h_{in\ g=0}}{T_{in\ g=0}}} = \frac{\frac{2.97211265581 \cdot 10^{16} m}{353.8231828 day}}{\frac{2.97211265581 \cdot 10^{16} m}{365.24218967 day}} = \frac{T_{in\ g=0}}{T_{in\ g=9.8}} = \frac{365.24218967 day}{353.8231828 day} = 1.0322732. \quad (20.a)$$

Viewed in the opposite direction in one-dimension, the relative refractive index ($n_{g0,g9.8}$) for the distance ($n_{g0,g9.8distance}$) traveled by light multiplied by the relative refractive index for the time ($n_{g0,g9.8time}$) it takes for the light to cover that distance is equal to the value of the speed of light. It is numerically:

$$n_{g0,g9.8distance} \cdot n_{g0,g9.8time} = \frac{c_0}{c} \cdot \frac{c'}{c} = 0.9687357945 \cdot 1.0322732 = 1. \quad (20.b)$$

However, the ratio of the two refractive indices ($n_{g0,g9.8distance}$ and $n_{g0,g9.8time}$) (the second division about distance and time) in two dimensions is less than the ratio in the previous formula (Eq.20):

$$\frac{n_{g0,g9.8distance}}{n_{g0,g9.8time}} = \frac{\frac{c_0}{c}}{\frac{c'}{c}} = \frac{c_0}{c'} = \frac{0.9687357945}{1.0322732} = 0.938449041. \quad (20.c)$$

Otherwise, also in two dimensions, the ratio of the two refractive indices ($n_{g0,g9.8time}$ and $n_{g0,g9.8distance}$) (the second division about time and distance) is greater than the ratio in the previous formula (Eq.19):

$$\frac{n_{g0,g9.8time}}{n_{g0,g9.8distance}} = \frac{\frac{c'}{c}}{\frac{c_0}{c}} = \frac{c'}{c_0} = \frac{1.0322732}{0.9687357945} = 1.065587961. \quad (20.d)$$

These numerical values can be as follows in a geometric representation (Fig.3.a).

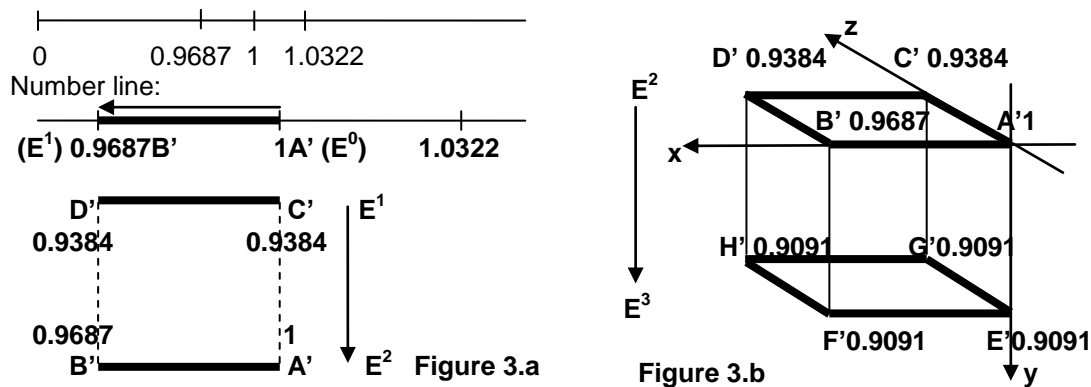

Figure 3. Symmetric representation of three-dimensional space relative to 1 (see Fig.2); the number lines are plotted along an x, y, z coordinate system where the x axis is to the left, the z axis is to the rear and the y axis is downwards, in the direction of decreasing numeric values. The data determined by algebraic calculations is transformed into a spatial geometrical figure formed in the larger (Fig.2) and smaller (Fig.3) directions of the number lines. This representation from the left-hand side is considered to be hyperbolic geometry due to its relative gravity (mass) deficiency.

Two-dimensionally, when a beam of light propagates from a non-gravity space into gravity, the inverse product of the refractive index of light over distance and time ($n_{g_0, g_9.8 \text{ distance}}$) ($n_{g_0, g_9.8 \text{ time}}$) as in Eq.20.c and Eq.20.d is:

$$\frac{n_{g_0, g_9.8 \text{ distance}}}{n_{g_0, g_9.8 \text{ time}}} \cdot \frac{n_{g_0, g_9.8 \text{ time}}}{n_{g_0, g_9.8 \text{ distance}}} = \frac{\frac{c_0}{c}}{\frac{c'}{c}} \cdot \frac{\frac{c'}{c_0}}{\frac{c}{c_0}} = \frac{c_0}{c'} \cdot \frac{c'}{c_0} = \frac{0.9687358}{1.0322732} \cdot \frac{1.0322732}{0.9687358} = 0.938449041 \cdot 1.065587961 = 1. \quad (20.e)$$

By dividing the numeric value representing the line segment one more time, the third (sub) division, ABCD is shifted to points EFGH to form a cube (Fig.3.b).

Taking into account three-dimensional space (E^3), when light propagates from gravity free space into gravity, another alternative of the ratio of the three refractive indices is:

$$\frac{\frac{n_{g_0, g_9.8 \text{ time}}}{n_{g_0, g_9.8 \text{ distance}}}}{\frac{n_{g_0, g_9.8 \text{ time}}}{1}} = \frac{\frac{\frac{c'}{c_0}}{\frac{c}{c_0}}}{\frac{c'}{c}} = \frac{c}{c_0} = \frac{c}{n_{g_9.8, g_0 \text{ distance}}} = \frac{1}{0.9687357945} = 1.0322732. \quad (20.f)$$

Furthermore, when taking into account three-dimensional space (E^3), when light enters gravity from gravity free space, the ratio of the three refractive indices is:

$$\frac{\frac{n_{g_0, g_9.8 \text{ distance}}}{n_{g_0, g_9.8 \text{ time}}}}{\frac{n_{g_0, g_9.8 \text{ distance}}}{1}} = \frac{\frac{\frac{c_0}{c'}}{\frac{c}{c'}}}{\frac{c_0}{c}} = \frac{c}{c'} = \frac{1}{n_{g_0, g_9.8 \text{ time}}} = \frac{1}{1.0322732} = 0.9687357945. \quad (20.g)$$

However, the ratio of the four refractive indices ($n_{g_0, g_9.8 \text{ distance}}/n_{g_0, g_9.8 \text{ time}}$ and $n_{g_0, g_9.8 \text{ time}}/n_{g_0, g_9.8 \text{ distance}}$), which represent the fourth dimension of space (E^4) on the bases of Eq.20.c and Eq.20.d is:

$$\frac{\frac{n_{g_0, g_9.8 \text{ distance}}}{n_{g_0, g_9.8 \text{ time}}}}{\frac{n_{g_0, g_9.8 \text{ distance}}}{n_{g_0, g_9.8 \text{ time}}}} = \frac{\frac{\frac{c_0}{c'}}{\frac{c}{c'}}}{\frac{c_0 \cdot c'}{c' \cdot c}} = \frac{c_0 \cdot c}{c \cdot c'} = \frac{c_0 \cdot c}{c \cdot c'} = \frac{c_0}{c'} \cdot \frac{c}{c_0} = \frac{c_0}{c'} \cdot \frac{c_0}{c'} = \frac{c_0^2}{c'^2} = \frac{0.9687358}{1.0322732} = \frac{0.938449}{1.065588} = 0.8806866. \quad (20.h)$$

Its inverse (complementary) ratio (Eq.20.h) is:

$$\frac{\frac{n_{g_0, g_9.8 \text{ time}}}{n_{g_0, g_9.8 \text{ distance}}}}{\frac{n_{g_0, g_9.8 \text{ time}}}{n_{g_0, g_9.8 \text{ distance}}}} = \frac{\frac{\frac{c'}{c_0}}{\frac{c}{c_0}}}{\frac{c'}{c}} = \frac{c_0}{c} = \frac{c'^2}{c_0^2} = \frac{1.0322732}{0.9687358} = \frac{1.065588}{0.938449} = 1.1354777. \quad (20.i)$$

In these cases, negative and positive differences in space-time occur and hyperbolic or spherical space curves are created. In Formula 20.h, after simplification, the smaller values of c_0 in the numerator and the larger values of c in the denominator are multiplied. This will distort the four-dimensional geometry that is analogous to the cube, with the upper edge shortened and the lower edge lengthened, so the top of the cube is shortened and the base broadened. In Formula 20.i, the opposite is noticeable, the upper edge lengthens and the lower one shortens. This numerical data geometrically determines the distortion of space-time (E^4) and its magnitude (Fig.4.a and Fig.4.b).

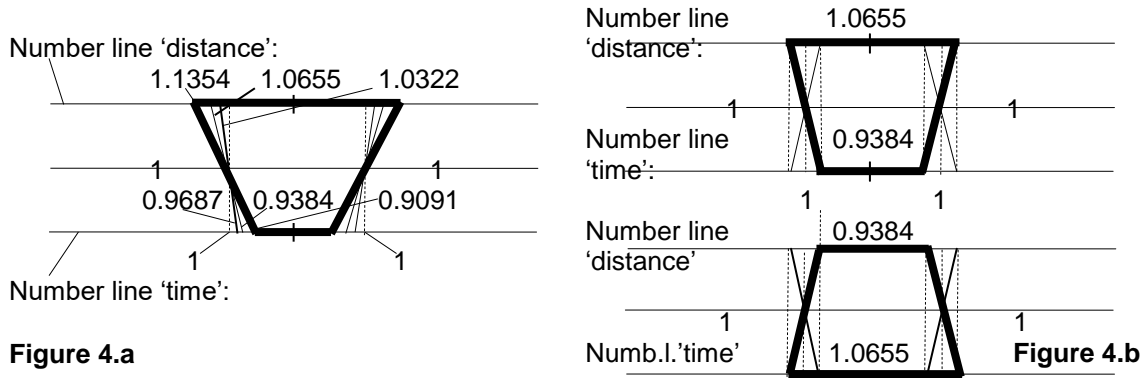

Figure 4.a. Gradually increasing space-time curvature in two dimensions, where the absolute values of the lines are proportional to the degree of deformation. **Figure 4.b.** A special case of two-dimensional distorted planes that are mirrored symmetrical to each other. The three or four dimensions shown in one or two dimensions appear curved, while the spatial curve in four dimensions straightens and forms a hypercube with itself.

Otherwise, the structure of the four-dimensional cube can be eliminated by multiplying the ratio of distance intervals ($n_{g_{9.8}, g_0 \text{ distance}} = 1.03222732$) (Eq.19). Namely, multiplying the derivative four-dimensional cube or its value (0.8806860162) four times will gradually reduce it (E^4, E^2, E^1, E^0). In this way negative changes (E^4) are annihilated by positive changes (E^4) / 0.8806860162 · (1.03222732)⁴ = 1/.

2.4 c

In the case of mirror symmetry for the fractional line, when light propagates out of gravity into non-gravity space (Eq.19.g) and the opposite, when entering gravity from gravity free space (Eq.20.h), the product of the two is:

$$\frac{n_{g_{9.8}, g_0 \text{ distance}}}{n_{g_{9.8}, g_0 \text{ time}}} \cdot \frac{n_{g_0, g_{9.8} \text{ distance}}}{n_{g_0, g_{9.8} \text{ time}}} = 1.1354777036 \cdot 0.880686602 = 1 \quad (20.j)$$

For the mirror symmetry of the fracture, when light propagates out of gravity into non-gravity space (Eq.19.h), and vice-versa (Eq.20.i), when it moves out of gravity free space into gravity, the product of the two is:

$$\frac{n_{g_{9.8}, g_0 \text{ time}}}{n_{g_{9.8}, g_0 \text{ distance}}} \cdot \frac{n_{g_0, g_{9.8} \text{ time}}}{n_{g_0, g_{9.8} \text{ distance}}} = 0.880686602 \cdot 1.1354777036 = 1 \quad (20.k)$$

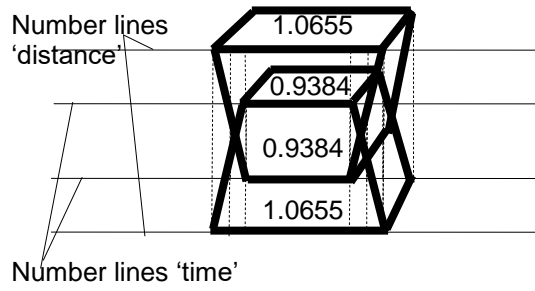
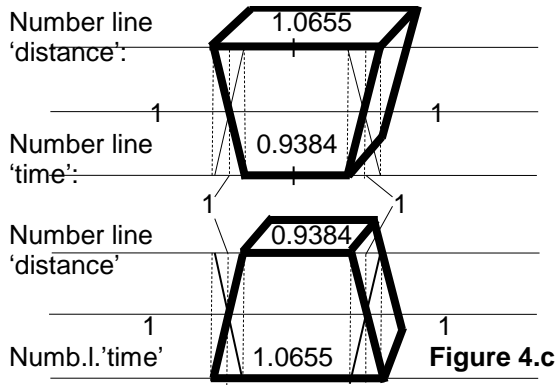

Figure 4.c. Representation of space-time distortion in three dimensions related to the values of the gravitational refractive indices. **Figure 4.d.** The elimination of space-time curvature in a three-dimensional representation with the transformation of a hyperbolically and a spherically curved space into each other (approximate illustration). The three dimensions appear curved, but the spatial curve in four dimensions straightens and forms a tesseract with itself. The curvature of space-time is taken over by the shape itself, integrated into its structure, eliminating distortion. However, this four-dimensional shape may also be curved and may exhibit positive or negative curvature relative to the mean if the ratio is equal to 1, depending on the force of gravity in which it is created. As a consequence, the structures themselves and their curvature can eliminate each other.

In the case of mirror symmetry for the fractional line of the two four-story fractions, but in a complementary arrangement, the gravitational refractive indices are as follows. In four dimensions, when light propagates out of gravity into non-gravity space (Eq.19.g) and enters gravity from non-gravity space (Eq.20.i) and their product is:

$$\frac{n_{g_{9,8},g_0dis\ tance}}{n_{g_{9,8},g_0time}} \cdot \frac{n_{g_0,g_{9,8}dis\ tance}}{n_{g_0,g_{9,8}time}} = 1.1354777036 \cdot 1.1354777036 = 1.28930961. \quad (20.l)$$

However, in the case of the mirror symmetry of the four-story fractions and the complementarity of the gravitational refractive indices in four dimensions there is another possibility (Eq.19.h and Eq.20.h), which is:

$$\frac{n_{g_{9,8},g_0time}}{n_{g_{9,8},g_0dis\ tance}} \cdot \frac{n_{g_0,g_{9,8}dis\ tance}}{n_{g_0,g_{9,8}time}} = 0.8806860162 \cdot 0.8806860162 = 0.77560786. \quad (20.m)$$

The proportion of refractive indices (Eq.20.c and 20.d) can be an important factor in determining the age of the cosmos. Moreover, these values (Eq.20.h, Eq.20.i and Eq.20.l, Eq.20.m) provide valuable help in determining the upper and lower limits of the age of the universe.

Changes that occur in the propagation of light from gravity in all directions of space-time are counteracted by the complementary properties of another beam of light entering from non-gravity to gravity. This complex four-dimensional system, viewed from both sides, results in a constant speed of light. This phenomenon explains the difference between the lower and upper age limits of the universe. However, this approach is also needed to keep the actual age (13.7355 billion years) unchanged. Positive (E^4) and negative (E^{-4}) changes from the median age of the cosmos are consistent with Einstein's four-dimensional plasticity of space-time (Fig.5 and Fig.7). Taking into account the actual spatial location of the cubes (see Figs. 2 and 3), the representation is as follows (Fig.5):

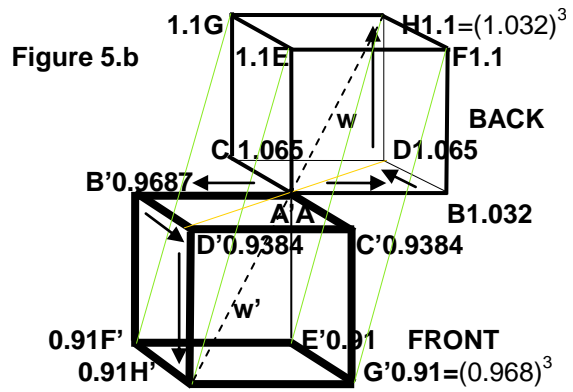
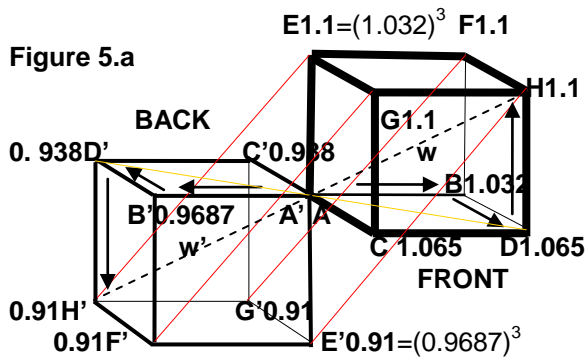
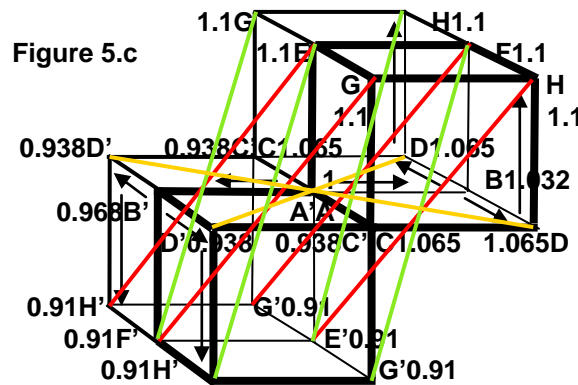
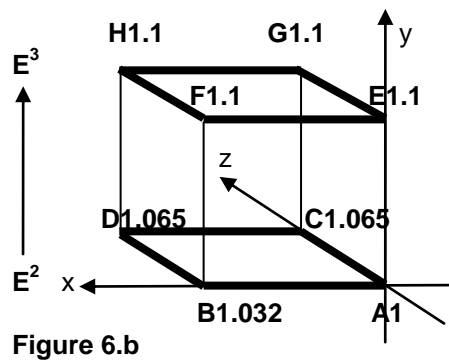
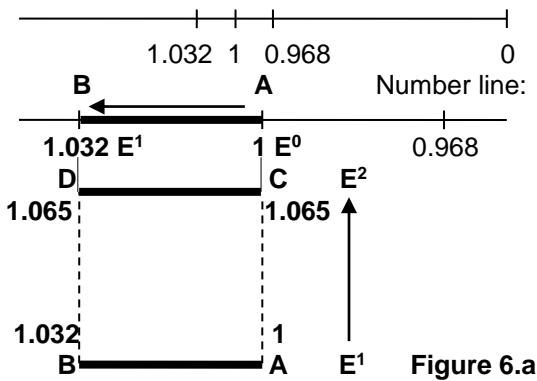

Figure 5. The two cubes occupy two of the 8 quadrants of the space surrounding them. To illustrate the increase in 1.032, they are taken upwards and demonstrate a decrease of 0.96 in the backward direction; the right cube is placed in the front and the left one is placed in the back. The direction of the arrows represents multiplying the index of refraction by itself, increasing it to a square or a cube (for a four-dimensional power, the fourth power). The two cubes (with a refractive index smaller and larger than one) join together at their corners (A) and connect to other corners. This representation of the two 3-dimensional cubes in itself provides an opportunity to create a fourth dimension. The other cube, symmetrical to a plane perpendicular to this axis, together represents a hypercube. Otherwise, the fourth dimension (w and w') is recorded in the x, y, z coordinate system according to the diagonal of the cube. With an equivalent offset to the diagonal, point H' moves to point A , and A to H so that the two cubes will meet at point A at their corner (indicated by dashed lines in Figures 5.a and 5.b).



Contrary to the previous one, the representation from right to left for rising dimensions is as follows.



Right to left illustration with decreasing proportions:

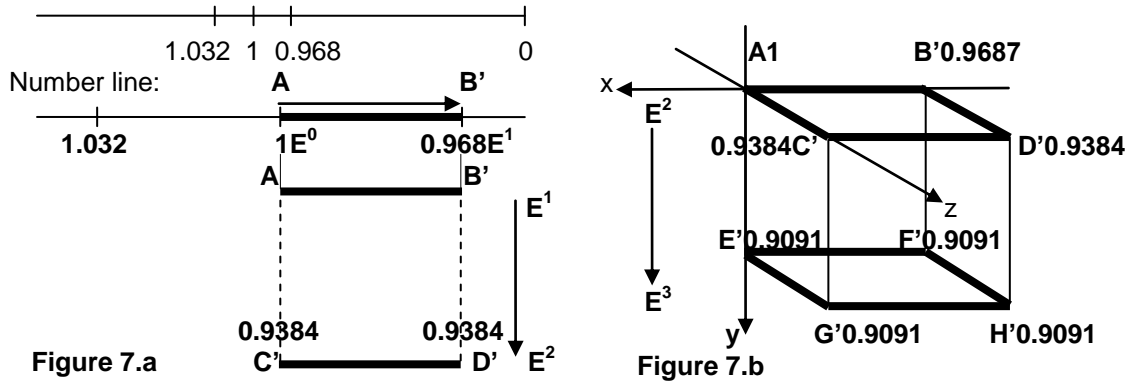

From right to left representation, the complementary double cubes are as follows.

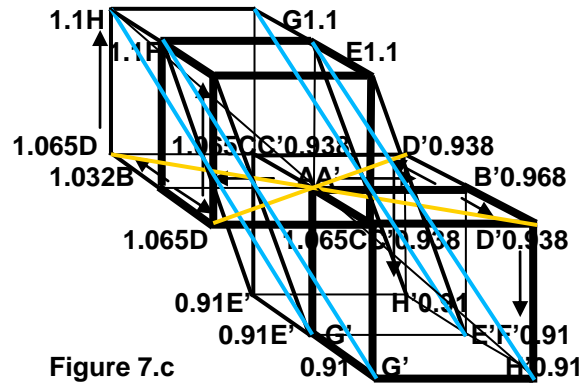

Figure 7.c. By placing the zero value on the right of the number line and increasing the rising number to the left (Fig.6.a, Fig.6.b, Fig.7.a and Fig.7.b) (black and blue oblique blocks) the inverse of Fig. 5.a, Fig.5.b and Fig.5.c is created (red and green oblique blocks)

Representation of gravity refractive index ratios in four-dimensional space-time for light beams traveling in opposite directions, taking into account possible variations. The set of options outlined in Figures 5, 6 and 7 is as follows, which is shown in Figure 8:

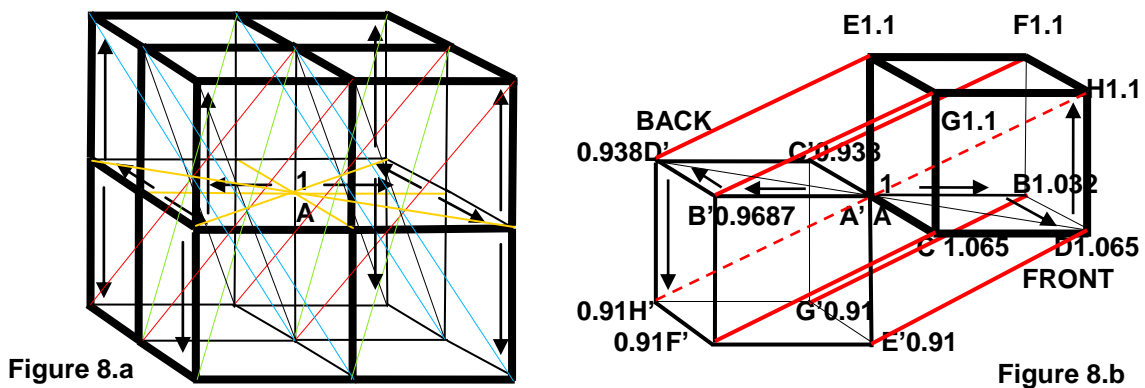

Figure 8.a. As in Fig.5, 6 and Fig.7, the remaining four of the eight quadrants are also filled. In this way possible variations are realized. The product of the endpoints of both diagonals (orange line) of the top face of the lower four cubes is also equal to 1 ($D' \cdot D \cdot D' \cdot D = 0.938 \cdot 1.065 \cdot 0.938 \cdot 1.065 = 1$, see Figure 5.c). **Figure 8.b.** The four double cubes in contact with each other at the apex of the origo (point A at 1) give a total of four tesseracts (for example, $H' \cdot H = 0.91 \cdot 1.1 = 1$ / dashed red line/ or in Fig.7.c a black line: $H \cdot H' = 1.1 \cdot 0.91 = 1$), also filling the available space. Bodies can annihilate each other, eventually forming a zero dimension (E^0) in the origin (A). The point A is zero-dimensional and

forms the endpoint of the one-dimensional radius of the universe. Its value is, by definition, 1, so the value of the cosmos radius changes only with an increasing number of dimensions.

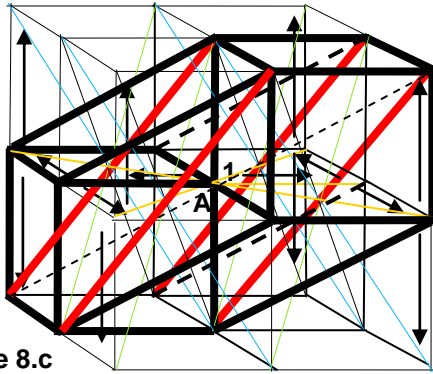

Figure 8.c

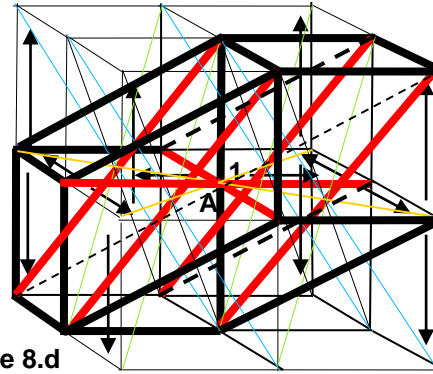

Figure 8.d

Figure 8.c and Figure 8.d. Comparison of the relationship between the top and base faces of the cubes (red oblique column) and the geometric shape created from the external connection of the cube vertices (black hypercube). The product of the numeric values corresponding to the base and top faces of the oblique column will be equal to 1 ($H' \cdot E \cdot G' \cdot F \cdot E' \cdot H \cdot F' \cdot G = 0.91 \cdot 1.1 \cdot 0.91 \cdot 1.1 \cdot 0.91 \cdot 1.1 \cdot 0.91 \cdot 1.1 = 1$ as in Fig.5.c). The product of the numerical values corresponding to the most distant vertices of the two cubes will also be equal to 1. The total product of the values corresponding to the ends of the six lines connecting the corners of the two cubes (which form the edges of the shape) will also be equal to 1 ($D' \cdot E \cdot C' \cdot F \cdot G' \cdot B \cdot E' \cdot D \cdot F' \cdot C \cdot B' \cdot G = 0.938 \cdot 1.1 \cdot 0.938 \cdot 1.1 \cdot 0.91 \cdot 1.032 \cdot 0.91 \cdot 1.065 \cdot 0.91 \cdot 1.065 \cdot 0.968 \cdot 1.1 = 1$; Fig.8.b). This geometric shape can be called the 'Einstein's hypercube' or 'cosmic tesseract'. The product of the numeric value corresponding to the center of the 6 sides of the big cube (orange line) will also be equal to 1 ($B \cdot B' \cdot C \cdot C' \cdot E \cdot E' = 0.968 \cdot 1.032 \cdot 0.938 \cdot 1.065 \cdot 1.1 \cdot 0.91 = 1$, and $C \cdot C \cdot C' \cdot C' = 1.065 \cdot 1.065 \cdot 0.938 \cdot 0.938 = 1$ as in Fig.5.c and Fig.7.c).

The gravitational refractive index of the rays of light traveling opposite each other along the upper four edges of the big cube ($H \cdot H = 1.1 \cdot 1.1$) is 1.21. However, going along the lower edges of the cube, the value ($H' \cdot H' = 0.91 \cdot 0.91$) will be 0.828. Looking at the same case in four dimensions, the numerical values are 1.288 (1.135·1.135) and 0.77 (0.8806·0.8806). The product of the numbers corresponding to the endpoints of the upper and lower edges of the big cube will also be equal to 1.

2.4 d

Since the speed of light is by definition constant in spaces with different gravity, the apparent difference could transform into the Hubble constant. In the first case (Eq.14.), when the Hubble constant decreases the radius of the universe should increase to a similar extent. An increase in the radius of the universe may also occur as the redshift increases (Eq.7). If c is equal to c_0 , then the value of H_0 and $H_{\text{universe present Mpc}}$ after simplification is as follows:

$$v_{at\ c} = \frac{c}{c_0 \cdot 1.0322732} \cdot H_{0\ at\ c} \cdot 1.0322732 \cdot H_{\text{universe present Mpc}} = \frac{1}{1.0322732} \cdot H_{0\ at\ c} \cdot 1.0322732 \cdot H_{\text{universe present Mpc}} \quad (21)$$

At this point, the reduction of H_0 is eliminated by a similar increase in redshift (Eq.7). Therefore, the light velocity expansion of the cosmos remains constant:

$$v_{at\ c} = 68.964637235\ km \cdot s^{-1} \cdot Mpc^{-1} \cdot 4.34704611 \cdot 10^3\ Mpc = 2.99792458 \cdot 10^8\ m \cdot s^{-1}. \quad (22)$$

So, if the value of the Hubble constant decreases the radius of the universe increases.

In the latter case, when the Hubble constant increases, the radius of the universe should decrease to the same extent. A decrease in the radius of the cosmos may occur as the redshift decreases (Eq.7).

At this point, the growth of H_0 is eliminated by a similar decrease in redshift. When c_0 is equal to c , after simplification:

$$v_{at\ c} = \frac{c_0 \cdot 1.0322732}{c} \cdot H_{0\ at\ c} \cdot \frac{H_{universe\ present\ Mpc}}{1.0322732} = 1.0322732 \cdot H_{0\ at\ c} \cdot \frac{H_{universe\ present\ Mpc}}{1.0322732} \quad (23)$$

Numerically:

$$v_{at\ c} = 73.486235554\ km \cdot s^{-1} \cdot Mpc^{-1} \cdot 4.079572945 \cdot 10^3\ Mpc = 2.99792458 \cdot 10^8\ m \cdot s^{-1} \quad (24)$$

Consequently, the light velocity expansion of the universe remains constant.

Based on the above we can conclude that the value of H_0 may be 68.9646 km/s/Mpc and 73.4862 km/s/Mpc. This correlates well with recent measurement results, the values of which vary somewhere between the two (ScienceDaily 2019; Shajib et al. 2019).

However, in the case of an increasing number of space dimensions, especially in the fourth dimension, for some variations and for a special set of refractive indices, even higher or lower H_0 values may be realized. This time interval, augmented by dimensions, is called the 'dimensional gravity refractive index age'. This is consistent with the results of all measurements to date ($H_0 = 50 - 100$ km/s/Mpc) (Huchra 2010). Due to changes in the structure of the universe in space-time (plasticity), the radius and age of the universe may be even greater. As a result of space-time stretch or space-time densification, Formulas 20.j and 20.k show that the cosmos has a lower limit of 10.653 billion years and an upper limit of 17.71 billion years (Jimenez 1998), when $H_0 = 91.78$ km/s/Mpc (71.188 km/s/Mpc · 1.2893) and $H_0 = 55.16$ km/s/Mpc (71.188 km/s/Mpc · 0.7756).

Alternatively, what may contribute to differences in the value of H_0 is the uneven distribution of mass and gravity within the cosmos; the homogeneous representation of gravity and mass distribution in Figure 1 only illustrates the realities of the universe in an idealized way; in actuality there exist local differences. This distribution of mass and related gravity in the universe, together with the geometric representation of Einstein's four-dimensional space-time, may explain the differences in H_0 values that are expected to be stochastic in this non-ideal but real case.

2.4 e

If only gravity refractive indices are considered and distance contraction and time dilation are not taken into account (although their origin is the same) for control purposes; the ratio will not change in the following variations. When light exits the gravitational field in the direction of all four dimensions, and simultaneously moves inwards from the four-dimensional space, the ratio also increases downward and upward:

$$\begin{aligned} & \frac{n_{g_0, g_{9.8}}}{n_{g_{9.8}, g_0}} \cdot \frac{n_{g_{9.8} \leftarrow g_0}}{n_{g_0 \rightarrow g_{9.8}}} \cdot \frac{n_{g_0 \rightarrow g_{9.8}}}{n_{g_{9.8} \leftarrow g_0}} \\ & \frac{n_{g_{9.8}, g_0}}{n_{g_0, g_{9.8}}} \cdot \frac{n_{g_0 \rightarrow g_{9.8}}}{n_{g_{9.8} \leftarrow g_0}} \cdot \frac{n_{g_{9.8} \leftarrow g_0}}{n_{g_0 \rightarrow g_{9.8}}} \\ & \frac{n_{g_{9.8}, g_0}}{n_{g_0, g_{9.8}}} \cdot \frac{n_{g_{9.8} \rightarrow g_0}}{n_{g_0 \leftarrow g_{9.8}}} \cdot \frac{n_{g_0 \leftarrow g_{9.8}}}{n_{g_{9.8} \rightarrow g_0}} \cdot \frac{n_{g_0, g_{9.8}}}{n_{g_{9.8}, g_0}} \cdot \frac{n_{g_0, g_{9.8}}}{n_{g_{9.8}, g_0}} \cdot \frac{n_{g_{9.8} \leftarrow g_0}}{n_{g_0 \rightarrow g_{9.8}}} \cdot \frac{n_{g_{9.8} \leftarrow g_0}}{n_{g_0 \rightarrow g_{9.8}}} \\ & \frac{n_{g_0, g_{9.8}}}{n_{g_{9.8}, g_0}} = \frac{n_{g_{9.8} \leftarrow g_0}}{n_{g_0 \rightarrow g_{9.8}}} = \frac{n_{g_0 \rightarrow g_{9.8}}}{n_{g_{9.8} \leftarrow g_0}} = \frac{n_{g_{9.8}, g_0}}{n_{g_0, g_{9.8}}} \cdot \frac{n_{g_{9.8}, g_0}}{n_{g_0, g_{9.8}}} = \frac{n_{g_{9.8} \rightarrow g_0}}{n_{g_0 \leftarrow g_{9.8}}} \cdot \frac{n_{g_{9.8} \rightarrow g_0}}{n_{g_0 \leftarrow g_{9.8}}} = \left(\frac{n_{g_0, g_{9.8}}}{n_{g_{9.8}, g_0}} \right)^4 = \left(\frac{n_{g_{9.8} \leftarrow g_0}}{n_{g_0 \rightarrow g_{9.8}}} \right)^4 = \\ & \frac{n_{g_{9.8}, g_0}}{n_{g_0, g_{9.8}}} \cdot \frac{n_{g_{9.8} \rightarrow g_0}}{n_{g_0 \leftarrow g_{9.8}}} \cdot \frac{n_{g_0 \leftarrow g_{9.8}}}{n_{g_{9.8} \rightarrow g_0}} \cdot \frac{n_{g_0, g_{9.8}}}{n_{g_{9.8}, g_0}} \cdot \frac{n_{g_0, g_{9.8}}}{n_{g_{9.8}, g_0}} \cdot \frac{n_{g_{9.8} \leftarrow g_0}}{n_{g_0 \rightarrow g_{9.8}}} \cdot \frac{n_{g_{9.8} \leftarrow g_0}}{n_{g_0 \rightarrow g_{9.8}}} \\ & \frac{n_{g_0, g_{9.8}}}{n_{g_{9.8}, g_0}} \cdot \frac{n_{g_{9.8} \leftarrow g_0}}{n_{g_0 \rightarrow g_{9.8}}} \cdot \frac{n_{g_0 \rightarrow g_{9.8}}}{n_{g_{9.8} \leftarrow g_0}} \\ & \frac{n_{g_{9.8}, g_0}}{n_{g_0, g_{9.8}}} \cdot \frac{n_{g_0 \rightarrow g_{9.8}}}{n_{g_{9.8} \leftarrow g_0}} \cdot \frac{n_{g_{9.8} \leftarrow g_0}}{n_{g_0 \rightarrow g_{9.8}}} \\ & = \frac{n_{g_{9.8} \leftarrow g_0}}{n_{g_0 \rightarrow g_{9.8}}} \cdot \frac{n_{g_{9.8} \leftarrow g_0}}{n_{g_0 \rightarrow g_{9.8}}} \cdot \frac{n_{g_{9.8} \leftarrow g_0}}{n_{g_0 \rightarrow g_{9.8}}} \cdot \frac{n_{g_{9.8} \leftarrow g_0}}{n_{g_0 \rightarrow g_{9.8}}} = \left(\frac{0.9687357945}{1.0322732} \right)^4 = 0.775608891 \quad (25.a) \end{aligned}$$

and:

$$\begin{aligned}
& \frac{n_{g_{9.8},g_0}}{n_{g_0,g_{9.8}}} \cdot \frac{n_{g_{9.8} \rightarrow g_0}}{n_{g_{9.8} \leftarrow g_0}} \cdot \frac{n_{g_0 \leftarrow g_{9.8}}}{n_{g_0 \rightarrow g_{9.8}}} \\
& \frac{n_{g_{9.8},g_0}}{n_{g_0,g_{9.8}}} \cdot \frac{n_{g_{9.8} \rightarrow g_0}}{n_{g_{9.8} \leftarrow g_0}} \cdot \frac{n_{g_0 \leftarrow g_{9.8}}}{n_{g_0 \rightarrow g_{9.8}}} \\
& \frac{n_{g_{9.8},g_0}}{n_{g_0,g_{9.8}}} \cdot \frac{n_{g_{9.8} \rightarrow g_0}}{n_{g_{9.8} \leftarrow g_0}} \cdot \frac{n_{g_0 \leftarrow g_{9.8}}}{n_{g_0 \rightarrow g_{9.8}}} \cdot \frac{n_{g_{9.8},g_0}}{n_{g_0,g_{9.8}}} \cdot \frac{n_{g_{9.8},g_0}}{n_{g_0,g_{9.8}}} \cdot \frac{n_{g_{9.8} \rightarrow g_0}}{n_{g_{9.8} \leftarrow g_0}} \cdot \frac{n_{g_{9.8} \rightarrow g_0}}{n_{g_{9.8} \leftarrow g_0}} \\
& \frac{n_{g_{9.8},g_0}}{n_{g_0,g_{9.8}}} = \frac{n_{g_{9.8} \rightarrow g_0}}{n_{g_{9.8} \leftarrow g_0}} = \frac{n_{g_0 \leftarrow g_{9.8}}}{n_{g_0 \rightarrow g_{9.8}}} = \frac{n_{g_{9.8},g_0}}{n_{g_0,g_{9.8}}} \cdot \frac{n_{g_{9.8},g_0}}{n_{g_0,g_{9.8}}} = \frac{n_{g_{9.8} \rightarrow g_0}}{n_{g_{9.8} \leftarrow g_0}} \cdot \frac{n_{g_{9.8} \rightarrow g_0}}{n_{g_{9.8} \leftarrow g_0}} = \left(\frac{n_{g_{9.8},g_0}}{n_{g_0,g_{9.8}}} \right)^4 = \left(\frac{n_{g_{9.8} \rightarrow g_0}}{n_{g_{9.8} \leftarrow g_0}} \right)^4 = \\
& \frac{n_{g_{9.8},g_0}}{n_{g_0,g_{9.8}}} \cdot \frac{n_{g_{9.8} \rightarrow g_0}}{n_{g_{9.8} \leftarrow g_0}} \cdot \frac{n_{g_0 \leftarrow g_{9.8}}}{n_{g_0 \rightarrow g_{9.8}}} \\
& \frac{n_{g_{9.8},g_0}}{n_{g_0,g_{9.8}}} \cdot \frac{n_{g_{9.8} \rightarrow g_0}}{n_{g_{9.8} \leftarrow g_0}} \cdot \frac{n_{g_0 \leftarrow g_{9.8}}}{n_{g_0 \rightarrow g_{9.8}}} \\
& \frac{n_{g_{9.8},g_0}}{n_{g_0,g_{9.8}}} \cdot \frac{n_{g_{9.8} \rightarrow g_0}}{n_{g_{9.8} \leftarrow g_0}} \cdot \frac{n_{g_0 \leftarrow g_{9.8}}}{n_{g_0 \rightarrow g_{9.8}}} \\
& \frac{n_{g_{9.8},g_0}}{n_{g_0,g_{9.8}}} \cdot \frac{n_{g_{9.8} \rightarrow g_0}}{n_{g_{9.8} \leftarrow g_0}} \cdot \frac{n_{g_0 \leftarrow g_{9.8}}}{n_{g_0 \rightarrow g_{9.8}}} \\
& = \frac{n_{g_{9.8} \rightarrow g_0}}{n_{g_{9.8} \leftarrow g_0}} \cdot \frac{n_{g_{9.8} \rightarrow g_0}}{n_{g_{9.8} \leftarrow g_0}} \cdot \frac{n_{g_{9.8} \rightarrow g_0}}{n_{g_{9.8} \leftarrow g_0}} \cdot \frac{n_{g_{9.8} \rightarrow g_0}}{n_{g_{9.8} \leftarrow g_0}} = \left(\frac{1.0322732}{0.9687357945} \right)^4 = 1.289309613 . \quad (25.b)
\end{aligned}$$

(The arrows in the formula further illustrate the path of incoming and outgoing light beams.)

Then the lower and upper limits of the age of the universe will be 10.65 and 17.7 billion years, but the average age of the cosmos will remain unchanged (13.7355 billion years). It can be indirect evidence that the cosmos can only be four-dimensional, otherwise an unrealistically small and large age limit would be obtained.

2.5 Determination of the age of the universe from the Hubble time

Using the reciprocal of the Hubble constant value ($1/H_0$) defined in this model at $v = c$ as in Equation 13, the Hubble time (t_H) is as follows:

$$t_H = \frac{1}{H_0 \text{ at } c} = \frac{1}{71.188746 \frac{km}{s \cdot Mpc}} = \frac{1}{71.188746 \frac{km}{s}} \cdot 3.08568 \cdot 10^{22} m = 4.3345 \cdot 10^{17} s . \quad (26)$$

This value is the same as the result of the time interval of the universe ($t_H = T_{\text{universe}}$) in Equation 7, which is 13.7355 billion years. In the case of $H_0 = 68.9646$ and $H_0 = 73.4862$ km/s/Mpc the ages of the cosmos are $4.4743 \cdot 10^{17} s$ or 14.178 billion years and $4.2 \cdot 10^{17} s$ or 13.3 billion years respectively (Chaboyer 1996).

2.6 Effect of light propagation in different media on the 3.14 redshift

In the case of constant c , the redshift cannot be less than 3.14, because then the value of $H_0 \text{ at } c$ should increase. If this were to happen (e.g. $H_0 = 73.4862$ km·s⁻¹·Mpc⁻¹) the radius and then age of the cosmos would be reduced. By contrast, if the Hubble constant ($H_0 \text{ at } c$) decreased to less than 71.188 km·s⁻¹·Mpc⁻¹ e.g. 68.9646 km·s⁻¹·Mpc⁻¹ (Eq.17), the redshift would increase, increasing the age of the universe slightly. In the last case the radius of the cosmos ($H_{\text{universe present}}$) in Mpc is:

$$H_{\text{universe present Mpc}} = \frac{v_{\text{at } c}}{H_0} = \frac{2.99792458 \cdot 10^5 \frac{km}{s}}{68.964637235 \frac{km}{s} \cdot \frac{1}{Mpc}} = 4.34704611 \cdot 10^3 Mpc . \quad (27)$$

Since $1 \text{ Mpc}/3.08 \cdot 10^{22} m = 4.347 \cdot 10^3 \text{ Mpc}/H_{\text{universe present}}$, the radius of the universe ($H_{\text{universe present}}$) in meters is:

$$H_{\text{universe present}} = 4.34704611 \cdot 10^3 \cdot 3.08567758 \cdot 10^{22} m = 13.41358272 \cdot 10^{25} m . \quad (27.a)$$

In time ($T_{\text{universe}} = H_{\text{universe}}/c$) this is $4.474289583 \cdot 10^{17}$ s. Since one tropical/solar year is $3.1556926 \cdot 10^7$ s, this equates to 14.178788 billion years, which is 442.971 million years more than the original age given for the universe (Eq.8). This extra time interval can also be called the '*additional gravitational refractive index age*'.

However, due to symmetry and differences in refractive indices compared to the measured minimum value of the Hubble constant ($H_{0\text{minimum}1} = 68.9646$ km/s/Mpc), its maximum value ($H_{0\text{maximum}1}$) will be 73.4862 km/s/Mpc on the bases of Equations 19 and 22:

$$H_{0\text{maximum}1} = H_{0\text{at } c} \cdot 1.0322732 = 71.188746 \frac{\text{km}}{\text{s} \cdot \text{Mpc}} \cdot 1.0322732 = 73.486235 \frac{\text{km}}{\text{s} \cdot \text{Mpc}}. \quad (28)$$

Along this line, the stable value of the 3.141592653-redshift decreases; it would be 3.04337326, decreasing the age of cosmos from 13.7355 billion years to 13.30607 billion years (Eq.19 and Eq.7). This decrease in time interval can also be called '*gravitational refractive index age deficit*'. The difference between the two ages for the universe (14.178788 billion years and 13.30607 billion years) is 872.7 million years due to the differences in curvature of the cosmos. This combined time interval can also be called the '*integrated gravitational refractive index age difference*'.

In the case of further reduced refractive index ratios (Eq.20.c), when the H_0 value reaches the minimum2, (Planck Collab. 2015) this follows:

$$H_{0\text{minimum}2} = H_{0\text{at } c} \cdot \frac{n_{g_0, g_9, s \text{ dist}}}{n_{g_0, g_9, s \text{ time}}} = H_{0\text{at } c} \cdot 0.93845 = 71.1887 \frac{\text{km}}{\text{s} \cdot \text{Mpc}} \cdot 0.93845 = 66.807 \frac{\text{km}}{\text{s} \cdot \text{Mpc}}. \quad (28.a)$$

At this point the universe is 14.6363 billion years in age, which is essentially the same as the age of globular clusters in galaxies (Krauss & Chaboyer 2003). In the case of further increased refractive index ratios (Eq.19.c and Eq.20.d.), when the H_0 value reaches the maximum2 (Riess et al. 2016) this

$$H_{0\text{maximum}2} = H_{0\text{at } c} \cdot \frac{n_{g_0, g_9, s \text{ time}}}{n_{g_0, g_9, s \text{ dist}}} = H_{0\text{at } c} \cdot 1.0656 = 71.1887 \frac{\text{km}}{\text{s} \cdot \text{Mpc}} \cdot 1.0656 = 75.857 \frac{\text{km}}{\text{s} \cdot \text{Mpc}}. \quad (28.b)$$

follows:

Then the age of the universe is 12.89 billion years; this is the lower limit of the age of the universe. For Eq.20.h and Eq.20.i, the lower and upper limits for the age of the universe are 12.0982 and 15.5835 billion years respectively. Unlike before, there is now no significant difference between these cosmic ages based on the redshift (as modified in this article) and the evolution of stars. Therefore, there is a link between the two basic methods of determining the physical age of the cosmos.

Apart from these limited time dilations, which result in a discrete redshift change, the maximum redshift of 3.141592653 is fixed by both the symmetry between the cosmos and the Earth's radius as well as the stability of $H_{0\text{at } c}$ and $v_{\text{at } c}$. If all three factors (H_0 , $H_{\text{universe present}}$, and $v_{\text{at } c}$) are constant and only the degree of redshift changes ($2\pi/\alpha \cdot (v-v_0)/v_0$ or $\alpha/2 \cdot \pi^{-1} \cdot (v-v_0)/v_0$), according to the measurements when reducing to smaller values there are different time intervals for the age of the universe according to the stages of its development. This means relocation on the distance scale at the same time too.

However, as in the case of accelerating systems (see Lorentz transformation), distortion occurs in the space-time structure. The time dilation and distance contraction in this phenomenon is transformed into the curvature of space-time and eliminated. According to this, the resulting positive or negative space-time curve increases or decreases the radius of the cosmos in relation to its n_g value ($n_{g_9, 8, g_0}$, $n_{g_0, g_9, 8}$) as in Equations 21 and 24.

2.7 Effect of extreme redshift on the Earth's size: a black hole sized Earth

Nevertheless, there are redshifts of greater than 3.14 in the universe and replacing them in the formula would result in changes in the Earth's parameters (Eq.15) if the other factors do not change. In this case the increase in redshift is compensated by the distance reduction inherent in the radius of the Earth. If $(v-v_0)/v_0$ is equal to $2 \cdot \pi/\alpha \cdot 3.14$, with this immense value of redshift ($1.4178 \cdot 10^{10}$) the Earth's radius (R_{Earth}) would reduce to a size where it would be a black hole ($\alpha/2 \cdot \pi^{-1} \cdot R_{\text{Earth}}$) (Nagy 2016):

$$v_{at\ c} = H_{0\ at\ c} \cdot H_{universe\ present\ Mpc} = H_{0\ at\ c} \cdot h \cdot \frac{2 \cdot \pi}{\alpha} \cdot \frac{1}{3.08567758 \cdot 10^{22}} \cdot (29)$$

This is detailed:

$$v_{at\ c} = H_{0\ at\ c} \cdot H_{u.pr.Mpc} = H_{0\ at\ c} \cdot \frac{2 \cdot \pi}{\alpha} \cdot \frac{v - v_0}{v_0} \cdot \frac{c^2}{g_{Earth}} \cdot \frac{\pi \cdot c^2 \cdot \frac{\alpha}{2 \cdot \pi} \cdot R_{Earth}}{G \cdot M_{Earth}} \cdot \frac{1}{3.08567758 \cdot 10^{22}} \cdot (29.a)$$

Since $(\alpha/2 \cdot \pi^{-1}) \cdot R_{Earth}$ ($0.2215698698 \cdot 10^{-9} \cdot 6.371005 \cdot 10^6$ m) is 1.411622 mm and multiplying this value by $2 \cdot \pi$ it is 0.886948 cm when the Earth is a black hole. In the case of no change in the Earth's mass (M_{Earth}), in order to avoid an increase in gravity (g_{Earth}) the decrease in the Earth's radius (R_{Earth}) may manifest itself in the separation of the Earth ($\alpha/2 \cdot \pi^{-1} \cdot R_{Earth}$), which recession means a reduction in the angle of view (α_{Earth}). The result, the expansion of the universe at the speed of light is maintained. (A decrease in the Earth's angle of view also means a collapse of space, which does not mean a decrease in its interior volume.)

2.8 The magnitude of the redshift if the Earth were actually a black hole

Another way to preserve the universe's speed of light expansion in this system is to eliminate the enormous redshift by changing the parameters of the Earth. This can be done by leaving the original mass of the Earth (M_{Earth}) with the reduction of its radius ($\alpha/2 \cdot \pi^{-1} \cdot R_{Earth}$) and the increase of its parallel gravitational force ($2 \cdot \pi/\alpha \cdot g_{Earth}$). Thus, the elimination of extreme redshift ($6.3998 \cdot 10^{20}$) can be achieved by compressing the Earth into a black hole ($\alpha/2 \cdot \pi^{-1} \cdot R_{Earth}$) by a reduction in space:

$$v_{at\ c} = H_{0\ at\ c} \cdot \left(\frac{2 \cdot \pi}{\alpha} \right)^2 \cdot \frac{v - v_0}{v_0} \cdot \frac{c^2}{\frac{2 \cdot \pi}{\alpha} \cdot g_{Earth}} \cdot \frac{\pi \cdot c^2 \cdot \frac{\alpha}{2 \cdot \pi} \cdot R_{Earth}}{G \cdot M_{Earth}} \cdot \frac{1}{3.08567758 \cdot 10^{22}} \cdot (30)$$

2.9 Redshift the Earth were as remote as a black hole and actually a black hole

Continuing the concept, as a third option the Earth moves away in space and gradually becomes 1.41 mm by a gradual decrease in its angle of view ($\alpha/2 \cdot \pi^{-1} \cdot R_{Earth}$). Then an external force (due to a narrowing of space) actually compresses it into a black hole ($\alpha/2 \cdot \pi^{-1} \cdot R_{Earth}$) raising its gravity ($2 \cdot \pi/\alpha \cdot g_{Earth}$) too; the factors vary as follows:

$$v_{at\ c} = H_{0\ at\ c} \cdot H_{u.pr.Mpc} = H_{0\ at\ c} \cdot \left(\frac{2 \cdot \pi}{\alpha} \right)^3 \cdot \frac{v - v_0}{v_0} \cdot \frac{c^2}{\frac{2 \cdot \pi}{\alpha} \cdot g_{Earth}} \cdot \frac{\pi \cdot c^2 \cdot \left(\frac{\alpha}{2 \cdot \pi} \right)^2 \cdot R_{Earth}}{G \cdot M_{Earth}} \cdot \frac{1}{3.08567 \cdot 10^{22}} \cdot (31)$$

This requires maximum redshift to reach the third power of $2\pi/\alpha$. This is also an extreme case, which results from a change in distances relative to one another depending on the circumstances. In this case, for example, along with the decrease in the viewing angle, an extreme degree of distance reduction occurs, resulting in an enormous collapse of three-dimensional space. When viewed from a retrograde direction the opposite is true: an extreme degree of three-dimensional space inflation is created with the immense increase of the viewing angle. Finally, because of the symmetry of events with opposites, the idea of a universe expanding at the speed of light is retained.

In summary, it can be concluded that the decrease or increase of the redshift (see sections 2.3 and 2.9) in relation to the radius and age of the cosmos results in a return to the past by changing the structure of space-time. Value 3.14 in this sense is a maximum, therefore the increase in its value no longer increases the age of the universe.

2.10 Effect of maximum or minimum redshift on the Earth's mass: the mass of the present and initial universe

If the Earth's size and surface gravity do not change in Formula 32, the Earth's mass will have to multiply as the redshift increases due to the inverse proportionality. The degree of mass increase should be equal to the degree of redshift in the case of other factors being unchanged.

In this case, the Earth's mass would be equal to $2\pi/\alpha$ to the power of 3. Numerically this is:

$$v_{at\ c} = H_{0\ at\ c} \cdot \left(\frac{2 \cdot \pi}{\alpha}\right)^3 \cdot \frac{v - v_0}{v_0} \cdot \frac{c^2}{g_{Earth}} \cdot \frac{\pi \cdot c^2 \cdot R_{Earth}}{G \cdot \left(\frac{2 \cdot \pi}{\alpha}\right)^3 \cdot M_{Earth}} \cdot \frac{1}{3.08567758 \cdot 10^{22}} \cdot (32)$$

Given that the formula contains well-defined parameters of the universe in close algebraic and geometric contexts, it can be assumed that this extrapolated value would be equal to the entire mass of the present universe ($M_{universe\ present}$) (Nagy 2016).

Based on a similar consideration, the third power of the reciprocal angles $(\alpha/2\pi)^3$ allows for the determination of the mass of the initial cosmos ($M_{universe\ initial}$):

$$v_{at\ c} = H_{0\ at\ c} \cdot H_{universe\ present\ Mpc} = H_{0\ at\ c} \cdot h \cdot \frac{2 \cdot \pi}{\alpha} \cdot \frac{1}{3.08567 \cdot 10^{22}} \cdot (33)$$

This is detailed:

$$v_{at\ c} = H_{0\ at\ c} \cdot \left(\frac{\alpha}{2 \cdot \pi}\right)^3 \cdot \frac{v - v_0}{v_0} \cdot \frac{c^2}{g_{Earth}} \cdot \frac{\pi \cdot c^2 \cdot R_{Earth}}{G \cdot \left(\frac{\alpha}{2 \cdot \pi}\right)^3 \cdot M_{Earth}} \cdot \frac{1}{3.08567 \cdot 10^{22}} \cdot (34)$$

The extrapolated mass of the Earth separated from the formula is:

$$M_{universe\ initial} = \left(\frac{\alpha}{2 \cdot \pi}\right)^3 \cdot M_{Earth} = 1.087757554 \cdot 10^{-27} \cdot 5.97219 \cdot 10^{24} \text{ kg} = 6.496294 \cdot 10^{-5} \text{ kg} \cdot (35)$$

This mass may be the substance which existed at the time of the creation of the universe (Nagy 2016).

In these cases, the variable members in the formulae attain their maximum or minimum values (Eq.33 and Eq.35). Higher values for the mass of the cosmos, satisfying both equations up and down by $(2 \cdot \pi/\alpha)^3$ or $(\alpha/2 \cdot \pi)^3$, cannot be mathematically or physically interpreted in this model.

2.11 Increase in the Earth's surface gravity due to redshift growth

In addition to the above ideas, if the redshift is greater than 3.14 with $2\pi/\alpha$ for example, the Earth's surface gravity (1g) will increase to a similar extent ($2\pi/\alpha$) if the other parameters of the Earth remain unchanged. (This is probably due to gravity wave compression, or on the contrary, a gravitational wave rarefaction may occur). Since:

$$v_{at\ c} = H_{0\ at\ c} \cdot H_{univ.\ pres.\ Mpc} = H_{0\ at\ c} \cdot \frac{2 \cdot \pi}{\alpha} \cdot \frac{H_{univ.\ pres.\ Mpc}}{\frac{2 \cdot \pi}{\alpha}} = H_{0\ at\ c} \cdot \frac{2 \cdot \pi}{\alpha} \cdot \frac{h \cdot \frac{2 \cdot \pi}{\alpha}}{\frac{2 \cdot \pi}{\alpha}} \cdot \frac{1}{3.08567758 \cdot 10^{22}} \cdot (36)$$

$H_{\text{universe present}}$ is detailed and $2\pi/\alpha$ is raised before g:

$$v_{at\ c} = H_{0\ at\ c} \cdot \frac{2 \cdot \pi}{\alpha} \cdot \frac{v - v_0}{v_0} \cdot \frac{c^2}{\frac{2 \cdot \pi}{\alpha} \cdot g_{Earth\ stand}} \cdot \frac{\pi \cdot c^2 \cdot R_{Earth\ mean}}{G \cdot M_{Earth}} \cdot \frac{1}{3.08567758 \cdot 10^{22}} \quad (37)$$

In this case the value of g increase ($4.513249028 \cdot 10^9 \cdot 9.80665 \text{ m} \cdot \text{s}^{-2} = 4.426 \cdot 10^{10} \text{ m} \cdot \text{s}^{-2}$), which in itself compensates for the increase in redshift ($4.513249028 \cdot 10^9$), leaving the radius of the universe constant and the light-speed universe expansion unchanged.

2.12 Inverse effect of extreme redshift on the radius of the universe

Based on the above, it has been proved that the extreme increase in the Earth's redshift was compensated for by a change in a parameter of the planet and thus the cosmic radius remained unchanged. Therefore, if the parameters of the Earth change for it to become a black hole with a constant mass (Eq.30), it is illogical that the remaining redshift ($2\pi/\alpha$) increases the radius of the universe beyond all boundaries; there must be a hidden factor in the formula that prohibits this. Therefore, if the redshift rate continues to increase, the redshift exclusively causes distance contraction. Thus, the radius of the cosmos does not change and the expansion of the universe at the speed of light remains constant:

$$v_{at\ c} = H_{0\ at\ c} \cdot \left(\frac{2 \cdot \pi}{\alpha}\right)^3 \cdot \frac{\alpha}{2 \cdot \pi} \cdot \frac{v - v_0}{v_0} \cdot \frac{c^2}{\frac{2 \cdot \pi}{\alpha} \cdot g_{Earth\ stand}} \cdot \frac{\pi \cdot c^2 \cdot \frac{\alpha}{2 \cdot \pi} \cdot R_{Earth\ mean}}{G \cdot M_{Earth}} \cdot \frac{1}{3.08567758 \cdot 10^{22}} \quad (38)$$

In addition to this, a significant time dilation occurs as the redshift increases further, when it can no longer be converted to gravity and the size of the Earth cannot be reduced. With this phenomenon a value greater than the 3.14 redshift of the current universe would result in an extreme increase in size that would be eliminated by increasing time dilation.

The relationship between distance (x) and time (t') based on the Lorentz transformation is:

$$x = c \cdot t' \quad (39)$$

This principle is as follows relative to the radius of the universe ($H_{\text{universe present}}$):

$$H_{\text{universe present}} = 2.99792458 \cdot 10^8 \text{ m} \cdot \text{s}^{-1} \cdot 4.3345010 \cdot 10^{17} \text{ s} = 12.9945 \cdot 10^{25} \text{ m} \quad (40)$$

When the redshift is $(2\pi/\alpha)^3$, the movement of clocks gradually slows down. According to Equation 41, carrying the radius-reducing factor implicitly incorporates time dilation. Therefore, the increase in the value of $H_{\text{universe present}}$ is equalized by time dilation. Specifying the $H_{\text{universe present}}$ component of the equation and using the $(2\pi/\alpha)^3$ ratio:

$$v_{at\ c} = H_{0\ at\ c} \cdot \left(\frac{2 \cdot \pi}{\alpha}\right)^3 \cdot \frac{c \cdot T_{\text{universe present}}}{\left(\frac{2 \cdot \pi}{\alpha}\right)^3} = 71.1887 \frac{\text{km}}{\text{s} \cdot \text{Mpc}} \cdot 4.3345 \cdot 10^{17} \text{ s} = 308.567694 \cdot 10^{17} \frac{\text{km}}{\text{Mpc}} \quad (41)$$

Simplifying Equation 41 with c ($v_{at\ c} = c$) and $(2\pi/\alpha)^3$ and knowing that 1 Mpc is equal to $3.08567758 \cdot 10^{22} \text{ m}$:

$$1 = 308567.694132 \cdot 10^{17} \text{ m} \cdot \frac{1}{3.08567758 \cdot 10^{22} \text{ m}} = 0.999999793 \quad (42)$$

In this case, the seriatim rising universe radius decreases due to the continuous increase in the time interval. Therefore, the value ($H_{\text{universe present}}$) measured at redshift 3.14 does not change (Eq.7). In

other words, with a redshift of 3.14 an extreme degree of distance increase would occur resulting in a three-dimensional extension enlargement of the early stage of the cosmos that is canceled by time dilation (Fig.9). When viewed from an opposite direction in time, from the distant past towards the past (down to the 3.14 redshift) the opposite occurs; the immense decrease in time dilation requires an extreme degree of three-dimensional size decrease (distance contraction) to eliminate this initial excessive collapse of the universe.

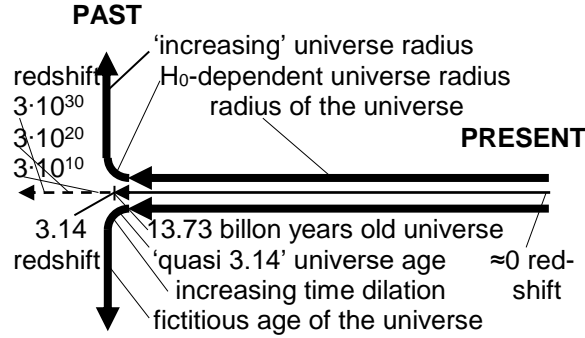

Figure 9

Figure 9. The division of the radius and age of the universe according to its essential elements in the case of extremely rising redshifts.

3. Calculation of the size of the Earth

The 'short evolving distance' (h) (Eq.3) can be provided (h_h) by the ratio of the deviating angle (α) of a light beam passing near the Earth's surface as a result of the gravitational field (g) and of the entire plane angle (2π): $h_h/\alpha = h/2\pi$, therefore $h_h = h \cdot \alpha/2\pi$ (Herrmann 1990). With this ratio, a previously unknown length can be calculated which falls in the range of the radius of the Earth.

The deviation angle (α) of a light beam, which passes near a celestial body's surface according to Einstein's formula, is: $\alpha = 2 \cdot G \cdot M \cdot c^{-2} \cdot R^{-1}$. Therefore:

$$h_{h(Earth)} = \frac{v-v_0}{v_0} \cdot \frac{c^2}{g_{Earth\ stand}} \cdot \frac{2 \cdot G \cdot M_{Earth}}{c^2 \cdot R_{Earth\ mean}} \cdot \frac{1}{2\pi} = \frac{v-v_0}{v_0} \cdot \frac{G \cdot M_{Earth}}{g_{Earth\ stand} \cdot R_{Earth\ mean} \cdot \pi}, \quad (43)$$

where $h_{h(Earth)}$ is the radius of the Earth, $(v-v_0)/v_0$ is the ratio of redshift of the Milky Way Galaxy (including the Earth), c is the speed of light ($2.99792458 \cdot 10^8 \text{ m} \cdot \text{s}^{-1}$), G is the gravitational constant ($6.673848 \cdot 10^{-11} \text{ m}^3 \cdot \text{kg}^{-1} \cdot \text{s}^{-2}$), M is the mass of the Earth ($5.97219 \cdot 10^{24} \text{ kg}$), g is the standard gravity of the Earth ($9.80665 \text{ m} \cdot \text{s}^{-2}$), π is 3.141592 and R is the volumetric mean radius of the Earth ($6.371005 \cdot 10^6 \text{ m}$). (The parameter references are the same as in Equation 7.)

When this method is extended to such a large redshift of 3.141592, which can be measured at farther stars (Bacon et al. 2017), substituting the values into the formula, the equatorial radius of the Earth can be calculated:

$$h_{h(Earth)} = 3.141592 \cdot \frac{6.673848 \cdot 10^{-11} \text{ m}^3 \cdot \text{kg}^{-1} \cdot \text{s}^{-2} \cdot 5.97219 \cdot 10^{24} \text{ kg}}{9.80665 \text{ m} \cdot \text{s}^{-2} \cdot 6.371005 \cdot 10^6 \text{ m} \cdot 3.141592} = 6379.42 \text{ km}. \quad (44)$$

This average Earth radius, taking into account the changes created by the introduction of the four-dimensional space-time, can take smaller and larger values. As a result, the mean that gradually unfolds in the negative and positive directions can decrease to a minimum of 4.947 ($6.379 \cdot 0.7756$) km or to a maximum of 8.224 km ($6.379 \cdot 1.2893$). These differences in size can be explained by the uncertainty of the true position of the Earth (similar to the uncertainty of the radius of the universe), that is, by changes in its angle of view. This may be related to its orbit around the Sun, or to certain phases of its formation in the past.

3.1. The time needed for light to run the radius of the Earth

The distance of the Earth's radius ($h_{h(\text{Earth})}$) will be run by light (c) in the following time ($T_{h(\text{Earth})}$):

$$T_{h(\text{Earth})} = \frac{h_{h(\text{Earth})}}{c} . \quad (45)$$

Numerically:

$$T_{h(\text{Earth})} = \frac{6.37942 \cdot 10^6 \text{ m}}{2.99792458 \cdot 10^8 \text{ m} \cdot \text{s}^{-1}} = 2.12794546 \cdot 10^{-2} \text{ s} , \quad (46)$$

This time interval multiplied by $2 \cdot \pi / \alpha$ is:

$$T_{h(\text{Earth})} \cdot \frac{2 \cdot \pi}{\alpha} = \frac{6.283185307179}{1.392164551 \cdot 10^{-9}} \cdot 2.12794546 \cdot 10^{-2} \text{ s} = 9.60394778 \cdot 10^7 \text{ s} . \quad (47)$$

It is $(9.60394778 \cdot 10^7 \text{ s} / 60 / 60 / 24)$ 1111.5680301 days; divided by π this is 353.8231 days (which is approximately 1 tropical year /365.242189 days/). (In formula 4.a, the distance traveled by light in non-gravity space should be multiplied by π , but here the time, Eq.46 and Eq.47, resulting from the Earth's radius from the distance created by gravity, h , should be divided by π due to symmetry.) Their rate $(353.8231 \text{ day} / 365.24219 \text{ day})$ is 0.968735, which is the same as in Equation 4.a, the proportion of the distance of light propagating in 1g gravity (c_0) and non-gravity space (c).

3.2. Relationship between the radius of the Earth running by light and of the age of the cosmos

If the time interval ($T_{h(\text{Earth})}$) in Equation 46 is multiplied by $(2 \cdot \pi / \alpha)^2$, it could determine the entire age of the universe:

$$T_{\text{universe present}} = \left(\frac{2 \cdot \pi}{\alpha} \right)^2 \cdot T_{h(\text{Earth})} . \quad (48)$$

Numerically, this is:

$$T_{\text{universe present}} = \left(\frac{6.283185307179}{1.392164551 \cdot 10^{-9}} \right)^2 \cdot 2.12794546 \cdot 10^{-2} \text{ s} = 4.3345 \cdot 10^{17} \text{ s} . \quad (49)$$

Since one tropical/solar year is 365.242189 days long or $3.1556926 \cdot 10^7 \text{ s}$, this value (Eq.49) equates to 13.7355 billion years. It is equal to the result of the method for determining the age of the universe in Equation 7. (Multiplied by 0.968735, the result is 13.306 billion years, divided by the same number it can be 14.179 billion years as before, see section 2.6.)

6. Discussion

In attempting to establish a link between basic physical laws and attempts to describe nature as a whole, some important circumstances must be taken into account. Using the ratio of the complete angle and the deviating angle of a light beam passing through the gravitational field of the Earth symmetrically ($\alpha/2\pi^{-1}$ and $2\pi/\alpha$) could determine the age of the universe and the radius of the Earth as well. The multiplication and division by π , $2\pi/\alpha$ refers to the correlations between the common mathematical (geometrical) and physical bases of phenomena. However, for this solution it is advisable to consider the following aspects and introduce all necessary changes.

1. A paradigm change has to be made in the movement of the Earth and a special motion assigned to it with correlation to the notion of an expanding universe.

2. An example needs to be found in the cosmos to have a sufficiently long homogenous gravitational field, which fits the Einstein requirement by the enormous motion of the Earth with light propagation in its gravitational field.

3. Einstein's formulae describing the redshift phenomenon and the light deflection effect must be linked by classical geometry.
4. The specified one-dimensional universe radius shall be related to four-dimensional space-time through the introduction of the gravitational index of refraction and the geometric shape thereby constructed.
5. By introducing a Hubble constant defined in a universe expanding at the speed of light and utilizing known Earth parameters, it is possible to examine changes in many cosmological parameters (distance, time, mass, space-time curvature) associated with all redshifts in the cosmos.

7. Conclusion

The purpose of this dissertation was to find other relatively stable points in the universe using known physical constants. With the introduction of well-defined parameters, it was still desirable to reduce uncertainties due to phenomena that are not completely known in the cosmos and only partially revealed data. Moreover, from the aspect of the high redshifted Milky Way Galaxy (including the Earth) in correlation with the expanding universe, it may also describe the cosmos from various points of view. The resulting increase in precision in this simplified model is suitable for evaluating the various astronomical measurement results obtained and for creating correlations. Analyzing and discovering these relationships can help us understand our universe in a less complicated way.

8. Acknowledgments

I would very much like to thank all of those who, over the course of the last three decades, have commented on specific and sundry details relating to this topic, or have reviewed this thesis and, consequently, contributed to its development and completion: Prof. Péter Raics, physicist (University of Debrecen); Prof. István Lovas (ATOMKI); Csilla Csóri Blaskóné, mathematician, Ágnes Papp and Zoltán Dankó, physicists (Kenézy Hospital); Zoltán Nagy mechanical engineer. Finally, I am grateful to my father, Zoltán Nagy Ph.D., a chemist (University of Debrecen) who taught me the basics of spectroscopy.

Figures (1.a, 1.b, and 9) are not to scale.

References

- Bacon, R., Conseil, S., Mary, D., et al. 2017, The MUSE Hubble Ultra Deep Field Survey, *A&A*, **608** A1
- Beckwith, S.V.W., Stiavelli, M., Koekemoer, A. M., et al. 2006, The Hubble Ultra Deep Field, *AJ*, **132** No.5. 1729-1755.
- Bennett, C.L., Larson, D., Weiland, J. L., et al. 2013, Nine-Year Wilkinson Microwave Anisotropy Probe (WMAP) Observations: Final maps and results, *AJ*, Supplement Series, 208:20 p. 54
- Chaboyer, B. 1996, The age of the universe, *Nuclear Physics B, Proceedings Supplements*, **51**, 2, pp. 10-19
- Committee on Data for Science and Technology (CODATA) 2010, Recommended Values of the Fundamental Physical Constants, <https://physics.nist.gov/cuu/Constants/index.html>.
- Convert Units - Measurement Unit Converter, Convert tropical year to seconds <https://www.convertunits.com/from/tropical+year/to/seconds>
- Dunford, B. 2012, Solar System Exploration: Earth: Facts & Figures <http://solarsystem.nasa.gov/planets/earth/facts>
- Einstein, A. 1916, *Relativity: The Special and General Theory* (Translation 1920), New York: H. Holt and Company
- Einstein, A. 1911 Über den Einfluß der Schwerkraft auf die Ausbreitung des Lichtes, *Ann Phys.*, **35**, pp. 898-908.
- Herrmann, J. 1990, *dtv-Atlas Astronomie München*. Deutscher Taschenbuch Verlag GmbH & Co. ISBN 3423030062, ISBN-13: 9783423030069
- Hubble, E.P. 1926, "Extragalactic nebulae", *ApJ*, **64**, (64): 321–369.
- Hubble, E.P. 1929, A relation between distance and radial velocity among extra-galactic nebulae. *Astronomy* **15** (3):168-173.
- Huchra, J. 2010, Estimates of the Hubble Constant <https://www.cfa.harvard.edu/~dfabricant/huchra/hubble.plot.dat>.
- Jimenez, R. 1998, Globular cluster ages, *PNAS*, **95**, (1) pp. 13-17

- Krauss, L.M., Chaboyer, B. 2003, Age Estimates of Globular Clusters in the Milky Way: Constraints on Cosmology, *Science*, **299** 3
- Lemaitre, G. 1931, The Beginning of the World from the Point of View of Quantum Theory, *Nature*, **127**, 706
- Lemaître, G. 1933, "l'Universen expansion", *Annales de la Société Scientifique de Bruxelles*, A53: 51–85
- Nagy, E.T. 2015, The age of the universe the size of the Sun and planets based upon the Theory of General Relativity and Euclidean geometry, v1.0, <http://vixra.org/abs/1509.0254>.
- Nagy, E.T. 2016, Determining the size, mass, gravity and density of the present and primordial universe by means of a modified Einstein's gravitational field equation, v1.0, <http://vixra.org/abs/1609.0299>
- Planck Collab. 2015, *Results XIII*, *A & A*, 594, A13 (2016).
- Riess, A.G., Macri, L. M., Hoffmann, S.L., et al. 2016, A 2.4% determination of the local value of the Hubble constant, *ApJ*, 826, 56
- ScienceDaily 2019, New Hubble constant measurement adds to mystery of universe's expansion rate
NASA/Goddard Space Flight Center
<https://www.sciencedaily.com/releases/2019/07/190716095501.htm>.
- Shajib, A. J., Birrer, S., Treu, T., et al. 2019, A 3.9 per cent measurement of the Hubble constant from the strong lens system, *AJ*, DES, J0408-5354

28 April 2020