

# Electrons, Electric Fields and Currents: Houston, we have a Problem

by David Johnson

## Introduction

There are many of the unknowns, problems and inconsistencies related to electric charge, electric fields and electric currents, and that well-known Apollo 13 movie quote *'Houston, we have a problem'* seems appropriate. This paper explores how a change of model for the electron can redress many of these problems so that [Jack Swigert's original assertion](#): *'Houston, we've had a problem here'*, indicating the problem has been resolved, can be used.

## Electron Models

The **electron** is a well-studied and documented **elementary particle**. The classical (or conventional Science) view is based upon the **Orbital Nuclear Atomic Model (ONAM)**, which assumes the **electron** to be a **point-form monopole particle** that carries a **negative charge** and which satisfies the **Dirac wave equation**. When the point-form elementary particle carries a **positive charge** it is considered to be a **positron**.

A well-documented alternative model to classical ONAM approach is the **Toroidal Solenoidal Electron (TSE)** which defines the electron as a spinning point electric charge that moves at high speeds in a solenoidal pattern around a torus-shaped pathway. More recently the **Charged-Electromagnetic-Wave-Loop (CEWL)** model, which also satisfies the Dirac equation, differs from the TSE model in that the energy of its torus core has no solenoidal spin component.

The ONAM, TSE and CEWL models all **assume** that electrons have an **inherent** negative electric charge and that positrons have a distinctly different positive electric charge. **STEM** (the **Spin Torus Energy Model**) resembles the CEWL model most closely, but differs in that it considers the electric charge associated with electrons and positrons to be due to **different chiral flow patterns** of their outer **energy-fields** rather than being due to **inherent positive and negative electric charge** manifestations.

## From Bitrons to Electrons and Positrons

STEM uses the term **'bitron'** for an elementary particle that can be converted into either an **electron** or a **positron**. A **neutral bitron** consists of a torus core of concentrated energy that moves or spins around its z-axis (see figure 1) and thins radially outwards in its X-Y plane to form a flattened, edge-stretched, discus-like torus.

The transition from concentrated core to the less concentrated discus-like shim is possibly due to centrifugal action, or the thinning could occur naturally and merely be shaped by the centrifugal action of the torus spin. The physical characteristics of the continuum change from an energy core that behaves more like a viscous liquid to the outer shim energy that behaves more as a gas or a vapour-like liquid.

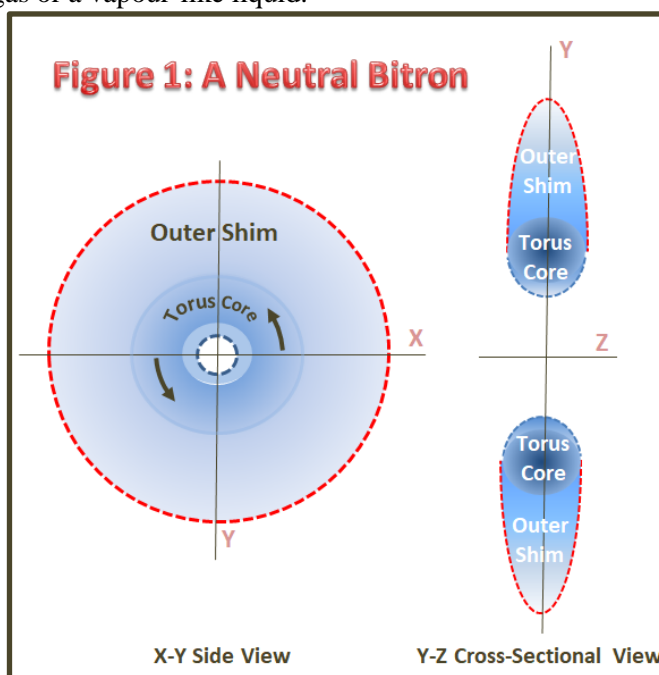

The outer shim is a bitron's **energy field**, which can become polarised by an applied **electromagnetic force (emf)** or via **magnetic induction**. An applied emf causes the energy core of bitrons to be sharply bump-moved in their z-axis (i.e. the spin axis) direction resulting in their field-energy shim taking on a conical shape that immediately collapses to form an outer torus-shaped field of **low-concentration field-energy** that circulates around the inner torus of core-energy. This process is called 'polarisation' and the field-energy of polarised bitrons has **chirality**, and that chirality determines whether it is an **electron** or a **positron** as shown in figure 2.

Neutral bitrons do not have **chirality**: look from one side and their spin direction is the reverse to that when looking from the other side; turn them 180° along any axis in the torus plane and their spin reverses. One neutral bitron looks exactly the same as another, and they are neither an electron nor a positron. When a neutral bitron is polarised, the direction of the bump-movement, which is dictated by the applied emf, together with its spin direction, determines whether it becomes an electron or a positron: should the direction of the applied emf be reversed then an electron can be converted into a positron and vice versa. This is a most important capability that helps to explain capacitor charge and discharge, semiconductor electric current generation, the chirality of circularly polarised light, and beta decay of atoms.

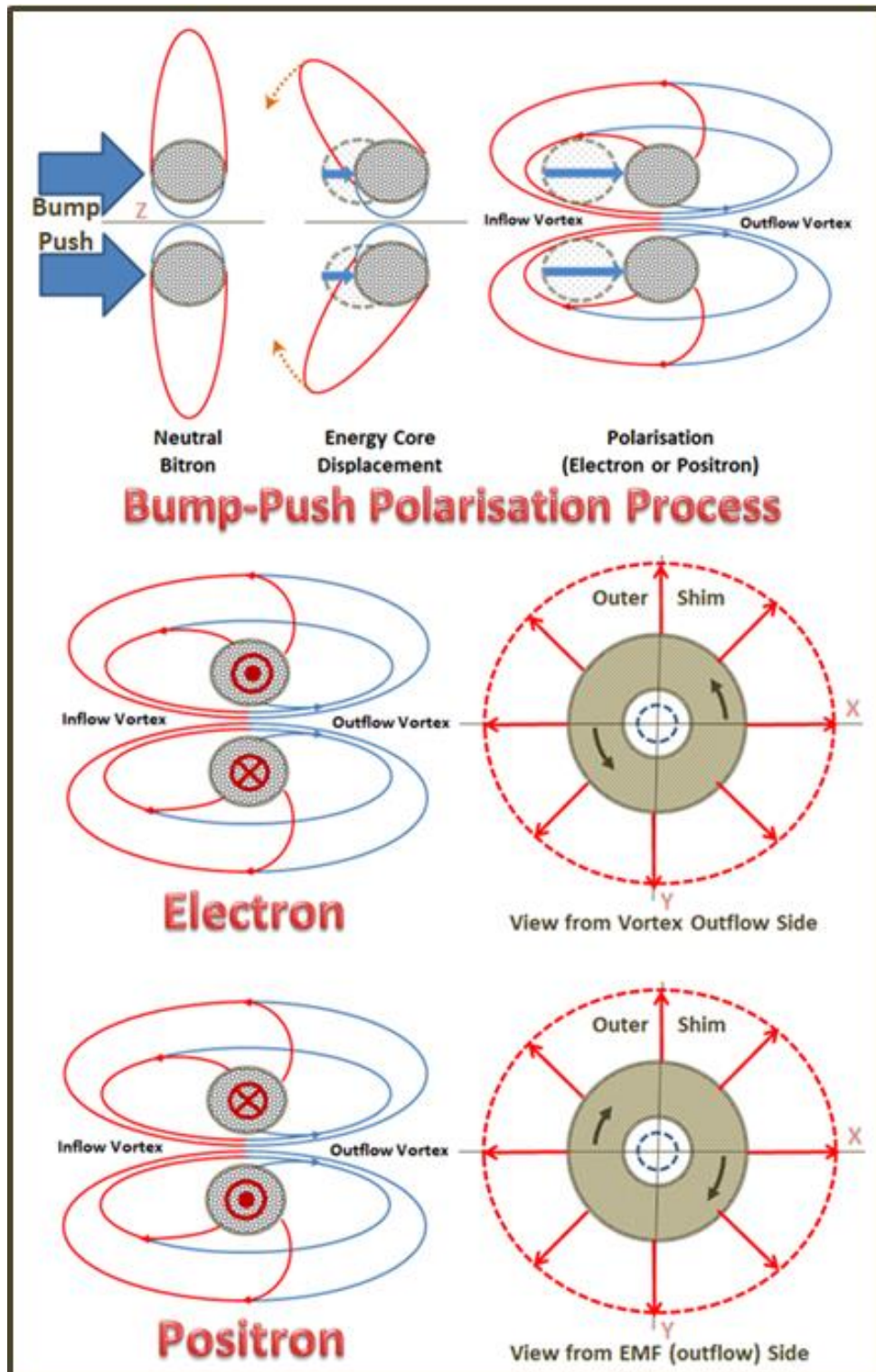

**Figure 2: Bitron Polarisation → Electrons and Positrons**

The STEM approach means that, within a metal conductor, both low-speed electrons and positrons are dynamically created and are only different in terms of their chirality as shown in figure 3. Note that the energy fields have both linear (z-axis direction) and circular (torus spin direction) flow components that diverge from one polar end and converge towards the other to create a **dipolar energy field**.

The possibility that positrons or positron-like particles might be present within materials such as electrical conductors runs contrary to the **Orbital Nuclear Atomic Model (ONAM)**. This situation is made worse (*'Houston, we have a new problem'*) by STEM suggesting that such low-speed positrons could be involved in the formation of **electric currents** in combination with electrons. The up-side of the STEM approach is that, unlike the ONAM approach, it does not rely upon the dubious concept of **positive holes** to explain the formation electric currents in **semiconductors** (e.g. diodes and LEDs), or to rely upon orbital distortion of atoms within dielectric materials to create a dipole effect to explain **capacitor charge and discharge**. *'Houston, we have some new solutions'*.

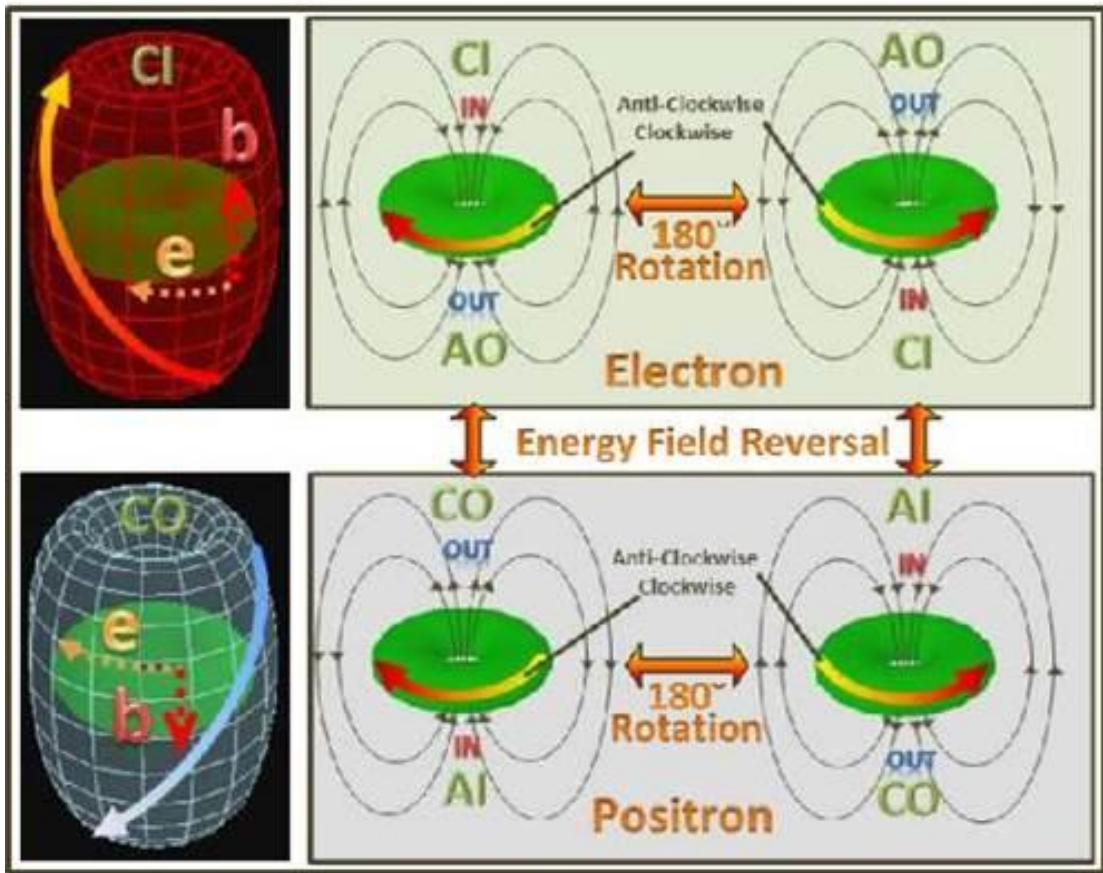

**Figure 3: Low-Speed Electrons and Positrons**

**Bump-push polarisation**, as described above, results in **low-speed** electrons and positrons that have insufficient kinetic energy to escape from their host medium.

Should a particle with high kinetic energy, such as sufficiently energised photons, collide with a neutral bitron, a **fast-speed** (or **kinetic**) electron or positron can be created. Such high-impact collisions cause the energy-core torus to move off at high speed, dragging its energy-field as a comet-like skewed-ellipsoidal shaped tail. As the leading outflow vortex is flattened and possibly non-existent, fast-speed electrons and positrons have the appearance and characteristics of a **monopole electric charge**, as shown in figure 4.

Free low-speed electrons and positrons exist only within their host material such as an electrical conductor and are involved in the generation of electric currents: they present as electromagnetic dipoles that can revert back to their neutral bitron form. They are quite different to their fast-speed counterparts and more appropriate names would possibly be 'e-bitrons' for low-speed electrons and 'p-bitrons' for low-speed positrons.

The energy field of free **fast-speed** or **kinetic** electrons and positrons is stable and they remain a monopole charged particle even when physically slowed down or made stationary (e.g. by a magnetic field). Apart from having the same energy-core size and structure to their low-speed equivalents, they are distinctly different to them and more closely resemble the monopole electrons and positrons of conventional Science. Fast-speed electrons and positrons are far easier to isolate and examine in a laboratory, but it could be a mistake to assume that they represent the same elementary particles that form electric currents and populate atomic orbitals. *'Houston, the problems may be more subtle than previously suspected'*.

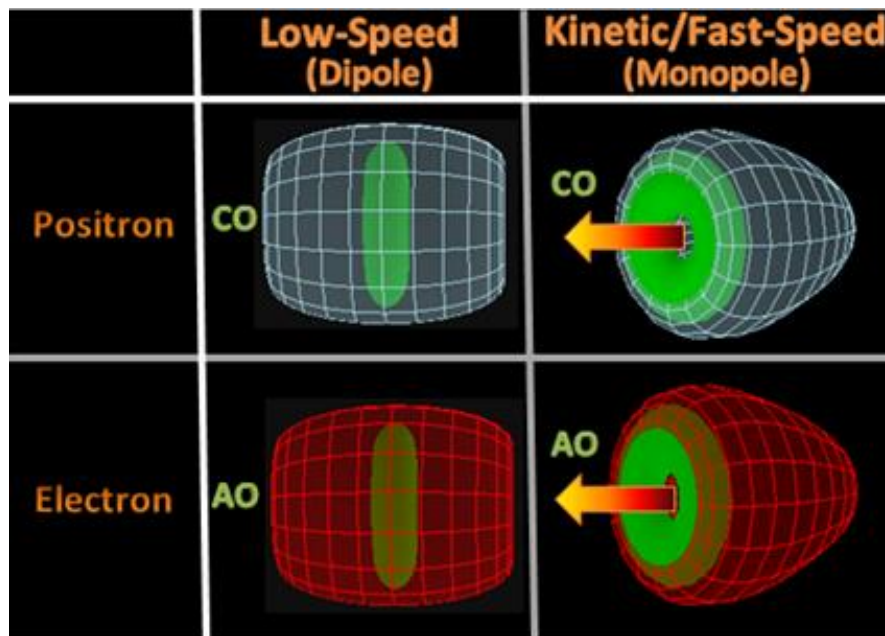

**Figure 4: Low and Fast-Speed Electrons and Positrons**

## Electric Currents

**Electric currents** result from the movement of electric charge caused by:

1. the movement of low-speed **electrons** from the **negative** terminal of a power source to the **positive** terminal, or
2. the movement of low-speed **positrons** from the **positive** terminal of a power source to the **negative** terminal, or
3. the simultaneous **duplex** movement of low-speed electrons and positrons in opposite directions.

The **Conventional Science** view is that an electric current is the movement of electrons from negative to positive terminal (as per point 1), or, for the purpose of calculations compatible with electrical trade polarity definition, consider it to be the movement of positive charge from the positive to negative terminal (as per point 2). STEM, on the other hand, contends that most common-use AC and DC electric currents result from the combined duplex movement of low-speed electrons and positrons (as per point 3 and shown in figure 5). Only electric currents generated by semiconductor-based **photovoltaic cells** and **photodiodes** consist of the one-way movement of electrons and positrons respectively.

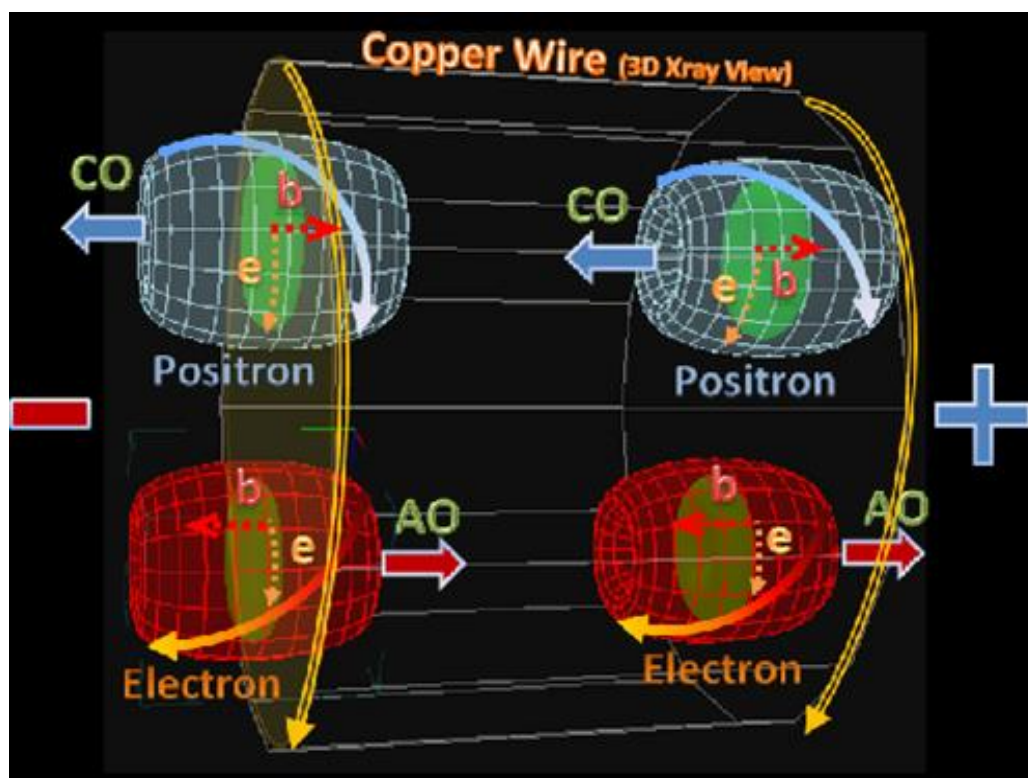

**Figure 5: Electrons and Positrons in a Current-Carrying Wire**

Note that in the duplex movement the electrons and positrons involved have the same spin direction and when they move as an electric current the linear charge-density increases resulting in a net circular flow of field-energy (the large curved orange arrows in figure 5) that presents as the **induced magnetic field** around a current-carrying wire conductor.

Furthermore, rather than moving independently along random meandering pathways through a conductor as suggested by conventional Science, STEM contends that low-speed electrons and positrons form into and move within linear like-spin groups called **strands**, such as shown in figure 6. Thus an **electric current** is considered to consist of **dipole electrons** and/or **positrons** moving within their respective strands away from a **source** terminal and towards a **sink** terminal. For chemical energy sources (e.g. batteries) the terminals represent physical sources-and-sinks, whereas induced currents have virtual or implied sources-and-sinks.

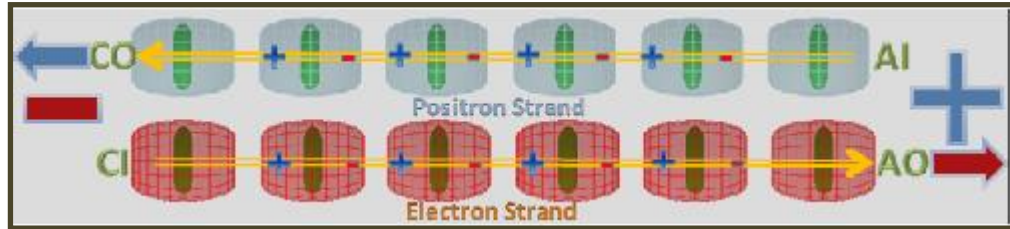
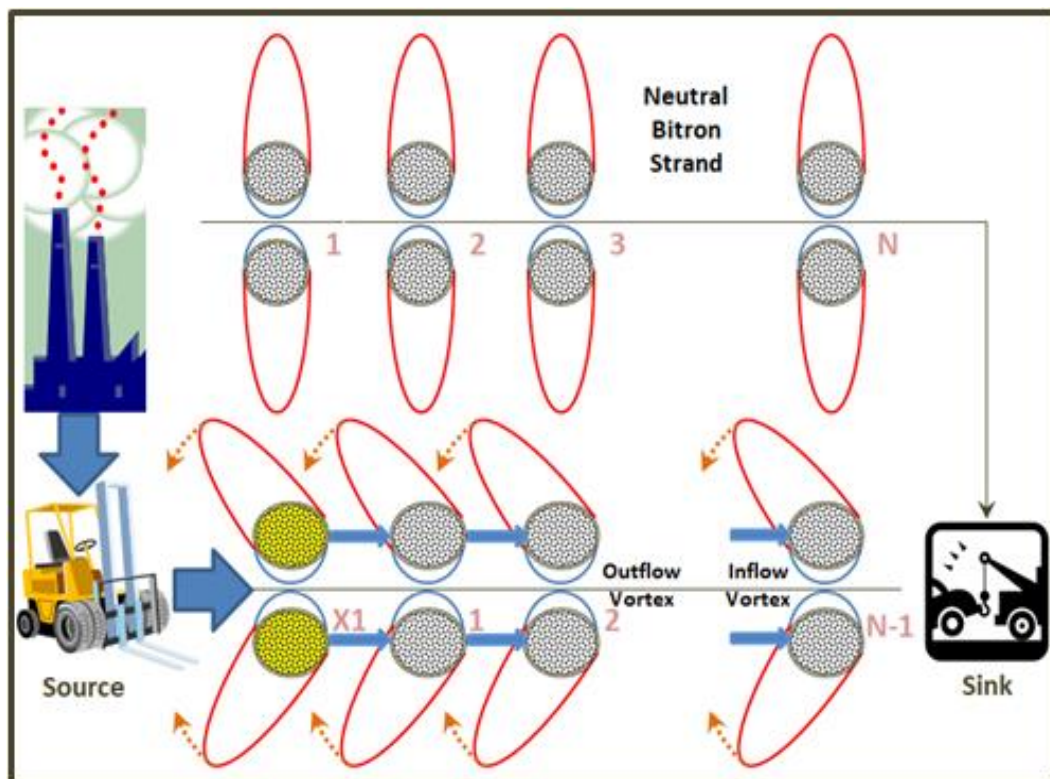

**Figure 6: Polarised Electron and Positron Strands**

Using the analogy of a factory production-and-dispatch system, the bitrons are produced by the energy-source *factory* and distributed via a network of strand-based *delivery channels* (the electric circuit). The *factory production rate* places pressure on the *delivery channels*: it is the power supply's **electromagnetic potential** or **emf** as measured in **volts**. The *delivery channels* can contain various *delivery routes* that each have their own *distribution rates* defined either by a **resistance** rating (in **ohms**) or by a charge-transfer rating (**current** in **amperes**) for an **applied emf**.

Whenever an obstacle (e.g. a resistor) is encountered within a *delivery route*, the two-way movement of electrons and positrons is restricted, causing a change in electric current inversely proportional to the resistance as indicated by **Ohm's Law**: for a resistor of **R ohms** ( $\Omega$ ) and emf (or an electric potential difference) of **V volts**, the corresponding charge movement rate is **V/R amperes**.

Figure 7 shows the bitron **source factory** that produces large numbers of same-spin bitrons. *New stock* (such as bitron X1) have to bump-push the energy-core of the end-member (bitron 1) at the source end of the targeted strand (shown as a neutral strand in figure 7) to the right to make room for itself: the sudden sideways movement of the forced entry polarises them both. Bitron 1 then proceeds to bump-push bitron 2, so polarising it instantaneously, with the bump-push-and-polarise process continuing as a chain reaction rippling along the length of the strand to create or to re-enforce a **polarised strand**.



**Figure 7: Strand Polarisation by the Bump-Push process**

When the power source is attached and the circuit is first switched ON, the new bitron arrivals cause **strand-compactation**, with each member being bump-shuffled along by its neighbour so polarising them and bringing strand members closer together without the need for any members to be removed by the **sink**. However, the shuffle-movement of the compactation process still represents a movement of electric charge, and thus the start of an **electric current**, but it is only a micro-current lasting a few microseconds as the circuit is powered up (should there be a flat-plate **capacitor** in the circuit, compactation lead-time can increase significantly as discussed in the [capacitor charge and discharge](#) chapter).

After the compactation phase, more space has to be created within strands to accommodate additional bitrons, and this can only be achieved by the end member (bitron N in figure 7) of the strand being popped off and absorbed by the corresponding sink. As there is a distinct possibility that several bitrons might have already been removed by the sink prior, the push-and-pop action is far more likely to be **asynchronous** rather than synchronous.

Let us consider a **simple electric circuit** consisting of a power source, a resistor and an ON/OFF switch (i.e. a circuit breaker). When the circuit is first powered up with the switch being ON, after strand compactation and initial polarisation, an electric current will flow around the circuit. When the switch is then turned to the **OFF** position, polarised bitrons cannot move across the circuit break, and thus the electric current stops, which in turn causes the induced magnetic field around the wire conductor to disappear.

However, in spite of the power being turned OFF, the polarised strands remain polarised as the power source is still active and attempting, albeit unsuccessfully, to push more bitrons into circuit strands. Polarised strands thus remain polarised until the power source is physically completely disconnected, which allows strands to return to their neutral mode, or until the polarity of the power source is reversed. These are important issues as we shall soon discover in the next chapter about electric fields.

## Strands and Electric Fields

Whereas figure 7 represents a snapshot of strand members in the process of being polarised, figure 8 represents the fully polarised strands. The **green crosses** in the top part of figure 8 indicate the zones where the linear (z-axial) component of the energy-fields of adjacent polarised bitrons cancel each other out, so that there is just a circular component to the field-energy flow in this region between bitrons.

The linear flow components of a polarised strand become concentrated in an **outer flow tube** of spiralling (i.e. it has a solenoidal-like circular motion) field-energy, and a quite powerful concentrated **central flow** of fast-moving field-energy that spirals through the centre of the torus core of each strand member.

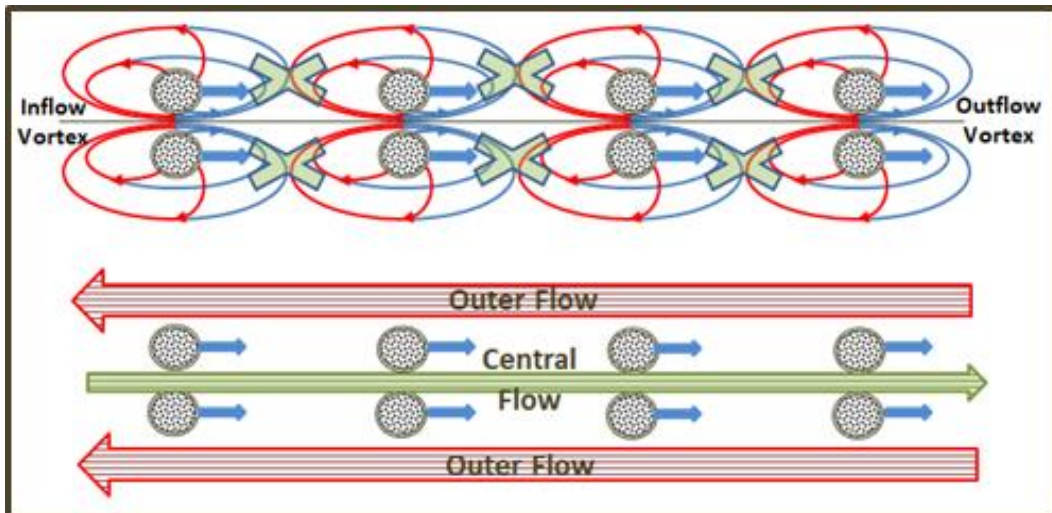

**Figure 8: The Inner and Outer Flow Zones of Polarised Strands**

Should a pointed metal **probe** be attached to each terminal of the power source, compactation causes those strands with the appropriate spin-direction within each probe to become polarised but, because each probe does not have access to an appropriate sink, no current can flow through the probes. Instead **electric fields** develop around the probe tips regardless of whether the attached circuit switch is ON or OFF: this phenomenon, which is never adequately addressed by conventional Science, deserves explanation. *'Houston, can you resolve our problem?'*

No current flows through the probes because the post-compactation polarised bitrons cannot move forward to a sink. The **central flow** zone of the polarised strands within the probes represent a strong concentrated directional flow of field-energy that pushes forward to extend well beyond the probe tip as **wisps** (see figure 9).

Wisps derived from e-strands are called **e-wisps** and those from p-strands are called **p-wisps**. At the outer surface of the probe tip the e-wisps present as a **negative electric monopole field**, which, depending upon the strength of the power supply, extends well beyond the end of the probe tip. The probe attached to the positive terminal generates p-wisps which present as a **positive electric monopole field**.

When e-wisps and p-wisps associated with positive and negative monopole charges join, they create **threads**. Thus the **electric fields** are the projection of e-strand and p-strand energy beyond the outer surface of the probe tips, with the wisps and threads so produced collectively representing the **electric lines of force**. Note that threads only have a circular spin component rather than the negative-to-positive energy flow indicated by conventional electric lines of force diagrams. *'Houston, we have conflicting solutions to our problem'*.

The spherical **equipotential lines** for the electric fields around the electric point charges represent the drop-off of field-energy concentration moving away from the probe surface, and are shown as blue and red dashed circles in the 2-dimensional cross-section shown in figure 9.

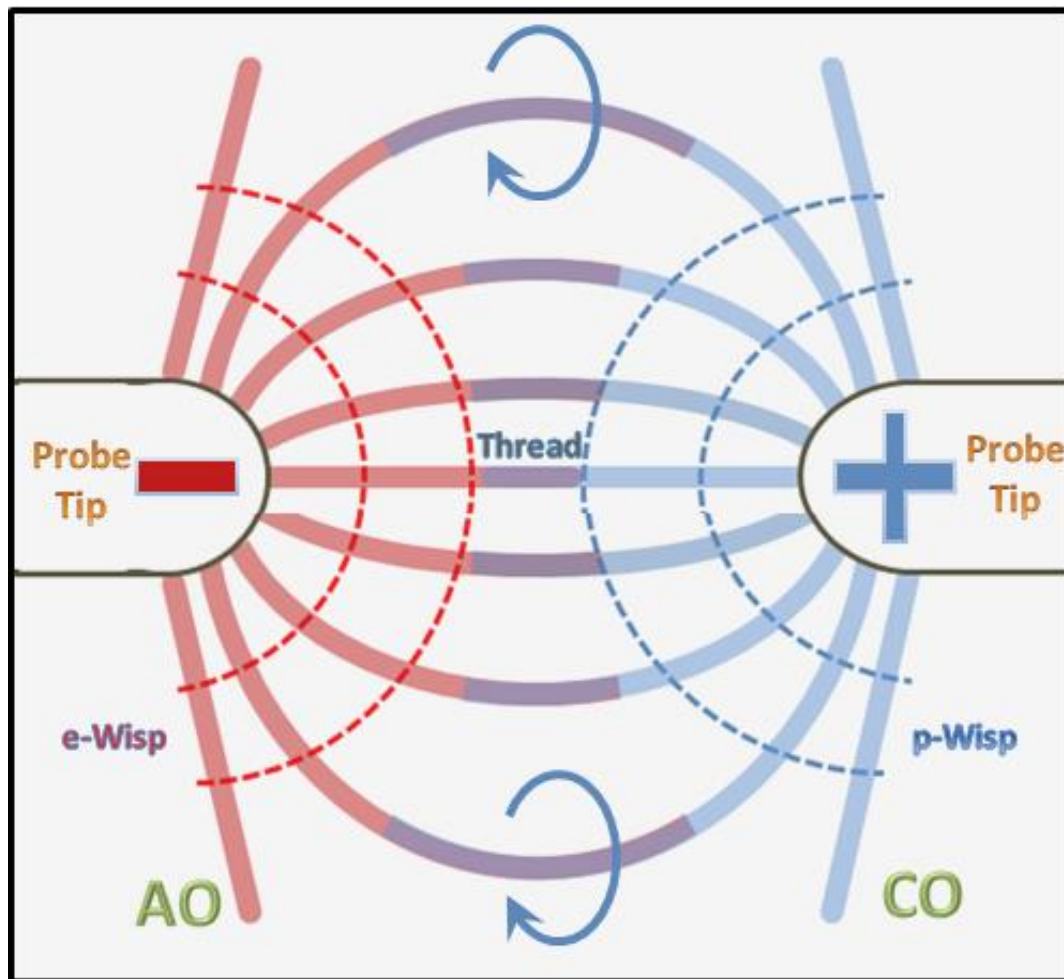

**Figure 9: Lines of Force between Oppositely Charged Probe Tips**

The two probes attached to opposite polarity terminals of the power source thus represent **oppositely charged electric monopoles**. When they are brought closer together, the thread density increases as more e-wisp and p-wisp pairs join, so increasing their mutual attraction; the reverse effect occurs as they are moved further apart. When the probes are about to touch, some outer electrons of e-strands prematurely jump the gap, ionising other molecules along the way so as to generate heat and light that ranges from an **electric spark** to an **electric arc**.

Note that, compared with electrons, positrons require much more encouragement to coerce them to leave the host material, and thus it is mainly electrons that prematurely jump the gap from the negatively charged probe to the positively charged probe.

By the time that the two probes are in physical contact with each other, the circuit's energy now has a pathway that offers zero resistance and an un-moderated rapid transfer of energy results which is called a **short-circuit**.

Should the probes be attached to flat metal plates that are parallel and close to each other, we have a **capacitor**, the function of which is explained in the next chapter. Probes can also be considered to be mini-capacitors but their tip-to-tip capacitor charge-holding ability is miniscule and can be considered to be non-existent.

## Capacitor Charge and Discharge

A **capacitor** consists of a thickness of dielectric sandwiched between a positively and a negatively charged surface. Energy is stored within the **threads** of an electric field that develops across the capacitor during the **capacitor charge** process, which can be released to induce an electric current as **capacitor discharge**.

The capacitor represents circuit break in an open circuit, with the **central flows** of e-strands on the negative terminal side of the capacitor and p-strands on the other side to join as electric field **threads**. During the **charge phase** (figure 10a) the polarised strands become more compacted resulting in a charge movement (i.e. current flow) that progressively reduces as the thread charge densities build and widen (see the orange and green dashed plots in the figure 10b graphs).

**Back-pressure** from increasing thread charge densities reduces compaction-related charge movement commensurately until all electric current flow leading to the capacitor plates via resistor  $R_C$  ceases. The capacitor then is **fully charged**, with the back-pressure from the threads forming the electric field between the capacitor plates equalling the emf voltage applied by the power source to that branch of the circuit.

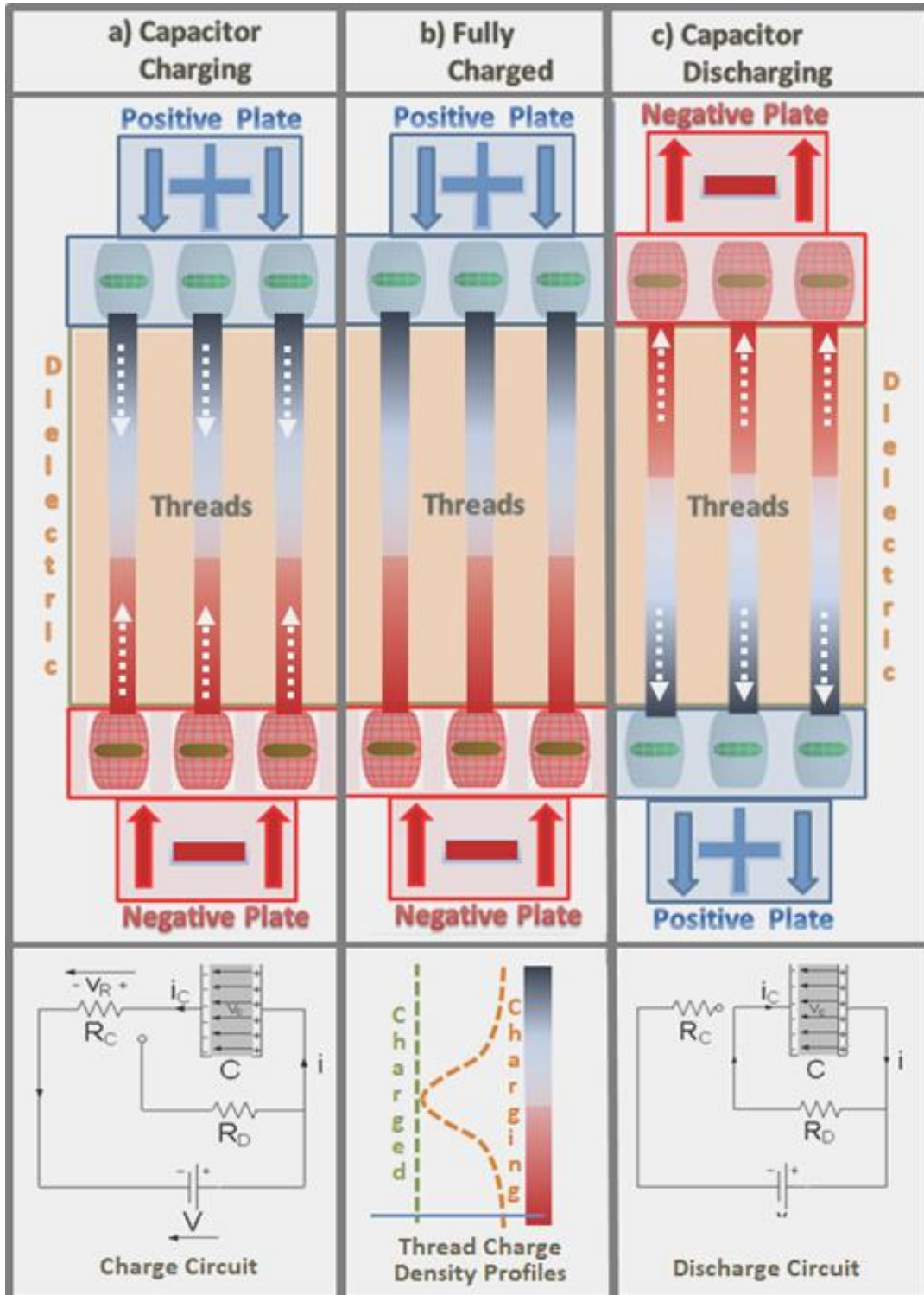

**Figure 10: Capacitor Charge and Discharge**



For the **discharge phase**, the charging power supply and  $R_C$  are switched out as in figure 10c circuit diagram, which causes the polarised bitrons to return to neutral mode. However, the switching out of the charging power supply also releases spring-like all the energy concentrated within the capacitor threads, which is equal in strength to the emf of the charging power source. Thus within an instant bitrons, that were **electrons** during the charging phase, become transformed back into **neutral bitrons** which are in turn polarised in the opposite direction to convert them into **positrons**, as shown in figure 11.

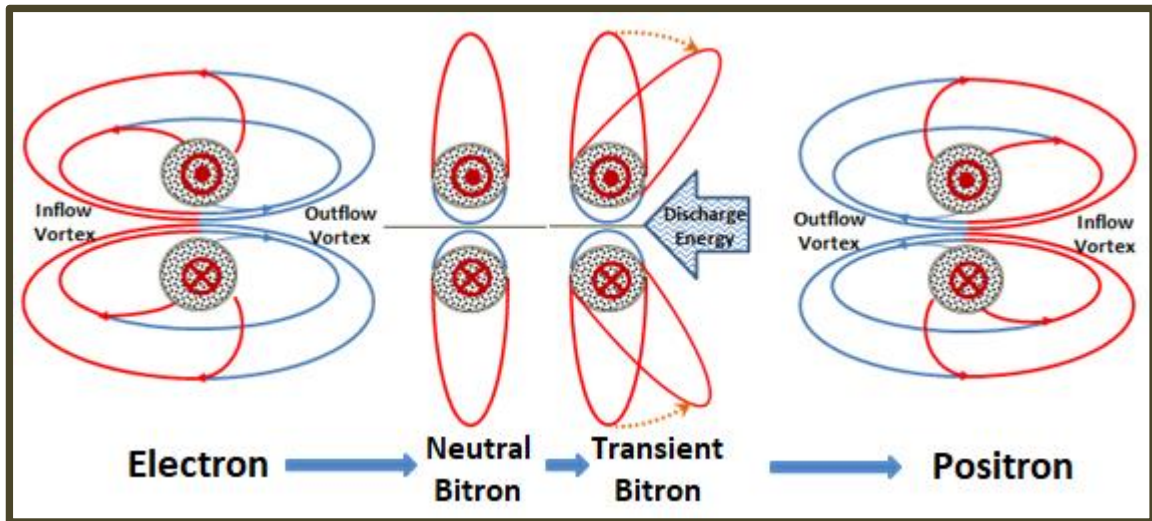

**Figure 11: Electron to Positron Conversion by Energy-Field Flip**

This reversal of energy-field is referred to as an **energy-field flip**, which is a simple change in the linear (z-axial) energy flow direction that causes a **change of chirality** and a change of dipole polarity. Energy-field flipping (simply referred to as **flipping**) is a most important phenomenon that can be used to help explain semiconductor electric current generation as well as the instantaneous conversion of neutrons to protons (and vice versa) for beta decay, electron-positron annihilation and pair production. ‘Houston, we have a means to explain some of our trickier problems’.

Energy-field flipping converts the charging phase e-strands into p-strands to create a positive terminal for capacitor discharge. Similarly the p-strands are converted into e-strands to create a negative terminal as shown in figure 10c. A **discharge current** is thus generated, which flows in the **opposite direction** to the charge current, with the capacitor now acting as the power source for the circuit containing  $R_O$ , as in the circuit diagrams of figure 10c.

When the capacitor plate charge becomes de-energised, the capacitor power is exhausted and the discharge current flow stops. In general terms the thinner the dielectric layer the quicker the recharge and discharge rates; or conversely, the thicker the dielectric layer then greater becomes the latency between charge and discharge cycles.

Interestingly, the ONAM explanation for capacitor charge and discharge involves the creation of a dipole effect by a polarisation process involving the **electric field distortion** of the electron cloud surrounding an atom’s nucleus, as shown crudely in figure 11. The [Wikipedia definition for a dielectric](#) is ‘an electrical insulator that can be **polarised** by an applied electric field’: the associated explanation, while being singularly unconvincing (‘Houston, we don’t think that will solve our problems’), and is not dissimilar to the creative use of positive holes to explain semiconductor charge transfer, which is addressed in the next chapter.

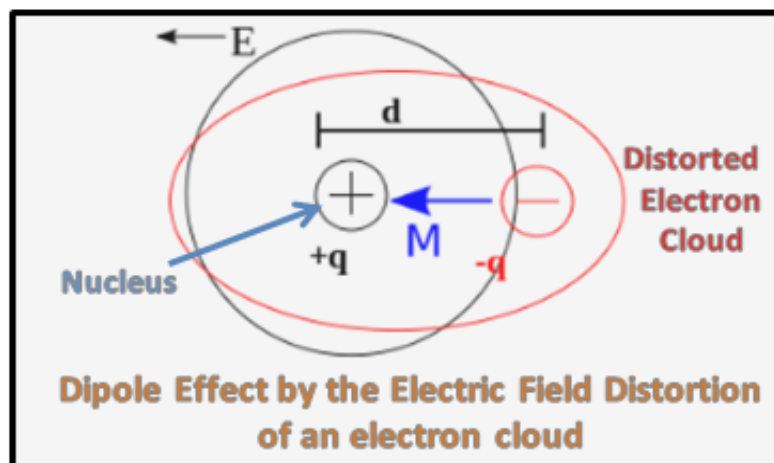

**Figure 12: Electron Cloud Distortion (ONAM)**

## Semiconductor Electric Current Generation

The main commercial manufacturing process for **silicon wafers** is the **Czochralski process**. It involves the addition of measured quantities of **dopants** of about one dopant atom per five million silicon atoms to a molten **silicon dioxide** mix. Commonly **Boron (B-11)** is used for **p-type** semiconductor wafers and **Phosphorus (P-31)** for **n-type**. The Czochralski process produces silicon that can be shaved into thin wafers containing an even dispersion of dopants.

P-N junctions are formed by abutting p-type and n-type wafers together so that the silicon layers are close to parallel to their join surface. The **depletion zone** is a thin area spanning the abutment zone that contains bitrons that, due to simple geometry related to silicon layering, all have the **same spin direction**. Thus the depletion zone can only support the movement of polarised bitrons that have that same spin direction.

When a power source causes the polarisation of strands consisting of bitrons with the spin direction required by the depletion zone, a **forward bias** situation exists (see figure 13) and current can flow across the depletion zone. However when a power source causes the polarisation of strands with the opposite spin direction to the bitrons within the depletion zone, a **reverse bias** situation exists and no current can flow across the depletion zone which acts as a **capacitor** across which charge builds up. The capacitor-effect of the depletion zone helps shape the **I-V** (Current-Voltage) characteristics of **photovoltaic cells**, with the peak power occurring in the **Discharge Region**; it is also the provides a mechanism that explains why a **transistor** can act as a switch and a current amplifier. *'Houston, we have a possible solution to our semiconductor problems'*.

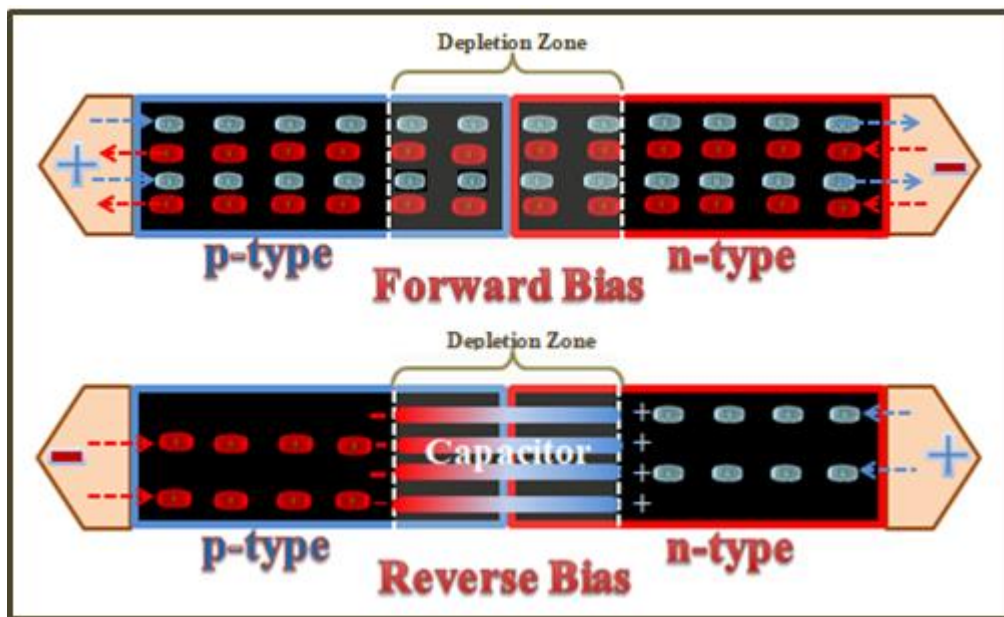

**Figure 13: Forward and Reverse Bias for a P-N Junction**

For a **photovoltaic cell** photons from incident electromagnetic radiation (EMR) collide with and polarise free bitrons in the n-type layer which is called the **photoelectric effect**. The collisions impart kinetic energy to the bitrons causing them to recoil, become polarised and to move in the direction of the depletion zone: approximately equal numbers of slow-moving electrons and positrons are created by photon bombardment. Positrons, however, have the wrong spin direction (reverse bias) to allow them to pass through the depletion zone; only the electrons can pass and do so to generate a forward bias electric current as shown in figure 14.

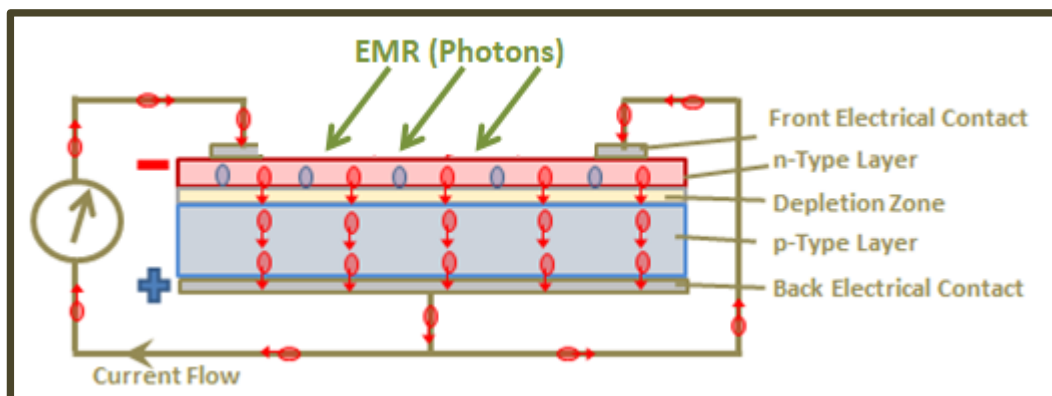

**Figure 14: Operation of a Photovoltaic Cell (STEM)**

The conventional Science (or ONAM) explanation for the equivalent photovoltaic cell requires the introduction of the concept of a **positive hole**. A positive hole is a [quasiparticle](#) attributed to an atom that temporarily loses an electron from its **conduction band** so as to present as a positive charge. As an electron moves into a positive hole (i.e. the atom's conduction band) it leaves behind another hole: thus positive holes appear to migrate in the opposite direction to electron movement.

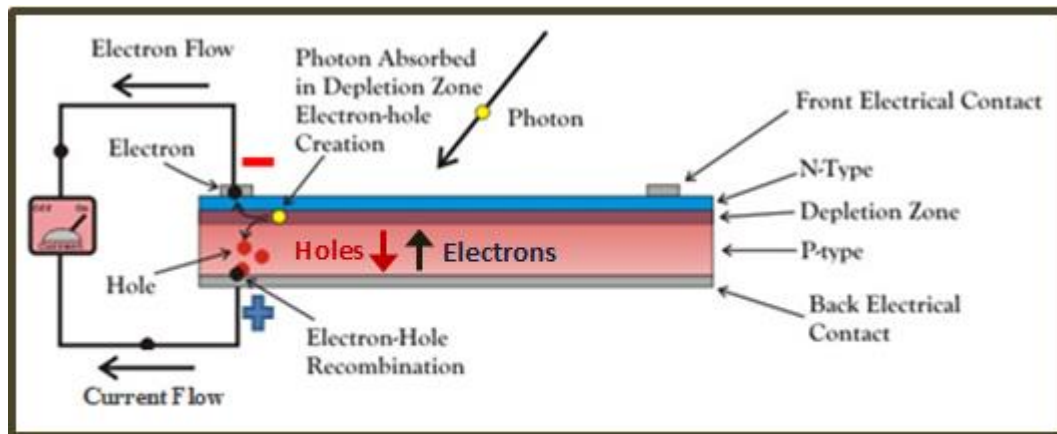

**Figure 15: Operation of a Photovoltaic Cell (ONAM)**

A positive hole is a [Claytons](#) positron (i.e. 'the quasiparticle you have when you don't have a positron'), and although holes appear to be the functional equivalent of STEM low-speed positrons, their use to explain the photovoltaic cell current generation is flawed. 'Houston, we detect an unexpected problem', which is elaborated below.

The corresponding conventional Science explanation for photovoltaic cell operation contends that free monopole electrons are generated by the removal of an electron in the outer electron band of silicon atoms within the n-type and depletion zones. Although orbital electrons are considered to be wave-like with only have a small probability of being at a defined location at any point in time, they are apparently energised and escape their atomic orbital as a monopole particle via the **photoelectric effect**, so creating positive holes in silicon atoms. The increase of free electrons causes **electrons to migrate towards the front electrical contact**, with holes moving in the opposite direction away from the front contact surface. The electrons then proceed to move down the connected wire to the back contact (see figure 15).

As **electrons** arrive at the back electrical contact via the wire they start **migrating upwards** (as drawn) via positive holes through the p-type zone. As electrons work their way towards the depletion zone the holes appear to move down to accommodate electrons arriving via the wire. Sufficient electrons work their way through the p-type and depletion zones into the n-type layer to maintain a continuous electron flow (i.e. electric current) around the circuit.

This explanation contends that the **positive holes** are **moving down** towards the back contact, which results in the broad movement of **electrons** working their way **upwards** via available holes from the back contact through the p-type and **into the depletion zone** to reach the **n-type layer**. However this electron movement direction is in the **reverse bias direction**, which is problematic because the whole point of the P-N junction is that **electrons cannot and do not move in the reverse bias direction!!** 'Houston, that work-around has produced quite a serious problem.'

## Micro and Radio Waves

Man-made micro and radio waves are generated by circuitry consisting of a capacitor and inductor loop that delivers an oscillating current to broadcasting aerial, such as a **dipole antenna**. A dipole antenna consists of two vertical metal rods, with the electric monopoles generated by the high frequency AC current face away from each other, as shown in figures 16 and 17.

As the voltage builds up across each rod in the dipole antenna, threads and wisps are generated as shown in figure 16. When the power source terminals are switched by AC reversal, the wisps and threads (figure 16a) are summarily cut-off, to be rapidly and unceremoniously pushed away from the dipole rod by new wisps and threads that are generated with opposite spin (figure 16b).

The energy of each successive group of cut-off wisps and threads form an energy peak or crest moving away from the dipole antenna forming another layer within **the expanding torus-shaped electromagnetic radio wave**. The wavelength ( $\lambda$ ) of such radio waves is defined by the equation  $\lambda = c / f$ , where the  $f$  = the frequency as governed by the AC frequency, and  $c$  = the speed of light.

Assuming the speed of light (rounded) to be  $300 \times 10^6$  metres/second, then for radio waves with a frequency of 600 MHz the wavelength is calculated as:  $\lambda = 300 \times 10^6 / 600 \times 10^6 = 0.5$  metres

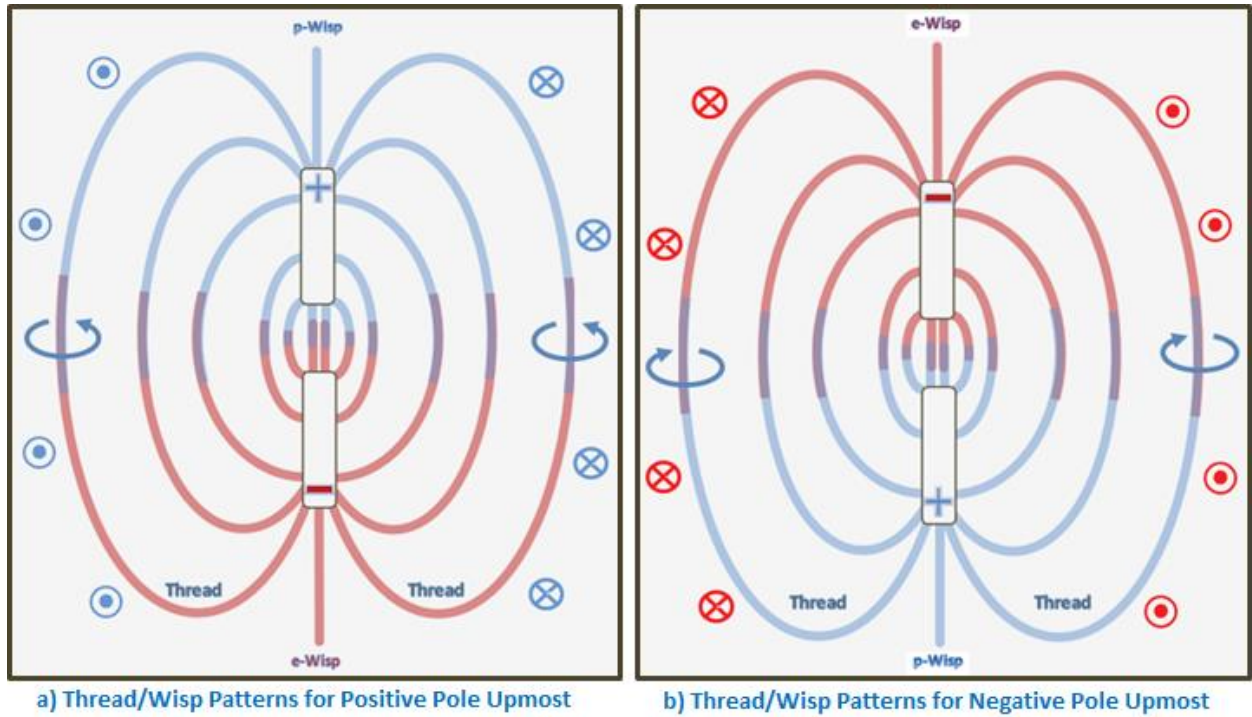

**Figure 16: Electric Fields around a Dipole Antenna**

Figure 17 shows a vertical cross section through a vertical dipole antenna which indicates the energy patterns being generated. The bent ellipsoidal isocline-like lines represent the electromagnetic radio wave crests, coloured blue for a positive crest and red for a negative crest. The graphics are two frame shots taken (and modified) from a [Wikipedia animated gif](#), which is certainly worth viewing.

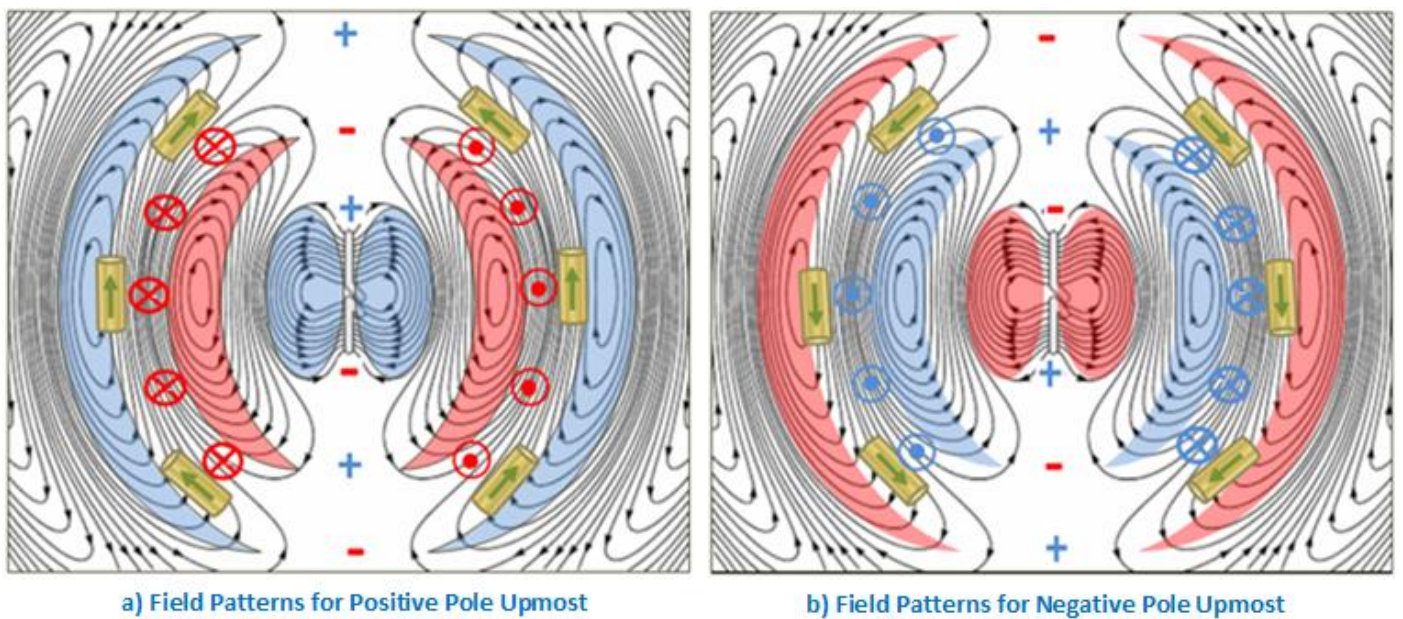

**Figure 17: Radio Wave Electromagnetic Field Patterns for a Dipole Antenna**

Note that the directional mini-arrows in figure 17 and the [animated gif](#) imply a circulation of the field-energy contained within crests and troughs which unfortunately is incorrect: there is only circular spin around each positive and negative energy crest, as shown by the arrow tip-and-quill icons, plus the outward expansion of the doughnut shaped waves themselves. The directional mini-arrows should be removed as the lines are **isoclines** that map increasing or decreasing energy-field levels associated with crests and troughs of the radio waves.

The arrow tip-and-quill symbols of figure 17 indicate the flow direction of field-energy within crests, which presents as a circular **magnetic field**. The magnetic flux associated with this magnetic field is tangential to the expanding crests of electromagnetic energy.

For a piece of copper wire lying tangentially to an advancing crest, the approaching magnetic flux induces an electric current in the direction of the green arrows. The current in the wire builds, peaks and decays as the negative crest of figure 17a passes by, and reverses in similar fashion as the next positive crest passes by as in figure 17b.

The copper wire represents an **aerial** responding with a current that is synchronised to the radio wave frequency. The current so generated may be amplified and fed to an electromagnetically driven diaphragm for **analogue sound** or to a **digital decoder** for digitised sound, pictures or messages. *'Houston, we had a problem related to radio transmission'*.

## Summary and Conclusions

The STEM approach explains the formation of electric currents in a variety of situations (including semiconductors) without the need of quasiparticles; provides a feasible explanation the formation of electric lines of force associated with electric monopole charges; and provides an explanation of how capacitor charge and discharge takes place without the need for electron-cloud distortion. *'Houston, we've had a problem here'*, rings true because for the most part the problems of the conventional Science approach have been resolved.

Although some problems are resolved, the implications of STEM are far wider than the electromagnetic energy issues raised in this paper. There are many areas of Science theory that are impacted and need to be addressed. Thus the final transmission from mission to base was *'Houston, the problems could be more complex and widespread than first reported'*, before transmission crackled and became silent, with the spacecraft disappearing, forever lost in the vastness of Space (sorry, this might be the wrong movie).

A more detailed, and Houston quasi-quote free, in-depth coverage of the topics briefly covered in this paper, and addressing some of the implications of STEM to Science, industry and education, can be found in the three part book series '**STEM and the Orbital Model**'. These are available free of charge in a range of **epub** formats (flexible and easy to read using a wide range of devices) or in a **pdf** format.

Book 1: [Electrons and Electricity](#)

Book 2: [Atomic Structure](#)

Book 3: [Electromagnetic Radiation \(EMR\) and Gravity](#)

[Book 1](#) introduces STEM's energy-centric model for the **electron** in far more detail than provided in this paper and extends the model to explain electromagnetic attraction and repulsion, electrostatic charge, and micro and radio waves.

[Book 2](#) extends the STEM electron model to the **preon**, and develops a model for the **up** and **down quarks**, which are in turn used to define a structure for the **nucleons** (protons and neutrons) that build into **atoms**. It then proceeds to explain how such an atomic structure results in the observed bonding geometry and valency preferences of chemical compounds and in the allotropic forms adopted by many elements. It also provides an explanation for the phenomena of electron capture and beta decay.

[Book 3](#) builds on books 1 and 2 to provide a STEM explanation for the particle-wave nature of EMR, spectral line emission and absorption, the photo-electric and Compton effects, P-N semiconductors, electron pair generation and annihilation, plasma, cosmic radiation and Gravity.

David Johnson

Email Contact: [David.Johnson.Pivot@gmail.com](mailto:David.Johnson.Pivot@gmail.com)

Perth, Australia (*a long way from Houston*)

25 March 2020