

# Neutrons Dance in UC Berkeley Campus

---

*In an underground vault enclosed by six-foot concrete walls and accessed by a rolling, 25-ton concrete-and-steel door, University of California, Berkeley, students are making neutrons dance to a new tune: one better suited to producing isotopes required for geological dating, police forensics, hospital diagnosis and treatment. [30]*

*Polymer gels, a gel type with unique properties, have piqued the interest of researchers because of their potential uses in medical applications. [29]*

*Tensorial neutron tomography promises new insights into superconductors, battery electrodes and other energy-related materials. [28]*

*CERN's nuclear physics facility, ISOLDE, has minted a new coin in its impressive collection of isotopes. [27]*

*In the case of several light nuclei, experimental confirmation of the individualism or family nature of nucleons will now be simpler, thanks to predictions presented by Polish physicists from Cracow and Kielce. [26]*

*The identification of the magic number of six provides an avenue to investigate the origin of spin-orbit splittings in atomic nuclei. [25]*

*Now, physicists are working toward getting their first CT scans of the inner workings of the nucleus. [24]*

*The process of the sticking together of quarks, called hadronisation, is still poorly understood. [23]*

*In experimental campaigns using the OMEGA EP laser at the Laboratory for Laser Energetics (LLE) at the University of Rochester, Lawrence Livermore National Laboratory (LLNL), University of California San Diego (UCSD) and Massachusetts Institute of Technology (MIT) researchers took radiographs of the shock front, similar to the X-ray radiology in hospitals with protons instead of X-rays. [22]*

*Researchers generate proton beams using a combination of nanoparticles and laser light. [21]*

*Devices based on light, rather than electrons, could revolutionize the speed and security of our future computers. However, one of the major challenges in today's physics is the design of photonic devices, able to transport and switch light through circuits in a stable way. [20]*

*Researchers characterize the rotational jiggling of an optically levitated nanoparticle, showing how this motion could be cooled to its quantum ground state. [19]*

*Researchers have created quantum states of light whose noise level has been “squeezed” to a record low. [18]*

*An elliptical light beam in a nonlinear optical medium pumped by “twisted light” can rotate like an electron around a magnetic field. [17]*

*Physicists from Trinity College Dublin's School of Physics and the CRANN Institute, Trinity College, have discovered a new form of light, which will impact our understanding of the fundamental nature of light. [16]*

*Light from an optical fiber illuminates the metasurface, is scattered in four different directions, and the intensities are measured by the four detectors. From this measurement the state of polarization of light is detected. [15]*

*Converting a single photon from one color, or frequency, to another is an essential tool in quantum communication, which harnesses the subtle correlations between the subatomic properties of photons (particles of light) to securely store and transmit information. Scientists at the National Institute of Standards and Technology (NIST) have now developed a miniaturized version of a frequency converter, using technology similar to that used to make computer chips. [14]*

*Harnessing the power of the sun and creating light-harvesting or light-sensing devices requires a material that both absorbs light efficiently and converts the energy to highly mobile electrical current. Finding the ideal mix of properties in a single material is a challenge, so scientists have been experimenting with ways to combine different materials to create “hybrids” with enhanced features. [13]*

*Condensed-matter physicists often turn to particle-like entities called quasiparticles—such as excitons, plasmons, magnons—to explain complex phenomena. Now Gil Refael from the California Institute of Technology in Pasadena and colleagues report the theoretical concept of the topological polariton, or “topolariton”: a hybrid half-light, half-matter quasiparticle that has special topological properties and might be used in devices to transport light in one direction. [12]*

*Solitons are localized wave disturbances that propagate without changing shape, a result of a nonlinear interaction that compensates for wave packet dispersion. Individual solitons may collide, but a defining feature is that they pass through one another and emerge from the collision unaltered in shape, amplitude, or velocity, but with a new trajectory reflecting a discontinuous jump.*

*Working with colleagues at the Harvard-MIT Center for Ultracold Atoms, a group led by Harvard Professor of Physics Mikhail Lukin and MIT Professor of Physics Vladan Vuletic have managed to coax photons into binding together to form molecules – a state of*

*matter that, until recently, had been purely theoretical. The work is described in a September 25 paper in Nature.*

*New ideas for interactions and particles: This paper examines the possibility to origin the Spontaneously Broken Symmetries from the Planck Distribution Law. This way we get a Unification of the Strong, Electromagnetic, and Weak Interactions from the interference occurrences of oscillators. Understanding that the relativistic mass change is the result of the magnetic induction we arrive to the conclusion that the Gravitational Force is also based on the electromagnetic forces, getting a Unified Relativistic Quantum Theory of all 4 Interactions.*

Students make neutrons dance beneath UC Berkeley campus.....	4
The long road to desktop fusion .....	6
Neutrons allow analysis of polymer gels' unusual attributes .....	8
Neutrons scan magnetic fields inside samples.....	10
3-D image calculated with new TMART algorithm .....	10
Applications from basic research to industry.....	11
ISOLDE mints isotopes of chromium.....	11
The chances of detecting clumps in atomic nuclei are growing .....	12
Scientists discover the secret behind the stability of carbon isotopes .....	13
The nucleus—coming soon in 3-D.....	15
How are hadrons born at the huge energies available in the LHC?.....	17
Shock front probed by protons.....	18
Liquid Light with a Whirl .....	22
Physicists discover a new form of light .....	24
Novel metasurface revolutionizes ubiquitous scientific tool .....	25
New nanodevice shifts light's color at single-photon level.....	26
Quantum dots enhance light-to-current conversion in layered semiconductors .....	27
Quasiparticles dubbed topological polaritons make their debut in the theoretical world .....	29
'Matter waves' move through one another but never share space.....	29
Photonic molecules .....	30
The Electromagnetic Interaction .....	31

Asymmetry in the interference occurrences of oscillators .....	31
Spontaneously broken symmetry in the Planck distribution law.....	33
The structure of the proton.....	35
The Strong Interaction.....	35
Confinement and Asymptotic Freedom .....	35
The weak interaction .....	36
The General Weak Interaction .....	37
Fermions and Bosons .....	37
The fermions' spin .....	38
The source of the Maxwell equations .....	38
The Special Relativity.....	39
The Heisenberg Uncertainty Principle .....	39
The Gravitational force.....	40
The Graviton.....	41
What is the Spin? .....	41
The Casimir effect .....	41
The Fine structure constant .....	42
Path integral formulation of Quantum Mechanics.....	42
Conclusions.....	43
References .....	44

Author: George Rajna

### **Students make neutrons dance beneath UC Berkeley campus**

In an underground vault enclosed by six-foot concrete walls and accessed by a rolling, 25-ton concrete-and-steel door, University of California, Berkeley, students are making neutrons dance to a new tune: one better suited to producing isotopes required for geological dating, police forensics, hospital diagnosis and treatment.

Dating and forensics rely on a spray of neutrons to convert atoms to radioactive isotopes, which betray the chemical composition of a substance, helping to trace a gun or reveal the age of a rock, for example. Hospitals use isotopes produced by neutron irradiation to kill tumors or pinpoint diseases like cancer in the body.

For these applications, however, only nuclear reactors can produce a strong enough spray of neutrons, and there are only two such reactors west of the Mississippi.

As an alternative, a team including UC Berkeley students has built a tabletop neutron source that would be relatively inexpensive to reproduce and eventually portable and also able to produce a narrower range of neutron energies, minimizing the production of unwanted radioactive byproducts.

"Any hospital in the country could have this thing, they could build it for a few hundred thousand dollars to make local, very short-lived medical isotopes—you could just run them up the elevator to the patient," said Karl van Bibber, a UC Berkeley professor of nuclear engineering who oversees the students perfecting the device. "It has application in geochronology, neutron activation analysis for law enforcement agencies—when the FBI wants to determine the provenance of a sample as evidence, for example—neutron radiography, to look for cracks in aircraft parts. This is very compact, the size of a little convection oven; I think it's great, we are excited about this."

UC Berkeley researchers have now demonstrated that the high flux neutron generator (HFNG) can produce "boutique" neutrons—neutrons within a very narrow range of energies—that can be used to accurately date fine-grained rocks nearly impossible to date by other radioisotope techniques. The study will be published this week in the journal *Science Advances*.

"This will expand the capability of dating fine-grained materials, like clay minerals associated with ore deposits, including gold, or lava flows," said Paul Renne, a UC Berkeley professor-in-residence in the Department of Earth and Planetary Science and director of the Berkeley Geochronology Center. "This device might also let us look at the most primitive objects in our solar system—calcium/aluminum-rich inclusions found in certain types of meteorites—which are also very fine-grained."

As they report in the new paper, the researchers used the neutron generator to determine the age of fine-grained lava from the 79 A.D. eruption of Vesuvius, which buried the Roman city of Pompeii. The date they calculated was as precise as the answer given by an exhaustive study in 1997 using state-of-the-art argon-argon dating of samples irradiated at a nuclear reactor.

"It's making it possible to do things that were not possible otherwise," Renne said.

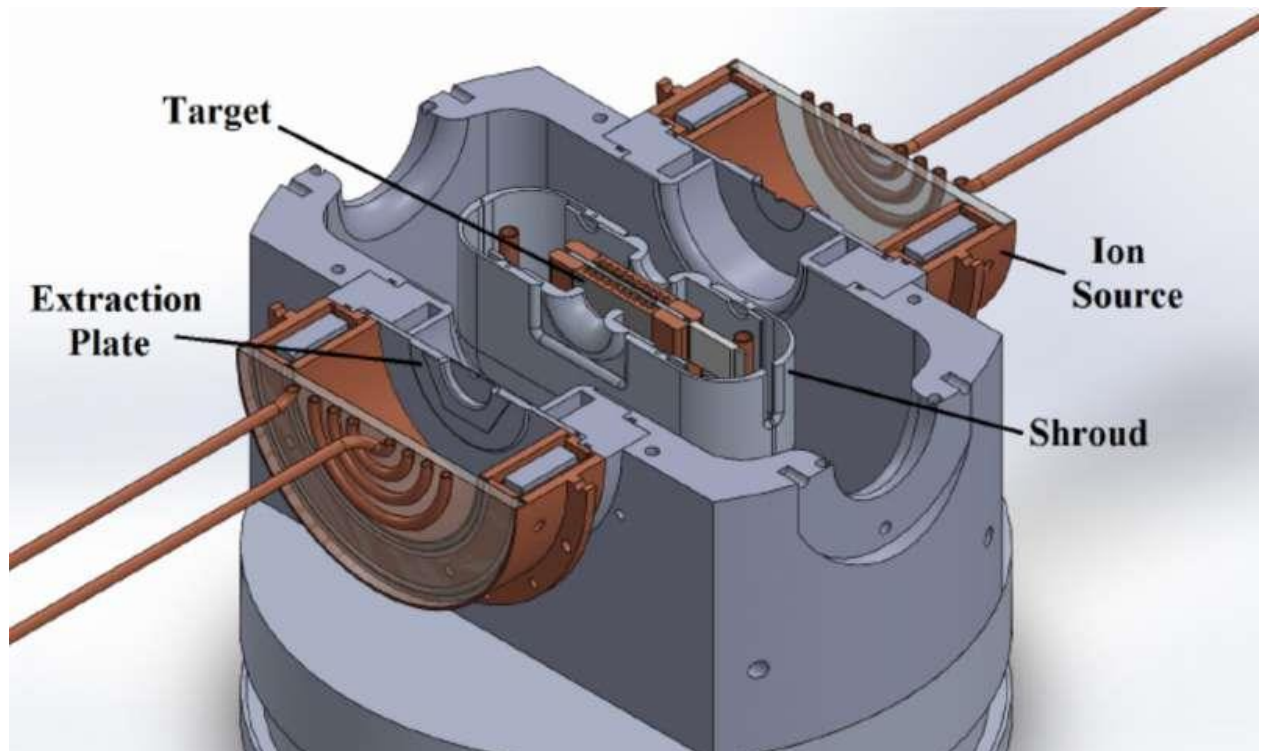

This cutaway of the high flux neutron generator shows the two chambers (bronze) where the deuterium is heated to 50,000 degrees Celsius, creating a plasma of ionized deuterium. A 100,000-volt charge at the extraction plate accelerates the ions toward the target, which contains more deuterium atoms. When two deuterium atoms fuse, they produce a neutron, which irradiates a sample placed nearby. The shroud prevents excessive heating from backstreaming electrons. Credit: Karl van Bibber, UC Berkeley

### ***The long road to desktop fusion***

Renne has been searching for better ways to irradiate rock samples for decades and heard about one possible method from the late UC Berkeley nuclear engineering professor Stanley Prussin, who died in 2015. The technique involves the fusion of two deuterium atoms, which are isotopes of hydrogen, to produce helium-3 and one neutron. These neutrons have an energy—about 2.5 million electron volts—that is ideal for irradiating rocks to conduct argon-argon dating, one of the most precise methods in use today.

Argon-argon dating relies on the fact that about one in every 1,000 potassium atoms in rock is the radioactive isotope potassium-40, which decays to argon-40 with a half-life of more than a billion years. Using neutrons, scientists convert some of the stable potassium, potassium-39, to argon-39, then measure the ratio of Ar-40 to Ar-39 in the sample to calculate its age.

Rock samples must now be irradiated at nuclear reactors, but reactors produce very energetic neutrons that can knock argon atoms out of the sample—a particular problem for rocks with microscopic grains—and also produce unwanted radioactive elements. Both effects make age calculation more difficult.

The HFNG avoids both of these problems, because the neutrons are one-tenth the energy of those from a nuclear reactor and have a narrower range of energies, while still maintaining a high flux of neutrons.

"Eliminating the recoil issue, plus reduction of interfering reactions, is huge," Renne said. "But the radiological aspects are also improved."

"The beauty of this thing, we realized, is that you don't have this thing spewing neutrons everywhere and creating a radiological issue," added van Bibber, who is the Shankar Sastry Chair of Leadership and Innovation. "You're actually having a modest number of neutrons, but by getting the target close to the point source—the thing that matters—the neutron flux at the sample is very high."

The first device to create neutrons via deuterium-deuterium (D-D) fusion was designed 10 years ago by Renne's team, which included plasma physicist Ka-Ngo Leung, formerly of Lawrence Berkeley National Laboratory (Berkeley Lab). But their prototype languished until van Bibber took an interest in 2012, shortly after his appointment as chair of UC Berkeley's Department of Nuclear Engineering. To house the fusion generator, van Bibber took over a concrete vault formerly used for experiments conducted with the campus's nuclear reactor, which used to sit under what is now Soda Hall—though it sits in a large underground room that is part of the basement of Etcheverry Hall—until the reactor closed in 1987 and was removed.

The generator employs about 100,000 volts to accelerate ionized deuterium atoms toward a metal cathode made of titanium. The deuterium accumulates on the cathode in a thin layer that then serves as a target for other incoming ions. When colliding deuterons fuse, a neutron is produced in a broad beam that irradiates the sample located about a third of an inch away.



Graduate students Mauricio Ayllon Unzueta (left) and Jonathan Morrell adjust the high flux neutron generator in an underground vault at UC Berkeley. The aluminum vacuum chamber contains the deuterium plasma and the cathode target where the neutrons are generated via fusion. Credit: UC Berkeley photo by Irene Yi

Over the years, van Bibber enlisted many undergraduates, graduate students and postdoctoral fellows to help make the neutron generator a reality. One of them, transfer student Max Wallace, a rising senior interested in nuclear forensics, was amazed at the access he had to such a machine.

"It's rare to be able to work with radioisotopes as an undergraduate," said the former software engineer. "I learned to do so much late at night, wearing gloves and goggles to measure the radiation, taking samples, doing safety checks and running the software. Really, I'd learn something in my nuclear physics class and then come down here to work on a direct application of it."

For Mauricio Ayllon Unzueta, a fourth-year graduate student in nuclear engineering, the experience he obtained in helping to perfect the neutron generator led directly to a new project at Berkeley Lab: designing a variant of the HFNG that could be taken into the field to do neutron activation of soils to measure carbon content—a key piece of information if society hopes to sequester carbon in soils to mitigate climate change.

"Through three generations of graduate students, we turned it from something which barely worked into a high performing neutron generator," van Bibber said.

Daniel Rutte, a UC Berkeley postdoctoral researcher in geology working with Renne and BGC lab manager Tim Becker, played a critical role in designing and conducting the first dating experiment, according to Renne.

"Daniel was literally the key player in demonstrating that this would work for Ar-Ar geochronology," he said.

Rutte's goal is to develop new methods and instruments to better understand Earth processes, in particular the deformation of the Earth's crust, which occurs by slow creep or rapid rupture resulting in earthquakes.

"To understand long-term crustal deformation, I date old ruptures preserved in the rock record," Rutte said. "The neutron generator will aid progress in this field by expanding the range of materials we can date."

With ongoing student help, van Bibber and Renne expect to be able to make the neutron generator more compact and to produce a more intense spray of neutrons, making it more broadly useful for geochronology, as well as for other specialized uses. Researchers at UC Berkeley's Space Sciences Laboratory have already shown interest in using these neutrons to test electronic hardware to determine how it will survive in the radioactive environment of space. Higher energy neutrons could be used for neutron radiography, which can complement X-ray radiography in imaging the interior of dense objects, like metals.

"The purpose all along had been to test Paul's dream of whether we could use a very compact, low-voltage device to do neutron irradiation," van Bibber said. "We've now shown that any university can have a [neutron](#) source for doing the argon-argon dating technique." [30]

## **Neutrons allow analysis of polymer gels' unusual attributes**

Products like cosmetics, adhesives, and paints rely on a common key component: gels. Polymer gels, a gel type with unique properties, have piqued the interest of researchers because of their potential uses in medical applications.

Studies have shown that modifying the structures of [polymer gels](#) can significantly affect their properties, but it is unclear why. To learn how and why that happens, a team of researchers from the



Massachusetts Institute of Technology (MIT) and the Department of Energy's (DOE's) Oak Ridge National Laboratory (ORNL) are using [neutron scattering](#) to take a deeper look.

Polymer gels are made up of polymer chains with junctions connecting them. As thermodynamic conditions change, the sizes of the junctions change relative to the chains connecting them. The changes can cause the gels to become stronger and develop better response properties. To investigate these relationships, the researchers are using the EQ-SANS instrument at ORNL's Spallation Neutron Source—a DOE Office of Science User Facility.

"We're trying to understand the role of the junction size and how the junction interactions contribute to the mechanical properties of the gel," said Christopher Lam, a postdoctoral research associate at ORNL.

Polymer gels are useful for [drug delivery](#) because their structures adapt to changes in their environment. For example, a polymer gel with temperature response properties could flow easily at room temperature but then stiffen in a warmer environment like the human body. These types of gels can help ensure that when a drug is injected into the body, it stays in the area it is meant to impact.

Similarly, polymer gels with pressure response properties can be designed to flow easily while under low pressure in a syringe but then stiffen as the gel is ejected and pressure increases.

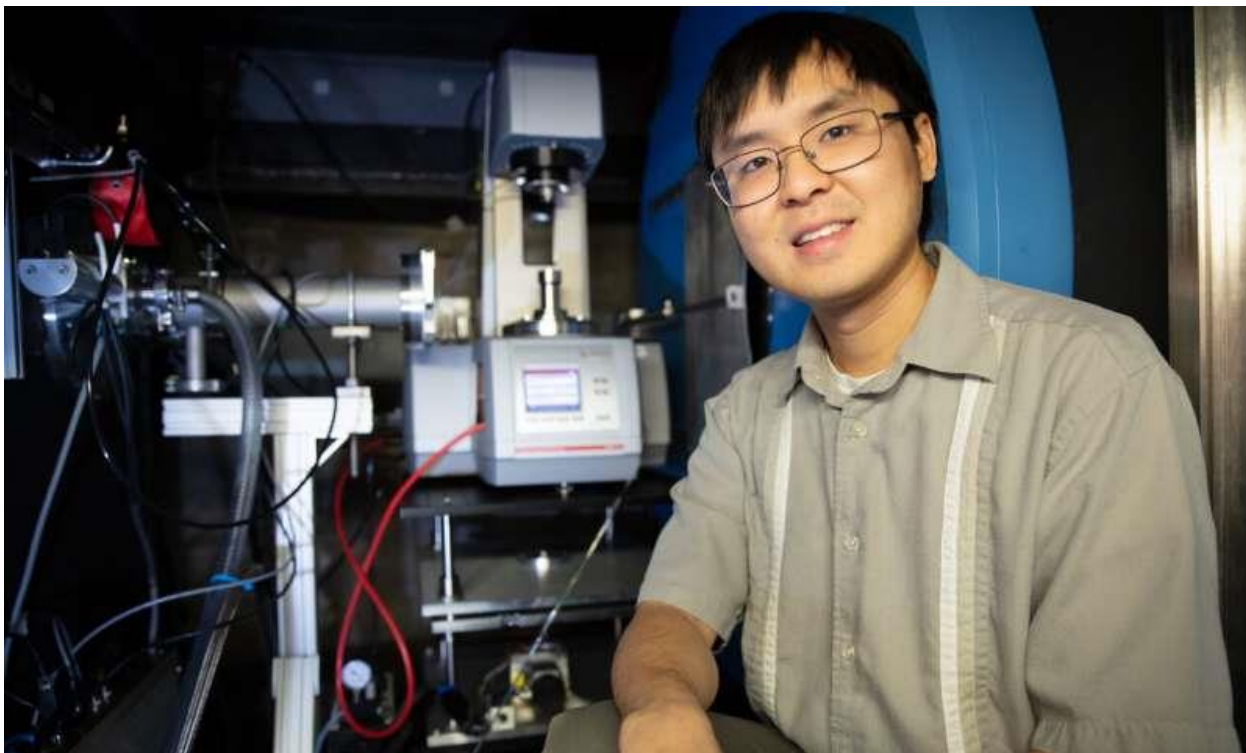

The rheo-SANS environment allowed ORNL's Christopher Lam to investigate the response properties of polymer gels at the EQ-SANS beamline at the Spallation Neutron Source. Credit: ORNL/Genevieve Martin

Neutrons are good probes of materials like polymer gels, largely because of their sensitivity to hydrogen and its isotope, deuterium. Using a unique technique known as contrast matching, researchers replaced some of the hydrogen atoms in the gel with deuterium, which allowed specific structural components to be highlighted by the neutrons.

Using the EQ-SANS instrument's new rheo-SANS environment enabled the researchers to subject the gels to shear stress—which is stress parallel to the cross section of the material, like two plates sliding past each other—and observe the corresponding changes in structure.

By comparing how the structures of gels with large junctions and those with small junctions shear and deform, the researchers can begin to understand how the sizes of gel junctions can impact the gel properties. Using their findings, the researchers can find ways to develop improved [polymer](#) gels.

"If we have an understanding of the structure of the gels, that basically gives us a better framework," said Lam. "Then we can say 'we need this property, this chemical design, and this ratio of components and concentration.'

"I'm always trying to find a balance between how much we do fundamentally and how we can think about applying that to something we'll use. I'm trying to use this fundamental understanding to really design better biomedical gels."

Other researchers on this experiment include lead principal investigators Bradley D. Olsen of the Department of Chemical Engineering at MIT, ORNL's Wei-Ren Chen, and Michelle Calabrese, a postdoctoral researcher at MIT. The research is supported by DOE's Office of Science. [29]

## Neutrons scan magnetic fields inside samples

With a newly developed neutron tomography technique, an HZB team has mapped for the first time magnetic field lines inside materials at the BER II research reactor. Tensorial neutron tomography promises new insights into superconductors, battery electrodes and other energy-related materials.

Measuring magnetic fields inside samples has only been possible indirectly up to now. Magnetic orientations can be scanned with light, X-rays or electrons—but only on the surfaces of materials. Neutrons, on the other hand, penetrate deeply into the sample, and, thanks to their own magnetic orientation, can provide precise information about the magnetic fields inside. So far, however, it has only been possible to approximate the variously aligned magnetic domains using neutrons, but not the vector fields (directions and strengths) of the magnetic fields inside samples.

A team led by Dr. Nikolay Kardjilov and Dr. Ingo Manke at the HZB has now developed a new method for measuring the [magnetic field lines](#) inside massive, thick samples: For tensorial neutron tomography, they employ spin filters, spin flippers, and spin polarisers that allow only neutrons with mutually aligned spins to penetrate the sample. When these spin-polarised neutrons encounter a magnetic field inside, the field excites the neutron spins to precess, so that the direction of the spin polarisation changes, allowing new conclusions about the field lines encountered.

## ***3-D image calculated with new TMART algorithm***

The newly developed experimental method allows the calculation of a three-dimensional image of the magnetic field inside the sample using nine individual tomographic scans, each with a different [neutron](#) spin setting. A highly complex mathematical tensor algorithm was developed for this purpose by Dr. André Hilger at the HZB, christened TMART.

The experts tested and evaluated the new method on well-understood samples. Subsequently, they were able to map the complex magnetic field inside superconducting lead for the first time.

The sample of solid, polycrystalline lead was cooled to 4 degrees Kelvin (lead becomes superconducting below 7 degrees Kelvin) and exposed to a magnetic field of 0.5 millitesla. Although the magnetic field is displaced from the interior of the sample due to the Meissner effect, magnetic flux lines nevertheless remain attached to the (non-superconducting) grain boundaries of the polycrystalline sample. These flux lines do not disappear even after the external field has been switched off, because they have previously induced currents inside the superconducting crystal grains, which now maintain these fields.

"For the first time, we can make the magnetic vector field visible in three dimensions in all its complexity within a massive material," says HZB physicist Manke. "Neutrons can simultaneously penetrate massive materials and detect magnetic fields. There is currently no other method that can accomplish this."

### ***Applications from basic research to industry***

Magnetic tensor tomography is non-destructive and can achieve resolutions down to the micrometer range. The areas of application are extremely diverse. They range from the mapping of magnetic fields in superconductors and the observation of magnetic phase transitions, to material analysis, which is also of great interest for industry: Field distributions in electric motors and metallic components can be mapped and current flows in batteries, fuel cells, or other propulsion systems can be visualized with this method. [28]

### **ISOLDE mints isotopes of chromium**

CERN's nuclear physics facility, ISOLDE, has minted a new coin in its impressive collection of isotopes. The facility has forged neutron-rich isotopes of the element chromium for the first time, and in prodigious quantities. These isotopes were measured by the precision balance ISOLTRAP, which has been performing mass measurements at ISOLDE for the last 30 years. The new mass values, reported in *Physical Review Letters*, are up to 300 times more precise than previous results, offering new insight into the nuclear structure of chromium isotopes.

The fact that atoms weigh less than the sum of the masses of their constituent protons, neutrons and electrons gives access to their nuclear binding energy – the minimum energy required to disassemble an atom's nucleus. Therefore, the nuclear binding energy provides information about an atom's nuclear structure. Certain configurations of protons and neutrons are more strongly bound than others, revealing "magic numbers" of protons or neutrons that are arranged into filled shells within the nucleus. One of the main goals of modern nuclear physics is to produce systems at the extremes of nuclear stability to check whether these magic numbers are still valid (see [CERN Courier](#)), providing a tough test for nuclear models.

Chromium (Cr) has 24 protons, situating it midway between the magic calcium (with 20 protons) and the magic nickel (with 28). Its isotopes with a large number of neutrons, around  $^{63}\text{Cr}$ , are interesting for the study of nuclear structure. This is because these isotopes are located midway between the magic neutron numbers 28 and 50, where different nuclear models predict different deformed nuclear shapes and in some cases a new magic number at neutron number 40.

In this new study, the ISOLDE researchers have used a chemically selective ion source called resonant ionization laser ion source (RILIS) to deliver beams of neutron-rich chromium isotopes to the ISOLTRAP weigh station, allowing it to venture as far in neutron number as  $^{63}\text{Cr}$ , whose half-life is only 130 ms.

The filled shells of nuclei with magic numbers favour spherical nuclear shapes. By contrast, the nuclei of the chromium isotopes weighed by ISOLTRAP are deformed. However, contrary to previous conclusions, the ISOLTRAP measurements show that the deformation sets in gradually with the addition of a further neutron. Comparison between the ISOLDE measurements and improved models to describe unfilled-shell nuclei is expected to shed more light on the [nuclear structure of chromium isotopes](#). [27]

## The chances of detecting clumps in atomic nuclei are growing

What do atomic nuclei really look like? Are the protons and neutrons they contain distributed chaotically? Or do they perhaps bind into alpha clusters, that is, clumps made up of two protons and two neutrons? In the case of several light nuclei, experimental confirmation of the individualism or family nature of nucleons will now be simpler, thanks to predictions presented by Polish physicists from Cracow and Kielce.

Any high school student worth his salt knows exactly what an atomic [nucleus](#) looks like: a conglomerate of randomly distributed protons and neutrons (i.e. nucleons). Physicists themselves, however, do not have such clear-cut ideas. In 1931, only 20 years after the discovery of the atomic nucleus, the first suggestions were put forward that protons and neutrons in [atomic nuclei](#) merge into [helium nuclei](#), that is, into groups of two protons and two neutrons, often called alpha clusters. Atomic nuclei are, however, structures that are so extremely small and difficult to study that although almost a century has passed since the first predictions, it still has not been possible to explicitly confirm the occurrence of alpha clusters within them.

The lowering of energy in physical systems favours the merging of structures into groups. This powerful, universal mechanism occurs in nature on all size scales: quarks combine into mesons or baryons, atoms into molecules, stars into galaxies, and galaxies into groups of galaxies. In the case of atomic nuclei, computer simulations suggest that, e.g., the nucleus of beryllium  $^9\text{Be}$  contains two alpha clusters and one neutron (the whole complex would look like a dumbbell). In the  $^{12}\text{C}$  carbon nucleus, there should be three alpha clusters (the shape of the nucleus would thus be triangular), four in oxygen  $^{16}\text{O}$  (here the nucleus would resemble a pyramid), 10 in calcium  $^{40}\text{Ca}$  and 14 in nickel  $^{56}\text{Ni}$ .

In 2014, scientists from the Institute of Nuclear Physics of the Polish Academy of Sciences (IFJ PAN) in Cracow, in collaboration with physicists from the Universidad de Grenada, presented a method of detecting traces of the original structure of atomic nuclei in the distribution of velocities of particles diverging from the points of ultrarelativistic collisions of light atomic nuclei with a shield made of [heavy nuclei](#), such as lead  $^{208}\text{Pb}$  lead or gold  $^{197}\text{Au}$ . Those predictions focused on methods of detection of alpha clusters in  $^{12}\text{C}$  carbon nuclei.

"In our latest publication, written together with physicists from the Institute of Physics at the Jan Kochanowski University in Kielce, we present more detailed predictions concerning the possibility of observing traces of alpha clusters in atomic nuclei. We show how these clusters could be detected in

subsequent nuclei, not only carbon  $^{12}\text{C}$ , but also beryllium  $^7\text{Be}$  and  $^9\text{Be}$  and oxygen  $^{16}\text{O}$ ," says Prof. Wojciech Broniowski (IFJ PAN, UJK).

The method of detecting alpha clusters in atomic nuclei, described in the publication distinguished by the editors of *Physical Review C*, is based on an interesting relationship. Heavy atomic nuclei, even if they were to consist of alpha clusters, are so large that with good approximation, they can be treated as quite homogeneous spheres. When a light atomic nucleus strikes such a nucleus at an ultrarelativistic velocity (thus very close to the speed of light), the collision energy is so great that for fractions of a second, protons and neutrons disintegrate into quarks and the gluons that stick them together. The likely result is a [quark-gluon plasma](#), the most exotic state of matter.

"In our work, we note that if the light [atomic nucleus](#) is not homogeneous, the cloud of quark-gluon plasma created as a result of the collision is deformed. Its shape will at least to some extent correspond to the shape of the light nucleus. Plasma will therefore spill over in all directions, but in different directions at slightly different speeds," explains Dr. Maciej Rybczynski.

The quark-gluon plasma cools down so fast that its direct observation is not currently possible. After just a few femtoseconds (millionths of 1 billionth of a second), the quarks and gluons merge again into particles in a process called hadronization.

"In the directions in which the quark-gluon plasma flows slightly faster, we can expect slightly higher particle velocities caused by hadronization. So if we record momenta of particles diverging from the point of collision with sufficient precision, we are potentially able to extract information about the shape of the nucleus that has struck the shield from minor differences. In addition, this information will concern nuclei in the ground state," explains Milena Piotrowska, Ph.D. student at UJK.

The research of physicists from the IFJ PAN and UJK, co-financed by Polish National Science Centre grants, provides specific theoretical predictions. The next step now belongs to the experimental physicists working on high-energy accelerators, such as the Super Proton Synchrotron (SPS) or Large Hadron Collider (LHC) in the European CERN organization or Relativistic Heavy-Ion Collider (RHIC) in the American Brookhaven National Laboratory. Since experiments confirming the lumpy structure of atomic [nuclei](#) do not require the expansion of currently operating apparatus, it will be possible to carry out these experiments within the next few years. [26]

## Scientists discover the secret behind the stability of carbon isotopes

A magic number is a number of protons or neutrons in the nucleus of an elemental particle that results in much greater stability than that of nuclei with other numbers of protons or neutrons.

The [magic numbers](#) of nuclei are partly determined by the spin-orbit coupling force, which is related to the spins of the protons or neutrons in a nucleus. The spin-orbit coupling force was introduced by Nobel Laureates Maria Goeppert Mayer and J. Hans D. Jensen in 1949 to explain the splittings of quantum states of protons or neutrons. Its actual nuclear force origin is still not fully understood.

Researchers have identified that the magic number of six is particularly important because it should allow the origin of spin-orbit coupling to be thoroughly investigated. However, the existence of an atomic species with a magic number of six had not been confirmed.

Now, an international research team led by Osaka University has changed this situation by identifying a species of carbon—an essential element for life—that possesses a proton magic number of six. They conducted experiments that allowed them to measure the radii of protons in the nuclei of different carbon isotopes (isotopes have the same number of protons but different numbers of neutrons in their nuclei). Interestingly, the different carbon isotopes displayed very similar proton radii. They published their findings in *Nature Communications*.

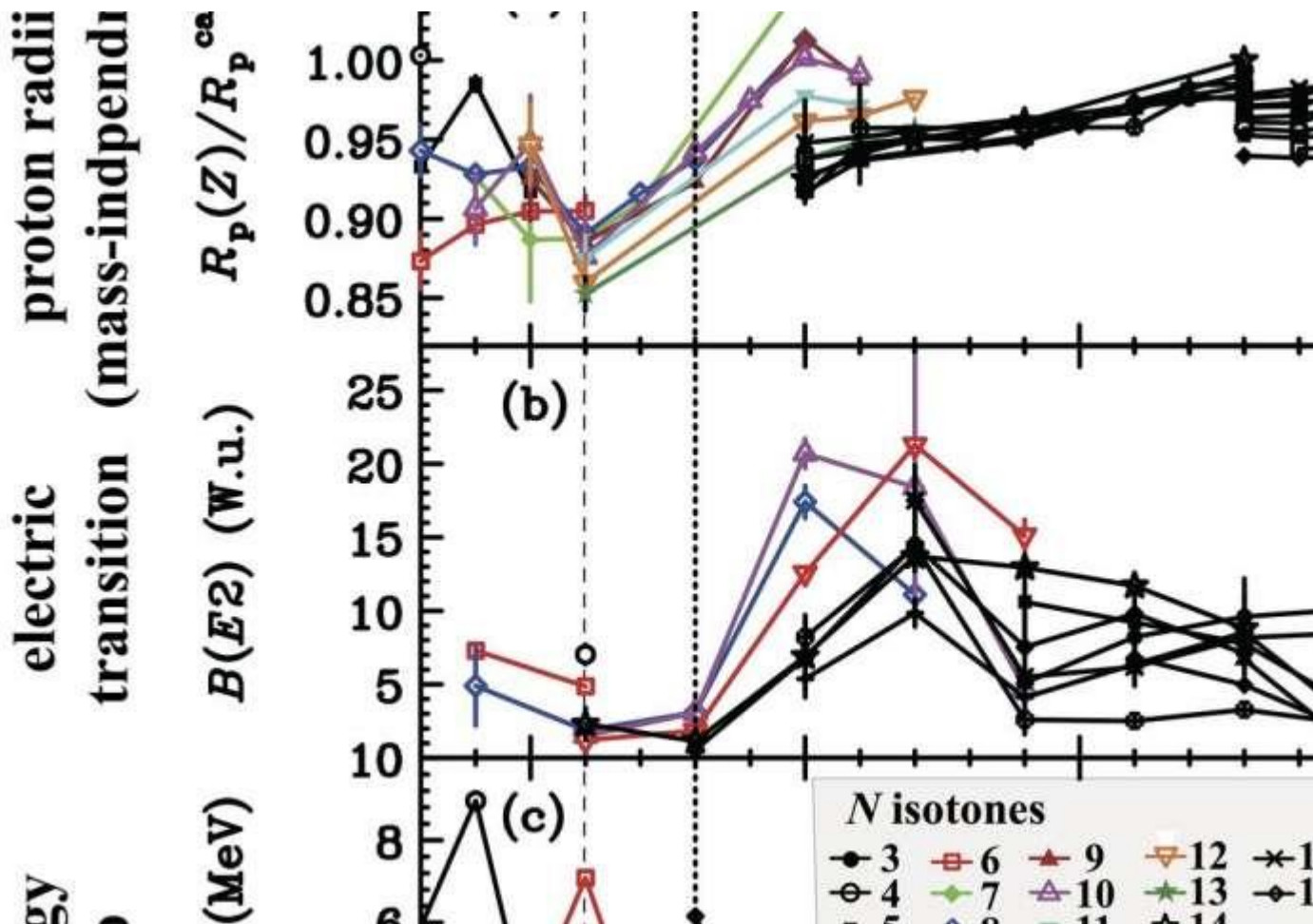

Figure 2. Evidence for a proton magic number of six (indicated by blue arrows) obtained through systematic evaluation of experimental data. (a) Mass-independent proton radius, (b) electronic transition probability, (c) proton shell gap, and ...more

"Combining our radii measurement results with nuclear charge radii, electric quadrupole transition rates, and atomic mass data allowed us to identify a carbon isotope with a predominant magic number of six" study first author Dinh Trong Tran says.

To help understand the experimental results, the researchers conducted computational calculations. Calculated proton radii agreed well with experimental values. The spin-orbit splitting of the carbon isotopes

was also investigated by analysis of experimental and theoretical data for the energy to add or remove a [proton](#) from the nucleus of each isotope.

"Our analysis clearly demonstrated that large spin–orbit splittings exist universally for atomic nuclei," corresponding author Hooi Jin Ong explains. "In addition, the magic number of six is as prominent as that of other identified magic numbers."

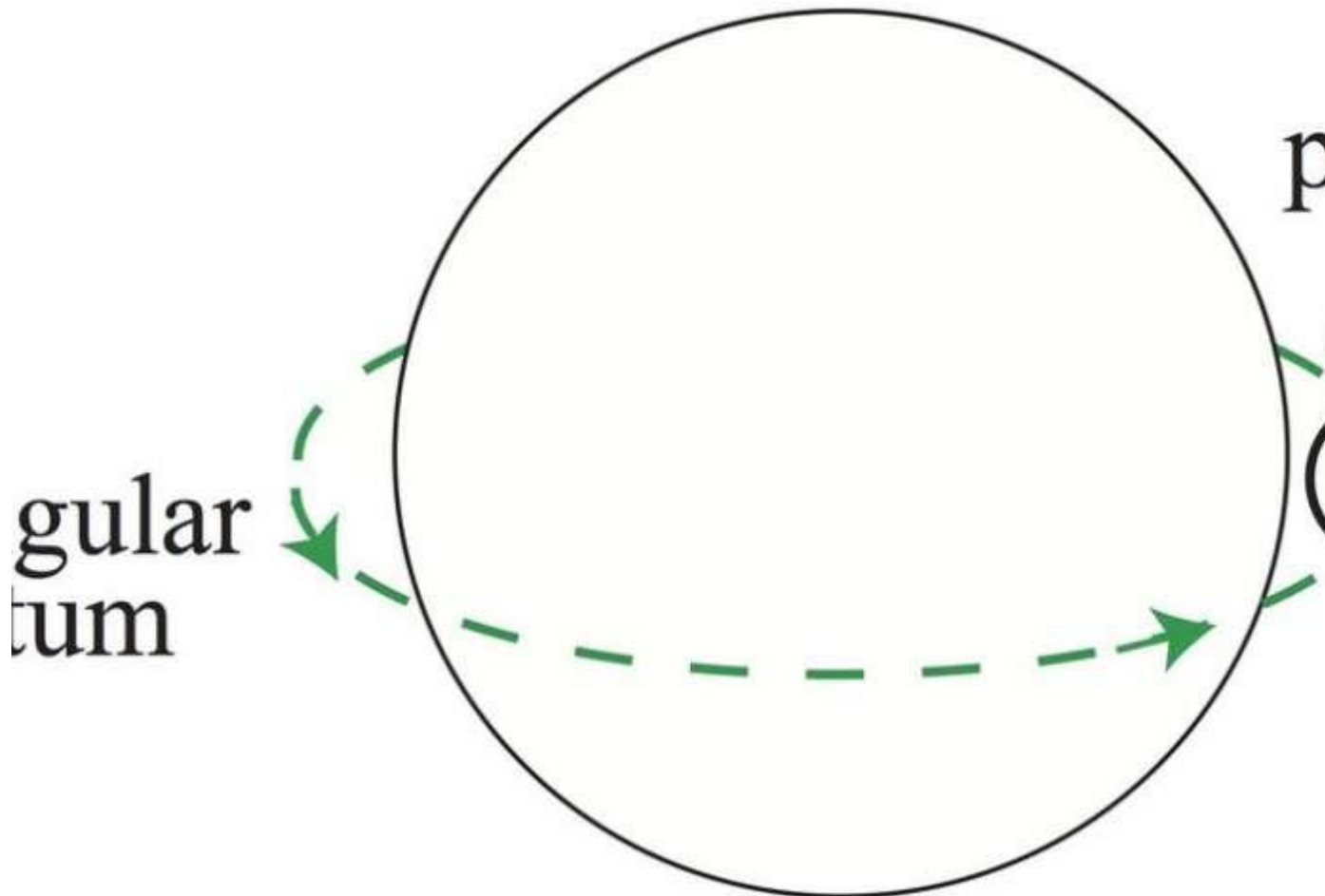

Figure 3. Illustration of spin–orbit coupling force. Atomic nuclei gain extra stability when the angular orbital momentum and spin of a proton or neutron are in the same direction. Credit: Hooi Jin Ong

The identification of the magic number of six provides an avenue to investigate the origin of spin–orbit splittings in [atomic nuclei](#). The team's findings increase fundamental knowledge of the spin–orbit force, the origin of the magic [number](#) of [nuclei](#), and nucleus stability, representing a contribution to eventual comprehensive understanding of nuclear physics. [25]

### **The nucleus—coming soon in 3-D**

Physicians have long used CT scans to get 3-D imagery of the inner workings of the human body. Now, physicists are working toward getting their first CT scans of the inner workings of the nucleus. A

measurement of quarks in helium nuclei demonstrates that 3-D imaging of the inner structure of the nucleus is now possible.

Nathan Baltzell is a postdoctoral researcher at the Department of Energy's Thomas Jefferson National Accelerator Facility in Newport News, Va. He says this successful measurement is one of the first steps toward imaging nuclei in a new way.

"It's a proof-of-principle measurement that opens up a new field – imaging nuclear structure in three dimensions with GPD tomography," he says.

He explains that GPDs, or generalized parton distributions, provide a framework that, when combined with experimental results, allows nuclear physicists to complete a 3-D rendering of the building blocks of subatomic particles, such as the proton, neutron, and now, even the nucleus.

GPDs are already being applied to 3-D imaging studies of protons and neutrons at Jefferson Lab. These studies are helping researchers understand how quarks and gluons build protons and neutrons. Now, Baltzell and his colleagues want to open a new window into the structure of the nucleus by extending this GPD tomography technique to nuclei.

"We've done these kinds of studies of quarks and gluons inside protons and neutrons for quite a while," he says. "But in a nucleus, where you have multiple neutrons and protons together... We don't quite know how the behaviors of quarks and gluons change and how they move together differently when you put them in a nucleus."

The experiment was conducted in 2009 at Jefferson Lab's Continuous Electron Beam Accelerator Facility, a DOE Office of Science User Facility. In it, electrons were beamed into the nuclei of helium-4 atoms.

"We started with helium-4 as our proof of principle for this study," Baltzell says. "We chose helium-4 because it is a light nucleus, relatively dense, and spinless. These characteristics make it experimentally attractive and the theoretical interpretation much simpler."

The experimenters were interested in the roughly 3,200 events they recorded of the electrons interacting with individual quarks inside the nuclei. For each of these events, the outgoing electron, the helium nucleus and a photon given off by the individual quark were all recorded.

"To make a precise measurement like this, you want to measure everything that comes out. This is the first time we measured all of the particles in the final state," Baltzell adds.

The result of the experiment was published last fall in *Physical Review Letters*.

Now that the researchers have shown that this technique is feasible, the collaboration is taking the next step to continue these studies with the new capabilities afforded by the upgraded accelerator and experimental equipment at Jefferson Lab. A new experiment has already been planned to begin the long process of actually composing that 3-D image of the internal quark-gluon structure of the helium-4 nucleus. [24]



## How are hadrons born at the huge energies available in the LHC?

Our world consists mainly of particles built up of three quarks bound by gluons. The process of the sticking together of quarks, called hadronisation, is still poorly understood. Physicists from the Institute of Nuclear Physics Polish Academy of Sciences in Cracow, working within the LHCb Collaboration, have obtained new information about it, thanks to the analysis of unique data collected in high-energy collisions of protons in the LHC.

When protons accelerated to the greatest energy collide with each other in the LHC, their component particles - quarks and gluons - create a puzzling intermediate state. The observation that in the collisions of such relatively simple particles as protons this intermediate state exhibits the properties of a liquid, typical for collisions of much more complex structures (heavy ions), was a big surprise. Properties of this type indicate the existence of a new state of matter: a quark-gluon plasma in which quarks and gluons behave almost as free particles. This exotic liquid cools instantly. As a result, the quarks and gluons re-connect with each other in a process called hadronisation. The effect of this is the birth of hadrons, particles that are clumps of two or three quarks. Thanks to the latest analysis of data collected at energies of seven teraelectronvolts, researchers from the Institute of Nuclear Physics Polish Academy of Sciences (IFJ PAN) in Cracow, working within the LHCb Collaboration, acquired new information on the mechanism of hadronisation in proton-proton collisions.

"The main role in proton collisions is played by strong interaction, described by the quantum chromodynamics. The phenomena occurring during the cooling of the quark-gluon plasma are, however, so complex in terms of computation that until now it has not been possible fully understand the details of hadronisation. And yet it is a process of key significance! It is thanks to this that in the first moments after the Big Bang, the dominant majority of particles forming our everyday environment was formed from quarks and gluons," says Assoc. Prof. Marcin Kucharczyk (IFJ PAN).

In the LHC, hadronisation is extremely fast, and occurs in an extremely small area around the point of proton collision: its dimensions reach only femtometres, or millionths of one billionth of a metre. It is no wonder then, that direct observation of this process is currently not possible. To obtain any information about its course, physicists must reach for various indirect methods. A key role is played by the basic tool of quantum mechanics: a wave function whose properties are mapped by the characteristics of particles of a given type (it is worth noting that although it is almost 100 years since the birth of quantum mechanics, there still exists various interpretations of the wave function!).

"The wave functions of identical particles will effectively overlap, i.e. interfere. If they are enhanced as a result of interference, we are talking about Bose-Einstein correlations, if they are suppressed - Fermi-Dirac correlations. In our analyses, we were interested in the enhancements, that is, the Bose-Einstein correlations. We were looking for them between the pi mesons flying out of the area of hadronisation in directions close to the original direction of the colliding beams of protons," explains Ph.D. student Bartosz Malecki (IFJ PAN).

The method used was originally developed for radioastronomy and is called HBT interferometry (from the names of its two creators: Robert Hanbury Brown and Richard Twiss). When used with reference to

particles, HBT interferometry makes it possible to determine the size of the area of hadronisation and its evolution over time. It helps to provide information about, for example, whether this area is different for different numbers of emitted particles or for their different types.

The data from the LHCb detector made it possible to study the hadronisation process in the area of so-called small angles, i.e. for hadrons produced in directions close to the direction of the initial proton beams. The analysis performed by the group from the IFJ PAN provided indications that the parameters describing the source of hadronisation in this unique region covered by LHCb experiment at LHC are different from the results obtained for larger angles.

"The analysis that provided these interesting results will be continued in the LHCb experiment for various collision energies and different types of colliding structures. Thanks to this, it will be possible to verify some of the models describing hadronisation and, consequently, to better understand the course of the process itself," sums up Prof. Mariusz Witek (IFJ PAN).

The work of the team from the IFJ PAN was financed in part by the OPUS grant from the Polish National Science Centre.

The Henryk Niewodniczanski Institute of Nuclear Physics (IFJ PAN) is currently the largest research institute of the Polish Academy of Sciences. The broad range of studies and activities of IFJ PAN includes basic and applied research, ranging from particle [physics](#) and astrophysics, through hadron physics, high-, medium-, and low-energy [nuclear physics](#), condensed matter physics (including materials engineering), to various applications of methods of nuclear physics in interdisciplinary research, covering medical physics, dosimetry, radiation and environmental biology, environmental protection, and other related disciplines. The average yearly yield of the IFJ PAN encompasses more than 600 scientific papers in the Journal Citation Reports published by the Thomson Reuters. The part of the Institute is the Cyclotron Centre Bronowice (CCB) which is an infrastructure, unique in Central Europe, to serve as a clinical and research centre in the area of medical and nuclear physics. IFJ PAN is a member of the Marian Smoluchowski Krakow Research Consortium: "Matter-Energy-Future" which possesses the status of a Leading National Research Centre (KNOW) in physics for the years 2012-2017. The Institute is of A+ Category (leading level in Poland) in the field of sciences and engineering. [23]

## Shock front probed by protons

A shock front is usually considered as a simple discontinuity in density or pressure. Yet in strongly shocked gases, the atoms are ionized into electrons and ions. The large difference in the electron pressure across the shock front can generate a strong electric field.

In experimental campaigns using the OMEGA EP laser at the Laboratory for Laser Energetics (LLE) at the University of Rochester, Lawrence Livermore National Laboratory (LLNL), University of California San Diego (UCSD) and Massachusetts Institute of Technology (MIT) researchers took radiographs of the shock front, similar to the X-ray radiology in hospitals with protons instead of X-rays.

Protons are charged particles that can be deflected by an electric field. Therefore, detecting the changes in their trajectories will provide information on the electric field. "Our proton probe is broadband," said Rui Hua, a graduate student at UCSD and the first author of the paper published in Applied Physical Letters. "Measuring energy-dependent deflections allows us to quantitatively study the electric potential and the potential width." The team also published a paper in Review of Scientific Instruments earlier this year to describe this platform.

The team observed an electric field of about 800 million volts per meter. "An analytical model agrees very well with our data," said Yuan Ping, LLNL co-author and the campaign lead. "So we don't have to rely on hydrodynamic codes to interpret the data."

The team plans to carry out more shots with higher-pressure shocks, and also in convergent geometry to simulate the conditions in the capsule implosion for ICF. "This is a perfect example of collaboration between the Lab and academia," said Farhat Beg, director of the Center for Energy Research at UCSD.

The team's research is available at Applied Physical Letters. [22]

## **Researchers generate proton beams using a combination of nanoparticles and laser light**

Light, when strongly concentrated, is enormously powerful. Now, a team of physicists led by Professor Jörg Schreiber from the Institute of Experimental Physics – Medical Physics, which is part of the Munich-Centre for Advanced Photonics (MAP), a Cluster of Excellence at LMU Munich, has used this energy source with explosive effect. The researchers focus high-power laser light onto beads of plastic just a few micrometers in size. The concentrated energy blows the nanoparticles apart, releasing radiation made up of positively charged atoms (protons). Such proton beams could be used in future for treating tumors, and in advanced imaging techniques. Their findings appear in the journal Physical Review E.

At Texas Petawatt Lasers in Austin, Texas, the LMU physicists concentrated laser light so strongly on plastic nanobeads that these essentially exploded. In the experiment, approximately one quadrillion billion photons (3 times  $10^{20}$  photons) were focused onto microspheres of about 500 nanometers in diameter. Each bead consists of about 50 billion carbon and hydrogen atoms and is held in suspension by the electromagnetic fields of a so-called "Paul trap", where the laser beam can irradiate them.

The laser radiation rips away some 15 per cent of the electrons bound in these atoms. The remaining, positively charged atomic nuclei are then violently repelled, and the nanospheres explode at speeds of around 10 per cent the speed of light. The radiation from the positively charged particles (protons) then spreads out in all directions.

This mode of production of proton beams with laser light promises to open up new opportunities for nuclear medicine – for example, in the fight against tumors. At present, proton beams are produced in conventional accelerators. In contrast, laser-generated proton beams open the door to the development of novel, perhaps even cheaper and more efficient, methods of treatment. The Munich-based team led by Jörg Schreiber has hitherto produced proton radiation using a

diamondlike film, which is targeted by extremely strong laser light. The proton radiation thus emitted could then be directed onto the body of a patient.

The ability to produce radiation by the explosive disintegration of plastic nanobeads might even allow the nanoparticles to be placed inside a tumor, and be vaporized with laser light. Thus proton beams could be put to work in destroying tumors without causing damage to surrounding healthy tissue. [21]

## **Towards stable propagation of light in nano-photonic fibers**

Devices based on light, rather than electrons, could revolutionize the speed and security of our future computers. However, one of the major challenges in today's physics is the design of photonic devices, able to transport and switch light through circuits in a stable way. Sergej Flach, Director of the Center for Theoretical Physics of Complex Systems, within the Institute for Basic Science (IBS) and colleagues from the National Technical University of Athens and the University of Patras (Greece) have studied how to achieve a more stable propagation of light for future optical technologies. Their model was recently published in Scientific Reports.

Optical fibers can carry a large amount of information and are already used in many countries for communications via phone, internet and TV. However, when light travels long distances through these fibers, it suffers from losses and leakages, which could lead to a loss of information. In order to compensate for this problem, amplifiers are positioned at specific intervals to amplify the signal. For example, amplifiers are needed in submarine communications cables that allow the transfer of digital data between all continents (except for Antarctica). Researchers have tried to build fibers where the signal is stable along the pathway and does not need amplifiers, using the so-called "PT symmetry". P stands for parity reversal and T for time reversal.

The PT symmetry can be simplified with an example. Imagine a situation where two cars are traveling at the same speed at some instant in time. However, one car is speeding up and the other one is slowing down. Using parity reversal (P) we exchange one car for the other. Using time reversal (T) we go back in time. If you are in the car that is accelerating, you can jump to the car that is slowing down (P) and you also go back in time (T). As a result, you will end up with the same speed as the accelerating car. The cars are like light waves inside the optical fibers and the speed is a representation of the intensity of light. The jumping symbolizes of the transfer of light from one fiber to another, which happens when the light waves propagating in each fiber overlap partially with each other, through a phenomenon called tunneling.

The PT symmetry idea is that one can carefully balance the intensity of light inside the fibers and achieve a stable propagation. Researchers expected PT symmetry to be the solution to achieve stable propagation in all-optical devices (diodes, transistors, switches etc.). However, stable propagation is still a challenge because the PT symmetry conditions have to be balanced extremely carefully, and because the material of the fibers reacts and destroys the exact balance. In the example of the cars, in order to achieve perfect PT symmetry, you would need really identical cars and street conditions. Reality is of course much different.

The team led by IBS found that the stability of light propagation can be achieved by breaking the PT symmetry in a controlled way. In the example of the cars, you would have to choose two cars that

are actually different (for example, one has a better engine than the other), but you choose the differences deliberately.

"You have the potential to realize a lot of the items of the wish-list of the PT symmetry, by breaking the PT symmetry. But you have to break it in the right way," explains Professor Flach. "Now we know how to tune the characteristics of the fiber couplers to achieve a long-lasting constant light propagation." [20]

### **Synopsis: Twisting in Thin Air**

Levitated nanoparticles can be used in ultrasensitive force measurements and fundamental tests of quantum physics. Unlike prior efforts that have focused on the translational vibrations of these nanoparticles, a new study considers the torsional motion. The researchers used polarized laser light to measure, for the first time, the twisting oscillations of oblong-shaped nanoparticles in a vacuum. The results suggest that this torsional motion can be cooled to zero oscillations (on average), corresponding to the torsional ground state.

For levitation experiments, focused laser beams create a trap that confines the translational motion of nanoparticles to back-and-forth oscillations at a specific frequency. Laser cooling can reduce these oscillations, but current techniques cannot reach the ground state. One solution is higher oscillation frequencies. In this case, the energy left after cooling is less than one quantum of oscillation, so the nanoparticle ends up in its ground state. However, making a higher-frequency optical trap would require higher laser power, which has the negative effect of heating the nanoparticles.

An alternative path is the use of a different oscillation mode. Tongcang Li of Purdue University, Indiana, and collaborators investigated the torsional motions of nanoparticles levitated with a linearly polarized laser. The oblong-shaped nanoparticles within the sample aligned themselves lengthwise along the laser's polarization axis. The researchers showed that these ellipsoids twist back and forth around this axis with a frequency of 1 MHz, a factor of 6 higher than that of the particles' translational vibrations. The team outlined a possible cooling method that could place nanoparticles in their torsional ground state. They also imagined the system as an ultrasensitive detector that could measure torques on single particles. [19]

### **Researchers have created quantum states of light whose noise level has been "squeezed" to a record low**

Squeezed quantum states of light can have better noise properties than those imposed by classical limits set by shot noise. Such states might help researchers boost the sensitivity of gravitationalwave (GW) detectors or design more practical quantum information schemes. A team of researchers at the Institute for Gravitational Physics at the Leibniz University of Hanover, Germany, has now demonstrated a method for squeezing noise to record low levels. The new approach—compatible with the laser interferometers used in GW detectors—may lead to technologies for upgrading LIGO and similar observatories.

Squeezed light is typically generated in nonlinear crystals, in which one pump photon produces two daughter photons. Because the two photons are generated in the same quantum process, they exhibit correlations that can be exploited to reduce noise in measuring setups. Quantum squeezing can, in principle, reduce noise to arbitrarily low levels. But in practice, photon losses and detector noise limit the maximum achievable squeezing. The previous record was demonstrated by the Hanover team, who used a scheme featuring amplitude fluctuations that were about a factor of 19 lower than those expected from classical noise (12.7 dB of squeezing).

In their new work, the researchers bested themselves by increasing this factor to 32 (15 dB of squeezing), using a light-squeezing scheme with low optical losses and minimal fluctuations in the phase of the readout scheme. The squeezed states are obtained at 1064 nm, the laser wavelength feeding the interferometers of all current GW observatories.

This research is published in Physical Review Letters. [18]

## Liquid Light with a Whirl

An elliptical light beam in a nonlinear optical medium pumped by “twisted light” can rotate like an electron around a magnetic field.

Magnetism and rotation have a lot in common. The effect of a magnetic field on a moving charge, the Lorentz force, is formally equivalent to the fictitious force felt by a moving mass in a rotating reference frame, the Coriolis force. For this reason, atomic quantum gases under rotation can be used as quantum simulators of exotic magnetic phenomena for electrons, such as the fractional quantum Hall effect. But there is no direct equivalent of magnetism for photons, which are massless and chargeless. Now, Niclas Westerberg and co-workers at Heriot-Watt University, UK, have shown how to make synthetic magnetic fields for light. They developed a theory that predicts how a light beam in a nonlinear optical medium pumped by “twisted light” will rotate as it propagates, just as an electron will whirl around in a magnetic field. More than that, the light will expand as it goes, demonstrating fluid-like behavior. We can expect synthetic magnetism for light to bring big insights into magnetism in other systems, as well as some beautiful images.

The idea that light can behave like a fluid and, even more interestingly, a superfluid (a fluid with zero viscosity), goes back at least to the 1990s. The analogy comes about because Maxwell’s equations for nearly collimated light in a nonlinear medium look like the Schrödinger equation for a superfluid of matter, modified to include particle interactions. Fluids of light, or photon fluids, propagating in bulk nonlinear media show a range of fluid and superfluid behavior, such as free expansion and shock waves. In microcavities, fluids of light can be strongly coupled to matter, such as semiconductor electron-hole pairs, to make hybrid entities known as polariton condensates. These condensates can exhibit quantized vortices, which are characteristic of superfluidity. Despite these impressive advances, it has proven difficult to induce the strong bulk rotation required for phenomena such as the quantum Hall effect to show up in photon fluids, hence the need for synthetic magnetism.

The concept of synthetic magnetism is borrowed from ultracold atoms. With atoms, it is experimentally unfeasible to reach a regime of rapid rotation corresponding to a large magnetic field, not least because the traps that confine the atoms are unable to provide the centripetal force

to stop them from flying out. Instead, it is possible to take advantage of the fact that atoms have multiple internal states. These can be used to generate geometric phases, as opposed to dynamic phases (which can be imposed by any forces, whatever the structure of the internal states may be). A geometric phase, otherwise known as a Berry phase, arises when a system's internal states (for example, its spin) smoothly follow the variations of an external field, so that its phase depends on which path it takes between two external states (for example, two positions of the system), even if the paths have the same energy. In atomic systems, the variations of the external field in position are achieved with phase or amplitude structures of the electromagnetic field of laser light. These variations can be engineered to produce the rotational equivalent of the vector potential for a magnetic field on a charged particle, inducing strong bulk rotation that shows up as many vortices in a superfluid Bose-Einstein condensate.

To produce a geometric phase in a fluid of light, Westerberg and colleagues considered light with two coupled internal states—a spinor photon fluid. They studied two types of nonlinear media, with second- and third-order optical nonlinearities, respectively. The second-order nonlinearity comes in the form of mixing of three fields in a birefringent crystal, in which one field, the pump light field, splits into two further fields with orthogonal polarizations, these being the two required internal states of the spinor fluid. Slow spatial variations of the strong pump field generate a synthetic vector potential that is equivalent to a magnetic field for electric charges or rotation for atoms.

The third-order optical nonlinearity occurs in a medium with a refractive index that depends on the intensity of light. The spinor photon fluid in this case consists of weak fluctuations around a strong light field that carries orbital angular momentum (colloquially known as twisted light). The two internal states of the fluid are distinguished by their differing orbital angular momentum. The resulting vector potential produces synthetic magnetism, much as with the second-order nonlinearity.

Coincidentally, for the medium with a second-order nonlinearity, Westerberg and co-workers also propose using twisted light.

The authors present numerical simulations for both types of nonlinearity. For the second-order nonlinear medium, they show that an elliptical light beam in a synthetic magnetic field rotates about its propagation axis and expands as it propagates (Fig 1). The expansion shows that the light is behaving as a fluid in rotation. For the third-order nonlinear medium there is a trapped vortex that causes the beam to rotate, which is akin to cyclotron motion of a charge in a magnetic field. Short of spinning the medium extremely rapidly [9], it is not obvious how one could otherwise make a beam continuously rotate as it propagates.

Westerberg and colleagues' work makes important connections between several disparate topics: nonlinear optics, atomic physics, geometric phases, and light with orbital angular momentum. Spinor photon fluids in themselves are a new development. The complete state of a photon fluid—its amplitude, phase, and polarization—can be mapped out; this is not possible for atoms or electrons. Some of the authors of the present study have recently experimentally driven photon fluids past obstacles in ways that are hard to achieve for atoms, and obtained evidence for superfluidity through the phase of the photon fluid [10]—evidence that cannot be obtained for electronic magnetism. Furthermore, they have also made photon fluids that have nonlocal

interactions, via thermal effects. Generalizing synthetic magnetism to nonlocal fluids of light will enlighten us about magnetism and rotation in solid-state and atomic superfluids. Experimental implementation will surely follow hot on the heels of this proposal. [17]

## Physicists discover a new form of light

Physicists from Trinity College Dublin's School of Physics and the CRANN Institute, Trinity College, have discovered a new form of light, which will impact our understanding of the fundamental nature of light.

One of the measurable characteristics of a beam of light is known as angular momentum. Until now, it was thought that in all forms of light the angular momentum would be a multiple of Planck's constant (the physical constant that sets the scale of quantum effects).

Now, recent PhD graduate Kyle Ballantine and Professor Paul Eastham, both from Trinity College Dublin's School of Physics, along with Professor John Donegan from CRANN, have demonstrated a new form of light where the angular momentum of each photon (a particle of visible light) takes only half of this value. This difference, though small, is profound. These results were recently published in the online journal Science Advances.

Commenting on their work, Assistant Professor Paul Eastham said: "We're interested in finding out how we can change the way light behaves, and how that could be useful. What I think is so exciting about this result is that even this fundamental property of light, that physicists have always thought was fixed, can be changed."

Professor John Donegan said: "My research focuses on nanophotonics, which is the study of the behaviour of light on the nanometer scale. A beam of light is characterised by its colour or wavelength and a less familiar quantity known as angular momentum. Angular momentum measures how much something is rotating. For a beam of light, although travelling in a straight line it can also be rotating around its own axis. So when light from the mirror hits your eye in the morning, every photon twists your eye a little, one way or another."

"Our discovery will have real impacts for the study of light waves in areas such as secure optical communications."

Professor Stefano Sanvito, Director of CRANN, said: "The topic of light has always been one of interest to physicists, while also being documented as one of the areas of physics that is best understood. This discovery is a breakthrough for the world of physics and science alike. I am delighted to once again see CRANN and Physics in Trinity producing fundamental scientific research that challenges our understanding of light."

To make this discovery, the team involved used an effect discovered in the same institution almost 200 years before. In the 1830s, mathematician William Rowan Hamilton and physicist Humphrey Lloyd found that, upon passing through certain crystals, a ray of light became a hollow cylinder. The team used this phenomenon to generate beams of light with a screw-like structure.

Analyzing these beams within the theory of quantum mechanics they predicted that the angular momentum of the photon would be half-integer, and devised an experiment to test their



prediction. Using a specially constructed device they were able to measure the flow of angular momentum in a beam of light. They were also able, for the first time, to measure the variations in this flow caused by quantum effects. The experiments revealed a tiny shift, one-half of Planck's constant, in the angular momentum of each photon.

Theoretical physicists since the 1980s have speculated how quantum mechanics works for particles that are free to move in only two of the three dimensions of space. They discovered that this would enable strange new possibilities, including particles whose quantum numbers were fractions of those expected. This work shows, for the first time, that these speculations can be realised with light. [16]

## **Novel metasurface revolutionizes ubiquitous scientific tool**

Light from an optical fiber illuminates the metasurface, is scattered in four different directions, and the intensities are measured by the four detectors. From this measurement the state of polarization of light is detected.

What do astrophysics, telecommunications and pharmacology have in common? Each of these fields relies on polarimeters—instruments that detect the direction of the oscillation of electromagnetic waves, otherwise known as the polarization of light.

Even though the human eye isn't particularly sensitive to polarization, it is a fundamental property of light. When light is reflected or scattered off an object, its polarization changes and measuring that change reveals a lot of information. Astrophysicists, for example, use polarization measurements to analyze the surface of distant, or to map the giant magnetic fields spanning our galaxy. Drug manufacturers use the polarization of scattered light to determine the chirality and concentration of drug molecules. In telecommunications, polarization is used to carry information through the vast network of fiber optic cables. From medical diagnostics to high-tech manufacturing to the food industry, measuring polarization reveals critical data.

Scientists rely on polarimeters to make these measurements. While ubiquitous, many polarimeters currently in use are slow, bulky and expensive.

Now, researchers at the Harvard John A. Paulson School of Engineering and Applied Sciences and Innovation Center Iceland have built a polarimeter on a microchip, revolutionizing the design of this widely used scientific tool.

"We have taken an instrument that is can reach the size of a lab bench and shrunk it down to the size of a chip," said Federico Capasso, the Robert L. Wallace Professor of Applied Physics and Vinton Hayes Senior Research Fellow in Electrical Engineering, who led the research. "Having a microchip polarimeter will make polarization measurements available for the first time to a much broader range of applications, including in energy-efficient, portable devices."

"Taking advantage of integrated circuit technology and nanophotonics, the new device promises high-performance polarization measurements at a fraction of the cost and size," said J. P. Balthasar Mueller, a graduate student in the Capasso lab and first author of the paper.

The device is described in the journal *Optica*. Harvard's Office of Technology Development has filed a patent application and is actively exploring commercial opportunities for the technology.

Capasso's team was able to drastically reduce the complexity and size of polarimeters by building a two-dimensional metasurface—a nanoscale structure that interacts with light. The metasurface is covered with a thin array of metallic antennas, smaller than a wavelength of light, embedded in a polymer film. As light propagates down an optical fiber and illuminates the array, a small amount scatters in four directions. Four detectors measure the intensity of the scattered light and combine to give the state of polarization in real time.

"One advantage of this technique is that the polarization measurement leaves the signal mostly intact," said Mueller. "This is crucial for many uses of polarimeters, especially in optical telecommunications, where measurements must be made without disturbing the data stream."

In telecommunications, optical signals propagating through fibers will change their polarization in random ways. New integrated photonic chips in fiber optic cables are extremely sensitive to polarization, and if light reaches a chip with the wrong polarization, it can cause a loss of signal.

"The design of the antenna array make it robust and insensitive to the inaccuracies in the fabrication process, which is ideal for large scale manufacturing," said Kristjan Leosson, senior researcher and division manager at the Innovation Center and coauthor of the paper.

Leosson's team in Iceland is currently working on incorporating the metasurface design from the Capasso group into a prototype polarimeter instrument.

Chip-based polarimeters could for the first time provide comprehensive and real-time polarization monitoring, which could boost network performance and security and help providers keep up with the exploding demand for bandwidth.

"This device performs as well as any state-of-the-art polarimeter on the market but is considerably smaller," said Capasso. "A portable, compact polarimeter could become an important tool for not only the telecommunications industry but also in drug manufacturing, medical imaging, chemistry, astronomy, you name it. The applications are endless." [15]

## **New nanodevice shifts light's color at single-photon level**

Converting a single photon from one color, or frequency, to another is an essential tool in quantum communication, which harnesses the subtle correlations between the subatomic properties of photons (particles of light) to securely store and transmit information. Scientists at the National Institute of Standards and Technology (NIST) have now developed a miniaturized version of a frequency converter, using technology similar to that used to make computer chips.

The tiny device, which promises to help improve the security and increase the distance over which next-generation quantum communication systems operate, can be tailored for a wide variety of uses, enables easy integration with other information-processing elements and can be mass produced.

The new nanoscale optical frequency converter efficiently converts photons from one frequency to the other while consuming only a small amount of power and adding a very low level of noise, namely background light not associated with the incoming signal.

Frequency converters are essential for addressing two problems. The frequencies at which quantum systems optimally generate and store information are typically much higher than the frequencies required to transmit that information over kilometer-scale distances in optical fibers. Converting the photons between these frequencies requires a shift of hundreds of terahertz (one terahertz is a trillion wave cycles per second).

A much smaller, but still critical, frequency mismatch arises when two quantum systems that are intended to be identical have small variations in shape and composition. These variations cause the systems to generate photons that differ slightly in frequency instead of being exact replicas, which the quantum communication network may require.

The new photon frequency converter, an example of nanophotonic engineering, addresses both issues, Qing Li, Marcelo Davanço and Kartik Srinivasan write in *Nature Photonics*. The key component of the chip-integrated device is a tiny ring-shaped resonator, about 80 micrometers in diameter (slightly less than the width of a human hair) and a few tenths of a micrometer in thickness. The shape and dimensions of the ring, which is made of silicon nitride, are chosen to enhance the inherent properties of the material in converting light from one frequency to another. The ring resonator is driven by two pump lasers, each operating at a separate frequency. In a scheme known as four-wave-mixing Bragg scattering, a photon entering the ring is shifted in frequency by an amount equal to the difference in frequencies of the two pump lasers.

Like cycling around a racetrack, incoming light circulates around the resonator hundreds of times before exiting, greatly enhancing the device's ability to shift the photon's frequency at low power and with low background noise. Rather than using a few watts of power, as typical in previous experiments, the system consumes only about a hundredth of that amount. Importantly, the added amount of noise is low enough for future experiments using single-photon sources.

While other technologies have been applied to frequency conversion, "nanophotonics has the benefit of potentially enabling the devices to be much smaller, easier to customize, lower power, and compatible with batch fabrication technology," said Srinivasan. "Our work is a first demonstration of a nanophotonic technology suitable for this demanding task of quantum frequency conversion." [14]

## **Quantum dots enhance light-to-current conversion in layered semiconductors**

Harnessing the power of the sun and creating light-harvesting or light-sensing devices requires a material that both absorbs light efficiently and converts the energy to highly mobile electrical current. Finding the ideal mix of properties in a single material is a challenge, so scientists have been experimenting with ways to combine different materials to create "hybrids" with enhanced features.

In two just-published papers, scientists from the U.S. Department of Energy's Brookhaven National Laboratory, Stony Brook University, and the University of Nebraska describe one such approach that combines the excellent light-harvesting properties of quantum dots with the tunable electrical conductivity of a layered tin disulfide semiconductor. The hybrid material exhibited enhanced light-harvesting properties through the absorption of light by the quantum dots and their energy transfer to tin disulfide, both in laboratory tests and when incorporated into electronic devices. The research paves the way for using these materials in optoelectronic applications such as energy-harvesting photovoltaics, light sensors, and light emitting diodes (LEDs).

According to Mircea Cotlet, the physical chemist who led this work at Brookhaven Lab's Center for Functional Nanomaterials (CFN), a DOE Office of Science User Facility, "Two-dimensional metal dichalcogenides like tin disulfide have some promising properties for solar energy conversion and photodetector applications, including a high surface-to-volume aspect ratio. But no semiconducting material has it all. These materials are very thin and they are poor light absorbers. So we were trying to mix them with other nanomaterials like light-absorbing quantum dots to improve their performance through energy transfer."

One paper, just published in the journal ACS Nano, describes a fundamental study of the hybrid quantum dot/tin disulfide material by itself. The work analyzes how light excites the quantum dots (made of a cadmium selenide core surrounded by a zinc sulfide shell), which then transfer the absorbed energy to layers of nearby tin disulfide.

"We have come up with an interesting approach to discriminate energy transfer from charge transfer, two common types of interactions promoted by light in such hybrids," said Prahlad Routh, a graduate student from Stony Brook University working with Cotlet and co-first author of the ACS Nano paper. "We do this using single nanocrystal spectroscopy to look at how individual quantum dots blink when interacting with sheet-like tin disulfide. This straightforward method can assess whether components in such semiconducting hybrids interact either by energy or by charge transfer."

The researchers found that the rate for non-radiative energy transfer from individual quantum dots to tin disulfide increases with an increasing number of tin disulfide layers. But performance in laboratory tests isn't enough to prove the merits of potential new materials. So the scientists incorporated the hybrid material into an electronic device, a photo-field-effect-transistor, a type of photon detector commonly used for light sensing applications.

As described in a paper published online March 24 in Applied Physics Letters, the hybrid material dramatically enhanced the performance of the photo-field-effect transistors—resulting in a photocurrent response (conversion of light to electric current) that was 500 percent better than transistors made with the tin disulfide material alone.

"This kind of energy transfer is a key process that enables photosynthesis in nature," said ChangYong Nam, a materials scientist at Center for Functional Nanomaterials and co-corresponding author of the APL paper. "Researchers have been trying to emulate this principle in light-harvesting electrical devices, but it has been difficult particularly for new material systems such as the tin disulfide we studied. Our device demonstrates the performance benefits realized by using both energy transfer processes and new low-dimensional materials."

Cotlet concludes, "The idea of 'doping' two-dimensional layered materials with quantum dots to enhance their light absorbing properties shows promise for designing better solar cells and photodetectors." [13]

## Quasiparticles dubbed topological polaritons make their debut in the theoretical world

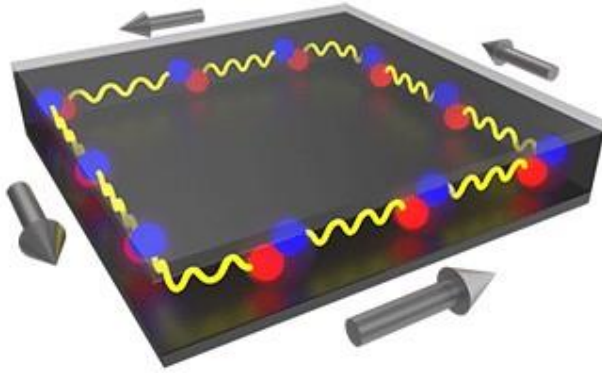

Condensed-matter physicists often turn to particle-like entities called quasiparticles—such as excitons, plasmons, magnons—to explain complex phenomena. Now Gil Refael from the California Institute of Technology in Pasadena and colleagues report the theoretical concept of the topological polariton, or “topolariton”: a hybrid half-light, half-matter quasiparticle that has special topological properties and might be used in devices to transport light in one direction.

The proposed topolaritons arise from the strong coupling of a photon and an exciton, a bound state of an electron and a hole. Their topology can be thought of as knots in their gapped energy-band structure. At the edge of the systems in which topolaritons emerge, these knots unwind and allow the topolaritons to propagate in a single direction without back-reflection. In other words, the topolaritons cannot make U-turns. Back-reflection is a known source of detrimental feedback and loss in photonic devices. The topolaritons’ immunity to it may thus be exploited to build devices with increased performance.

The researchers describe a scheme to generate topolaritons that may be feasible to implement in common systems—such as semiconductor structures or atomically thin layers of compounds known as transition-metal dichalcogenides—embedded in photonic waveguides or microcavities. Previous approaches to make similar one-way photonic channels have mostly hinged on effects that are only applicable at microwave frequencies. Refael and co-workers’ proposal offers an avenue to make such “one-way photonic roads” in the optical regime, which despite progress has remained a challenging pursuit. [12]

## 'Matter waves' move through one another but never share space

Physicist Randy Hulet and colleagues observed a strange disappearing act during collisions between forms of Bose Einstein condensates called solitons. In some cases, the colliding clumps of matter appear to keep their distance even as they pass through each other. How can two clumps of matter pass through each other without sharing space? Physicists have documented a strange

disappearing act by colliding Bose Einstein condensates that appear to keep their distance even as they pass through one another.

BECs are clumps of a few hundred thousand lithium atoms that are cooled to within one-millionth of a degree above absolute zero, a temperature so cold that the atoms march in lockstep and act as a single "matter wave." Solitons are waves that do not diminish, flatten out or change shape as they move through space. To form solitons, Hulet's team coaxed the BECs into a configuration where the attractive forces between lithium atoms perfectly balance the quantum pressure that tends to spread them out.

The researchers expected to observe the property that a pair of colliding solitons would pass through one another without slowing down or changing shape. However, they found that in certain collisions, the solitons approached one another, maintained a minimum gap between themselves, and then appeared to bounce away from the collision.

Hulet's team specializes in experiments on BECs and other ultracold matter. They use lasers to both trap and cool clouds of lithium gas to temperatures that are so cold that the matter's behavior is dictated by fundamental forces of nature that aren't observable at higher temperatures.

To create solitons, Hulet and postdoctoral research associate Jason Nguyen, the study's lead author, balanced the forces of attraction and repulsion in the BECs.

Cameras captured images of the tiny BECs throughout the process. In the images, two solitons oscillate back and forth like pendulums swinging in opposite directions. Hulet's team, which also included graduate student De Luo and former postdoctoral researcher Paul Dyke, documented thousands of head-on collisions between soliton pairs and noticed a strange gap in some, but not all, of the experiments.

Many of the events that Hulet's team measures occur in one-thousandth of a second or less. To confirm that the "disappearing act" wasn't causing a miniscule interaction between the soliton pairs -- an interaction that might cause them to slowly dissipate over time -- Hulet's team tracked one of the experiments for almost a full second.

The data showed the solitons oscillating back and fourth, winking in and out of view each time they crossed, without any measurable effect.

"This is great example of a case where experiments on ultracold matter can yield a fundamental new insight," Hulet said. "The phase-dependent effects had been seen in optical experiments, but there has been a misunderstanding about the interpretation of those observations." [11]

## Photonic molecules

Working with colleagues at the Harvard-MIT Center for Ultracold Atoms, a group led by Harvard Professor of Physics Mikhail Lukin and MIT Professor of Physics Vladan Vuletic have managed to coax photons into binding together to form molecules – a state of matter that, until recently, had been purely theoretical. The work is described in a September 25 paper in Nature.

The discovery, Lukin said, runs contrary to decades of accepted wisdom about the nature of light. Photons have long been described as massless particles which don't interact with each other – shine two laser beams at each other, he said, and they simply pass through one another.

"Photonic molecules," however, behave less like traditional lasers and more like something you might find in science fiction – the light saber.

"Most of the properties of light we know about originate from the fact that photons are massless, and that they do not interact with each other," Lukin said. "What we have done is create a special type of medium in which photons interact with each other so strongly that they begin to act as though they have mass, and they bind together to form molecules. This type of photonic bound state has been discussed theoretically for quite a while, but until now it hadn't been observed. [9]

## The Electromagnetic Interaction

This paper explains the magnetic effect of the electric current from the observed effects of the accelerating electrons, causing naturally the experienced changes of the electric field potential along the electric wire. The accelerating electrons explain not only the Maxwell Equations and the Special Relativity, but the Heisenberg Uncertainty Relation, the wave particle duality and the electron's spin also, building the bridge between the Classical and Quantum Theories. [2]

## Asymmetry in the interference occurrences of oscillators

The asymmetrical configurations are stable objects of the real physical world, because they cannot annihilate. One of the most obvious asymmetry is the proton – electron mass rate  $M_p = 1840 M_e$  while they have equal charge. We explain this fact by the strong interaction of the proton, but how remember it his strong interaction ability for example in the H – atom where are only electromagnetic interactions among proton and electron.

This gives us the idea to origin the mass of proton from the electromagnetic interactions by the way interference occurrences of oscillators. The uncertainty relation of Heisenberg makes sure that the particles are oscillating.

The resultant intensity due to n equally spaced oscillators, all of equal amplitude but different from one another in phase, either because they are driven differently in phase or because we are looking at them an angle such that there is a difference in time delay:

$$(1) \quad I = I_0 \frac{\sin^2 n \varphi/2}{\sin^2 \varphi/2}$$

If  $\varphi$  is infinitesimal so that  $\sin \varphi = \varphi$  than

$$(2) \quad I = n^2 I_0$$

This gives us the idea of

$$(3) \quad M_p = n^2 M_e$$

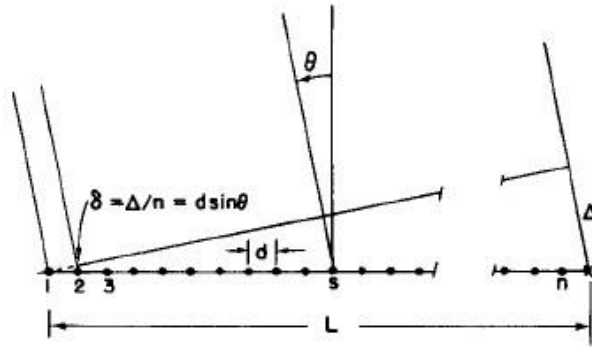

Fig. 30-3. A linear array of  $n$  equal oscillators, driven with phases  $\alpha_s = s\alpha$ .

Figure 1.) A linear array of  $n$  equal oscillators

There is an important feature about formula (1) which is that if the angle  $\varphi$  is increased by the multiple of  $2\pi$  it makes no difference to the formula.

So

$$(4) \quad d \sin \theta = m \lambda \text{ and we get } m\text{-order beam if } \lambda \text{ less than } d. [6]$$

If  $d$  less than  $\lambda$  we get only zero-order one centered at  $\theta = 0$ . Of course, there is also a beam in the opposite direction. The right choices of  $d$  and  $\lambda$  we can ensure the conservation of charge.

For example

$$(5) \quad 2(m+1) = n$$

Where  $2(m+1) = N_p$  number of protons and  $n = N_e$  number of electrons.

In this way we can see the  $H_2$  molecules so that  $2n$  electrons of  $n$  radiate to  $4(m+1)$  protons, because  $d_e > \lambda_e$  for electrons, while the two protons of one  $H_2$  molecule radiate to two electrons of them, because of  $d_e < \lambda_e$  for this two protons.

To support this idea we can turn to the Planck distribution law, that is equal with the Bose – Einstein statistics.



## Spontaneously broken symmetry in the Planck distribution law

The Planck distribution law is temperature dependent and it should be true locally and globally. I think that Einstein's energy-matter equivalence means some kind of existence of electromagnetic oscillations enabled by the temperature, creating the different matter formulas, atoms molecules, crystals, dark matter and energy.

Max Planck found for the black body radiation

As a function of wavelength ( $\lambda$ ), Planck's law is written as:

$$B_{\lambda}(T) = \frac{2hc^2}{\lambda^5} \frac{1}{e^{\frac{hc}{\lambda k_B T}} - 1}.$$

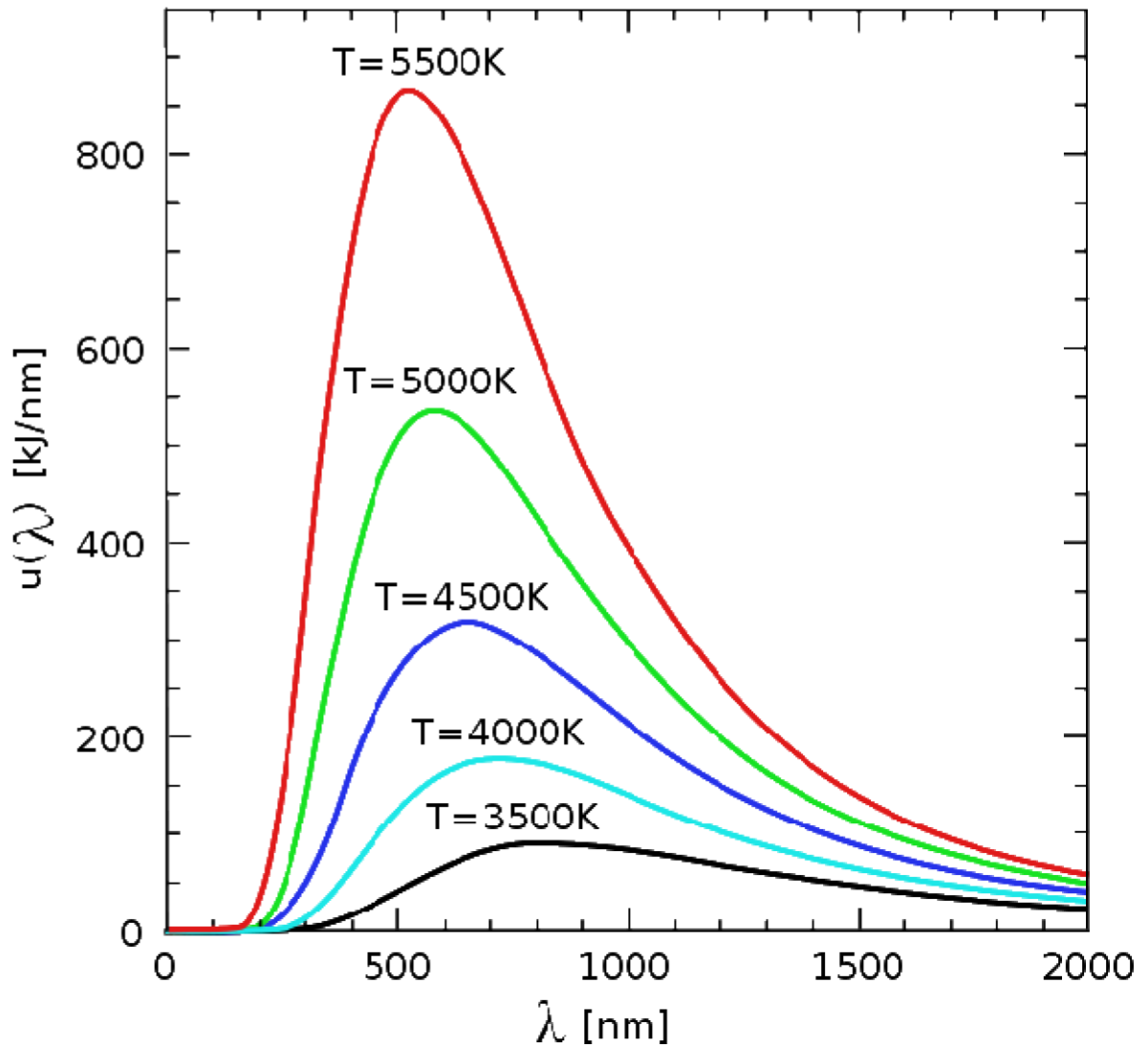

Figure 2. The distribution law for different T temperatures

We see there are two different  $\lambda_1$  and  $\lambda_2$  for each T and intensity, so we can find between them a d so that  $\lambda_1 < d < \lambda_2$ .

We have many possibilities for such asymmetrical reflections, so we have many stable oscillator configurations for any T temperature with equal exchange of intensity by radiation. All of these configurations can exist together. At the  $\lambda_{\max}$  is the annihilation point where the configurations are symmetrical. The  $\lambda_{\max}$  is changing by the Wien's displacement law in many textbooks.

$$(7) \quad \lambda_{\max} = \frac{b}{T}$$

where  $\lambda_{\max}$  is the peak wavelength, T is the absolute temperature of the black body, and b is a constant of proportionality called *Wien's displacement constant*, equal to  $2.8977685(51) \times 10^{-3} \text{ m} \cdot \text{K}$  (2002 CODATA recommended value).

By the changing of T the asymmetrical configurations are changing too.

## The structure of the proton

We must move to the higher T temperature if we want look into the nucleus or nucleon arrive to  $d < 10^{-13}$  cm. If an electron with  $\lambda_e < d$  move across the proton then by (5)  $2(m+1) = n$  with  $m = 0$  we get  $n = 2$  so we need two particles with negative and two particles with positive charges. If the proton can fraction to three parts, two with positive and one with negative charges, then the reflection of oscillators are right. Because this very strange reflection where one part of the proton with the electron together on the same side of the reflection, the all parts of the proton must be quasi lepton so  $d > \lambda_q$ . One way dividing the proton to three parts is, dividing his oscillation by the three direction of the space. We can order  $1/3$  e charge to each coordinates and  $2/3$  e charge to one plane oscillation, because the charge is scalar. In this way the proton has two  $+2/3$  e plane oscillation and one linear oscillation with  $-1/3$  e charge. The colors of quarks are coming from the three directions of coordinates and the proton is colorless. The flavors of quarks are the possible oscillations differently by energy and if they are plane or linear oscillations. We know there is no possible reflecting two oscillations to each other which are completely orthogonal, so the quarks never can be free, however there is an asymptotic freedom while their energy are increasing to turn them to the orthogonally. If they will be completely orthogonal then they lose this reflection and take new partners from the vacuum. Keeping the symmetry of the vacuum the new oscillations are keeping all the conservation laws, like charge, number of baryons and leptons. The all features of gluons are coming from this model. The mathematics of reflecting oscillators show Fermi statistics.

Important to mention that in the Deuteron there are 3 quarks of  $+2/3$  and  $-1/3$  charge, that is three u and d quarks making the complete symmetry and because this its high stability.

The Pauli Exclusion Principle says that the diffraction points are exclusive!

## The Strong Interaction

### ***Confinement and Asymptotic Freedom***

For any theory to provide a successful description of strong interactions it should simultaneously exhibit the phenomena of confinement at large distances and asymptotic freedom at short distances. Lattice calculations support the hypothesis that for non-abelian gauge theories the two domains are analytically connected, and confinement and asymptotic freedom coexist. Similarly, one way to show that QCD is the correct theory of strong interactions is that the coupling extracted at various scales (using experimental data or lattice simulations) is unique in the sense that its variation with scale is given by the renormalization group. [4]

Lattice QCD gives the same results as the diffraction theory of the electromagnetic oscillators, which is the explanation of the strong force and the quark confinement. [1]

## The weak interaction

The weak interaction transforms an electric charge in the diffraction pattern from one side to the other side, causing an electric dipole momentum change, which violates the CP and time reversal symmetry.

Another important issue of the quark model is when one quark changes its flavor such that a linear oscillation transforms into plane oscillation or vice versa, changing the charge value with 1 or -1. This kind of change in the oscillation mode requires not only parity change, but also charge and time changes (CPT symmetry) resulting a right handed anti-neutrino or a left handed neutrino.

The right handed anti-neutrino and the left handed neutrino exist only because changing back the quark flavor could happen only in reverse, because they are different geometrical constructions, the u is 2 dimensional and positively charged and the d is 1 dimensional and negatively charged. It needs also a time reversal, because anti particle (anti neutrino) is involved.

The neutrino is a  $1/2$  spin creator particle to make equal the spins of the weak interaction, for example neutron decay to 2 fermions, every particle is fermions with  $1/2$  spin. The weak interaction changes the entropy since more or less particles will give more or less freedom of movement. The entropy change is a result of temperature change and breaks the equality of oscillator diffraction intensity of the Maxwell–Boltzmann statistics. This way it changes the time coordinate measure and makes possible a different time dilation as of the special relativity.

The limit of the velocity of particles as the speed of light appropriate only for electrical charged particles, since the accelerated charges are self maintaining locally the accelerating electric force. The neutrinos are CP symmetry breaking particles compensated by time in the CPT symmetry, that is the time coordinate not works as in the electromagnetic interactions, consequently the speed of neutrinos is not limited by the speed of light.

The weak interaction T-asymmetry is in conjunction with the T-asymmetry of the second law of thermodynamics, meaning that locally lowering entropy (on extremely high temperature) causes the weak interaction, for example the Hydrogen fusion.

Probably because it is a spin creating movement changing linear oscillation to 2 dimensional oscillation by changing d to u quark and creating anti neutrino going back in time relative to the proton and electron created from the neutron, it seems that the anti neutrino fastest then the velocity of the photons created also in this weak interaction?

A quark flavor changing shows that it is a reflection changes movement and the CP- and T-symmetry breaking. This flavor changing oscillation could prove that it could be also on higher level such as atoms, molecules, probably big biological significant molecules and responsible on the aging of the life.

Important to mention that the weak interaction is always contains particles and antiparticles, where the neutrinos (antineutrinos) present the opposite side. It means by Feynman's interpretation that these particles present the backward time and probably because this they seem to move faster than the speed of light in the reference frame of the other side.

Finally since the weak interaction is an electric dipole change with  $\frac{1}{2}$  spin creating; it is limited by the velocity of the electromagnetic wave, so the neutrino's velocity cannot exceed the velocity of light.

## The General Weak Interaction

The Weak Interactions T-asymmetry is in conjunction with the T-asymmetry of the Second Law of Thermodynamics, meaning that locally lowering entropy (on extremely high temperature) causes for example the Hydrogen fusion. The arrow of time by the Second Law of Thermodynamics shows the increasing entropy and decreasing information by the Weak Interaction, changing the temperature dependent diffraction patterns. A good example of this is the neutron decay, creating more particles with less known information about them.

The neutrino oscillation of the Weak Interaction shows that it is a general electric dipole change and it is possible to any other temperature dependent entropy and information changing diffraction pattern of atoms, molecules and even complicated biological living structures.

We can generalize the weak interaction on all of the decaying matter constructions, even on the biological too. This gives the limited lifetime for the biological constructions also by the arrow of time. There should be a new research space of the Quantum Information Science the 'general neutrino oscillation' for the greater than subatomic matter structures as an electric dipole change.

There is also connection between statistical physics and evolutionary biology, since the arrow of time is working in the biological evolution also.

The Fluctuation Theorem says that there is a probability that entropy will flow in a direction opposite to that dictated by the Second Law of Thermodynamics. In this case the Information is growing that is the matter formulas are emerging from the chaos. So the Weak Interaction has two directions, samples for one direction is the Neutron decay, and Hydrogen fusion is the opposite direction. [5]

## Fermions and Bosons

The fermions are the diffraction patterns of the bosons such a way that they are both sides of the same thing.

The Higgs boson or Higgs particle is a proposed elementary particle in the Standard Model of particle physics. The Higgs boson's existence would have profound importance in particle physics because it would prove the existence of the hypothetical Higgs field - the simplest of several

proposed explanations for the origin of the symmetry-breaking mechanism by which elementary particles gain mass. [3]

## The fermions' spin

The moving charges are accelerating, since only this way can self maintain the electric field causing their acceleration. The electric charge is not point like! This constant acceleration possible if there is a rotating movement changing the direction of the velocity. This way it can accelerate forever without increasing the absolute value of the velocity in the dimension of the time and not reaching the velocity of the light.

The Heisenberg uncertainty relation says that the minimum uncertainty is the value of the spin:  $1/2 \hbar = \Delta x \Delta p$  or  $1/2 \hbar = \Delta t \Delta E$ , that is the value of the basic energy status.

What are the consequences of this in the weak interaction and how possible that the neutrinos' velocity greater than the speed of light?

The neutrino is the one and only particle doesn't participate in the electromagnetic interactions so we cannot expect that the velocity of the electromagnetic wave will give it any kind of limit.

The neutrino is a  $1/2$  spin creator particle to make equal the spins of the weak interaction, for example neutron decay to 2 fermions, every particle is fermions with  $1/2$  spin. The weak interaction changes the entropy since more or less particles will give more or less freedom of movement. The entropy change is a result of temperature change and breaks the equality of oscillator diffraction intensity of the Maxwell–Boltzmann statistics. This way it changes the time coordinate measure and makes possible a different time dilation as of the special relativity.

## The source of the Maxwell equations

The electrons are accelerating also in a static electric current because of the electric force, caused by the potential difference. The magnetic field is the result of this acceleration, as you can see in [2].

The mysterious property of the matter that the electric potential difference is self maintained by the accelerating electrons in the electric current gives a clear explanation to the basic sentence of the relativity that is the velocity of the light is the maximum velocity of the matter. If the charge could move faster than the electromagnetic field than this self maintaining electromagnetic property of the electric current would be failed.

Also an interesting question, how the changing magnetic field creates a negative electric field? The answer also the accelerating electrons will give. When the magnetic field is increasing in time by increasing the electric current, then the acceleration of the electrons will increase, decreasing the charge density and creating a negative electric force. Decreasing the magnetic field by decreasing the electric current will decrease the acceleration of the electrons in the electric current and increases the charge density, creating an electric force also working against the change. In this way

we have explanation to all interactions between the electric and magnetic forces described in the Maxwell equations.

The second mystery of the matter is the mass. We have seen that the acceleration change of the electrons in the flowing current causing a negative electrostatic force. This is the cause of the relativistic effect - built-in in the Maxwell equations - that is the mass of the electron growing with its acceleration and its velocity never can reach the velocity of light, because of this growing negative electrostatic force. The velocity of light is depending only on 2 parameters: the magnetic permeability and the electric permittivity.

There is a possibility of the polarization effect created by electromagnetic forces creates the negative and positive charges. In case of equal mass as in the electron-positron pair it is simply, but on higher energies can be asymmetric as the electron-proton pair of neutron decay by weak interaction and can be understood by the Feynman graphs.

Anyway the mass can be electromagnetic energy exceptionally and since the inertial and gravitational mass are equals, the gravitational force is electromagnetic force and since only the magnetic force is attractive between the same charges, is very important for understanding the gravitational force.

The Uncertainty Relations of Heisenberg gives the answer, since only this way can be sure that the particles are oscillating in some way by the electromagnetic field with constant energies in the atom indefinitely. Also not by chance that the uncertainty measure is equal to the fermions spin, which is one of the most important feature of the particles. There are no singularities, because the moving electron in the atom accelerating in the electric field of the proton, causing a charge distribution on  $\Delta x$  position difference and with a  $\Delta p$  momentum difference such a way that they product is about the half Planck reduced constant. For the proton this  $\Delta x$  much less in the nucleon, than in the orbit of the electron in the atom, the  $\Delta p$  is much higher because of the greatest proton mass.

## **The Special Relativity**

The mysterious property of the matter that the electric potential difference is self maintained by the accelerating electrons in the electric current gives a clear explanation to the basic sentence of the relativity that is the velocity of the light is the maximum velocity of the matter. If the charge could move faster than the electromagnetic field than this self maintaining electromagnetic property of the electric current would be failed. [8]

## **The Heisenberg Uncertainty Principle**

Moving faster needs stronger acceleration reducing the  $\Delta x$  and raising the  $\Delta p$ . It means also mass increasing since the negative effect of the magnetic induction, also a relativistic effect!

The Uncertainty Principle also explains the proton – electron mass ratio since the  $\Delta x$  is much less requiring bigger  $\Delta p$  in the case of the proton, which is partly the result of a bigger mass  $m_p$  because of the higher electromagnetic induction of the bigger frequency (impulse).

## The Gravitational force

The changing magnetic field of the changing current causes electromagnetic mass change by the negative electric field caused by the changing acceleration of the electric charge.

The gravitational attractive force is basically a magnetic force.

The same electric charges can attract one another by the magnetic force if they are moving parallel in the same direction. Since the electrically neutral matter is composed of negative and positive charges they need 2 photons to mediate this attractive force, one per charges. The Big Bang caused parallel moving of the matter gives this magnetic force, experienced as gravitational force.

Since graviton is a tensor field, it has spin = 2, could be 2 photons with spin = 1 together.

You can think about photons as virtual electron – positron pairs, obtaining the necessary virtual mass for gravity.

The mass as seen before a result of the diffraction, for example the proton – electron mass ratio  $M_p = 1840 M_e$ . In order to move one of these diffraction maximum (electron or proton) we need to intervene into the diffraction pattern with a force appropriate to the intensity of this diffraction maximum, means its intensity or mass. [1]

The Big Bang caused acceleration created radial currents of the matter, and since the matter is composed of negative and positive charges, these currents are creating magnetic field and attracting forces between the parallel moving electric currents. This is the gravitational force experienced by the matter, and also the mass is result of the electromagnetic forces between the charged particles. The positive and negative charged currents attracts each other or by the magnetic forces or by the much stronger electrostatic forces!?

The gravitational force attracting the matter, causing concentration of the matter in a small space and leaving much space with low matter concentration: dark matter and energy.

There is an asymmetry between the mass of the electric charges, for example proton and electron, can understood by the asymmetrical Planck Distribution Law. This temperature dependent energy distribution is asymmetric around the maximum intensity, where the annihilation of matter and antimatter is a high probability event. The asymmetric sides are creating different frequencies of electromagnetic radiations being in the same intensity level and compensating each other. One of these compensating ratios is the electron – proton mass ratio. The lower energy side has no compensating intensity level, it is the dark energy and the corresponding matter is the dark matter.



## The Graviton

In physics, the graviton is a hypothetical elementary particle that mediates the force of gravitation in the framework of quantum field theory. If it exists, the graviton is expected to be massless (because the gravitational force appears to have unlimited range) and must be a spin-2 boson. The spin follows from the fact that the source of gravitation is the stress-energy tensor, a second-rank tensor (compared to electromagnetism's spin-1 photon, the source of which is the four-current, a first-rank tensor). Additionally, it can be shown that any massless spin-2 field would give rise to a force indistinguishable from gravitation, because a massless spin-2 field must couple to (interact with) the stress-energy tensor in the same way that the gravitational field does. This result suggests that, if a massless spin-2 particle is discovered, it must be the graviton, so that the only experimental verification needed for the graviton may simply be the discovery of a massless spin-2 particle. [3]

## What is the Spin?

So we know already that the new particle has spin zero or spin two and we could tell which one if we could detect the polarizations of the photons produced. Unfortunately this is difficult and neither ATLAS nor CMS are able to measure polarizations. The only direct and sure way to confirm that the particle is indeed a scalar is to plot the angular distribution of the photons in the rest frame of the centre of mass. A spin zero particles like the Higgs carries no directional information away from the original collision so the distribution will be even in all directions. This test will be possible when a much larger number of events have been observed. In the mean time we can settle for less certain indirect indicators.

## The Casimir effect

The Casimir effect is related to the Zero-point energy, which is fundamentally related to the Heisenberg uncertainty relation. The Heisenberg uncertainty relation says that the minimum uncertainty is the value of the spin:  $1/2 h = \Delta x \Delta p$  or  $1/2 h = \Delta t \Delta E$ , that is the value of the basic energy status.

The moving charges are accelerating, since only this way can self maintain the electric field causing their acceleration. The electric charge is not point like! This constant acceleration possible if there is a rotating movement changing the direction of the velocity. This way it can accelerate forever without increasing the absolute value of the velocity in the dimension of the time and not reaching the velocity of the light. In the atomic scale the Heisenberg uncertainty relation gives the same result, since the moving electron in the atom accelerating in the electric field of the proton, causing a charge distribution on  $\Delta x$  position difference and with a  $\Delta p$  momentum difference such a way that they product is about the half Planck reduced constant. For the proton this  $\Delta x$  much less in the nucleon, than in the orbit of the electron in the atom, the  $\Delta p$  is much higher because of the greater proton mass. This means that the electron is not a point like particle, but has a real

charge distribution.

Electric charge and electromagnetic waves are two sides of the same thing; the electric charge is the diffraction center of the electromagnetic waves, quantified by the Planck constant  $h$ .

## The Fine structure constant

The Planck constant was first described as the proportionality constant between the energy ( $E$ ) of a photon and the frequency ( $\nu$ ) of its associated electromagnetic wave. This relation between the energy and frequency is called the **Planck relation** or the **Planck–Einstein equation**:

$$E = h\nu .$$

Since the frequency  $\nu$ , wavelength  $\lambda$ , and speed of light  $c$  are related by  $\lambda\nu = c$ , the Planck relation can also be expressed as

$$E = \frac{hc}{\lambda} .$$

Since this is the source of Planck constant, the electric charge countable from the Fine structure constant. This also related to the Heisenberg uncertainty relation, saying that the mass of the proton should be bigger than the electron mass because of the difference between their wavelengths.

The expression of the fine-structure constant becomes the abbreviated

$$\alpha = \frac{e^2}{\hbar c}$$

This is a dimensionless constant expression, 1/137 commonly appearing in physics literature.

This means that the electric charge is a result of the electromagnetic waves diffractions, consequently the proton – electron mass ratio is the result of the equal intensity of the corresponding electromagnetic frequencies in the Planck distribution law, described in my diffraction theory.

## Path integral formulation of Quantum Mechanics

The path integral formulation of quantum mechanics is a description of quantum theory which generalizes the action principle of classical mechanics. It replaces the classical notion of a single, unique trajectory for a system with a sum, or functional integral, over an infinity of possible trajectories to compute a quantum amplitude. [7]

It shows that the particles are diffraction patterns of the electromagnetic waves.

## Conclusions

The proposed topolaritons arise from the strong coupling of a photon and an exciton, a bound state of an electron and a hole. Their topology can be thought of as knots in their gapped energy-band structure. At the edge of the systems in which topolaritons emerge, these knots unwind and allow the topolaritons to propagate in a single direction without back-reflection. In other words, the topolaritons cannot make U-turns. Back-reflection is a known source of detrimental feedback and loss in photonic devices. The topolaritons' immunity to it may thus be exploited to build devices with increased performance. [12]

Solitons are localized wave disturbances that propagate without changing shape, a result of a nonlinear interaction that compensates for wave packet dispersion. Individual solitons may collide, but a defining feature is that they pass through one another and emerge from the collision unaltered in shape, amplitude, or velocity, but with a new trajectory reflecting a discontinuous jump. This remarkable property is mathematically a consequence of the underlying integrability of the onedimensional (1D) equations, such as the nonlinear Schrödinger equation, that describe solitons in a variety of wave contexts, including matter waves<sup>1, 2</sup>. Here we explore the nature of soliton collisions using Bose–Einstein condensates of atoms with attractive interactions confined to a quasi-1D waveguide. Using real-time imaging, we show that a collision between solitons is a complex event

that differs markedly depending on the relative phase between the solitons. By controlling the strength of the nonlinearity we shed light on these fundamental features of soliton collisional dynamics, and explore the implications of collisions in the proximity of the crossover between one and three dimensions where the loss of integrability may precipitate catastrophic collapse. [10]

"It's a photonic interaction that's mediated by the atomic interaction," Lukin said. "That makes these two photons behave like a molecule, and when they exit the medium they're much more likely to do so together than as single photons." To build a quantum computer, he explained, researchers need to build a system that can preserve quantum information, and process it using quantum logic operations. The challenge, however, is that quantum logic requires interactions between individual quanta so that quantum systems can be switched to perform information processing. [9]

The magnetic induction creates a negative electric field, causing an electromagnetic inertia responsible for the relativistic mass change; it is the mysterious Higgs Field giving mass to the particles. The Planck Distribution Law of the electromagnetic oscillators explains the electron/proton mass ratio by the diffraction patterns. The accelerating charges explain not only the Maxwell Equations and the Special Relativity, but the Heisenberg Uncertainty Relation, the wave particle duality and the electron's spin also, building the bridge between the Classical and Relativistic Quantum Theories. The self-maintained electric potential of the accelerating charges equivalent with the General Relativity space-time curvature, and since it is true on the quantum level also, gives the base of the Quantum Gravity. The electric currents causing self-maintaining electric potential is the source of the special and general relativistic effects. The Higgs Field is the result of the electromagnetic induction. The Graviton is two photons together.

## References

- [1] [http://www.academia.edu/3834454/3\\_Dimensional\\_String\\_Theory](http://www.academia.edu/3834454/3_Dimensional_String_Theory)
- [2] [http://www.academia.edu/3833335/The\\_Magnetic\\_field\\_of\\_the\\_Electric\\_current](http://www.academia.edu/3833335/The_Magnetic_field_of_the_Electric_current)
- [3] [http://www.academia.edu/4158863/Higgs\\_Field\\_and\\_Quantum\\_Gravity](http://www.academia.edu/4158863/Higgs_Field_and_Quantum_Gravity)
- [4] [http://www.academia.edu/4196521/The\\_Electro-Strong\\_Interaction](http://www.academia.edu/4196521/The_Electro-Strong_Interaction)
- [5] [http://www.academia.edu/4221717/General\\_Weak\\_Interaction](http://www.academia.edu/4221717/General_Weak_Interaction)
- [6] The Feynman Lectures on Physics p. 274 (30.6)  
Author: Richard Phillips Feynman  
**Publisher:** Addison Wesley Longman (January 1970)  
ISBN-10: **0201021153** | ISBN-13: **978-0201021158**
- [7] Path Integral Formulation of Quantum Mechanics  
[http://en.wikipedia.org/wiki/Path\\_integral\\_formulation](http://en.wikipedia.org/wiki/Path_integral_formulation)
- [8] [https://www.academia.edu/4215078/Accelerated\\_Relativity](https://www.academia.edu/4215078/Accelerated_Relativity)
- [9] <http://phys.org/news/2013-09-scientists-never-before-seen.html>
- [10] <http://www.nature.com/nphys/journal/vaop/ncurrent/full/nphys3135.html>
- [11] <http://www.sciencedaily.com/releases/2014/11/141102160109.htm>
- [12] <http://physics.aps.org/synopsis-for/10.1103/PhysRevX.5.031001>
- [13] Quantum dots enhance light-to-current conversion in layered semiconductors  
<http://phys.org/news/2016-04-quantum-dots-light-to-current-conversion-layered.html>
- [14] New nanodevice shifts light's color at single-photon level  
<http://phys.org/news/2016-04-nanodevice-shifts-single-photon.html>
- [15] Novel metasurface revolutionizes ubiquitous scientific tool  
<http://phys.org/news/2016-01-metasurface-revolutionizes-ubiquitous-scientific-tool.html>
- [16] Physicists discover a new form of light  
<http://phys.org/news/2016-05-physicists.html>
- [17] Liquid Light with a Whirl  
<http://physics.aps.org/articles/v9/88>

[18] Researchers have created quantum states of light whose noise level has been “squeezed” to a record low.

<http://physics.aps.org/synopsis-for/10.1103/PhysRevLett.117.110801>

[19] Synopsis: Twisting in Thin Air <http://physics.aps.org/synopsis-for/10.1103/PhysRevLett.117.123604> [20] Towards stable propagation of light in nano-photonic fibers <http://phys.org/news/2016-09-stable-propagation-nano-photonic-fibers.html>

[21] Researchers generate proton beams using a combination of nanoparticles and laser light <http://phys.org/news/2016-09-proton-combination-nanoparticles-laser.html>

[22] Shock front probed by protons <https://phys.org/news/2017-08-front-probed-protons.html>

[23] How are hadrons born at the huge energies available in the LHC? <https://phys.org/news/2018-03-hadrons-born-huge-energies-lhc.html>

[24] The nucleus—coming soon in 3-D <https://phys.org/news/2018-03-nucleuscoming-d.html>

[25] Scientists discover the secret behind the stability of carbon isotopes <https://phys.org/news/2018-05-scientists-secret-stability-carbon-isotopes.html>

[26] The chances of detecting clumps in atomic nuclei are growing <https://phys.org/news/2018-06-chances-clumps-atomic-nuclei.html>

[27] ISOLDE mints isotopes of chromium <https://phys.org/news/2018-07-isolde-mints-isotopes-chromium.html>

[28] Neutrons scan magnetic fields inside samples <https://phys.org/news/2018-10-neutrons-scan-magnetic-fields-samples.html>

[29] Neutrons allow analysis of polymer gels' unusual attributes <https://phys.org/news/2019-06-neutrons-analysis-polymer-gels-unusual.html>

[30] Students make neutrons dance beneath UC Berkeley campus <https://phys.org/news/2019-09-students-neutrons-beneath-uc-berkeley.html>

