

Low-Power Lighting Technology

Researchers from the Moscow Institute of Physics and Technology and Lebedev Physical Institute of the Russian Academy of Sciences have designed and tested a prototype cathodoluminescent lamp for general lighting. [27]

A team of researchers affiliated with several institutions in Spain and the U.S. has announced that they have discovered a new property of light—self-torque. [26]

When studying biological cells using optical tweezers, one main issue is the damage caused to the cell by the tool. Giovanni Volpe, University of Gothenburg, has discovered a new type of force that will greatly reduce the amount of light used by optical tweezers—and improve the study of all kinds of cells and particles. [25]

The device, which works in the mesoscopic mass range for the first time, might not only be used to help solve fundamental problems in quantum mechanics, it might also find use in precision metrology applications. [24]

Although previous research shows that metal nanoparticles have properties useful for various biomedical applications, many mysteries remain regarding how these tiny materials form, including the processes that generate size variations. [23]

With a novel electrochemical biosensing device that identifies the tiniest signals these biomarkers emit, a pair of NJIT inventors are hoping to bridge this gap. [22]

The dark skin pigment melanin protects against the sun's damaging rays by absorbing light energy and converting it to heat. [21]

Wang, Bren Professor of Medical Engineering and Electrical Engineering, is using PAM to improve on an existing technology for measuring the oxygen-consumption rate (OCR) in collaboration with Professor Jun Zou at Texas A&M University. [20]

A remote command could one day send immune cells on a rampage against a malignant tumor. The ability to mobilize, from outside the body, targeted cancer immunotherapy inside the body has taken a step closer to becoming reality. [19]

It's called gene editing, and University of Alberta researchers have just published a game-changing study that promises to bring the technology much closer to therapeutic reality. [18]

An LMU team now reveals the inner workings of a molecular motor made of proteins which packs and unpacks DNA. [17]

Chemist Ivan Huc finds the inspiration for his work in the molecular principles that underlie biological systems. [16]

What makes particles self-assemble into complex biological structures? [15]

Scientists from Moscow State University (MSU) working with an international team of researchers have identified the structure of one of the key regions of telomerase—a so-called "cellular immortality" ribonucleoprotein. [14]

Researchers from Tokyo Metropolitan University used a light-sensitive iridium-palladium catalyst to make "sequential" polymers, using visible light to change how building blocks are combined into polymer chains. [13]

Researchers have fused living and non-living cells for the first time in a way that allows them to work together, paving the way for new applications. [12]

UZH researchers have discovered a previously unknown way in which proteins interact with one another and cells organize themselves. [11]

Dr Martin Sweatman from the University of Edinburgh's School of Engineering has discovered a simple physical principle that might explain how life started on Earth. [10]

Nearly 75 years ago, Nobel Prize-winning physicist Erwin Schrödinger wondered if the mysterious world of quantum mechanics played a role in biology. A recent finding by Northwestern University's Prem Kumar adds further evidence that the answer might be yes. [9]

A UNSW Australia-led team of researchers has discovered how algae that survive in very low levels of light are able to switch on and off a weird quantum phenomenon that occurs during photosynthesis. [8]

This paper contains the review of quantum entanglement investigations in living systems, and in the quantum mechanically modeled photoactive prebiotic kernel systems. [7]

The human body is a constant flux of thousands of chemical/biological interactions and processes connecting molecules, cells, organs, and fluids, throughout the brain, body, and nervous system. Up until recently it was thought that all these interactions operated in a linear sequence, passing on information much like a runner passing the

baton to the next runner. However, the latest findings in quantum biology and biophysics have discovered that there is in fact a tremendous degree of coherence within all living systems.

The accelerating electrons explain not only the Maxwell Equations and the Special Relativity, but the Heisenberg Uncertainty Relation, the Wave-Particle Duality and the electron's spin also, building the Bridge between the Classical and Quantum Theories.

The Planck Distribution Law of the electromagnetic oscillators explains the electron/proton mass rate and the Weak and Strong Interactions by the diffraction patterns. The Weak Interaction changes the diffraction patterns by moving the electric charge from one side to the other side of the diffraction pattern, which violates the CP and Time reversal symmetry.

The diffraction patterns and the locality of the self-maintaining electromagnetic potential explains also the Quantum Entanglement, giving it as a natural part of the Relativistic Quantum Theory and making possible to understand the Quantum Biology.

Contents

Preface	5
Engineers report a new low-power lighting technology	6
New property of light discovered	10
A new force for optical tweezers	11
Optical tweezer helps make phonon laser	12
Expanding on the optical tweezer	13
Controlling the population of steady-state, coherent, phonons.....	13
Mesoscopic mass regime	13
Technique is readily extendable to other materials.....	14
Laser focus sheds light on two sources of nanoparticle formation.....	15
Following virtual clues	15
A blueprint for improvements.....	16
Researchers detect minute levels of disease with a nanotechnology-enhanced biochip	17
Black nanoparticles slow the growth of tumors	19
Nanoparticles carrying a black cargo	20
Heat build-up reduces tumor growth	20
Laser technology helps researchers scrutinize cancer cells	21

Remote-control shoots laser at nano-gold to turn on cancer-killing immune cells.....	22
Laser, gold, and T-cells	23
Hyper-activated T-cells.....	23
Better immunotherapy	23
T-cell toxicities	23
Heat-shock switch.....	24
Immuno-goals and dreams.....	24
Breakthrough brings gene-editing medicine one step closer to patient applications	24
Study reveals the inner workings of a molecular motor that packs and unpacks DNA.....	25
Biomimetic chemistry—DNA mimic outwits viral enzyme	27
Simulations document self-assembly of proteins and DNA.....	28
Scientists explore the structure of a key region of longevity protein telomerase	29
Custom sequences for polymers using visible light.....	30
Artificial and biological cells work together as mini chemical factories	31
New interaction mechanism of proteins discovered	32
Particles in charged solution form clusters that reproduce.....	33
Experiment demonstrates quantum mechanical effects from biological systems.....	34
Quantum biology: Algae evolved to switch quantum coherence on and off	35
Photoactive Prebiotic Systems	36
Significance Statement.....	37
Figure legend.....	39
Quantum Biology.....	40
Quantum Consciousness.....	40
Creating quantum technology	41
Quantum Entanglement.....	41
The Bridge.....	42
Accelerating charges	42
Relativistic effect.....	42
Heisenberg Uncertainty Relation	42
Wave – Particle Duality.....	42
Atomic model	42
The Relativistic Bridge	43
The weak interaction.....	43
The General Weak Interaction.....	44
Fermions and Bosons	45

Van Der Waals force.....	45
Electromagnetic inertia and mass.....	45
Electromagnetic Induction	45
Relativistic change of mass	45
The frequency dependence of mass	45
Electron – Proton mass rate	46
Gravity from the point of view of quantum physics.....	46
The Gravitational force	46
The Higgs boson	47
Higgs mechanism and Quantum Gravity.....	47
What is the Spin?.....	48
The Graviton	48
Conclusions.....	48
References.....	49

Author: George Rajna

Preface

We define our modeled self-assembled supramolecular photoactive centers, composed of one or more sensitizer molecules, precursors of fatty acids and a number of water molecules, as a photoactive prebiotic kernel system. [7]

The human body is a constant flux of thousands of chemical/biological interactions and processes connecting molecules, cells, organs, and fluids, throughout the brain, body, and nervous system. Up until recently it was thought that all these interactions operated in a linear sequence, passing on information much like a runner passing the baton to the next runner. However, the latest findings in quantum biology and biophysics have discovered that there is in fact a tremendous degree of coherence within all living systems. [5]

Quantum entanglement is a physical phenomenon that occurs when pairs or groups of particles are generated or interact in ways such that the quantum state of each particle cannot be described independently – instead, a quantum state may be given for the system as a whole. [4]

I think that we have a simple bridge between the classical and quantum mechanics by understanding the Heisenberg Uncertainty Relations. It makes clear that the particles are not point like but have a dx and dp uncertainty.

Engineers report a new low-power lighting technology

Researchers from the Moscow Institute of Physics and Technology and Lebedev Physical Institute of the Russian Academy of Sciences have designed and tested a prototype cathodoluminescent lamp for general lighting. The new lamp, which relies on the phenomenon of field emission, is more reliable, durable, and luminous than its analogues available worldwide. The development was reported in the *Journal of Vacuum Science & Technology B*.

While LED lamps have become commonplace, they are not the only clean and power-saving alternative to [incandescent lamps](#). Since the 1980s, engineers around the world have been looking into the so-called cathodoluminescent lamps as another option for general lighting purposes.

Shown in figure 1, a [lamp](#) of this kind relies on the same principle that powered TV cathode-ray tubes: A negatively charged electrode, or cathode, at one end of a vacuum tube serves as an electron gun. A potential difference of up to 10 kilovolts accelerates the emitted electrons toward a flat positively charged phosphor-coated electrode—the anode—at the opposite end of the tube. This electron bombardment results in light.

Cathodoluminescent lamps have the advantage of emitting light almost at any wavelength, from red to ultraviolet, depending on which fluorescent material is used.

Novel ultraviolet light bulbs would be a particularly timely development, considering the recent ban on household appliances using mercury under the Minamata Convention, a United Nations treaty signed by 128 countries that came into effect in August 2017. Among other products, the ban targets ultraviolet fluorescent tubes, widely used for greenhouse lighting and other applications. Cathodoluminescent UV light bulbs contain no mercury and are generally cleaner in service and upon disposal.

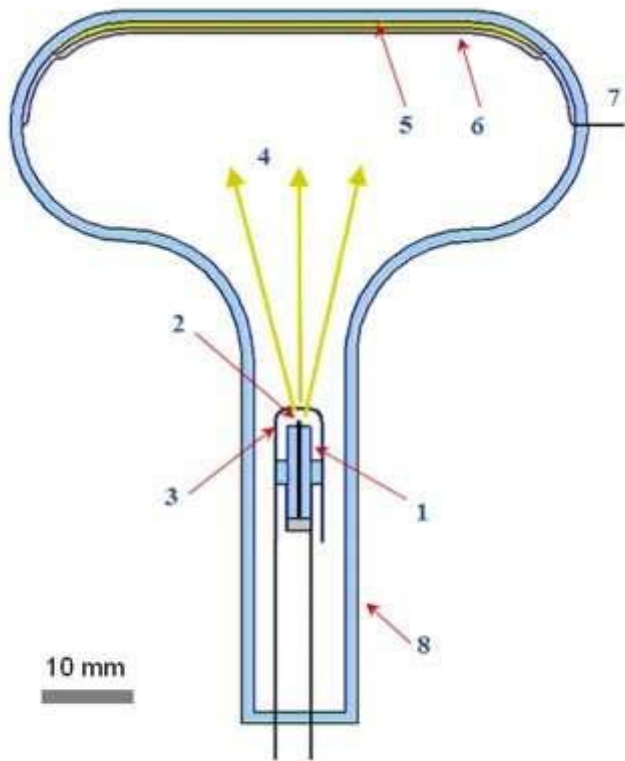

FIG. 1. Schematic diagram of the vacuum bulb. (1) Cathode-modulator unit, (2) cathode, (3) modulator, (4) emitted electrons, (5) luminophore, (6) anode (aluminum mirror), (7) anode output, and (8) glass vacuum envelope.

Figure 1. Cathodoluminescent lamp:

cathode modulator unit (1), cathode (2), modulator (3), emitted electrons (4), phosphor (5), aluminum mirror serving as anode (6), anode output (7), glass vacuum tube (8). Credit: Image courtesy of the researchers

"Some industries using mercury lamps for [water treatment](#) and air disinfection, for example, will be very slow and unwilling to phase them out," commented Mikhail Danilkin of Lebedev Physical Institute, RAS. "But medicine is different, because the issue of mercury lamp disposal at individual medical facilities has not been resolved, while the environmental standards are becoming stricter. Cathodoluminescent lamps could be used in operating room decontamination, UV irradiation of throat and tonsils, and dental filling curing."

Another important advantage of the new lamp over LEDs and fluorescent bulbs is that it does not rely on the so-called critical raw materials. These include gallium, indium, and some rare-earth elements. While their supply is limited, these materials are essential and irreplaceable in the health, defense, aerospace, and other key industries. The European Commission lists them as strategically important for the European economy.

Attempts to mass-produce commercial cathodoluminescent light bulbs have been made in the United States, but the consumers did not embrace the device, mostly because it was bulky and took several seconds to warm up the cathode to operating temperature. Similarly, the old TV sets began displaying the image after a brief delay.

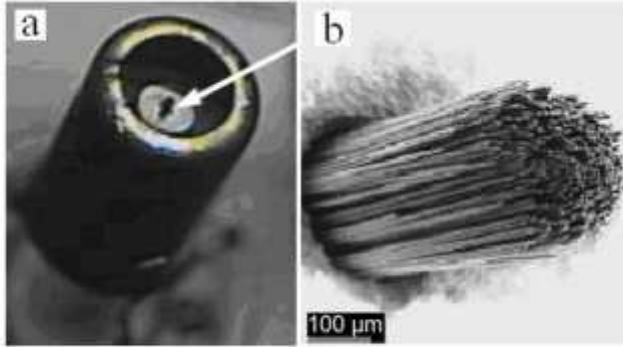

FIG. 2. Cathode-modulator unit (a); arrow indicates the field emission cathode. The magnified image of the field emission cathode based on carbon fiber (b).

Figure 2. Cathode modulator unit (a) with an emitting carbon fiber cathode indicated by the white arrow, and a magnified depiction of the cathode (b) at 100-micrometer scale. Credit: Image courtesy of the researchers

Some cathodes require no warmup, though. They are known as field emission cathodes, because they rely on the phenomenon of field emission. It involves a cold cathode emitting electrons under an electrostatic field alone, due to tunneling.

However, designing an efficient, long-lasting, and technologically advanced cathode that could be mass-produced and sold at an affordable price has proved challenging. Despite an ongoing effort in Japan and the U.S., the recent Russian study marks the first successful attempt at this.

"Our [field emission](#) cathode is made of ordinary carbon," said Professor Evgenii Sheshin, deputy chair of vacuum electronics at MIPT, who led the research team. "But this carbon is not used merely as a chemical, but rather as a structure. We found a way to fashion a structure from carbon fibers that is resistant to ion bombardment, outputs a high emission current, is technological and affordable in production. This technology is our know-how, no one else in the world has it."

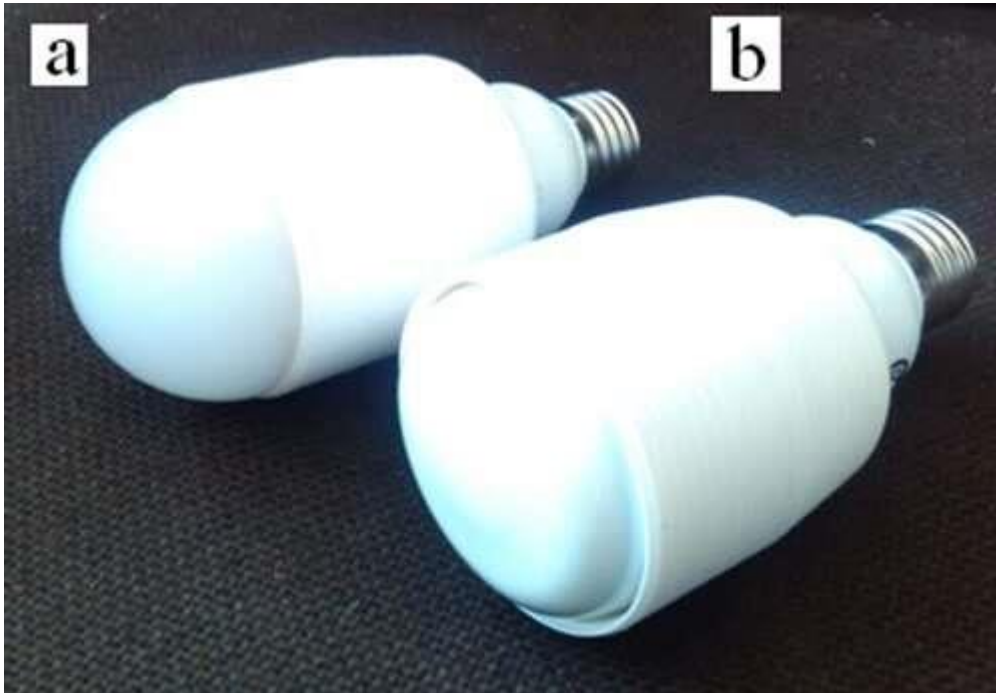

Figure 3.

Laboratory prototypes of cathodoluminescent bulbs with a built-in voltage converter for an E27 cap with a diffuser (a) and without it (b). The luminous power is up to 250 lumens, which is about the output of a 25-watt incandescent lamp, but the power consumption is only 5.5 watts. Credit: Image courtesy of the researchers

By subjecting the carbon to special treatment, many submicrometer protrusions—less than a millionth of a meter in size—are formed at the tip of the cathode (figure 2). This results in an ultrahigh electric field at the tip, driving electrons out, into the vacuum.

The MITP research group has also developed a compact power source for their cathodoluminescent lamp, which supplies enough kilovolts for successful field electron emission. The source is fitted around the glass light bulb (figure 3) with almost no effect on its size.

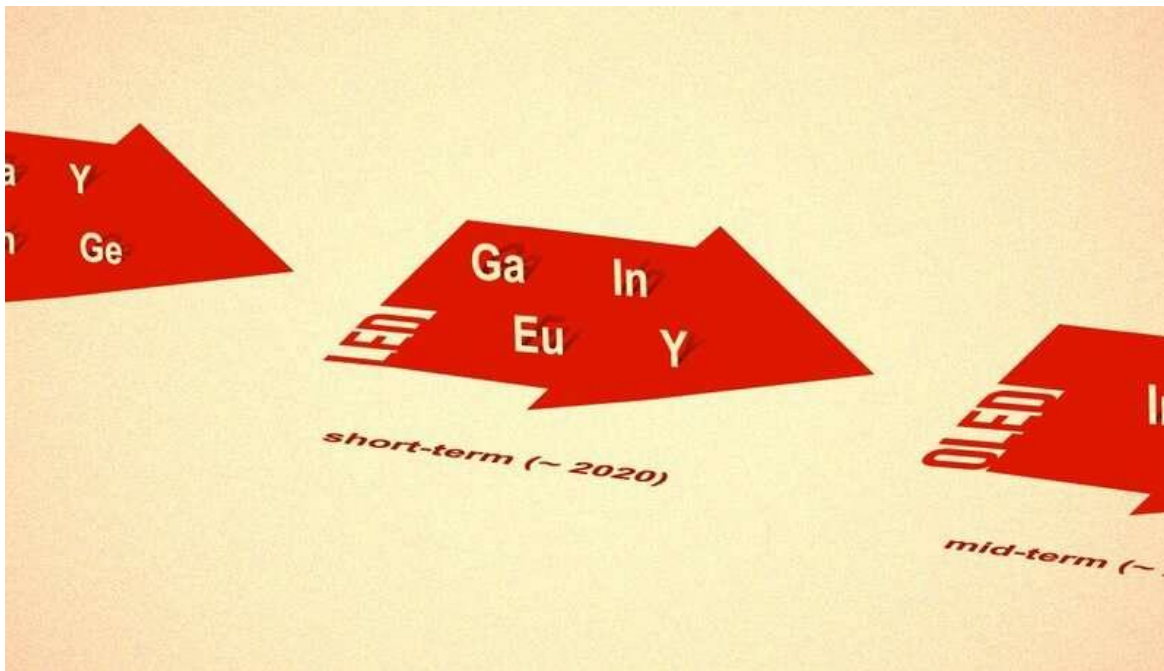

Figure 4. Possible megatrends in lighting applications. While light-emitting diodes rely on fewer critical raw materials than the currently used fluorescent bulbs, organic LEDs are expected to eliminate the need for these materials altogether, with the exception of indium. Credit: @Linasmth.art/MIPT

The paper reports prototype tests and the lamp's technical characteristics. These data suggest that if mass-produced, the new cathodoluminescent bulb could compete with the cheap lamps based on light-emitting diodes. The new bulb would also help phase out the hazardous fluorescent lamps containing mercury, which are still used in many households.

"Unlike the LED bulb, our lamp is not afraid of elevated temperatures. You can use it where diodes quickly fade, such as in ceiling spotlights, where insufficient cooling is provided," added study co-author Dmitry Ozol from MIPT's vacuum electronics department. [27]

New property of light discovered

A team of researchers affiliated with several institutions in Spain and the U.S. has announced that they have discovered a new property of light—self-torque. In their paper published in the journal *Science*, the group describes how they happened to spot the new property and possible uses for it.

Scientists have long known about such properties of light as wavelength. More recently, researchers have found that light can also be twisted, a property called [angular momentum](#). Beams with highly structured angular momentum are said to have orbital angular momentum (OAM), and are called [vortex beams](#). They appear as a helix surrounding a common center, and when they strike

a flat surface, they appear as doughnut-shaped. In this new effort, the researchers were working with OAM beams when they found the light behaving in a way that had never been seen before.

The experiments involved firing two lasers at a cloud of argon gas—doing so forced the beams to overlap, and they joined and were emitted as a single beam from the other side of the argon cloud. The result was a type of vortex beam. The researchers then wondered what would happen if the lasers had different orbital angular momentum and if they were slightly out of sync. This resulted in a beam that looked like a corkscrew with a gradually changing twist. And when the beam struck a [flat surface](#), it looked like a crescent moon. The researchers noted that looked at another way, a [single photon](#) at the front of the beam was orbiting around its center more slowly than a photon at the back of the [beam](#). The researchers promptly dubbed the new property self-torque—and not only is it a newly discovered property of light, it is also one that has never even been predicted. [26]

A new force for optical tweezers

When studying biological cells using optical tweezers, one main issue is the damage caused to the cell by the tool. Giovanni Volpe, University of Gothenburg, has discovered a new type of force that will greatly reduce the amount of light used by optical tweezers—and improve the study of all kinds of cells and particles.

"We call it 'intra-cavity feedback force.' The basic idea is that, depending on where the particle or cell you want to study is, the amount of laser light used to trap it changes automatically. Whenever the particle is in focus, the laser switches off. When the particle tries to escape, the laser switches on again," says Giovanni Volpe, senior lecturer at the Department of Physics, University of Gothenburg.

An optical tweezer is a focused laser beam that can trap [particles](#). Previously, two different types of forces that emerge from this type of tool have been identified: gradient force (which means the particle goes against the intensity of the laser) and scattering force (where the particle is pushed towards the [laser](#)). Giovanni Volpe and his team have discovered a third type of force in this realm, and a new way of constructing [optical tweezers](#). These breakthroughs are poised to greatly improve the study of single [biological cells](#).

"With this method, as much as 100 times less light is needed, in some cases, compared to using a traditional optical tweezer," Giovanni Volpe explains. "With less light, you cause less photo damage to the cell you are studying."

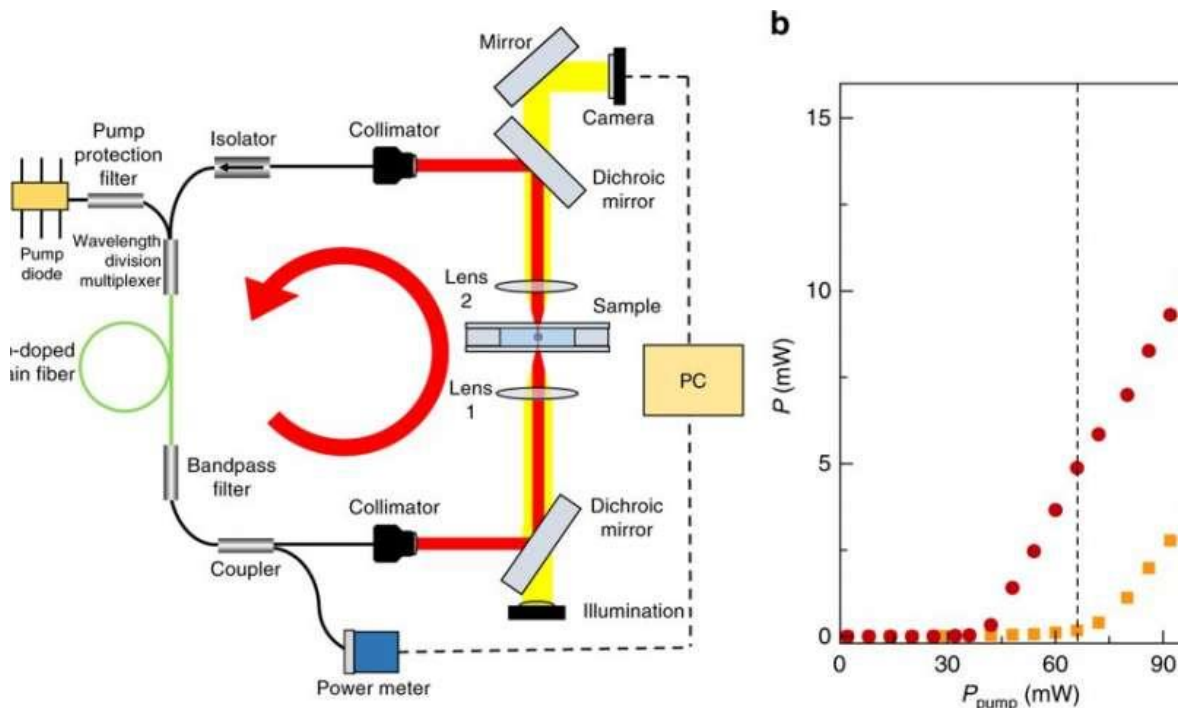

Experimental setup. a The setup comprises a diode-pumped Yb-doped fiber laser, the trapping optics, and the digital video microscope. The arrow represents the direction in which the light travels. b Measured power scaling with a trapped 4.9- μm -diameter polystyrene particle (orange squares) and without the trapped particle (red circles). At a pump power of 66 mW (dashed vertical line), the laser is below threshold with the particle (orange squares), but above threshold without the particle (red circles)

This could be useful for studying any cell that is usually suspended in a solution—a blood cell or a yeast cell, for example—that a researcher would want to study over a long period of time.

"One of the main issues when using optical tweezers is that the light raises the temperature of the cell, which is damaging. A rise of 10 degrees might not be tolerable, but the rise of 0,1 degrees might be fine. So using less [light](#), and therefore limiting the rise in temperature, could make a huge difference. Experiments could be done in a more realistic manner in relation to the cell's natural life cycle," says Giovanni Volpe.

The findings are published in *Nature Communications*. [25]

Optical tweezer helps make phonon laser

The optical laser, which will celebrate its 60th anniversary next year, has led to a host of technology applications that have changed our lives and researchers hope that its mechanical analogue – the phonon laser – will one day be just as important. A team at the [University of Rochester](#) and the [Rochester Institute of Technology](#), both in New York, has now succeeded in making a phonon laser based on nanospheres of glass suspended in vacuum using an optical tweezer (or dipole

trap). The device, which works in the mesoscopic mass range for the first time, might not only be used to help solve fundamental problems in quantum mechanics, it might also find use in precision metrology applications.

Researchers have been working on the phonon laser – a coherent beam amplifier for sound rather than light – for the last decade. In such a device, phonons (which are the smallest discrete unit of vibrations of a material’s crystal lattice) are amplified to generate a highly coherent beam of sound in the same way that an optical laser produces a highly coherent beam of light.

Expanding on the optical tweezer

A team led by [Nick Vamivakas](#) has now made the levitated optomechanical analogue to the optical laser by expanding on the optical tweezer. This optical dipole trap, as it is also known, was originally invented by American physicist Arthur Ashkin, who was recently awarded a share of the Nobel prize in physics. It relies on a highly focused laser beam to provide an attractive or repulsive force to physically hold and move micron-sized objects in the trajectory of the beam.

The new phonon laser, whose frequency can be tuned, is based on the centre-of-mass oscillation of silicon nanospheres, which is comprised of phonons, and Vamivakas and colleagues’ experimental apparatus consists of a free-space optical dipole trap in which they suspend the nanospheres in a vacuum chamber. The researchers then employ a feedback technique based on light scattering from the nanospheres. “By measuring the scattered light, we are then able to alter the way the beads oscillate and increase the output of energy as measured in phonons,” says Vamivakas.

“If we do it just right, we can cause an oscillation that starts at one amplitude, and becomes bigger and bigger, until we start to exhibit mechanical motion that is analogous to what you would see if you turned on an ordinary optical laser.”

Controlling the population of steady-state, coherent, phonons

“This technique allows us to modulate the optical potential created by the laser beam that holds the nanospheres in the trap in just the right way to produce the phonon laser,” explains Vamivakas. “The feedback signals then control the centre-of-mass dynamics of the sphere.

“One signal provides nonlinear parametric cooling of centre-of-mass phonons, while the other induces linear amplification of centre-of-mass phonons,” he says. “This allows us to control the population of steady-state, coherent, phonons – into the quantum regime, in principle.”

Mesoscopic mass regime

The new device operates in the mesoscopic mass regime – that is around 1×10^{-18} kg. This makes it different to previously demonstrated phonon lasers that worked on the microscale (1×10^{-9} kg) and atomic scale (1×10^{-25} kg).

“There was a large mass regime in between these two scales, and this is the range in which our device works,” Vamivakas tells *Physics World*. “It is also unique in that it makes use of a levitated object. With the exception of single trapped atoms, all other phonon lasers to date have been demonstrated in mechanically clamped or tethered platforms in which the laser is attached to a substrate.

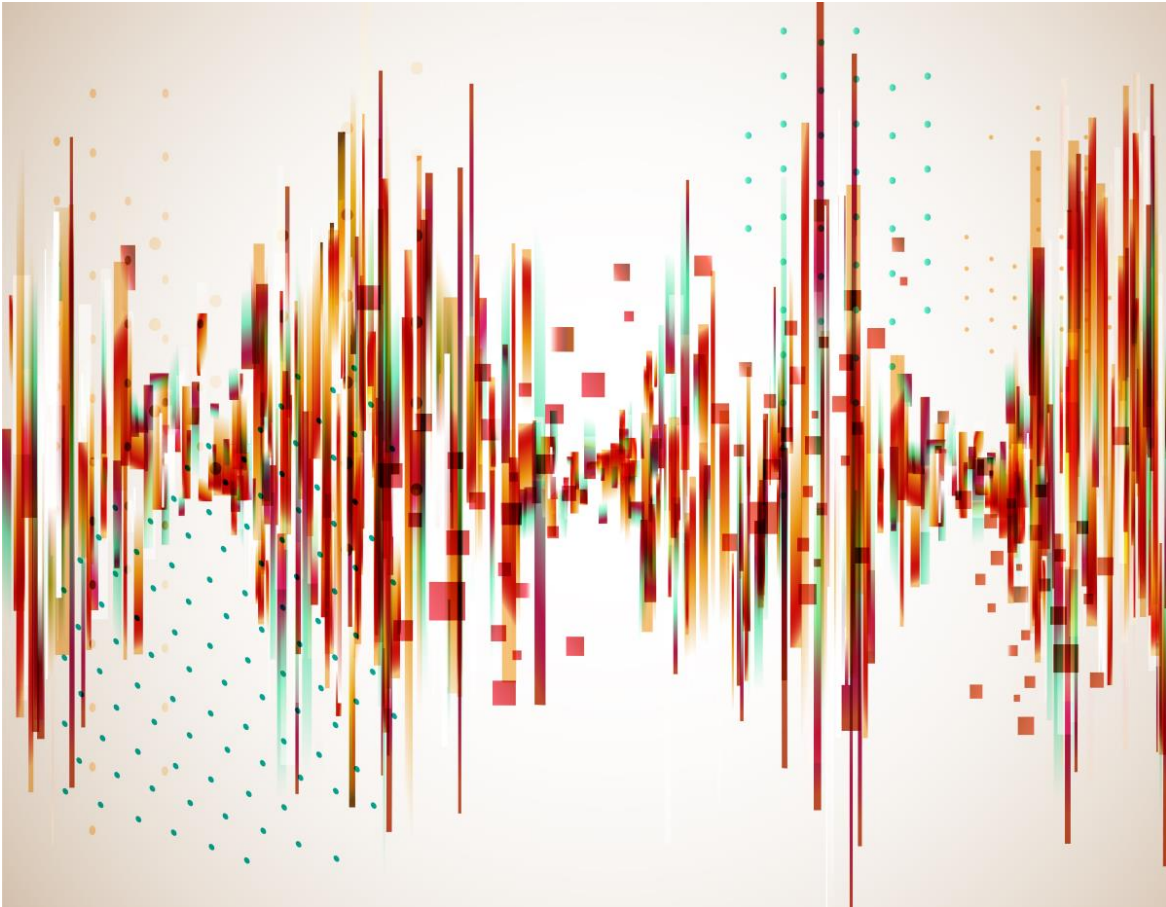

Calculations provide insight into why sound waves carry 'negative mass'

“Using a levitated object provides a high degree of mechanical isolation not possible in these other set ups.”

Technique is readily extendable to other materials

The new laser might help advance precision metrology, he adds. What is more, the technique employed in this study, which is published in [Nature Photonics 10.1038/s41566-019-0395-5](https://doi.org/10.1038/s41566-019-0395-5), is insensitive to the structural details of the particle suspended in the optical dipole trap. This means that it could be readily extended to other materials – for example, single electrons, levitated droplets or even biological organisms.

The team, which also includes researchers from the [Los Alamos National Laboratory](https://www.lanl.gov/), says that it is now busy exploring the connections between the optical laser and its phonon cousin. “We are also looking at the ways in which our laser could enhance precision measurements in levitated optomechanical systems,” reveals Vamivakas. [24]

Laser focus sheds light on two sources of nanoparticle formation

Although previous research shows that metal nanoparticles have properties useful for various biomedical applications, many mysteries remain regarding how these tiny materials form, including the processes that generate size variations. To crack this case, a team of scientists turned to computational sleuthing tactics.

Led by Leonid Zhigilei of the University of Virginia (UVA), the team used the Oak Ridge Leadership Computing Facility's (OLCF's) 27-petaflop Titan supercomputer to model the interactions between [short laser pulses](#) and [metal](#) targets at the atomic scale. Known as laser [ablation](#), this process involves irradiating metals with a [laser beam](#) to selectively remove layers of material, which changes the target's surface structure, or morphology, and generates nanoparticles.

As part of broader research into the relationship between laser ablation and nanoparticle generation, Zhigilei's team spent computing hours earned through the Innovative and Novel Computational Impact on Theory and Experiment (INCITE) program on investigating the mechanisms responsible for forming two distinct populations of nanoparticles. This project focused exclusively on how these processes manifest in liquid environments, building on previous research that studied them in a vacuum.

To corroborate their findings, the UVA scientists collaborated with a research group from the University of Duisburg-Essen, Germany. In 2018, their results were published in *Nanoscale*; the journal's back cover featured a laser ablation image OLCF computer scientist Benjamin Hernandez created using SIGHT, a customizable visualization tool he developed. The OLCF is a US Department of Energy (DOE) Office of Science User Facility located at DOE's Oak Ridge National Laboratory (ORNL).

Following virtual clues

To differentiate between the sources of nanoparticles categorized as small (less than 10 nanometers) and large (10 or more nanometers), the team ran a series of molecular dynamics simulations on Titan, which modeled silver and gold targets in water irradiated by laser ablation.

"These metals are stable, inert, and do not actively react with the surrounding environment," Zhigilei said. "Additionally, silver has useful antibacterial properties."

The simulation results indicated that small nanoparticles are more likely to form from the condensation of metal vapor rapidly cooled through its interaction with water vapor, whereas large ones may emerge when hydrodynamic instabilities, which are unstable flows of one fluid through another fluid of a different density, cause the metal to disintegrate.

During ablation, laser pulses superheat part of the metal target's surface, leading to an explosive decomposition of that region into a mixture of vapor and small liquid droplets. This hot mixture is then ejected from the irradiated target, forming the so-called ablation plume. Known as phase explosion or "explosive boiling," this phenomenon has been studied extensively for laser ablation in a vacuum.

However, when ablation takes place in a liquid environment, the interaction of the ablation plume with the surrounding water complicates the process by slowing down the ablation plume, which leads to the formation of a hot metal layer pushing against the water.

This dynamic interaction can trigger a rapid succession of hydrodynamic instabilities in the molten metal layer, causing it to partially or entirely disintegrate and produce large nanoparticles. A well-known novelty item illustrates this behavior.

"When you first turn on a lava lamp, the heavy fluid sits on top of the light fluid, but then it begins to flow under the action of gravitational acceleration and creates some interesting flow patterns and particle formation," Zhigilei said. "Something similar happens with laser ablation—the heavy layer of hot metal is rapidly decelerated by water, which produces hydrodynamic instabilities at the metal–water interface that generate large nanoparticles."

A representation of how molten silver (green) and individual silver atoms (red) evolve near the metal–water interface during laser ablation. Credit: Benjamin Hernandez, ORNL

The team observed the movements of individual atoms to extrapolate useful information concerning both paths to nanoparticle generation.

"We had to quickly pivot from atoms on the scale of less than one nanometer to hundreds of nanometers, which required solving equations for hundreds of millions of atoms in our simulations," Zhigilei said. "This type of work is only possible on large supercomputers like Titan."

Both processes that lead to nanoparticle generation take place within a transient "reaction chamber" known as the cavitation bubble, which results from the interaction between the hot ablation plume and the liquid environment. By studying the bubble's lifetime from start to finish, scientists can identify which types of nanoparticles emerge at certain stages.

"Irradiating a metal target in water with [laser pulses](#) creates a hot environment that leads to the formation, expansion, and collapse of a large bubble similar to those created by conventional boiling," Zhigilei said. "Any nanoparticle generation process happens either within the bubble or in the interface between the ablation plume and the surface of the bubble."

Complementary imaging experiments performed at the Center for Nanointegration Duisburg-Essen (CENIDE) confirmed the team's computational findings by revealing the existence of smaller microbubbles containing nanoparticles that formed around the main cavitation bubble.

The CENIDE researchers also made videos demonstrating the production of gold nanoparticles and displaying a gold target immersed in a liquid ablation chamber.

A blueprint for improvements

Scientists traditionally have relied on synthesis techniques to efficiently produce nanoparticles through a sequence of chemical reactions. Although this process allows for precise control over nanoparticle size, chemical contamination can prevent the resulting materials from functioning properly. Laser ablation avoids this pitfall by generating superior, clean nanoparticles while subtly molding metal into more suitable configurations.

"Laser ablation creates a completely clean colloidal solution of nanoparticles without using any other chemicals, and these pristine materials are ideal for biomedical applications," Zhigilei said. "The results of our calculations may help to scale up this process and improve productivity so that ablation can eventually compete with chemical synthesis in terms of the number of nanoparticles produced."

Finding the source of the size discrepancy paves the way to a future where researchers can optimize laser ablation to control the size of clean nanoparticles, making them cheaper and more readily available for potential biomedical purposes such as selectively killing cancer cells.

This achievement also exemplifies the benefits of laser technology while taking steps toward uncovering the fundamental factors that influence the outcomes of interactions between a laser pulse and a metal. This knowledge could lead to great strides in the team's nanoparticle research, as well as advances in [laser](#) ablation and related techniques, which in turn would enable more precise interpretation of existing data.

Cheng-Yu Shih, lead author of the Nanoscale paper and a recent graduate of UVA, now works to combine modeling with experimental studies to further explore how different metals generate nanoparticles in response to [laser ablation](#).

Zhigilei hopes the research will result in a breakthrough that removes the need for the tedious task of sorting small and large [nanoparticles](#). [23]

Researchers detect minute levels of disease with a nanotechnology-enhanced biochip

The difficulty in spotting minute amounts of disease circulating in the bloodstream has proven a stumbling block in the detection and treatment of cancers that advance stealthily with few symptoms. With a novel electrochemical biosensing device that identifies the tiniest signals these biomarkers emit, a pair of NJIT inventors are hoping to bridge this gap.

Their work in disease detection is an illustration of the power of electrical sensing—and the growing role of engineers—in [medical research](#).

"Ideally, there would be a simple, inexpensive test—performed at a regular patient visit in the absence of specific symptoms—to screen for some of the more silent, deadly cancers," says Bharath Babu Nunna, a recent Ph.D. graduate who worked with Eon Soo Lee, an assistant professor of mechanical engineering, to develop a nanotechnology-enhanced biochip to detect cancers, malaria and viral diseases such as pneumonia early in their progression with a pin prick blood test.

Their device includes a microfluidic channel through which a tiny amount of drawn blood flows past a sensing platform coated with biological agents that bind with targeted biomarkers of disease in body fluids such as blood, tears and urine—thereby triggering an electrical nanocircuit that signals their presence.

In research recently published in *Nano Convergence*, Nunna and his co-authors demonstrated the use of gold nanoparticles to enhance the sensor signal response of their device in cancer detection, among other findings.

One of the device's core innovations is the ability to separate [blood plasma](#) from whole blood in its microfluidic channels. Blood plasma carries the disease biomarkers and it is therefore necessary to separate it to enhance the "signal to noise ratio" in order to achieve a highly accurate test. The standalone device analyzes a [blood sample](#) within two minutes with no need for external equipment.

"Our approach detects targeted disease biomolecules at the femto scale concentration, which is smaller than nano and even pico scale, and is akin to searching for a planet in a galaxy cluster. Current sensing technology is limited to concentrations a thousand times larger. Using a nanoscale platform allows us to identify these lower levels of disease," Nunna says, adding, "And by separating the plasma from the blood, we are able to concentrate the disease biomarkers."

In another recent paper in *BioNanoScience*, Nunna, Lee and their co-authors detailed their findings on variations in sensitivity based on microfluidic flow.

Nunna is now a postdoctoral research fellow at Harvard Medical School, where he is expanding his expertise in microfluidic platforms, using them in organ-on-the-chip research conducted with Su Ryon Shin, a principal investigator and instructor in the medical school's Department of Medicine who develops 3-D-bioprinted organoids—artificial organs composed of cultured cells within structured hydrogels—for medical experimentation.

"I'm primarily responsible for developing the microfluidic devices that will automate the process of bioprinting 3-D organs that will be incorporated on a chip for a number of purposes. I'm tasked, for example, with developing an automated platform for long-term drug efficacy and toxicity analysis to track liver cancer and cardiac biomarkers. I'll be integrating the microfluidic biosensor with the liver cancer- and heart-on-a-chip model for continuous monitoring," he says.

By measuring the biomarker concentrations secreted from drug-injected 3-D-bioprinted organs, we can study drug effects on several organs without harming a live patient. Creating artificial organs allows us to experiment freely."

Down the road, he adds, the work at Harvard could potentially be applied in regenerative medicine. "The goal is to develop fully functional 3-D-bioprinted organoids and clinically relevant 3-D tissues to address the issue of donor shortages in transplantation."

Nunna says his research at Harvard Medical School will expand his knowledge of programmable microfluidics and precise electrochemical sensing techniques, which will in turn help him advance his biochip technology. The goal is a simple, standard assay for cancer diagnosis that avoids conventional, complex diagnostic steps.

Lee and Nunna have been working with oncologists at Weill Cornell Medicine and Hackensack Medical Center to identify clinical applications. As currently designed, the device would provide both qualitative and quantitative results of cancer antigens in blood samples, providing information on the

presence and the severity of the cancer. Their next step, he says, will be to expand the platform to detect multiple diseases using a single blood sample obtained with a pin prick.

"Although [healthcare technology](#) is considered to be a fast-evolving technology, there are still many unmet needs that need to be addressed. Diagnosing potentially deadly diseases at the early stages is the key to saving lives and improving patient treatment outcomes," he says, adding, "There is a huge need for healthcare technology, including a universal diagnostic platform that can provide instant results at the physician's office and other point-of-care settings."

Nunna is the co-founder and chief research scientist for Abonics, Inc., a startup formed by Lee to commercialize their device. He is named as a co-inventor with Lee on three published biochip patents and six additional patents that are now under review by the U.S. Patent and Trademark Office. Their technology has won financial backing from the National Science Foundation I-Corps program and the New Jersey Health Foundation (NJHF), a not-for-profit corporation that supports top biomedical research and health-related education programs in New Jersey.

"As we know, early detection can improve treatment outcomes for patients significantly," explained George F. Heinrich, M.D., vice chair and CEO of NJHF, in announcing the award. "Currently, doctors rely on diagnostic devices requiring a minimum of four hours of sample preparation through centralized diagnostic centers rather than their local offices."

In 2017, Nunna received the "Best Design in Healthcare Innovations and Point-of-Care Innovations Award" at the Healthcare Innovation and Point-of-Care Technologies conference from the Engineering in Medicine and Biology Society, held at the National Institute of Health headquarters in Bethesda, MD. That same year, the technology received the national innovation award at the TechConnect World Innovation Conference and Expo, an annual gathering of technology transfer offices, companies, and investment firms who meet to identify promising technologies from across the globe. [22]

Black nanoparticles slow the growth of tumors

The dark skin pigment melanin protects against the sun's damaging rays by absorbing light energy and converting it to heat. This could make it a very effective tool in tumor diagnosis and treatment, as demonstrated by a team from the Technical University of Munich (TUM) and Helmholtz Zentrum München. The scientists created melanin-loaded cell membrane-derived nanoparticles, which improved tumor imaging in an animal model while also slowing the growth of the tumor.

Nanoparticles are considered a promising weapon in the fight against tumors due to the fact that [tumor tissue](#) absorbs them more readily than healthy cells because their vascular system is more permeable. A good example is provided by outer membrane vesicles (OMVs), which are basically small bubbles surrounded by bacterial membrane. These 20- to 200-nanometer particles are of interest because they are biocompatible, biodegradable and can be easily and inexpensively produced in bacteria, even in large volumes. Once loaded with medicinal active agents, they are easy to administer.

Nanoparticles carrying a black cargo

The huge potential of OMVs in tumor diagnosis and treatment has been demonstrated by Prof. Vasilis Ntziachristos, Professor of Biological Imaging at TUM, and his team. Their work builds on the characteristic properties of OMVs and [melanin](#).

Dr. Vipul Gujrati, first author of the study, explains the principle: "Melanin absorbs light very readily—even in the infrared spectrum. We use this light in our optoacoustic imaging technique for [tumor diagnosis](#). It simultaneously converts this absorbed energy into heat, which is then emitted. Heat is also a way to combat tumors—other researchers are currently exploring this method in clinical trials."

Optoacoustics, a method which has been significantly advanced by Ntziachristos, combines the benefits of optical imaging and ultrasound technology. Weak laser pulses gently heat the tissue, causing it to briefly expand very slightly. Ultrasound signals are produced when the tissue contracts again as it cools down. The measured signals vary depending on the tissue type. The scientists record them with special detectors and "translate" them into three-dimensional images. Sensor molecules or probes (such as OMVs) can improve the specificity and accuracy of the technique even further.

Heat build-up reduces tumor growth

The scientists initially had to overcome a problem specific to melanin: It is not very water-soluble and therefore difficult to administer. This is where the OMVs came into play. The researchers engineered bacteria in such a way that they produce melanin and store it in their membrane derived nanoparticles. They then tested the black nanoparticles in mice which had tumors in their lower back region. The particles were injected directly into the tumor, which was excited with infrared laser pulses as part of the optoacoustic procedure.

OMVs proved to be suitable sensor probes for this diagnosis technique because they delivered sharp, high-contrast images of the tumor. They are also well-suited to photothermal therapy approaches, where the tumor tissue is heated with stronger laser pulses in order to kill the cancer cells. The melanin in the nanoparticles caused the temperature of the tumor tissue to rise from 37 °C to up to 56 °C. Control tumors with no melanin only reached a maximum temperature of 39 °C. In the ten days following the treatment, the tumors grew at a significantly slower rate than those in the control group that had not received melanin OMVs. This heat effect was amplified by another positive effect of the particles: By causing a slight non-specific inflammation in the tumor tissue, the immune system was triggered to attack the tumor.

"Our melanin [nanoparticles](#) fit into the new medical field of [theranostics](#)—where therapy and diagnostics are combined. This makes them a highly interesting option for use in clinical practice," says Ntziachristos. The scientists will now develop their OMVs further to bring them into clinical use in the future. [21]

Laser technology helps researchers scrutinize cancer cells

Devising the best treatment for a patient with cancer requires doctors to know something about the traits of the cancer from which the patient is suffering. But one of the greatest difficulties in treating cancer is that cancer cells are not all the same. Even within the same tumor, cancer cells can differ in their genetics, behavior, and susceptibility to chemotherapy drugs.

Cancer cells are generally much more metabolically active than [healthy cells](#), and some insights into a [cancer](#) cell's behavior can be gleaned by analyzing its [metabolic activity](#). But getting an accurate assessment of these characteristics has proven difficult for researchers. Several methods, including position emission tomography (or PET) scans, [fluorescent dyes](#), and contrasts have been used, but each has drawbacks that limit their usefulness.

Caltech's Lihong Wang believes he can do better through the use of photoacoustic microscopy (PAM), a technique in which [laser light](#) induces ultrasonic vibrations in a sample. Those vibrations can be used to image cells, [blood vessels](#), and tissues.

Wang, Bren Professor of Medical Engineering and Electrical Engineering, is using PAM to improve on an existing technology for measuring the oxygen-consumption rate (OCR) in collaboration with Professor Jun Zou at Texas A&M University. That existing technology takes many [cancer cells](#) and places them each into individual "cubbies" filled with blood. Cells with higher metabolisms will use up more oxygen and will lower the blood oxygen level, a process which is monitored by a tiny oxygen sensor placed inside each cubby.

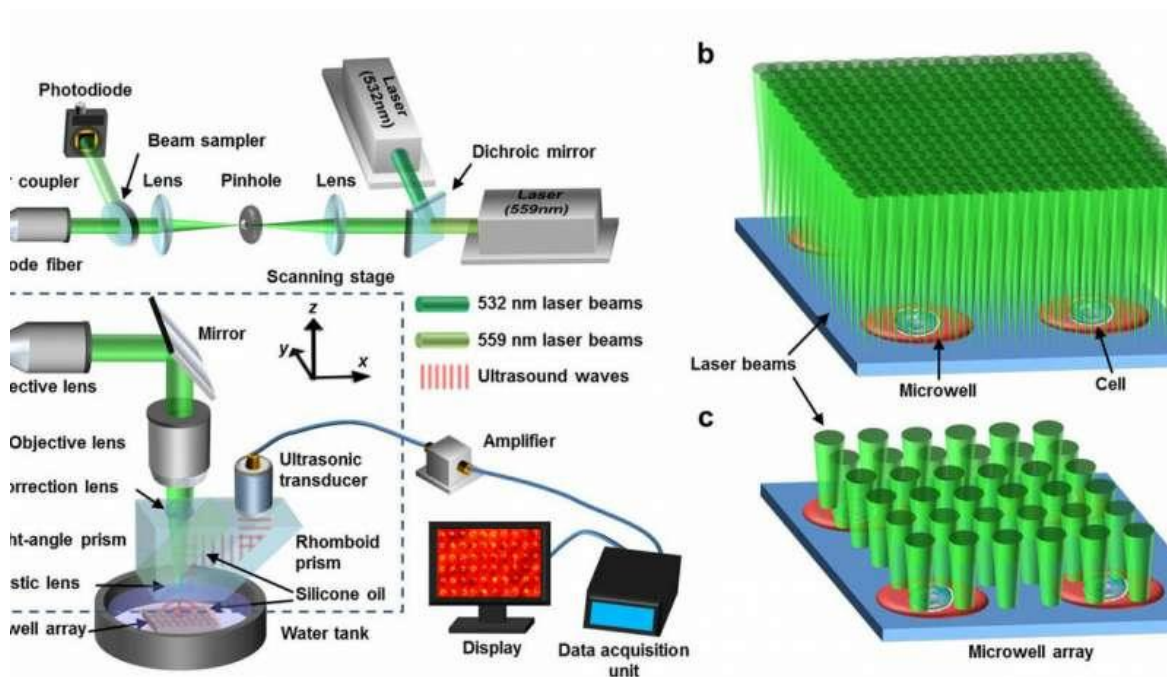

The photoacoustic microscopy apparatus used for imaging the metabolic rates of cancer cells. Credit: Caltech

This method, like those previously mentioned, has weaknesses. To get a meaningful sample size of metabolic data for cancer cells would require researchers to embed thousands of sensors into a grid. Additionally, the presence of the sensors within the cubbies can alter the metabolic rates of the cells, causing the collected data to be inaccurate.

Wang's improved version does away with the oxygen sensors and instead uses PAM to measure the oxygen level in each cubby. He does this with laser light that is tuned to a wavelength that the hemoglobin in blood absorbs and converts into vibrational energy—sound. As a hemoglobin molecule becomes oxygenated, its ability to absorb light at that wavelength changes. Thus, Wang is able to determine how oxygenated a sample of blood is by "listening" to the sound it makes when illuminated by the laser. He calls this single-cell metabolic photoacoustic microscopy, or SCM-PAM.

In a new paper, Wang and his co-authors show that SCM-PAM represents a huge improvement in the ability to assess the OCR of cancer cells. Using individual [oxygen](#) sensors to measure OCR limited researchers to analyzing roughly 30 cancer cells every 15 minutes. Wang's SCM-PAM improves that by two orders of magnitude and allows researchers to analyze around 3,000 [cells](#) in about 15 minutes.

"We have techniques to improve the throughput further by orders of magnitude, and we hope this new technology can soon help physicians make informed decisions on cancer prognosis and therapy," says Wang.

The paper, titled, "Label-free High-throughput Single-cell Photoacoustic Microscopy of Intratumoural Metabolic Heterogeneity," was published online by *Nature Biomedical Engineering* on April 1. [20]

Remote-control shoots laser at nano-gold to turn on cancer-killing immune cells

A remote command could one day send immune cells on a rampage against a malignant tumor. The ability to mobilize, from outside the body, targeted cancer immunotherapy inside the body has taken a step closer to becoming reality.

Bioengineers at the Georgia Institute of Technology have installed a heat-sensitive [switch](#) into T-cells that can activate the T-cells when heat turns the switch on. The method, tested in mice and published in a new study, is locally targeted and could someday help turn immunotherapy into a precision instrument in the fight against cancer.

Immunotherapy has made headlines with startling high-profile successes like saving former U.S. President Jimmy Carter from brain cancer. But the treatment, which activates the [body's](#) own immune system against cancer and other diseases, has also, unfortunately, proved to be hit-or-miss.

"In patients where radiation and traditional chemotherapies have failed, this is where T-cell therapies have shined, but the therapy is still new," said principal investigator Gabe Kwong. "This study is a step toward making it even more effective."

Cancer is notoriously wily, and when T-cells crawl into a [tumor](#), the tumor tends to switch off the T-cells' cancer-killing abilities. Researchers have been working to switch them back on.

Laser, gold, and T-cells

Kwong's remote control has done this in the lab, while also boosting T-cell activity.

In the study, Kwong's team successfully put their remote-control method through initial tests in mice with implanted tumors (so-called tumor phantoms, specially designed for certain experiments). The remote works via three basic components.

First, the researchers modified T-cells, a type of white blood cell, to include a [genetic switch](#) that, when switched on, increased the cells' expression of specific proteins by more than 200 times. That ability could be used to guide T-cells' cancer-fighting activities.

The T-cells, with the switch off, were introduced into the tumor phantom which was placed into the mice. The tumor phantom also included gold nanorods, just dozens of atoms in size. The researchers shone pulses of a gentle laser in the near-infrared (NIR) range from outside the mouse's body onto the spot where the tumor was located.

The nanorods receiving the light waves turned them into useful, localized mild heat, allowing the researchers to precisely warm the tumor. The elevated heat turned on the T-cells' engineered switch.

Hyper-activated T-cells

This study honed the method and confirmed that its components worked in living animals. It was not the intention of the study to treat cancer yet, although undertaking that is the next step, which is already on its way.

"In upcoming experiments, we are implementing this approach to treat aggressive tumors and establish cancer-fighting effectiveness," said Kwong, who is an assistant professor in the Wallace H. Coulter Department of Biomedical Engineering at Georgia Tech and Emory University.

The researchers published their results in the current edition of the journal *ACS Synthetic Biology*. The study's first author was graduate research assistant Ian Miller. The research was funded by the National Institutes of Health, the National Science Foundation, the Burroughs Wellcome Fund, and the Shurl and Kay Curci Foundation.

Better immunotherapy

Bioengineers have been able to do a lot with T-cells already when they're outside of the body.

"Right now, we're adept at harvesting a patient's own T-cells, modifying to target cancer, growing them outside the body until there are hundreds of millions of them," Kwong said. "But as soon as we inject them back into a patient, we lose control over the T-cells' activity inside the body."

The on-switch changes that.

T-cell toxicities

Having an off-switch is also important. If T-cells were engineered to be always-on and hyper-activated, as they moved through the body, they could damage healthy tissue.

"There would be off-target toxicities, so you really want to pinpoint their activation," Kwong said. "Our long-term goal for them is to activate site-specifically, so T-cells can overcome immunosuppression by the tumor and become better killers there."

When the heat remote is turned off, so are Kwong's engineered T-cells, because customary body temperatures are not high enough to activate their switch.

Heat-shock switch

The switch is a natural safety mechanism in human cells that has evolved to protect against heat shock and turns on when tissue temperatures rise above the body's normal operating range, which centers on 37 degrees Celsius (98.6 F). But the researchers re-fitted T-cells with the switch to make it turn on other functions, and it could be used to hyper-activate the cells.

The Georgia Tech bioengineers found that the switch worked in a range of 40 to 42 degrees Celsius (104—107.6 F), high enough to not react to the majority of high fevers and low enough to not damage healthy tissue nor the engineered T-cells.

"When the local temperature is raised to 45 degrees (113 F), some cells in our body don't like it," Kwong said. "But if heating is precisely controlled in a 40 to 42 degrees window with short pulses of the NIR light, then it turns on the T-cells' switch, and body cells are still very comfortable."

Immuno-goals and dreams

The researchers want to combine the switch with some additional cancer-fighting weapons they envision engineering into T-cells.

For example, secreted molecules called cytokines can boost immune cells' ability to kill cancer, but cytokines, unfortunately, can also be toxic. "Our long-term goal is to engineer T-cells to make and release powerful immune system stimulants like cytokines on command locally and sparingly," Kwong said.

In other studies, gently heated gold nanorods have been shown to kill tumors or hinder metastasis. But T-cell treatments could be even more thorough and, in addition, hopefully, one day give patients treated with them a long-lasting memory immune response to any recurrence of their cancer. [19]

Breakthrough brings gene-editing medicine one step closer to patient applications

Imagine a future where a guided biomachine put into your body seeks out defective gene sequences in each cell and edits in the correct information with precision accuracy.

It's called gene editing, and University of Alberta researchers have just published a game-changing study that promises to bring the technology much closer to therapeutic reality.

"We've discovered a way to greatly improve the accuracy of gene-editing technology by replacing the natural guide molecule it uses with a synthetic one called a bridged nucleic acid, or BNA," said Basil Hubbard, Canada Research Chair in Molecular Therapeutics and an assistant professor in the U of A's Department of Pharmacology, who led the study.

He and his team have filed a patent on their discovery and are hoping to partner with the pharmaceutical industry to incorporate it into a therapeutic.

Interest in gene-editing technology has been rapidly rising since the discovery of CRISPR/Cas9. This system is naturally present in bacteria, which use it for protection against their natural predators, called bacteriophages.

"It allows bacteria to store information about previous infections and then use it to seek out and destroy the DNA of new invaders by cutting it," explained Hubbard.

"What researchers have realized is that this system can be programmed to cut a specific DNA sequence in a human cell also, allowing us to edit our genes. One of the main issues, however, is that the system is not perfectly specific—sometimes it cuts a similar but incorrect gene."

Using its natural RNA guide molecule, the Cas9 system is quite accurate, only making a mistake about one per cent of the time, he noted.

"However, given that there are trillions of cells in the human body, even one percentage off is quite significant, especially because gene editing is permanent. One wrong cut and a patient could end up with a serious condition like cancer."

The new BNA guide molecule that Hubbard and his team—which includes PhD student Christopher Cromwell, who is first author on the study—developed was shown to be much more stable and stringent in its quest for finding the right DNA to cut.

"Our research shows that the use of bridged nucleic acids to guide Cas9 can improve its specificity by over 10,000 times in certain instances—a dramatic improvement," said Hubbard.

Though gene-editing technology still has several hurdles to overcome, including the challenge of how to deliver it effectively into the human body, it may someday be used to treat a wide variety of genetic diseases, from muscular dystrophy to hemophilia and various cancers.

The study, published in *Nature Communications*, was funded by the Natural Sciences and Engineering Research Council of Canada. [18]

Study reveals the inner workings of a molecular motor that packs and unpacks DNA

DNA is tightly packed into the nucleus of a cell. Nevertheless, the cellular machinery needs to constantly access the genomic information. An LMU team now reveals the inner workings of a molecular motor made of proteins which packs and unpacks DNA.

The genomic DNA of higher organisms is compacted in a highly condensed form known as chromatin. The DNA is tightly wound around a myriad of tiny histone spools called nucleosomes. A single human cell, for instance, accommodates in this manner about two meters of DNA. However, genes must be constantly transcribed into messenger RNAs to direct protein synthesis. Moreover, the entire DNA

must be replicated before cell division and DNA damage needs to be repaired. Thus, there must be way to actively grant access to the genome.

This is when chromatin remodelers come into play. Chromatin remodelers have an essential role as they are molecular machines: they unpick and unpack segments of the DNA by sliding nucleosome spools back and forth, replacing individual histones, freeing up the DNA for transcription, and finally compacting it again, when the job is done. Since all of this happens in a highly dynamic fashion, chromatin remodelers enable cells to react rapidly to alterations in their environment – and this holds for brewer's yeast as well as for human cells. In mediating gene accessibility, chromatin remodelers are vital for development and cell differentiation; cell types are defined by the sets of genes they express, remodelers help to determine cell identity.

So far, however, very little is known about what remodeling proteins look like and how they go about doing what they do. In molecular terms, functional remodelers are often very large complexes comprising many different protein components, whose coordinated action makes them akin to molecular machines. These features also make it very difficult to determine their detailed structure. But a team led by Professor Karl-Peter Hopfner, who holds a Chair in Structural Molecular Biology at LMU's Gene Center, has now used cryo-electron microscopy to reconstruct the three-dimensional structure of the nucleosome-sliding remodeler INO80 (which itself consists of 15 subunits) bound to a single nucleosome. "Even with innovative approaches, the best available technology and intensive teamwork, we were always working at the cutting edge," says Dr. Sebastian Eustermann, who worked out the molecular structure of the complex on the basis of electron micrographs of thousands of individual complexes.

By analyzing images of randomly oriented views of the complex formed between INO80 and a nucleosome in the electron micrographs, Hopfner and his team have pieced together its structure at a resolution which has seldom been achieved for a chromatin complex of comparable size. This allowed the researchers to unravel the intricate interaction of the remodeler with its substrate DNA spooled around histones and dissect how the whole machinery works.

From a biochemical point of view, remodelers are responsible for heavy-duty reorganizational tasks. To perform these tasks, they must execute "large-scale conformational changes, which are carried out with astounding precision," says Eustermann. In order to alter the relative positions of nucleosomes, the INO80 complex must first weaken the contacts between the nucleosomal histones and the DNA. A molecular motor which is part of the INO80 complex segmentally detaches the double-stranded DNA from the nucleosome. In doing so, it progressively breaks the contacts that normally keep the DNA tightly wound around the histone particle.

The motor subunit feeds DNA it into the nucleosome. This results in the transient formation of a double-stranded DNA loop that is likely an important intermediate in complex remodeling reactions on the nucleosome. On one hand, the loop exposes some histone proteins that could be replaced by other histones to form a different type of nucleosome. On the other hand, the loop is eventually passed over another subunit and the machine then acts as a ratchet, allowing the nucleosome to "move" on the DNA. Throughout this unpacking process, other subunits in the complex serve to support and stabilize the partially 'denuded' nucleosome itself.

The structure of the complex revealed in the new study sheds new light on the function and mode of action of chromatin remodelers in general. These [molecular machines](#) play an essential part in the workings of the cell by maintaining the flexibility of the [chromatin](#), thus enabling the genetic apparatus to respond dynamically to changing metabolic demands. "Our results provide the first well-founded picture of how they do that," says Hopfner. "Moreover, it has recently become clear that remodelers play a central role in tumorigenesis, because they often misregulated in tumor tissue. So structural and mechanistic insights into their functions will be vital for the future development of new therapies for cancer," he adds. [17]

Biomimetic chemistry—DNA mimic outwits viral enzyme

Not only can synthetic molecules mimic the structures of their biological models, they can also take on their functions and may even successfully compete with them, as an artificial DNA sequence designed by Ludwig-Maximilians-Universitaet (LMU) in Munich chemist Ivan Huc now shows.

Chemist Ivan Huc finds the inspiration for his work in the molecular principles that underlie biological systems. As the leader of a research group devoted to biomimetic supramolecular chemistry, he creates 'unnatural' molecules with defined, predetermined shapes that closely resemble the major biological polymers, proteins and DNA found in cells. The backbones of these molecules are referred to as 'foldamers' because, like origami patterns, they adopt predictable shapes and can be easily modified. Having moved to LMU from his previous position at Bordeaux University last summer, Huc has synthesized a helical molecule that mimics surface features of the DNA double helix so closely that bona fide DNA-binding proteins interact with it.

This work is described in a paper published in *Nature Chemistry*. The new study shows that the synthetic compound is capable of inhibiting the activities of several DNA-processing enzymes, including the 'integrase' used by the [human immunodeficiency virus](#) (HIV) to insert its genome into that of its host cell. The successful demonstration of the efficacy of the synthetic DNA mimic might lead to a new approach to the treatment of AIDS and other retroviral diseases.

The new paper builds on advances described in two previous publications in *Nature Chemistry* published earlier this year. In the first of these papers, Huc and his colleagues developed a pattern of binding interactions required to enable synthetic [molecules](#) to assume stable forms similar to the helical backbones of proteins. In the second, they worked out the conditions required to append their synthetic helix to natural proteins during synthesis by cellular ribosomes. "As always in biology, shape determines function," he explains. In the new study, he introduces a synthetic molecule that folds into a helical structure that mimics surface features of the DNA double helix, and whose precise shape can be altered in a modular fashion by the attachment of various substituents. This enables the experimenter to imitate in detail the shape of natural DNA double helix, in particular the position of negative charges. The imitation is so convincing that it acts as a decoy for two DNA-binding enzymes, including the HIV integrase, which readily bind to it and are essentially inactivated.

However, the crucial question is whether or not the foldamer can effectively compete for the enzymes in the presence of their normal DNA substrate. "If the enzymes still bind to the foldamer

under competitive conditions, then the mimic must be a better binder than the natural DNA itself," Huc says. And indeed, the study demonstrates that the HIV integrase binds more strongly to the foldamer than to natural DNA. "Furthermore, although initially designed to resemble DNA, the foldamer owes its most useful and valuable properties to the features that differentiate it from DNA," Huc points out.

Thanks to the modular nature of foldamer design, the structures of these artificial DNA mimics can be readily altered, which enables a broad range of variants to be produced using the same basic platform. In the current study, Huc and his colleagues have focused on enzymes that are generically capable of binding to DNA, irrespective of its base sequence. However, it may also be possible to use the foldamer approach to develop DNA mimics that can block the action of the many important DNA-binding proteins whose functions depend on the recognition of specific nucleotide sequences. [16]

Simulations document self-assembly of proteins and DNA

What makes particles self-assemble into complex biological structures? Often, this phenomenon is due to the competition between forces of attraction and repulsion, produced by electric charges in various sections of the particles. In nature, these phenomena often occur in particles that are suspended in a medium—referred to as colloidal particles—such as proteins, DNA and RNA. To facilitate self-assembly, it is possible to "decorate" various sites on the surface of such particles with different charges, called patches.

In a new study published in *EPJE*, physicists have developed an algorithm to simulate the molecular dynamics of these patchy [particles](#). The findings published by Silvano Ferrari and colleagues from the TU Vienna and the Centre for Computational Materials Science (CMS), Austria, will improve our understanding of what makes self-assembly in biological systems possible.

In this study, the authors model charged patchy particles, which are made up of a rigid body with only two charged patches, located at opposite poles. They then develop the equations governing the dynamics of an ensemble of such colloidal patchy particles.

Based on an existing approach originally developed for molecular particles, their simulation includes additional constraints to guarantee that the electrical charge "decorations" are preserved over time. In this regard, they develop equations for describing the particles' motion; the solutions to these equations describe the trajectories of these colloidal particles. Such [molecular dynamics](#) simulations lend themselves to being run in parallel on a huge number of particles.

With these findings, the authors complement the lessons learned from experimental observations of similar particles recently synthesised in the lab. Recent experiments have demonstrated that [colloidal particles](#) decorated at two interaction sites display a remarkable propensity for self-organising into highly unusual structures that remain stable over a broad temperature range. [15]

Scientists explore the structure of a key region of longevity protein telomerase

Scientists from Moscow State University (MSU) working with an international team of researchers have identified the structure of one of the key regions of telomerase—a so-called "cellular immortality" ribonucleoprotein. Structural and functional studies on this protein are important for the development of potential anticancer drugs. The results of the study have been published in *Nucleic Acids Research*.

Each cell goes through a DNA replication process before division. This is a precise, fine-tuned process controlled by the coordinated work of a sophisticated enzymatic machinery. However, due to the nature of the copying process, the termini of DNA molecules are left uncopied, and DNA becomes shorter with each replication. However, no important data is lost in the process, as the termini of DNA molecules (telomeres) consist of thousands of small, repeated regions that do not carry hereditary information. When the reserve of telomere repetitions is exhausted, the cell ceases to divide, and eventually, it can die. Scientists believe that this is the mechanism of cellular aging, which is necessary for the renewal of cells and tissues of the body.

But how do "immortal" strains and stem cells that give life to a huge number of offspring cope with this? This is where the enzyme [telomerase](#) comes into play. It can restore telomeric termini of chromosomes and therefore compensate for their shortening during mitosis. The telomerase protein catalytic subunit works together with the RNA molecule, and its short fragment is used as a template to synthesize telomeric repetitions. MSU-based scientists discovered the structure of the telomerase fragment that is in charge of this process.

"Our work is aimed at the structural characterization of the telomerase complex. In a living cell, it includes a catalytic subunit, an RNA molecule, a segment of telomeric DNA, and several auxiliary components. Anomalously low activity of telomerase caused by genetics can result in serious pathogenic conditions (telomeropathy), while its anomalous activation is the reason for the cellular "immortality" of most known cancers. Information on the structure of telomerase and the relationships between its components is necessary for understanding the function and regulation of this enzyme, and in the future, for directed control of its activity," said Elena Rodina, assistant professor of the Department for the Chemistry of Natural Products, Faculty of Chemistry, MSU.

Working with thermotolerant yeast, a model eukaryotic organism, the researchers determined the structure of one of the major domains of the telomerase catalytic subunit (the so-called TEN-domain) and determined which parts of it are responsible for the interaction of the enzyme with the RNA molecule and the synthesized DNA. Based on the experimental data obtained, the scientists constructed a theoretical model of the catalytic core of telomerase.

The activity of the enzyme may be described in a simplified way: Telomerase can be represented as a molecular machine containing an RNA molecule. This machine, with the help of a template part of RNA, binds to the end of a long chain of DNA, and synthesizes a fragment of a new DNA chain along the remaining template fragment. After that, the telomerase machine has to move to the newly synthesized end of the DNA in order to continue to build up the chain. The scientists assume that the TEN-domain allows telomerase to synthesize DNA fragments of strictly defined length, after which the

RNA template should be detached from the DNA strand to move closer to its edge. Thus, the TEN domain facilitates the movement of the enzyme to building up a new region, i.e. the next telomeric fragment, and this is how the synthesis cycle is repeated.

In addition, the researchers identified the structural core of the TEN domain that remained unchanged in a variety of organisms, despite all the evolutionary vicissitudes, which indicates the important role of this core in the function of the enzyme. The team also revealed the elements specific for different groups of organisms, which interact with own proteins of individual telomerase complex.

"The data obtained bring us closer to an understanding of the structure, function and regulation of telomerase. In the future, this knowledge can be used to create drugs aimed at regulating telomerase activity—either to increase it (for example, to increase the cell life span in biomaterials for transplantology) or to reduce (for instance, for immortal cancer cells to lose their immortality)," concludes Elena Rodina. [14]

Custom sequences for polymers using visible light

Researchers from Tokyo Metropolitan University used a light-sensitive iridium-palladium catalyst to make "sequential" polymers, using visible light to change how building blocks are combined into polymer chains. By simply switching the light on or off, they were able to realize different compositions along the polymer chain, allowing precise control over physical properties and material function. This may drastically simplify existing polymer production methods, and help overcome fundamental limits in creating new polymers.

The world is full of long, chain-like molecules known as polymers. Famous examples of "sequential" copolymers, i.e. polymers made of multiple [building blocks](#) (or "monomers") arranged in a specific order, include DNA, RNA and proteins; their specific structure imparts the vast range of molecular functionality that underpins biological activity. However, making sequential polymers from scratch is a tricky business. We can design special monomers that assemble in different ways, but the complex syntheses that are required limit their availability, scope and functionality.

To overcome these limits, a team led by Associate Professor Akiko Inagaki from the Department of Chemistry, Tokyo Metropolitan University, applied a light-sensitive catalyst containing iridium and palladium. By switching a light on and off, they were able to control the speed at which two different monomers, styrene and vinyl ether, become part of a [polymer chain](#). When exposed to light, the styrene monomer was found to be incorporated into the copolymer structure much more rapidly than in the dark, resulting in a single copolymer chain with different compositions along its length. Parts that are rich in styrene are more rigid than those rich in vinyl ether; by using different on/off [light](#) sequences, they could create polymers with a range of [physical properties](#) e.g. different "glass transition" temperatures, above which the [polymer](#) becomes softer.

The newly developed process is significantly simpler than existing methods. The team also found that both types of monomer were built into the polymer via a mechanism known as non-radical

coordination-insertion; this is a generic mechanism, meaning that this new method might be applied to make polymers using a wide range of catalysts and monomers, with the potential to overcome the limited availability of monomer candidates. [13]

Artificial and biological cells work together as mini chemical factories

Researchers have fused living and non-living cells for the first time in a way that allows them to work together, paving the way for new applications.

The system, created by a team from Imperial College London, encapsulates biological cells within an artificial cell. Using this, researchers can harness the natural ability of biological cells to process chemicals while protecting them from the environment.

This system could lead to applications such as cellular 'batteries' powered by photosynthesis, synthesis of drugs inside the body, and biological sensors that can withstand harsh conditions.

Previous artificial cell design has involved taking parts of biological cell 'machinery' - such as enzymes that support chemical reactions - and putting them into artificial casings. The new study, published today in *Scientific Reports*, goes one step further and encapsulates entire cells in artificial casings.

The artificial cells also contain enzymes that work in concert with the biological cell to produce new chemicals. In the proof-of-concept experiment, the artificial cell systems produced a fluorescent chemical that allowed the researchers to confirm all was working as expected.

Lead researcher Professor Oscar Ces, from the Department of Chemistry at Imperial, said: "Biological cells can perform extremely complex functions, but can be difficult to control when trying to harness one aspect. Artificial cells can be programmed more easily but we cannot yet build in much complexity.

"Our new system bridges the gap between these two approaches by fusing whole biological cells with artificial ones, so that the machinery of both works in concert to produce what we need. This is a paradigm shift in thinking about the way we design artificial cells, which will help accelerate research on applications in healthcare and beyond."

To create the system, the team used microfluidics: directing liquids through small channels. Using water and oil, which do not mix, they were able to make droplets of a defined size that contained the biological cells and enzymes. They then applied an artificial coating to the droplets to provide protection, creating an artificial cell environment.

They tested these artificial cells in a solution high in copper, which is usually highly toxic to biological cells. The team were still able to detect fluorescent chemicals in the majority of the artificial cells, meaning the biological cells were still alive and functioning inside. This ability would be useful in the human body, where the artificial cell casing would protect the foreign biological cells from attack by the body's immune system.

First author of the study Dr Yuval Elani, an EPSRC Research Fellow also from the Department of Chemistry, said: "The system we designed is controllable and customisable. You can create different sizes of artificial cells in a reproducible manner, and there is the potential to add in all kinds of cell machinery, such as chloroplasts for performing photosynthesis or engineered microbes that act as sensors."

To improve the functionality of these artificial cell systems, the next step is to engineer the artificial coating to act more like a biological membrane, but with special functions.

For example, if the membrane could be designed to open and release the chemicals produced within only in response to certain signals, they could be used to deliver drugs to specific areas of the body. This would be useful for example in cancer treatment to release targeted drugs only at the site of a tumour, reducing side effects.

While a system like that may be a way off yet, the team say this is a promising leap in the right direction. The work is the first example of fusing living and non-living components to emerge from Imperial and King's College's new FABRICELL centre for artificial cell science. [12]

New interaction mechanism of proteins discovered

UZH researchers have discovered a previously unknown way in which proteins interact with one another and cells organize themselves. This new mechanism involves two fully unstructured proteins forming an ultra-high-affinity complex due to their opposite net charge. Proteins usually bind one another as a result of perfectly matching shapes in their three-dimensional structures.

Proteins are among the most important biomolecules and are the key mediators of molecular communication between and within cells. For two proteins to bind, specific regions of their three-dimensional structures have to match one another exactly, as a key fits into a lock. The structure of proteins is extremely important for their functioning and for triggering the required responses in cells. Now, researchers at the University of Zurich, together with colleagues from Denmark and the U.S., have discovered that unstructured proteins can also have ultra-high-affinity interactions.

One of these proteins is histone H1, which, as a component of chromatin, is responsible for DNA packaging. Its binding partner, prothymosin α , acts as a kind of shuttle that deposits and removes the histone from the DNA. This process determines whether or not genes in specific parts of the DNA can be read. Both proteins are involved in several regulatory processes in the body, such as cell division and proliferation, and therefore also play a role when it comes to a number of diseases, including cancer. Ben Schuler, professor at the Department of Biochemistry at UZH and head of the research project published in *Nature*, says, "The interesting thing about these proteins is that they're completely unstructured—like boiled noodles in water." How such disordered proteins should be able to interact according to the key/lock principle had puzzled the team of researchers.

Notably, the two proteins bind to one another much more strongly than the average protein partners. The research team used single-molecule fluorescence and nuclear magnetic

resonance spectroscopy to determine the arrangement of the proteins. Observed in isolation, they show extended unstructured protein chains. The chains become more compact as soon as both binding partners come together and form a complex. The strong interaction is caused by the strong electrostatic attraction, since histone H1 is highly positively charged while prothymosin α is highly negatively charged. Even more surprising was the discovery that the protein complex was also fully unstructured, as several analyses confirmed.

To investigate the shape of the protein complex, the researchers labeled both proteins with fluorescent probes, which they then added to selected sites on the proteins. Together with computer simulations, this molecular map yielded the following results: Histone 1 interacts with prothymosin α preferably in its central region, which is the region with the highest charge density. Moreover, it emerged that the complex is highly dynamic: The proteins' position in the complex changes extremely quickly—in a matter of approx. 100 nanoseconds.

The interaction behavior is likely to be fairly common. Cells have many proteins that contain highly charged sequences and may be able to form such protein complexes. There are hundreds of such proteins in the human body alone. "It's likely that the interaction between disordered, highly charged proteins is a basic mechanism for how cells function and organize themselves," concludes Ben Schuler. According to the biophysicist, textbooks will need revision to account for this new way of binding. The discovery is also relevant for developing new therapies, since unstructured proteins are largely unresponsive to traditional drugs, which bind to specific structures on the protein surface. [11]

Particles in charged solution form clusters that reproduce

Dr Martin Sweatman from the University of Edinburgh's School of Engineering has discovered a simple physical principle that might explain how life started on Earth.

He has shown that particles that become charged in solution, like many biological molecules, can form giant clusters that can reproduce. Reproduction is shown to be driven by simple physics—a balance of forces between short-range attraction and long-range repulsion. Once cluster reproduction begins, he suggests chemical evolution of clusters could follow, leading eventually to life.

Many biological molecules, like DNA and proteins, might show this behaviour. Even the building blocks of life, amino acids and nucleobases, might show this behaviour. Reproduction in modern cells might even be driven by this simple physical mechanism, i.e. chemistry is not so important.

Dr Sweatman's research uses theoretical methods and computer simulations of simple particles. They clearly show giant clusters of molecules with the right balance of forces can reproduce. No chemistry is involved. However, these theoretical predictions have yet to be confirmed by experiment.

Dr Sweatman said, "Although it will be difficult to see this behaviour for solutions of small biomolecules, it should be possible to confirm this behaviour experimentally with much larger particles that can be seen under a microscope, like charged colloids.

"If this [behaviour](#) is confirmed, then we take another step towards Darwin's idea of life beginning in a warm little pond. A simple evaporation and condensation cycle in a pond might be sufficient to drive [cluster](#) reproduction initially. Survival of the fittest clusters of chemicals might then eventually lead to life."

The research has been published in the international journal *Molecular Physics*.

Experiment demonstrates quantum mechanical effects from biological systems

Nearly 75 years ago, Nobel Prize-winning physicist Erwin Schrödinger wondered if the mysterious world of quantum mechanics played a role in biology. A recent finding by Northwestern University's Prem Kumar adds further evidence that the answer might be yes.

Kumar and his team have, for the first time, created quantum entanglement from a biological system. This finding could advance scientists' fundamental understanding of biology and potentially open doors to exploit biological tools to enable new functions by harnessing [quantum mechanics](#).

"Can we apply quantum tools to learn about biology?" said Kumar, professor of electrical engineering and computer science in Northwestern's McCormick School of Engineering and of physics and astronomy in the Weinberg College of Arts and Sciences. "People have asked this question for many, many years—dating back to the dawn of quantum mechanics. The reason we are interested in these new quantum states is because they allow applications that are otherwise impossible."

Partially supported by the Defense Advanced Research Projects Agency, the research was published Dec. 5 in *Nature Communications*.

Quantum entanglement is one of quantum mechanics' most mystifying phenomena. When two [particles](#)—such as atoms, photons, or electrons—are entangled, they experience an inexplicable link that is maintained even if the particles are on opposite sides of the universe. While entangled, the particles' behavior is tied one another. If one particle is found spinning in one direction, for example, then the other particle instantaneously changes its spin in a corresponding manner dictated by the entanglement. Researchers, including Kumar, have been interested in harnessing quantum entanglement for several applications, including quantum communications. Because the particles can communicate without wires or cables, they could be used to send secure messages or help build an extremely fast "quantum Internet."

"Researchers have been trying to entangle a larger and larger set of atoms or photons to develop substrates on which to design and build a quantum machine," Kumar said. "My laboratory is asking if we can build these machines on a biological substrate."

In the study, Kumar's team used green fluorescent proteins, which are responsible for bioluminescence and commonly used in biomedical research. The team attempted to entangle the photons generated from the fluorescing molecules within the algae's barrel-shaped protein structure by exposing them to spontaneous four-wave mixing, a process in which multiple wavelengths interact with one another to produce new wavelengths.

Through a series of these experiments, Kumar and his team successfully demonstrated a type of entanglement, called [polarization](#) entanglement, between photon pairs. The same feature used to make glasses for viewing 3D movies, polarization is the orientation of oscillations in light waves. A wave can oscillate vertically, horizontally, or at different angles. In Kumar's entangled pairs, the photons' polarizations are entangled, meaning that the oscillation directions of light waves are linked. Kumar also noticed that the barrel-shaped structure surrounding the fluorescing molecules protected the [entanglement](#) from being disrupted.

"When I measured the vertical polarization of one particle, we knew it would be the same in the other," he said. "If we measured the horizontal polarization of one particle, we could predict the horizontal polarization in the other particle. We created an entangled state that correlated in all possibilities simultaneously."

Now that they have demonstrated that it's possible to create [quantum entanglement](#) from biological particles, next Kumar and his team plan to make a biological substrate of [entangled particles](#), which could be used to build a [quantum](#) machine. Then, they will seek to understand if a biological substrate works more efficiently than a synthetic one. [9]

Quantum biology: Algae evolved to switch quantum coherence on and off

A UNSW Australia-led team of researchers has discovered how algae that survive in very low levels of light are able to switch on and off a weird quantum phenomenon that occurs during photosynthesis.

The function in the algae of this quantum effect, known as coherence, remains a mystery, but it is thought it could help them harvest energy from the sun much more efficiently. Working out its role in a living organism could lead to technological advances, such as better organic solar cells and quantum-based electronic devices.

The research is published in the journal Proceedings of the National Academy of Sciences.

It is part of an emerging field called quantum biology, in which evidence is growing that quantum phenomena are operating in nature, not just the laboratory, and may even account for how birds can navigate using the earth's magnetic field.

"We studied tiny single-celled algae called cryptophytes that thrive in the bottom of pools of water, or under thick ice, where very little light reaches them," says senior author, Professor Paul Curmi, of the UNSW School of Physics.

"Most cryptophytes have a light-harvesting system where quantum coherence is present. But we have found a class of cryptophytes where it is switched off because of a genetic mutation that alters the shape of a light-harvesting protein.

"This is a very exciting find. It means we will be able to uncover the role of quantum coherence in photosynthesis by comparing organisms with the two different types of proteins."

In the weird world of quantum physics, a system that is coherent – with all quantum waves in step with each other – can exist in many different states simultaneously, an effect known as superposition. This phenomenon is usually only observed under tightly controlled laboratory conditions.

So the team, which includes Professor Gregory Scholes from the University of Toronto in Canada, was surprised to discover in 2010 that the transfer of energy between molecules in the light harvesting systems from two different cryptophyte species was coherent.

The same effect has been found in green sulphur bacteria that also survive in very low light levels.

"The assumption is that this could increase the efficiency of photosynthesis, allowing the algae and bacteria to exist on almost no light," says Professor Curmi.

"Once a light-harvesting protein has captured sunlight, it needs to get that trapped energy to the reaction centre in the cell as quickly as possible, where the energy is converted into chemical energy for the organism.

"It was assumed the energy gets to the reaction centre in a random fashion, like a drunk staggering home. But quantum coherence would allow the energy to test every possible pathway simultaneously before travelling via the quickest route."

In the new study, the team used x-ray crystallography to work out the crystal structure of the light harvesting complexes from three different species of cryptophytes.

They found that in two species a genetic mutation has led to the insertion of an extra amino acid that changes the structure of the protein complex, disrupting coherence.

"This shows cryptophytes have evolved an elegant but powerful genetic switch to control coherence and change the mechanisms used for light harvesting," says Professor Curmi.

The next step will be to compare the biology of different cryptophytes, such as whether they inhabit different environmental niches, to work out whether the quantum coherence effect is assisting their survival. [8]

Photoactive Prebiotic Systems

We propose that life first emerged in the form of such minimal photoactive prebiotic kernel systems and later in the process of evolution these photoactive prebiotic kernel systems would have produced fatty acids and covered themselves with fatty acid envelopes to become the minimal cells of the Fatty Acid World. Specifically, we model self-assembling of photoactive

prebiotic systems with observed quantum entanglement phenomena. We address the idea that quantum entanglement was important in the first stages of origins of life and evolution of the biospheres because simultaneously excite two prebiotic kernels in the system by appearance of two additional quantum entangled excited states, leading to faster growth and self-replication of minimal living cells. The quantum mechanically modeled possibility of synthesizing artificial self-reproducing quantum entangled prebiotic kernel systems and minimal cells also impacts the possibility of the most probable path of emergence of photocells on the Earth or elsewhere. We also examine the quantum entangled logic gates discovered in the modeled systems composed of two prebiotic kernels. Such logic gates may have application in the destruction of cancer cells or becoming building blocks of new forms of artificial cells including magnetically active ones.

Significance Statement

Our investigated self-assembly of molecules towards supramolecular bioorganic and minimal cellular systems depends on the quantum mechanics laws which induce hydrogen and Van der Waals bindings (Tamulis A, Grigalavicius, M, *Orig Life Evol Biosph* 41:51-71, 2011).

In the work presented here, quantum entanglement takes the form of a quantum superposition of the active components in synthesized self-assembling and self-replicating living systems. When a quantum calculation of an entangled system is made that causes one photoactive biomolecule of such a pair to take on a definite value (e.g., electron density transfer or electron spin density transfer), the other member of this entangled pair will be found to have taken the appropriately correlated value (e.g., electron density transfer or electron spin density transfer). In our simulations, the separation distance of supramolecular bio systems changes took place during geometry optimization procedures, which mimic real-world intermolecular interaction processes.

Our discovered phenomenon of the quantum entanglement in the prebiotic systems enhance the photosynthesis in the proposed systems because simultaneously excite two prebiotic kernels in the system by appearance of two additional quantum entangled excited states (Tamulis A, Grigalavicius M, Baltrusaitis J, *Orig Life Evol Biosph* 43:49-66, 2013; Tamulis A, Grigalavicius M, Krisciukaitis S (2014) , *J Comput Theor Nanos*, 11, 1597-1608, 2014; Tamulis A, Grigalavicius M, 8:117-140, 2014.). We can propose that quantum entanglement enhanced the emergence of photosynthetic prebiotic kernels and accelerated the evolution of photosynthetic life because of additional absorbed light energy, leading to faster growth and self-replication of minimal living cells.

We can state that: Livings are self-assembled and self-replicating wet and warm stochastically moving supramolecular systems where quantum entanglement can be continuously generated and destroyed by non-equilibrium effects in an environment where no static entanglement exists; quantum entanglement involve the biomolecule inside one living or between other neighboring livings.

This warm quantum coherence is basic for the explanation of DNA stability and for the understanding of brain magnetic orientation during migration in more than 50 species of birds, fishes and insects. Exists experimental evidence for quantum-coherent is used for more efficient light-harvesting in plant photosynthesis. Quantum entanglement exists in supramolecules determining the sense of smell and in the brain neurons microtubules due to quantum vibrations.

In the work presented here, we started to design and quantum mechanical investigations of the molecular logical devices which are useful for construction of nano medicine biorobots against the molecular diseases such a cancer tumors, and against the new kinds of synthesized microorganisms and nano guns.

Figure legend



You can see in the enclosed figure the quantum entanglement phenomenon in the closely self-assembled two synthesized protocell system due to the photo excited electron charge transfer from one protocell to another that leads to closer self-assembly and exchange of energy and information.

Visualization of the electron charge tunneling associated with the 6th (467.3 nm) excited state. The transition is mainly from squaraine molecule of the first protocell situated in the bottom of this bicellular system to precursor of fatty acid (pFA) molecule of the second subsystem (in the top) and little from the 1,4-bis(N,N-dimethylamino)naphthalene molecule (in the top-right) to the same pFA molecule of the second subsystem (in the top). The electron cloud hole is indicated by the dark blue color while the transferred electron cloud location is designated by the gray color.

As a result, these nonlinear quantum interactions compressed the overall molecular system resulting in a smaller gap between the HOMO and LUMO electron energy levels which allows

enhanced tunneling of photo excited electrons from the sensitizer squaraine and (1,4bis(N,Ndimethylamino)naphthalene) to the pFA molecule resulting in its cleavage. The new fatty acid joins the existing minimal cell thus increasing it in size. After reaching some critical size, the minimal cell should divide (i.e. self-replicate) into two separate smaller minimal cells. [7]

Quantum Biology

Researchers have long suspected that something unusual is afoot in photosynthesis. Particles of light called photons, streaming down from the Sun; arrive randomly at the chlorophyll molecules and other light-absorbing 'antenna' pigments that cluster inside the cells of every leaf, and within every photosynthetic bacterium. But once the photons' energy is deposited, it doesn't stay random. Somehow, it gets channeled into a steady flow towards the cell's photosynthetic reaction centre, which can then use it at maximum efficiency to convert carbon dioxide into sugars. Quantum coherence in photosynthesis seems to be beneficial to the organisms using it. But did their ability to exploit quantum effects evolve through natural selection? Or is quantum coherence just an accidental side effect of the way certain molecules are structured? [6]

Quantum Consciousness

Extensive scientific investigation has found that a form of quantum coherence operates within living biological systems through what is known as biological excitations and biophoton emission. What this means is that metabolic energy is stored as a form of electromechanical and electromagnetic excitations. These coherent excitations are considered responsible for generating and maintaining long-range order via the transformation of energy and very weak electromagnetic signals. After nearly twenty years of experimental research, Fritz-Albert Popp put forward the hypothesis that biophotons are emitted from a coherent electrodynamic field within the living system.

What this means is that each living cell is giving off, or resonating, a biophoton field of coherent energy. If each cell is emitting this field, then the whole living system is, in effect, a resonating field—a ubiquitous nonlocal field. And since biophotons are the entities through which the living system communicates, there is near-instantaneous intercommunication throughout. And this, claims Popp, is the basis for coherent biological organization -- referred to as quantum coherence. This discovery led Popp to state that the capacity for evolution -- rests not on aggressive struggle and rivalry but on the capacity for communication and cooperation. In this sense the built-in capacity for species evolution is not based on the individual but rather living systems that are interlinked within a coherent whole: Living systems are thus neither the subjects alone, nor objects isolated, but both subjects and objects in a mutually communicating universe of meaning. . . . Just as the cells in an organism take on different tasks for the whole, different populations unfold information not only for themselves, but for all other organisms, expanding the consciousness of the whole, while at the same time becoming more and more aware of this collective consciousness.

Biophysicist Mae-Wan Ho describes how the living organism, including the human body, is coordinated throughout and is "coherent beyond our wildest dreams." It appears that every part of our body is "in communication with every other part through a dynamic, tunable, responsive, liquid crystalline medium that pervades the whole body, from organs and tissues to the interior of every cell."

What this tells us is that the medium of our bodies is a form of liquid crystal, an ideal transmitter of communication, resonance, and coherence. These relatively new developments in biophysics have discovered that all biological organisms are constituted of a liquid crystalline medium. Further, DNA is a liquid-crystal, lattice-type structure (which some refer to as a liquid crystal gel), whereby body cells are involved in a holographic instantaneous communication via the emitting of biophotons (a source based on light). This implies that all living biological organisms continuously emit radiations of light that form a field of coherence and communication. Moreover, biophysics has discovered that living organisms are permeated by quantum wave forms. [5]

Creating quantum technology

Another area of potential application is in quantum computing. The long-standing goal of the physicists and engineers working in this area is to manipulate data encoded in quantum bits (qubits) of information, such as the spin-up and spin-down states of an electron or of an atomic nucleus. Qubits can exist in both states at once, thus permitting the simultaneous exploration of all possible answers to the computation that they encode. In principle, this would give quantum computers the power to find the best solution far more quickly than today's computers can — but only if the qubits can maintain their coherence, without the noise of the surrounding environment, such as the jostling of neighboring atoms, destroying the synchrony of the waves. [6]

Quantum Entanglement

Measurements of physical properties such as position, momentum, spin, polarization, etc. performed on entangled particles are found to be appropriately correlated. For example, if a pair of particles is generated in such a way that their total spin is known to be zero, and one particle is found to have clockwise spin on a certain axis, then the spin of the other particle, measured on the same axis, will be found to be counterclockwise. Because of the nature of quantum measurement, however, this behavior gives rise to effects that can appear paradoxical: any measurement of a property of a particle can be seen as acting on that particle (e.g. by collapsing a number of superimposed states); and in the case of entangled particles, such action must be on the entangled system as a whole. It thus appears that one particle of an entangled pair "knows" what measurement has been performed on the other, and with what outcome, even though there is no known means for such information to be communicated between the particles, which at the time of measurement may be separated by arbitrarily large distances. [4]

The Bridge

The accelerating electrons explain not only the Maxwell Equations and the Special Relativity, but the Heisenberg Uncertainty Relation, the wave particle duality and the electron's spin also, building the bridge between the Classical and Quantum Theories. [1]

Accelerating charges

The moving charges are self maintain the electromagnetic field locally, causing their movement and this is the result of their acceleration under the force of this field. In the classical physics the charges will distributed along the electric current so that the electric potential lowering along the current, by linearly increasing the way they take every next time period because this accelerated motion. The same thing happens on the atomic scale giving a dp impulse difference and a dx way difference between the different part of the not point like particles.

Relativistic effect

Another bridge between the classical and quantum mechanics in the realm of relativity is that the charge distribution is lowering in the reference frame of the accelerating charges linearly: $ds/dt = at$ (time coordinate), but in the reference frame of the current it is parabolic: $s = a/2 t^2$ (geometric coordinate).

Heisenberg Uncertainty Relation

In the atomic scale the Heisenberg uncertainty relation gives the same result, since the moving electron in the atom accelerating in the electric field of the proton, causing a charge distribution on Δx position difference and with a Δp momentum difference such a way that they product is about the half Planck reduced constant. For the proton this Δx much less in the nucleon, than in the orbit of the electron in the atom, the Δp is much higher because of the greater proton mass.

This means that the electron and proton are not point like particles, but has a real charge distribution.

Wave – Particle Duality

The accelerating electrons explains the wave – particle duality of the electrons and photons, since the elementary charges are distributed on Δx position with Δp impulse and creating a wave packet of the electron. The photon gives the electromagnetic particle of the mediating force of the electrons electromagnetic field with the same distribution of wavelengths.

Atomic model

The constantly accelerating electron in the Hydrogen atom is moving on the equipotential line of the proton and it's kinetic and potential energy will be constant. Its energy will change only when it

is changing its way to another equipotential line with another value of potential energy or getting free with enough kinetic energy. This means that the Rutherford-Bohr atomic model is right and only that changing acceleration of the electric charge causes radiation, not the steady acceleration. The steady acceleration of the charges only creates a centric parabolic steady electric field around the charge, the magnetic field. This gives the magnetic moment of the atoms, summing up the proton and electron magnetic moments caused by their circular motions and spins.

The Relativistic Bridge

Commonly accepted idea that the relativistic effect on the particle physics it is the fermions' spin - another unresolved problem in the classical concepts. If the electric charges can move only with accelerated motions in the self maintaining electromagnetic field, once upon a time they would reach the velocity of the electromagnetic field. The resolution of this problem is the spinning particle, constantly accelerating and not reaching the velocity of light because the acceleration is radial. One origin of the Quantum Physics is the Planck Distribution Law of the electromagnetic oscillators, giving equal intensity for 2 different wavelengths on any temperature. Any of these two wavelengths will give equal intensity diffraction patterns, building different asymmetric constructions, for example proton - electron structures (atoms), molecules, etc. Since the particles are centers of diffraction patterns they also have particle – wave duality as the electromagnetic waves have. [2]

The weak interaction

The weak interaction transforms an electric charge in the diffraction pattern from one side to the other side, causing an electric dipole momentum change, which violates the CP and time reversal symmetry. The Electroweak Interaction shows that the Weak Interaction is basically electromagnetic in nature. The arrow of time shows the entropy grows by changing the temperature dependent diffraction patterns of the electromagnetic oscillators.

Another important issue of the quark model is when one quark changes its flavor such that a linear oscillation transforms into plane oscillation or vice versa, changing the charge value with 1 or -1. This kind of change in the oscillation mode requires not only parity change, but also charge and time changes (CPT symmetry) resulting a right handed anti-neutrino or a left handed neutrino.

The right handed anti-neutrino and the left handed neutrino exist only because changing back the quark flavor could happen only in reverse, because they are different geometrical constructions, the u is 2 dimensional and positively charged and the d is 1 dimensional and negatively charged. It needs also a time reversal, because anti particle (anti neutrino) is involved.

The neutrino is a 1/2spin creator particle to make equal the spins of the weak interaction, for example neutron decay to 2 fermions, every particle is fermions with ½ spin. The weak interaction changes the entropy since more or less particles will give more or less freedom of movement. The entropy change is a result of temperature change and breaks the equality of oscillator diffraction

intensity of the Maxwell–Boltzmann statistics. This way it changes the time coordinate measure and makes possible a different time dilation as of the special relativity.

The limit of the velocity of particles as the speed of light appropriate only for electrical charged particles, since the accelerated charges are self maintaining locally the accelerating electric force. The neutrinos are CP symmetry breaking particles compensated by time in the CPT symmetry, that is the time coordinate not works as in the electromagnetic interactions, consequently the speed of neutrinos is not limited by the speed of light.

The weak interaction T-asymmetry is in conjunction with the T-asymmetry of the second law of thermodynamics, meaning that locally lowering entropy (on extremely high temperature) causes the weak interaction, for example the Hydrogen fusion.

Probably because it is a spin creating movement changing linear oscillation to 2 dimensional oscillation by changing d to u quark and creating anti neutrino going back in time relative to the proton and electron created from the neutron, it seems that the anti neutrino fastest then the velocity of the photons created also in this weak interaction?

A quark flavor changing shows that it is a reflection changes movement and the CP- and T-symmetry breaking!!! This flavor changing oscillation could prove that it could be also on higher level such as atoms, molecules, probably big biological significant molecules and responsible on the aging of the life.

Important to mention that the weak interaction is always contains particles and antiparticles, where the neutrinos (antineutrinos) present the opposite side. It means by Feynman's interpretation that these particles present the backward time and probably because this they seem to move faster than the speed of light in the reference frame of the other side.

Finally since the weak interaction is an electric dipole change with $\frac{1}{2}$ spin creating; it is limited by the velocity of the electromagnetic wave, so the neutrino's velocity cannot exceed the velocity of light.

The General Weak Interaction

The Weak Interactions T-asymmetry is in conjunction with the T-asymmetry of the Second Law of Thermodynamics, meaning that locally lowering entropy (on extremely high temperature) causes for example the Hydrogen fusion. The arrow of time by the Second Law of Thermodynamics shows the increasing entropy and decreasing information by the Weak Interaction, changing the temperature dependent diffraction patterns. A good example of this is the neutron decay, creating more particles with less known information about them.

The neutrino oscillation of the Weak Interaction shows that it is a general electric dipole change and it is possible to any other temperature dependent entropy and information changing diffraction pattern of atoms, molecules and even complicated biological living structures. We can generalize the weak interaction on all of the decaying matter constructions, even on the biological too. This gives the limited lifetime for the biological constructions also by the arrow of

time. There should be a new research space of the Quantum Information Science the 'general neutrino oscillation' for the greater than subatomic matter structures as an electric dipole change.

There is also connection between statistical physics and evolutionary biology, since the arrow of time is working in the biological evolution also.

The Fluctuation Theorem says that there is a probability that entropy will flow in a direction opposite to that dictated by the Second Law of Thermodynamics. In this case the Information is growing that is the matter formulas are emerging from the chaos. So the Weak Interaction has two directions, samples for one direction is the Neutron decay, and Hydrogen fusion is the opposite direction.

Fermions and Bosons

The fermions are the diffraction patterns of the bosons such a way that they are both sides of the same thing.

Van Der Waals force

Named after the Dutch scientist Johannes Diderik van der Waals – who first proposed it in 1873 to explain the behaviour of gases – it is a very weak force that only becomes relevant when atoms and molecules are very close together. Fluctuations in the electronic cloud of an atom mean that it will have an instantaneous dipole moment. This can induce a dipole moment in a nearby atom, the result being an attractive dipole–dipole interaction.

Electromagnetic inertia and mass

Electromagnetic Induction

Since the magnetic induction creates a negative electric field as a result of the changing acceleration, it works as an electromagnetic inertia, causing an electromagnetic mass. [1]

Relativistic change of mass

The increasing mass of the electric charges the result of the increasing inductive electric force acting against the accelerating force. The decreasing mass of the decreasing acceleration is the result of the inductive electric force acting against the decreasing force. This is the relativistic mass change explanation, especially importantly explaining the mass reduction in case of velocity decrease.

The frequency dependence of mass

Since $E = h\nu$ and $E = mc^2$, $m = h\nu/c^2$ that is the m depends only on the ν frequency. It means that the mass of the proton and electron are electromagnetic and the result of the electromagnetic induction, caused by the changing acceleration of the spinning and moving charge! It could be that the m_0 inertial mass is the result of the spin, since this is the only accelerating motion of the electric charge. Since the accelerating motion has different frequency for the electron in the atom

and the proton, their masses are different, also as the wavelengths on both sides of the diffraction pattern, giving equal intensity of radiation.

Electron – Proton mass rate

The Planck distribution law explains the different frequencies of the proton and electron, giving equal intensity to different lambda wavelengths! Also since the particles are diffraction patterns they have some closeness to each other – can be seen as a gravitational force. [2]

There is an asymmetry between the mass of the electric charges, for example proton and electron, can be understood by the asymmetrical Planck Distribution Law. This temperature dependent energy distribution is asymmetric around the maximum intensity, where the annihilation of matter and antimatter is a high probability event. The asymmetric sides are creating different frequencies of electromagnetic radiations being in the same intensity level and compensating each other. One of these compensating ratios is the electron – proton mass ratio. The lower energy side has no compensating intensity level, it is the dark energy and the corresponding matter is the dark matter.

Gravity from the point of view of quantum physics

The Gravitational force

The gravitational attractive force is basically a magnetic force.

The same electric charges can attract one another by the magnetic force if they are moving parallel in the same direction. Since the electrically neutral matter is composed of negative and positive charges they need 2 photons to mediate this attractive force, one per charges. The Big Bang caused parallel moving of the matter gives this magnetic force, experienced as gravitational force.

Since graviton is a tensor field, it has spin = 2, could be 2 photons with spin = 1 together.

You can think about photons as virtual electron – positron pairs, obtaining the necessary virtual mass for gravity.

The mass as seen before a result of the diffraction, for example the proton – electron mass ratio $M_p = 1840 M_e$. In order to move one of these diffraction maximum (electron or proton) we need to intervene into the diffraction pattern with a force appropriate to the intensity of this diffraction maximum, means its intensity or mass.

The Big Bang caused acceleration created radial currents of the matter, and since the matter is composed of negative and positive charges, these currents are creating magnetic field and attracting forces between the parallel moving electric currents. This is the gravitational force experienced by the matter, and also the mass is result of the electromagnetic forces between the charged particles. The positive and negative charged currents attracts each other or by the magnetic forces or by the much stronger electrostatic forces!?

The gravitational force attracting the matter, causing concentration of the matter in a small space and leaving much space with low matter concentration: dark matter and energy.

There is an asymmetry between the mass of the electric charges, for example proton and electron, can be understood by the asymmetrical Planck Distribution Law. This temperature dependent energy

distribution is asymmetric around the maximum intensity, where the annihilation of matter and antimatter is a high probability event. The asymmetric sides are creating different frequencies of electromagnetic radiations being in the same intensity level and compensating each other. One of these compensating ratios is the electron – proton mass ratio. The lower energy side has no compensating intensity level, it is the dark energy and the corresponding matter is the dark matter.

The Higgs boson

By March 2013, the particle had been proven to behave, interact and decay in many of the expected ways predicted by the Standard Model, and was also tentatively confirmed to have + parity and zero spin, two fundamental criteria of a Higgs boson, making it also the first known scalar particle to be discovered in nature, although a number of other properties were not fully proven and some partial results do not yet precisely match those expected; in some cases data is also still awaited or being analyzed.

Since the Higgs boson is necessary to the W and Z bosons, the dipole change of the Weak interaction and the change in the magnetic effect caused gravitation must be conducted. The Wien law is also important to explain the Weak interaction, since it describes the T_{\max} change and the diffraction patterns change. [2]

Higgs mechanism and Quantum Gravity

The magnetic induction creates a negative electric field, causing an electromagnetic inertia. Probably it is the mysterious Higgs field giving mass to the charged particles? We can think about the photon as an electron-positron pair, they have mass. The neutral particles are built from negative and positive charges, for example the neutron, decaying to proton and electron. The wave – particle duality makes sure that the particles are oscillating and creating magnetic induction as an inertial mass, explaining also the relativistic mass change. Higher frequency creates stronger magnetic induction, smaller frequency results lesser magnetic induction. It seems to me that the magnetic induction is the secret of the Higgs field.

In particle physics, the Higgs mechanism is a kind of mass generation mechanism, a process that gives mass to elementary particles. According to this theory, particles gain mass by interacting with the Higgs field that permeates all space. More precisely, the Higgs mechanism endows gauge bosons in a gauge theory with mass through absorption of Nambu–Goldstone bosons arising in spontaneous symmetry breaking.

The simplest implementation of the mechanism adds an extra Higgs field to the gauge theory. The spontaneous symmetry breaking of the underlying local symmetry triggers conversion of components of this Higgs field to Goldstone bosons which interact with (at least some of) the other fields in the theory, so as to produce mass terms for (at least some of) the gauge bosons. This mechanism may also leave behind elementary scalar (spin-0) particles, known as Higgs bosons.

In the Standard Model, the phrase "Higgs mechanism" refers specifically to the generation of masses for the W^\pm , and Z weak gauge bosons through electroweak symmetry breaking. The Large Hadron Collider at CERN announced results consistent with the Higgs particle on July 4, 2012 but stressed that further testing is needed to confirm the Standard Model.

What is the Spin?

So we know already that the new particle has spin zero or spin two and we could tell which one if we could detect the polarizations of the photons produced. Unfortunately this is difficult and neither ATLAS nor CMS are able to measure polarizations. The only direct and sure way to confirm that the particle is indeed a scalar is to plot the angular distribution of the photons in the rest frame of the centre of mass. A spin zero particles like the Higgs carries no directional information away from the original collision so the distribution will be even in all directions. This test will be possible when a much larger number of events have been observed. In the mean time we can settle for less certain indirect indicators.

The Graviton

In physics, the graviton is a hypothetical elementary particle that mediates the force of gravitation in the framework of quantum field theory. If it exists, the graviton is expected to be massless (because the gravitational force appears to have unlimited range) and must be a spin-2 boson. The spin follows from the fact that the source of gravitation is the stress-energy tensor, a second-rank tensor (compared to electromagnetism's spin-1 photon, the source of which is the four-current, a first-rank tensor). Additionally, it can be shown that any massless spin-2 field would give rise to a force indistinguishable from gravitation, because a massless spin-2 field must couple to (interact with) the stress-energy tensor in the same way that the gravitational field does. This result suggests that, if a massless spin-2 particle is discovered, it must be the graviton, so that the only experimental verification needed for the graviton may simply be the discovery of a massless spin-2 particle. [3]

Conclusions

Exists experimental evidence for quantum-coherent is used for more efficient light-harvesting in plant photosynthesis. Quantum entanglement exists in supramolecules determining the sense of smell and in the brain neurons microtubules due to quantum vibrations.

In the work presented here, we started to design and quantum mechanical investigations of the molecular logical devices which are useful for construction of nano medicine biorobots against the molecular diseases such a cancer tumors, and against the new kinds of synthesized microorganisms and nano guns. [7]

One of the most important conclusions is that the electric charges are moving in an accelerated way and even if their velocity is constant, they have an intrinsic acceleration anyway, the so called spin, since they need at least an intrinsic acceleration to make possible they movement . The accelerated charges self-maintaining potential shows the locality of the relativity, working on the quantum level also. [1]

The bridge between the classical and quantum theory is based on this intrinsic acceleration of the spin, explaining also the Heisenberg Uncertainty Principle. The particle – wave duality of the electric charges and the photon makes certain that they are both sides of the same thing. The

Secret of Quantum Entanglement that the particles are diffraction patterns of the electromagnetic waves and this way their quantum states every time is the result of the quantum state of the intermediate electromagnetic waves. [2]

These relatively new developments in biophysics have discovered that all biological organisms are constituted of a liquid crystalline medium. Further, DNA is a liquid-crystal, lattice-type structure (which some refer to as a liquid crystal gel), whereby body cells are involved in a holographic instantaneous communication via the emitting of biophotons (a source based on light). This implies that all living biological organisms continuously emit radiations of light that form a field of coherence and communication. Moreover, biophysics has discovered that living organisms are permeated by quantum wave forms. [5]

Basing the gravitational force on the accelerating Universe caused magnetic force and the Planck Distribution Law of the electromagnetic waves caused diffraction gives us the basis to build a Unified Theory of the physical interactions also.

References

[1] The Magnetic field of the Electric current and the Magnetic induction

http://academia.edu/3833335/The_Magnetic_field_of_the_Electric_current

[2] 3 Dimensional String Theory http://academia.edu/3834454/3_Dimensional_String_Theory

[3] Graviton Production By Two Photon and Electron-Photon Processes In Kaluza-Klein Theories With

Large Extra Dimensions <http://arxiv.org/abs/hep-ph/9909392>

[4] Quantum Entanglement

http://en.wikipedia.org/wiki/Quantum_entanglemen

t

[5] Quantum Consciousness

https://realitysandwich.com/155783/quantum_consciousness_0/

[6] Quantum Biology <http://www.nature.com/news/2011/110615/pdf/474272a.pdf> [7]

Quantum entanglement in photoactive prebiotic systems

<https://globalmedicaldiscovery.com/key-drug-discovery-articles/quantum-entanglementphotoactive-prebiotic-systems/>

[8] Quantum biology: Algae evolved to switch quantum coherence on and off

<http://phys.org/news/2014-06-quantum-biology-algae-evolved-coherence.html>

- [9] Experiment demonstrates quantum mechanical effects from biological systems
<https://phys.org/news/2017-12-quantum-mechanical-effects-biological.html>
- [10] Particles in charged solution form clusters that reproduce
<https://phys.org/news/2017-12-particles-solution-clusters.html>
- [11] New interaction mechanism of proteins discovered
<https://phys.org/news/2018-02-interaction-mechanism-proteins.html>
- [12] Artificial and biological cells work together as mini chemical factories
<https://phys.org/news/2018-03-artificial-biological-cells-mini-chemical.html>
- [13] Custom sequences for polymers using visible light
<https://phys.org/news/2018-03-custom-sequences-polymers-visible.html>
- [14] Scientists explore the structure of a key region of longevity protein telomerase
<https://phys.org/news/2018-03-scientists-explore-key-region-longevity.html>
- [15] Simulations document self-assembly of proteins and DNA
<https://phys.org/news/2018-03-simulations-document-self-assembly-proteins-dna.html>
- [16] Biomimetic chemistry—DNA mimic outwits viral enzyme
<https://phys.org/news/2018-04-biomimetic-chemistrydna-mimic-outwits-viral.html>
- [17] Study reveals the inner workings of a molecular motor that packs and unpacks DNA
<https://phys.org/news/2018-04-reveals-molecular-motor-dna.html>
- [18] Breakthrough brings gene-editing medicine one step closer to patient applications
<https://phys.org/news/2018-04-breakthrough-gene-editing-medicine-closer-patient.html>
- [19] Remote-control shoots laser at nano-gold to turn on cancer-killing immune cells
<https://phys.org/news/2018-04-remote-control-laser-nano-gold-cancer-killing-immune.html>
- [20] Laser technology helps researchers scrutinize cancer cells
<https://techxplore.com/news/2019-04-laser-technology-scrutinize-cancer-cells.html>
- [21] Black nanoparticles slow the growth of tumors
<https://phys.org/news/2019-04-black-nanoparticles-growth-tumors.html>
- [22] Researchers detect minute levels of disease with a nanotechnology-enhanced biochip

<https://phys.org/news/2019-04-minute-disease-nanotechnology-enhanced-biochip.html>

[23] Laser focus sheds light on two sources of nanoparticle formation

<https://phys.org/news/2019-04-laser-focus-sources-nanoparticle-formation.html>

[24] Optical tweezer helps make phonon laser

<https://physicsworld.com/a/optical-tweezer-help-makes-phonon-laser/>

[25] A new force for optical tweezers

<https://phys.org/news/2019-06-optical-tweezers.html>

[26] New property of light discovered

<https://phys.org/news/2019-06-property.html>

[27] Engineers report a new low-power lighting technology

<https://phys.org/news/2019-06-low-power-technology.html>