

Solving the $n_1 \times n_2 \times n_3$ Points Problem for $n_3 < 6$

Marco Ripà

sPIqr Society, World Intelligence Network

Rome, Italy

e-mail: marcokrt1984@yahoo.it

Abstract: In this paper, we show enhanced upper bounds of the nontrivial $n_1 \times n_2 \times n_3$ points problem for every $n_1 \leq n_2 \leq n_3 < 6$. We present new patterns that drastically improve the previously known algorithms for finding minimum-link covering paths, solving completely a few cases (e.g., $n_1 = n_2 = 3$ and $n_3 = 4$).

Keywords: Graph theory, Topology, Three-dimensional, Creative thinking, Link, Connectivity, Outside the box, Upper bound, Point, Game.

2010 Mathematics Subject Classification: 91A43, 05C57.

1 Introduction

The $n_1 \times n_2 \times n_3$ points problem [12] is a three-dimensional extension of the classic *nine dots problem* appeared in Samuel Loyd's *Cyclopedia of Puzzles* [1-9], and it is related to the well known NP-hard traveling salesman problem, minimizing the number of turns in the tour instead of the total distance traveled [1-15].

Given $n_1 \cdot n_2 \cdot n_3$ points in \mathbb{R}^3 , our goal is to visit all of them (at least once) with a polygonal path that has the minimum number of line segments connected at their end-points (links or generically *lines*), the so called Minimum-link Covering Path [3-4-5-8]. In particular, we are interested in the best solutions for the nontrivial $n_1 \times n_2 \times n_3$ dots problem, where (by definition) $1 \leq n_1 \leq n_2 \leq n_3$ and $n_3 < 6$.

Let $h_l(n_1, n_2, n_3) \leq h(n_1, n_2, n_3) \leq h_u(n_1, n_2, n_3)$ be the length of the covering path with the minimum number of links for the $n_1 \times n_2 \times n_3$ points problem, we define the best known upper bound as $h_u(n_1, n_2, n_3) \geq h(n_1, n_2, n_3)$ and we denote as $h_l(n_1, n_2, n_3) \leq h(n_1, n_2, n_3)$ the current proved lower bound [12].

For the simplest cases, the same problem has already been solved [3-12]. Let $n_1 = 1$ and $n_2 < n_3$, we have that $h(n_1, n_2, n_3) = h(n_2) = 2 \cdot n_2 - 1$, while $h(n_1 = 1, n_2 = n_3 \geq 3) = 2 \cdot n_2 - 2$ [6]. Hence, for $n_1 = 2$, it can be easily proved that

$$h(2, n_2, n_3) = 2 \cdot h(1, n_2, n_3) + 1 = \begin{cases} 4 \cdot n_2 - 1 & \text{iff } n_2 < n_3 \\ 4 \cdot n_2 - 3 & \text{iff } n_2 = n_3 \end{cases} \quad (1)$$

2X3X5 SOLUTION (trivial):
11 lines

NO INTERSECTION

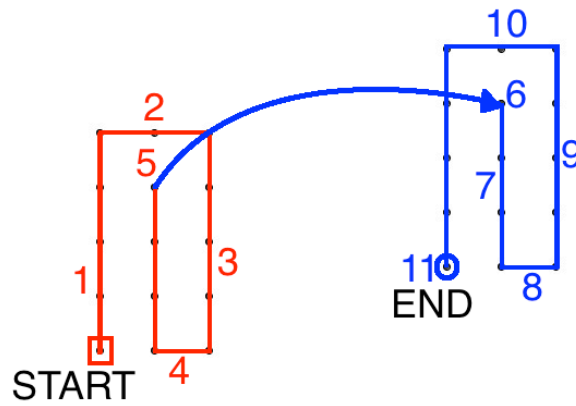

Figure 1. A trivial pattern that completely solves the $2 \times 3 \times 5$ points puzzle.

2X5X5 SOLUTION (trivial):
17 lines

NO INTERSECTION

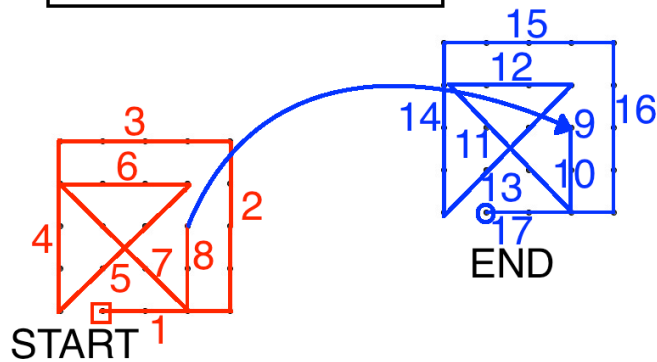

Figure 2. Another example of a trivial case: the $2 \times 5 \times 5$ points puzzle.

Therefore, the aim of the present paper is to solve the ten aforementioned nontrivial cases where the current upper bound does not match the proved lower bound.

2 Improving the solution of the $n_1 \times n_2 \times n_3$ points problem for $n_3 < 6$

In this complex brain challenge we need to stretch our pattern recognition [7-10] in order to find a plastic strategy that improves the known upper bounds [3-13] for the most interesting cases (such as the nontrivial $n_1 \times n_2 \times n_2$ points problem and the $n_1 \times n_1 \times (n_1 + 1)$ set of puzzles), avoiding those standardized methods which are based on fixed patterns that lead to suboptimal covering paths, as the approaches presented in [2-8-11].

Let $3 \leq n_1 \leq n_2 \leq n_3 \leq 5$, a lower bound of the $n_1 \times n_2 \times n_3$ problem is given by [12]

$$h_l(n_1, n_2, n_3) = \left\lceil \frac{n_1 \cdot (2 \cdot n_2 \cdot (n_3 + 1) - n_1 - 1) - 2}{n_3 + n_2 - 2} \right\rceil - 1 \quad (2)$$

The current best results are listed in Table 1, and a direct proof follows for each nontrivial upper bound shown below.

n_1	n_2	n_3	Best Lower Bound (h_l)	Best Upper Bound (h_u)	Discovered by	Gap ($h_u - h_l$)
2	2	3	7	<u>7</u>	trivial	0
2	3	3	9	<u>9</u>	trivial	0
3	3	3	14	<u>14</u>	Marco Ripà (proved in 2013 [14])	0
2	2	4	7	<u>7</u>	trivial	0
2	3	4	11	<u>11</u>	trivial	0
2	4	4	13	<u>13</u>	trivial	0
3	3	4	15	<u>15</u>	Marco Ripà (proved on Jun. 27, 2019 [v1])	0

3	4	4	17	19	Marco Ripà (ibid.)	2
4	4	4	22	23	Marco Ripà (NNTDM [13])	1
2	2	5	7	<u>7</u>	trivial	0
2	3	5	11	<u>11</u>	trivial	0
2	4	5	15	<u>15</u>	trivial	0
2	5	5	17	<u>17</u>	trivial	0
3	3	5	15	16	Marco Ripà (proved on Jun. 27, 2019 [v1])	1
3	4	5	18	20	Marco Ripà (ibid.)	2
3	5	5	20	24	Marco Ripà (ibid.)	4
4	4	5	24	26	Marco Ripà (ibid.)	2
4	5	5	27	31	Marco Ripà (ibid.)	4
5	5	5	33	36	Marco Ripà (proved on Jul. 8, 2019 [v3])	3

Table 1: Current solutions for the $n_1 \times n_2 \times n_3$ points problem, where $n_1 \leq n_2 \leq n_3 \leq 5$.

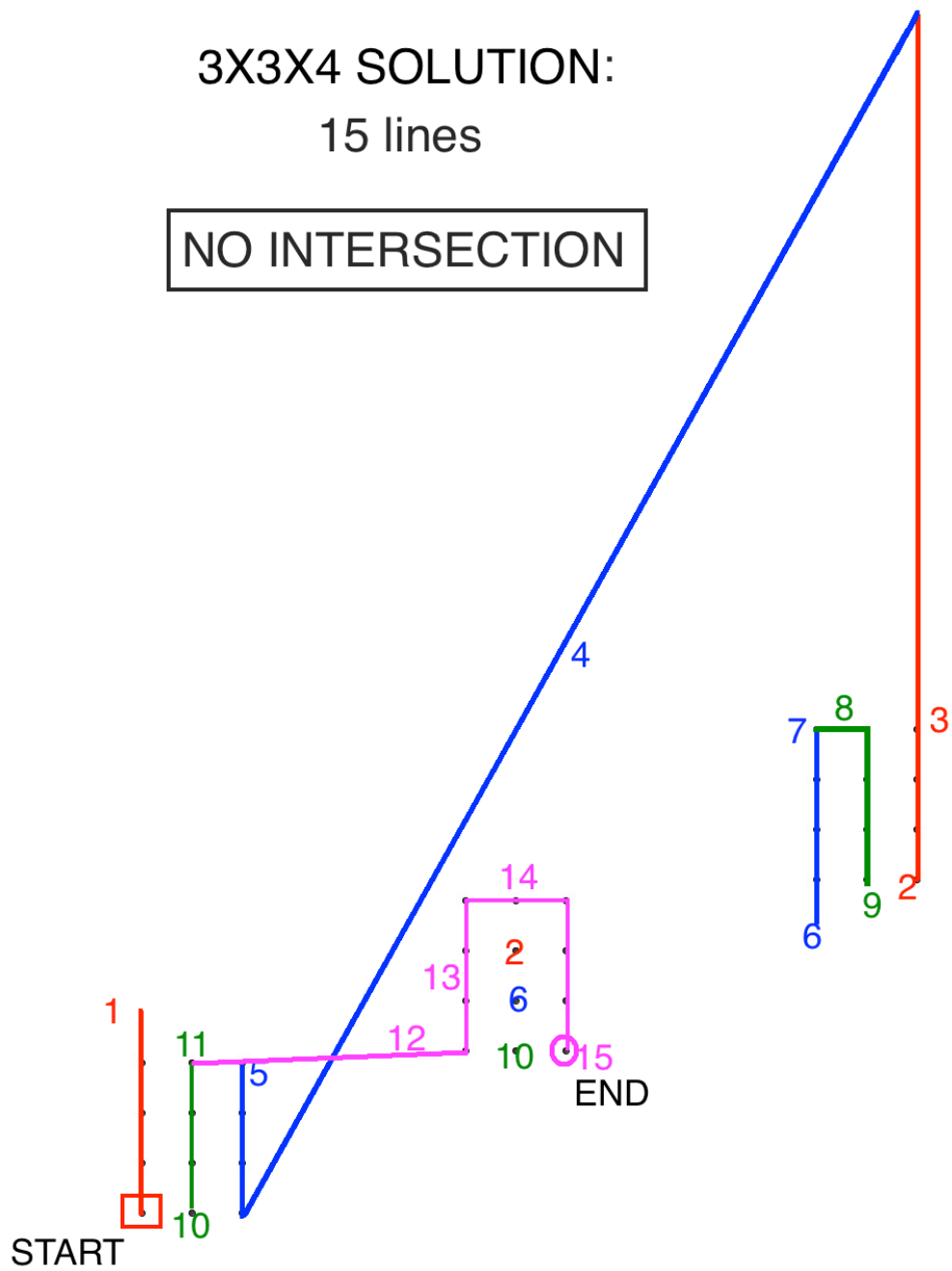

Figure 4. The $3 \times 3 \times 4$ puzzle has finally been solved. $h_u = h_l = 15$ and no crossing lines.

3X3X5 best upper bound:

16 lines

NO INTERSECTION

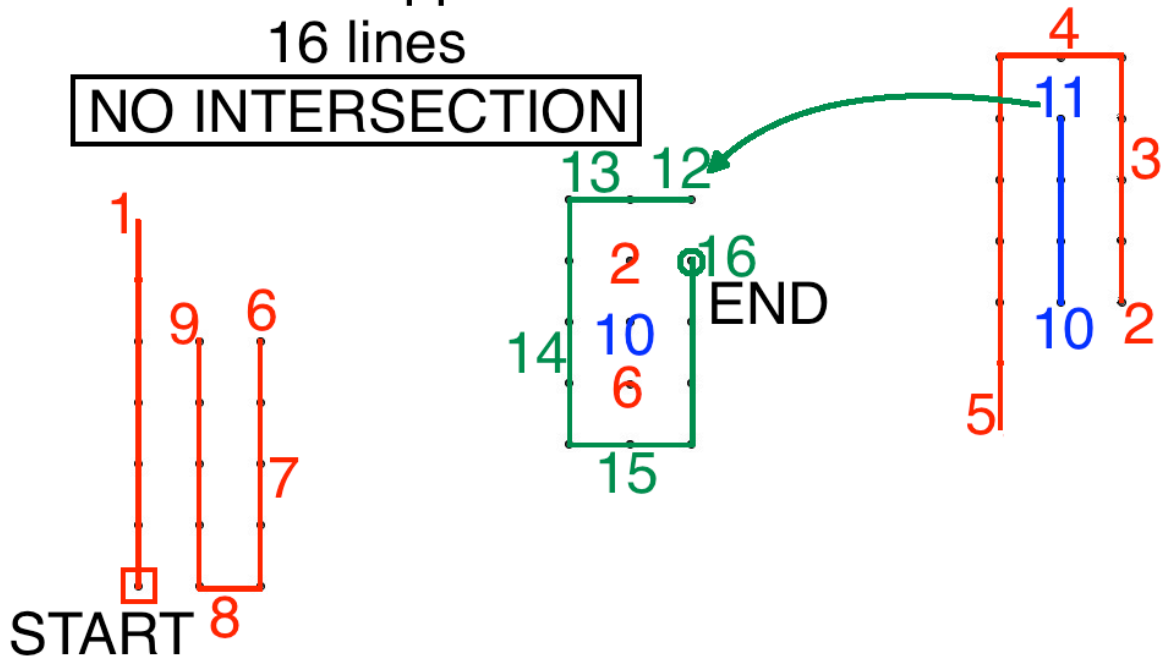

Figure 7. Best known upper bound of the 3x3x5 puzzle. $16 = h_u = h_l + 1$.

3x4x5 best upper bound:

20 lines

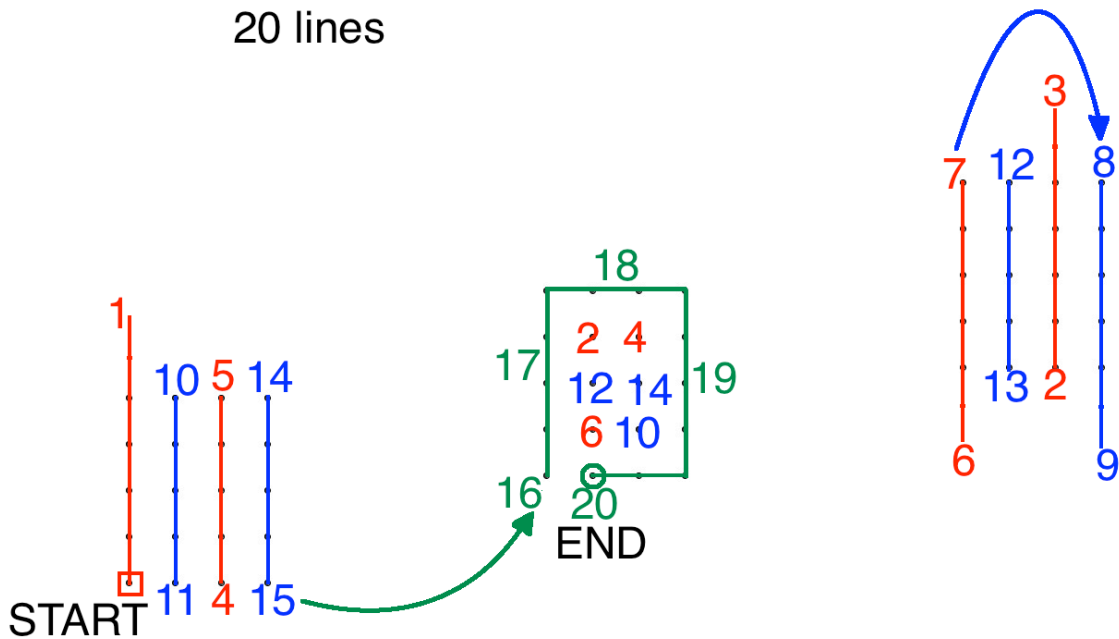

Figure 8. Best known upper bound of the 3x4x5 puzzle. $20 = h_u = h_l + 2$.

3x5x5 best upper bound:
24 lines

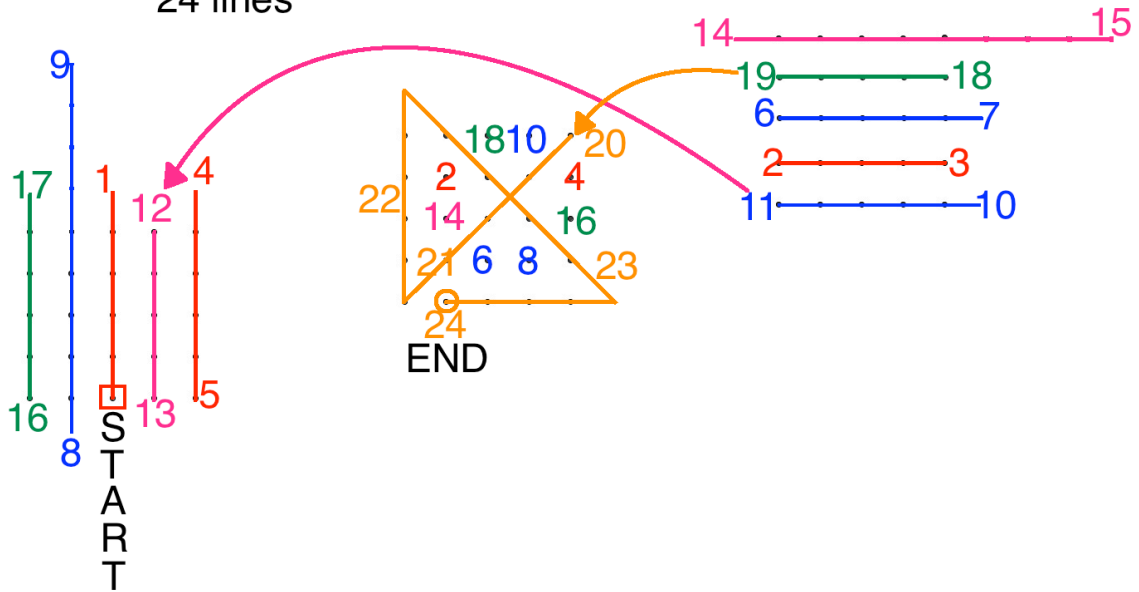

Figure 9. Best known upper bound of the 3x5x5 puzzle. $24 = h_u = h_l + 4$.

4x4x5 best upper bound:
26 lines

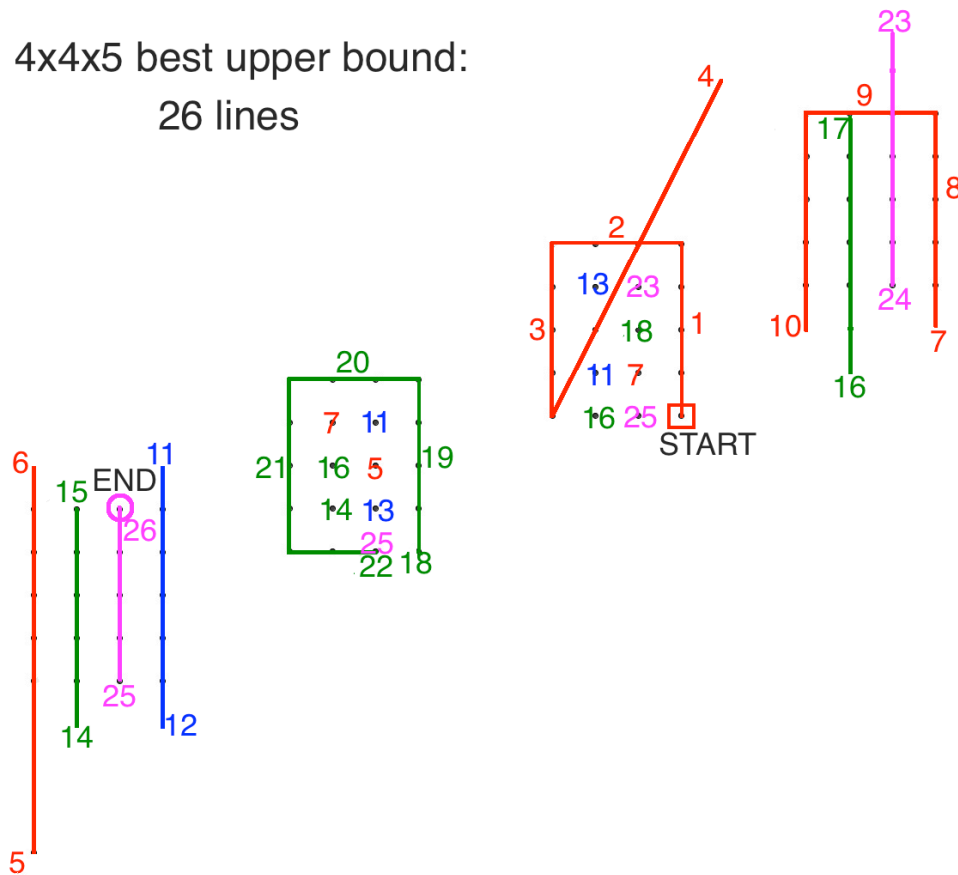

Figure 10. Best known upper bound of the 4x4x5 puzzle. $26 = h_u = h_l + 2$.

4x5x5 best upper bound:
31 lines

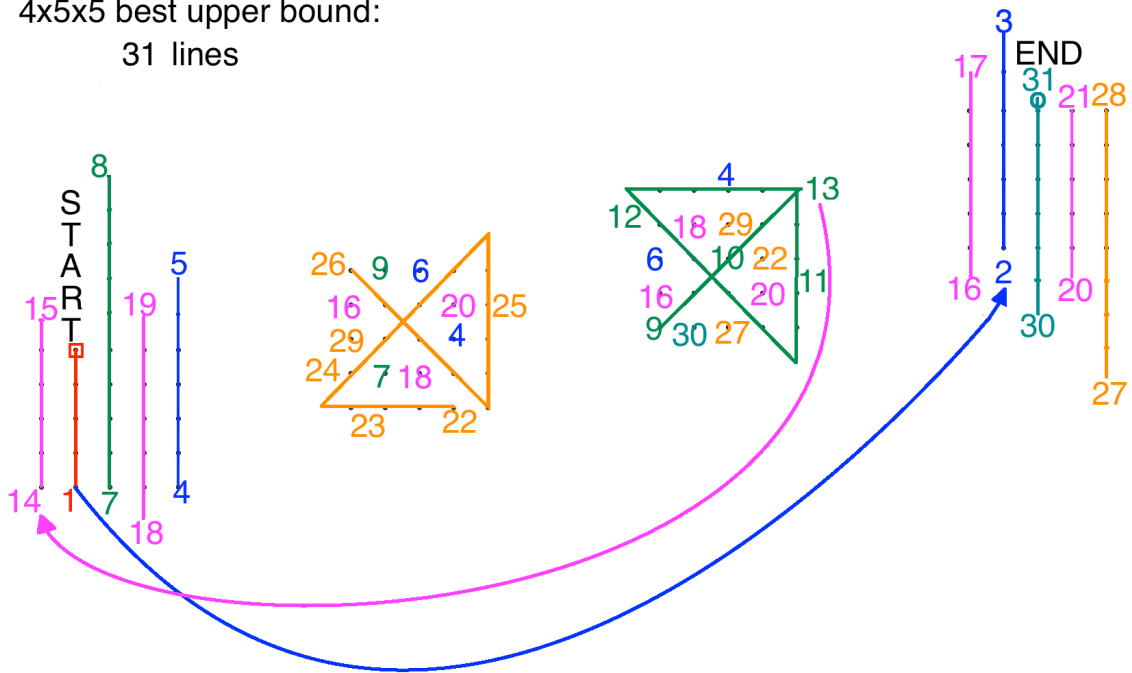

Figure 11. Best known upper bound of the 4x5x5 puzzle. $31 = h_u = h_l + 4$.

5x5x5 best upper bound:
36 lines

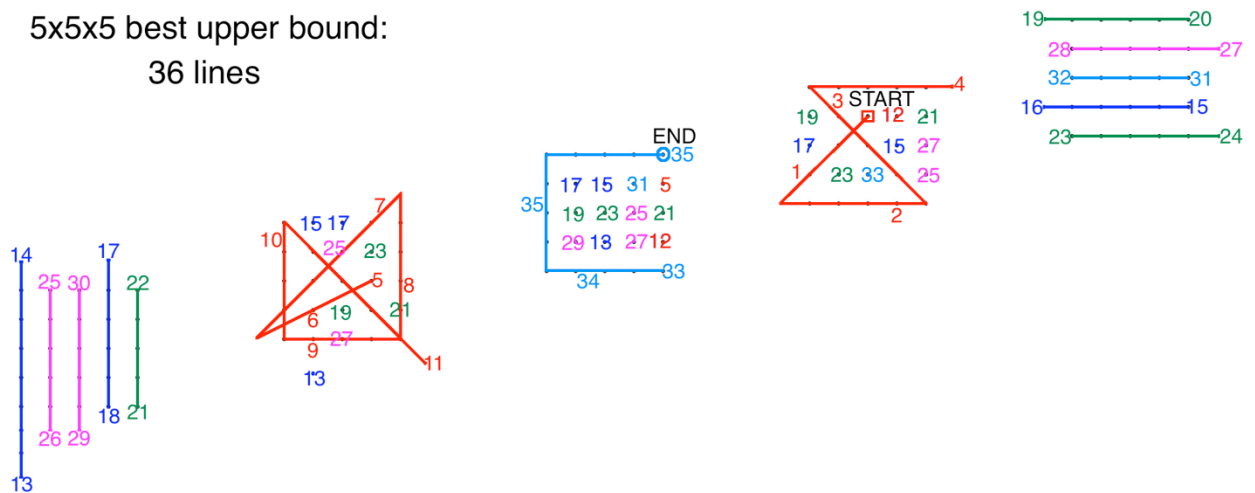

Figure 12. Best known upper bound of the 5x5x5 puzzle. $37 = h_u = h_l + 4$ [13].

Finally, it is interesting to note that the improved $h_u(n_1, n_2, n_3)$ can lower down the upper bound of the generalized k -dimensional puzzle too. As an example, we can apply the aforementioned 3D patterns to the generalized $n_1 \times n_2 \times \dots \times n_k$ points problem using the simple method described in [12].

Let $k \geq 4$, given $n_k \leq n_{k-1} \leq \dots \leq n_4 \leq n_1 \leq n_2 \leq n_3$, we can conclude that

$$h_u(n_1, n_2, n_3, \dots, n_k) = (h_u(n_1, n_2, n_3) + 1) \cdot \prod_{j=4}^k n_j - 1 \quad (3)$$

3 Conclusion

In the present paper we have drastically reduced the gap $h_u(n_1, n_2, n_3) - h_l(n_1, n_2, n_3)$ for every previously unsolved puzzle such that $n_3 < 6$. Moreover, we can easily disprove Bencini's claim that $h_u(3,3,4) = 17 = h_l(3,3,4)$ (see [2], page 7, lines 2-3), since $h_u(3,3,4) = 15 = h_l(3,3,4)$, as shown by combining (2) with the upper bound from figure 4. We do not know if any of the patterns shown in figures 5 to 12 represent optimal solutions, since (by definition) $h_l(n_1, n_2, n_3) \leq h(n_1, n_2, n_3)$. Therefore, some open questions about the $n_1 \times n_2 \times n_3$ points problem remain to be answered, and the research in order to cancel the gap $h_u(n_1, n_2, n_3) - h_l(n_1, n_2, n_3)$, at least for every $n_3 \leq 5$, is not over yet.

References

- [1] Aggarwal, A., Coppersmith, D., Khanna, S., Motwani, R., Schieber, B. (1999). The angular-metric traveling salesman problem. *SIAM Journal on Computing* **29**, 697–711.
- [2] Bencini, V. (2019). $n_1 \times n_2 \times n_3$ Dots Puzzle: A Method to Improve the Current Upper Bound. *viXra*, 6 Jun. 2019, <http://vixra.org/pdf/1906.0110v1.pdf>
- [3] Bereg, S., Bose, P., Dumitrescu, A., Hurtado, F., Valtr, P. (2009). Traversing a set of points with a minimum number of turns. *Discrete & Computational Geometry* **41(4)**, 513–532.
- [4] Collins, M. J. (2004). Covering a set of points with a minimum number of turns. *International Journal of Computational Geometry & Applications* **14(1-2)**, 105–114.
- [5] Collins, M.J., Moret, M.E. (1998). Improved lower bounds for the link length of rectilinear spanning paths in grids. *Information Processing Letters* **68(6)**, 317–319.
- [6] Keszegh, B. (2013). Covering Paths and Trees for Planar Grids. *arXiv*, 3 Nov. 2013, <https://arxiv.org/abs/1311.0452>
- [7] Kihn, M. (1995). Outside the Box: The Inside Story. *FastCompany*.
- [8] Kranakis, E., Krizanc, D., Meertens, L. (1994). Link length of rectilinear Hamiltonian tours in grids. *Ars Combinatoria* **38**, 177–192.
- [9] Loyd, S. (1914). Cyclopedia of Puzzles. *The Lamb Publishing Company*, p. 301.
- [10] Lung, C. T., Dominowski, R. L. (1985). Effects of strategy instructions and practice on nine-dot problem solving. *Journal of Experimental Psychology: Learning, Memory, and Cognition* **11(4)**, 804–811.

- [11] Ripà, M., Bencini, V. (2018). $n \times n \times n$ Dots Puzzle: An Improved “Outside The Box” Upper Bound. *viXra*, 25 Jul. 2018, <http://vixra.org/pdf/1807.0384v2.pdf>
- [12] Ripà, M. (2014). The Rectangular Spiral or the $n_1 \times n_2 \times \dots \times n_k$ Points Problem. *Notes on Number Theory and Discrete Mathematics* **20(1)**, 59-71.
- [13] Ripà, M. (2019). The $3 \times 3 \times \dots \times 3$ Points Problem solution. *Notes on Number Theory and Discrete Mathematics* **25(2)**, 68-75.
- [14] Sloane, N. J. A. (2013). *The Online Encyclopedia of Integer Sequences*. Inc. 2 May. 2013. Web. 25 Jun. 2015, <http://oeis.org/A225227>
- [15] Stein, C., Wagner, D.P. (2001). Approximation algorithms for the minimum bends traveling salesman problem. In: Aardal K., Gerards B. (eds) *Integer Programming and Combinatorial Optimization*. IPCO 2001. LNCS, vol 2081, 406–421. Springer, Berlin, Heidelberg.