

# A New Theoretical Framework of Absolute and Relative Motion, the Speed of Light, Electromagnetism and Gravity

HenokTadesse, Electrical Engineer, BSc

Ethiopia, Debrezeit, POBox 412, Mobile: +251 910751339/+251 912228639 email: entkidmt@yahoo.com or wchmar@gmail.com

03 June 2019

## Abstract

In this paper, a new theoretical framework for absolute motion and the speed of light is presented. The new theoretical framework consists of two parts: 1. Constancy of phase velocity of light 2. Apparent Source Theory. The theory of constancy of phase velocity of light is a consequence of non-existence of the ether. Thus the phase velocity of light in vacuum is always constant  $c$ , irrespective of absolute or relative motion of the light source, the observer and the mirror, for uniform or accelerated motions. The constancy of phase velocity of light leads to a new Exponential Doppler Effect of light:  $f' = f e^{v/c}$  and  $\lambda' = \lambda e^{-v/c}$ , which fulfills the constant phase velocity condition:  $f' \lambda' = f e^{v/c} \lambda e^{-v/c} = f \lambda = c$ . The Exponential Doppler Effect theory can also explain the Ives-Stilwell experiment. The Michelson-Morley disproved the ether hypothesis but failed to detect absolute motion, which was decisively detected by the Silvertooth experiment, in combination with the NASA CMBR anisotropy experiment. Absolute motion is not motion relative to the ether. According to Apparent Source Theory, the effect of absolute motion is to create an *apparent change in the point of light emission* relative to an inertial observer, in the reference frame of an absolutely moving inertial observer. In the case of the Michelson-Morley experiment, an apparent change in point of light emission relative to the observer/detector will create only a small fringe shift for the same reason that an actual/physical change in the source position ( actual change in point of light emission ) will result only in a small fringe shift. This is the small fringe shift observed in the original Michelson-Morley experiment and in the Miller experiments. A profound prediction of Apparent Source Theory regarding the phenomenon of stellar aberration is that the apparent change in star position is not in the same direction as the observer's velocity, but in the opposite direction! Thus, an observer in absolute motion needs to tilt his telescope *backwards*, not forward, to see star light. A formulation of Apparent Source Theory for a non-inertial observer is also presented. For a non-inertial observer/detector, the light speed experiment is analyzed based on the following principle. An imaginary inertial observer is assumed who will be at the same point and moving with the same velocity as the instantaneous velocity of the real accelerating observer at the instant of light detection. In other words, the real accelerating observer and the imaginary inertial observer will detect the light at the same point in space, simultaneously, while moving with the same instantaneous velocity. This general formulation of Apparent Source Theory is applied to analyze the Sagnac effect. The Sagnac effect is shown to be an acceleration effect, not an absolute motion effect. Apparent Source Theory is also applied to static electric, magnetic and gravitational sources. A qualitative analysis of Mercury perihelion advance is presented. It is proposed that magnetic field is a form of electric field as described by Weber's formula for electrostatic force between two charges. Weber's formula, which is a modification of Coulomb's formula, is adopted and combined with Apparent Source Theory, which may explain all electromagnetic phenomenon. Analogous Weber's formula for gravitation, which is a modification of Newton's law of gravitation, might solve some of the outstanding problems in physics, such as dark matter, dark energy and Pioneer anomaly.

## 1. Introduction

Scientists had been in the dark regarding the nature of light and motion for centuries until the 18th century. Beginning from this time, however, through the different experiments and observations, the nature of light began to be revealed. The Ole Roemer experiment revealed for the first time the order of magnitude of the speed of light. Bradley's stellar aberration experiment confirmed the Roemer result of the speed of light. The Thomas Young double slit experiment revealed for the first time the wave nature of light. Finally Maxwell's discovery that light is an electromagnetic phenomenon was the culmination of efforts of several scientists before him, such as Coulomb, Ørsted, Ampere, Henry and Michael Faraday.

The question of whether absolute motion exists was another related fundamental problem in physics. In his principle of relativity, Galileo asserted that it is fundamentally impossible to detect absolute motion by using mechanical experiments. The principle of relativity is implicit in Newton's laws of motion and gravitation, which proved to be successful, such as in the explanation of planetary orbits. However, Galileo's principle of relativity, which apparently held for Newtonian mechanics, appeared to be in conflict with Maxwell's electrodynamics which predicted a constant speed of light.

Although the nature of light was somewhat gradually being revealed, light has defied all efforts to create a consistent *model* to explain its behavior in the different apparently contradictory experiments and observations made over centuries.

The two *competing* classical theories of light were ether theory and emission theory. According to ether theory, there is a medium called ether for the transmission of light. Thus light would be nothing but a wave travelling with a definite speed on the ether. Scientists naturally assumed the ether in analogy with material waves, such as sound waves. However, the ether was a highly hypothetical substance whose exact nature could not be conceived. Emission theory, on the other hand, assumed that light is a stream of particles whose velocity depends on the source velocity, in the same way the velocity of a bullet depends on the muzzle velocity. However, the exact nature of these hypothetical particles was also unknown. Emission theory and ether theory were considered to be *rivals*. In retrospect, this turns out to be a wrong view as we shall see in this paper.

In 1810 Arago carried out an experiment on the effect on star light aberration and refraction of moving transparent media, in order to decide between emission theory and ether theory. He put a glass prism in front of the telescope to test if light from the different stars are refracted by different amounts, based on the hypothesis that light from different stars had different speeds according to emission theory. He found that the light from all stars was refracted by the same amount, implying that the speed of light is independent of star velocity. Next he observed light from the same star at different times of the year, expecting that the speed of light relative to the prism would vary, resulting in variation in the angle of refraction. Again he found that the angle

of refraction was always the same, regardless of the time of the year. This disproved ether theory. Motion of the observer and motion of the source did not affect Snell's law of refraction. In 1871 Airy performed a modified form of Arago's experiment. He used water-filled telescope to observe the effect on the angle of aberration of the stars. According to classical law of addition of velocities, the angle of aberration should be increased. However, all Airy observed was the usual stellar aberration. The Arago and Airy star light refraction and aberration experiment was the first experiment that exhibited the paradoxical nature of the speed of light. Neither ether theory nor emission theory could explain these experiments.

Light has continued to exhibit its puzzling nature in experiments performed ever since. The Michelson-Morley experiment null result appeared to be a strong evidence for emission theory, hence supporting the principle of relativity. On the other hand, recent experiments such as the Marinov, the Silvertooth, the CMBR anisotropy experiment and the Roland de Witte experiment have clearly confirmed Earth's absolute translational motion. Yet, modern Michelson-Morley experiments using optical cavity resonators have given almost a complete null result.

Paradoxically again another less known experiment appears to support the emission theory: the Venus radar range anomaly as reported by Bryan G Wallace, hence supporting the principle of relativity. Astronomical and terrestrial moving source experiments, on the contrary, have shown that the speed of light is independent of the source velocity.

Thus, the failure of classical ether and emission theories led to the introduction and development of new, unconventional ideas in physics, which eventually developed into the Lorentz's ether theory and Einstein's special relativity theory. However, in hind sight, this was a wrong turn. The new insight in this paper is that many of the light speed experiments could be explained *either by ether theory or by emission theory*, which could be a hint that the true model of the speed of light was some form of fusion of these two theories [1]. We will come back to this later. For now let us briefly look at the historical development of Lorentz's and Einstein's theories.

In order to explain the Arago experiment, Fresnel in 1818 proposed the Fresnel ether drag coefficient, which was, curiously, confirmed by the Fizeau 1851 experiment. This apparent confirmation of the Fresnel drag coefficient is one of the turning points in the history of physics. Although the Fresnel drag coefficient was empirically confirmed, there were conceptual problems with the physical explanation given by Fresnel. This led physicists to search for alternative theories. But 'predicting' the Fresnel drag coefficient became the requirement for such theories. We know that Albert Einstein formulated special relativity in an effort to explain stellar aberration and the Fizeau experiment.

Lorentz invented the so-called 'local time' in order to give an alternative explanation to the Arago star light refraction experiment and the Fizeau experiment, hence the Fresnel drag coefficient. The use of local time enabled Lorentz to keep Maxwell's equations invariant in a system moving relative to the ether, to first order in  $V/c$ . However, the Michelson-Morley experiment null result

was a second order effect which could not be explained by Lorentz's local time. The Lorentz-Fitzgerald length contraction hypothesis was then added to explain the Michelson-Morley null result. However, based on the principle of relativity that no absolute motion effect should be detected for all orders of  $V/c$  and for all physical phenomenon, Lorentz, Larmor and Poincare subsequently developed the complete Lorentz transformation we know today. Under this transformation, Maxwell's equations are invariant for *all* orders of  $V/c$ .

The Lorentz transformation equations are shown below.

$$\begin{aligned}x' &= \gamma (x - vt) \\y' &= y \\z' &= z \\t' &= \gamma (t - vx/c^2)\end{aligned}$$

The next development was Albert Einstein's special theory of relativity, which gave a new interpretation to the Lorentz transformation equations. Whereas the velocity  $V$  is the velocity relative to the ether according to Lorentz, Einstein rejected the ether altogether and assigned  $V$  to the relative velocity of two inertial reference frames. Lorentz's length contraction and time dilation are dynamical effects, whereas these are purely kinematic effects in special relativity theory.

Despite all claimed successes of Lorentz's and Einstein's theories, however, numerous experimental evidences, theoretical and logical arguments exist that disprove the theory of relativity. It is well known that the original Michelson 1881 experiment did not give exactly a null result: there was a small fringe shift much less than the expected value. Unfortunately, no one has repeated the original experimental setup ever since. The Miller experiments are known to have detected small but consistent fringe shifts, which were, crucially, extracted based on sidereal time and always pointed in the same direction in space.

After decades of confusion and controversy, Earth's absolute motion has been detected, beyond reasonable doubt, in the relatively recent Silvertooth experiment and the NASA CMBR anisotropy experiment, both of which independently gave the same magnitude and direction of velocity.

Experimental evidences against other aspects of special relativity are also accumulating. In a recent experiment[2], the speed of electrostatic field of an electron has been apparently shown to be infinite. In another recent experiment[3], the velocity of light has been shown to vary relative to a moving observer.

There are also numerous logical and theoretical evidences against Lorentz's ether theory and Einstein's special relativity theory (SRT). Perhaps SRT has created many more paradoxes than it solved. The Twin paradox and the Trouton-Noble paradox are just two of these.

A flaw in the origin of Lorentz Contraction analysis of the Michelson-Morley experiment has also been pointed out [4]. It has been found that in the classical analysis of the experiment the fact that the light beams were actually being reflected from mirrors moving relative to the ether has been overlooked, originally by Lorentz and Fitzgerald and then in the subsequent development of the theory of relativity. The angle of incidence and reflection from the beam splitter will not be the same because of an apparent tilt of the beam splitter due to its motion relative to the ether, hence affecting the classical analysis on which the Lorentz-Fitzgerald contraction formula is based. This will invalidate the length contraction hypothesis because the *exact* classical analysis of the experiment will give a more *complicated* formula for the round trip times of the beams. The Michelson-Morley experiment will give a null fringe shift only in the reference frame in which it is at rest, and will always give a non-null fringe shift in all reference frames in which it is moving, even with the Lorentz contraction applied. This issue has already been recognized [5] and it has been proposed that the apparent tilting of the beam splitter will be compensated by the length contraction of the beam splitter. However, this procedure is not correct because length contraction has to be applied only after, not before, a strict classical analysis.

Thus no existing classical or modern theory of the speed of light exists that can *consistently* predict and explain the outcome of numerous apparently contradictory experiments, such as the Michelson-Morley experiment and the Sagnac effect. Perhaps the problem in physics today is the failure of the scientific community in general to recognize the failure of all known classical, neo-classical and relativistic theories of light. The crucial question today should be: what is the true theory of the speed of light that has eluded physicists for centuries?

In this paper, I will present a new model and theoretical framework for the problem of (absolute) motion and the speed of light. It turns out that the new theoretical framework is a fusion of some of the classical and 'relativistic' concepts. Although much of Lorentz's and Einstein's theories will be discarded in this paper, the postulate of constancy of the speed of light has been adopted with a new interpretation. Also the ether and ballistic theories have been discarded as they are, i.e. the ether doesn't exist and ballistic theory is wrong as it is, yet features of ether theory and emission theory have been united into a single theory in a novel way. The new theoretical framework is a seamless fusion of features of ether theory, emission theory, and special relativity.

The new theoretical framework has two parts:

1. Constant phase velocity and Exponential Doppler Effect of light
2. Apparent Source Theory

## 2. Constant phase velocity, invariance of Maxwell's equations and Lorentz transformation

The root of Lorentz's and Einstein's theories is the invariance of Maxwell's equations. When he formulated these equations, Maxwell assumed the constant  $c$  to be the speed of light relative to the ether. However, the null results of the Arago and Airy star light refraction and aberration experiments and the Michelson-Morley experiment led Lorentz, Poincare and Einstein to postulate the principle of relativity that absolute motion cannot be detected not only by mechanical experiments, which was Galileo-Newton principle of relativity, but also by electromagnetic experiments. For this, they assumed Maxwell's equations must have the same simple form in all inertial reference frames. This means that for all inertial observers moving relative to each other (or relative to the ether), Maxwell's equations must hold in the same simple forms as for the observer at rest in the ether.

For this, as discussed above, Lorentz, Larmor and Poincare developed the Lorentz transformation equations that will make Maxwell's equations invariant for all orders of  $V/c$ , as demanded by the principle of relativity. The principle of relativity demands that absolute motion fundamentally cannot be detected by optical, electromagnetic, mechanical and gravitational or other experiments.

The development of Lorentz transformation equations was based on a wrong interpretation of experiments according to the principle of relativity. In hind sight, according to the theory proposed in this paper, the Arago star light refraction and aberration was a truly null result. However, the small non-null results of the Michelson-Morley and the Trouton-Noble experiments were wrongly interpreted as null according to the dogmatic principle of relativity. Mainstream physicists have denied a glaring experimental fact when they ignored and suppressed the Silvertooth experiment, which, in combination with the NASA CMBR anisotropy experiment, unambiguously detected the magnitude and direction of Earth's absolute velocity.

However, at this point we will not make the unqualified conclusion that Maxwell's equations are not invariant, which the expected conclusion given that absolute motion has been detected in numerous experiments. We will see that only part of Maxwell's equations is invariant.

We will start presenting the new theoretical framework by the argument that although the Michelson-Morley experiment gave a 'null' fringe shift, the Silvertooth experiment in combination with the NASA CMBR anisotropy experiment clearly determined the absolute velocity of the Earth, both in magnitude and direction. The question is: why did the Michelson-Morley experiment give a 'null' result ?

Absolute motion has been universally presumed to be motion relative to the ether. This is the view shared by supporters and opponents of absolute motion alike. The explanation proposed here is that the Michelson-Morley (MM) experiment was *designed to detect the ether* and failed to detect the ether because the ether doesn't exist. At this point, I introduce a crucial distinction that absolute motion is not motion relative to the ether. The Michelson-Morley experiment

*succeeded* in disproving the non-existent ether but *failed* to detect the existent absolute motion. This is the conclusion one would make given the fact that the Silvertooth experiment detected absolute motion but the Michelson-Morley experiment failed to detect it.

For the scientists, failure to detect the ether in the MM experiment was synonymous with failure to detect absolute motion. One way to describe this is that it was a misrepresentation of absolute motion by the scientists. They had a simplistic view that light is a wave on the ether and absolute motion is motion relative to the ether and when they failed to detect the ether they concluded that absolute motion doesn't exist. The new distinction made in this paper is that the MM experiment was capable to detect the ether ( if the ether existed ) but was not capable to detect absolute motion.

The idea of a medium for light transmission was not a novel one from the start. Light, which was presumed to be an ether wave, would behave just as ordinary material waves ( such as water wave and sound wave). We already know that light had displayed novel behaviors in various observations and experiments, and needs a truly novel theory. Scientists hypothesized the ether simply because they could not conceive a wave without a medium. The ether is a highly hypothetical substance whose exact nature could never be conceived. The Michelson-Morley experiment was based on such a simplistic view. Absolute motion, which is presumed to be motion relative to the ether, would also have no novel effects. Motion of an object relative to the ether is not different from motion of an object relative to air, for example. Absolute motion would be a novel phenomenon if it has an effect not only on the interference fringes, but also on the whole apparatus and the light source itself. For example, absolute motion of an atom or a star-planet system should manifest itself by somehow modifying the atom and the star-planet system itself.

This raises a fundamental question: if absolute motion is not motion relative to the ether, then what is absolute motion ? The aim of this paper is to introduce a new *model* of the speed of light and absolute motion that will enable the prediction of experimental results, and not what light *is* and what absolute motion *is*. The purpose of this paper is to introduce a new theory on the *effect* of absolute motion. It should be noted again that there is no consistent model of the speed of light to date, let alone a deep understanding of what light *is*. A correct model would guide in the search for the fundamental question of what light *is* and what absolute motion *is*. However, I briefly state here that absolute motion can be viewed as motion of an object relative to all matter in the universe.

Later on we will see the new model that describes the effect of absolute motion and will analyze the Michelson-Morley and other experiments. The main point I would like to make here is the non-existence of the ether. Having reached this conclusion, let us go back to our discussion about the invariance of Maxwell's equations.

## Constancy of phase velocity of light

What is the implication of the non-existence of the ether, as discussed above, on the postulate of invariance of Maxwell's equations ? At this point I would like to make the distinction between invariance of Maxwell's equations as a whole and invariance of the *phase velocity* of light. The new postulate I propose here is the invariance of the phase velocity of light. The phase velocity of light is always constant  $c$ , irrespective of source or observer motion, for uniform or accelerated motion. This postulate is a direct consequence of the non-existence of a medium for light transmission. Regarding other parts of Maxwell's equations, we will see the new interpretation of their invariance (or variance) after the introduction of Apparent Source Theory. For example, the electrostatic part can be seen both as invariant or variant: *physically* variant, but *apparently* invariant. However, it is the apparently invariant interpretation that is fundamental. We see here the intricate nature of light and absolute motion which is novel and distinct from the usual simplistic view. Maxwell's equations can be invariant and absolute motion can exist at the same time. We will discuss this later.

The question arises: How is the postulate of constancy of phase velocity related to the Lorentz transformation ?

I propose the simple answer that no mathematical transformation laws are needed because the ether doesn't exist. In the past, scientists assumed that they needed coordinate transformation equations between different inertial frames because the extremely subtle and intricate nature of light eluded them. The ether was always implicit in their thinking and they could never truly escape the ether trap. One could say that the ether was as pervasive in the physicists' thinking as it was (supposed to be) in the universe. Einstein succeeded in discarding the universal ether but could not get rid of the 'personal' ether. Subtly, each of Einstein's inertial reference frames were actually ether frames in relative motion. It was such an implicit ether thinking that made scientists assume the need for transformation equations. Perhaps the only way to get rid of ether thinking is to start with classical emission (ballistic) theory of light, which considers light as stream of particles.

The scientists thought they needed transformation equations in order to explain how two observers moving relative to each other could measure the same speed  $c$  of the *same* photon. The word 'same' here subtly implies the ether view and is the fallacy. The subtlety of light is that no two observers see the same light. Each observer sees 'his own' photon. This is a direct consequence of the non-existence of a medium for light transmission, which is already an accepted fact. Light is not an objective phenomenon in the sense of classical waves. Light becomes real only when observed.

Therefore, the constancy of the phase velocity of light is a phenomenon that should be just accepted without the need for further 'explanation', such as the Lorentz transformation. It should



also be noted that the constancy of the phase velocity has been proposed here as a consequence of the non-existence of the ether, and not as a consequence of the principle of relativity.

What about the group velocity ? We propose that the group velocity behaves in a conventional way: it is independent of source velocity, but varies with mirror and observer velocity. This makes the phase velocity and the group velocity of light completely independent. This is an unconventional concept because for ordinary material waves such as the sound wave the phase velocity and the group velocity are connected and are equal. The group velocity of light will be discussed in relation to Apparent Source Theory.

To further clarify the new concept, consider Einstein's 'chasing a beam of light' thought experiment. For simplicity, consider a light source that is at absolute rest and an observer that is moving at or near the speed of light away from the source. According to the new interpretation of Einstein's thought experiment, the phases still go past the observer at the speed of light  $c$ , whereas the group will be 'frozen'. Classically, the wave length as measured by such an observer will be infinite. However, from the new theory of Doppler effect for light to be proposed in this paper, the wave length will be:  $\lambda' = \lambda e^{V/c} = \lambda e^{c/c} = \lambda e$ , where  $e$  is Euler's constant.

If the phase velocity is always constant, therefore, not only the frequency but also the wave length changes for an observer moving relative to a light source. Therefore,

$$\lambda' f' = \lambda f = c$$

Therefore, the new law of Doppler effect of light should satisfy the above condition. It can be seen that classical Doppler effect laws that contain the  $c \pm V$  terms cannot fulfill this criteria.

### **Exponential Doppler effect of light**

In searching for a new law governing the Doppler effect of light that fulfills the criteria of constant phase velocity, I found that the exponential function fulfills the above condition and is perhaps the only possibility.

The new Exponential law of Doppler effect of light is :

$$f' = f e^{-V/c} \quad \text{and} \quad \lambda' = \lambda e^{V/c}$$

where  $e$  Euler's constant and  $V$  is the source observer *relative* velocity and is positive for source and observer receding from each other.

The validity of our argument of constant phase velocity is clear and is based on the non-existence of the ether. The constancy of phase velocity of light raised the question of a new law of Doppler effect of light. Therefore, the Exponential Doppler Effect law is a logically sound conclusion.

We can see that the Exponential Doppler Effect law satisfies the condition of constant phase velocity:

$$f' \lambda' = f e^{\frac{v}{c}} \lambda e^{-\frac{v}{c}} = f \lambda = c$$

Now let us apply the new formula to explain the red shift in the Ives Stilwell experiment.

Doppler shift for approaching ion:

$$\lambda_A' = \lambda e^{-\frac{v}{c}}$$

Doppler shift for receding ion:

$$\lambda_R' = \lambda e^{\frac{v}{c}}$$

By applying

$$e^x = 1 + x + \frac{1}{2}x^2 + \frac{1}{6}x^3 + \dots \quad (\text{for } -\infty < x < \infty)$$

Average wavelength

$$\Lambda = \frac{1}{2}(\lambda_A' + \lambda_R') = \frac{1}{2}(\lambda e^{-\frac{v}{c}} + \lambda e^{\frac{v}{c}})$$

$$\Lambda = \frac{1}{2}\lambda \left( 1 - \frac{v}{c} + \frac{1}{2}\frac{v^2}{c^2} + \dots + 1 + \frac{v}{c} + \frac{1}{2}\frac{v^2}{c^2} + \dots \right)$$

$$\Lambda \cong \frac{1}{2}\lambda \left( 1 - \frac{v}{c} + \frac{1}{2}\frac{v^2}{c^2} + 1 + \frac{v}{c} + \frac{1}{2}\frac{v^2}{c^2} \right), \quad \text{for } v \ll c$$

$$\Lambda \cong \lambda \left( 1 + \frac{1}{2}\frac{v^2}{c^2} \right)$$

$$\Delta\lambda = \Lambda - \lambda = \lambda \left( 1 + \frac{1}{2}\frac{v^2}{c^2} \right) - \lambda$$

$$\Delta\lambda = \frac{1}{2}\frac{v^2}{c^2} \lambda = \frac{1}{2}\beta^2 \lambda$$

This is exactly the value predicted by SRT and confirmed by the Ives Stilwell experiment.

For  $v \ll c$ , it can be shown that the exponential formula reduces to the classical one.

$$f' = f e^{\frac{v}{c}} = f \left( 1 + \frac{v}{c} + \frac{1}{2}\frac{v^2}{c^2} + \dots \right) \cong f \left( 1 + \frac{v}{c} \right) = f \frac{c+v}{c} \cong \frac{c}{c-v}, \quad \text{for } v \ll c$$

So far we have introduced the first part of the new theoretical framework, namely: *The theory of constant phase velocity and Exponential Doppler Effect*. The theory of constant phase velocity is

useful to explain experiments in which source and observer are in relative motion and the phase velocity is relevant, such as in the Ives-Stilwell experiment. This theory cannot explain absolute motion effects such as the (small) fringe shifts detected in the Michelson-Morley experiment and the (apparent) change in wavelength detected in the Silvertooth experiment. In the next section we will present the second part of the new theoretical framework.

### **On transverse Doppler effect**

Unlike classical waves, Doppler effect of light depends only on relative velocity and hence completely symmetrical for source and observer motion.



Hence, the Doppler effect of light is determined by the physical relative velocity of the source and the observer.

Light emitted at the moment of closest approach will be red shifted. And light detected at the moment of closest approach will not be Doppler shifted. These results are similar for light and for classical waves and hence transverse Doppler effect does not exist for light.

### 3. Apparent Source Theory (AST) for inertial observers

Unlike the usual interpretation that the Michelson-Morley experiments gave null fringe shifts, these experiments, especially the Miller experiments, are known to have detected small but consistent fringe shifts, which were always consistent in direction and which were related to sidereal time. In this paper, so far we have established that the ether doesn't exist but absolute motion does exist and, as a consequence of the nonexistence of the ether, the phase velocity of light is always constant.

However, constancy of phase velocity alone cannot explain the Michelson-Morley experiment and the Silvertooth experiment. Then what is the origin of the non-null effects in these experiments ?

I gained the initial insight in an attempt to reconcile the conflicting results of the Michelson-Morley experiment and the Sagnac effect. The new theory is called Apparent Source Theory (AST).

#### The initial insight of Apparent Source Theory

At first I will introduce the initial insight of Apparent Source Theory based on the Michelson-Morley experiment[6], in which the light source and the detector are co-moving inertially, which is a special case in which no relative motions are involved. From this an accurate and more general formulation of AST will be presented which applies to any experiment involving an *inertial observer* in which the observer, the light source and the mirrors can be in relative motion. The most general formulation of AST is one which applies to a *non-inertial observer*, with relative motions and accelerations of the light source, the observer and the mirrors involved. This will be presented in the next chapter.

Apparent Source Theory is formulated as follows [7]:

*The effect of absolute motion for absolutely co-moving light source and observer is to create an apparent change in position of the light source as seen by the observer, i.e., as seen from point of observation.. Therefore, the effect of absolute motion of the Michelson-Morley ( MM ) experiment is to create an apparent change in position of the light source as seen by the detector/observer.*

*The procedure of analysis of the MM experiment is:*

- 1. Replace the real light source by an apparent source. The apparent change in position of the source is determined by the direct source-observer distance, the magnitude and direction of the absolute velocity and the orientation of the source-observer line with respect to the direction of absolute velocity.*

2. Analyze the experiment by assuming that the speed of light is constant relative to the apparent source.

Therefore, for the Michelson-Morley (MM) experiment, the effect of *apparent* change in source position is the same as *actually/physically* shifting the source to the same position. The distinction of AST is that there will be apparent change in position of the *light source only* and all other parts of the MM apparatus ( the mirrors, the beam splitter, ) are assumed to be at their actual/physical position, to analyze the experiment.

It can be easily explained intuitively why the MM experiment gave only a small fringe shift. Suppose that the MM apparatus is absolutely moving to the right, which will create apparent shift of the source position to the left as shown below. Obviously, apparent or physical/actual shift of the source backwards, for example, will not create any fringe shift at all because both the longitudinal and transverse beams will be affected identically: both will be delayed by the same amount.

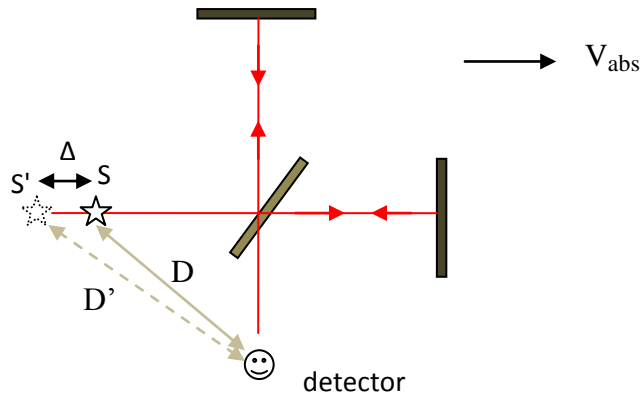

If the absolute velocity is directed downwards, there will be an apparent shift of source position upwards, as shown below. In this case, there may be a small fringe shift because the longitudinal and lateral (virtual) light beams will follow different paths to meet at the detector, as shown below. This explains the small fringe shifts that were always observed in the Miller experiments. Once the real source is replaced by an apparent source, simple geometrical optics is used to analyze the path lengths of the two light beams, from which the fringe shift can be determined.

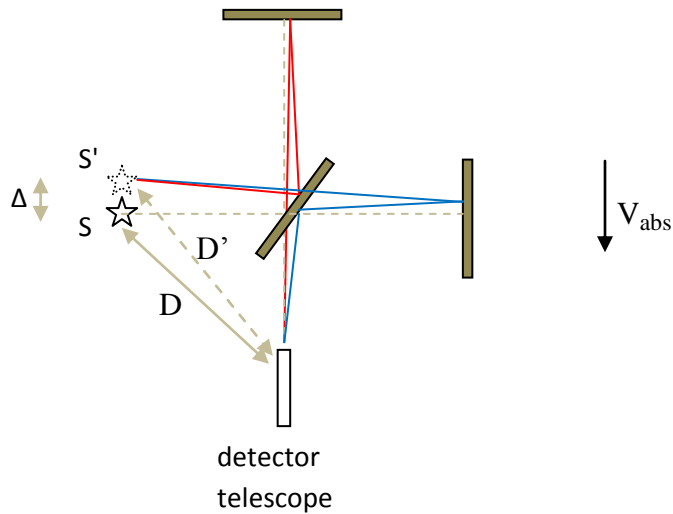

We have seen qualitative description of Apparent Source Theory. In the next section we will see the quantitative determination of the apparent change in position of the light source relative to the observer.

### Quantitative determination of apparent source position relative to the observer

We restate Apparent Source Theory as follows:

*The effect of absolute motion for co-moving light source and observer is to create an apparent change in the position ( distance and direction) of the light source relative to the observer.*

Imagine a light source S and an observer O, both at (absolute) rest, i.e.  $V_{abs} = 0$ .

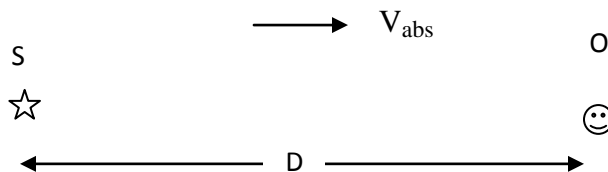

A light pulse emitted by S will be detected after a time delay of

$$t_d = \frac{D}{c}$$

Now suppose that the light source and the observer are absolutely co-moving to the right.

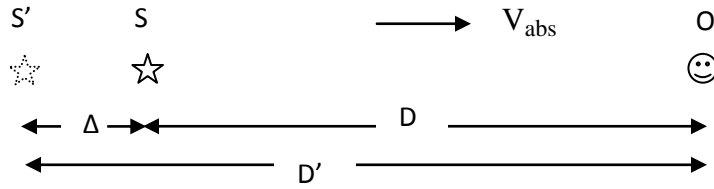

The new interpretation proposed here is that the position of the source S changes apparently to S', as seen by the observer, relative to the observer.

During the time ( $t_d$ ) that the source 'moves' from point S' to point S, the light pulse moves from point S' to point O, i.e. the time taken for the source to move from point S' to point S is equal to the time taken for the light pulse to move from point S' to point O.

$$\frac{\Delta}{V_{abs}} = \frac{D'}{c}$$

But

$$D + \Delta = D'$$

From the above two equations:

$$D' = D \frac{c}{c - V_{abs}}$$

and

$$\Delta = D \frac{V_{abs}}{c - V_{abs}}$$

The effect of absolute motion is thus to create an apparent change of position of the light source relative to the observer, in this case by amount  $\Delta$ .

Once we have determined the apparent position of the source as seen by the co-moving observer, we can analyze the experiment by assuming that light was emitted from S' ( not from S ) and that the speed of light is constant relative to the apparent source.

Therefore, a light pulse emitted by the source is detected at the observer after a time delay of:

$$t_d = \frac{D'}{c} = \frac{D \frac{c}{c - V_{abs}}}{c} = \frac{D}{c - V_{abs}}$$

To the observer, the source S appears to be farther away than it physically is.

In the same way, for absolute velocity directed to the left:

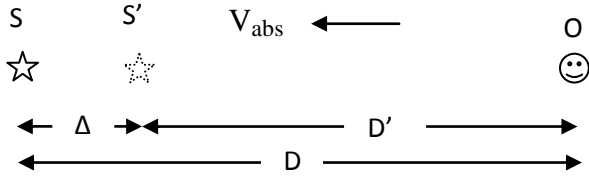

$$\frac{\Delta}{V_{abs}} = \frac{D'}{c} \quad \text{and} \quad D - \Delta = D'$$

From which

$$D' = D \frac{c}{c + V_{abs}}$$

and

$$\Delta = D \frac{V_{abs}}{c + V_{abs}}$$

In this case, it appears to the observer that the source is nearer than it actually is by amount  $\Delta$ .

Once we have determined the apparent position ( $S'$ ) of the source as seen by the co-moving observer, we can determine the time delay  $t_d$ . Therefore, a light pulse emitted by the source is detected at the observer after a time delay of:

$$t_d = \frac{D'}{c} = \frac{D \frac{c}{c + V_{abs}}}{c} = \frac{D}{c + V_{abs}}$$

Now imagine a light source S and an observer O as shown below, with the relative position of S and O orthogonal to the direction of their common absolute velocity.

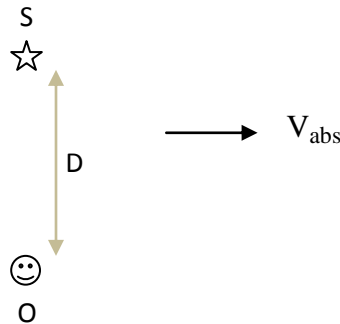

S and O are moving to the right with common absolute velocity  $V_{abs}$ .



If  $V_{abs}$  is zero, a light pulse emitted from S will be received by O after a time delay  $t_d$

$$t_d = \frac{D}{c}$$

In this case, light arrives at the observer from the direction of the source, S.

If  $V_{abs}$  is not zero, then the source position appears to have shifted to the left as seen by the observer O.

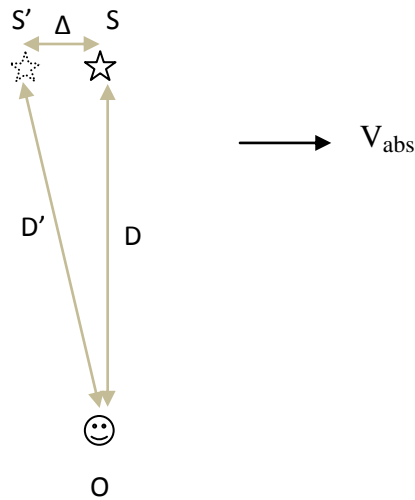

In this case also, the effect of absolute velocity is to create an apparent change in the *position*( distance and direction ) of the light source relative to the observer.

In the same way as explained previously,

$$\frac{D'}{c} = \frac{\Delta}{V_{abs}}$$

i.e. during the time interval that the light pulse goes from S' to O, the source goes from S' to S.

But,

$$D^2 + \Delta^2 = D'^2$$

From the above two equations

$$D' = D \frac{c}{\sqrt{c^2 - V_{abs}^2}} \text{ and } \Delta = D \frac{V_{abs}}{\sqrt{c^2 - V_{abs}^2}}$$

Therefore, the time delay  $t_d$  between emission and reception of the light pulse in this case will be

$$t_d = \frac{D'}{c} = \frac{D}{\sqrt{c^2 - V_{abs}^2}}$$

For a more general case of co-moving source and observer relative positions with respect to the direction of absolute velocity, the situation will be as follows.

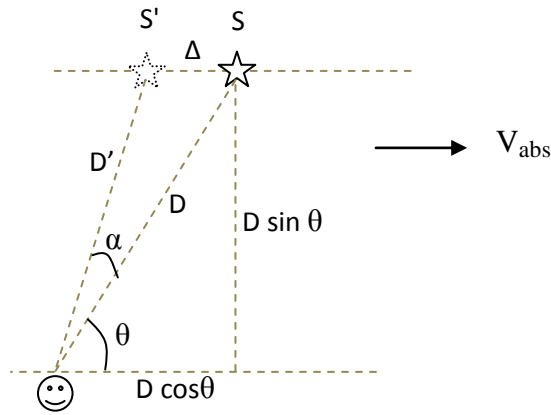

We want to get the relationship between  $\theta$  and  $\Delta$ .

$$\frac{D'}{c} = \frac{\Delta}{V_{abs}} \quad (1)$$

$$\Delta = D \cos \theta - \sqrt{D'^2 - D^2 \sin^2 \theta} \quad (2)$$

From (1) and (2)

$$D'^2 \left( 1 - \frac{V_{abs}^2}{c^2} \right) + \frac{2DV_{abs}}{c} \cos \theta D' - D^2 = 0$$

which is a quadratic equation from which  $D'$  can be determined, which in turn enables the determination of  $\Delta$  and  $\alpha$ .

### Quantitative analysis of the Michelson-Morley experiment

To analyze the Michelson-Morley experiment quantitatively, therefore, we must first determine the apparent position of the light source as seen by the detector, according to the procedures described in the last section.

It is crucial to note that the determination of the apparent position of the light source is determined only by the actual/physical position ( distance and direction ) of the source relative to the observer, the magnitude and direction of the absolute velocity. According to AST, the presence or absence or the position of all other parts of the MM apparatus ( the beam splitter, the mirrors, and other parts ) are irrelevant in the determination of the apparent position of the source.

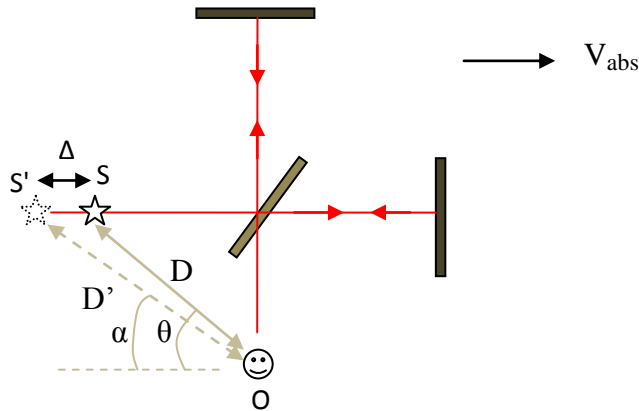

Therefore, we determine the apparent position of the source as follows, as described in the last section.

During the time interval that the source 'moves' from S' to S, the light moves from S' to O . Therefore, the apparent source position ,  $D'$  and  $\alpha$  , can be determined from the following equations.

$$\frac{D'}{c} = \frac{\Delta}{V_{abs}} \quad (1)$$

$$\Delta = \sqrt{D'^2 - D^2 \sin^2 \theta} - D \cos \theta \quad (2)$$

$$\sin \alpha = \frac{D \sin \theta}{D'} \quad (3)$$

Once the apparent position of the source is determined, the paths of the two light beams can be determined from optics, which is simply a problem of geometry, from which the difference in path lengths and fringe shift can be determined.

## The Silvertooth experiment

The Silvertooth experiment, in combination with the NASA CMBR anisotropy experiment, has decisively determined the absolute velocity of the Earth in space. However, the scientific community has dismissed it based on the excuse that Silvertooth didn't provide a clear theoretical explanation for the wavelength change effect observed in the experiment. An experimental fact should not be ignored just because of lack of a clear theoretical explanation. In fact, the scientific community is expected to find a theoretical explanation.

The Silvertooth experiment is the main evidence in this paper for the existence of absolute motion and deserves much attention. However, we will only demonstrate the wavelength change effect based on simple experimental set ups, and will not analyze the actual experiment.

The diagram below is taken from the Silvertooth paper of 1989 from the journal *Electronics and Wireless World*.

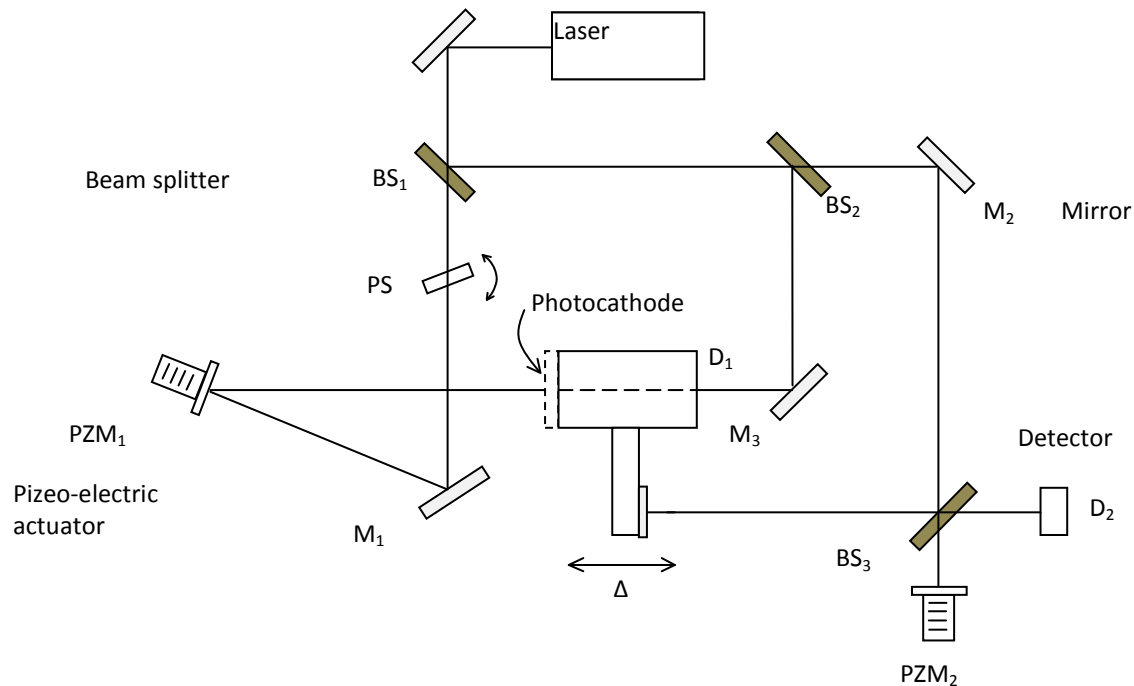

Imagine a light source  $S$ , an observer  $O$  and a mirror  $M$ , co-moving with absolute velocity  $V_{\text{abs}}$  to the right as shown below.

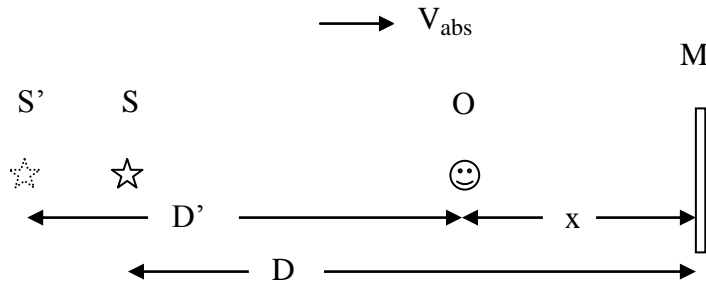

### 'Wavelength' and velocity of incident light

Light emitted by S at time  $t = 0$  will be received by observer O after time delay  $t_d$ . From the previous discussions:

$$D' = D \frac{c}{c - V_{abs}}$$

(note that D in this equation is not the one shown in the above figure)

Substituting  $D - x$  in place of D

$$D' = (D - x) \frac{c}{c - V_{abs}}$$

Time delay will be

$$t_d = \frac{D'}{c} = \frac{D - x}{c - V_{abs}}$$

Assume that the source emits a light wave according to

$$\sin \omega t$$

The light wave will be received at the detector as

$$\begin{aligned} \sin \omega(t - t_d) &= \sin \omega \left( t - \frac{D}{c - V_{abs}} + \frac{x}{c - V_{abs}} \right) \\ &= \sin \left( \omega t - \frac{\omega D}{c - V_{abs}} + \frac{\omega x}{c - V_{abs}} \right) \end{aligned}$$

The above is a wave equation. If we take a 'snapshot' of the wave at an instant of time  $t = \tau$ , the above equation will be:

$$\sin \left( \omega \tau - \frac{\omega D}{c - V_{abs}} + \frac{\omega x}{c - V_{abs}} \right)$$

The two terms  $\omega \tau$  and  $\omega D / (c - V_{abs})$  represent phase shifts. The 'wavelength' is determined

from the third term:

$$\frac{\omega x}{c - V_{abs}}$$

If we have a function

$$\sin kx$$

then the wavelength can be shown to be

$$\frac{2\pi}{k}$$

In the same way, for the function

$$\sin\left(\frac{\omega x}{c - V_{abs}}\right)$$

$$k = \frac{\omega}{c - V_{abs}}$$

Hence the 'wave length' of the incident light will be

$$\lambda_{INC} = \frac{2\pi}{k} = \frac{2\pi}{\frac{\omega}{c - V_{abs}}} = (c - V_{abs}) \frac{2\pi}{\omega} = \frac{c - V_{abs}}{f}$$

Note that the 'wavelength' predicted here is different in form from the 'wavelength' predicted by Silvertooth, in his paper, but the results obtained are nearly the same as will be shown shortly.

This shows an *apparent* change in wavelength and hence an apparent change of speed of light relative to the observer, for absolutely co-moving source and observer. However, to interpret this as an actual/real change in wavelength is wrong or inaccurate. Neither the wavelength nor the phase velocity has changed. To understand this rather confusing statement, the best way is to ask: assuming Galilean space, will an *actual*/physical change of the position of the source result in change of speed or wavelength observed by the observer, for co-moving source and observer? Obviously no. For the same reason, an *apparent* change in the position of the source should not result in change of wavelength and speed of light. This can be confirmed by measuring the wavelength with a spectroscope. The independence of wavelength and speed of light from Earth's absolute velocity has been confirmed because no variation of spectroscopic measurements of characteristic wavelengths emitted by atoms has ever been observed or reported. The Ives-Stilwell experiment confirms that absolute velocity of the Earth doesn't affect phase velocity and wavelength of light, because, if it did, large variations in 'transverse Doppler shift' would be observed in different experiments due to possible variations in orientation of the experimental apparatus, as the ion velocity in the Ives-Stilwell experiment ( $\approx 1000\text{Km/s}$ ) is comparable to Earth's absolute velocity ( $390\text{ Km/s}$ ). The fast ion beam experiment is another evidence. Wavelength change occurs only due to Doppler effect, which depends only on source observer *relative* velocity.

The apparent wavelength pattern observed in the Silvertooth experiment arises due to Apparent Source Theory. This means that for every point, the apparent position of the light source is different. For material waves, such as the sound wave, the wave starts from the same point for all observers in the same reference frame. In AST, the apparent past position of the light source

( the point where it was at the instant of emission) is different for different observers at different positions ( distance and direction) even if they are in the same reference frame.

### Wavelength and velocity of reflected light

Next we determine the 'wavelength' of the reflected light.

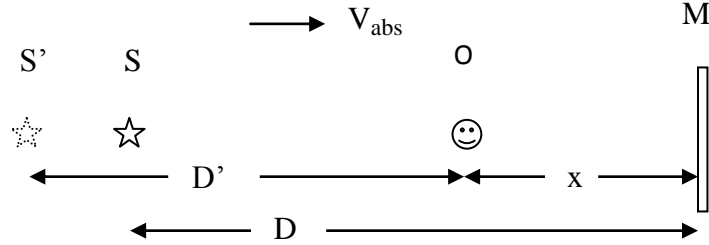

Time delay between emission and reception before reflection of light from mirror M, at point  $x$ , has been determined as follows (preceding section).

$$D' = (D - x) \frac{c}{c - V_{abs}}$$

Relative to an observer at point  $x$ , who is observing the reflected light, time delay between emission and reception of reflected light will be:

$$\begin{aligned} t_d &= \frac{D'}{c} + \frac{2x}{c} = \frac{D - x}{c - V_{abs}} + \frac{2x}{c} \\ &= \frac{D}{c - V_{abs}} - x \left( \frac{1}{c - V_{abs}} - \frac{2}{c} \right) \\ &= \frac{D}{c - V_{abs}} + x \frac{c - 2V_{abs}}{c(c - V_{abs})} \end{aligned}$$

If the source emits light according to

$$\sin \omega t$$

The reflected light wave will be received at point  $x$  as

$$\sin \omega(t - t_d) = \sin \omega \left( t - \frac{D}{c - V_{abs}} - x \frac{c - 2V_{abs}}{c(c - V_{abs})} \right)$$

The coefficient of  $x$  is:

$$k = \omega \frac{c - 2V_{abs}}{c(c - V_{abs})}$$

As before, the 'wavelength' of reflected light will be:

$$\lambda_{REF} = \frac{2\pi}{k} = \frac{2\pi}{\omega \frac{c-2V_{abs}}{c(V_{abs})}}$$

$$= \frac{c(c - V_{abs})}{f(c - 2V_{abs})} = \frac{1}{f} \cdot \frac{c(c - V_{abs})}{c - 2V_{abs}}$$

Conventionally, one would expect the 'wave length' of the reflected light to be equal to  $(c + V_{abs}) / f$ , because the 'wavelength' of incident light is  $(c - V_{abs}) / f$ , such as in ether theory. However, it turned out in the above analysis that this is not the case. However, it can be shown that the actual difference between the two expressions is very small for  $V_{abs} \ll c$ , as will be shown below.

### **Precise formulation of Apparent Source Theory for inertial observer**

After I gained the initial insight discussed above, it took me about five years to formulate the general form of Apparent Source Theory to analyze experiments in which accelerations and relative motions between light source, observer, mirrors and beam-splitters are involved, such as the Sagnac effect. The Michelson-Morley experiment was easy to explain by AST because it was a special case in which no relative motions and acceleration are involved. It was challenging to formulate the general Apparent Source Theory starting from the initial insight.

The mystery was finally revealed that the key variable in the analysis of light speed experiments is the state of motion of the *observer/detector: inertial or non-inertial*. The fundamental difference in the analysis of experiments is due to a difference in the state of motion of the observer or detector. All experiments involving *inertial* observers are fundamentally analyzed in the same way, irrespective of their motion (uniform or accelerated, relative or absolute) of the light source, the mirrors, the beam-splitters. On the other hand, all experiments involving *non-inertial* observers are analyzed fundamentally in the same way. The analysis of such experiments will be presented later in this paper.

We have already formulated AST as: *the effect of absolute motion for co-moving light source and observer is to create an apparent change in the position of the source relative to the observer*. In this case, the light source and the observer have the same absolute motion, so there is no relative motion between them. Therefore, the next question is: what if the observer and the light source have independent motions, i.e. if both have absolute and relative motions?

We just present the general formulation of AST.

Consider an observer at the origin of an inertial reference frame moving with absolute velocity  $V_{abs}$  in the +x direction. Assume that light is emitted at point (x,y). *The effect of absolute motion*



of the observer is to create an apparent change in the point of light emission in the reference frame of the observer; in other words, an apparent change in the past position of the source.

Therefore, the *source* in the previous formulation is not strictly the physical source, but the *point* of light emission in the reference frame of the observer. Accordingly the source is the actual point of light emission, whereas the apparent source is the apparent point of light emission.

Assume that initially the observer is at absolute rest. In this case the apparent point of light emission is the same as the actual point of light emission. Note that the motion of the source relative to the observer is irrelevant. What matters is only the point of light emission in the observer's reference frame. Now imagine that the observer starts moving with absolute velocity  $V_{abs}$  to the right. In this case, the point of light emission will change from  $(x, y)$  to  $(x', y')$  in the observer's reference frame. This means that even if the light source emitted light from a point  $(x, y)$ , light acts as if it was emitted from point  $(x', y')$ .

Now we will quantitatively determine the *apparent point of light emission* for the absolutely moving observer based on Apparent Source Theory.

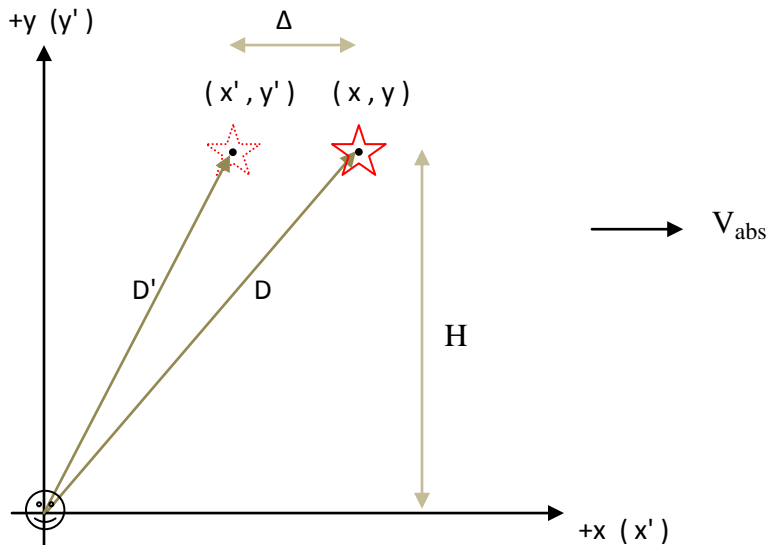

According to Apparent Source Theory :

$$\frac{D'}{c} = \frac{\Delta}{V_{abs}}$$

$$\Rightarrow \Delta = \frac{V_{abs}}{c} D'$$

Space apparently compresses/expands only in the direction of absolute velocity and since the absolute velocity of the observer is parallel to the  $x'$ -axis,

$$y' = y$$

$$\Rightarrow \sqrt{D^2 - H^2} - \sqrt{D'^2 - H^2} = \Delta$$

Substituting the previous value of  $\Delta$  in the above equation:

$$\sqrt{D^2 - H^2} - \sqrt{D'^2 - H^2} = \frac{V_{abs}}{c} D'$$

$$\Rightarrow \sqrt{D^2 - H^2} - \frac{V_{abs}}{c} D' = \sqrt{D'^2 - H^2}$$

Since

$$\sqrt{D^2 - H^2} = x$$

Therefore

$$\Rightarrow x - \frac{V_{abs}}{c} D' = \sqrt{D'^2 - H^2}$$

Squaring both sides:

$$x^2 - 2x \frac{V_{abs}}{c} D' + \left( \frac{V_{abs}}{c} D' \right)^2 = D'^2 - H^2$$

$$\Rightarrow D'^2 \left( 1 - \frac{V_{abs}^2}{c^2} \right) + D' \left( 2x \frac{V_{abs}}{c} \right) - (H^2 - x^2) = 0$$

This is a quadratic equation from which  $D'$  can be determined in terms of  $x$ ,  $H$  and  $V_{abs}$ .

Once  $D'$  is obtained,  $\Delta$  can also be determined.

$$D' = \frac{-\left(2x \frac{V_{abs}}{c}\right) + \sqrt{\left(2x \frac{V_{abs}}{c}\right)^2 + 4\left(1 - \frac{V_{abs}^2}{c^2}\right)(H^2 - x^2)}}{2\left(1 - \frac{V_{abs}^2}{c^2}\right)}$$

Since

$$D' = \sqrt{x'^2 + y'^2} = \sqrt{x'^2 + y^2}$$

$$\Rightarrow \sqrt{x'^2 + y^2} = \frac{-\left(2x \frac{V_{abs}}{c}\right) + \sqrt{\left(2x \frac{V_{abs}}{c}\right)^2 + 4\left(1 - \frac{V_{abs}^2}{c^2}\right)(H^2 - x^2)}}{2\left(1 - \frac{V_{abs}^2}{c^2}\right)}$$

From the above equation  $x'$  can be determined.

Note again that the *observer is always at the origin of the co-ordinate system* and hence  $(x, y)$  or  $(x', y')$  are coordinates of the *source* ( point of light emission) **relative to the observer**.

With the above formulation of Apparent Source Theory one can analyze any experiment involving an *inertial observer*, a light source and mirrors, all in relative motion. Since this is a general formulation of AST, the Michelson-Morley and other experiments in which no source observer relative motions are involved can also be analyzed by using this formulation.

Therefore, the first step in the analysis of a light speed experiment is to determine the apparent change in the point of light emission in the reference frame of the inertial observer/detector. Next we will see the whole procedure.

Consider the case of observer and source in relative motion, as shown below. We assume that the light source and the mirrors are moving in the observer's reference frame. Regarding the motion of the source, we have already stated that it is not relevant and only the point of light emission needs to be known in the reference frame of the observer.

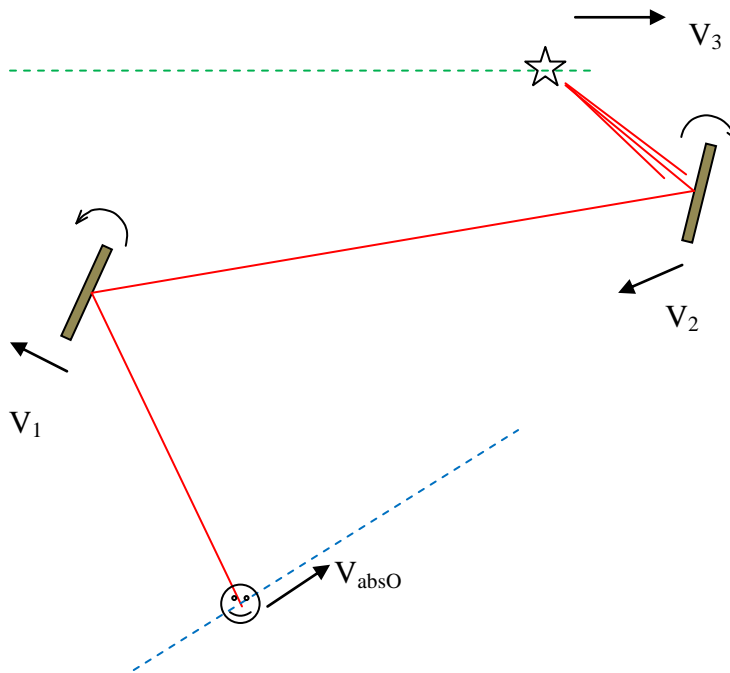

According to AST:

1. All light speed experiments should be analyzed from the perspective of an *inertial* observer. The observer is the human or device directly detecting the light. The problems of the speed of light should be analyzed only from the perspective of the light detector (whether this is a human being or a device).
2. The speed of light coming *directly* from a light source is constant  $c$  relative to the inertial observer, irrespective of observer's absolute velocity. However, the group velocity of light varies with mirror velocity.
3. The apparent change in position applies *only to the point of light emission from the source*. There will be no apparent change in the point of reflection of light from a mirror.

The procedure of analysis of this problem is as follows:

1. Define a coordinate system (x,y), with the inertial observer at its origin and with the x-axis parallel to the absolute velocity vector  $\mathbf{V}_{absO}$ .
2. Define the physical positions and motions of the light source and mirrors ( and beam splitters ) in the reference frame of the inertial observer.
3. From knowledge of actual point of light emission, determine the *apparent point of light emission*(i.e. the apparent position of the source at the instant of light emission) in the observer's reference frame, *relative to the inertial observer*.

To determine the apparent point (x,y) of light emission, use the following equation which was derived already

$$\sqrt{x'^2 + y^2} = \frac{-\left(2x \frac{v_{abs}}{c}\right) + \sqrt{\left(2x \frac{v_{abs}}{c}\right)^2 + 4\left(1 - \frac{v_{abs}^2}{c^2}\right)(H^2 - x^2)}}{2\left(1 - \frac{v_{abs}^2}{c^2}\right)}$$

$$y' = y$$

4. Once the apparent point of emission is determined in the observer's frame, we imagine a light source fixed at the apparent point of emission and simply use emission ( ballistic ) theory according to which the velocity of light is constant relative to the source and varies with mirror velocity. Emission theory is wrong for a moving source, but correct for a stationary source. Emission theory is also correct regarding the velocity of light reflected from a moving mirror. However, emission theory is wrong regarding phase velocity of light. Since we are assuming an imaginary source fixed at the apparent point of light emission, we can use emission theory to analyze the problem. Also since only group velocity ( and not phase velocity ) of light is relevant to determine the path length and time of flight, we can apply emission theory. Phase velocity will

be used to get phase of detected light based on path length of light which is determined by group velocity.

To summarize this:

1. use emission (ballistic) theory to determine the path, path length and time of flight
2. use path length calculated in (1) above and constant phase velocity  $c$  to determine the phase of detected light.

*Note that Apparent Source Theory is applied only to determine the apparent past position of the source. For the mirrors, beam-splitters and all other parts, only their physical/actual positions relative to the observer is used.*

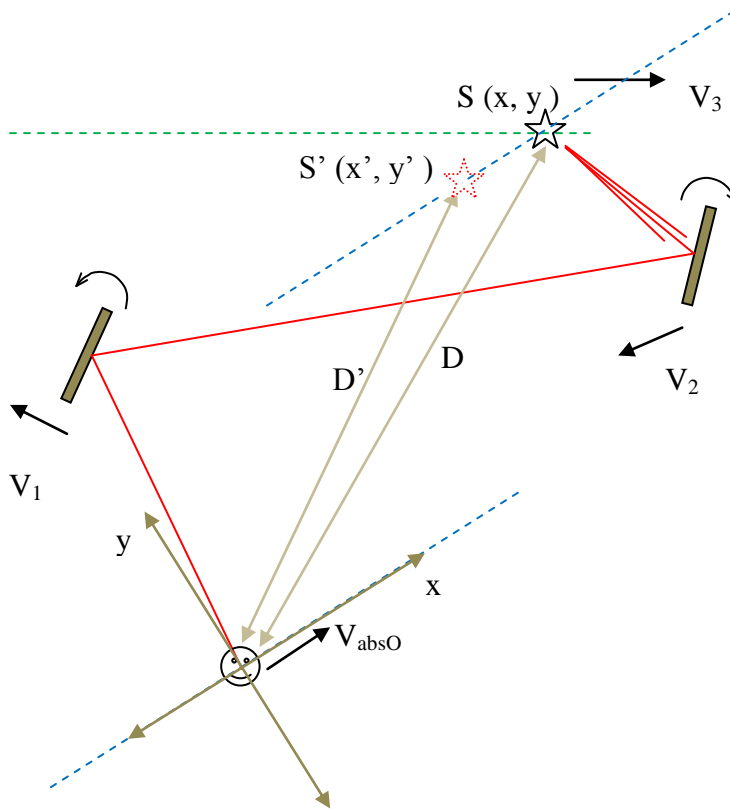

The above procedure can be used to analyze any light speed experiment involving an inertial observer, light source, mirrors and beam splitters in relative motion. Note that only the absolute motion of the inertial observer is relevant, which is used to determine the apparent point of light emission as presented above. The absolute motion of the light source, the mirrors, the beam splitters is irrelevant to analyze the experiment. Only their positions and motions in the reference frame of the inertial observer are relevant.

Let us apply this theory to simple light speed experiments.

## Velocity of light relative to an observer at absolute rest

According to Apparent Source Theory, the speed of light ( both phase velocity and group velocity ) is constant  $c$  relative to an observer at absolute rest, independent of source motion. However, the group velocity of light varies with mirror velocity. The phase velocity of light in vacuum is an absolute constant  $c$ , irrespective of uniform or accelerated motion of the source, the observer and the mirror.

Consider a light source and an observer at rest located close to each other as shown below. Assume that a mirror is moving directly towards the observer so that light reflects back on itself to the observer.

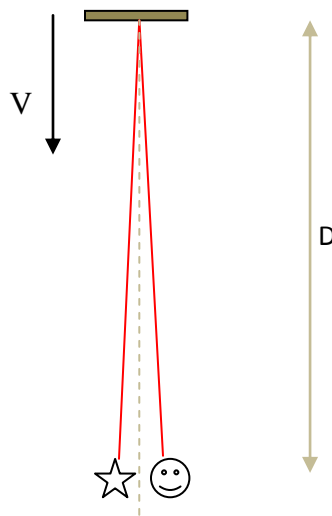

Obviously, for mirror not moving relative to the observer and the light source, the time delay  $t_d$  between emission and detection of light is:

$$t_d = \frac{2D}{c}$$

If the mirror is moving towards the observer with velocity  $V$ , then the distance  $D$  is continuously changing. The group velocity of light after reflection is  $c + 2V$ . ( For a mirror moving away from the observer, the group velocity of light after reflection is  $c - 2V$  ).

The group delay is, therefore,

$$t_d = \frac{D}{c} + \frac{D}{c + 2V} = \frac{2D}{c} \frac{c + V}{c + 2V}$$

where  $D$  is the distance of the mirror at the instance of reflection. This is based on the Bryan G Wallace analysis of Venus radar range data 'anomaly'.

## Moving observer experiments

According to the new theoretical framework, the phase velocity of light is always constant  $c$ , irrespective of source, observer or mirror velocity, for uniform or accelerated motion. However, the group velocity of light is independent of source velocity but varies with observer and mirror velocity. However, fundamentally, the group velocity of light coming directly from a source can also be seen as being constant irrespective of observer's velocity. For example, for an observer moving away with absolute velocity  $V_{\text{abs}}$  from a light source that is at absolute rest, the group velocity of light can be seen as both dependent or independent of observer velocity. If one assumes real/physical space, then the group velocity varies with observer velocity. However, if one assumes apparent contraction or expansion of space relative to an absolutely moving observer, then there will be an alternative interpretation that the group velocity of light is also independent of observer's (absolute) velocity.

Therefore, according to the latter interpretation, Apparent Source Theory states that the speed of light (both phase velocity and group velocity) is constant  $c$  irrespective of absolute motion of the observer. Special Relativity Theory (SRT) makes the same claim, but since it denies absolute motion, it modifies not only space but also time so that absolute motion is not detectable. AST postulates absolute motion and absolute time and constancy of the speed of light for an absolutely moving observer. AST assumes detection of absolute motion of an observer which will result in change in time delay of light detection, but it attributes this change in time delay to apparent expansion or contraction of space and not to change in speed of light. Therefore, AST is able to incorporate the unconventional and beautiful ideas of Einstein's constancy of the speed of light for a moving observer by postulating contraction and expansion of space, without introducing any paradoxes. AST assumes universal time and absolute motion. Einstein proposed one of the greatest ideas in physics: the constancy of the speed of light for a moving observer and the contraction of space; but he spoiled the beauty of his theory when he introduced relativity of time so that absolute motion is not detectable, and this has led to paradoxes. He paid the price of relativity of time just to deny absolute motion.

Consider a light source that is at absolute rest and an observer that is moving with absolute velocity  $V_{\text{abs}}$  directly away from the source.

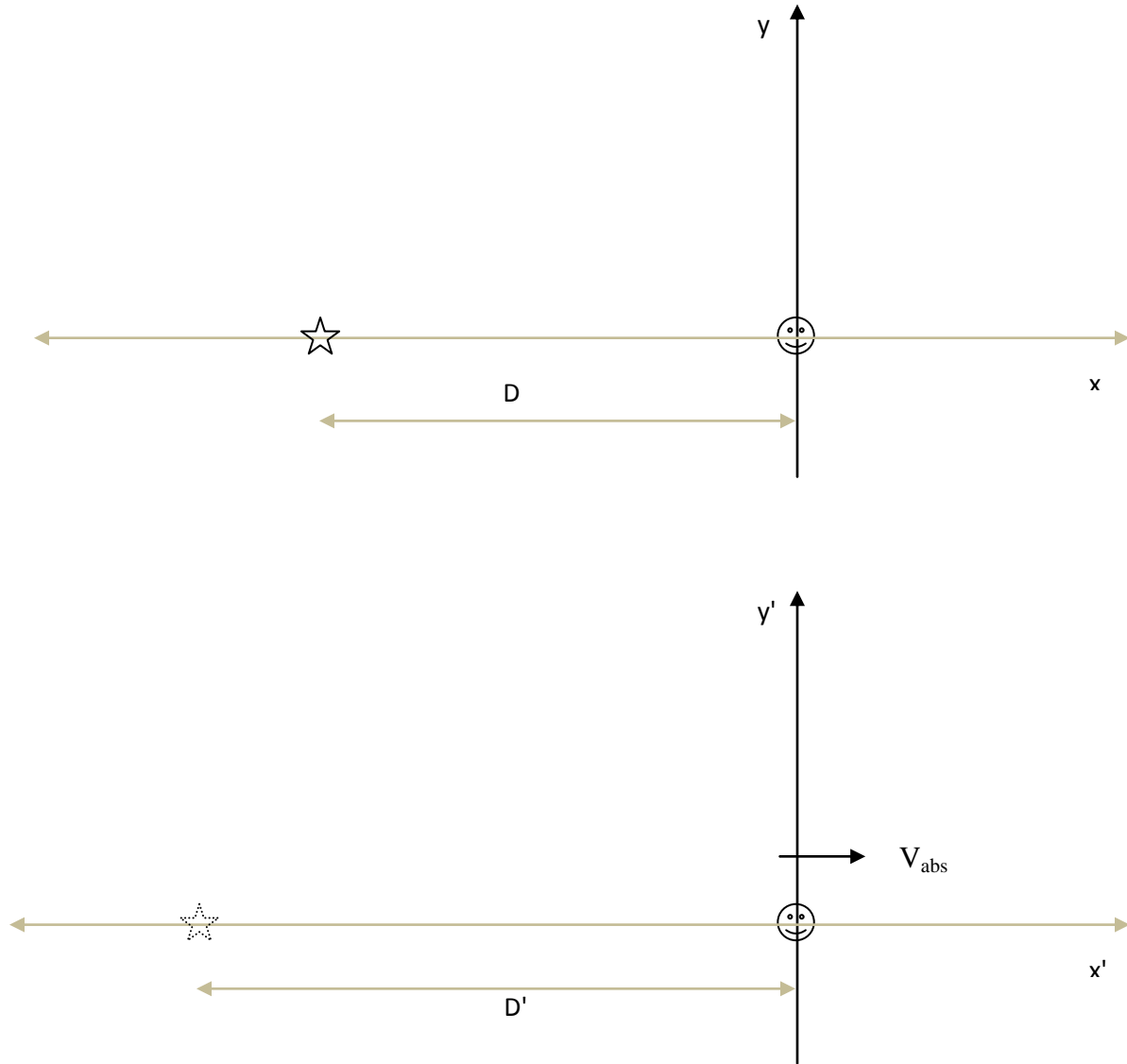

Imagine that initially the observer was at absolute rest and at distance  $D$  from the source just before emission of light, and then starts moving with absolute velocity  $V_{abs}$  to the right instantaneously. AST states that, in the reference frame of the absolutely moving observer, light was emitted not from  $x = -D$ , but from  $x = -D'$ , where

$$D' = D \frac{c}{c - V_{abs}}$$

Therefore, the time taken for light to catch up with the observer will be:

$$t_d = \frac{D'}{c} = \frac{D}{c - V_{abs}}$$



Note again that we have assumed that the speed of light relative to the moving observer is still  $c$ , regardless of motion of the observer, and not  $c - V_{\text{abs}}$ .

Therefore, AST postulates that there will be an additional time delay for light to catch up with an observer moving away from a light source, as compared to an observer at rest, but this additional delay is not because the velocity of light has decreased relative to the observer, *but because space behind the observer has apparently expanded!*

However, the constancy of the *group* velocity of light for a moving observer can be seen as only a matter of interpretation. If one thinks of space as fixed, it is equally valid to say that the group velocity of light varies with observer velocity.

### Moving source experiments

Consider an observer that is at absolute rest and a light source that is moving directly towards or away from the observer with ( absolute ) velocity  $V$ . We propose that the group velocity of light varies with observer velocity, but the phase velocity is independent of source, observer or mirror velocity and is always a constant  $c$  in vacuum.

### Stellar aberration

As I mentioned already, one of the most difficult problems I faced regarding Apparent Source Theory was its contradiction with the well known phenomenon of stellar aberration.

Imagine absolutely co-moving light source  $S$  and observer  $O$ .

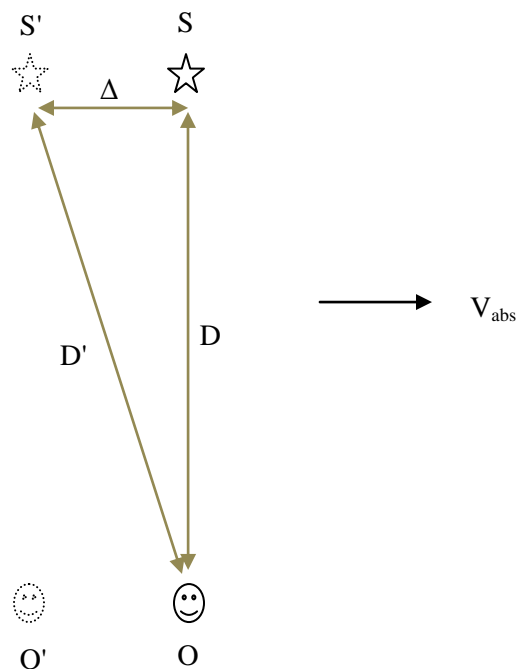

Assume that the source emits light at the instant when it is at position S' and the co-moving observer is at position O'. Assume that moving observer O detects the light just at the instant that he/she is passing through point O. According to Apparent Source Theory, the co-moving observer O has to point his telescope towards point S' to see the light, due to apparent change in position of the light source for absolutely co-moving source and observer[1]. But according to the accepted theory of stellar aberration,observer O should point his telescope towards S, and not towards S'.

This puzzle has been solved after I gained the crucial insight of space contraction and expansion. One of the profound consequences of Apparent Source Theory( AST ) is that it changes current understanding of the phenomenon of stellar aberration, in totally unexpected way.

According to conventional, universally accepted knowledge, the apparent change in position of a star relative to a moving observer is towards the direction of motion. AST reveals that the apparent position of the star is opposite to the direction of observer velocity!!!

*The phenomenon of stellar aberration is due to contraction ( expansion ) of space in front of ( behind ) an absolutely moving observer !!!*

current, universally  
accepted understanding of  
stellar aberration

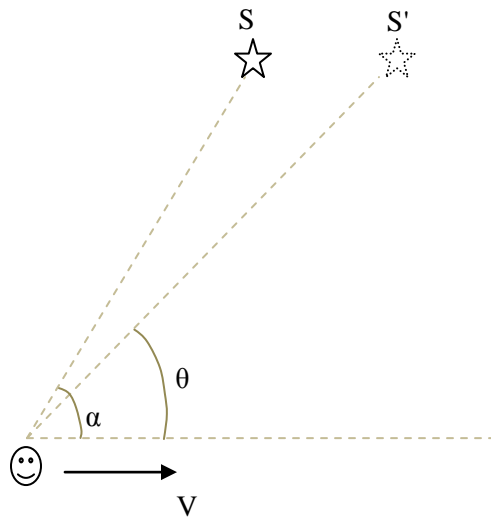

stellar aberration  
according to Apparent  
Source Theory

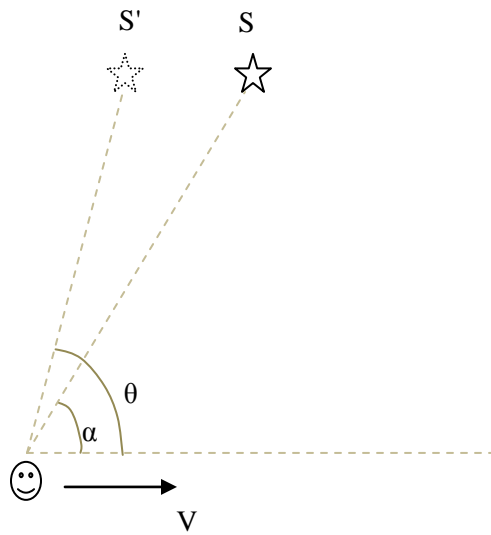

The quantitative expression of the angle of aberration for a star directly overhead is determined as follows.

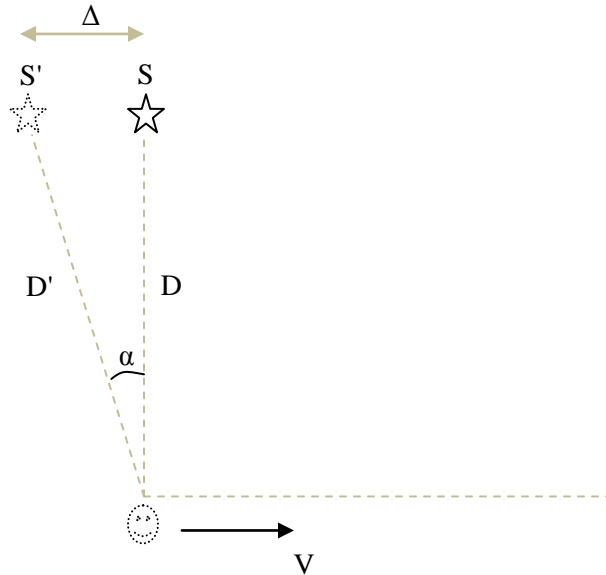

Using previous results based on Apparent Source Theory:

$$D' = D \frac{c}{\sqrt{c^2 - V_{abs}^2}} \text{ and } \Delta = D \frac{V_{abs}}{\sqrt{c^2 - V_{abs}^2}}$$

$$\sin \alpha = \frac{\Delta}{D'} = \frac{D \frac{V_{abs}}{\sqrt{c^2 - V_{abs}^2}}}{D \frac{c}{\sqrt{c^2 - V_{abs}^2}}} = \frac{V_{abs}}{c}$$

which agrees with the conventional and experimentally confirmed formula. An alternative interpretation of stellar aberration is given in the Appendix at the end of this paper.

### The Arago and the Airy star light refraction and aberration experiments

In 1810 François Arago performed an experiment on star light to test the emission and the ether hypotheses of light. He put a prism at the front of his telescope to test whether the velocity of light from the stars differed and hence whether the angle of refraction differed for light from different stars.

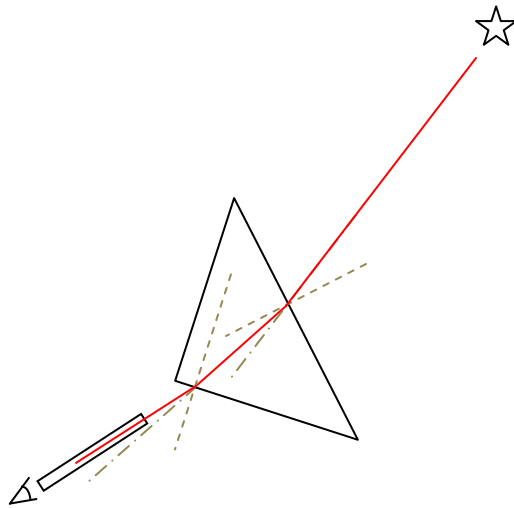

Arago found that the light rays from the different stars are refracted by the same amount, showing that the speed of light does not vary with source velocity. Arago repeated the experiment by observing light from the same star at different times of the year, in which case the variation in velocity of the Earth relative to the ether would be detected as variation in the refraction angle of light. Again Arago didn't observe any such variation. In hind sight, the Arago experiment was the first experiment to reveal the paradoxical nature of the speed of light.

Airy in 1871 carried out a modified version of the Arago experiment, in which he used a telescope filled with water to observe stellar aberration. According to the classical explanation of stellar aberration which was based on the law of addition of velocities, the aberration angle should increase compared to that obtained with air filled telescope. However, Airy didn't observe any change in the angle of aberration due to the presence of medium (water) in the telescope, as compared to the aberration angle for air filled telescope.

In 1818, Augustin Fresnel proposed the Fresnel drag coefficient to explain the Arago experiment, which was, curiously, confirmed by the 1851 Fizeau experiment.

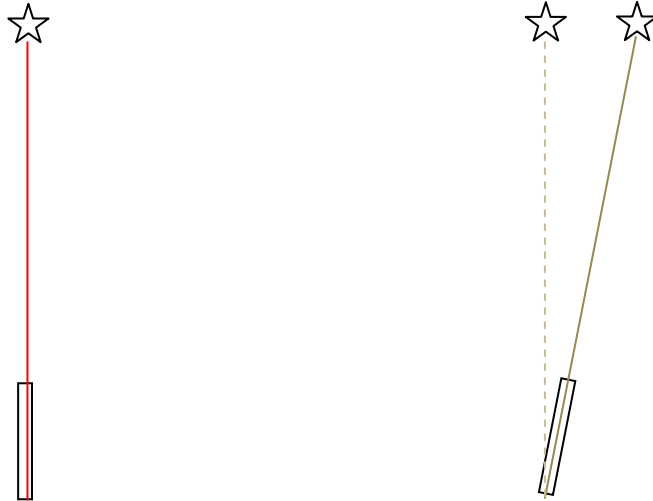

In this paper, we will propose an explanation of the Arago and the Airy experiments based on the new theoretical framework:

1. Constancy of phase velocity of light
2. Apparent Source Theory

The Arago and the Airy experiments can be explained by both the constancy of phase velocity and Apparent Source Theory.

Consider the Arago experiment above. The motion of the telescope (and the prism) to the *right* will create an apparent change in position of the star, to the *left*. This is explained by *rotation of the wave fronts*. This is also why the aberration angle of the water filled telescope was the same as that of air filled telescope. Additionally *the phase velocity of light is always constant*. These two unconventional behaviors of light explain the Arago and the Airy experiments. The absence of change in the angle of refraction in the Arago experiment is explained by the constancy of phase velocity.

#### 4. Apparent Source Theory for non-inertial observer

In this section we will introduce the most general form of Apparent Source Theory. In the previous section, we have seen the procedure of analysis of light speed experiments in which the observer or detector is *inertial*. In this section the procedure of analysis for experiments involving *non-inertial* observer is presented. We consider the general case in which the light source, the mirrors and the observer/detector move in an accelerated motions ( both magnitude and direction ), in arbitrary curved paths.

In order to illustrate the generalized AST, we first analyze a light speed problem involving an observer in rectilinear acceleration. Light speed problems involving observers accelerating in curved paths, such as in the Sagnac effect, are basically analyzed with the same procedure.

Consider a simple case in which an observer is accelerating rectilinearly directly away from a light source that is at absolute rest.

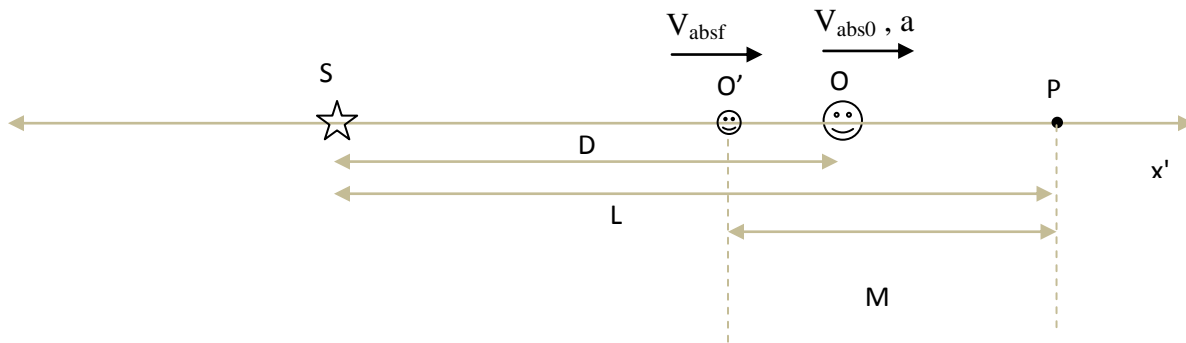

Suppose that, initially, at the instant of light emission, the observer was moving with initial absolute velocity  $V_{abs0}$ , at distance  $D$  from the source. Imagine that, just after emission of light, the observer starts accelerating to the right. The problem is to determine the time it takes light to catch up with the observer.

We will start by assuming that the observer  $O$  will detect the light at point  $P$ , which is at distance  $L$  from the light source.

According to the new principle proposed here, the problem is to find the imaginary inertial observer that will be just passing through point  $P$ , moving with the same instantaneous velocity as observer  $O$  at point  $P$ , at the instant of light detection. In other words, observer  $O$  and the imaginary inertial observer will detect the light at point  $P$  simultaneously, while moving with the same instantaneous velocity. For this, we first have to determine the absolute velocity of observer  $O$  at the instant that he/she is just passing through point  $P$ .

We use the formula for uniformly accelerated motion:

$$S = V_0 t + \frac{1}{2} a t^2$$

In this case

$$\frac{1}{2} a t^2 + V_0 t - S = 0$$

$$\Rightarrow a t^2 + 2V_0 t - 2S = 0$$

$$\Rightarrow t = \frac{-2V_0 \pm \sqrt{(2V_0)^2 - 4a(-2S)}}{2a}$$

$$\Rightarrow t = \frac{-2V_0 + \sqrt{4V_0^2 + 8aS}}{2a}$$

But

$$S = L - D$$

Therefore,

$$\Rightarrow t = \frac{-2V_0 + \sqrt{4V_0^2 + 8a(L - D)}}{2a}$$

$$\Rightarrow t = \frac{-2V_{abs0} + \sqrt{4V_{abs0}^2 + 8a(L - D)}}{2a}$$

During this time the observer will attain a final velocity of:

$$V_f = V_0 + at$$

$$\Rightarrow V_{absf} = V_{abs0} + a \left( \frac{-2V_{abs0} + \sqrt{4V_{abs0}^2 + 8a(L - D)}}{2a} \right)$$

$$\Rightarrow V_{absf} = V_{abs0} + \frac{-2V_{abs0} + \sqrt{4V_{abs0}^2 + 8a(L - D)}}{2}$$

This means that the observer O is moving at this velocity at the instant that he/she is just passing through point P. We have to determine the imaginary inertial observer O' moving with the same constant velocity as the instantaneous velocity ( $V_{absf}$ ) of observer O at point P.



So, at the instant of light emission, the inertial observer was at a distance of:

$$M = V_{absf} * t$$

to the left of point P, as shown in the above diagram.

$$M = \left( V_{abs0} + \frac{-2V_{abs0} + \sqrt{4V_{abs0}^2 + 8a(L-D)}}{2} \right) * \frac{-2V_{abs0} + \sqrt{4V_{abs0}^2 + 8a(L-D)}}{2a}$$

The distance between S and O', i.e. the distance between the source and imaginary *inertial* observer at the instant of light emission is:

$$L - M$$

Now we can determine the time of detection of light by the imaginary observer.

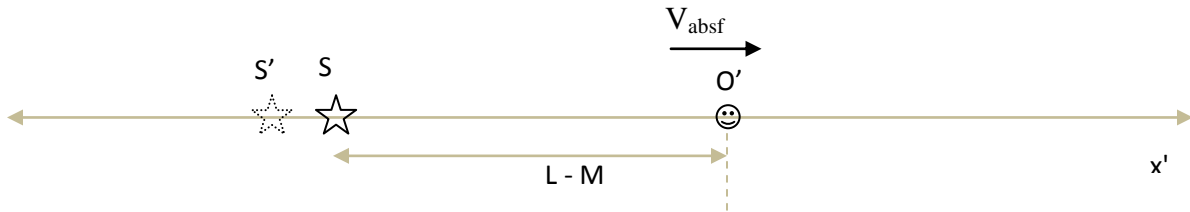

The apparent position of the source in the reference frame of the imaginary inertial observer is:

$$(L - M) \frac{c}{c - V_{absf}}$$

The time delay of light, therefore, will be:

$$t = \frac{D'}{c} = \frac{(L - M) \frac{c}{c - V_{absf}}}{c} = \frac{L - M}{c - V_{absf}} = \frac{L - V_{absf}t}{c - V_{absf}}$$

$$t = \frac{L - \left( V_{abs0} + \frac{-2V_{abs0} + \sqrt{4V_{abs0}^2 + 8a(L-D)}}{2} \right) * \frac{-2V_{abs0} + \sqrt{4V_{abs0}^2 + 8a(L-D)}}{2a}}{c - \left( V_{abs0} + \frac{-2V_{abs0} + \sqrt{4V_{abs0}^2 + 8a(L-D)}}{2} \right)}$$

Equating this value of  $t$  with the previous value of  $t$  :

$$\frac{L - \left( V_{abs0} + \frac{-2V_{abs0} + \sqrt{4V_{abs0}^2 + 8a(L-D)}}{2} \right) * \frac{-2V_{abs0} + \sqrt{4V_{abs0}^2 + 8a(L-D)}}{2a}}{c - \left( V_{abs0} + \frac{-2V_{abs0} + \sqrt{4V_{abs0}^2 + 8a(L-D)}}{2} \right)} = \frac{-2V_{abs0} + \sqrt{4V_{abs0}^2 + 8a(L-D)}}{2a}$$

$L$  is determined from the above equation and then used to determine time of flight  $t$ .

In the above example, we assumed rectilinear acceleration of the observer. In reality, the motion of the observer can be non-rectilinear accelerated motion, as shown below.

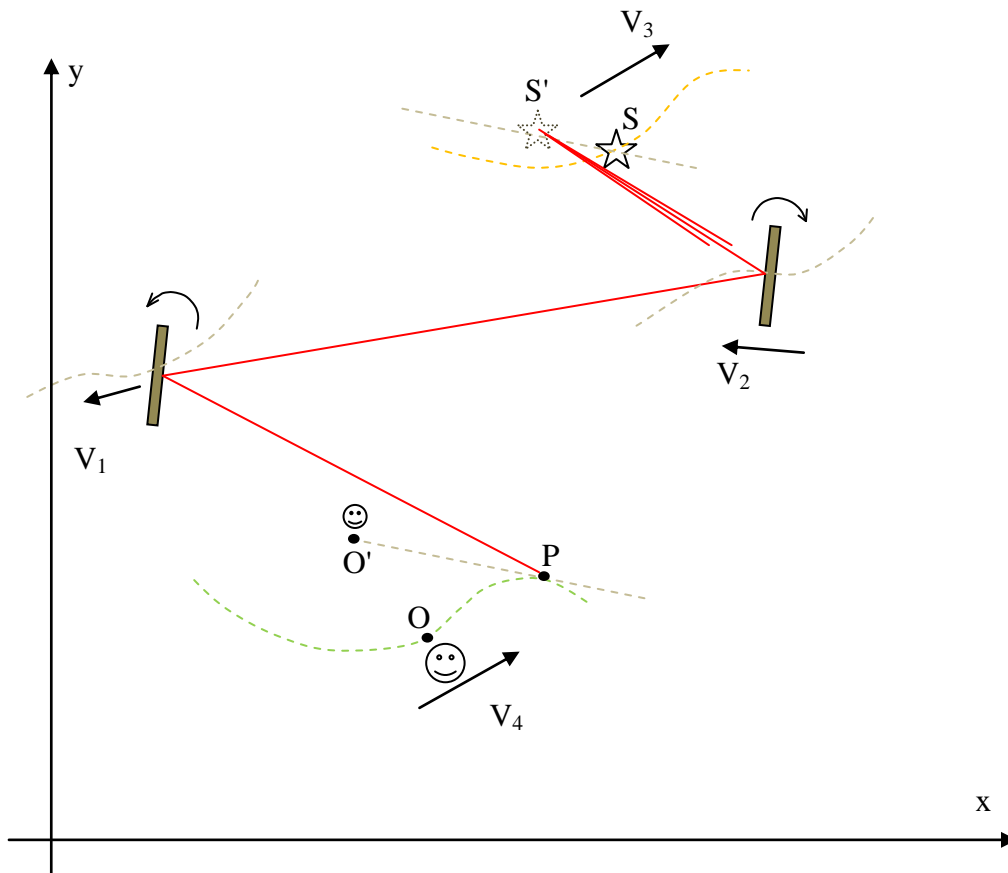

The procedure of analysis is first to define the positions and motions of the mirrors, the beam splitters, the observer/detector and the light source in the absolute reference frame.

***For an experiment involving an observer in (rectilinear or non-rectilinear) accelerated motion, the experiment is analyzed by applying Apparent Source Theory to an imaginary inertial observer who will be just passing through the same point and moving with the same instantaneous velocity as the real accelerated observer at the instant of light detection.***

The procedure of analysis is as follows:

1. We start by assuming that the observer O will detect the light when he is just passing through point P. At the instant of light emission( at  $t = 0$  ), observer O is at point O.
2. Based on the velocity function of the observer O, we get the expression for the time  $t$  taken by the observer to move from point O to point P. The initial absolute velocity (at the instant of light emission) of the observer is  $V_{abs0}$  and the final absolute velocity (at the instant of light detection) is  $V_{absf}$ , which is the instantaneous velocity of observer O at point P.
3. We get the expression for the instantaneous velocity ( magnitude and direction )  $V_{absf}$  of the observer at the instant of light detection ( at the instant of passing through P ).
4. We assume an imaginary inertial observer O' whose velocity is  $V_{absf}$  and determine his initial location at the instant of light emission (  $t = 0$  ) so that he/she will arrive at point P at the instant of light detection, i.e., real observer O and imaginary observer O' will arrive at point P simultaneously, so that both will detect the light at point P. Imaginary observer O' is at point O' at the instant of light emission.

This means we get an expression for the distance of imaginary inertial observer from point P ( i.e. the distance between point P and point O' ) at the instant of light emission:

$$\text{distance between P and O'} = V_{absf} * t$$

where  $t$  is the time taken by observer O to move from point O to point P. Note that distances OP and O'P have been exaggerated in the diagram.

6. We then attach a reference frame to the imaginary inertial observer O', with the x'-axis parallel to the path of observer O' ,i.e. parallel to  $V_{absf}$  vector, with observer O' at the origin, as shown in the next figure.

7. In the reference frame of imaginary observer O', we determine the apparent point of light emission ( in other words, apparent past position of the source, as opposed to actual past position of the source ), shown as S' in the figure. Note that S is the actual position of the source at the instant of light emission and S' is the apparent position of the source at the instant of emission, in the reference frame of the inertial observer. Up to this point we used only relative velocities. We use the absolute velocity of the observer to determine the apparent past position of the source.

Therefore, although all parts of an optical experiment will have their own absolute velocities, the only relevant absolute velocity in analysis of light speed experiments is the absolute velocity of the inertial observer and we only use it to determine the apparent past position of the source, i.e. the apparent point of emission. Once we have determined the apparent past position of the source, we use only velocities in the reference frame of inertial observer  $O'$ .

8. In the reference frame of the imaginary observer  $O'$ , we define the positions and motions (velocities) of the mirrors, beam splitters and other optical components.

9. By assuming that light was emitted from  $S'$ , and taking into consideration the positions and velocities/motions of mirrors, beam splitters e.t.c., we get the expression for the time delay of light between emission from  $S'$  and detection by the imaginary inertial observer  $O'$ .

10. By equating the expression for the time delay obtained in (2) with that obtained in (9), we solve the equation for the length of path  $OP$ , from which we get the time of flight  $t$ , the path and path length of the light. The phase of detected light is then determined by using the path length of light.

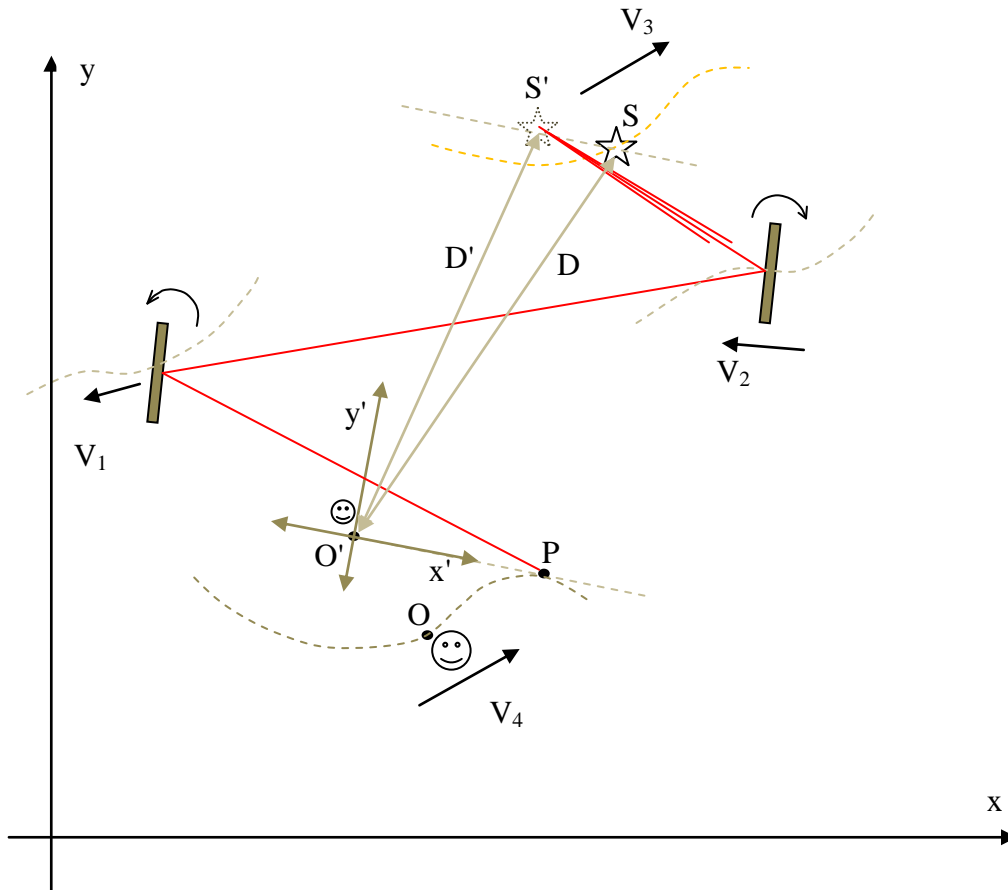

Next we apply the above principle to the Sagnac effect. In the Sagnac experiment, the light source, the beam splitter, the mirrors and the detector are in accelerated motions, with rotations of the mirrors and beam splitter. Therefore, the above procedure applies to the Sagnac experiment. Note again that the motion of the light source is irrelevant in determining the outcome of the experiment; only the position of the source relative to the imaginary inertial observer at the instant of light emission is relevant.

Let us first consider a simple problem involving rotation. An observer O and a light source S are attached to the two ends of a rigid rod and rotate about the center of the rod, as shown below.

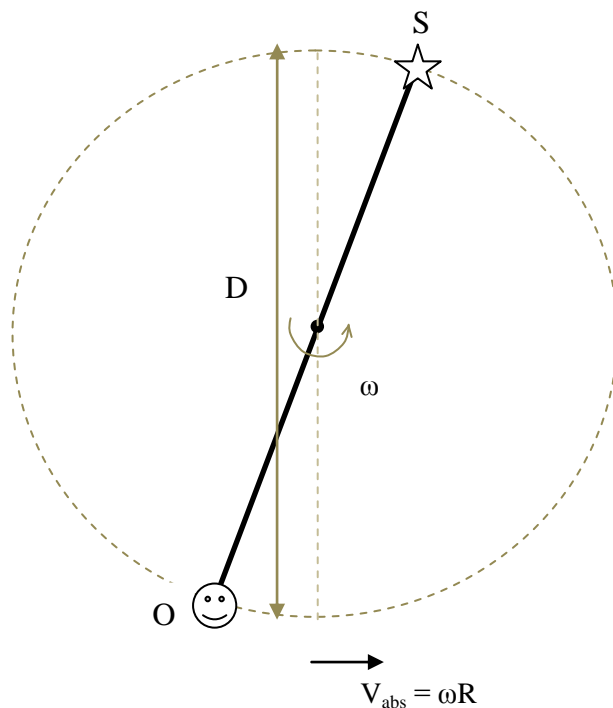

The problem is to determine the path, the path length, the time delay and phase of a photon emitted by the light source and detected by the observer.

We first use a convenient inertial reference frame to define the positions and motions/velocities of the different parts of the apparatus, in this case the source and the observer/detector. We assume the apparatus to have zero absolute translational velocity. The most convenient inertial reference frame is the reference frame in which the device is rotating. For simplicity, we assume that the device ( the whole system ) is not in absolute translational motion. Therefore, the tangential velocity of the observer will also be his/her absolute velocity.

So the magnitude of absolute velocity of the observer will be:

$$V_{abs} = \omega R, \text{ where } R = \frac{D}{2}$$

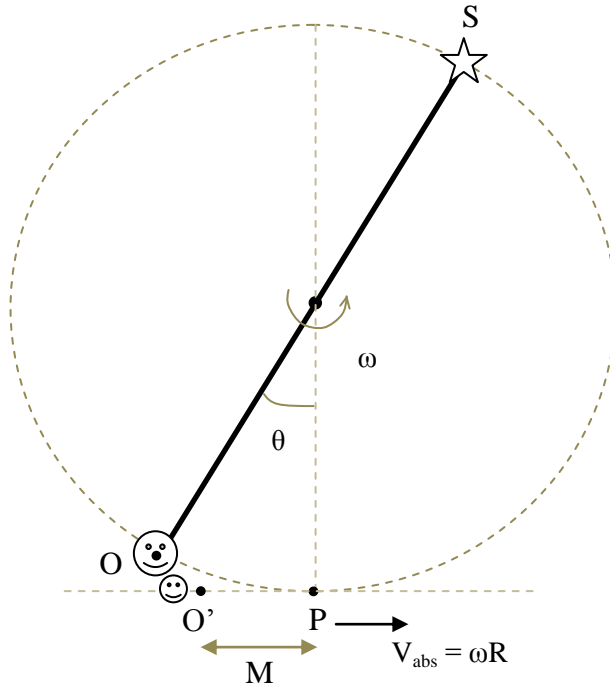

Suppose that the source emits a photon at  $t = 0$  at the position shown, when the observer is at point O. We start by assuming that the observer O will detect the light at point P. Therefore, observer O will be moving with absolute velocity  $\omega R$  to the right as he is just passing through point P. According to the general procedure we introduced already, we find an imaginary inertial observer O' who will arrive at point P simultaneously with observer O and who is moving with the same velocity ( magnitude and direction ) as the instantaneous velocity of observer O at point P , which is  $\omega R$  to the right . Therefore, observer O' will have a constant velocity  $\omega R$  to the right.

The time taken for observer O to move from point O ( his position at  $t = 0$  ) to point P is the same as the time taken by the imaginary inertial observer O' to move from point O' to point P. O' is the position of observer O' at  $t = 0$ .

We first get the expression of the time taken by observer O to move from point O to point P.

$$t = \frac{\left( \frac{2\pi R\theta}{360} \right)}{\omega R}$$

Next we get the expression for distance from O' to P, i.e. the position of imaginary inertial observer O' at the instant of light emission, denoted as length M in the figure above.

$$M = (\omega R)t$$

Once we get the expression for the location of the imaginary inertial observer at the instant of light emission, we attach a reference frame  $(x', y')$  to  $O'$ , with  $+x'$  axis parallel to the direction of the velocity of observer  $O'$ . We then define the *physical* positions and velocities of all components of the experimental setup in the optical path in the  $(x', y')$  reference frame. In this case, there are no mirrors and beam splitters and the only component of the experimental apparatus other than the observer  $O$  is the source  $S$ . For the source, we need only to find its location in the reference frame of imaginary observer  $O'$ , at the instant of light emission. Therefore, for the source, all we need is its initial position at  $t = 0$  in the inertial frame. We don't need to define its motion because, once the source emits light, its motion is irrelevant. We don't need the velocity of the source at the instant of emission or afterwards. However, for all other parts of optical experiments except observer  $O$ , which are mirrors and beam splitters, we need to define their positions and motions in the inertial frame.

Then we determine the *apparent* position of the source relative to the inertial frame of imaginary observer  $O'$ , which is always assumed to be at the origin. As before, the apparent position of the source is obtained by Apparent Source Theory, by using the physical position of the source in the frame of inertial observer  $O'$ . Note that what apparently changes position in the imaginary observer's frame is the *point of emission*, not the physical source itself. This means we use Apparent Source Theory only to determine the apparent point of emission.

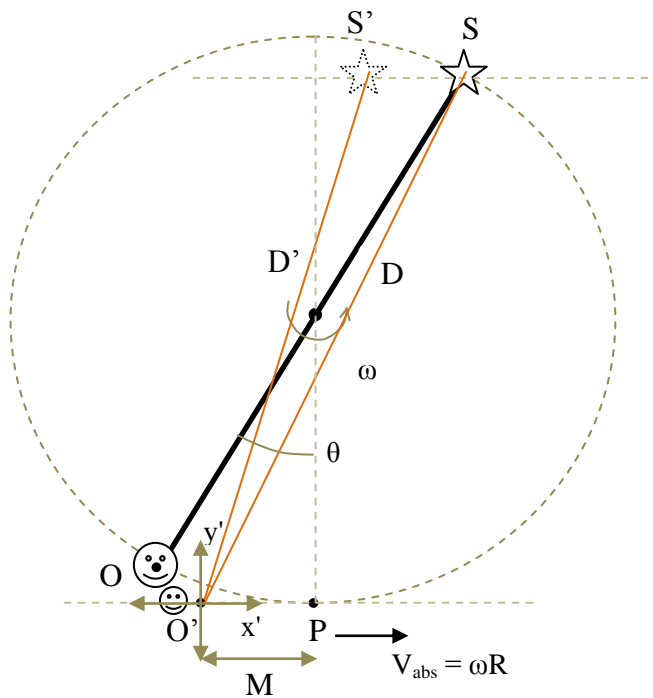

Then the problem is analyzed in the reference frame of imaginary inertial observer  $O'$ , to get the expression for the time delay of light from emission by the source to detection by the observer  $O'$ , i.e. the time of flight.

This expression is equated with the expression for time taken by observer  $O$  to move from point  $O$  to point  $P$ , which is:

$$t = \frac{\left( \frac{2\pi R\theta}{360} \right)}{\omega R}$$

The solution of this equation will give the value of  $\theta$ , from which time of flight  $t$  can be obtained, which in turn will enable the determination of path and path length of light detected by observer O. Note that the time  $t$  determines the time of flight of the light pulse, which is the group delay, whereas the *path length* determines the *phase* of light observed by O.

$$\text{phase of detected light relative to emitted light} = \Delta\phi = 2\pi f * \frac{\text{path length of light}}{\text{the phase velocity of light (c)}}$$

The same procedure can be followed if, for example, a mirror co-moving with the source and observer is added to the experiment, as shown below. Note also that the group velocity of light reflected from a moving mirror will acquire a component of the velocity of the mirror ( ballistic hypothesis ). Ballistic hypothesis is correct only for the *group* velocity of light reflected from a moving mirror. The group velocity of light is independent of the source velocity, but depends on mirror velocity.

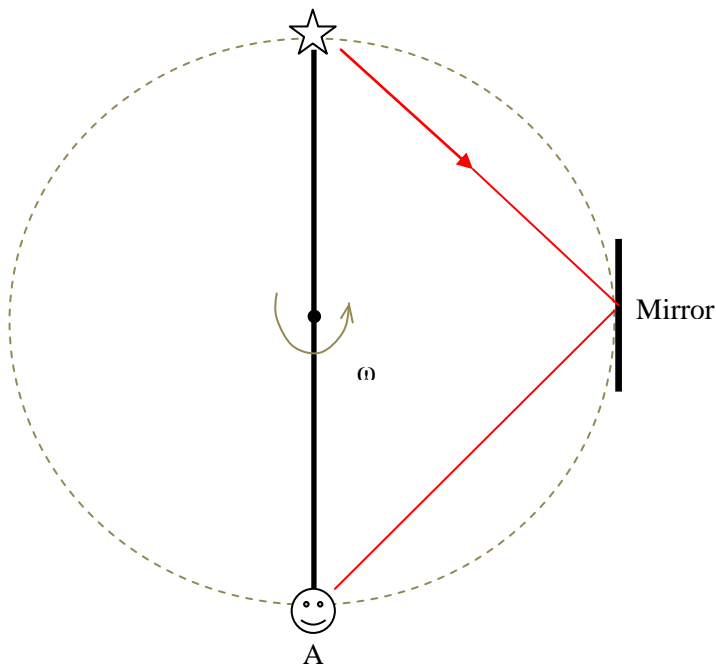

The Sagnac effect is analyzed with the same basic procedure.

Suppose that light is emitted by the source at the position of the apparatus shown below. As before, we start by assuming that the accelerating observer O will detect the light at the instant that he is just passing through some point P, at which his absolute velocity is  $\omega R$  to the right.



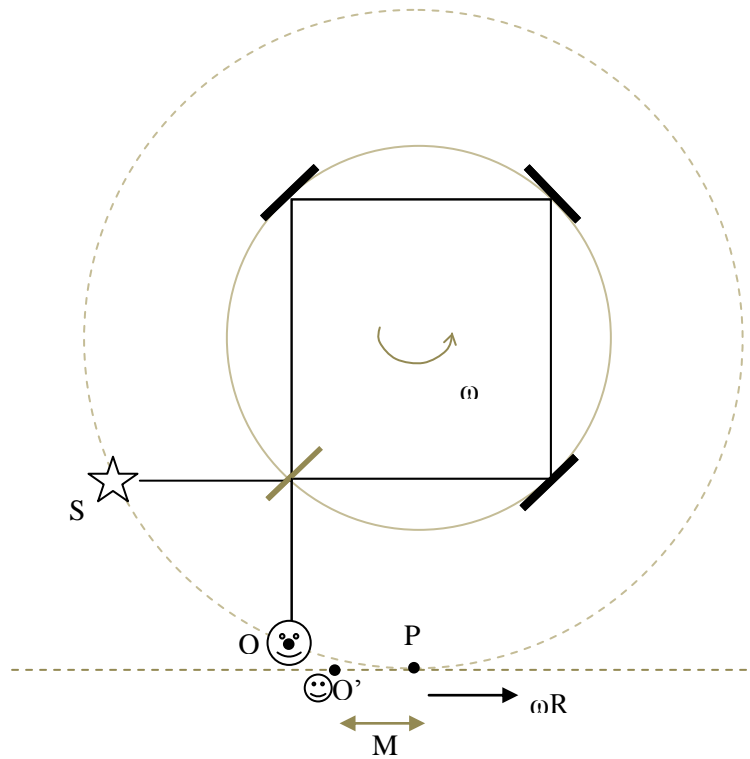

First we get the expression of the time  $t$  required for the observer O to move from its current position, point O, ( position at instant of light emission,  $t = 0$  ) to point P. This will be the length of arc OP divided by the tangential velocity of the observer.

Then we find the position of an imaginary inertial observer O' who will be just passing through point P at the same instant of time as observer O, and who has the same velocity as the instantaneous velocity of observer O at point P, which is equal to  $\omega R$  to the right.

Therefore, for imaginary observer O' to arrive at point P simultaneously with observer O, observer O' should be at a distance of:

$$M = \omega R * t$$

from point P at the instant of light emission (at  $t = 0$  ), where  $t$  is the time taken by observer O to move from point O to point P.

We then attach a reference frame  $(x', y')$  to inertia observer O', with observer O' at the origin and with +x axis parallel with the velocity vector of observer O'. Then the positions and motions of the mirrors and the beam splitters are defined in the  $(x', y')$  reference frame. We then determine the apparent position ( $S'$ ) of the source relative to observer O' (i.e. relative to the origin of  $(x', y')$  ), by applying Apparent Source Theory for inertial observers. By assuming that

light is emitted from  $S'$ , and by taking into account the positions and motions/velocities of the beam splitter and the mirrors, we determine the expression for the time  $t$  taken for light to travel from source to observer  $O'$ . Note that we assume that the phase velocity of light is always constant, whereas the group velocity varies with mirror velocity. Once the expression for the time  $t$  is obtained, we equate it with the expression for  $t$  we obtained earlier, which was the time taken by observer  $O$  to move from point  $O$  to point  $P$ . Solving the resulting equation enables the determination of time  $t$  and the path and path length of light. The phase of the detected light is determined by the path length, whereas the time of flight will be the time  $t$  itself.

In this procedure, note that we analyze the problem from the perspective of imaginary inertial observer  $O'$ . We determine the time of flight of light observed by observer  $O'$ . We solve the problem for imaginary observer  $O'$ , and not for real observer  $O$ . Since  $O$  and  $O'$  will detect the light simultaneously at the same instant, solving the problem for observer  $O'$  will automatically solve the problem for observer  $O$ . When we say that we define the positions and motions of the mirrors and the beam splitter in the reference frame of the imaginary observer, we mean all parts except the accelerating observer  $O$ . We don't need to define the position and motion of the accelerating observer in the inertial frame because the accelerating observer will not affect the path of light and his/her position and motion in the inertial frame is not relevant. There is also a distinction regarding the source. We only need to locate the apparent point of emission, by using actual/physical position of the source at the instant of emission. Afterwards, the position and motion of the source is not relevant. Even at the instant of light emission, we need to know only the physical *position* of the source; the velocity of the source is not relevant at the instant of emission. For mirrors, beam splitters and other parts, we need to define their positions and motions in the reference frame of imaginary observer  $O'$ .

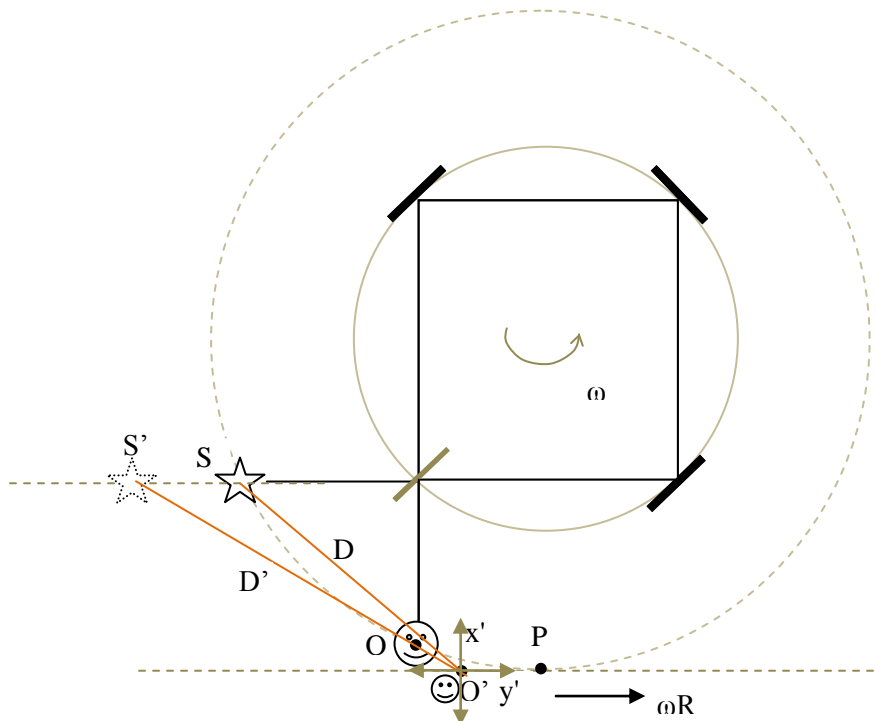

Therefore, we are analyzing the problem in the reference frame of an imaginary inertial observer  $O'$  who is moving with velocity of  $\omega R$  to the right. It is as if the Sagnac device is translating to the left ( relative to reference frame  $(x', y')$  ) and rotating at the same time.

We will not undertake the quantitative analysis in this paper. However, we will see if this theory predicts the behavior of light in Sagnac's experiment, qualitatively.

We have stated that the Sagnac effect should be analyzed in the reference frame of an inertial observer moving with velocity  $\omega R$  to the right, in the present case. Thus, the Sagnac apparatus is not only rotating in this reference frame, but also translating with velocity  $\omega R$  to the left.

Therefore, there will be a combination of translational and rotational motions. The question is, can we ignore the translational motion of the device and only deal with the rotational motion, which would simplify the problem?

As we have stated above, once we have defined the positions and motions of the mirrors and the beam splitter and determined the apparent point of emission ( apparent past position of the source) in the reference frame of the imaginary inertial observer  $O'$ , we simply use conventional emission theory to analyze the path, path length and time of flight of light, in which only the group velocity ( not the phase velocity ) of light is relevant. Phase of the observed light is determined from the path length and frequency of observed light. But the path length is determined by using group velocity. According to conventional emission theory, the speed of light varies with source and mirror velocity. However, conventional emission theory is wrong regarding the dependence of light speed on source velocity. It is also wrong regarding the phase velocity of light, which I have proposed to be an absolute constant in vacuum, irrespective of source, mirror, and observer velocity. However, emission theory is correct with regard to group velocity of light and mirror velocity: the *group* velocity of light varies with mirror velocity.

Therefore, even though conventional emission theory is wrong in general, we will use it in analysis of light speed experiments, as introduced in this paper, because we use only its correct feature.

In the case of Sagnac effect, we can use emission theory for the analysis which involves only group velocity. Once we have determined the apparent point of emission in the inertial imaginary observer's reference frame, the motion of the source is irrelevant. The motion of the source is relevant only to determine the Doppler effect on observed light, for source and observer in relative motion. Since in the Sagnac experiment the path length of light is not changing, Doppler effect does not exist. Once we have determined the apparent past position of the source ( apparent point of emission ) we can put an imaginary source that is at rest in that inertial frame, at that point. Therefore, since the *apparent* source (apparent point of emission ) is at rest in the inertial frame, we can say that the speed of light is constant relative to the *apparent* source. I mean that emission theory is correct for a stationary source. It fails only for a moving source.

Therefore, for our purpose, since we are not considering the motion of the source, we can use emission theory of light for group velocity of light. In other words, emission theory fails only when the source starts moving and our imaginary source is stationary in the inertial observer's reference frame, fixed at the apparent past position of the source.

Going back to our earlier question regarding the effect of translational motion on Sagnac effect, we have reduced the problem of Sagnac effect to a simpler problem as follows. We can consider the inertial observer's frame as an absolute reference frame in which a light source is at rest but the mirrors and the beam splitter are in translational and rotational motions, i.e. the Sagnac apparatus is being translated as a whole while rotating at the same time.

As we have discussed above, therefore, we can apply emission theory to analyze the Sagnac experiment because the apparent source is at rest ( in this case the apparent source is the apparent point of light emission ). In any inertial reference frame in absolute motion, the *apparent source* is the apparent *point* of light emission in that reference frame. For an observer at absolute rest, the apparent point of emission is the same as the actual point of emission. So, in this case the source is the (actual) point where light was emitted, which is fixed (not moving) in that reference frame. For an observer in inertial absolute motion, the (apparent) source is the *apparent fixed point of emission* in that observer's reference frame. In all cases, the source is the fixed point in that inertial frame where light was actually or apparently emitted. The point here is that the source (or apparent source) is a *point* in an inertial frame, which is fixed.

Therefore, since a *source* ( as a *point* of light emission ) cannot be moving, we can apply emission theory to analyze the Sagnac effect that is in both translational and rotational motions at the same time.

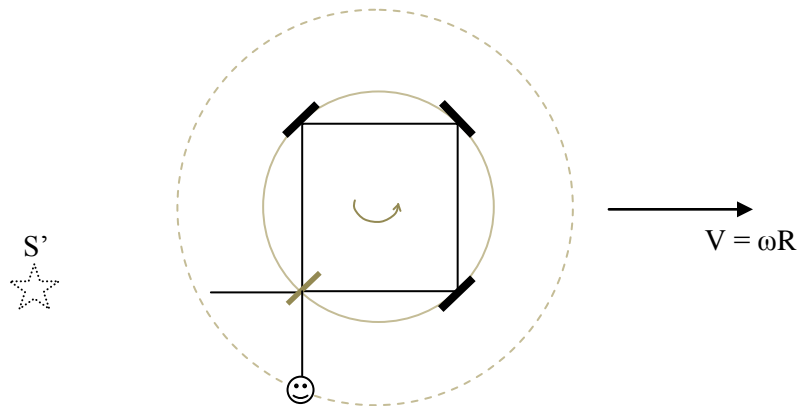

$S'$  , which is the apparent point of emission, is at rest, so the speed (group velocity ) of light emitted by the source is equal to  $c$  in the inertial reference frame in which the device is translating, until it hits the beam splitter. Once the light hits the beam splitter and the mirrors, it

will attain a component of the translational velocity of the whole device. Therefore, once the light beam hits the mirrors, it almost behaves as if it came from a co-rotating imaginary source located on the apparatus so that it directs light with the same angle and towards the same point on the beam splitter and the mirrors, but relative to which the speed of light is  $c + V$ , which is the velocity of light coming from the source relative to an observer sitting on the beam splitter. So we have reduced the problem to conventional emission theory, according to which the *time of flight* of the two counter-propagating light beams is (almost ? ) equal. So for the purpose of analysis, we can apply conventional emission theory in which the speed of light varies with both source and mirror velocity.

Therefore, even according to emission theory, even though the clockwise propagating and counterclockwise propagating *groups* will arrive simultaneously at the observer ( both will have equal times of flight ), the path lengths of the two beams differ. In the above diagram of counterclockwise rotating Sagnac device, the counter clockwise propagating light will have to travel larger distance than the clockwise propagating light. This means that the path lengths of the two light beams is different.

Since we have stated that the phase of observed light is determined only by the frequency and path length of light, and not by time of flight, we conclude that the Sagnac experiment will give a fringe shift.

In effect what we have seen is that absolute motion has little effect in the Sagnac effect. The only effect of absolute motion of the observer in the above analysis is to create an apparent change in past position of the light source ( i.e. apparent point of emission ). We can see that this has little effect on the fringe shift because it will affect both light beams almost equally.

Therefore, Sagnac effect is almost not a result of absolute motion, but a consequence of the distinction between phase velocity and group velocity of light. It is a consequence of the dependence of group velocity on mirror velocity and the absolute constancy of the phase velocity. Even though the two light beams arrive (almost) at the same time at the observer, their path lengths are different and this is what gives rise to a fringe shift.

*The Sagnac effect is a result of acceleration, not absolute motion*[8].

## 5. Apparent Source Theory for electrostatic, magnetic and gravitational fields

So far in this paper we have applied Apparent Source Theory to light and electromagnetic waves. In this section we will see the application of AST to static electrical, magnetic and gravitational fields.

### Absolutely co-moving charge and observer

Consider absolutely co-moving charge  $Q$  and an observer  $O$ , both on a common platform, initially at rest. While both are at rest, radial, straight electric lines of force emanate from the charge. Imagine that the charge and observer instantaneously accelerate from rest to a common absolute velocity  $V_{\text{abs}}$ .

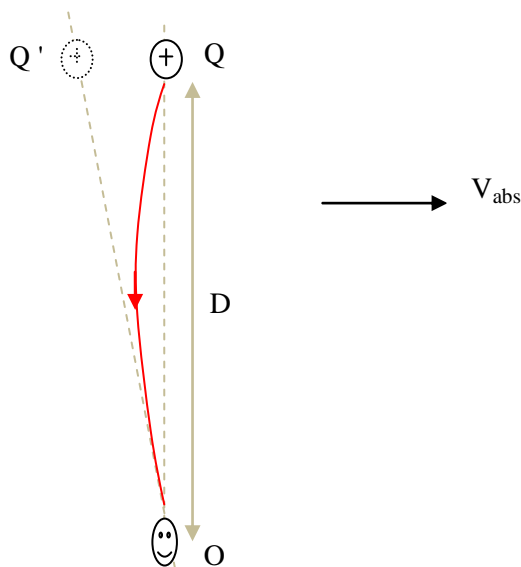

The new theory proposed here is that the observer detects the absolute velocity instantaneously, as there will be an instantaneous apparent change in the position of the charge relative to the observer. The observer detects the change in state of motion of the platform instantaneously, but the position of the charge changes apparently. To the observer, the electric lines of force come from apparent charge  $Q'$  and not from the physical charge  $Q$ . It is *as if* electrostatic field propagated at the speed of light, and yet, at the same time, the observer detects change in state of (absolute) motion of the co-moving charge instantaneously.

For absolutely co-moving charge and observer, the line of force will be bent, creating an apparent change of position of the charge, as shown above.

We state the above theory more fundamentally as follows: *the electric lines of force emanating from an absolutely moving charge bend, as seen by co-moving observer. Only lines of force*

emanating from a charge at absolute rest are straight lines. There will be aberration of static fields even for absolutely co-moving charge and observer.

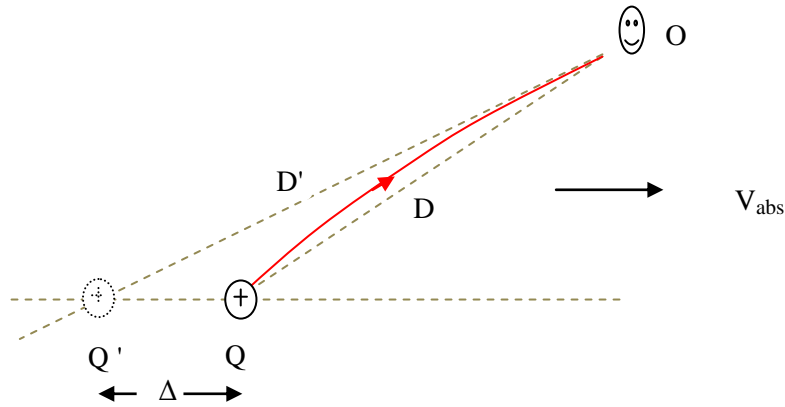

The apparent change in position of a light source depends on the speed of light. In this case, it is *as if* the electrostatic field was 'propagated' at the speed of light. Actually there is no propagation.

The apparent change in position of the charge is determined from the following equation:

$$\frac{D'}{c} = \frac{\Delta}{V_{abs}} = \frac{|\mathbf{D}' - \mathbf{D}|}{c}$$

where  $\mathbf{D}$  and  $\mathbf{D}'$  are written in bold to denote vector quantities.

The above notation *seems* to mean that during the time that the field 'propagates' from position Q' to observer O, the charge moves from position Q' to position Q. This is only apparent, however. There is no propagation of static fields.

The precise formulation of Apparent Source Theory for static fields is the same as for light, except that the formulation is the same both for inertial and non-inertial observers in the case of static fields.

The effect of absolute motion for an absolutely moving (inertial or non-inertial) observer is to create an apparent change in the position of the source (an electric charge, magnet, or mass) in the reference frame of the observer.

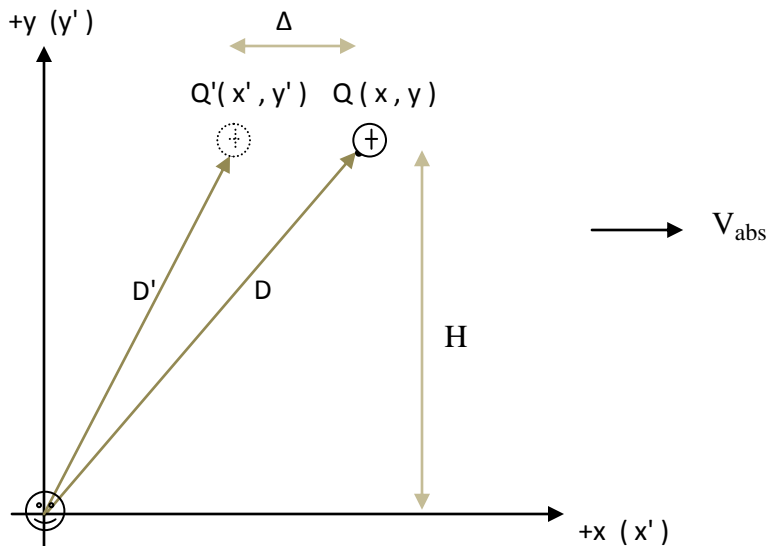

The apparent change in charge position is given by following equations:

$$\sqrt{x'^2 + y'^2} = \frac{-\left(2x \frac{V_{abs}}{c}\right) + \sqrt{\left(2x \frac{V_{abs}}{c}\right)^2 + 4\left(1 - \frac{V_{abs}^2}{c^2}\right)(H^2 - x^2)}}{2\left(1 - \frac{V_{abs}^2}{c^2}\right)}$$

$$y' = y$$

Thus, relative to an absolutely moving observer, a charge at point  $(x, y)$  appears to be at  $(x', y')$ . This means that, to the observer, it appears as if the electric lines of force are coming from  $Q'$ , not from  $Q$ . The larger the absolute velocity of the observer, the larger the apparent change in charge position.

The same applies to all sources of static fields: gravitational, magnetic.



## Apparent Source Theory and the magnetic field

The application of Apparent Source Theory to static magnetic fields has been a problem which has been difficult to understand and solve for a long time. The questions are: what is the *source* in the case of magnetic field ? Is a moving charge source of magnetic field? If so, then relative to what is the velocity of the charge defined ? Is it absolute velocity or relative velocity of the charge that we use in the Biot-Savartlaw ? If we use absolute velocity, how does Apparent Source Theory apply to a moving charge as a *source* of static magnetic field?

One objection I thought is that if absolute velocity of a charge was to be used in the determination of magnetic forces between two co-moving current carrying coils, therefore change in orientation of the experimental setup in space would result in significant change in the force of interaction. Given the Earth's absolute velocity of 390 Km/s, the effect would be significant. But no such effect has been observed or reported. However, this argument is wrong because the current carrying coils are electrically neutral, so the coils will not create any magnetic field even if we consider their absolute velocity. The magnetic field created by the positive charges will be canceled by the magnetic field created by the negative charges, for each coil.

Let us consider another problem. Assume a charged ball suspended by a string near a permanent magnet.

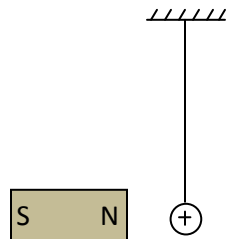

If absolute velocity was to be used in the determination of magnetic field, then, although the charge and the magnet are at rest relative to each other, the charge would be attracted to or repelled from the magnet because of the absolute velocity of the charge which is about 390km/s and this force would change with change in orientation of the experimental setup in space. But no such effect has been observed. Again this argument is wrong because, since the magnet is neutral, it will not create any magnetic field due to its absolute motion.

It is tempting to conclude that it is relative velocity of the charge and not absolute velocity that is to be used. This means that it is the velocity of the charges relative to the current carrying coil that is to be used. Biot-Savartlaw, therefore, is to be redefined to apply only in the reference frame of the current loop. Although this idea seems to be promising at first, it will also lead to

difficulties. One difficulty would be how to explain the interaction between charges moving in space, which it is believed that magnetic interaction occurs between them, even though these charges are not moving in a coil but freely in space.

These problems led me to question the classical view that a moving charge is the *source* of magnetic field. The question follows: strictly what is the *source* in the case of the static magnetic field? We know that the electric charge is source of electrostatic field and massive objects are sources of gravitational field.

Let us first consider the idea that a moving charge is not strictly source of magnetic field. Let us assume that the source of magnetic field is a current loop. Biot-Savart law should be applied to a charge moving in the current loop. This means that only a moving charge in a current loop is the source of magnetic field. Thus a moving charge that does not form a current loop would not create magnetic field.

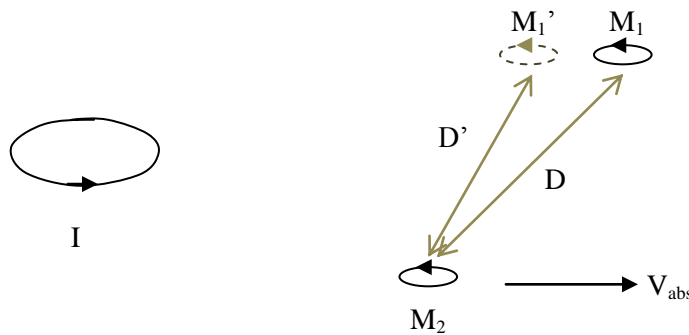

However, this idea is wrong because it is known from experience that lightning current is known to deflect magnetic needle.

The classical view that a moving charge is source of magnetic fields also made it difficult to apply AST for magnetic fields. It was not clear how to apply AST to a moving charge as a *source* of magnetic field.

It was also tempting to reduce the magnetic field to electric field by applying Apparent Source Theory. I could not explain the force between two current carrying conductors by applying AST.

With this view that only current loops create magnetic fields, Apparent Source Theory can now be applied also for magnetic fields.

It is not clear how to formulate Apparent Source Theory for magnetic fields with the conventional view that a moving charge is the source of magnetic field. The problem is that the concept of a source in AST implies a *point*, which is the center where electrical and magnetic

effects originate in every direction. In the case of a moving charge, the source is not a *point* but a *line*, for which Apparent Source Theory is not applicable.

There is a fundamental problem with classical electromagnetism from the perspective of Apparent Source Theory. According to classical physics, the force between two moving charged particles is determined in a reference frame in which they are moving. According to Apparent Source Theory, the force acting on charge Q1 by another charge Q2 is always determined relative to (as seen by) Q1, which is the 'observer', in the case of electrostatics. However, in the case of classical magnetic fields, the force is determined relative to (as seen by) a third observer. This is a fundamental difference between Apparent Source Theory and classical electromagnetism. In AST, the *observer* is the charge or the current loop which is acted upon by another charge or current loop, respectively.

The view of a moving charge as a *source* of magnetic field does not conform to the view of Apparent Source Theory explained above. An electric charge is an intrinsic property in electrostatics. There is no such corresponding intrinsic property or 'charge' for magnetism in classical electromagnetism. Strictly, what is the source of magnetic field? A charge? No. A moving charge? But motion is not an intrinsic property.

Despite the above arguments, the belief that there is magnetic force between charges moving freely in space contradicts the above view that only current loops are sources of magnetic field.

These thoughts have been presented to show the vagueness of classical electromagnetism regarding magnetic fields and its inadequacy from the perspective of Apparent Source Theory.

The difficulties one faces regarding classical magnetic field theory makes one oscillate between two ideas: Biot-Savart's law should be used in the absolute reference frame or in the reference frame of the current carrying coil and the magnet.

I have made an attempt to resolve this difficulty as follows.

We identify two kinds of objects regarding magnetic fields: objects with intrinsic magnetic property and objects with no intrinsic magnetic property. By 'intrinsic' we mean a property of the object to create magnetic field even when it is at absolute rest. A permanent magnet and a current carrying coil are objects with intrinsic magnetic property because a magnet or a current carrying coil has magnetic field even when at absolute rest. An electron or an ion, on the other hand, is an object without intrinsic magnetic property because it does not have a magnetic field around it when it is at absolute rest.

We propose that only objects with intrinsic magnetic property can produce a magnetic field. If an object does not have a magnetic field when it is at absolute rest, then it cannot be a source of magnetic field. This means that (absolute) motion cannot cause magnetic field. Like electric field of an electron, magnetic field is an intrinsic property of an object. Therefore, a freely moving

electron cannot be a source of magnetic field because it does not have a magnetic field when at absolute rest.

Magnetic field is attached to objects with intrinsic magnetic property the same way electric field is attached to an electron. This means that the magnetic field of a permanent magnet (or a current carrying coil ) will move with the magnet ( or the current carrying coil ) when it is in absolute motion. However, this statement should be qualified as follows. For an observer at absolute rest, the magnetic field of an absolutely moving magnet originates and moves with the magnet. However, for a co-moving observer the magnetic field moves with the magnet but there will be an apparent change in position of the magnet as seen by the observer. This means that the magnetic field appears to come from the apparent magnet.

This means that the absolute velocity of the coil will not be added to the velocity of the electrons in determining the magnetic field. Absolute motion has an effect, but this effect is only an apparent change in position of the coil relative to the observer. This is the same effect discussed already regarding co-moving charge and observer: the effect of absolute motion for co-moving charge and observer is to create an apparent change in position of the charge relative to the observer. Thus Biot-Savart law applies to the *apparent coil*.

The magnetic force between two current carrying coils is determined by the Biot-Savart's law and the Lorentz's law , when both coils are at absolute rest. In other words, Biot-Savart's law applies only when both current carrying coils are at absolute rest. However, when the two coils are co-moving with a certain absolute velocity, the effect of absolute motion is just to create an apparent change in position of each coil as seen by the other coil. The profound finding in this paper is that absolute velocity does not enter in the Biot-Savart's law. The effect of absolute motion is only to create an apparent change in the position of each coil as seen by the other coil. Once the real current coil is replaced by an apparent current coil, Biot-Savart's law can be applied directly to the apparent coil.

Although the above argument is sound, I find that it serves only as a guide to point out the flaws in classical electromagnetism; it explains only what magnetic field is not: it does not explain what magnetic field is. It leads to deep conceptual problems. There is no question that the electric field of an electron is attached to and moving with the electron. However, claiming that the magnetic field is attached to its source ( coil or magnet ) will lead to a difficult question: why should the magnetic field be attached to the source ? Why should the electrons moving in the conductor act differently from electrons moving freely in space ?

I have struggled for years to understand and explain magnetism in terms of Apparent Source Theory. I have never been comfortable with the concept of magnetic field as a fundamentally separate phenomenon from (albeit linked to) electric field. I sought to reduce magnetism to a form of electric phenomenon, in terms of AST, without success.

## Relation between Weber's formula and Apparent Source Theory

It was in the midst of this difficulty that I have come across a paper [10] recently. In this paper, Weber's ( and Gauss's ) formula, which is a modification of Coulomb's law of electrostatic force between two charges, is shown to explain Ampere's law of magnetic field and Faraday's law of induction, thus eliminating the concept of magnetic field.

The Weber's formula is given by :

$$F = \frac{Q_1 Q_2}{4\pi\epsilon_0 r^2} \left[ 1 + \frac{u^2}{c^2} - \frac{3\dot{r}^2}{2c^2} + \frac{\vec{r} \cdot \vec{a}}{c^2} \right]$$

where  $u$  is the relative velocity of the charges,  $r$  is the distance between the charges,  $\dot{r} = \frac{dr}{dt}$

is the rate of change of distance between the charges,  $a$  is the relative acceleration of the charges.

Assuming that this formula correctly explains much of classical electromagnetism, naturally the next step would be to figure out how it is related to Apparent Source Theory.

There is one phenomenon that cannot be explained by the Weber's formula : the Biefeld- Brown effect. For two absolutely co-moving charges, the above formula reduces to Coulomb's law and therefore does not predict the Biefeld-Brown effect, which is one of the profound predictions of Apparent Source Theory.

Therefore, the logical question is how to modify the Weber's formula so that it can predict the Biefeld-Brown effect. In the previous version of this paper, I tried to combine Apparent Source Theory with the Weber formula by using the apparent distance between the charges instead of the actual distance in the Weber's formula.

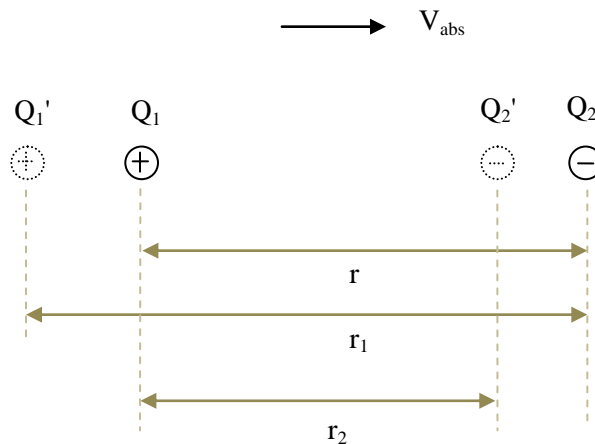

Therefore,

$$F_{21} = \frac{Q_1 Q_2}{4\pi\epsilon_0 r_1^2} \left[ 1 + \frac{u_1^2}{c^2} - \frac{3 r_1^2}{2 c^2} + \frac{\vec{r}_1 \cdot \vec{a}_1}{c^2} \right]$$

where  $F_{21}$  is the force on  $Q_1$  due to  $Q_2$ ,  $r_1$  is the apparent distance of  $Q_2$  as seen by  $Q_1$ ,  $u_1$  is the relative velocity of  $Q_2$  as seen by  $Q_1$  and  $a_1$  is the relative acceleration of  $Q_2$  as seen by  $Q_1$ .

The apparent distance of  $Q_2$  as seen by  $Q_1$  is given by :

$$r_1 = \frac{c}{c - V_{abs}} r$$

Likewise,

$$F_{12} = \frac{Q_1 Q_2}{4\pi\epsilon_0 r_2^2} \left[ 1 + \frac{u_2^2}{c^2} - \frac{3 r_2^2}{2 c^2} + \frac{\vec{r}_2 \cdot \vec{a}_2}{c^2} \right]$$

where  $F_{12}$  is the force on  $Q_2$  due to  $Q_1$  and  $r_2$  is the apparent distance of  $Q_1$  as seen by  $Q_2$ ,  $u_2$  is the relative velocity of  $Q_1$  as seen by  $Q_2$ , and  $a_2$  is the relative acceleration of  $Q_1$  as seen by  $Q_2$ .

The apparent distance of  $Q_1$  as seen by  $Q_2$  is given by :

$$r_2 = \frac{c}{c + V_{abs}} r$$

For  $V_{abs} \ll c$ ,  $r_1 = r_2 = r$  and the above formulas reduce to Weber's formula.

However, now I have realized that the above modification of Weber's formula is wrong. This is because in electromagnetism, unlike for example classical waves, there is no 'mixing' between absolute motion and relative motion effects. This has already been observed in the Ives-Stilwell experiments in which no effect of Earth's absolute velocity has been observed, as explained in my paper [12]. In the Weber's formula, only the first component, that is Coulomb's law, will be affected by absolute motion. The other three components are based on relative motion only and will not be affected by absolute motion.

Therefore, if we consider two charges  $Q_1$  and  $Q_2$ , each of them having independent absolute velocities, and if the two charges are also in relative motion, the electric force between them is determined independently both by Apparent Source Theory and Weber's theory.

The corrected formulas are as follows.

$$F_{21} = \frac{Q_1 Q_2}{4\pi\epsilon_0 r_1^2} + \frac{Q_1 Q_2}{4\pi\epsilon_0 r^2} \left[ \frac{u^2}{c^2} - \frac{3\dot{r}^2}{2c^2} + \frac{\vec{r} \cdot \vec{a}}{c^2} \right]$$

where

$$r_1 = \frac{c}{c - V_{abs}} r$$

and

$$F_{12} = \frac{Q_1 Q_2}{4\pi\epsilon_0 r_2^2} + \frac{Q_1 Q_2}{4\pi\epsilon_0 r^2} \left[ \frac{u^2}{c^2} - \frac{3\dot{r}^2}{2c^2} + \frac{\vec{r} \cdot \vec{a}}{c^2} \right]$$

where

$$r_2 = \frac{c}{c + V_{abs}} r$$

Note that in the above formulas  $r$ ,  $u$  and  $\dot{r}$  and  $a$  are the actual/physical, not apparent, distance, relative velocities, rate of change of distance and acceleration, respectively.

### **The Trouton Noble experiment**

The Trouton-Noble experiment was performed to detect the motion of the Earth relative to the ether. Charges  $Q_1$  and  $Q_2$  are in absolute motion, each of them creating a magnetic field through which the other charge is moving and hence subjected to Lorentz's force, creating a torque which will tend to orient the line connecting the two charges perpendicular to the direction of absolute motion.

It has been reported by Trouton and Noble that no rotation of the charge system was observed upon application of high voltage.

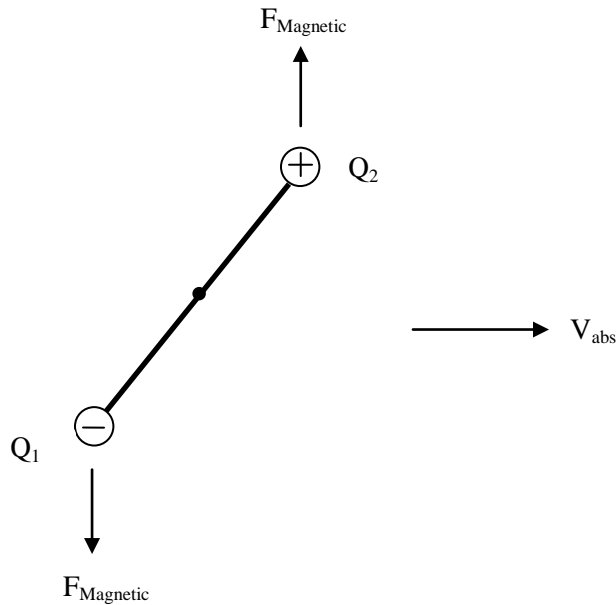

Trouton and Noble reported a null result, that no torque was observed. However, in a recent experiment [9] a positive result was observed and it has been proposed that the original Trouton-Noble experiment gave a null result because the capacitors were put in an electrostatic shield, possibly shielding the capacitors from any absolute motion effect.

According to the modified Weber's formulas above, there is no relative velocity between the charges, so  $u_1 = u_2 = 0$  and  $dr_1/dt = dr_2/dt = 0$  and  $a_1 = a_2 = 0$ .

Therefore,

$$F_{21} = \frac{Q_1 Q_2}{4\pi\epsilon_0 r_1^2}$$

and

$$F_{12} = \frac{Q_1 Q_2}{4\pi\epsilon_0 r_2^2}$$

Apparent Source Theory predicts an electrostatic torque caused by an apparent change in position of  $Q_1$  as seen by  $Q_2$  and  $Q_2$  as seen by  $Q_1$ , as shown below.



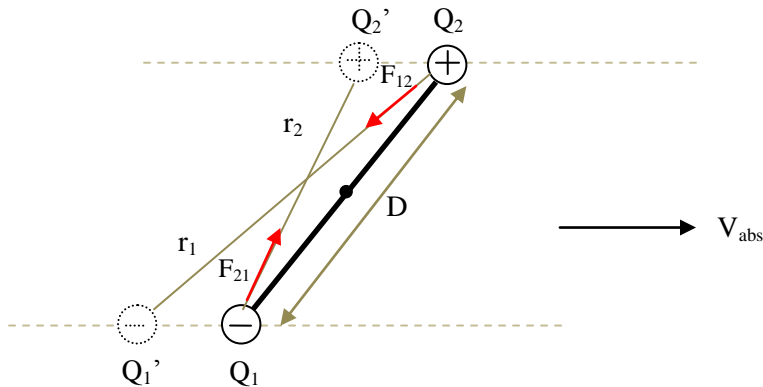

$F_{21}$  is the force of  $Q_2$  on  $Q_1$  and  $F_{12}$  is the force of  $Q_1$  on  $Q_2$ . Although  $F_{21}$  and  $F_{12}$  create opposite torques that will tend to cancel each other, there will be a net torque because the two torques are not exactly equal. This net torque will tend to orient the rod connecting  $Q_1$  and  $Q_2$  perpendicular to the direction of absolute velocity.

### Moving magnet conductor problem

The moving magnet conductor problem, which was one of Einstein's arguments in his special theory of relativity, concerns a permanent magnet and a conductor in relative motion.

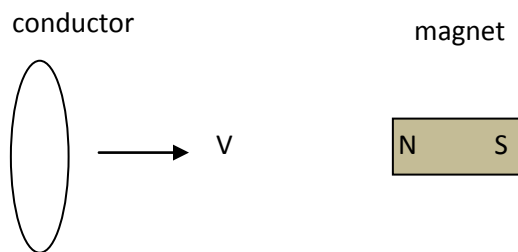

We know that whenever a permanent magnet and a conductor are in relative motion, voltage (and current) will be induced in the conductor. According to classical physics, if the magnet is at rest and the conductor is moving, the electrons in the conductor will be subjected to magnetic force (because of conductor electrons moving in the magnetic field), causing current. If the conductor is at rest and the magnet is moving, electric field will be induced in the conductor (due to rate of change of flux linking the conductor), again causing current. According to classical electromagnetism the current in both cases is the same. If motion is absolute, why are

the currents in the two cases equal ? This motivated Einstein to postulate that absolute motion doesn't exist.

In the previous version of this paper, I have argued that Einstein's argument holds only in the case of either the magnet is at rest or the conductor is at rest, and that Einstein's argument fails in the case of magnet conductor experiment carried out on the Earth because in this case both have not only relative motions, but also common absolute motions. In this case, motion of the conductor would not be equivalent to motion of the magnet.

However, in my previous paper [12] I have already proposed that in electromagnetism, unlike the case of classical waves, there is no mixing of absolute motion and relative motion effects. Therefore, Einstein's argument that motion of the magnet is equivalent to motion of the conductor is correct. The fallacy in Einstein's argument is the conclusion that absolute motion doesn't exist based on this symmetry. The phenomenon of induction is a purely relative motion effect and cannot be used as an argument against absolute motion. Therefore, Einstein's argument only points out an error in classical electromagnetism and should have been used to correct it, and not as an argument against absolute motion.

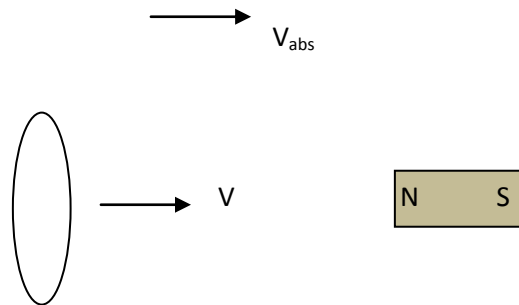

The crucial insight that there is no mixing of absolute motion and relative motion effects for electromagnetism has solved previous confusions.

## Invariance of Maxwell's equations

We have already proposed the constancy of phase velocity of light and hence the invariance of that aspect of Maxwell's equations. What about other aspects of Maxwell's equations? Is Coulomb's law not invariant? What about Biot-Savartlaw?

Consider charges  $Q_1$  and  $Q_2$  both at absolute rest, each of them attached to the two ends of a rod. We know that Coulomb's law applies to determine the electrostatic force of  $Q_2$  on  $Q_1$ .

$$F = \epsilon_0 \frac{Q_1 Q_2}{R^2}$$

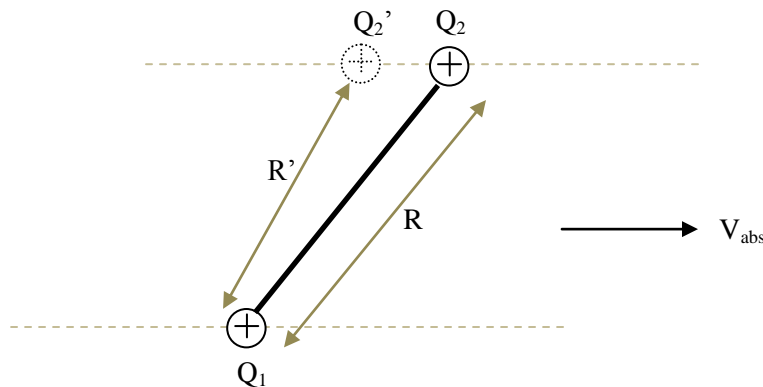

Now suppose that the two co-moving charges start moving with absolute velocity  $V_{abs}$  to the right. According to Apparent Source Theory, the apparent position of  $Q_2$  will change as seen by  $Q_1$ . This means that Coulomb's law no more holds if we take the physical/actual charge  $Q_2$  which is at distance  $R$  from  $Q_1$ . We can apply Coulomb's law only by assuming the apparent position of  $Q_2$ .

Hence Coulomb's law will be:

$$F = \epsilon_0 \frac{Q_1 Q_2}{R'^2}$$

where  $R'$  is a function of  $R$  and  $V_{abs}$ .

By replacing  $R$  by  $R'$ , we have made the form of Coulomb's law invariant. However, from the change in the magnitude and direction of the electrostatic force absolute motion is detected.

So is the Coulomb's law invariant or non-invariant? We can say that Coulomb's law is actually, physically non-invariant, but apparently invariant. It is the 'apparently invariant' interpretation that is fundamental. Therefore, absolute motion exists and yet Maxwell's equations can be invariant. The same theory applies to magnetic fields and gravitational fields.

### Gravity as an electrostatic phenomenon

Gravity is currently thought to be a phenomenon fundamentally different from the electromagnetic field. I had the same view before I realized that gravity is an electrostatic phenomenon.

Let me explain the path to this possible discovery. We know that the Solar System has an absolute velocity of 390 Km/s in space. According to Apparent Source Theory, the light from the Sun appears to come not from the real/physical position of the Sun, but from its apparent position.

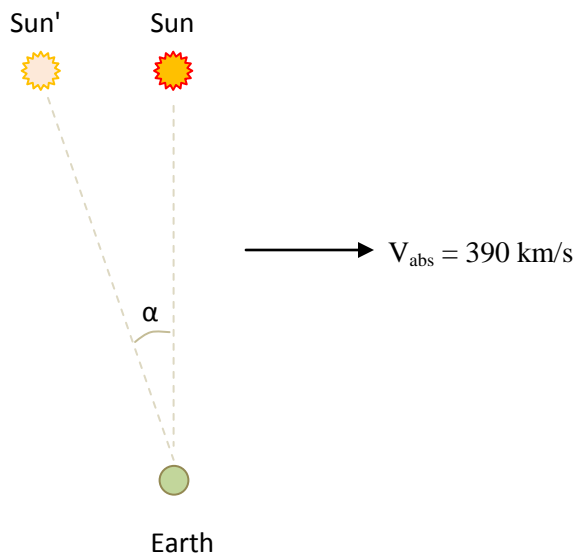

For simplicity, assume that the absolute velocity vector of the Solar System lies in the plane of Earth's revolution around the Sun, which is an almost correct assumption.

The angle  $\alpha$  between the real position of the Sun and its apparent position as seen from the Earth is given by:

$$\alpha = \tan^{-1} \frac{V_{abs}}{c}$$

With  $V_{abs} = 390 \text{ Km/s}$  and  $c = 300,000 \text{ Km/s}$ ,  $\alpha$  is about 268 arc seconds.

Astronomical experiments [11] show that Sun's gravity on Earth is directed almost in the same direction ( except for a 20 arc seconds due to Earth's speed of 30 Km/s around the Sun, causing light aberration, ) as the direction of arrival of Sun light. If gravity was an instantaneous phenomenon, it should come from the direction of the real Sun, not the apparent Sun. This means that the 'speed' of gravity is equal to the speed of light !

At first I thought that this can be a mere coincidence. It never happened to me that this 'coincidence' had a profound implication. Even with this new revelation, I still thought that gravity is a separate phenomenon, fundamentally different from electromagnetism.

It was when I started searching for a theoretical explanation for gravity that this 'coincidence' awakened my curiosity : if gravity is a fundamentally different phenomenon from electromagnetism, why is its speed the same as that of light ?! This led me to the conclusion that gravity is indeed an electromagnetic phenomenon.

Once I reached that conclusion, it did not take me long to figure out that gravitational force is a difference between electrostatic attraction forces and repulsion forces of all the charged particles in objects.

Coulomb's law is modified as follows:

$$F_{att} = \frac{1}{4\pi\epsilon_0} \frac{Q1 \cdot Q2}{r^2} K_{att}$$

$$F_{rep} = \frac{1}{4\pi\epsilon_0} \frac{Q1 \cdot Q2}{r^2} K_{rep}$$

Note that there is nothing propagating in the case of gravity. Gravity simply acts *as if* it propagates at the speed of light.

### **Mercury Planet Anomalous Perihelion Advance**

As we know, Newton's laws of mechanics and gravitation do not predict perihelion advance for a single Sun and single planet system. They predict pure elliptical or circular orbits in such case. However, astronomers in the nineteenth century observed a small residual advance of the perihelion of planet Mercury that could not be explained by Newton's laws. This anomalous effect was much smaller than the total observed perihelion advance, most of which could be explained by Newton's laws.

A scientist by the name Paul Gerber developed a successful explanation by assuming finite speed of gravity, which he assumed to be the speed of light. According to this assumption, Mercury is

not attracted towards the current, instantaneous position of the Sun, but towards the *retarded position* of the Sun, i.e. the position where it was  $t$  seconds ago, where  $t = D/c$ ,  $D$  being the distance between Mercury and Sun  $t$  seconds ago and  $c$  the speed of light. Likewise, the Sun is attracted towards the retarded position of Mercury.

However, the new theory introduced in this paper, i.e. the theory of contraction and expansion of space relative to an absolutely moving observer, makes a prediction opposite to that of Paul Gerber. The new theory suggests that the planet Mercury is attracted towards neither the current, instantaneous position, nor the retarded position of the Sun. Mercury is attracted towards the *advanced* position of the Sun and the Sun is attracted towards the advanced position of Mercury. Note that by ‘advanced’ we don’t mean the actual future position of the bodies, which will be on the circular orbit; it just means a point in front of the Sun ( not behind ) and a point in front of Mercury.

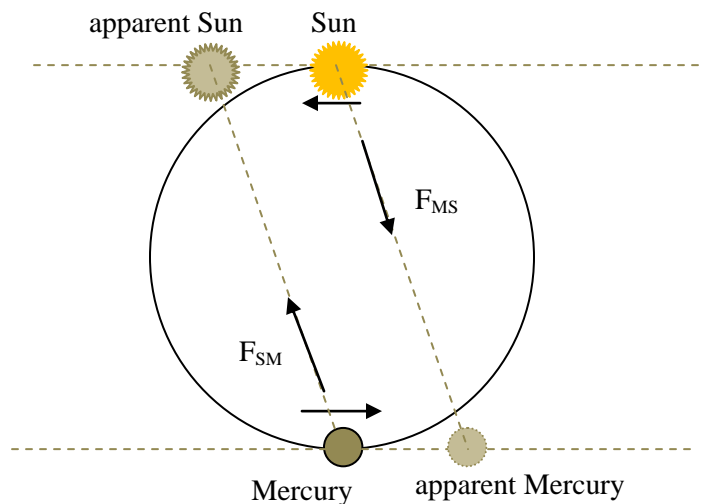

$F_{SM}$  is the gravitational force of Sun on Mercury and  $F_{MS}$  is the gravitational force of Mercury on Sun.

One objection to this view is that this will create a couple which will lead to continuous increase of the velocities of the two bodies, resulting in instability of planetary orbits. However, this argument is based on conventional, simplistic, ‘ether’ view and is fallacious because the system should be seen only from the perspective of the *observer*, which in this case is the Sun or Mercury. There will be no couple from the perspective of Mercury because it is always attracted towards the apparent Sun, so there is no couple between Mercury and the apparent Sun. There is no couple between the real Sun and apparent Mercury also. The two bodies are not orbiting about a single common center, which is the conventional view; Apparent Source Theory revealed that both rotate about their own centers[7].

The resulting orbit is a complicated, continuously changing *instantaneous* but stable orbit. Therefore, calculations based on conventional physics will not give strictly accurate results for planetary orbits; the orbits of planets are more complex than predicted with conventional physics.

The above argument applies only if the Sun and Mercury were attached to the ends of a huge rigid rod, so that they would be forced not to orbit in their complex but stable orbit. In this case, the Sun and Mercury would be constrained to rotate around a single common center, so a couple would arise and accelerate the system, with continuously increasing acceleration. This will clearly violate the principle of conservation of energy, which should no more be considered as a universal principle.

This explanation is based on Apparent Source Theory. If we consider a Sun-Mercury system that is at absolute rest, meaning that the absolute translational velocity of the system is zero, for simplicity, the absolute velocity of the Sun and Mercury is only that resulting from their respective angular velocities in their respective orbits. If the radius of *instantaneous orbit* of Mercury is  $R_M$  and that of the Sun is  $R_S$ , then their respective absolute velocities will be  $\omega R_M$  and  $\omega R_S$ , respectively. We apply the equations of Apparent Source Theory to determine the apparent position of the Sun from the perspective of Mercury and the apparent position of Mercury from the perspective of Sun, as shown below.

As for the quantitative analysis of the value of Mercury perihelion advance based on this theory, I will not undertake that in this paper.

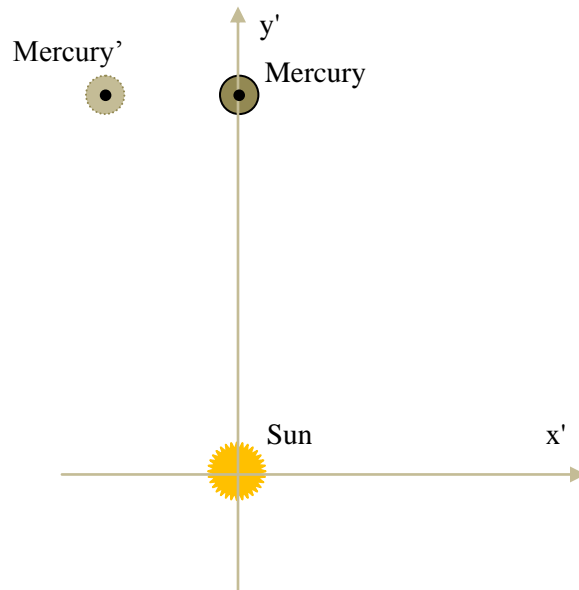
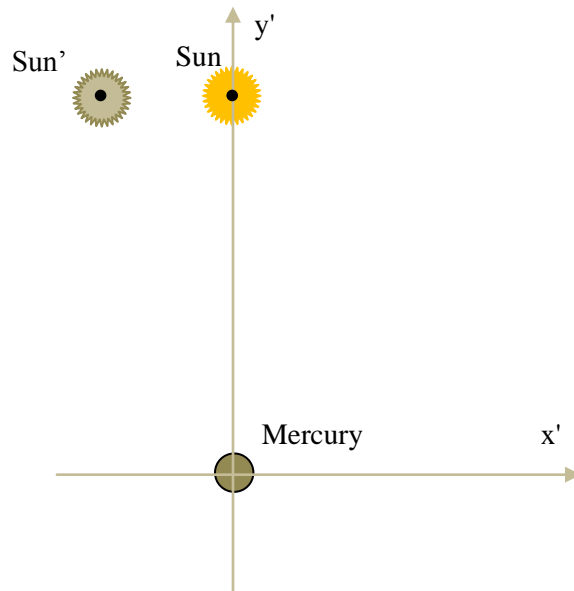



## Modification of Newton's law of gravitation

If gravity is fundamentally an electrostatic phenomenon, therefore, perhaps there may be an analogous Weber's formula for gravitation also:

$$F = G \frac{Mm}{r^2} \left[ K_0 + K_1 \frac{u^2}{c^2} + K_2 \frac{\dot{r}^2}{c^2} + K_3 \frac{\vec{r} \cdot \vec{a}}{c^2} \right]$$

where  $K_0 = 1$

I speculate that the solution to the problems of dark matter, dark energy and Pioneer anomaly may require somewhat modifying Newton's law of gravitation.

For example, the third component with coefficient  $K_2$  may be connected with the phenomenon of dark energy.

From Hubble's law we know that

$$\dot{r} = H r$$

where  $H$  is Hubble's constant.

Therefore,

$$\frac{\dot{r}^2}{c^2} = \frac{(Hr)^2}{c^2} = \frac{H^2 r^2}{c^2}$$

Therefore, the second term of the force  $F$  will be:

$$G \frac{Mm}{r^2} * K_2 \frac{\dot{r}^2}{c^2} = G \frac{Mm}{r^2} * K_2 \frac{H^2 r^2}{c^2} = G \frac{H^2}{c^2} Mm K_2$$

This term is independent of distance  $r$  !

The acceleration due to this term is :

$$\frac{G \frac{H^2}{c^2} Mm K_2}{m} = G \frac{H^2}{c^2} M K_2$$

which is constant.

This may be a hint that this component may be related to dark energy.

## 6. Discussion

The contraction and expansion of space for an absolutely moving observer should be seen only as an apparent phenomenon because it applies only to light sources. More precisely, it is the point of light emission that will apparently change in the reference frame of an absolutely moving inertial observer, not the physical source itself. In other words, light is assumed to be emitted from the apparent past position of the source, not from the actual/physical past position of the source, in the reference frame of an absolutely moving inertial observer. Light acts *as if* it originated from the apparent point of emission, not from the actual/physical point of emission. As we have stated, *source* is the apparent *point* of light emission in the inertial observer's reference frame. This means that *source* is a *point* in the observer's reference frame, not the physical light emitting device. Since a *point* in the observer's frame is fixed, *source* is always fixed relative to the observer (in the reference frame of the observer). This means that the *source* cannot move. Even if the physical source is in motion relative to the observer, the *source* to be used in the analysis of the experiment is a point, an apparent point of light emission and is *always* at rest relative to the observer; a *source* cannot move relative to the inertial observer.

The ballistic behavior of (group) velocity of light reflected from moving mirrors was revealed in the Venus planet radar range data, as analyzed by Bryan G Wallace. The explanation is that once the apparent point of light emission in the reference frame of the observer is determined, we simply apply the ballistic theory of light to determine the path, path length and time of flight of light, all of which depend on group velocity. The dependence of group velocity of light on mirror velocity is just to be accepted as a postulate, and does not require further physical explanation.

The distinction between Apparent Source Theory (AST) and the theory of relativity is that according to AST the *observer* is the person or the device directly detecting the light. Strictly, the observer is the atom detecting the light. In AST, the observer observes the light. In the theory of relativity, the *observer* is the person who observes the laws of physics and is not necessarily the person or device directly detecting the photons.

## 7. Conclusion

A new theoretical framework has been introduced in this paper, which has two parts: 1. constant phase velocity 2. Apparent Source Theory. Einstein's 'chasing a beam of light' thought experiment has been given a new interpretation: constant phase velocity and variable group velocity of light. The postulate of constancy of the speed of light has led to the discovery of a profound law governing the Doppler effect of light: Exponential Doppler Effect (EDE). EDE has been shown to be not only a logical consequence of constancy of phase velocity, but also in agreement with the Ives-Stilwell experiment. The Arago star light refraction experiment has also

been explained by the theory of constancy of phase velocity of light. Apparent Source Theory ( AST ) has been shown to resolve many of the longstanding and puzzling problems of absolute motion, the speed of light and electromagnetism. Two forms of AST has been presented: for inertial observers and for non-inertial observers. AST has solved many of the mutually contradicting experiments of the speed of light: the Michelson-Morley experiment, the Sagnac effect, the Silvertooth experiment, moving source, moving observer and moving mirror experiments. AST has also shed light on the enigmatic problems of magnetic fields and electrostatics. A profound revelation of AST is that the conventional understanding of the phenomenon of stellar aberration is completely wrong. The direction of apparent change in position of the star is not in the same direction as the observer's velocity, but in the opposite direction !

Thanks to God and the Mother of God, Our Lady Saint Virgin Mary

## Notes and References

1. However, the new insight of Apparent Source Theory ( AST ) was just a flash of novel idea that occurred to me while thinking about Sagnac effect. I did not start by an explicit aim to create a fusion of ether theory and emission theory, which would have probably been an unsuccessful effort. In other words, I did not *construct* AST from ether theory and emission theory. It was after I gained the new insight that I realized that AST is a fusion of features of the two theories.
2. Measuring Propagation Speed of Coulomb's Field, A. Calcaterra, et al
3. LUNAR LASER RANGING TEST OF THE INVARIANCE OF  $c$ , Daniel Y. Gezari  
<https://arxiv.org/ftp/arxiv/papers/0912/0912.3934.pdf>
4. The Michelson-Morley Experiment and Classical Analysis of Reflection of Light From a Moving Mirror - Implications for the Lorentz Transformation Equations, by HenokTadesse, Vixra
5. Special Relativity and the Michelson-Morley Interferometer, American Journal of Physics. Schumacher, Reinhard A. (1994).
6. Actually I gained the initial crucial insight of Apparent Source Theory while trying to understand the fringe shift in the Sagnac effect, which contradicted the null result of the Michelson-Morley experiment. I have introduced the initial insight based on the Michelson-Morley experiment for convenience. Ironically, however, it took me about five years to fully understand the Sagnac effect in terms of AST.
7. Absolute/Relative Motion and the Speed of Light, Electromagnetism, Inertia and Universal Speed Limit  $c$  - an Alternative Interpretation and Theoretical Framework, HenokTadesse, Vixra
8. Historically, the Sagnac effect has been universally seen as evidence for absolute motion or the ether, by the supporters of ether theory. In fact, it is inconceivable how one could see the Sagnac effect as other than an absolute motion effect.
9. Replication of the Trouton-Noble Experiment, Patrick Cornille *et al*
10. Occam's razor vs. magnetic field , YefimBakman, E-mail: bakmanyef@gmail.com
11. The Speed of Gravity – What the experiments say, Tom Van Flandern
12. Disentanglement of Absolute Velocity and Doppler Effect, Henok Tadesse, [www.vixra.org](http://www.vixra.org)

## APPENDIX

### Refinement of Apparent Source Theory

I have proposed in this paper and previous papers that the apparent change in source position in stellar aberration is not in the same direction but in opposite direction to the velocity of the observer. However, I found that this leads to a contradiction, as follows.

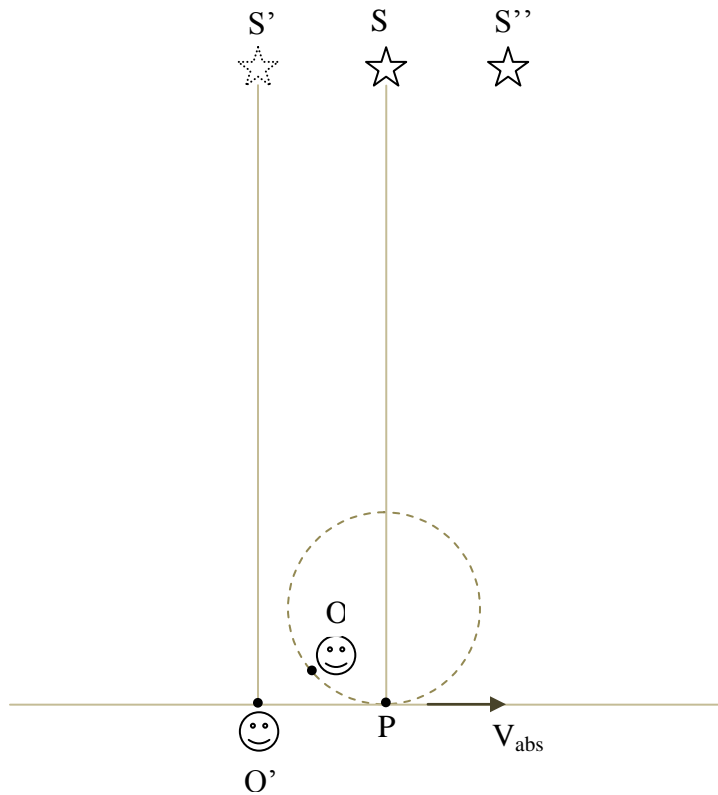

O is the real observer and O' is an imaginary inertial observer, in accordance with our discussions so far. At point P, O and O' arrive at point P simultaneously and observe the light from S.

Now, according to the formulation of Apparent Source Theory (AST) presented so far, imaginary observer O' will see star light as coming from S and not from S'. This means that real observer O will also see light coming from S, which means no stellar aberration. This contradicts with the observed phenomenon of stellar aberration.

The new explanation is that both O and O' will observe the light at point P, but observer O will see it as coming from direction S'' , while observer O' will see it as coming from the direction S.

The traditional Bradley's stellar aberration is a result of accelerated motion. We consider observer O an accelerated observer, and observer O' a non-accelerated inertial observer. Only velocities caused by acceleration will result in stellar aberration. The velocity (30 km/s) of the Earth relative to the Sun is a velocity caused by acceleration. All terrestrial velocities will cause stellar aberration.

The absolute velocity of the Earth, which is 390 km/s, is to be considered as a velocity that existed for ever, and should not be considered to have been caused by any acceleration, and will not result in stellar aberration. I will call it a 'primordial' velocity.

Therefore, all our previous analyses in this paper will hold except that (conventional) aberration of light will occur. Therefore, this new reformulation does not affect our analysis of the Michelson-Morley experiment, Sagnac effect, Silvertooth experiment, and other experiments except that there will be light aberration caused by terrestrial velocities and the velocity of the observer relative to the Sun which is 30 km/s. This aberration is only an illusion and will not affect any experimental results such as fringe shift.

With this modification, Apparent Source Theory can explain why the direction of Sun light and the direction of Sun's gravitational force on Earth differ by 20 arc seconds.