

# 4x and 3x Interference for Stringy Bose Einstein Black Hole production.

Leo Vuyk,  
Architect  
The Netherlands.

## **Abstract,**

Quantum FFF ( Function Follows Form) theory is a Rigid String Theory postulating, that the vacuum is filled with a local variable Planck scaled lattice of oscillating closed torus strings called Axion-Higgs (AH) particles, analog to Dark Energy and the origin of Casimir effects.

These AH strings are able to transform over 4x internal hinges due to real particle collision into different singular open Strings, such as the Electron and Positron or all Photons and Gluons.

Photons and Gluons, Electrons and Positrons can wrap around each other, to form a series of compound Quarks or Bosons, well know as the “Standard Model” (SM) with new physics extensions like monopole photons.

Model research on string form possibilities, show that only the single so called general photon and two monopole magnetic photons ( N and S) are able to form very rigid closed complex rigid string knots.

Three copy magnetic monopole particles ( North or South) are able to form two different ring shaped string knots, which are both called the Higgs particles possessing 124,5 and 126 GeV.

Four general photon copy strings however, are able to form a ring shaped knot which is also called Higgs which is assumed to possess more mass. Indications of a third high mass Higgs particle are already showed up in the LHC at Geneva at about 375 GeV.

As a consequence of these ring shaped Higgs particles, I suggest, that the ring shape is a suitable form to connect with other ring shaped Higgses and form more complex compound black hole nuclei.

Such combined Higgs nuclei could be able to grow by laser- of magnetic interference into a more massive particle which can become stable and resistant for the vacuum oscillations after it has reached a certain minimum volume.

The result is called a Bose Einstein stringy black hole, which can be compared with a Ball Lightning nucleus.

## Introduction.

According to Quantum FFF Theory, attraction forces on fermions should be the result of the dual push effect of two opposing photon pulses, A: The general Axion-Higgs vacuum field pressure (dark energy) and B: The opposing incidental Graviton Photon produced by the collision of the Axion Higgs particle ( closed string) transforming into a Graviton (open) string travelling away with the local speed of light.

As a consequence, only the result of two opposing photons impinging on Fermions has to count as a quantum force and the so called “Feynman diagrams” should be adapted accordingly.

In Q-FFF Theory, the vacuum is seeded with fast oscillating massless Axion/Higgs particles, oscillating along a complex chiral tetrahedral vacuum lattice, which has the ability to transfer Photon and Graviton information in wavelength bunches of oscillations, through the vacuum lattice with the local (mass related) speed of light and the origin of the so called Dark Energy observed e.g. in the Casimir effect.

At the same time, only the sum of the different kinds of vacuum impulses with the local vacuum oscillation spectrum coming from all directions on Fermions are responsible for all energetic phenomena in the universe.

So, we may call this force a fifth force as it opposes and interacts or compensates all Photon/ Gluon pressure effects on fermions in the universe.

The gravity around Black Holes is assumed to be based only on the zero point oscillation spectrum from outside the black hole without the opposing repulsive gravitons coming out of the black hole.

Black holes don't emit gravitons, consequently they are massless and harbor a nucleus of massless Axion/Higgs based Quantum vacuum knots only able to absorb the incoming oscillating vacuum particles and polarize the surrounding vacuum structure.

The polarization of the local vacuum is also origin of the black hole repulsion horizon of all propeller shaped Fermions at a certain distance from the nucleus and even the creation of fermions and baryons ( plasma) out of the local vacuum.

Reason to accept that the vacuum energy around dark matter black holes ( fifth force) combined with the propeller shape of fermions, is the origin of **apparent violation of the second law**, (entropy decrease) observed on earth and in space.

Examples are: plasma tails of Ball lightning and (micro) Comets and Proplyds.

## The Fermion repelling black hole found inside Herbig Haro bowshocks. (fig 1)

Evidence for a Fermion Repelling New Physics Black Hole inside Herbig Haro (HH34) Bowshock ! Outflow Velocity differences between the leading black hole and the secondary Fermion plasma hotspots are the indication, according to Q-FFF Theory.

The black hole (O) has the smallest relative velocity. Conclusion: Secondary Fermionic plasma hotspots are repelled ! As predicted!

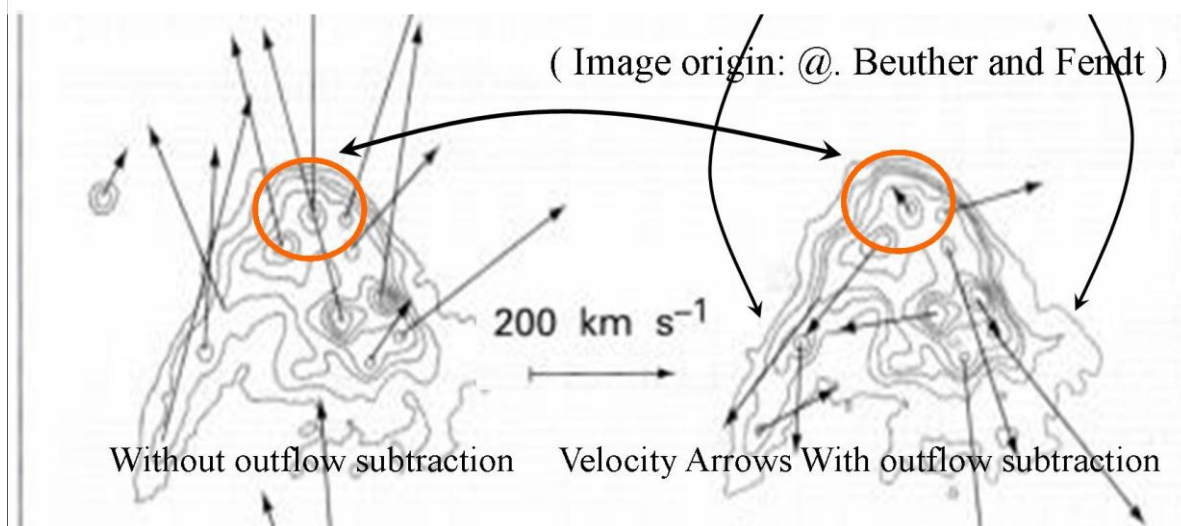

Figure 1. Latest find: evidence for new physics black hole based bowshock. Original bowshock Image presented by Beuther and Fendt ( uni of Heidelberg.)

**In Q-FFF Theory, equal sized Rigid String based Black Holes do not merge but, form Herbig Haro systems with a White Hole in the middle as the center of plasma jet production.**

Q-FFF Theory postulates, that all rigid string based black hole nuclei (Bhs), with variable sizes, from semi-stable Ball lightning up to stable Comets, Dual Herbig Haro black hole bow shocks and even dual Galaxy Anchor Bhs, are negative charged from the outside and positive charged from the inside.

Q-FFF = Quantum Function Follows Form at the stringy quantum scale.

The origin of different charged Bh zones, is counter intuitive

- 1: the Bh repulsion of all Fermions and
- 2: the continuous pair production out of the chiral oscillating Axion-Higgs particle based vacuum lattice at the BH horizon and
- 3: the preference for positrons in the chiral vacuum, to merge with photons, forming a positive charged quark plasma at the inside of the Bh horizon. (see poster below)

At the outside of the Bh horizon the negative charged electrons are separated due to their low mass and less gravity attraction on to the Bh..

Equal sized black holes tend to form stable pairs called Herbig Haro systems, with a white hole in between, also called wormhole.

The white hole (wormhole) can be interpreted as the location with the lowest vacuum pressure position forming a sink hole and even a pressure cooker effect for stars (star clusters) or failed stars, depending on the size of the BH pair.

The Bh locations can be interpreted as the positions with the highest vacuum pressure, because black holes eat the oscillating stringy Axion -Higgs vacuum leading to concentrated pressure gravity without the counter acting (new physics) graviton pressure assumed to be present around baryonic matter such as stars, planets etc. called "dipole repeller gravity" see below:

Equal sized Black Holes do not merge but form Herbig Haro systems with a White Hole in the middle.

Star Forming Herbig Haro system HH34: are postulated to be two equal sized stringy Stellar Anchor Black Holes (negative charged SABHs / Bowshocks) with Star forming Sink (White Hole) in the middle. ( Quantum FFF Model)

According to Einstein cosmology, a Wormhole is the opposite of a Black Hole.

In Q-FFF Theory however, a Wormhole is a diluted spacetime area of the oscillating Axion Higgs lattice vacuum in between two or even more equal sized stringy black holes nuclei. Diluted spacetime area means, a vacuum lattice with variable Planck lattice lengths of the surrounding area. ( fig 2)

According to Quantum FFF Theory, stable Black Holes are growing by "eating" the gravitating ( Casimir) pressure vacuum.

Mass is the potency of rigid strings, to produce and radiate Gravitons as a collision product, between mass less ring shaped oscillating Axion Higgs vacuum field particles and Fermions or Bosons also called Dipole Repeller gravity or dipole Emergent Gravity.

More extended loops or "arms" of each rigid string particle is supposed to create more Axion transformation into Gravitons or other electromagnetic monopole photons per time unit.

Secondly, gravitons are assumed to exert not an attraction force on fermions and bosons but only a reduced pressure force in opposition to the vacuum pressure of the Axion Higgs field..

So, Gravity can be described as the statistical difference between the collision pressure of "new" gravitons opposing the pressure of Axion Higgs field particles all around us.

Emergent gravity as proposed by E.Verlinde and Dipole Rropeller gravity by Yehuda Hoffman, are in line with this assumption.

Non inertial black hole effects are the other side of the coin..

The ring shaped Axion Higgs field particles are supposed to oscillate in tandem (as the boxer engine pistons) along each vacuum lattice with the local Planck length and transfer information of monopole photons through the whole universe as long no fermion or boson comes too close.

So if the new physics black hole nucleus is represented as a compact quantum knot then there is no graviton production supposed.

As a consequence the incoming Axion Higgs field pressure is the only origin of the Gravity pressure effect around each black hole nucleus and the result of the Casimir absorption effect of the vacuum by the black hole nucleus.

At the same time, gravitons are not leaving the black hole at all.

In Quantum FFF Theory, the inertial mass effects of the earth and all atomic fermions is supposed to be originated by the real Lorentz polarization of all fermionic mass of the earth mainly pointing into the direction of motion around the sun, as the opposing effort for the resisting vacuum.

Rigid string shaped Fermions are assumed to have a propeller shape able to plow into the direction of motion through the local spacetime creating vacuum lattice.

Conclusion Bosons (Higgs, W and Z particles) seem to be not able to polarize and will present signals to be "stuck" in the local solar centered vacuum lattice. The LHC could perhaps be able to show this

anti inertial mass effect created by the solar reference frame or solar LASOF ( Local Oscillating vacuum Frame).

The Bose Einstein stringy Black Hole Nucleus with variable Planck length vacuum and pair production (fig 2)

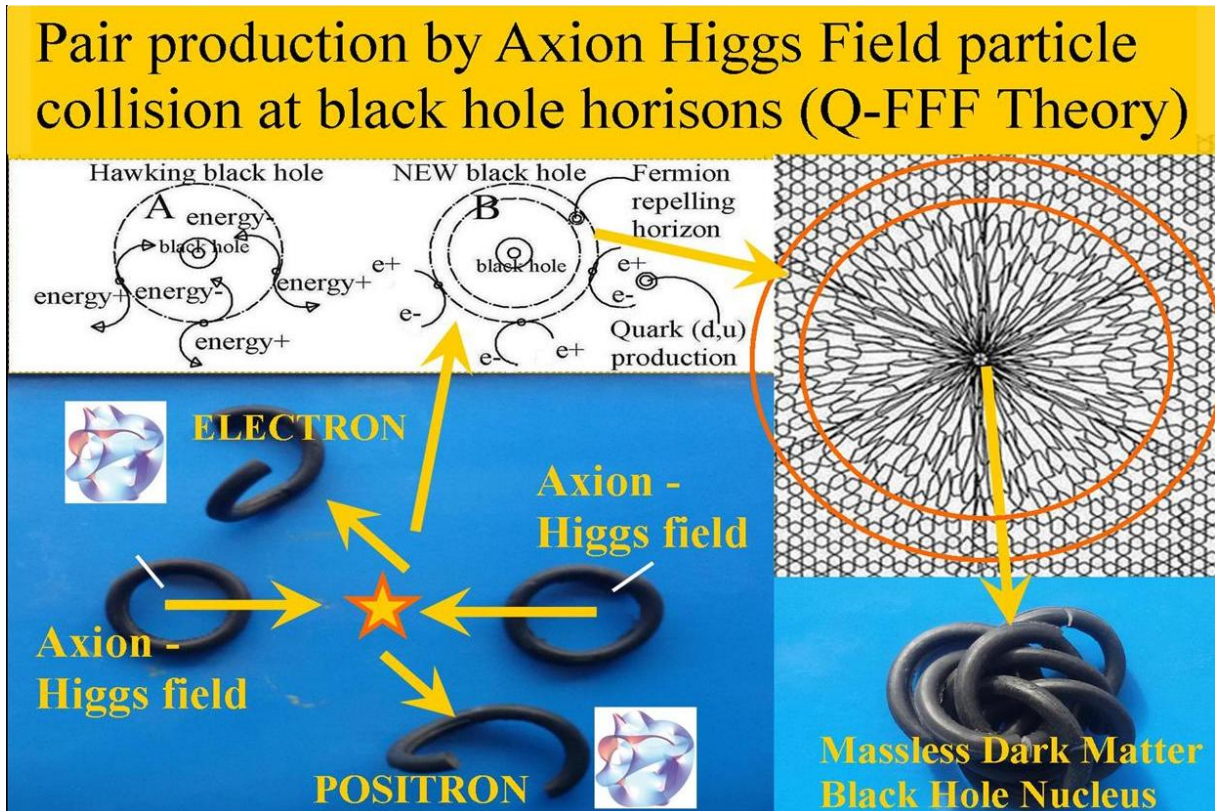

Figure 2, pair production around black holes.

According to Quantum FFF Theory, ( Function Follows Form at the quantum scale), the new black hole nucleus is represented as a bunch of rigid string particles compressed by the oscillating Axion Higgs field vacuum particles.

All Fermions should be repelled at a new physics Black Hole (BH) repelling horizon which is supposed to have two globular shells of positive or negative charge!

As a result, each black hole is assumed to have a globular shell of positron and proton based plasma at the inside and a negative electron based plasma shell outside this positive shell.

If we include existence of small interference black holes (or Quantum Knots) then Ball lightning and micro comets ( including Comets and sunspots) are to be explained as micro black holes violating the second law of thermodynamics.

The form and microstructure of elementary particles, is supposed to be the origin of functional differences between Higgs- Graviton- Photon and Fermion particles.

As a consequence of the quantum gravity difference on fermions and black hole nuclei, the new splitting, accelerating and pairing massless black hole, is able to convert vacuum energy (ZPE) into real energy by entropy decrease. This explains quick Galaxy- and Star formation, down to Sunspots, (Micro) Comets, Lightning bolts, Sprites and Elves, Sprite Fireballs and Ball Lightning according to quantum.

In Quantum FFF Theory, the inertial mass effects of the earth is supposed to be originated by the real Lorentz polarization of all fermionic mass of the earth, on average pointing into the direction of motion around the sun, as the opposing effort for the resisting vacuum. Conclusion Bosons (Higgs, W and Z particles) seem to be not able to polarize and will present signals to be "stuck" in the local solar centered vacuum lattice.

Black Hole merging without rotation, due to massless BH Inertia absence, according to Quantum FFF Theory. (duration about 1 sec.)

Neutron stars however have normal baryonic mass and consequently rotational based strain effects. (duration about 30 sec )

**Below:** the First evidence for the existence of a new physics dark matter based negative charged massless black hole ( described by Quantum FFF Theory) inside one of the bowshocks of HH 34. Found at the internet by Beuther and Fnedt.

Called "Velocity Arrows With Outflow Subtraction".

**Rigid String based information building blocks with Fermion Calabi Yaw propellers (right) and Boson non propellers (left)**

Rigid String Quantum Knot suggestions for different configuration: 125-375-500-750-1600 GeV and More called dark matter black holes. (According to Quantum FFF Theory architecture)

125GeV + 375GeV = 500GeV And More

500GeV

375GeV + 375GeV = 750GeV

2x750GeV + 125 = 1625GeV

6x Leptons Electron Muon Tau

6x UP quarks

6x CHARM quarks

6x DOWN quarks

6x BOTTOM quarks

6x STRANGE quarks

6x TOP quarks

Figure 3, 3x or 4x Bose Einstein black hole nuclei able to grow by warping and ring coupling.

The difference between Higgs bosons left and propeller shaped Fermions according to Quantum FFF model design.

Equal sized Black Holes do not merge but form Herbig Haro systems with a White Hole in the middle.

Star Forming Herbig Haro system HH34: two equal sized stringy Stellar Anchor Black Holes (negative charged SABHs / Bowshocks) with Star forming Sink (White Hole) in the middle. (Quantum FFF Model)



The New Black Hole according to the Quantum-FFF Model: Negative Charged (outside) and Fermion (Plasma) Creation out of the massless Axion-Higgs String vacuum. (Fermion repulsion).

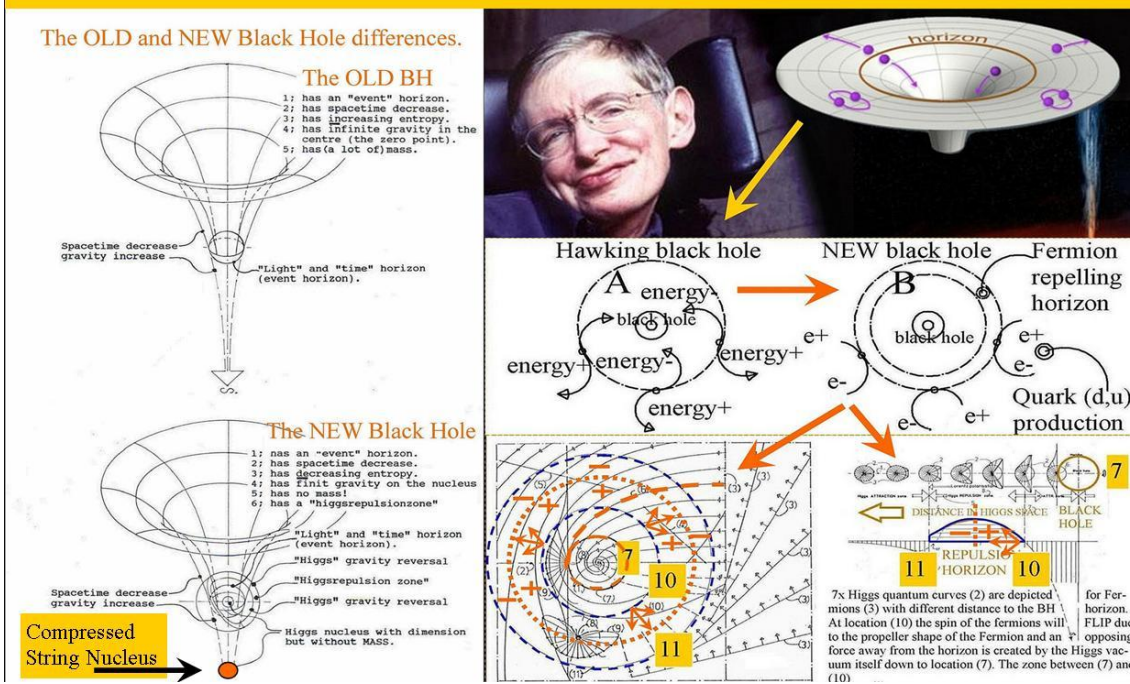

Figure 4, Equal sized Rigid String based Black Holes do not merge but, form Herbig Haro systems with a White Hole (also Wormhole) in the middle.

# Non Inertial Gravitating Dark Matter Black holes.

According to Quantum FFF Theory, stable Black Holes are growing by "eating" the gravitating ( Casimir) pressure vacuum without the standard gravity related inertial effects, the result is that 1: Small BHs seem to concentrate around the central giant Galaxy BH . 2: Galaxy cluster mergers like Abell 520 overshoot and leaving behind their own Dark Matter content. <http://vixra.org/pdf/1710.0050v1.pdf>

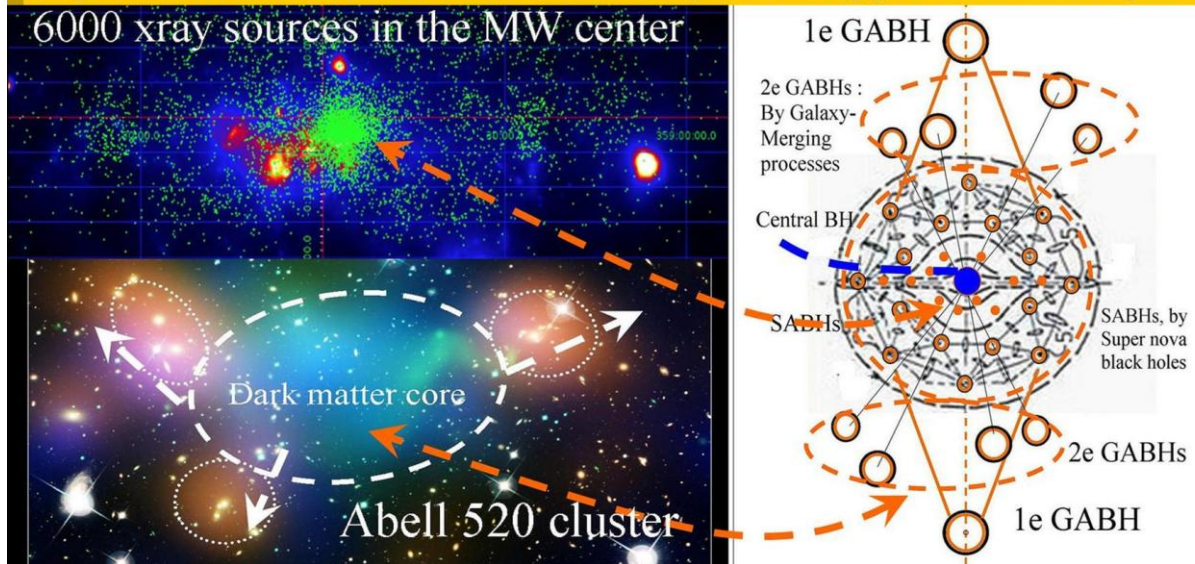
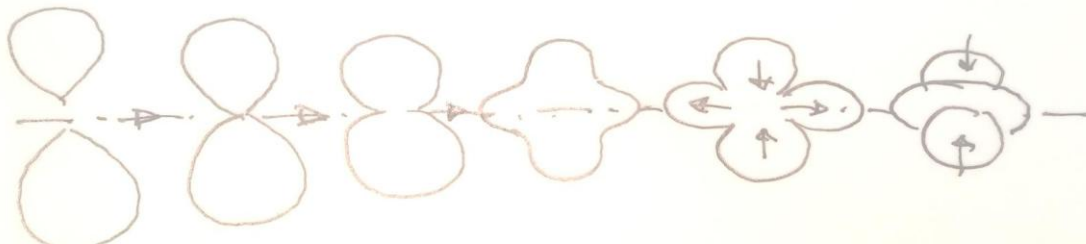

Figure 5, Merger dynamics of NON inertial Dark Matter Black Holes left behind after merging in the middle.

Black Hole merging without rotation, due to massless BH Inertia absence, according to Quantum FFF Theory.



If Black holes have no inertial mass, due to their non Baryonic Dark matter Axion/Higgs content, then no rotational strain but only nuclear particle Tension effects will take place during merging.

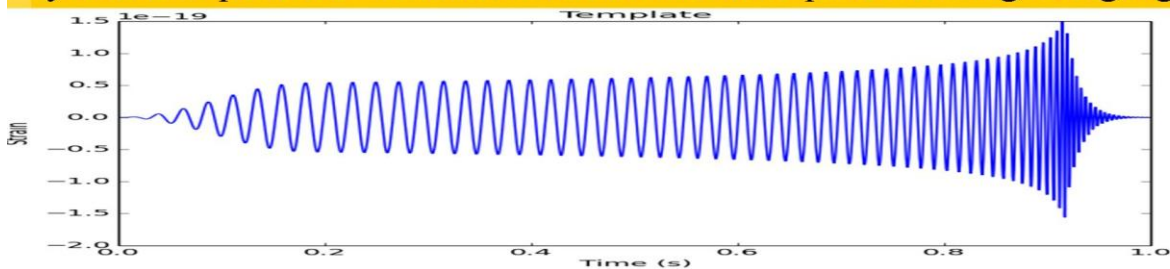
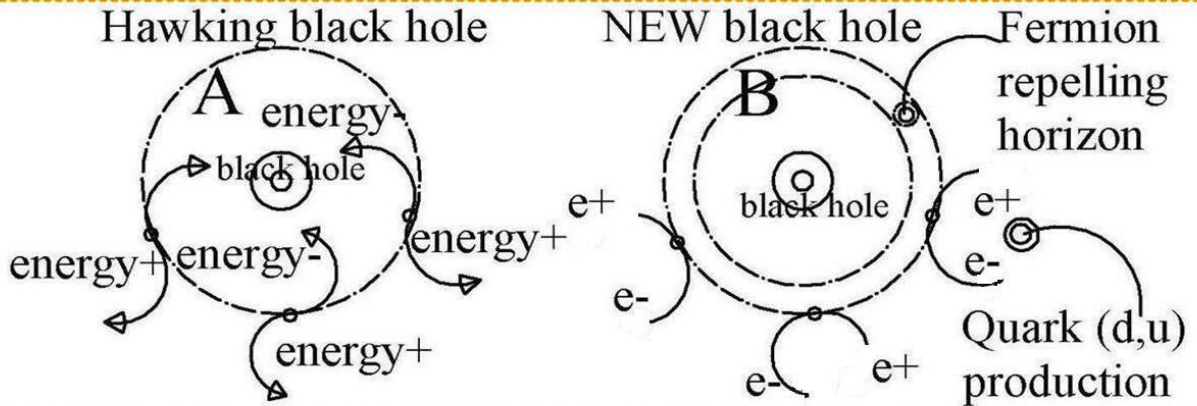

Figure 6, Massless Black Holes without Inertia effect have no rotational strain but only oscillation strains



# No Fermion Information Loss in Black Holes by Fermion Repelling Horizon.



According to Quantum FFF Theory, there is no fermion information loss, only photonic information loss in a black hole. Quantum fluctuations around the BH horizon produce pairs of leptons.  $e^-$ ,  $e^+$  and even compound quarks (d,u, etc, see Fermion 3D string propeller theory: Fermion repelling by spin flip). For tripple BH horizons see image nrs 7, 10 and 11. Event horizon=7, Inner photon ring = 10, Outer photon ring = 11. Conclusion The Big Bang did not produce instantly all the Fermions in the universes. Even now lots of Fermions are produced by all BHs even the largest primordial Big bang splinters located outside large galaxies. see also: <<http://vixra.org/abs/1410.0039>

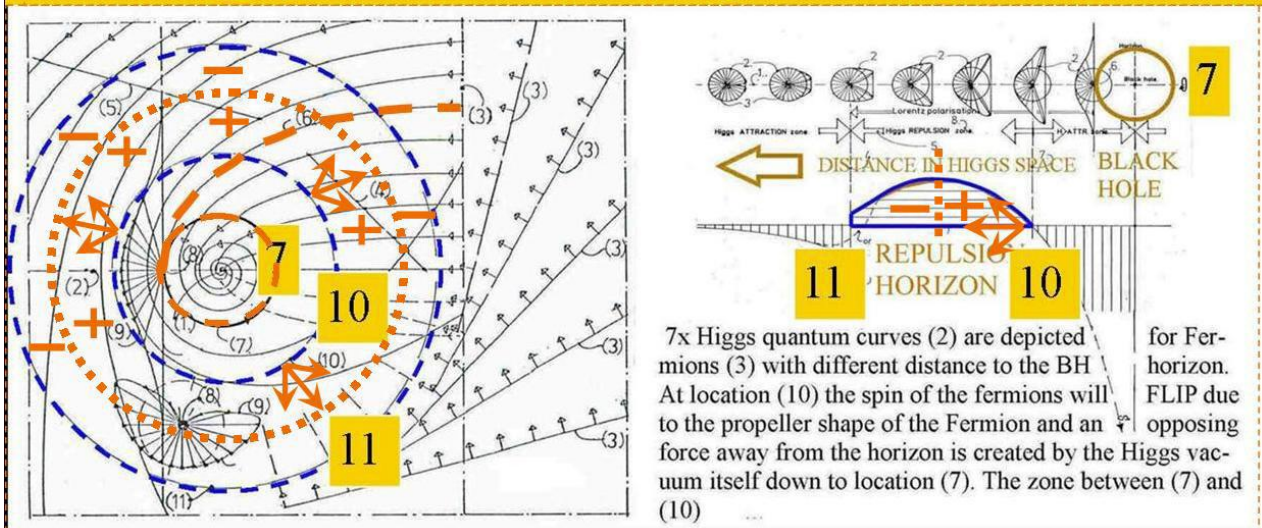
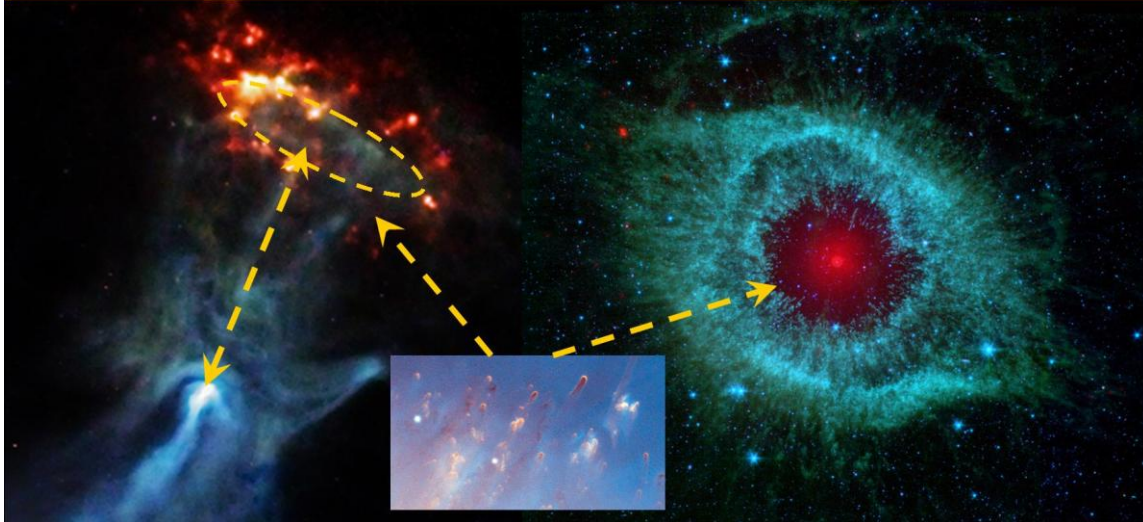

Figure 7, Electric Dark Matter Black Holes (EDMBHs) have a Fermion repelling horizon and are negative charged in our part of the multiverse.

## PSR B1509-58 Pulsar nova (blue)with exploded ring of Starspot black holes (x-ray, orange)

According to Quantum FFF Theory, (Function Follows Form) sunspots are micro (new physics) Electro Dark Matter Black Holes ( EDM-BHs), also found in the Helix Supernova remnants see below. The central neutron star is clearly shifted out of the center of the of the BH ring, which supports the quantum gravity difference between BHs and Neutron fermionic matter.



**Figure 8, The A-symmetric B 1509-58 nebula , and symmetric Helix nebula as examples of the difference between Fermion- and non- inertial dark matter black hole Quantum Gravity effects.**

“One of the big mysteries of this object (B1509-58 “The hands of God”) is whether the pulsar Fermion particles are interacting with the material in a specific way to make it look like a hand ( NASA)

In this paper I support the idea that the orange x-ray elements of B1509) represent a ring of star spot black holes ejected from the exploding star

The micro black hole ring looks as hotspots accelerating away, with the white Pulsar (white) far relocated by the different quantum vacuum gravity effects on Fermion matter and Black hole nuclear matter, assumed to be a bunch of Higgs string particles with resistance in space for motion through the oscillating vacuum lattice.

In Quantum FFF Theory, (Function Follows Form) black hole nuclei are assumed to be a bunch of massless rigid strings compressed by the surrounding oscillating Axion-Higgs vacuum lattice.

Fermion mass however is assumed to be created by the ongoing interaction with the same surrounding oscillating vacuum lattice including the collision production of photon/gluons and gravitons.

Black hole nuclei can move through the vacuum lattice only by the deformation of its horizon system by horizon deforming and repelled plasma tails observed in so called Tadpoles, often found inside nebula.

Fermionic mass like neutrons however feel the gravitational influence of the local vacuum lattice polarization and graviton influence of local Fermionic matter.

In the shape of “the hands of God” ( B1509) we observe a clear relocation of the central Fermionic Neutron star ( white) and the ejected elliptic star spot black hole system (orange).

This in contrast with black hole supernovas where we observe often a symmetric ring or globular shell nebula around the just formed central black hole.

## Multiple Horizons created around Supernova Black Holes.

Proposal for the relation between different S-Nova shapes and the external primordial black hole configuration called Herbig Haro hotspot or Stellar Anchor Black Holes (SABHs)

Different Super Nova shapes are created around two star types:  
 A: Stars with distant “dual or quadrupole Stellar Anchor Black Holes” assumed to be located in the center of a former open star cluster. ( SN1987, NGC2440, Crab Nebula)  
 B: stars without SABHs. (SN1572) Our sun is equipped with two sunspot rings assumed to be of type A, with two SABHs, according to Quantum Function Follows Form Theory.

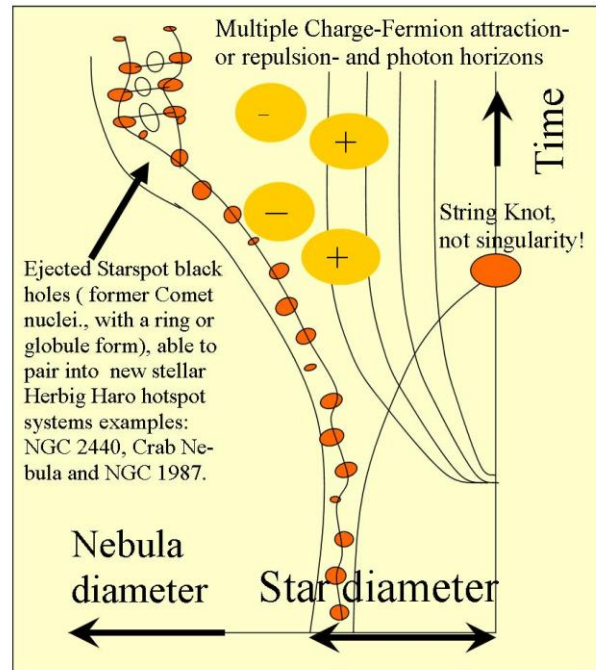
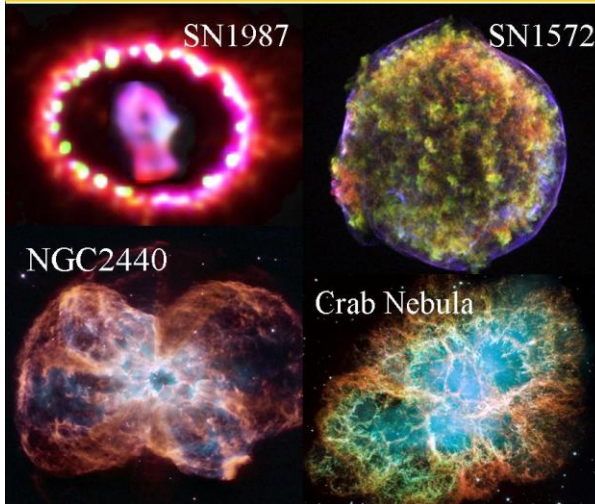

**Figure 9, Other examples of Quantum Gravity effects on ejected rings of micro black hole starspots at work in different nebula .**

Complex galaxy / star evolution seems to be not only created by galaxy or star merging, but even by central galaxy- and stellar mass black hole chopping into two equal parts to form black hole based Hotspots for Herbig Haro systems or even for Double Radio Galaxies. ( figure 10)

This process is supposed to be the consequence of the new physics Electric Dark Matter Black Hole (EDM-BH) principle of Quantum FFF Theory ( Function Follows Forms) and supported by observation of Triple Double Radio Galaxies and even by BH splitting in the Spire Eagle nebula. ( Figure 9)

The EDM-BH is assumed to contain a real particle nucleus of so called Axion-Higgs rigid transformable strings , which are compressed together by the pressure of the oscillation Axion Higgs vacuum lattice. Even the Big Bang nucleus is assumed to contain only compressed Axion Higgs strings which could explode into splinters and dual vacuum particles by the reduced vacuum pressure around the Big Crunch nucleus of a former universe.

There seems to be a EDM- BH Ratio related black hole ability to merge (see LIGO) or split into Equal parts if the dual BH ratio is smaller than a LIGO BH ratio boundary which will be found in the future.

Until now, the smallest LIGO ratio is found to be: 1/ 1.9. (or 0.52: LIGO 2016), however future LIGO results could shift this boundary to lower ratios. (Figure 9)

As a consequence for increasing galaxy- and star complexity there is a need for different sized primordial dual black holes instead of two equal sized.

Consequently for the first star formation between the equal BH hotspots ( bow shocks) of a Herbig Haro system , the equal nuclear mass/size ratio of both i black holes is important. ( fig 9)

Quasars such as Cygnus A are supposed to be a larger copies of a Herbig Haro system with larger BHs observed also as (radio) hotspots.

Markarian 231 seems to represent a large scale multiplying BH chopping system for symmetric so

called Galaxy Anchor Black Hole ( GABH) complexity, forming a Triple-Double lobed Radio Galaxy (TDRG).(Figure 11)

The Spire nebula seems to show a more complex BH. splitting process. ( Figure 9)

LIGO based Black Hole ratios and the ability to merge or split into two equal BH parts, able to create Herbig Haro systems and Gamma Ray Bursts. Such splitting systems are observed in the so called Spire part of the Eagle nebula.

The origin of Gamma Ray Bursts, by splitting black holes of different size, leaving three BHs behind. Two of them could form a Herbig Haro Object with a dumbbell structure. (Quantum FFF theory@Leo Vuyk).

Dual black hole merger nominal mass contents observed by LIGO in 2015 and 2016 resp. 29/36x and 7.5/14.2x sun masses. see: Quantum FFF Theory. The related ratios are:1/1.24 resp.1/1.9.

TWO REPULSIVE ION TAILS around electron jets (bar shaped) between two DIFFERENT sized black holes. THE SMALLER BLACK HOLE WILL SPLIT THE LARGER ONE BY ITS CONCENTRATED ELECTRON JET AND VACUUM INFLUENCE. Author: Leo Vuyk.

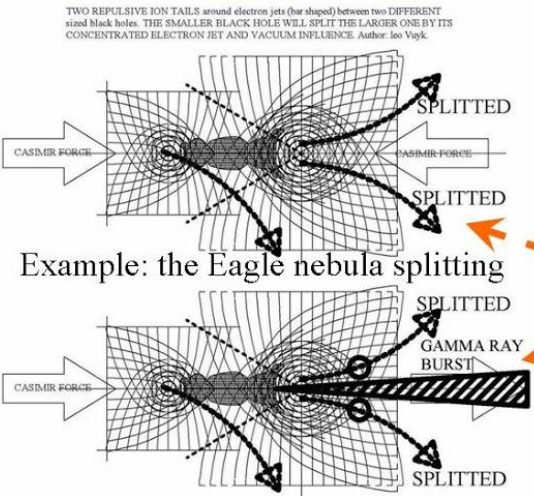

Example: the Eagle nebula splitting

Small black holes should split larger BHs into two equal parts to create dual Herbig Haro hotspots also called bowshocks or accretion outburst sources.

Galaxy central BH merger: 1.0 //>50.0?

2 LIGO ratios: 29-36/7,5-14.2sun= 1.0/1.24/1.9

1.0//1.24-1.9?

1.0// 1.0

Herbig Haro creation ratio: 1x

BH splitting ratio 1.0>>1.9-?-50.0?

1.0//>50.0?

### Black hole splitting in the Spire Eagle nebula

According to the Quantum Function Follows Form Model, small black holes split larger BHs in equal halves, (A) which are able to repel each other and form Dumbbell shaped Herbig Haro systems (B,C) with star formation in between.

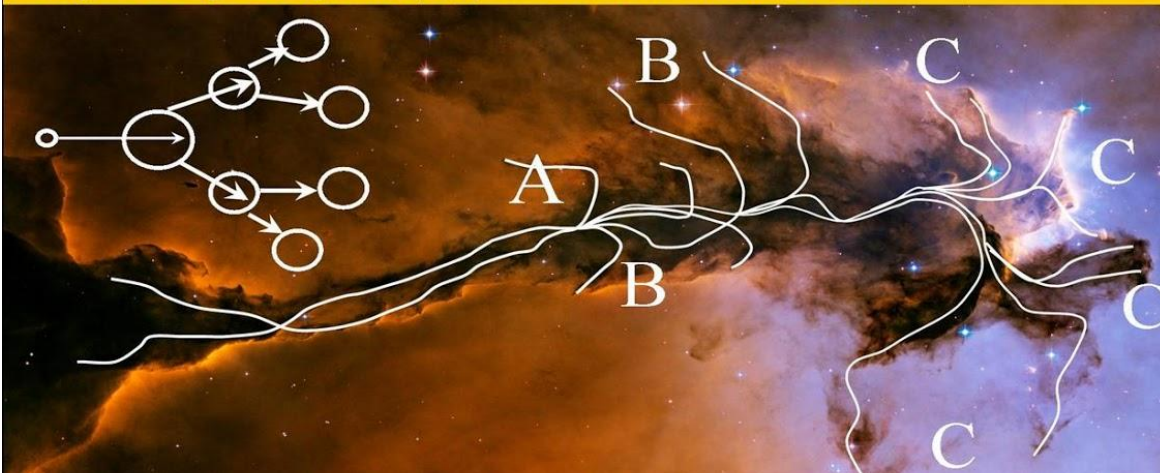

At location (A) both unequal sized black holes seem to split into 4x dual sets of smaller BHs one dual set has even evolved into a second 4x dual sets of BHs.

Figure 10, LIGO BH ratios and the BH multiplier splitting process in the Spire- Eagle nebula.

# Markarian 231 as the Infant Stage of Cygnus-A Quasar. By EDM Black Hole

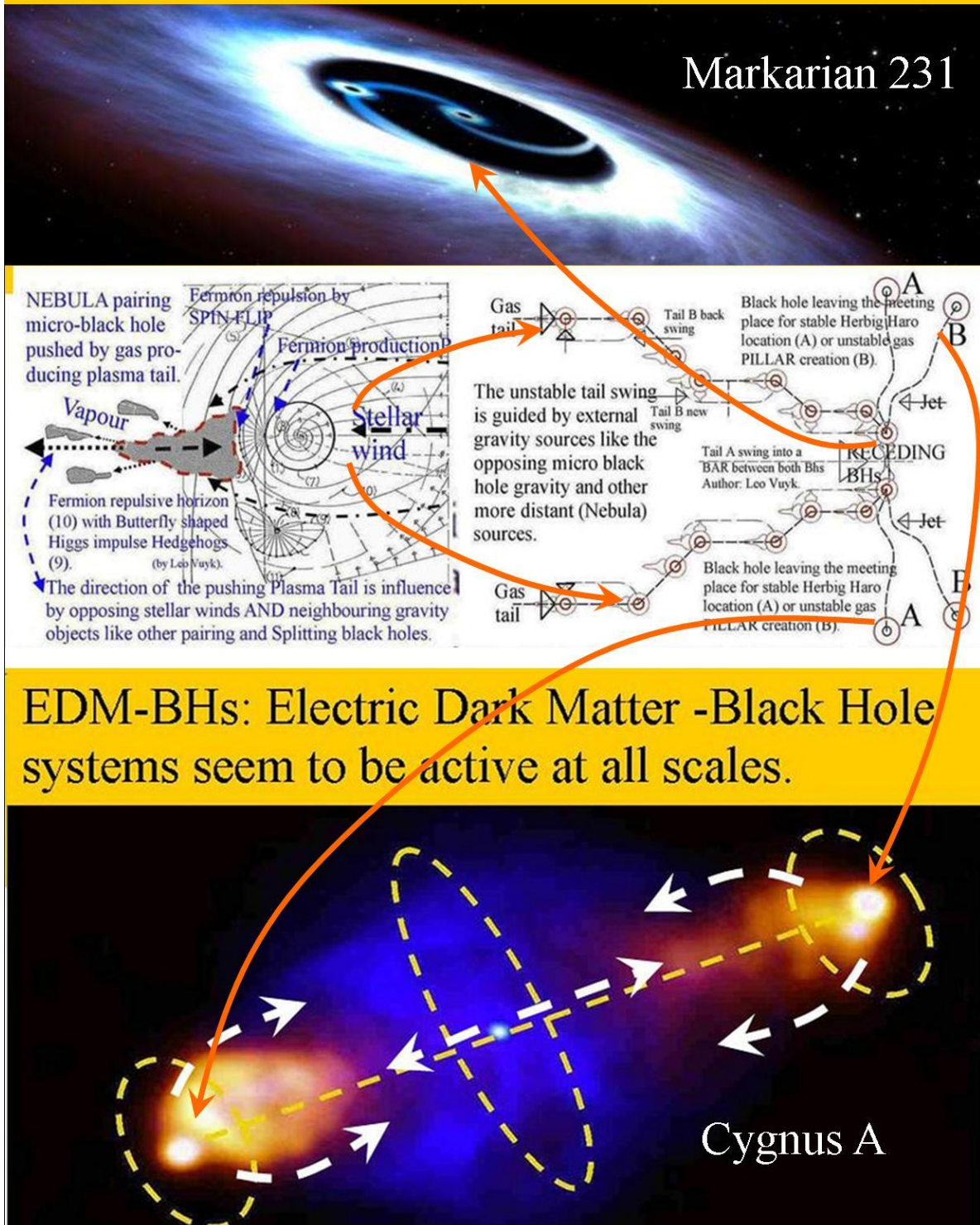

EDM-BHs: Electric Dark Matter -Black Hole systems seem to be active at all scales.

Figure 11. . the relation between Markarian 231 and other BH splitting systems

# Black hole splitting as the origin of spiral Galaxies after a double or multiple lobed Quasar process.

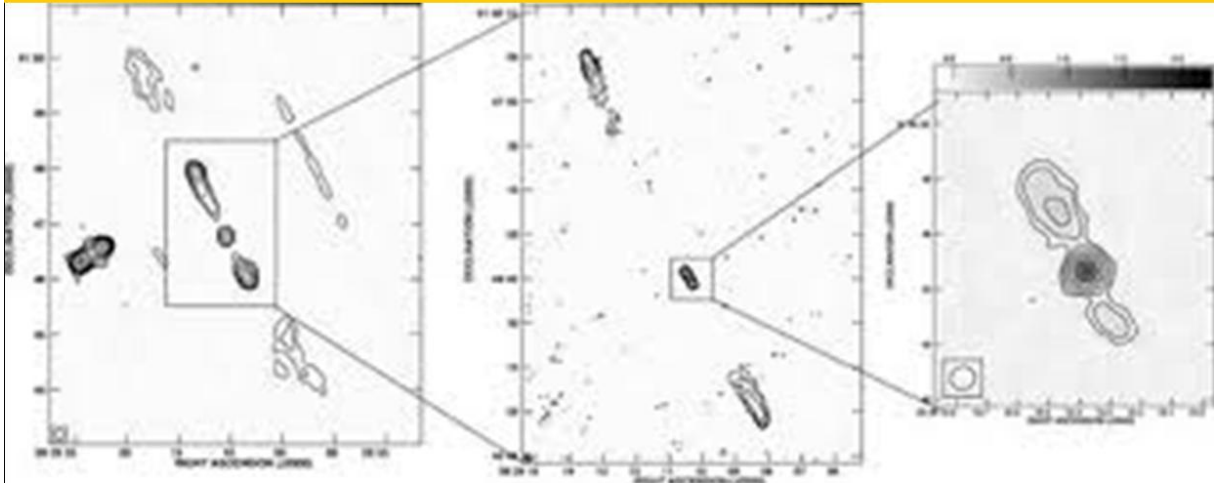

In Quantum FFF theory, stars and galaxies need at least two new physics Electric Dark Matter Black Holes (EDMBHs) for a Herbig Haro system (or dual lobed Quasar) . However multiple symmetric lobed systems seem also possible by a repeated central black hole splitting process.

LIGO based Black Hole ratios and the ability to merge or split into two equal BH parts, able to create Herbig Haro systems and Gamma Ray Bursts. Such splitting systems are observed in the so called Spire part of the Eagle nebula.

The origin of Gamma Ray Bursts, by splitting black holes of different size, leaving three BHs behind. Two of them could form a Herbig Haro Object with a dumbbell structure. (Quantum FFF theory@Leo Vuyk).

Dual black hole merger nominal mass contents observed by LIGO in 2015 and 2016 resp. 29/36x and 7.5/14.2x sun masses. see: Quantum FFF Theory. The related ratios are: 1/1.24 resp. 1/1.9.

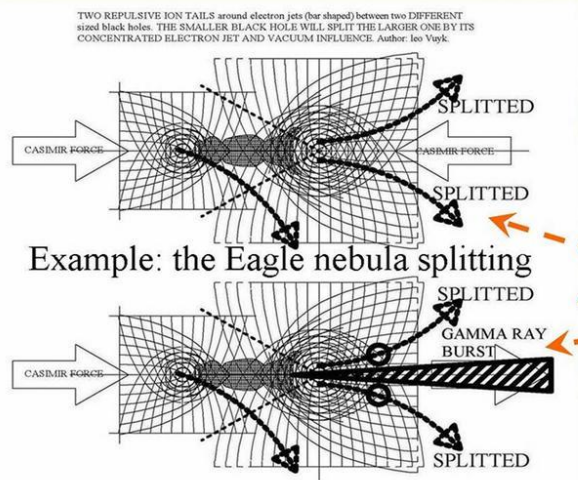

Example: the Eagle nebula splitting

Small black holes should split larger BHs into two equal parts to create dual Herbig Haro hotspots also called bowshocks or accretion outburst sources.

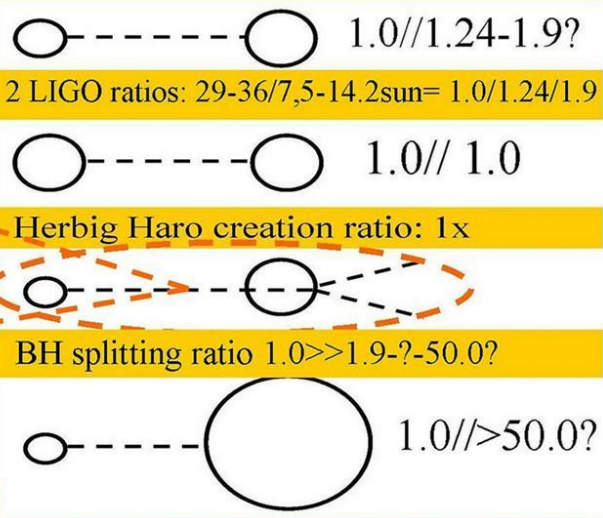

Galaxy central BH Merger: 1.0 //>50.0?

Figure 12, Markarian 231 at a larger scale with triple- double lobed radio sources.

# Quantum FFF Theory effects.

According to Quantum FFF Theory, early Galaxies have growing potential by the number and size of external primordial dark matter black holes initially formed as big bang splinters able to pair into Quasars with star forming galaxies in between the so coined “Galaxy Anchor Black Holes” ( GABHs) The galaxies can merge with other galaxy-systems into complex spirals and elliptical OR produce complexity by the BH splitting ( chopping) process. Irregular galaxies and Dwarf galaxies are supposed to be the result of secondary star forming interaction between GABHs.

After Supernova black hole production these smaller black holes are able to pair as hotspots or “bow shocks” into new Herbig Haro systems,.

If no galaxy merger candidates are available in the neighborhood, or no BH ratio differences are able to split larger BHs into two halves for HH systems, then galaxy will soon reach a maximum size and die.

Also according to Quantum FFF ( Function Follows Form) Theory, all star forming molecular clouds are the result of one or more Herbig Haro systems, equipped with so called dual hotspots which are assumed to be the result of dual new physics “electric dark matter black holes” in contrast with general accepted black hole theories. As a consequence there is a great misconception in mainstream Astronomical theories.

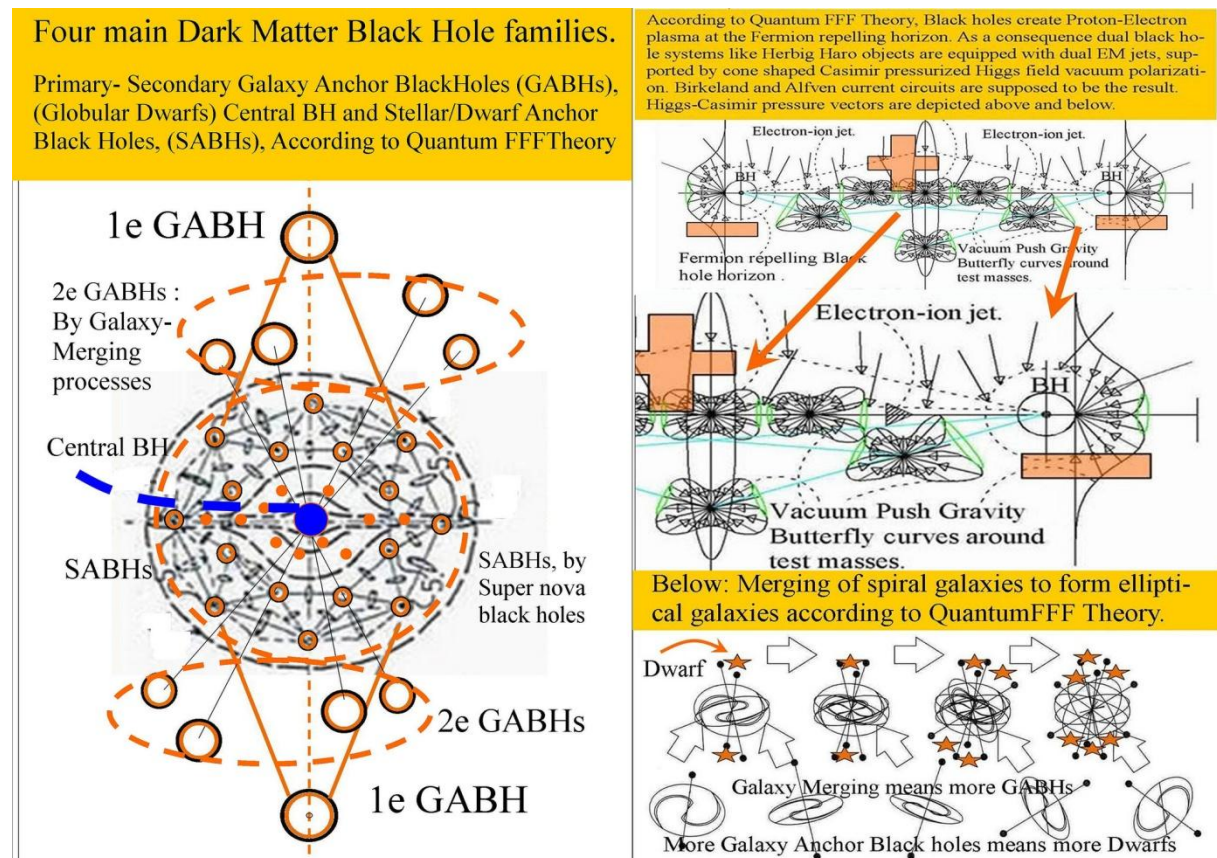
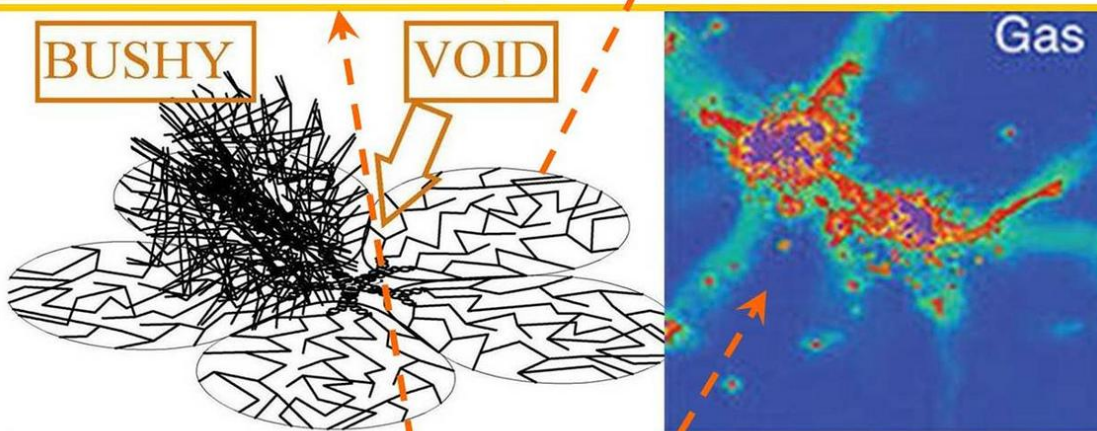
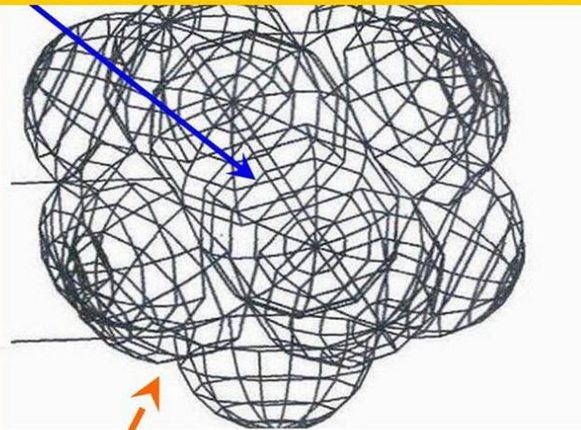

Figure 13, GABHs as the largest unit of Dark Matter black hole families

According to Quantum FFF Theory, the Big Bang can be described as the explosion of a giant Dark Matter Black Hole nucleus which is assumed to contain all the particles and smaller black hole nuclei of a former multiverse after a big crunch process.

How the symmetric Dark Matter Big Bang of the Raspberry Multiverse produced accelerating Big Bang Black Hole (BBBH) splinters in a fractal structure, forming dual Herbig Haro systems (HH) and the oscillating Higgs field by BH evaporation, according to Quantum FFF Theory.

Explanation of the numbers: 10, splitting Dark Matter BBBH splinter. 11, Higgs field pressure. 12, forward pressure area. 13, stable BH splinters. 14, Evaporating BH splinters. 15, Higgs BH gravity funnel. 16, Dual HH system formation. 17, Multiple HH system formation around the Higgs BH gravity funnel.



“Branched Inflation” of the Universe: the Origin of Fingers and Voids.

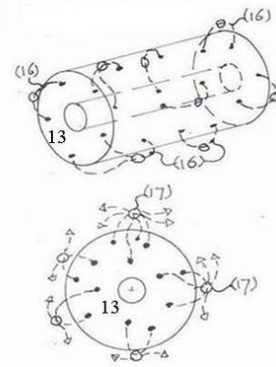
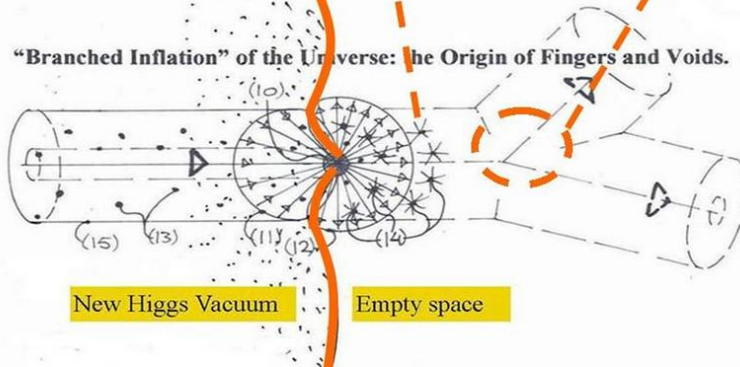

Figure 14 , BBBH , the Big Bang Black Hole splintering into smaller BHs and evaporating into the oscillating Axion Higgs Vacuum lattice .



Equivalence between gravity and acceleration does not hold in Quantum FFF Theory. Mass in motion needs a reference frame of ZPE oscillating Higgs field and Lorentz polarization of conscious propeller Fermions (s) to keep a non accelerated flight.

Quantum Gravity as pressure distribution of the oscillating dual Higgs/Graviton vector field.

Polarized Fermion Mass in motion through the resistive, but also pushing oscillating Higgs vacuum (according to Quantum FFF theory)

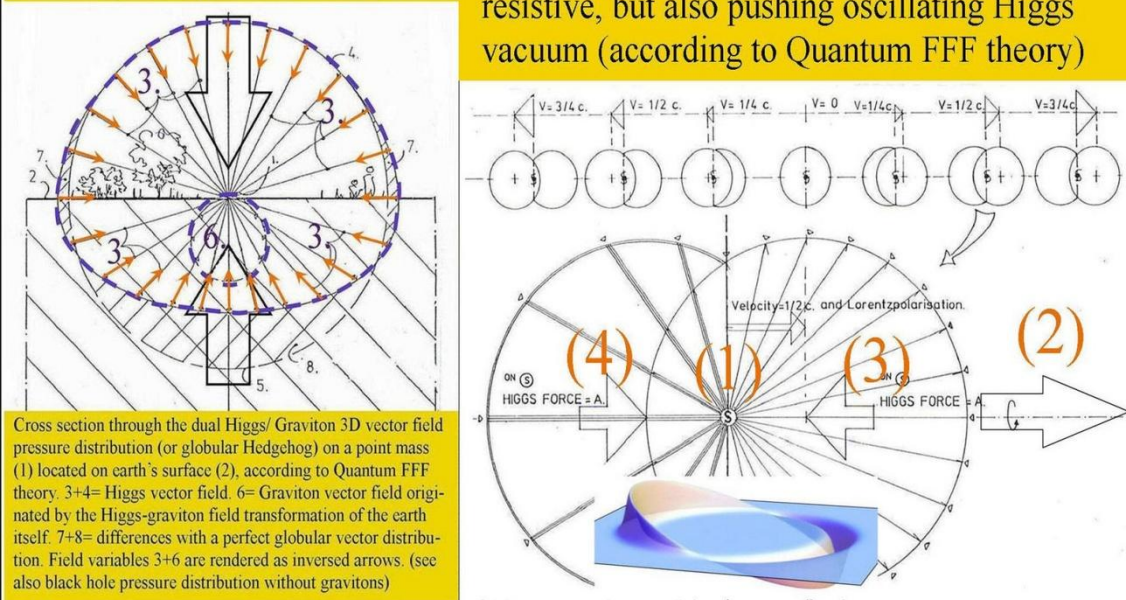

**Figure 15, Quantum Gravity and Mass in motion. ( Quantum FFF Theory)**

Why 125 GeV Higgs does not decay via 2x bosons into 2x Taus and 2x Bottom quarks? (see: Lubos Motl)

According to the Quantum FFF Model, 2x Taus and 2x Bottom quarks together need 10x electron/positron propellers (silver colored, see at the bottom below) .

Light Higgses seem to decay into: (aa) 2x bosons containing 4x or 6x or possibly for ZZ bosons even 8x electron positron propellers.



See below counting silver particles: 4x Taus = 8x elements, 2x Muon with 2x Taus = 6x. 2x Muon with 2x Bottom = 8x.!



Figure 16, Some examples of 3D particle structures according to Quantum FFF Theory.

# Quantum Dipole Repeller Gravity pushing our Galaxy.

According to Quantum FFF Theory, empty space is filled with a fast oscillating lattice of massless Axion-Higgs field particles as a half base for our opposing dipole pressure Higgs-graviton gravity on earth. Now prof. Yehuda Hoffman shows us a support for this hypothesis.

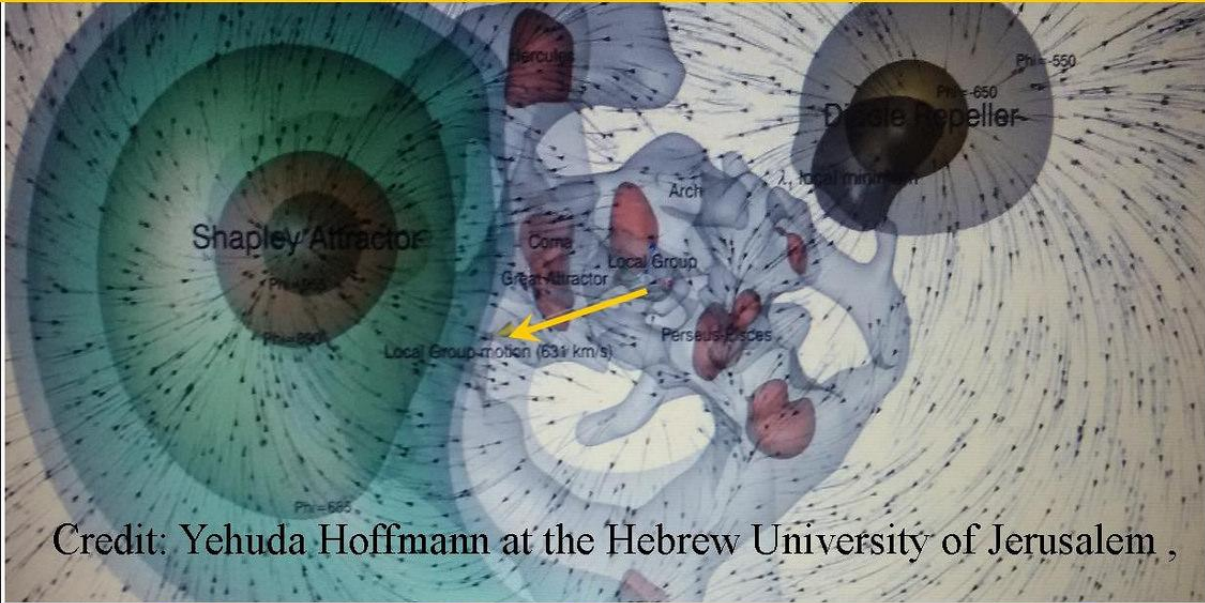

Credit: Yehuda Hoffmann at the Hebrew University of Jerusalem ,

Quantum Gravity as pressure distribution of the oscillating dual Higgs/Graviton vector field.

New Dark Matter Black Hole, "Eat" the chiral oscillating Higgs vacuum.(Quantum-FFF Theory)

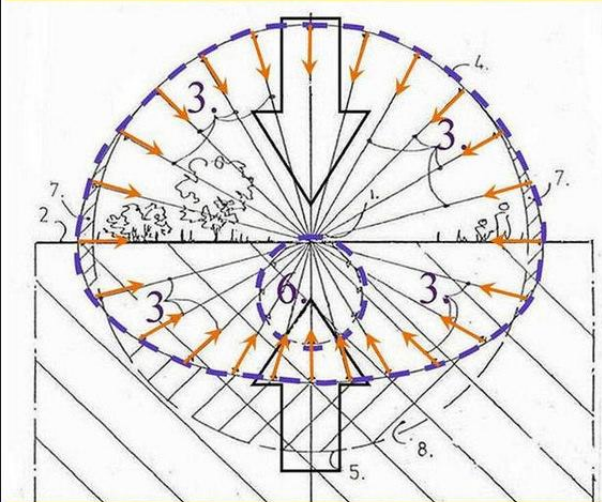

Cross section through the dual Higgs/ Graviton 3D vector field pressure distribution (or globular Hedgehog) on a point mass (1) located on earth's surface (2), according to Quantum FFF theory. 3+4= Higgs vector field. 6= Graviton vector field originated by the Higgs-graviton field transformation of the earth itself. 7+8= differences with a perfect globular vector distribution. Field variables 3+6 are rendered as inversed arrows. (see also black hole pressure distribution without gravitons)

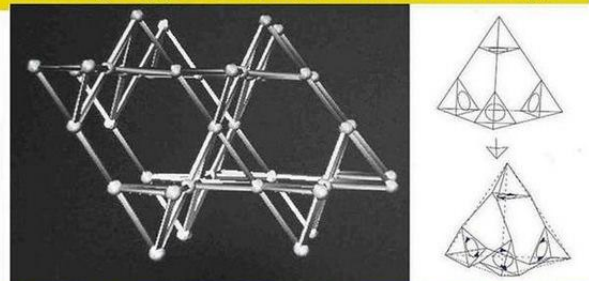

Simplified tetrahedral vacuum lattice structure (left), constructed by complex chiral tetrahedral building blocks (right). Each universe has to choose between a left- or right-handed rotation of its tetrahedral building blocks. Each chiral lattice has the Planck length and is supposed to be equipped with at least two oscillating massless new Higgs particles.

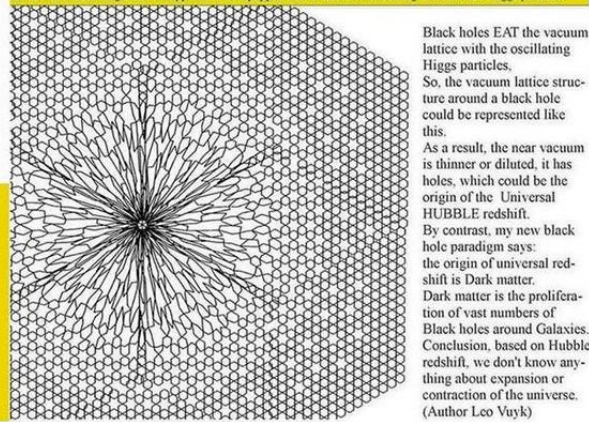

Black holes EAT the vacuum lattice with the oscillating Higgs particles. So, the vacuum lattice structure around a black hole could be represented like this. As a result, the near vacuum is thinner or diluted, it has holes, which could be the origin of the Universal HUBBLE redshift. By contrast, my new black hole paradigm says: the origin of universal redshift is Dark matter. Dark matter is the proliferation of vast numbers of Black holes around Galaxies. Conclusion, based on Hubble redshift, we don't know anything about expansion or contraction of the universe. (Author Leo Vuyk)

**Figure 17,** Quantum dipole repeller gravity ( the oscillating Casimir vacuum ) combined with less pressure from pushing gravitons.

Alternative Feynman diagrams without Loops, but based only on Duality Repulsion of Monopole Photon-Gluons (2x electric (ROR-LOL), 2x magnetic (LOU-ROU), 1x graviton (ROL/LOR) and 1x general photon (UOU)) colliding with vacuum particles called Axion-Higgs ( OOO) ( according to Quantum FFF Theory)

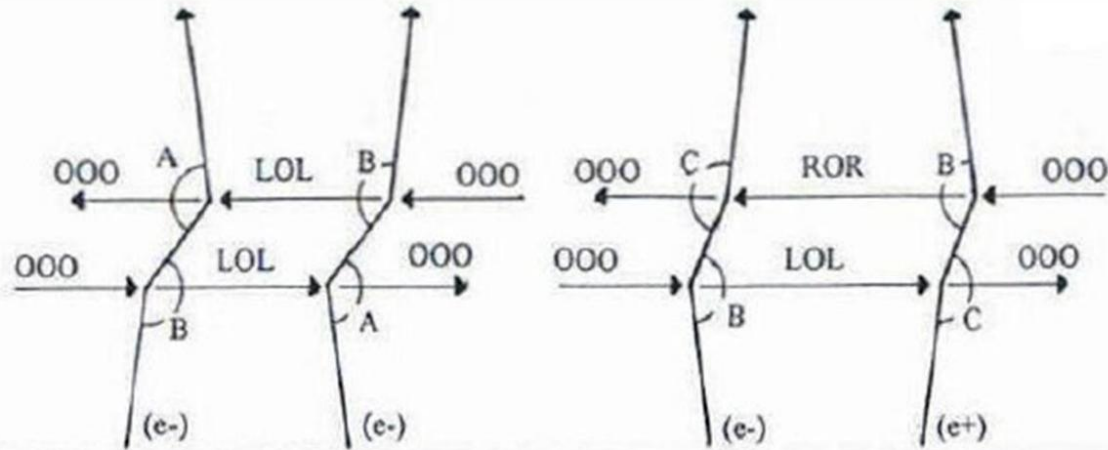

Feynman diagram for Electron Positron attraction, compared with Quantum FFF Theory repulsion

Explanation of the codes:  
 U= Up rotation (180 degrees)  
 O= Unchanged circle.  
 L= Left rotation (90 degrees)  
 R= Right rotation (90 degrees)

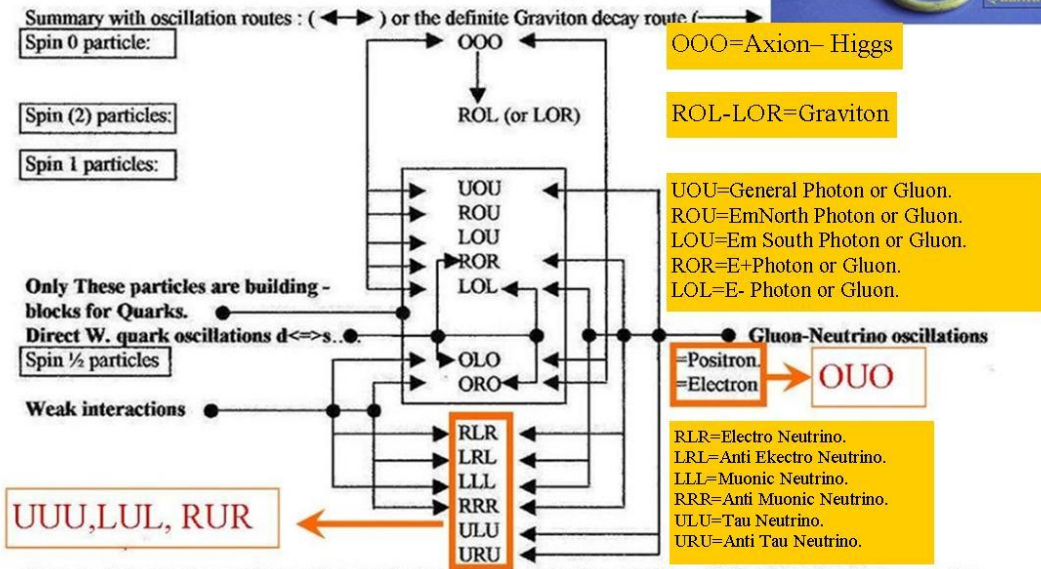
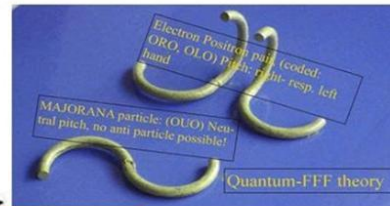
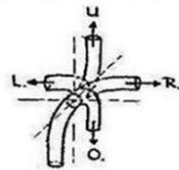

Higgs particles are supposed to oscillate in Tandem along so called linear Vacuum Lattices, two by two in opposite directions, as the symmetrical opposite pistons of a boxer engine, as the origin of all energy, spin and mass effects. This enables the Tandem Higgs particles to change the form of their own Torus into an Electron and Positron pair at

Figure 18, alternative Feynman diagrams with basic rigid string cartoons.

**Black Hole Nucleus is a Quantum Knot, evaporate or eat the local Axion-Higgs vacuum if it has large enough scale, ( Quantum FFF Theory)**

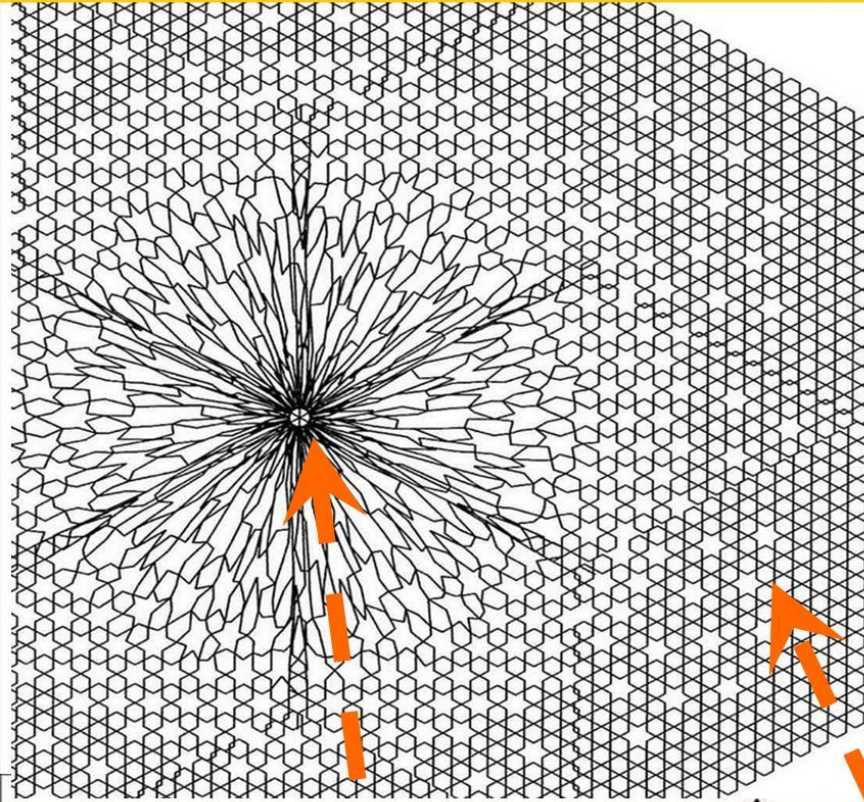

Black holes EAT the vacuum lattice with the oscillating Higgs particles, So, the vacuum lattice structure around a black hole could be represented like this.

As a result, the near vacuum is thinner or diluted, it has holes, which could be the origin of the Universal HUBBLE redshift.

By contrast, my new black hole paradigm says: the origin of universal redshift is Dark matter.

Dark matter is the proliferation of vast numbers of Black holes around Galaxies. Conclusion, based on Hubble redshift, we don't know anything about expansion or contraction of the universe.

(Author Leo Vuyk)

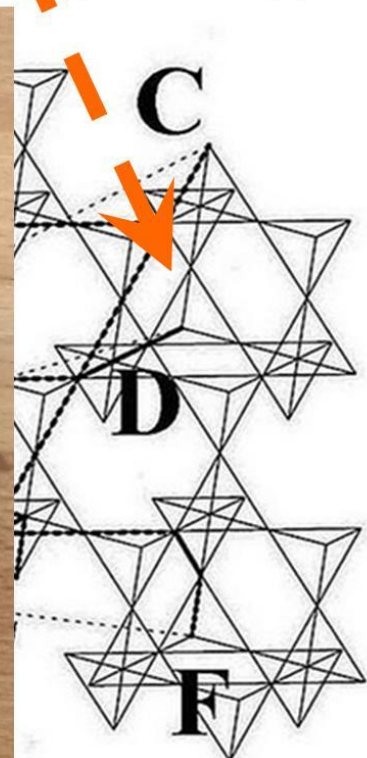

**Figure 19**, Variable Planck length around a black hole nucleus.

## QUANTUM FFF THEORY.

According to Quantum FFF Theory, ( Function Follows Form) the FORM and microstructure of elementary particles, is supposed to be the origin of FUNCTIONAL differences between HiggsGraviton- Photon- and Fermion particles.

As a result, a NEW paradigm of splitting-,accelerating- and pairing Black Hole seems to be able to accelerate itself by a -Zero Point Energy driven-self created plasma tails ( by a new Quantum Fluctuation process), to form dumbbell systems, of two or even more black holes. Inside Nebula these dumbbell systems are called Herbig Haro systems.

I think that Stephen Hawking did not calculate with the possibility of a chiral oscillating Higgs field vacuum lattice combined with propeller shaped Fermions. Then, due to Vacuum Chirality, Electron- and Positron propellers could both pushed away from the BH horizon after

spin flip polarization at different distances, forming two charged separated spheres. With quark ( plasma) formation in between.

Based on such a simple object ( propeller and process) oriented ontology, Black Holes could be imagined as charge splitters violating the 2e law af thermodynamics, combined with a continuous microscopic big bang plasma creation process!

The result I try to describe :

- 1: Black holes are the same as Dark Matter, they all consume photons, even gravitons and the Higgs field, but REPEL Fermions due to their propeller shape. They produce electric charged plasma.
- 2: Dark Energy is the oscillating ( Casimir) energy of the Higgs Field equipped with a tetrahedron lattice structure with variable Planck length..
- 3: Quantum Gravity = Dual Push gravity= Attraction (Higgs-Casimir opposing Graviton push).
- 4: The Big Bang is a Splitting dark matter Big Bang Black Hole (BBBH), splitting into smaller Primordial Big Bang Spinters (PBBS) forming the Fractalic Lyman Alpha forest and evaporating partly into a zero mass energetic oscillating Higgs particle based Higgs field.
- 5: Dual PBBSs hotspots, produce central plasma concentration in electric Herbig Haro systems as a base for star formation in open star clusters as a start for Spiral Galaxies.
- 6: Spiral Galaxies will keep both Primordial Dark Matter Black Holes as Galaxy Anchor Black Holes (GABHs) at long distance.
- 7: After Galaxy Merging, these GABHs are the origin of Galaxy- and Magnetic field complexity and distant dwarf galaxies .
- 8: Black Holes produce Plasma direct out of the Higgs field because two Higgs particles are convertible into symmetric electron and positron (or even dual quark-) propellers (by BH horizon fluctuations).
- 9: The chirality of the (spiraling) vacuum lattice is the origin our material universe. (propeller shaped positrons merge preferentially first with gluons to form (u) Quarks to form Hydrogen.
- 10: The first Supernovas produce medium sized Black Holes as the base for secondary Herbig Haro systems and open star clusters.
- 11: ALL Dark Matter Black Holes are supposed to be charge separators with internal positive charge and an external globular shell of negative charged Quark electron plasma.
- 12: The lightspeed is related to gravity fields like the earth with long extinction distances to adapt with the solar gravity field.
13. Quantum FFF Theory states that the raspberry shaped multiverse is symmetric and instant

entangled down to the smallest quantum level. Also down to living and dying CATS in BOXES.

14 Large Primordial Big Bang Spinters (PBBS) are responsible for the creation of the Lyman Alpha forest structure and first spiral galaxy forming of the universe, but they seem to be also responsible for the implosion of the universe at the end in the form of Galaxy Anchor Black Holes (GABHs) located mainly outside galaxies. see: (Quasisoft Chandra sources)

15, As a consequence of 12-14, Time is always local time in combination with cyclic period time of the multiverse.

16, If our material universes has a chiral left handed oscillating Higgs field, then our material Right Handed DNA helix molecule could be explained. However it also suggests that in our opposing symmetric anti-material entangled neighbor universe the DNA helix should have a Left handed spiral.

According to Max Tegmark: in an entangled multiverse we may ask: is there COPY PERSON over there, who is reading the same lines as I do? If this copy person is indeed living over there, then even our consciousness should be shared in a sort of entangled democratic form. Then we are not alone with our thoughts and doubts, see: Democratic Free Will in the instant Entangled Multiverse.

17, All particles and waves should be entangled with anti-copy particles and Higgs field based waves in our opposing anti universes. Then wave particle duality and the so called one particle double slit interference could be explained by accepting that real shaped 3D photon particles only exist in their function of Gluons. However Gluons should transfer form information to the oscillating luminiferous Higgs field ether, within about 1 cm distance from a fermion.(see: Babock and Bergman anomaly,1964)

18, Different elementary particles have different qualities by their different complex stringy shape. Leptons and Quarks have a propeller shape with left or right handed pitch creating charge difference. Gluons, Photons and Neutrino particles have no pitch.

20 All particles can be converted to one or more Higgs particles, Lepto Quarks can be compound particles.

21 All particles are assumed to be present as Higgs particles already in the cyclic Big Bang Black Hole (BBBH) after the former multiverse has collapsed into a Big Crunch Black Hole.

22, We seem to live inside one material universal bubble of an instant entangled (Charge Parity Time) CPT symmetric raspberry bubble multiverse. Each quantum jump or wave function collapse or human choice is guided by this instant entanglement at long distant.

If our material universes has a chiral oscillating Higgs field, then our material Right Handed DNA helix molecule could be explained. However it also suggests that in our opposing Anti materialmultiverse neighbour universe the DNA helix should have a left handed spiral.

According to Max Tegmark: in an entangled multiverse we may ask: is

There copy pesron over there, who is reading the same lines as I do? If this copy person is indeed living over there, then even our consciousness should be shared in a sort of democratic form,

## References:

Books: The New God Particle and Free Will. Author: Leo Vuyk, LuLu publishers, 2008.  
ISBN number 978-1-4092-1031-3 <http://www.lulu.com/spotlight/LeoVuyk>  
Quantum FFF Theory is also published in the form of POSTERS at the Flickr site:  
<http://www.flickr.com/photos/93308747@N05/>

## References:

- [112] [viXra:1807.0437](#) Preference for Dual Herbig Haro Black Hole Consumption by the Central MW Black Hole, Leaving Plasma Jets Behind.
- [111] [viXra:1806.0368](#) A Fifth Force Vacuum Dipole Repeller, Needed to Create All Attraction Forces Even Around Black Holes in Quantum FFF Theory.
- [110] [viXra:1806.0298](#) Expanding Earth, by Growing Water based Crashed Comet
- [109] [viXra:1806.0068](#) Primordial Electric Dark Matter Black Holes Outside Galaxies
- [108] [viXra:1805.0541](#) Tidal Star Disruption Events (TDE) by Fermion Repelling Black Holes in Quantum FFF Theory.
- [107] [viXra:1805.0307](#) Fulgurite Created by Lightning Bullet Also Known as Ball Lightning, According to Quantum FFF Theory.
- [106] [viXra:1804.0138](#) Dark Matter Black Hole Galaxy Hierarchy According to Quantum FFF Theory.
- [105] [viXra:1803.0100](#) Free Will Readiness Potential Ratios, the Key for a Multiverse Number Calculation.
- [104] [viXra:1803.0093](#) Skyrmion Interference Black Holes, Photonic Molecules, Ball Lightning, Micro Comets, Sprite-Fireballs and Sunspots According to Quantum FFF Theory.
- [103] [viXra:1801.0121](#) Quantum FFF Theory, a Conscious String Theory with Different Vacuum Trajectories for Axion-Higgs Field/ Photons Respectively Fermions,
- [102] [viXra:1801.0040](#) A Consciousness Theory of Everything based on Rigid Transformable Strings, Instantly Entangled Between 8 or 12 CP Symmetric Universal Bubbles.
- [101] [viXra:1712.0349](#) Tabby Star's Support for New Physics Starspot Black Holes of Quantum FFF Theory.
- [100] [viXra:1712.0122](#) The Massless Axion-Higgs Vacuum Rigid String Particle, Even in Micro and Macro Dark Matter Black Hole Nuclei.



[99] [viXra:1711.0443](#) The Semi Classical Model of Quantum FFF Theory based on Symmetric Transformable Entangled Rigid Strings.

[98] [viXra:1711.0379](#) The Raspberry Shaped Multiverse, Pulsating Between Big Crunch and Big Bang, Based on Rigid Transformable Massless Axion Higgs Particles.

[97] [viXra:1711.0327](#) The Einstein Cross Lensing Effect Explained by the Quadruple Dark Matter Formation Process of Edge-on Spiral Galaxies, According to Quantum FFF Theory.

[96] [viXra:1711.0237](#) Higgs Particle Based SIMPs for Ancient and Future (Stone) Cutting Technology.

[95] [viXra:1711.0112](#) Higgs Quantum Knots is Dark Matter is Black Holes or: Higgs Dark Matter Black Holes.

=====