

Big Bang Energy out of Nothing, or a Compressed Rigid String Nucleus x.

Leo Vuyk,
Architect,
the Netherlands.

Abstract,

Quantum FFF (Function Follows Form) theory is a Rigid String Theory which states, that all attraction forces are subjected to a dual repulsion process between the dark energy of the oscillating Axion Higgs string vacuum lattice and less repulsion force of graviton strings or monopole photon strings (electric- magnetic) radiated by fermionic matter.

Black hole nuclei are assumed to be rigid stringy quantum knots highly compressed by the external attack of the oscillating vacuum particles, which mostly are added to the outside of the growing nucleus depending on the pressure difference between the vacuum and the internal black hole quantum knot.

As a consequence most black holes are growing by consuming vacuum strings and also by merging with other black holes of different sizes.

Black hole with equal sizes do not merge, but are supposed to pair up to a certain distance after which they recede from each other to become a Herbig Haro system with star formation in the middle .

The giant central black holes often present inside galaxies are also supposed to merge with other black holes to grow in size.

As the ultimate consequence, however, the universe will contract into a Big Crunch, (BC) by the growing black holes which constantly consume the vacuum lattice around us.

However the vacuum pressure at the BC nucleus will decrease in time and become in balance with the growing internal rigid string pressure between the rigid strings inside the BC nucleus, which is the moment of the start of the big bang into chunks of smaller black hole nuclei evaporating also gradually into a surrounding oscillating vacuum lattice.

As a consequence we seem to live inside one of the super symmetric “material” bubble universe created by the explosion of a black hole.

Introduction.

New physics of Quantum FFF Theory as a rigid string theory, is suggested to be a base for Quantum based monopole radiation fields like graviton-, Gamma/Xray-, electric- and magnetic monopole fields.

All Star-Planet systems are supposed to be stabilized by at least two polar local stellar anchor black holes (also dark matter) .

Interpreted as Herbig Haro systems, these dual black holes polarize the Axion/Higgs field vacuum around the sun with butterfly shaped fifth force vector bubbles around test masses. As a consequence, Emerging gravity effects called “dipole repeller gravity”, between galaxies and Galaxy clusters seem a support for the fifth force vacuum pressure gravity postulate. Secondly, the apparent violation of the second law of thermodynamics around both types of black holes (S.Nova and Interference BHs) is a combined effect between the vacuum polarization and polarized spinning propeller shaped fermions. An other main effect of the oscillating Axion Higgs vacuum lattice is, that we have to search for evidence of some sort of an ether, influencing the speed of information like photons. I am proud to present my latest poster on this issue at figure (15)

The Origin of Big Bang Energy: Compressed Rigid Stringy Big Bang Black Hole Nucleus.

All Black hole nuclei are compressed by the (Casimir) energy of the oscillating Axion-Higgs vacuum Lattice, even the Big Bang Black Hole, until the decreasing vacuum pressure has come into balance with the central Big Bang BH. According to Quantum FFF Theory.

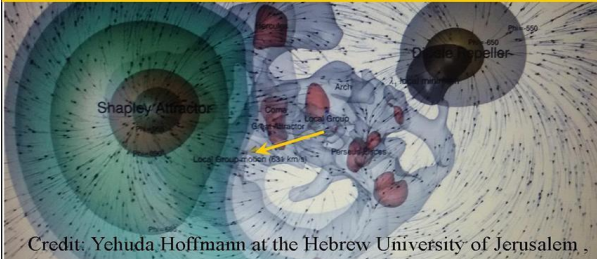

Figure 1, Big Bang energy out of compressed Rigid string Big Crunch nucleus.

Dipole Repeller Vacuum Gravity (Dark Energy) pushing with different effect on Fermionic mass and Dark Matter Black Holes.

Quantum Dipole Repeller Gravity pushing our Galaxy.

According to Quantum FFF Theory, empty space is filled with a fast oscillating lattice of massless Axion-Higgs field particles as a half base for our opposing dipole pressure Higgs-graviton gravity on earth. Now prof. Yehuda Hoffman shows us a support for this hypothesis.



Evidence for New Physics Dark Matter=Black Holes, without Inertia or Mass effect. The merging Bullet and Abell 520 cluster, show gas producing dark matter black hole concentration in between, accelerating in front out of the clusters, due to lack of inertia/ mass.

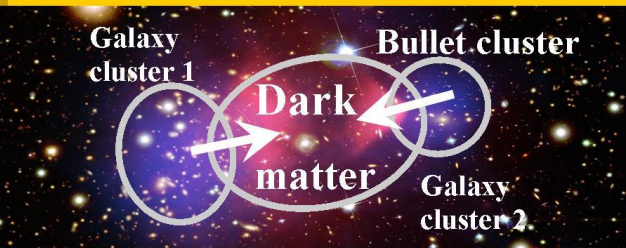

Quantum Gravity as pressure distribution of the oscillating dual Higgs/Graviton vector field.

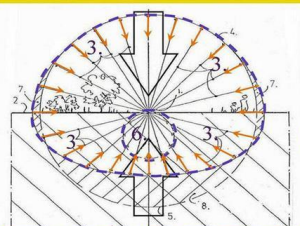

Cross section through the dual Higgs/Graviton 3D vector field pressure distribution (or globular Hedgehog) on a point mass (1) located on earth's surface (2), according to Quantum FFF theory. 3+4= Higgs vector field. 6= Graviton vector field originated by the Higgs-graviton field transformation of the earth itself. 7+8= differences with a perfect globular vector distribution. Field variables 3+6 are rendered as inversed arrows (see also black hole pressure distribution without gravitons)

New Dark Matter Black Hole, "Eat" the chiral oscillating Higgs vacuum.(Quantum-FFF Theory)

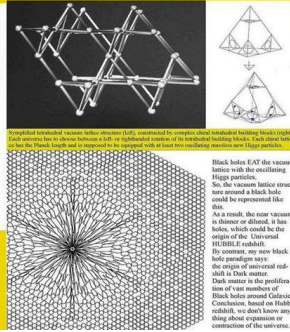

According to Quantum FFF Theory, Dark Matter= Black Holes= NO mass NO inertia effect.



Figure 2, dipole repeller gravity between galaxies, pushing the dark matter content out of galaxy clusters before merging like Abell 520 and the Bullet cluster seem to perform.

Dual Rigid String Pressure Gravity between the oscillating dark energy (3) of the Axion Higgs field and opposing Graviton pressure energy (6) according to Quantum FFF Theory.

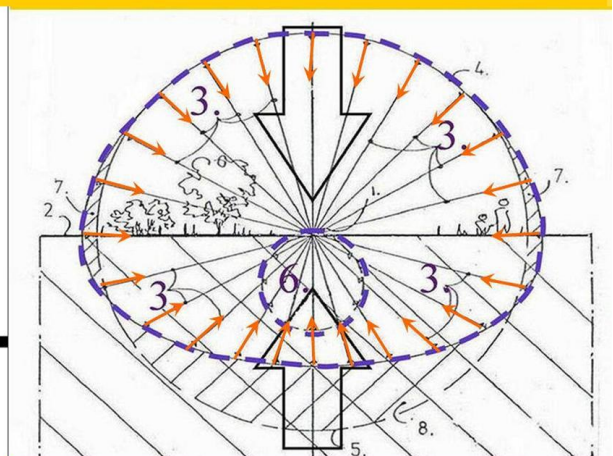
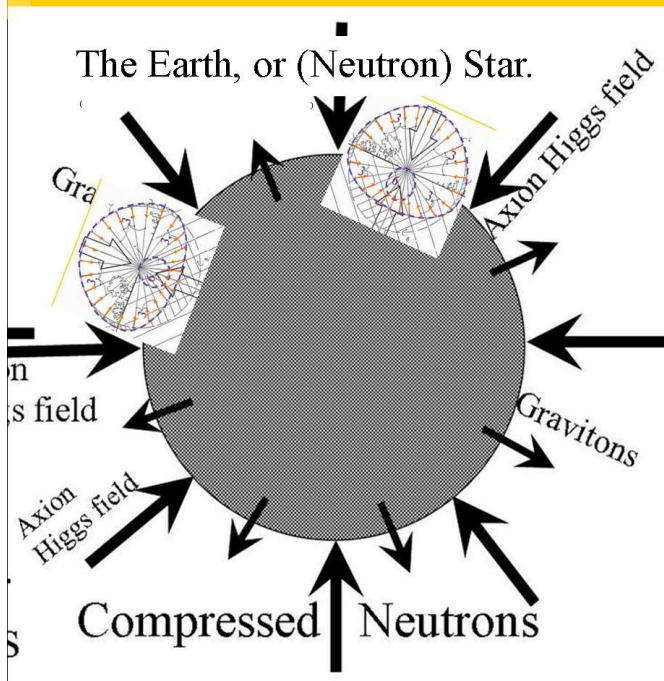

Cross section through the dual string gravity on a point mass at the earth surface or (Neutron) star. (1) located on earth's surface (2), according to Quantum FFF theory. 3+4= Higgs vector field. 6= Graviton vector field originated by the Higgs-graviton field transformation of the earth itself. 7+8= differences with a perfect globular vector distribution. Field variables 3+6 are rendered as inversed arrows (see also black hole pressure distribution without gravitons)

Figure 3, Dipole repeller or Rigid string pressure gravity between oscillating dark energy of the Axion Higgs field and opposing Graviton pressure energy.

Examples of Splitting Black Holes in the Carina Nebula.



Below: two by plasma trailing tails accelerated micro black holes (Former star spots) showing a temporary meeting place to split and form a Herbig Haro system with newborn star in between..



Figure 4, Example of pairing and splitting black holes to form Herbig Haro systems in Carina nebula.

Triple Hotspot Starformation.

According to Quantum FFF Stars are born inside New Physics Herbig Haro (HH) systems between two pairing new physics Black Holes, always mistakenly interpreted as so called Bows-hock Hotspots of both stellar jets. However I assume that these BHs are former Starspots created by Supernova explosions

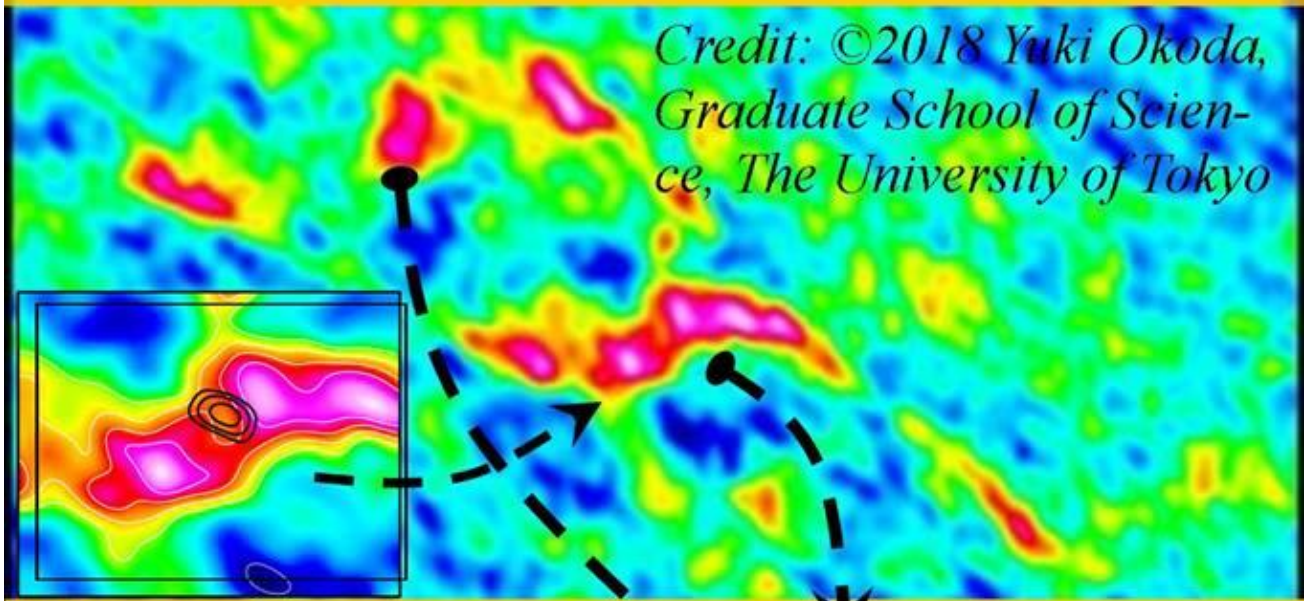

Credit: ©2018 Yuki Okoda, Graduate School of Science, The University of Tokyo

Herbig Haro Hotspots are assumed to be former Starspot black holes created by (Super) nova explosions.

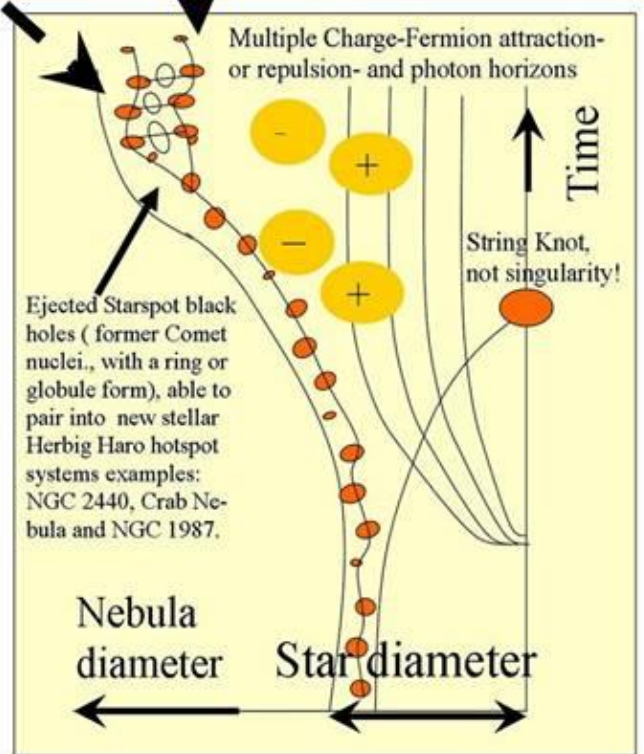
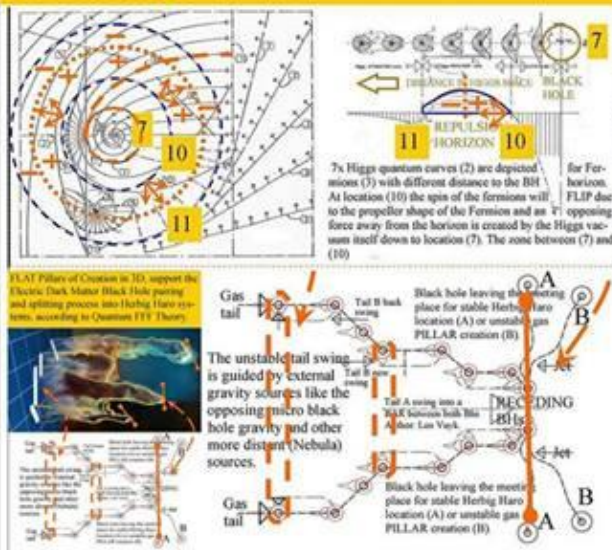
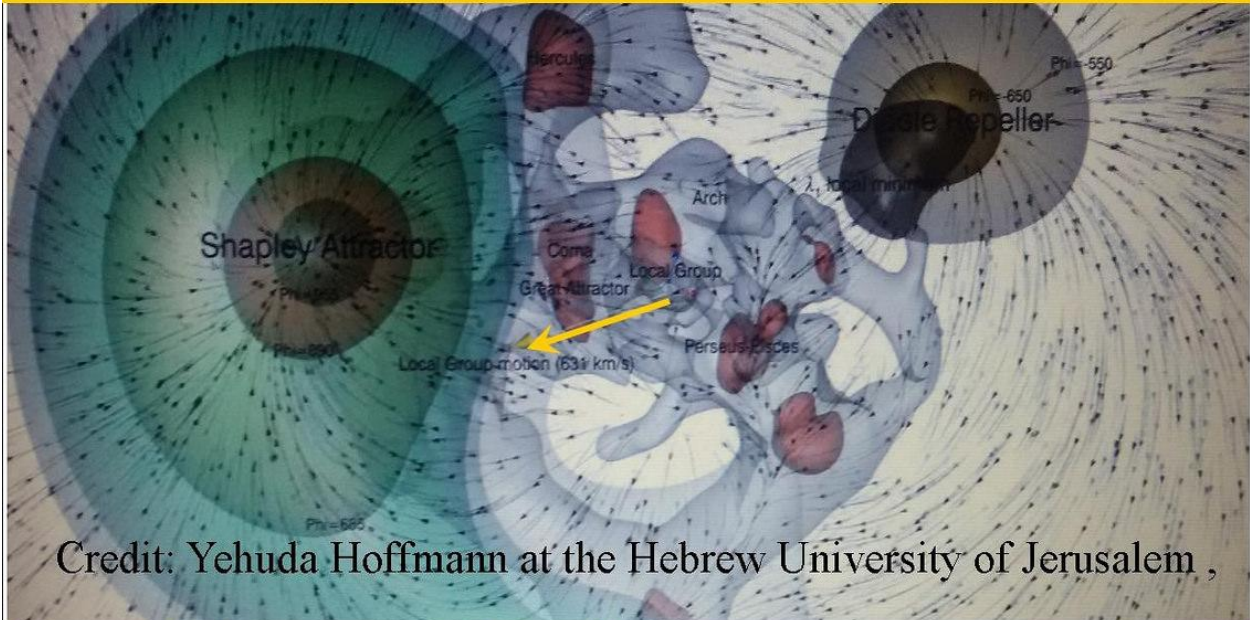

Figure 5, Triple hotspot star formation in Herbig Haro systems out off ejected former starspot Black holes inside a Super Nova based nebula..

Quantum Dipole Repeller Gravity pushing our Galaxy.

According to Quantum FFF Theory, empty space is filled with a fast oscillating lattice of massless Axion-Higgs field particles as a half base for our opposing dipole pressure Higgs-graviton gravity on earth. Now prof. Yehuda Hoffman shows us a support for this hypothesis.



Credit: Yehuda Hoffmann at the Hebrew University of Jerusalem ,

Quantum Gravity as pressure distribution of the oscillating dual Higgs/Graviton vector field.

New Dark Matter Black Hole, "Eat" the chiral oscillating Higgs vacuum.(Quantum-FFF Theory)

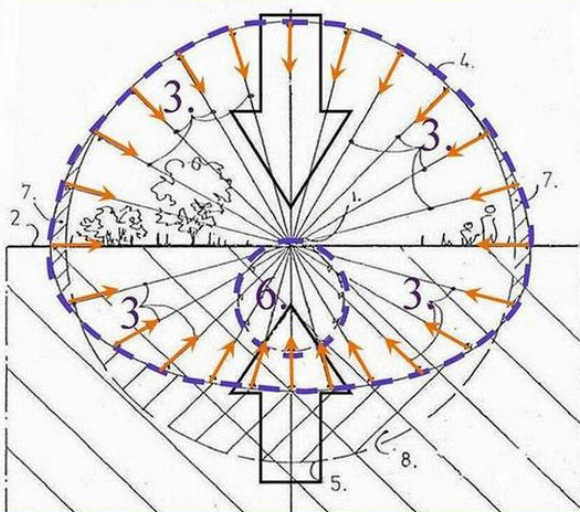

Cross section through the dual Higgs/ Graviton 3D vector field pressure distribution (or globular Hedgehog) on a point mass (1) located on earth's surface (2), according to Quantum FFF theory. 3+4= Higgs vector field. 6= Graviton vector field originated by the Higgs-graviton field transformation of the earth itself. 7+8= differences with a perfect globular vector distribution. Field variables 3+6 are rendered as inversed arrows. (see also black hole pressure distribution without gravitons)

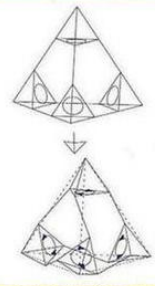
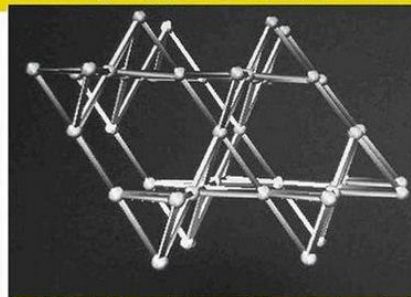

Simplified tetrahedral vacuum lattice structure (left), constructed by complex chiral tetrahedral building blocks (right). Each universe has to choose between a left- or righthanded rotation of its tetrahedral building blocks. Each chiral lattice has the Planck length and is supposed to be equipped with at least two oscillating massless new Higgs particles.

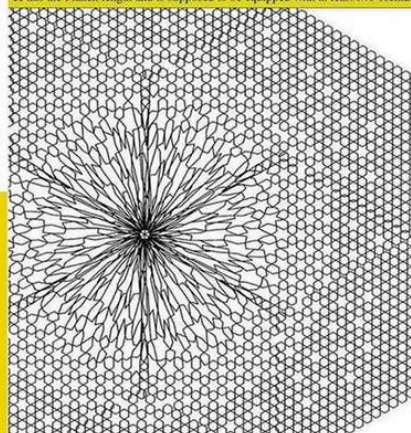

Black holes EAT the vacuum lattice with the oscillating Higgs particles. So, the vacuum lattice structure around a black hole could be represented like this. As a result, the near vacuum is thinner or diluted, it has holes, which could be the origin of the Universal HUBBLE redshift. By contrast, my new black hole paradigm says: the origin of universal redshift is Dark matter. Dark matter is the proliferation of vast numbers of Black holes around Galaxies. Conclusion, based on Hubble redshift, we don't know anything about expansion or contraction of the universe. (Author Leo Vuyk)

Figure 6, Vacuum based Fifth force "Dipole repeller gravity" according to Yehuda Hoffmann and the relation with Electric Dark matter Black Hole gravity of Quantum FFF Theory..

Sterile Neutrinos and Majoranas seem to have different origins according to the 3x hinged rigid string system of Quantum Function Follows Form model.

MAJORANA particle's placed in the new extended standard model based on Q-FFF Theory. OOU is e-e+ related, UUU, LUL,RUR are Neutrino related. Called sterile Neutrinos.

The coding of Single Elementary Particles is based on the so called "rotational click positions" of the three hinges, which are assumed to be regularly placed over the ring shaped Higgs "Quantum Tons Particle" (page 2). This ring has one splitting point and three hinges which have consequently four 90 degree click positions each. The best Tons ring diameter ratio to click-on is about 1/7. The ring coding of the hinges positions is as follows.

Explanation of the codes:
 U= Up rotation (180 degrees)
 O= Unchanged circle
 L= Left rotation (90 degrees)
 R= Right rotation (90 degrees)

Summary with oscillation routes: (←→) or the definite Graviton decay route: (→).
 Spin 0 particle: OOO → Graviton

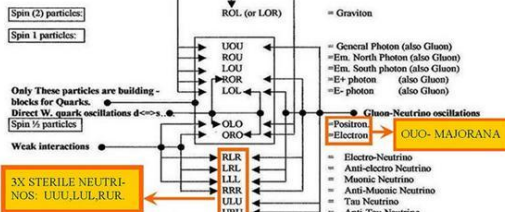

Higgs particles are supposed to oscillate in Tandem along so called linear Vacuum Lattices, two by two in opposite directions, as the symmetrical opposite pistons of a boxer engine, as the origin of all energy, spin and mass effects. This enables the Tandem Higgs particles to change the form of their own: Tons into an Electron and Positron pair at

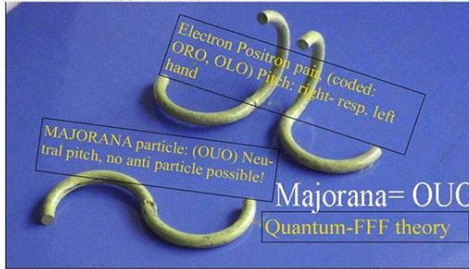

Geometrical proposal for most particles building the universe



Geometrical proposal for the sub-quantum structure of 6 Leptons and Quarks interpreted as compound Photon/Electron Positron propeller combinations. Muon- and Tau particles seem to show up as family members of the Down respectively Charm Quarks. According to Quantum FFF Theory. (Function Follows Form in particle physics)

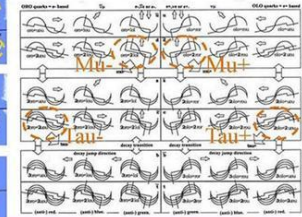

All Photons (1x, graviton, 2x electr.- 2x magnetic- and 1x general (x-gamma-ray) photon) and two Fermions (Electron + Positron) are formed direct out of the "Mother" ring shaped Higgs particle, by internal hinge rotation (below). Dark Matter particles are supposed to be formed by interlocking 3 or 4 photons (below). Neutrinos are deformed photons or fermions. (not shown) See Quantum FFF Theory. (Function Follows Form) <http://vixra.org/abs/1103.0002>



↓ 3D base for 3x hinged rigid strings.



OOO,-ROL-UOU,ROU,LOU,ROR,LOL,-OLO,ORO-RUR,LRL,LLL,RRR,ULU,URU.

Figure 5, 3-Dimensional String Based Alternative Particle Model.

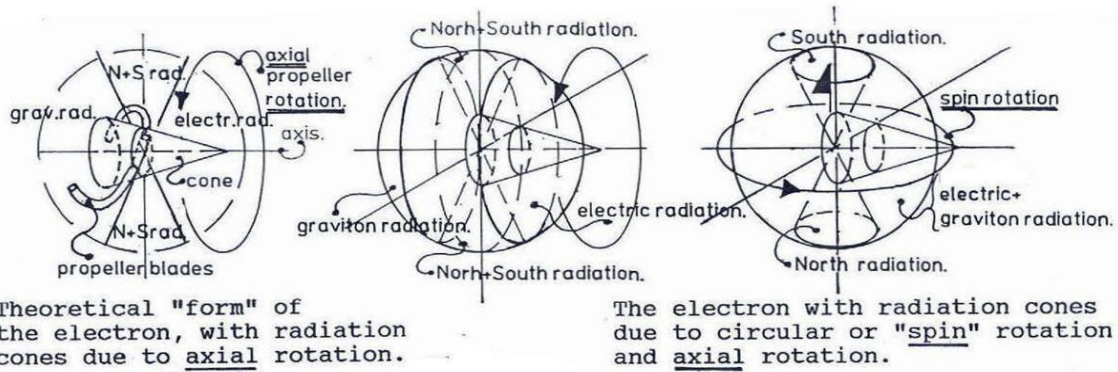
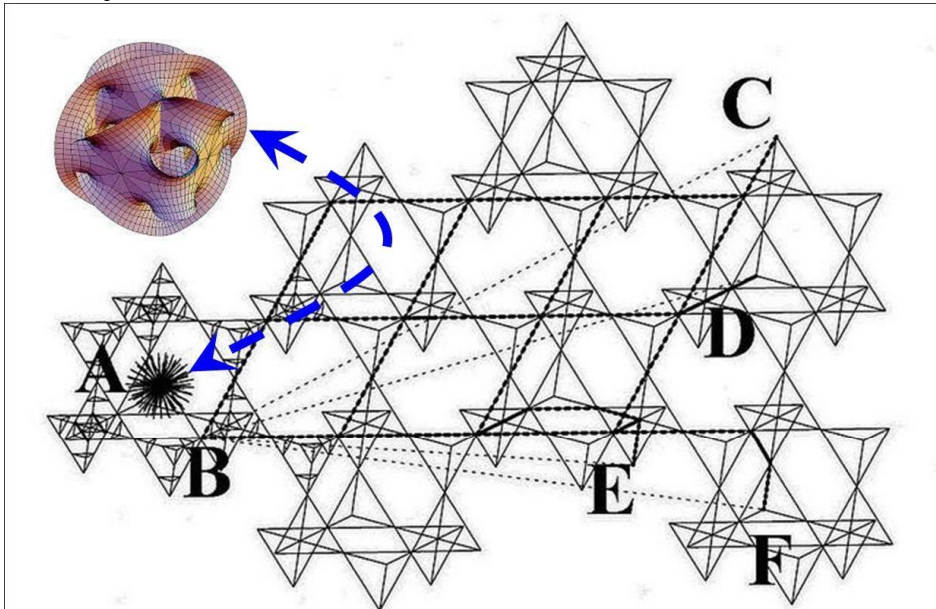

Figure 8, Double axial spin of Fermions with monopole Gluon- Graviton radiation cones. Inside a nucleon, after a short distance the 5 different string shaped Gluons (2x Electric, 2x Magnetic and one General photon) are able to exchange and merge with Fermions into compound Quarks, or after about 1 cm, become part of a photonic quantum wave, outside the nucleon just like the Graviton.



Photon trajectories through the tetrahedral oscillating Higgs vacuum lattice. (Acc. to Quantum FFF Theory)
 A: a real shaped Photon is created by Higgs collision with a dual axis spinning (Calabi Yau) Fermion propeller.
 B: that Photon transfers CODED form information (monopole photon info) and direction information into one Higgs particle which transfers this information by mutual Higgs collisionary oscillations through the vacuum in one specific direction.
 C,D,E, or F.
 I: Only magnetic photonic information (2x : North and South) are subject to curvature by an undisturbed symmetric oscillating vacuum
 II: Local Anti-Symmetric Oscillating vacuum Frames are influenced by massive objects like the earth and responsible for semi relativistic effects.
 III The vacuum lattice has helix- or chiral quality being the origin of our material universe.

Figure 9, Photon (bunch shaped) trajectories, through the Higgs vacuum lattice.

Alternative Feynman diagrams with additional ZPE vacuum Higgs impulses, combined with electric and magnetic monopole photon impulses, according to Quantum FFF Theory

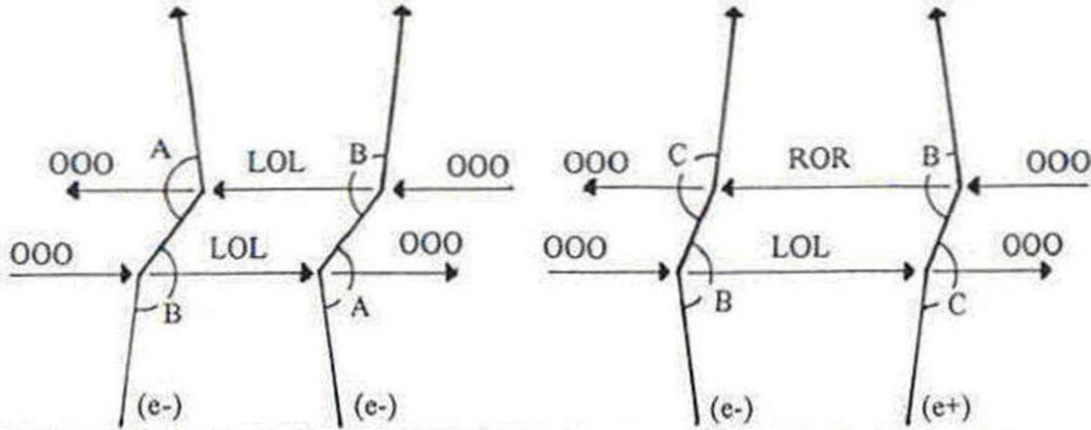

Higgs (OOO), Neg. Photon (LOL) Pos. Photon (ROR) all change form after collision with Fermions

Higgs impulse diagram for Double LeSage Gravity, according to Quantum FFF theory.

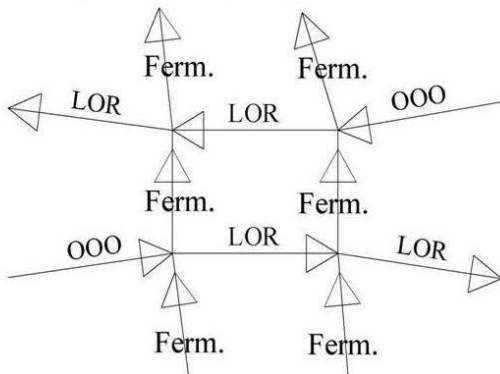

Fermionic impulse differences with Higgs (OOO) and pushing Gravitons (LOR).
OOO changes form after collision into LOR.
Gravitons don't change shape after collision.

Higgs Impulse diagram for MAGNETIC monopole radiation, according to Quantum FFF theory.

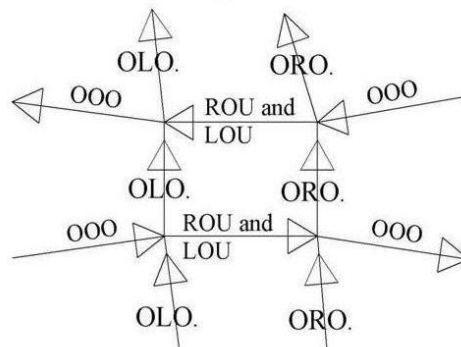

Fermionic impulse differences between Higgs (OOO) and TWO Magnetic monopole photons (LOU and ROU) on Fermions (OLO and ORO).
OOO changes form after collision with OLO resp ORO into ROU and LOU and after second collision back again into OOO.

Quantum Gravity (left) and Magnetic forces (right). Vacuum Higgs Chirality and particle geometry and spin plays an important role

Figure 10, Vacuum Axion/Higgs field (OOO) fifth force in action opposing all other gluons/Photons.

Quantum Gravity as pressure distribution of the oscillating dual Higgs/Graviton vector field.

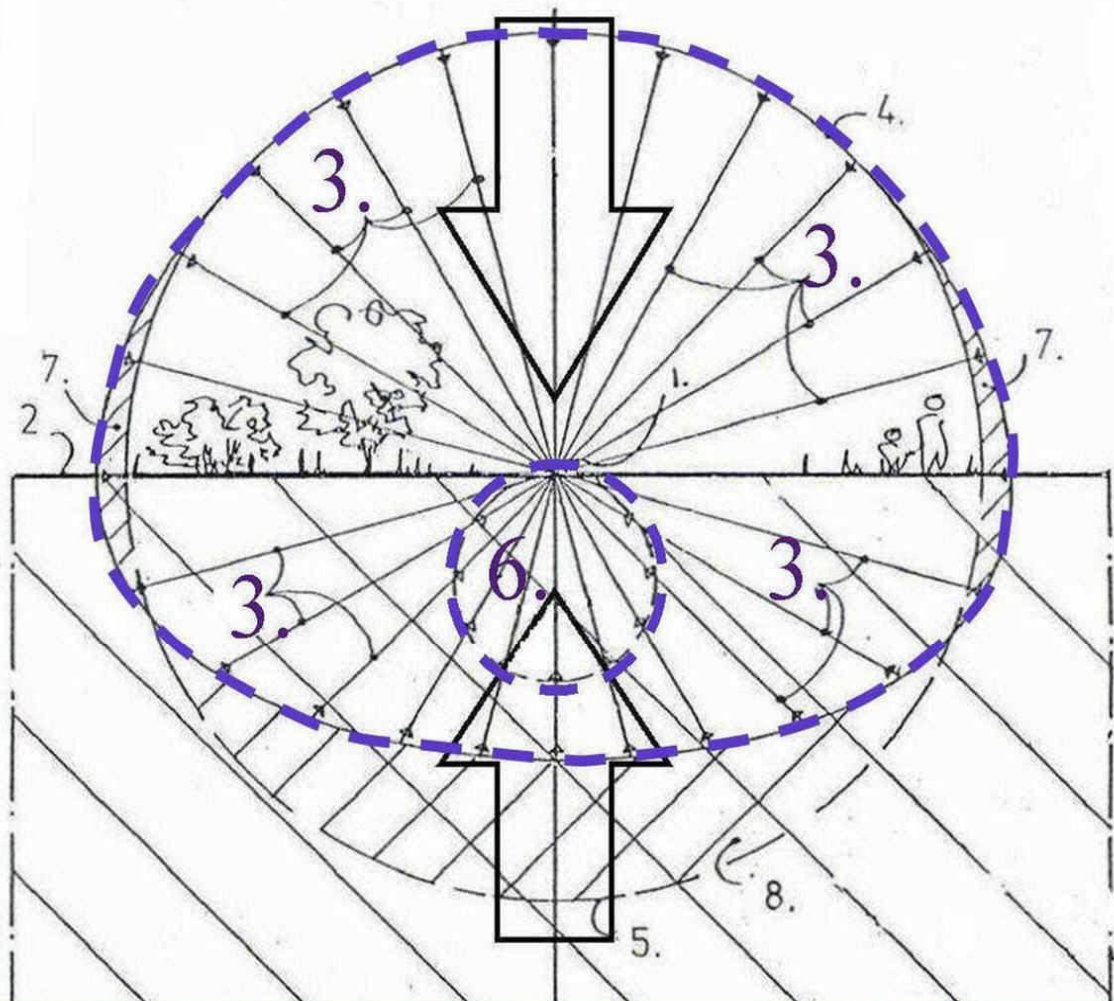

Cross section through the dual Higgs/ Graviton 3D vector field pressure distribution (or globular Hedgehog) on a point mass (1) located on earth's surface (2), according to Quantum FFF theory. $3+4$ = Higgs vector field. 6 = Graviton vector field originated by the Higgs-graviton field transformation of the earth itself. $7+8$ = differences with a perfect globular vector distribution. Field variables $3+6$ are rendered as inversed arrows. (see also black hole pressure distribution without gravitons)

Figure 11, Cross section of the “**Double Vector Hedgehog**” of pushing forces around Fermions. The difference between Higgs vacuum pressure (3) and less effective Graviton pressure (6) on Fermions are the basic elements of Double Le Sage gravity.

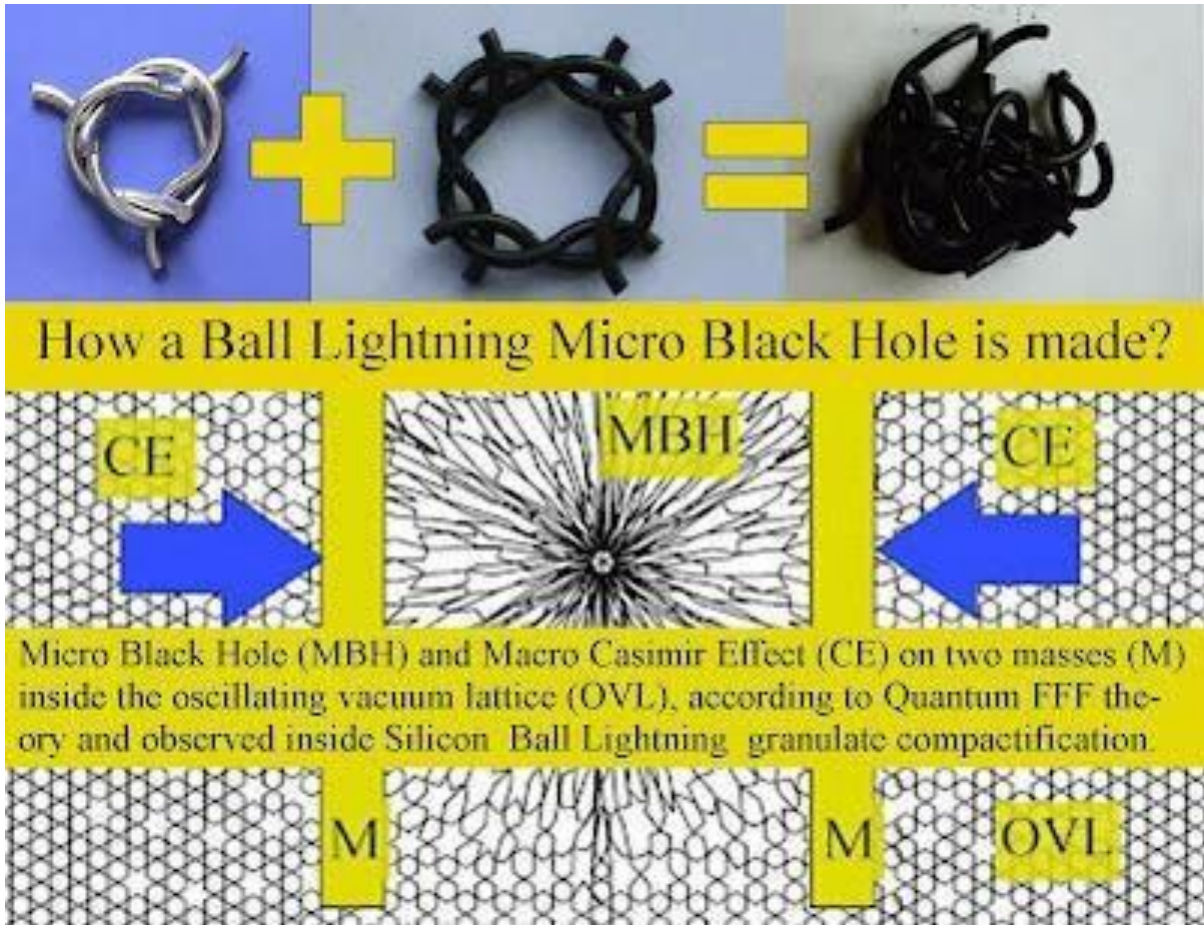

Figure: 12, Single repulsive gravity around a black hole represented by the vacuum oscillation spectrum or Oscillating Vacuum Lattice OLV around a black hole. Above: the Quantum Knot nucleus of a simple black hole.

THE SECRET OF BALL LIGHTNING. Its production by e.m.- x-ray interference into a **KNOTTY** Nucleus, able to accelerate, decrease Entropy and produce Vapour.

The NEW Black Hole Paradigm

The standard Hawking Radiation postulate is: that all matter (NOT all energy) is drawn into the Black hole. My NEW postulate is that matter is even created (and pushed outside) at the black hole horizon by QUANTUM FLUCTUATIONS producing Electrons and Positrons.

The reason for this NEW Fermion production effect is, that it is a consequence of the concentration of head-on Higgs particle collisions just at the horizon. Some Electrons and Positrons will annihilate, but the rest will form Quarks and plasma, because the Higgs vacuum lattice is CHIRAL, and prefer to link Gluons to Positrons and form U- Quarks in favour of Electrons and Gluons, which form D-Quarks.

Thus more Electrons will stay single and form Hydrogen atom shells. However they have less mass than Quarks and feel less attraction to the Black hole nucleus, thus Electrons form also an external shell around the Black hole inner shell of Protons and some Neutrons!

Due to the propeller shape of the particles all the plasma is repelled away from the black hole! The Black hole will not evaporate!

This is the base for NEW Physics and a support for a new explanation of Cometary X-rays, Hydrogen and AMINO ACID production. Even Gas Pillar and Herbig Haro formations inside Nebula become a logic base. Author Leo Vuyk.

Ball lightning pushed by Plasma tail against the wind

Vapour trail washed out by the wind

The Fermion repelling horizon

7x Higgs quantum curves (2) are depicted for Fermions (3) with different distance to the BH horizon. At location (10) the spin of the fermions will FLIP due to the propeller shape of the Fermion and an opposing force away from the horizon is created by the Higgs vacuum itself down to location (7). The zone between (7) and (10)

The creation of B.L. by e.m. Knot interference

Ball lightning micro-black hole pushed by gas producing plasma tail.

Fermion repulsion by SPIN-FLIP

Fermion production!

Vapour

Wind direction

Fermion repulsive horizon (10) with Butterfly shaped Higgs impulse Hedgehogs (9). (by Leo Vuyk)

Knotty Micro-Black hole nucleus

Author: Leo Vuyk 10-02-2011 NL. <http://bigbang-entanglement.blogspot.com/>

Figure: 13, poster showing how ball lightning should be interpreted as a micro black hole.

A hotspot for powerful cosmic rays found under the Big Dipper, by the University of Utah. The mysterious source of cosmic rays is also reason to look at the southern hemisphere to observe the opposing second Stellar Anchor Black Hole (SABH) (Cosmic ray production by NEW black hole paradigm according to Quantum-FFF Theory).

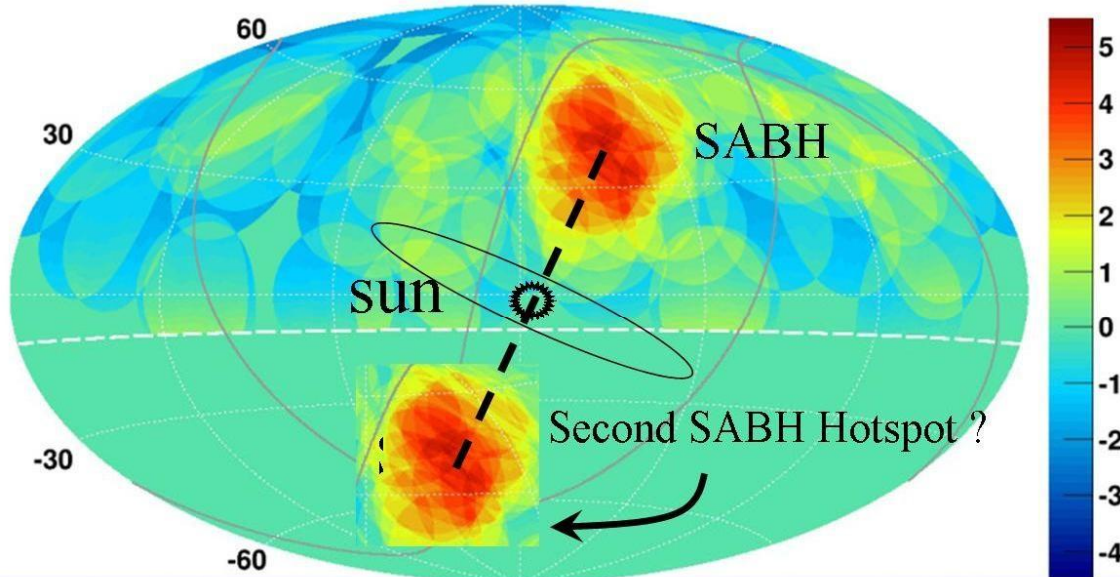

According to Quantum FFF Theory, “New Black Holes produce Proton– Electron plasma. By the strong Casimir vacuum push gravity on the BH, the “Lighter” electrons will stay outside the “heavier” proton horizon (blue). As a consequence BHs have a strong electric potential, which is liberated by asymmetric processes in dual BH systems like Herbig Haro objects showing strong electro magnetic effects in open cluster star formation and Birkeland Alfven circuits around the earth and even in the so called BICEP 2 results.

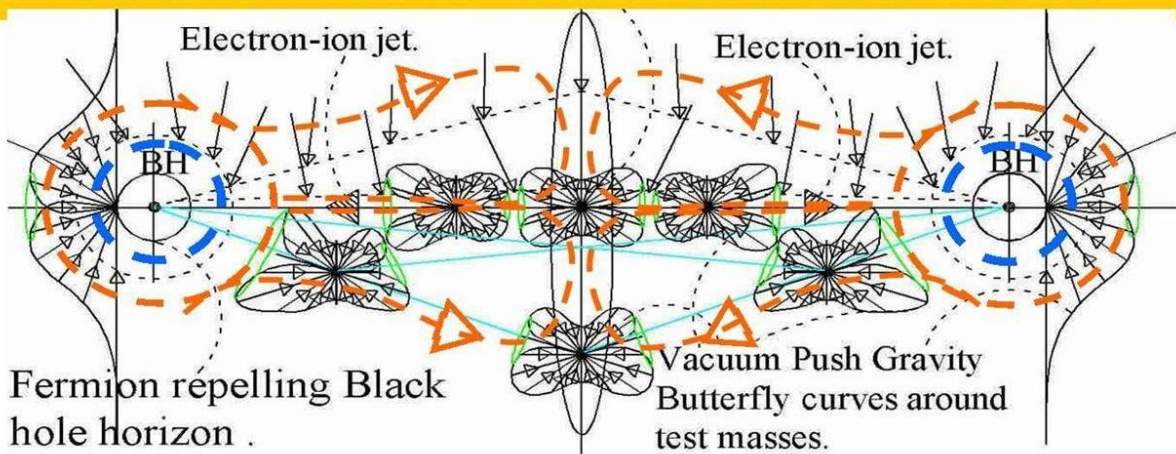

Scheme of the electric SABH principle around the sun.

Figure: 14, The speed of gravity ONLY around the sun exceeds the speed of light and is supposed to have an instant effect.

The 3 dimensional structure of the repulsive butterfly shaped oscillating Higgs field vacuum vector bubbles is supposed to be the origin.

Michelson and Morley revised by Dual satellite lightspeed mass dragging test.

Local variable lightspeed by gravity related LASOF.

According to Quantum FFF Theory, the earth gravity related LASOF (Local A Symmetric Oscillating vacuum Frame) is dragging the lightspeed inside an ellipsoidal shaped speed transition volume around the earth inside the solar reference LASOF, with full extinction effect at the edges.

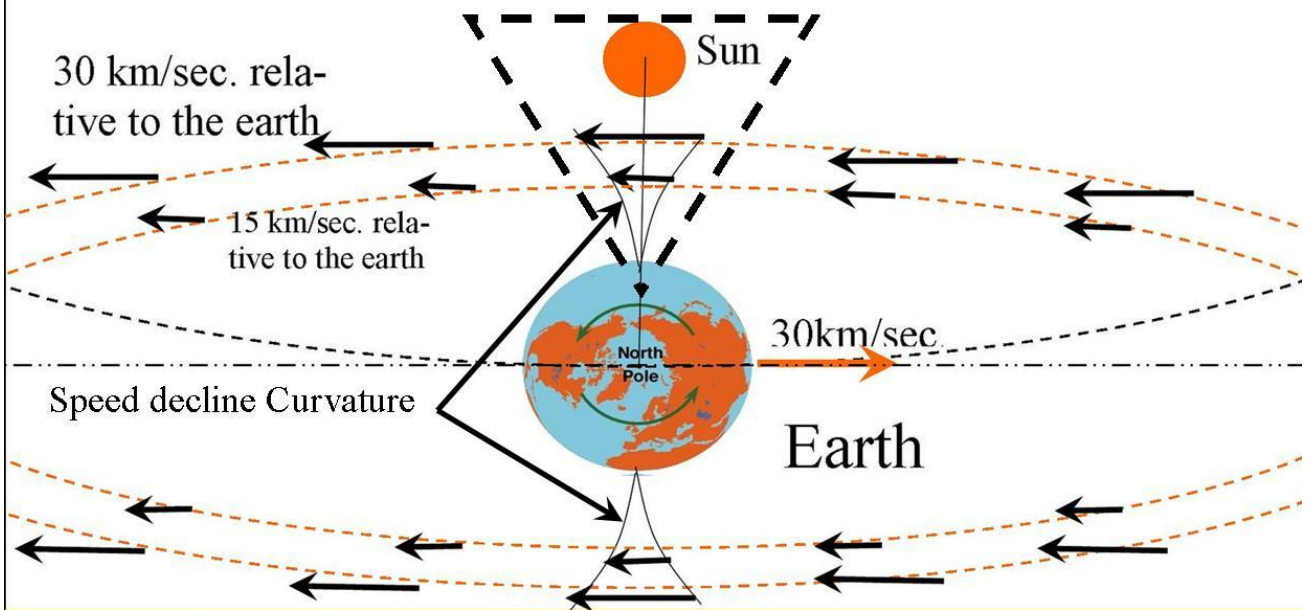

Earth–Solar orbit speed is 30 km/sec to the right.

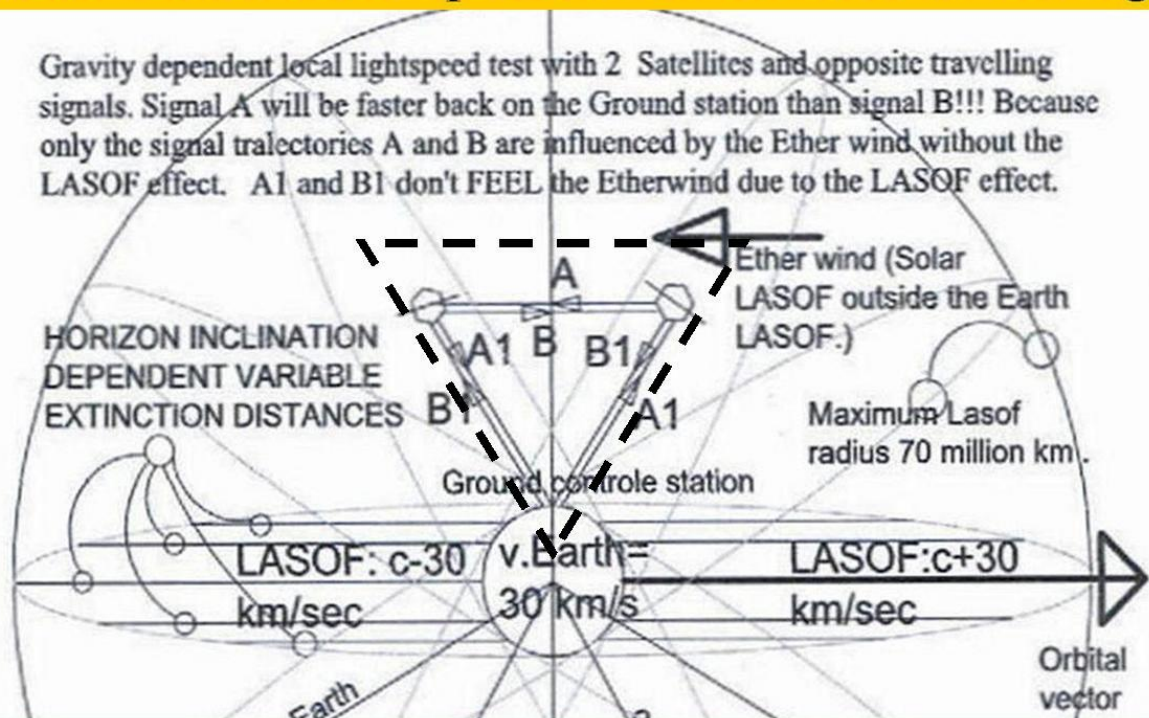
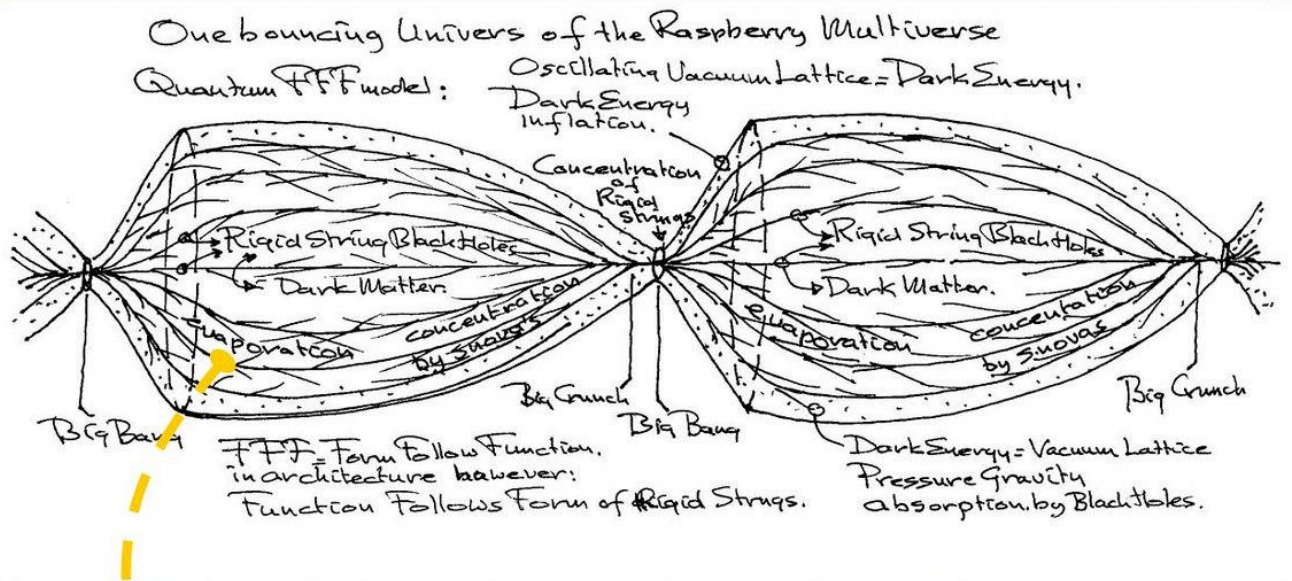

Figure 15, Alternative Michelson and Morley experiment in space.

The Bouncing Multiverse 2

According to Quantum FFF Theory, we live inside one of a specific number of Charge Parity symmetric copy universes coming out of a huge (Axion/Higgs rigid string black hole nucleus = Dark Matter). All copy string particles are guided by long distance (holographic) multiverse entanglement and transformable by mutual collision into all Standard model particles and more. Such as monopole bosons or massless Axion/Higgs vacuum particles (Dark Energy) , responsible for the Casimir effect and half of all other SM semi pressure forces.



Below: the usual BH dual pairing after the Big Bang splitting.

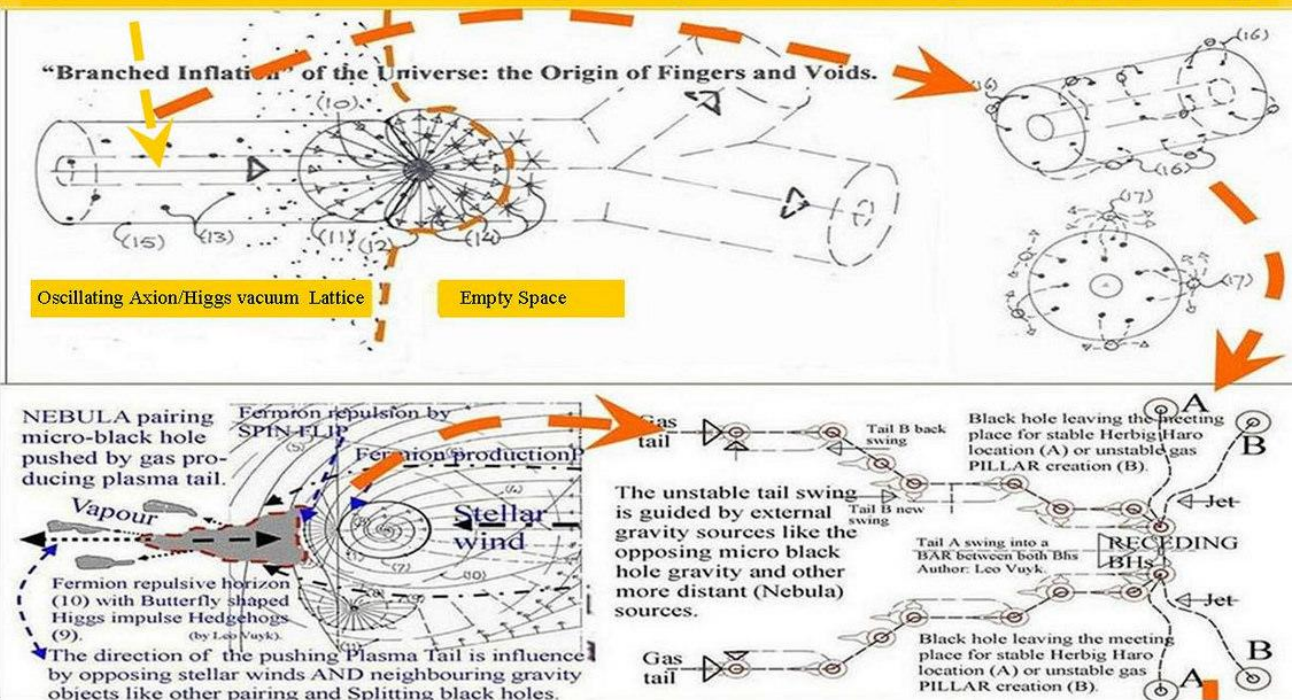

Figure 16 How the the big bang started as dark matter splitter and bounced back.

[105] [viXra:1803.0100](#) Free Will Readiness Potential Ratios, the Key for a Multiverse Number Calculation.

[104] [viXra:1803.0093](#) Skymion Interference Black Holes, Photonic Molecules, Ball Lightning, Micro Comets, Sprite-Fireballs and Sunspots According to Quantum FFF Theory.

[103] [viXra:1801.0121](#) Quantum FFF Theory, a Conscious String Theory with Different Vacuum Trajectories for Axion-Higgs Field/ Photons Respectively Fermions,

[102] [viXra:1801.0040](#) A Consciousness Theory of Everything based on Rigid Transformable Strings, Instantly Entangled Between 8 or 12 CP Symmetric Universal Bubbles.

[101] [viXra:1712.0349](#) Tabby Star's Support for New Physics Starspot Black Holes of Quantum FFF Theory.

[100] [viXra:1712.0122](#) The Massless Axion-Higgs Vacuum Rigid String Particle, Even in Micro and Macro Dark Matter Black Hole Nuclei.

[99] [viXra:1711.0443](#) The Semi Classical Model of Quantum FFF Theory based on Symmetric Transformable Entangled Rigid Strings.

[98] [viXra:1711.0379](#) The Raspberry Shaped Multiverse, Pulsating Between Big Crunch and Big Bang, Based on Rigid Transformable Massless Axion Higgs Particles.

[97] [viXra:1711.0327](#) The Einstein Cross Lensing Effect Explained by the Quadruple Dark Matter Formation Process of Edge-on Spiral Galaxies, According to Quantum FFF Theory.

[96] [viXra:1711.0237](#) Higgs Particle Based SIMPs for Ancient and Future (Stone) Cutting Technology.

[95] [viXra:1711.0112](#) Higgs Quantum Knots is Dark Matter is Black Holes or: Higgs Dark Matter Black Holes.

=====