

# **Ether Theory of Everything**

November 16, 2018

Website: <https://github.com/etoe/etoe>

Copyright © 2018, Aleksei Morozov, 1973.03.16, Nizhny Novgorod, Russia,  
aleksei.morozov.19730316.nn.ru@gmail.com

## Keywords

ether, luminiferous aether, etheron, ether philosophy, ether science, etheristics, ether physics, ether chemistry, etheronics, hyperphysics, hyperatomistics, hyperatomism, ether theory of everything, ether theory of matter and consciousness, ether theory of relativity of gravity and magnetism, inertial-wave theory of gravity and magnetism, ether theory of gravity and magnetism, ether relativity, ether relativity of gravity and magnetism, ether unification of science, primary entity, triune superentity, space-time-ether, inertial etheron, etheron inertia, inertia of etheron, maximum velocity of etheron, inertial ether, amount of inertia, ether simulation, ether frame of reference, etheron dynamics, protodynamics, primary dynamics, ether dynamics, etheron event, collision of etherons, etheron group, ether Newton's cradle, etheron exchange of inertia and composition, simplex etheron exchange, transit etheron exchange, duplex etheron exchange, accelerative etheron exchange, ether hyperexchange, ether travel, ether drive, ether drift, instant ether shift, ether motion, gravitation, ether object, outside etheron, gravitatable ether object, eth, gravitating ether object, geth, ether aura, superposition of ether auras, ether superposition, gravitating ether subobject, subgeth, ether aura generation, ether aura regeneration, ether aura transformation, ether waves, ether waves interference, magnetic field, ether object-wave duality, ether wave-object duality, ether levitation, gravitational-magnetic levitation, ether evolution, evolution of ether objects, hyperevolution, gravitational-magnetic mechanism of synthesis-isolation, ether cluster, ether hyperobject, ether subobject, ether configuration, ether code, ether tree of ether cluster, ether cloud, ether bunch, ether atmosphere, gravitational-magnetic mechanism of heat oscillation, gravitational-magnetic heat oscillation of gravitating ether subobject, heat oscillation of ether cluster, stream of gravitatable ether objects, stream of eths, stream of gravitating ether objects, stream of geths, stream of ether clusters, ether fugitivity, ether conductivity, electrical conductivity, superconductivity, ether fluidity, superfluidity, proteon, proton, neutron, elementary atom, hyperatom, collective ether atmosphere, subatom, subatom levitation, levitation orbit, hyperatom levitation tree of subatoms, hyperatomic tree, hyperatomic periodic form, orbital configuration, orbital transformation, orbital code, orbital sequence, chemical number, hyperatomic number, hyperatomic identifier, proteon heat oscillation, subatom heat oscillation, hyperatom heat oscillation, ether atomic model, hyperatomic model, hyperatomic sequence, hypersequence, periodic sequence, hyperatomic periodic table, classic hyperatomic periodic table, ether periodic table, classic ether periodic table, chemical periodic list, periodic matrix, hyperatomic periodic map, hyperatomic map, hyperatomic map of chemical element, helithreum, periodic graph, periodic map, ether quantum mechanics, ether quantum interpretation, ether quantum effects, ether cosmology, ether cosmological model, photon decay, proton synthesis, proton decay, hyperatomic reactor, ether reactor, thermoreactor of atomic fission, thermoreactor of hyperatomic fission, thermoatomic fission, hyperatomic fission, controlled thermoatomic fission, controlled hyperatomic fission, ether neural network, associative broadcast neural network, ether memory, ether pattern, broadcasting of output ether pattern of a neuron, ether pattern superposition, ether association, ether association superposition, explainable associations, associative compression, associative archive, ether archive, ether stream of consciousness, associative synthesis, ether information, ether learning, ether deep learning, ether machine learning, ether artificial

intelligence, ether informatics, ether information theory, ether computing, ether processor, ether computer, ether program synthesis, distributed ether computing, ether epoch, ether epoch dawn, worldwide ether neural network, ether Internet, Worldwide Academy of Sciences, ether technologies, ether nanotechnologies, nanoether, ether technological singularity, ethernomics, ether civilization

## **Preface**

Ether Theory of Everything (aka Ether Theory) is Ether Theory of Relativity of Gravity and Magnetism, HyperAtomic Model, Ether Quantum Mechanics, Ether Cosmology, HyperAtomic Reactor, Ether Neural Network.

## **Acknowledgements**

Rene Descartes, Isaac Newton, Nicolas Fatio de Duillier, Georges-Louis Le Sage, all theorists and popularizers of luminiferous aether, and you.

# Contents

Keywords . . . . .	1
Preface . . . . .	2
Acknowledgements . . . . .	2
<b>I Ether theory of relativity</b>	<b>10</b>
<b>1 Primary entities</b>	<b>11</b>
1.1 Space . . . . .	11
1.2 Time . . . . .	11
1.3 Etherons . . . . .	11
<b>2 Primary relations</b>	<b>12</b>
2.1 Occupation of space by etheron . . . . .	12
2.2 Inertia of etheron . . . . .	12
2.3 Collision of etherons . . . . .	12
<b>3 Primary effects</b>	<b>13</b>
3.1 Deceleration of etheron . . . . .	13
3.2 Acceleration of etheron . . . . .	13
3.3 Exchange of roles between etherons . . . . .	13
<b>4 Ether objects</b>	<b>14</b>
4.1 Eth . . . . .	14
4.2 Ether aura . . . . .	14
4.3 Geth . . . . .	14
<b>5 Ether dynamics</b>	<b>15</b>
5.1 Ether drive . . . . .	15
5.2 Ether drift . . . . .	15
5.3 Ether motion . . . . .	15
<b>6 Gravity</b>	<b>16</b>
6.1 Etheron exchange . . . . .	16
6.2 Gravitational acceleration . . . . .	16
<b>7 Magnetism</b>	<b>17</b>
7.1 Ether aura transformation . . . . .	17
7.2 Ether waves . . . . .	17
7.3 Ether object-wave duality . . . . .	17
7.4 Magnetic field . . . . .	17

<b>II</b>	<b>Hyperatomic model</b>	<b>18</b>
<b>8</b>	<b>Ether evolution</b>	<b>19</b>
8.1	Gravitational-magnetic mechanism of synthesis-isolation . . . . .	19
8.2	Gravitational-magnetic levitation . . . . .	19
8.3	Ether cluster . . . . .	19
8.3.1	Ether cloud . . . . .	20
8.3.2	Ether bunch . . . . .	20
8.3.3	Ether atmosphere . . . . .	20
8.4	Proton . . . . .	20
<b>9</b>	<b>Hyperatom</b>	<b>21</b>
9.1	Hyperatomic configuration . . . . .	21
9.2	Hyperatomic sequence . . . . .	22
9.3	Chemical element . . . . .	23
9.4	Hyperatomic fullness . . . . .	23
9.5	Hyperatomic set . . . . .	23
9.6	Hyperatomic number . . . . .	24
9.7	Hyperatomic identifier . . . . .	24
9.8	Hyperatomic transformation . . . . .	24
<b>III</b>	<b>Ether quantum mechanics</b>	<b>26</b>
<b>10</b>	<b>Ether quantum interpretation</b>	<b>27</b>
<b>11</b>	<b>Ether quantum effects</b>	<b>28</b>
11.1	Ether fugitivity . . . . .	28
11.2	Ether conductivity . . . . .	28
11.3	Ether fluidity . . . . .	28
<b>IV</b>	<b>Ether cosmology</b>	<b>29</b>
<b>12</b>	<b>Universe</b>	<b>30</b>
<b>13</b>	<b>Synthesis and decay of proton</b>	<b>31</b>
<b>14</b>	<b>Decay of photon</b>	<b>32</b>
<b>V</b>	<b>Hyperatomic reactor</b>	<b>33</b>
<b>15</b>	<b>Hyperatomic fission</b>	<b>34</b>
<b>16</b>	<b>Controlled hyperatomic fission</b>	<b>35</b>
<b>17</b>	<b>Ether reactor</b>	<b>36</b>

<b>VI</b>	<b>Ether neural network</b>	<b>37</b>
<b>18</b>	<b>Associative broadcast neural network</b>	<b>38</b>
18.1	Electrically conductive network . . . . .	38
18.2	Neuron . . . . .	38
18.3	Neural network . . . . .	39
18.3.1	Input tree of cables of a neuron . . . . .	40
18.3.2	Output tree of cables of a neuron . . . . .	40
18.3.3	Output ether pattern of a neuron . . . . .	40
18.3.4	Input ether pattern of a neuron . . . . .	40
18.4	Broadcasting of output ether pattern of a neuron . . . . .	40
18.5	Ether multipattern . . . . .	40
18.6	Ether association . . . . .	41
18.7	Ether stream of consciousness . . . . .	41
18.8	Testable predictions . . . . .	41
<b>VII</b>	<b>Technological singularity</b>	<b>42</b>
<b>19</b>	<b>Ether technological singularity</b>	<b>43</b>
<b>20</b>	<b>Etheristics</b>	<b>44</b>
20.1	Etheronics . . . . .	44
20.2	Hyperatomistics . . . . .	44
<b>21</b>	<b>Worldwide ether neural network</b>	<b>45</b>
<b>22</b>	<b>Worldwide Academy of Sciences</b>	<b>46</b>
	<b>Appendix</b>	<b>47</b>
<b>A</b>	<b>Periodic table</b>	<b>47</b>
A.1	Chemical elements . . . . .	47
A.2	Classic hyperatomic periodic table . . . . .	48
A.3	Chemical periodic list . . . . .	49
<b>B</b>	<b>Periodic sequence</b>	<b>50</b>
B.1	Primary periodic sequence . . . . .	50
B.2	Basic periodic sequence . . . . .	51
B.3	Extra periodic sequence . . . . .	52
<b>C</b>	<b>Periodic list</b>	<b>53</b>
C.1	Primary periodic list . . . . .	53
C.2	Basic periodic list . . . . .	54
C.3	Extra periodic list . . . . .	55
<b>D</b>	<b>Periodic map</b>	<b>57</b>
D.1	Level 1 . . . . .	57
D.2	Level 2 . . . . .	57
D.3	Level 3 . . . . .	57
D.4	Level 4 . . . . .	57

D.5	Level 5	58
D.6	Level 6	58
D.7	Level 7	58
D.8	Level 8	59
D.9	Level 9	60
D.10	Level 10	61
<b>E</b>	<b>Hyperatomic category</b>	<b>62</b>
E.1	Diatomic nonmetal	62
E.2	Alkali metal	63
E.3	Alkaline earth metal	64
E.4	Noble gas	64
E.5	Post transition metal	65
E.6	Metalloid	65
E.7	Polyatomic nonmetal	66
E.8	Transition metal	67
E.9	Lanthanide	68
E.10	Actinide	69
<b>F</b>	<b>Hyperatomic map</b>	<b>70</b>
F.1	Level 1	70
F.2	Level 2	70
F.3	Level 3	70
F.4	Level 4	70
F.5	Level 5	71
F.6	Level 6	72
F.7	Level 7	73
F.8	Level 8	74
F.9	Level 9	75
F.10	Level 10	76
<b>G</b>	<b>Hyperatomic group</b>	<b>77</b>
G.1	Be, B	77
G.2	N, O, F	77
G.3	Mg, Al	78
G.4	Si, P	78
G.5	Sc, Ti, V, Cr, Mn	78
G.6	Fe, Co, Ni, Cu	79
G.7	Ga, Ge, As, Se, Br, Kr	79
G.8	Ru, Rh	80
G.9	Sb, Te, I	80
G.10	Cs, Ba	81
G.11	La, Ce, Pr, Nd	81
G.12	Pt, Au	82
G.13	Hg, Tl, Pb, Bi, Po, At	82
G.14	Fr, Ra	83
G.15	Ac, Th, Pa, U	83

<b>H Hyperatomic element</b>	<b>84</b>
H.1 Level 1 . . . . .	84
H.1.1 Protium . . . . .	84
H.2 Level 2 . . . . .	84
H.2.1 Deuterium . . . . .	84
H.2.2 Helithreem . . . . .	84
H.3 Level 3 . . . . .	84
H.3.1 Tritium . . . . .	84
H.3.2 Helium . . . . .	85
H.4 Level 4 . . . . .	85
H.4.1 Lithium . . . . .	85
H.4.2 Beryllium . . . . .	85
H.5 Level 5 . . . . .	86
H.5.1 Boron . . . . .	86
H.5.2 Carbon . . . . .	86
H.5.3 Nitrogen . . . . .	87
H.5.4 Oxygen . . . . .	87
H.6 Level 6 . . . . .	88
H.6.1 Fluorine . . . . .	88
H.6.2 Neon . . . . .	88
H.6.3 Sodium . . . . .	89
H.6.4 Magnesium . . . . .	89
H.6.5 Aluminium . . . . .	90
H.6.6 Silicon . . . . .	90
H.6.7 Phosphorus . . . . .	91
H.6.8 Sulfur . . . . .	91
H.7 Level 7 . . . . .	92
H.7.1 Chlorine . . . . .	92
H.7.2 Argon . . . . .	92
H.7.3 Potassium . . . . .	93
H.7.4 Calcium . . . . .	93
H.7.5 Scandium . . . . .	94
H.7.6 Titanium . . . . .	95
H.7.7 Vanadium . . . . .	96
H.7.8 Chromium . . . . .	97
H.7.9 Manganese . . . . .	99
H.7.10 Iron . . . . .	100
H.7.11 Cobalt . . . . .	101
H.7.12 Nickel . . . . .	102
H.7.13 Copper . . . . .	103
H.7.14 Zinc . . . . .	104
H.8 Level 8 . . . . .	104
H.8.1 Gallium . . . . .	104
H.8.2 Germanium . . . . .	105
H.8.3 Arsenic . . . . .	105
H.8.4 Selenium . . . . .	106
H.8.5 Bromine . . . . .	107
H.8.6 Krypton . . . . .	107
H.8.7 Rubidium . . . . .	108
H.8.8 Strontium . . . . .	108



H.8.9	Yttrium	109
H.8.10	Zirconium	109
H.8.11	Niobium	110
H.8.12	Molybdenum	110
H.8.13	Techneium	111
H.8.14	Ruthenium	112
H.8.15	Rhodium	114
H.8.16	Palladium	114
H.8.17	Silver	116
H.8.18	Cadmium	117
H.8.19	Indium	118
H.8.20	Tin	119
H.8.21	Antimony	120
H.8.22	Tellurium	120
H.8.23	Iodine	122
H.8.24	Terbium	122
H.9	Level 9	123
H.9.1	Xenon	123
H.9.2	Caesium	124
H.9.3	Barium	124
H.9.4	Lanthanum	125
H.9.5	Cerium	125
H.9.6	Praseodymium	126
H.9.7	Neodymium	126
H.9.8	Promethium	127
H.9.9	Samarium	128
H.9.10	Europium	128
H.9.11	Gadolinium	129
H.9.12	Dysprosium	129
H.9.13	Holmium	129
H.9.14	Erbium	130
H.9.15	Thulium	130
H.9.16	Ytterbium	130
H.9.17	Lutetium	131
H.9.18	Hafnium	131
H.9.19	Tantalum	132
H.9.20	Tungsten	132
H.9.21	Rhenium	132
H.9.22	Osmium	133
H.9.23	Iridium	133
H.9.24	Platinum	134
H.9.25	Gold	135
H.9.26	Mercury	135
H.9.27	Thallium	136
H.9.28	Lead	136
H.9.29	Bismuth	137
H.9.30	Polonium	138
H.9.31	Astatine	138
H.9.32	Actinium	139
H.9.33	Thorium	139

H.9.34 Protactinium . . . . .	140
H.9.35 Uranium . . . . .	140
H.10 Level 10 . . . . .	141
H.10.1 Radon . . . . .	141
H.10.2 Francium . . . . .	141
H.10.3 Radium . . . . .	141
<b>I Hyperatoms</b>	<b>142</b>
<b>Bibliography</b>	<b>152</b>
<b>Index</b>	<b>155</b>

# Part I

## Ether theory of relativity

# Chapter 1

## Primary entities

Primary entity is that which is determined by the relationships with other primary entities. Primary entities are space, time, and etherons. Triune superentity is space-time-ether.

### 1.1 Space

Space is a primary entity with the boundless three-dimensional extent in which etherons have relative position and direction.

### 1.2 Time

Time is a primary entity of the indefinite continued progress of existence of etherons and events with etherons that occur in irreversible succession from the past through the present to the future.

### 1.3 Etherons

Etheron is a primary entity of inertial elementary particle.

Ether is the etherons.

Mass is the number of etherons.

# Chapter 2

## Primary relations

Primary relation is a relationship between primary entities.

### 2.1 Occupation of space by etheron

Etheron occupies the same amount of space all the time. Etherons cannot occupy the same space at the same time.

### 2.2 Inertia of etheron

Inertia of etheron is a relation of etheron with space and time by which etheron that is not moving remains still and etheron that is moving goes at the same speed and in the same direction until another etheron affects it or another etherons affect it.

Ether frame of reference is a frame of reference in which the vector sum of the velocities of all considered etherons is minimal.

Vector of inertia is the vector sum of velocities.

Amount of inertia is a sum of squares of velocities.

Vector of inertia of the closed group of etherons is invariable.

Amount of inertia of the closed group of etherons is invariable.

Vector of inertia of the open group of etherons is variable.

Amount of inertia of the open group of etherons is variable.

### 2.3 Collision of etherons

Collision of etherons is an elastic collision when trying to occupy the same space. Total inertia of the etherons after the encounter is equal to their total inertia before the encounter.

Duration of collision of etherons depends on quantity of etherons.

# Chapter 3

## Primary effects

Primary effect is an effect to etheron from a collision of etherons.

### **3.1 Deceleration of etheron**

Deceleration of etheron is an effect of etheron speed decrease relative to the collision site when colliding with one or several etherons.

### **3.2 Acceleration of etheron**

Acceleration of etheron is an effect of etheron speed increase relative to the collision site when colliding with one or several etherons.

### **3.3 Exchange of roles between etherons**

Exchange of roles between etherons is an effect of exchange of velocities with respect to the place of collision between several etherons.

# Chapter 4

## Ether objects

Ether object is an object consisting of etherons that exhibits dynamic properties. Outside etheron is free etheron outside ether object.

### 4.1 Eth

Eth is lower gravitatable ether object consisting of etherons that have insignificant velocity relative to each other.

### 4.2 Ether aura

Ether aura is an area of increased concentration of outside etherons with reduced speed relative to ether object around ether object.

Superposition of ether auras is a summation of concentrations of outside etherons with reduced speed relative to ether objects.

### 4.3 Geth

Geth is gravitating ether object with ether aura.

# Chapter 5

## Ether dynamics

Ether dynamics is a branch of mechanics that describes the motion of etherons, and groups of etherons.

### 5.1 Ether drive

Ether drive is an inertial travel of ether object.

### 5.2 Ether drift

Ether drift is a shift travel of ether object and possible change of speed of ether object as a result of etheron exchange of inertia and composition with ether auras.

### 5.3 Ether motion

Ether motion is ether drive and ether drift.



# Chapter 6

## Gravity

### 6.1 Etheron exchange

Etheron exchange is an exchange of inertia and etherons between ether object and ether auras, as a result of which etheron composition, position and velocity of ether object can change.

Simplex etheron exchange is one-sided etheron exchange with a change of velocity.

Transit etheron exchange is one-sided etheron exchange with a change of etheron composition, position, but without changing the velocity.

Duplex etheron exchange is double-sided etheron exchange with possible change of velocity.

Accelerative etheron exchange is duplex etheron exchange with a change of velocity.

### 6.2 Gravitational acceleration

Gravitational acceleration is an acceleration of ether object in the direction of slow etherons as a result of accelerative etheron exchange.

# Chapter 7

## Magnetism

### 7.1 Ether aura transformation

Ether aura transformation is a change of ether aura of ether object as a result of regeneration of ether aura during a movement of ether object in ether auras of other ether objects.

### 7.2 Ether waves

Ether waves is waves in the ether, arising from the transformation of the ether aura of one ether object during the movement of this object in the ether auras of other ether objects.

### 7.3 Ether object-wave duality

Ether object-wave duality is a property of ether, consisting in the fact that ether objects with ether aura can exhibit the properties of waves under certain conditions, and for others - the properties of objects.

### 7.4 Magnetic field

Magnetic field is a result of interference of ether waves.

**Part II**

**Hyperatomic model**

# Chapter 8

## Ether evolution

Ether evolution is the process of qualitative transformation of ether objects by means of gravity and magnetism.

### 8.1 Gravitational-magnetic mechanism of synthesis-isolation

Gravitational-magnetic mechanism of synthesis-isolation is a synthesis of ether object through gravitational attraction, and a separation of ether object through magnetic repulsion.

### 8.2 Gravitational-magnetic levitation

Gravitational-magnetic levitation is mutual levitation of ether objects when gravitational attraction is compensated by magnetic repulsion.

### 8.3 Ether cluster

Ether cluster is a cluster of ether objects by means of gravitational attraction.

Ether hyperobject is isolated ether cluster.

Ether subobject is ether object in the ether cluster.

Ether configuration is conditional simplified configuration of ether cluster according to the degree of gravitational connectivity and magnetic isolation of ether subobjects.

Ether tree is conditional simplified hierarchical representation of ether subobjects of ether cluster according to the degree of gravitational connectivity and magnetic isolation.

Ether code is conditional code of ether configuration of ether cluster. Format of text notation of ether code contains following elements.

- A - ether object A.
- A'B - object B levitates around object A.
- A''B - object B orbits around object A.
- A,B - object B levitates or orbits around object A.
- (A'B) - hyperobject with levitating subobjects A and B.

### **8.3.1 Ether cloud**

Ether cloud is sparse ether cluster.

### **8.3.2 Ether bunch**

Ether bunch is dense ether cluster.

### **8.3.3 Ether atmosphere**

Ether atmosphere is an ether cloud around ether object.

## **8.4 Proteon**

Proteon is big nonhierarchical ether bunch.

Proton is a proteon with ether atmosphere.

Neutron is a proteon without ether atmosphere.

# Chapter 9

## Hyperatom

Atom is a proteon, or ether cluster of proteons with collective ether atmosphere, or ether cluster of atoms with collective ether atmosphere.

Elementary atom is a proteon.

Hyperatom is ether cluster of elementary atoms with collective ether atmosphere, or ether cluster of hyperatoms with collective ether atmosphere.

Subatom is elementary atom in hyperatom, or hyperatom in hyperatom.

### 9.1 Hyperatomic configuration

Hyperatomic configuration is ether configuration of hyperatom.

Hyperatomic tree is ether tree of hyperatom.

Hyperatomic periodic form is tetrahedron.

Hyperatomic code is ether code of hyperatom.

Format of a text notation of hyperatomic code contains following elements.

- H - proteon as Protium subatom.
- p - proteon as first proteon of a pair or as solitary proteon or as proton.
- n - proteon as second proteon of a pair or as proteon without a pair or as neutron.
- S - subatom identifier.
- 1 - hyperatomic number.
- A'B - subatom B levitates around subatom A.
- A" B - subatom B orbits around subatom A.
- A,B - subatom B levitates or orbits around subatom A.
- (A'B) - hyperatom with levitating subatoms A and B.

Here are some examples of simplest hyperatomic configurations.

- Protium (Hydrogen-1). 1.  $H = p$
- Deuterium (Hydrogen-2).  $2=1'1$ .  $D = H'H = p'n$
- Tritium (Hydrogen-3).  $3=2'1$ .  $T = D'H = (H'H)'H = (p'n)'n$
- Helium-3.  $1'1'1$ .  $He-3 = H'H'H = (p'n'p)$

- Helium-4.  $4=2'2$ .  $\text{He-4} = \text{D}'\text{D} = (\text{H}'\text{H})'(\text{H}'\text{H}) = (\text{p}'\text{n})'(\text{p}'\text{n})$

Here are some examples of graphs and 3D schemes of simplest hyperatoms.

- Protium

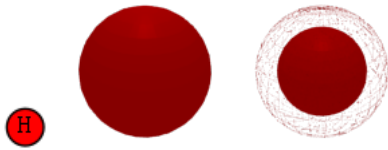

- Deuterium

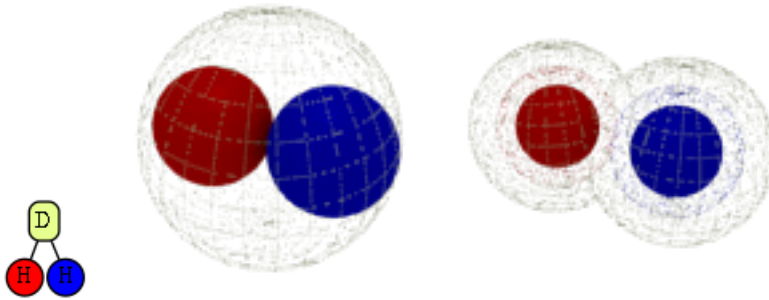

- Tritium

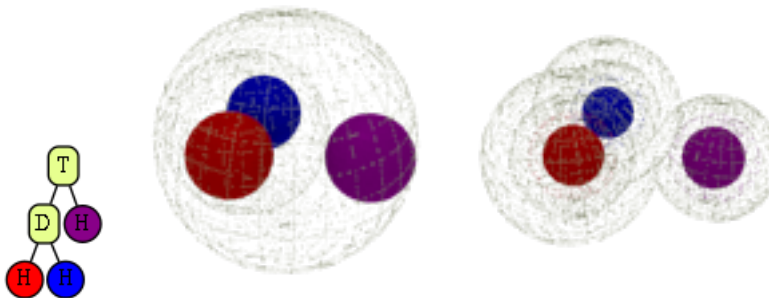

- Helium-4

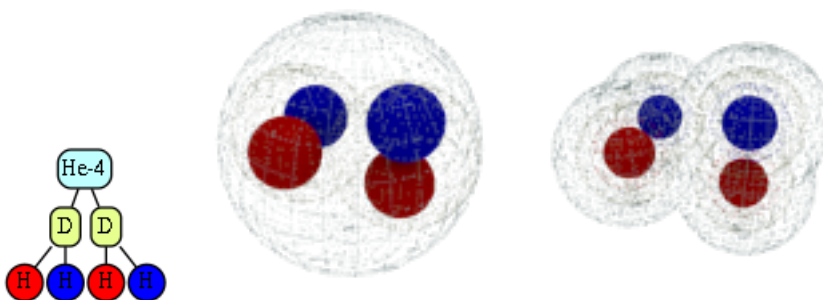

Other examples of hyperatomic configurations are presented in the appendix.

## 9.2 Hyperatomic sequence

Hyperatomic sequence is a sequence of hyperatomic configurations becoming more complex. Dimensionality of hyperatomic sequence is maximum number of subatoms of the previous level in a hyperatom of hyperatomic sequence.

### 9.3 Chemical element

Chemical element (or element) is a collection of hyperatomic configurations of one or several sections of hyperatomic sequence.

Chemical number is a classic number of chemical element.

### 9.4 Hyperatomic fullness

Completed configuration is hyperatomic configuration of hyperatom with filled hyperatomic periodic form.

- 1. Protium H
- 2=1'1. Deuterium D = H ' H
- 4=2'2. Helium He = He-4 = D ' D = (H ' H) ' (H ' H)
- 8=4'4. Beryllium Be = Be-8 = He-4 ' He-4 = He ' He = (D ' D) ' (D ' D)
- 16=8'8. Oxygen O = O-16 = Be-8 ' Be-8 = Be ' Be = (He ' He) ' (He ' He)
- 32=16'16. Sulfur S = S-32 = O-16 ' O-16 = O ' O = (Be ' Be) ' (Be ' Be)
- 64=32'32. Zinc Zn = Zn-64 = S-32 ' S-32 = S ' S = (O ' O) ' (O ' O)
- 128=64'64. Tellurium Te = Te-128 = Zn-64 ' Zn-64 = Zn ' Zn = (S ' S) ' (S ' S)

Uncompleted configuration is hyperatomic configuration of hyperatom with partially filled hyperatomic periodic form.

- 3=2'1. Tritium T = D ' H = (H ' H) ' H
- 6=4'2. Lithium Li = Li-6 = He-4 ' D = (D ' D) ' D
- 12=8'4. Carbon C = C-12 = Be-8 ' He-4 = (He ' He) ' He
- 24=16'8. Magnesium Mg = Mg-24 = O-16 ' Be-8 = (Be ' Be) ' Be
- 48=32'16. Titanium Ti = Ti-48 = S-32 ' O-16 = (O ' O) ' O
- 96=64'32. Molybdenum Mo = Mo-96 = Zn-64 ' S-32 = (S ' S) ' S
- 192=128'64. Osmium Os = Os-192 = Te-128 ' Zn-64 = (Zn ' Zn) ' Zn

### 9.5 Hyperatomic set

Hyperatomic set is a collection of hyperatomic configurations from hyperatomic sequence.

Dimensionality of hyperatomic set is maximum number of subatoms of the previous level in a hyperatom of hyperatomic set.

Primary numbered hyperatomic set is numbered two-dimensional atomic set from primary two-dimensional hyperatomic sequence.

- Level 1. {1}
- Level 2. {2}
- Level L={3, ..., 9}. { $2^{L-2} + 1, \dots, 2^{L-1}$ }



Full primary numbered hyperatomic set -  $\{ \{1\}, \{2\}, \{3, 4\}, \{5, \dots, 8\}, \{9, \dots, 16\}, \{17, \dots, 32\}, \{33, \dots, 64\}, \{65, \dots, 128\}, \{129, \dots, 256\} \}$

Basic hyperatomic set is a set of combinations of elements from primary numbered atomic set.

Extra hyperatomic set is a set of combinations of elements from basic atomic set.

## 9.6 Hyperatomic number

Hyperatomic number is a number of numbered item of hyperatomic sequence.

## 9.7 Hyperatomic identifier

Hyperatomic identifier is a symbolic name that identifies hyperatomic configuration.

Format of a text notation of hyperatomic identifier contains following elements.

- Name of chemical element.
- Quantity of protons.
- Hyperatomic code.

Here are some examples of hyperatomic identifiers.

- Beryllium-10-(5'5) = Be-10-(5'5) = Be-(5'5) = 5'5
- Boron-10-(8'2) = B-10-(8'2) = B-(8'2) = B-10 = 10 = 8'2

## 9.8 Hyperatomic transformation

Hyperatomic transformation is a transition of hyperatom from one hyperatomic configuration to another.

For example, hyperatomic transformation from beryllium-10 (Be-10) to boron-10 (B-10).  
 $5'5 \Rightarrow 8'2 = 10$ .

$\text{Be-10} = \text{He-5} \text{ ' } \text{He-5} \Rightarrow \text{Be-8} \text{ ' } \text{D} = \text{B-10}$

- Beryllium-10

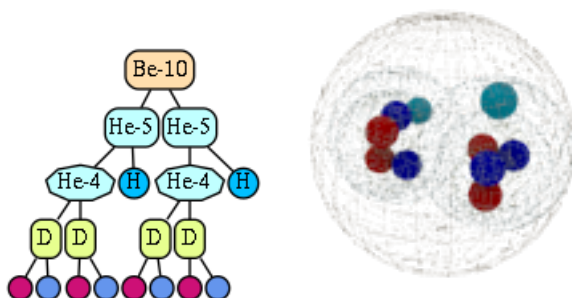

- Boron-10

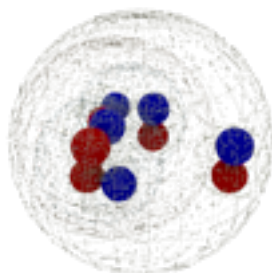
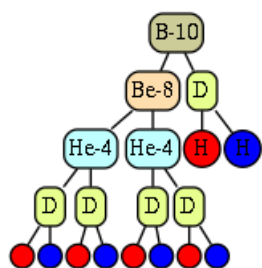

## Part III

# Ether quantum mechanics

# Chapter 10

## Ether quantum interpretation

Ether quantum interpretation is the interpretation of quantum mechanics on the basis of ether theory of relativity of gravity and magnetism, ether object-wave duality, ether fugitivity, hyperatomic model, gravitational-magnetic mechanism of heat oscillations of gravitating ether subobjects in ether hyperobjects.

# Chapter 11

## Ether quantum effects

Ether quantum effects are the effects of movement and interaction of lower ether objects through ether waves.

### 11.1 Ether fugitivity

Ether fugitivity is the ability of lower gravitatable and gravitating ether objects to move over ether waves.

### 11.2 Ether conductivity

Ether conductivity is the ability of groups of ether objects to provide a stream of lower ether objects.

### 11.3 Ether fluidity

Ether fluidity is the ability of groups of ether objects to levitational move relative to each other.

**Part IV**

**Ether cosmology**

# Chapter 12

## Universe

The Universe is all space and all ether.

# Chapter 13

## Synthesis and decay of proton

Synthesis of proton is a gravitational synthesis of a big structureless ether bunch in the inner cores of stars and planets.

Decay of proton is the gravitational weakening of the proton and the dispersion of ether subobjects of the proton in interstellar space. Proton decay causes ether waves.



# Chapter 14

## Decay of photon

Decay of photon is the gravitational weakening of the photon and the dispersion of ether subobjects of the photon in interstellar space. Photon decay is accompanied by an increase of the wavelength.

**Part V**

**Hyperatomic reactor**

# Chapter 15

## Hyperatomic fission

Hyperatomic fission is a process of splitting hyperatom into subatoms.

Thermoatomic fission is a hyperatomic fission through heat oscillations of subatoms.

# Chapter 16

## Controlled hyperatomic fission

Controlled hyperatomic fission is regulable hyperatomic fission.

Controlled thermoatomic fission is regulable thermoatomic fission.

# Chapter 17

## Ether reactor

Hyperatomic reactor (aka ether reactor) is a reactor of controlled hyperatomic fission.  
Thermoreactor of hyperatomic fission (aka thermoreactor of atomic fission, or thermoatomic reactor) is a reactor of controlled thermoatomic fission.

## Part VI

# Ether neural network

# Chapter 18

## Associative broadcast neural network

Associative broadcast neural network (ABNN) (aka ether neural network) is an artificial neural network inspired by a hypothesis of broadcasting of neuron's output pattern in a biological neural network.

### 18.1 Electrically conductive network

Associative broadcast neural network contains an aggregate electrically conductive network (ECN). ECN represents electrically conductive medium around neurons in a biological neural network. ECN provides a broadcasting of electrical impulses. Electrical impulses propagate via ECN at a speed close to the speed of light. ECN provides a summation of impulses from different sources. Group of impulses composes a pattern.

### 18.2 Neuron

Neuron of ABNN has multiple input cable and one output cable. Neuron scheme is shown in figure 1. Input cable represents a dendritic branch. Output cable represents an axon. Each cable is electrically isolated from the ECN. Each input cable comprises a transmitter of electrical impulse to the ECN, and a receiver of electrical impulse from the ECN. Electrical impulse in an input cable represents a dendritic spike. Each transmitter and each receiver has an electrically conductive connection to the ECN. Input cable signal is a linear combination of wire signal and ether signal. Neuron signal is an activation function of a linear combination of signals from input cables. Neuron signal is supplied to the output cable.

Figure 18.1: Scheme of a neuron of an associative broadcast neural network

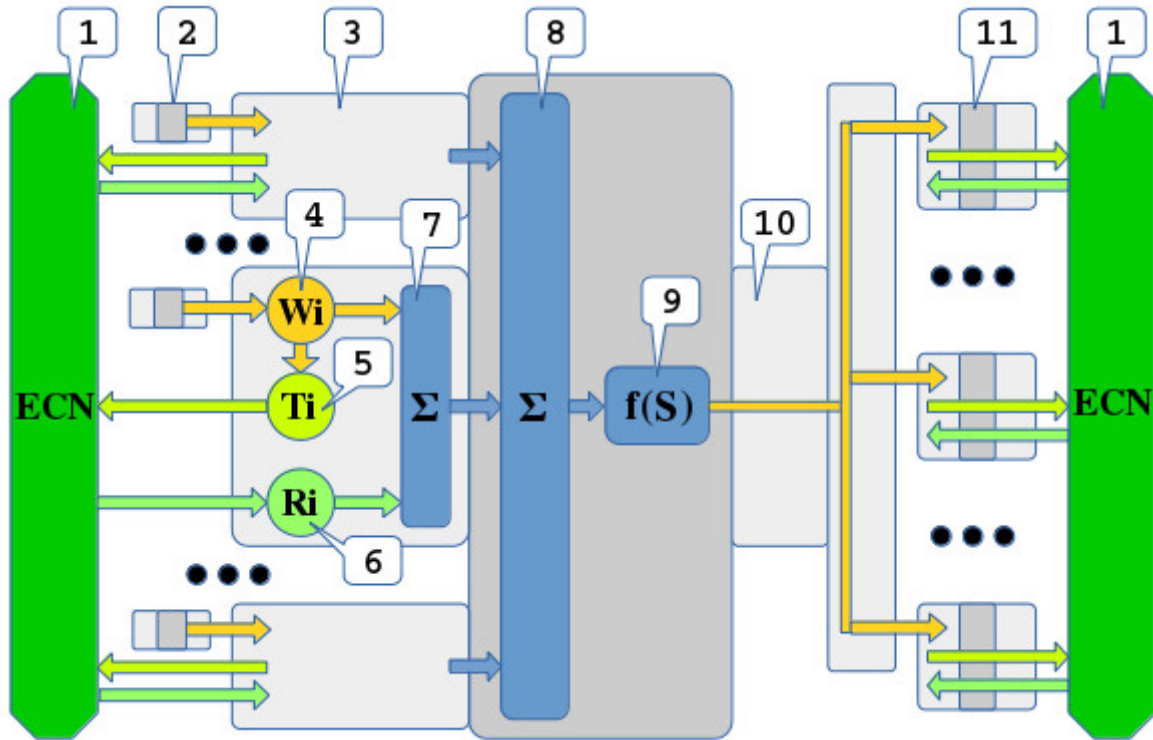

Figure 1 numerals designate the following elements.

1. Electrically conductive network (ECN).
2. Neurons, whose output cables are connected to the input cables of the neuron.
3. Input cables of the neuron.
4.  $W_i$  - weight of an input wire signal.
5.  $T_i$  - weight of an output ether signal.
6.  $R_i$  - weight of an input ether signal.
7. Adder of an input wire signal and an input ether signal.
8. Adder of input cable signals.
9. Transfer function.
10. Output cable of the neuron.
11. Neurons, whose input cables are connected to the output cable of the neuron.

### 18.3 Neural network

The input cable of one neuron can have wire connection with the output cable of other neuron. Wire connection of two cables represents a synapse in a biological neural network. The output cable of neuron can have several wire connections with other neurons. Group of neurons forms a neural network. The input cable of neuron can provide wire incoming connection of a neural network. The output cable of neuron can provide the wire outgoing connection of a neural network. Each wire connection in ABNN is characterized by a weight.



### 18.3.1 Input tree of cables of a neuron

The input tree of cables of neuron consists of input cables of the neuron. The input tree of cables is a part of one neuron.

### 18.3.2 Output tree of cables of a neuron

The output tree of cables of neuron consists of input cables of other neurons, whose cables are connected to the output cable of this neuron. The output tree of cables of neuron isn't a part of this neuron.

### 18.3.3 Output ether pattern of a neuron

The output ether pattern of a neuron is defined by geometry of an output tree of cables of the neuron. The output wire electrical impulse of neuron on the output cable arrives on the associated input cables of other neurons. The transmitter of each of these input cables gives out electrical impulse to an electroconductive network. Electrical connection of the transmitter to ECN forms the output ether connection. Each output ether connection in ABNN is characterized by weight. Impulses can come to ECN not at the same time. This group of impulses defines an output ether pattern of neuron. In ABNN the output ether pattern of a neuron is defined by a set of weights of ether connections of input cables of neurons connected to the output cable of neuron.

### 18.3.4 Input ether pattern of a neuron

The input ether pattern of a neuron is defined by geometry of an input tree of cables of the neuron. Electrical impulses from an electroconductive network come to receivers on input cables of neuron. Impulses from ECN can come to receivers not at the same time. Electrical connection of the receiver to ECN forms an input ether connection. Each input ether connection in ABNN is characterized by weight. In a simple ABNN the output ether connection and the input ether connection can be characterized by same weight. Group of impulses from ECN can cause activation of a neuron even in the absence of signals from wire connections. Such group of impulses defines an input ether pattern of the neuron. Neuron can have some set of input ether patterns.

## 18.4 Broadcasting of output ether pattern of a neuron

The output ether pattern of an active neuron broadcasts via electroconductive network and reaches each neuron. Broadcast of a pattern of a neuron provides ether functionality of the neuron. The ether pattern arrives from ECN to ether inputs of a neuron and can cause activation of this neuron.

## 18.5 Ether multipattern

Several active neurons can send their output ether patterns to the electroconductive network at the same time. Superposition of several patterns forms an ether multipattern.

## 18.6 Ether association

Neurons have an ether association if one or several active neurons cause activity of one or several other neurons by transmission to their ether inputs the output ether patterns through the electroconductive network. Ether association has a direction. In the simplest case the active neuron can cause activity of other neuron, having transmitted to it his output ether pattern through ECN. Ether multiassociation is an ether association of several neurons.

## 18.7 Ether stream of consciousness

Flow of patterns in the electroconductive network forms an ether stream of consciousness. In a combination with wire transfer of signals between neurons the ether stream of consciousness forms a basis for a distributed multi-level multiassociation of neurons.

## 18.8 Testable predictions

It is necessary to break input wire connections in some part of a functioning biological neural network. At the same time it is necessary to save the electroconductive network in full neural network. If the neurons in the isolated part have spikes, then the hypothesis of broadcasting of neuron's output pattern in a biological neural network is correct.

## Part VII

# Technological singularity

# Chapter 19

## Ether technological singularity

Ether technological singularity is technological growth, triggered by ether theory of matter and consciousness. “Everything in the name of man, for the good of man” is the motto of ether technological singularity.

# Chapter 20

## Etheristics

Etheristics is ether physics and ether chemistry.

### 20.1 Etheronics

Etheronics is a branch of etheristics that describes the motion of etherons.

### 20.2 Hyperatomistics

Hyperatomistics is a branch of etheristics that describes hyperatoms.

# Chapter 21

## Worldwide ether neural network

Worldwide ether neural network is ether neural network in the Internet.

## Chapter 22

# Worldwide Academy of Sciences

Worldwide Academy of Sciences is academy of sciences in worldwide ether neural network.

# Appendix A

## Periodic table

### A.1 Chemical elements

#### Diatomic nonmetal

**H**-Protium **D**-Deuterium **T**-Tritium **N**-Nitrogen **O**-Oxygen **F**-Fluorine **Cl**-Chlorine **Br**-Bromine  
**I**-Iodine

#### Alkali metal

**Li**-Lithium **Na**-Sodium **K**-Potassium **Rb**-Rubidium **Cs**-Caesium **Fr**-Francium

#### Alkaline earth metal

**Be**-Beryllium **Mg**-Magnesium **Ca**-Calcium **Sr**-Strontium **Ba**-Barium **Ra**-Radium

#### Noble gas

**Ht**-Helithreem **He**-Helium **Ne**-Neon **Ar**-Argon **Kr**-Krypton **Xe**-Xenon **Rn**-Radon

#### Post transition metal

**Al**-Aluminium **Ga**-Gallium **In**-Indium **Sn**-Tin **Tl**-Thallium **Pb**-Lead **Bi**-Bismuth **Po**-Polonium  
**Fl**-Flerovium

#### Metalloid

**B**-Boron **Si**-Silicon **Ge**-Germanium **As**-Arsenic **Sb**-Antimony **Te**-Tellurium **At**-Astatine

#### Polyatomic nonmetal

**C**-Carbon **P**-Phosphorus **S**-Sulfur **Se**-Selenium

#### Transition metal

**Sc**-Scandium **Ti**-Titanium **V**-Vanadium **Cr**-Chromium **Mn**-Manganese **Fe**-Iron **Co**-Cobalt **Ni**-Nickel  
**Cu**-Copper **Zn**-Zinc **Y**-Yttrium **Zr**-Zirconium **Nb**-Niobium **Mo**-Molybdenum **Tc**-Technetium  
**Ru**-Ruthenium **Rh**-Rhodium **Pd**-Palladium **Ag**-Silver **Cd**-Cadmium **Hf**-Hafnium **Ta**-Tantalum  
**W**-Tungsten **Re**-Rhenium **Os**-Osmium **Ir**-Iridium **Pt**-Platinum **Au**-Gold **Hg**-Mercury  
**Rf**-Rutherfordium **Db**-Dubnium **Sg**-Seaborgium **Bh**-Bohrium **Hs**-Hassium **Cn**-Copernicium

#### Lanthanide

**La**-Lanthanum **Ce**-Cerium **Pr**-Praseodymium **Nd**-Neodymium **Pm**-Promethium **Sm**-Samarium  
**Eu**-Europium **Gd**-Gadolinium **Tb**-Terbium **Dy**-Dysprosium **Ho**-Holmium **Er**-Erbium **Tm**-Thulium  
**Yb**-Ytterbium **Lu**-Lutetium

#### Actinide

**Ac**-Actinium **Th**-Thorium **Pa**-Protactinium **U**-Uranium **Np**-Neptunium **Pu**-Plutonium  
**Am**-Americium **Cm**-Curium **Bk**-Berkelium **Cf**-Californium **Es**-Einsteinium **Fm**-Fermium  
**Md**-Mendelevium **No**-Nobelium **Lr**-Lawrencium

#### Unknown

**Mt**-Meitnerium **Ds**-Darmstadtium **Rg**-Roentgenium **Nh**-Nihonium **Mc**-Moscovium **Lv**-Livermorium  
**Ts**-Tennessine **Og**-Oganesson



A.2 Classic hyperatomic periodic table

	1	2	3	4	5	6	7	8	9	10	11	12	13	14	15	16	17	18		
1	Hydrogen H H <sup>D</sup> H <sup>H</sup> D <sup>H</sup> He <sup>H</sup>																		Helium He	
2	Lithium Li He <sup>D</sup> Be <sup>H</sup>	Beryllium Be He <sup>He</sup> Be <sup>H</sup>	Scandium Sc Na <sup>Na</sup> Mg <sup>Na</sup> Mg <sup>Na</sup>	Titanium Ti Mg <sup>Mg</sup> S <sup>O</sup> S <sup>O</sup>	Vanadium V Al <sup>Na</sup> Si <sup>Na</sup> Si <sup>Na</sup>	Chromium Cr Al <sup>Mg</sup> Si <sup>Mg</sup> Si <sup>Mg</sup>	Manganese Mn Si <sup>Al</sup>	Iron Fe Al <sup>Al</sup> Si <sup>Si</sup> Si <sup>Si</sup>	Cobalt Co P <sup>Al</sup> S <sup>Al</sup>	Nickel Ni P <sup>Si</sup> S <sup>Si</sup> S <sup>Si</sup>	Copper Cu S <sup>P</sup>	Zinc Zn S <sup>H</sup> Zn <sup>H</sup> Zn <sup>D</sup> Zn <sup>D</sup>	Galium Ga Zn <sup>He</sup> Zn <sup>Li</sup>	Germanium Ge Zn <sup>Be</sup> Zn <sup>B</sup> Zn <sup>Li</sup>	Arsenic As Zn <sup>B</sup>	Selenium Se Zn <sup>N</sup> Zn <sup>O</sup> Zn <sup>O</sup>	Bromine Br Zn <sup>N</sup> Zn <sup>O</sup> Zn <sup>F</sup>	Krypton Kr Zn <sup>Ne</sup>	Xenon Xe Xe	
3	Sodium Na O <sup>Li</sup>	Magnesium Mg O <sup>Be</sup>	Yttrium Y Zn <sup>Mg</sup>	Zirconium Zr Zn <sup>Al</sup>	Niobium Nb Zn <sup>Si</sup>	Molybdenum Mo Zn <sup>S</sup>	Technetium Tc Zr <sup>Ti</sup> Ti <sup>Ti</sup> Ti <sup>H</sup> Tc <sup>D</sup>	Ruthenium Ru V <sup>V</sup> Cr <sup>V</sup> Cr <sup>Cr</sup>	Rhodium Rh Ru <sup>V</sup>	Palladium Pd Fe <sup>Cr</sup>	Silver Ag Co <sup>V</sup>	Cadmium Cd Zn <sup>Ti</sup>	Indium In Zn <sup>V</sup>	Tin Sn Ni <sup>Ni</sup>	Antimony Sb Cu <sup>Co</sup> Zn <sup>Co</sup>	Tellurium Te Zn <sup>Ni</sup> Zn <sup>Zn</sup> Te <sup>H</sup>	Iodine I Te <sup>53</sup>	Raon Rn At At	Oganesson Og Ts Ts	
4	Potassium K S <sup>Li</sup>	Calcium Ca S <sup>Be</sup>	Strontium Sr Zn <sup>Mg</sup>	Zirconium Zr Hf <sup>Al</sup>	Niobium Nb Ta <sup>Al</sup>	Molybdenum Mo W <sup>Fe</sup>	Technetium Tc Fe <sup>Fe</sup> Rh <sup>Co</sup> Tc <sup>D</sup>	Ruthenium Ru Os <sup>Zn</sup>	Rhodium Rh Ir <sup>Cu</sup>	Palladium Pd Tc <sup>Tc</sup>	Silver Ag Au <sup>Tc</sup>	Cadmium Cd Hg <sup>Ti</sup>	Indium In Rh <sup>Ru</sup>	Tin Sn Pb <sup>Ru</sup> Rn <sup>Rh</sup> Rn <sup>Ru</sup>	Antimony Sb Bi <sup>Ru</sup>	Tellurium Te Po <sup>Ru</sup>	Iodine I At <sup>Ru</sup>	Raon Rn At At	Oganesson Og Ts Ts	
5	Rubidium Rb Zn <sup>Na</sup>	Strontium Sr Zn <sup>Mg</sup>	Yttrium Y Lu <sup>Sc</sup>	Zirconium Zr Hf <sup>Al</sup>	Niobium Nb Ta <sup>Al</sup>	Molybdenum Mo W <sup>Fe</sup>	Technetium Tc Fe <sup>Fe</sup> Rh <sup>Co</sup> Tc <sup>D</sup>	Ruthenium Ru Os <sup>Zn</sup>	Rhodium Rh Ir <sup>Cu</sup>	Palladium Pd Tc <sup>Tc</sup>	Silver Ag Au <sup>Tc</sup>	Cadmium Cd Hg <sup>Ti</sup>	Indium In Rh <sup>Ru</sup>	Tin Sn Pb <sup>Ru</sup> Rn <sup>Rh</sup> Rn <sup>Ru</sup>	Antimony Sb Bi <sup>Ru</sup>	Tellurium Te Po <sup>Ru</sup>	Iodine I At <sup>Ru</sup>	Raon Rn At At	Oganesson Og Ts Ts	
6	Caesium Cs I <sup>Li</sup> Te <sup>Li</sup>	Barium Ba I <sup>Be</sup> Te <sup>Be</sup>	Lawrencium Lr Lu <sup>Sc</sup>	Hafnium Hf Ta <sup>Al</sup>	Tantalum Ta Nb <sup>Al</sup>	Tungsten W Te <sup>Fe</sup>	Rhenium Re Te <sup>Fe</sup> Rh <sup>Co</sup>	Osmium Os Te <sup>Zn</sup>	Iridium Ir Te <sup>Cu</sup>	Platinum Pt Tc <sup>Tc</sup>	Gold Au Tc <sup>Tc</sup>	Mercury Hg Ru <sup>Ru</sup>	Cadmium Cd Hg <sup>Ti</sup>	Indium In Rh <sup>Ru</sup>	Tin Sn Pb <sup>Ru</sup> Rn <sup>Rh</sup> Rn <sup>Ru</sup>	Antimony Sb Bi <sup>Ru</sup>	Tellurium Te Po <sup>Ru</sup>	Iodine I At <sup>Ru</sup>	Raon Rn At At	Oganesson Og Ts Ts
7	Francium Fr Hg <sup>Na</sup>	Radium Ra Hg <sup>Mg</sup>																		

\* \* \*

\* \* \*

\* \* \*

### A.3 Chemical periodic list

1: H.

2: D-(H'H). Ht-(H'H'H).

3: T-(D'H). He-(D'D).

4: He-(He'H). Li-(He'D). Li-(He'T). Be-(He'He).

5: Be-(Be'H). B-(Be'D). B-(Be'T). C-(Be'He). N-(Be'Li). O-(Be'Be).

6: C-(C'H). O-(O'H). O-(O'D). F-(O'T). Ne-(O'He). Na-(O'Li). Mg-(O'Be). Al-(O'B). Si-(O'C). P-(O'N). S-(O'O).

7: S-(S'H). S-(S'D). Cl-(S'T). K-(S'Li). Ar-(Ne'Ne). Ca-(S'Be). Sc-(Na'Na). Sc-(Mg'Na). Ti-(Mg'Mg). Ti-(S'O). V-(Al'Na). Cr-(Al'Mg). V-(Si'Na). Cr-(Si'Mg). Fe-(Al'Al). Mn-(Si'Al). Co-(P'Al). Fe-(Si'Si). Co-(S'Al). Ni-(P'Si). Ni-(S'Si). Cu-(S'P). Zn-(S'S).

8: Zn-(Zn'H). Zn-(Zn'D). Ga-(Zn'He). Ga-(Zn'Li). Ge-(Zn'Be). As-(Zn'B). Ge-(Zn'B). Ge-(Zn'C). Br-(Zn'N). Se-(Zn'N). Br-(Zn'O). Se-(Zn'O). Br-(Zn'F). Kr-(Zn'Ne). Rb-(Zn'Na). Sr-(Zn'Mg). Y-(Zn'Mg). Tb-(Ar'Cr). Zr-(Zn'Al). Nb-(Zn'Si). Mo-(Zn'S). Tc-(Ti'Ti). Ru-(V'V). Ru-(Cr'V). Rh-(Cr'V). Ru-(Cr'Cr). Pd-(Fe'Cr). Ag-(Co'V). Cd-(Zn'Ti). In-(Zn'V). Sn-(Ni'Ni). Sb-(Cu'Co). Sb-(Zn'Co). Te-(Zn'Ni). I-(Zn'Cu). Te-(Zn'Zn).

9: Tc-(Tc'H). Tc-(Tc'D). Tc-(Tc'T). Te-(Te'H). Te-(Te'D). Xe-(Te'He). Cs-(Te'Li). Ba-(Te'Be). Xe-(I'He). Ce-(Te'B). Cs-(I'Li). Ba-(I'Be). Ce-(Te'C). La-(Te'C). Pr-(Te'C). Ce-(Te'N). Nd-(Te'O). La-(I'C). Nd-(I'O). Pm-(Tc'V). Eu-(Ru'Cr). Sm-(Ru'Cr). Dy-(Pd'Cr). Dy-(Pd'Fe). Gd-(Te'S). Ho-(Pd'Mn). Tm-(Pd'Co). Er-(Pd'Ni). Lu-(Te'Sc). Yb-(Te'Sc). Hf-(Te'Cr). Ta-(Te'Fe). Re-(Te'Fe). W-(Te'Fe). Re-(Te'Co). Ir-(Te'Cu). Os-(Te'Zn). Au-(Tc'Tc). Bi-(Ru'Ru). Hg-(Ru'Ru). Pb-(Ru'Ru). Po-(Ru'Ru). Pt-(Tc'Tc). Pb-(Rh'Ru). Tl-(Rh'Ru). Pb-(Rh'Rh). At-(Pd'Rh). At-(Pd'Pd). Ac-(Cd'Cd). Ac-(Cd'In). Ac-(In'In). Pa-(Sn'In). Th-(Sn'Sn). U-(Sn'Sn).

10: Rn-(Hg'Ne). Fr-(Hg'Na). Ra-(Hg'Mg).

# Appendix B

## Periodic sequence

### B.1 Primary periodic sequence

**1:** 1.

**2:**  $2=1'1$ .

**3:**  $3=2'1$ .  $4=2'2$ .

**4:**  $5=4'1$ .  $6=4'2$ .  $7=4'3$ .  $8=4'4$ .

**5:**  $9=8'1$ .  $10=8'2$ .  $11=8'3$ .  $12=8'4$ .  $13=8'5$ .  $14=8'6$ .  $15=8'7$ .  $16=8'8$ .

**6:**  $17=16'1$ .  $18=16'2$ .  $19=16'3$ .  $20=16'4$ .  $21=16'5$ .  $22=16'6$ .  $23=16'7$ .  $24=16'8$ .  $25=16'9$ .  $26=16'10$ .  $27=16'11$ .  $28=16'12$ .  $29=16'13$ .  $30=16'14$ .  
 $31=16'15$ .  $32=16'16$ .

**7:**  $33=32'1$ .  $34=32'2$ .  $35=32'3$ .  $36=32'4$ .  $37=32'5$ .  $38=32'6$ .  $39=32'7$ .  $40=32'8$ .  $41=32'9$ .  $42=32'10$ .  $43=32'11$ .  $44=32'12$ .  $45=32'13$ .  $46=32'14$ .  
 $47=32'15$ .  $48=32'16$ .  $49=32'17$ .  $50=32'18$ .  $51=32'19$ .  $52=32'20$ .  $53=32'21$ .  $54=32'22$ .  $55=32'23$ .  $56=32'24$ .  $57=32'25$ .  $58=32'26$ .  $59=32'27$ .  
 $60=32'28$ .  $61=32'29$ .  $62=32'30$ .  $63=32'31$ .  $64=32'32$ .

**8:**  $65=64'1$ .  $66=64'2$ .  $67=64'3$ .  $68=64'4$ .  $69=64'5$ .  $70=64'6$ .  $71=64'7$ .  $72=64'8$ .  $73=64'9$ .  $74=64'10$ .  $75=64'11$ .  $76=64'12$ .  $77=64'13$ .  $78=64'14$ .  
 $79=64'15$ .  $80=64'16$ .  $81=64'17$ .  $82=64'18$ .  $83=64'19$ .  $84=64'20$ .  $85=64'21$ .  $86=64'22$ .  $87=64'23$ .  $88=64'24$ .  $89=64'25$ .  $90=64'26$ .  $91=64'27$ .  
 $92=64'28$ .  $93=64'29$ .  $94=64'30$ .  $95=64'31$ .  $96=64'32$ .  $97=64'33$ .  $98=64'34$ .  $99=64'35$ .  $100=64'36$ .  $101=64'37$ .  $102=64'38$ .  $103=64'39$ .  $104=64'40$ .  
 $105=64'41$ .  $106=64'42$ .  $107=64'43$ .  $108=64'44$ .  $109=64'45$ .  $110=64'46$ .  $111=64'47$ .  $112=64'48$ .  $113=64'49$ .  $114=64'50$ .  $115=64'51$ .  $116=64'52$ .  
 $117=64'53$ .  $118=64'54$ .  $119=64'55$ .  $120=64'56$ .  $121=64'57$ .  $122=64'58$ .  $123=64'59$ .  $124=64'60$ .  $125=64'61$ .  $126=64'62$ .  $127=64'63$ .  $128=64'64$ .

**9:**  $129=128'1$ .  $130=128'2$ .  $131=128'3$ .  $132=128'4$ .  $133=128'5$ .  $134=128'6$ .  $135=128'7$ .  $136=128'8$ .  $137=128'9$ .  $138=128'10$ .  $139=128'11$ .  
 $140=128'12$ .  $141=128'13$ .  $142=128'14$ .  $143=128'15$ .  $144=128'16$ .  $145=128'17$ .  $146=128'18$ .  $147=128'19$ .  $148=128'20$ .  $149=128'21$ .  $150=128'22$ .  
 $151=128'23$ .  $152=128'24$ .  $153=128'25$ .  $154=128'26$ .  $155=128'27$ .  $156=128'28$ .  $157=128'29$ .  $158=128'30$ .  $159=128'31$ .  $160=128'32$ .  $161=128'33$ .  
 $162=128'34$ .  $163=128'35$ .  $164=128'36$ .  $165=128'37$ .  $166=128'38$ .  $167=128'39$ .  $168=128'40$ .  $169=128'41$ .  $170=128'42$ .  $171=128'43$ .  $172=128'44$ .  
 $173=128'45$ .  $174=128'46$ .  $175=128'47$ .  $176=128'48$ .  $177=128'49$ .  $178=128'50$ .  $179=128'51$ .  $180=128'52$ .  $181=128'53$ .  $182=128'54$ .  $183=128'55$ .  
 $184=128'56$ .  $185=128'57$ .  $186=128'58$ .  $187=128'59$ .  $188=128'60$ .  $189=128'61$ .  $190=128'62$ .  $191=128'63$ .  $192=128'64$ .  $193=128'65$ .  $194=128'66$ .  
 $195=128'67$ .  $196=128'68$ .  $197=128'69$ .  $198=128'70$ .  $199=128'71$ .  $200=128'72$ .  $201=128'73$ .  $202=128'74$ .  $203=128'75$ .  $204=128'76$ .  $205=128'77$ .  
 $206=128'78$ .  $207=128'79$ .  $208=128'80$ .  $209=128'81$ .  $210=128'82$ .  $211=128'83$ .  $212=128'84$ .  $213=128'85$ .  $214=128'86$ .  $215=128'87$ .  $216=128'88$ .  
 $217=128'89$ .  $218=128'90$ .  $219=128'91$ .  $220=128'92$ .  $221=128'93$ .  $222=128'94$ .  $223=128'95$ .  $224=128'96$ .  $225=128'97$ .  $226=128'98$ .  $227=128'99$ .  
 $228=128'100$ .  $229=128'101$ .  $230=128'102$ .  $231=128'103$ .  $232=128'104$ .  $233=128'105$ .  $234=128'106$ .  $235=128'107$ .  $236=128'108$ .  $237=128'109$ .  
 $238=128'110$ .  $239=128'111$ .  $240=128'112$ .  $241=128'113$ .  $242=128'114$ .  $243=128'115$ .  $244=128'116$ .  $245=128'117$ .  $246=128'118$ .  $247=128'119$ .  
 $248=128'120$ .  $249=128'121$ .  $250=128'122$ .  $251=128'123$ .  $252=128'124$ .  $253=128'125$ .  $254=128'126$ .  $255=128'127$ .  $256=128'128$ .

## B.2 Basic periodic sequence

**1:** 1.

**2:**  $2=1'1$ .

**3:**  $3=2'1$ .  $4=2'2$ .

**4:**  $3'1$ .  $3'2$ .  $3'3$ .  $5=4'1$ .  $6=4'2$ .  $7=4'3$ .  $8=4'4$ .

**5:**  $5'1$ .  $5'2$ .  $5'3$ .  $5'4$ .  $5'5$ .  $6'1$ .  $6'2$ .  $6'3$ .  $6'4$ .  $6'5$ .  $6'6$ .  $7'1$ .  $7'2$ .  $7'3$ .  $7'4$ .  $7'5$ .  $7'6$ .  $7'7$ .  $9=8'1$ .  $10=8'2$ .  $11=8'3$ .  $12=8'4$ .  $13=8'5$ .  $14=8'6$ .  $15=8'7$ .  
 $16=8'8$ .

**6:**  $9'1$ .  $9'2$ .  $9'3$ .  $9'4$ .  $9'5$ .  $9'6$ .  $9'7$ .  $9'8$ .  $9'9$ .  $10'1$ .  $10'2$ .  $10'3$ .  $10'4$ .  $10'5$ .  $10'6$ .  $10'7$ .  $10'8$ .  $10'9$ .  $10'10$ .  $11'1$ .  $11'2$ .  $11'3$ .  $11'4$ .  $11'5$ .  $11'6$ .  $11'7$ .  $11'8$ .  
 $11'9$ .  $11'10$ .  $11'11$ .  $12'1$ .  $12'2$ .  $12'3$ .  $12'4$ .  $12'5$ .  $12'6$ .  $12'7$ .  $12'8$ .  $12'9$ .  $12'10$ .  $12'11$ .  $12'12$ .  $13'1$ .  $13'2$ .  $13'3$ .  $13'4$ .  $13'5$ .  $13'6$ .  $13'7$ .  $13'8$ .  $13'9$ .  $13'10$ .  
 $13'11$ .  $13'12$ .  $13'13$ .  $14'1$ .  $14'2$ .  $14'3$ .  $14'4$ .  $14'5$ .  $14'6$ .  $14'7$ .  $14'8$ .  $14'9$ .  $14'10$ .  $14'11$ .  $14'12$ .  $14'13$ .  $14'14$ .  $15'1$ .  $15'2$ .  $15'3$ .  $15'4$ .  $15'5$ .  $15'6$ .  $15'7$ .  
 $15'8$ .  $15'9$ .  $15'10$ .  $15'11$ .  $15'12$ .  $15'13$ .  $15'14$ .  $15'15$ .  $17=16'1$ .  $18=16'2$ .  $19=16'3$ .  $20=16'4$ .  $21=16'5$ .  $22=16'6$ .  $23=16'7$ .  $24=16'8$ .  $25=16'9$ .  
 $26=16'10$ .  $27=16'11$ .  $28=16'12$ .  $29=16'13$ .  $30=16'14$ .  $31=16'15$ .  $32=16'16$ .

**7:**  $17'1$ .  $17'2$ .  $17'3$ .  $17'4$ .  $17'5$ .  $17'6$ .  $17'7$ .  $17'8$ .  $17'9$ .  $17'10$ .  $17'11$ .  $17'12$ .  $17'13$ .  $17'14$ .  $17'15$ .  $17'16$ .  $17'17$ .  $18'1$ .  $18'2$ .  $18'3$ .  $18'4$ .  $18'5$ .  $18'6$ .  $18'7$ .  
 $18'8$ .  $18'9$ .  $18'10$ .  $18'11$ .  $18'12$ .  $18'13$ .  $18'14$ .  $18'15$ .  $18'16$ .  $18'17$ .  $18'18$ .  $19'1$ .  $19'2$ .  $19'3$ .  $19'4$ .  $19'5$ .  $19'6$ .  $19'7$ .  $19'8$ .  $19'9$ .  $19'10$ .  $19'11$ .  $19'12$ .  
 $19'13$ .  $19'14$ .  $19'15$ .  $19'16$ .  $19'17$ .  $19'18$ .  $19'19$ .  $20'1$ .  $20'2$ .  $20'3$ .  $20'4$ .  $20'5$ .  $20'6$ .  $20'7$ .  $20'8$ .  $20'9$ .  $20'10$ .  $20'11$ .  $20'12$ .  $20'13$ .  $20'14$ .  $20'15$ .  $20'16$ .  
 $20'17$ .  $20'18$ .  $20'19$ .  $20'20$ .  $21'1$ .  $21'2$ .  $21'3$ .  $21'4$ .  $21'5$ .  $21'6$ .  $21'7$ .  $21'8$ .  $21'9$ .  $21'10$ .  $21'11$ .  $21'12$ .  $21'13$ .  $21'14$ .  $21'15$ .  $21'16$ .  $21'17$ .  $21'18$ .  $21'19$ .  
 $21'20$ .  $21'21$ .  $22'1$ .  $22'2$ .  $22'3$ .  $22'4$ .  $22'5$ .  $22'6$ .  $22'7$ .  $22'8$ .  $22'9$ .  $22'10$ .  $22'11$ .  $22'12$ .  $22'13$ .  $22'14$ .  $22'15$ .  $22'16$ .  $22'17$ .  $22'18$ .  $22'19$ .  $22'20$ .  $22'21$ .  
 $22'22$ .  $23'1$ .  $23'2$ .  $23'3$ .  $23'4$ .  $23'5$ .  $23'6$ .  $23'7$ .  $23'8$ .  $23'9$ .  $23'10$ .  $23'11$ .  $23'12$ .  $23'13$ .  $23'14$ .  $23'15$ .  $23'16$ .  $23'17$ .  $23'18$ .  $23'19$ .  $23'20$ .  $23'21$ .  $23'22$ .  
 $23'23$ .  $24'1$ .  $24'2$ .  $24'3$ .  $24'4$ .  $24'5$ .  $24'6$ .  $24'7$ .  $24'8$ .  $24'9$ .  $24'10$ .  $24'11$ .  $24'12$ .  $24'13$ .  $24'14$ .  $24'15$ .  $24'16$ .  $24'17$ .  $24'18$ .  $24'19$ .  $24'20$ .  $24'21$ .  $24'22$ .  
 $24'23$ .  $24'24$ .  $25'1$ .  $25'2$ .  $25'3$ .  $25'4$ .  $25'5$ .  $25'6$ .  $25'7$ .  $25'8$ .  $25'9$ .  $25'10$ .  $25'11$ .  $25'12$ .  $25'13$ .  $25'14$ .  $25'15$ .  $25'16$ .  $25'17$ .  $25'18$ .  $25'19$ .  $25'20$ .  $25'21$ .  
 $25'22$ .  $25'23$ .  $25'24$ .  $25'25$ .  $26'1$ .  $26'2$ .  $26'3$ .  $26'4$ .  $26'5$ .  $26'6$ .  $26'7$ .  $26'8$ .  $26'9$ .  $26'10$ .  $26'11$ .  $26'12$ .  $26'13$ .  $26'14$ .  $26'15$ .  $26'16$ .  $26'17$ .  $26'18$ .  $26'19$ .  
 $26'20$ .  $26'21$ .  $26'22$ .  $26'23$ .  $26'24$ .  $26'25$ .  $26'26$ .  $27'1$ .  $27'2$ .  $27'3$ .  $27'4$ .  $27'5$ .  $27'6$ .  $27'7$ .  $27'8$ .  $27'9$ .  $27'10$ .  $27'11$ .  $27'12$ .  $27'13$ .  $27'14$ .  $27'15$ .  $27'16$ .  
 $27'17$ .  $27'18$ .  $27'19$ .  $27'20$ .  $27'21$ .  $27'22$ .  $27'23$ .  $27'24$ .  $27'25$ .  $27'26$ .  $27'27$ .  $28'1$ .  $28'2$ .  $28'3$ .  $28'4$ .  $28'5$ .  $28'6$ .  $28'7$ .  $28'8$ .  $28'9$ .  $28'10$ .  $28'11$ .  $28'12$ .  
 $28'13$ .  $28'14$ .  $28'15$ .  $28'16$ .  $28'17$ .  $28'18$ .  $28'19$ .  $28'20$ .  $28'21$ .  $28'22$ .  $28'23$ .  $28'24$ .  $28'25$ .  $28'26$ .  $28'27$ .  $28'28$ .  $29'1$ .  $29'2$ .  $29'3$ .  $29'4$ .  $29'5$ .  $29'6$ .  $29'7$ .  
 $29'8$ .  $29'9$ .  $29'10$ .  $29'11$ .  $29'12$ .  $29'13$ .  $29'14$ .  $29'15$ .  $29'16$ .  $29'17$ .  $29'18$ .  $29'19$ .  $29'20$ .  $29'21$ .  $29'22$ .  $29'23$ .  $29'24$ .  $29'25$ .  $29'26$ .  $29'27$ .  $29'28$ .  $29'29$ .  
 $30'1$ .  $30'2$ .  $30'3$ .  $30'4$ .  $30'5$ .  $30'6$ .  $30'7$ .  $30'8$ .  $30'9$ .  $30'10$ .  $30'11$ .  $30'12$ .  $30'13$ .  $30'14$ .  $30'15$ .  $30'16$ .  $30'17$ .  $30'18$ .  $30'19$ .  $30'20$ .  $30'21$ .  $30'22$ .  $30'23$ .  
 $30'24$ .  $30'25$ .  $30'26$ .  $30'27$ .  $30'28$ .  $30'29$ .  $30'30$ .  $31'1$ .  $31'2$ .  $31'3$ .  $31'4$ .  $31'5$ .  $31'6$ .  $31'7$ .  $31'8$ .  $31'9$ .  $31'10$ .  $31'11$ .  $31'12$ .  $31'13$ .  $31'14$ .  $31'15$ .  $31'16$ .  
 $31'17$ .  $31'18$ .  $31'19$ .  $31'20$ .  $31'21$ .  $31'22$ .  $31'23$ .  $31'24$ .  $31'25$ .  $31'26$ .  $31'27$ .  $31'28$ .  $31'29$ .  $31'30$ .  $31'31$ .  $33=32'1$ .  $34=32'2$ .  $35=32'3$ .  $36=32'4$ .  
 $37=32'5$ .  $38=32'6$ .  $39=32'7$ .  $40=32'8$ .  $41=32'9$ .  $42=32'10$ .  $43=32'11$ .  $44=32'12$ .  $45=32'13$ .  $46=32'14$ .  $47=32'15$ .  $48=32'16$ .  $49=32'17$ .  $50=32'18$ .  
 $51=32'19$ .  $52=32'20$ .  $53=32'21$ .  $54=32'22$ .  $55=32'23$ .  $56=32'24$ .  $57=32'25$ .  $58=32'26$ .  $59=32'27$ .  $60=32'28$ .  $61=32'29$ .  $62=32'30$ .  $63=32'31$ .  
 $64=32'32$ .

**8:** ...

### B.3 Extra periodic sequence

1: 1.

2:  $2=1'1$ .

3:  $3=2'1$ .  $4=2'2$ .

4:  $3'1$ .  $3'2$ .  $3'3$ .  $5=4'1$ .  $6=4'2$ .  $7=4'3$ .  $8=4'4$ .

5:  $(3'1)'1$ .  $(3'1)'2$ .  $(3'1)'3$ .  $(3'1)'4$ .  $(3'1)'(3'1)$ .  $(3'2)'1$ .  $(3'2)'2$ .  $(3'2)'3$ .  $(3'2)'4$ .  $(3'2)'(3'1)$ .  $(3'2)'(3'2)$ .  $(3'3)'1$ .  $(3'3)'2$ .  $(3'3)'3$ .  $(3'3)'4$ .  $(3'3)'(3'1)$ .  
 $(3'3)'(3'2)$ .  $(3'3)'(3'3)$ .  $5'1$ .  $5'2$ .  $5'3$ .  $5'4$ .  $5'(3'1)$ .  $5'(3'2)$ .  $5'(3'3)$ .  $5'5$ .  $6'1$ .  $6'2$ .  $6'3$ .  $6'4$ .  $6'(3'1)$ .  $6'(3'2)$ .  $6'(3'3)$ .  $6'5$ .  $6'6$ .  $7'1$ .  $7'2$ .  $7'3$ .  $7'4$ .  $7'(3'1)$ .  
 $7'(3'2)$ .  $7'(3'3)$ .  $7'5$ .  $7'6$ .  $7'7$ .  $9=8'1$ .  $10=8'2$ .  $11=8'3$ .  $12=8'4$ .  $8'(3'1)$ .  $8'(3'2)$ .  $8'(3'3)$ .  $13=8'5$ .  $14=8'6$ .  $15=8'7$ .  $16=8'8$ .

6: ...

# Appendix C

## Periodic list

### C.1 Primary periodic list

**1:** H-1-(1).

**2:** D-2-(1'1).

**3:** T-3-(2'1). He-4-(2'2).

**4:** He-5-(4'1). Li-6-(4'2). Li-7-(4'3). Be-8-(4'4).

**5:** Be-9-(8'1). B-10-(8'2). B-11-(8'3). C-12-(8'4). C-13-(8'5). N-14-(8'6). N-15-(8'7). O-16-(8'8).

**6:** O-17-(16'1). O-18-(16'2). F-19-(16'3). Ne-20-(16'4). Ne-21-(16'5). Na-22-(16'6). Na-23-(16'7). Mg-24-(16'8). Mg-25-(16'9). Al-26-(16'10). Al-27-(16'11). Si-28-(16'12). Si-29-(16'13). P-30-(16'14). P-31-(16'15). S-32-(16'16).

**7:** S-33-(32'1). S-34-(32'2). Cl-35-(32'3). K-39-(32'7). Ca-40-(32'8). Ti-48-(32'16). Co-58-(32'26). Co-59-(32'27). Ni-60-(32'28). Ni-61-(32'29). Cu-62-(32'30). Cu-63-(32'31). Zn-64-(32'32).

**8:** Zn-66-(64'2). Ga-69-(64'5). Ga-71-(64'7). Ge-72-(64'8). Ge-74-(64'10). As-75-(64'11). Ge-76-(64'12). Se-78-(64'14). Br-79-(64'15). Se-80-(64'16). Br-81-(64'17). Se-82-(64'18). Br-83-(64'19). Kr-84-(64'20). Rb-87-(64'23). Sr-88-(64'24). Y-89-(64'25). Zr-90-(64'26). Zr-91-(64'27). Zr-92-(64'28). Nb-93-(64'29). Zr-94-(64'30). Mo-96-(64'32). Cd-112-(64'48). Sb-123-(64'59). Te-124-(64'60). Te-125-(64'61). Te-126-(64'62). I-127-(64'63). Te-128-(64'64).

**9:** Te-129-(128'1). Te-130-(128'2). Xe-132-(128'4). Ba-136-(128'8). Ce-138-(128'10). Ce-140-(128'12). Pr-141-(128'13). Ce-142-(128'14). Nd-144-(128'16). Nd-145-(128'17). Nd-146-(128'18). Gd-160-(128'32). Re-187-(128'59). Ir-191-(128'63). Os-192-(128'64).

## C.2 Basic periodic list

- 1:** H-1-(1).
- 2:** D-2-(1'1). Ht-3-(1'1'1).
- 3:** T-3-(2'1). He-4-(2'2).
- 4:** He-5-(4'1). Li-6-(4'2). Li-7-(4'3). Be-8-(4'4).
- 5:** Be-9-(8'1). B-10-(8'2). Be-10-(5'5). B-11-(8'3). C-12-(8'4). C-13-(8'5). N-14-(8'6). N-15-(8'7). O-16-(8'8).
- 6:** C-13-(12'1). O-17-(16'1). O-18-(16'2). F-19-(16'3). Ne-20-(16'4). Ne-21-(16'5). Na-22-(16'6). Na-23-(16'7). Mg-24-(16'8). Mg-25-(16'9). Al-26-(16'10). Al-27-(16'11). Si-28-(16'12). Si-29-(16'13). P-30-(16'14). P-31-(16'15). S-32-(16'16).
- 7:** S-33-(32'1). S-34-(32'2). Cl-35-(32'3). K-39-(32'7). Ar-40-(20'20). Ca-40-(32'8). Sc-44-(22'22). Sc-45-(23'22). Sc-46-(23'23). Sc-46-(24'22). Sc-47-(24'23). Sc-47-(25'22). Sc-48-(25'23). Ti-48-(24'24). Ti-48-(32'16). V-48-(26'22). Ti-49-(25'24). V-49-(26'23). V-49-(27'22). Cr-50-(26'24). Ti-50-(25'25). V-50-(27'23). V-50-(28'22). Cr-51-(26'25). Cr-51-(27'24). V-51-(28'23). V-51-(29'22). Cr-52-(27'25). Cr-52-(28'24). Fe-52-(26'26). V-52-(29'23). Cr-53-(28'25). Cr-53-(29'24). Fe-53-(27'26). Cr-54-(29'25). Fe-54-(27'27). Mn-55-(29'26). Fe-56-(28'28). Fe-57-(29'28). Co-58-(32'26). Ni-58-(30'28). Fe-58-(29'29). Co-59-(32'27). Ni-60-(32'28). Ni-61-(32'29). Cu-62-(32'30). Cu-63-(32'31). Zn-64-(32'32).
- 8:** K-40-(33'7). K-41-(34'7). Ti-49-(48'1). Ti-50-(48'2). Cu-65-(34'31). Zn-66-(64'2). Ga-69-(64'5). Ga-71-(64'7). Ge-72-(64'8). Ge-74-(64'10). As-75-(64'11). Ge-76-(64'12). Se-78-(64'14). Br-79-(64'15). Se-80-(64'16). Br-81-(64'17). Se-82-(64'18). Br-83-(64'19). Kr-84-(64'20). Sr-86-(62'24). Sr-87-(63'24). Rb-87-(64'23). Sr-88-(64'24). Y-89-(64'25). Zr-90-(64'26). Zr-91-(64'27). Zr-92-(64'28). Nb-93-(64'29). Zr-94-(64'30). Mo-96-(64'32). Tc-96-(48'48). Cd-112-(64'48). Sn-120-(60'60). Sb-121-(62'59). Sb-123-(64'59). Te-124-(64'60). Te-125-(64'61). Te-126-(64'62). I-127-(64'63). Te-128-(64'64).
- 9:** Cd-114-(66'48). Xe-128-(124'4). Te-129-(128'1). Xe-129-(125'4). Te-130-(128'2). Xe-130-(126'4). Xe-131-(127'4). Xe-132-(128'4). Cs-133-(126'7). Cs-133-(127'6). Ba-134-(126'8). Ba-135-(127'8). Ba-136-(128'8). Ce-136-(126'10). Ce-138-(128'10). La-138-(126'12). La-139-(127'12). Ce-140-(128'12). Pr-141-(128'13). Ce-142-(128'14). Nd-142-(126'16). Nd-143-(127'16). Nd-144-(128'16). Nd-145-(128'17). Nd-146-(128'18). Gd-160-(128'32). Re-187-(128'59). Ir-191-(128'63). Os-192-(128'64).
- 10:** Ba-137-(129'8). Ba-138-(130'8).

### C.3 Extra periodic list

**1:** H-1-(1).

**2:** D-2-(1'1). Ht-3-(1'1'1).

**3:** T-3-(2'1). He-4-(2'2).

**4:** He-5-(4'1). Li-6-(4'2). Li-7-(4'3). Be-8-(4'4).

**5:** Be-9-(8'1). B-10-(8'2). Be-10-(5'5). B-11-(8'3). C-12-(8'4). C-13-(8'5). N-14-(8'6). N-15-(8'7). O-16-(8'8).

**6:** C-13-(12'1). O-17-(16'1). O-18-(16'2). F-19-(16'3). Ne-20-(16'4). Ne-21-(16'5). Na-22-(16'6). Na-23-(16'7). Mg-24-(16'8). Mg-25-(16'9). Al-26-(16'10). Mg-26-(16'10-(5'5)). Al-27-(16'11). Si-28-(16'12). Si-29-(16'13). P-30-(16'14). P-31-(16'15). S-32-(16'16).

**7:** S-33-(32'1). S-34-(32'2). Cl-35-(32'3). K-39-(32'7). Ar-40-(20'20). Ca-40-(32'8). Sc-44-(22'22). Sc-45-(23'22). Sc-46-(23'23). Sc-46-(24'22). Sc-47-(24'23). Sc-47-(25'22). Sc-48-(25'23). Ti-48-(24'24). Ti-48-(32'16). V-48-(26'22). Ti-49-(25'24). V-49-(26'23). V-49-(27'22). Cr-50-(26'24). Ti-50-(25'25). V-50-(27'23). V-50-(28'22). Cr-51-(26'25). Cr-51-(27'24). V-51-(28'23). V-51-(29'22). Cr-52-(27'25). Cr-52-(28'24). Fe-52-(26'26). V-52-(29'23). Cr-53-(28'25). Cr-53-(29'24). Fe-53-(27'26). Cr-54-(29'25). Fe-54-(27'27). Mn-55-(29'26). Fe-56-(28'28). Fe-57-(29'28). Co-58-(32'26). Ni-58-(30'28). Fe-58-(29'29). Co-59-(32'27). Ni-60-(32'28). Ni-61-(32'29). Cu-62-(32'30). Cu-63-(32'31). Zn-64-(32'32).

**8:** K-40-(33'7). K-41-(34'7). Ti-49-(48'1). Ti-50-(48'2). Cu-65-(34'31). Zn-66-(64'2). Ga-69-(64'5). Ga-71-(64'7). Ge-72-(64'8). Ge-74-(64'10). As-75-(64'11). Ge-76-(64'12). Se-78-(64'14). Br-79-(64'15). Se-80-(64'16). Br-81-(64'17). Se-82-(64'18). Br-83-(64'19). Kr-84-(64'20). Sr-86-(62'24). Sr-87-(63'24). Rb-87-(64'23). Sr-88-(64'24). Y-89-(64'25). Zr-90-(64'26). Zr-91-(64'27). Zr-92-(64'28). Nb-93-(64'29). Zr-94-(64'30). Mo-96-(64'32). Tc-96-(48-(24'24)'48-(24'24)). Tc-96-(48'48). Ru-96-(48-(26'22)'48-(26'22)). Ru-98-(50-(26'24)'48-(26'22)). Ru-99-(50-(26'24)'49-(26'23)). Ru-100-(50-(26'24)'50-(26'24)). Ru-101-(51-(28'23)'50-(26'24)). Ru-102-(51-(28'23)'51-(28'23)). Ru-102-(51-(29'22)'51-(28'23)). Ru-102-(51-(29'22)'51-(29'22)). Pd-102-(52-(26'26)'50-(26'24)). Rh-103-(52-(28'24)'51-(28'23)). Rh-103-(52-(28'24)'51-(29'22)). Ru-104-(52-(28'24)'52-(28'24)). Pd-104-(54-(27'27)'50-(26'24)). Ru-105-(53-(28'25)'52-(28'24)). Pd-105-(54-(27'27)'51-(27'24)). Pd-106-(54-(27'27)'52-(28'24)). Ag-107-(58-(32'26)'49-(26'23)). Ag-107-(58-(32'26)'49-(27'22)). Pd-108-(56-(28'28)'50-(26'24)). Ag-109-(58-(32'26)'51-(29'22)). Ag-109-(59-(32'27)'50-(28'22)). Pd-110-(56-(28'28)'52-(28'24)). Cd-112-(64'48-(24'24)). Cd-112-(64'48). In-113-(64'49-(27'22)). In-115-(64'51-(28'23)). Sn-116-(58-(30'28)'58-(30'28)). Sn-118-(60'58-(30'28)). Sn-120-(60'60). Sb-121-(62'59). Sb-123-(64'59). Te-124-(64'60). Te-125-(64'61). Te-126-(64'62). I-127-(64'63). Te-128-(64'64). Tb-159-(58-(32'26)'49-(26'23)'52-(28'24)).

**9:** Tc-97-(96-(48'48)'1). Tc-98-(96-(48'48)'2). Tc-99-(96-(48'48)'3). Cd-114-(64'50-(48'2)). Cd-114-(66'48-(24'24)). Cd-114-(66'48). Cd-116-(66'50-(48'2)). Xe-128-(124'4). Te-129-(128'1). Xe-129-(125'4). Te-130-(128'2). Xe-130-(126'4). Xe-131-(127'4).



Xe-132-(128'4). Cs-133-(126'7). Cs-133-(127'6). Ba-134-(126'8). Ba-135-(127'8).  
 Ba-136-(128'8). Ce-136-(126'10). Ce-138-(128'10). La-138-(126'12). La-139-(127'12).  
 Ce-140-(128'12). Pr-141-(128'13). Ce-142-(128'14). Nd-142-(126'16). Nd-143-(127'16).  
 Nd-144-(128'16). Nd-145-(128'17). Pm-145-(96-(48-(24'24)'48-(24'24))'49-(26'23)).  
 Nd-146-(128'18). Pm-146-(96-(48-(24'24)'48-(24'24))'50-(28'22)).  
 Pm-147-(96-(48-(24'24)'48-(24'24))'51-(28'23)).  
 Eu-151-(99-(50-(26'24)'49-(26'23))'52-(28'24)).  
 Sm-152-(100-(50-(26'24)'50-(26'24))'52-(28'24)).  
 Eu-153-(101-(51-(28'23)'50-(26'24))'52-(28'24)).  
 Sm-154-(102-(51-(28'23)'51-(28'23))'52-(28'24)). Gd-160-(128'32).  
 Dy-162-(106-(54-(27'27)'52-(28'24))'56-(28'28)).  
 Ho-165-(110-(56-(28'28)'52-(28'24))'55-(29'26)). Er-166-(106-(54-(27'27)'52-(28'24))'60).  
 Tm-169-(110-(56-(28'28)'52-(28'24))'59). Yb-172-(128'44-(22'22)). Yb-174-(128'46-(23'23)).  
 Lu-175-(128'47-(24'23)). Hf-178-(128'50-(26'24)). Hf-180-(128'52-(28'24)).  
 Ta-181-(128'53-(27'26)). W-184-(128'56-(28'28)). Re-185-(128'57-(29'28)). Re-187-(128'59).  
 Ir-191-(128'63). Os-192-(128'64). Pt-192-(96-(48'48)'96-(48'48)). Ir-193-(128'65-(34'31)).  
 Hg-200-(100-(50-(26'24)'50-(26'24))'100-(50-(26'24)'50-(26'24))).  
 Hg-202-(101-(51-(28'23)'50-(26'24))'101-(51-(28'23)'50-(26'24))).  
 Tl-203-(103-(52-(28'24)'51-(29'22))'100-(50-(26'24)'50-(26'24))).  
 Pb-204-(102-(51-(29'22)'51-(29'22))'102-(51-(29'22)'51-(29'22))).  
 Tl-205-(103-(52-(28'24)'51-(29'22))'102-(51-(28'23)'51-(28'23))).  
 Pb-206-(103-(52-(28'24)'51-(29'22))'103-(52-(28'24)'51-(29'22))).  
 Pb-207-(104-(52-(28'24)'52-(28'24))'103-(52-(28'24)'51-(29'22))).  
 Pb-208-(104-(52-(28'24)'52-(28'24))'104-(52-(28'24)'52-(28'24))).  
 Bi-209-(105-(53-(28'25)'52-(28'24))'104-(52-(28'24)'52-(28'24))).  
 At-210-(105-(54-(27'27)'51-(27'24))'105-(54-(27'27)'51-(27'24))).  
 Po-210-(105-(53-(28'25)'52-(28'24))'105-(53-(28'25)'52-(28'24))).  
 Pa-231-(116-(58-(30'28)'58-(30'28))'115-(64'51-(28'23))).  
 Th-232-(116-(58-(30'28)'58-(30'28))'116-(58-(30'28)'58-(30'28))).  
 U-238-(120-(60'60)'118-(60'58-(30'28))).

**10:** Ba-137-(129'8). Ba-138-(130'8). Pt-194-(97-(96-(48'48)'1)'97-(96-(48'48)'1)).  
 Pt-195-(98-(96-(48'48)'2)'97-(96-(48'48)'1)). Pt-196-(98-(96-(48'48)'2)'98-(96-(48'48)'2)).  
 Au-197-(99-(96-(48'48)'3)'98-(96-(48'48)'2)). Pt-198-(99-(96-(48'48)'3)'99-(96-(48'48)'3)).  
 Fr-222-(200-(100-(50-(26'24)'50-(26'24))'100-(50-(26'24)'50-(26'24)))'22).  
 Rn-222-(202-(101-(51-(28'23)'50-(26'24))'101-(51-(28'23)'50-(26'24)))'20).  
 Fr-223-(200-(100-(50-(26'24)'50-(26'24))'100-(50-(26'24)'50-(26'24)))'23).  
 Ra-226-(202-(101-(51-(28'23)'50-(26'24))'101-(51-(28'23)'50-(26'24)))'24).  
 Ac-227-(114-(64'50-(48'2))'113-(64'49-(27'22))).  
 Ra-228-(202-(101-(51-(28'23)'50-(26'24))'101-(51-(28'23)'50-(26'24)))'26-(16'10-(5'5))).

# Appendix D

## Periodic map

### D.1 Level 1



### D.2 Level 2

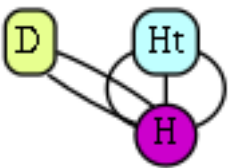

### D.3 Level 3

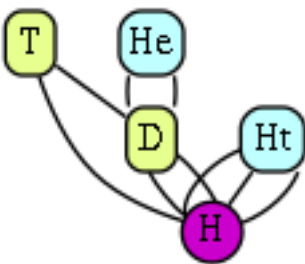

### D.4 Level 4

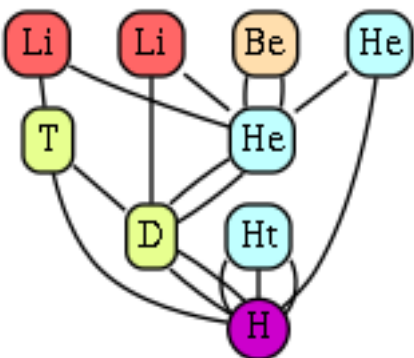

### D.5 Level 5

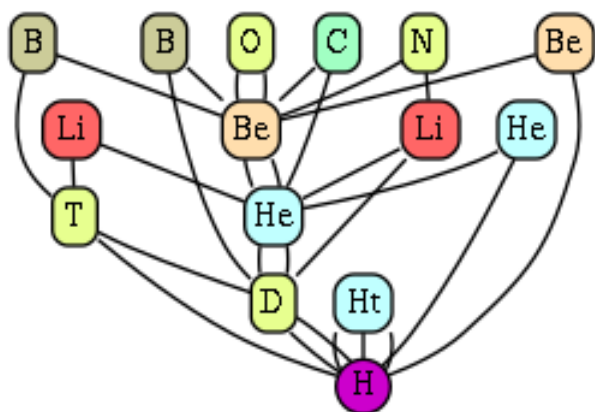

### D.6 Level 6

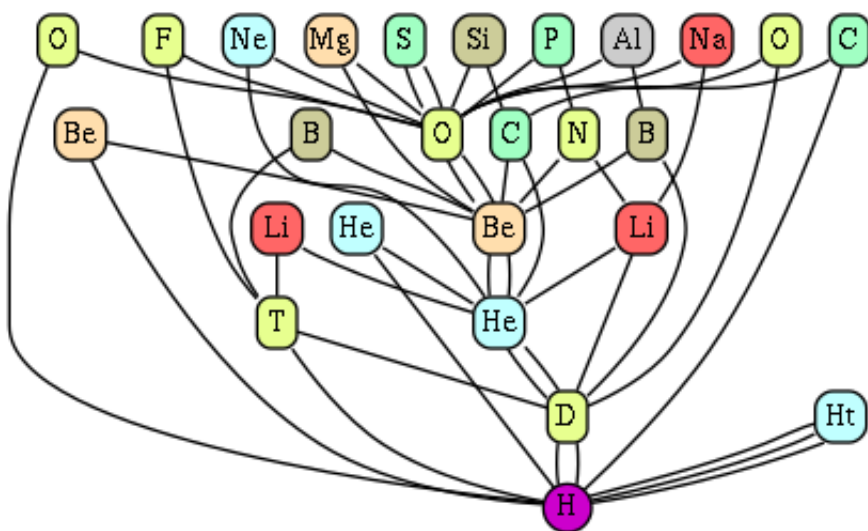

### D.7 Level 7

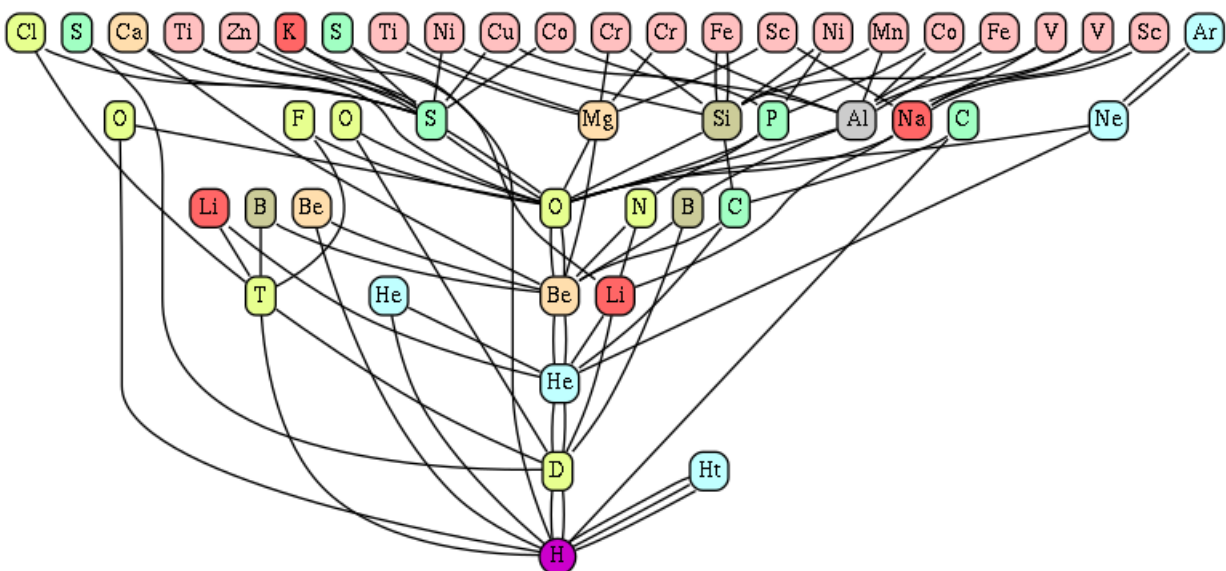

### D.8 Level 8

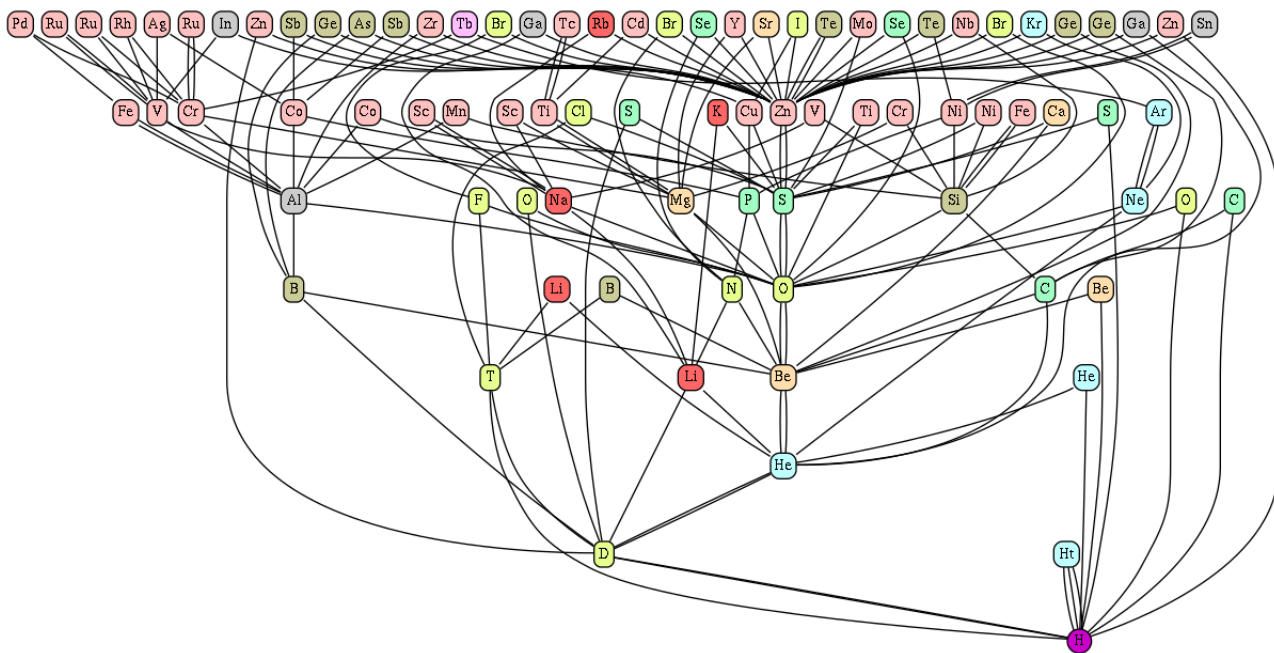

# D.9 Level 9

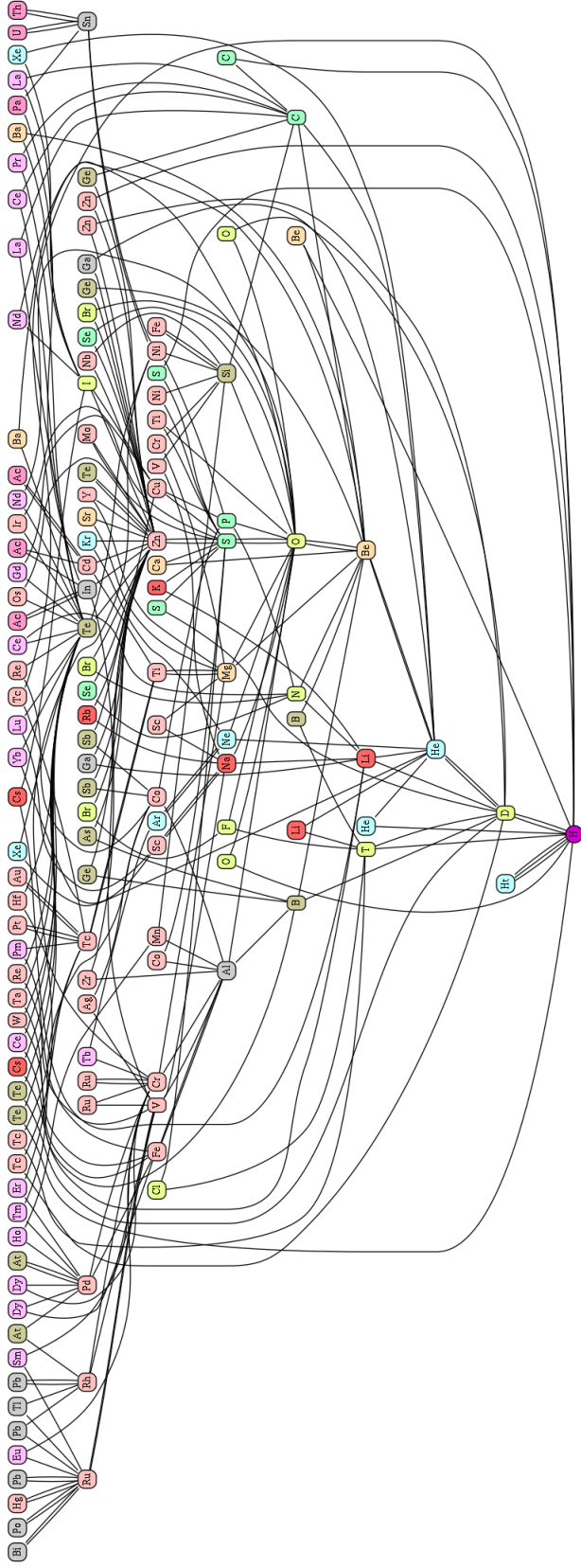

D.10 Level 10

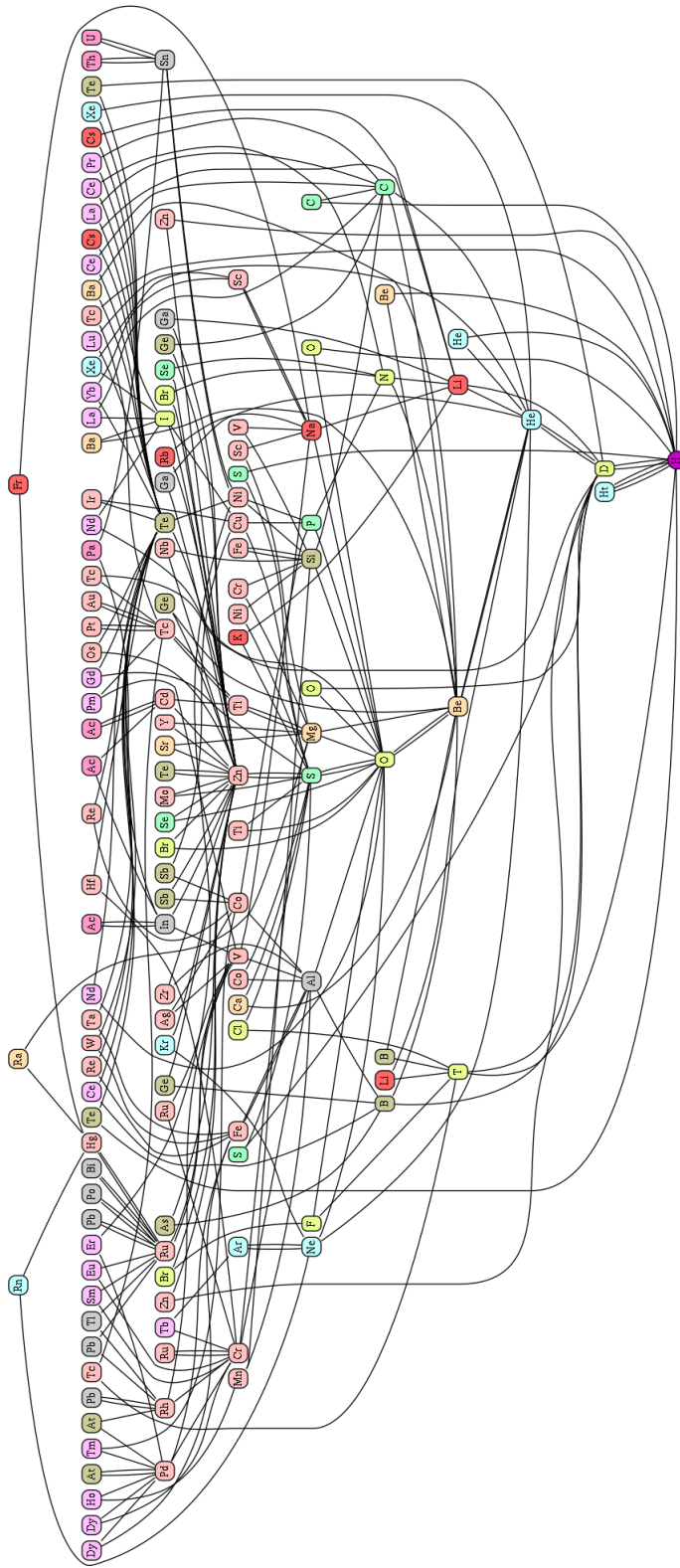

# Appendix E

## Hyperatomic category

### E.1 Diatomic nonmetal

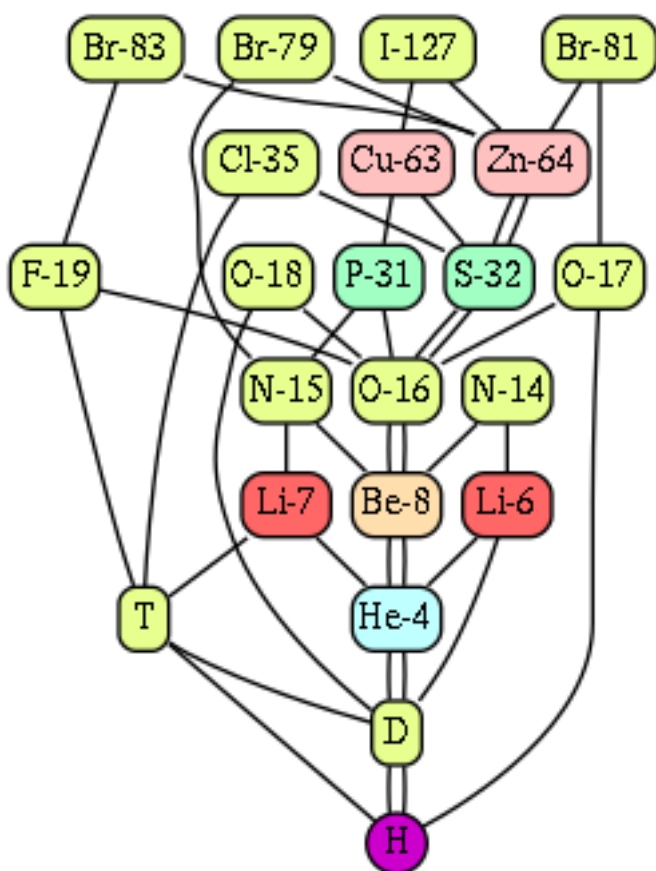

## E.2 Alkali metal

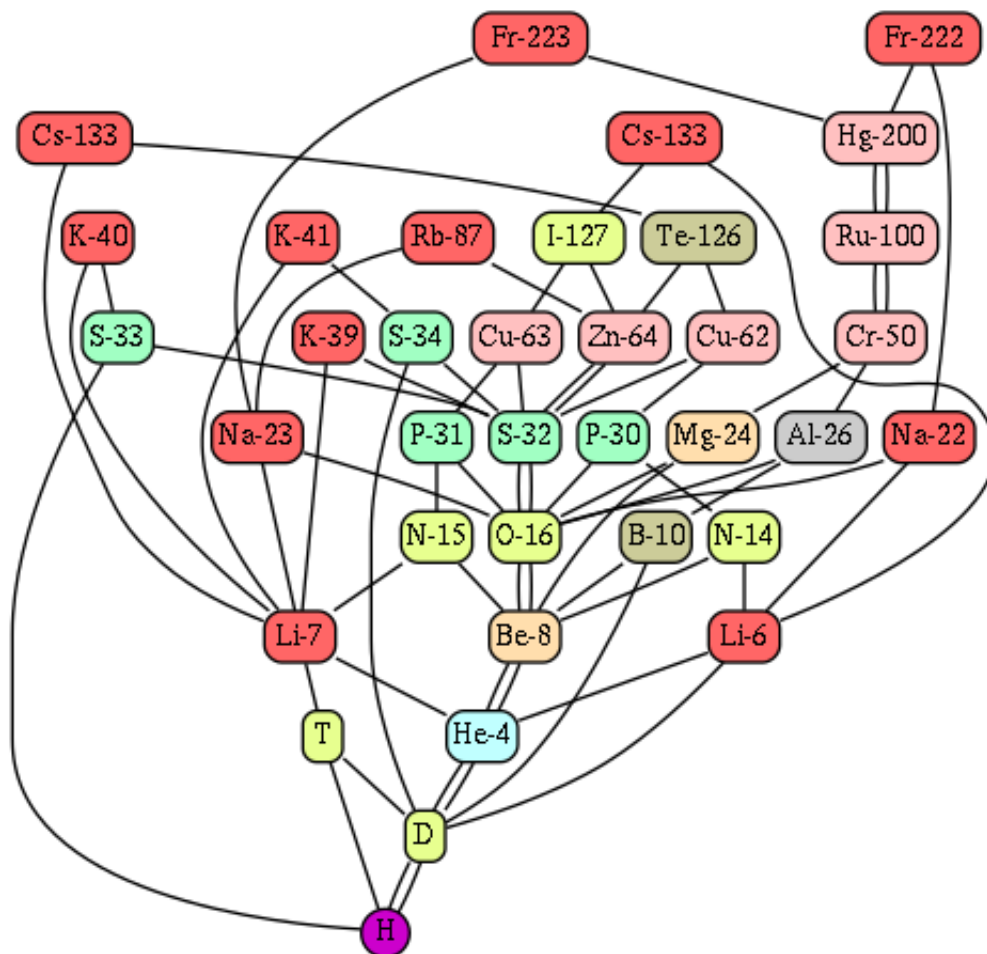



### E.3 Alkaline earth metal

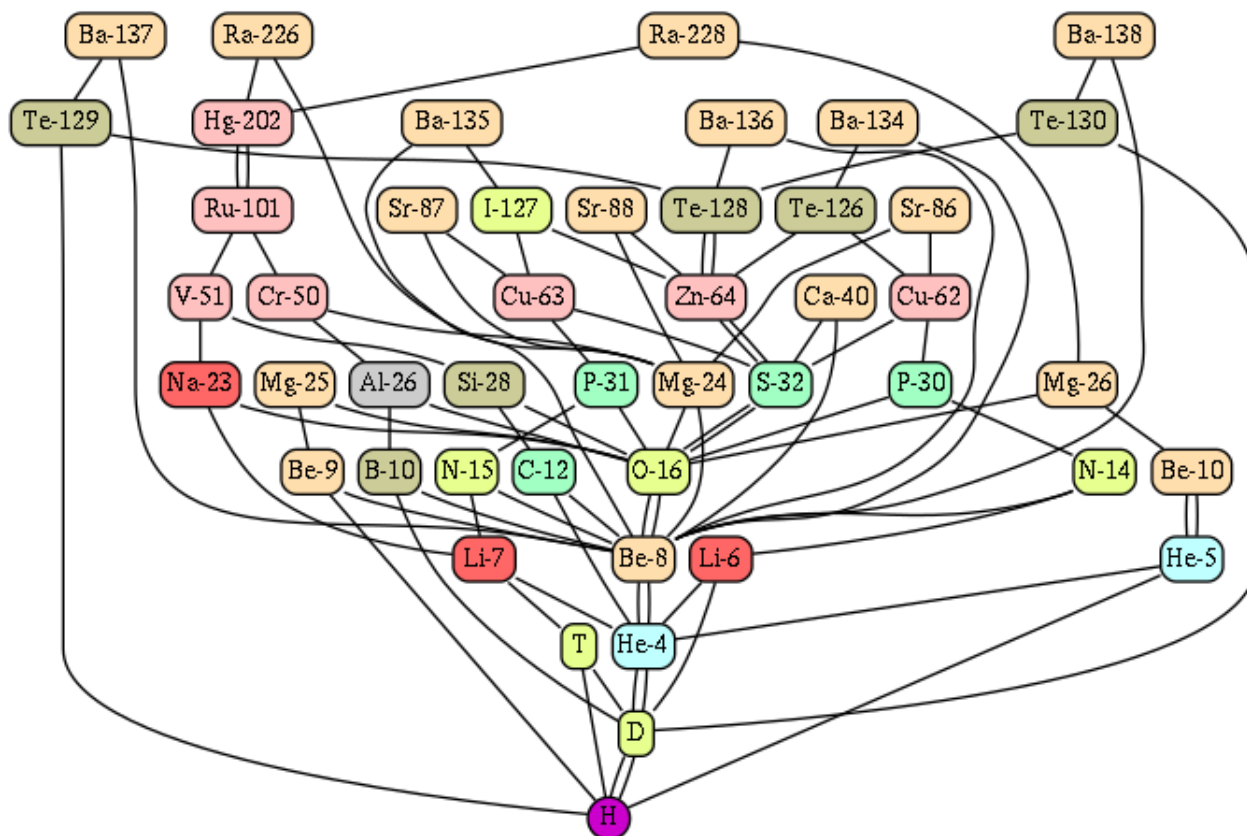

### E.4 Noble gas

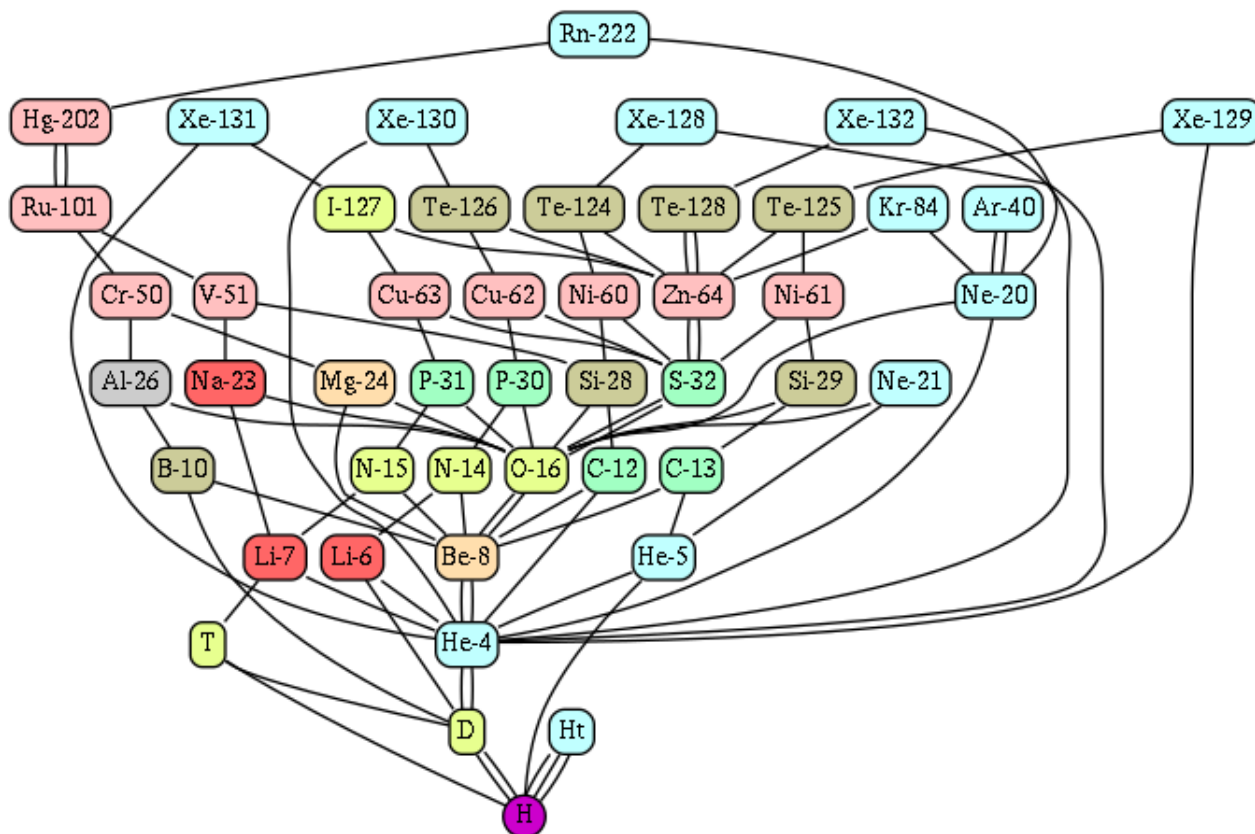

### E.5 Post transition metal

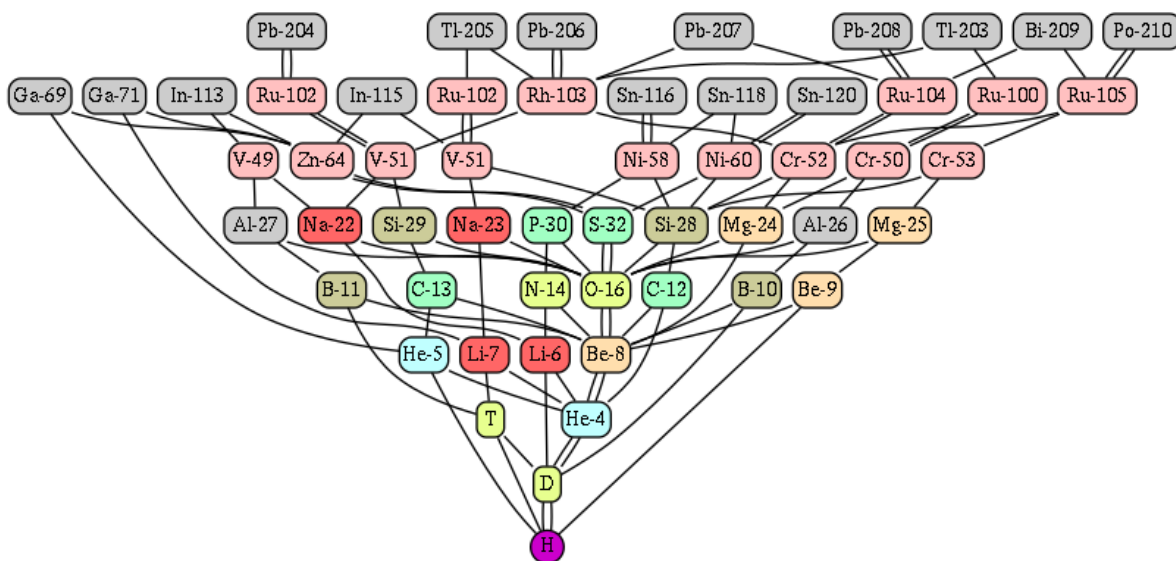

### E.6 Metalloid

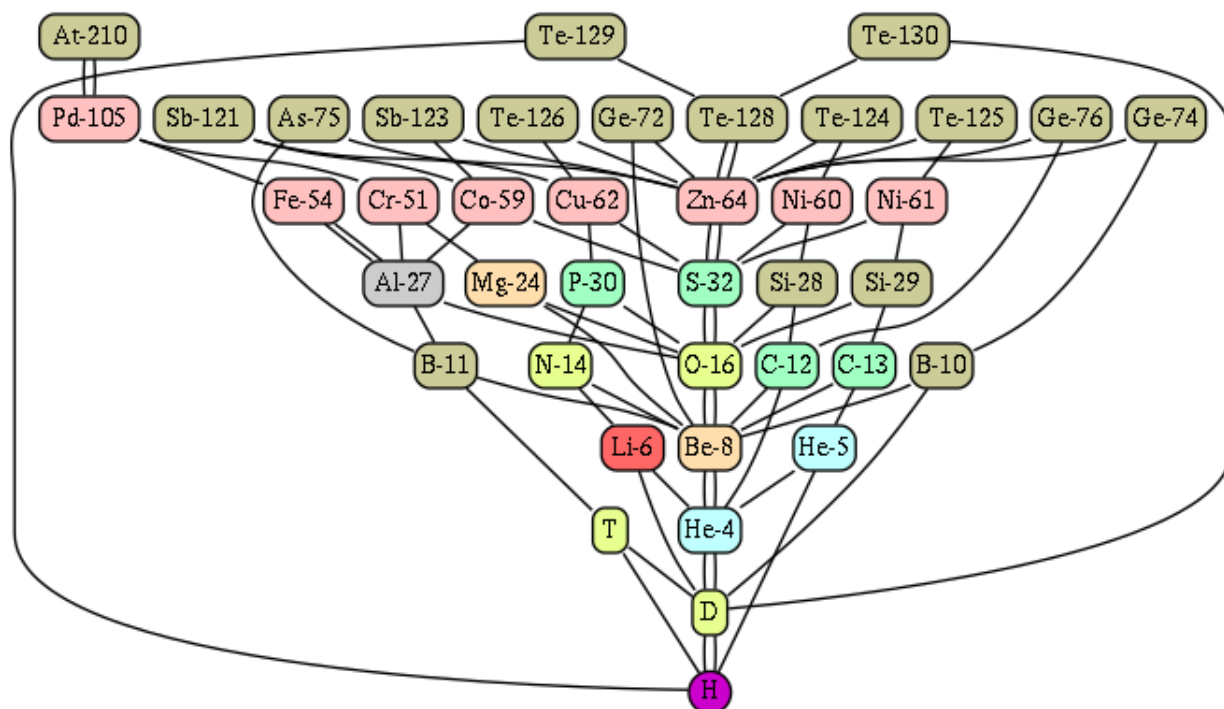

### E.7 Polyatomic nonmetal

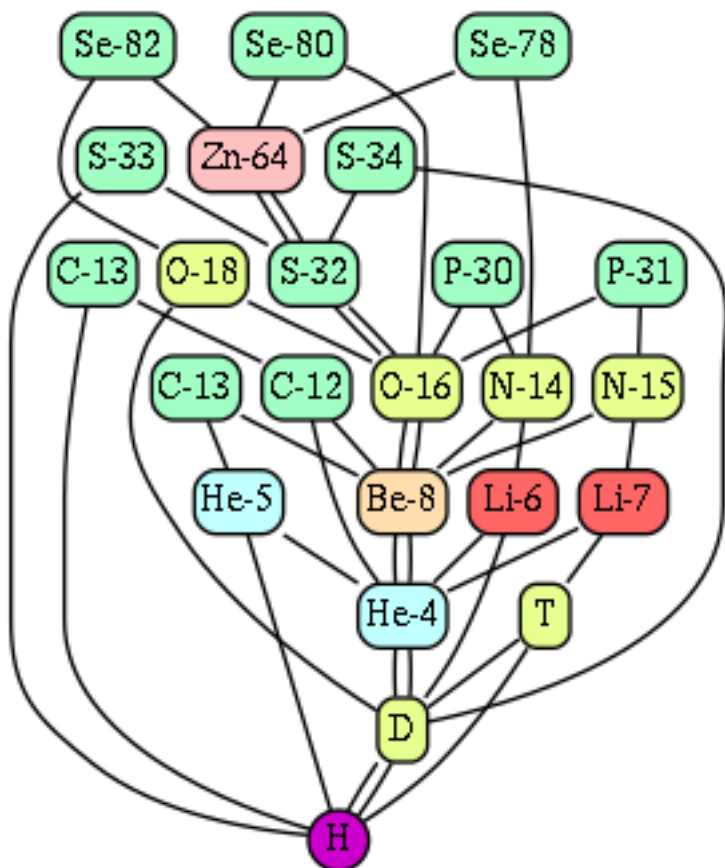

# E.8 Transition metal

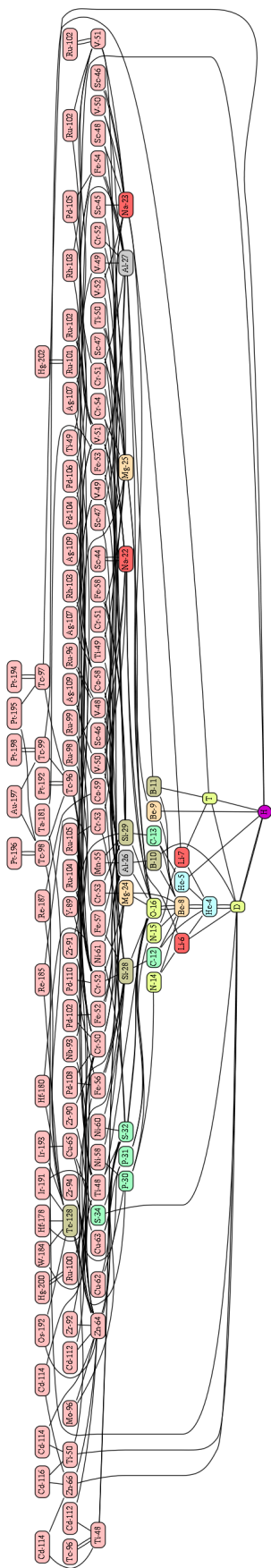

# E.9 Lanthanide

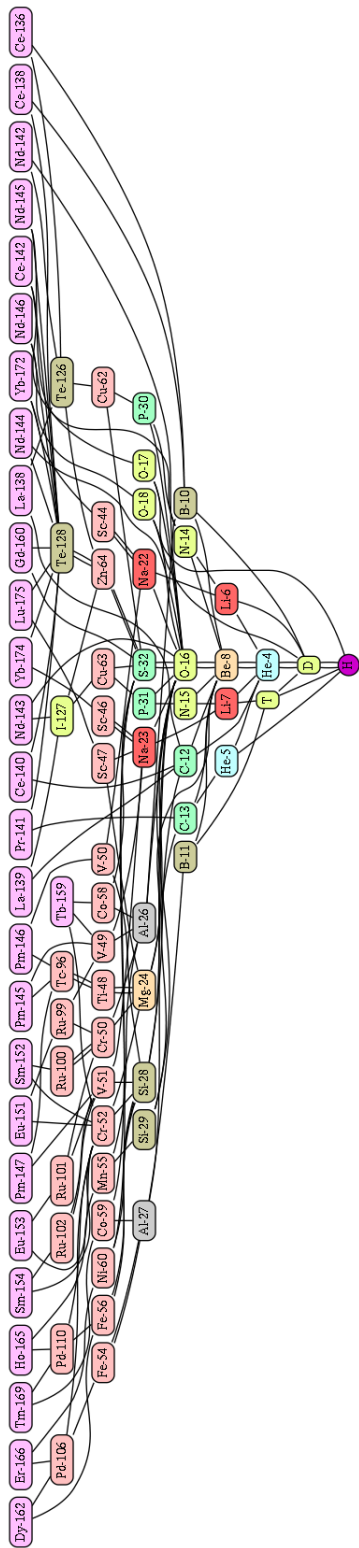

### E.10 Actinide

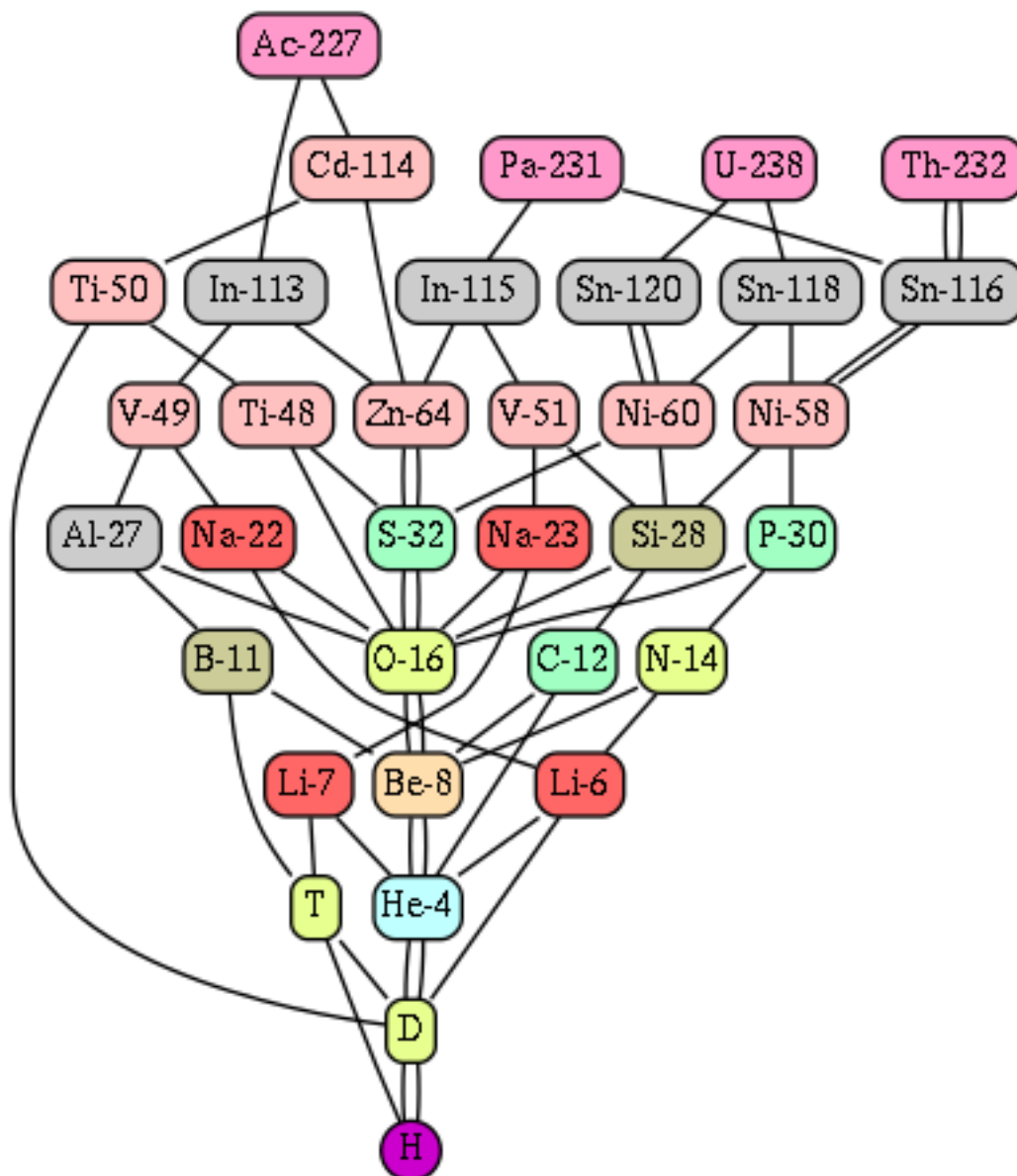

# Appendix F

## Hyperatomic map

### F.1 Level 1



### F.2 Level 2

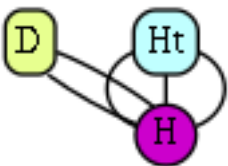

### F.3 Level 3

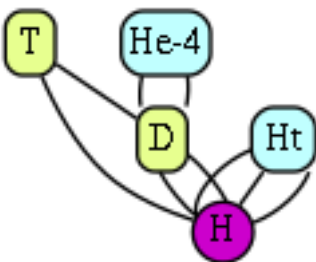

### F.4 Level 4

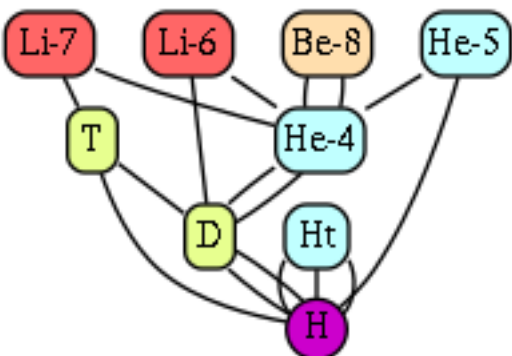

### F.5 Level 5

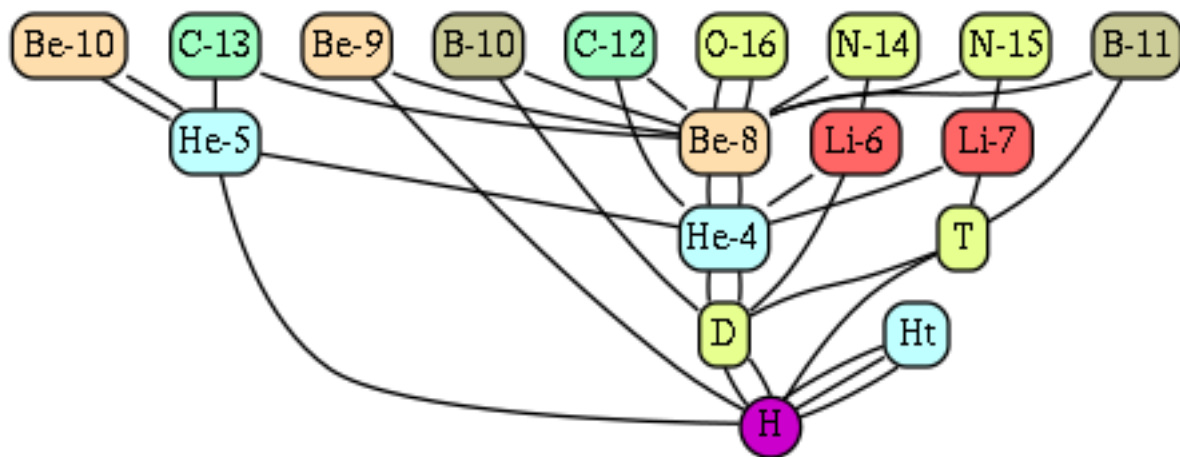



F.6 Level 6

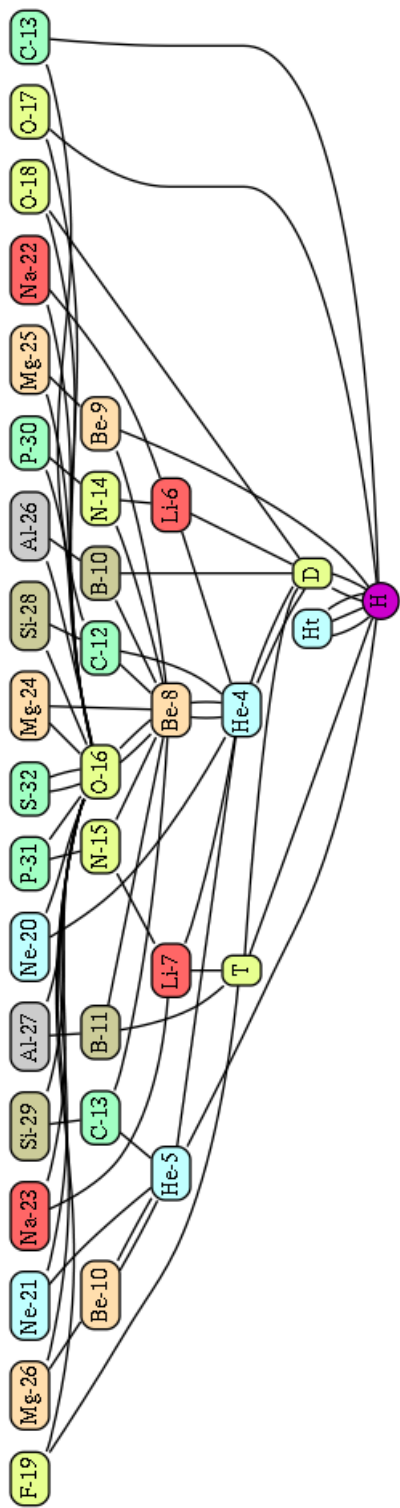



### F.8 Level 8

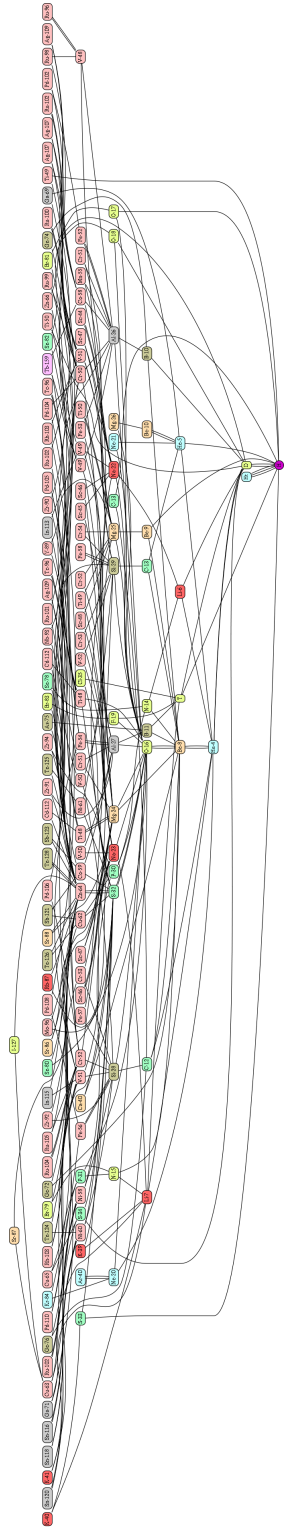

### F.9 Level 9

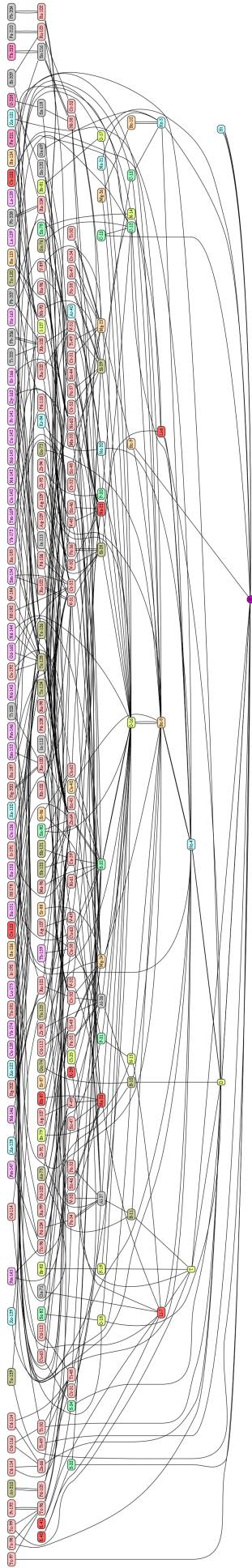

### F.10 Level 10

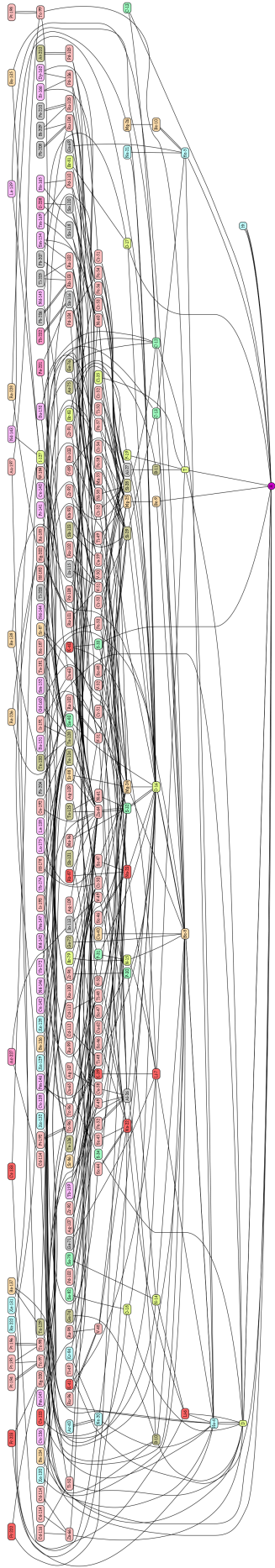

# Appendix G

## Hyperatomic group

### G.1 Be, B

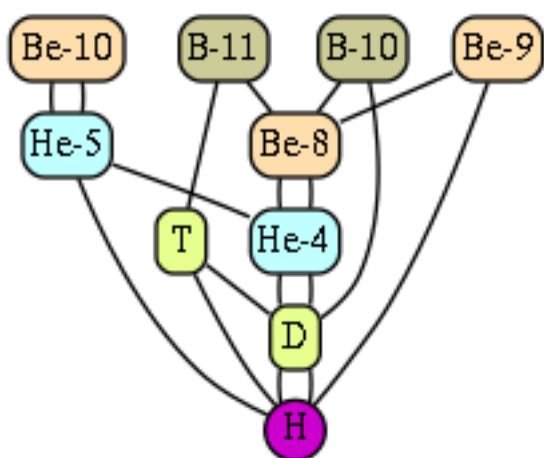

### G.2 N, O, F

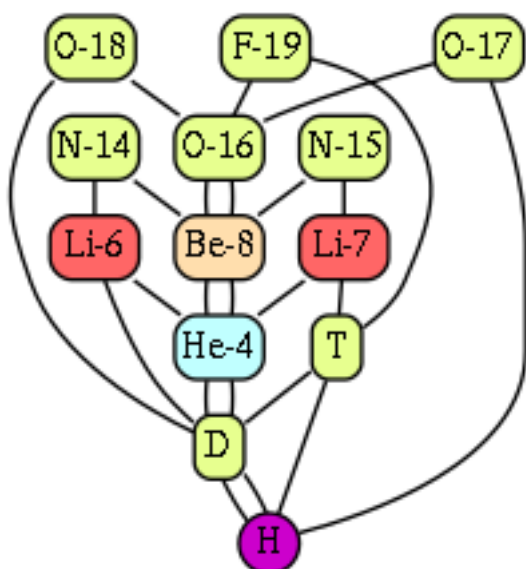

### G.3 Mg, Al

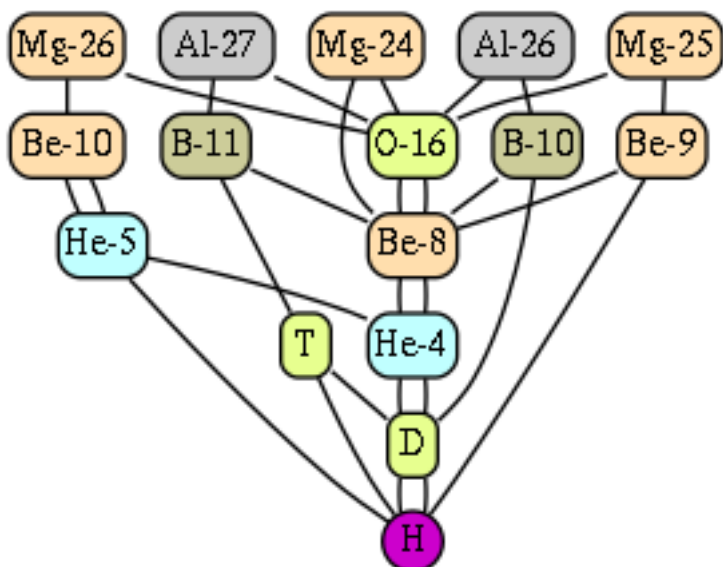

### G.4 Si, P

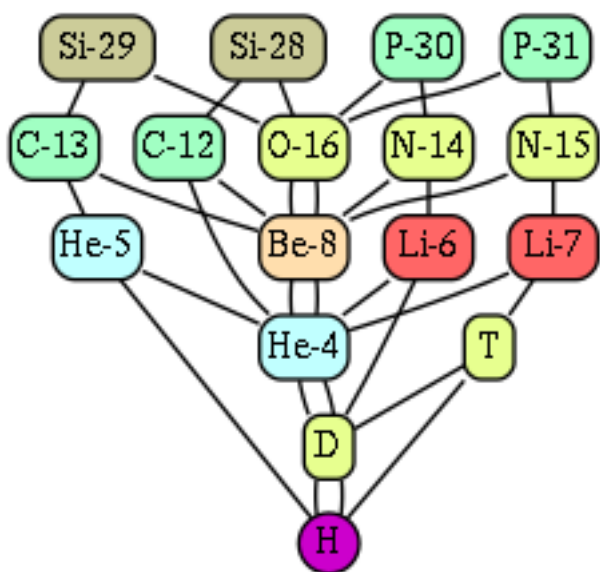

### G.5 Sc, Ti, V, Cr, Mn

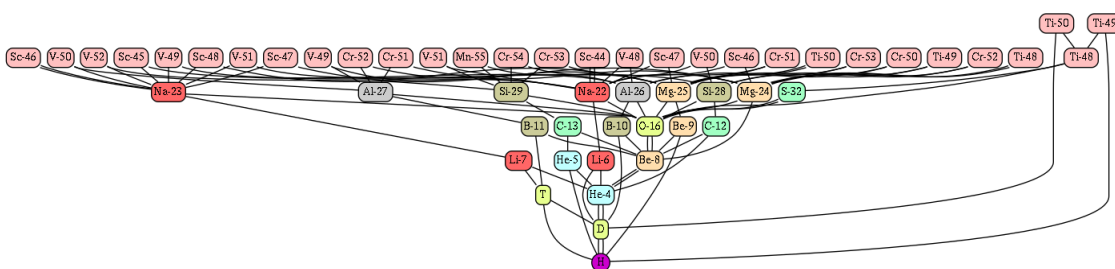

### G.6 Fe, Co, Ni, Cu

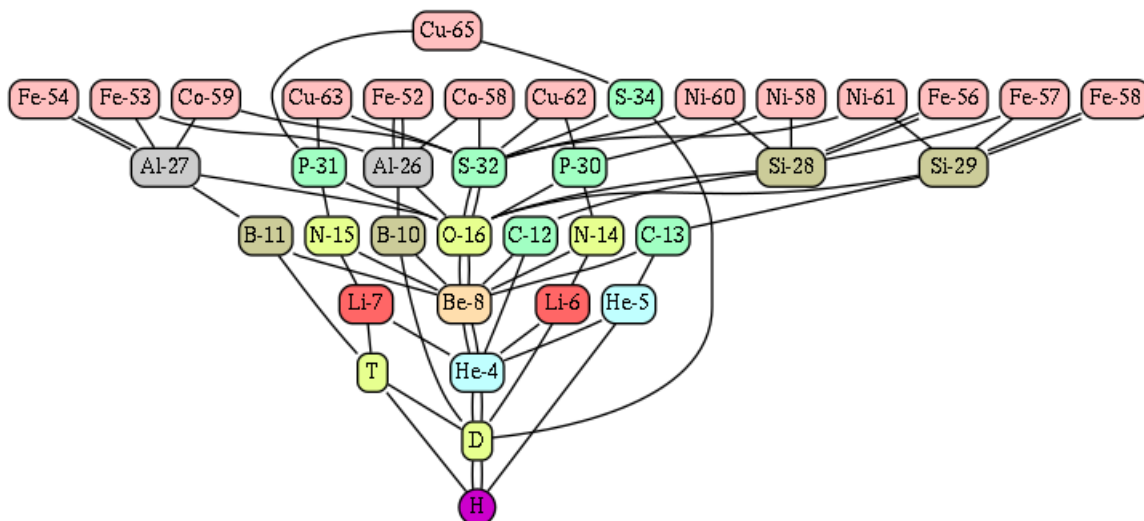

### G.7 Ga, Ge, As, Se, Br, Kr

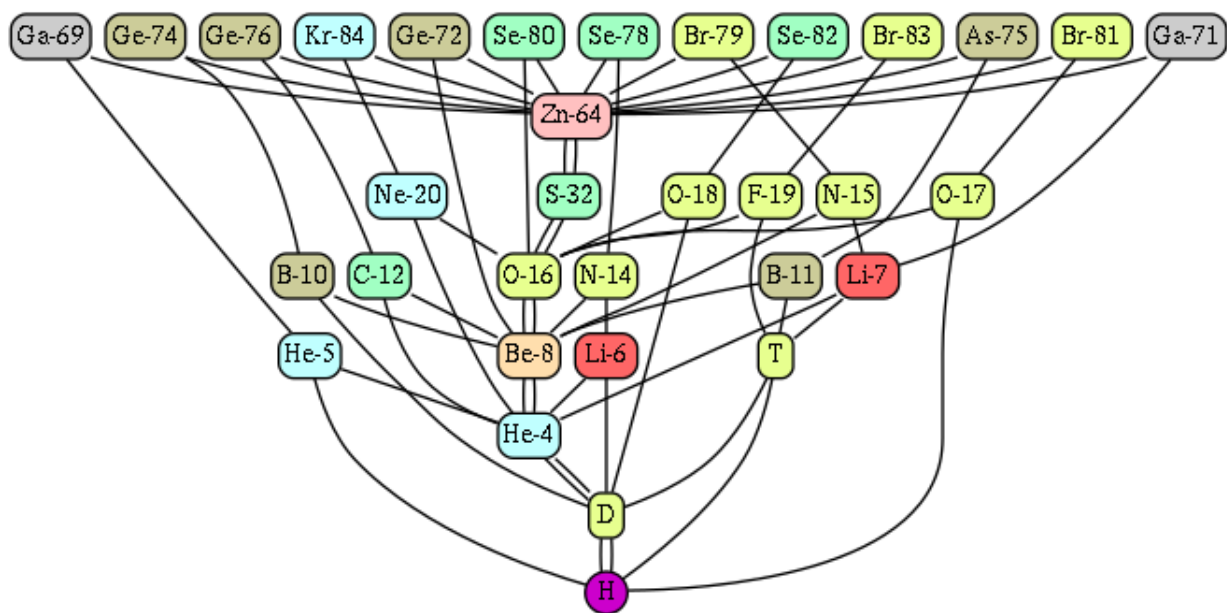



### G.8 Ru, Rh

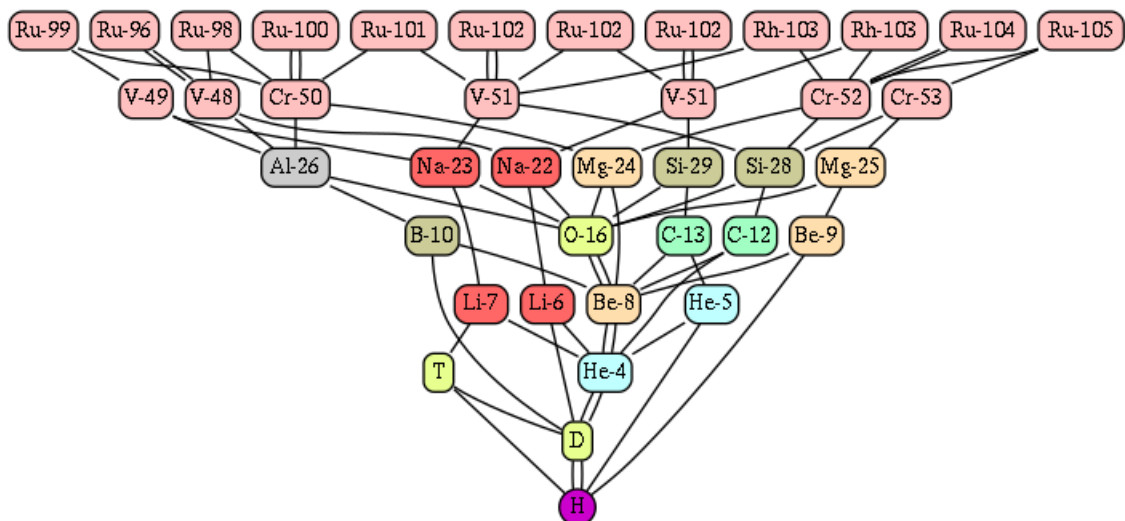

### G.9 Sb, Te, I

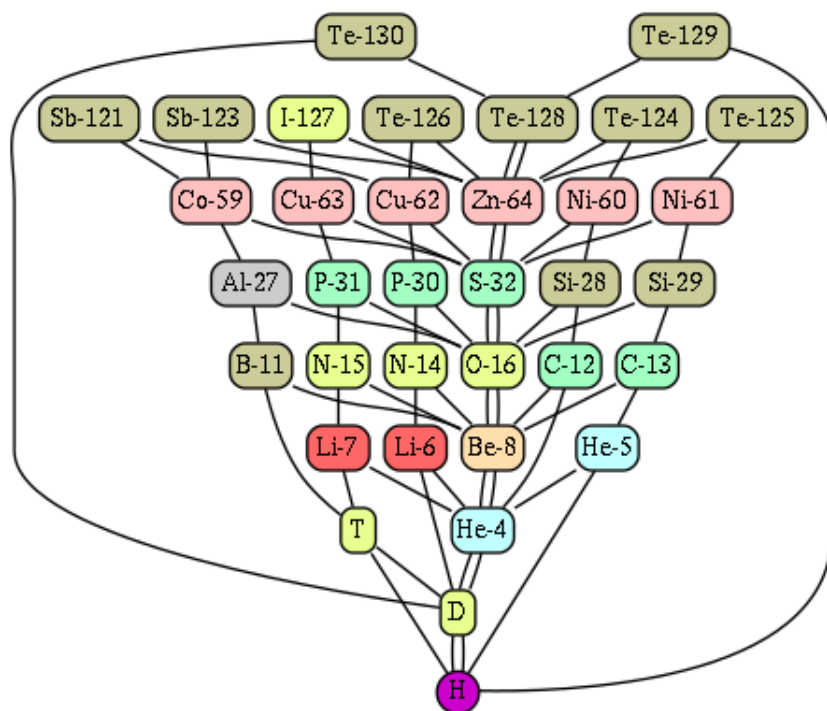

### G.10 Cs, Ba

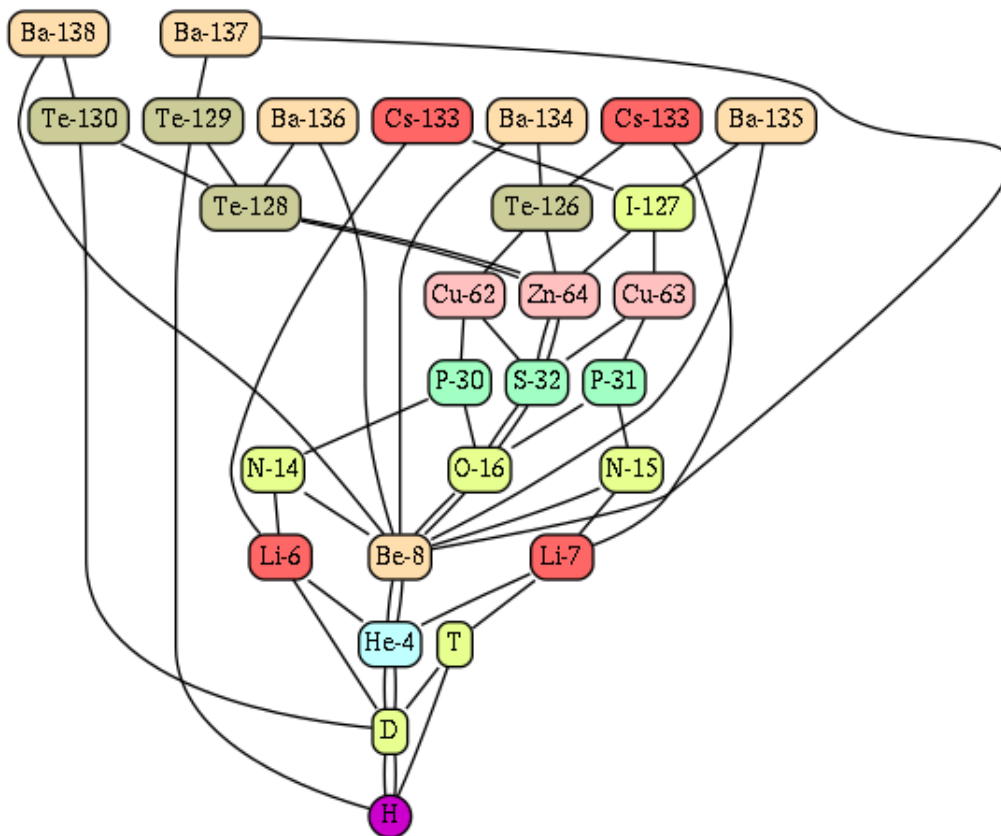

### G.11 La, Ce, Pr, Nd

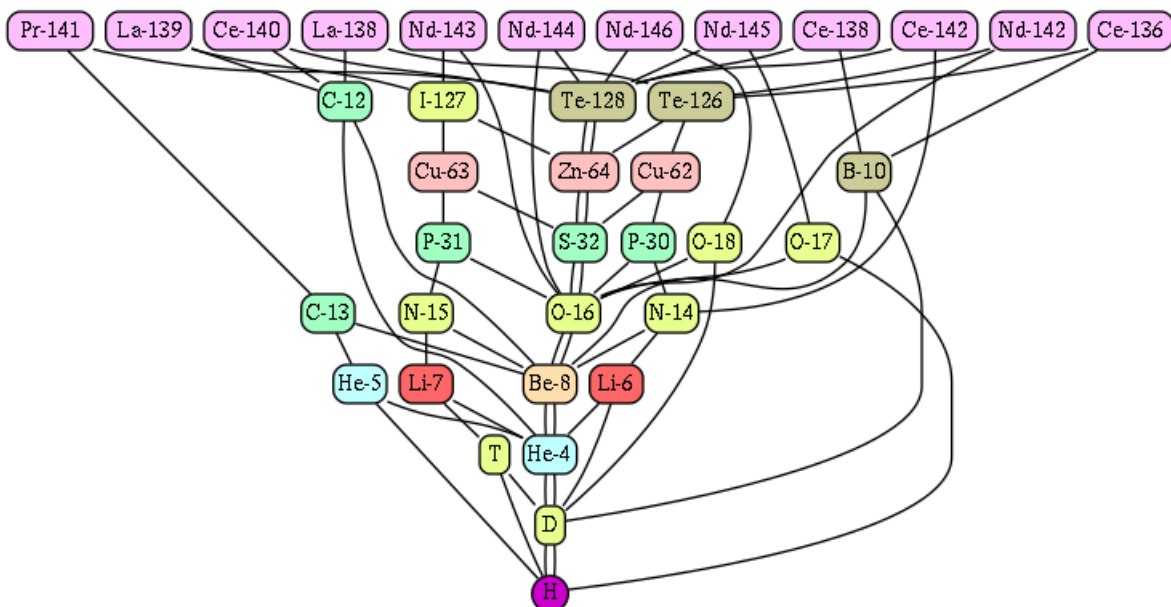

### G.12 Pt, Au

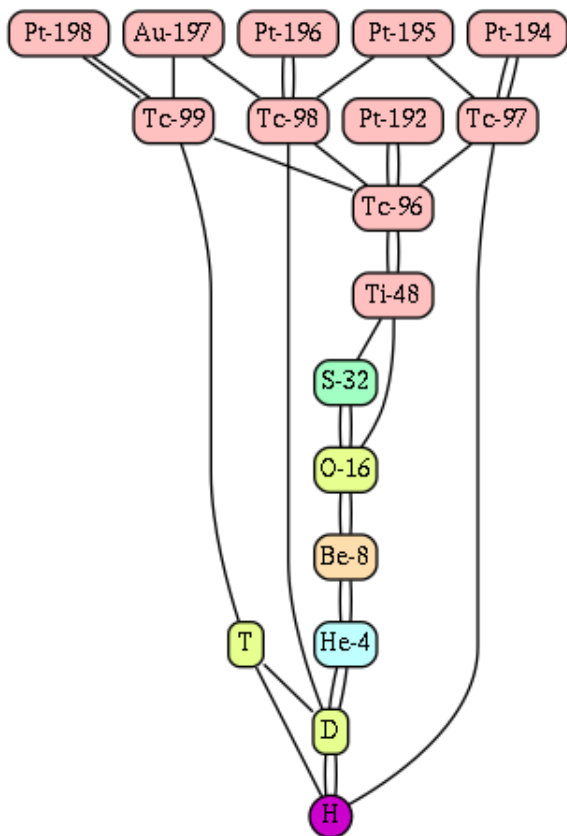

### G.13 Hg, Tl, Pb, Bi, Po, At

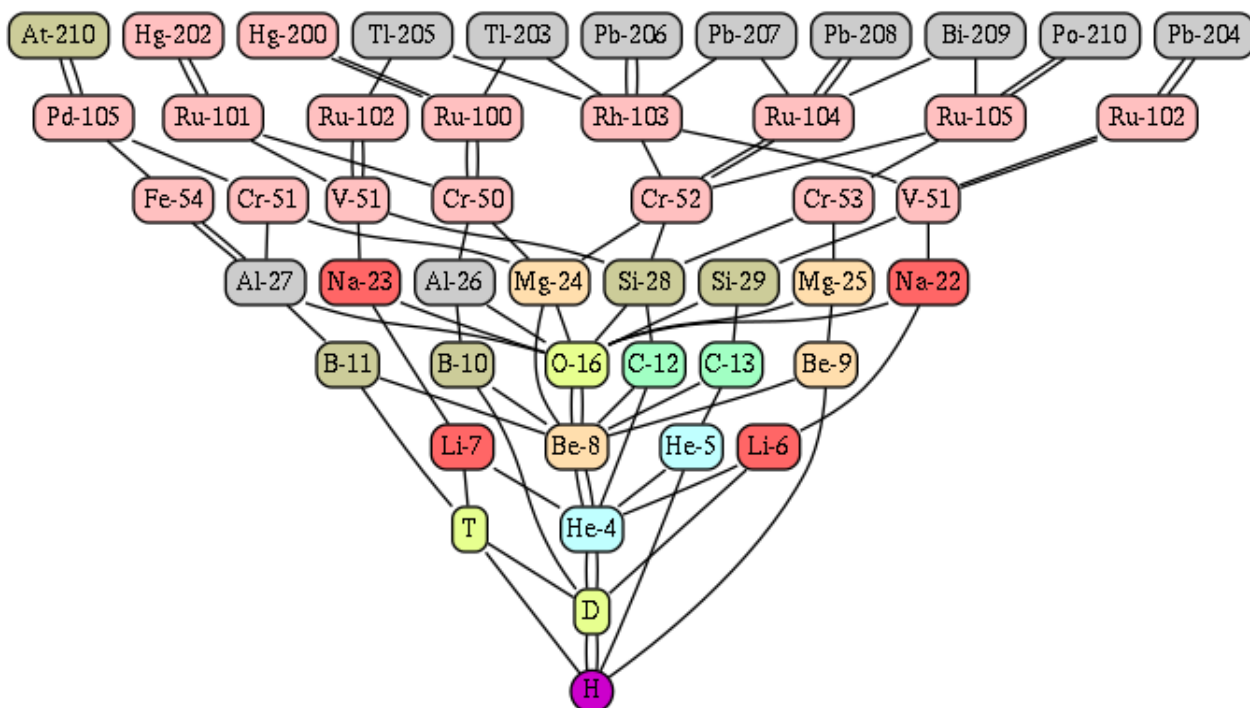

### G.14 Fr, Ra

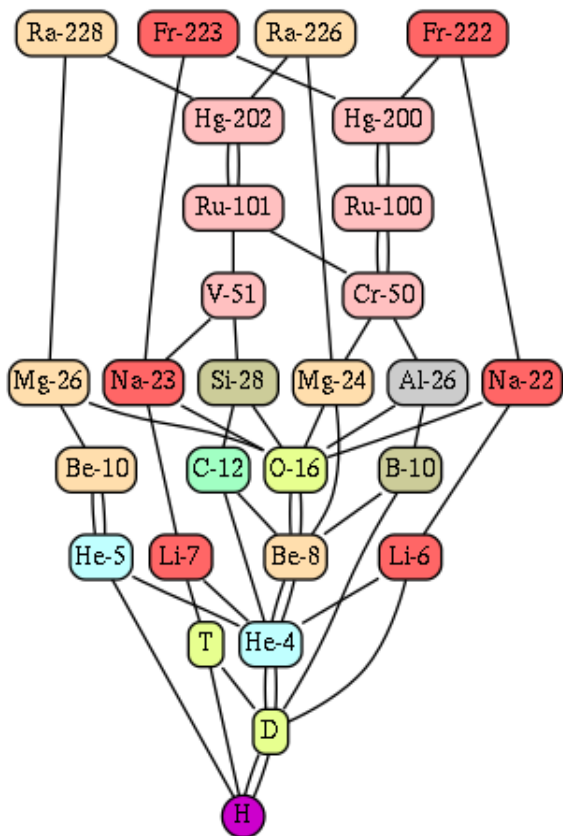

### G.15 Ac, Th, Pa, U

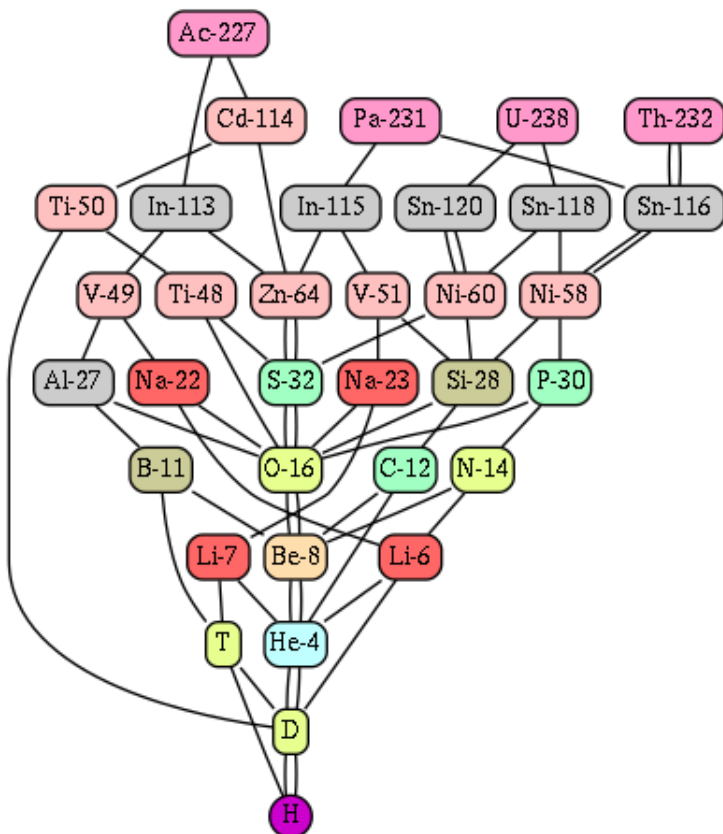

# Appendix H

## Hyperatomic element

### H.1 Level 1

#### H.1.1 Protium



### H.2 Level 2

#### H.2.1 Deuterium

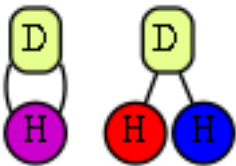

#### H.2.2 Helithreeum

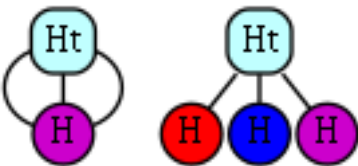

### H.3 Level 3

#### H.3.1 Tritium

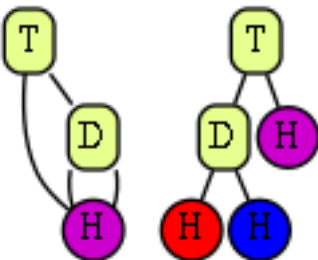

### H.3.2 Helium

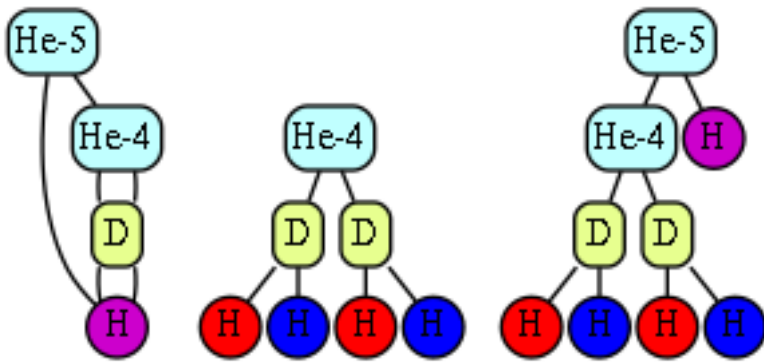

## H.4 Level 4

### H.4.1 Lithium

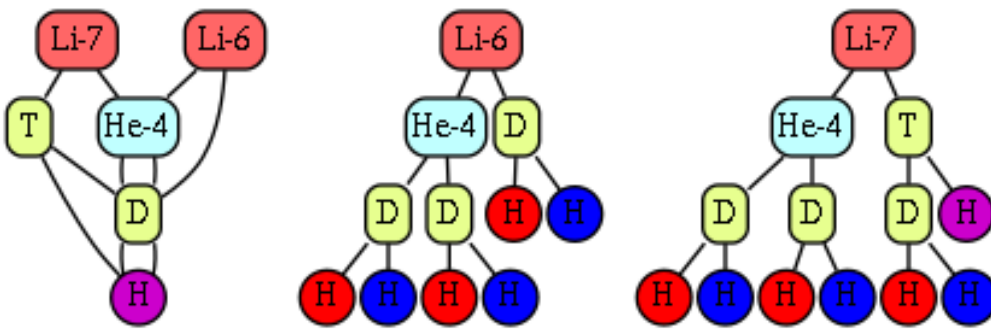

### H.4.2 Beryllium

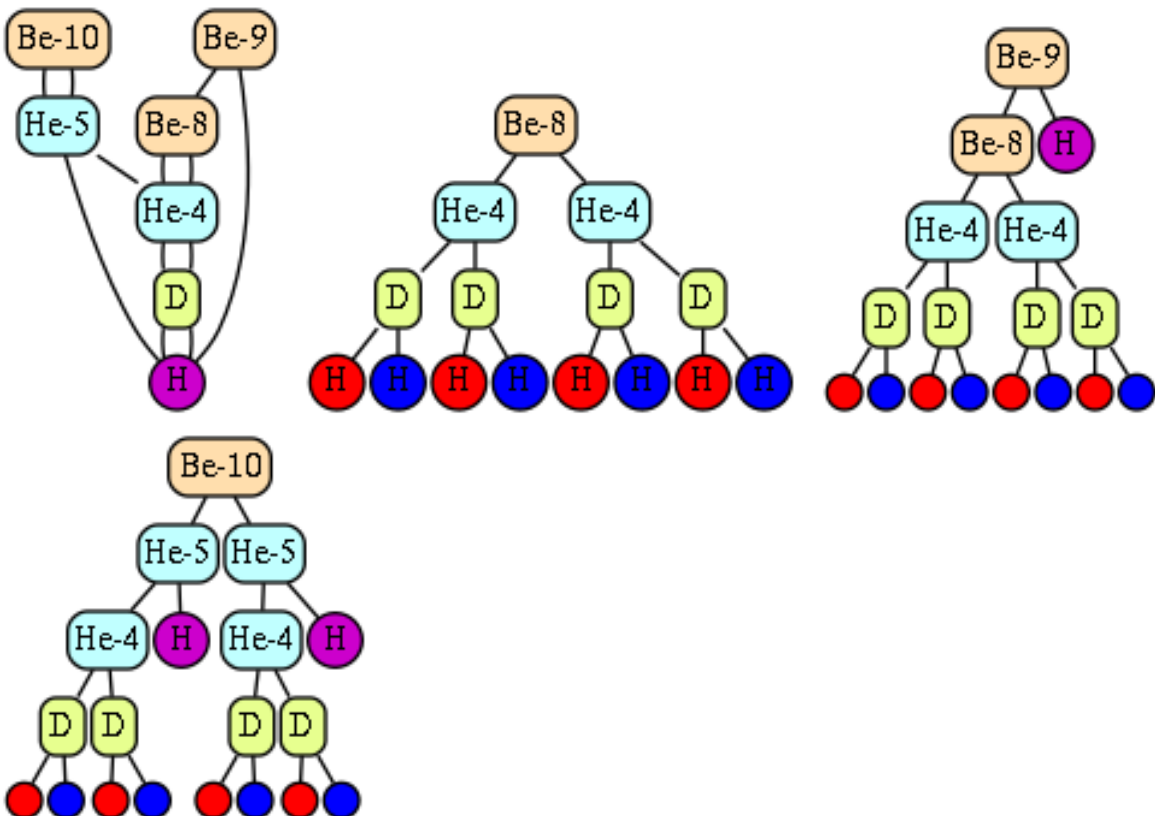

## H.5 Level 5

### H.5.1 Boron

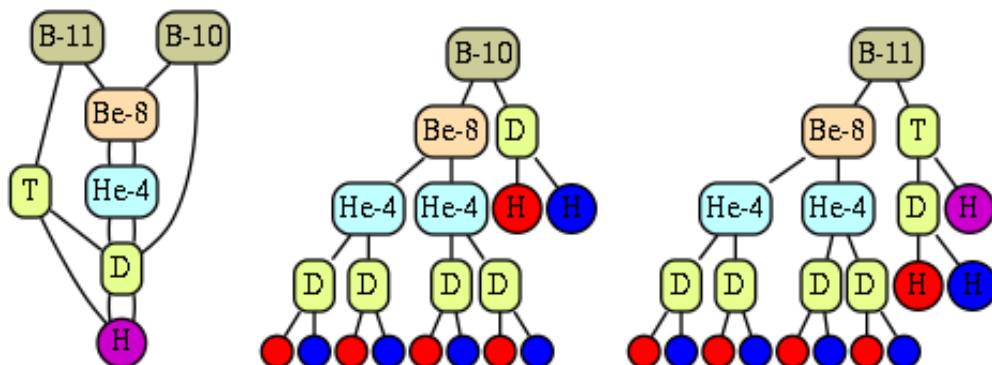

### H.5.2 Carbon

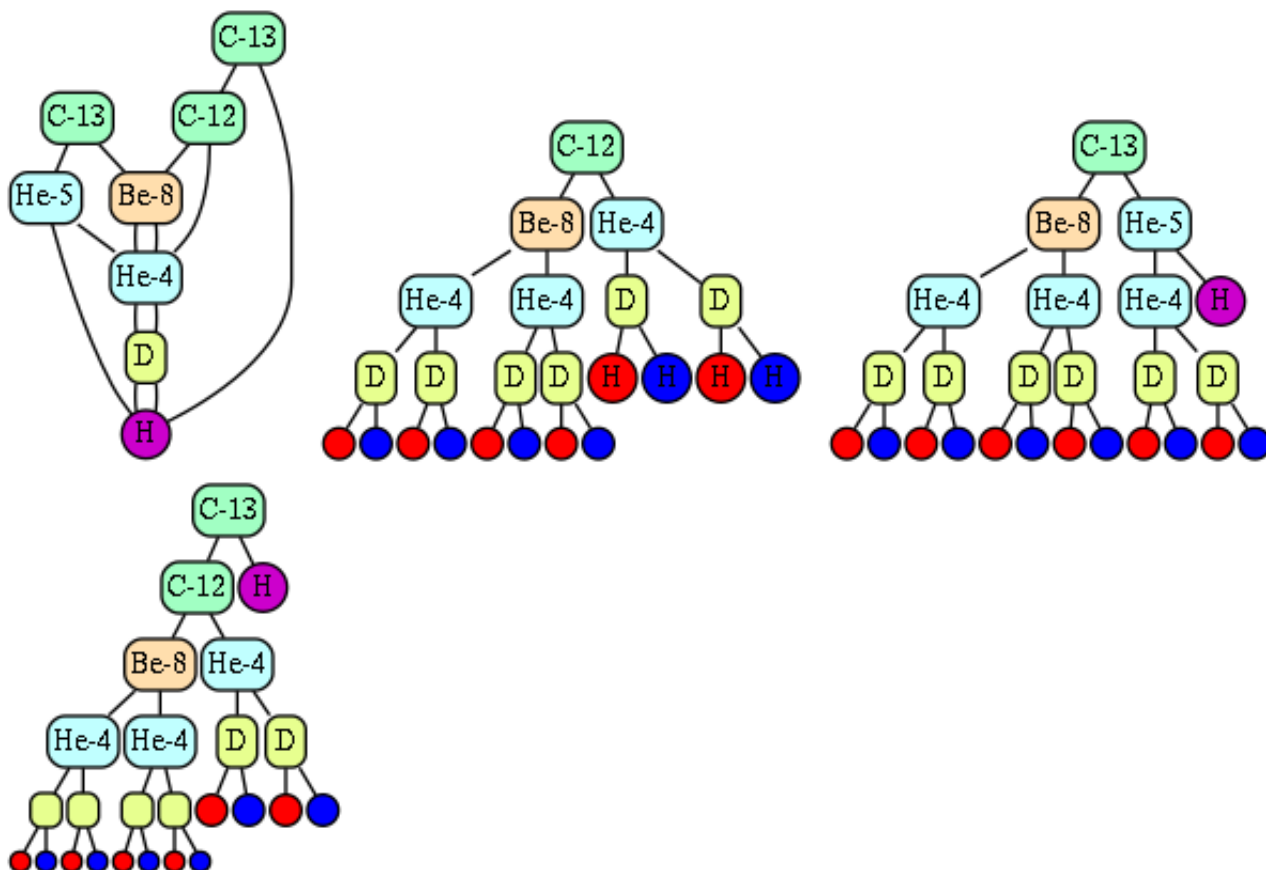

### H.5.3 Nitrogen

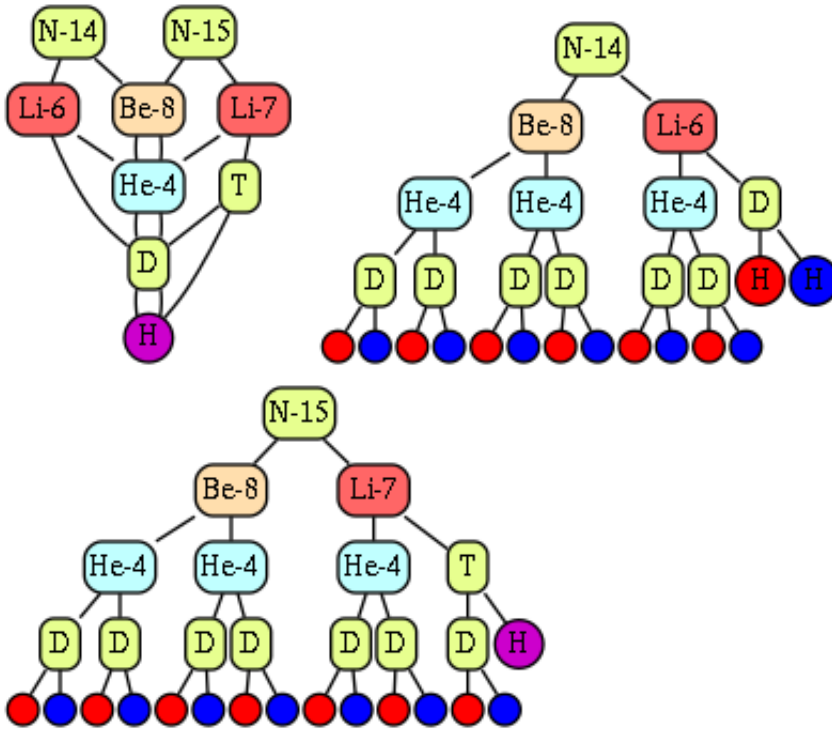

### H.5.4 Oxygen

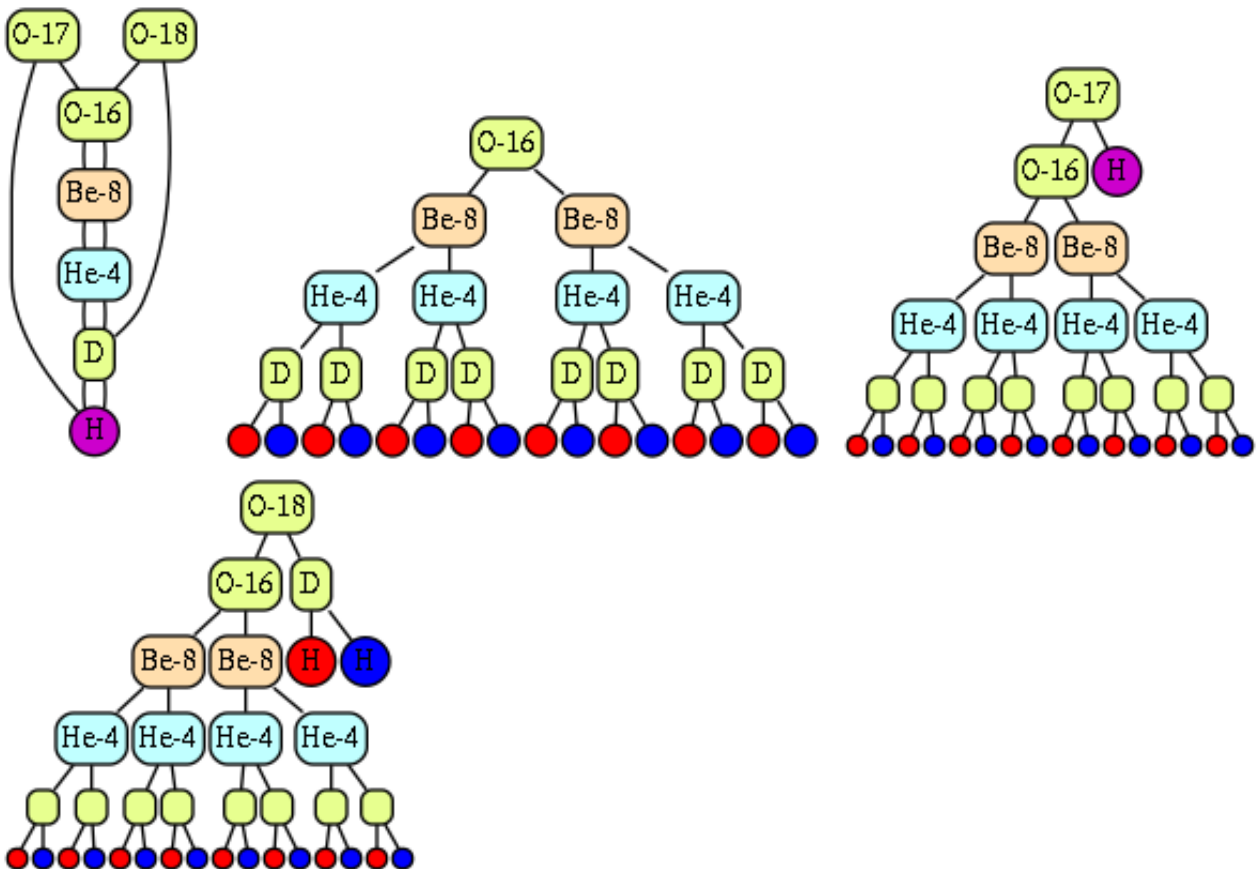



## H.6 Level 6

### H.6.1 Fluorine

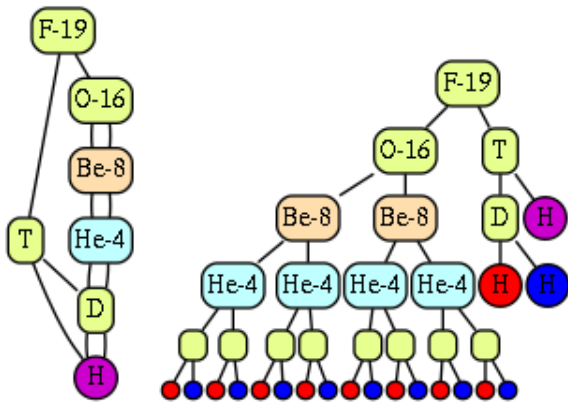

### H.6.2 Neon

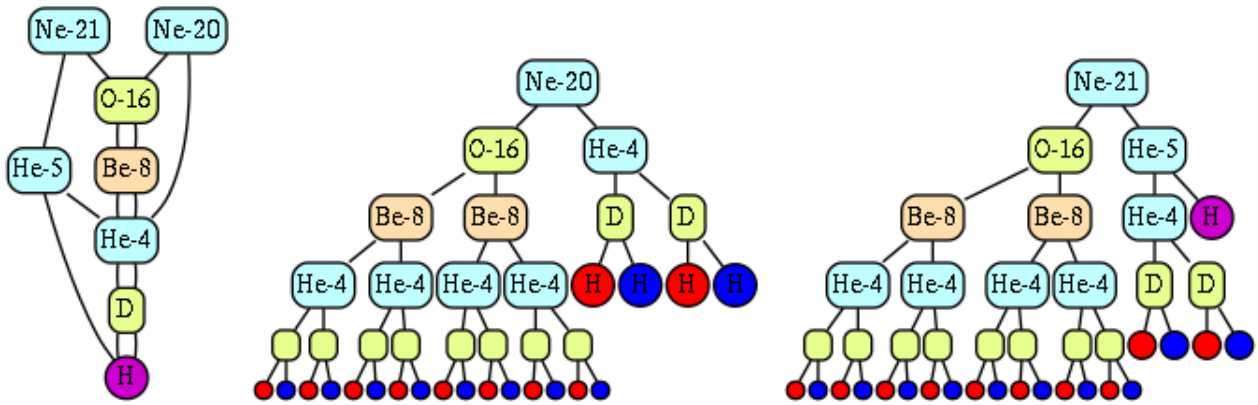

H.6.3 Sodium

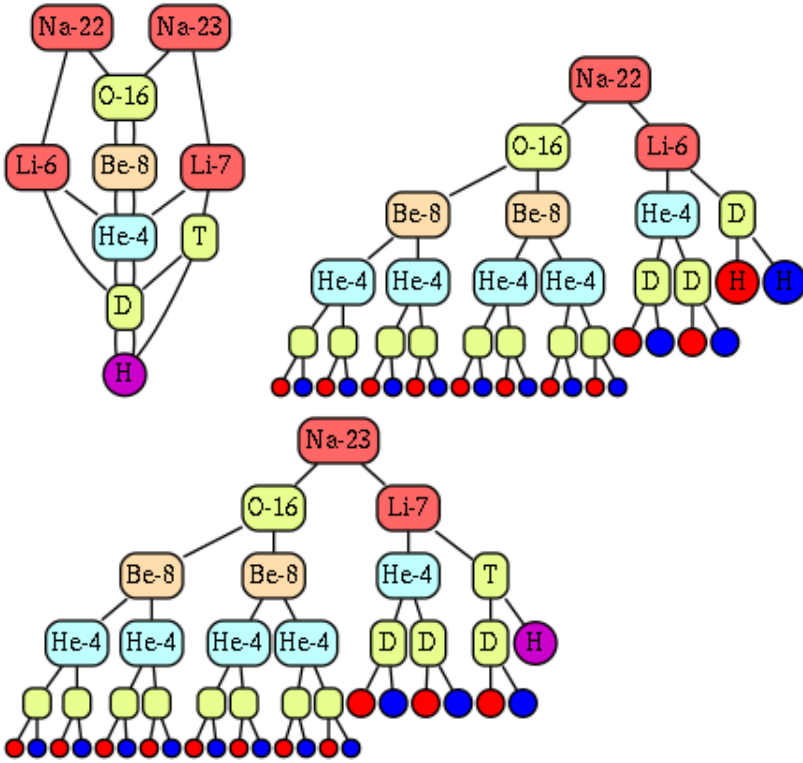

H.6.4 Magnesium

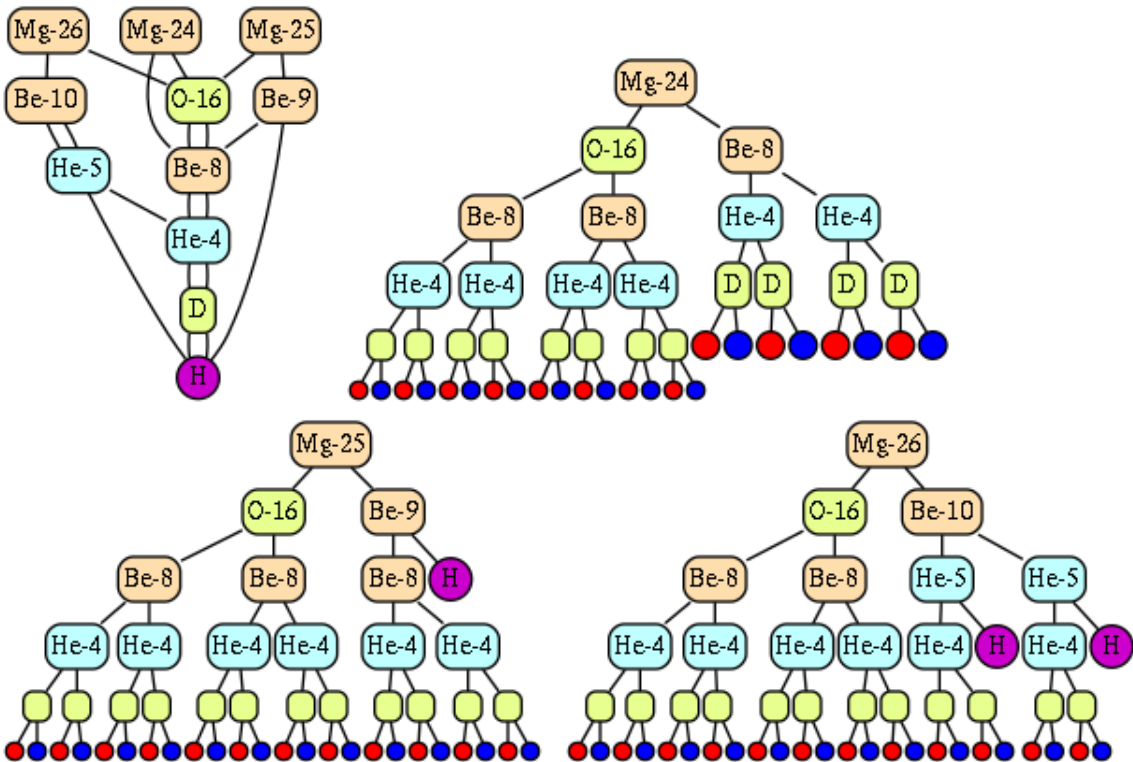

### H.6.5 Aluminium

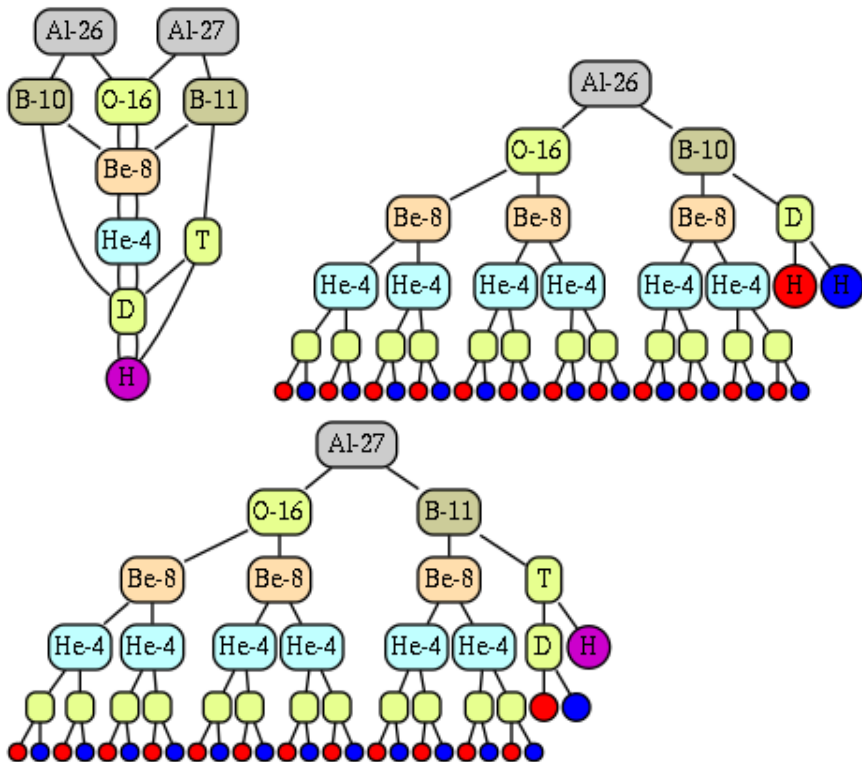

### H.6.6 Silicon

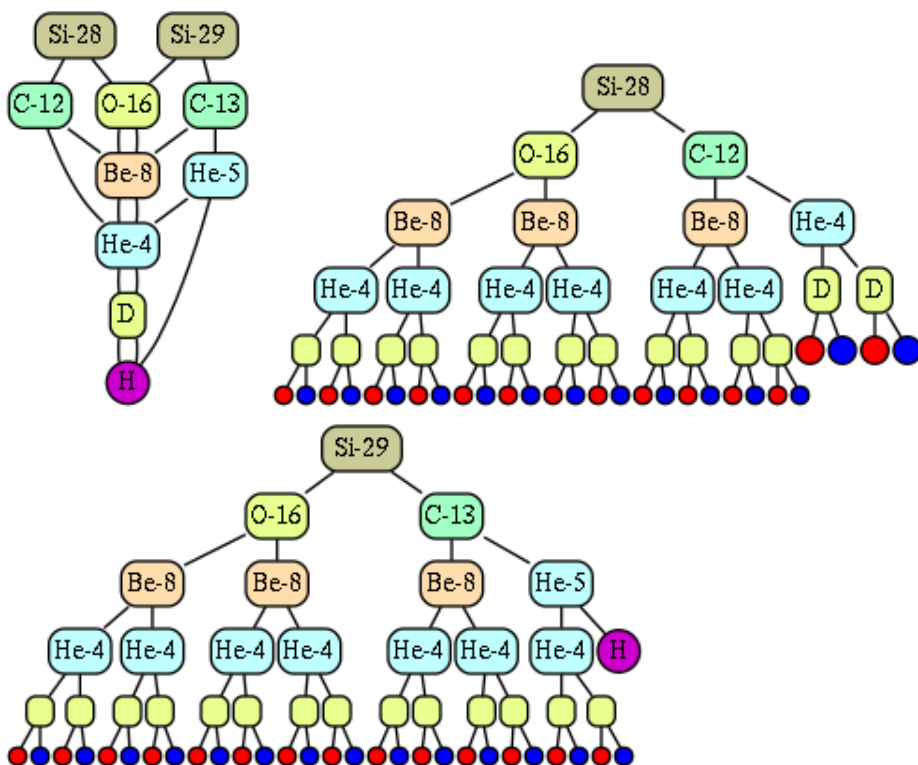

### H.6.7 Phosphorus

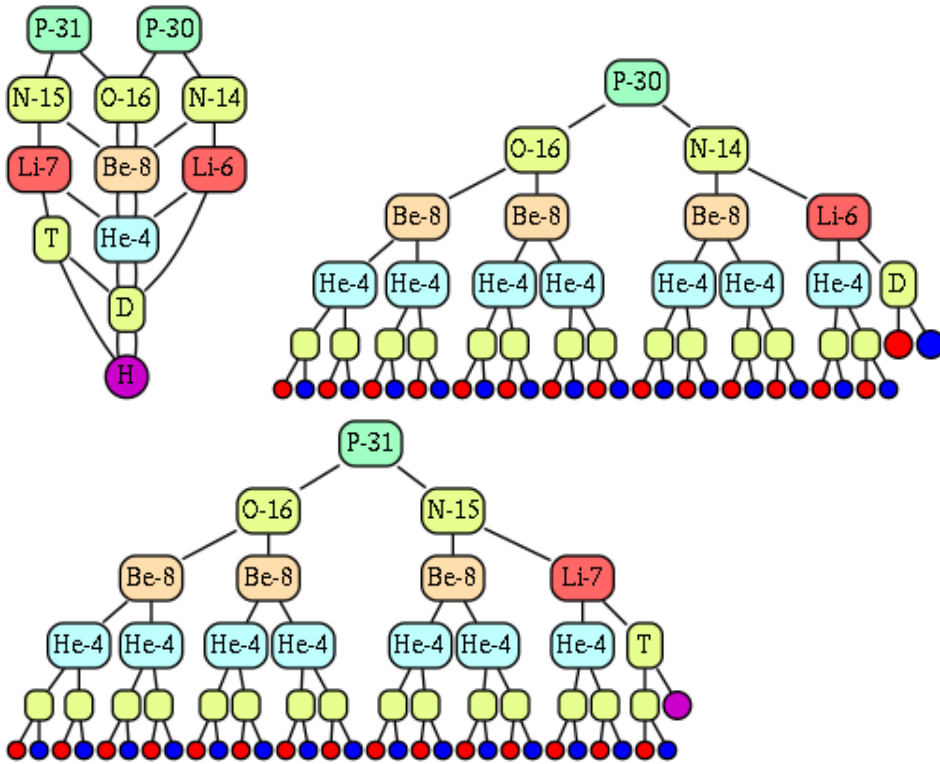

### H.6.8 Sulfur

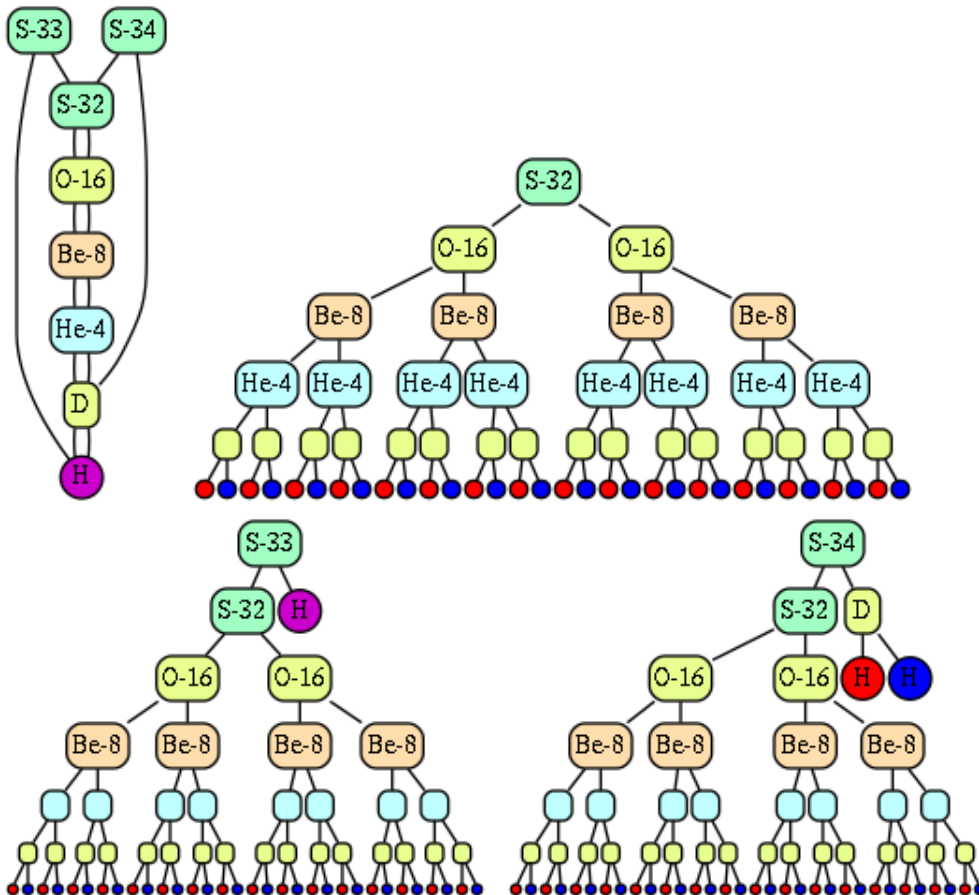

## H.7 Level 7

### H.7.1 Chlorine

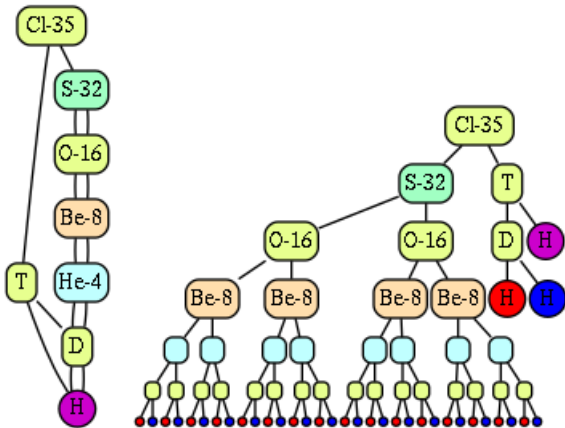

### H.7.2 Argon

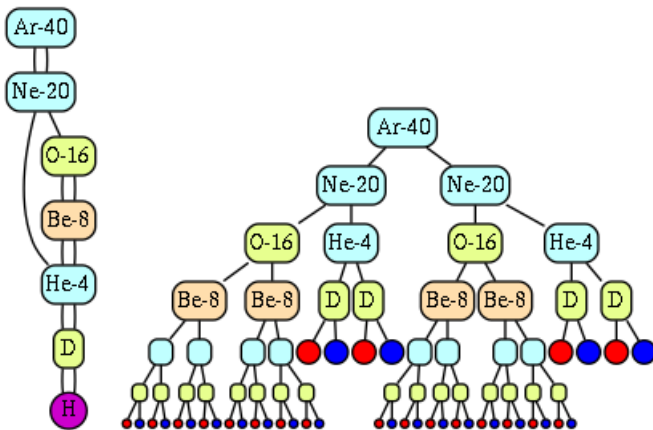

### H.7.3 Potassium

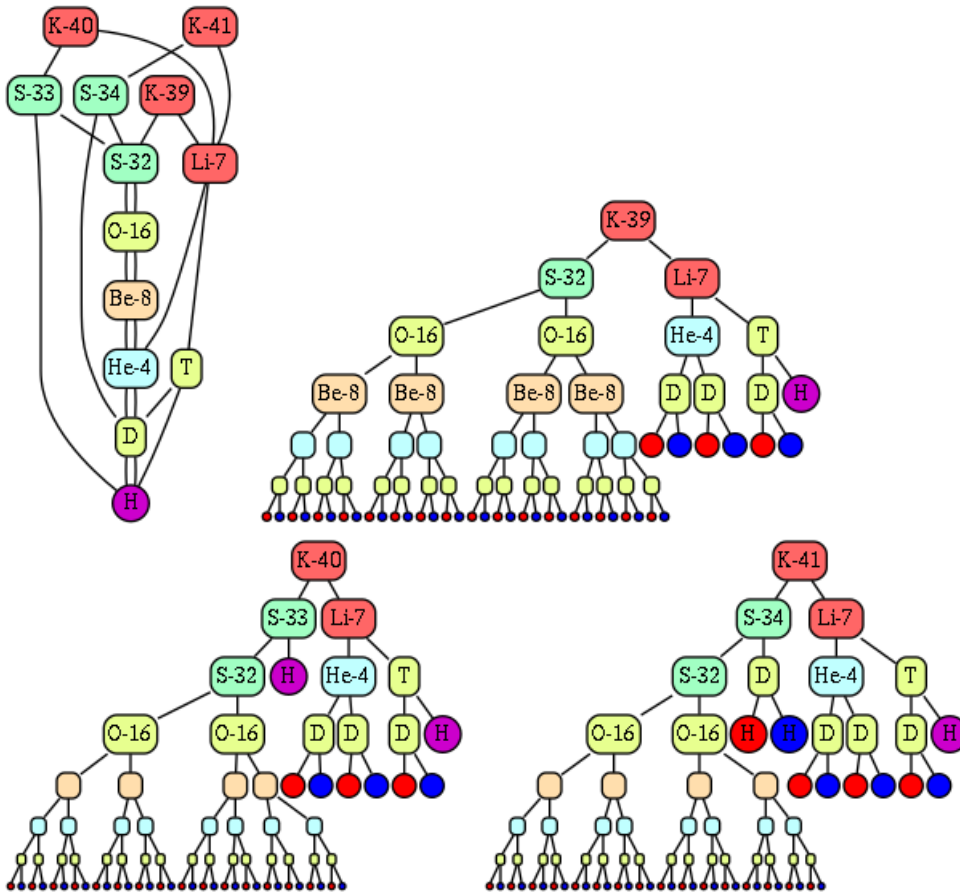

### H.7.4 Calcium

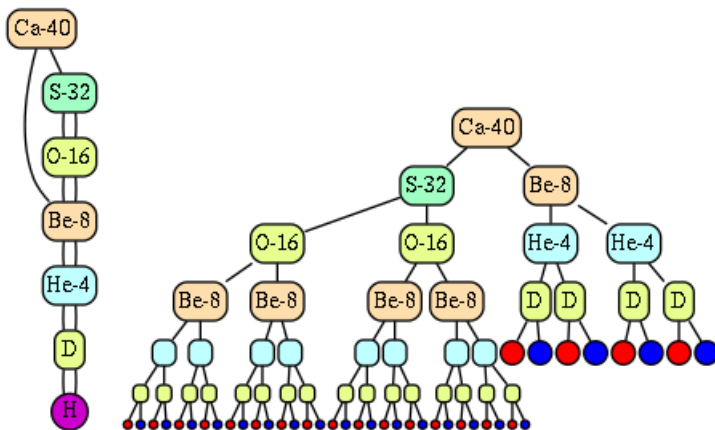

### H.7.5 Scandium

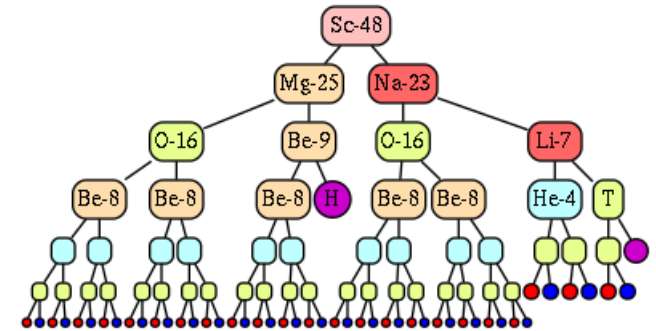
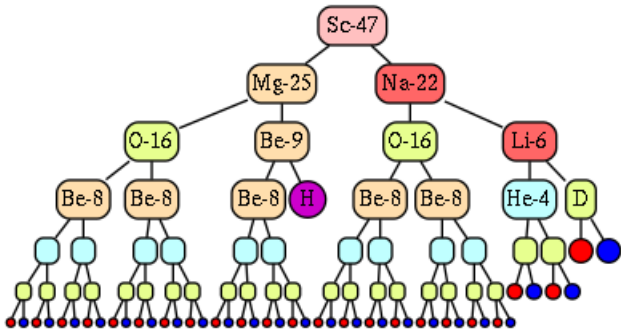
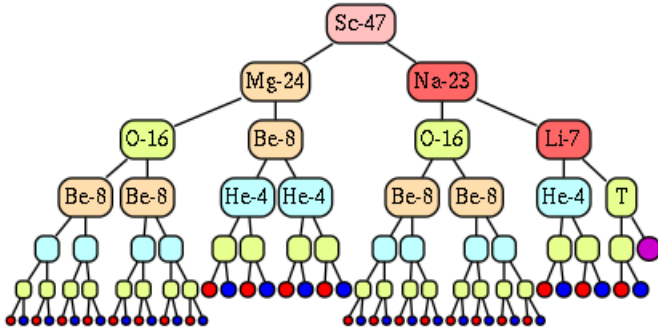
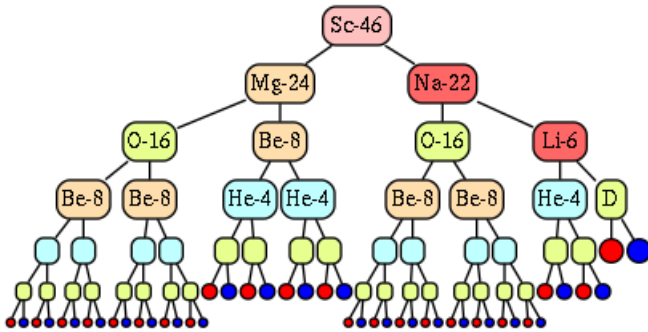
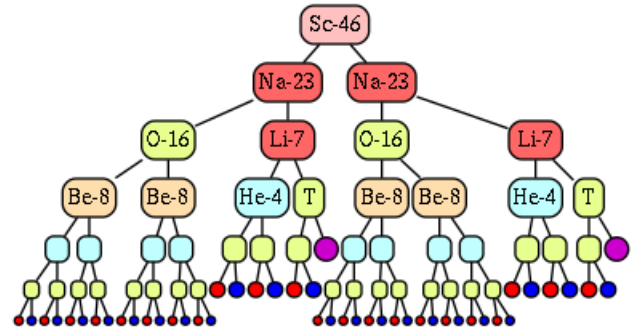
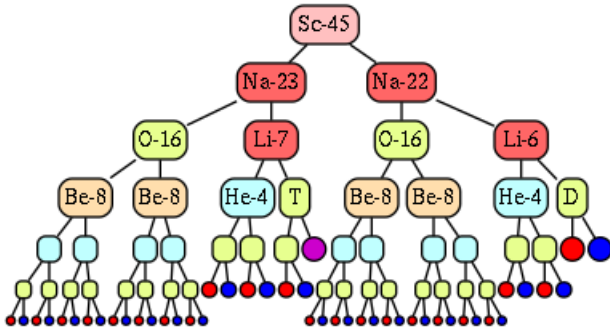
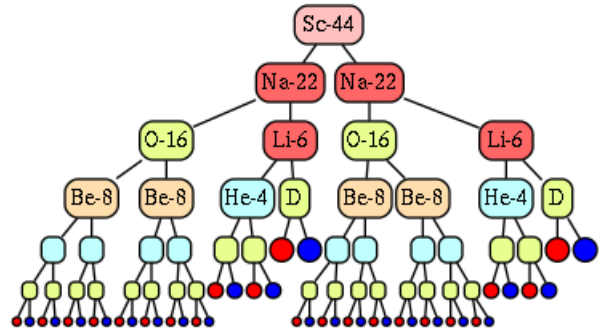
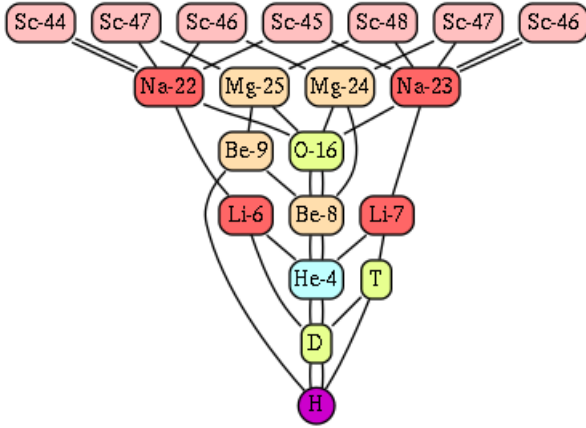

### H.7.6 Titanium

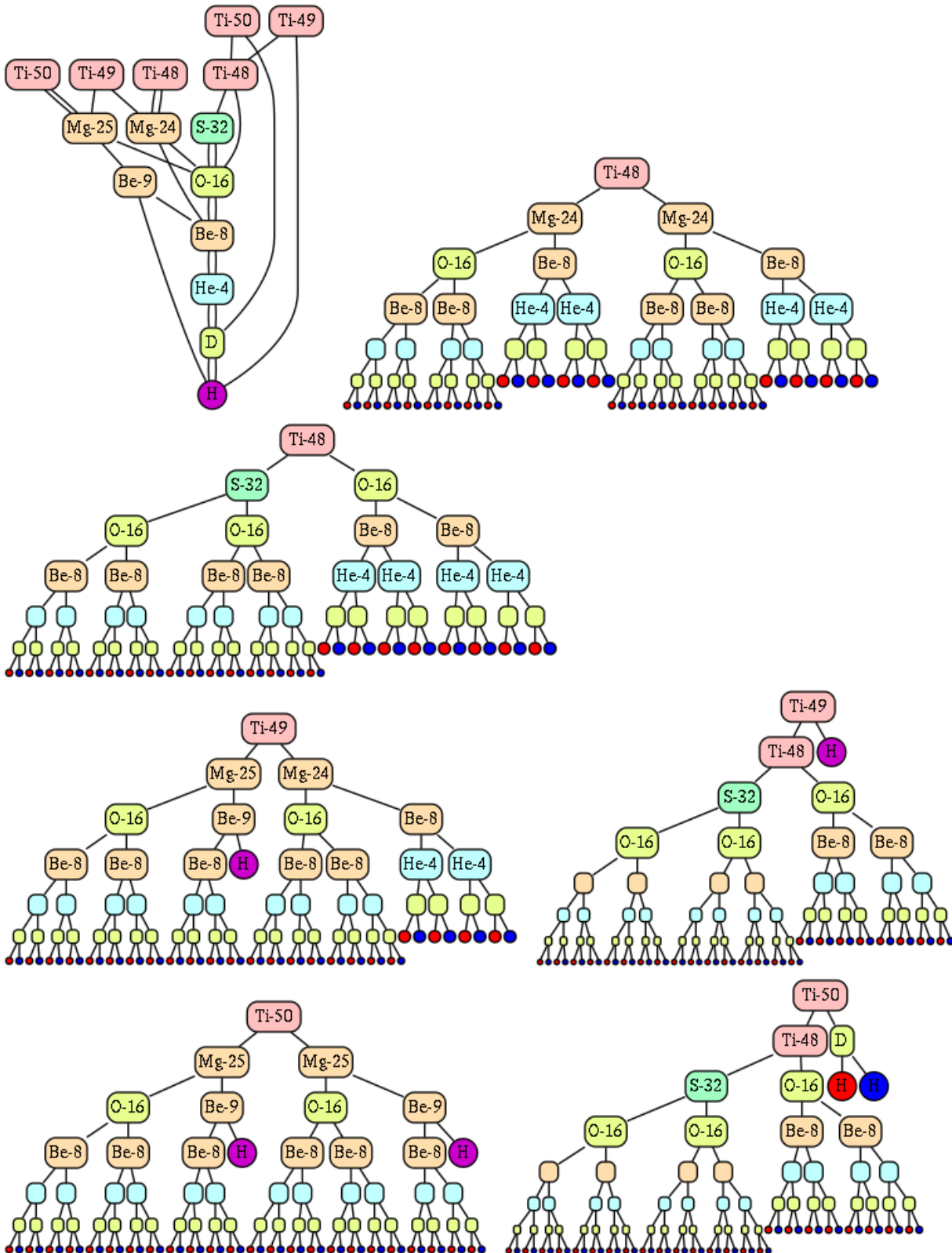



### H.7.7 Vanadium

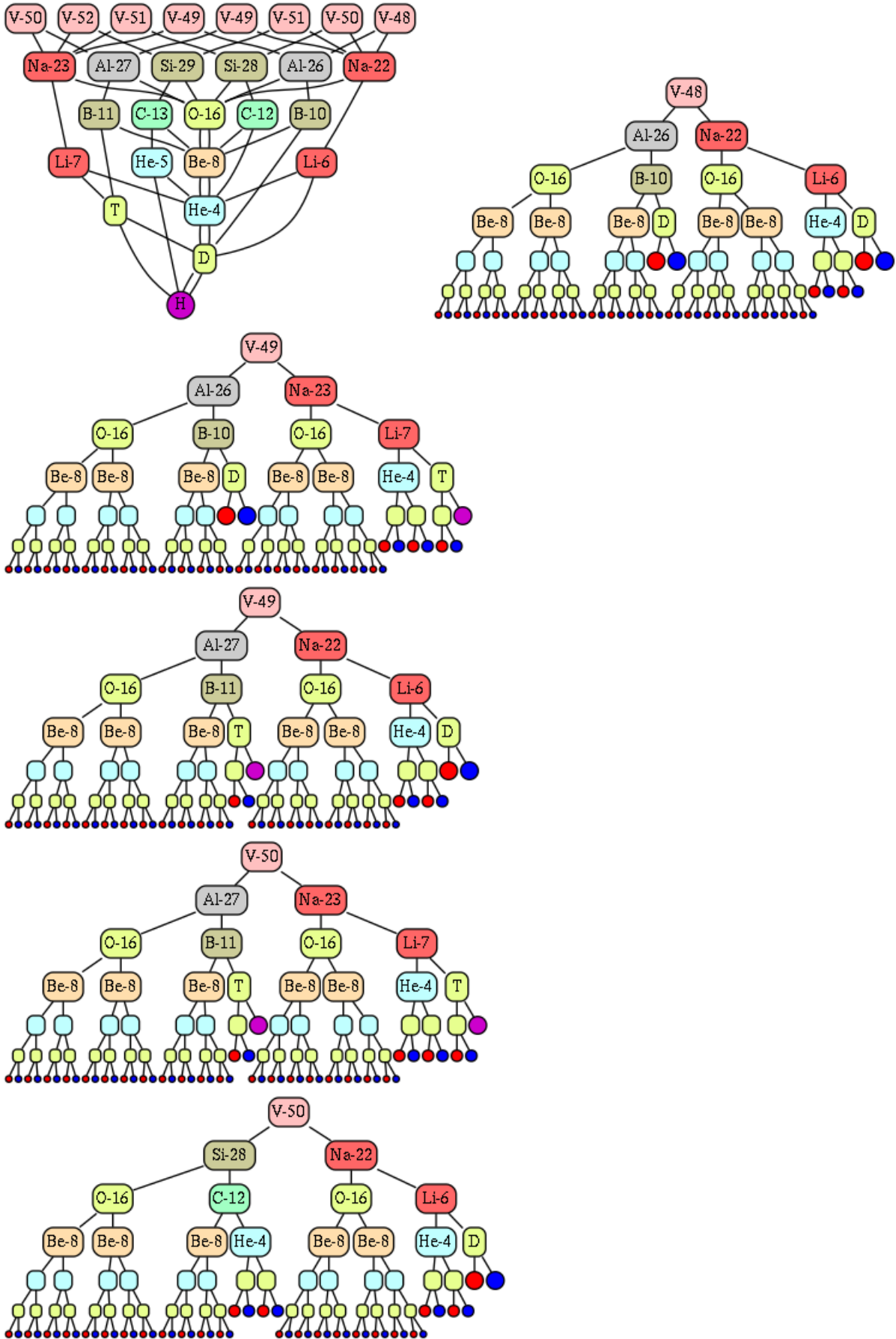

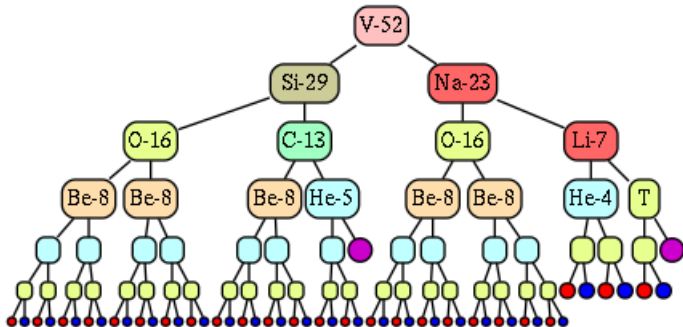
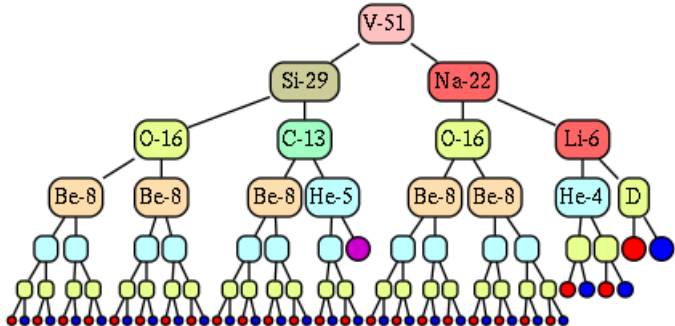
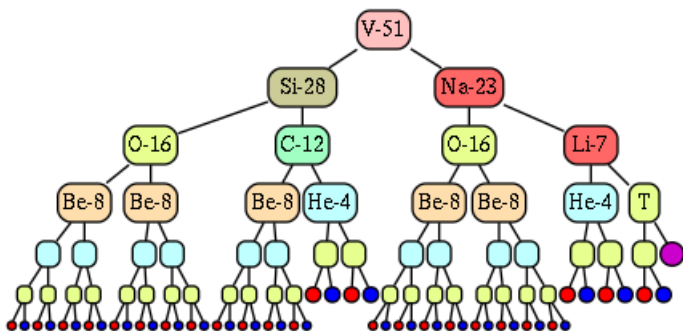

H.7.8 Chromium

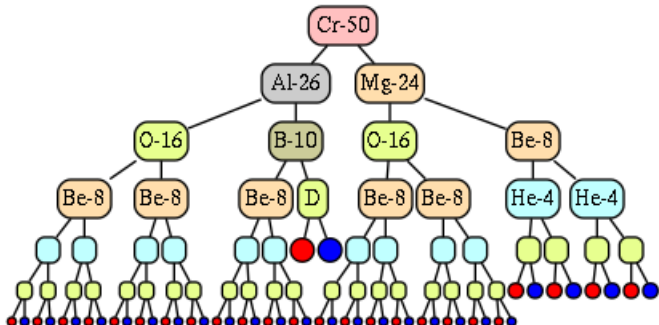
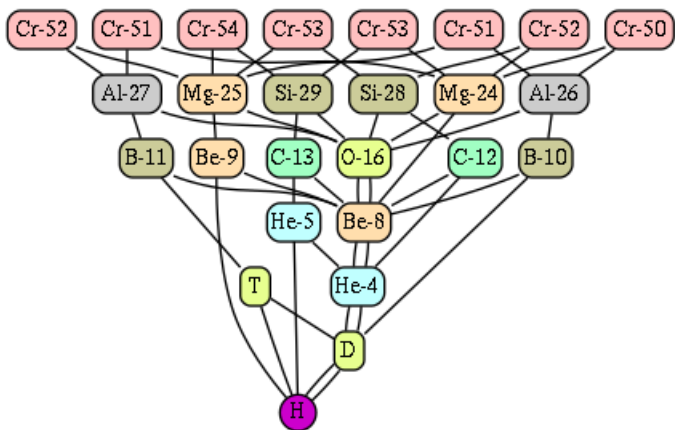

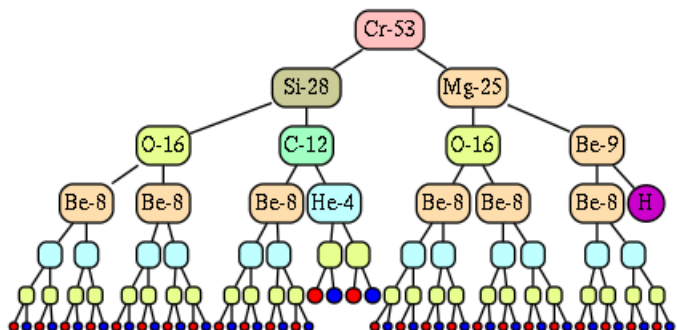
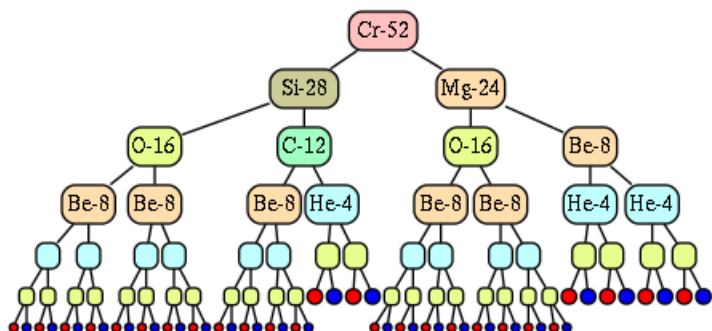
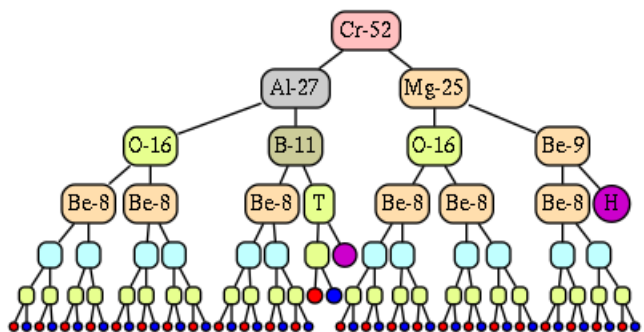
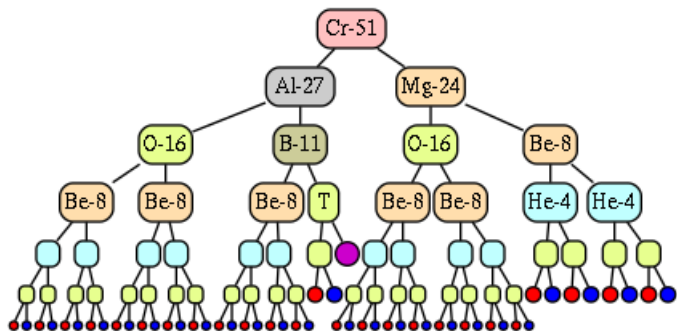
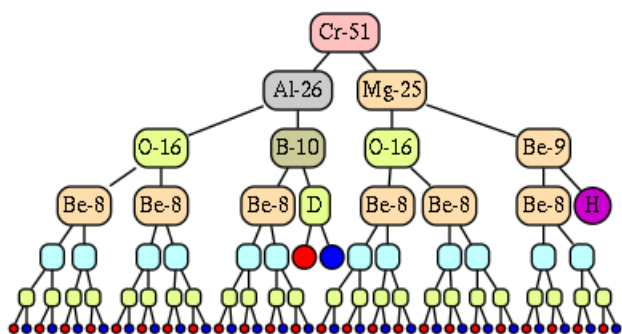

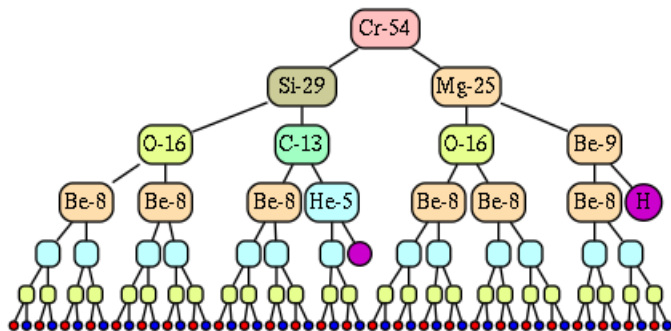
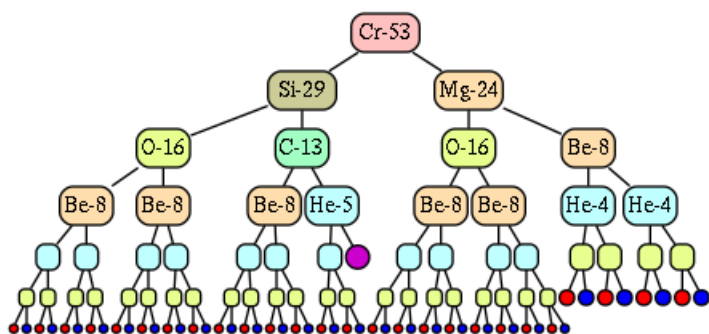

### H.7.9 Manganese

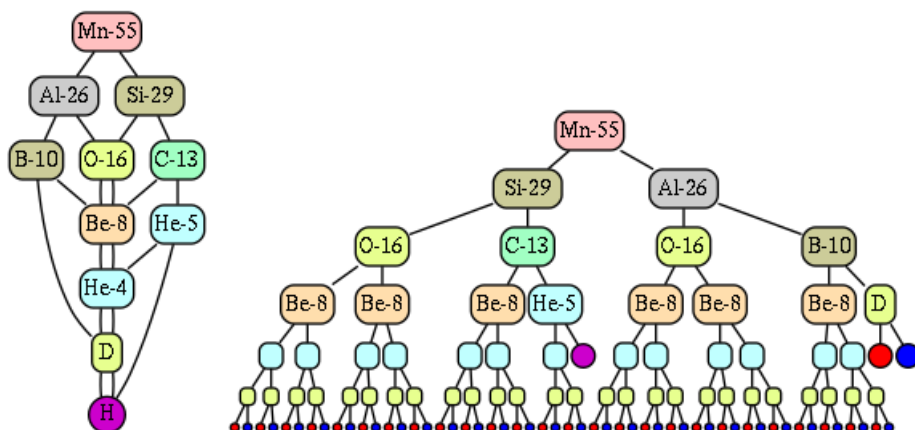

H.7.10 Iron

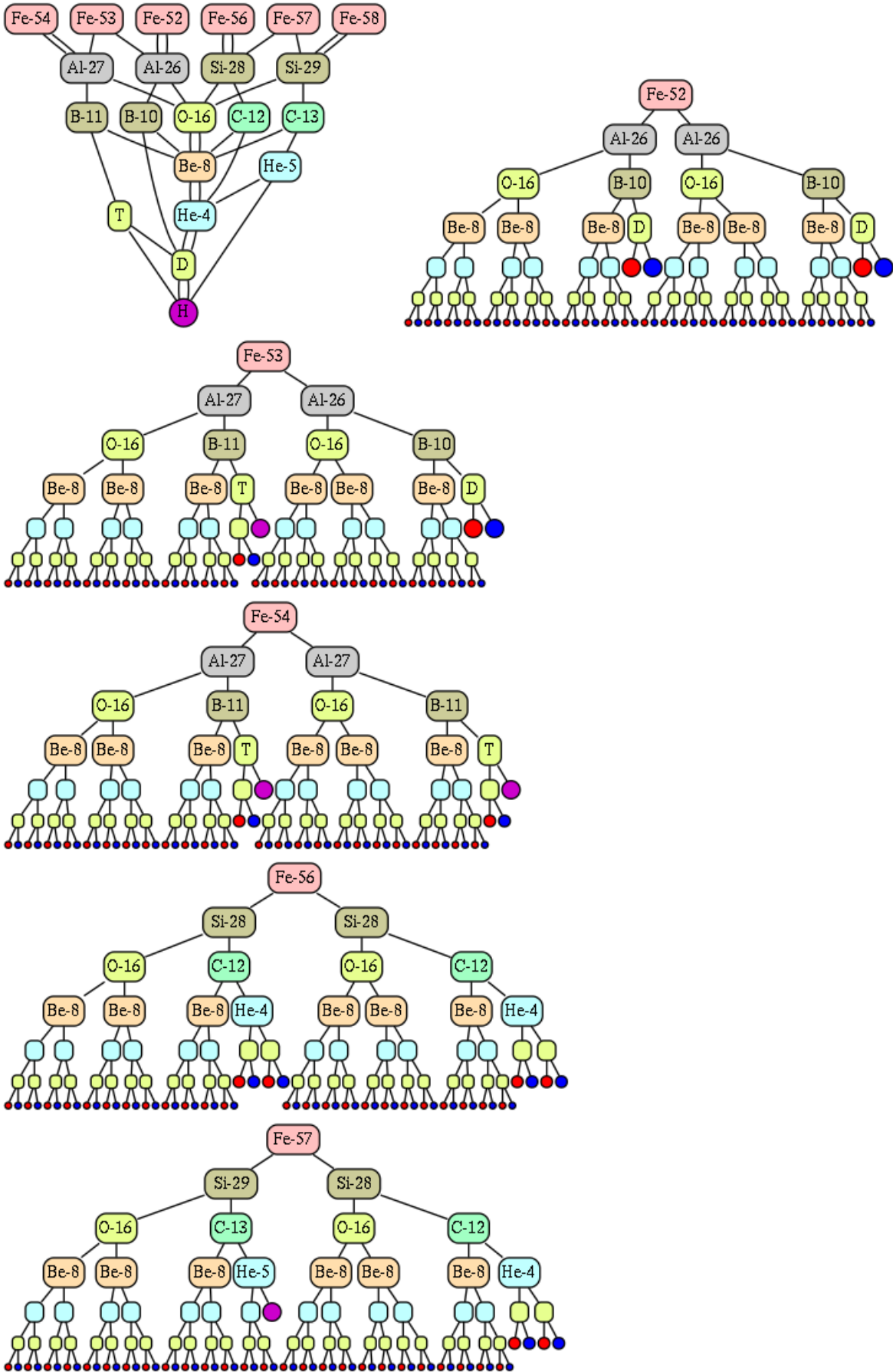

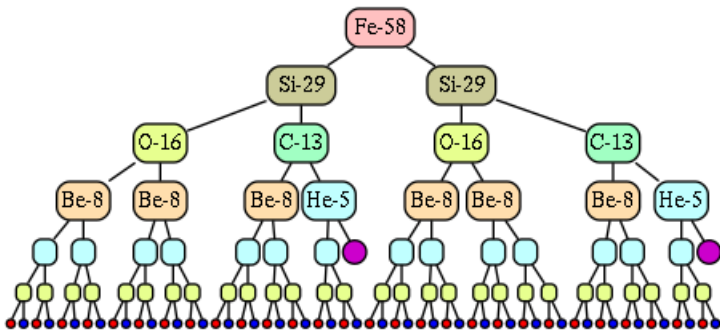

H.7.11 Cobalt

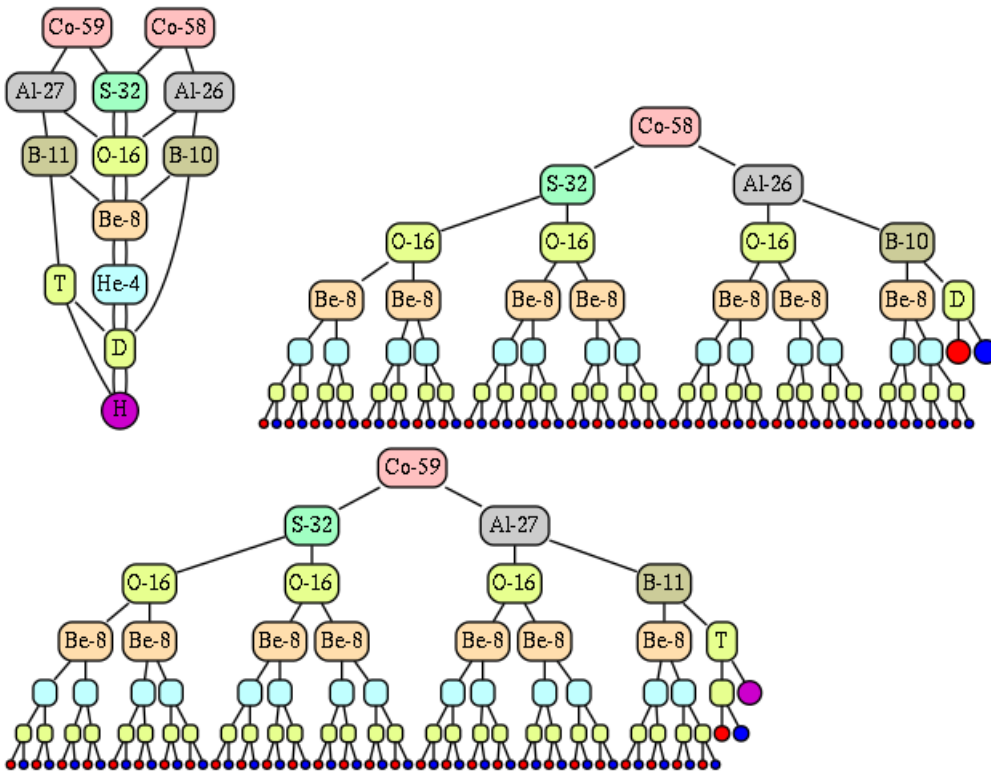

### H.7.12 Nickel

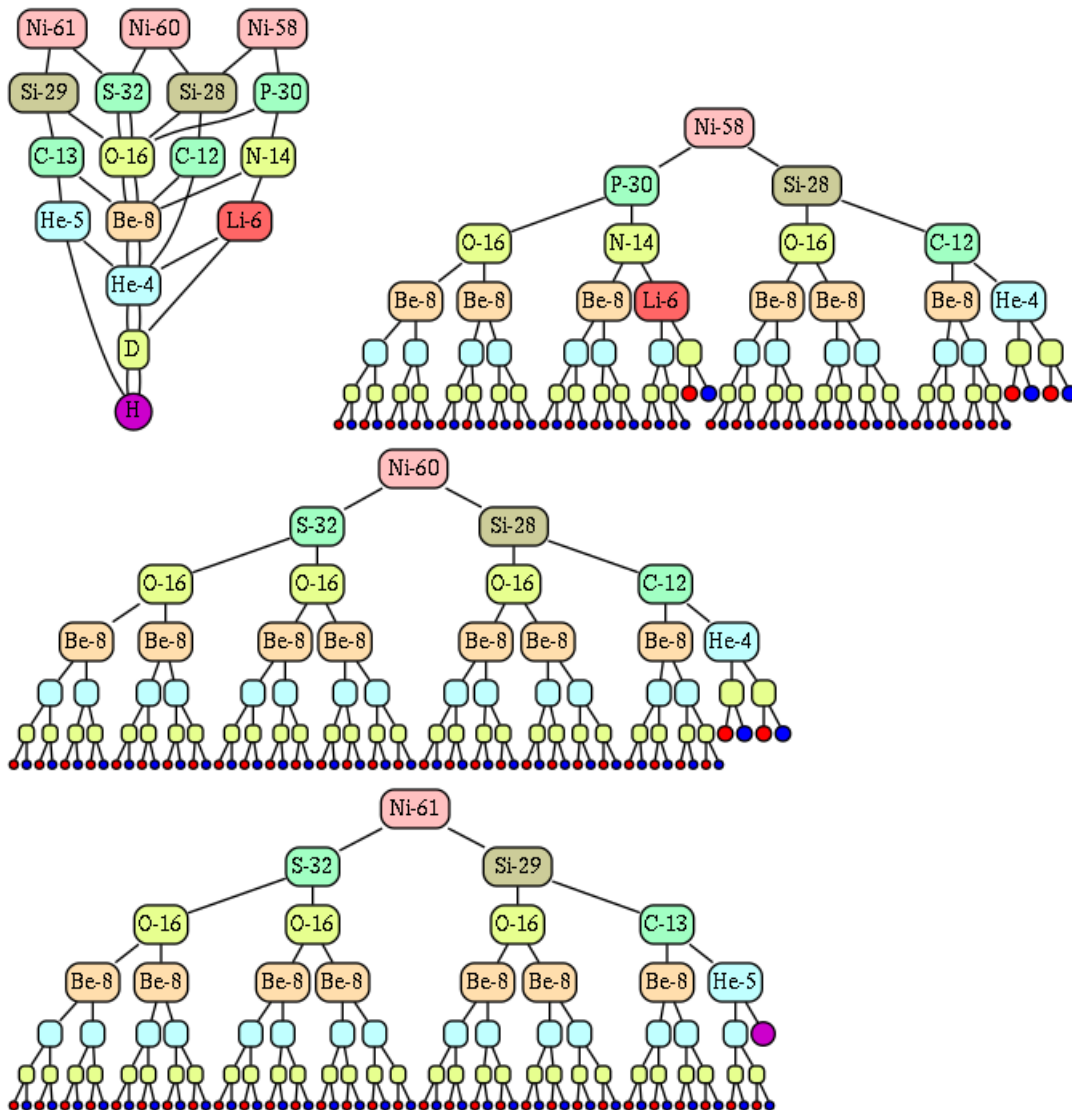

### H.7.13 Copper

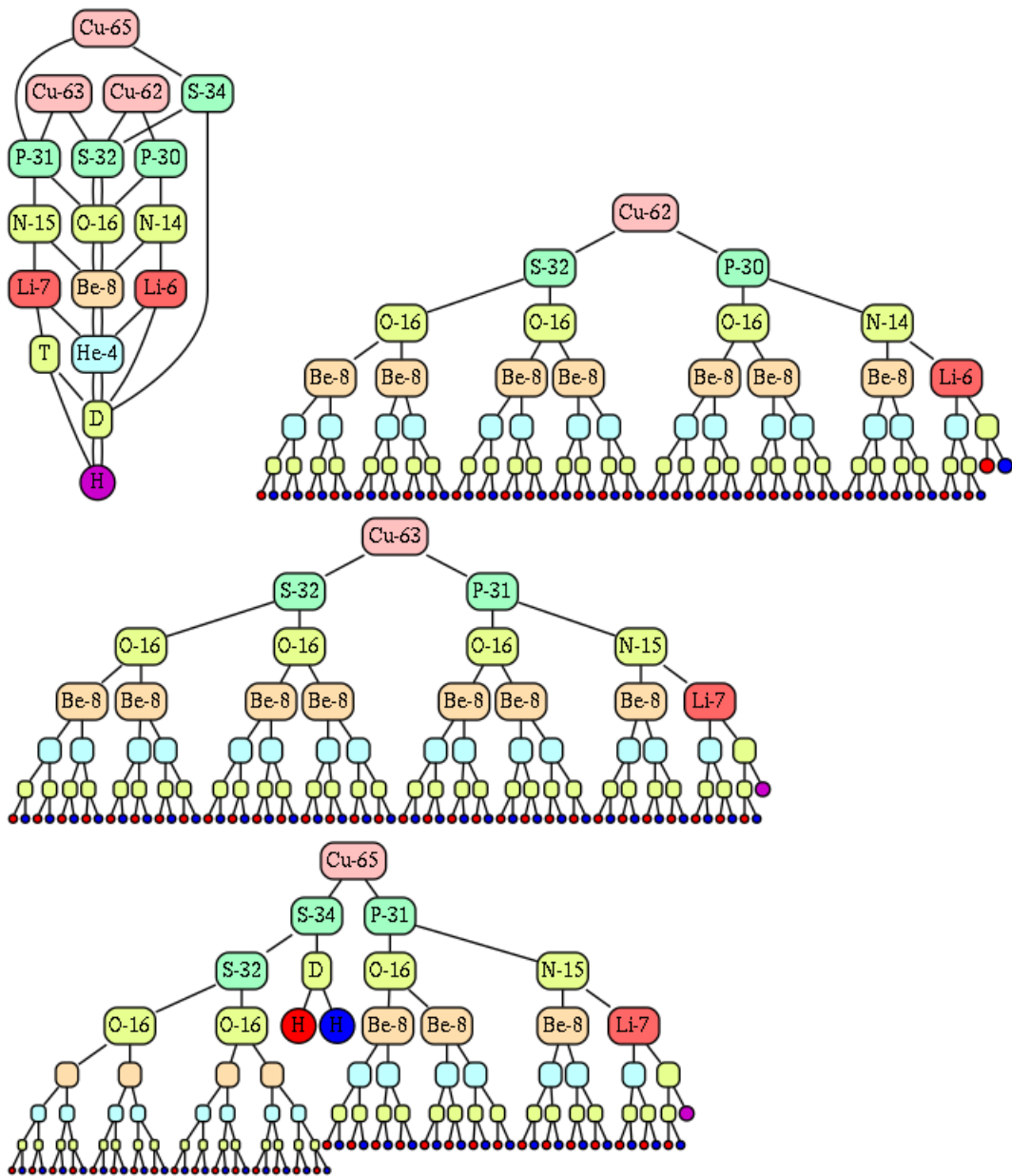



H.7.14 Zinc

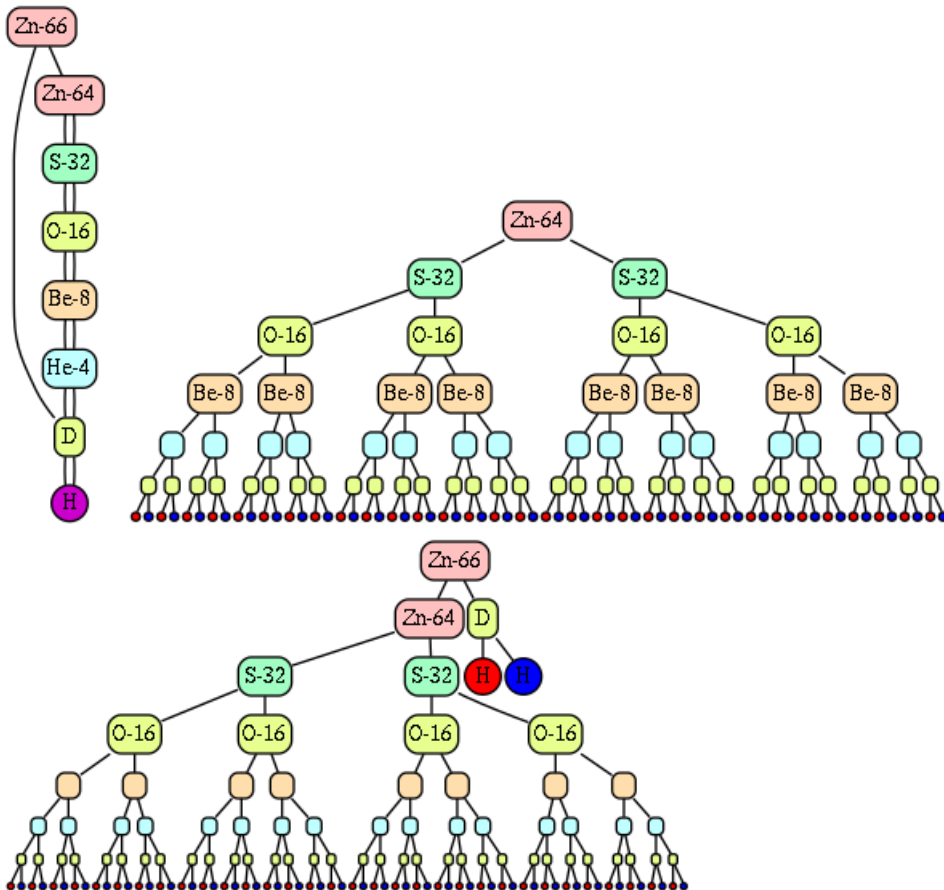

H.8 Level 8

H.8.1 Gallium

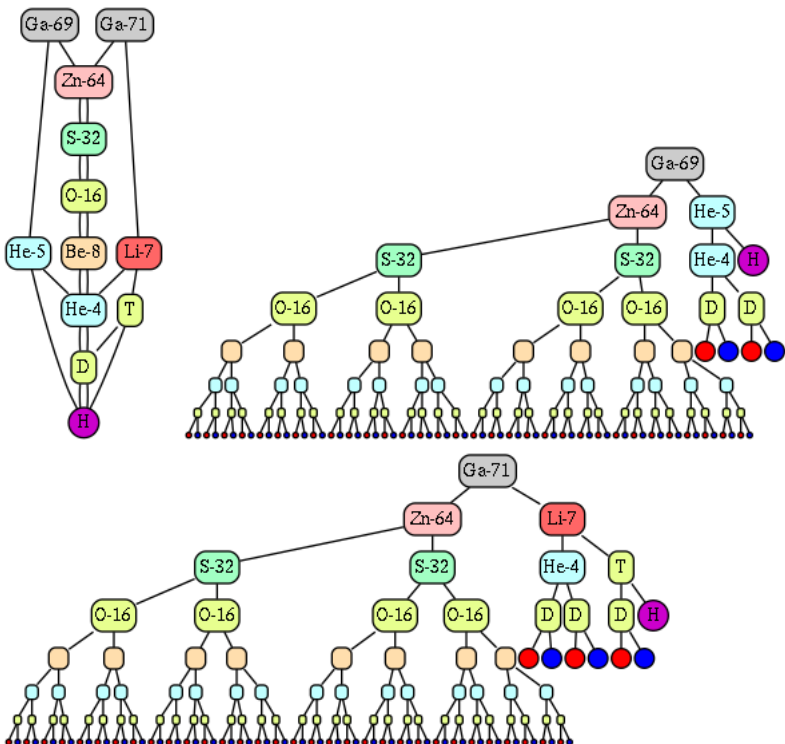

### H.8.2 Germanium

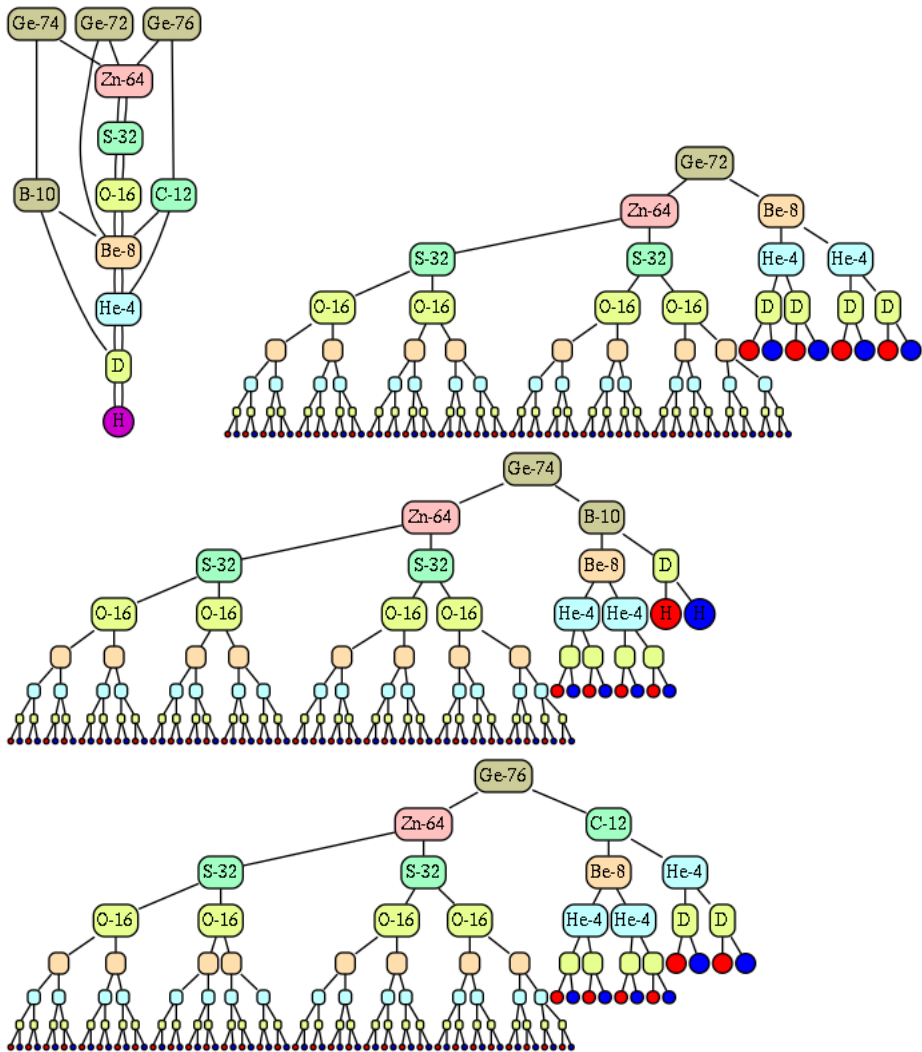

### H.8.3 Arsenic

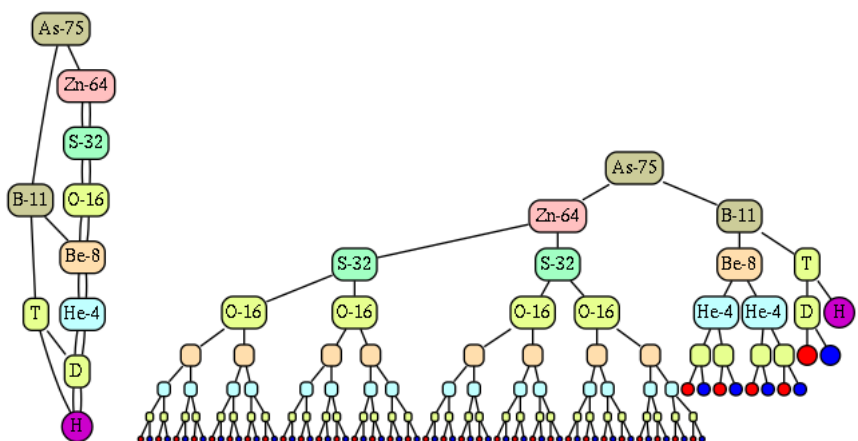

### H.8.4 Selenium

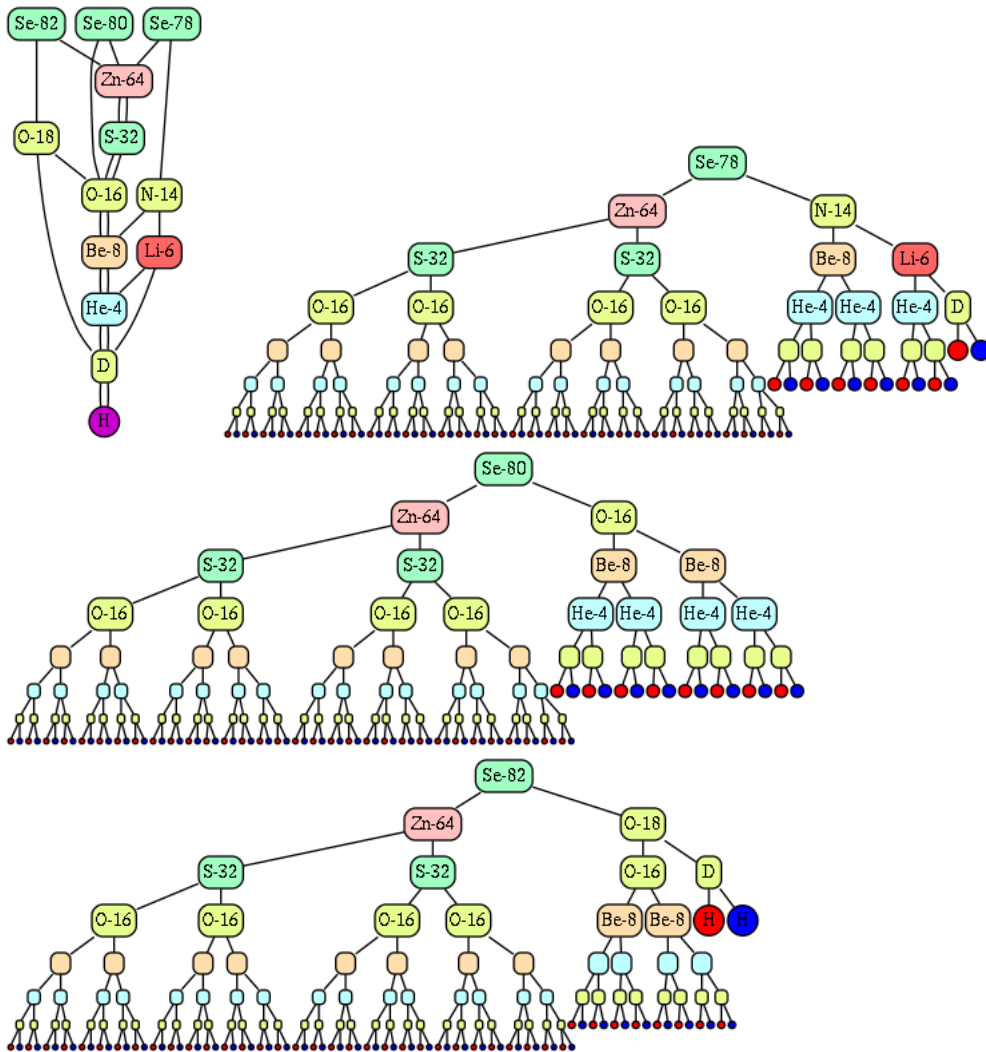

### H.8.5 Bromine

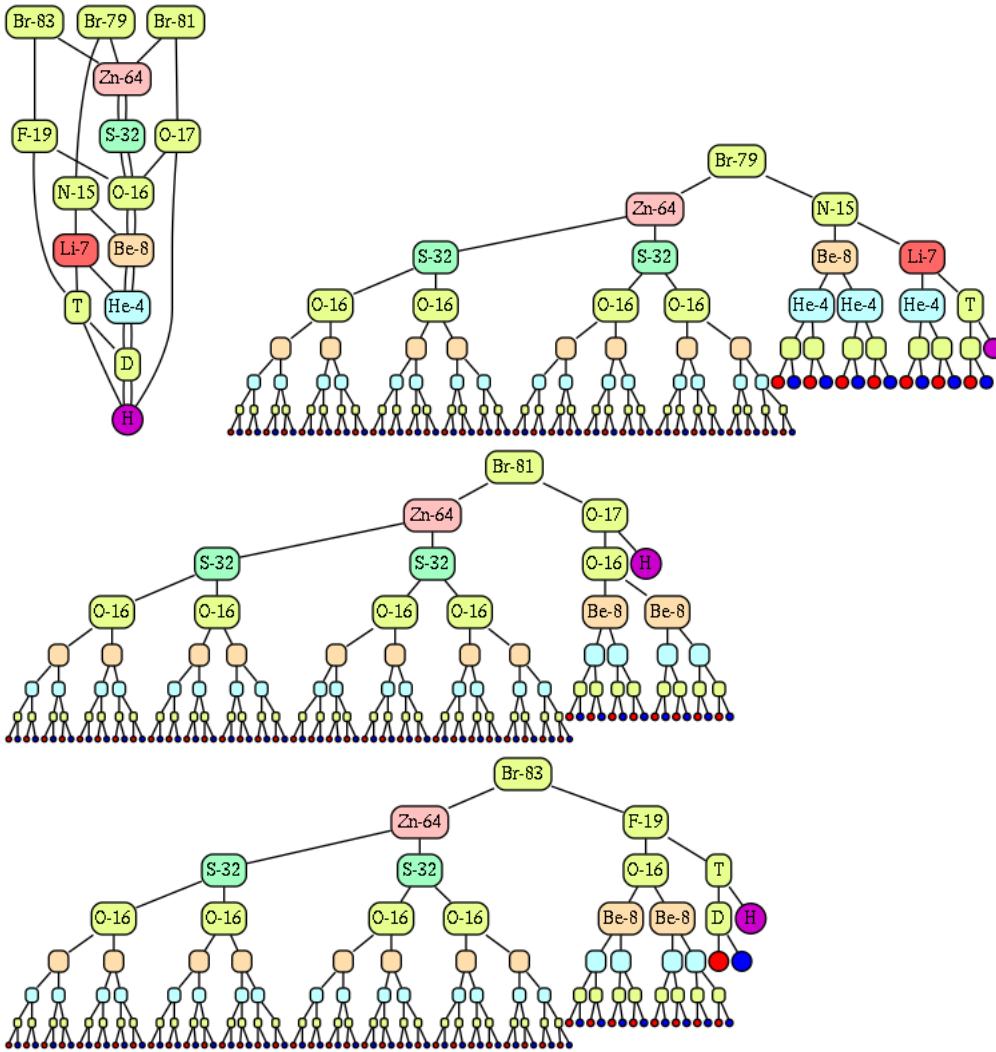

### H.8.6 Krypton

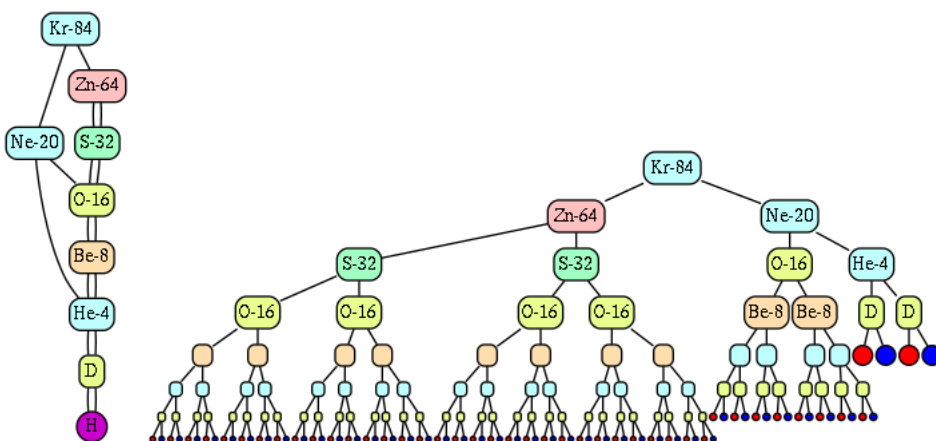

### H.8.7 Rubidium

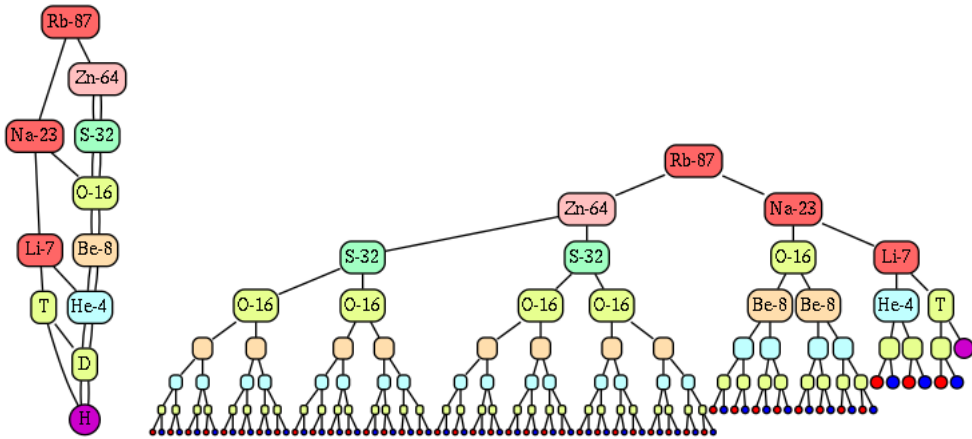

### H.8.8 Strontium

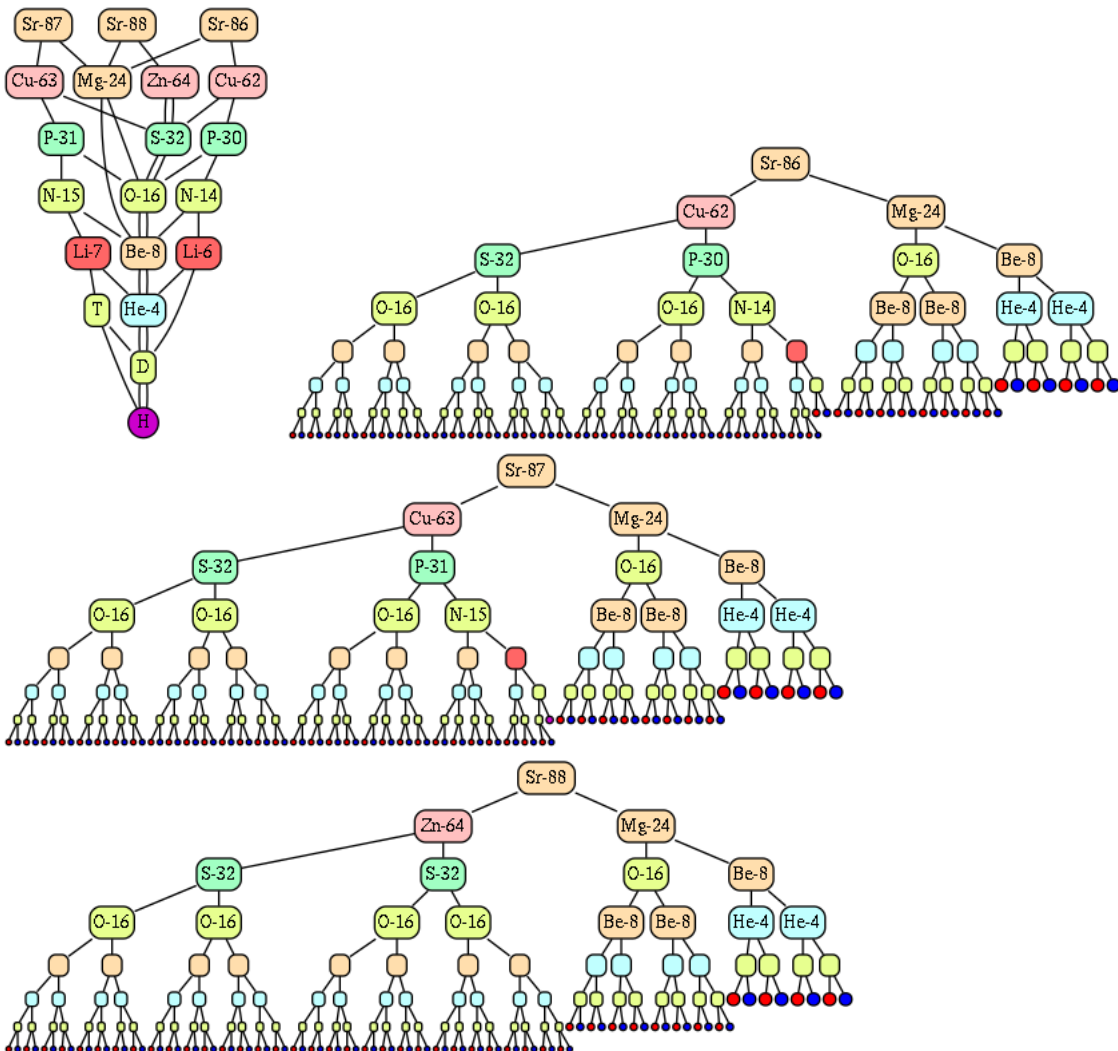

### H.8.9 Yttrium

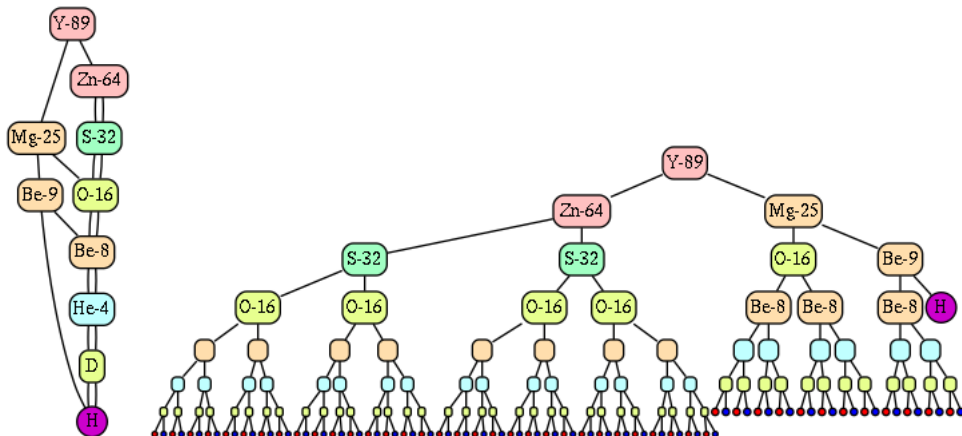

### H.8.10 Zirconium

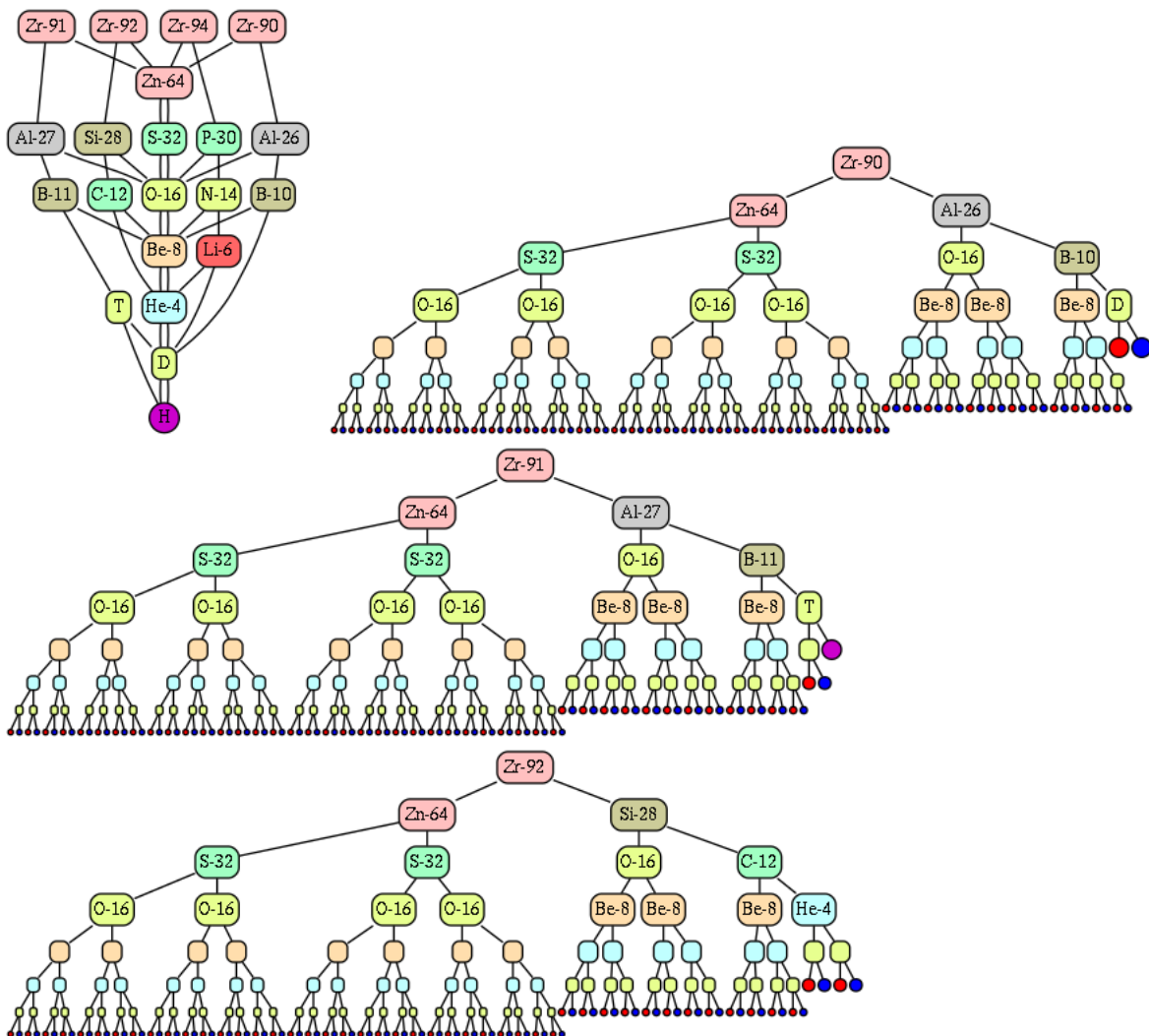

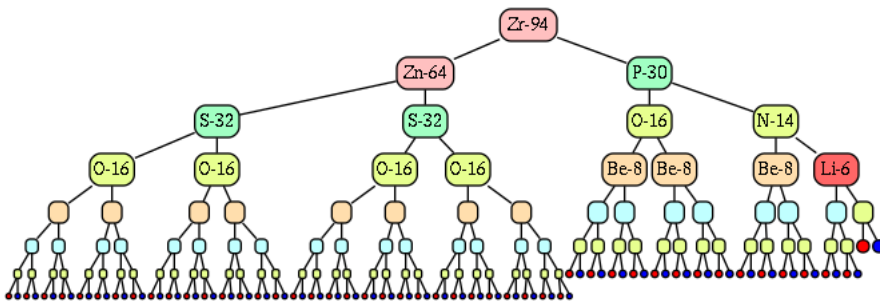

H.8.11 Niobium

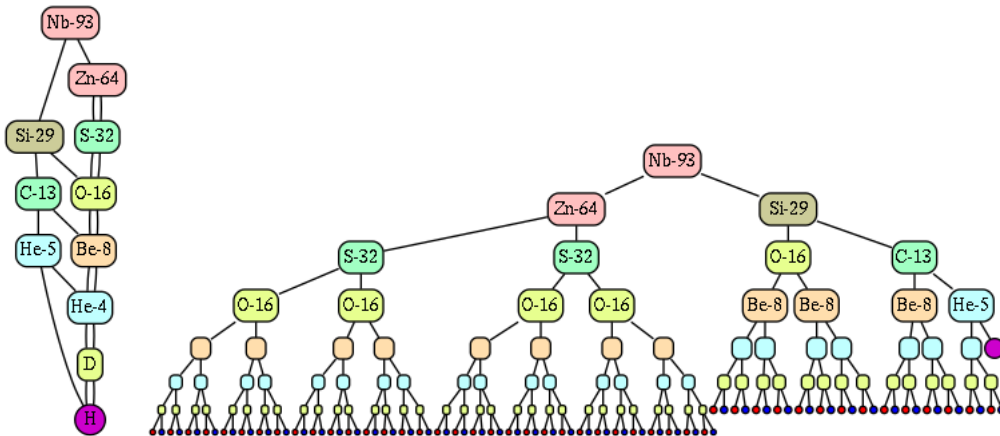

H.8.12 Molybdenum

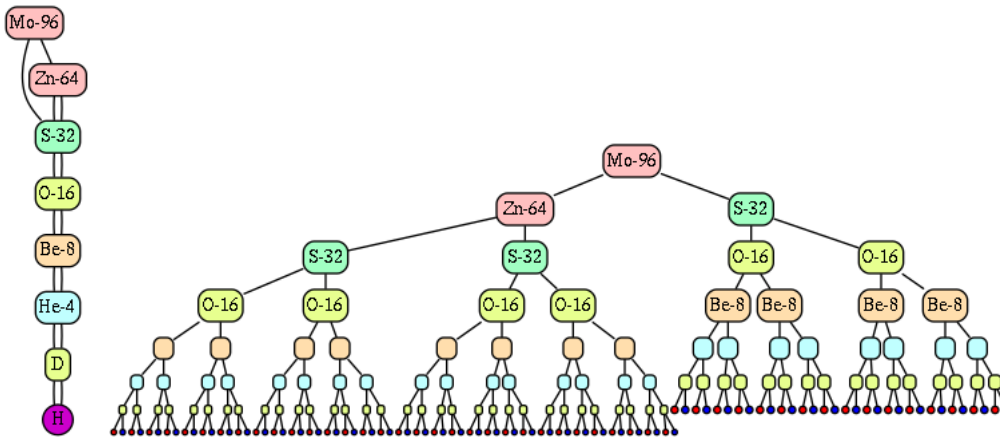

### H.8.13 Technetium

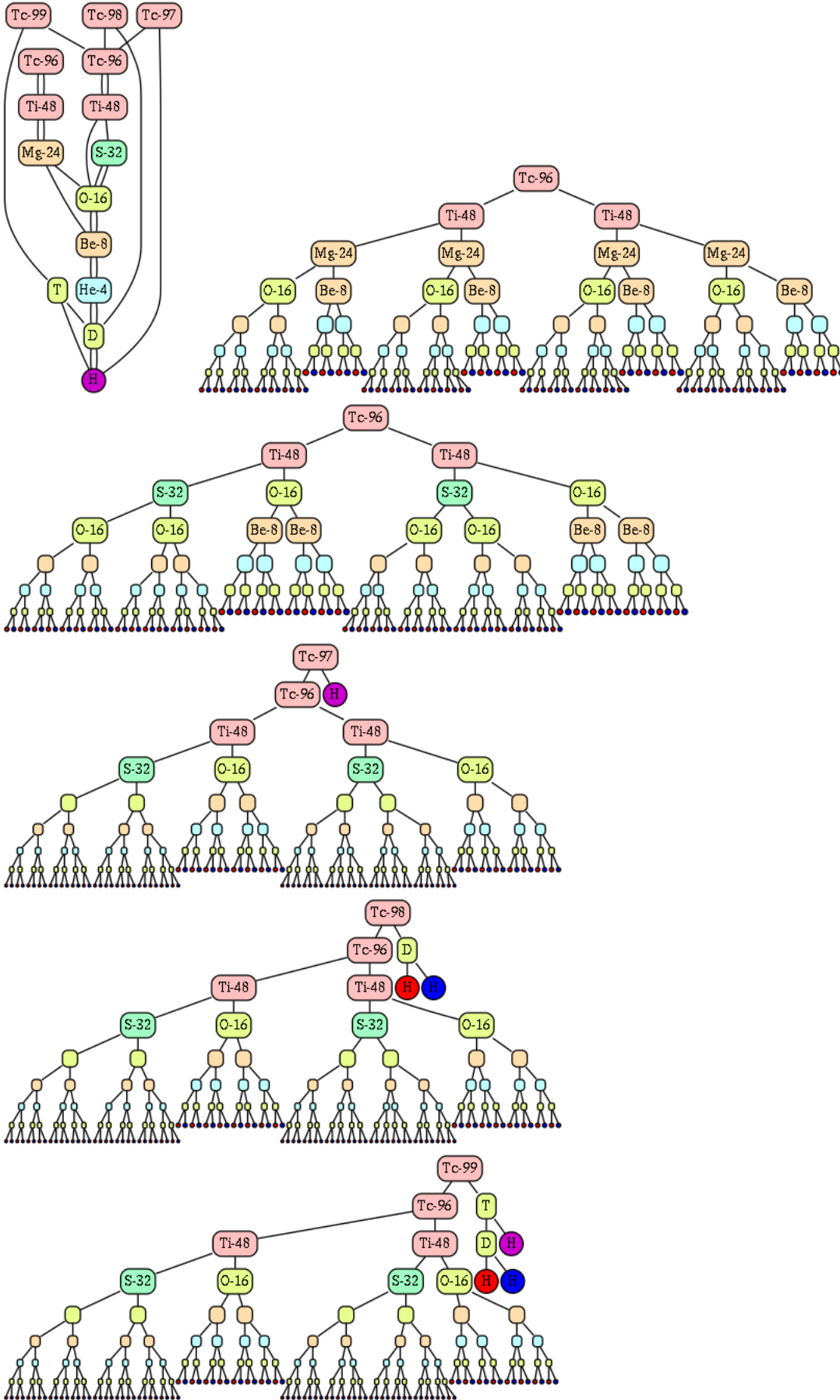



### H.8.14 Ruthenium

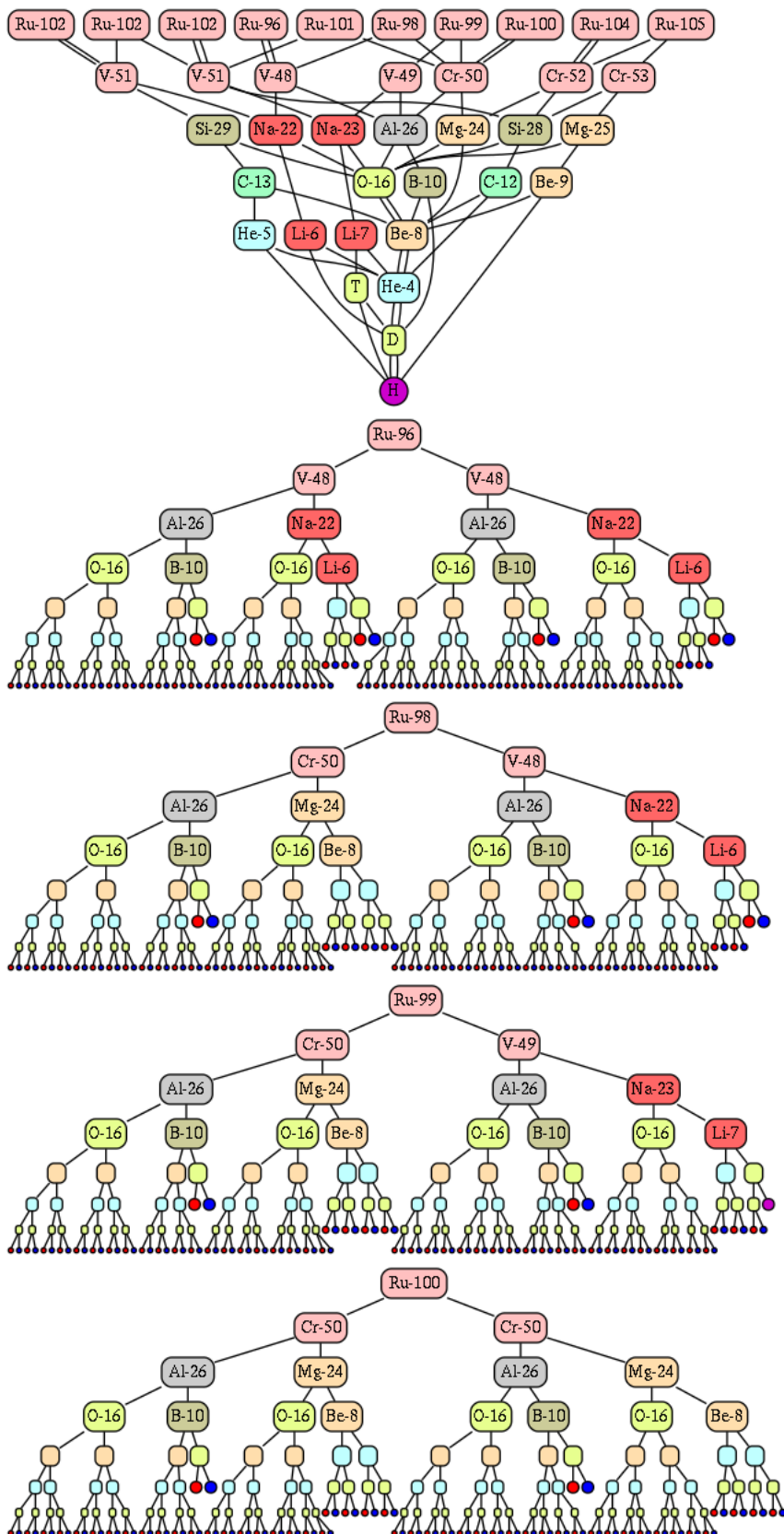

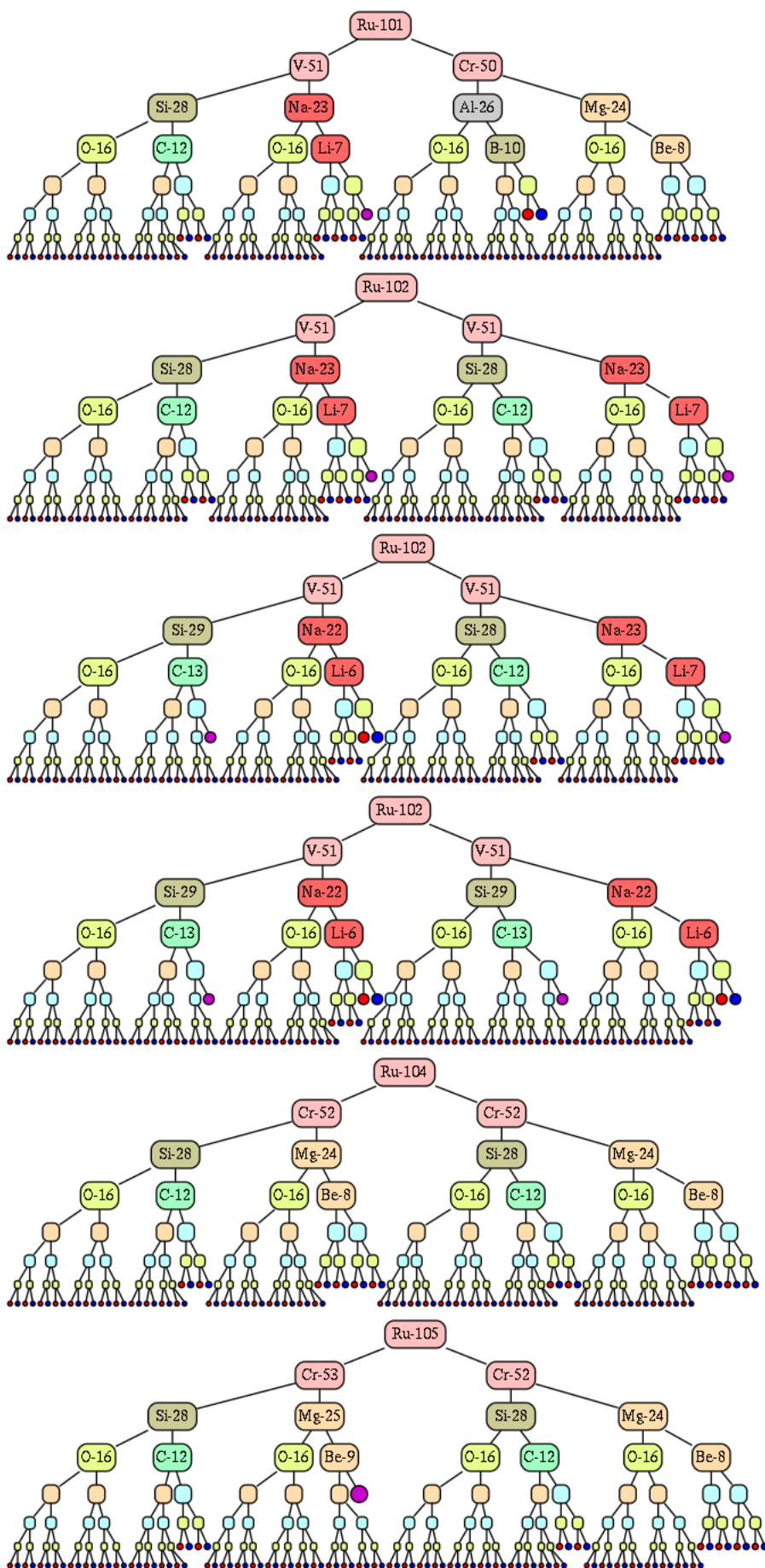

### H.8.15 Rhodium

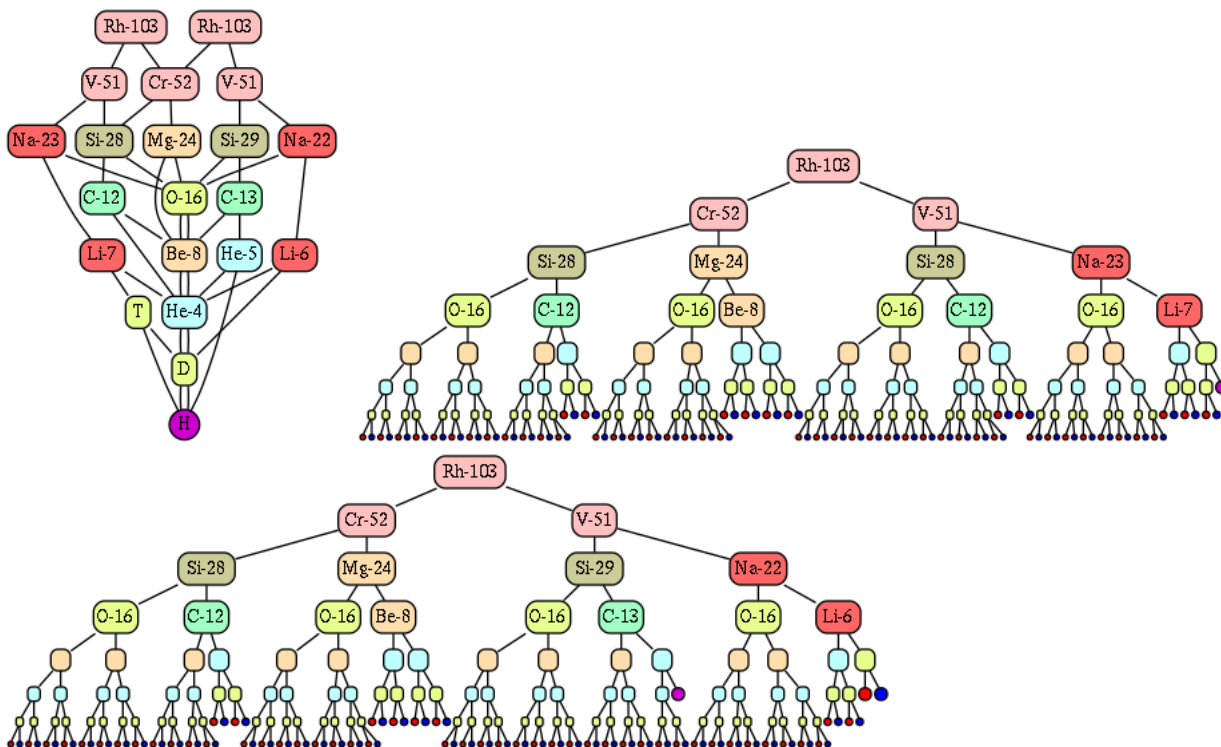

### H.8.16 Palladium

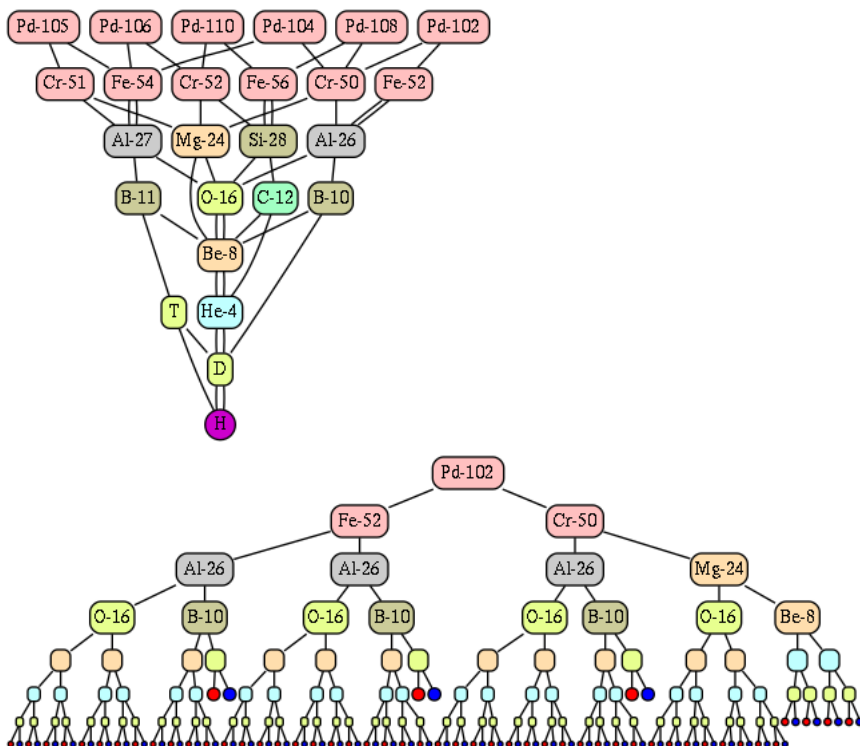

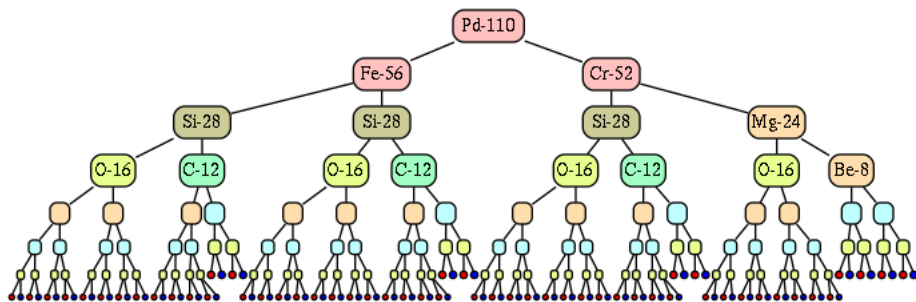
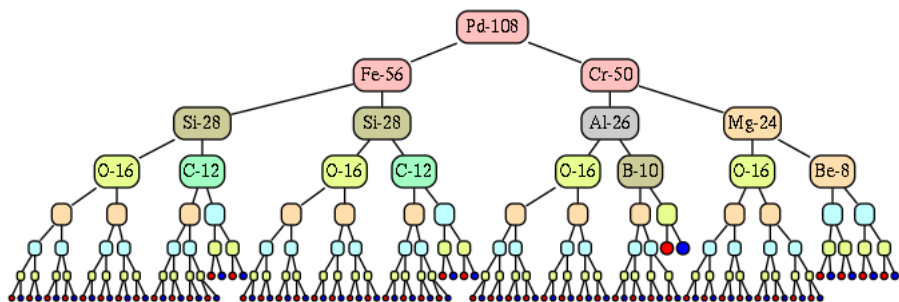
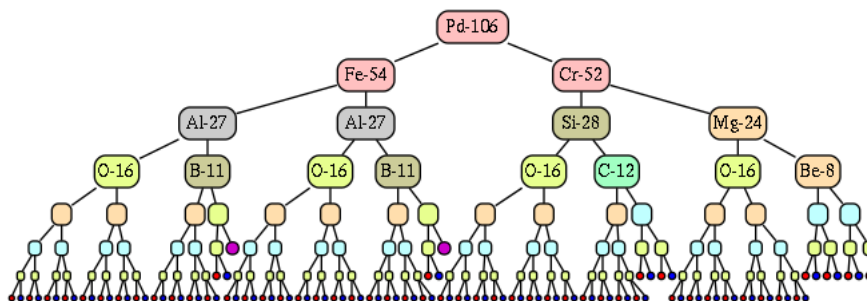
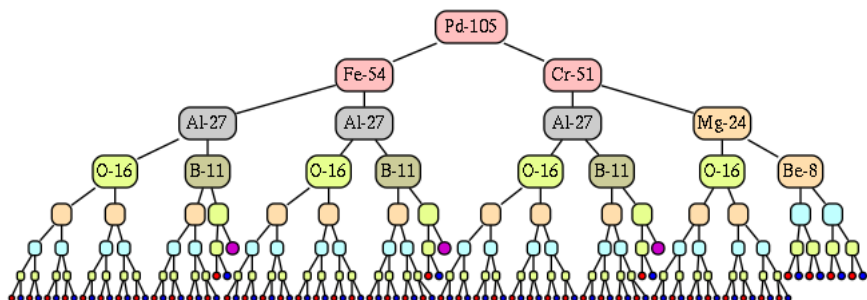
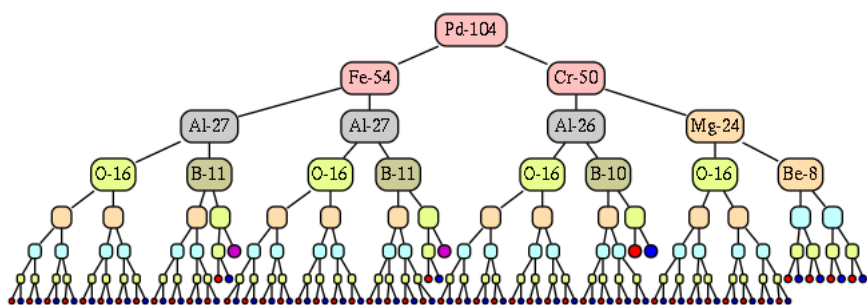

### H.8.17 Silver

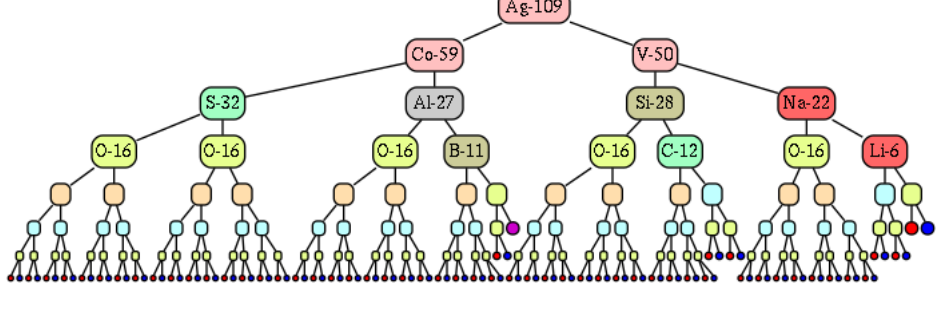
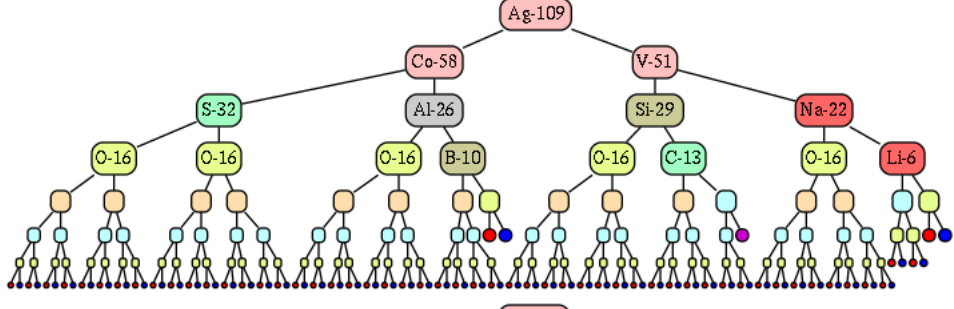
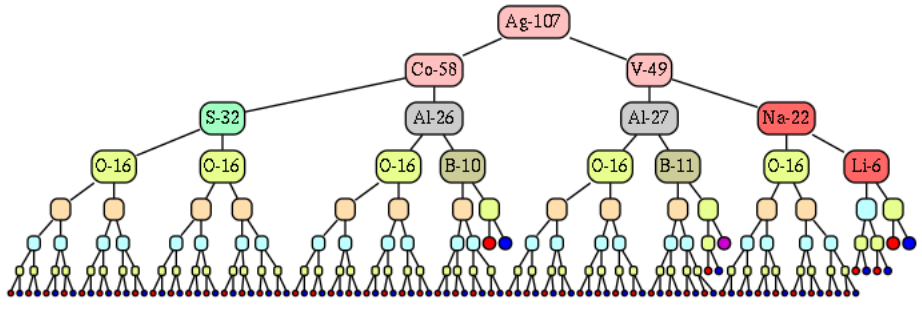
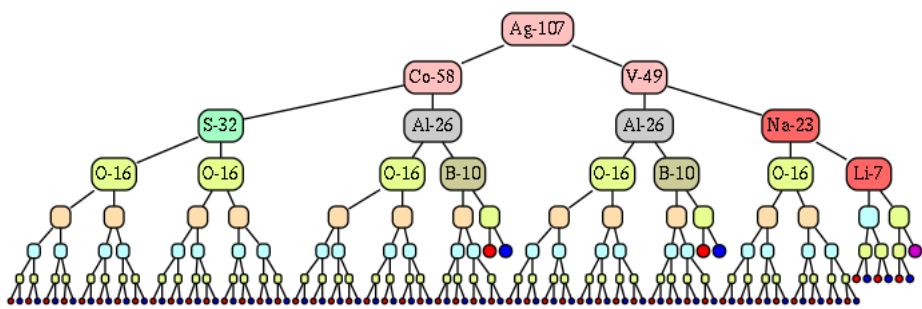
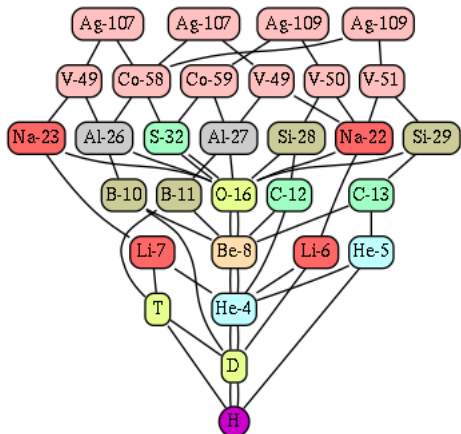

### H.8.18 Cadmium

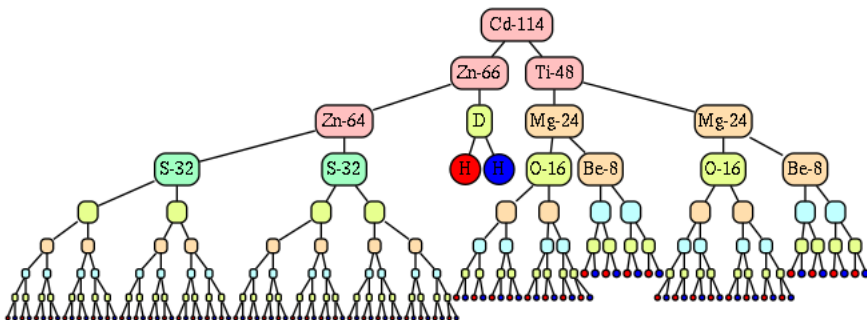
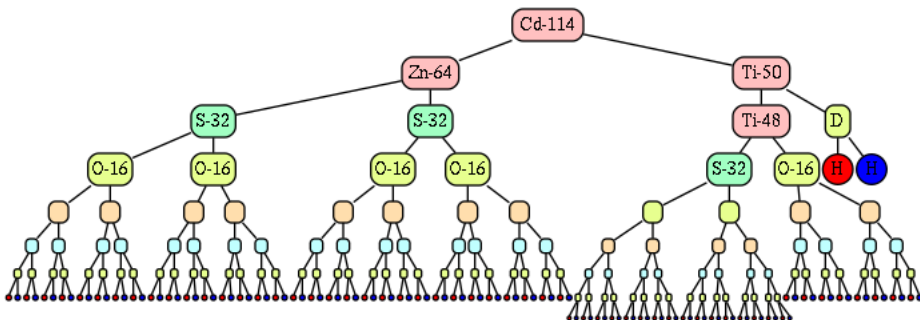
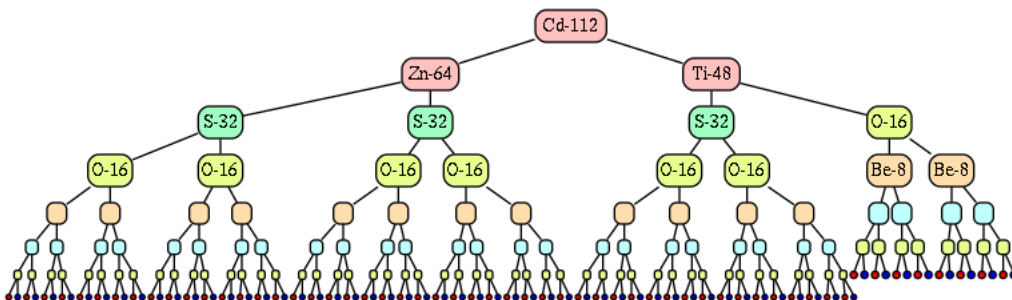
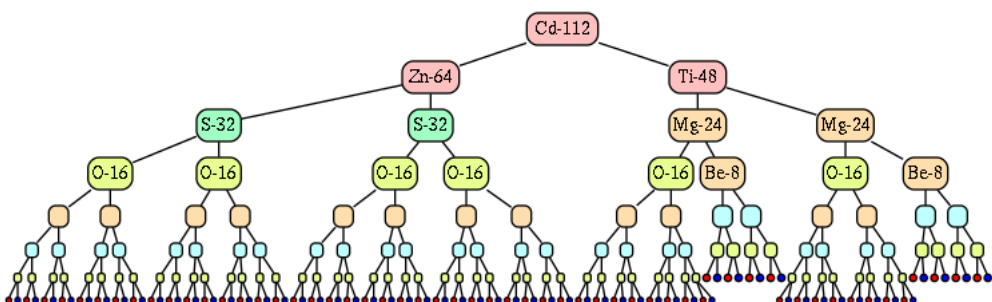
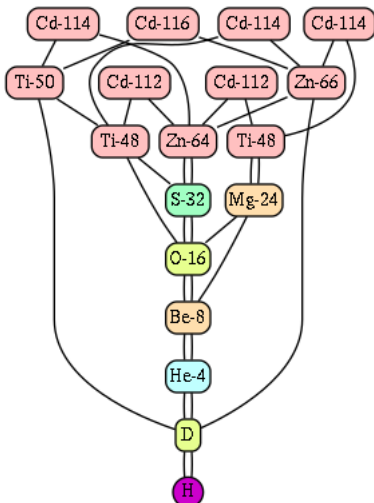

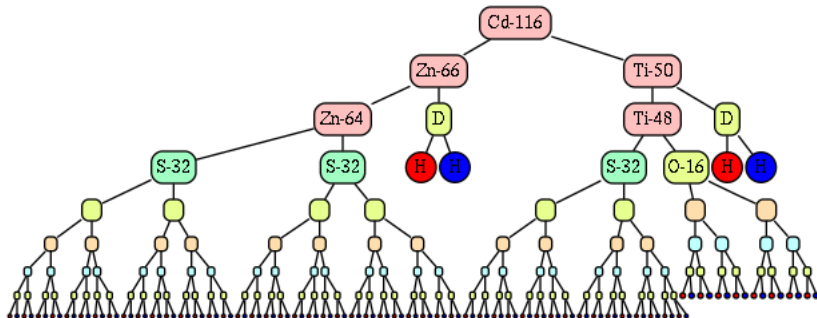
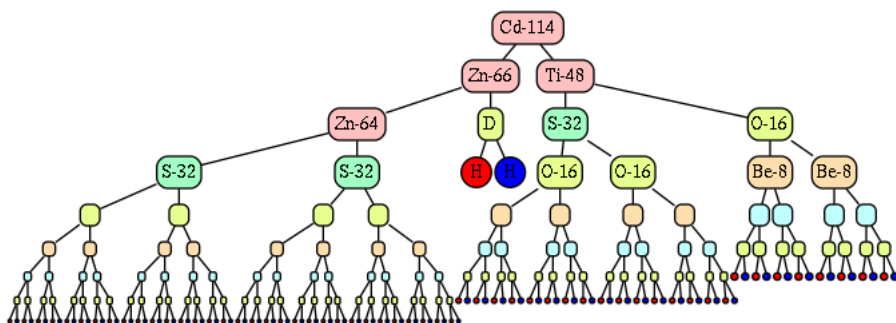

H.8.19 Indium

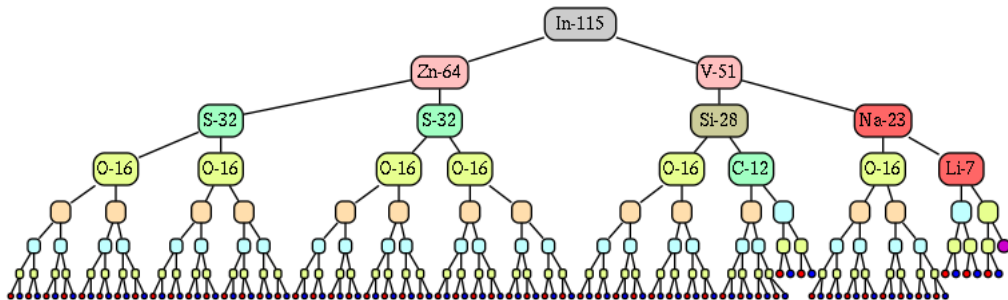
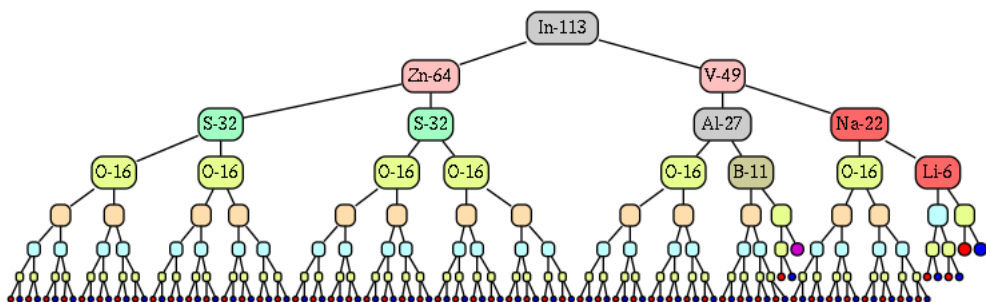
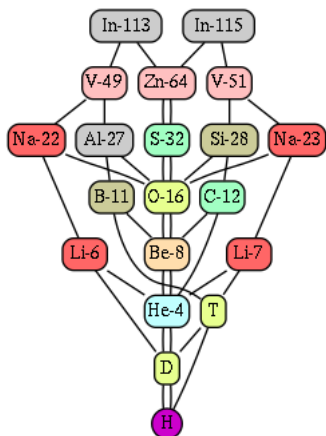

### H.8.20 Tin

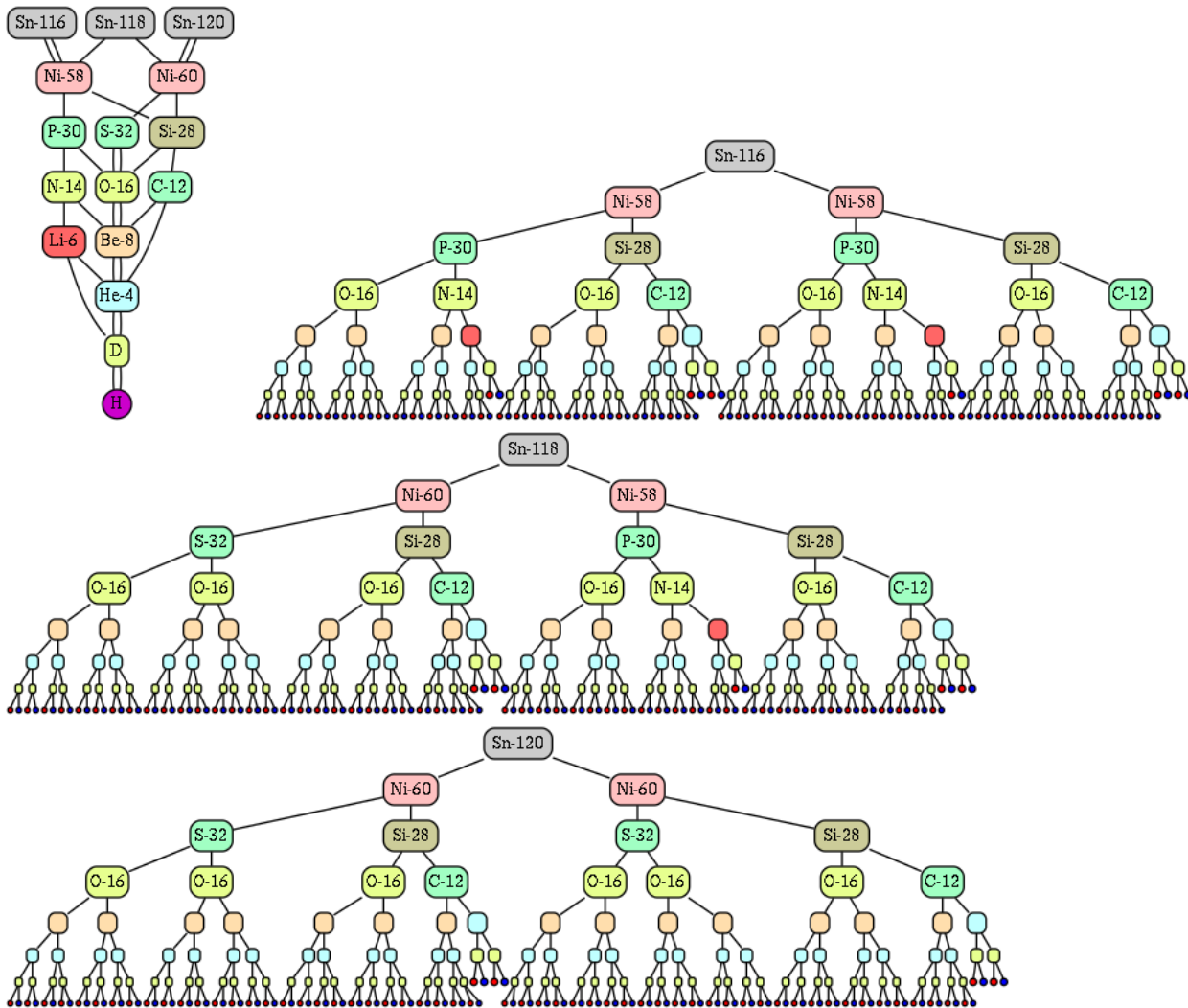



H.8.21 Antimony

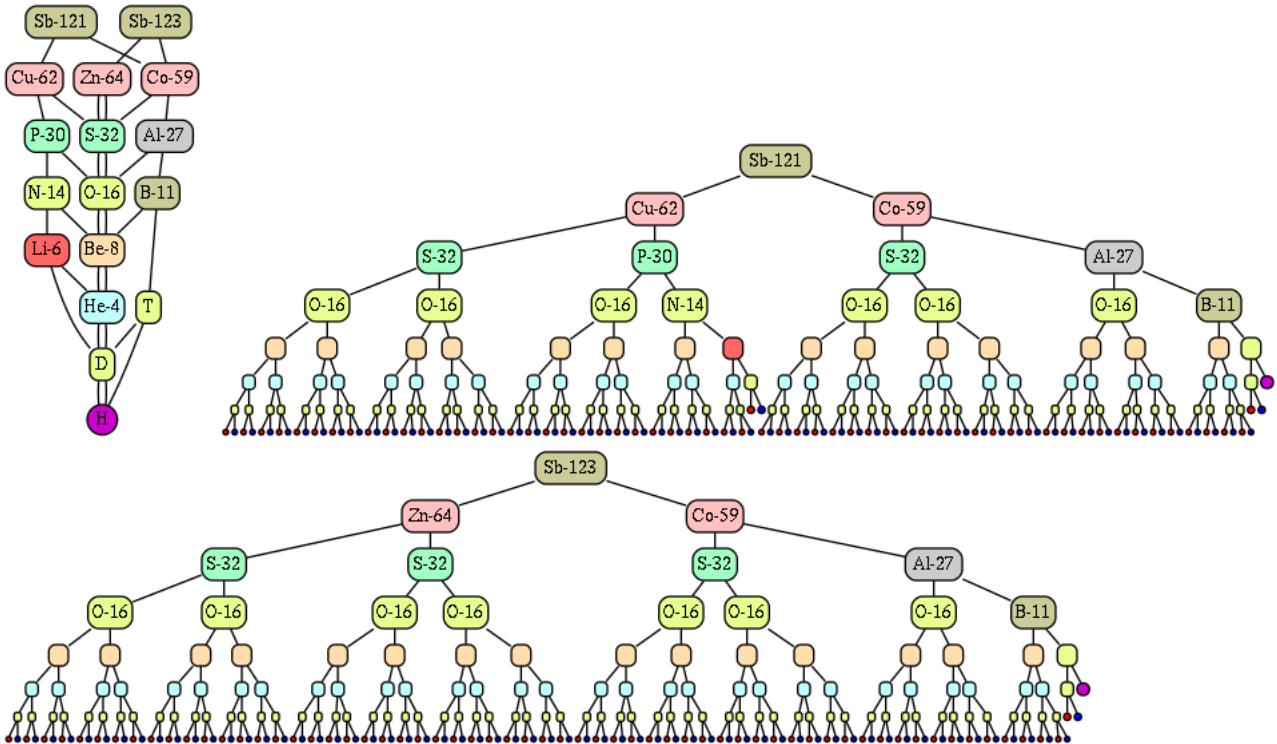

H.8.22 Tellurium

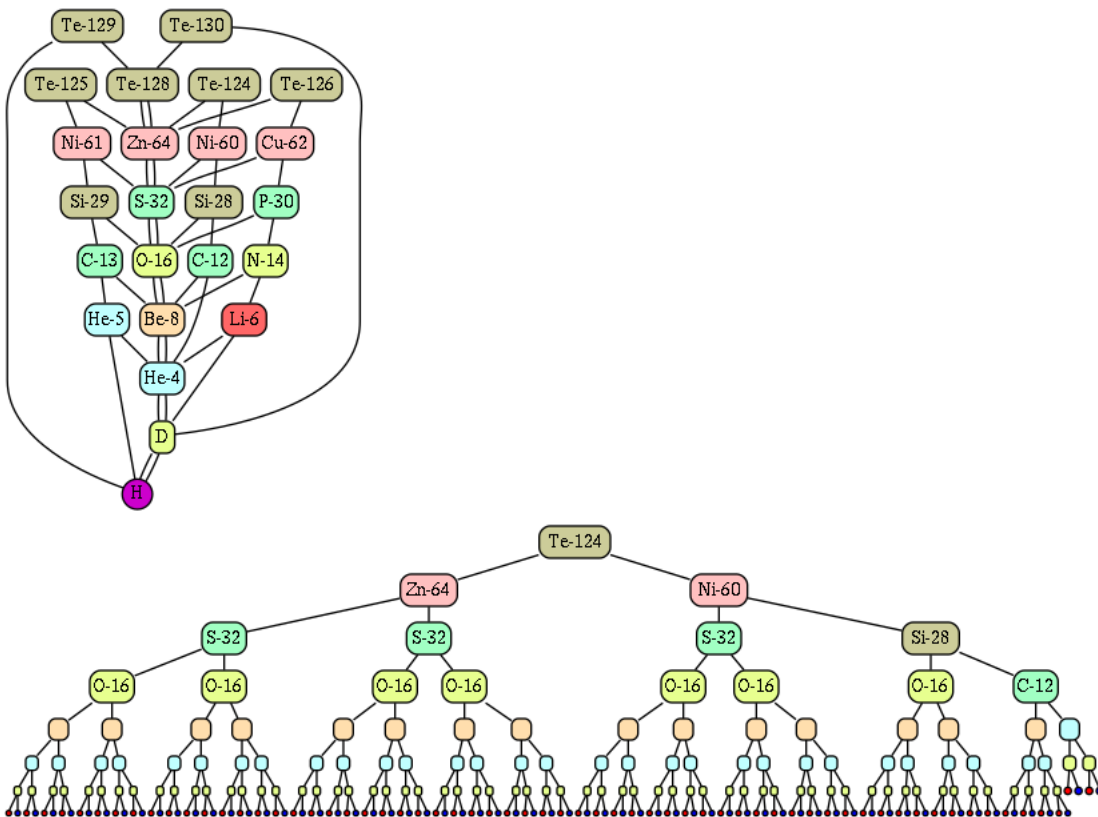

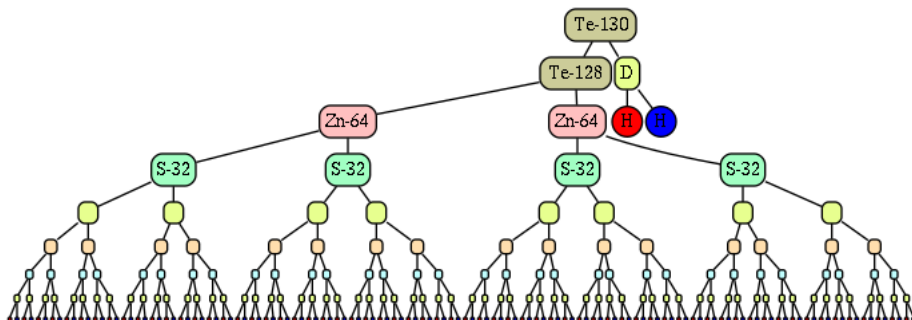
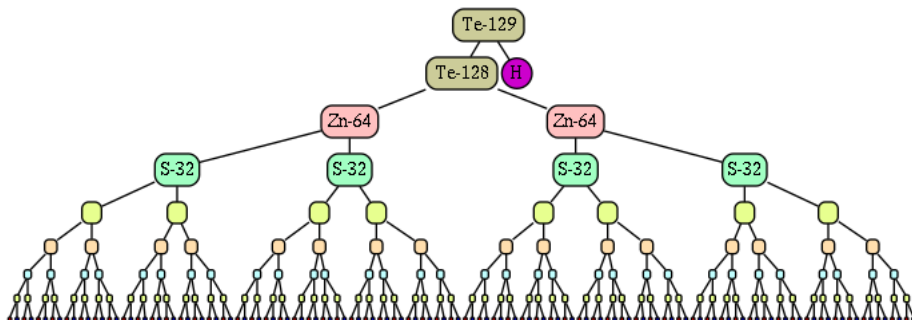
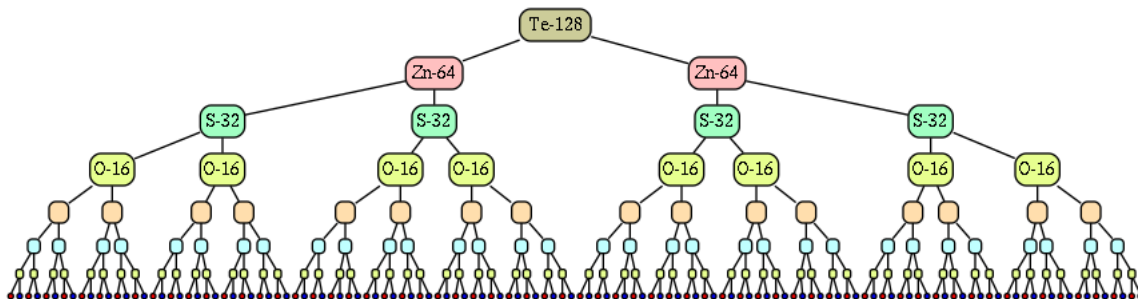
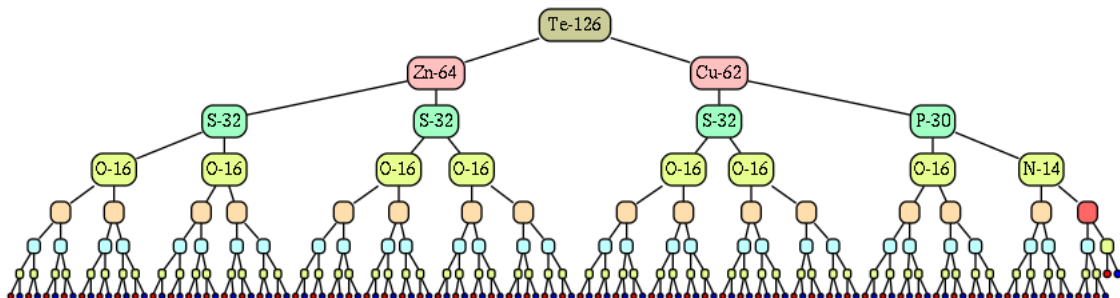
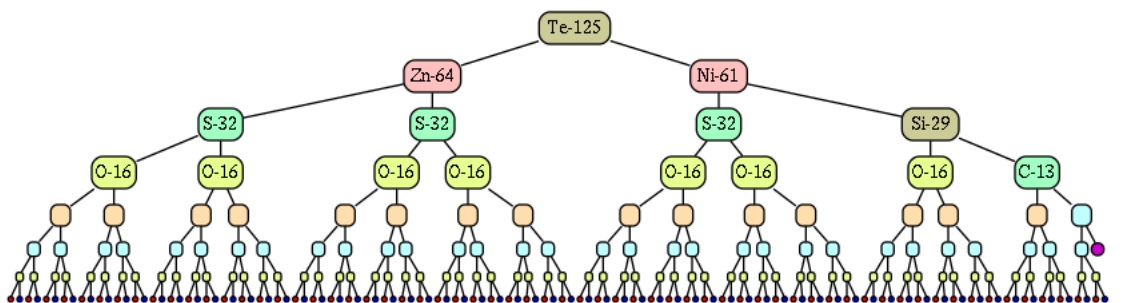

### H.8.23 Iodine

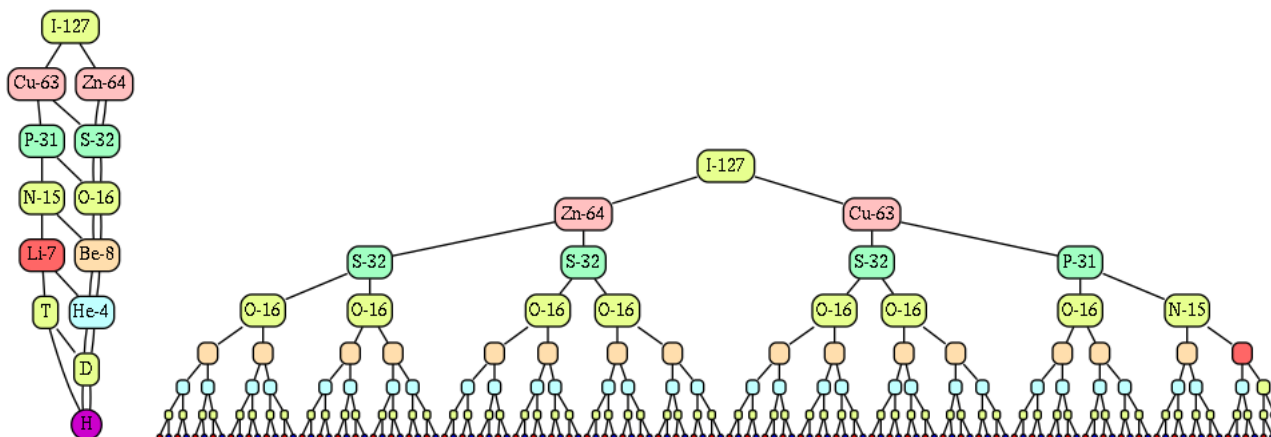

### H.8.24 Terbium

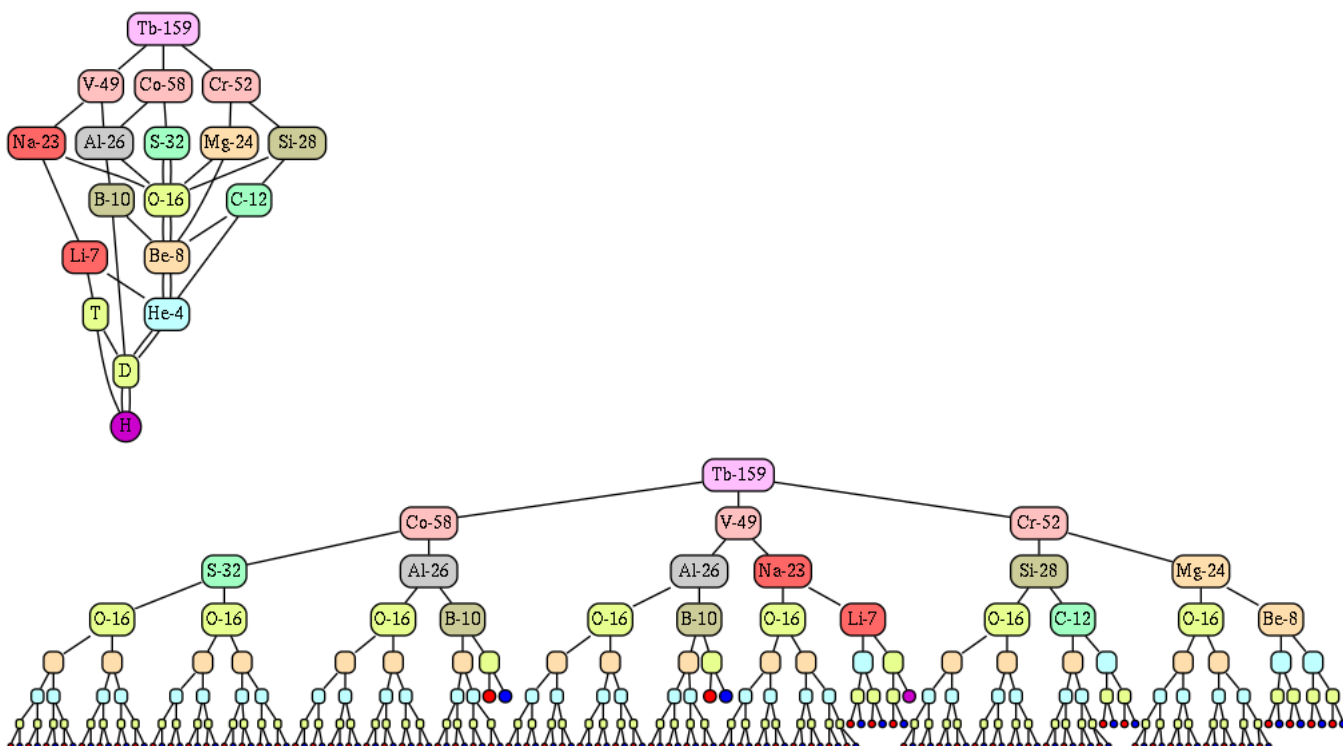

## H.9 Level 9

### H.9.1 Xenon

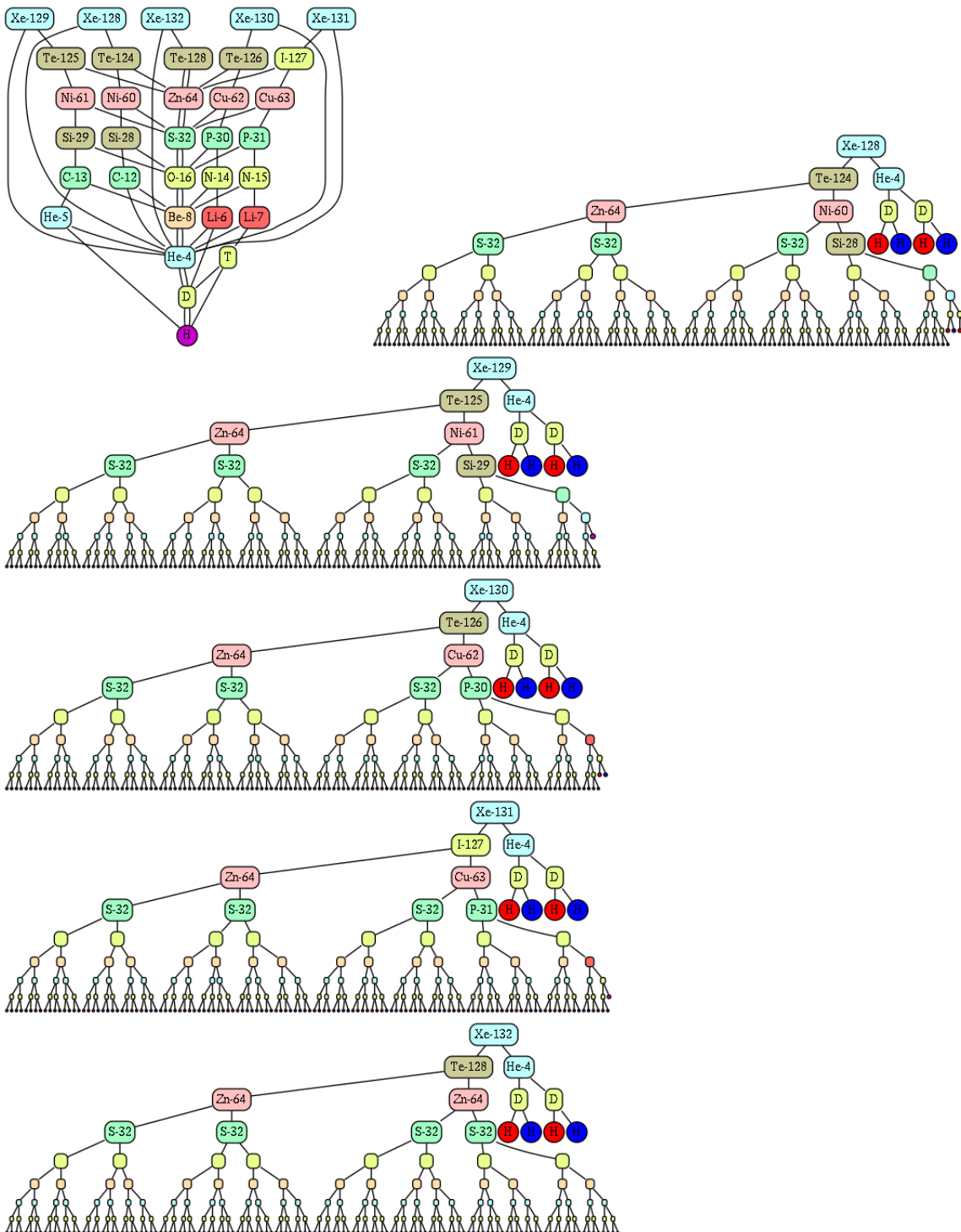

### H.9.2 Caesium

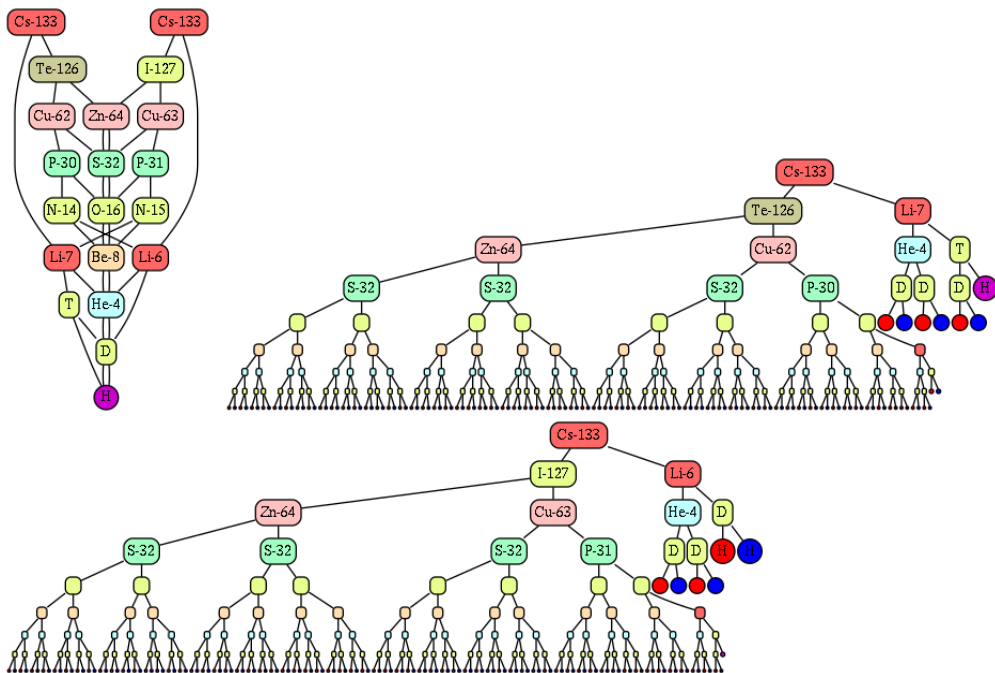

### H.9.3 Barium

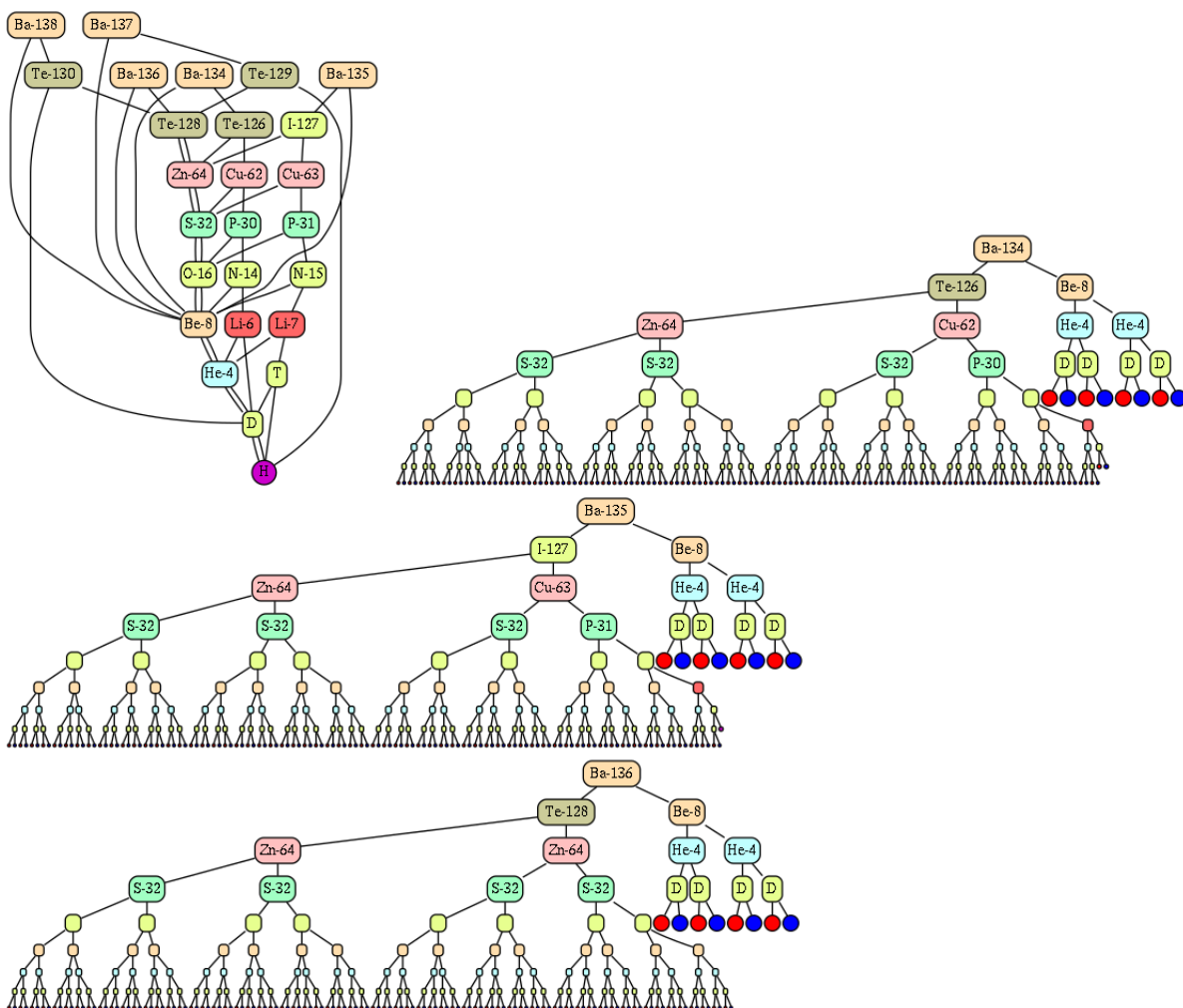

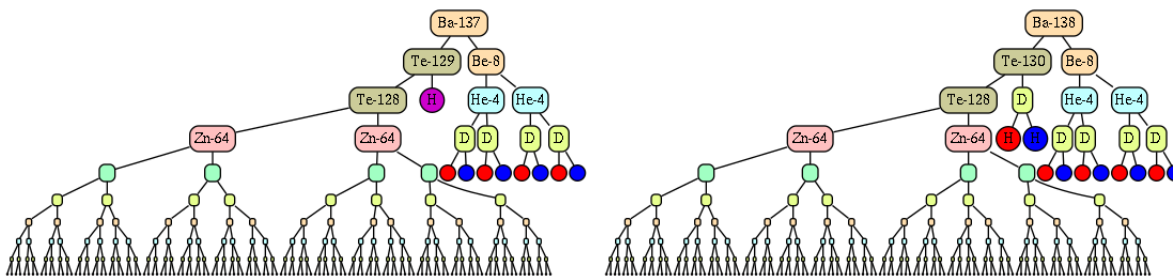

### H.9.4 Lanthanum

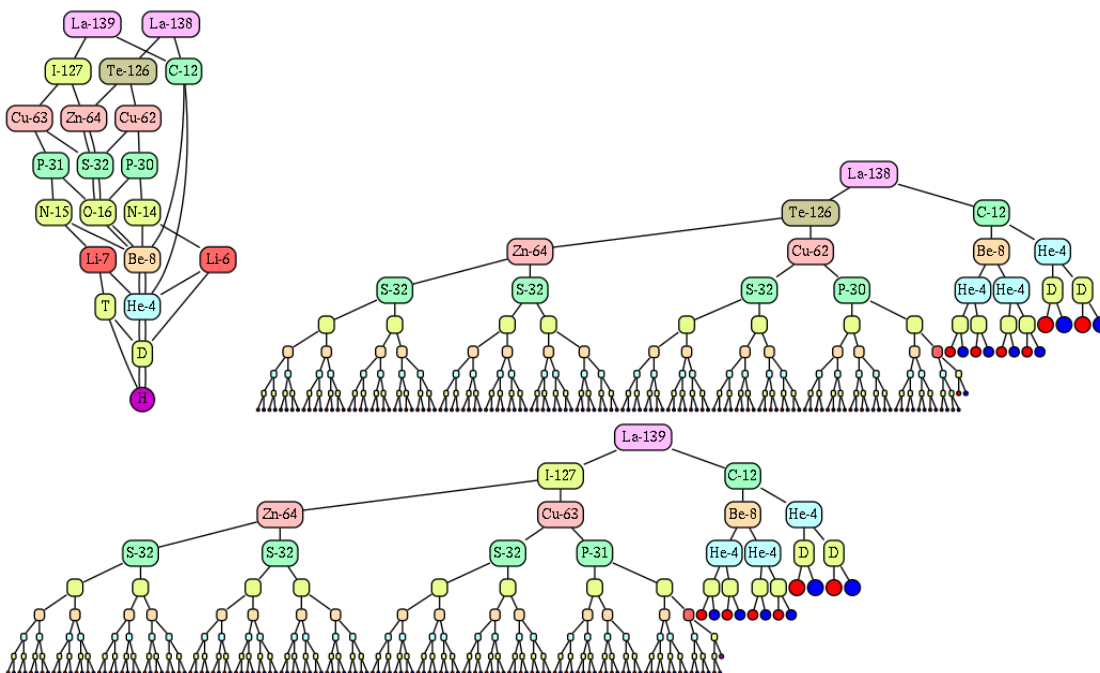

### H.9.5 Cerium

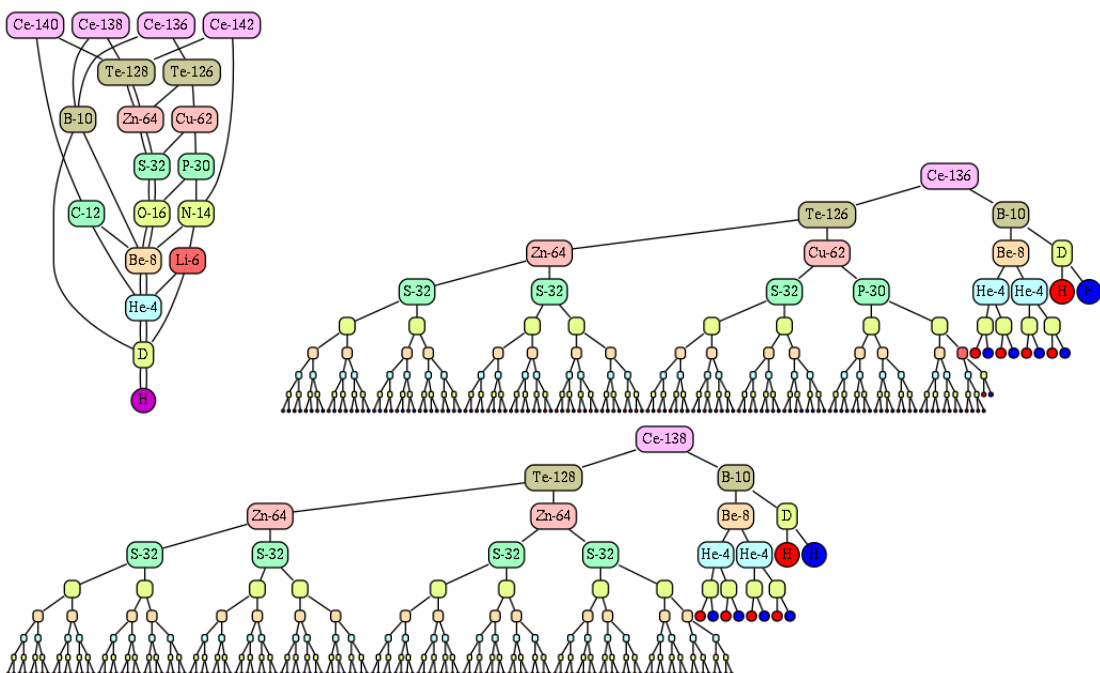

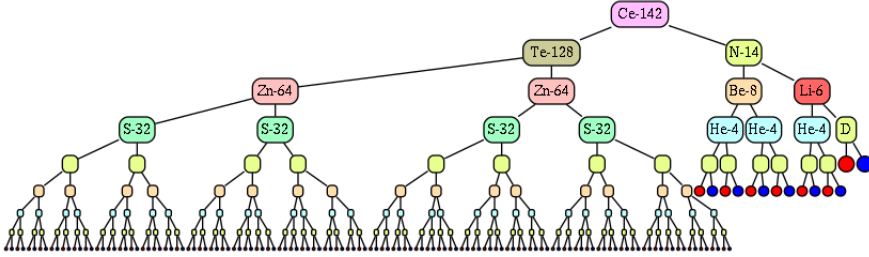
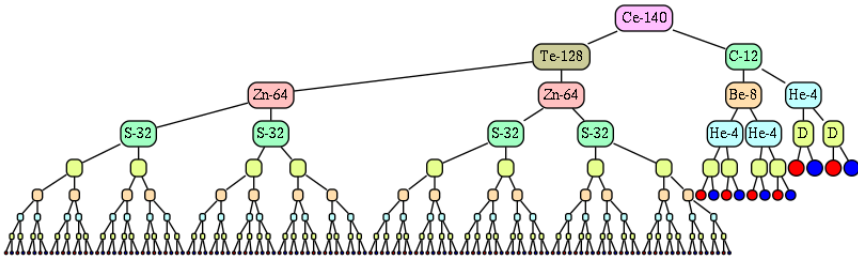

### H.9.6 Praseodymium

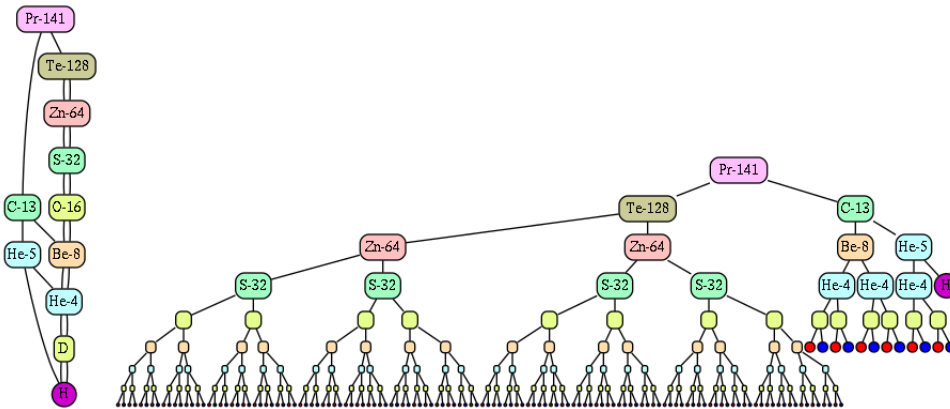

### H.9.7 Neodymium

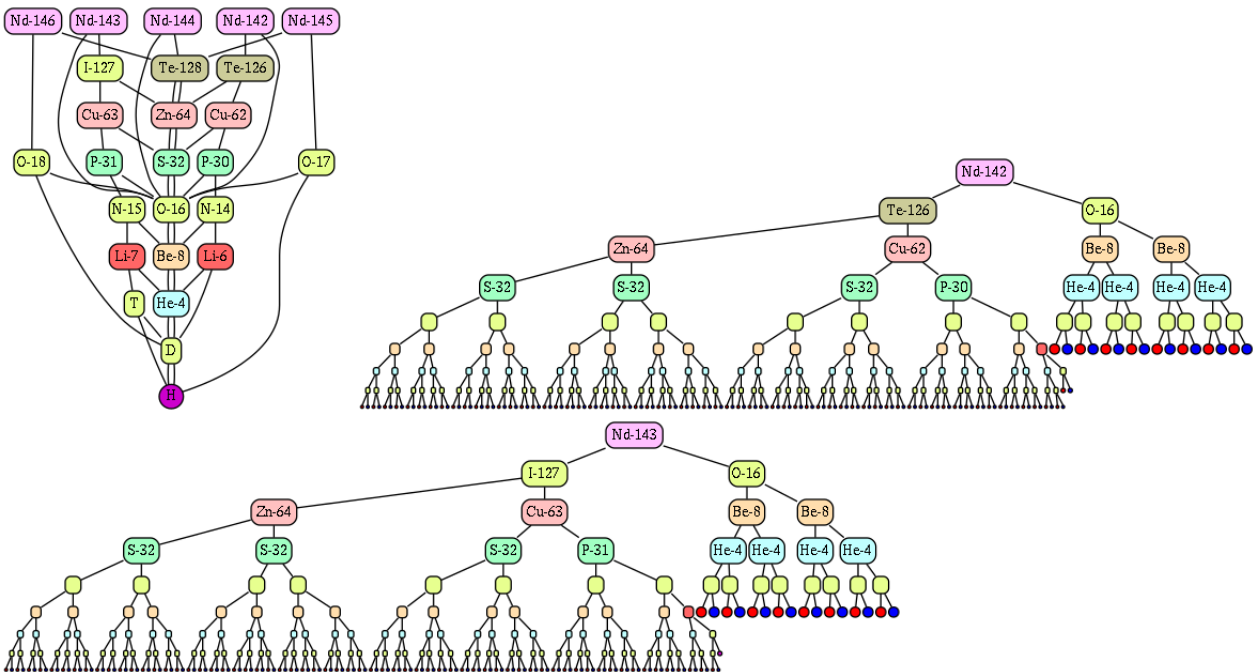

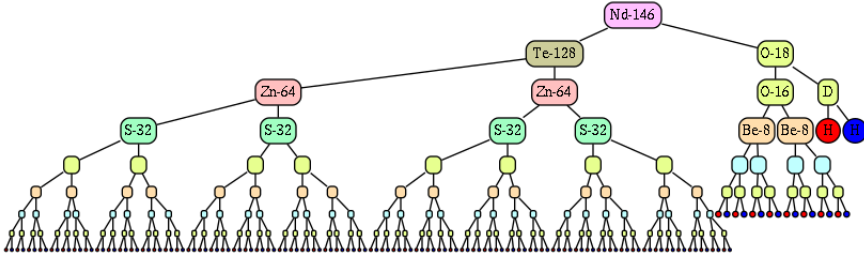
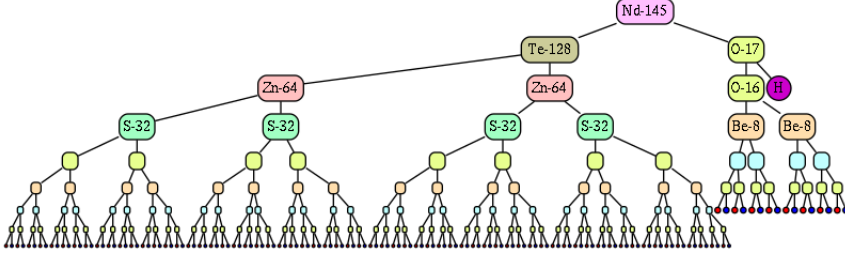
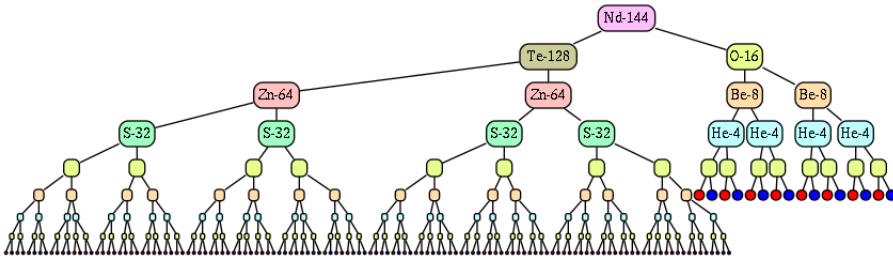

H.9.8 Promethium

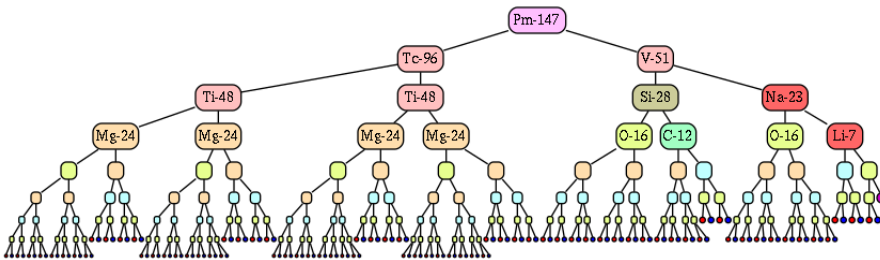
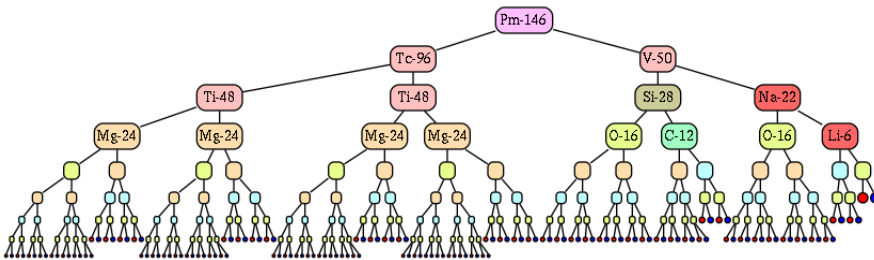
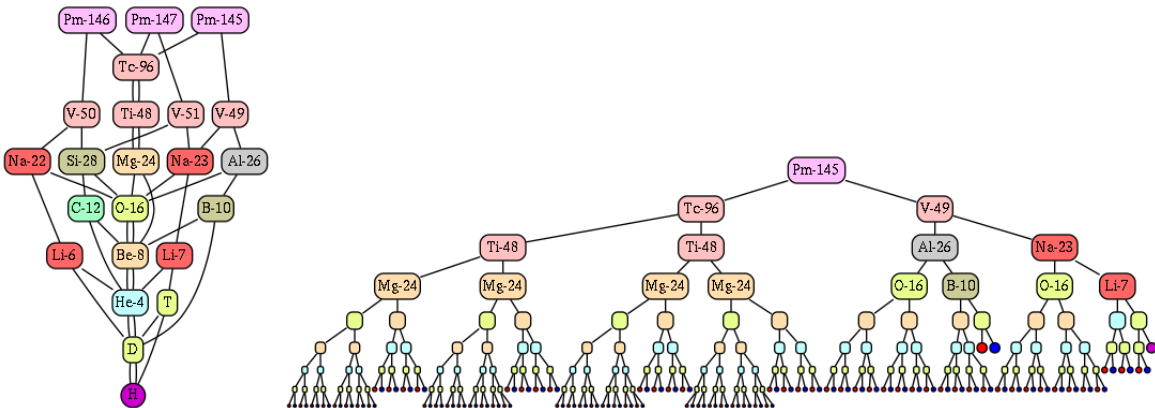



### H.9.9 Samarium

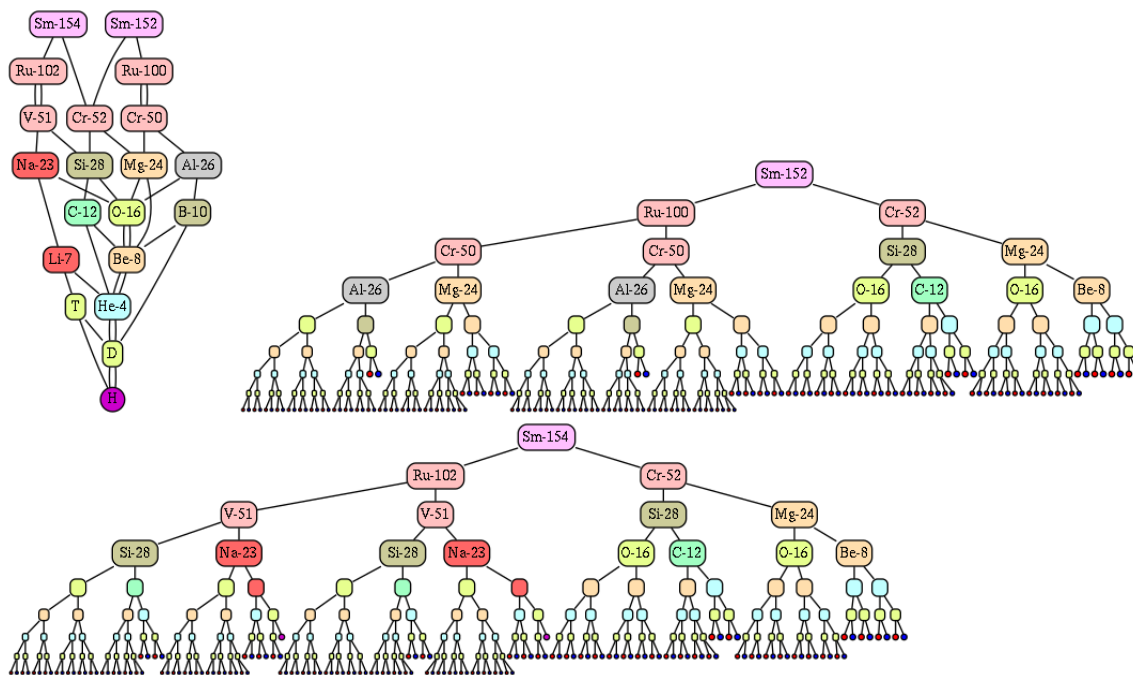

### H.9.10 Europium

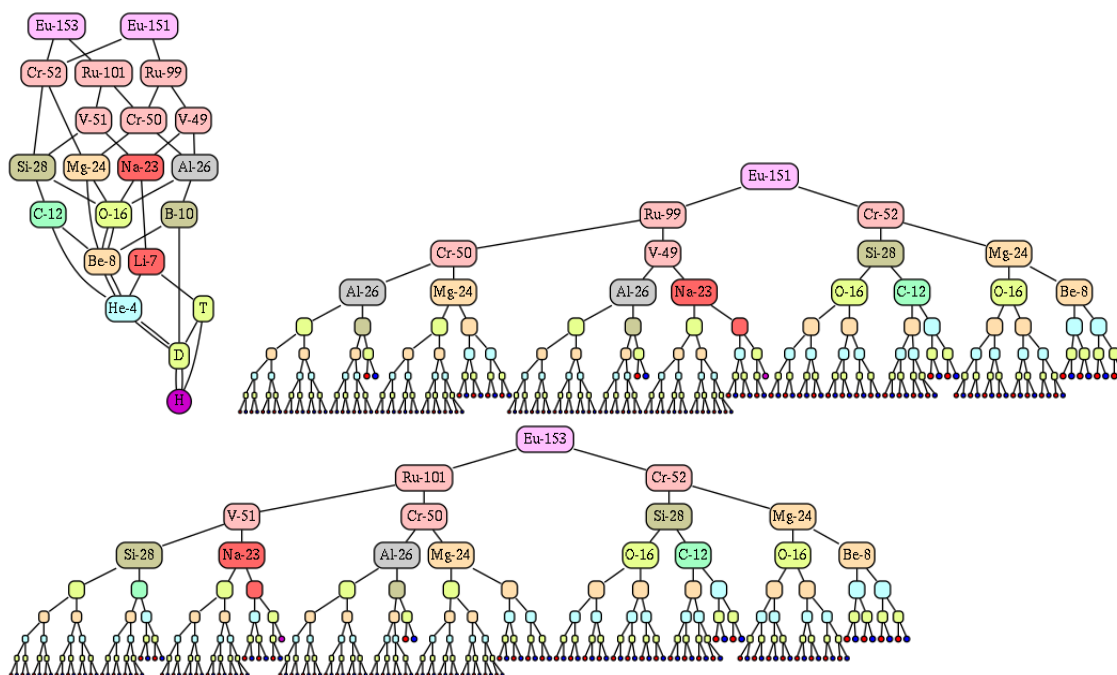

### H.9.11 Gadolinium

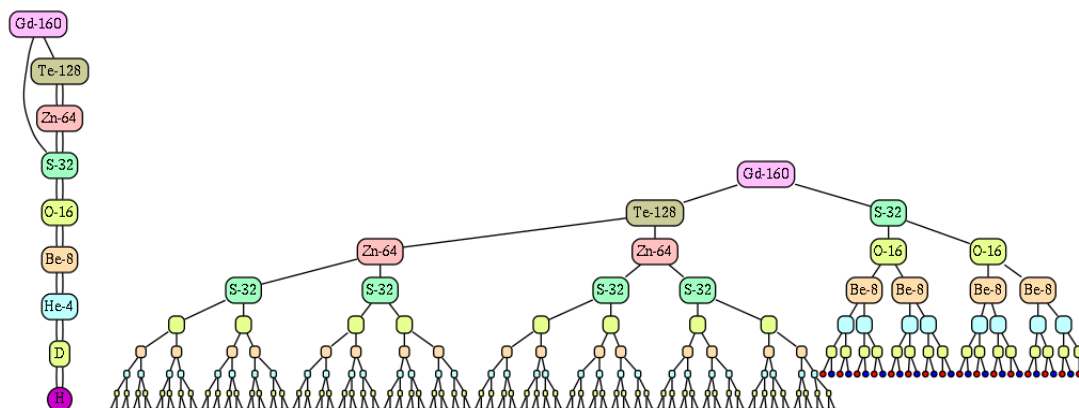

### H.9.12 Dysprosium

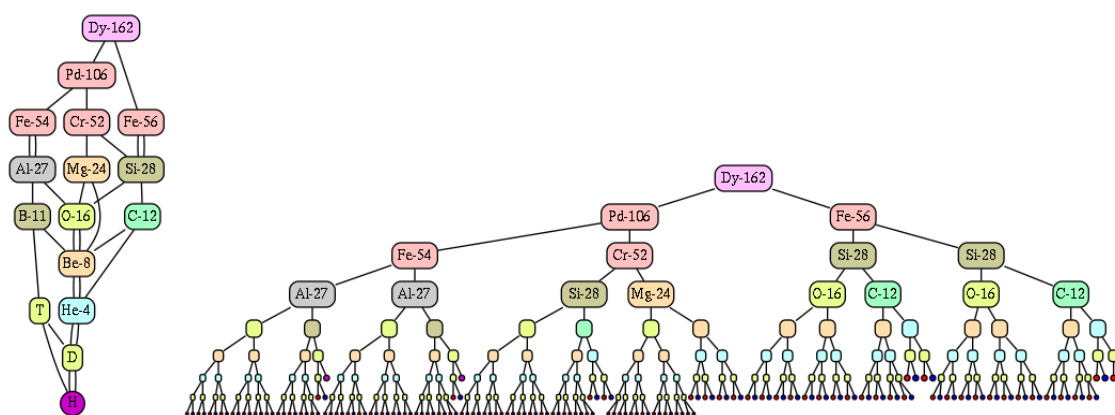

### H.9.13 Holmium

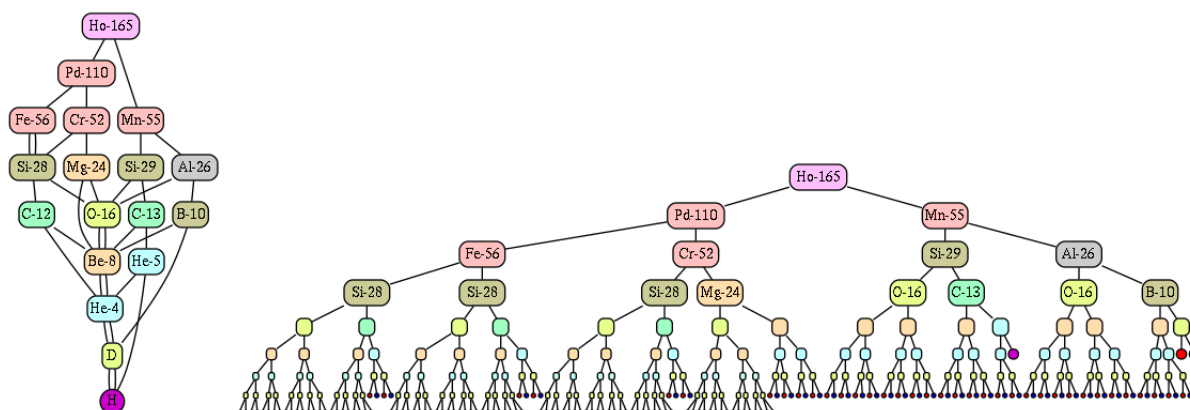

### H.9.14 Erbium

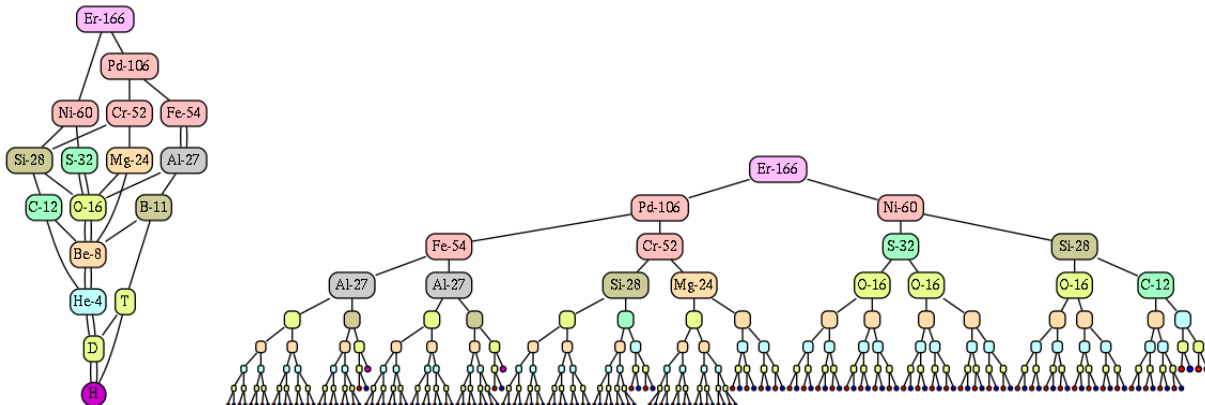

### H.9.15 Thulium

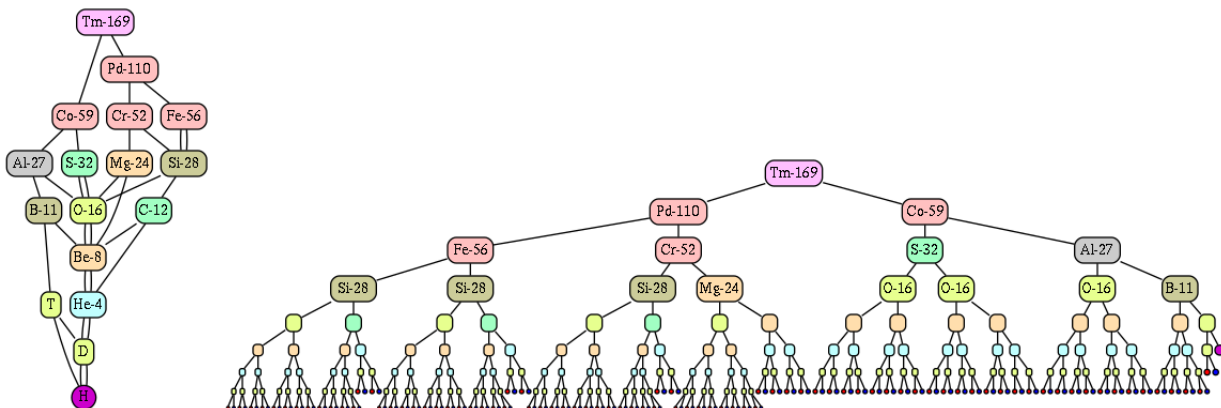

### H.9.16 Ytterbium

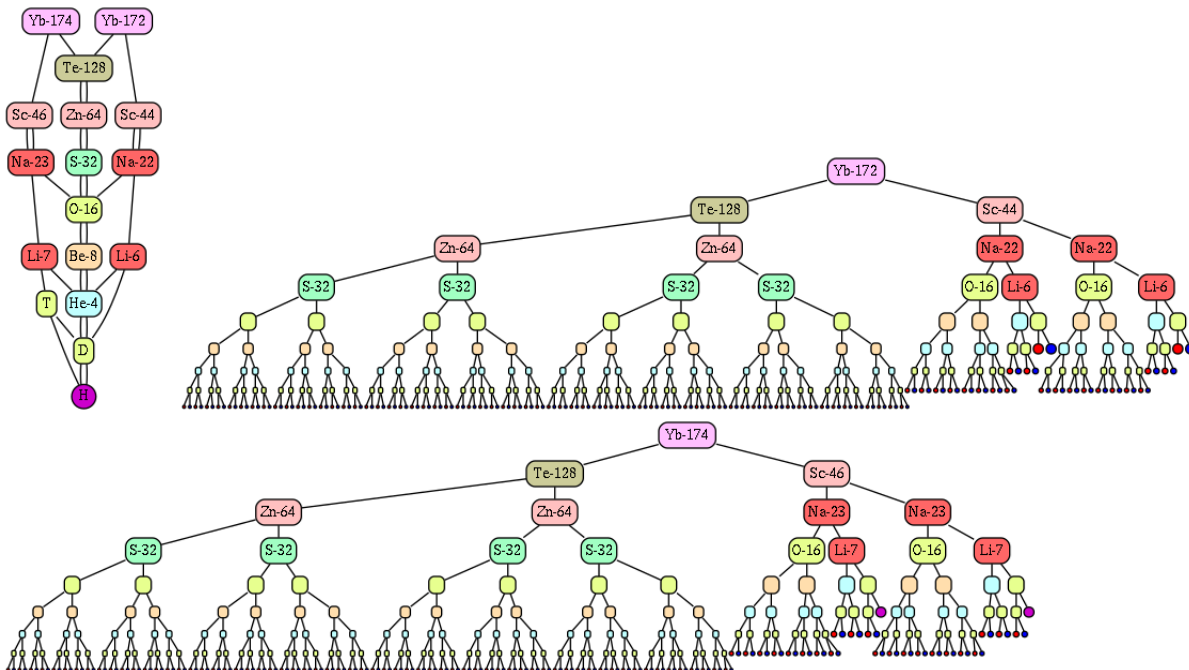

### H.9.17 Lutetium

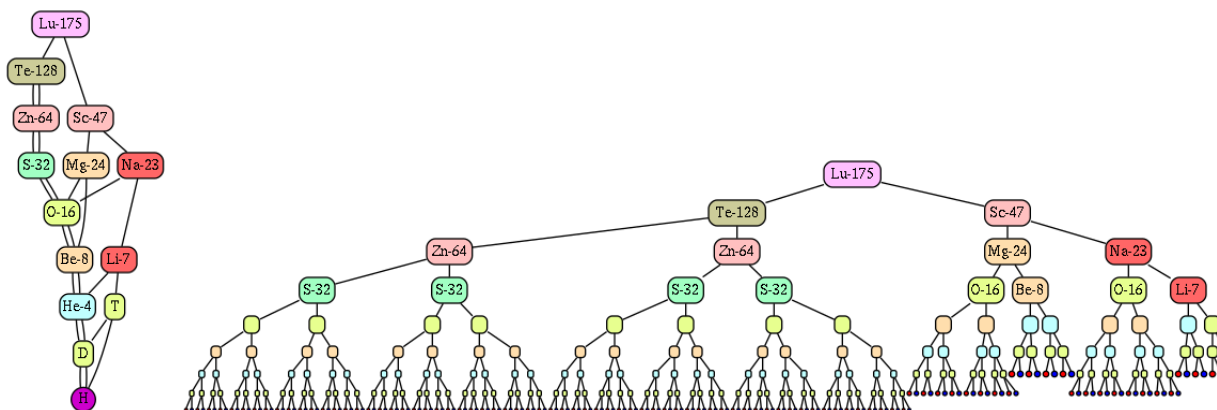

### H.9.18 Hafnium

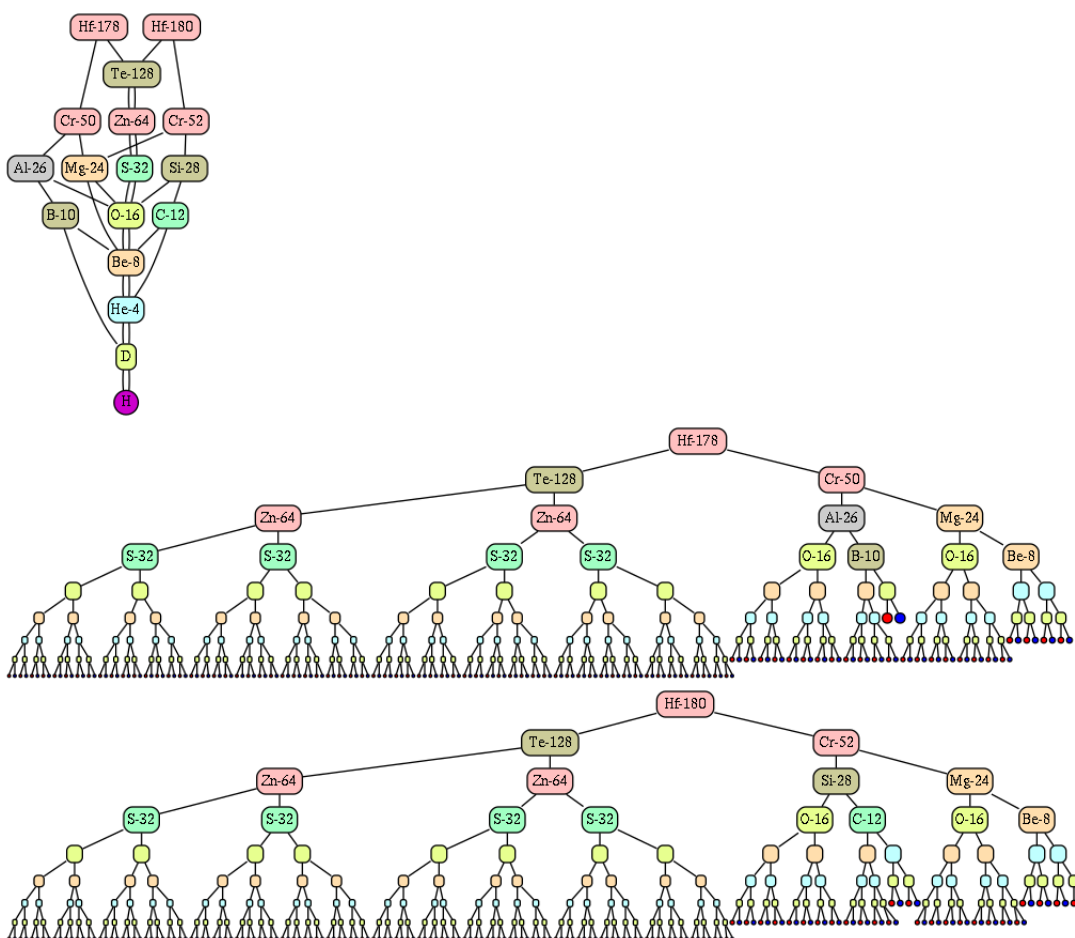

### H.9.19 Tantalum

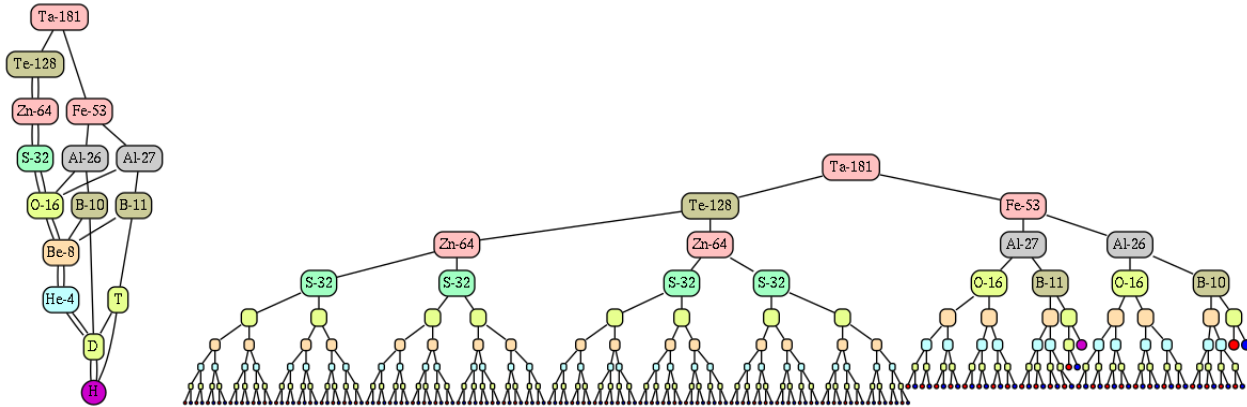

### H.9.20 Tungsten

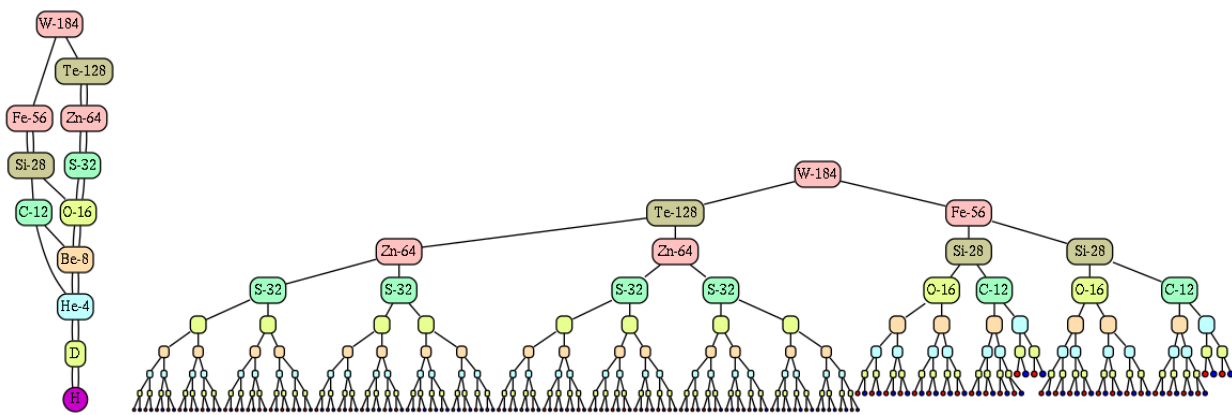

### H.9.21 Rhenium

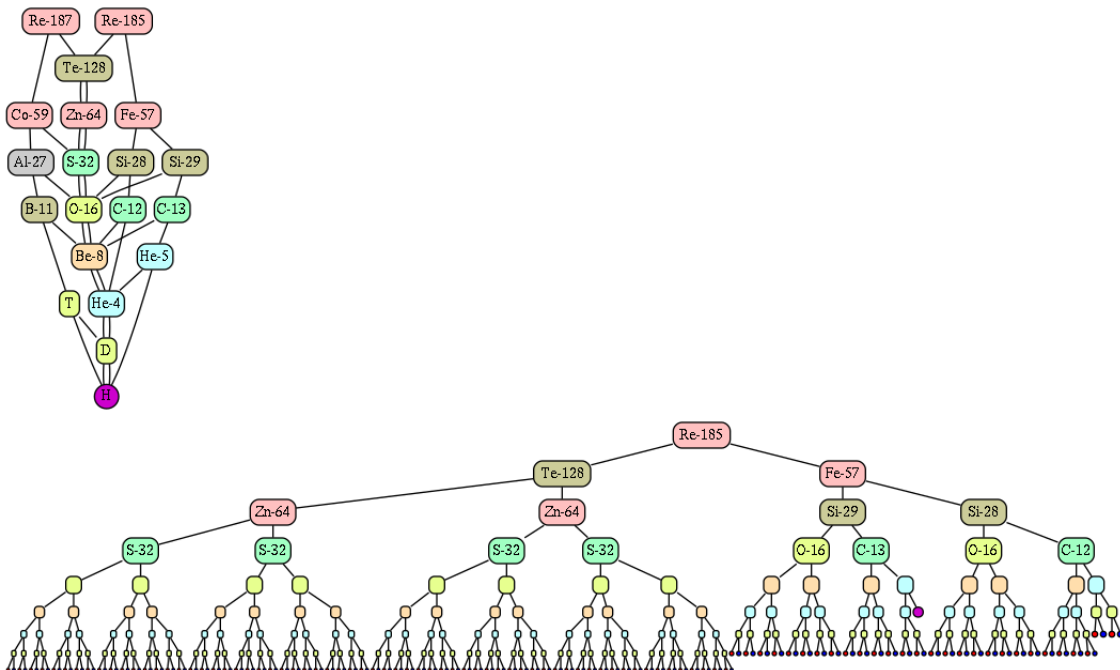

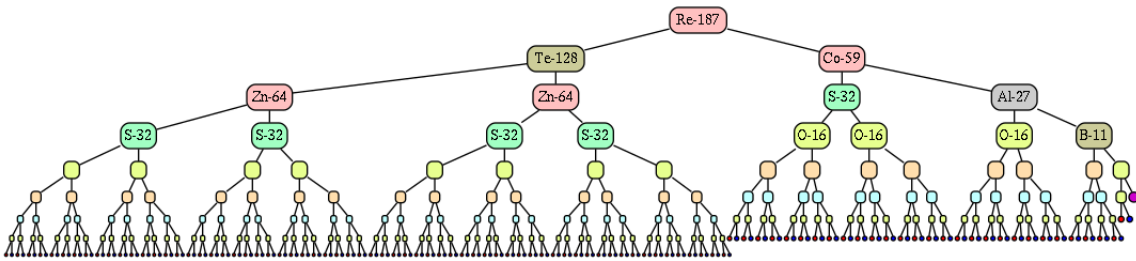

H.9.22 Osmium

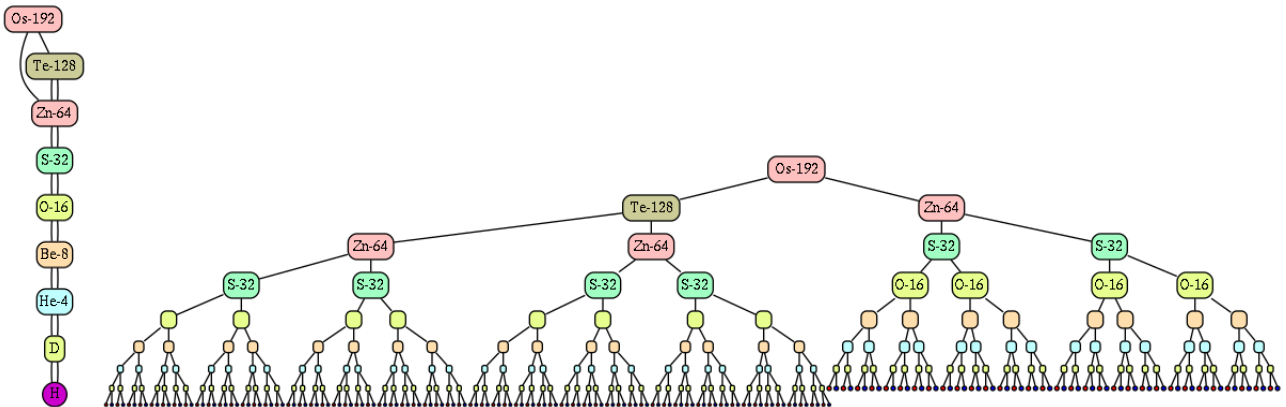

H.9.23 Iridium

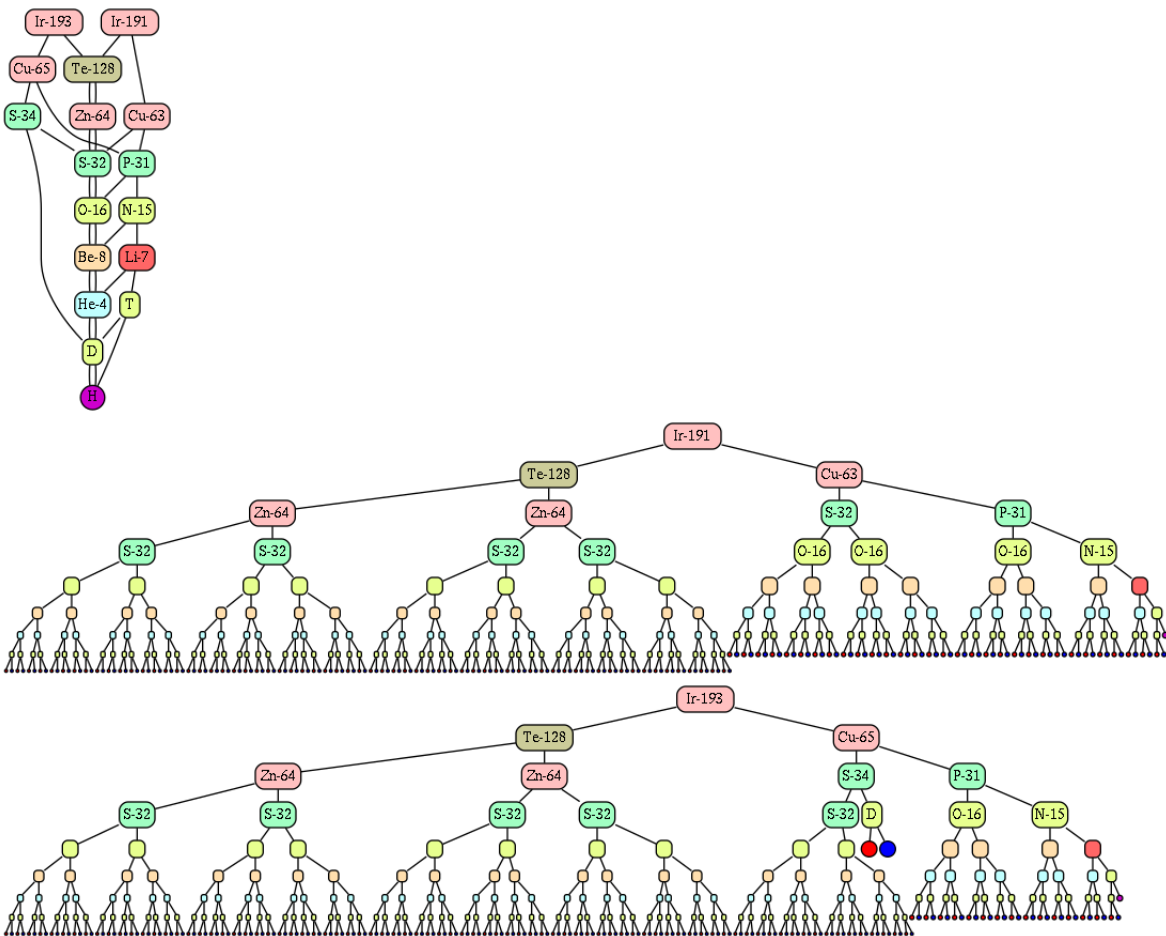

### H.9.24 Platinum

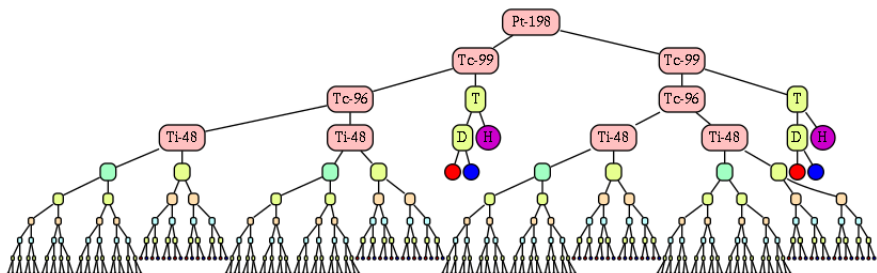
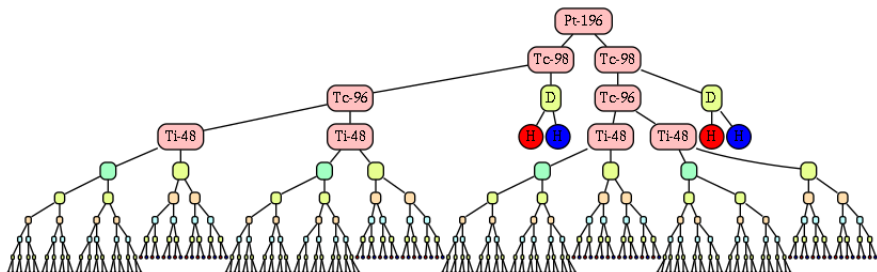
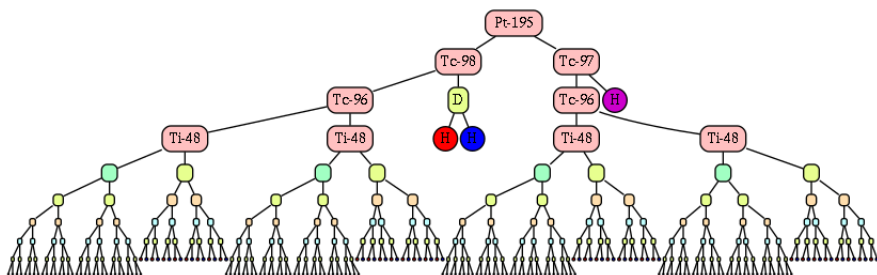
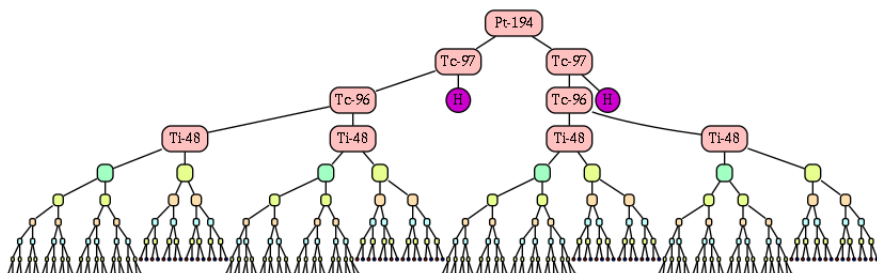
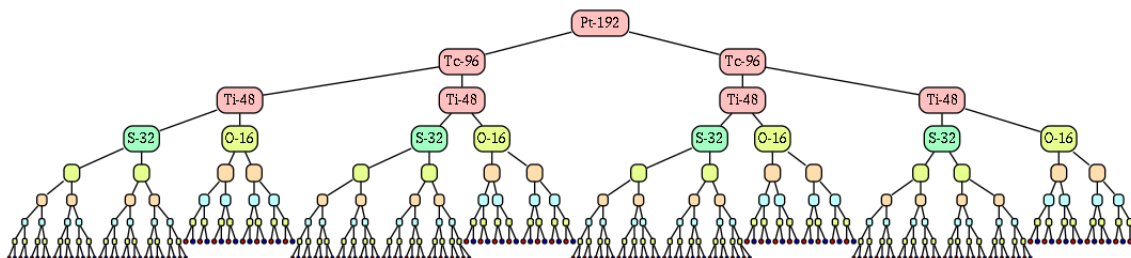
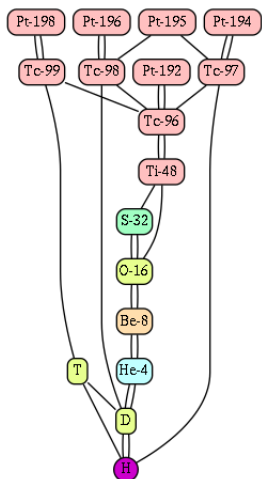

### H.9.25 Gold

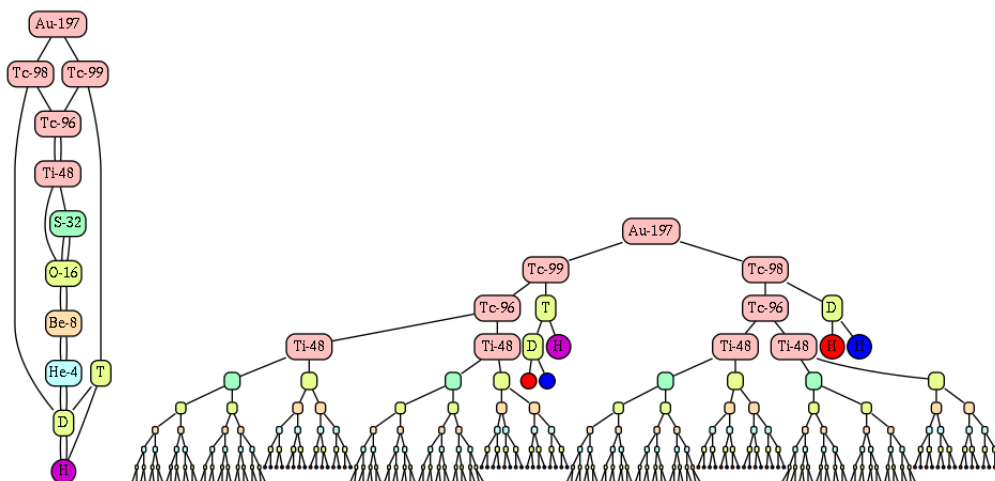

### H.9.26 Mercury

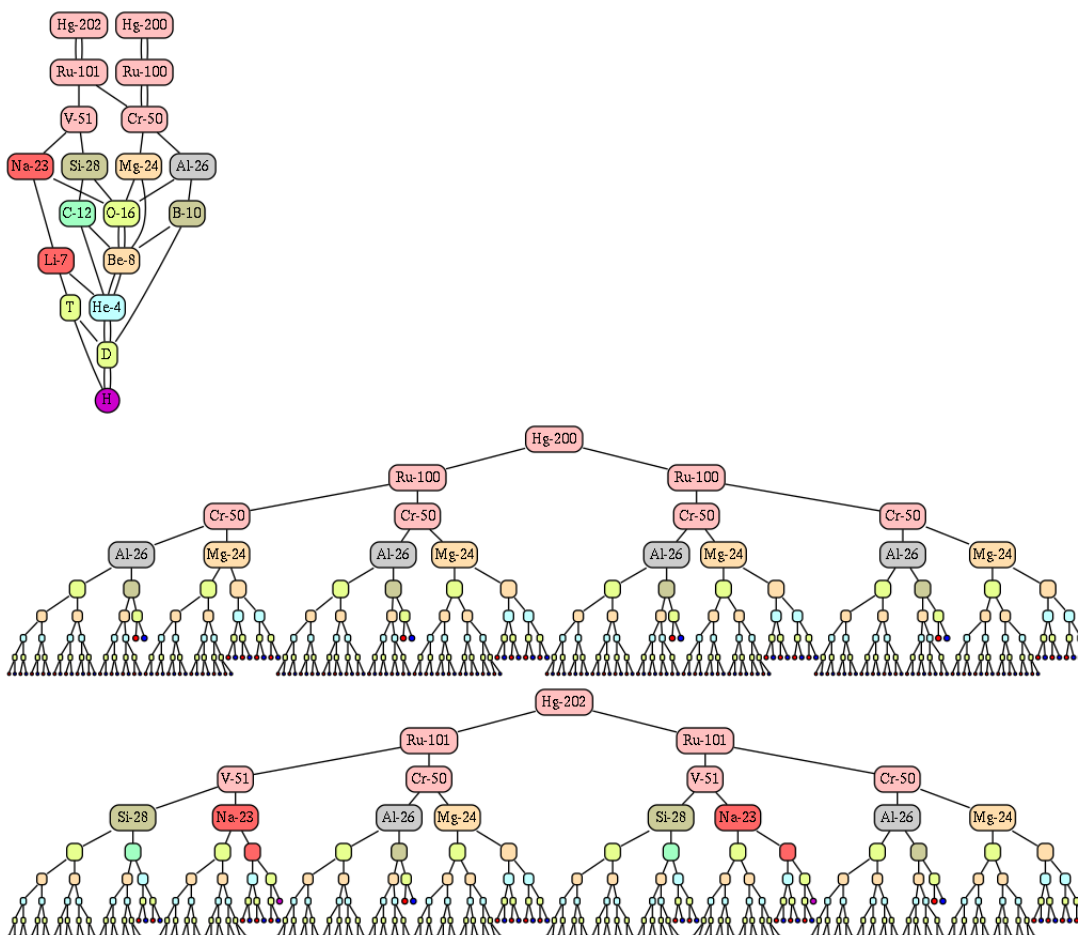



### H.9.27 Thallium

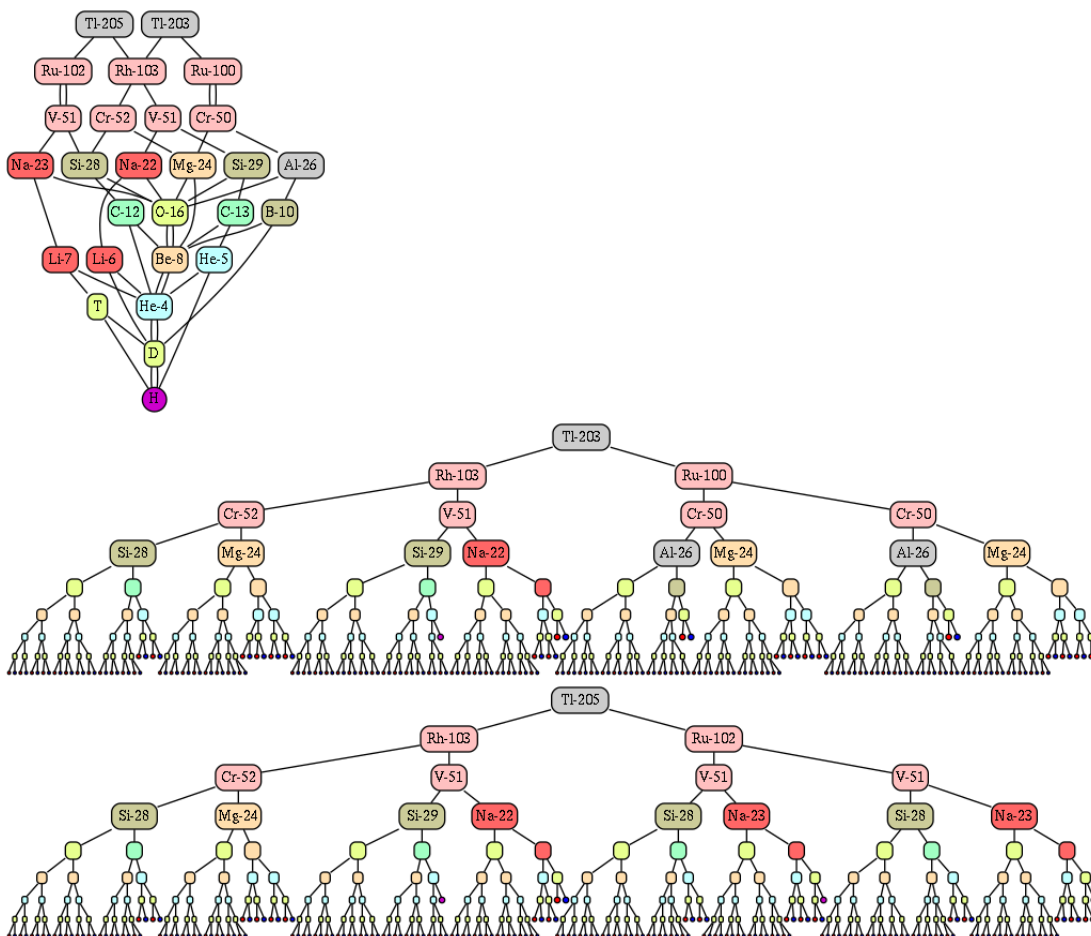

### H.9.28 Lead

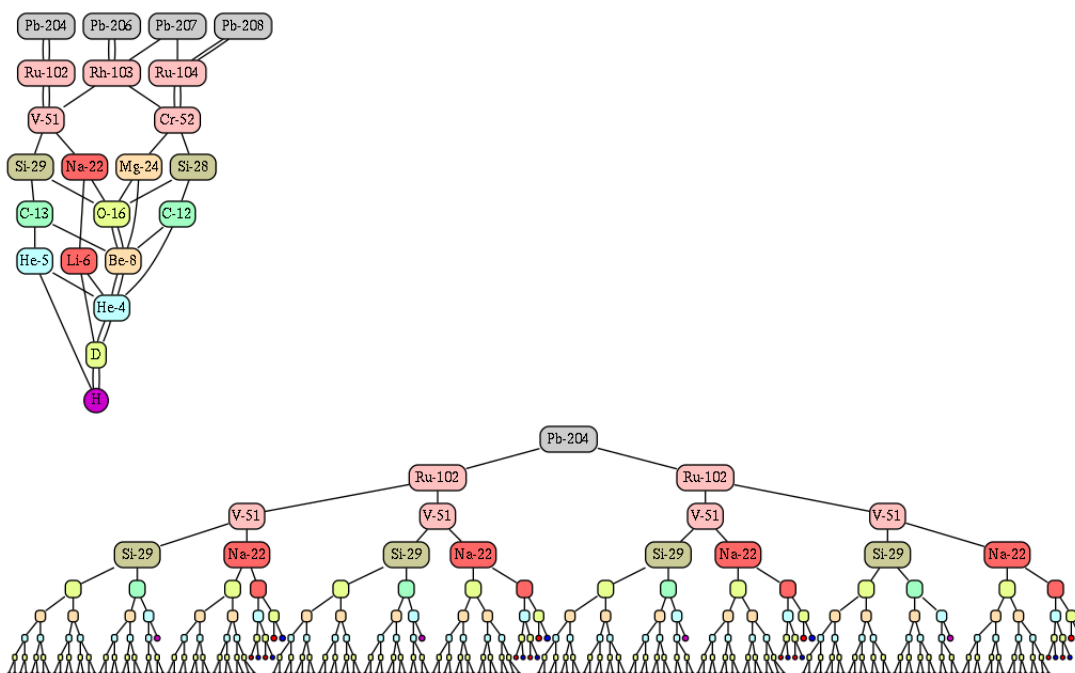

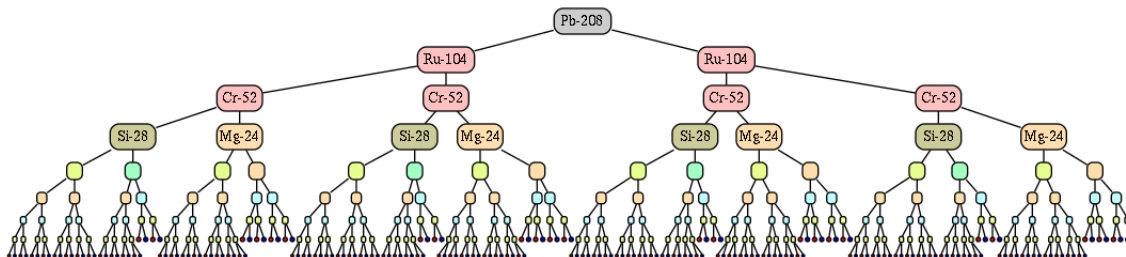
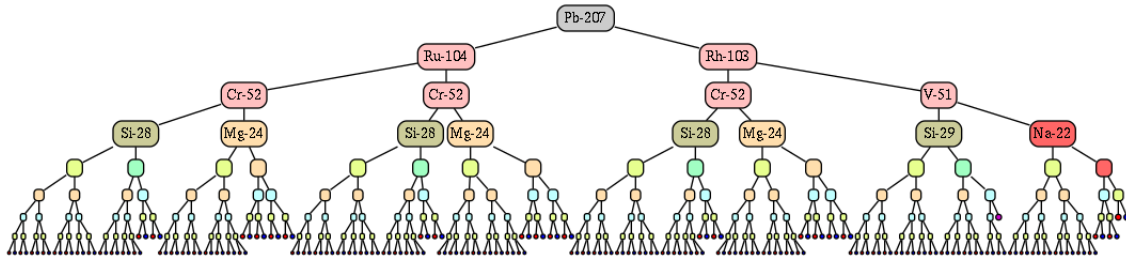
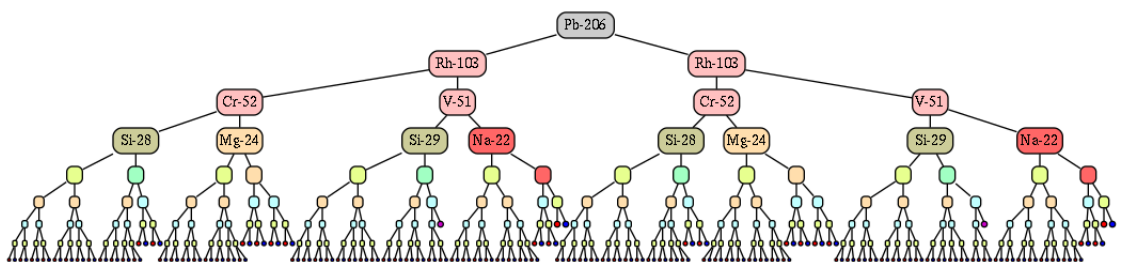

### H.9.29 Bismuth

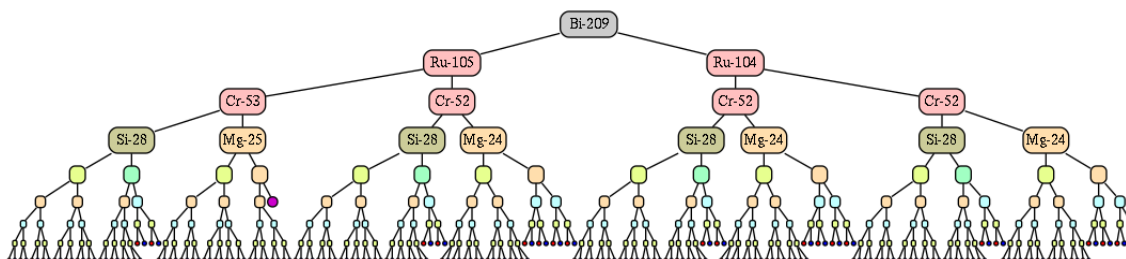
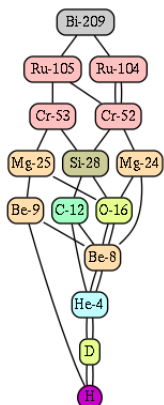

### H.9.30 Polonium

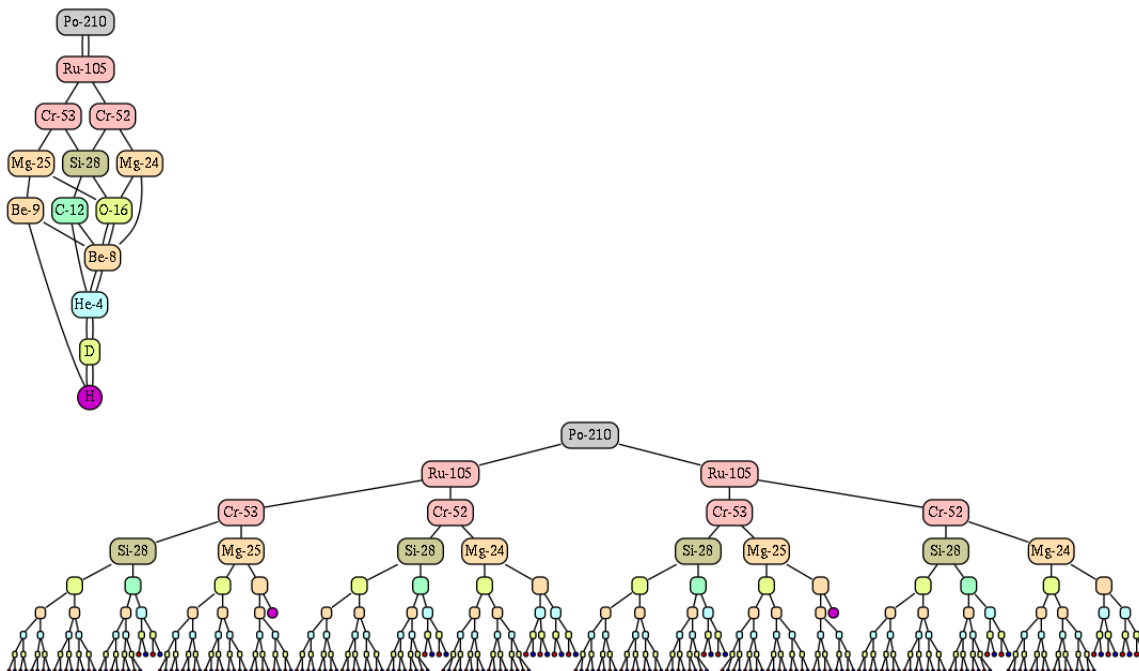

### H.9.31 Astatine

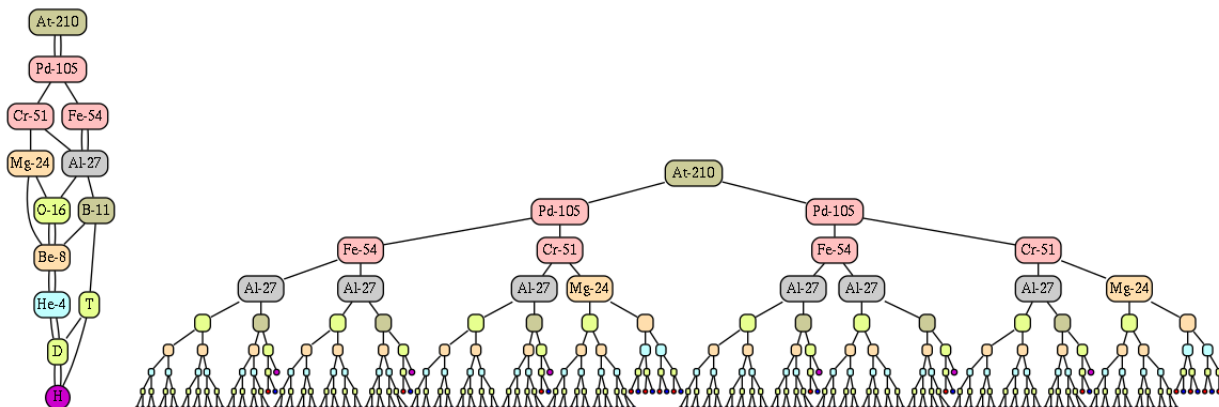

### H.9.32 Actinium

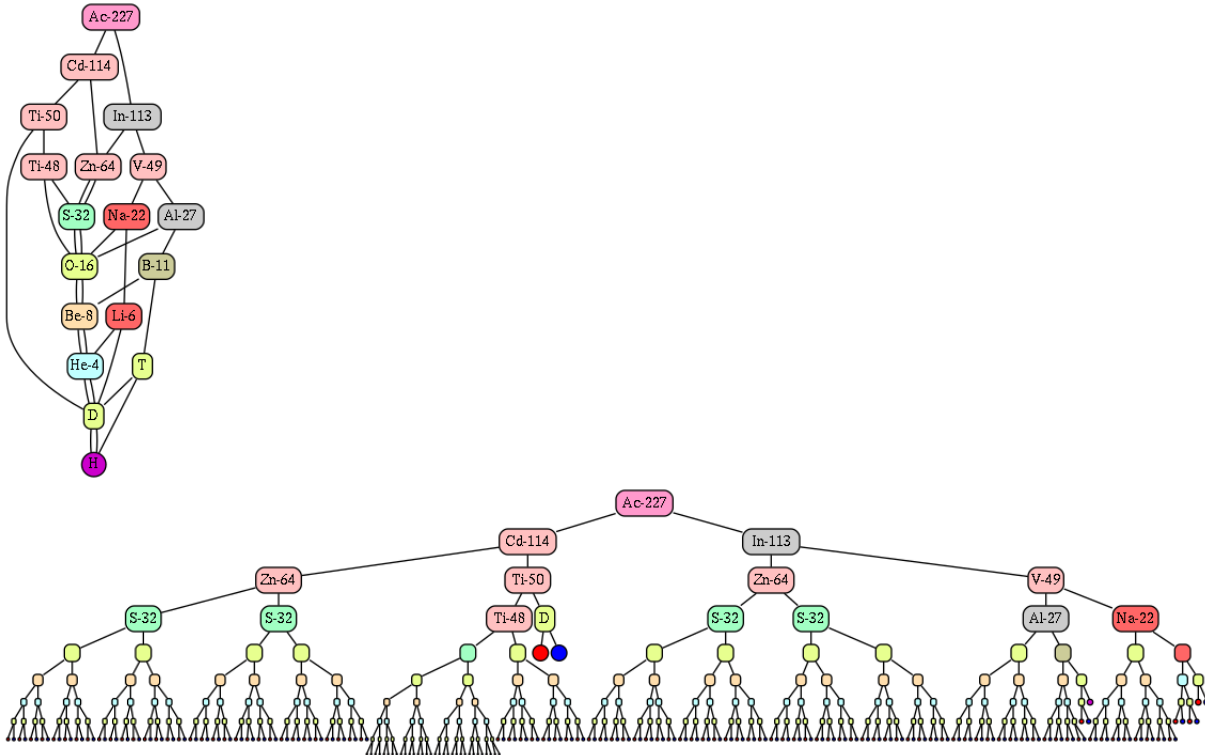

### H.9.33 Thorium

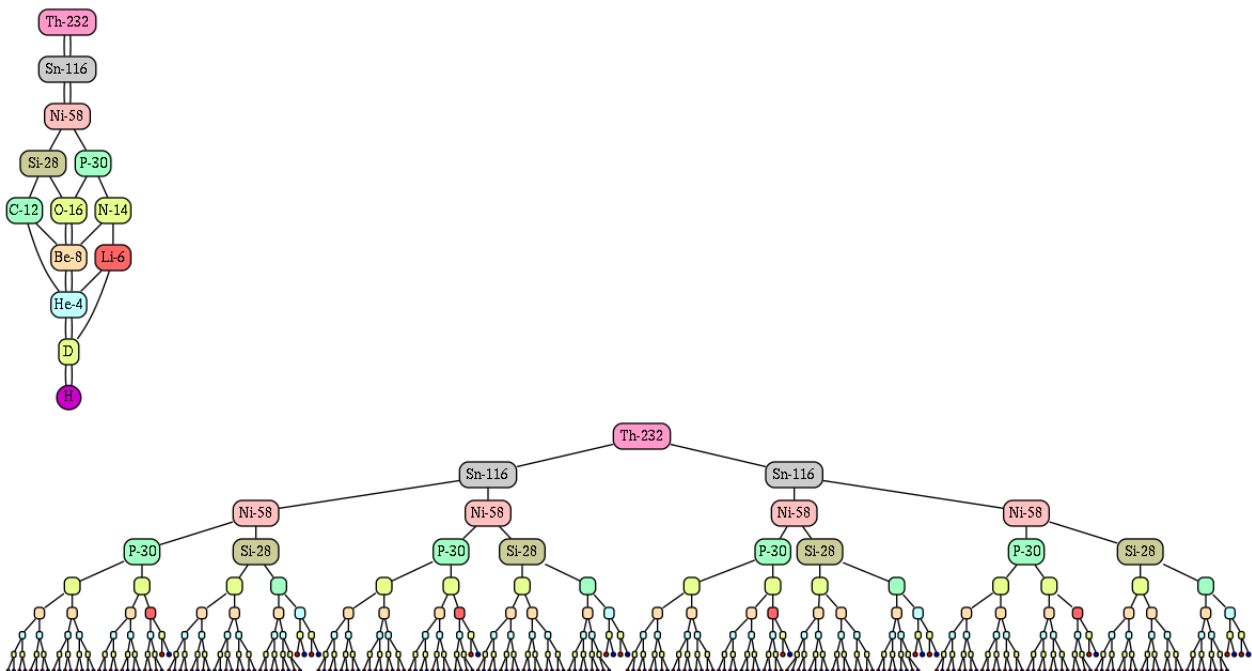

### H.9.34 Protactinium

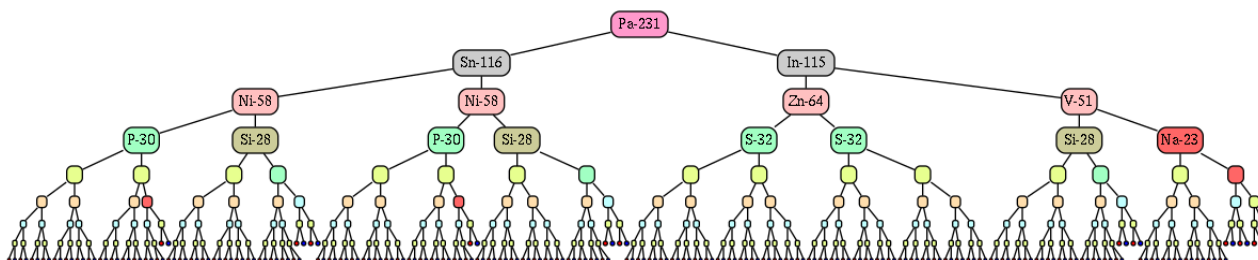
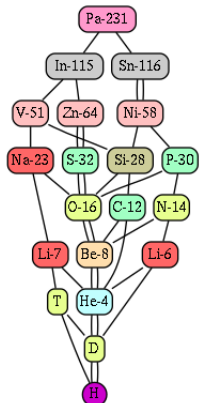

### H.9.35 Uranium

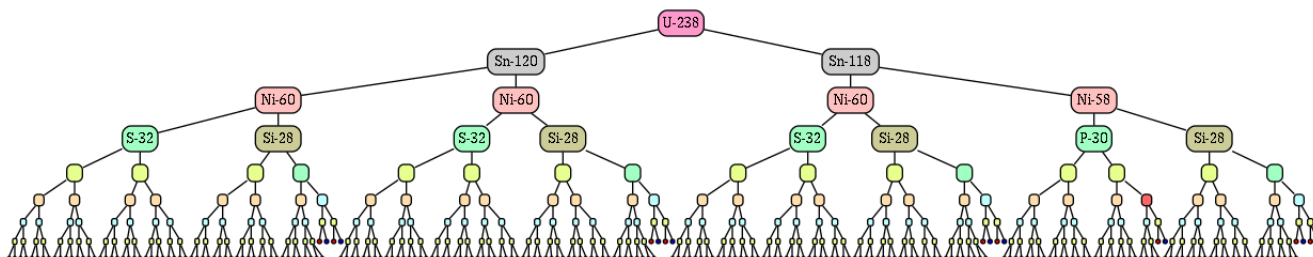
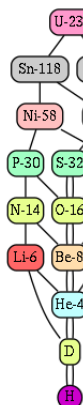

## H.10 Level 10

### H.10.1 Radon

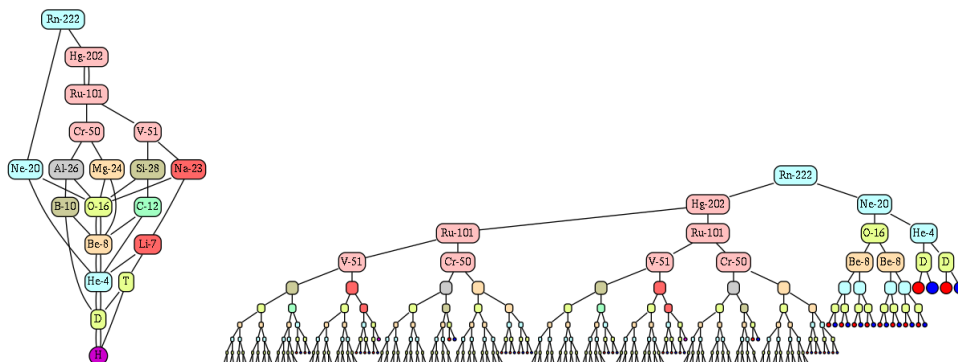

### H.10.2 Francium

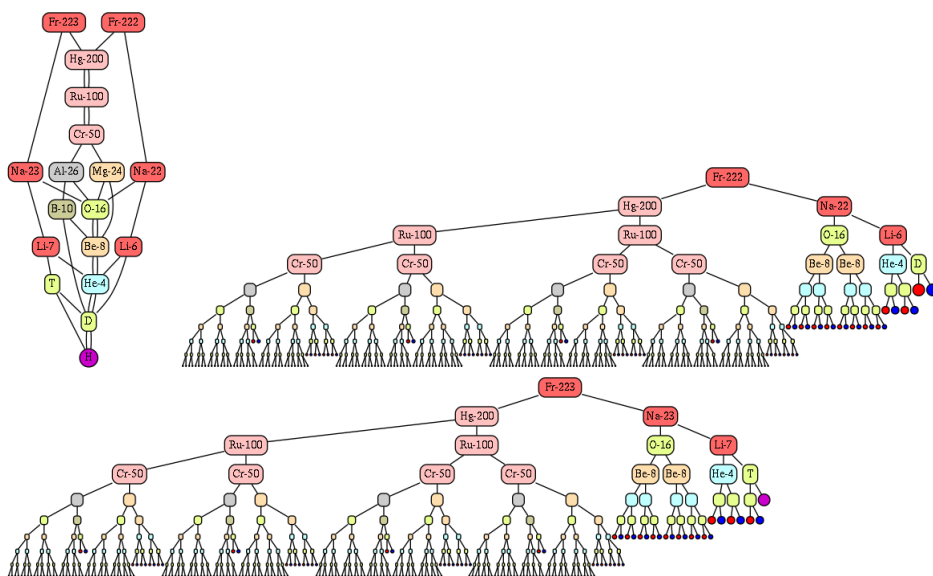

### H.10.3 Radium

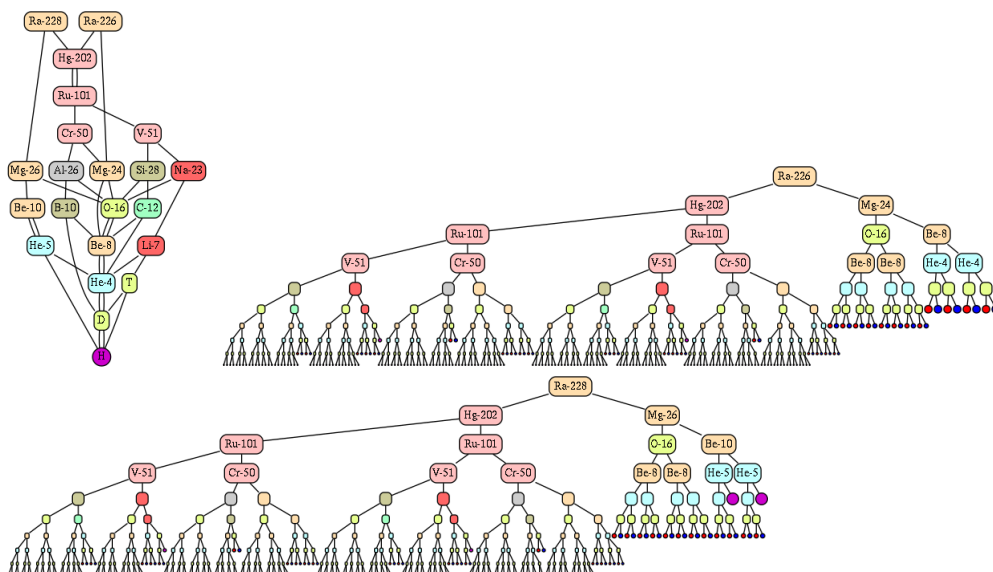

# Appendix I

## Hyperatoms

- Level 1
  - Protium
    - \*  $H-1-(1) = (1)$
- Level 2
  - Deuterium
    - \*  $D-2-(1'1) = (H-1-(1) \text{ ' } H-1-(1))$
  - Helithreem
    - \*  $Ht-3-(1'1'1) = (H-1-(1) \text{ ' } H-1-(1) \text{ ' } H-1-(1))$
- Level 3
  - Tritium
    - \*  $T-3-(2'1) = (D-2-(1'1) \text{ ' } H-1-(1))$
  - Helium
    - \*  $He-4-(2'2) = (D-2-(1'1) \text{ ' } D-2-(1'1))$
- Level 4
  - Helium
    - \*  $He-5-(4'1) = (He-4-(2'2) \text{ ' } H-1-(1))$
  - Lithium
    - \*  $Li-6-(4'2) = (He-4-(2'2) \text{ ' } D-2-(1'1))$
    - \*  $Li-7-(4'3) = (He-4-(2'2) \text{ ' } T-3-(2'1))$
  - Beryllium
    - \*  $Be-8-(4'4) = (He-4-(2'2) \text{ ' } He-4-(2'2))$
- Level 5
  - Beryllium
    - \*  $Be-9-(8'1) = (Be-8-(4'4) \text{ ' } H-1-(1))$
    - \*  $Be-10-(5'5) = (He-5-(4'1) \text{ ' } He-5-(4'1))$
  - Boron
    - \*  $B-10-(8'2) = (Be-8-(4'4) \text{ ' } D-2-(1'1))$
    - \*  $B-11-(8'3) = (Be-8-(4'4) \text{ ' } T-3-(2'1))$

- Carbon
  - \* C-12-(8'4) = (Be-8-(4'4) ' He-4-(2'2))
  - \* C-13-(8'5) = (Be-8-(4'4) ' He-5-(4'1))
- Nitrogen
  - \* N-14-(8'6) = (Be-8-(4'4) ' Li-6-(4'2))
  - \* N-15-(8'7) = (Be-8-(4'4) ' Li-7-(4'3))
- Oxygen
  - \* O-16-(8'8) = (Be-8-(4'4) ' Be-8-(4'4))
- Level 6
  - Carbon
    - \* C-13-(12'1) = (C-12-(8'4) ' H-1-(1))
  - Oxygen
    - \* O-17-(16'1) = (O-16-(8'8) ' H-1-(1))
    - \* O-18-(16'2) = (O-16-(8'8) ' D-2-(1'1))
  - Fluorine
    - \* F-19-(16'3) = (O-16-(8'8) ' T-3-(2'1))
  - Neon
    - \* Ne-20-(16'4) = (O-16-(8'8) ' He-4-(2'2))
    - \* Ne-21-(16'5) = (O-16-(8'8) ' He-5-(4'1))
  - Sodium
    - \* Na-22-(16'6) = (O-16-(8'8) ' Li-6-(4'2))
    - \* Na-23-(16'7) = (O-16-(8'8) ' Li-7-(4'3))
  - Magnesium
    - \* Mg-24-(16'8) = (O-16-(8'8) ' Be-8-(4'4))
    - \* Mg-25-(16'9) = (O-16-(8'8) ' Be-9-(8'1))
    - \* Mg-26-(16'10-(5'5)) = (O-16-(8'8) ' Be-10-(5'5))
  - Aluminium
    - \* Al-26-(16'10) = (O-16-(8'8) ' B-10-(8'2))
    - \* Al-27-(16'11) = (O-16-(8'8) ' B-11-(8'3))
  - Silicon
    - \* Si-28-(16'12) = (O-16-(8'8) ' C-12-(8'4))
    - \* Si-29-(16'13) = (O-16-(8'8) ' C-13-(8'5))
  - Phosphorus
    - \* P-30-(16'14) = (O-16-(8'8) ' N-14-(8'6))
    - \* P-31-(16'15) = (O-16-(8'8) ' N-15-(8'7))
  - Sulfur
    - \* S-32-(16'16) = (O-16-(8'8) ' O-16-(8'8))
- Level 7
  - Sulfur
    - \* S-33-(32'1) = (S-32-(16'16) ' H-1-(1))



- \* S-34-(32'2) = (S-32-(16'16) ' D-2-(1'1))
- Chlorine
  - \* Cl-35-(32'3) = (S-32-(16'16) ' T-3-(2'1))
- Potassium
  - \* K-39-(32'7) = (S-32-(16'16) ' Li-7-(4'3))
- Argon
  - \* Ar-40-(20'20) = (Ne-20-(16'4) ' Ne-20-(16'4))
- Calcium
  - \* Ca-40-(32'8) = (S-32-(16'16) ' Be-8-(4'4))
- Scandium
  - \* Sc-44-(22'22) = (Na-22-(16'6) ' Na-22-(16'6))
  - \* Sc-45-(23'22) = (Na-23-(16'7) ' Na-22-(16'6))
  - \* Sc-46-(23'23) = (Na-23-(16'7) ' Na-23-(16'7))
  - \* Sc-46-(24'22) = (Mg-24-(16'8) ' Na-22-(16'6))
  - \* Sc-47-(24'23) = (Mg-24-(16'8) ' Na-23-(16'7))
  - \* Sc-47-(25'22) = (Mg-25-(16'9) ' Na-22-(16'6))
  - \* Sc-48-(25'23) = (Mg-25-(16'9) ' Na-23-(16'7))
- Titanium
  - \* Ti-48-(24'24) = (Mg-24-(16'8) ' Mg-24-(16'8))
  - \* Ti-48-(32'16) = (S-32-(16'16) ' O-16-(8'8))
  - \* Ti-49-(25'24) = (Mg-25-(16'9) ' Mg-24-(16'8))
  - \* Ti-50-(25'25) = (Mg-25-(16'9) ' Mg-25-(16'9))
- Vanadium
  - \* V-48-(26'22) = (Al-26-(16'10) ' Na-22-(16'6))
  - \* V-49-(26'23) = (Al-26-(16'10) ' Na-23-(16'7))
  - \* V-49-(27'22) = (Al-27-(16'11) ' Na-22-(16'6))
  - \* V-50-(27'23) = (Al-27-(16'11) ' Na-23-(16'7))
  - \* V-50-(28'22) = (Si-28-(16'12) ' Na-22-(16'6))
  - \* V-51-(28'23) = (Si-28-(16'12) ' Na-23-(16'7))
  - \* V-51-(29'22) = (Si-29-(16'13) ' Na-22-(16'6))
  - \* V-52-(29'23) = (Si-29-(16'13) ' Na-23-(16'7))
- Chromium
  - \* Cr-50-(26'24) = (Al-26-(16'10) ' Mg-24-(16'8))
  - \* Cr-51-(26'25) = (Al-26-(16'10) ' Mg-25-(16'9))
  - \* Cr-51-(27'24) = (Al-27-(16'11) ' Mg-24-(16'8))
  - \* Cr-52-(27'25) = (Al-27-(16'11) ' Mg-25-(16'9))
  - \* Cr-52-(28'24) = (Si-28-(16'12) ' Mg-24-(16'8))
  - \* Cr-53-(28'25) = (Si-28-(16'12) ' Mg-25-(16'9))
  - \* Cr-53-(29'24) = (Si-29-(16'13) ' Mg-24-(16'8))
  - \* Cr-54-(29'25) = (Si-29-(16'13) ' Mg-25-(16'9))
- Iron
  - \* Fe-52-(26'26) = (Al-26-(16'10) ' Al-26-(16'10))
  - \* Fe-53-(27'26) = (Al-27-(16'11) ' Al-26-(16'10))

- \* Fe-54-(27'27) = (Al-27-(16'11) ' Al-27-(16'11))
- \* Fe-56-(28'28) = (Si-28-(16'12) ' Si-28-(16'12))
- \* Fe-57-(29'28) = (Si-29-(16'13) ' Si-28-(16'12))
- \* Fe-58-(29'29) = (Si-29-(16'13) ' Si-29-(16'13))
- Manganese
  - \* Mn-55-(29'26) = (Si-29-(16'13) ' Al-26-(16'10))
- Cobalt
  - \* Co-58-(32'26) = (S-32-(16'16) ' Al-26-(16'10))
  - \* Co-59-(32'27) = (S-32-(16'16) ' Al-27-(16'11))
- Nickel
  - \* Ni-58-(30'28) = (P-30-(16'14) ' Si-28-(16'12))
  - \* Ni-60-(32'28) = (S-32-(16'16) ' Si-28-(16'12))
  - \* Ni-61-(32'29) = (S-32-(16'16) ' Si-29-(16'13))
- Copper
  - \* Cu-62-(32'30) = (S-32-(16'16) ' P-30-(16'14))
  - \* Cu-63-(32'31) = (S-32-(16'16) ' P-31-(16'15))
- Zinc
  - \* Zn-64-(32'32) = (S-32-(16'16) ' S-32-(16'16))
- Level 8
  - Potassium
    - \* K-40-(33'7) = (S-33-(32'1) ' Li-7-(4'3))
    - \* K-41-(34'7) = (S-34-(32'2) ' Li-7-(4'3))
  - Titanium
    - \* Ti-49-(48'1) = (Ti-48-(32'16) ' H-1-(1))
    - \* Ti-50-(48'2) = (Ti-48-(32'16) ' D-2-(1'1))
  - Copper
    - \* Cu-65-(34'31) = (S-34-(32'2) ' P-31-(16'15))
  - Zinc
    - \* Zn-66-(64'2) = (Zn-64-(32'32) ' D-2-(1'1))
  - Gallium
    - \* Ga-69-(64'5) = (Zn-64-(32'32) ' He-5-(4'1))
    - \* Ga-71-(64'7) = (Zn-64-(32'32) ' Li-7-(4'3))
  - Germanium
    - \* Ge-72-(64'8) = (Zn-64-(32'32) ' Be-8-(4'4))
    - \* Ge-74-(64'10) = (Zn-64-(32'32) ' B-10-(8'2))
    - \* Ge-76-(64'12) = (Zn-64-(32'32) ' C-12-(8'4))
  - Arsenic
    - \* As-75-(64'11) = (Zn-64-(32'32) ' B-11-(8'3))
  - Selenium
    - \* Se-78-(64'14) = (Zn-64-(32'32) ' N-14-(8'6))
    - \* Se-80-(64'16) = (Zn-64-(32'32) ' O-16-(8'8))

- \* Se-82-(64'18) = (Zn-64-(32'32) ' O-18-(16'2))
- Bromine
  - \* Br-79-(64'15) = (Zn-64-(32'32) ' N-15-(8'7))
  - \* Br-81-(64'17) = (Zn-64-(32'32) ' O-17-(16'1))
  - \* Br-83-(64'19) = (Zn-64-(32'32) ' F-19-(16'3))
- Krypton
  - \* Kr-84-(64'20) = (Zn-64-(32'32) ' Ne-20-(16'4))
- Strontium
  - \* Sr-86-(62'24) = (Cu-62-(32'30) ' Mg-24-(16'8))
  - \* Sr-87-(63'24) = (Cu-63-(32'31) ' Mg-24-(16'8))
  - \* Sr-88-(64'24) = (Zn-64-(32'32) ' Mg-24-(16'8))
- Rubidium
  - \* Rb-87-(64'23) = (Zn-64-(32'32) ' Na-23-(16'7))
- Yttrium
  - \* Y-89-(64'25) = (Zn-64-(32'32) ' Mg-25-(16'9))
- Zirconium
  - \* Zr-90-(64'26) = (Zn-64-(32'32) ' Al-26-(16'10))
  - \* Zr-91-(64'27) = (Zn-64-(32'32) ' Al-27-(16'11))
  - \* Zr-92-(64'28) = (Zn-64-(32'32) ' Si-28-(16'12))
  - \* Zr-94-(64'30) = (Zn-64-(32'32) ' P-30-(16'14))
- Niobium
  - \* Nb-93-(64'29) = (Zn-64-(32'32) ' Si-29-(16'13))
- Molybdenum
  - \* Mo-96-(64'32) = (Zn-64-(32'32) ' S-32-(16'16))
- Technetium
  - \* Tc-96-(48-(24'24)'48-(24'24)) = (Ti-48-(24'24) ' Ti-48-(24'24))
  - \* Tc-96-(48'48) = (Ti-48-(32'16) ' Ti-48-(32'16))
- Ruthenium
  - \* Ru-96-(48-(26'22)'48-(26'22)) = (V-48-(26'22) ' V-48-(26'22))
  - \* Ru-98-(50-(26'24)'48-(26'22)) = (Cr-50-(26'24) ' V-48-(26'22))
  - \* Ru-99-(50-(26'24)'49-(26'23)) = (Cr-50-(26'24) ' V-49-(26'23))
  - \* Ru-100-(50-(26'24)'50-(26'24)) = (Cr-50-(26'24) ' Cr-50-(26'24))
  - \* Ru-101-(51-(28'23)'50-(26'24)) = (V-51-(28'23) ' Cr-50-(26'24))
  - \* Ru-102-(51-(28'23)'51-(28'23)) = (V-51-(28'23) ' V-51-(28'23))
  - \* Ru-102-(51-(29'22)'51-(28'23)) = (V-51-(29'22) ' V-51-(28'23))
  - \* Ru-102-(51-(29'22)'51-(29'22)) = (V-51-(29'22) ' V-51-(29'22))
  - \* Ru-104-(52-(28'24)'52-(28'24)) = (Cr-52-(28'24) ' Cr-52-(28'24))
  - \* Ru-105-(53-(28'25)'52-(28'24)) = (Cr-53-(28'25) ' Cr-52-(28'24))
- Palladium
  - \* Pd-102-(52-(26'26)'50-(26'24)) = (Fe-52-(26'26) ' Cr-50-(26'24))
  - \* Pd-104-(54-(27'27)'50-(26'24)) = (Fe-54-(27'27) ' Cr-50-(26'24))
  - \* Pd-105-(54-(27'27)'51-(27'24)) = (Fe-54-(27'27) ' Cr-51-(27'24))

- \* Pd-106-(54-(27'27)'52-(28'24)) = (Fe-54-(27'27) ' Cr-52-(28'24))
- \* Pd-108-(56-(28'28)'50-(26'24)) = (Fe-56-(28'28) ' Cr-50-(26'24))
- \* Pd-110-(56-(28'28)'52-(28'24)) = (Fe-56-(28'28) ' Cr-52-(28'24))
- Rhodium
  - \* Rh-103-(52-(28'24)'51-(28'23)) = (Cr-52-(28'24) ' V-51-(28'23))
  - \* Rh-103-(52-(28'24)'51-(29'22)) = (Cr-52-(28'24) ' V-51-(29'22))
- Silver
  - \* Ag-107-(58-(32'26)'49-(26'23)) = (Co-58-(32'26) ' V-49-(26'23))
  - \* Ag-107-(58-(32'26)'49-(27'22)) = (Co-58-(32'26) ' V-49-(27'22))
  - \* Ag-109-(58-(32'26)'51-(29'22)) = (Co-58-(32'26) ' V-51-(29'22))
  - \* Ag-109-(59-(32'27)'50-(28'22)) = (Co-59-(32'27) ' V-50-(28'22))
- Cadmium
  - \* Cd-112-(64'48-(24'24)) = (Zn-64-(32'32) ' Ti-48-(24'24))
  - \* Cd-112-(64'48) = (Zn-64-(32'32) ' Ti-48-(32'16))
- Indium
  - \* In-113-(64'49-(27'22)) = (Zn-64-(32'32) ' V-49-(27'22))
  - \* In-115-(64'51-(28'23)) = (Zn-64-(32'32) ' V-51-(28'23))
- Tin
  - \* Sn-116-(58-(30'28)'58-(30'28)) = (Ni-58-(30'28) ' Ni-58-(30'28))
  - \* Sn-118-(60'58-(30'28)) = (Ni-60-(32'28) ' Ni-58-(30'28))
  - \* Sn-120-(60'60) = (Ni-60-(32'28) ' Ni-60-(32'28))
- Antimony
  - \* Sb-121-(62'59) = (Cu-62-(32'30) ' Co-59-(32'27))
  - \* Sb-123-(64'59) = (Zn-64-(32'32) ' Co-59-(32'27))
- Tellurium
  - \* Te-124-(64'60) = (Zn-64-(32'32) ' Ni-60-(32'28))
  - \* Te-125-(64'61) = (Zn-64-(32'32) ' Ni-61-(32'29))
  - \* Te-126-(64'62) = (Zn-64-(32'32) ' Cu-62-(32'30))
  - \* Te-128-(64'64) = (Zn-64-(32'32) ' Zn-64-(32'32))
- Iodine
  - \* I-127-(64'63) = (Zn-64-(32'32) ' Cu-63-(32'31))
- Terbium
  - \* Tb-159-(58-(32'26)'49-(26'23)'52-(28'24)) = (Co-58-(32'26) ' V-49-(26'23) ' Cr-52-(28'24))
- Level 9
  - Technetium
    - \* Tc-97-(96-(48'48)'1) = (Tc-96-(48'48) ' H-1-(1))
    - \* Tc-98-(96-(48'48)'2) = (Tc-96-(48'48) ' D-2-(1'1))
    - \* Tc-99-(96-(48'48)'3) = (Tc-96-(48'48) ' T-3-(2'1))
  - Cadmium
    - \* Cd-114-(64'50-(48'2)) = (Zn-64-(32'32) ' Ti-50-(48'2))
    - \* Cd-114-(66'48-(24'24)) = (Zn-66-(64'2) ' Ti-48-(24'24))

- \* Cd-114-(66'48) = (Zn-66-(64'2) ' Ti-48-(32'16))
- \* Cd-116-(66'50-(48'2)) = (Zn-66-(64'2) ' Ti-50-(48'2))
- Xenon
  - \* Xe-128-(124'4) = (Te-124-(64'60) ' He-4-(2'2))
  - \* Xe-129-(125'4) = (Te-125-(64'61) ' He-4-(2'2))
  - \* Xe-130-(126'4) = (Te-126-(64'62) ' He-4-(2'2))
  - \* Xe-131-(127'4) = (I-127-(64'63) ' He-4-(2'2))
  - \* Xe-132-(128'4) = (Te-128-(64'64) ' He-4-(2'2))
- Tellurium
  - \* Te-129-(128'1) = (Te-128-(64'64) ' H-1-(1))
  - \* Te-130-(128'2) = (Te-128-(64'64) ' D-2-(1'1))
- Caesium
  - \* Cs-133-(126'7) = (Te-126-(64'62) ' Li-7-(4'3))
  - \* Cs-133-(127'6) = (I-127-(64'63) ' Li-6-(4'2))
- Barium
  - \* Ba-134-(126'8) = (Te-126-(64'62) ' Be-8-(4'4))
  - \* Ba-135-(127'8) = (I-127-(64'63) ' Be-8-(4'4))
  - \* Ba-136-(128'8) = (Te-128-(64'64) ' Be-8-(4'4))
- Cerium
  - \* Ce-136-(126'10) = (Te-126-(64'62) ' B-10-(8'2))
  - \* Ce-138-(128'10) = (Te-128-(64'64) ' B-10-(8'2))
  - \* Ce-140-(128'12) = (Te-128-(64'64) ' C-12-(8'4))
  - \* Ce-142-(128'14) = (Te-128-(64'64) ' N-14-(8'6))
- Lanthanum
  - \* La-138-(126'12) = (Te-126-(64'62) ' C-12-(8'4))
  - \* La-139-(127'12) = (I-127-(64'63) ' C-12-(8'4))
- Praseodymium
  - \* Pr-141-(128'13) = (Te-128-(64'64) ' C-13-(8'5))
- Neodymium
  - \* Nd-142-(126'16) = (Te-126-(64'62) ' O-16-(8'8))
  - \* Nd-143-(127'16) = (I-127-(64'63) ' O-16-(8'8))
  - \* Nd-144-(128'16) = (Te-128-(64'64) ' O-16-(8'8))
  - \* Nd-145-(128'17) = (Te-128-(64'64) ' O-17-(16'1))
  - \* Nd-146-(128'18) = (Te-128-(64'64) ' O-18-(16'2))
- Promethium
  - \* Pm-145-(96-(48-(24'24)'48-(24'24))'49-(26'23)) = (Tc-96-(48-(24'24)'48-(24'24)) ' V-49-(26'23))
  - \* Pm-146-(96-(48-(24'24)'48-(24'24))'50-(28'22)) = (Tc-96-(48-(24'24)'48-(24'24)) ' V-50-(28'22))
  - \* Pm-147-(96-(48-(24'24)'48-(24'24))'51-(28'23)) = (Tc-96-(48-(24'24)'48-(24'24)) ' V-51-(28'23))
- Europium
  - \* Eu-151-(99-(50-(26'24)'49-(26'23))'52-(28'24)) = (Ru-99-(50-(26'24)'49-(26'23)) ' Cr-52-(28'24))

- \* Eu-153-(101-(51-(28'23)'50-(26'24))'52-(28'24)) = (Ru-101-(51-(28'23)'50-(26'24))'Cr-52-(28'24))
- Samarium
  - \* Sm-152-(100-(50-(26'24)'50-(26'24))'52-(28'24)) = (Ru-100-(50-(26'24)'50-(26'24))'Cr-52-(28'24))
  - \* Sm-154-(102-(51-(28'23)'51-(28'23))'52-(28'24)) = (Ru-102-(51-(28'23)'51-(28'23))'Cr-52-(28'24))
- Gadolinium
  - \* Gd-160-(128'32) = (Te-128-(64'64)'S-32-(16'16))
- Dysprosium
  - \* Dy-162-(106-(54-(27'27)'52-(28'24))'56-(28'28)) = (Pd-106-(54-(27'27)'52-(28'24))'Fe-56-(28'28))
- Holmium
  - \* Ho-165-(110-(56-(28'28)'52-(28'24))'55-(29'26)) = (Pd-110-(56-(28'28)'52-(28'24))'Mn-55-(29'26))
- Erbium
  - \* Er-166-(106-(54-(27'27)'52-(28'24))'60) = (Pd-106-(54-(27'27)'52-(28'24))'Ni-60-(32'28))
- Thulium
  - \* Tm-169-(110-(56-(28'28)'52-(28'24))'59) = (Pd-110-(56-(28'28)'52-(28'24))'Co-59-(32'27))
- Ytterbium
  - \* Yb-172-(128'44-(22'22)) = (Te-128-(64'64)'Sc-44-(22'22))
  - \* Yb-174-(128'46-(23'23)) = (Te-128-(64'64)'Sc-46-(23'23))
- Lutetium
  - \* Lu-175-(128'47-(24'23)) = (Te-128-(64'64)'Sc-47-(24'23))
- Hafnium
  - \* Hf-178-(128'50-(26'24)) = (Te-128-(64'64)'Cr-50-(26'24))
  - \* Hf-180-(128'52-(28'24)) = (Te-128-(64'64)'Cr-52-(28'24))
- Tantalum
  - \* Ta-181-(128'53-(27'26)) = (Te-128-(64'64)'Fe-53-(27'26))
- Tungsten
  - \* W-184-(128'56-(28'28)) = (Te-128-(64'64)'Fe-56-(28'28))
- Rhenium
  - \* Re-185-(128'57-(29'28)) = (Te-128-(64'64)'Fe-57-(29'28))
  - \* Re-187-(128'59) = (Te-128-(64'64)'Co-59-(32'27))
- Iridium
  - \* Ir-191-(128'63) = (Te-128-(64'64)'Cu-63-(32'31))
  - \* Ir-193-(128'65-(34'31)) = (Te-128-(64'64)'Cu-65-(34'31))
- Osmium
  - \* Os-192-(128'64) = (Te-128-(64'64)'Zn-64-(32'32))
- Platinum

- \* Pt-192-(96-(48'48)'96-(48'48)) = (Tc-96-(48'48) ' Tc-96-(48'48))
- Mercury
  - \* Hg-200-(100-(50-(26'24)'50-(26'24))'100-(50-(26'24)'50-(26'24))) = (Ru-100-(50-(26'24)'50-(26'24)) ' Ru-100-(50-(26'24)'50-(26'24)))
  - \* Hg-202-(101-(51-(28'23)'50-(26'24))'101-(51-(28'23)'50-(26'24))) = (Ru-101-(51-(28'23)'50-(26'24)) ' Ru-101-(51-(28'23)'50-(26'24)))
- Thallium
  - \* Tl-203-(103-(52-(28'24)'51-(29'22))'100-(50-(26'24)'50-(26'24))) = (Rh-103-(52-(28'24)'51-(29'22)) ' Ru-100-(50-(26'24)'50-(26'24)))
  - \* Tl-205-(103-(52-(28'24)'51-(29'22))'102-(51-(28'23)'51-(28'23))) = (Rh-103-(52-(28'24)'51-(29'22)) ' Ru-102-(51-(28'23)'51-(28'23)))
- Lead
  - \* Pb-204-(102-(51-(29'22)'51-(29'22))'102-(51-(29'22)'51-(29'22))) = (Ru-102-(51-(29'22)'51-(29'22)) ' Ru-102-(51-(29'22)'51-(29'22)))
  - \* Pb-206-(103-(52-(28'24)'51-(29'22))'103-(52-(28'24)'51-(29'22))) = (Rh-103-(52-(28'24)'51-(29'22)) ' Rh-103-(52-(28'24)'51-(29'22)))
  - \* Pb-207-(104-(52-(28'24)'52-(28'24))'103-(52-(28'24)'51-(29'22))) = (Ru-104-(52-(28'24)'52-(28'24)) ' Rh-103-(52-(28'24)'51-(29'22)))
  - \* Pb-208-(104-(52-(28'24)'52-(28'24))'104-(52-(28'24)'52-(28'24))) = (Ru-104-(52-(28'24)'52-(28'24)) ' Ru-104-(52-(28'24)'52-(28'24)))
- Bismuth
  - \* Bi-209-(105-(53-(28'25)'52-(28'24))'104-(52-(28'24)'52-(28'24))) = (Ru-105-(53-(28'25)'52-(28'24)) ' Ru-104-(52-(28'24)'52-(28'24)))
- Astatine
  - \* At-210-(105-(54-(27'27)'51-(27'24))'105-(54-(27'27)'51-(27'24))) = (Pd-105-(54-(27'27)'51-(27'24)) ' Pd-105-(54-(27'27)'51-(27'24)))
- Polonium
  - \* Po-210-(105-(53-(28'25)'52-(28'24))'105-(53-(28'25)'52-(28'24))) = (Ru-105-(53-(28'25)'52-(28'24)) ' Ru-105-(53-(28'25)'52-(28'24)))
- Protactinium
  - \* Pa-231-(116-(58-(30'28)'58-(30'28))'115-(64'51-(28'23))) = (Sn-116-(58-(30'28)'58-(30'28)) ' In-115-(64'51-(28'23)))
- Thorium
  - \* Th-232-(116-(58-(30'28)'58-(30'28))'116-(58-(30'28)'58-(30'28))) = (Sn-116-(58-(30'28)'58-(30'28)) ' Sn-116-(58-(30'28)'58-(30'28)))
- Uranium
  - \* U-238-(120-(60'60)'118-(60'58-(30'28))) = (Sn-120-(60'60) ' Sn-118-(60'58-(30'28)))
- Level 10
  - Barium
    - \* Ba-137-(129'8) = (Te-129-(128'1) ' Be-8-(4'4))
    - \* Ba-138-(130'8) = (Te-130-(128'2) ' Be-8-(4'4))
  - Platinum
    - \* Pt-194-(97-(96-(48'48)'1)'97-(96-(48'48)'1)) = (Tc-97-(96-(48'48)'1) ' Tc-97-(96-(48'48)'1))

$$* \text{Pt-195-(98-(96-(48'48)'2)'97-(96-(48'48)'1))} = (\text{Tc-98-(96-(48'48)'2)}', \\ \text{Tc-97-(96-(48'48)'1)})$$

$$* \text{Pt-196-(98-(96-(48'48)'2)'98-(96-(48'48)'2))} = (\text{Tc-98-(96-(48'48)'2)}', \\ \text{Tc-98-(96-(48'48)'2)})$$

$$* \text{Pt-198-(99-(96-(48'48)'3)'99-(96-(48'48)'3))} = (\text{Tc-99-(96-(48'48)'3)}', \\ \text{Tc-99-(96-(48'48)'3)})$$

– Gold

$$* \text{Au-197-(99-(96-(48'48)'3)'98-(96-(48'48)'2))} = (\text{Tc-99-(96-(48'48)'3)}', \\ \text{Tc-98-(96-(48'48)'2)})$$

– Francium

$$* \text{Fr-222-(200-(100-(50-(26'24)'50-(26'24))'100-(50-(26'24)'50-(26'24)))'22} = \\ (\text{Hg-200-(100-(50-(26'24)'50-(26'24))'100-(50-(26'24)'50-(26'24)))}' \text{Na-22-(16'6)})$$

$$* \text{Fr-223-(200-(100-(50-(26'24)'50-(26'24))'100-(50-(26'24)'50-(26'24)))'23} = \\ (\text{Hg-200-(100-(50-(26'24)'50-(26'24))'100-(50-(26'24)'50-(26'24)))}' \text{Na-23-(16'7)})$$

– Radon

$$* \text{Rn-222-(202-(101-(51-(28'23)'50-(26'24))'101-(51-(28'23)'50-(26'24)))'20} = \\ (\text{Hg-202-(101-(51-(28'23)'50-(26'24))'101-(51-(28'23)'50-(26'24)))}' \text{Ne-20-(16'4)})$$

– Radium

$$* \text{Ra-226-(202-(101-(51-(28'23)'50-(26'24))'101-(51-(28'23)'50-(26'24)))'24} = \\ (\text{Hg-202-(101-(51-(28'23)'50-(26'24))'101-(51-(28'23)'50-(26'24)))}' \text{Mg-24-(16'8)})$$

$$* \\ \text{Ra-228-(202-(101-(51-(28'23)'50-(26'24))'101-(51-(28'23)'50-(26'24)))'26-(16'10-(5'5))} \\ = (\text{Hg-202-(101-(51-(28'23)'50-(26'24))'101-(51-(28'23)'50-(26'24)))}' \\ \text{Mg-26-(16'10-(5'5))})$$

– Actinium

$$* \text{Ac-227-(114-(64'50-(48'2))'113-(64'49-(27'22)))} = (\text{Cd-114-(64'50-(48'2))}' \\ \text{In-113-(64'49-(27'22))})$$



# Bibliography

- [1] Ab initio
- [2] Science
- [3] Physics
- [4] Space
- [5] Time
- [6] Matter
- [7] Ether
- [8] Ether theories
- [9] Grand Unified Theory
- [10] Theory of Everything
- [11] Elementary particle
- [12] Inertia
- [13] Velocity
- [14] Momentum
- [15] Closed system
- [16] Collision
- [17] Elastic collision
- [18] Newton's cradle
- [19] Acceleration
- [20] Electron
- [21] Proton
- [22] Neutron
- [23] Positron
- [24] Wave
- [25] Speed of light

- [26] Superposition principle
- [27] Kinematics
- [28] Gravity
- [29] Gravitational constant
- [30] Le Sage's theory of gravitation
- [31] Wave interference
- [32] Magnetism
- [33] Motion
- [34] Dynamics
- [35] Interaction
- [36] Levitation
- [37] Annihilation
- [38] Chemistry
- [39] Atom
- [40] Nucleon
- [41] Van der Waals radius
- [42] Tree
- [43] Graph
- [44] Magic number
- [45] Atomic number
- [46] Isotope
- [47] Isotone
- [48] Nuclear isomer
- [49] Metastability
- [50] Nucleosynthesis
- [51] Nuclear fission
- [52] Cluster decay
- [53] Chemical element
- [54] Isobar
- [55] Table of nuclides

- [56] Periodic table
- [57] Molecule
- [58] Substance
- [59] Temperature
- [60] Body
- [61] Cosmology
- [62] Universe
- [63] Redshift
- [64] Consciousness
- [65] Electricity
- [66] Electrical conductivity
- [67] Pattern
- [68] Broadcasting
- [69] Neuron
- [70] Dendrite
- [71] Dendritic spike
- [72] Axon
- [73] Synapse
- [74] Biological neural network
- [75] Artificial neuron
- [76] Artificial neural network
- [77] Spiking neural network
- [78] Association
- [79] Artificial intelligence
- [80] Technological singularity
- [81] GNU Free Documentation License
- [82] GNU General Public License
- [83] Creative Commons license

# Index

- acceleration of etheron, 13
- accelerative etheron exchange, 16
- amount of inertia, 12
- atom, 21
  
- chemical element, 23
- chemical number, 23
- collision of etherons, 12
- completed configuration, 23
- controlled hyperatomic fission, 35
- controlled thermoatomic fission, 35
  
- decay of photon, 32
- decay of proton, 31
- deceleration of etheron, 13
- dimensionality of hyperatomic sequence, 22
- dimensionality of hyperatomic set, 23
- duplex etheron exchange, 16
  
- element, 23
- elementary atom, 21
- eth, 14
- ether, 11
- ether atmosphere, 20
- ether aura, 14
- ether aura transformation, 17
- ether bunch, 20
- ether cloud, 20
- ether cluster, 19
- ether code, 19
- ether conductivity, 28
- ether configuration, 19
- ether drift, 15
- ether drive, 15
- ether dynamics, 15
- ether evolution, 19
- ether fluidity, 28
- ether frame of reference, 12
- ether fugitivity, 28
- ether hyperobject, 19
- ether motion, 15
- ether object, 14
- ether object-wave duality, 17
- ether quantum effects, 28
- ether quantum interpretation, 27
- ether reactor, 36
- ether subobject, 19
- ether technological singularity, 43
- ether tree, 19
- ether waves, 17
- etheristics, 44
- etheron, 11
- etheron exchange, 16
- etheronics, 44
- exchange of roles between etherons, 13
  
- geth, 14
- gravitational acceleration, 16
- gravitational-magnetic levitation, 19
- gravitational-magnetic mechanism of synthesis-isolation, 19
  
- hyperatom, 21
- hyperatomic code, 21
- hyperatomic configuration, 21
- hyperatomic fission, 34
- hyperatomic identifier, 24
- hyperatomic number, 24
- hyperatomic periodic form, 21
- hyperatomic reactor, 36
- hyperatomic sequence, 22
- hyperatomic set, 23
- hyperatomic transformation, 24
- hyperatomic tree, 21
- hyperatomistics, 44
  
- inertia of etheron, 12
  
- magnetic field, 17
- mass, 11
  
- neutron, 20

- occupation of space by etheron, 12
- outside etheron, 14
  
- primary effect, 13
- primary entity, 11
- primary relation, 12
- proteon, 20
- proton, 20
  
- simplex etheron exchange, 16
- space, 11
- space-time-ether, 11
- subatom, 21
- superposition of ether auras, 14
- synthesis of proton, 31
  
- tetrahedron, 21
- thermoatomic fission, 34
- thermoatomic reactor, 36
- thermoreactor of atomic fission, 36
- thermoreactor of hyperatomic fission, 36
- time, 11
- transit etheron exchange, 16
- triune superentity, 11
  
- uncompleted configuration, 23
- Universe, 30
  
- vector of inertia, 12
  
- Worldwide Academy of Sciences, 46
- worldwide ether neural network, 45