

# Geisteswissenschaft and Cl(16) Physics

Frank Dodd (Tony) Smith, Jr. - 2018

## Abstract

Geisteswissenschaft is the term Rudolf Steiner used for study of the Spirit World and how it relates to the Physical World described by Cl(16) - E8 - Fr3(O) - Cl(1,25) Physics of viXra 1807.0166 and 1804.0121 (called herein Cl(16) Physics) and to Human History, including the Human History shown by the National Geographic Genographic project.

Cl(16) Physics shows that our Universe originated with Finkelstein Iteration of Real Clifford Algebras from the Void ( First Grothendieck Universe ) to Cl(16) ( Second Grothendieck Universe ) whose BiVectors and two quarter-Spinors ( ++ and -- ) give Cl(16) Physics and whose TriVectors give Fr3(O) String Theory leading to a Cl(1,25) Algebraic Quantum Field Theory ( AQFT ) that generalizes Hyperfinite II1 von Neumann factor Fock Space from 2-Periodic Complex Clifford Algebra to 8-Periodic Real Clifford Algebra to get the Third Grothendieck Universe.

Rudolf Steiner used his Geisteswissenschaft to construct the First Goetheneanum in 1913 (it was burned down by arson in 1922) with structural designs corresponding to the structure of Cl(16) Physics. He viewed History as a succession of 7 cultures which I would call (also using the chronology of Manetho):

- Polarea (during Octonionic Inflation) (Spirit World)
- Hyperborea (Quaternionic, following Inflation) (Spirit World)
- Lemuria (50,000 years ago) (Spirit and Physical Worlds) - Angkor and Rig Veda
- Atlantis (40,000 years ago) (Spirit and Physical Worlds) - Pyramids and Sphinx
- Era of Demigods - connection with Spirit World declines
- Era of Spirits of the Dead - Spirit World is only a memory
- Era of Mortal Humans - Technology dominates Spirit until 2012

## Table of Contents

Title, Abstract, and Table of Contents ...	page 1
Cl(16) at the Beginning of Our Universe ...	page 3
Rudolf Steiner's Geisteswissenschaft ...	page 4
Human History = 2 Tracks: Physical and Spirit ...	page 14
Lemuria - Angkor - Rig Veda ...	page 15
Atlantis - Giza Pyramids and Sphinx ...	page 21
Microtubule Bohm Quantum Consciousness ...	page 24
History Chart and Terence McKenna ...	page 32
Africa - Cellular Automata ...	page 34
Africa - Llull - Cambridge ...	page 32 + 7 = 39
Third Age of Scholasticism ...	page 41

240 E8 Root Vectors Physical Interpretation ...	page 42
Fermions ...	page 44
Spacetime ...	page 46
Standard Model + GravityDE Ghosts ...	page 47
GravityDE + Standard Model Ghosts ...	page 50
E8 Lagrangian ...	page 51
Three Generations of Fermions ...	page 54
CI(16) Physics Calculation Results Summary ...	page 55
Nambu - Jona-Lasinio Truth Quark-AntiQuark Condensate Higgs ...	page 56
Fermilab see 3 Truth Quark Mass States - CMS sees 3 Higgs Mass States ...	page 60
Schwinger Sources, Hua Geometry, Wyler Force Strengths ...	page 62
African Origin of Indra's Net ...	page 67
Wyler Force Strength and Mass Calculation Details ...	page 70
Force Strengths ...	page 73
Higgs mass ...	page 79
Weak Boson masses and Weinberg Angle ...	page 81
Fermion masses ...	page 84
Kobayashi-Maskawa Parameters ...	page 96
Neutrino masses ...	page 106
Proton-Neutron mass difference ...	page 111
Pion as Sine-Gordon Breather ...	page 112
Planck mass ...	page 117
Conformal Gravity+Dark Energy and DE : DM : OM ...	page 118
World-Line String Bohm Quantum Theory ...	page 128
Algebraic Quantum Field Theory (AQFT) ...	page 142
Massless Spin-2 carrier of Bohm Quantum Potential ...	page 143
Penrose-Hameroff Quantum Consciousness ...	page 144
Appendix I - Some of my personal Ancestors ...	page 156
Appendix II - Deuterium - Palladium - Zeolite Fusion by Klein Paradox Quantum Tunnelling ...	page 184
Appendix III - Overview ...	page 233

## Cl(16) at the Beginning of Our Universe

The **Real Clifford Algebra Cl(16)** is the culmination of David Finkelstein's process of Iteration of Clifford Algebras that began when Our Universe emerged from an Empty Set Void in its Parent Universe by Quantum Fluctuation

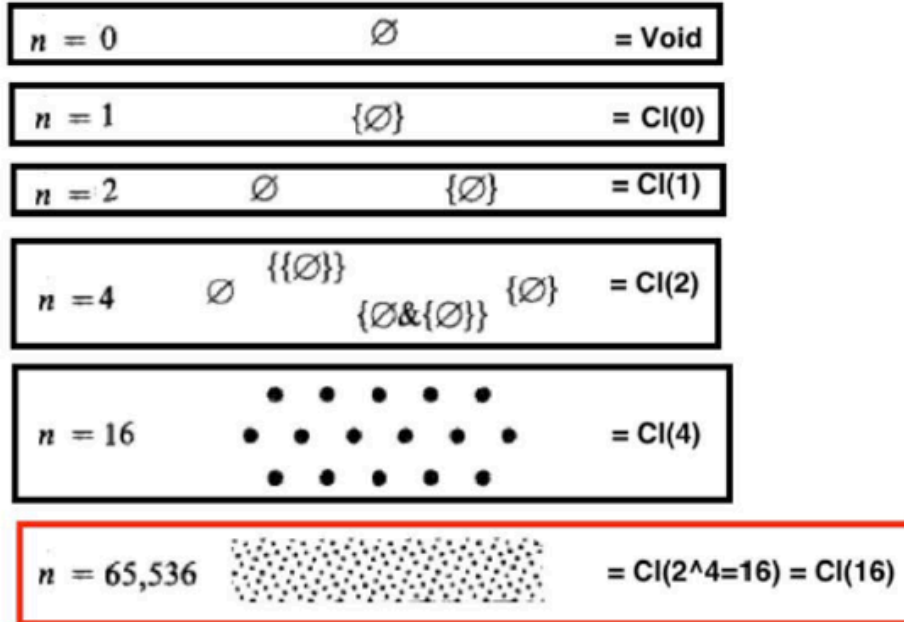

Cl(16) = Algebra of 256 x 256 Matrices of Real Numbers.

**Cl(8)** = Algebra of 16 x 16 Matrices of Real Numbers.

Cl(16) = tensor product Cl(8) x Cl(8) due to the 8-Periodicity of Real Clifford Algebras.

Cl(8) is 256-dimensional with Graded Structure  $1+8+28+56+70+56+28+8+1$

and with Spinor Structure  $8+8 = 16 = \text{sqrt}(256)$

52-dimensional **Exceptional Lie Algebra F4** lives in Cl(8) as

Grade-1 Vector 8 + Grade-2 BiVector 28 + +half-Spinor 8 + -half-Spinor 8  
BiVector Gauge Bosons and Ghosts  
28

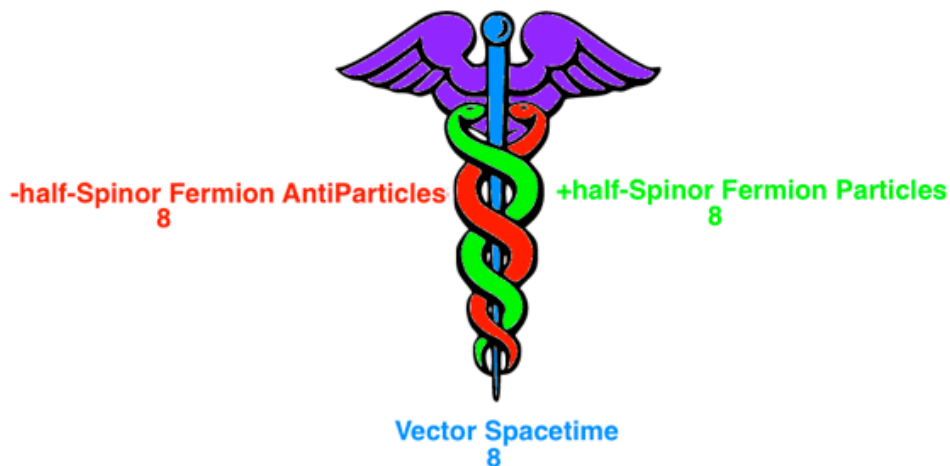

248-dimensional **Exceptional Lie Algebra E8** lives in Cl(16) = Cl(8) x Cl(8)

# Rudolf Steiner's Geisteswissenschaft

## First Goetheanum

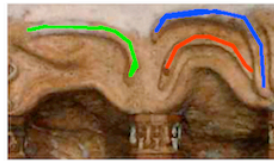
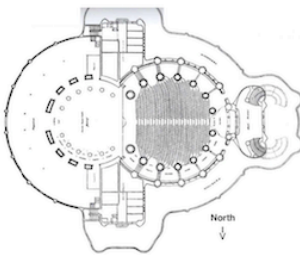

## Geisteswissenschaft

**Initial Quantum Fluctuation VOID**  
 from Parent Universe to Our Universe  
 $CI(VOID) \rightarrow CI(0) \rightarrow CI(1) \rightarrow CI(2) \rightarrow CI(4) \rightarrow CI(16)$   
 $CI(16)$  Vectors =  $D5 / D4xU(1)$  Lie Ball Interior Spirit World  
 with  $RP1xS7$  Shilov Boundary Physical World  
 $CI(16)$  BiVectors + half-Spinors =  $E8$   
 real form  $E8(-248)$  and  $E8 / Spin(16)$

### Polarea

**Octonionic Non-Unitary Creation Inflation**  
 $CI(16)$  TriVectors = 10 copies of  $Fr3(O) \text{ Aut}(Fr3(O)) = E6$   
 $E6 / D5xU(1)$  has non-tube Complex Domain  
 Shilov Boundary = fibre  $RP1xS7$  over  $S9$   
 with  $RP1 \rightarrow S9 \rightarrow CP4$  and  $CP4$  unit sphere =  $S7$   
 so  $S9$  base space contains a second  $RP1xS7$   
 $D5 / D4xU(1)$  is tube-type Complex Domain  
 with Shilov Boundary a third  $RP1xS7$   
 3 Shilov Boundary  $RP1xS7$  are isomorphic by Triality  
**Fermion Particles + Fermion AntiParticles + Spacetime**  
 real form  $E8(-248)$  and  $E8 / Spin(16)$

**CI(16) with 2-track History**  
 Physical Lie Sphere and Spirit Lie Ball Interior

**Hyperborea** - End of Octonionic Inflation  
 Quaternionic  $RP1xS3 \times CP2$   
 Separation of Lie Sphere Shilov Boundary  
 real form  $E8(-24)$  and  $E8 / Spin^*(16)$   
 from Lie Ball Interior of  $D5 / D4xU(1)$

**Quaternionic Unitary Expansion of Physical Lie Sphere**  
 to Lemuria - Atlantis (Gods) -> Demigods ->  
 -> Spirits of the Dead -> Mortal Humans

**Quaternionic Unitary Expansion of Spirit Lie Ball Interior**  
 with Complex Barnes-Wall Lattice Structure

<-- Evolutionary Metamorphosis ( 7 columns ) -->



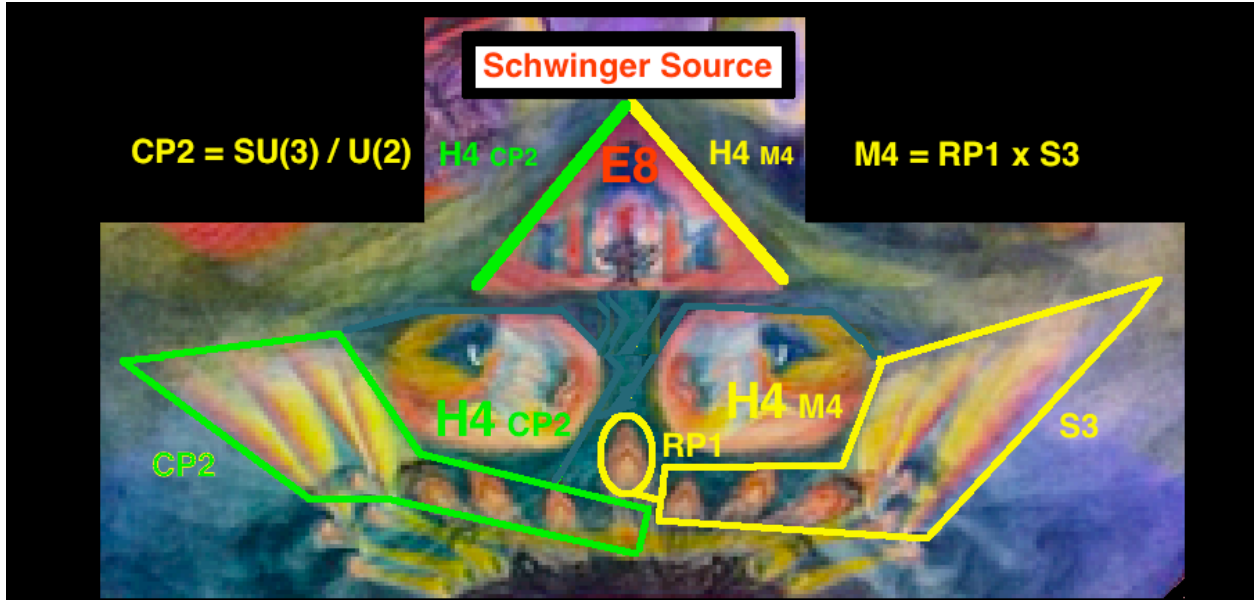

Rudolf Steiner, in Cosmic Memory, said "... The Fourfold Man ... consists of ... the **physical body**, the ether ... body, the **astral body** and the " I " ...".

My view is of the **Shilov Boundary Lie Sphere Physical World**

Physical Body is constructed of 40-micron Microtubules = 65,536 Tubulin Dimers

Ether Body is Information = 64,712 elements per Microtubule

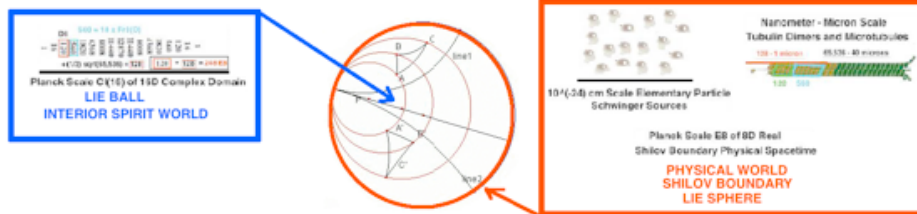

and the **Complex Domain Lie Ball Spirit World**:

Astral Body is 26D World-Line Theory Lattice Cell with 65,536-dim  $Cl(16)$  Symmetry

" I " is Information = 64,712 elements per Lattice Cell

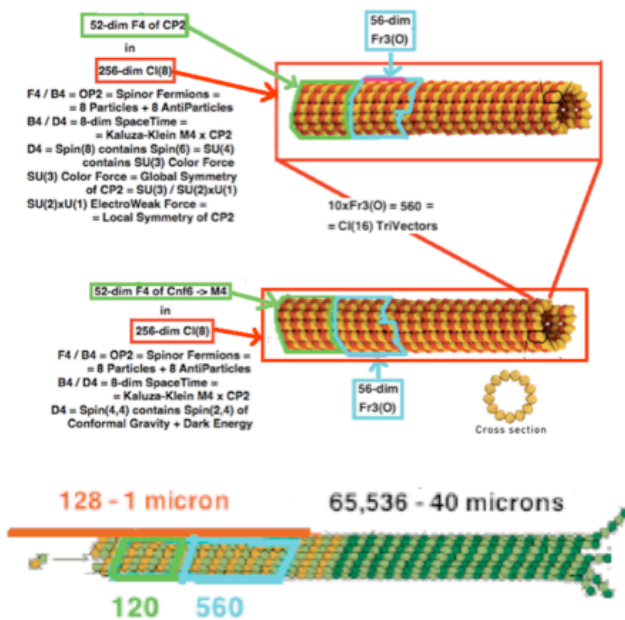

Human Brain Microtubules 40 microns = 65,536 Tubulin Dimers

**Physical Body** contains Information

- $Cl(16) = 65,536$
- 16 Vector Complex Domain
- 128 half-Spinor part of  $E_8$
- 120 BiVector part of  $E_8$
- 560 TriVector  $Fr_3(O)$
- = 64,712 Etheral Information

Kaluza-Klein Spacetime		
$M_4 \times CP_2$	$Cl(8)$ that contains 28 = $D_4$ for $M_4$ Gravity	$Cl(8)$ that contains 28 = $D_4$ for $CP_2$ Std Model
	1	1
	8	8
	28	28
	56	56
	70	70
	56	56
	28	28
	8	8
	1	1
	1	1
	8	8
	28	28
	56	56
	70	70
	56	56
	28	28
	8	8
	1	1
	16	16
	120	120
	1820	1820
	4368	4368
	8008	8008
	11440	11440
	12870	12870
	11440	11440
	8008	8008
	4368	4368
	1820	1820
	120	120
	16	16
	1	1

Spinors:  $(8s+8c) \times (8s+8c) = (8s+8c) \times (8s+8c)$

TriVectors: 560  
BiVectors: 120  
Vectors: 16

$Cl(8) \times Cl(8) = Cl(16)$

++half-half-Spinors  
--half-half-Spinors

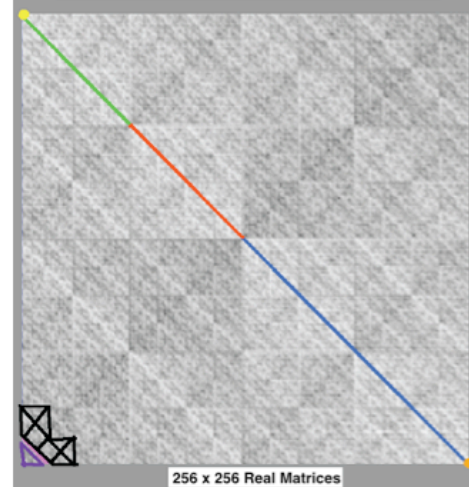

**Astral Body** contains Information

$$Cl(16) = 65,536 - 16 - 128 - 120 - 560 = 64,712 \text{ Spirit Information}$$

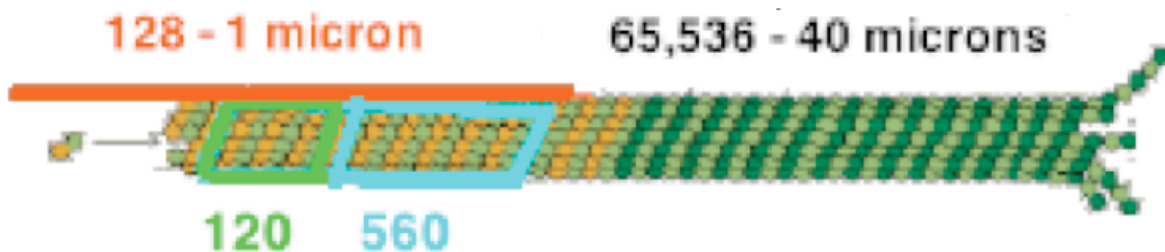
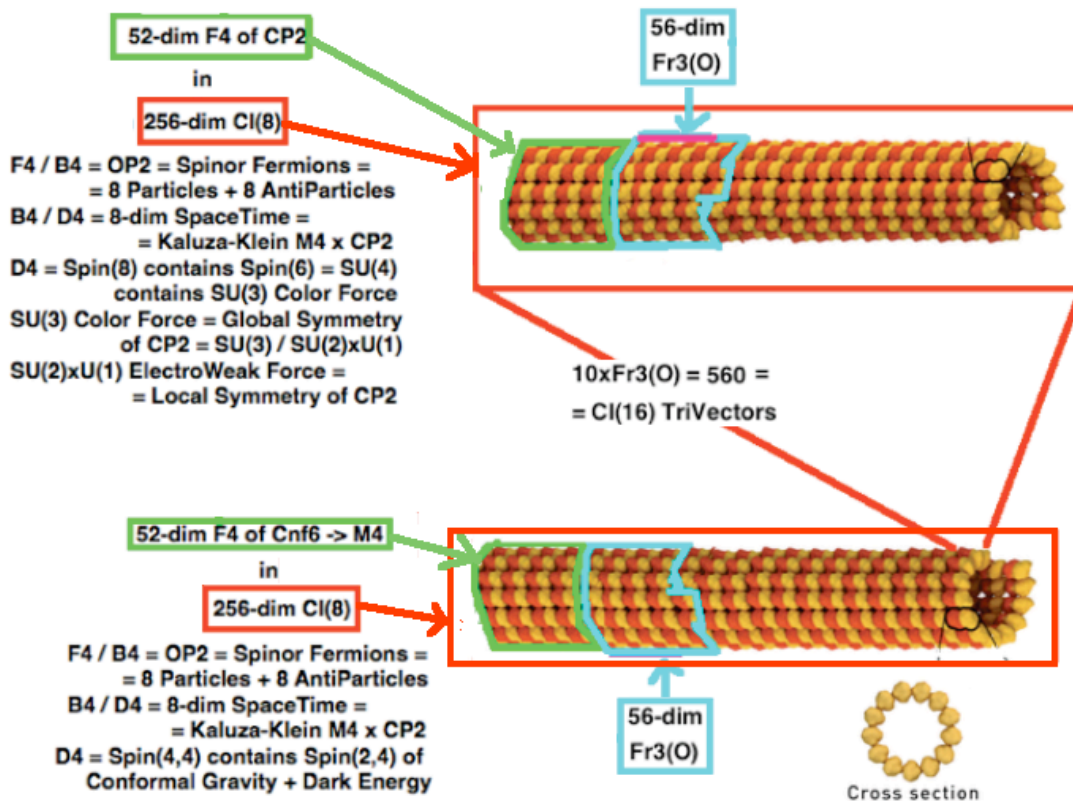

**Human Brain Microtubules 40 microns = 65,536 Tubulin Dimers**

### **Physical Body contains Information**

$$Cl(16) = 65,536$$

- 16 Vector Complex Domain
  - 128 half-Spinor part of E8
  - 120 BiVector part of E8
  - 560 TriVector Fr3(O)
- = 64,712 Ethereal Information

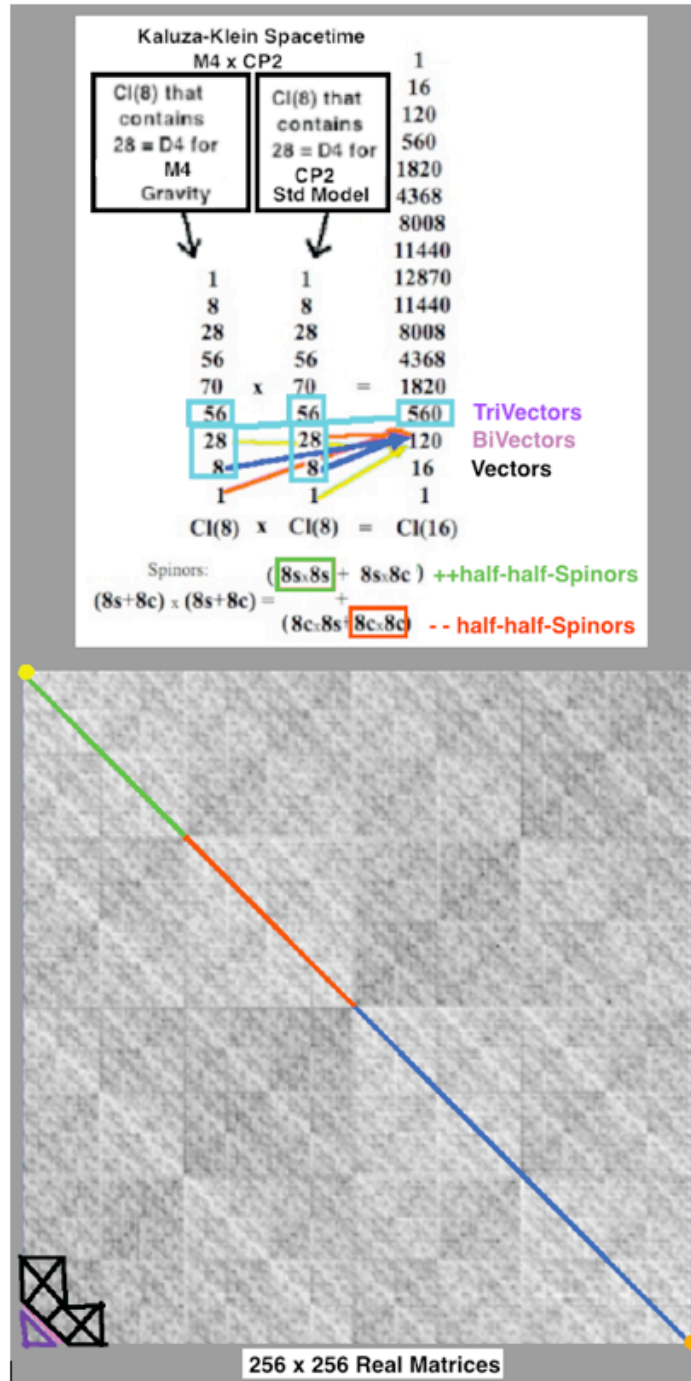

**Astral Body contains Information**  
 $Cl(16) = 65,536 - 16 - 128 - 120 - 560 =$   
 $= 64,712 \text{ Spirit Information}$



Jennie Louise Cain in her 2016 U. Michigan Ph.D. thesis says:

“... **Rudolf Steiner** (1861-1925) ... was the **founder of Anthroposophy**, a philosophy and spiritual movement whose aim ... is to develop supersensible capacities that enable access to what Steiner described as a spiritual dimension underlying all of life ... Steiner argues that the loss of original clairvoyant capacities ... of ... the ancient ... culture ... was necessary for the development of intellectualism ... **“Geisteswissenschaft” ... is the re-awakening of a spiritual awareness ...** Steiner ... regards ...the ancient Egyptians ... as oriented toward connection and interaction with the outer world, and ... the greater astronomical cosmos

...

the age of the Egyptian pyramids [was] the time of development of the “Empfindungsseele” ... the ability to experience the outer world internally ... The pyramid itself is ... a large, sensing organ (an “Empfindungsorgan”) that picks up the relationship of the earth culture as a whole to the cosmos ... Steiner’s concept of the architecture of the future ... which he would seek to materialize in his Goetheanum ... is meant as a ... re-connection with the spiritual world ... In 1913, Steiner began constructing the **Goetheanum** building in Dornach, Switzerland, ... as the headquarters of the Anthroposophical movement ...”.

Here is its floor plan from *Architecture, Painting, and Sculpture of the First Goetheanum, Nine Lectures by Rudolf Steiner 1915-1920* ( hereinafter referred to as APSFG ). He said “... Our building should portray ... how the spirits ... of the cosmos speak

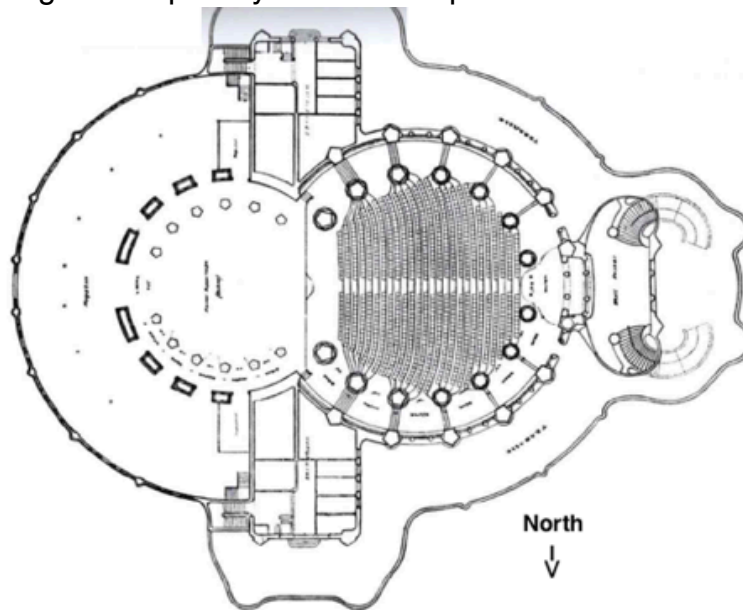

into the physical world. When we enter the building from the west and go east ... the two times seven columns ... stand in relation to each other like the ... strings of a violin ... in the twenty-seven glass windows is lurking the mystery of the path into the spiritual world ...”. The 27 windows correspond to 27-dim Jordan Algebra  $J_3(O)$  with symmetry of Lie Algebra  $F_4$  of Clifford Algebra  $Cl(8)$  of  $Cl(8) \times Cl(8) = Cl(16)$  Physics.

Its Small Cupola (Eastern) was a stage for performances. It contained 28 elements corresponding to 28-dim D4 Lie Algebra

**4+4 + 4+4 + 6+6 = 28 elements of D4 Lie Algebra that describes Gauge Boson / Ghost structure of the E8 Physics Lagrangian**

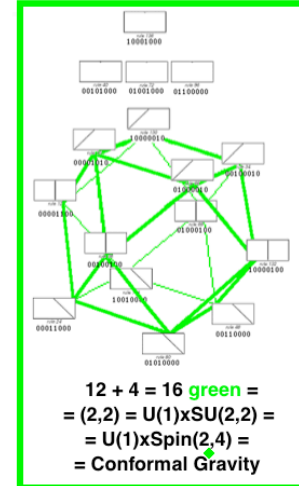
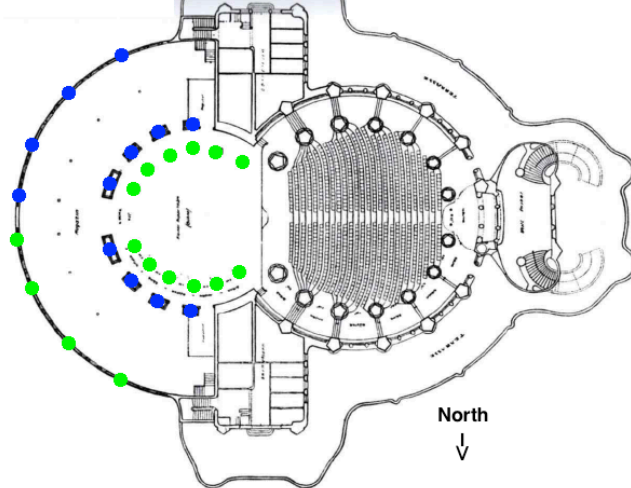
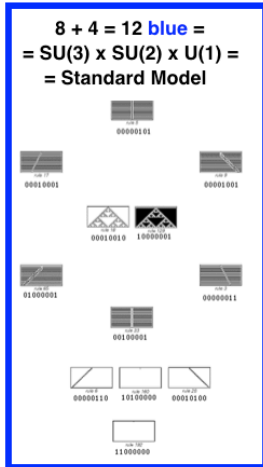

that describes how the Gauge Bosons / Ghosts of the Cl(16) Physics Lagrangian perform interactions on their stage of Spacetime.

Its Large Cupola (Western) was for the audience. It contained two sets of 7 columns.

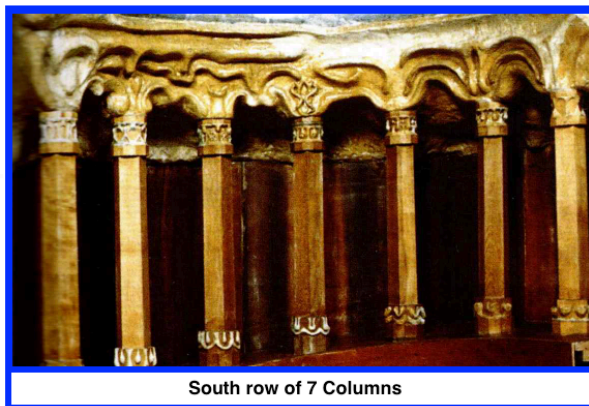
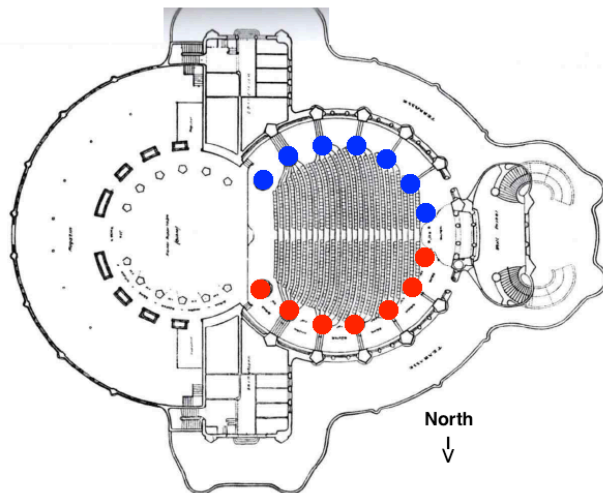

In APSFG Rudolf Steiner said "... When you come in ...[ from the West, along ]... the sole axis of symmetry ... you see a series of columns ... formed in such a way that only the symmetrical pairs have the same base and the same column. The capital formation progresses as you move from the entrance toward the stage ... you feel how the following capital always grows out of the previous with organic necessity. ...".

The 2 rows of 7 columns correspond to the 2 tracks (Physical and Spiritual) of History.

As to columns 4 and 5 of the South row, Rudolf Steiner in APSFG said "Here we come

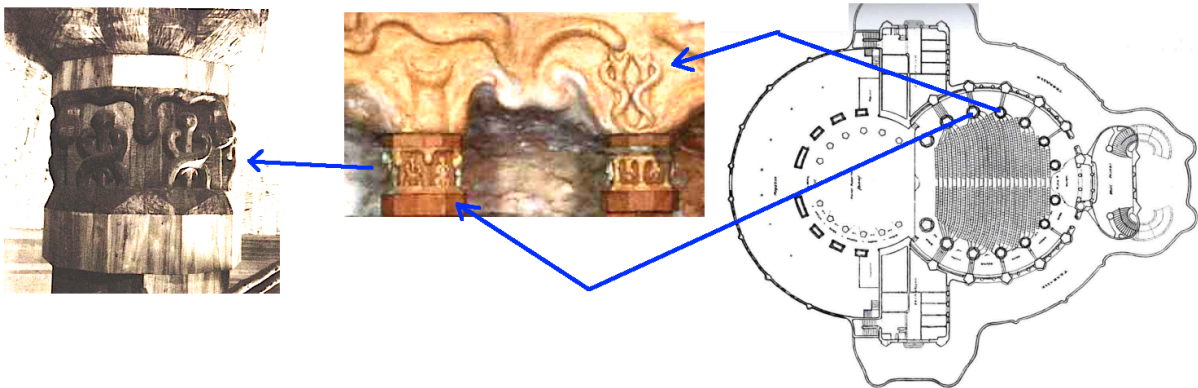

to something that causes the ... mystic ... to say: There he created a caduceus. I didn't create a caduceus; I allowed the previous forms to grow. The form originated on its own ...".

Although Rudolf Steiner claimed that his art avoided symbolism, the form of the fifth column of the First Goetheanum represents F4 Lie Algebra and the caduceus-like form of the fourth column has a similar physics interpretation:

**BiVector Gauge Bosons and Ghosts  
and Unimodular Gravity**

$$1 \times 28 + 28 \times 1 + 8 \times 8 = 120$$

**+half-half-Spinor  
Fermion Particle Components  
8x8 = 64**

**- half-half-Spinor  
Fermion AntiParticle Components  
8x8 = 64**

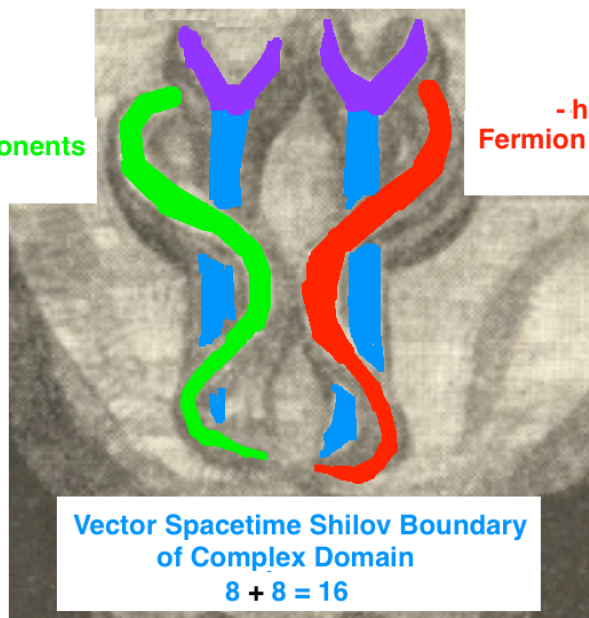

$$E8 = 120 + 64 + 64 \text{ lives in } Cl(16) = Cl(8) \times Cl(8)$$

8+8 Vectors of Cl(16) and 120 BiVectors of Cl(16) and 64+64 half-Spinors of Cl(16) with the 120 + 64+64 = 248 = E8 Lie Algebra  
In terms of Cl(8) x Cl(8) = Cl(16) and the two F4s living in the two Cl(8)s

$$1 \times 28 = D4 = 16 \text{ Gravity+Dark Energy Gauge Bosons} + 12 \text{ Standard Model Ghosts}$$

**28x1** = D4 = 12 Standard Model Gauge Bosons + 16 Gravity+Dark Energy Ghosts

**8x8** = A7+R = center of E8 Maximal Contraction Heisenberg Algebra =  
= Creation / Annihilation of 8-dim Spacetime

The Goetheanum Form has two (**blue**) Vector 8-dim Spacetime Rods  
one from the F4 in each of the two Cl(8)  
so for Cl(16) Physics of Cl(16) Spacetime Geometry has 8-Complex-dim Structure  
8+8 = 16-real dimensional D5 / D4 x U(1) Lie Sphere Symmetric Space Type BDI  
with

**8-complex-dim Bounded Complex Domain Type IV(8)**

**whose Real Part is**  
**the Shilov Boundary = 8-real-dim RP1 x S7**  
which represents the M4 x CP2 Kaluza-Klein Spacetime M4 x CP2  
( M4 = Minkowski and CP2 = SU(3) / U(2) )  
which represents  
the Earthly World

in which Human Consciousness is based on Microtubules with 65,536 Tubulin Dimers



and

**whose Imaginary Part is**  
**the interior of the Lie Ball Bounded Complex Domain of Type IV(8)**  
which represents  
the Sprit World  
in which  
the unit lattice cells have structure of Cl(16) with 65,536 elements

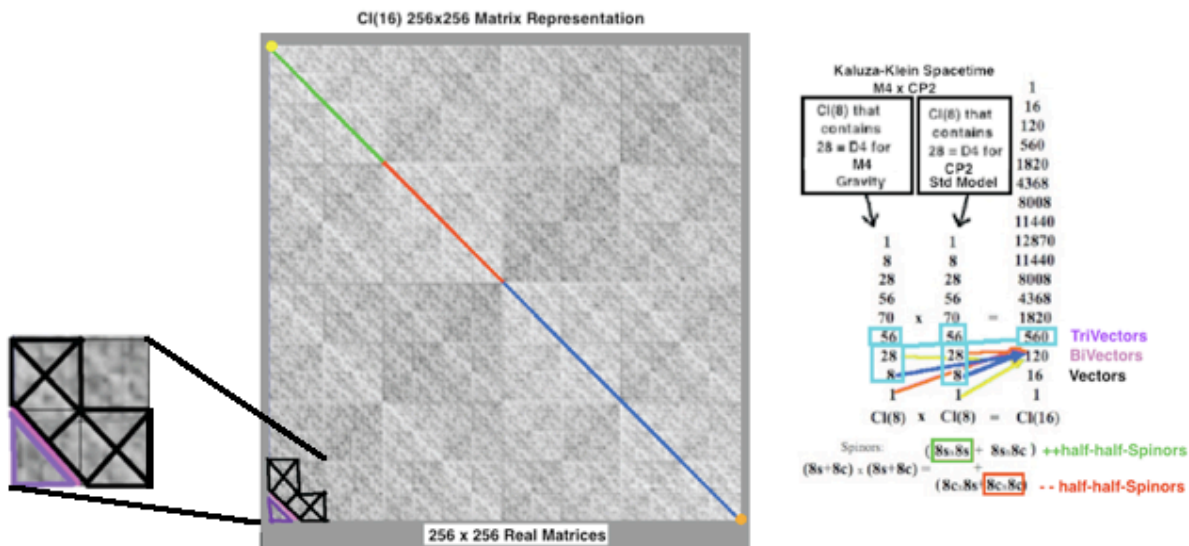

Therefore:

the art of the First Goetheanum  
shows how Rudolf Steiner's Geisteswissenschaft works  
so that

each Human Microtubule with 65,536 Tubulin Dimers  
can have a Bohm Quantum Resonant Connection with  
a Spirit World Unit Lattice Cell with 65,536-element Cl(16) Structure

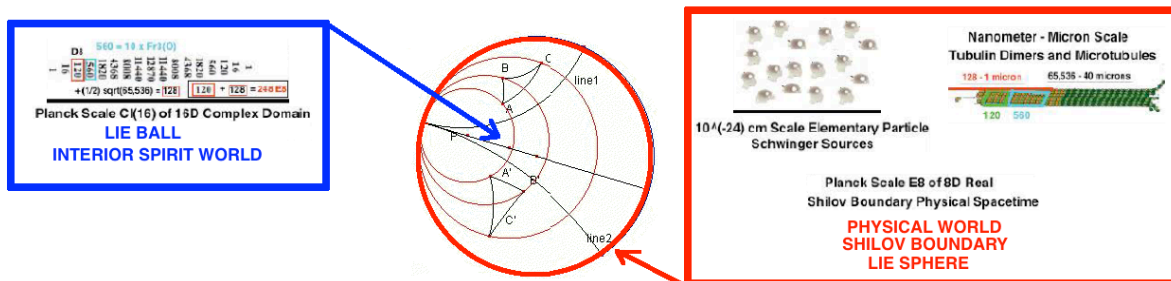

The Earthly World is the 8-real-dim Lie Sphere Shilov Boundary  $RP1 \times S7$

The Spirit World is the interior of that Shilov Boundary  
which is the Type IV(8) Bounded Complex Domain  
corresponding to the Lie Ball Symmetric Space  $D5 / D4 \times U(1)$

**The 2-fold Complex Structure of Vector Spacetime carries over by Triality  
to each of the two Fermion half-half-Spinors (green and red)  
which therefore each have  
the same Symmetric Space and Complex Domain and Shilov Boundary Structure  
as the Vector Spacetime.**

The Goetheanum Form has two (purple) D4 “wings”,  
 one from the F4 in each of the two CI(8),  
 representing the two D4 subalgebras of E8  
**D4 = 16 Gravity+Dark Energy Gauge Bosons + 12 Standard Model Ghosts**  
 and  
**D4 = 12 Standard Model Gauge Bosons + 16 Gravity+Dark Energy Ghosts**

**Human History = 2 Tracks: Physical and Spirit**

Just as the caduceus-like form of the First Goetheanum has two columns representing  
 Real Spacetime of Physical Humans and Complex Domain Interior of Spirit Space

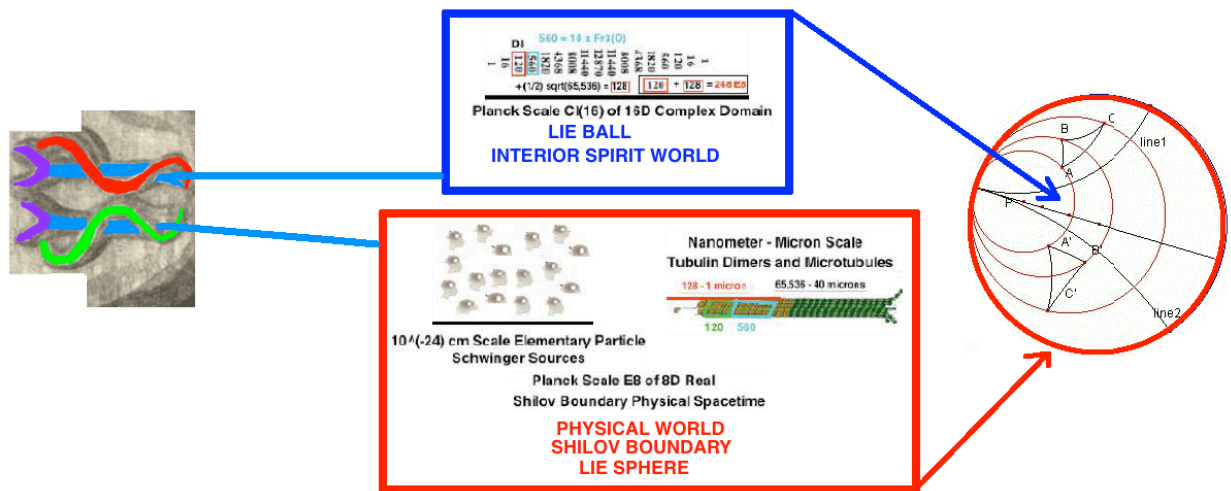

so **Human History moves along two tracks**. Now, with Physical Humans having  
 Consciousness based Microtubules in Resonance with Spirit Space CI(16) Cells,  
 the two tracks of Human History are moving in concert together  
 but  
 in earlier times before the Physical Ancestors of Humans had fully developed  
 Microtubule Quantum Consciousness  
 there was no Resonant Connection with Spirit Space CI(16) Cells  
 and  
 the evolutionary History of the Spirits of Humanity was quite independent of  
 and different from the evolutionary History of the Physical Ancestors of Humanity.

This was known to Rudolf Steiner in his 1909 book Cosmic Memory about the History of  
 the Spirits of Humanity: “... this history ... is called the “**Akasha Chronicle**”

... **it should be said that spiritual perception is not infallible** ...

the ... root races of our earth.

The first is called the **Polarean** ...

the second, the **Hyperborean** race ...

the third human root race ... inhabited the **Lemurian** Continent

...

Actually, one can only begin to speak of "races" in connection with the development attained in ... the ... third principal condition ... (Lemurian) ... originating the two sexes ...

[ comment by TS: this is when the two tracks of Human History Merged into Concert: when the unisex Spirit Beings, then the Hyperboreans, connected with the 2-sex Physical Lemurians emerging in Africa, thus giving Lemurians high Spiritual capabilities ] ...

the main part of ... the Lemurian Continent ... lay south of contemporary Asia ... the Lemurian could communicate with his fellow-men without needing a language. This communication consisted in a kind of "thought reading." ... their ideas had a quite different strength from those of later men. Through this strength they acted upon their environment. Other men, animals, plants, and even lifeless objects could feel this action and could be influenced purely by ideas. ... The Lemurian derived the strength of his ideas directly from the objects which surrounded him. ... the **Lemurians ...[were the]... ancestors of the Atlanteans** ...

the ... Atlantean Continent ... was once ... the floor of the Atlantic Ocean ... the last remnants of this continent sank in the tenth millennium B.C. ...”.

The National Geographic Genographic Project studied the migration of Humans out of Africa using Y-DNA data. The first group to leave Africa was **Lemurian M174** about 50,000 years ago along the dark blue line in the map below:

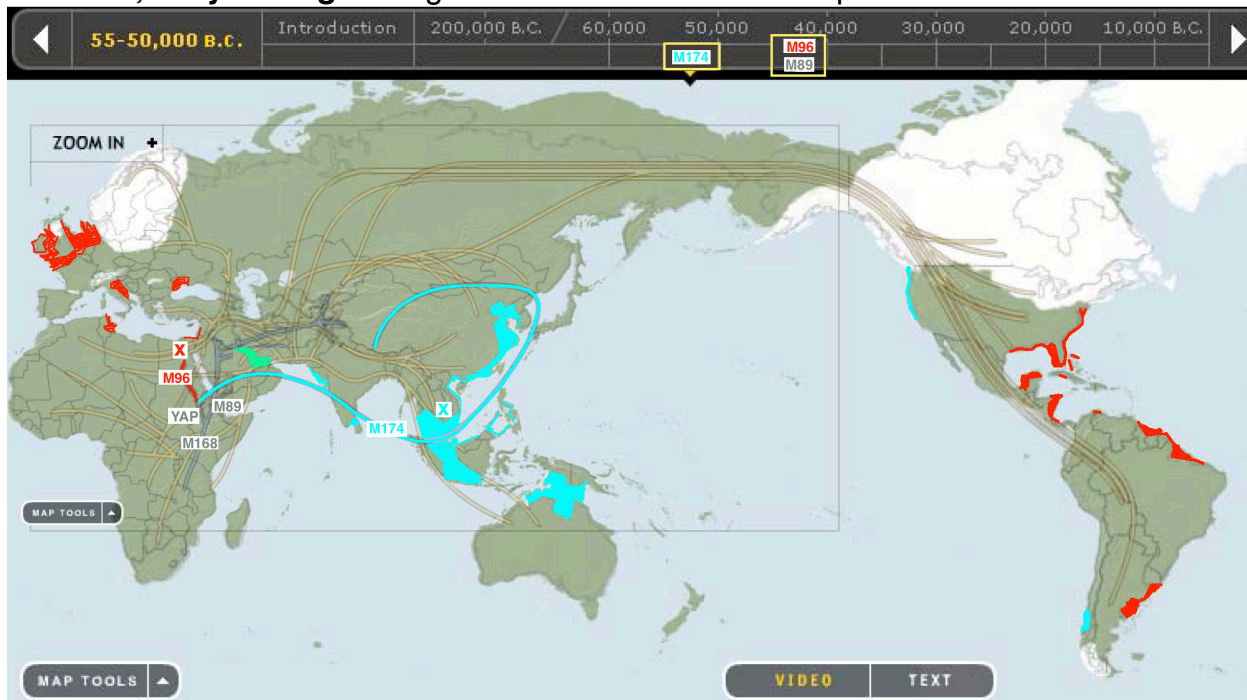

At that time all the area colored cyan was dry land and home of many Lemurians. The x colored cyan is the location of the Angkor Temple Complex that I think was built by the Lemurians shortly after they arrived. I think they also then developed Sanskrit and wrote the Rig Veda to preserve the high culture they had developed back in Africa. Lemurians crossed the Pacific Ocean to the West Coast of the Americas. About 50,000 years ago (National Geographic Genographic) YAP and M174 went out of Africa to Sunda (then dry land South of Angkor Wat and SouthEast of India)

and on to Japan and Tibet:



Angkor Thom, Angkor Wat, Phnom Bakheng

<->

Giza Great Pyramid Cl(8) (gde), Second Pyramid Cl(8) (sm), Sphinx Cl(16) (E8+Fr3(O))  
**Angkor Thom:** 8 yellow Outer Towers + 16 green Middle Towers =  
 = 24-dim OxOxO of Fr3(O) 26-D String=World-Line Theory



1 orange Inner Tower = Bohm Quantum Potential from Cl(16) TriVectors  
 4 red + 12 Gray Inner Towers = Fundamental Lepton + Quark  
 Particles / AntiParticles from Cl(16) half-spinors

**Angkor Wat:** 4 yellow Inner Towers = 4-dim Minkowski Physical Spacetime  
 of Kaluza-Klein M4 x CP2 from Cl(16) BiVectors  
 4 orange Middle Towers = 4-dim CP2 = SU(3) / SU(2) x U(1) Internal Space  
 of Kaluza-Klein M4 x CP2 from Cl(16) BiVectors

**Phnom Bakheng:** 64 cyan Towers = D8 / D4 x D4 = by Cl(16) Triality =  
 = ++half-Spinor Fermion Particles (8 components) =  
 = - -half-Spinor Fermion AntiParticles (8 components)  
 = 64 + 64 = 128 = E8 / D8

### Rig Veda

Akashkar	Buddhi	Manas	Akash	Vayu	Agni	Jal	Prithvi	Akashkar	Buddhi	Manas	Akash	Vayu	Agni	Jal	Prithvi	Akashkar	Buddhi	Manas	Akash	Vayu	Agni	Jal	Prithvi
अक	नि	मी	ले	पु	रो	हि	तं	य	ज्ञ	स्यं	दे	व	मू	त्वि	जम्	हो	ता	रं	र	लु	धा	तं	मम्
AK	NI	MI	LE	PU	RO	HI	TAM	YA	GYA	SYA	DE	VA	MRI	TVI	JAM	HO	TA	RAM	RA	TNA	DHA	TA	MAM
अ	मिः	पू	वै	मिः	अ	वि	प्रि	री	ड	सो	नू	तं	नै	इ	त	स	दे	वाँ	ए	ह	दं	च	ति
अ	मि	नां	उ	मि	भं	श्न	उ	त्वो	वं	मे	व	दि	वे	दि	वे	स	श	सं	वो	र	वं	त	मम्
अ	मे	यं	यु	ज्ञ	मं	ध्व	रं	वि	श्	कं	प	दि	पु	र	सिं	स	इ	दे	वे	धुं	ग	च्छ	ति
अ	मिः	हो	वां	क	वि	कं	तुः	सु	त्यश्	चि	त्र	श्रं	व	स्त	पः	दे	वो	दे	वे	पि	रा	गं	मव
य	ड	ङ्ग	दा	सु	धे	तु	वं	अ	गै	पु	इं	क	रि	प्य	सिं	त	वेत्	तत्	सु	त्व	मं	ङ्गि	रः
उ	पं	त्वा	शे	दि	वे	दि	वे	दो	भं	व	स्वर	धि	या	वु	यम्	न	मो	भ	रं	नु	ए	मं	सि
रा	वं	न्त	म	ध्व	रा	शां	गो	पा	मू	त	स्व	दी	दि	वि	प	व	धं	मा	तुं	सु	वे	द	यं
स	नः	पि	ते	वं	सु	न	वे	अ	मं	सु	षा	यु	नो	वं	व	स	वं	सु	आ	नः	स्व	स्त	यं

24 First Richa Syllables + 24 First Richa Gaps = D4sm + D4gde (purple box)

8x8 = 64 Last-8 Syllables of Last 8 lines = D8 / D4sm x D4gde (blue box)

8x8 = 64 (red box) plus 8x8 = 64 (green box) give 128 = E8 / D8 = Fermions  
 Middle-8 Syllables of Last 8 lines plus First-8 Syllables of Last 8 Lines

According to Wikipedia and emails from John Small:

“... The Rig Veda is composed of ten books (called mandalas in Sanskrit)  
 [that correspond to 10 Spacetime dimensions of 26D World-Line=String Theory] ...

The first book [RV1] is a collection of hymns from seers of different families  
 [encapsulating the whole Rig Veda] ...

Seven of the books [RV2 through RV8] each relate primarily to one great seer  
 [and represent the 7 imaginary Octonions] ...

The ninth book is [RV9] Soma hymns [and represent the Octonion Real Axis]

Terence McKenna postulates that the most likely candidate for soma is the mushroom  
 Psilocybe cubensis, a hallucinogenic mushroom that grows in cow dung ... the 9th  
 mandala of the Rig Veda makes ... references to the cow as the embodiment of soma ...

The tenth book [RV10] [complements the first and fills in the gaps]...”.

RV2 through RV9 together represent  
the Octonion Structure of  $\text{Spin}(0,8) = \text{Spin}(1,7)$   
and the  $\text{RP}1 \times \text{S}7$  Lie Sphere Shilov Boundary of Type IV(8) Complex Domain  
of Lie Ball Symmetric Space  $\text{Spin}(2,8) / \text{Spin}(8) \times \text{U}(1)$

RV1 and RV10 together represent  
the (1,1) Conformal Structure of  $\text{Spin}(1,9) = \text{Spin}(2,8) = \text{SL}(2,0)$

According to **The Constitution of the Universe by Maharishi Mahesh Yogi**, printed in The Wall Street Journal (6 January 1992) a copy of which was sent to me in pamphlet form by John Small in August 2003:

"... the ancient Vedic wisdom ... identifies a single, universal source of all orderliness in nature ... the Constitution of the Universe ... is embodied in the very structure of the sounds of the Rik Ved, the most fundamental aspect of the Vedic literature ...

According to Maharishi's Apaurusheya Bhashya, the structure of the Ved provides its own commentary ... The knowledge of the total Ved ... is contained in the first sukt of the Rik Ved ... The precise sequence of sounds is highly significant; it is in the sequential progression of sound and silence that the true meaning and content of the Ved reside ... The complete knowledge of the Ved contained in the first sukt (stanza) is also found in the first richa (verse) - the first twenty-four syllables of the first sukt (stanza 1).

This complete knowledge is again contained in the first pad, or first eight syllables of the first richa, and is also found in the first syllable of the Ved, 'AK', which contains the total dynamics of consciousness knowing itself.

According to Maharishi's Apaurusheya Bhashya of the Ved, 'AK' describes the collapse of the fullness of consciousness (A) within itself to its own point value (K).

This collapse, which represents the eternal dynamics of consciousness knowing itself, occurs in eight successive stages.

In the next stage of unfoldment of the Ved, these eight stages of collapse are separately elaborated in the eight syllables of the first pad, which emerges from, and provides a further commentary on, the first syllable of Rik Ved, 'AK'.

These eight syllables correspond to the eight 'Prakritis' (Ahamkar, etc.) or eight fundamental qualities of intelligence ...

The first line, or 'richa', of the first sukt, comprising 24 syllables, provides a further commentary on the first pad (phrase of eight syllables);

The first pad expresses the eight Prakritis ... with respect to the knower ... observer ... or 'Rishi' quality of pure consciousness.

The second pad expresses the eight Prakritis with respect to the process of knowing ... process of observation ... of 'Devata' (dynamism) quality of pure consciousness.

The third pad expresses the eight Prakritis with respect to the known ... observed ... or 'Chhandas' quality of pure consciousness. ...

The subsequent eight lines complete the remainder of the first sukt - the next stage of sequential unfoldment of knowledge in the Ved. These eight lines consist of 24 padas (phrases), comprising  $8 \times 24 = 192$  syllables. ... these 24 padas of eight syllables elaborate the unmanifest, eight-fold structure of the 24 gaps between the syllables of the first richa (verse). ... Ultimately, in the subsequent stages of unfoldment, these 192 syllables of the first sukt (stanza) get elaborated in the 192 suktas that comprise the first mandal (circular cyclical eternal structure) of the Rik Ved, which in turn gives rise to the rest of the Ved and the entire Vedic literature. ...".

According to Wikipedia:

"... Indra is praised as the highest god in 250 hymns of the Rigveda ... the earliest reference to a net belonging to Indra is in the Atharva Veda ... "Indra's net" is the net of the Vedic deva Indra, whose net hangs over his palace on Mount Meru, the axis mundi of Buddhist and Hindu cosmology. In this metaphor, Indra's net has a multifaceted jewel at each vertex, and each jewel is reflected in all of the other jewels. ...

Aspects of Indra as a deity are cognate to other ... thunder gods

...

Chango is the most feared god in Santería ... Şàngó is viewed as the most powerful ... orisha ... He casts a "thunderstone" to earth, which creates **thunder** and lightning ... Chango ... had three wives ... Princess Oshun, Princess Oba, and Princess Oya ... Oshun is the deity of the river ... She is connected to destiny and **divination** ... The abèbè is the ritual object most associated with Oşun. The abèbè is a fan in circular form ... with a **mirror** in the center ...".

**Chango and Indra both use Thunder,  
and Chango's wife Oshun does Divination with a Mirror so  
Chango and Oshun are two of the African IFA Orishas  
who are precursors of Vedic Indra and Indra's Net.**

Japan, the next stop beyond Sunda of Human M174 migration Out of Africa, has 128-element ( Dixon Spinor part of IFA ) Futomani Divination and similar culture:



the sacred Yata no Kagami, or Eight-Handed Mirror - analogous to Indra Net Reflections  
the Sword Kusanagi no Tsurugi - analogous to ThunderBolts  
the curved Yasakani no Magatama Jewel - analogous to Indra Jewels

Graham Hancock, in *Heaven's Mirror*, said "... Our current world age is Pisces because on the spring equinox ... Pisces rises just ahead of the sun ... because of precession ... ( 1 degree in 72 years) ... the sun spends around 2160 years [ 2160 = second layer vertices of all E8 Lie Algebra Lattices ] in each constellation - a complete revolution taking 26,000 years!  
 The great Hindu temple-complex ... spread over 200 square miles confirms that they correspond to the stars in the constellation of Draco, as they appeared in 10,500 BC! ...

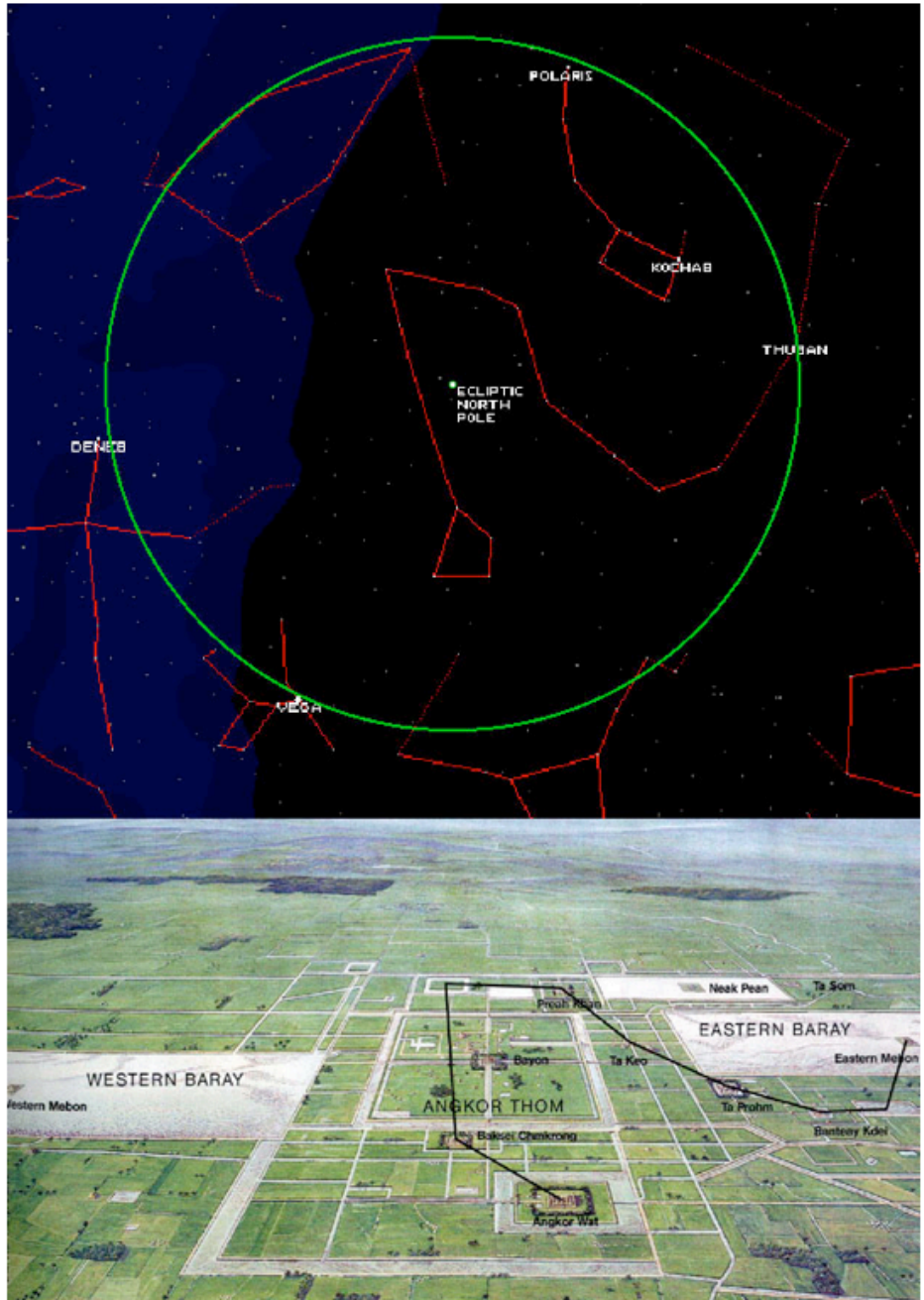

... "

The same star configuration of 10,500 BC = 12,500 years ago would have appeared in the previous precession period about 38,500 years ago, with Vega as North Star and Angkor Thom as the Ecliptic North Pole, about the time humans first arrived from Africa.

Somewhat later, **about 40,000 years ago, another group, the Atlantean M96,** migrated up the Nile River to Giza, marked by the x colored red, where I think the Atlanteans built the Great and Second Pyramids and the Sphinx shortly after they arrived in Giza, encoding African wisdom in those structures. At that time all the area colored red was dry land and home of many Atlanteans. Atlanteans crossed the Atlantic Ocean to the East Coast of the Americas.

Yet another group, M89, ordinary Humans neither Lemurian nor Atlantean, migrated by crossing the Red Sea. Their descendants are now 90-95 percent of all non-Africans.

About 12,000 years ago, also about the time of the Vela X supernova, the red part of Atlantis and the cyan part of Lemuria were submerged by floods from melted glaciers.

The last 12,000 years have been marked by conflicts over the more limited resources that remained after so much productive land was flooded.

As M174 Lemurians and M96 Atlanteans merged with indigenous M89 ordinary Humans their Spiritual capabilities decreased and relatively recent conflicts resembled wars between M174 Lemurians to the East and M96 Atlanteans to the West of a Middle Ground near the Garden of Eden populated by the M89 vast majority of non-Africans



Some of the relatively recent Atlantean-Lemurian conflicts were  
Egyptian-Babylonian battles of Megiddo and Carchemish around 2600 years ago  
Greco-Persian Wars around 2500 years ago  
Alexander the Great around 2300 years ago

After the victories of Alexander the Great, his friend, historian, and general Ptolemy I ruled Egypt and its cultural center Alexandria and commissioned Manetho to document history.

Manetho's history of Humans included:

- 36,525 years ago** - Rule of Gods = M174 Lemurians and M96 Atlanteans -
  - North Star Vega - Geminga Supernova Shock Wave hits Earth
- 22,625 years ago** - Rule of Demigods
  - Lemurian and Atlantean Spiritual Capabilities begin to decline
- 17,413 years ago** - Rule of Spirits of the Dead =
  - = Lemurians and Atlanteans have lost much of their Spritual Capabilities and try to rule by remembering lost abilities
- 11,600 years ago** - Rule of Mortal Humans = M89 ordinary Humans -
  - Technology dominates Spirit -
- North Star Vega - Vela X Supernova - Taurid / Encke comet fragmented -
  - floods due to melted glaciers

**Vega was North Star at time of Pyramids-Sphinx and Angkor Temples.  
were built when Vega was North Star.**

**Were they built 12,000 years ago or 38,000 years ago ?**

**Gobekli Tepe Temple of Hunter-Gatherers favors earlier construction.**

Wikipedia: "... Göbekli Tepe ... is an archaeological site in ... Southeastern Anatolia ... The tell has a height of 15 m (49 ft) and is about 300 m (980 ft) in diameter. It is approximately 760 m (2,490 ft) above sea level. The tell includes two phases dating back to the 10th–8th millennium BCE. At the first phase ... circular compounds or temene first appear. They range from 10 to 30 metres in diameter ... Scholars cannot interpret the pictograms ... The ... structures ... not only predate pottery, metallurgy, and the invention of writing or the wheel, but were built before the so-called Neolithic Revolution, i.e., the beginning of agriculture and animal husbandry around 9000 BCE. But the construction of Göbekli Tepe implies organization of an advanced order not hitherto associated with Paleolithic, PPNA, or PPNB societies ... **If indeed the site was built by hunter-gatherers ... then it would mean that the ability to erect monumental complexes was within ... [their]... capacities ... which would overturn previous assumptions ...**".

Therefore, when Atlantean Humans reached Giza they built

**two large Pyramids - each representing Cl(8)  
whose 8 Vectors + 28 BiVectors + 16 Spinors = F4 Lie Algebra**

**one for F4gde = Conformal Gravity + Dark Energy  
one for F4sm = Standard Model  
and the Sphinx - representing Cl(16)**

**whose 120 BiVectors + 128 half-Spinors = E8 = Lagrangian  
and  
whose 560 TriVectors = 10 copies of Fr3(O) = 26D World-Line-String Theory**

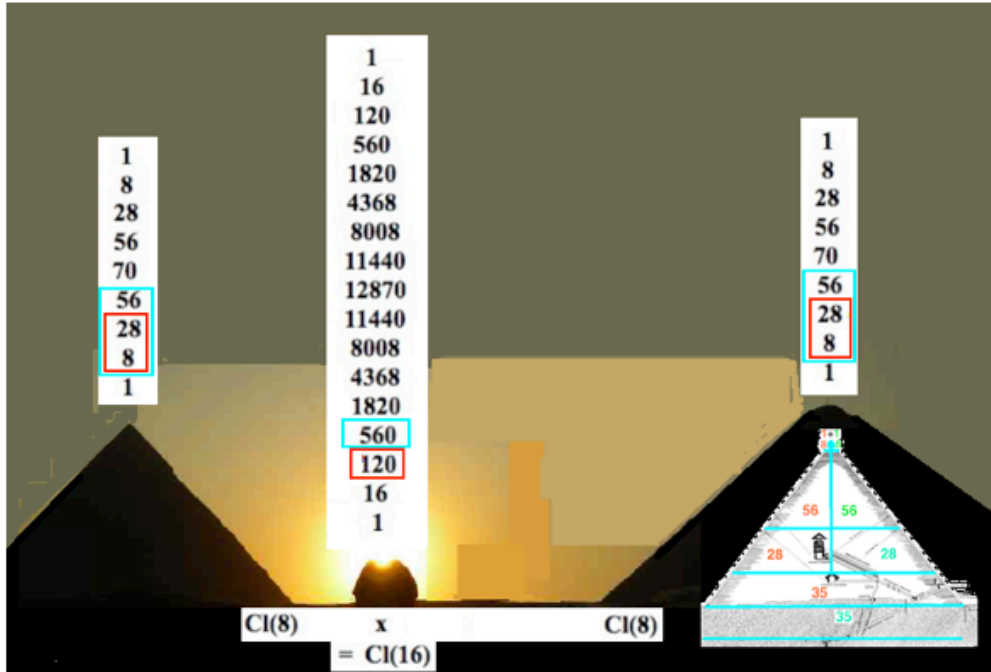

Each Pyramid represented a copy of  $Cl(8)$  with graded structure  
 $256 = 1 + 8 + 28 + 56 + 70 + 56 + 28 + 8 + 1 = (8L+8R) \times (8L+8R)$   
 so that each contained a copy of 56-dim  $Fr3(O)$   
 and of 52-dim  $F4 = 8 + 28 + (8L+8R)$

By 8-Periodicity of Real Clifford Algebras the tensor product  $Cl(8) \times Cl(8) = Cl(16)$   
 $Cl(16)$  contains 10 copies of  $Fr3(O) = 1 \times 56 + 8 \times 28 + 28 \times 8 + 56 \times 1 = 560$  elements  
 related to 26D World-Line=String Theory

$Cl(16)$  contains  $(1 \times 28 + 8 \times 8 + 28 \times 1 = 120) + (8L \times 8L + 8R \times 8R = 128) = 248$ -dim  $E8$

248-dim  $E8$  structure came from the  $F4_{gde}$  and  $F4_{sm}$  of the two Pyramids:

tensor product  $Cl(16) = Cl(8) \times Cl(8)$

induces the product

$E8 = F4_{gde} \times F4_{sm}$

120-dim  $Cl(16)$  BiVectors =  $1 \times 28 + 8 \times 8 + 28 \times 1$  of  $Cl(8) \times Cl(8)$

128-dim  $Cl(16)$  Half-Spinors =  $8L \times 8L + 8R \times 8R$  of  $Cl(8) \times Cl(8)$

where  $8L$  denotes left-handed Half-Spinors of  $Cl(8)$

and  $8R$  denotes right-handed Half-Spinors of  $Cl(8)$

and

$8L \times 8L + 8R \times 8R$  are the Half-Spinors of  $Cl(16)$  with consistent handed-ness structure.

**256-dim  $Cl(8) \times 256$ -dim  $Cl(8) = 65,536$ -dim  $Cl(16)$  Clifford Algebra structure is also present in Microtubules = 40 micron size aggregates of 65,536 tubulin dimers that are the basis of Penrose-Hameroff Bohm Potential Quantum Consciousness.**

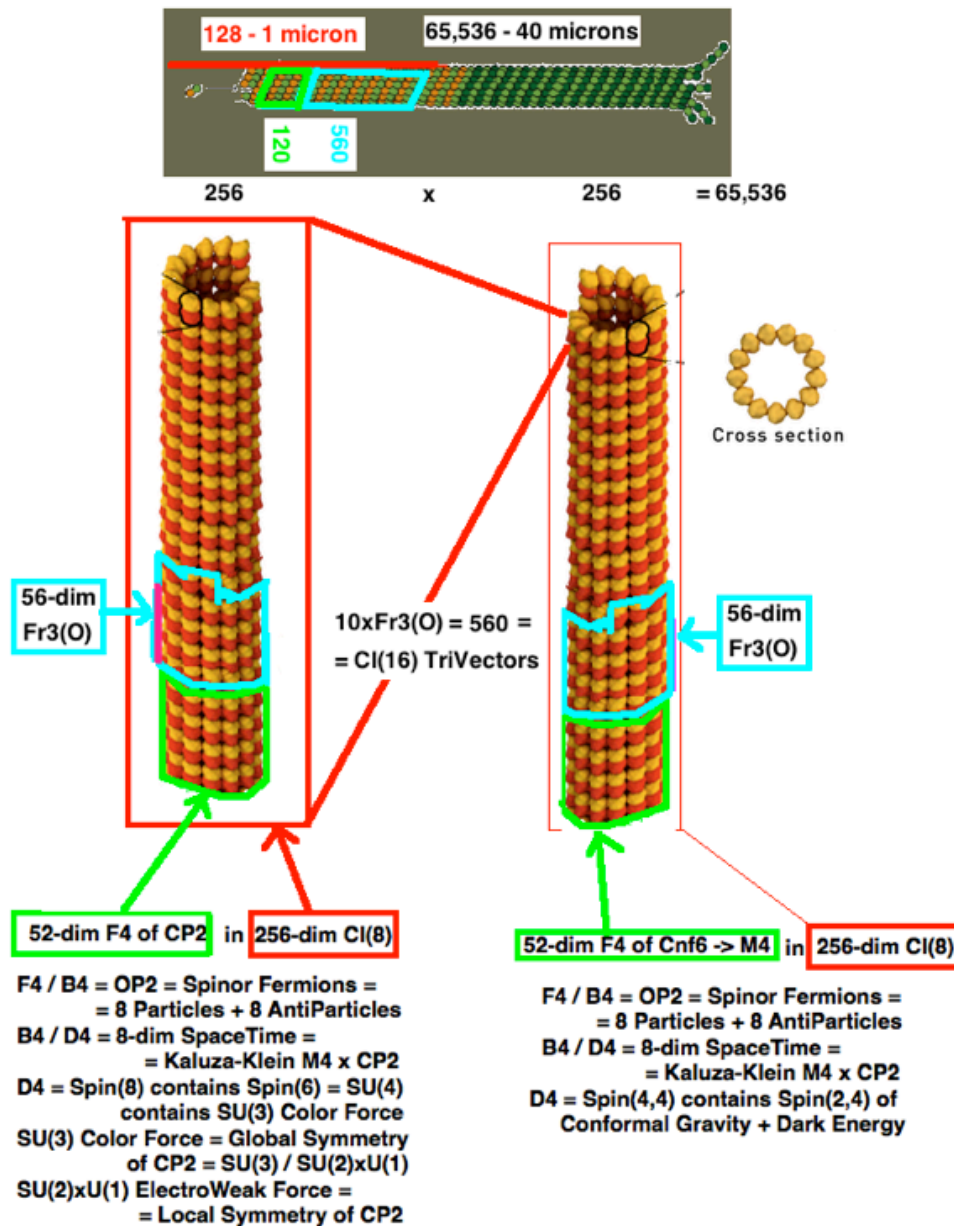

Assembly of 65,536 tubulins into a 40-micron microtubule can be seen to be analogous to the  $256 \times 256$  tensor product  $Cl(8) \times Cl(8)$  where one 256-dim  $Cl(8)$  represents Conformal Gravity+Dark Energy with  $F_4gde$  related to the Minkowski  $M_4$  of Kaluza-Klein  $M_4 \times CP^2$  and the other  $Cl(8)$  represents Standard Model  $U(1) \ SU(2) \ SU(3)$  with  $F_4sm$  related to the  $CP^2 = SU(3) / SU(2) \times U(1)$  of Kaluza-Klein  $M_4 \times CP^2$

**The  $E_8$  and 10 copies of  $Fr_3(O)$  of  $Cl(16)$  only use  $248 + 560$  of the 65,536 elements so that 64,728  $Cl(16)$  elements are available for Quantum Consciousness thought processes**



The Great Pyramid slope is of a Golden Ratio Right Triangle representing Conformal Gravity+Dark Energy with Gauge Group Spin(2,4) = SU(2,2)  
 It represents M4 of Kaluza-Klein M4 x CP2 and is represented by F4gde

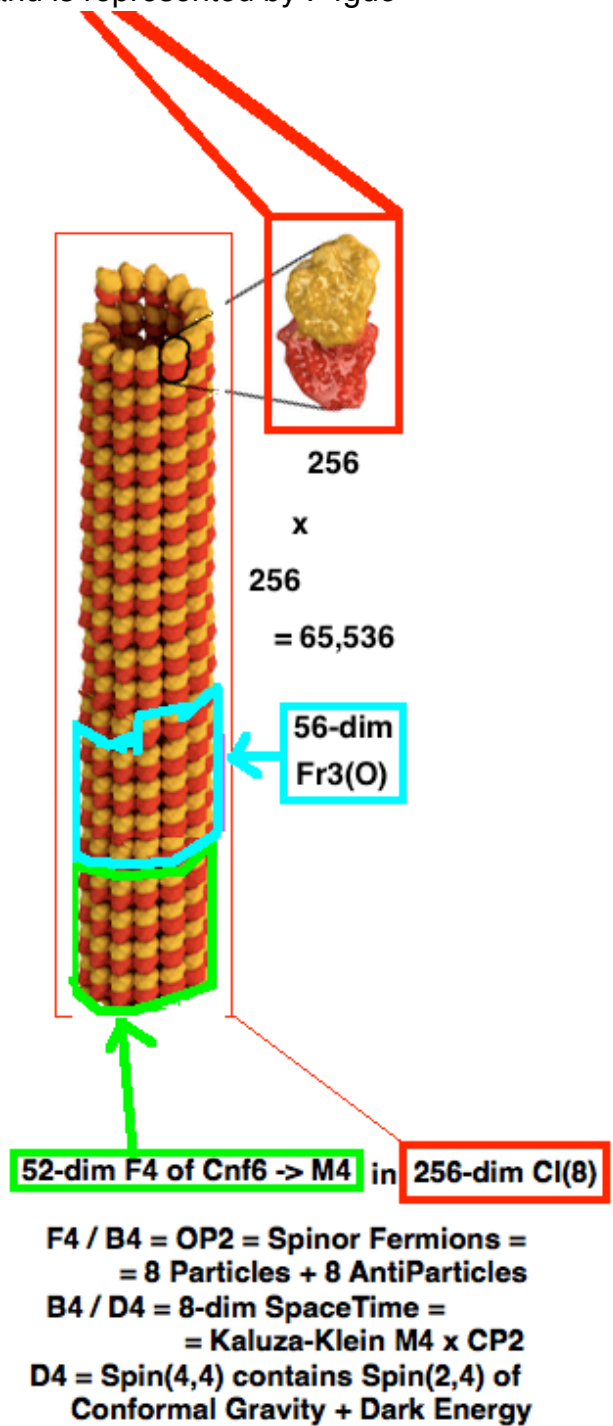
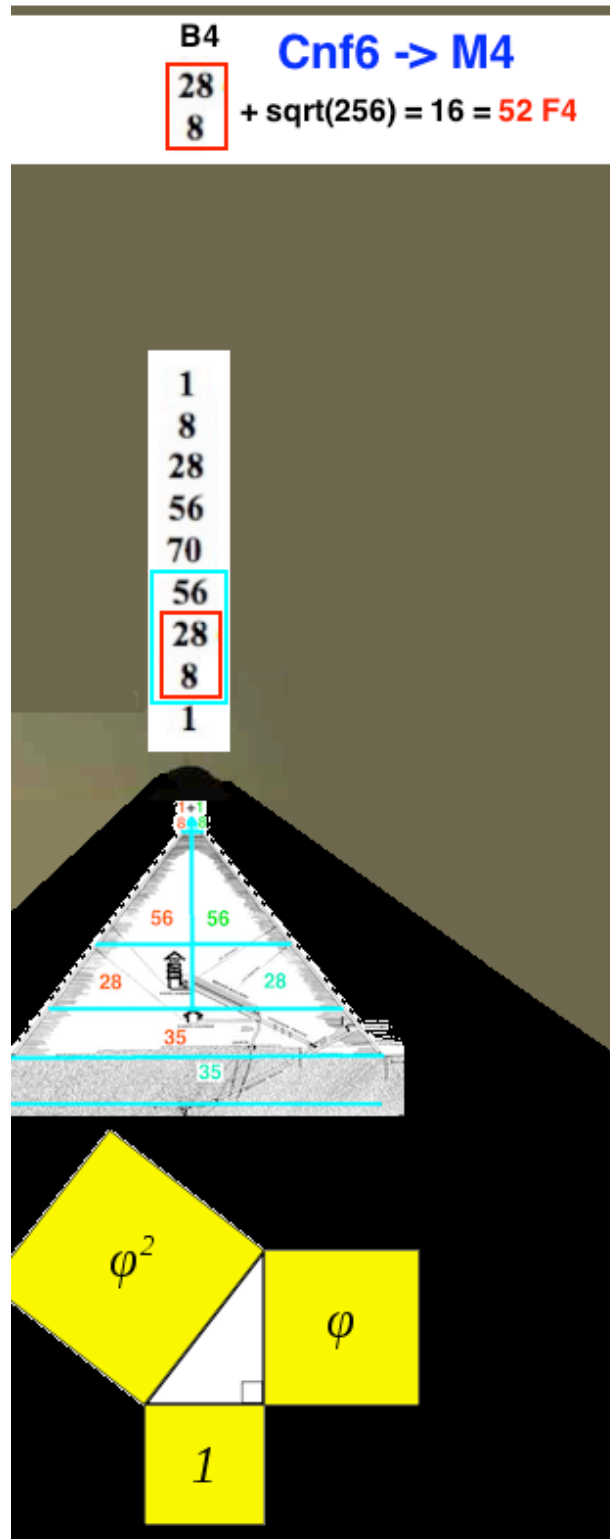

Clifford Algebras were not known to European mathematicians until Clifford in the 19th century and not known to European physicists until Dirac in the 20th century but it seems to me that their structure was known to Africans in ancient times. The courses of the Great Pyramid of Giza correspond to the graded structure of 256-dim Cl(8):

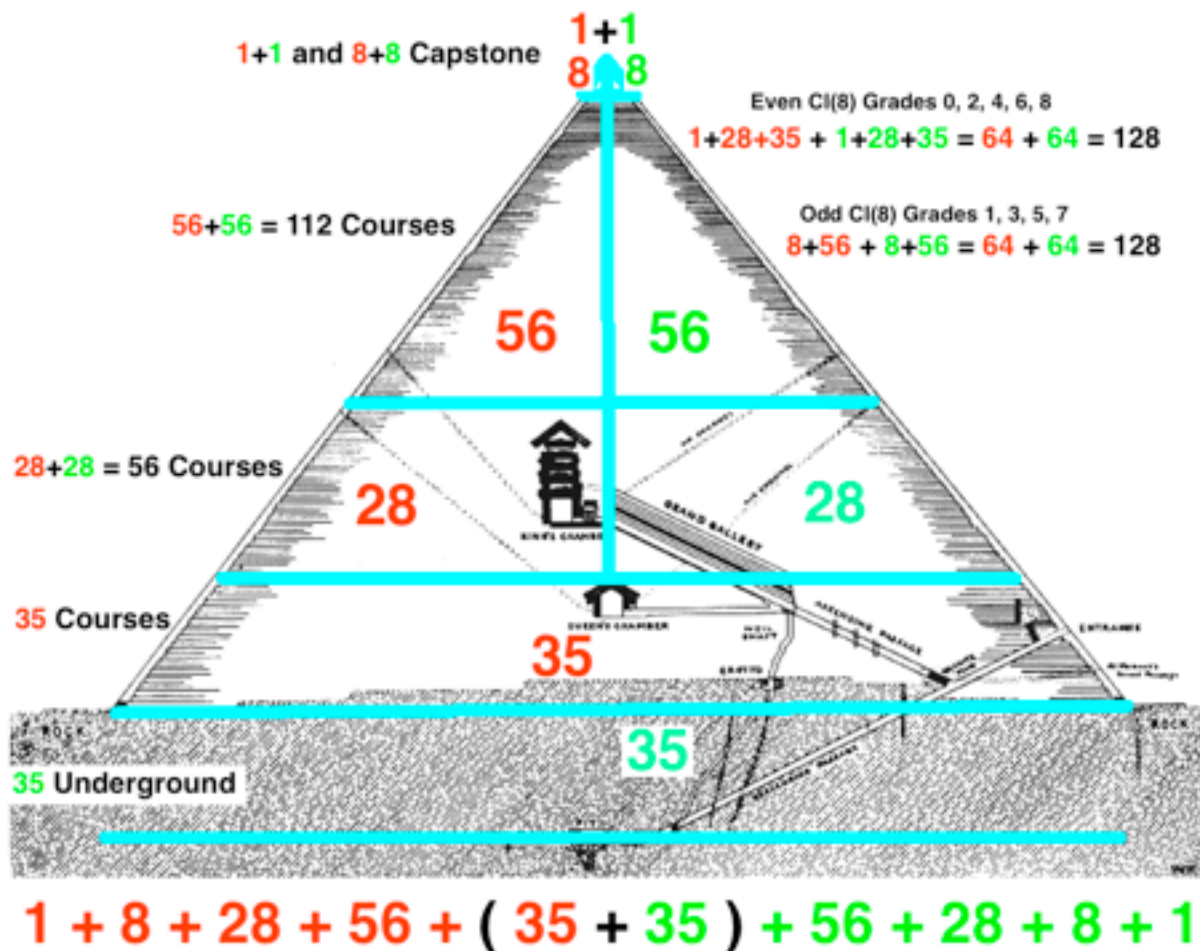

( image adapted from David Davidson image - for larger size see [tony5m17h.net/GreatPyrCl8.png](http://tony5m17h.net/GreatPyrCl8.png) )

William Kingdon Clifford (1845 - 1879) described that Geometry in terms of his invention: Real Clifford Algebras, which he called “mind-stuff”, saying: “... That element of which ... even the simplest feeling is a complex, I shall call **Mind-stuff**.

A moving molecule of inorganic matter does not possess mind or consciousness ; but it possesses a small piece of mind-stuff. ... When molecules are ... combined together ... **the elements of mind-stuff which go along with them ... combine ... to form the ... beginnings of Sentience.** When the molecules are so combined as to form the brain and nervous system ... the corresponding elements of mind-stuff are so combined as to form some kind of consciousness ... changes in the complex which take place at the same time get so linked together that the repetition of one implies the repetition of the other.

When matter takes the complex form of a living human brain,  
the corresponding mind-stuff takes the form of a human consciousness ...".  
(Wikipedia - (1878, "On the Nature of Things-in-Themselves", Mind, Vol. 3, No. 9, pp. 57–67))

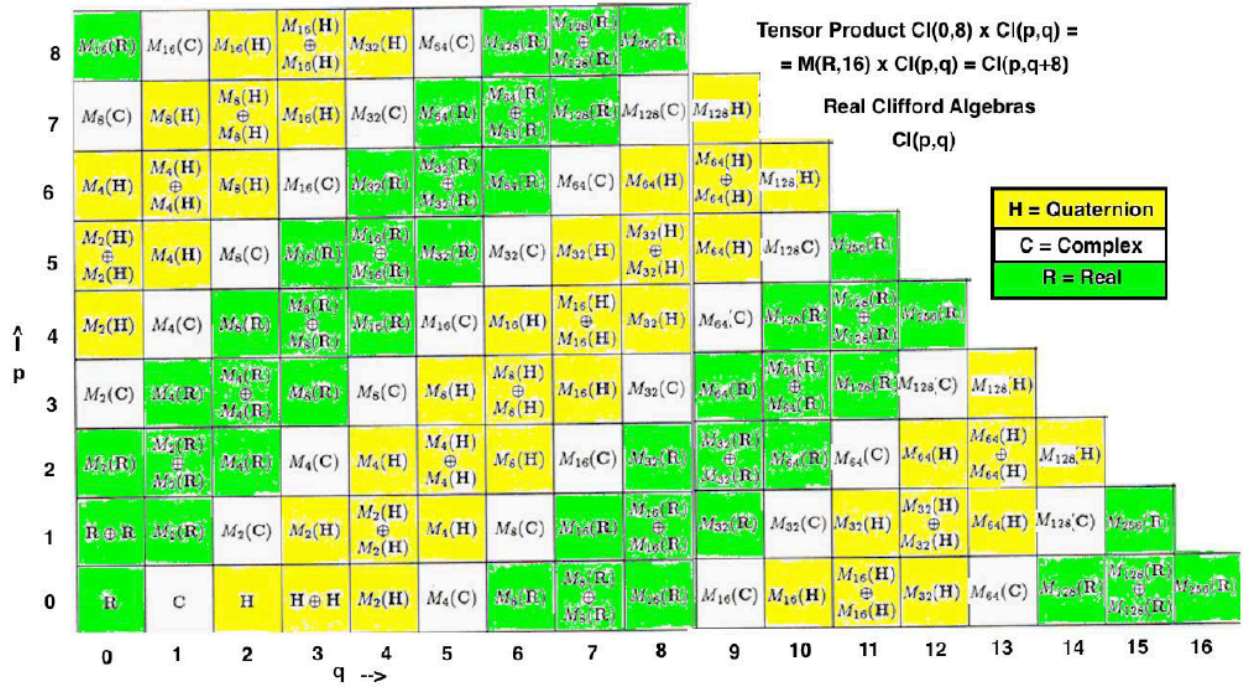

Above the Grand Gallery is a Great Void leading to Ceiling Chambers above the Upper Chamber - (image from ScanPyramids web site)



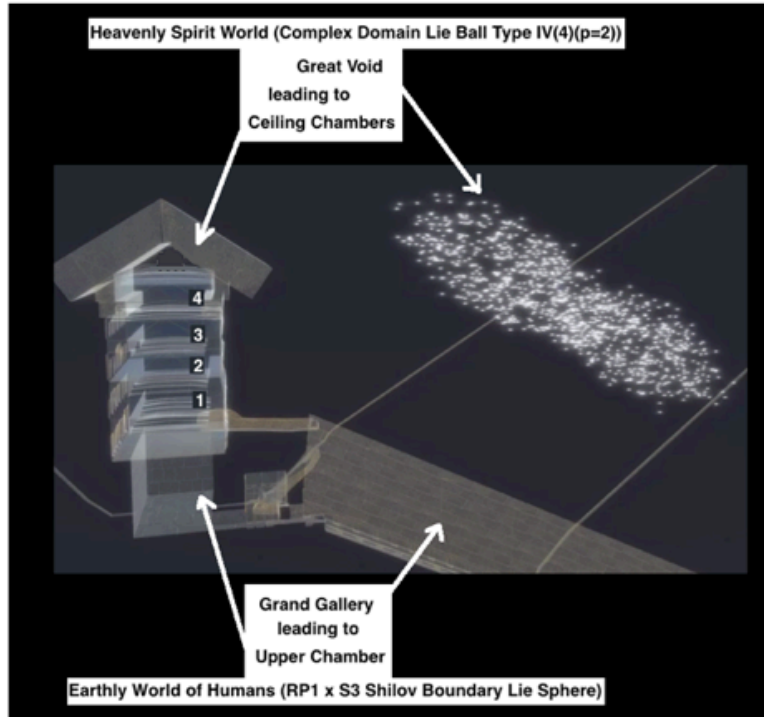

The Builders of the Great Pyramid represented the Real Shilov Boundary Physical world by the Grand Gallery and Upper Chamber that are easily accessible by Humans with Microtubule Quantum Consciousness and they represented the Imaginary Complex World of  $Cl(16)$  Spacetime Cells mirroring the Human Microtubule World as Ceiling Chamber spaces and the Great Void that are more accessible to Souls of the Spirit World than to Physical Humans.

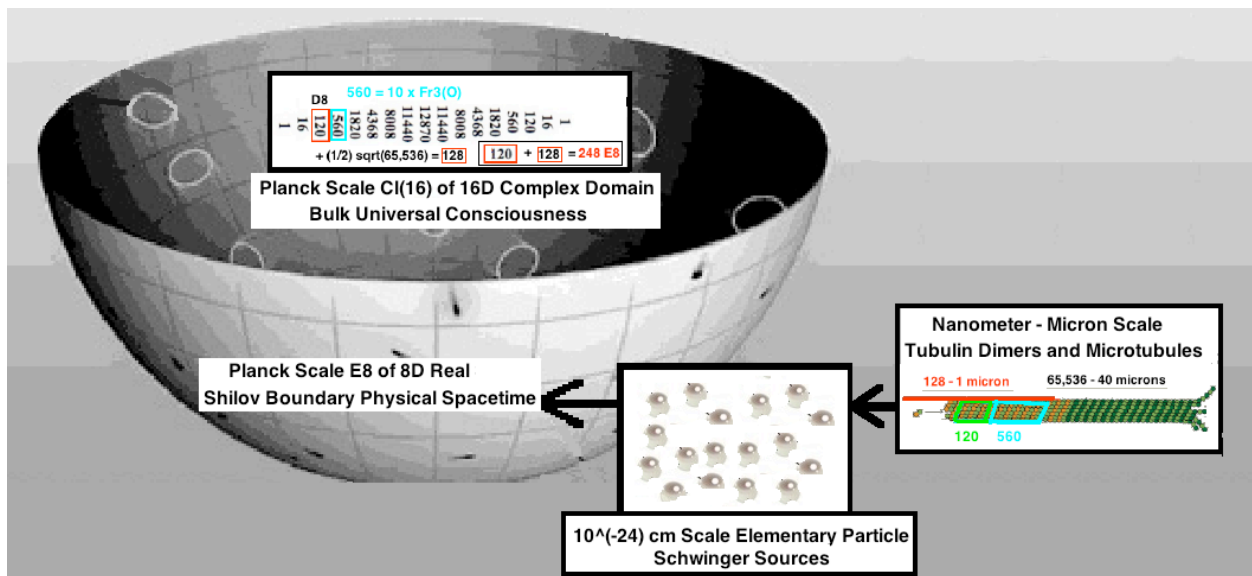

The Second Pyramid slope is of a 3-4-5 Right Triangle representing the Standard Model with Gauge Groups U(1) SU(2) SU(3) It represents CP2 of Kaluza-Klein M4 x CP2 and is represented by F4sm

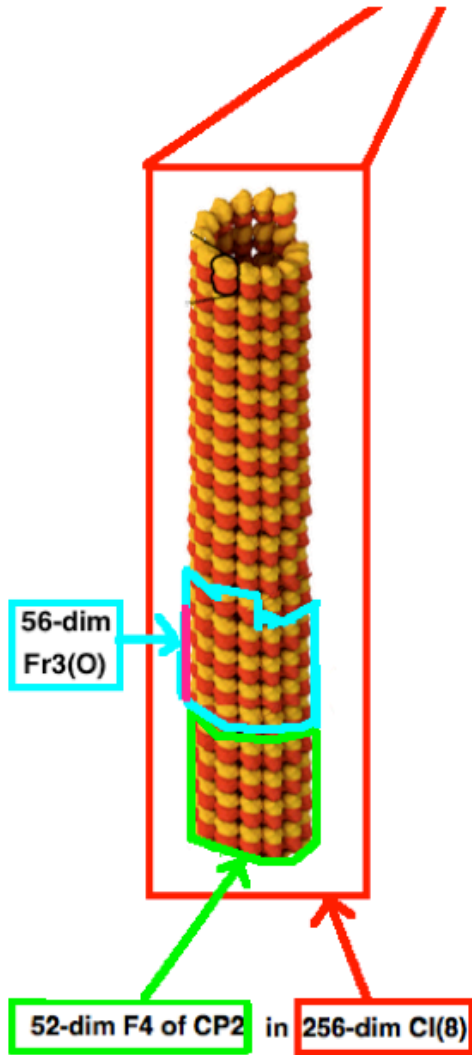

52-dim F4 of CP2 in 256-dim Cl(8)

F4 / B4 = OP2 = Spinor Fermions =  
 = 8 Particles + 8 AntiParticles  
 B4 / D4 = 8-dim SpaceTime =  
 = Kaluza-Klein M4 x CP2  
 D4 = Spin(8) contains Spin(6) = SU(4)  
 contains SU(3) Color Force  
 SU(3) Color Force = Global Symmetry  
 of CP2 = SU(3) / SU(2)xU(1)  
 SU(2)xU(1) ElectroWeak Force =  
 = Local Symmetry of CP2

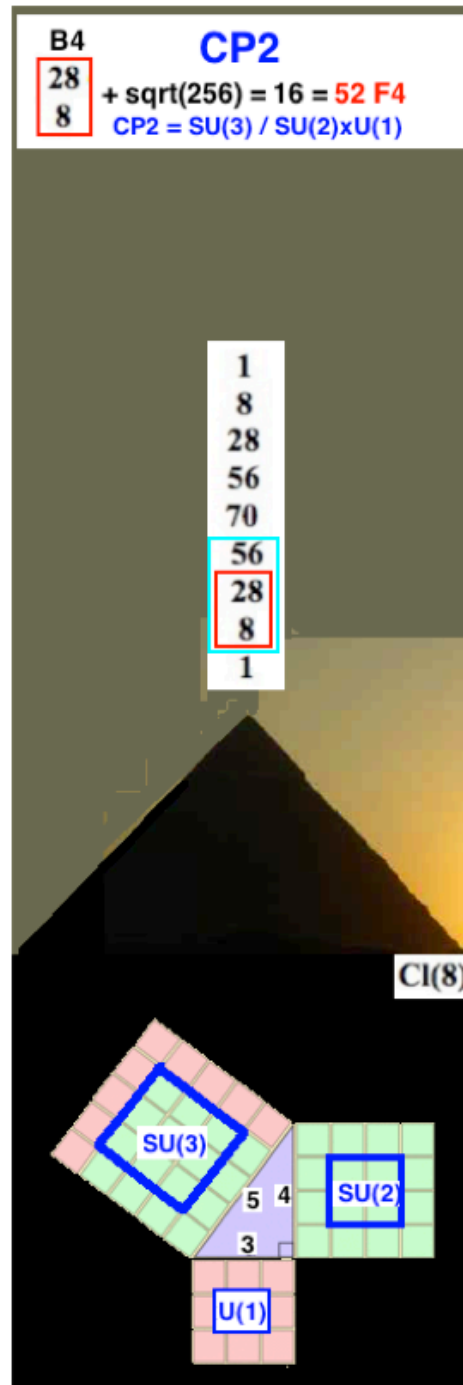

The Sphinx represents 65,536-dim  $Cl(16)$  containing 248-dim  $E_8$   
as the tensor product combination of  
the 256-dim  $Cl(8)$  containing 52-dim  $F_4$ sm related to  $CP^2$  of  $M_4 \times CP^2$   
and the 256-dim  $Cl(8)$  containing 52-dim  $F_4$ gde related to  $M_4$  of  $M_4 \times CP^2$

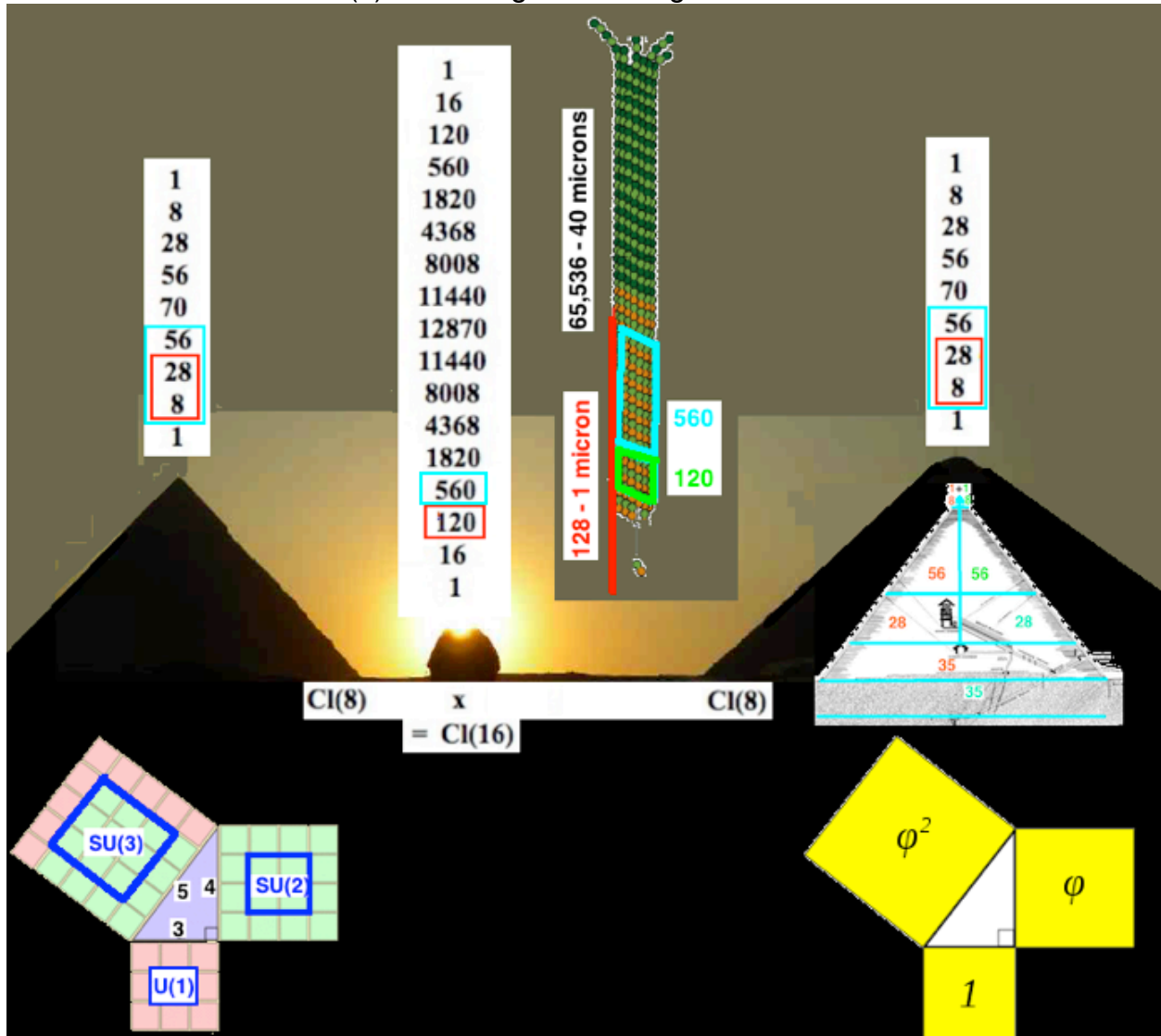

The image on the following page summarizes how the Sphinx represents  
the  $Cl(16)$  combination of the two large  $Cl(8)$  Pyramids  
and also  
the 65,536-element 40 micron Microtubules of Bohm Quantum Consciousness

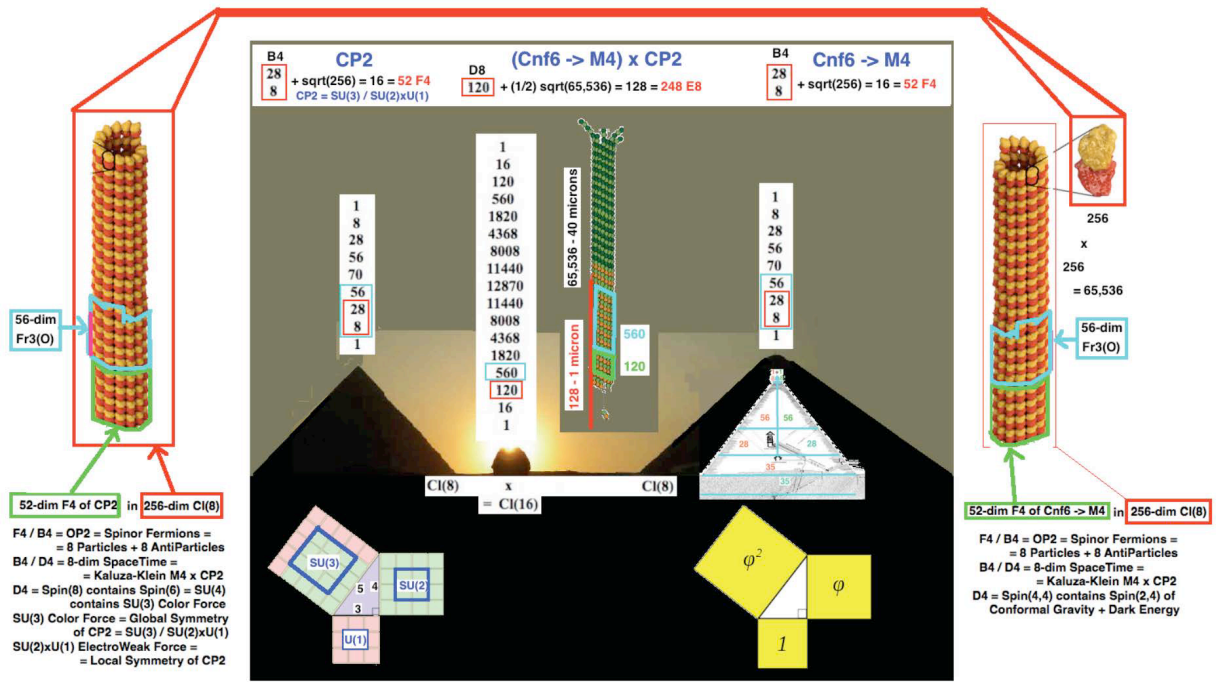

two large Pyramids - each representing  $Cl(8)$   
whose 8 Vectors + 28 BiVectors + 16 Spinors =  $F_4$  Lie Algebra

one for  $F_4gde = \text{Conformal Gravity} + \text{Dark Energy}$

one for  $F_4sm = \text{Standard Model}$

and

the Sphinx - representing  $Cl(16)$

whose 120 BiVectors + 128 half-Spinors =  $E_8 = \text{Lagrangian}$

whose 560 TriVectors = 10 copies of  $Fr_3(O) = 26D \text{ World-Line-String Theory}$

Here is a diagram ( adapted from diagram of Henry Montieth ) that indicates my view of Manetho's history of Humans and how it is likely to extend into the future :

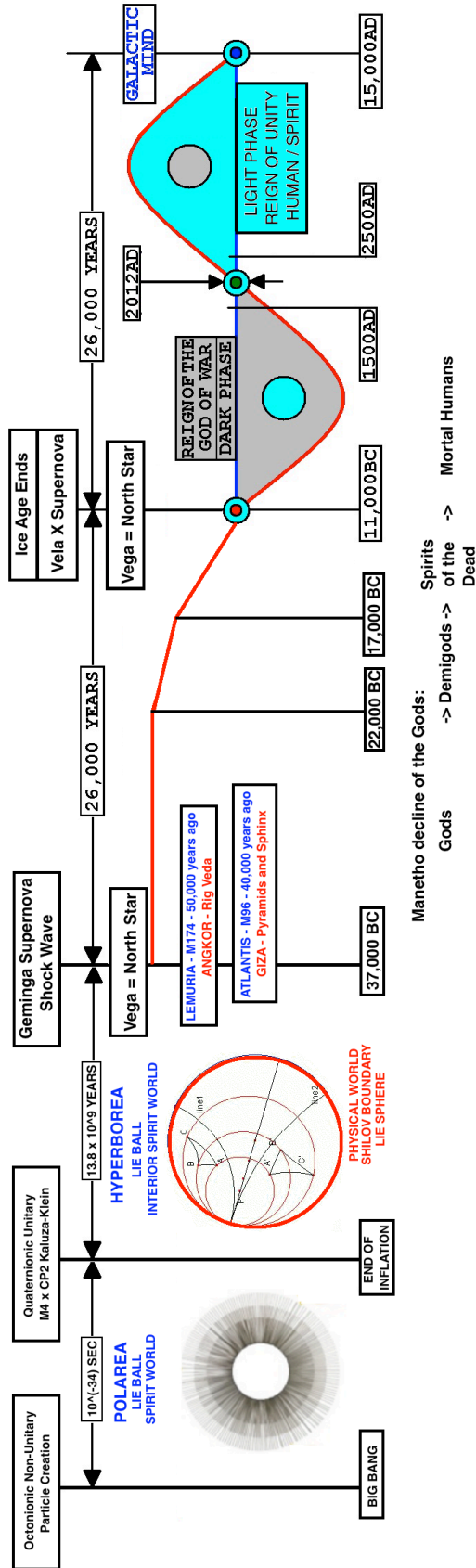



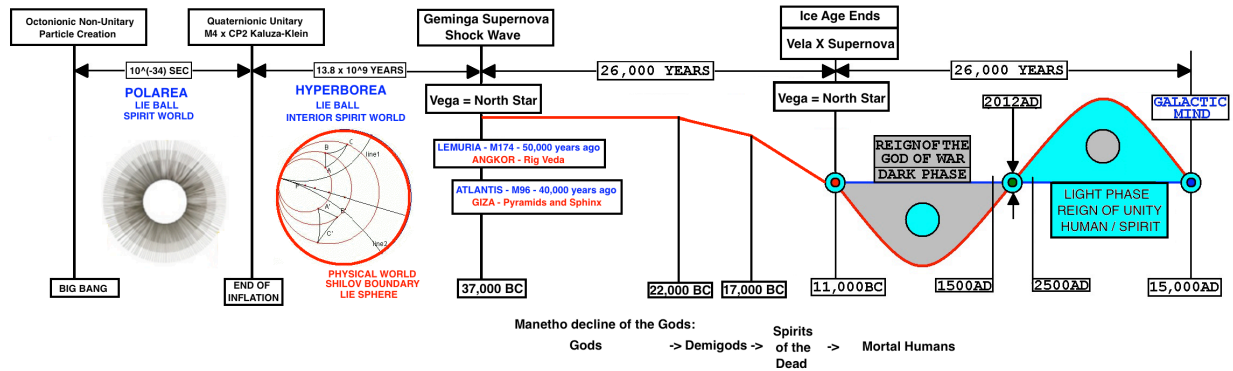

The Lemurian / Atlantean Rule of Gods / Demigods with high Spiritual capabilities confirms what Terence McKenna said in the May 1993 OMNI magazine:

“... From 75,000 to about 15,000 years ago, there was a kind of human paradise on Earth. ... Community, loyalty, altruism, self-sacrifice -- all these values that we take to be the basis of humanness -- arose at the time in a situation in which the ego was absent ... Human beings created an altruistic communal society; then ...[ for the past ]... 10,000 years ... we've pursued an agenda of beasts and demons ... we've had nothing ... except ... all tooth-and-claw dominance ... For the last 500 years, Western culture has suppressed the idea of disembodied intelligences -- of the presence and reality of spirit. ... You can be a New York psychotherapist or a Yoruba shaman, but these are just provisional realities you're committed to out of conventional ... customs. ... The world is not a single, one-dimensional, forward-moving, causal, connected thing, but some kind of interdimensional nexus. ... Entities there are completely formed. There's no ambiguity about the fact that these entities are there ... On one level I call them self-transforming machine elves; half machine, half elf ... They are teaching something. Theirs is a higher dimensional language that condenses as a visible syntax. For us, syntax is the structure of meaning; meaning is something heard or felt ... There, the boundless meanings of language cause it to overflow ... They offer you an object so beautiful, so intricately wrought, so something else that cannot be said in English, that just gazing on this thing, you realize such an object is impossible. ... The object generates other objects ... Ordinarily language creates a system of conventional meanings based on pathways determinate by experience. ... [this is] a place where the stress is on a transcending language ... Something in an unseen dimension is acting as an attractor for our forward movement in understanding ... It's a point in the future that affects us in the present. ... Our model that everything is pushed by the past into the future, by the necessity of causality, is wrong. There are actual attractors ahead of us in time ... Once you fall under an attractor's influence, your trajectory is diverted ...

If history goes off endlessly into the future [ on its present path ],  
it will be about scarcity, preservation of privilege, forced control of populations,  
the ever-more-sophisticated use of ideology to enchain and delude people.

We are at the breakpoint.

It's like when a woman comes to term.

At a certain point, if the child is not severed from the mother  
and launched into its own separate existence,  
toxemia will set in and create a huge medical crisis

...

When a species prepares to depart for the stars, the planet will be shaken to its core.

All evolution has pushed for this moment, and there is no going back.

What lies ahead is a dimension of such freedom and transcendence,  
that once in place, the idea of returning to the womb will be preposterous.

We will live in the imagination.

We will quickly become unrecognizable to our former selves ...

We ... will ... expand infinitely into pleasure, caring, attention, and connectedness. ...".

Ron Eglash (in his book "African Fractals" (Rutgers 1999) and on his web site) says: "...  
**a historical path for base-2 calculation ... begins with African divination,**  
**runs through the geomancy of European alchemists,**  
**and is finally transformed into binary calculation,**  
where it is now applied in every digital circuit ...".

Raymond Aschheim (email May 2015) said, about **Cellular Automata (CA)**:

"... An elementary CA is defined by the next value (either 0 or 1) for a cell,  
depending on its ... value, and the ... value of it[s] left and of it[s] right neighbor cell  
(it is one dimensional, and involve only the first neighbors, and the cell itself) ... So the  
next value depends [on] 3 bits ... eight possible combination of three bits, and for  
each ... combination... the next value is either zero or one.

So the[re] are **256 ... CAs ...**".

256 Cellular Automata correspondence with 256-dim  $Cl(8)$  means that by 8-Periodicity  
**any Real Clifford Algebra can be described by Cellular Automata**  
**so  $Cl(16)$  physics can also be seen in terms of Cellular Automata.**

For example consider the 28 Cl(8) BiVector grade-2 Cellular Automata:

These 1 + 12 + 3 = 16 grade-2 Cellular Automata correspond to propagator phase, Conformal Lie Algebra Root Vectors, and Conformal Lie Algebra Cartan Subalgebra



The Conformal Group  $Spin(2,4) = SU(2,2)$  gives Gravity+Dark Energy by the MacDowell-Mansouri mechanism.

$U(2,2) = U(1) \times SU(2,2)$  also contains the propagator phase

These 1 + 3 + 8 = 12 grade-2 Cellular Automata correspond to  $U(1)$ ,  $SU(2)$ ,  $SU(3)$  of the Standard Model



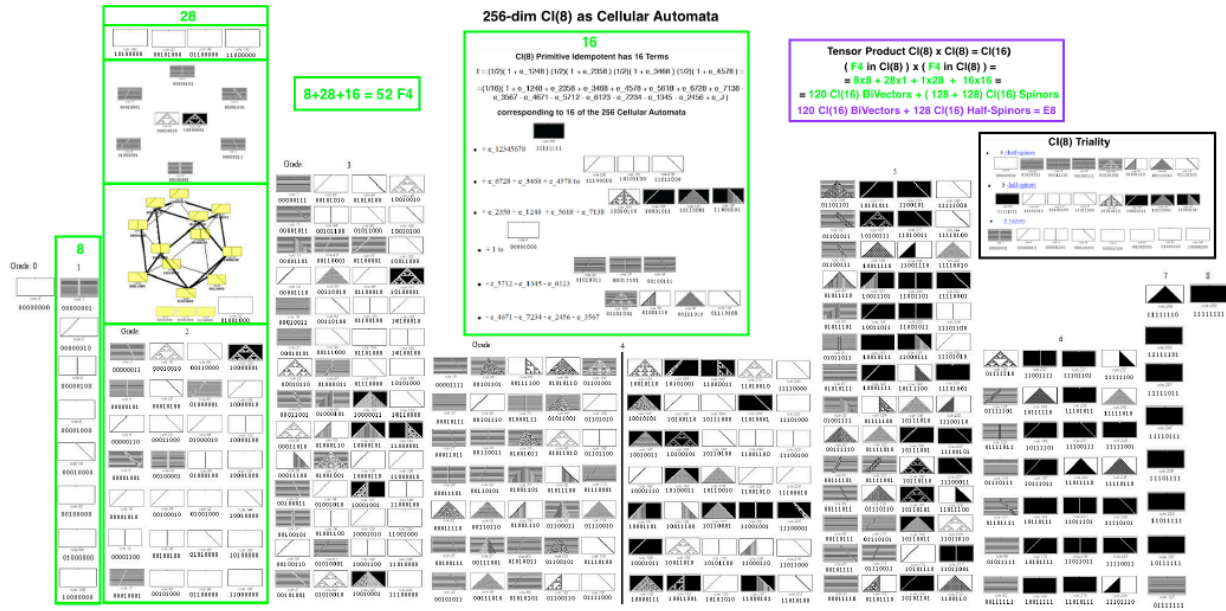

The 256 Elementary Cellular Automata correspond to the 256-dim Cl(8) Clifford Algebra with graded structure 1 8 28 56 (35+35=70) 56 28 8 1

The 8 Vectors have clear physical interpretation as 8-dim Spacetime.

The 28 BiVectors have clear physical interpretation as Gauge Bosons or Ghosts of Standard Model (12) and Gravity+ Dark Energy(16)

The 1 scalar, 1 pseudoscalar, and 7+7=14 of grade 4 have physical interpretation as 8 +half-spinors and 8 -half-spinors

The 8+28+8+8 = 52 with fixed physical interpretation form 52-dim F4.

The remaining 256 - 8 - 28 - 8 - 8 = 204 Cl(8) Cellular Automata are not bound to any physical interpretation but are available to carry information.

When Cl(16) is formed from the tensor product Cl(8) x Cl(8) the two F4 in Cl(8) go to  $1 \times 28 + 8 \times 8 + 28 \times 1 = 120$  D8 BiVectors and  $(8+8) \times (8+8) = 256$  D8 Spinors all of which inherit clear physical interpretations leaving  $65,536 - 120 - 256 = 65,160$  Cl(16) elements available to carry information either in Lorentz Leech Lattice Spacetime Cells of Our Conscious Universe or in 40-micron Microtubules of Human Quantum Consciousness.

All of the 120 D8 BiVectors and 128 = half of the D8 Spinors form 248-dim E8 which has fixed physical interpretation inherited from the F4 in Cl(8) so 248-dim E8 and the other 128 half-Spinors are fixed structure markers in Cl(16) that do not carry information.

There are two D4 = C(8) BiVectors in the D8 = C(16) Bivectors that live in E8

### D4 for Gravity + Dark Energy Gauge Bosons and Standard Model Ghosts

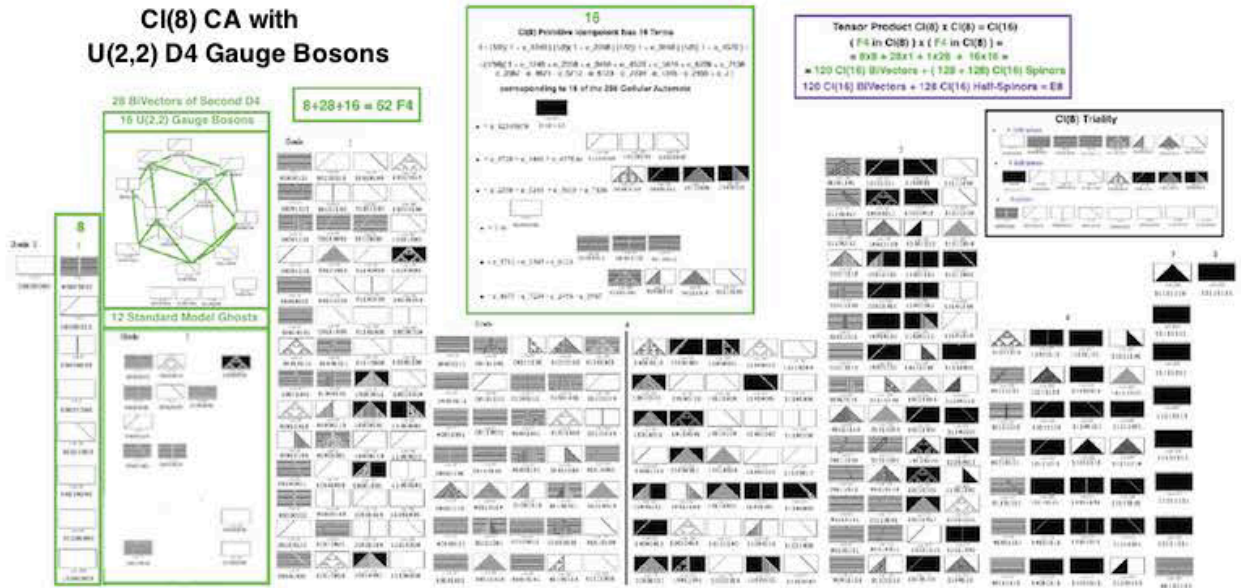

Spin(2,4) / Spin(1,3) x Spin(1,1) =  
= 15-6-1 = 8-dim Lie Ball Complex Domain  
with Lie Sphere Shilov Boundary RP1 x S3

Octonionic Spin(1,7) -> Quaternionic Spin(2,6)

Spin(2,6) / Spin(2,4) x Spin(0,2) =  
= 28-15-1 = 12 Standard Model Ghosts

Spin(2,8) / Spin(1,7) x Spin(1,1) =  
= 45-28-1 = 16-dim Lie Ball Complex Domain  
with Lie Sphere Shilov Boundary RP1 x S7

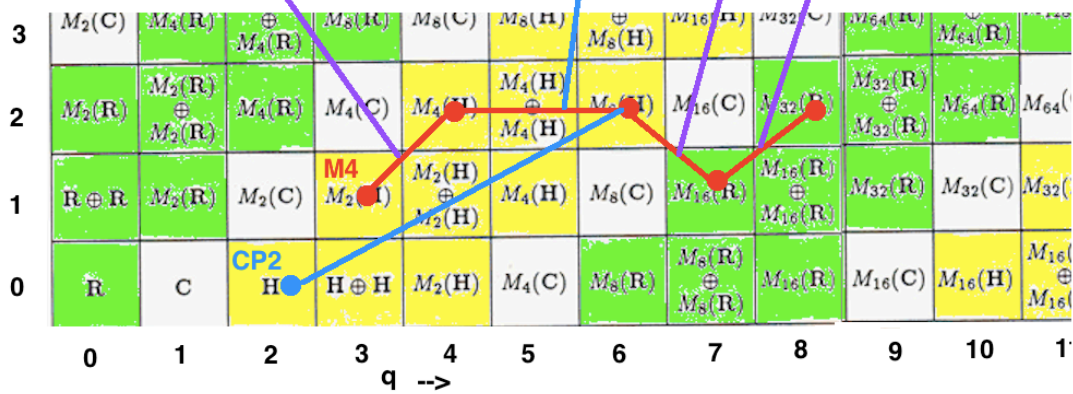

# D4 for Standard Model Gauge Bosons and Gravity + Dark Energy Ghosts

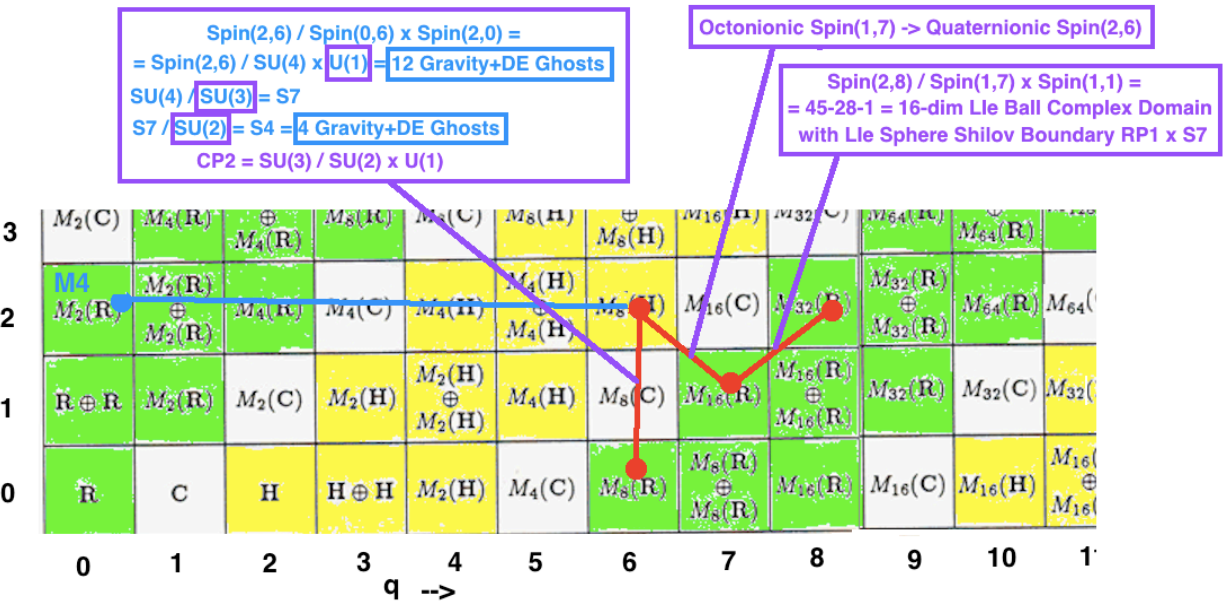
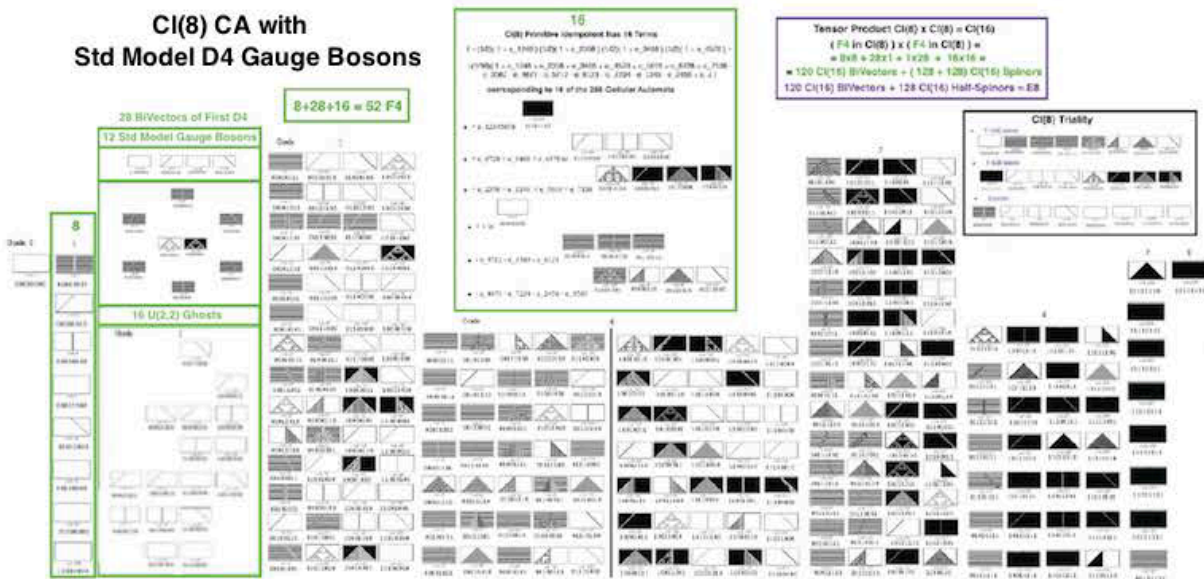

Ron Eglash (in his book "African Fractals" and on his web site) also says:  
 ... **Following the introduction of geomancy to Europe by Hugo of Santalla in twelfth-century Spain ... European geomancers ... Ramon Lull ... and others ...** persistently replaced the deterministic aspects of the system with chance. **By mounting the 16 figures on a wheel and spinning it, they maintained their society's exclusion of any connections between determinism and unpredictability ...**".

Anthony Bonner in his book The Art and Logic of Ramon Llull (Brill 2007) ( unless otherwise stated illustrations herein are adapted from that book ) said:  
 "... **Lull wanted to make the Art "general to everyone"** ...  
 "a religiously neutral universal science" ... for Lull the Art is not enclosed in its own shell, but ... can even be adapted to "many other principles of science" ...".  
 Ramon Llull's Y and Z Figures



are analogous to the binary structure of IFA  
 Ramon Llull's Wheels A and X

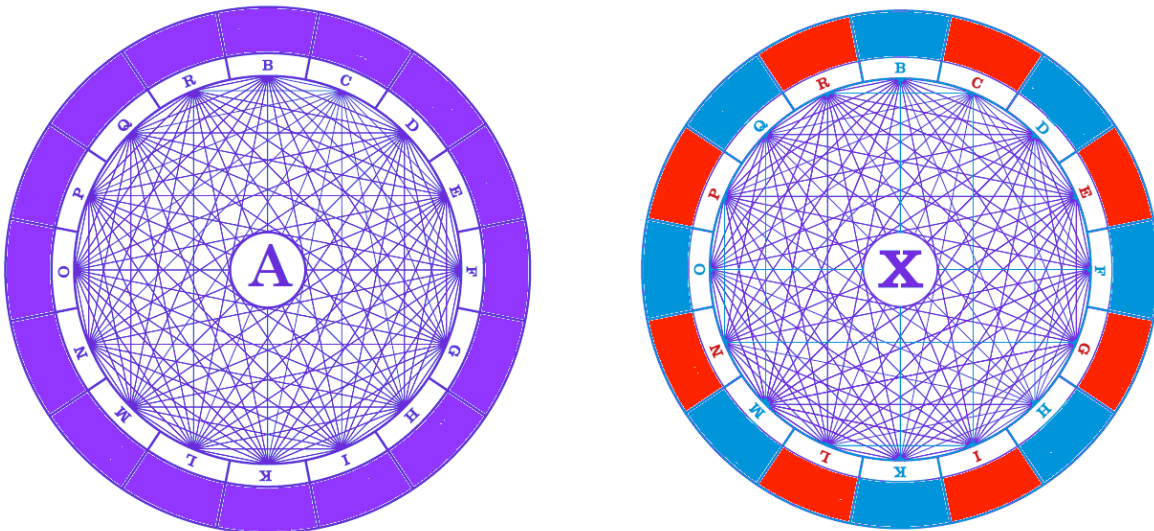

have 16 vertices and 120 lines connecting pairs of vertices,  
 corresponding to the 16 vectors of the Real Clifford Algebra  $Cl(16)$   
 and the 120 bivectors of  $Cl(16)$  that generate the 120-dim  $D_8$  Lie Algebra  
 in the 248-dim  $E_8$  Lie Algebra with  $E_8 / D_8 = 64 + 64$  Fermion Particles + AntiParticles  
 representing  $64 + 64$  of  $E_8$  Maximal Contraction  $28 + 64 + (A_7+R) + 64 + 28$

By 8-Periodicity of Real Clifford Algebras  $Cl(16) = \text{tensor product } Cl(8) \times Cl(8)$   
 so the 16 vectors of  $Cl(16) = 1 \times 8 + 8 \times 1$  where  $8 = 8$  vectors of  $Cl(8)$   
 and 8 of the 16 Wheel A vertices are the 8 blue vertices of Wheel X  
 and the other 8 Wheel A vertices are the 8 red vertices of Wheel X.

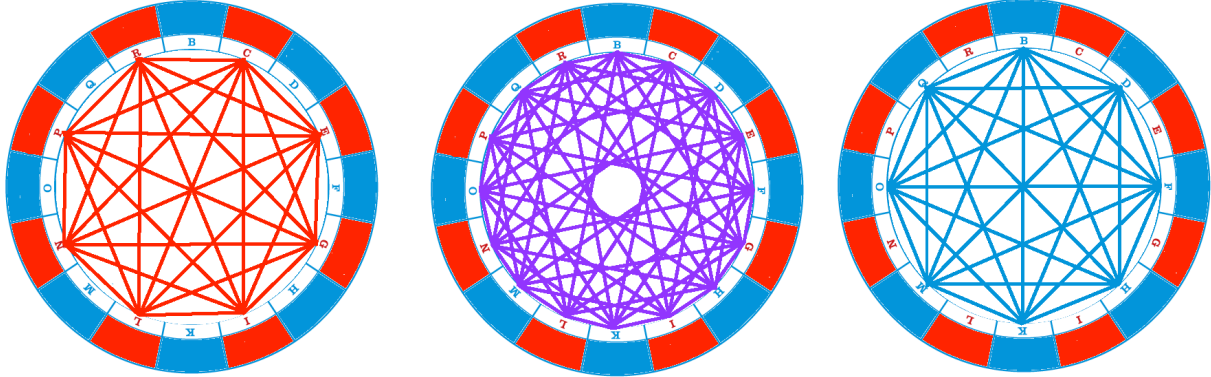

$28 = 1 \times 28$  of the 120 D8 bivectors connect red vertices with red vertices  
 and represent the D4 Lie Algebra acting on the red 8-dim  $Cl(8)$  vector space  
 and 12 Standard Model Gauge Bosons plus 16 Gravity+Dark Energy Ghosts  
 representing 28 of E8 Maximal Contraction  $28 + 64 + (A7+R) + 64 + 28$

$64 = 8 \times 8$  of the 120 D8 bivectors connect red vertices with blue vertices  
 and represent A7+R of E8 Maximal Contraction  $28 + 64 + A7+R + 64 + 28$

$28 = 28 \times 1$  of the 120 D8 bivectors connect blue vertices with blue vertices  
 and represent the D4 Lie Algebra acting on the blue 8-dim  $Cl(8)$  vector space  
 and 16 Gravity+Dark Energy Gauge Bosons plus 12 Standard Model Ghosts  
 representing 28 of E8 Maximal Contraction  $28 + 64 + (A7+R) + 64 + 28$



Around 1300 Scholasticism was being developed at the University of Paris, then the world's leading University, and Cambridge and Oxford Universities which were getting organized based on Paris.

Doctor Illuminatus = Ramon Llull (1232-1315) produced a system of Logic and a mathematical Art based on what is now known as the Clifford Algebra  $Cl(16)$  and the 120 dimensional Lie algebra  $Spin(16)$ . 700 years ago the details of that mathematics were not known, nor was it known that the math structure of the Art gives a realistic representation of  $Cl(16)$  Physics of the Standard Model and Gravity +Dark Energy along with its Algebraic Quantum Field Theory. (see viXra 1804.0121)

Doctor Subtilis = John Duns Scotus (1266-1308) developed Llull's system of Logic into sophisticated Scholasticism, but did not have the math and physics knowledge to show that the mathematical Art of Doctor Illuminatus gives a realistic physics model.

A Second Scholasticism began in 1540 with Ignatius Loyola under Pope Paul III who founded the Jesuits, but, without the ability to experimentally measure the relative strengths of the forces of the Standard Model and Gravity and the relative masses of the elementary fermion particles and to compare those observations with the physics model of Llull's mathematical Art, by 1700 Scholasticism had been displaced by the Enlightenment of Descartes et al.

**Now that we can do such experiments and make such observations we can use  $Cl(16)$  Physics as a foundation for a Third Scholasticism using  $Cl(16)$  geometry including 240 E8 Root Vectors.**

Ron Eglash (in his book "African Fractals" and on his web site) also says: "... European geomancers ... maintained their society's exclusion of any connections between determinism and unpredictability ...

The Africans, on the other hand, seem to have emphasized such connections ...[with]... a "trickster" god, one who is both deterministic and unpredictable. ...

The fractal settlement patterns of Africa stand in sharp contrast to the Cartesian grids of Euro-American settlements. ... Euro-American cultures are ... "top-down" organization.

**Precolonial African cultures included ... societies that are organized "bottom-up"** rather than "top-down". ... African architecture tends to be fractal because that is a prominent design theme in African culture ... most of the indigenous African societies were neither utterly anarchic, nor frozen in static order; rather they utilized an adaptive flexibility

...  
**African traditions of decentralized decision making could ... be combined with new information technologies, creating new forms that combine democratic rule with collective information sharing ...".**

## 240 E8 Root Vectors Physical Interpretation

Since the 48 Root Vectors of F4 = 24 vertices of 24-cell + 24 vertices of dual 24-cell  
 the 240 Root Vectors of E8 are made up of  
 120 Root Vectors of H4 = 24 F4 24-cell vertices + 96 F4 dual 24-cell edges of CP2  
 120 Root Vectors of H4 = 24 F4 24-cell vertices + 96 F4 dual 24-cell edges of M4

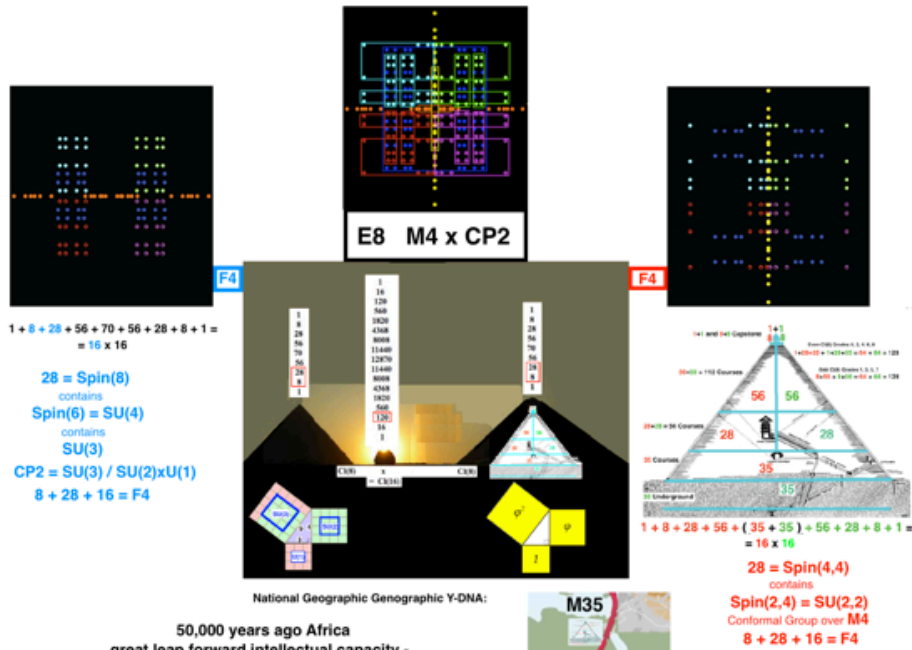
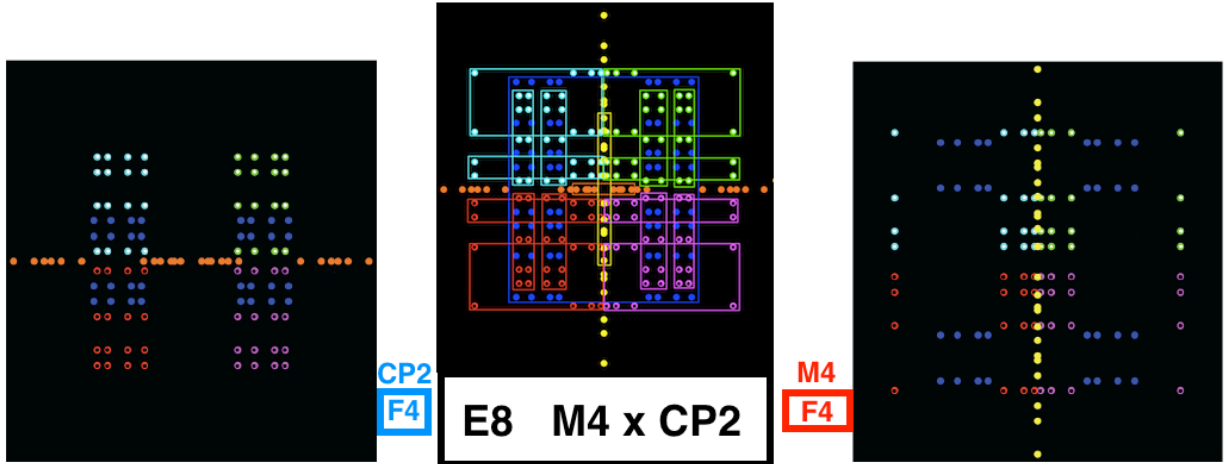

248-dim Lie Group E8 has 240 Root Vectors arranged on a 7-sphere S7 in 8-dim space. Since it is hard to visualize points on S7 in 8-dim space, I prefer to represent the 240 E8 Root Vectors in 2-dim / 3-dim space as in this 2D representation by Ray Aschheim (see Appendix - Mathematica CDF)

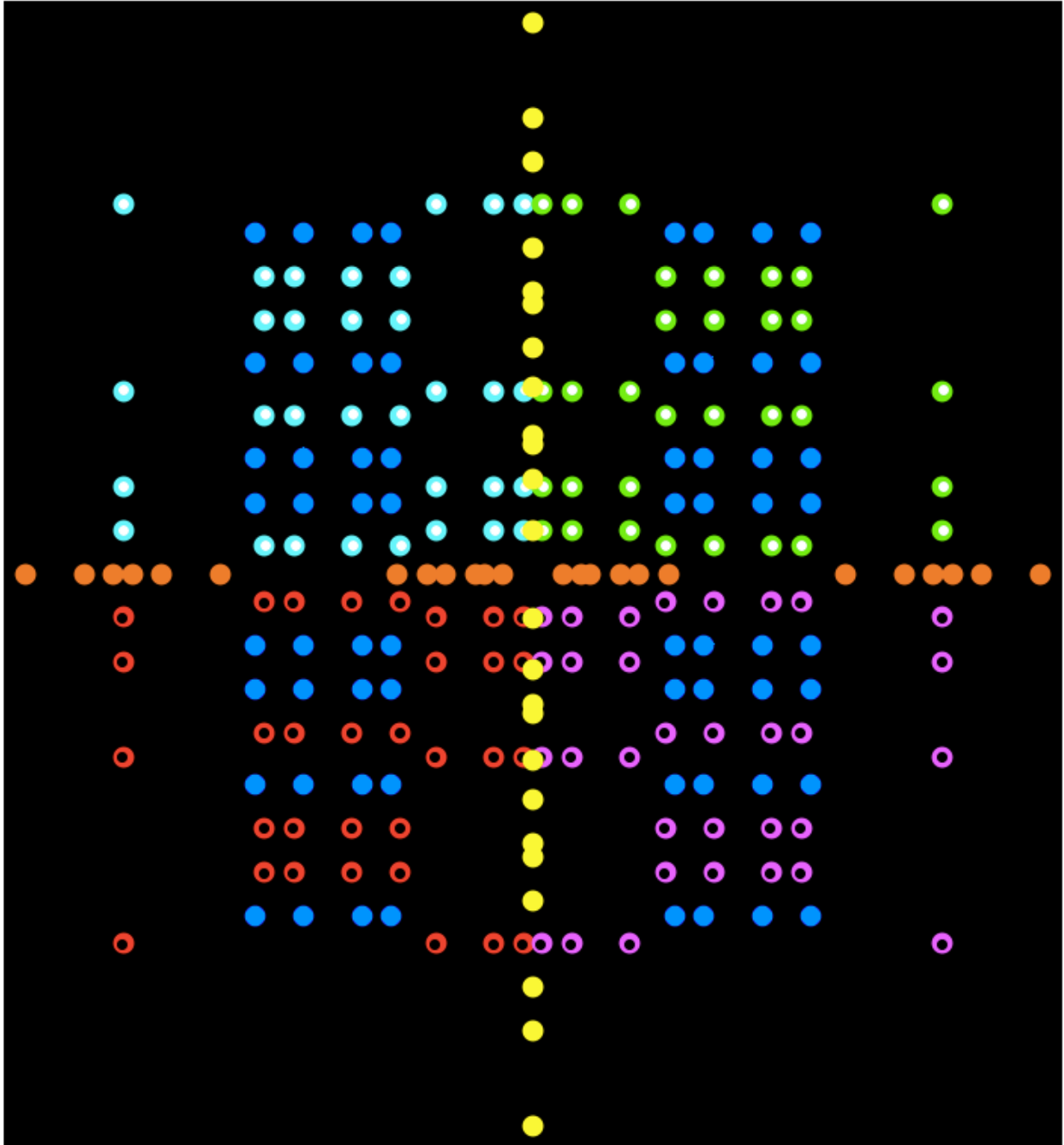

248-dim E8 = 120-dim Spin(16) D8 + 128-dim half-spinor of Spin(16) D8

**240 E8 Root Vectors = 112 D8 Root Vectors + 128 D8 half-spinors**

**112 D8 Root Vectors = 24 D4 (orange) + 24 D4 (yellow) + 64 (blue)**

**128 D8 half-spinors = 128 elements of E8 / D8**

Green and Cyan dots with white centers (32+32 = 64 dots) and

Red and Magenta dots with black centers (32+32 = 64 dots)

correspond to the 128 elements of E8 / D8.

**240 = 24 + 24 + 64 + 64 + 64**

The 64 Green and Cyan Root Vectors represent half of the First Generation Fermions of E8 / D8.  
 The White Centers of their dots indicate that they are Particles.

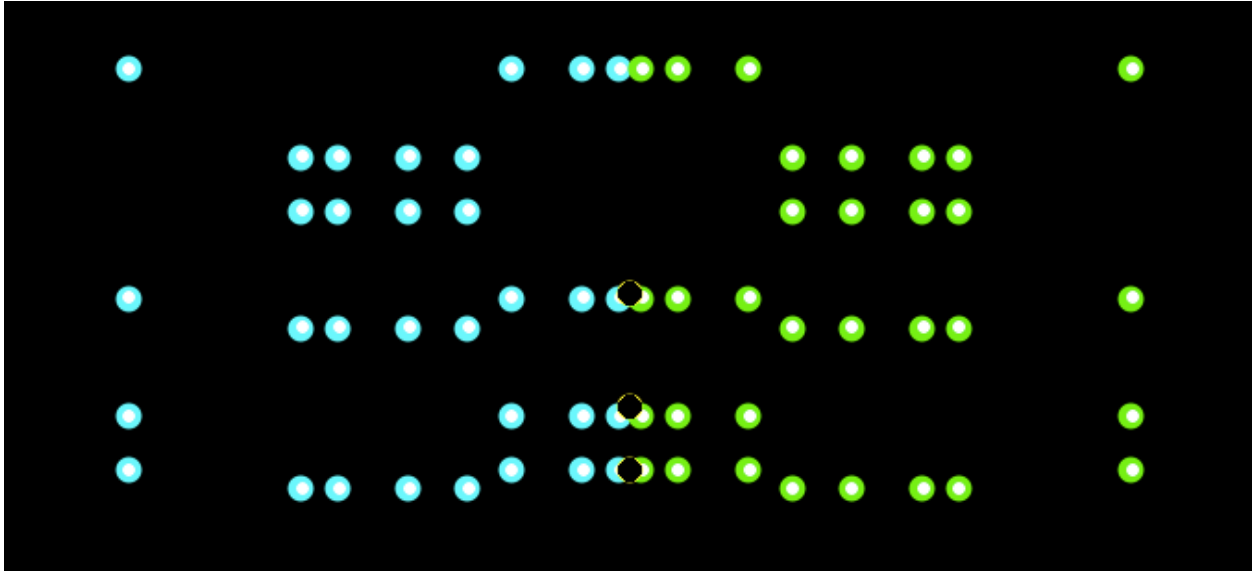

Their physical interpretations are

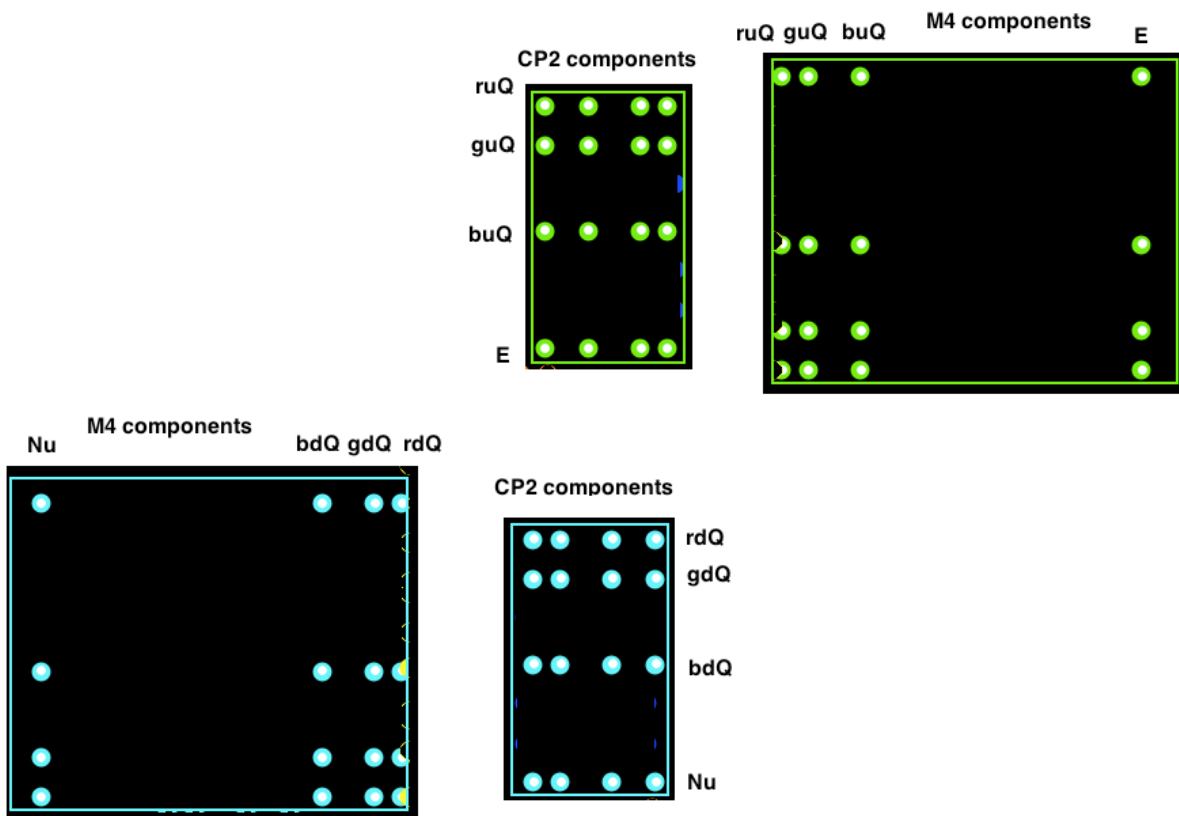

The 64 Red and Magenta Root Vectors represent the other half

of the First Generation Fermions of E8 / D8.  
 The Black Centers of their dots indicate that they are AntiParticles.

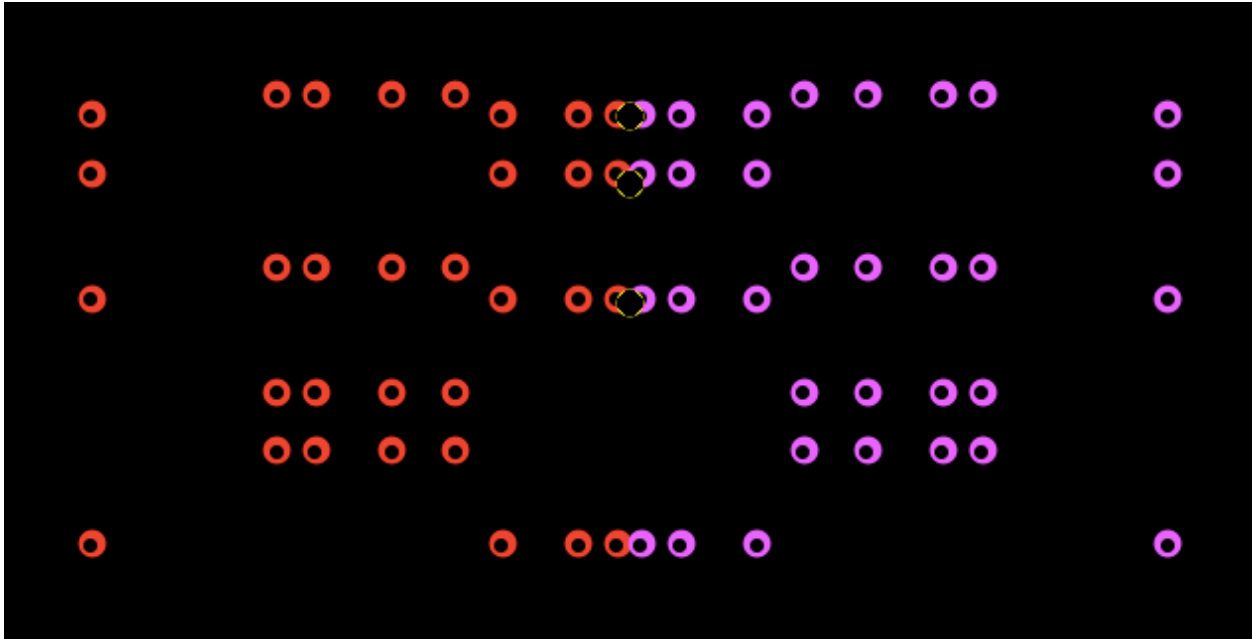

Their physical interpretations are

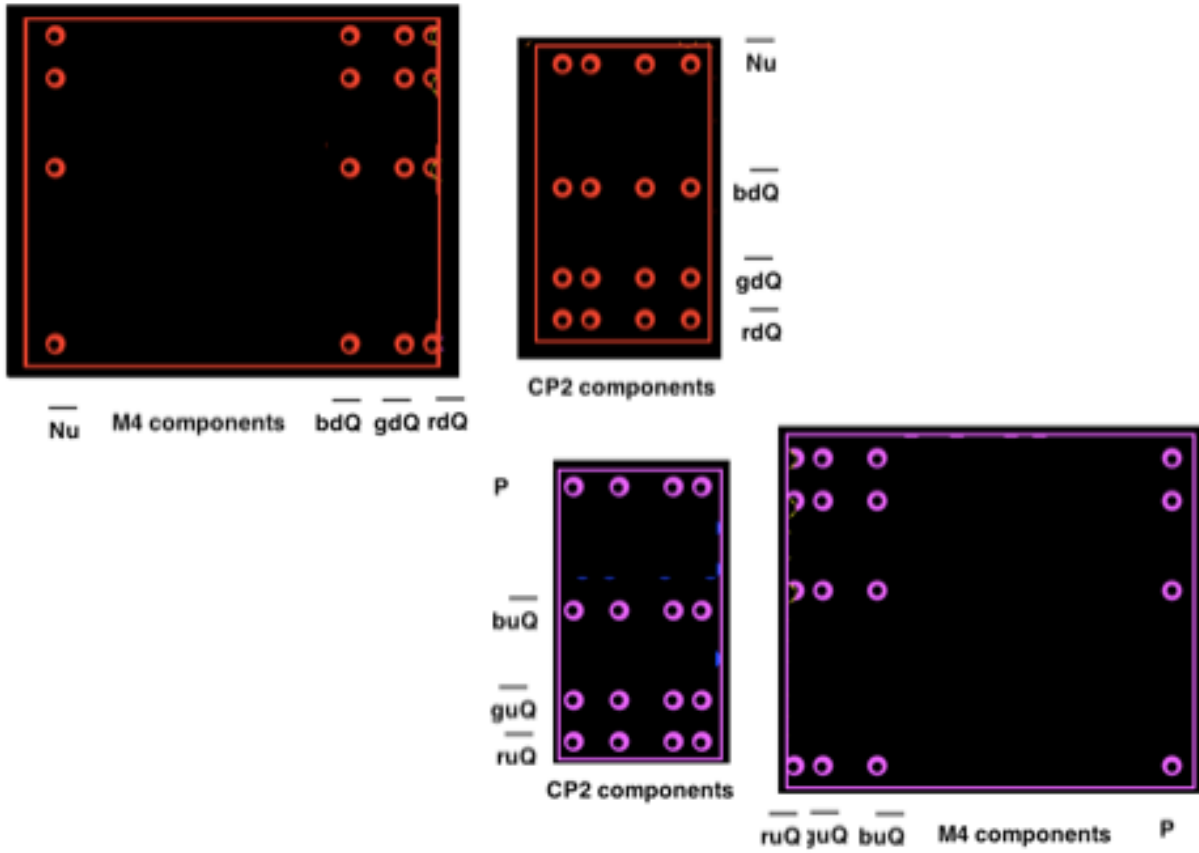

## Spacetime, Unimodular Gravity, and Strong CP

The 64 Blue Root Vectors of the space  $D_8 / D_4 \times D_4$  represent 8D Spacetime and its symmetries such as 8 position x 8 momentum and the  $A_7 = SL(8,R)$  of Unimodular Gravity that is in the Maximal Contraction Heisenberg Algebra of  $E_8$  with structure  $28 + 64 + (A_7+1) = 64 + 28$ .

(see Rutwig Campoamor-Stursberg in "Contractions of Exceptional Lie Algebras and SemiDirect Products" (Acta Physica Polonica B 41 (2010) 53-77)

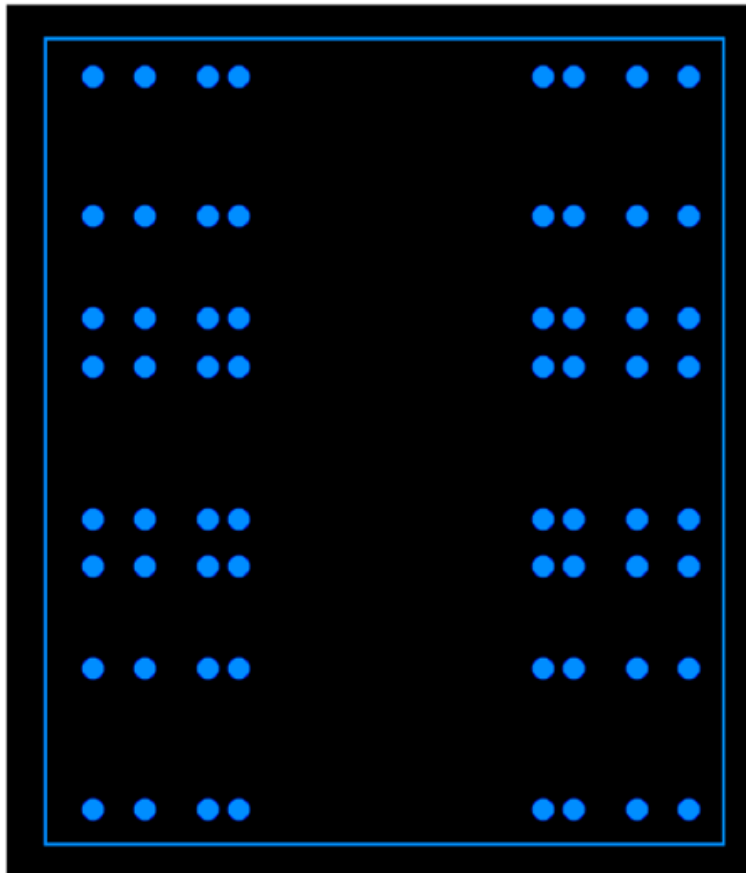

The  $4 \times 16 = 64$  blue correspond to the 64-dim symmetric space  $D_8 / D_4 \times D_4 = Gr(8,16)$  Grassmannian = set of  $RP^7$  in  $RP^{15}$   
**They are related by Triality to the 64 + 64 Fermion Components of  $E_8 / D_8$**

Creation-Annihilation Operators for 8-dim spacetime x 8-dim momentum space are the 64-dim grade-0 part of the  $E_8$  Maximal Contraction generalized Heisenberg Algebra  
 $\hbar^2 \times A_7 = 28 + 64 + ((SL(8,R)+1) + 64 + 28$

Bradonjic and Stachel in arXiv 1110.2159 said: "... in ... Unimodular relativity ... the metric tensor ... break[s up] ... into the conformal structure represented by a conformal metric ... with  $\det = -1$  and a four-volume element ... at each point of space-time ... [that]... may be the remnant, in the ... continuum limit, of a more fundamental discrete quantum structure of space-time itself ...".

### In the Initial and Inflation Octonionic Phases of Our Universe

the 64 generators of  $D_8 / D_4 \times D_4$  act as an Octonionic Conformal Structure where  $Spin(0,8)$  of  $Cl(0,8)$  does rotations of 8-dim Octonion Space and  $Spin(2,8) = Spin(1,9) = SL(2, O)$  of  $Cl(2,8) = Cl(1,9) = M(32, R) = M(2, Cl(0,8))$  indicates a 10-dim Conformal Spacetime within 26-dim String Theory and an 8-volume element at each point of Octonion Space indicates a fundamental discrete structure of an underlying 26-dim String Theory in which Strings = World-Lines and **a spin-2 particle carries Bohm Quantum Potential.**

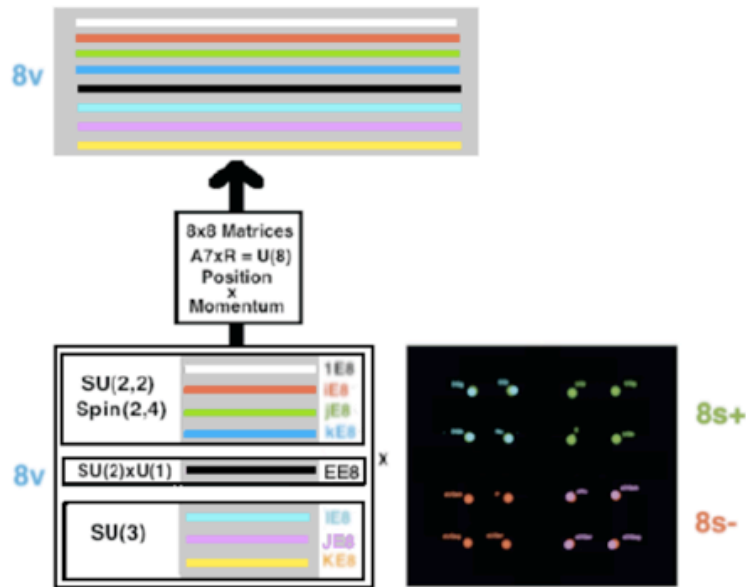

Green, Schwartz, and Witten, in "Superstring Theory" vol. 1, describe 26D String Theory saying "... The first excited level ... consists of ... the ground state ... tachyon ... and ... a scalar ... 'dilaton' ... and ...  $SO(24)$  ... little group of a ... massless particle ... and ... **a ... massless ... spin two state** ...".

Unimodular  $SL(8, R)$  Gravity effectively describes a generalized checkerboard of 8-dim SpaceTime HyperVolume Elements and, with respect to  $Cl(16) = Cl(8) \times Cl(8)$ , is the tensor product of the two  $8v$  vector spaces of the two  $Cl(8)$  factors of  $Cl(16)$ . If those two  $Cl(8)$  factors are regarded as Fourier Duals, then  **$8v \times 8v$  describes Position x Momentum in 8-dim SpaceTime.**

### In the Post-Inflation Quaternionic Phase of Our Universe

8-dim Octonionic Spacetime splits into (4+4)-dim **M4 x CP2 Kaluza-Klein Spacetime**

M4 underlies a 6-dim Conformal Spacetime of  $Spin(2,4) = SU(2,2)$

where  $Spin(2,4) = BiVectors$  of  $Cl(2,4) = M(4, H) = 4 \times 4$  Quaternion Matrices

$CP^2 = SU(3) / SU(2) \times U(1)$

carries the Gauge Groups of the Standard Model

Frampton, Ng, and Van Dam in J. Math. Phys. 33 (1992) 3881-3882 said: "... Because of the existence of ... QCD ... instantons the quantized theory contains a dimensionless parameter  $\theta$  ( $0 < \theta < 2\pi$ ) not explicit in the classical lagrangian. ... **the quantum dynamics of ... unimodular gravity ... may lead to the relaxation of  $\theta$  to  $\theta = 0 \pmod{\pi}$  without the need ... for a new particle ... such as the axion ...".**

The 24 Orange Root Vectors of the D4 of **E8 Standard Model + Gravity Ghosts** are on the Horizontal X-axis.

The 4 Cartan Subalgebra elements of D4 of E8 Standard Model + Gravity Ghosts correspond to half of the 8 Cartan Subalgebra elements of E8.

**In the Initial and Inflation Octonionic Phases of Our Universe**

the 24+4 = 28 generators of D4 of E8 Standard Model + Gravity Ghosts act as a Spin(8) Gauge Group rotating all 8 Fermion types into each other.



**In the Post-Inflation Quaternionic Phase of Our Universe**

8-dim Octonionic Spacetime splits into (4+4)-dim M4 x CP2 Kaluza-Klein Spacetime  
 8 generators in the Orange Box represent the 8 Root Vectors of the Standard Model Gauge Groups SU(3) SU(2) U(1).

Their 4 Cartan Subalgebra elements correspond to the 4 Cartan Subalgebra elements of D4 of E8 Standard Model + Gravity Ghosts and to half of the 8 Cartan Subalgebra elements of E8.

The other 24-8 = 16 Orange Root Vectors represent Ghosts of 16D U(2,2) which contains the Conformal Group SU(2,2) = Spin(2,4) that produces Gravity + Dark Energy by the MacDowell-Mansouri mechanism.

Standard Model Gauge groups come from CP2 = SU(3) / SU(2) x U(1)  
 (as described by Batakis in Class. Quantum Grav. 3 (1986) L99-L105)

Electroweak SU(2) x U(1) is gauge group as isotropy group of CP2.

SU(3) is global symmetry group of CP2 but due to Kaluza-Klein M4 x CP2 structure of compact CP2 at every M4 spacetime point, it acts as Color gauge group with respect to M4.



The  $24 - 8 = 16$  D4 of CP2 Root Vectors represent Ghosts of U(2,2) Conformal Gravity.

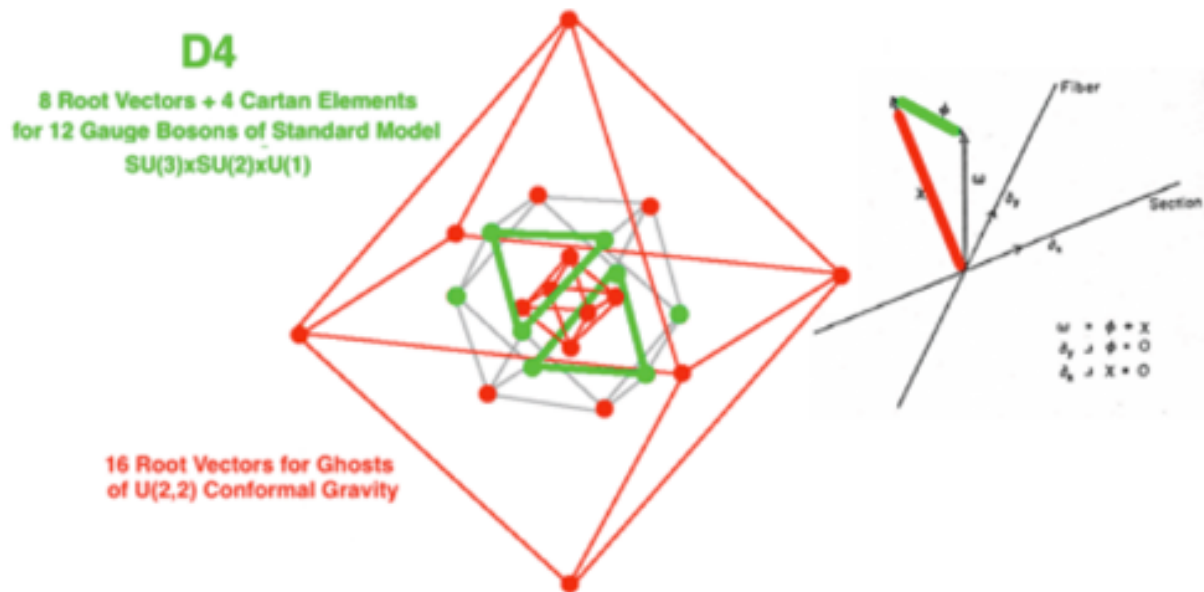

Jean Thierry-Mieg in J. Math. Phys. 21 (1980) 2834-2838 said:

“... The ghost and the gauge field:

The single lines represent a local coordinate system of a principal fiber bundle of base space-time.

The double lines are 1 forms.

The connection of the principle bundle  $w$  is assumed to be vertical.

Its contravariant components  $\Phi$  and  $X$  are recognized, respectively, as the Yang-Mills gauge field and the Faddeev-Popov ghost form ...”.

Steven Weinberg in The Quantum Theory of Fields Volume II Section 15.7 said:

“... there is a beautiful geometric interpretation of the ghosts and the BRST symmetry ...

The gauge fields  $A_a^\mu$  may be written as one-forms  $A_a = A_{a\mu} dx^\mu$ , where  $dx^\mu$  are a set of anticommuting c-numbers. ... This can be combined with the ghost to compose a one-form  $A_a = A_a + w_a$  in an extended space.

Also, the ordinary exterior derivative  $d = dx^\mu \partial / \partial x^\mu$  may be combined with the BRST operator  $s$  to form an exterior derivative  $D = d + s$  in this space, which is nilpotent because  $s^2 = d^2 = sd + ds = 0$  ...”.

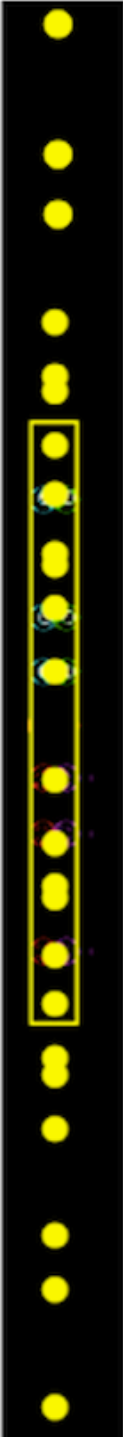

The 24 Yellow Root Vectors of the D4 of E8 Gravity + Standard Model Ghosts are on the Vertical Y-axis.

The 4 Cartan Subalgebra elements of D4 of E8 Gravity + Standard Model Ghosts correspond to half of the 8 Cartan Subalgebra elements of E8.

**In the Initial and Inflation Octonionic Phases of Our Universe**

the 24+4 = 28 generators of D4 of E8 Gravity + Standard Model Ghosts act as a Spin(8) Gauge Group rotating all 8 dimensions of Octonionic Spacetime into each other.

**In the Post-Inflation Quaternionic Phase of Our Universe**

8-dim Octonionic Spacetime splits into (4+4)-dim M4 x CP2 Kaluza-Klein Spacetime  
 12 generators in the Yellow Box represent the 12 Root Vectors of the Conformal Gauge Group SU(2,2) = Spin(2,4) of Conformal Gravity + Dark Energy  
 The 4 Cartan Subalgebra elements of SU(2,2)xU(1) = U(2,2) correspond to the 4 Cartan Subalgebra elements of D4 of E8 Gravity + Standard Model Ghosts and to the other half of the 8 Cartan Subalgebra elements of E8.

The other 24-12 = 12 Yellow Root Vectors represent Ghosts of 12D Standard Model whose Gauge Groups are SU(3) SU(2) U(1)

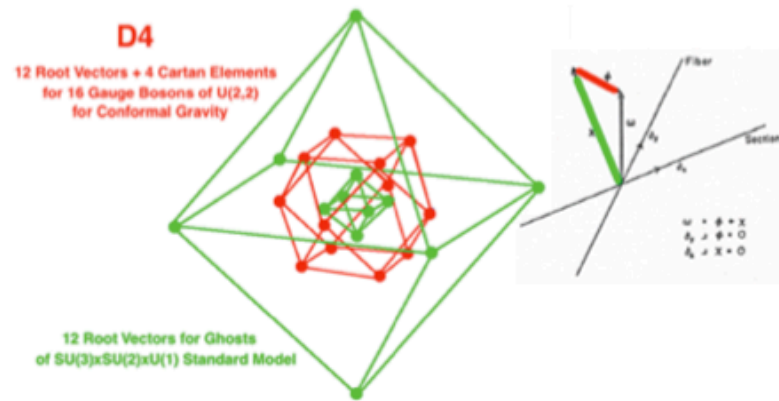

Gravity and Dark Energy come from D4 Conformal Subgroup SU(2,2) = Spin(2,4)

SU(2,2) = Spin(2,4) has 15 generators:

- 1 Dilation representing Higgs Ordinary Matter
- 4 Translations representing Primordial Black Hole Dark Matter
- 10 = 4 Special Conformal + 6 Lorentz representing Dark Energy  
 (see Irving Ezra Segal, "Mathematical Cosmology and Extragalactic Astronomy" (Academic 1976))

The basic ratio Dark Energy : Dark Matter : Ordinary Matter = 10:4:1 = 0.67 : 0.27 : 0.06  
 When the dynamics of our expanding universe are taken into account, the ratio is calculated to be **0.75 : 0.21 : 0.04**

## E8 Lagrangian

$$248\text{-dim E8} = 120\text{-dim D8} + 128\text{-dim E8 / D8}$$

$$128\text{-dim E8 / D8} = 64\text{-dim 8 components of 8 First-Generation Fermion Particles} \\ + \\ 64\text{-dim 8 components of 8 First-Generation Fermion AntiParticles}$$

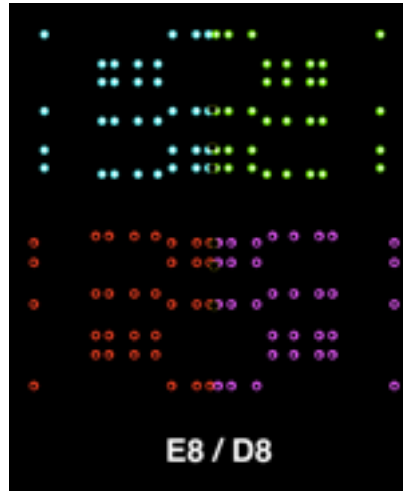

$$120\text{-dim D8} = 28\text{-dim D4sm} + 28\text{-dim D4gde} + 64\text{-dim ( D8 / D4sm x D4gde )}$$

28-dim D4sm = Spin(8) contains SU(4) contains Color Force SU(3) of Standard Model  
 28-dim D4gde = Spin(4,4) contains SU(2,2) = Spin(2,4) Conformal Group that gauges  
 by MacDowell-Mansouri to produce Einstein-Hilbert Gravity plus DE  
 DE = Dark Energy for Universe Expansion by I. E. Segal SU(2,2) Conformal Gravity



64-dim ( D8 / D4sm x D4gde ) Bosonic term  $SL(8,R)+1 =$  Unimodular Gravity in 8-dim

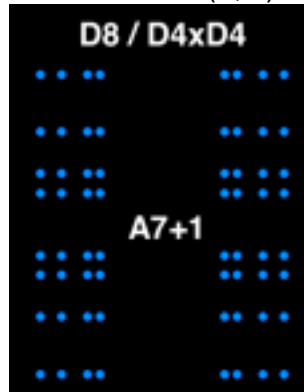

$SL(8,R)+1 = A7+1$  is the grade 0 part of the Heisenberg-type Algebra that is the Maximal Contraction  $h_{92} \times A7$  ( $\times =$  semidirect product) of  $E8$  with graded structure  $28 + 64 + (A7+1) + 64 + 28$

which is the Creation / Annihilation algebra

grades -2 and 2 for  $D4sm$  and  $D4gde$

grades -1 and 1 for  $E8 / D8$  Fermion AntiParticle and Particle Components

grade 0 for 8-dim Octonionic Spacetime Position and Momentum

To build a Lagrangian for  $Cl(16)$  Physics with  $E8$  inside  $Cl(16)$  so that  $E8 = D8 + E8 / D8$  start with a Lagrangian Density with these terms:

Fermion terms =

= 64-dim 8 components of 8 Particles + 64-dim 8 components of 8 AntiParticles

Gauge Boson and Ghost terms =  $D8 = D4sm + D4gde + ( A7+1 = SL(8,R)+1 )$

To find the Base Manifold Spacetime over which to integrate the Lagrangian Density:

1 - The Fermion term components are consistent with 8-dim Base Manifold Spacetime

2 - The 64-dim Bosonic term  $SL(8,R)+1$  describes Unimodular Gravity in 8-dim

So: the  $Cl(16)$  Physics Lagrangian (at high energies) is

$$\int D4sm + D4gde + SL(8,R)+1 + \text{Fermion Terms}$$

8D Octonionic Spacetime

There are two terms that act as Gravity:

$SL(8,R)+1$  Unimodular on 8D Octonionic Spacetime

and

$D4gde$  Conformal  $SU(2,2)$  on 4D Quaternionic Spacetime

# The Initial Octonionic Lagrangian, through Inflation, of $Cl(16)$ Physics is



## End of Inflation and Quaternionic Structure

Octonionic symmetry of 8-dim spacetime is broken at the End of Octonionic Inflation to Quaternionic symmetry of  $(4+4)$ -dim Kaluza-Klein  $M4 \times CP2$

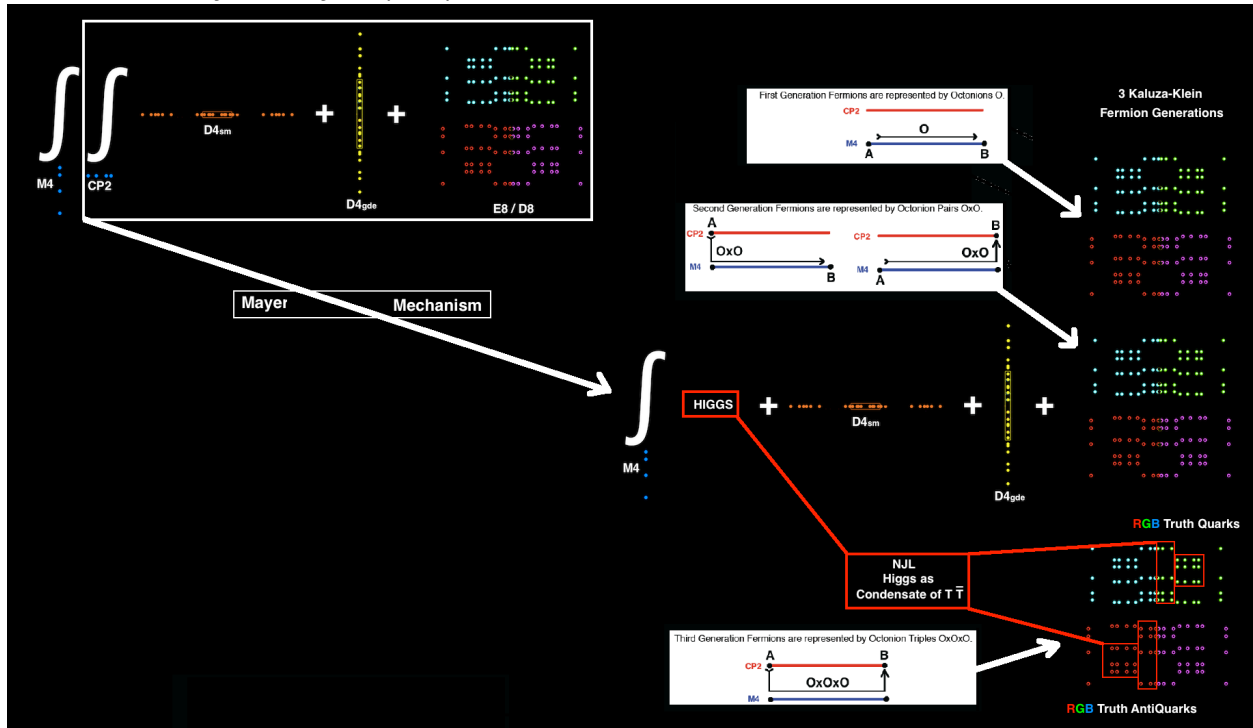

$CP2 = SU(3) / SU(2) \times U(1)$  gives Standard Model  $SU(3) \times SU(2) \times U(1)$   
( Batakis mechanism )

Decomposition to  $M4 \times CP2$  Kaluza-Klein gives Higgs  
( Mayer-Trautman mechanism )

and

## gives 2nd and 3rd generations of Fermions

In Kaluza-Klein  $M4 \times CP2$  there are 3 possibilities for a fermion represented by an Octonion  $O$  basis element to go from point  $A$  to point  $B$ :

1 -  $A$  and  $B$  are both in  $M4$ : First Generation Fermion whose path can be represented by the single  $O$  basis element so that First Generation Fermions are represented by Octonions  $O$ .

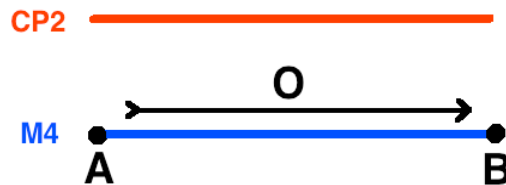

2 - Either  $A$  or  $B$ , but not both, is in  $CP2$ : Second Generation Fermion whose path must be augmented by one projection from  $CP2$  to  $M4$ , which projection can be represented by a second  $O$  basis element so that Second Generation Fermions are represented by Octonion Pairs  $OxO$ .

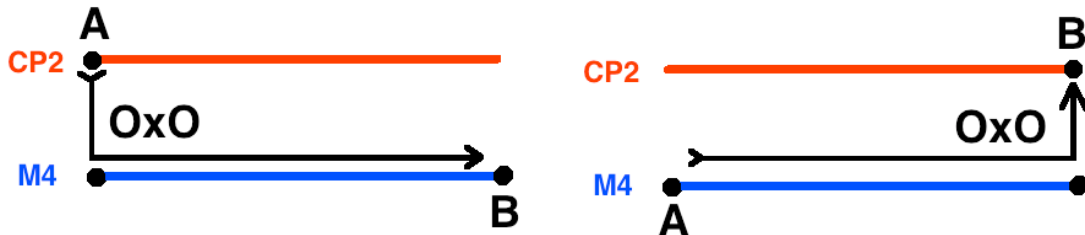

3 - Both  $A$  and  $B$  are in  $CP2$ : Third Generation Fermion whose path must be augmented by two projections from  $CP2$  to  $M4$ , which projections can be represented by a second  $O$  and a third  $O$ , so that Third Generation Fermions are represented by Octonion Triples  $OxOxO$

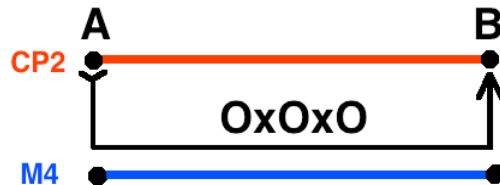

## CI(16) Physics Calculation Results

Here is a summary of CI(16) Physics model calculation results. Since ratios are calculated, values for one particle mass and one force strength are assumed. Quark masses are constituent masses. Most of the calculations are tree-level, so more detailed calculations might be even closer to observations.

Dark Energy : Dark Matter : Ordinary Matter = 0.75 : 0.21 : 0.04

Fermions as Schwinger Sources have geometry of Complex Bounded Domains with Kerr-Newman Black Hole structure size about  $10^{(-24)}$  cm.

Particle/Force	Tree-Level	Higher-Order	
e-neutrino	0	0 for nu_1	
mu-neutrino	0	$9 \times 10^{(-3)}$ eV for nu_2	
tau-neutrino	0	$5.4 \times 10^{(-2)}$ eV for nu_3	
electron	0.5110 MeV		
down quark	312.8 MeV	charged pion = 139 MeV	
up quark	312.8 MeV	proton = 938.25 MeV	
		neutron - proton = 1.1 MeV	
muon	104.8 MeV	106.2 MeV	
strange quark	625 MeV		
charm quark	2090 MeV		
tauon	1.88 GeV		
beauty quark	5.63 GeV		
truth quark (low state)	130 GeV	(middle state) 174 GeV (high state) 218 GeV	
W+	80.326 GeV		
W-	80.326 GeV		
W0	98.379 GeV	Z0 = 91.862 GeV	
Mplanck	$1.217 \times 10^{19}$ GeV		
Higgs VEV (assumed)	252.5 GeV		
Higgs (low state)	126 GeV	(middle state) 182 GeV (high state) 239 GeV	
Gravity Gg (assumed)	1		
(Gg)(Mproton <sup>2</sup> / Mplanck <sup>2</sup> )		$5 \times 10^{(-39)}$	
EM fine structure	1/137.03608		
Weak Gw	0.2535		
Gw(Mproton <sup>2</sup> / (Mw+ <sup>2</sup> + Mw- <sup>2</sup> + Mz0 <sup>2</sup> ))		$1.05 \times 10^{(-5)}$	
Color Force at 0.245 GeV	0.6286	0.106 at 91 GeV	
Kobayashi-Maskawa parameters for W+ and W- processes are:			
	d	s	b
u	0.975	0.222	0.00249 -0.00388i
c	-0.222 -0.000161i	0.974 -0.0000365i	0.0423
t	0.00698 -0.00378i	-0.0418 -0.00086i	0.999
The phase angle d13 is taken to be 1 radian.			

# Nambu - Jona-Lasinio Truth Quark-AntiQuark Condensate Higgs

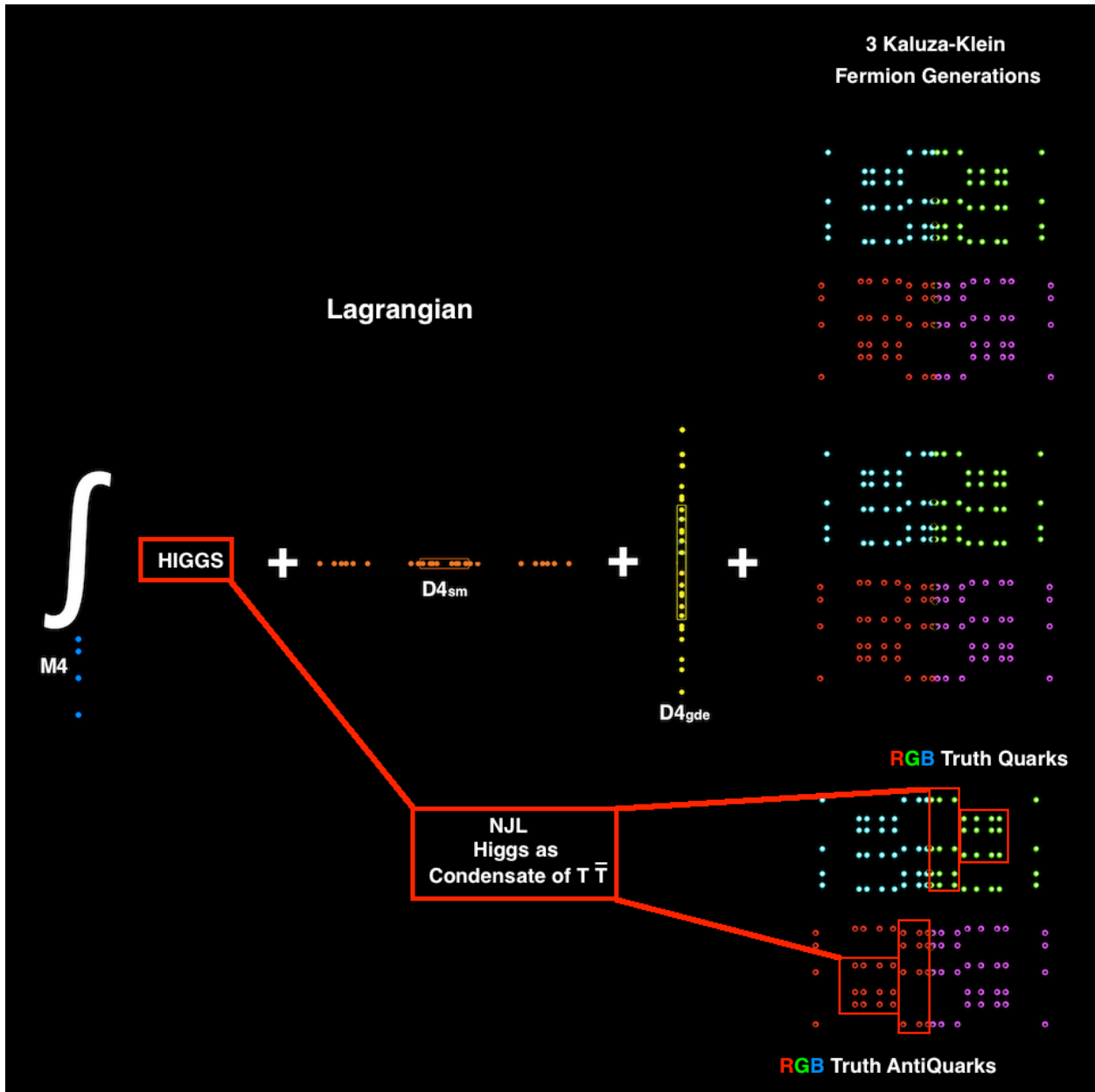

forms a Higgs-Tquark NJL-type system with 3 Mass States



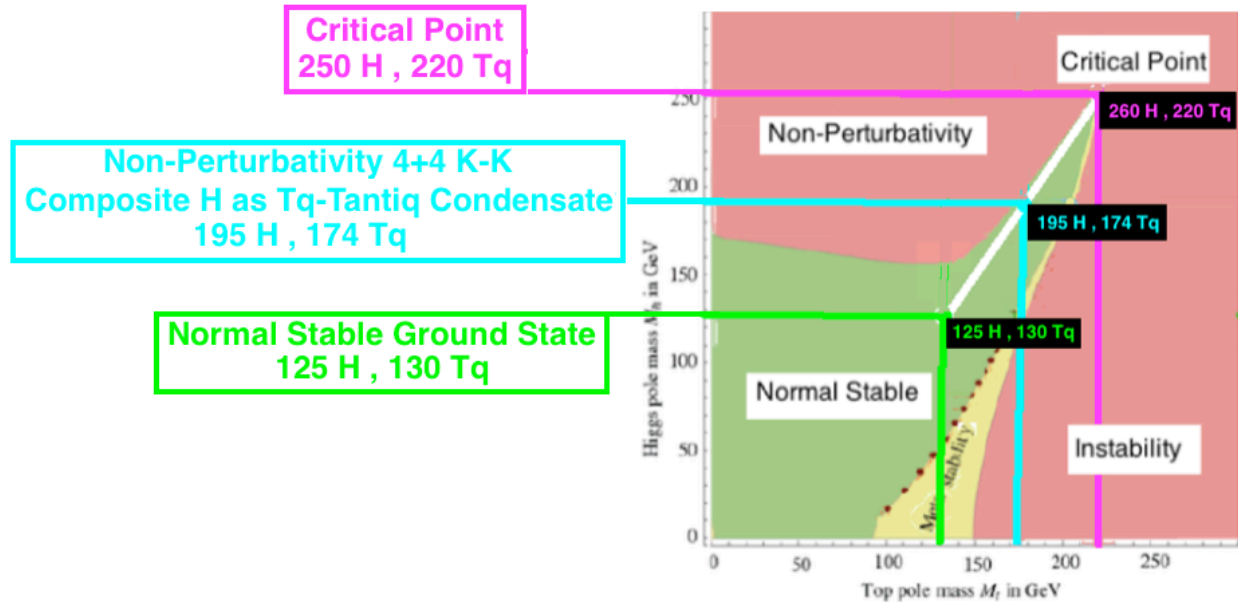

The Green Dot ● where the White Line originates in our Ordinary Phase is the **Low-mass state of a 130 GeV Truth Quark and a 125 GeV Higgs.**

**The 130 GeV Tquark mass is also predicted by Connes's NCG (NonCommutative Geometry) by the formula  $M_t = \sqrt{8/3} M_w$**

The Cyan Dot  where the White Line hits the Triviality Boundary leaving the Ordinary Phase is the **Middle-mass state of a 174 GeV Truth Quark and Higgs around 200 GeV**. It corresponds to the Higgs mass calculated by Hashimoto, Tanabashi, and Yamawaki in hep-ph/0311165 where they say:

"... We perform the most attractive channel (MAC) analysis in the top mode standard model with TeV-scale extra dimensions, where the standard model gauge bosons and the third generation of quarks and leptons are put in  $D(=6,8,10,\dots)$  dimensions. In such a model, bulk gauge couplings rapidly grow in the ultraviolet region. In order to make the scenario viable, only the attractive force of the top condensate should exceed the critical coupling, while other channels such as the bottom and tau condensates should not. We then find that the top condensate can be the MAC for  $D=8$  ... We predict masses of the top ( $m_t$ ) and the Higgs ( $m_H$ ) ... based on the renormalization group for the top Yukawa and Higgs quartic couplings with the compositeness conditions at the scale where the bulk top condenses ... for ... [Kaluza-Klein type] ... dimension...  $D=8$  ...  $m_t = 172-175$  GeV and  $m_H=176-188$  GeV ...".

As to composite Higgs and the Triviality boundary, Pierre Ramond says in his book *Journeys Beyond the Standard Model* ( Perseus Books 1999 ) at pages 175-176: "... The Higgs quartic coupling has a complicated scale dependence. It evolves according to  $d\lambda/dt = (1/16\pi^2)\beta_\lambda$  where the one loop contribution is given by  $\beta_\lambda = 12\lambda^2 - \dots - 4H$  ... The value of  $\lambda$  at low energies is related [to] the physical value of the Higgs mass according to the tree level formula  $m_H = v\sqrt{2\lambda}$  while the vacuum value is determined by the Fermi constant ... for a fixed vacuum value  $v$ , let us assume that the Higgs mass and therefore  $\lambda$  is large. In that case,  $\beta_\lambda$  is dominated by the  $\lambda^2$  term, which drives the coupling towards its Landau pole at higher energies. Hence the higher the Higgs mass, the higher  $\lambda$  is and the closer [r] the Landau pole to experimentally accessible regions.

This means that for a given (large) Higgs mass, we expect the standard model to enter a strong coupling regime at relatively low energies, losing in the process our ability to calculate. This does not necessarily mean that the theory is incomplete, only that we can no longer handle it ... it is natural to think that this effect is caused by new strong interactions, and that the Higgs actually is a composite ...

The resulting bound on  $\lambda$  is sometimes called the triviality bound.

The reason for this unfortunate name (the theory is anything but trivial) stems from lattice studies where the coupling is assumed to be finite everywhere; in that case the coupling is driven to zero, yielding in fact a trivial theory.

In the standard model  $\lambda$  is certainly not zero. ...".

The Magenta Dot  at the end of the White Line is the **High-mass state of a 220 GeV Truth Quark and a 240 GeV Higgs**. It is at the critical point of the Higgs-Tquark System with respect to Vacuum Instability and Triviality. It corresponds to the description in hep-ph/9603293 by Koichi Yamawaki of the Bardeen-Hill-Lindner model: "... the BHL formulation of the top quark condensate ... start[s] with the SM Lagrangian which includes explicit Higgs field at the Lagrangian level ... BHL is crucially based on the perturbative picture ...[which]... breaks down at high energy near the compositeness scale  $\Lambda$  ... [  $10^{19}$  GeV ]... there must be a certain matching scale  $\Lambda_{\text{Matching}}$  such that the perturbative picture (BHL) is valid for  $\mu < \Lambda_{\text{Matching}}$ , while only the nonperturbative picture (MTY) becomes consistent for  $\mu > \Lambda_{\text{Matching}}$  ... However, thanks to the presence of a quasi-infrared fixed point, BHL prediction is numerically quite stable against ambiguity at high energy region, namely, rather independent of whether this high energy region is replaced by MTY or something else. ... Then we expect  $m_t = m_t(\text{BHL}) = \dots = 1/(\sqrt{2}) y_{\text{bar}} v$  within 1-2%, where  $y_{\text{bar}}$  is the quasi-infrared fixed point given by  $\text{Beta}(y_{\text{bar}}) = 0$  in ... the one-loop RG equation ... The composite Higgs loop changes  $y_{\text{bar}}^2$  by roughly the factor  $N_c/(N_c + 3/2) = 2/3$  compared with the MTY value, i.e., 250 GeV  $\rightarrow$  250 x  $\sqrt{2/3} = 204$  GeV, while the electroweak gauge boson loop with opposite sign pulls it back a little bit to a higher value. The BHL value is then given by  $m_t = 218 \pm 3$  GeV, at  $\Lambda = 10^{19}$  GeV. The Higgs boson was predicted as a  $t\bar{t}$  bound state with a mass  $M_H = 2m_t$  based on the pure NJL model calculation. Its mass was also calculated by BHL through the full RG equation ... the result being ...  $M_H / m_t = 1.1$  ) at  $\Lambda = 10^{19}$  GeV ... ... the top quark condensate proposed by Miransky, Tanabashi and Yamawaki (MTY) and by Nambu independently ... entirely replaces the standard Higgs doublet by a composite one formed by a strongly coupled short range dynamics (four-fermion interaction) which triggers the top quark condensate. The Higgs boson emerges as a  $t\bar{t}$  bound state and hence is deeply connected with the top quark itself. ... MTY introduced explicit four-fermion interactions responsible for the top quark condensate in addition to the standard gauge couplings. Based on the explicit solution of the ladder SD equation, MTY found that even if all the dimensionless four-fermion couplings are of  $O(1)$ , only the coupling larger than the critical coupling yields non-zero (large) mass ... The model was further formulated in an elegant fashion by Bardeen, Hill and Lindner (BHL) in the SM language, based on the RG equation and the compositeness condition. BHL essentially incorporates  $1/N_c$  sub-leading effects such as those of the composite Higgs loops and ... gauge boson loops which were disregarded by the MTY formulation. We can explicitly see that BHL is in fact equivalent to MTY at  $1/N_c$ -leading order. Such effects turned out to reduce the above MTY value 250 GeV down to 220 GeV ...".

**Fermilab has seen all 3 Truth Quark Mass States:**

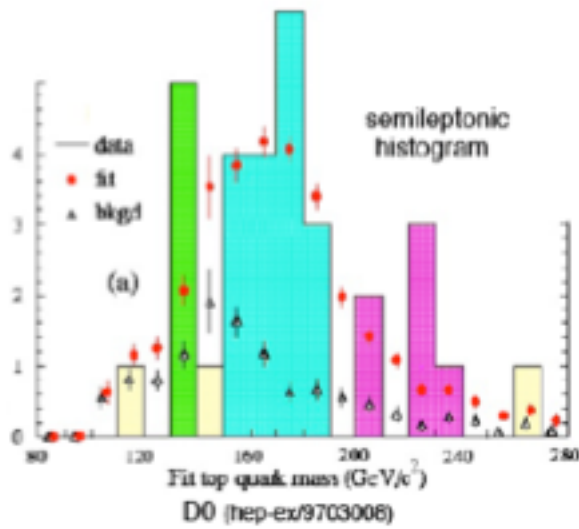
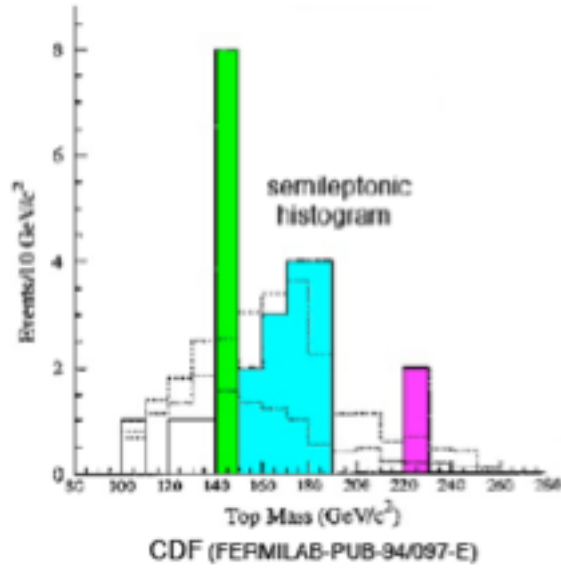

**At the LHC, CMS has seen all 3 Higgs Mass States:**

CMS at arXiv 1804.01939 released a histogram in the Higgs -> ZZ\* -> 4l channel for the 35.9 fb<sup>-1</sup> of 2015-2016 LHC Run2 data that shows all 3 Higgs Mass States

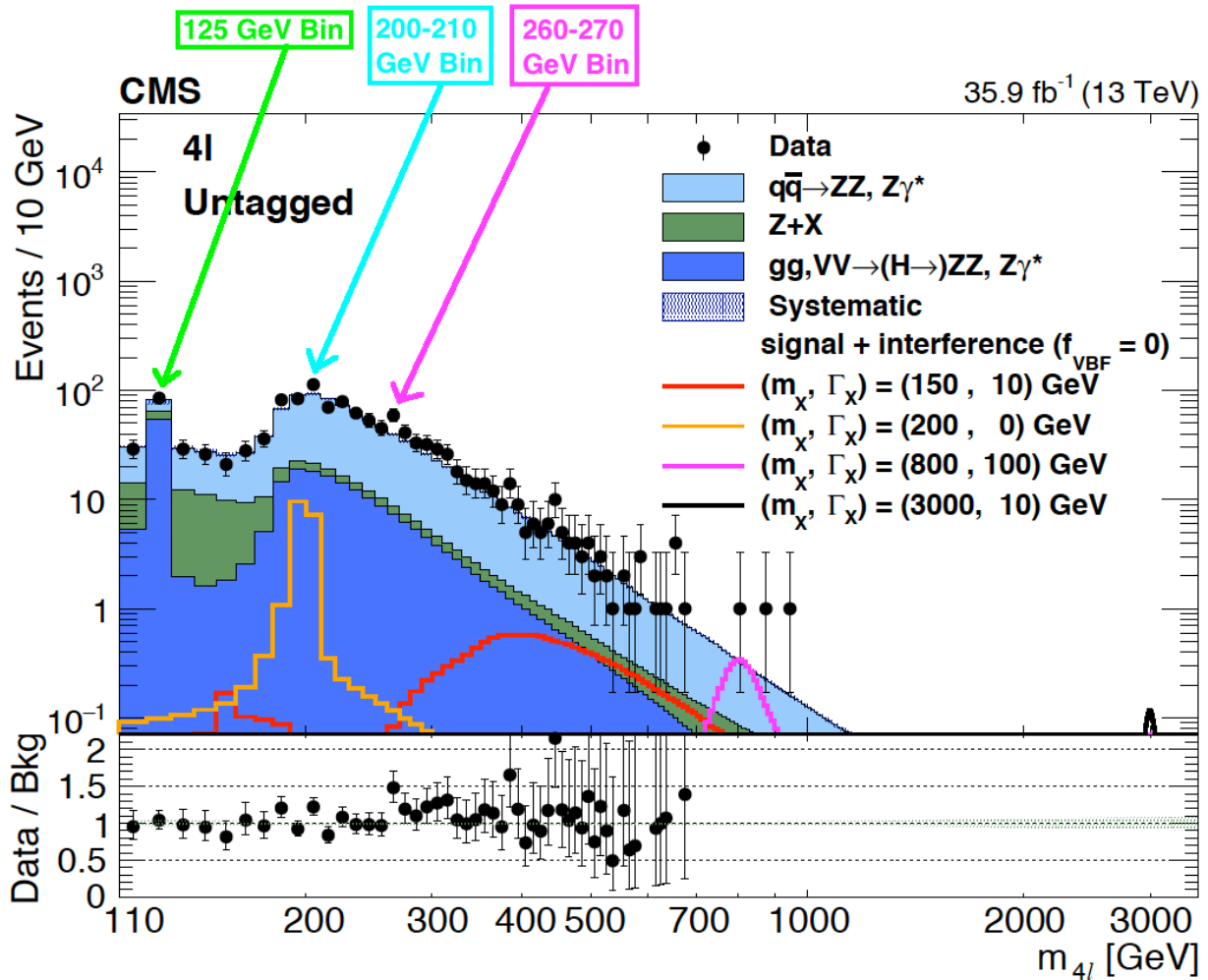

The log scale for event number used by CMS makes the Higgs peaks look small. The peaks appear more realistic using a linear scale for event number:

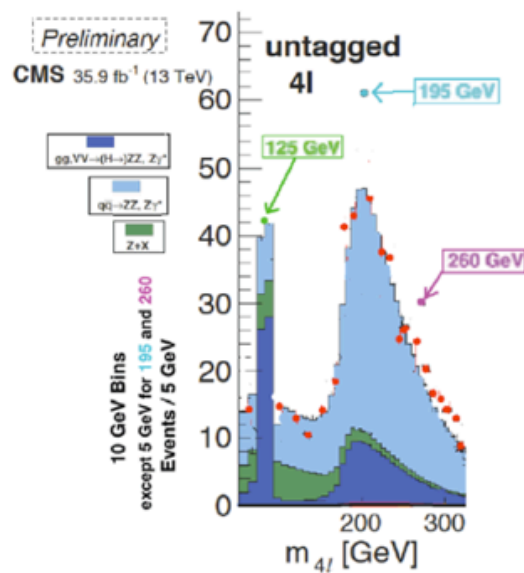

## Schwinger Sources, Hua Geometry, and Wyler Calculations

Fock “Fundamental of Quantum Mechanics” (1931) showed that Quantum requires Linear Operators “... represented by a definite integral [of a]... kernel ... function ...”.

Schwinger (1951 - see Schweber, PNAS 102, 7783-7788) “... introduced a description in terms of Green’s functions, what Feynman had called propagators ... The Green’s functions are vacuum expectation values of time-ordered Heisenberg operators, and the field theory can be defined non-perturbatively in terms of these functions ...[which]... gave deep structural insights into QFTs; in particular ... the structure of the Green's functions when their variables are analytically continued to complex values ...”.

Wolf (J. Math. Mech 14 (1965) 1033-1047) showed that the Classical Domains (complete simply connected Riemannian symmetric spaces) representing 4-dim Spacetime with Quaternionic Structure are:

**S<sup>4</sup>** = 4-sphere = Spin(5) / Spin(4) where Spin(5) = Schwinger-Euclidean version of the Anti-DeSitter subgroup of the Conformal Group that gives **MacDowell-Mansouri Gravity**  
**CP<sup>2</sup>** = complex projective 2-space = SU(3) / U(2) with **the SU(3) of the Color Force**  
**S<sup>2</sup> x S<sup>2</sup>** = SU(2)/U(1) x SU(2)/U(1) with two copies of **the SU(2) of the Weak Force**  
**S<sup>1</sup> x S<sup>1</sup> x S<sup>1</sup> x S<sup>1</sup>** = U(1) x U(1) x U(1) x U(1) = 4 copies of **the U(1) of the EM Photon** ( 1 copy for each of the 4 covariant components of the Photon )

Hua “Harmonic Analysis of Functions of Several Complex Variables in the Classical Domains” (1958) showed Kernel Functions for Complex Classical Domains and calculated compact volumes (such as Euclidean spacetime) whose ratios correspond to ratios of measures of noncompact spaces (such as hyperbolic signature spacetime). Here M = Spacetime Structure and D = Gauge Domain and Q = Shilov Boundary of D:

Force	M	Vol(M)
gravity	S <sup>4</sup>	8pi <sup>2</sup> /3 - S <sup>4</sup> is 4-dimensional
color	CP <sup>2</sup>	8pi <sup>2</sup> /3 - CP <sup>2</sup> is 4-dimensional
weak	S <sup>2</sup> x S <sup>2</sup>	2 x 4pi - S <sup>2</sup> is a 2-dim boundary of 3-dim ball 4-dim S <sup>2</sup> x S <sup>2</sup> = topological boundary of 6-dim 2-polyball Shilov Boundary of 6-dim 2-polyball = S <sup>2</sup> + S <sup>2</sup> = = 2-dim surface frame of 4-dim S <sup>2</sup> x S <sup>2</sup>
e-mag	T <sup>4</sup>	4 x 2pi - S <sup>1</sup> is 1-dim boundary of 2-dim disk 4-dim T <sup>4</sup> = S <sup>1</sup> x S <sup>1</sup> x S <sup>1</sup> x S <sup>1</sup> = topological boundary of 8-dim 4-polydisk Shilov Boundary of 8-dim 4-polydisk = S <sup>1</sup> + S <sup>1</sup> + S <sup>1</sup> + S <sup>1</sup> = = 1-dim wire frame of 4-dim T <sup>4</sup>

Force	M	Vol(M)	Q	Vol(Q)	D	Vol(D)
gravity	S <sup>4</sup>	8pi <sup>2</sup> /3	RP <sup>1</sup> xS <sup>4</sup>	8pi <sup>3</sup> /3	IV5	pi <sup>5</sup> /2 <sup>4</sup> 5!
color	CP <sup>2</sup>	8pi <sup>2</sup> /3	S <sup>5</sup>	4pi <sup>3</sup>	B <sup>6</sup> (ball)	pi <sup>3</sup> /6
Weak	S <sup>2</sup> xS <sup>2</sup>	2x4pi	RP <sup>1</sup> xS <sup>2</sup>	4pi <sup>2</sup>	IV3	pi <sup>3</sup> /24
e-mag	T <sup>4</sup>	4x2pi	-	-	-	-

Armand Wyler (1971 - C. R. Acad. Sc. Paris, t. 271, 186-188) showed how to use Green's Functions = Kernel Functions of Classical Domain structures characterizing Sources = Leptons, Quarks, and Gauge Bosons, to calculate Particle Mass and **Force Strength = (1 / Mforce^2) ( Vol(M) ( Vol(Q) / Vol(D)^( 1 / mforce ))**

where Mforce = characteristic mass (Planck for Gravity, Weak Bosons for Weak)

Gauge Group	Force	Characteristic Energy Level	Geometric Strength	Full Strength
Spin(5)	gravity	approx 10 <sup>19</sup> GeV	1	GGmproton <sup>2</sup> approx 5 x 10 <sup>-39</sup>
SU(3)	color	approx 245 MeV	0.6286	0.6286
SU(2)	weak	approx 100 GeV	0.2535	GWmproton <sup>2</sup> approx 1.05 x 10 <sup>-5</sup>
U(1)	e-mag	approx 4 KeV	1/137.03608	1/137.03608

Schwinger (1969 - see physics/0610054) said: "... operator field theory ... replace[s] the particle with ... properties ... distributed throughout ... small volumes of three-dimensional space ... particles ... must be created ... even though we vary a number of experimental parameters ... The properties of the particle ... remain the same ... We introduce a quantitative description of the particle source in terms of a source function ... we do not have to claim that we can make the source arbitrarily small ... the experimenter... must detect the particles ...[by]... collision that annihilates the particle ... the source ... can be ... an abstraction of an annihilation collision, with the source acting negatively, as a sink ... The basic things are ... the source functions ... describing the intermediate propagation of the particle ...".

**Schwinger Sources can be described by continuous manifold structures of Bounded Complex Domains and their Shilov Boundaries**

but

Cl(16) Physics at the Planck Scale has spacetime condensing out of Clifford structures forming a Leech lattice underlying 26-dim String Theory of World-Lines with  $8 + 8 + 8 = 24$ -dim of fermion particles and antiparticles and of spacetime.

The automorphism group of a single 26-dim String Theory cell modulo the Leech lattice is the Monster Group of order about  $8 \times 10^{53}$ .

The Monster Group is of order

8080 , 17424, 79451, 28758, 86459, 90496, 17107, 57005, 75436, 80000, 00000  
 =  
 $2^{46} \cdot 3^{20} \cdot 5^9 \cdot 7^6 \cdot 11^2 \cdot 13^3 \cdot 17 \cdot 19 \cdot 23 \cdot 29 \cdot 31 \cdot 41 \cdot 47 \cdot 59 \cdot 71$   
 or about  $8 \times 10^{53}$

This chart (from Wikipedia) shows the Monster M and other Sporadic Finite Groups

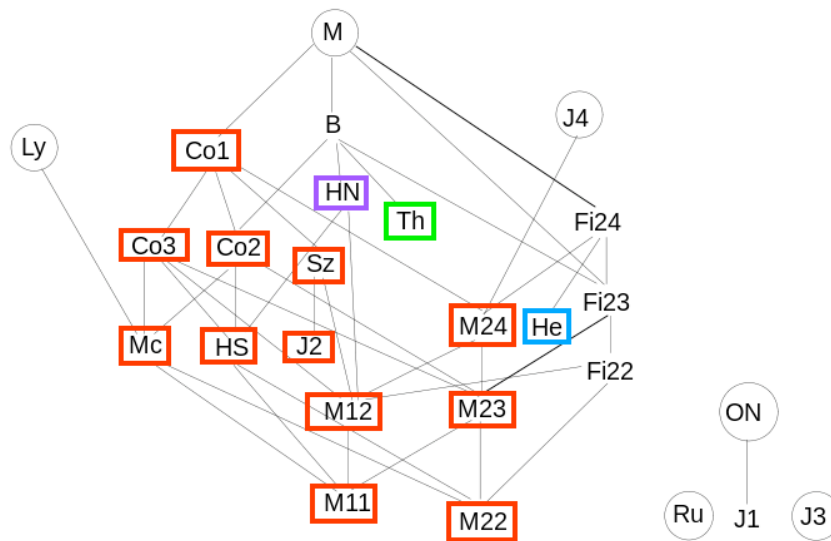

$Co1 \times Th \times He \times HN / HS$  together have order about  $4 \times 9 \times 4 \times 10^{(18+16+9+7)}$   
 = about  $10^{52}$

The order of Co1 is  $2^{21} \cdot 3^9 \cdot 5^4 \cdot 7^2 \cdot 11 \cdot 13 \cdot 23$  or about  $4 \times 10^{18}$ .

Aut(Leech Lattice) = double cover of Co1.

The order of the double cover  $2.Co1$  is  $2^{22} \cdot 3^9 \cdot 5^4 \cdot 7^2 \cdot 11 \cdot 13 \cdot 23$  or about  $0.8 \times 10^{19}$ .

Taking into account the non-sporadic part of the Leech Lattice symmetry according to the ATLAS at [brauer.maths.qmul.ac.uk/Atlas/v3/spor/M/](http://brauer.maths.qmul.ac.uk/Atlas/v3/spor/M/) the Schwinger Source Kerr-Newman Cloud Symmetry is  $2^{(1+24)}.Co1$  of order  $139511839126336328171520000 = 1.4 \times 10^{26}$



The components of the Monster Group describe the composition of Schwinger Sources:

Co1 gives the number of particles in the Schwinger Source Kerr-Newman Cloud emanating from a Valence particle in a Planck-scale cell of Cl(16) Physics SpaceTime.

Th = Thompson Group. Wikipedia says "... Th ... acts on a vertex operator algebra over the field with 3 elements. This vertex operator algebra contains the E8 Lie algebra over  $F_3$ , giving the embedding of Th into E8(3) ...". Th gives the 3-fold E8 Triality structure relating 8-dim SpaceTime to First-Generation Fermion Particles and AntiParticles.

He = Held Group. Wikipedia says "... The smallest faithful complex representation has dimension 51; there are two such representations that are duals of each other. It centralizes an element of order 7 in the Monster group. ...". He gives the 7-fold algebraically independent Octonion Imaginary E8 Integral Domains that make up 7 of the 8 components of Octonion Superposition E8 SpaceTime.

HN = Harada-Norton Group. Wikipedia says "... The prime 5 plays a special role ... it centralizes an element of order 5 in ... the Monster group ...". HN / HS gives the 5-fold symmetry of 120-element Binary Icosahedral E8 McKay Group beyond the 24-element Binary Tetrahedral E6 McKay Group at which level the Shilov Boundaries of Bounded Complex Domains emerge to describe SpaceTime and Force Strengths and Particle Masses.

**When a fermion particle/antiparticle appears in E8 spacetime  
it does not remain a single Planck-scale entity  
because Tachyons create a cloud of particles/antiparticles.**

The cloud is one Planck-scale Fundamental Fermion Valence Particle plus an effectively neutral cloud of particle/antiparticle pairs forming a Kerr-Newman black hole. That Kerr-Newman cloud constitutes the Cl(16) Physics model Schwinger Source.

The cloud structure comes from the 24-dim Leech lattice part of the Monster Group which is  $2^{(1+24)}$  times the double cover of Co1, for a total order of about  $10^{26}$ .

Since a Leech lattice is based on copies of an E8 lattice and since there are 7 distinct E8 integral domain lattices there are 7 (or 8 if you include a non-integral domain E8 lattice) distinct Leech lattices. The physical Leech lattice is a superposition of them, effectively adding a factor of 8 to the order, so the volume of the Kerr-Newman Cloud is on the order of  $10^{27}$  x Planck scale and the Kerr-Newman Cloud should contain about  $10^{27}$  particle/antiparticle pairs. Its size should be about  $10^{(27/3)} \times 1.6 \times 10^{(-33)}$  cm = roughly  $10^{(-24)}$  cm.

Each of those particle-antiparticle pairs should see (with Bohm Potential) the rest of our Universe in the perspective of  $8 \times 10^{53}$  Monster Symmetry so a single Schwinger Source acting as a Jewel of Indra's Net should see / reflect

$10^{27} \times 8 \times 10^{53} = 8 \times 10^{80}$  Other Schwinger Source Jewels of Indra's Net which is consistent with the number of Schwinger Sources in our Universe. Andrew Gray in arXiv quant-ph/9712037 said: "... probabilities are ... assigned to entire fine-grained histories ... base[d] ... on the Feynman path integral formulation ..." so in CI(16) Physics the Indra's Net of Schwinger Source Jewels would not have Bohm Quantum Potential interactions between two Jewels, rather the interactions would be between the two entire World-Line History Strings



( image adapted from <http://www.blockchaintechnologies.com> / which is source of this quote: )  
 "... A **blockchain** is a type of distributed ledger, comprised of unchangeable, digitally recorded data in packages called blocks. These digitally recorded "blocks" of data is stored in a linear chain ... A distributed ledger is a consensus of replicated, shared, and synchronized digital data geographically spread across multiple sites, countries, and/or institutions ..." or, for **CI(16) Physics Indra's Net of Schwinger Source Jewels, spread across the entirety of our Universe.**

Roderick I. Sutherland ( arXiv 1509.02442v3 ) has given a Lagrangian for the Gray Fine-Grained Nambu-Goto Quantum Bohm Potential that has been extended by Jack Sarfatti to include nonlinear Back-Reaction

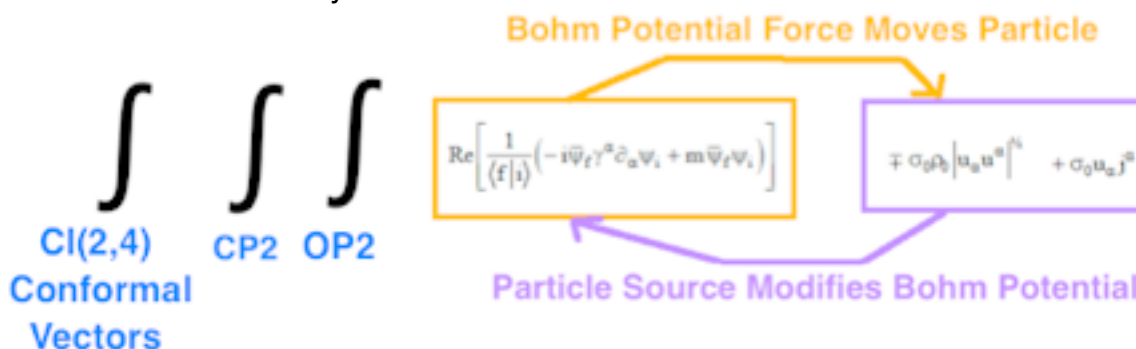

that enables Penrose-Hameroff Quantum Consciousness and Free Will, justifying **Clifford's characterization of Real Clifford Algebras as** "... mind-stuff tak[ing] the form of ... human consciousness ...".

Each **Blockshain Node is a Schwinger Source** connected by Bohm Quantum Potential to all other Schwinger Source Nodes in our Universe and governed by the "algorithms and rules" of the CI(16) Physics Lagrangian and the Algebraic Quantum Field Theory arising from the completion of the union of all tensor products of copies of CI(16) each copy of CI(16) containing E8 and the E8 Lagrangian.

## African Origin of Indra's Net.

About 50,000 years ago (National Geographic Genographic) YAP and M174 went out of Africa to Sunda (which was dry land South of Angkor Wat and SouthEast of India) and on to Japan and Tibet. After M174 left Africa they no longer had a sufficiently extensive social network to pass their culture (IFA, Real Clifford Algebras, E8) from one generation to the next, so they had to develop more formal ways to preserve culture:

- in Sunda / Angkor Wat / India - Sanskrit language and the Rig Veda
- in Japan - Shinto Futomani 128 poems of Amateru = half of 256 Odu of IFA
- in Tibet - 64 elements of I Ching = quarter of 256 Odu of IFA



Therefore the Rig Veda is likely to be the oldest book on Earth.

David Frawley in a hindubooks riverheaven web site said:  
“... The Rig Veda is composed of ten books (called mandalas in Sanskrit) ...  
The first book is a collection of hymns from seers of different families ...  
Each hymn is given to a certain deity (devata).  
The main deities are Indra, Agni, Soma and Surya. ...”.

According to The Constitution of the Universe by Maharishi Mahesh Yogi  
 "... the Constitution of the Universe ... is embodied in the very structure of the sounds of the Rik Ved, the most fundamental aspect of the Vedic literature ... the structure of the Ved provides its own commentary - a commentary which is contained in the sequential unfoldment of the Ved itself in its various stages of expression. The knowledge of the total Ved ... is contained in the first sukt of the Rik Ved, which is ...

Ahankar	Buddhi	Manas	Akash	Vayu	Agni	Jal	Prithivi	Ahankar	Buddhi	Manas	Akash	Vayu	Agni	Jal	Prithivi	Ahankar	Buddhi	Manas	Akash	Vayu	Agni	Jal	Prithivi
अकृ	नि	मी	ळे	पु	रो	हि	तं	य	ज्ञ	स्य	दे	व	मु	त्वि	जम्	हो	ता	रं	रं	लु	धा	तं	मम्
AK	NI	MI	LE	PU	RO	HI	TAM	YA	GYA	SYA	DE	VA	MRI	TVI	JAM	HO	TA	RAM	RA	TNA	DHA	TA	MAM
अ	मि	पू	वै	भिः	अ	भि	भि	री	ड	गो	नू	तं	नै	तु	त	स	दे	जा	ए	ह	वं	च	ति
अ	मि	नां	उ	धि	मं	इन	व	त्पो	वं	गु	व	दि	वे	दि	वे	यु	श	सै	खी	र	वं	त	मम्
अ	मे	यं	यु	ज्ञ	मं	ध्व	रं	वि	श्च	तेः	प	दि	पु	र	सिं	स	इ	दे	वे	धु	ग	च्छ	ति
अ	मिर	हो	तां	कृ	वि	कं	तुः	सु	त्यश्	वि	त्र	अं	ख	स्त	मः	दे	यो	दे	वे	भि	रा	गं	मत्
य	ड	ङ्	दा	शु	षे	तुः	ब	अ	जै	पु	दं	क	रि	प्य	सिं	त	वेत्	तत्	सु	त्थ	मं	ङ्गि	रः
उ	पं	त्वा	मे	दि	वे	दि	खे	दो	र्षां	व	स्तर	धि	या	वु	यम्	न	गो	म	रं	नु	ए	मं	सि
रा	अं	न्त	म	ध्व	रा	शीं	गो	पा	मु	तं	स्थ	दीं	दि	वि	म्	व	वै	मा	तुं	सु	वे	द	धं
स	नः	धि	ते	वं	सु	न	वे	अ	मै	सू	षा	यु	नो	वं	व	स	वं	सु	आ	नः	स्तु	स्त	यं

... The complete knowledge of the Ved contained in the first sukt (stanza) is also found in the first richa (verse) - the first twenty-four syllables [purple box] of the first sukt ... The subsequent eight lines [green box, red box, blue box] complete the remainder of the first sukt - the next stage of sequential unfoldment of knowledge in the Ved. These eight lines consist of 24 padas (phrases), comprising 8x24 = 192 syllables ... these 24 padas of eight syllables elaborate the unmanifest, eight-fold structure of the 24 gaps [purple box] between the syllables of the first richa (verse). ... these 192 syllables of the first sukt (stanza) get elaborated in the 192 suktas that comprise the first mandal (circular cyclical eternal structure) of the Rik Ved, which in turn gives rise to the rest of the Ved and the entire Vedic literature. ...".

Therefore the Rig Veda encodes E8 with 240 Root Vectors = 24+24+64+64+64

24 First Richa Syllables + 24 First Richa Gaps = D4sm + D4gde (purple box)

8x8 = 64 Last-8 Syllables of Last 8 Lines = D8 / D4sm x D4gde (blue box)

8x8 = 64 First-8 Syllables of Last 8 Lines (green box)

and

8x8 = 64 Middle-8 Syllables of Last 8 Lines (red box)

give 128 = E8 / D8 = Fermion Particles and AntiParticles

so

Indra and Indra's Net, which are described in the Rig Veda, which describes E8, have their source in Africa and IFA

According to Wikipedia:

"... Indra is praised as the highest god in 250 hymns of the Rigveda ... the earliest reference to a net belonging to Indra is in the Atharva Veda (c. 1000 BCE) ... "Indra's net" is the net of the Vedic deva Indra, whose net hangs over his palace on Mount Meru, the axis mundi of Buddhist and Hindu cosmology. In this metaphor, Indra's

net has a multifaceted jewel at each vertex, and each jewel is reflected in all of the other jewels. ...

Aspects of Indra as a deity are cognate to other ... thunder gods

...

Chango is the most feared god in Santería ... Şàngó is viewed as the most powerful ... orisha ... He casts a "thundersone" to earth, which creates **thunder** and lightning ... Chango ... had three wives ... Princess Oshun, Princess Oba, and Princess Oya ... Oshun is the deity of the river ... She is connected to destiny and **divination** ... The abèbè is the ritual object most associated with Oşun. The abèbè is a fan in circular form ... with a **mirror** in the center ...".

**Chango and Indra both use Thunder,  
and Chango's wife Oshun does Divination with a Mirror  
so  
Chango and Oshun are two of the African IFA Orishas  
who are precursors of Vedic Indra and Indra's Net.**

Japan, the next stop beyond Sunda of Human M174 migration Out of Africa, also has similar culture:



the sacred Yata no Kagami, or Eight-Handed Mirror -  
analogous to Indra Net Jewel Reflections

the Sword Kusanagi no Tsurugi -  
analogous to ThunderBolts

the curved Yasakani no Magatama Jewel -  
analogous to Indra Jewels

## Wyler Force Strength and Mass Calculation Details

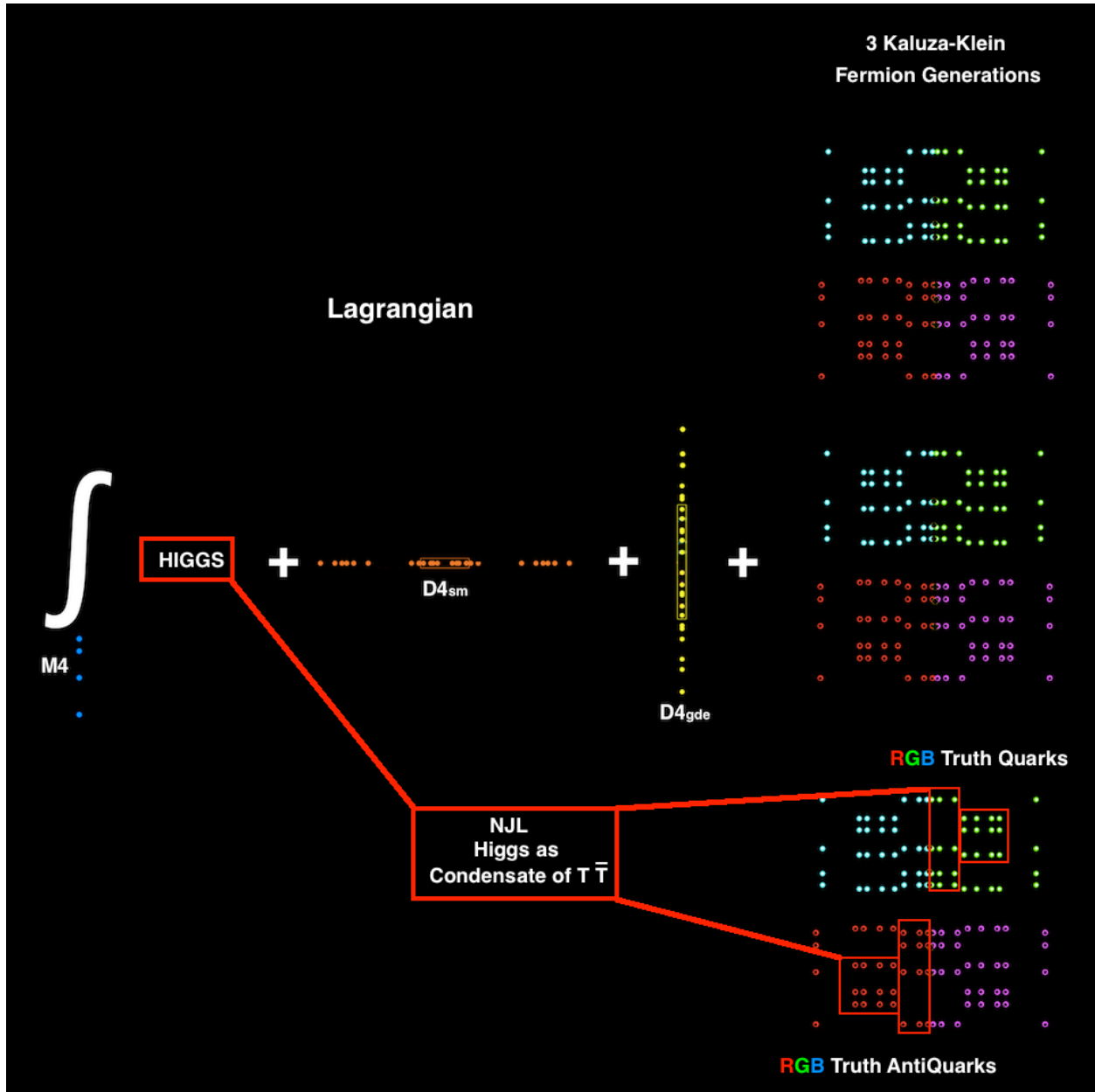

The E8 model constructs the Lagrangian integral such that the mass  $m$  emerges as the integral over the Schwinger Source spacetime region of its Kerr-Newman cloud of virtual particle/antiparticle pairs plus the valence fermion so that the volume of the Schwinger Source fermion defines its mass, which, being dressed with the particle/antiparticle pair cloud, gives quark mass as constituent mass.

Fermion Schwinger Sources correspond to the Lie Sphere Symmetric space

$$\text{Spin}(10) / \text{Spin}(8) \times U(1)$$

with Bounded Complex Domain D8 of type IV8 and Shilov Boundary Q8 =  $RP^1 \times S^7$  which has local symmetry of the Spin(8) gauge group from which the first generation spinor fermions are formed as **+half-spinor** and **-half-spinor** spaces

For the Gauge Gravity and Standard Model Gauge Bosons the process of breaking Octonionic 8-dim SpaceTime down to Quaternionic (4+4)-dim M4 x CP2 Kaluza-Klein creates differences in the way gauge bosons "see" 4-dim Physical SpaceTime. There are 4 equivalence classes of 4-dimensional Riemannian Symmetric Spaces with Quaternionic structure consistent with 4-dim Physical SpaceTime:

$S_4$  = 4-sphere = Spin(5) / Spin(4) where Spin(5) = Schwinger-Euclidean version of the Anti-DeSitter subgroup of the Conformal Group that gives [MacDowell-Mansouri Gravity](#)

$CP_2$  = complex projective 2-space = SU(3) / U(2) with [the SU\(3\) of the Color Force](#)

$S_2 \times S_2$  = SU(2)/U(1) x SU(2)/U(1) with two copies of [the SU\(2\) of the Weak Force](#)

$S_1 \times S_1 \times S_1 \times S_1$  = U(1) x U(1) x U(1) x U(1) = 4 copies of [the U\(1\) of the EM Photon](#) ( 1 copy for each of the 4 covariant components of the Photon )

The Gravity Gauge Bosons (Schwinger-Euclidean versions) live in a Spin(5) subalgebra of the Spin(6) Conformal subalgebra of D4 = Spin(8). They "see" M4 Physical spacetime as the 4-sphere  $S_4$  so that their part of the Physical Lagrangian is

$\int$  Gravity Gauge Boson Term

$S_4$  .

an integral over SpaceTime  $S_4$ .

The Schwinger Sources for GRb bosons are the Complex Bounded Domains and Shilov Boundaries for Spin(5) MacDowell-Mansouri Gravity bosons.

However, due to Stabilization of Condensate SpaceTime by virtual Planck Mass Gravitational Black Holes,

for Gravity, the effective force strength that we see in our experiments is not just composed of the  $S_4$  volume and the Spin(5) Schwinger Source volume, but is suppressed by the square of the Planck Mass.

The unsuppressed Gravity force strength is the Geometric Part of the force strength.

The Standard Model SU(3) Color Force bosons live in a SU(3) subalgebra of the SU(4) subalgebra of D4 = Spin(8). They "see" M4 Physical spacetime as the complex projective plane CP2 so that their part of the Physical Lagrangian is

$$\int_{\text{CP}^2} \text{SU(3) Color Force Gauge Boson Term}$$

CP2 .  
an integral over SpaceTime CP2.

The Schwinger Sources for SU(3) bosons are the Complex Bounded Domains and Shilov Boundaries for SU(3) Color Force bosons. The Color Force Strength is given by the SpaceTime CP2 volume and the SU(3) Schwinger Source volume.

Note that since the Schwinger Source volume is dressed with the particle/antiparticle pair cloud, the calculated force strength is for the characteristic energy level of the Color Force (about 245 MeV).

The Standard Model SU(2) Weak Force bosons live in a SU(2) subalgebra of the U(2) local group of CP2 = SU(3) / U(2). They "see" M4 Physical spacetime as two 2-spheres S2 x S2 so that their part of the Physical Lagrangian is

$$\int_{\text{S}^2 \times \text{S}^2} \text{SU(2) Weak Force Gauge Boson Term}$$

S2xS2 .  
an integral over SpaceTime S2xS2.

The Schwinger Sources for SU(2) bosons are the Complex Bounded Domains and Shilov Boundaries for SU(2) Weak Force bosons. However, due to the action of the Higgs mechanism, for the Weak Force, the effective force strength that we see in our experiments is not just composed of the S2xS2 volume and the SU(2) Schwinger Source volume, but is suppressed by the square of the Weak Boson masses.

The unsuppressed Weak Force strength is the Geometric Part of the force strength.

The Standard Model U(1) Electromagnetic Force bosons (photons) live in a U(1) subalgebra of the U(2) local group of CP2 = SU(3) / U(2). They "see" M4 Physical spacetime as four 1-sphere circles S1xS1xS1xS1 = T4 (T4 = 4-torus) so that their part of the Physical Lagrangian is

$$\int_{\text{T}^4} \text{(U(1) Electromagnetism Gauge Boson Term)}$$

T4 .  
an integral over SpaceTime T4.

The Schwinger Sources for U(1) photons are the Complex Bounded Domains and Shilov Boundaries for U(1) photons. The Electromagnetic Force Strength is given by the SpaceTime T4 volume and the U(1) Schwinger Source volume.



## Force Strength and Boson Mass Calculation

The Force Strength is made up of two parts:  
the relevant spacetime manifold of gauge group global action  
and  
the relevant symmetric space manifold of gauge group local action.

The 4-dim spacetime Lagrangian **GG SM** gauge boson term is:  
the integral over spacetime as seen by gauge boson acting globally  
of the gauge force term of the gauge boson acting locally  
for the gauge bosons of each of the four forces:

U(1) for electromagnetism  
SU(2) for weak force  
SU(3) for color force

Spin(5) - compact version of antiDeSitter Spin(2,3) subgroup of Conformal Spin(2,4) for gravity by the MacDowell-Mansouri mechanism.

In the conventional picture,  
for each gauge force the gauge boson force term contains the force strength,  
which in Feynman's picture is the amplitude to emit a gauge boson,  
and can also be thought of as the probability = square of amplitude,  
in an explicit ( like  $g |F|^2$  ) or an implicit ( incorporated into the  $|F|^2$  ) form.  
Either way, the conventional picture is that the force strength  $g$  is an ad hoc inclusion.

The E8 model does not put in force strength  $g$  ad hoc,  
but constructs the integral such that  
the force strength emerges naturally from the geometry of each gauge force.

To do that, for each gauge force:

1 - make the spacetime over which the integral is taken be spacetime as it is seen by that gauge boson, that is, in terms of the symmetric space with global symmetry of the gauge boson:

the U(1) photon sees 4-dim spacetime as  $T^4 = S^1 \times S^1 \times S^1 \times S^1$   
the SU(2) weak boson sees 4-dim spacetime as  $S^2 \times S^2$   
the SU(3) weak boson sees 4-dim spacetime as  $CP^2$   
the Spin(5) of gravity sees 4-dim spacetime as  $S^4$

2 - make the gauge boson force term have the volume of the Shilov boundary corresponding to the symmetric space with local symmetry of the gauge boson.  
The nontrivial Shilov boundaries are:

for SU(2) Shilov =  $RP^1 \times S^2$   
for SU(3) Shilov =  $S^5$   
for Spin(5) Shilov =  $RP^1 \times S^4$

The result is (ignoring technicalities for exposition) the geometric factor for force strengths.

Each gauge group is the global symmetry of a symmetric space

$$\begin{aligned} S1 & \text{ for } U(1) \\ S2 & = SU(2)/U(1) = Spin(3)/Spin(2) \text{ for } SU(2) \\ CP2 & = SU(3)/SU(2) \times U(1) \text{ for } SU(3) \\ S4 & = Spin(5)/Spin(4) \text{ for } Spin(5) \end{aligned}$$

Each gauge group is the local symmetry of a symmetric space

$$\begin{aligned} U(1) & \text{ for itself} \\ SU(2) & \text{ for } Spin(5) / SU(2) \times U(1) \\ SU(3) & \text{ for } SU(4) / SU(3) \times U(1) \\ Spin(5) & \text{ for } Spin(7) / Spin(5) \times U(1) \end{aligned}$$

The nontrivial local symmetry symmetric spaces correspond to bounded complex domains

$$\begin{aligned} SU(2) \text{ for } Spin(5) / SU(2) \times U(1) & \text{ corresponds to } IV3 \\ SU(3) \text{ for } SU(4) / SU(3) \times U(1) & \text{ corresponds to } B^6 \text{ (ball)} \\ Spin(5) \text{ for } Spin(7) / Spin(5) \times U(1) & \text{ corresponds to } IV5 \end{aligned}$$

The nontrivial bounded complex domains have Shilov boundaries

$$\begin{aligned} SU(2) \text{ for } Spin(5) / SU(2) \times U(1) & \text{ corresponds to } IV3 \text{ Shilov} = RP^1 \times S^2 \\ SU(3) \text{ for } SU(4) / SU(3) \times U(1) & \text{ corresponds to } B^6 \text{ (ball) Shilov} = S^5 \\ Spin(5) \text{ for } Spin(7) / Spin(5) \times U(1) & \text{ corresponds to } IV5 \text{ Shilov} = RP^1 \times S^4 \end{aligned}$$

Very roughly, think of the force strength as

integral over global symmetry space of physical (ie Shilov Boundary) volume =  
= strength of the force.

That is:

the geometric strength of the force is given by the product of  
the volume of a 4-dim thing with global symmetry of the force and  
the volume of the Shilov Boundary for the local symmetry of the force.

When you calculate the product volumes (using some tricky normalization stuff),  
you see that roughly:

Volume product for gravity is the largest volume

so since (as Feynman says) force strength = probability to emit a gauge boson means  
that the highest force strength or probability should be 1

the gravity Volume product is normalized to be 1, and so (approximately):

$$\begin{aligned} \text{Volume product for gravity} & = 1 \\ \text{Volume product for color} & = 2/3 \\ \text{Volume product for weak} & = 1/4 \\ \text{Volume product for electromagnetism} & = 1/137 \end{aligned}$$

There are two further main components of a force strength:

- 1 - for massive gauge bosons, a suppression by a factor of  $1 / M^2$
- 2 - renormalization running (important for color force)

Consider Massive Gauge Bosons:

Gravity as curvature deformation of SpaceTime, with SpaceTime as a condensate of Planck-Mass Black Holes, must be carried by virtual Planck-mass black holes, so that the geometric strength of gravity should be reduced by  $1/M_p^2$

The weak force is carried by weak bosons,

so that the geometric strength of the weak force should be reduced by  $1/M_W^2$

That gives the result (approximate):

$$\begin{aligned} \text{gravity strength} &= G \text{ (Newton's } G\text{)} \\ \text{color strength} &= 2/3 \\ \text{weak strength} &= G_F \text{ (Fermi's weak force } G\text{)} \\ \text{electromagnetism} &= 1/137 \end{aligned}$$

Consider Renormalization Running for the Color Force:: That gives the result:

$$\begin{aligned} \text{gravity strength} &= G \text{ (Newton's } G\text{)} \\ \text{color strength} &= 1/10 \text{ at weak boson mass scale} \\ \text{weak strength} &= G_F \text{ (Fermi's weak force } G\text{)} \\ \text{electromagnetism} &= 1/137 \end{aligned}$$

The use of compact volumes is itself a calculational device, because it would be more nearly correct, instead of the integral over the compact global symmetry space of the compact physical (ie Shilov Boundary) volume=strength of the force to use the integral over the hyperbolic spacetime global symmetry space of the noncompact invariant measure of the gauge force term.

However, since the strongest (gravitation) geometric force strength is to be normalized to 1, the only thing that matters is ratios, and the compact volumes (finite and easy to look up in the book by Hua) have the same ratios as the noncompact invariant measures.

In fact, I should go on to say that continuous spacetime and gauge force geometric objects are themselves also calculational devices, and that it would be even more nearly correct to do the calculations with respect to a discrete generalized hyperdiamond Feynman checkerboard.

**Here are more detailed force strength calculations:**

The force strength of a given force is

$$\text{alphaforce} = (1 / \text{Mforce}^2) ( \text{Vol}(\text{MISforce}) ) ( \text{Vol}(\text{Qforce}) / \text{Vol}(\text{Dforce})^{( 1 / \text{mforce} )} )$$

where:

alphaforce represents the force strength;

Mforce represents the effective mass;

MISforce represents the relevant part of the target Internal Symmetry Space;

Vol(MISforce) stands for volume of MISforce and is sometimes also denoted by Vol(M);

Qforce represents the link from the origin to the relevant target for the gauge boson;

Vol(Qforce) stands for volume of Qforce;

Dforce represents the complex bounded homogeneous domain of which Qforce is the Shilov boundary;

mforce is the dimensionality of Qforce, which is

4 for Gravity and the Color force,

2 for the Weak force (which therefore is considered to have two copies of QW for SpaceTime),

1 for Electromagnetism (which therefore is considered to have four copies of QE for SpaceTime)

Vol(Dforce)<sup>( 1 / mforce )</sup> stands for a dimensional normalization factor (to reconcile the dimensionality of the Internal Symmetry Space of the target vertex with the dimensionality of the link from the origin to the target vertex).

The Qforce, Hermitian symmetric space, and Dforce manifolds for the four forces are:

Spin(5)	Spin(7) / Spin(5)xU(1)	IV5	4	RP <sup>1</sup> xS <sup>4</sup>
SU(3)	SU(4) / SU(3)xU(1)	B <sup>6</sup> (ball)	4	S <sup>5</sup>
SU(2)	Spin(5) / SU(2)xU(1)	IV3	2	RP <sup>1</sup> xS <sup>2</sup>
U(1)	-	-	1	-

The geometric volumes needed for the calculations are mostly taken from the book Harmonic Analysis of Functions of Several Complex Variables in the Classical Domains (AMS 1963, Moskva 1959, Science Press Peking 1958) by L. K. Hua [unit radius scale].

Force	M	Vol(M)
gravity	$S^4$	$8\pi^2/3$ - $S^4$ is 4-dimensional
color	$CP^2$	$8\pi^2/3$ - $CP^2$ is 4-dimensional
weak	$S^2 \times S^2$	$2 \times 4\pi$ - $S^2$ is a 2-dim boundary of 3-dim ball 4-dim $S^2 \times S^2$ = topological boundary of 6-dim 2-polyball Shilov Boundary of 6-dim 2-polyball = $S^2 + S^2$ = = 2-dim surface frame of 4-dim $S^2 \times S^2$
e-mag	$T^4$	$4 \times 2\pi$ - $S^1$ is 1-dim boundary of 2-dim disk 4-dim $T^4 = S^1 \times S^1 \times S^1 \times S^1$ = topological boundary of 8-dim 4-polydisk Shilov Boundary of 8-dim 4-polydisk = $S^1 + S^1 + S^1 + S^1$ = = 1-dim wire frame of 4-dim $T^4$

Note ( thanks to Carlos Castro for noticing this ) also that the volume listed for  $CP^2$  is unconventional, but physically justified by noting that  $S^4$  and  $CP^2$  can be seen as having the same physical volume, with the only difference being structure at infinity.

Note that for  $U(1)$  electromagnetism, whose photon carries no charge, the factors  $Vol(Q)$  and  $Vol(D)$  do not apply and are set equal to 1, and from another point of view, the link manifold to the target vertex is trivial for the abelian neutral  $U(1)$  photons of Electromagnetism, so we take  $QE$  and  $DE$  to be equal to unity.

Force	M	Vol(M)	Q	Vol(Q)	D	Vol(D)
gravity	$S^4$	$8\pi^2/3$	$RP^1 \times S^4$	$8\pi^3/3$	$IV_5$	$\pi^5/2^4 5!$
color	$CP^2$	$8\pi^2/3$	$S^5$	$4\pi^3$	$B^6(\text{ball})$	$\pi^3/6$
Weak	$S^2 \times S^2$	$2 \times 4\pi$	$RP^1 \times S^2$	$4\pi^2$	$IV_3$	$\pi^3/24$
e-mag	$T^4$	$4 \times 2\pi$	-	-	-	-

Note ( thanks to Carlos Castro for noticing this ) that the volume listed for  $S^5$  is for a squashed  $S^5$ , a Shilov boundary of the complex domain corresponding to the symmetric space  $SU(4) / SU(3) \times U(1)$ .

Using the above numbers, the results of the calculations are the relative force strengths at the characteristic energy level of the generalized Bohr radius of each force:

Spin(5)	gravity	approx $10^{19}$ GeV	1	$Gm_{\text{proton}}^2$ approx $5 \times 10^{-39}$
SU(3)	color	approx 245 MeV	0.6286	0.6286
SU(2)	weak	approx 100 GeV	0.2535	$GW_{\text{proton}}^2$ approx $1.05 \times 10^{-5}$
U(1)	e-mag	approx 4 KeV	1/137.03608	1/137.03608

The force strengths are given at the characteristic energy levels of their forces, because the force strengths run with changing energy levels.

The effect is particularly pronounced with the color force.

The color force strength was calculated using a simple perturbative QCD renormalization group equation at various energies, with the following results:

Energy Level	Color Force Strength
245 MeV	0.6286
5.3 GeV	0.166
34 GeV	0.121
91 GeV	0.106

Taking other effects, such as Nonperturbative QCD, into account, should give a Color Force Strength of about 0.125 at about 91 GeV

## Higgs, W+, W-, Z0:

As with forces strengths, the calculations produce ratios of masses, so that only one mass need be chosen to set the mass scale.

In the CI(1,25) E8 model, the value of the fundamental mass scale vacuum expectation value  $v = \langle \text{PHI} \rangle$  of the Higgs scalar field is set to be the sum of the physical masses of the weak bosons, W+, W-, and Z0, whose tree-level masses will then be shown by ratio calculations to be 80.326 GeV, 80.326 GeV, and 91.862 GeV, respectively, and therefore the electron mass will be 0.5110 MeV.

The relationship between the Higgs mass and  $v$  is given by the Ginzburg-Landau term from the Mayer Mechanism as

$$(1/4) \text{Tr} ( [ \text{PHI} , \text{PHI} ] - \text{PHI} )^2$$

or, i

n the notation of quant-ph/9806009 by Guang-jiong Ni

$$(1/4!) \lambda \text{PHI}^4 - (1/2) \sigma \text{PHI}^2$$

where the Higgs mass  $M_H = \sqrt{2 \sigma}$

Ni says:

"... the invariant meaning of the constant  $\lambda$  in the Lagrangian is not the coupling constant, the latter will change after quantization ... The invariant meaning of  $\lambda$  is nothing but the ratio of two mass scales:

$$\lambda = 3 ( M_H / \text{PHI} )^2$$

which remains unchanged irrespective of the order ...".

Since  $\langle \text{PHI} \rangle^2 = v^2$ , if  $v = 252.514$  GeV and  $\lambda = 1$  for a single-mass-state Higgs,

$$1 = \sqrt{3} M_H / v \quad \text{so that} \quad M_H = 252.514 / \sqrt{3} = 145.789 \text{ GeV}$$

However, for 3-mass-state Higgs as Nambu - Jona-Lasinio Tquark condensate

$\lambda = ( \cos( \pi / 6 ) )^2 = 0.866^2$  we have

$$M_H^2 / v^2 = ( \cos( \pi / 6 ) )^2 / 3$$

In CI(16) Physics, the fundamental mass scale vacuum expectation value  $v$  of the Higgs scalar field is the fundamental mass parameter that is to be set to define all other masses by the mass ratio formulas of the model and  $v$  is set to be 252.514 GeV and we have

$$M_H = v \cos( \pi / 6 ) / \sqrt{3} = 126.257 \text{ GeV}$$

This is the value of the Low Mass State of the Higgs observed by the LHC.

Middle and High Mass States come from a Higgs-Tquark Condensate System.

The Middle and High Mass States may have been observed by the LHC at 20% of the Low Mass State cross section, and that may be confirmed by the LHC 2015-1016 run.

A Non-Condensate Higgs is represented by a Higgs at a point in M4 that is connected to a Higgs representation in CP2 ISS by a line whose length represents the Higgs mass with  $\lambda = 1 = 1^2$  and Higgs mass  $M_H = v / \sqrt{3} = 145.789 \text{ GeV}$

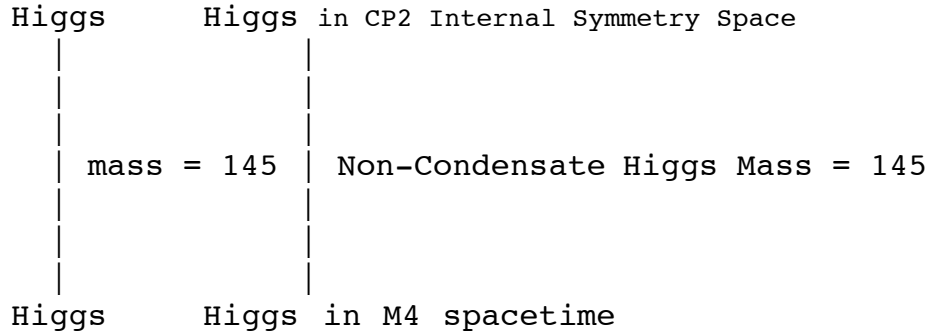

However, in Cl(16) Physics, the Higgs has structure of a Tquark condensate

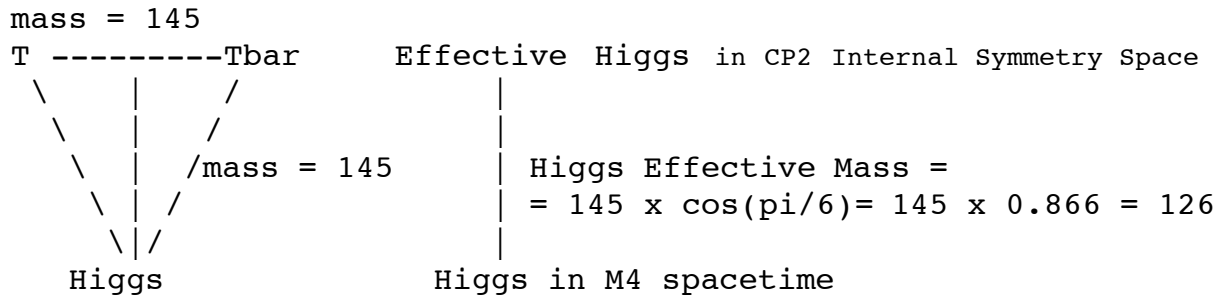

in which the Higgs at a point in M4 is connected to a T and Tbar in CP2 ISS so that the vertices of the Higgs-T-Tbar system are connected by lines forming an equilateral triangle composed of 2 right triangles (one from the CP2 origin to the T and to the M4 Higgs and another from the CP2 origin to the Tbar and to the M4 Higgs). In the T-quark condensate picture  $\lambda = 1^2 = \lambda(T) + \lambda(H) = (\sin(\pi / 6))^2 + (\cos(\pi / 6))^2$  and  $\lambda(H) = (\cos(\pi / 6))^2$

Therefore the Effective Higgs mass observed by LHC is:

$$\text{Higgs Mass} = 145.789 \times \cos(\pi/6) = 126.257 \text{ GeV.}$$



To get **W-boson masses**,

denote the 3 SU(2) high-energy weak bosons  
(massless at energies higher than the electroweak unification)

by  $W_+$ ,  $W_-$ , and  $W_0$ ,

corresponding to the massive physical weak bosons  $W_+$ ,  $W_-$ , and  $Z_0$ .

The triplet  $\{ W_+, W_-, W_0 \}$  couples directly with the  $T - T_{bar}$  quark-antiquark pair,  
so that the total mass of the triplet  $\{ W_+, W_-, W_0 \}$  at the electroweak unification  
is equal to the total mass of a  $T - T_{bar}$  pair, 259.031 GeV.

The triplet  $\{ W_+, W_-, Z_0 \}$  couples directly with the Higgs scalar,  
which carries the Higgs mechanism by which the  $W_0$  becomes the physical  $Z_0$ ,  
so that the total mass of the triplet  $\{ W_+, W_-, Z_0 \}$   
is equal to the vacuum expectation value  $v$  of the Higgs scalar field,  $v = 252.514$  GeV.

What are individual masses of members of the triplet  $\{ W_+, W_-, Z_0 \}$  ?

First, look at the triplet  $\{ W_+, W_-, W_0 \}$  which can be represented by the 3-sphere  $S^3$ .  
The Hopf fibration of  $S^3$  as

$$S^1 \rightarrow S^3 \rightarrow S^2$$

gives a decomposition of the  $W$  bosons into the neutral  $W_0$  corresponding to  $S^1$   
and the charged pair  $W_+$  and  $W_-$  corresponding to  $S^2$ .

The mass ratio of the sum of the masses of  $W_+$  and  $W_-$  to the mass of  $W_0$   
should be the volume ratio of the  $S^2$  in  $S^3$  to the  $S^1$  in  $S^3$ .

The unit sphere  $S^3$  in  $R^4$  is normalized by  $1 / 2$ .

The unit sphere  $S^2$  in  $R^3$  is normalized by  $1 / \sqrt{3}$ .

The unit sphere  $S^1$  in  $R^2$  is normalized by  $1 / \sqrt{2}$ .

The ratio of the sum of the  $W_+$  and  $W_-$  masses to the  $W_0$  mass should then be  
 $(2 / \sqrt{3}) V(S^2) / (2 / \sqrt{2}) V(S^1) = 1.632993$

Since the total mass of the triplet  $\{ W_+, W_-, W_0 \}$  is 259.031 GeV,  
the total mass of a  $T - T_{bar}$  pair, and the charged weak bosons have equal mass,  
we have

$$M_{W_+} = M_{W_-} = 80.326 \text{ GeV and } M_{W_0} = 98.379 \text{ GeV.}$$

The charged  $W_{\pm}$  neutrino-electron interchange must be symmetric  
with the electron-neutrino interchange, so that the tree-level absence  
of right-handed neutrino particles requires that

the charged  $W_{\pm}$  SU(2) weak bosons act only on left-handed electrons.

Each gauge boson must act consistently on the entire Dirac fermion particle sector,  
so that the  
charged  $W_{\pm}$  SU(2) weak bosons act only on left-handed fermion particles of all types.

The neutral  $W_0$  weak boson does not interchange Weyl neutrinos with Dirac fermions, and so is not restricted to left-handed fermions, but also has a component that acts on both types of fermions, both left-handed and right-handed, conserving parity.

However, the neutral  $W_0$  weak bosons are related to the charged  $W_{+/-}$  weak bosons by custodial  $SU(2)$  symmetry, so that the left-handed component of the neutral  $W_0$  must be equal to the left-handed (entire) component of the charged  $W_{+/-}$ .

Since the mass of the  $W_0$  is greater than the mass of the  $W_{+/-}$ , there remains for the  $W_0$  a component acting on both types of fermions.

Therefore the full  $W_0$  neutral weak boson interaction is proportional to  $(M_{W_{+/-}}^2 / M_{W_0}^2)$  acting on left-handed fermions and  $(1 - (M_{W_{+/-}}^2 / M_{W_0}^2))$  acting on both types of fermions.

If  $(1 - (M_{W_{+/-}}^2 / M_{W_0}^2))$  is defined to be  $\sin(\theta_w)^2$  and denoted by  $K$ , and if the strength of the  $W_{+/-}$  charged weak force (and of the custodial  $SU(2)$  symmetry) is denoted by  $T$ , then the  $W_0$  neutral weak interaction can be written as  $W_0L = T + K$  and  $W_0LR = K$ .

Since the  $W_0$  acts as  $W_0L$  with respect to the parity violating  $SU(2)$  weak force and as  $W_0LR$  with respect to the parity conserving  $U(1)$  electromagnetic force, the  $W_0$  mass  $m_{W_0}$  has two components: the parity violating  $SU(2)$  part  $m_{W_0L}$  that is equal to  $M_{W_{+/-}}$  and the parity conserving part  $M_{W_0LR}$  that acts like a heavy photon.

As  $M_{W_0} = 98.379 \text{ GeV} = M_{W_0L} + M_{W_0LR}$ , and as  $M_{W_0L} = M_{W_{+/-}} = 80.326 \text{ GeV}$ , we have  $M_{W_0LR} = 18.053 \text{ GeV}$ .

Denote by  $\alpha_E = e^2$  the force strength of the weak parity conserving  $U(1)$  electromagnetic type force that acts through the  $U(1)$  subgroup of  $SU(2)$ .

The electromagnetic force strength  $\alpha_E = e^2 = 1 / 137.03608$  was calculated above using the volume  $V(S^1)$  of an  $S^1$  in  $R^2$ , normalized by  $1 / \sqrt{2}$ .

The  $\alpha_E$  force is part of the  $SU(2)$  weak force whose strength  $\alpha_W = w^2$  was calculated above using the volume  $V(S^2)$  of an  $S^2 \subset R^3$ , normalized by  $1 / \sqrt{3}$ .

Also, the electromagnetic force strength  $\alpha_E = e^2$  was calculated above using a 4-dimensional spacetime with global structure of the 4-torus  $T^4$  made up of four  $S^1$  1-spheres, while the  $SU(2)$  weak force strength  $\alpha_W = w^2$  was calculated above using two 2-spheres  $S^2 \times S^2$ , each of which contains one 1-sphere of the  $\alpha_E$  force.

Therefore

$$\begin{aligned} *alphaE &= alphaE ( \sqrt{ 2 } / \sqrt{ 3 } )(2 / 4) = alphaE / \sqrt{ 6 } , \\ *e &= e / (4th \text{ root of } 6) = e / 1.565 , \end{aligned}$$

and

the mass mW0LR must be reduced to an effective value

$$M\_W0LReff = M\_W0LR / 1.565 = 18.053/1.565 = 11.536 \text{ GeV}$$

for the \*alphaE force to act like an electromagnetic force in the E8 model:

$$*e M\_W0LR = e (1/5.65) M\_W0LR = e M\_Z0,$$

where the physical effective neutral weak boson is denoted by Z0.

Therefore, the correct Cl(1,25) E8 model values for weak boson masses and the Weinberg angle theta\_w are:

$$M\_W+ = M\_W- = 80.326 \text{ GeV};$$

$$M\_Z0 = 80.326 + 11.536 = 91.862 \text{ GeV};$$

$$\text{Sin}(\text{theta}_w)^2 = 1 - (M\_W+/- / M\_Z0)^2 = 1 - ( 6452.2663 / 8438.6270 ) = 0.235.$$

Radiative corrections are not taken into account here, and may change these tree- level values somewhat.

## Fermion Mass Calculations

In Cl(16) Physics, the first generation spinor fermions are seen as +half-spinor and -half-spinor spaces of  $Cl(1,7) = Cl(8)$ . Due to Triality, Spin(8) can act on those 8-dimensional half-spinor spaces similarly to the way it acts on 8-dimensional vector spacetime.

Take the the spinor fermion volume to be the Shilov boundary corresponding to the same symmetric space on which Spin(8) acts as a local gauge group that is used to construct 8-dimensional vector spacetime: the symmetric space  $Spin(10) / Spin(8) \times U(1)$  corresponding to a bounded domain of type IV8 whose Shilov boundary is  $RP^1 \times S^7$

Since all first generation fermions see the spacetime over which the integral is taken in the same way ( unlike what happens for the force strength calculation ), the only geometric volume factor relevant for calculating first generation fermion mass ratios is in the spinor fermion volume term. Cl(16) Physics Fermions correspond to Schwinger Sources, so the quark mass in Cl(16) Physics is a constituent mass.

Fermion masses are calculated as a product of four factors:

$$V(Q\text{fermion}) \times N(\text{Graviton}) \times N(\text{octonion}) \times \text{Sym}$$

$V(Q\text{fermion})$  is the volume of the part of the half-spinor fermion particle manifold  $S^7 \times RP^1$  related to the fermion particle by photon, weak boson, or gluon interactions.

$N(\text{Graviton})$  is the number of types of Spin(0,5) graviton related to the fermion. The 10 gravitons correspond to the 10 infinitesimal generators of  $Spin(0,5) = Sp(2)$ . 2 of them are in the Cartan subalgebra. 6 of them carry color charge, and therefore correspond to quarks. The remaining 2 carry no color charge, but may carry electric charge and so may be considered as corresponding to electrons. One graviton takes the electron into itself, and the other can only take the first-generation electron into the massless electron neutrino. Therefore only one graviton should correspond to the mass of the first-generation electron. The graviton number ratio of the down quark to the first-generation electron is therefore  $6/1 = 6$ .

$N(\text{octonion})$  is an octonion number factor relating up-type quark masses to down-type quark masses in each generation.

Sym is an internal symmetry factor, relating 2nd and 3rd generation massive leptons to first generation fermions. It is not used in first-generation calculations.

### 3 Generation Fermion Combinatorics

#### First Generation (8)

(geometric representation of Octonions is from arXiv 1010.2979 )

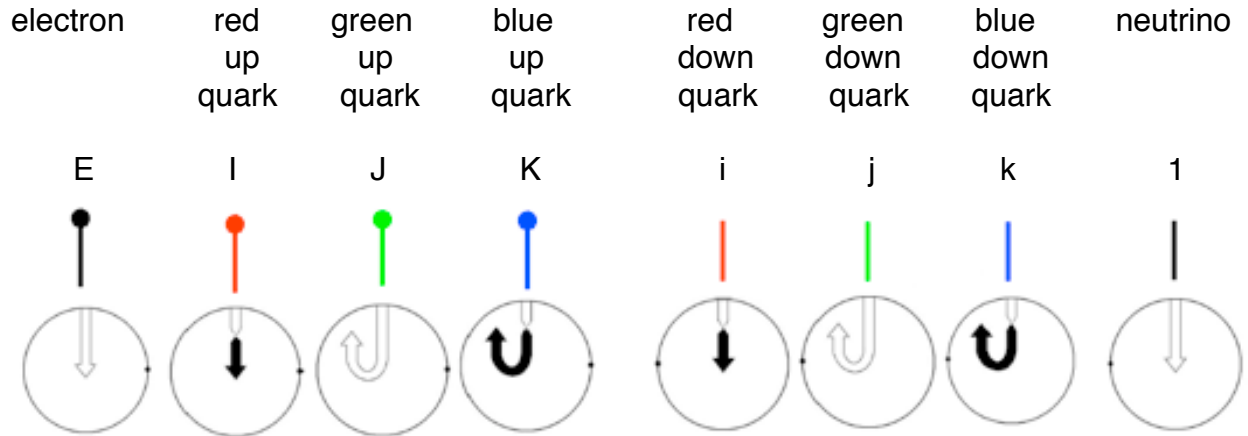

#### Second Generation (64)

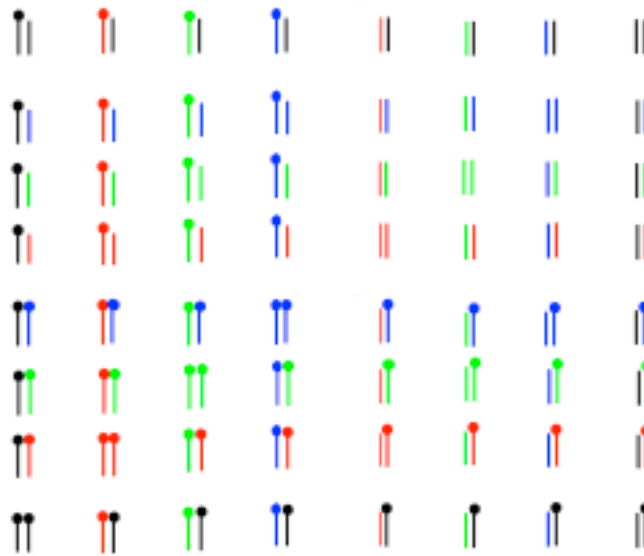

Mu Neutrino (1)

Rule: a Pair belongs to the Mu Neutrino if:  
 All elements are Colorless (black)  
 and all elements are Associative

(that is, is 1 which is the only Colorless Associative element) .

### Muon (3)

Rule: a Pair belongs to the Muon if:  
All elements are Colorless (black)  
and at least one element is NonAssociative  
(that is, is E which is the only Colorless NonAssociative element).

### Blue Strange Quark (3)

Rule: a Pair belongs to the Blue Strange Quark if:  
There is at least one Blue element and the other element is Blue or Colorless (black)  
and all elements are Associative (that is, is either 1 or i or j or k).

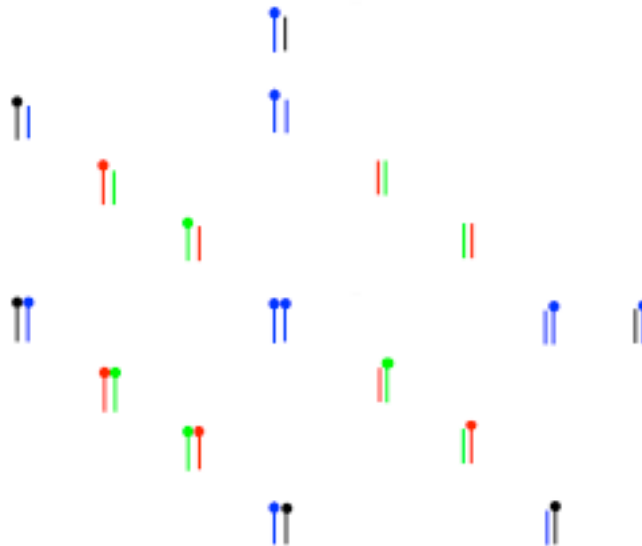

### Blue Charm Quark (17)

- Rules: a Pair belongs to the Blue Charm Quark if:
- 1 - There is at least one Blue element and the other element is Blue or Colorless (black) and at least one element is NonAssociative (that is, is either E or I or J or K)
  - 2 - There is one Red element and one Green element (Red x Green = Blue).

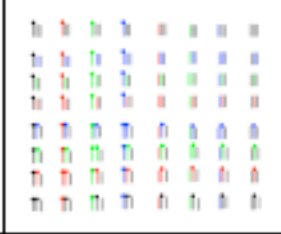
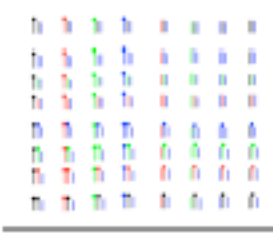

( Red and Green Strange and Charm Quarks follow similar rules )

### Third Generation (512)

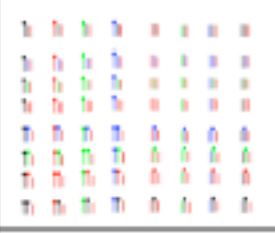
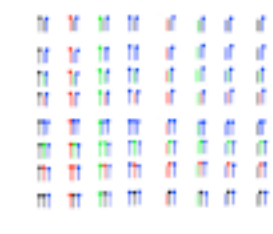
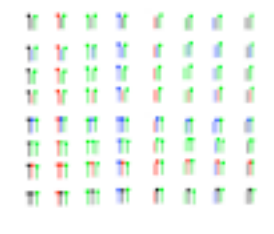
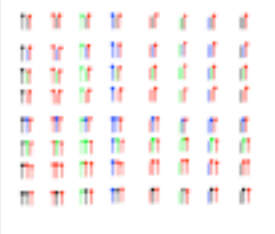
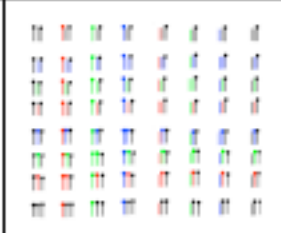
#### Tau Neutrino (1)

Rule: a Triple belongs to the Tau Neutrino if:  
All elements are Colorless (black)  
and all elements are Associative  
(that is, is 1 which is the only Colorless Associative element)

#### Tauon (7)

Rule: a Triple belongs to the Tauon if:  
All elements are Colorless (black)  
and at least one element is NonAssociative (that is, is E which is the only Colorless NonAssociative element)

Blue Beauty Quark (7)

Rule: a Triple belongs to the Blue Beauty Quark if:  
 There is at least one Blue element and all other elements are Blue or Colorless (black)  
 and all elements are Associative (that is, is either 1 or i or j or k).

Blue Truth Quark (161)

- Rules: a Triple belongs to the Blue Truth Quark if:
- 1 - There is at least one Blue element and all other elements are Blue or Colorless (black)  
 and at least one element is NonAssociative (that is, is either E or I or J or K)
  - 2 - There is one Red element and one Green element and the other element is Colorless (Red x Green = Blue)
  - 3 - The Triple has one element each that is Red, Green, or Blue, in which case the color of the Third element (for Third Generation) is determinative and must be Blue.

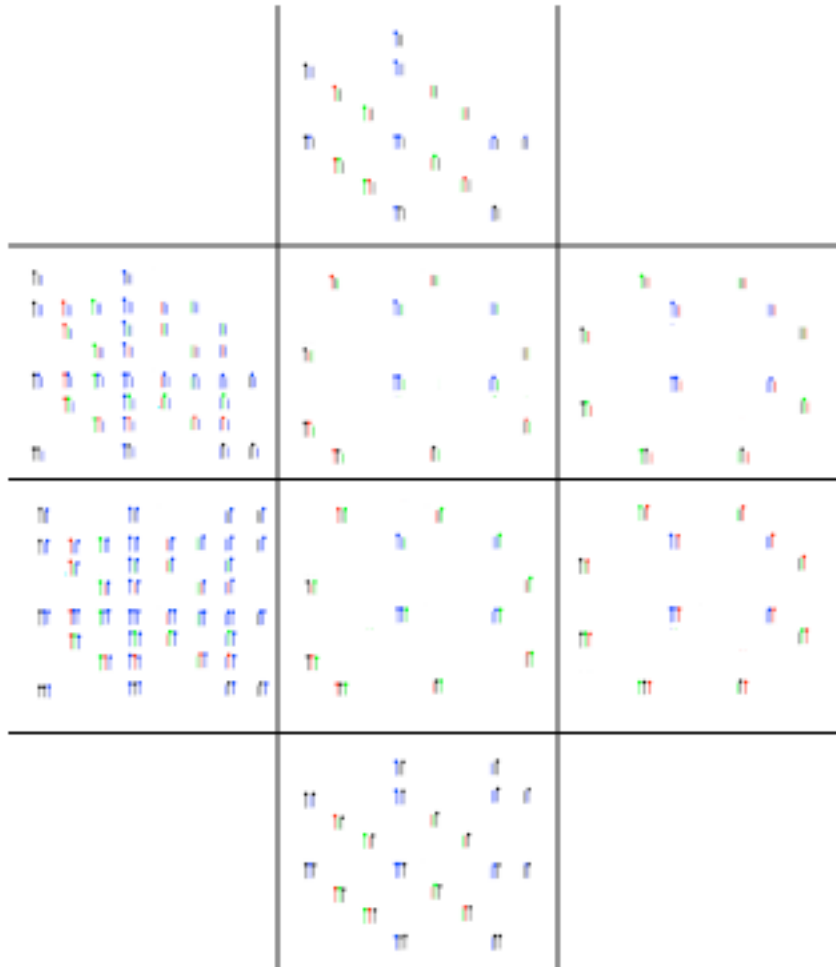

( Red and Green Beauty and Truth Quarks follow similar rules )



**The first generation** down quark constituent mass : electron mass ratio is:

The electron, E, can only be taken into the tree-level-massless neutrino, 1, by photon, weak boson, and gluon interactions.

The electron and neutrino, or their antiparticles, cannot be combined to produce any of the massive up or down quarks.

The neutrino, being massless at tree level, does not add anything to the mass formula for the electron.

Since the electron cannot be related to any other massive Dirac fermion, its volume  $V(Q_{\text{electron}})$  is taken to be 1.

Next consider a red down quark i.

By gluon interactions, i can be taken into j and k, the blue and green down quarks.

By also using weak boson interactions,

it can also be taken into l, J, and K, the red, blue, and green up quarks.

Given the up and down quarks, pions can be formed from quark-antiquark pairs, and the pions can decay to produce electrons and neutrinos.

Therefore the red down quark (similarly, any down quark)

is related to all parts of  $S^7 \times RP^1$ ,

the compact manifold corresponding to  $\{ 1, i, j, k, E, l, J, K \}$

and therefore

a down quark should have

a spinor manifold volume factor  $V(Q_{\text{down quark}})$  of the volume of  $S^7 \times RP^1$ .

The ratio of the down quark spinor manifold volume factor

to the electron spinor manifold volume factor is

$$V(Q_{\text{down quark}}) / V(Q_{\text{electron}}) = V(S^7 \times RP^1) / 1 = \pi^5 / 3.$$

Since the first generation graviton factor is 6,

$$m_d / m_e = 6 V(S^7 \times RP^1) = 2 \pi^5 = 612.03937$$

As the up quarks correspond to l, J, and K, which are the octonion transforms under E of i, j, and k of the down quarks, the up quarks and down quarks have the same constituent mass

$$m_u = m_d.$$

Antiparticles have the same mass as the corresponding particles.

Since the model only gives ratios of masses,

the mass scale is fixed so that the electron mass  $m_e = 0.5110 \text{ MeV}$ .

Then, the constituent mass of the down quark is  $m_d = 312.75 \text{ MeV}$ ,

and the constituent mass for the up quark is  $m_u = 312.75 \text{ MeV}$ .

These results when added up give a total mass of first generation fermion particles:

$$\Sigma_{\text{maf1}} = 1.877 \text{ GeV}$$

As the proton mass is taken to be the sum of the constituent masses of its constituent quarks

$$m_{\text{proton}} = m_u + m_u + m_d = 938.25 \text{ MeV}$$

which is close to the experimental value of 938.27 MeV.

**The third generation** fermion particles correspond to triples of octonions. There are  $8^3 = 512$  such triples.

The triple  $\{ 1, 1, 1 \}$  corresponds to the tau-neutrino.

The other 7 triples involving only 1 and E correspond to the tauon:

$\{ E, E, E \}$   
 $\{ E, E, 1 \}$   
 $\{ E, 1, E \}$   
 $\{ 1, E, E \}$   
 $\{ 1, 1, E \}$   
 $\{ 1, E, 1 \}$   
 $\{ E, 1, 1 \}$

The symmetry of the 7 tauon triples is the same as the symmetry of the first generation tree-level-massive fermions, 3 down, quarks, the 3 up quarks, and the electron, so by the Sym factor the tauon mass should be the same as the sum of the masses of the first generation massive fermion particles.

Therefore the tauon mass is calculated at tree level as 1.877 GeV.

The calculated tauon mass of 1.88 GeV is a sum of first generation fermion masses, all of which are valid at the energy level of about 1 GeV.

However, as the tauon mass is about 2 GeV, the effective tauon mass should be renormalized from the energy level of 1 GeV at which the mass is 1.88 GeV to the energy level of 2 GeV. Such a renormalization should reduce the mass.

If the renormalization reduction were about 5 percent, the effective tauon mass at 2 GeV would be about 1.78 GeV. The 1996 Particle Data Group Review of Particle Physics gives a tauon mass of 1.777 GeV.

All triples corresponding to the tau and the tau-neutrino are colorless.

The beauty quark corresponds to 21 triples.  
They are triples of the same form as the 7 tauon triples involving 1 and E,  
but for 1 and I, 1 and J, and 1 and K,  
which correspond to the red, green, and blue beauty quarks,  
respectively.

The seven red beauty quark triples correspond to the seven tauon triples,  
except that  
the beauty quark interacts with 6 Spin(0,5) gravitons  
while the tauon interacts with only two.

The red beauty quark constituent mass should be the tauon mass times  
the third generation graviton factor  $6/2 = 3$ ,  
so the red beauty quark mass is  $m_b = 5.63111 \text{ GeV}$ .

The blue and green beauty quarks are similarly determined to also be  $5.63111 \text{ GeV}$ .

The calculated beauty quark mass of  $5.63 \text{ GeV}$  is a constituent mass,  
that is, it corresponds to the conventional pole mass plus  $312.8 \text{ MeV}$ .  
Therefore, the calculated beauty quark mass of  $5.63 \text{ GeV}$   
corresponds to a conventional pole mass of  $5.32 \text{ GeV}$ .

The 1996 Particle Data Group Review of Particle Physics gives  
a lattice gauge theory beauty quark pole mass as  $5.0 \text{ GeV}$ .

The pole mass can be converted to an MSbar mass  
if the color force strength constant  $\alpha_s$  is known.  
The conventional value of  $\alpha_s$  at about  $5 \text{ GeV}$  is about  $0.22$ .

Using  $\alpha_s(5 \text{ GeV}) = 0.22$ , a pole mass of  $5.0 \text{ GeV}$   
gives an MSbar 1-loop beauty quark mass of  $4.6 \text{ GeV}$ ,  
and  
an MSbar 1,2-loop beauty quark mass of  $4.3$ , evaluated at about  $5 \text{ GeV}$ .

If the MSbar mass is run from  $5 \text{ GeV}$  up to  $90 \text{ GeV}$ ,  
the MSbar mass decreases by about  $1.3 \text{ GeV}$ ,  
giving an expected MSbar mass of about  $3.0 \text{ GeV}$  at  $90 \text{ GeV}$ .

DELPHI at LEP has observed the Beauty Quark  
and found a  $90 \text{ GeV}$  MSbar beauty quark mass of about  $2.67 \text{ GeV}$ ,  
with error bars  $\pm 0.25$  (stat)  $\pm 0.34$  (frag)  $\pm 0.27$  (theo).

The theoretical model calculated Beauty Quark mass of 5.63 GeV corresponds to a pole mass of 5.32 GeV, which is somewhat higher than the conventional value of 5.0 GeV.

However, the theoretical model calculated value of the color force strength constant  $\alpha_s$  at about 5 GeV is about 0.166, while the conventional value of the color force strength constant  $\alpha_s$  at about 5 GeV is about 0.216, and the theoretical model calculated value of the color force strength constant  $\alpha_s$  at about 90 GeV is about 0.106, while the conventional value of the color force strength constant  $\alpha_s$  at about 90 GeV is about 0.118.

The theoretical model calculations gives a Beauty Quark pole mass (5.3 GeV) that is about 6 percent higher than the conventional Beauty Quark pole mass (5.0 GeV), and a color force strength  $\alpha_s$  at 5 GeV (0.166) such that  $1 + \alpha_s = 1.166$  is about 4 percent lower than the conventional value of  $1 + \alpha_s = 1.216$  at 5 GeV.

Triples of the type  $\{ 1, I, J \}$ ,  $\{ I, J, K \}$ , etc., do not correspond to the beauty quark, but to the truth quark. The truth quark corresponds to those  $512 - 1 - 7 - 21 = 483$  triples, so the constituent mass of the red truth quark is  $161 / 7 = 23$  times the red beauty quark mass, and the red T-quark mass is  $m_t = 129.5155$  GeV

The blue and green truth quarks are similarly determined to also be 129.5155 GeV.

**This is the value of the Low Mass State of the Truth calculated in Cl(16) Physics.** The Middle Mass State of the Truth Quark has been observed by Fermilab since 1994. **The Low and High Mass States of the Truth Quark have, in my opinion, also been observed by Fermilab but the Fermilab and CERN establishments disagree.**

All other masses than the electron mass (which is the basis of the assumption of the value of the Higgs scalar field vacuum expectation value  $v = 252.514$  GeV), including the Higgs scalar mass and Truth quark mass, are calculated (not assumed) masses in Cl(16) Physics. These results when added up give a total mass of third generation fermion particles:

$$\mathbf{\Sigma_{maf3} = 1,629 \text{ GeV}}$$

**The second generation** fermion particles correspond to pairs of octonions.  
There are  $8^2 = 64$  such pairs.

The pair  $\{ 1, 1 \}$  corresponds to the mu-neutrino.

The pairs  $\{ 1, E \}$ ,  $\{ E, 1 \}$ , and  $\{ E, E \}$  correspond to the muon.

For the Sym factor, compare the symmetries of the muon pairs to the symmetries of the first generation fermion particles:  
The pair  $\{ E, E \}$  should correspond to the E electron.  
The other two muon pairs have a symmetry group  $S_2$ , which is  $1/3$  the size of the color symmetry group  $S_3$  which gives the up and down quarks their mass of 312.75 MeV.

Therefore the mass of the muon should be the sum of the  $\{ E, E \}$  electron mass and the  $\{ 1, E \}$ ,  $\{ E, 1 \}$  symmetry mass, which is  $1/3$  of the up or down quark mass. Therefore,  $m_{\mu} = 104.76$  MeV .

According to the 1998 Review of Particle Physics of the Particle Data Group, the experimental muon mass is about 105.66 MeV which may be consistent with radiative corrections for the calculated tree-level  $m_{\mu} = 104.76$  MeV as Bailin and Love, in "Introduction to Gauge Field Theory", IOP (rev ed 1993), say: "... considering the order alpha radiative corrections to muon decay ... Numerical details are contained in Sirlin ... 1980 Phys. Rev. D 22 971 ... who concludes that the order alpha corrections have the effect of increasing the decay rate about 7% compared with the tree graph prediction ...". Since the decay rate is proportional to  $m_{\mu}^5$  the corresponding effective increase in muon mass would be about 1.36%, which would bring 104.8 MeV up to about 106.2 MeV.

All pairs corresponding to the muon and the mu-neutrino are colorless.

The red, blue and green strange quark each corresponds to the 3 pairs involving 1 and i, j, or k.

The red strange quark is defined as the three pairs  $\{ 1, i \}$ ,  $\{ i, 1 \}$ ,  $\{ i, i \}$  because i is the red down quark.

Its mass should be the sum of two parts:  
the  $\{ i, i \}$  red down quark mass, 312.75 MeV, and  
the product of the symmetry part of the muon mass, 104.25 MeV,  
times the graviton factor.

Unlike the first generation situation,  
massive second and third generation leptons can be taken,  
by both of the colorless gravitons that may carry electric charge,  
into massive particles.

Therefore the graviton factor for the second and third generations is  $6/2 = 3$ .

So the symmetry part of the muon mass times the graviton factor 3 is 312.75 MeV, and  
the red strange quark constituent mass is  $m_s = 312.75 \text{ MeV} + 312.75 \text{ MeV} = 625.5 \text{ MeV}$

The blue strange quarks correspond to the three pairs involving j,  
the green strange quarks correspond to the three pairs involving k,  
and their masses are similarly determined to also be 625.5 MeV.  
The charm quark corresponds to the remaining  $64 - 1 - 3 - 9 = 51$  pairs.

Therefore, the mass of the red charm quark should be the sum of two parts:  
the  $\{ i, i \}$ , red up quark mass, 312.75 MeV;  
and  
the product of the symmetry part of the strange quark mass, 312.75 MeV,  
and the charm to strange octonion number factor  $51 / 9$ ,  
which product is 1,772.25 MeV.

Therefore the red charm quark constituent mass is  
 $m_c = 312.75 \text{ MeV} + 1,772.25 \text{ MeV} = 2.085 \text{ GeV}$

The blue and green charm quarks are similarly determined to also be 2.085 GeV.

The calculated Charm Quark mass of 2.09 GeV is a constituent mass,  
that is, it corresponds to the conventional pole mass plus 312.8 MeV.

Therefore, the calculated Charm Quark mass of 2.09 GeV corresponds to a  
conventional pole mass of 1.78 GeV.

The 1996 Particle Data Group Review of Particle Physics gives a range for the  
Charm Quark pole mass from 1.2 to 1.9 GeV.

The pole mass can be converted to an MSbar mass if the color force strength constant  $\alpha_s$  is known.

The conventional value of  $\alpha_s$  at about 2 GeV is about 0.39, which is somewhat lower than the theoretical model value.

Using  $\alpha_s(2 \text{ GeV}) = 0.39$ , a pole mass of 1.9 GeV gives an MSbar 1-loop mass of 1.6 GeV, evaluated at about 2 GeV.

These results when added up give a total mass of second generation fermion particles:

$$\mathbf{\Sigma_{f2} = 32.9 \text{ GeV}}$$

## Kobayashi-Maskawa Parameters

In Cl(16) Physics the KM Unitarity Triangle angles can be seen on the Stella Octangula

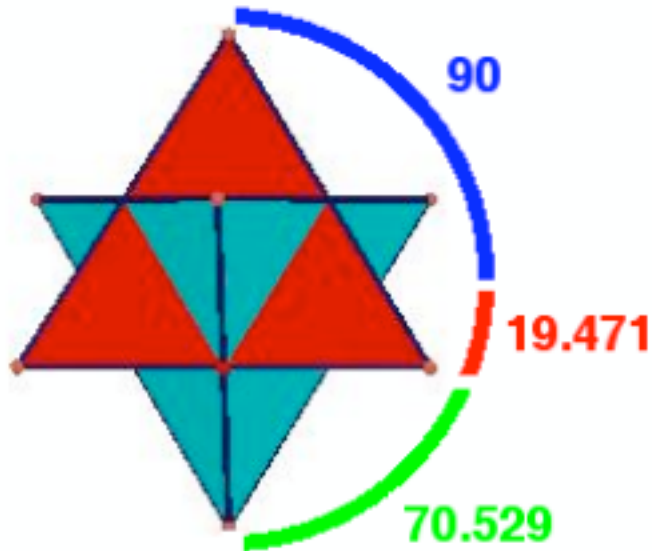

The Kobayashi-Maskawa parameters are determined in terms of the sum of the masses of the 30 first-generation fermion particles and antiparticles, denoted by

$$S_{mf1} = 7.508 \text{ GeV},$$

and the similar sums for second-generation and third-generation fermions, denoted by

$$S_{mf2} = 32.94504 \text{ GeV} \text{ and } S_{mf3} = 1,629.2675 \text{ GeV}.$$

The resulting KM matrix is:

	d	s	b
u	0.975	0.222 0.00249	-0.00388i
c	-0.222 -0.000161i	0.974 -0.0000365i	0.0423
t	0.00698 -0.00378i	-0.0418 -0.00086i	0.999



**Below the energy level of ElectroWeak Symmetry Breaking  
the Higgs mechanism gives mass to particles.**

According to a Review on the Kobayashi-Maskawa mixing matrix by Ceccucci, Ligeti, and Sakai in the 2010 Review of Particle Physics (note that I have changed their terminology of CKM matrix to the KM terminology that I prefer because I feel that it was Kobayashi and Maskawa, not Cabibbo, who saw that 3x3 was the proper matrix structure): "... the charged-current  $W_{\pm}$  interactions couple to the ... quarks with couplings given by ...

$$\begin{matrix} V_{ud} & V_{us} & V_{ub} \\ V_{cd} & V_{cs} & V_{cb} \\ V_{td} & V_{ts} & V_{tb} \end{matrix}$$

This Kobayashi-Maskawa (KM) matrix is a 3x3 unitary matrix. It can be parameterized by three mixing angles and the CP-violating KM phase ... The most commonly used unitarity triangle arises from  $V_{ud} V_{ub}^* + V_{cd} V_{cb}^* + V_{td} V_{tb}^* = 0$ , by dividing each side by the best-known one,  $V_{cd} V_{cb}^*$

...  $\bar{\rho} + i\bar{\eta} = -(V_{ud} V_{ub}^*) / (V_{cd} V_{cb}^*)$  is phase-convention-independent ...

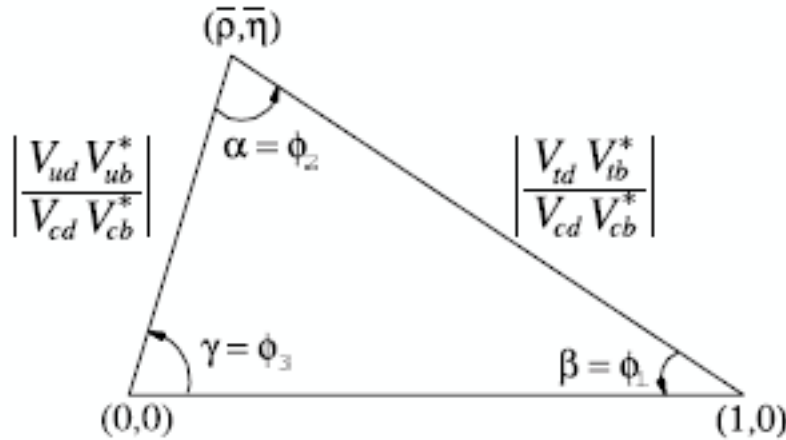
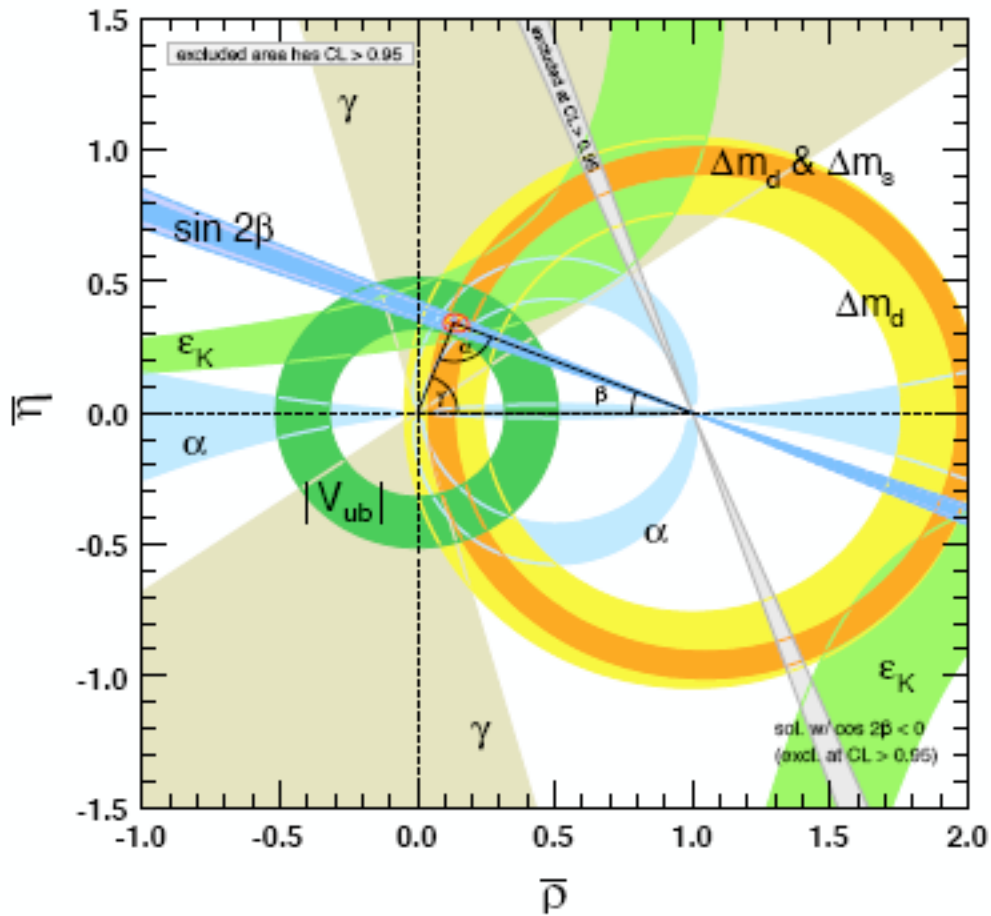

Figure 11.1: Sketch of the unitarity triangle.

...  $\sin 2\beta = 0.673 \pm 0.023$  ...  $\alpha = 89.0 + 4.4 - 4.2$  degrees ...  $\gamma = 73 + 22 - 25$  degrees ... The sum of the three angles of the unitarity triangle,  $\alpha + \beta + \gamma = (183 + 22 - 25)$  degrees, is ... consistent with the SM expectation. ...

The area... of ...[the]... triangle...[is]... half of the Jarlskog invariant,  $J$ , which is a phase-convention-independent measure of CP violation, defined by  $\text{Im } V_{ij} V_{kl} V_{il}^* V_{kj}^* = J \sum_{(m,n)} \epsilon_{ikm} \epsilon_{jln}$



**Figure 11.2:** Constraints on the  $\bar{\rho}, \bar{\eta}$  plane.  
The shaded areas have 95% CL.

The fit results for the magnitudes of all nine KM elements are ...

$0.97428 \pm 0.00015$	$0.2253 \pm 0.0007$	$0.00347 +0.00016 -0.00012$
$0.2252 \pm 0.0007$	$0.97345 +0.00015 -0.00016$	$0.0410 +0.0011 -0.0007$
$0.00862 +0.00026 -0.00020$	$0.0403 +0.0011 -0.0007$	$0.999152 +0.000030 -0.000045$

and the Jarlskog invariant is  $J = (2.91 +0.19 -0.11) \times 10^{-5}$ . ...".

**Above the energy level of ElectroWeak Symmetry Breaking  
particles are massless.**

Kea (Marni Sheppeard) proposed  
that in the Massless Realm the mixing matrix might be democratic.  
In Z. Phys. C - Particles and Fields 45, 39-41 (1989) Koide said: "...  
the mass matrix ... MD ... of the type ...  $1/3 \times m \times$

$$\begin{matrix} 1 & 1 & 1 \\ 1 & 1 & 1 \\ 1 & 1 & 1 \end{matrix}$$

... has name... "democratic" family mixing ...  
the ... democratic ... mass matrix can be diagonalized by the transformation matrix A ...

$$\begin{matrix} 1/\sqrt{2} & -1/\sqrt{2} & 0 \\ 1/\sqrt{6} & 1/\sqrt{6} & -2/\sqrt{6} \\ 1/\sqrt{3} & 1/\sqrt{3} & 1/\sqrt{3} \end{matrix}$$

as  $A M D A^t =$

$$\begin{matrix} 0 & 0 & 0 \\ 0 & 0 & 0 \\ 0 & 0 & m \end{matrix}$$

...".

Up in the Massless Realm you might just say that there is no mass matrix,  
just a democratic mixing matrix of the form  $1/3 \times$

$$\begin{matrix} 1 & 1 & 1 \\ 1 & 1 & 1 \\ 1 & 1 & 1 \end{matrix}$$

with no complex stuff and no CP violation in the Massless Realm.

When go down to our Massive Realm by ElectroWeak Symmetry Breaking  
then you might as a first approximation use  $m = 1$   
so that all the mass first goes to the third generation as

$$\begin{matrix} 0 & 0 & 0 \\ 0 & 0 & 0 \\ 0 & 0 & 1 \end{matrix}$$

which is physically like the Higgs being a T-Tbar quark condensate.

Consider a 3-dim Euclidean space of generations:

The case of mass only going to one generation  
can be represented as a line or 1-dimensional simplex



in which the blue mass-line covers the entire black simplex line.

If mass only goes to one other generation  
that can be represented by a red line extending to a second dimension  
forming a small blue-red-black triangle

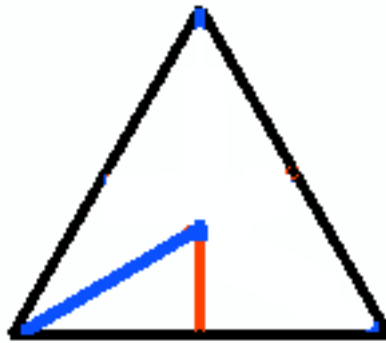

that can be extended by reflection to form six small triangles making up a large triangle

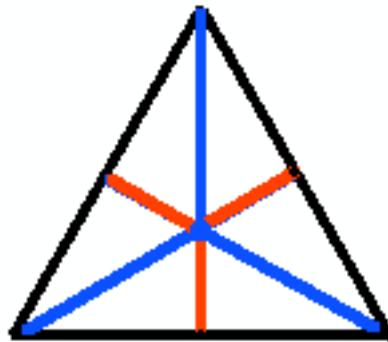

Each of the six component triangles has 30-60-90 angle structure:



If mass goes on further to all three generations  
that can be represented by a green line extending to a third dimension

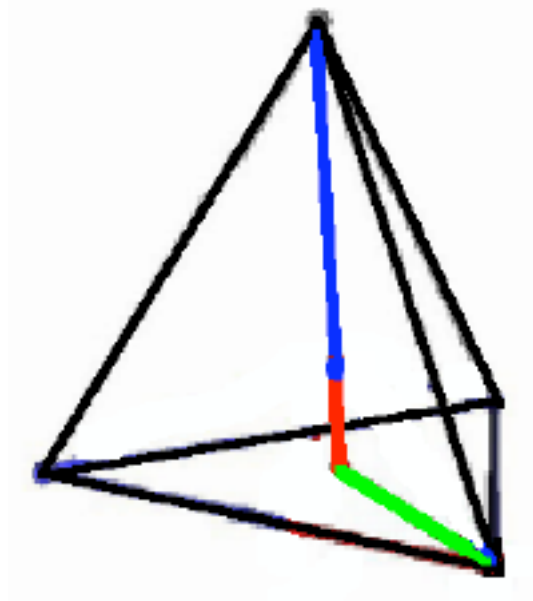

If you move the blue line from the top vertex to join the green vertex

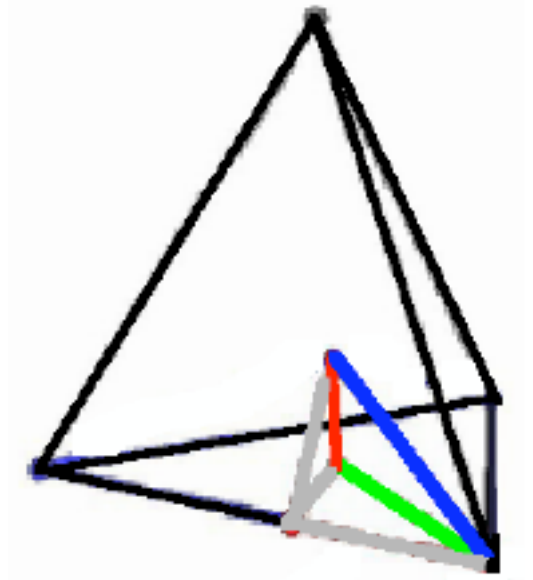

you get a small blue-red-green-gray-gray tetrahedron  
that can be extended by reflection to form 24 small tetrahedra  
making up a large tetrahedron.

Reflection among the 24 small tetrahedra corresponds  
to the  $12+12 = 24$  elements of the Binary Tetrahedral Group.

The basic blue-red-green triangle of the basic small tetrahedron

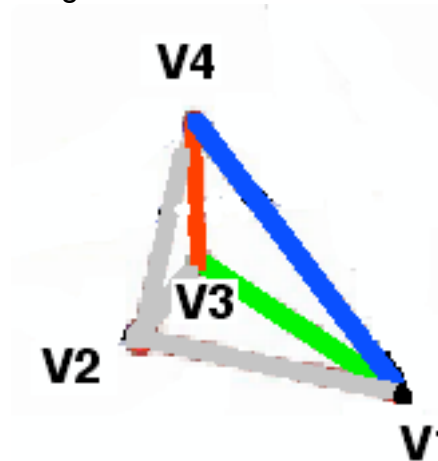

has the angle structure of the K-M Unitary Triangle.

Using data from R. W. Gray's "Encyclopedia Polyhedra: A Quantum Module" with lengths

$V1.V2 = (1/2) EL \cong$  Half of the regular Tetrahedron's edge length.

$V1.V3 = (1 / \sqrt{3}) EL \cong 0.577\ 350\ 269\ EL$

$V1.V4 = 3 / (2 \sqrt{6}) EL \cong 0.612\ 372\ 436\ EL$

$V2.V3 = 1 / (2 \sqrt{3}) EL \cong 0.288\ 675\ 135\ EL$

$V2.V4 = 1 / (2 \sqrt{2}) EL \cong 0.353\ 553\ 391\ EL$

$V3.V4 = 1 / (2 \sqrt{6}) EL \cong 0.204\ 124\ 145\ EL$

the Unitarity Triangle angles are:

$\beta = V3.V1.V4 = \arccos(2 \sqrt{2} / 3) \cong 19.471\ 220\ 634\ \text{degrees}$  so  $\sin 2\beta = 0.6285$

$\alpha = V1.V3.V4 = 90\ \text{degrees}$

$\gamma = V1.V4.V3 = \arcsin(2 \sqrt{2} / 3) \cong 70.528\ 779\ 366\ \text{degrees}$

which is substantially consistent with the 2010 Review of Particle Properties

$\sin 2\beta = 0.673 \pm 0.023$  so  $\beta = 21.1495\ \text{degrees}$

$\alpha = 89.0 +4.4 -4.2\ \text{degrees}$

$\gamma = 73 +22 -25\ \text{degrees}$

and so also consistent with the Standard Model expectation.

The constructed Unitarity Triangle angles can be seen on the Stella Octangula configuration of two dual tetrahedra (image from gauss.math.nthu.edu.tw):

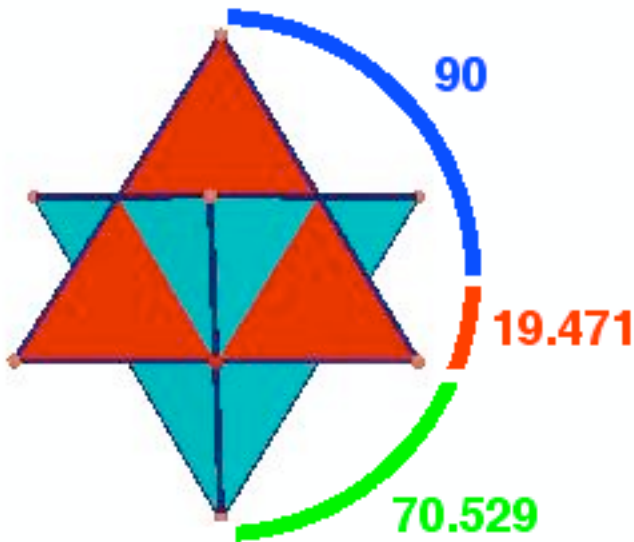

In the  $Cl(1,25)$   $E_8$  model the Kobayashi-Maskawa parameters are determined in terms of the sum of the masses of the 30 first-generation fermion particles and antiparticles, denoted by  $S_{mf1} = 7.508$  GeV,

and the similar sums for second-generation and third-generation fermions, denoted by  $S_{mf2} = 32.94504$  GeV and  $S_{mf3} = 1,629.2675$  GeV.

The reason for using sums of all fermion masses (rather than sums of quark masses only) is that all fermions are in the same spinor representation of  $Spin(8)$ , and the  $Spin(8)$  representations are considered to be fundamental.

The following formulas use the above masses to calculate Kobayashi-Maskawa parameters:

phase angle  $d_{13} = \gamma = 70.529$  degrees

$$\sin(\theta_{12}) = s_{12} = [m_e + 3m_d + 3m_\mu] / \sqrt{[m_e^2 + 3m_d^2 + 3m_\mu^2] + [3m_\nu^2 + 3m_s^2 + 3m_c^2]} = 0.222198$$

$$\sin(\theta_{13}) = s_{13} = [m_e + 3m_d + 3m_\mu] / \sqrt{[m_e^2 + 3m_d^2 + 3m_\mu^2] + [3m_\nu^2 + 3m_b^2 + 3m_t^2]} = 0.004608$$

$$\sin(\theta_{23}) = [3m_\nu + 3m_s + 3m_c] / \sqrt{[3m_\nu^2 + 3m_b^2 + 3m_t^2] + [3m_\nu^2 + 3m_s^2 + 3m_c^2]}$$

$$\sin(\theta_{23}) = s_{23} = \sin(\theta_{23}) \sqrt{(\Sigma_{f2} / \Sigma_{f1})} = 0.04234886$$

The factor  $\sqrt{(\Sigma_{f2} / \Sigma_{f1})}$  appears in  $s_{23}$  because an  $s_{23}$  transition is to the second generation and not all the way to the first generation, so that the end product of an  $s_{23}$  transition has a greater available energy than  $s_{12}$  or  $s_{13}$  transitions by a factor of  $\Sigma_{f2} / \Sigma_{f1}$ .

Since the width of a transition is proportional to the square of the modulus of the relevant KM entry and the width of an  $s_{23}$  transition has greater available energy than the  $s_{12}$  or  $s_{13}$  transitions by a factor of  $\Sigma_{f2} / \Sigma_{f1}$  the effective magnitude of the  $s_{23}$  terms in the KM entries is increased by the factor  $\sqrt{(\Sigma_{f2} / \Sigma_{f1})}$ .

The Chau-Keung parameterization is used, as it allows the K-M matrix to be represented as the product of the following three 3x3 matrices:

$$\begin{pmatrix} 1 & 0 & 0 \\ 0 & \cos(\theta_{23}) & \sin(\theta_{23}) \\ 0 & -\sin(\theta_{23}) & \cos(\theta_{23}) \end{pmatrix}$$

$$\begin{pmatrix} \cos(\theta_{13}) & 0 & \sin(\theta_{13})\exp(-i d_{13}) \\ 0 & 1 & 0 \\ -\sin(\theta_{13})\exp(i d_{13}) & 0 & \cos(\theta_{13}) \end{pmatrix}$$

$$\begin{pmatrix} \cos(\theta_{12}) & \sin(\theta_{12}) & 0 \\ -\sin(\theta_{12}) & \cos(\theta_{12}) & 0 \\ 0 & 0 & 1 \end{pmatrix}$$



The resulting Kobayashi-Maskawa parameters  
for  $W^+$  and  $W^-$  charged weak boson processes, are:

	d	s	b
u	0.975	0.222	0.00249 -0.00388i
c	-0.222 -0.000161i	0.974 -0.0000365i	0.0423
t	0.00698 -0.00378i	-0.0418 -0.00086i	0.999

The matrix is labelled by either (u c t) input and (d s b) output,  
or, as above, (d s b) input and (u c t) output.

For  $Z^0$  neutral weak boson processes, which are suppressed by the GIM  
mechanism of cancellation of virtual subprocesses, the matrix is labelled by either  
(u c t) input and (u'c't') output, or, as below, (d s b) input and (d's'b') output:

	d	s	b
d'	0.975	0.222	0.00249 -0.00388i
s'	-0.222 -0.000161i	0.974 -0.0000365i	0.0423
b'	0.00698 -0.00378i	-0.0418 -0.00086i	0.999

Since neutrinos of all three generations are massless at tree level,  
the lepton sector has no tree-level K-M mixing.

In hep-ph/0208080, Yosef Nir says: "... Within the Standard Model,  
the only source of CP violation is the Kobayashi-Maskawa (KM) phase ...  
The study of CP violation is, at last, experiment driven. ...  
The CKM matrix provides a consistent picture  
of all the measured flavor and CP violating processes. ...  
There is no signal of new flavor physics. ...  
Very likely,  
the KM mechanism is the dominant source of CP violation in flavor changing processes.  
... The result is consistent with the SM predictions. ...".

## Neutrino Masses Beyond Tree Level

Consider the three generations of neutrinos:  
nu\_e (electron neutrino); nu\_mu (muon neutrino); nu\_tau  
and three neutrino mass states: nu\_1 ; nu\_2 : nu\_3  
and  
the division of 8-dimensional spacetime into  
4-dimensional physical Minkowski spacetime  
plus  
4-dimensional CP2 internal symmetry space.

The heaviest mass state nu\_3 corresponds to a neutrino  
whose propagation begins and ends in CP2 internal symmetry  
space, lying entirely therein. According to the Cl(1,25) E8 model  
the mass of nu\_3 is zero at tree-level  
but it picks up a first-order correction  
propagating entirely through internal symmetry space by merging  
with an electron through the weak and electromagnetic forces,  
effectively acting not merely as a point  
but  
as a point plus an electron loop at beginning and ending points  
so  
the first-order corrected mass of nu\_3 is given by  
 $M_{\nu_3} \times (1/\sqrt{2}) = M_e \times GW(m_{\text{proton}}^2) \times \alpha_E$   
where the factor  $(1/\sqrt{2})$  comes from the Ut3 component  
of the neutrino mixing matrix  
so that

$$\begin{aligned} M_{\nu_3} &= \sqrt{2} \times M_e \times GW(m_{\text{proton}}^2) \times \alpha_E = \\ &= 1.4 \times 5 \times 10^5 \times 1.05 \times 10^{(-5)} \times (1/137) \text{ eV} = \\ &= 7.35 / 137 = 5.4 \times 10^{(-2)} \text{ eV}. \end{aligned}$$

The neutrino-plus-electron loop can be anchored by weak force  
action through any of the 6 first-generation quarks  
at each of the beginning and ending points, and that the  
anchor quark at the beginning point can be different from  
the anchor quark at the ending point,  
so that there are  $6 \times 6 = 36$  different possible anchorings.

The intermediate mass state  $\nu_2$  corresponds to a neutrino whose propagation begins or ends in CP2 internal symmetry space and ends or begins in M4 physical Minkowski spacetime, thus having only one point (either beginning or ending) lying in CP2 internal symmetry space where it can act not merely as a point but as a point plus an electron loop.

According to the Cl(1,25) E8 model the mass of  $\nu_2$  is zero at tree-level but it picks up a first-order correction at only one (but not both) of the beginning or ending points so that so that there are 6 different possible anchorings for  $\nu_2$  first-order corrections, as opposed to the 36 different possible anchorings for  $\nu_3$  first-order corrections, so that the first-order corrected mass of  $\nu_2$  is less than the first-order corrected mass of  $\nu_3$  by a factor of 6, so

the first-order corrected mass of  $\nu_2$  is  
$$M_{\nu_2} = M_{\nu_3} / \text{Vol}(\text{CP}2) = 5.4 \times 10^{(-2)} / 6$$
$$= 9 \times 10^{(-3)} \text{eV}.$$

The low mass state  $\nu_1$  corresponds to a neutrino whose propagation begins and ends in physical Minkowski spacetime. thus having only one anchoring to CP2 interna symmetry space.

According to the Cl(1,25) E8 model the mass of  $\nu_1$  is zero at tree-level but it has only 1 possible anchoring to CP2 as opposed to the 36 different possible anchorings for  $\nu_3$  first-order corrections or the 6 different possible anchorings for  $\nu_2$  first-order corrections so that the first-order corrected mass of  $\nu_1$  is less than the first-order corrected mass of  $\nu_2$  by a factor of 6, so

the first-order corrected mass of  $\nu_1$  is  
$$M_{\nu_1} = M_{\nu_2} / \text{Vol}(\text{CP}2) = 9 \times 10^{(-3)} / 6$$
$$= 1.5 \times 10^{(-3)} \text{eV}.$$

Therefore:

$$\begin{aligned} \text{the mass-squared difference } D(M_{23}^2) &= M_{\nu_3}^2 - M_{\nu_2}^2 = \\ &= (2916 - 81) \times 10^{(-6)} \text{ eV}^2 = \\ &= 2.8 \times 10^{(-3)} \text{ eV}^2 \end{aligned}$$

and

$$\begin{aligned} \text{the mass-squared difference } D(M_{12}^2) &= M_{\nu_2}^2 - M_{\nu_1}^2 = \\ &= (81 - 2) \times 10^{(-6)} \text{ eV}^2 = \\ &= 7.9 \times 10^{(-5)} \text{ eV}^2 \end{aligned}$$

The 3x3 unitary neutrino mixing matrix neutrino mixing matrix U

	nu_1	nu_2	nu_3
nu_e	Ue1	Ue2	Ue3
nu_m	Um1	Um2	Um3
nu_t	Ut1	Ut2	Ut3

can be parameterized (based on the 2010 Particle Data Book)  
by 3 angles and 1 Dirac CP violation phase

$$U = \begin{pmatrix} c_{12} c_{13} & s_{12} c_{13} & s_{13} e^{-i\delta} \\ -s_{12} c_{23} - c_{12} s_{23} s_{13} e^{i\delta} & c_{12} c_{23} - s_{12} s_{23} s_{13} e^{i\delta} & s_{23} c_{13} \\ s_{12} s_{23} - c_{12} c_{23} s_{13} e^{i\delta} & -c_{12} s_{23} - s_{12} c_{23} s_{13} e^{i\delta} & c_{23} c_{13} \end{pmatrix}$$

where  $c_{ij} = \cos(\theta_{ij})$  ,  $s_{ij} = \sin(\theta_{ij})$

The angles are

$\theta_{23} = \pi/4 = 45$  degrees

because

$\nu_3$  has equal components of  $\nu_m$  and  $\nu_t$  so  
that  $U_{m3} = U_{t3} = 1/\sqrt{2}$  or, in conventional  
notation, mixing angle  $\theta_{23} = \pi/4$

so that  $\cos(\theta_{23}) = 0.707 = \sqrt{2}/2 = \sin(\theta_{23})$

$\theta_{13} = 9.594$  degrees =  $\arcsin(1/6)$

and  $\cos(\theta_{13}) = 0.986$

because  $\sin(\theta_{13}) = 1/6 = 0.167 = |U_{e3}|$  = fraction of  $\nu_3$  that is  $\nu_e$

$\theta_{12} = \pi/6 = 30$  degrees

because

$\sin(\theta_{12}) = 0.5 = 1/2 = U_{e2}$  = fraction of  $\nu_2$  begin/end points  
that are in the physical spacetime where massless  $\nu_e$  lives

so that  $\cos(\theta_{12}) = 0.866 = \sqrt{3}/2$

$\delta = 70.529$  degrees is the Dirac CP violation phase

$e^{i(70.529)} = \cos(70.529) + i \sin(70.529) = 0.333 + 0.943 i$

This is because the neutrino mixing matrix has 3-generation structure

and so has the same phase structure as the KM quark mixing matrix

in which the Unitarity Triangle angles are:

$\beta = V_3.V_1.V_4 = \arccos( 2 \sqrt{2} / 3 ) \cong 19.471 220 634$  degrees so  $\sin 2\beta = 0.6285$

$\alpha = V_1.V_3.V_4 = 90$  degrees

$\gamma = V_1.V_4.V_3 = \arcsin( 2 \sqrt{2} / 3 ) \cong 70.528 779 366$  degrees

The constructed Unitarity Triangle angles can be seen on the Stella Octangula configuration of two dual tetrahedra (image from [gauss.math.nthu.edu.tw](http://gauss.math.nthu.edu.tw)):

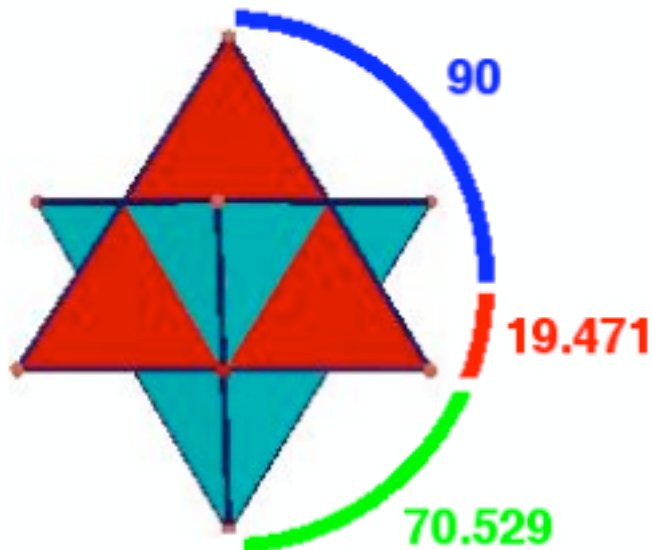

Then we have for the neutrino mixing matrix:

	nu_1	nu_2	nu_3
nu_e	0.866 x 0.986	0.50 x 0.986	0.167 x e-id
nu_m	-0.5 x 0.707 -0.866 x 0.707 x 0.167 x eid	0.866 x 0.707 -0.5 x 0.707 x 0.167 x eid	0.707 x 0.986
nu_t	0.5 x 0.707 -0.866 x 0.707 x 0.167 x eid	-0.866 x 0.707 -0.5 x 0.707 x 0.167 x eid	0.707 x 0.986

	nu_1	nu_2	nu_3
nu_e	0.853	0.493	0.167 e-id
nu_m	-0.354 -0.102 eid	0.612 -0.059 eid	0.697
nu_t	0.354 -0.102 eid	-0.612 -0.059 eid	0.697

Since  $e^{i(70.529)} = \cos(70.529) + i \sin(70.529) = 0.333 + 0.943 i$   
and  $.333e^{-i(70.529)} = \cos(70.529) - i \sin(70.529) = 0.333 - 0.943 i$

	nu_1	nu_2	nu_3
nu_e	0.853	0.493	0.056 - 0.157 i
nu_m	-0.354 -0.034 - 0.096 i	0.612 -0.020 - 0.056 i	0.697
nu_t	0.354 -0.034 - 0.096 i	-0.612 -0.020 - 0.056 i	0.697

for a result of

	nu_1	nu_2	nu_3
nu_e	0.853	0.493	0.056 - 0.157 i
nu_m	-0.388 - 0.096 i	0.592 - 0.056 i	0.697
nu_t	0.320 - 0.096 i	0.632 - 0.056 i	0.697

which is consistent with the approximate experimental values of mixing angles shown in the Michaelmas Term 2010 Particle Physics handout of Prof Mark Thomson if the matrix is modified by taking into account the March 2012 results from Daya Bay observing non-zero  $\theta_{13} = 9.54$  degrees.

## Proton-Neutron Mass Difference

An up valence quark, constituent mass 313 Mev,  
does not often swap places with a 2.09 Gev charm sea quark,  
but  
a 313 Mev down valence quark  
can more often swap places with a 625 Mev strange sea quark.

Therefore the Quantum color force  
constituent mass of the down valence quark is heavier by about

$$(m_s - m_d) (m_d/m_s)^2 a(w) |V_{ds}| = 312 \times 0.25 \times 0.253 \times 0.22 \text{ Mev} = 4.3 \text{ Mev},$$

(where  $a(w) = 0.253$  is the geometric part of the weak force strength  
and  $|V_{ds}| = 0.22$  is the magnitude  
of the K-M parameter mixing first generation down and second generation strange)

so that the Quantum color force constituent mass  $Q_{md}$  of the down quark is

$$Q_{md} = 312.75 + 4.3 = 317.05 \text{ MeV}.$$

Similarly, the up quark Quantum color force mass increase is about

$$(m_c - m_u) (m_u/m_c)^2 a(w) |V_{uc}| = 1777 \times 0.022 \times 0.253 \times 0.22 \text{ Mev} = 2.2 \text{ Mev},$$

(where  $|V_{uc}| = 0.22$  is the magnitude  
of the K-M parameter mixing first generation up and second generation charm)

so that the Quantum color force constituent mass  $Q_{mu}$  of the up quark is

$$Q_{mu} = 312.75 + 2.2 = 314.95 \text{ MeV}.$$

Therefore, the Quantum color force Neutron-Proton mass difference is

$$m_N - m_P = Q_{md} - Q_{mu} = 317.05 \text{ Mev} - 314.95 \text{ Mev} = 2.1 \text{ Mev}.$$

Since the electromagnetic Neutron-Proton mass difference is roughly

$$m_N - m_P = -1 \text{ MeV}$$

the total theoretical Neutron-Proton mass difference is

$$m_N - m_P = 2.1 \text{ Mev} - 1 \text{ Mev} = 1.1 \text{ Mev},$$

an estimate that is comparable to the experimental value of 1.3 Mev.

## Pion as Sine-Gordon Breather

The quark content of a charged pion is a quark - antiquark pair: either Up plus antiDown or Down plus antiUp. Experimentally, its mass is about 139.57 MeV.

The quark is a Schwinger Source Kerr-Newman Black Hole with constituent mass  $M$  312 MeV.

The antiquark is also a Schwinger Source Kerr-Newman Black Hole, with constituent mass  $M$  312 MeV.

According to section 3.6 of Jeffrey Winicour's 2001 Living Review of the Development of Numerical Evolution Codes for General Relativity (see also a 2005 update):

"... The black hole event horizon associated with ... slightly broken ... degeneracy [ of the axisymmetric configuration ]... reveals new features not seen in the degenerate case of the head-on collision ... If the degeneracy is slightly broken, the individual black holes form with spherical topology but as they approach, tidal distortion produces two sharp pincers on each black hole just prior to merger. ...

Tidal distortion of approaching black holes ... Formation of sharp pincers just prior to merger ..

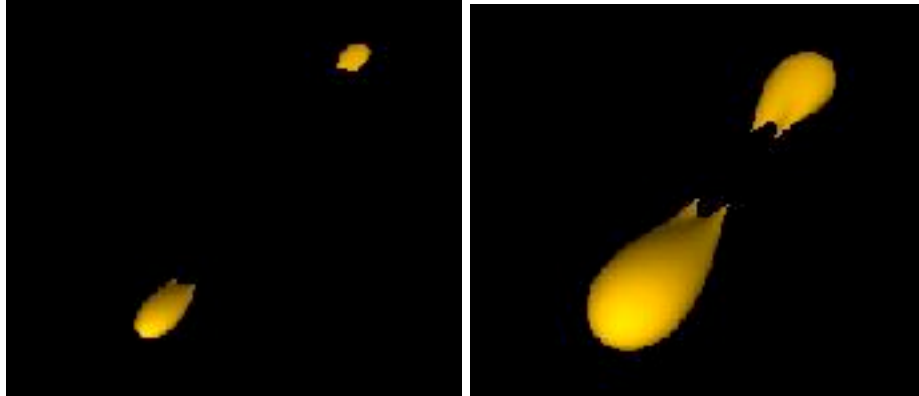

... toroidal stage just after merger ...

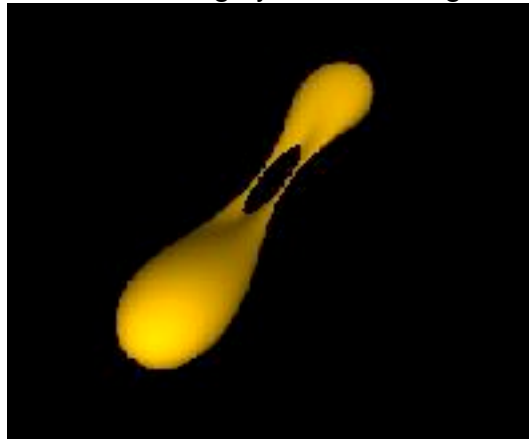

At merger, the two pincers join to form a single ... toroidal black hole.



The inner hole of the torus subsequently [ begins to] close... up (superluminally) ... [ If the closing proceeds to completion, it ]... produce[s] first a peanut shaped black hole and finally a spherical black hole. ...".

In the physical case of quark and antiquark forming a pion, the toroidal black hole remains a torus.

The torus is an event horizon and therefore is not a 2-spacelike dimensional torus, but is a (1+1)-dimensional torus with a timelike dimension.

The effect is described in detail in Robert Wald's book General Relativity (Chicago 1984). It can be said to be due to extreme frame dragging, or to timelike translations becoming spacelike as though they had been Wick rotated in Complex SpaceTime.

As Hawking and Ellis say in The LargeScale Structure of Space-Time (Cambridge 1973):

"... The surface  $r = r_+$  is ... the event horizon ... and is a null surface ...

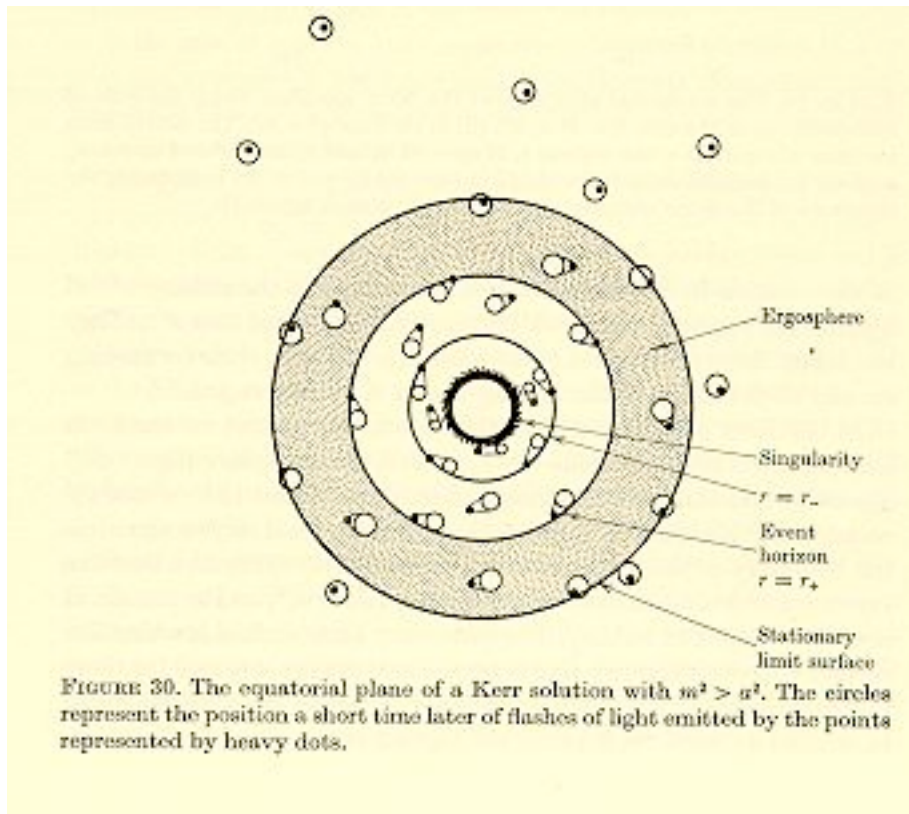

... On the surface  $r = r_+$  .... the wavefront corresponding to a point on this surface lies entirely within the surface. ...".

A (1+1)-dimensional torus with a timelike dimension can carry a Sine-Gordon Breather. The soliton and antisoliton of a Sine-Gordon Breather correspond to the quark and antiquark that make up the pion, analogous to the Massive Thirring Model.

Sine-Gordon Breathers are described by Sidney Coleman in his Erica lecture paper Classical Lumps and their Quantum Descendants (1975), reprinted in his book Aspects of Symmetry (Cambridge 1985), where he writes the Lagrangian for the Sine-Gordon equation as ( Coleman's eq. 4.3 ):

$$L = (1 / B^2) ( (1/2) (df)^2 + A ( \cos( f ) - 1 ) )$$

Coleman says: "... We see that, in classical physics, B is an irrelevant parameter: if we can solve the sine-Gordon equation for any non-zero B, we can solve it for any other B.

The only effect of changing B is the trivial one of changing the energy and momentum assigned to a given solution of the equation. This is not true in quantum physics, because the relevant object for quantum physics is not L but [ eq. 4.4 ]

$$L / \hbar = (1 / ( B^2 \hbar ) ) ( (1/2) (df)^2 + A ( \cos( f ) - 1 ) )$$

An other way of saying the same thing is to say that in quantum physics we have one more dimensional constant of nature, Planck's constant, than in classical physics. ... the classical limit, vanishing  $\hbar$ , is exactly the same as the small-coupling limit, vanishing B ... from now on I will ... set  $\hbar$  equal to one. ...

... the sine-Gordon equation ...[ has ]... an exact periodic solution ...[ eq. 4.59 ]...

$$f( x, t ) = ( 4 / B ) \arctan( ( n \sin( w t ) / \cosh( n w x ) )$$

where [ eq. 4.60 ]  $n = \sqrt{ A - w^2 } / w$  and  $w$  ranges from 0 to A.

This solution has a simple physical interpretation ... a soliton far to the left ...[ and ]... an antisoliton far to the right. As  $\sin( w t )$  increases, the soliton and antisoliton move farther apart from each other. When  $\sin( w t )$  passes through one, they turn around and begin to approach one another. As  $\sin( w t )$  comes down to zero ... the soliton and antisoliton are on top of each other ... when  $\sin( w t )$  becomes negative .. the soliton and antisoliton have passed each other.

... Thus, Eq. (4.59) can be thought of as a soliton and an antisoliton oscillation about their common center-of-mass. For this reason, it is called 'the doublet [ or Breather ] solution'. ... the energy of the doublet ...[ eq. 4.64 ]

$$E = 2 M \sqrt{ 1 - ( w^2 / A ) }$$

where [ eq. 4.65 ]  $M = 8 \sqrt{ A } / B^2$  is the soliton mass.

Note that the mass of the doublet is always less than twice the soliton mass, as we would expect from a soliton-antisoliton pair. ...

Dashen, Hasslacher, and Neveu ... Phys. Rev. D10, 4114; 4130; 4138 (1974).  
 ...[ found that ]... there is only a single series of bound states, labeled by the integer N ...  
 The energies ... are ... [ eq. 4.82 ]

$$E_N = 2 M \sin( B'^2 N / 16 )$$

where  $N = 0, 1, 2 \dots < 8 \pi / B'^2$ , [ eq. 4.83 ]

$B'^2 = B^2 / ( 1 - ( B^2 / 8 \pi ) )$  and M is the soliton mass.

M is not given by Eq. ( 4.65 ), but is the soliton mass corrected by the DHN formula, or, equivalently, by the first-order weak coupling expansion. ...

I have written the equation in this form .. to eliminate A, and thus avoid worries about renormalization conventions.

Note that the DHN formula is identical to the Bohr-Sommerfeld formula, except that B is replaced by B'.

Bohr and Sommerfeld[s] ... quantization formula says that if we have a one-parameter family of periodic motions, labeled by the period, T, then an energy eigenstate occurs whenever [ eq. 4.66 ]

$$[ \text{Integral from 0 to T} ]( dt p \dot{q} = 2 \pi N,$$

where N is an integer. ... Eq.( 4.66 ) is cruder than the WKB formula, but it is much more general;

it is always the leading approximation for any dynamical system ...

Dashen et al speculate that Eq. ( 4.82 ) is exact. ...

the sine-Gordon equation is equivalent ... to the massive Thirring model.

This is surprising,

because the massive Thirring model is a canonical field theory

whose Hamiltonian is expressed in terms of fundamental Fermi fields only.

Even more surprising, when  $B^2 = 4 \pi$ , that sine-Gordon equation is equivalent to a free massive Dirac theory, in one spatial dimension. ...

Furthermore, we can identify the mass term in the Thirring model with the sine-Gordon interaction, [ eq. 5.13 ]

$$M = - ( A / B^2 ) N_m \cos( B f )$$

.. to do this consistently ... we must say [ eq. 5.14 ]

$$B^2 / ( 4 \pi ) = 1 / ( 1 + g / \pi )$$

....[where]... g is a free parameter, the coupling constant [ for the Thirring model ]...

Note that if  $B^2 = 4 \pi$ ,  $g = 0$ ,

and the sine-Gordon equation is the theory of a free massive Dirac field. ...

It is a bit surprising to see a fermion appearing as a coherent state of a Bose field.

Certainly this could not happen in three dimensions,

where it would be forbidden by the spin-statistics theorem.

However, there is no spin-statistics theorem in one dimension,

for the excellent reason that there is no spin. ...

the lowest fermion-antifermion bound state of the massive Thirring model

is an obvious candidate for the fundamental meson of sine-Gordon theory. ...

equation ( 4.82 ) predicts that

all the doublet bound states disappear when  $B^2$  exceeds  $4 \pi$ .

This is precisely the point where the Thirring model interaction switches from attractive to repulsive. ... these two theories ... the massive Thirring model .. and ... the sine-Gordon equation ... define identical physics. ...

I have computed the predictions of ...[various]... approximation methods for the ration of the soliton mass to the meson mass for three values of  $B^2$  :  $4\pi$  (where the qualitative picture of the soliton as a lump totally breaks down),  $2\pi$ , and  $\pi$  . At  $4\pi$  we know the exact answer ... I happen to know the exact answer for  $2\pi$ , so I have included this in the table. ...

Method	$B^2 = \pi$	$B^2 = 2\pi$	$B^2 = 4\pi$
Zeroth-order weak coupling expansion eq2.13b	2.55	1.27	0.64
Coherent-state variation	2.55	1.27	0.64
First-order weak coupling expansion	2.23	0.95	0.32
Bohr-Sommerfeld eq4.64	2.56	1.31	0.71
DHN formula eq4.82	2.25	1.00	0.50
Exact	?	1.00	0.50

...[eq. 2.13b ]

$$E = 8 \sqrt{A} / B^2$$

...[ is the ]... energy of the lump ... of sine-Gordon theory ... frequently called 'soliton...' in the literature ...

[ Zeroth-order is the classical case, or classical limit. ] ...

... Coherent-state variation always gives the same result as the ... Zeroth-order weak coupling expansion ... . The ... First-order weak-coupling expansion ... explicit formula ... is  $( 8 / B^2 ) - ( 1 / \pi )$ . ...".

Using the  $Cl(1,25)$  E8 model constituent mass of the Up and Down quarks and antiquarks, about 312.75 MeV, as the soliton and antisoliton masses, and setting  $B^2 = \pi$  and using the DHN formula, the mass of the charged pion is calculated to be  $( 312.75 / 2.25 )$  MeV = 139 MeV which is close to the experimental value of about 139.57 MeV.

**Why is the value  $B^2 = \pi$  the special value that gives the pion mass ?**

( or, using Coleman's eq. ( 5.14 ), the Thirring coupling constant  $g = 3\pi$  )

**Because  $B^2 = \pi$  is where the First-order weak coupling expansion substantially coincides with the ( probably exact ) DHN formula.** In other words,

**The physical quark - antiquark pion lives where the first-order weak coupling expansion is exact.**

## Planck Mass as Superposition Fermion Condensate

At a single spacetime vertex, a Planck-mass black hole is the Many-Worlds quantum sum of all possible virtual first-generation particle-antiparticle fermion pairs allowed by the Pauli exclusion principle to live on that vertex.

Once a Planck-mass black hole is formed, it is stable in the E8 model. Less mass would not be gravitationally bound at the vertex. More mass at the vertex would decay by Hawking radiation.

There are 8 fermion particles and 8 fermion antiparticles for a total of 64 particle-antiparticle pairs. Of the 64 particle-antiparticle pairs, 12 are bosonic pions.

A typical combination should have about 6 pions so it should have a mass of about  $.14 \times 6 \text{ GeV} = 0.84 \text{ GeV}$ .

Just as the pion mass of .14 GeV is less than the sum of the masses of a quark and an antiquark, pairs of oppositely charged pions may form a bound state of less mass than the sum of two pion masses.

If such a bound state of oppositely charged pions has a mass as small as .1 GeV, and if the typical combination has one such pair and 4 other pions, then the typical combination could have a mass in the range of 0.66 GeV.

Summing over all  $2^{64}$  combinations, the total mass of a one-vertex universe should give a Planck mass roughly around  $0.66 \times 2^{64} = 1.217 \times 10^{19} \text{ GeV}$ .

The value for the Planck mass given in by the 1998 Particle Data Group is  $1.221 \times 10^{19} \text{ GeV}$ .

## Conformal Gravity+Dark Energy and DE : DM : OM

MacDowell-Mansouri Gravity is described by Rabindra Mohapatra in section 14.6 of his book "Unification and Supersymmetry":

### §14.6. Local Conformal Symmetry and Gravity

Before we study supergravity, with the new algebraic approach developed, we would like to discuss how gravitational theory can emerge from the gauging of conformal symmetry. For this purpose we briefly present the general notation for constructing gauge covariant fields. The general procedure is to start with the Lie algebra of generators  $X_A$  of a group

$$[X_A, X_B] = f_{AB}^C X_C, \quad (14.6.1)$$

where  $f_{AB}^C$  are structure constants of the group. We can then introduce a gauge field connection  $h_\mu^A$  as follows:

$$h_\mu \equiv h_\mu^A X_A. \quad (14.6.2)$$

Let us denote the parameter associated with  $X_A$  by  $\varepsilon^A$ . The gauge transformations on the fields  $h_\mu^A$  are given as follows:

$$\delta h_\mu^A = \partial_\mu \varepsilon^A + h_\mu^B \varepsilon^C f_{CB}^A \equiv (D_\mu \varepsilon)^A. \quad (14.6.3)$$

We can then define a covariant curvature

$$R_{\mu\nu}^A = \partial_\nu h_\mu^A - \partial_\mu h_\nu^A + h_\nu^B h_\mu^C f_{CB}^A. \quad (14.6.4)$$

Under a gauge transformation

$$\delta_{\text{gauge}} R_{\mu\nu}^A = R_{\mu\nu}^B \varepsilon^C f_{CB}^A. \quad (14.6.5)$$

We can then write the general gauge invariant action as follows:

$$I = \int d^4x Q_{AB}^{\mu\nu\sigma\tau} R_{\mu\nu}^A R_{\sigma\tau}^B. \quad (14.6.6)$$

Let us now apply this formalism to conformal gravity. In this case

$$h_\mu = P_\mu e_\nu^n + M_{nm} \omega_\mu^{mn} + K_\mu f_\nu^n + D b_\mu. \quad (14.6.7)$$

The various  $R_{\mu\nu}$  are

$$R_{\mu\nu}(P) = \partial_\nu e_\mu^n - \partial_\mu e_\nu^n + \omega_\mu^{mn} e_\nu^n - \omega_\nu^{mn} e_\mu^n - b_\mu e_\nu^n + b_\nu e_\mu^n, \quad (14.6.8)$$

$$R_{\mu\nu}(M) = \partial_\nu \omega_\mu^{mn} - \partial_\mu \omega_\nu^{mn} - \omega_\nu^{np} \omega_{\mu,p}^m - \omega_\mu^{mp} \omega_{\nu,p}^n - 4(e_\mu^n f_\nu^n - e_\nu^n f_\mu^n), \quad (14.6.9)$$

$$R_{\mu\nu}(K) = \partial_\nu f_\mu^n - \partial_\mu f_\nu^n - b_\mu f_\nu^n + b_\nu f_\mu^n + \omega_\mu^{mn} f_\nu^n - \omega_\nu^{mn} f_\mu^n, \quad (14.6.10)$$

$$R_{\mu\nu}(D) = \partial_\nu b_\mu - \partial_\mu b_\nu + 2e_\mu^n f_\nu^n - 2e_\nu^n f_\mu^n. \quad (14.6.11)$$

The gauge invariant Lagrangian for the gravitational field can now be written down, using eqn. (14.6.6), as

$$S = \int d^4x \varepsilon_{\mu\nu\sigma\tau} \varepsilon^{\mu\nu\sigma\tau} R_{\mu\nu}^{\mu\nu}(M) R_{\sigma\tau}^{\sigma\tau}(M). \quad (14.6.12)$$

We also impose the constraint that

$$R_{\mu\nu}(P) = 0, \quad (14.6.13)$$

which expresses  $\omega_a^{mn}$  as a function of  $(e, b)$ . The reason for imposing this constraint has to do with the fact that  $P_m$  transformations must be eventually identified with coordinate transformation. To see this point more explicitly let us consider the vierbein  $e_a^\mu$ . Under coordinate transformations

$$\delta_{GC}(\xi^\nu)e_a^\mu = \partial_\nu \xi^\lambda e_\lambda^\mu + \xi^\lambda \partial_\lambda e_a^\mu. \quad (14.6.14)$$

Using eqn. (14.6.8) we can rewrite

$$\delta_{GC}(\xi^\nu)e_a^\mu = \delta_P(\xi^\nu)e_a^\mu + \delta_M(\xi^\nu \omega^{mn})e_a^\mu + \delta_D(\xi^\nu b) e_a^\mu + \xi^\nu R_{\nu\alpha}^\mu(P),$$

where

$$\delta_P(\xi^\nu)e_a^\mu = \partial_\nu \xi^\mu + \xi^\nu \omega_a^{\mu\sigma} + \xi^\sigma b_{\nu\sigma}. \quad (14.6.15)$$

If  $R^{\mu\nu}(P) = 0$ , the general coordinate transformation becomes related to a set of gauge transformations via eqn. (14.6.15).

At this point we also wish to point out how we can define the covariant derivative. In the case of internal symmetries  $D_\mu = \partial_\mu - iX_A h_\mu^A$ ; now since momentum is treated as an internal symmetry we have to give a rule. This follows from eqn. (14.6.15) by writing a redefined translation generator  $\tilde{P}$  such that

$$\delta_{\tilde{P}}(\xi) = \delta_{GC}(\xi^\nu) - \sum_A \delta_A(\xi^\nu h_\nu^A), \quad (14.6.16)$$

where  $A'$  goes over all gauge transformations excluding translation. The rule is

$$\delta_{\tilde{P}}(\xi^\nu)\phi = \xi^\nu D_\nu^C \phi. \quad (14.6.17)$$

We also wish to point out that for fields which carry spin or conformal charge, only the intrinsic parts contribute to  $D_\mu^C$  and the orbital parts do not play any role.

Coming back to the constraints we can then vary the action with respect to  $f_a^m$  to get an expression for it, i.e.,

$$e_a^\nu f_{\nu m} = -\frac{1}{4}[e_a^\lambda e_{\nu\lambda} R_{\lambda\sigma}^{\nu m} - \frac{1}{6}g_{\mu\nu} R], \quad (14.6.18)$$

where  $f_a^m$  has been set to zero in  $R$  written in the right-hand side.

This eliminates (from the theory the degrees of freedom)  $\omega_a^{mn}$  and  $f_a^m$  and we are left with  $e_a^\mu$  and  $b_{\mu\nu}$ . Furthermore, these constraints will change the transformation laws for the dependent fields so that the constraints do not change.

Let us now look at the matter coupling to see how the familiar gravity theory emerges from this version. Consider a scalar field  $\phi$ . It has conformal weight  $\lambda = 1$ . So we can write a covariant derivative for it, eqn. (14.6.17)

$$D_\mu^C \phi = \partial_\mu \phi - \phi b_\mu. \quad (14.6.19)$$

We note that the conformal charge of  $\phi$  can be assumed to be zero since  $K_m = x^2 \partial$  and is the dimension of inverse mass. In order to calculate  $\square^C \phi$  we

start with the expression for d'Alembertian in general relativity

$$\frac{1}{e} \partial_\nu (g^{\mu\nu} e D_\mu^c \phi). \quad (14.6.20)$$

The only transformations we have to compensate for are the conformal transformations and the scale transformations. Since

$$\delta b_\mu = -2\xi_k^m e_{m\mu}, \quad \delta(\phi b_\mu) = \phi \delta b_\mu = -2\phi f_\mu^m e_m^\nu = +\frac{1}{2} \phi R, \quad (14.6.21)$$

where, in the last step, we have used the constraint equation (14.6.18). Putting all these together we find

$$\square^c \phi = \frac{1}{e} \partial_\nu (g^{\mu\nu} e D_\mu^c \phi) + b_\mu D_\mu^c \phi + \frac{1}{2} \phi R. \quad (14.6.22)$$

Thus, the Lagrangian for conformal gravity coupled to matter fields can be written as

$$S = \int e d^4x \frac{1}{2} \phi \square^c \phi. \quad (14.6.23)$$

Now we can use conformal transformation to gauge  $b_\mu = 0$  and local scale transformation to set  $\phi = \kappa^{-1}$  leading to the usual Hilbert action for gravity. To summarize, we start with a Lagrangian invariant under full local conformal symmetry and fix conformal and scale gauge to obtain the usual action for gravity. We will adopt the same procedure for supergravity. An important technical point to remember is that,  $\square^c$ , the conformal d'Alembertian contains  $R$ , which for constant  $\phi$ , leads to gravity. We may call  $\phi$  the auxiliary field.

After the scale and conformal gauges have been fixed, the conformal Lagrangian becomes a de Sitter Lagrangian.

Einstein-Hilbert gravity can be derived from the de Sitter Lagrangian, as was first shown by MacDowell and Mansouri (Phys. Rev. Lett. 38 (1977) 739).

( Frank Wilczek, in hep-th/9801184 says that the MacDowell-Mansouri "... approach to casting gravity as a gauge theory was initiated by MacDowell and Mansouri ...

S. MacDowell and F. Mansouri, Phys. Rev. Lett. 38 739 (1977) ... ,

and independently Chamseddine and West ... A. Chamseddine and P. West Nucl. Phys. B 129, 39 (1977);

also quite relevant is A. Chamseddine, Ann. Phys. 113, 219 (1978). ...". )



**The minimal group required to produce Gravity,  
and therefore the group that is used in calculating Force Strengths,  
is the [anti] de Sitter group,** as is described by

Freund in chapter 21 of his book Supersymmetry (Cambridge 1986) ( chapter 21 is a Non-Supersymmetry chapter leading up to a Supergravity description in the following chapter 22 ):

"... Einstein gravity as a gauge theory ... we expect a set of gauge fields  $w^{ab}_u$  for the Lorentz group and a further set  $e^a_u$  for the translations, ...

Everybody knows though, that Einstein's theory contains but one spin two field, originally chosen by Einstein as  $g_{uv} = e^a_u e^b_v n_{ab}$  ( $n_{ab}$  = Minkowski metric).

What happened to the  $w^{ab}_u$  ?

The field equations obtained from the Hilbert-Einstein action by varying the  $w^{ab}_u$  are algebraic in the  $w^{ab}_u$  ... permitting us to express the  $w^{ab}_u$  in terms of the  $e^a_u$  ... The  $w$  do not propagate ...

We start from the four-dimensional de-Sitter algebra ...  $so(3,2)$ .

Technically this is the anti-de-Sitter algebra ...

We envision space-time as a four-dimensional manifold  $M$ .

At each point of  $M$  we have a copy of  $SO(3,2)$  (a fibre ...) ...

and we introduce the gauge potentials (the connection)  $h^A_\mu(x)$

$A = 1, \dots, 10$ ,  $\mu = 1, \dots, 4$ . Here  $x$  are local coordinates on  $M$ .

From these potentials  $h^A_\mu$  we calculate the field-strengths

(curvature components) [let  $@$  denote partial derivative]

$R^A_{\mu\nu} = @_\mu h^A_\nu - @_\nu h^A_\mu + f^A_{BC} h^B_\mu h^C_\nu$

...[where]... the structure constants  $f^C_{AB}$  ...[are for]... the anti-de-Sitter algebra ....

We now wish to write down the action  $S$  as an integral over

the four-manifold  $M$  ...  $S(Q) = \text{INTEGRAL}_M R^A \wedge R^B Q_{AB}$

where  $Q_{AB}$  are constants ... to be chosen ... we require

... the invariance of  $S(Q)$  under local Lorentz transformations

... the invariance of  $S(Q)$  under space inversions ...

...[ AFTER A LOT OF ALGEBRA NOT SHOWN IN THIS QUOTE ]...

we shall see ...[that]... the action becomes invariant

under all local [anti]de-Sitter transformations ...[and]... we recognize ... t

he familiar Hilbert-Einstein action with cosmological term in vierbein notation ...

Variation of the vierbein leads to the Einstein equations with cosmological term.

Variation of the spin-connection ... in turn ... yield the torsionless Christoffel

connection ... the torsion components ... now vanish.

So at this level full  $sp(4)$  invariance has been checked.

... Were it not for the assumed space-inversion invariance ...

we could have had a parity violating gravity. ...

Unlike Einstein's theory ...[MacDowell-Mansouri]... does not require Riemannian invertibility of the metric. ... the solution has torsion ... produced by an interference between parity violating and parity conserving amplitudes.

Parity violation and torsion go hand-in-hand.

Independently of any more realistic parity violating solution of the gravity

equations this raises the cosmological question whether

the universe as a whole is in a space-inversion symmetric configuration. ...".

According to gr-qc/9809061 by R. Aldrovandi and J. G. Peireira:

"... If the fundamental spacetime symmetry of the laws of Physics is that given by the de Sitter instead of the Poincare group, the P-symmetry of the weak cosmological-constant limit and the Q-symmetry of the strong cosmological constant limit can be considered as limiting cases of the fundamental symmetry. ...

... N ... [ is the space ]... whose geometry is gravitationally related to an infinite cosmological constant ... [and]... is a 4-dimensional cone-space in which  $ds = 0$ , and whose group of motion is Q. Analogously to the Minkowski case, N is also a homogeneous space, but now under the kinematical group Q, that is,  $N = Q/L$  [ where L is the Lorentz Group of Rotations and Boosts ]. In other words, the point-set of N is the point-set of the special conformal transformations.

Furthermore, the manifold of Q is a principal bundle  $P(Q/L, L)$ , with  $Q/L = N$  as base space and L as the typical fiber. The kinematical group Q, like the Poincare group, has the Lorentz group L as the subgroup accounting for both the isotropy and the equivalence of inertial frames in this space. However, the special conformal transformations introduce a new kind of homogeneity. Instead of ordinary translations, all the points of N are equivalent through special conformal transformations. ...

... Minkowski and the cone-space can be considered as dual to each other, in the sense that their geometries are determined respectively by a vanishing and an infinite cosmological constants. The same can be said of their kinematical group of motions: P is associated to a vanishing cosmological constant and Q to an infinite cosmological constant.

The dual transformation connecting these two geometries is the spacetime inversion  $x^u \rightarrow x^u / \sigma^2$ . Under such a transformation, the Poincare group P is transformed into the group Q, and the Minkowski space M becomes the conespace N. The points at infinity of M are concentrated in the vertex of the conespace N, and those on the light-cone of M becomes the infinity of N. It is concepts of space isotropy and equivalence between inertial frames in the conespace N are those of special relativity. The difference lies in the concept of uniformity as it is the special conformal transformations, and not ordinary translations, which act transitively on N. ..."

**Gravity and the Cosmological Constant come from the MacDowell-Mansouri Mechanism and the 15-dimensional Spin(2,4) = SU(2,2) Conformal Group, which is made up of:**

**3 Rotations  
3 Boosts  
4 Translations  
4 Special Conformal transformations  
1 Dilatation**

The **Cosmological Constant / Dark Energy** comes from the **10 Rotation, Boost, and Special Conformal generators** of the Conformal Group Spin(2,4) = SU(2,2), so the fractional part of our Universe of the Cosmological Constant should be **about 10 / 15 = 67% for tree level.**

Black Holes, including **Dark Matter Primordial Black Holes**, are curvature singularities in our 4-dimensional physical spacetime, and since Einstein-Hilbert curvature comes from the **4 Translations** of the 15-dimensional Conformal Group Spin(2,4) = SU(2,2) through the MacDowell-Mansouri Mechanism (in which the generators corresponding to the 3 Rotations and 3 Boosts do not propagate), the fractional part of our Universe of Dark Matter Primordial Black Holes should be **about 4 / 15 = 27% at tree level.**

Since **Ordinary Matter** gets mass from the Higgs mechanism which is related to the **1 Scale Dilatation** of the 15-dimensional Conformal Group Spin(2,4) = SU(2,2), the fractional part of our universe of Ordinary Matter should be **about 1 / 15 = 6% at tree level.**

However,  
**as Our Universe evolves the Dark Energy, Dark Matter, and Ordinary Matter densities evolve at different rates,**  
so that the differences in evolution must be taken into account from the initial End of Inflation to the Present Time.

**Without taking into account any evolutionary changes with time,**  
our Flat Expanding Universe should have roughly:

**67% Cosmological Constant  
27% Dark Matter - possibly primordial stable Planck mass black holes  
6% Ordinary Matter**

As Dennis Marks pointed out to me,  
 since density  $\rho$  is proportional to  $(1+z)^3(1+w)$  for red-shift factor  $z$   
 and a constant equation of state  $w$ :  
 $w = -1$  for  $\Lambda$  and the average overall density of  $\Lambda$  Dark Energy remains constant  
 with time and the expansion of our Universe;  
 and  
 $w = 0$  for nonrelativistic matter so that the overall average density of Ordinary  
 Matter declines as  $1 / R^3$  as our Universe expands;  
 and  
 $w = 0$  for primordial black hole dark matter - stable Planck mass black holes - so  
 that Dark Matter also has density that declines as  $1 / R^3$  as our Universe expands;  
 so that the ratio of their overall average densities must vary with time, or scale  
 factor  $R$  of our Universe, as it expands.  
 Therefore,  
 the above calculated ratio  $0.67 : 0.27 : 0.06$  is valid  
 only for a particular time, or scale factor, of our Universe.

When is that time ? Further, what is the value of the ratio now ?

Since WMAP observes Ordinary Matter at 4% NOW,  
 the time when Ordinary Matter was 6% would be  
 at redshift  $z$  such that  
 $1 / (1+z)^3 = 0.04 / 0.06 = 2/3$ , or  $(1+z)^3 = 1.5$ , or  $1+z = 1.145$ , or  $z = 0.145$ .  
 To translate redshift into time,  
 in billions of years before present, or Gy BP, use this chart

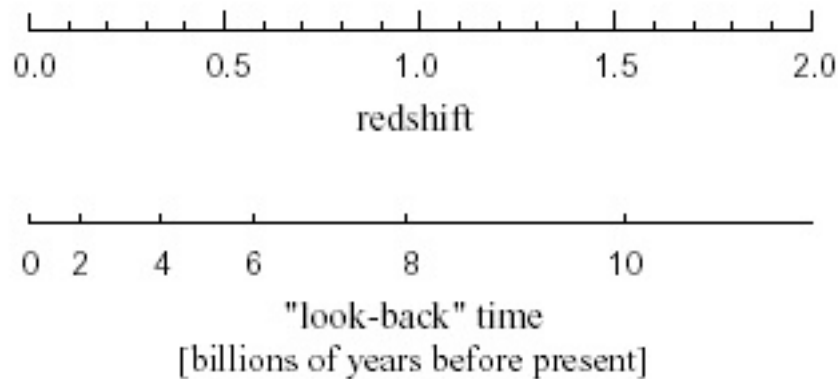

from a [www.supernova.lbl.gov](http://www.supernova.lbl.gov) file SNAPoverview.pdf to see that  
 the time when Ordinary Matter was 6%  
 would have been a bit over 2 billion years ago, or 2 Gy BP.

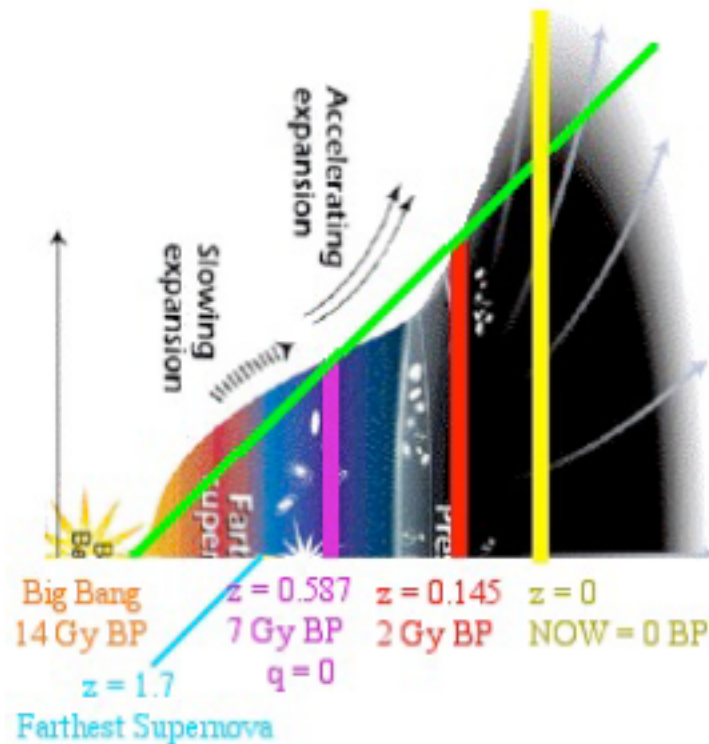

In the diagram, there are four Special Times in the history of our Universe: the Big Bang Beginning of Inflation (about 13.7 Gy BP);

1 - the End of Inflation = Beginning of Decelerating Expansion (beginning of green line also about 13.7 Gy BP);

2 - the End of Deceleration ( $q=0$ ) = Inflection Point = Beginning of Accelerating Expansion (purple vertical line at about  $z = 0.587$  and about 7 Gy BP).

According to a hubblesite web page credited to Ann Feild, the above diagram "... reveals changes in the rate of expansion since the universe's birth 15 billion years ago. The more shallow the curve, the faster the rate of expansion. The curve changes noticeably about 7.5 billion years ago, when objects in the universe began flying apart as a faster rate. ...".

According to a CERN Courier web page: "... Saul Perlmutter, who is head of the Supernova Cosmology Project ... and his team have studied altogether some 80 high red-shift type Ia supernovae. Their results imply that the universe was decelerating for the first half of its existence, and then began accelerating approximately 7 billion years ago. ...".

According to astro-ph/0106051 by Michael S. Turner and Adam G. Riess: "... current supernova data ... favor deceleration at  $z > 0.5$  ... SN 1997ff at  $z = 1.7$  provides direct evidence for an early phase of slowing expansion if the dark energy is a cosmological constant ...".

3 - the Last Intersection of the Accelerating Expansion of our Universe of Linear Expansion (green line) with the Third Intersection (at red vertical line at  $z = 0.145$  and about 2 Gy BP), which is also around the times of the beginning of the Proterozoic Era and Eukaryotic Life, Fe<sub>2</sub>O<sub>3</sub> Hematite ferric iron Red Bed formations, a Snowball Earth, and the start of the Oklo fission reactor. 2 Gy is also about 10 Galactic Years for our Milky Way Galaxy and is on the order of the time for the process of a collision of galaxies.

4 - Now.

Those four Special Times define four Special Epochs:

The Inflation Epoch, beginning with the Big Bang and ending with the End of Inflation. The Inflation Epoch is described by Zizzi Quantum Inflation ending with Self-Decoherence of our Universe ( see gr-qc/0007006 ).

The Decelerating Expansion Epoch, beginning with the Self-Decoherence of our Universe at the End of Inflation. During the Decelerating Expansion Epoch, the Radiation Era is succeeded by the Matter Era, and the Matter Components (Dark and Ordinary) remain more prominent than they would be under the "standard norm" conditions of Linear Expansion.

The Early Accelerating Expansion Epoch, beginning with the End of Deceleration and ending with the Last Intersection of Accelerating Expansion with Linear Expansion. During Accelerating Expansion, the prominence of Matter Components (Dark and Ordinary) declines, reaching the "standard norm" condition of Linear Expansion at the end of the Early Accelerating Expansion Epoch at the Last Intersection with the Line of Linear Expansion.

The Late Accelerating Expansion Epoch, beginning with the Last Intersection of Accelerating Expansion and continuing forever, with New Universe creation happening many times at Many Times. During the Late Accelerating Expansion Epoch, the Cosmological Constant  $\Lambda$  is more prominent than it would be under the "standard norm" conditions of Linear Expansion.

Now happens to be about 2 billion years into the Late Accelerating Expansion Epoch.

What about Dark Energy : Dark Matter : Ordinary Matter now ?

As to how the Dark Energy  $\Lambda$  and Cold Dark Matter terms have evolved during the past 2 Gy, a rough estimate analysis would be:

$\Lambda$  and CDM would be effectively created during expansion in their natural ratio  $67 : 27 = 2.48 = 5 / 2$ , each having proportionate fraction  $5 / 7$  and  $2 / 7$ , respectively; CDM Black Hole decay would be ignored; and pre-existing CDM Black Hole density would decline by the same  $1 / R^3$  factor as Ordinary Matter, from 0.27 to  $0.27 / 1.5 = 0.18$ .

The Ordinary Matter excess  $0.06 - 0.04 = 0.02$  plus the first-order CDM excess  $0.27 - 0.18 = 0.09$  should be summed to get a total first-order excess of  $0.11$ , which in turn should be distributed to the  $\Lambda$  and CDM factors in their natural ratio  $67 : 27$ , producing, for NOW after 2 Gy of expansion:

CDM Black Hole factor =  $0.18 + 0.11 \times 2/7 = 0.18 + 0.03 = 0.21$   
for a total calculated Dark Energy : Dark Matter : Ordinary Matter ratio for now of

$$0.75 : 0.21 : 0.04$$

so that the present ratio of  $0.73 : 0.23 : 0.04$  observed by WMAP seems to me to be substantially consistent with the cosmology of the E8 model.

2013 Planck Data ( arxiv 1303.5062 ) showed "... anomalies ... previously observed in the WMAP data ... alignment between the quadrupole and octopole moments ... asymmetry of power between two ... hemispheres ... Cold Spot ... are now confirmed at ... 3 sigma ... but a higher level of confidence ...".

**E8 model rough evolution calculation is: DE : DM : OM = 75 : 20 : 05**

**WMAP: DE : DM : OM = 73 : 23 : 04**

**Planck: DE : DM : OM = 69 : 26 : 05**

**basic unevolved E8 Conformal calculation: DE : DM : OM = 67 : 27 : 06**

Since uncertainties are substantial, I think that there is reasonable consistency.

## World-Line String Bohm Quantum Theory

In this Physics Model, with Fermions propagating in Spacetime,

**Strings are physically interpreted as World-Lines**, according to David Finkelstein's idea ( "Space-Time Code. III" Phys. Rev. D (1972) 2922-2931 )  
"... According to relativity, the world is a collection of processes (events) with an unexpectedly unified causal or chronological structure. Then an object is secondary ... [to]... a long causal sequence of processes, world line. ... [if] we assemble these ... into chromosomelike code sequences ... and braid and cross-link these strands to make more complex objects and their interactions ...[then]... The idea of the quantum jump comes into its own, and reigns supreme, even over space and time. ...".

Andrew Gray ( quant-ph/9712037v2 ) said:

"... A new formulation of quantum mechanics ... assign[s] ... probabilities ... to entire fine-grained histories ... [It] is fully relativistic and applicable to multi-particle systems ...[and]... makes the same experimental predictions as quantum field theory ... consider space and time cut up into small volume elements

... and then take the limit as ... volume ...  $\rightarrow 0$  ...

get the final amplitude ... by considering all possible distributions at a time  $t$  earlier ...

for each such distribution the amplitude for it to occur [is] multiplied by the amplitude to get ... the final distribution ... **the interference factor ... is a measure of how much interference between the different possible histories that contain the distribution of interest there is at each time** ... This result is the ...

**Feynman amplitude squared times the product of all the interference factors ...**".

Luis E. Ibanez and Angel M. Uranga in "String Theory and Particle Physics" said:

"... String theory proposes ... small one-dimensional extended objects, strings, of typical size  $L_s = 1/M_s$ , with  $M_s$  known as the string scale ...

As a string evolves in time, it sweeps out a two-dimensional surface in spacetime, known as the worldsheet, which is the analog of the ... worldline of a point particle ... for the bosonic string theory ... the classical string action is the total area spanned by the worldsheet ... This is the ... Nambu-Goto action ...".

Consider the Gray Fine-Grained History to be a World-Line String.



**The Gray Fine-Grained History Quantum Theory  
is equivalent to  
the Nambu-Goto action of 26D String Theory.  
Nambu-Goto 24x24 traceless spin-2 particle  
is  
Quantum Bohmion carrier of Bohm Quantum Potential**



Further, Ibanez and Uranga also said:

“... The string groundstate corresponds to a 26d spacetime tachyonic scalar field  $T(x)$ . This **tachyon** ... is ... unstable

...

The massless two-index tensor splits into irreducible representations of  $SO(24)$  ... Its **trace** corresponds to a scalar field, the **dilaton**  $\phi$ , whose vev fixes the string interaction coupling constant  $g_s$

...

the **antisymmetric** part is the 26d 2-form field  $BMN$

...

The **symmetric traceless** part is the 26d graviton  $GMN$  ...”.

Closed string **tachyons** localized at orbifolds of fermions produce virtual clouds of particles / antiparticles that dress fermions.

**Dilatons** are Goldstone bosons of spontaneously broken scale invariance that (analogous to Higgs) go from mediating a long-range scalar gravity-type force to the nonlocality of the Bohm-Sarfatti Quantum Potential.

The **antisymmetric**  $SO(24)$  little group is related to the Monster automorphism group that is the symmetry of each cell of Planck-scale local lattice structure.

Joe Polchinski in “String Theory, Volume 1, An Introduction to the Bosonic String” said: “... we find at  $m^2 = -4/\alpha'$  the tachyon, and at  $m^2 = 0$  the  $24 \times 24$  states of the graviton, dilaton, and antisymmetric tensor ...”.

**Must the  $24 \times 24$  symmetric matrices be interpreted as the graviton ? - !!! NO !!!**

The  $24 \times 24$  Real Symmetric Matrices form the Jordan Algebra  $J(24, \mathbb{R})$ .

Jordan algebras correspond to the matrix algebra of quantum mechanical states, that is, from a particle physics point of view, the configuration of particles in spacetime upon which the gauge groups act.

24-Real-dim space has a natural Octonionic structure of 3-Octonionic-dim space.

The corresponding Jordan Algebra is  $J(3, \mathbb{O}) = 3 \times 3$  Hermitian Octonion matrices.

Their 26-dim traceless part  $J(3, \mathbb{O})_0$  describes the 26-dim of Bosonic String Theory  
and  
the algebra of its Quantum States,  
so that

**the  $24 \times 24$  traceless symmetric spin-2 particle is the Quantum Bohmion.**

Joseph Polchinski, in his books String Theory vols. I and II( Cambridge 1998), says: "... the **closed ... unoriented ... bosonic string ... theory** has the maximal 26-dimensional Poincare invariance ... It is possible to have a consistent theory ...[with]... the **dilaton** ... the **[string-]graviton** ...[and]... the **tachyon** ...[whose]... negative mass-squared means that the no-string 'vacuum' is actually unstable ... "

The **dilaton** of Cl(16) Physics sets the Planck scale as the scale for the 16 dimensions that are orbifolded fermion particles and anti-particles and the 4 dimensions of the CP2 Internal Symmetry Space of M4xCP2 spacetime. The remaining  $26-16-4 = 6$  dimensions are the Conformal Physical Spacetime with  $\text{Spin}(2,4) = \text{SU}(2,2)$  symmetry that produces M4 Physical Spacetime

**Cl(16) Physics 26D String Theory Spacetime**  
**10D = 6D Conformal Spacetime + 4D Compact CP2 Internal Symmetry Space**  
**with CP2 = SU(3) / SU(2)xU(1) as unique Compactification**  
**which specifies Gauge Groups of the Standard Model.**

If Strings = World Lines and World Lines are past and future histories of particles, then **spin-2 string entities carry Bohm Quantum Potential** with Sarfatti Back-Reaction related to Cramer Transaction Quantum Theory.

Roger Penrose in "Road to Reality" (Knopf 2004) says: "... **quantum** mechanics ... alternates between ... **unitary** evolution **U** ... and state reduction **R** ... quantum state **reduction** ... is ... **objective** ... **OR** ... it is always a gravitational phenomenon ... [A] conscious event ... would be ... orchestrated **OR** ... of ... large-scale quantum coherence ... of ... microtubules ...".

**String-Gravity produces Sarfatti-Bohm Quantum Potential with Back-Reaction.**

It is distinct from the MacDowell-Mansouri Gravity of stars and planets.

The **tachyon** produces the instability of a truly empty vacuum state with no strings. It is natural, because if our Universe were ever to be in a state with no strings, then tachyons would create strings = World Lines thus filling our Universe with the particles and World-Lines = strings that we see. Something like this is necessary for particle creation in the Inflationary Era of non-unitary Octonionic processes.

Our construction of a 26D String Theory consistent with Cl(16) Physics uses a structure that is not well-known, so I will mention it here before we start:

There are 7 independent E8 lattices, each corresponding to one of the 7 imaginary octonions denoted by iE8, jE8, kE8, EE8, IE8, JE8, and KE8 and related to both D8 adjoint and half-spinor parts of E8 and with 240 first-shell vertices. An 8th E8 lattice 1E8 with 240 first-shell vertices related to the D8 adjoint part of E8 is related to the 7 octonion imaginary lattices (viXra 1301.0150v2) .

It can act as an effectively independent lattice as part of the basis subsets {1E8,EE8} or {1E8,iE8,jE8,kE8}.

With that in mind, here is the construction:

Step 1:

Consider the 26 Dimensions of Bosonic String Theory as the 26-dimensional traceless part  $J_3(O)_o$

$$\begin{array}{ccc} a & O_+ & O_v \\ O_+^* & b & O_- \\ O_v^* & O_-^* & -a-b \end{array}$$

(where  $O_v$ ,  $O_+$ , and  $O_-$  are in Octonion space with basis  $\{1, i, j, k, E, I, J, K\}$  and  $a$  and  $b$  are real numbers with basis  $\{1\}$ ) of the 27-dimensional Jordan algebra  $J_3(O)$  of  $3 \times 3$  Hermitian Octonion matrices.

Step 2:

Take a D3 brane to correspond to the Imaginary Quaternionic associative subspace spanned by  $\{i, j, k\}$  in the 8-dimensional Octonionic  $O_v$  space.

Step 3:

Compactify the 4-dimensional co-associative subspace spanned by  $\{E, I, J, K\}$  in the Octonionic  $O_v$  space as a  $CP^2 = SU(3)/U(2)$ , with its 4 world-brane scalars corresponding to the 4 covariant components of a Higgs scalar. Add this subspace to D3, to get D7.

Step 4:

Orbifold the 1-dimensional Real subspace spanned by  $\{1\}$  in the Octonionic  $O_v$  space by the discrete multiplicative group  $Z_2 = \{-1, +1\}$ , with its fixed points  $\{-1, +1\}$  corresponding to past and future time. This discretizes time steps and gets rid of the world-brane scalar corresponding to the subspace spanned by  $\{1\}$  in  $O_v$ . It also gives our brane a 2-level timelike structure, so that its past can connect to the future of a preceding brane and its future can connect to the past of a succeeding brane.

Add this subspace to D7, to get D8.

D8, our basic Brane, looks like two layers (past and future) of D7s.

Beyond D8 our String Theory has  $26 - 8 = 18$  dimensions, of which  $25 - 8$  have corresponding world-brane scalars:

- 8 world-brane scalars for Octonionic  $O_+$  space;
- 8 world-brane scalars for Octonionic  $O_-$  space;
- 1 world-brane scalars for real  $a$  space; and
- 1 dimension, for real  $b$  space, in which the D8 branes containing spacelike D3s are stacked in timelike order.

Step 5:

To get rid of the world-brane scalars corresponding to the Octonionic  $O_+$  space, orbifold it by the 16-element discrete multiplicative group

$$\text{Oct16} = \{+/-1, +/-i, +/-j, +/-k, +/-E, +/-I, +/-J, +/-K\}$$

to reduce  $O_+$  to 16 singular points  $\{-1, -i, -j, -k, -E, -I, -J, -K, +1, +i, +j, +k, +E, +I, +J, +K\}$ .

Let the 8  $O_+$  singular points  $\{-1, -i, -j, -k, -E, -I, -J, -K\}$  correspond to the fundamental fermion particles  
{neutrino, red up quark, green up quark, blue up quark,  
electron, red down quark, green down quark, blue down quark}  
located on the past D7 layer of D8.

Let the 8  $O_+$  singular points  $\{+1, +i, +j, +k, +E, +I, +J, +K\}$  correspond to the fundamental fermion particles  
{neutrino, red up quark, green up quark, blue up quark,  
electron, red down quark, green down quark, blue down quark}  
located on the future D7 layer of D8.

The 8 components of the 8 fundamental first-generation fermion particles =  $8 \times 8 = 64$  correspond to the 64 of the 128-dim half-spinor D8 part of E8.

This gets rid of the 8 world-brane scalars corresponding to  $O_+$ , and leaves:

8 world-brane scalars for Octonionic  $O_-$  space;

1 world-brane scalars for real a space; and

1 dimension, for real b space, in which the D8 branes containing spacelike D3s are stacked in timelike order.

Step 6:

To get rid of the world-brane scalars corresponding to the Octonionic  $O_-$  space, orbifold it by the 16-element discrete multiplicative group

$$\text{Oct16} = \{+/-1, +/-i, +/-j, +/-k, +/-E, +/-I, +/-J, +/-K\}$$

to reduce  $O_-$  to 16 singular points  $\{-1, -i, -j, -k, -E, -I, -J, -K, +1, +i, +j, +k, +E, +I, +J, +K\}$ .

Let the 8  $O_-$  singular points  $\{-1, -i, -j, -k, -E, -I, -J, -K\}$  correspond to the fundamental fermion anti-particles {anti-neutrino, red up anti-quark, green up anti-quark, blue up anti-quark, positron, red down anti-quark, green down anti-quark, blue down anti-quark}  
located on the past D7 layer of D8.

Let the 8  $O_-$  singular points  $\{+1, +i, +j, +k, +E, +I, +J, +K\}$  correspond to the fundamental fermion anti-particles {anti-neutrino, red up anti-quark, green up anti-quark, blue up anti-quark, positron, red down anti-quark, green down anti-quark, blue down anti-quark}  
located on the future D7 layer of D8.

The 8 components of 8 fundamental first-generation fermion anti-particles =  $8 \times 8 = 64$  correspond to the 64 of the 128-dim half-spinor D8 part of E8.

This gets rid of the 8 world-brane scalars corresponding to  $O_-$ , and leaves:

1 world-brane scalars for real a space; and

1 dimension, for real b space, in which the D8 branes containing spacelike D3s are stacked in timelike order.

Step 7:

Let the 1 world-brane scalar for real a space correspond to a Bohm-type Quantum Potential acting on strings in the stack of D8 branes.

Interpret strings as world-lines in the Many-Worlds, short strings representing virtual particles and loops.

Step 8:

Fundamentally, physics is described on HyperDiamond Lattice structures.

There are 7 independent E8 lattices, each corresponding to one of the 7 imaginary octonions. denoted by  $iE8$ ,  $jE8$ ,  $kE8$ ,  $EE8$ ,  $IE8$ ,  $JE8$ , and  $KE8$  and related to both D8 adjoint and half-spinor parts of E8 and with 240 first-shell vertices.

An 8th 8-dim lattice  $1E8$  with 240 first-shell vertices related to the E8 adjoint part of E8 is related to the 7 octonion imaginary lattices.

Give each D8 brane structure based on Planck-scale E8 lattices so that each D8 brane is a superposition/intersection/coincidence of the eight E8 lattices.

( see viXra 1301.0150 )

Step 9:

Since Polchinski says "... If  $r$  D-branes coincide ... there are  $r^2$  vectors, forming the adjoint of a  $U(r)$  gauge group ...", make the following assignments:

a gauge boson emanating from D8 from its  $1E8$  and  $EE8$  lattices is a  $U(2)$  ElectroWeak boson thus accounting for the photon and  $W+$ ,  $W-$  and  $Z0$  bosons.

a gauge boson emanating from D8 from its  $IE8$ ,  $JE8$ , and  $KE8$  lattices is a  $U(3)$  Color Gluon boson thus accounting for the 8 Color Force Gluon bosons.

The  $4+8 = 12$  bosons of the Standard Model Electroweak and Color forces correspond to 12 of the 28 dimensions of 28-dim  $Spin(8)$  that corresponds to one of the 28 of the 120-dim adjoint D8 parts of E8.

a gauge boson emanating from D8 from its  $1E8$ ,  $iE8$ ,  $jE8$ , and  $kE8$  lattices is a  $U(2,2)$  boson for conformal  $U(2,2) = Spin(2,4) \times U(1)$  MacDowell-Mansouri gravity plus conformal structures consistent with the Higgs mechanism and with observed Dark Energy, Dark Matter, and Ordinary matter.

The 16-dim  $U(2,2)$  is a subgroup of 28-dim  $Spin(2,6)$  that corresponds to the other 28 of the 120-dim adjoint D8 part of E8.

Step 10:  
Since Polchinski says

"... there will also be  $r^2$  massless scalars from the components normal to the D-brane. ... the collective coordinates ...  $X^u$  ... for the embedding of  $n$  D-branes in spacetime are now enlarged to  $n \times n$  matrices.

This 'noncommutative geometry' ...[may be]... an important hint about the nature of spacetime. ...",

make the following assignment:

The  $8 \times 8$  matrices for the collective coordinates linking a D8 brane to the next D8 brane in the stack are needed to connect the eight  $E_8$  lattices of the D8 brane to the eight  $E_8$  lattices of the next D8 brane in the stack.

The  $8 \times 8 = 64$  correspond to the 64 of the 120 adjoint D8 part of  $E_8$ .

We have now accounted for all the scalars  
and

have shown that the model has the physics content of the realistic  $Cl(16)$  Physics model with Lagrangian structure based on  $E_8 = (28 + 28 + 64) + (64 + 64)$

and

AQFT structure based on  $Cl(1,25)$  with real Clifford Algebra periodicity and generalized Hyperfinite II<sub>1</sub> von Neumann factor algebra.

26D String Theory structure can also be formulated directly in the Root Vector picture using redundancy in the E8 description of Quantum States:

Fermion components carry 8-dim Spacetime information

so  $E8 / D8 = 8 \times 8 + 8 \times 8$  can be reduced to 8+8

Spacetime position and momentum are redundant

so  $D8 / D4 \times D4 = 8 \times 8$  can be reduced to 8

Gauge Bosons and Ghosts are redundant

so  $D4 \times D4 = 28+28$  can be reduced to  $28 = 16$  for Gravity + 12 for Standard Model

Elimination of Redundancy gives  $8+8 + 8 + 28 = 52$ -dim F4 with 48 Root Vectors forming a 24-cell plus its dual

52-dim F4 has 26-dim smallest non-trivial representation which has structure of

$J(3,O)_o =$  traceless part of 27-dim exceptional Jordan Algebra  $J(3,O)$  and is

the minimal structure containing the basic information of Cl(16) Physics.

so

Cl(16) Physics Quantum Theory can be formulated in terms of 26-dim  $J(3,O)_o$ .

The Cl(1,25) E8 AQFT inherits structure from the Cl(1,25) E8 Local Lagrangian

$$\int_{8\text{-dim SpaceTime}} \text{Gauge Gravity} + \text{Standard Model} + \text{Fermion Particle-AntiParticle}$$

whereby World-Lines of Particles are represented by Strings moving in a space whose dimensionality includes  $8v = 8$ -dim SpaceTime Dimensions +  $8s+ = 8$  Fermion Particle Types +  $8s- = 8$  Fermion AntiParticle Types combined in the traceless part  $J(3,O)_o$  of the 3x3 Octonion Hermitian Jordan Algebra

a	$8s+$	$8v$
$8s+^*$	b	$8s-$
$8v^*$	$8s-^*$	-a-b

which has total dimension  $8v + 8s+ + 8s- + 2 = 26$  and is the space of a 26D String Theory with Strings seen as World-Lines.

$24 = 8v + 8s+ + 8s-$  of the 26 dimensions of 26D String Theory correspond to  $24 \times 8 = 192$  of the 240 E8 Root Vectors by representing the  $8v + 8s+ + 8s-$  as superpositions of their respective 8 components

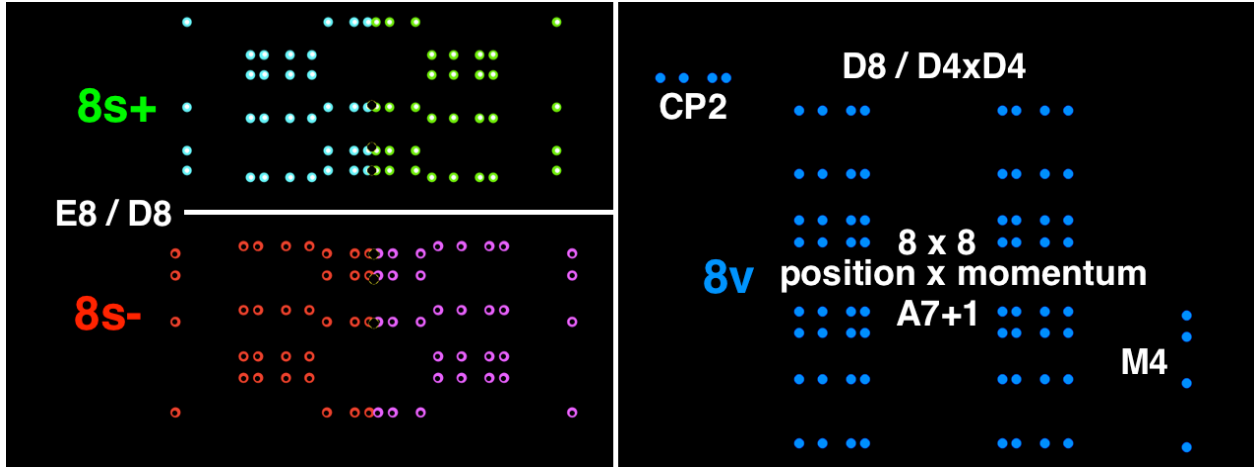

8v SpaceTime is represented by D8 branes. A D8 brane has Planck-Scale Lattice Structure superpositions of 8 types of E8 Lattice denoted by 1E8, iE8, jE8, kE8, EE8, IE8, JE8, KE8

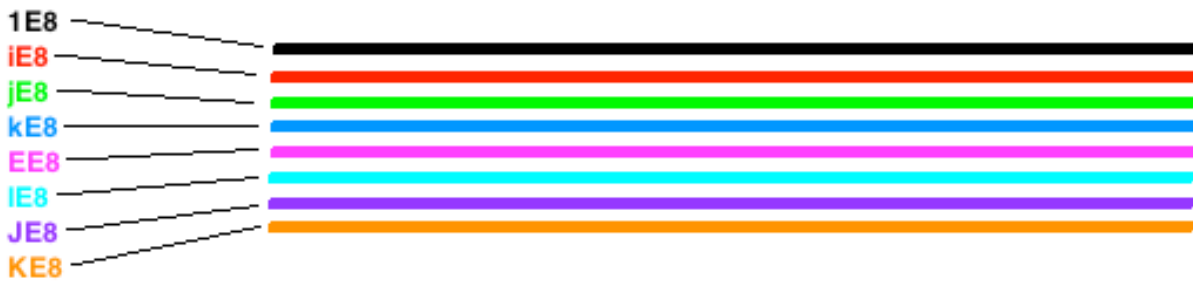

A single Snapshot of SpaceTime is represented by a D8 brane at each point of which is placed Fermion Particles or AntiParticles represented by 8+8 = 16 orbifolded dimensions of the 26 dimensions of 26D String Theory.

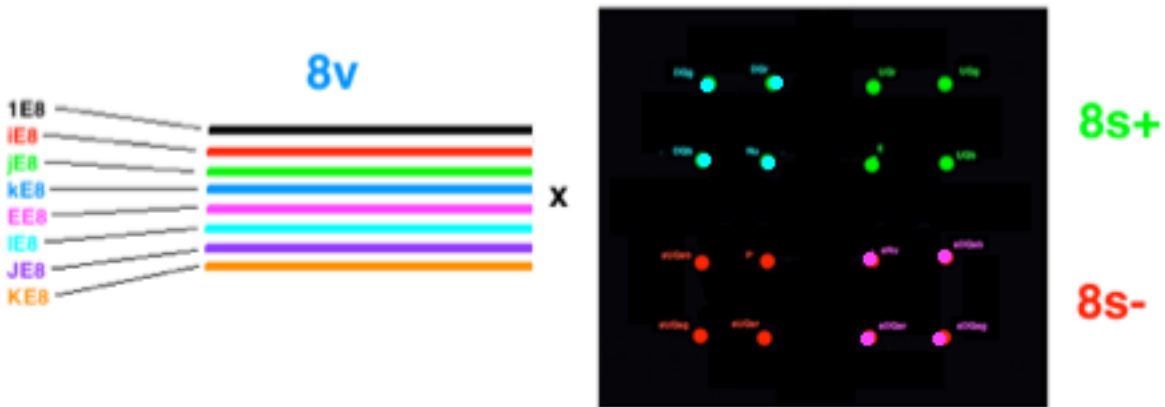



It is necessary to patch together SpaceTime Snapshots to form a Global Structure describing a Many-Worlds Global Algebraic Quantum Field Theory (AQFT) whose structure is described by Deutsch in "The Fabric of Reality" (Penguin 1997 pp. 276-283): "... there is no fundamental demarcation between snapshots of other times and snapshots of other universes ... Other times are just special cases of other universes ... Suppose ... we toss a coin ... Each point in the diagram represents one snapshot ... in the multiverse there are far too many snapshots for clock readings alone to locate a snapshot relative to the others. To do that, we need to consider the intricate detail of which snapshots determine which others. ...

in some regions of the multiverse, and in some places in space, the snapshots of some physical objects do fall, for a period, into chains, each of whose members determines all the others to a good approximation ...".

**The Many-Worlds Snapshots are structured as a 26-dim Lorentz Leech Lattice** of 26D String Theory parameterized by the a and b of  $J(3,0)_0$  as indicated in this 64-element subset of Snapshots

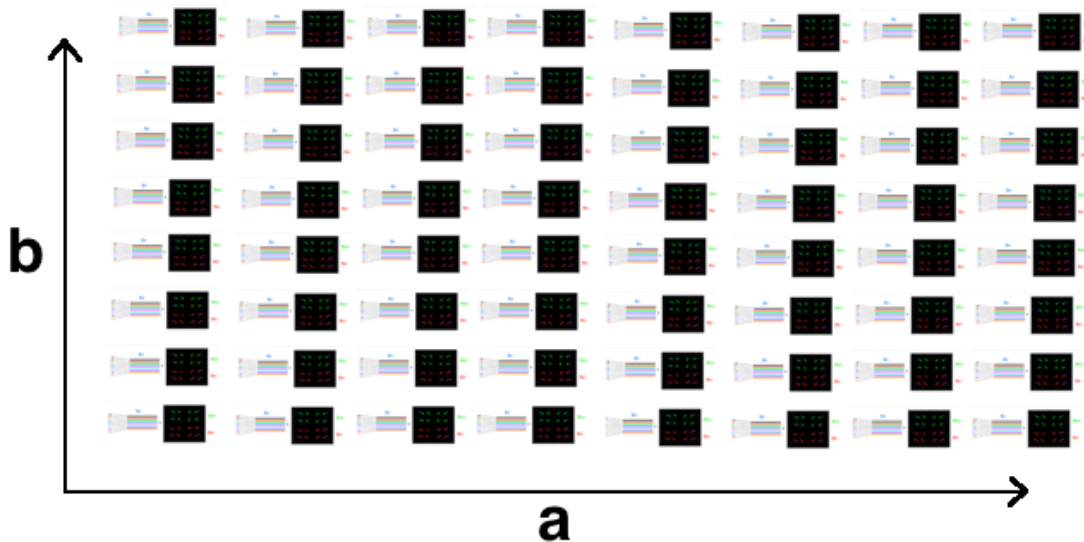

The  $240 - 192 = 48 = 24+24$  Root Vector Vertices of  $E_8$  that do not represent the 8-dim D8 brane or the  $8+8 = 16$  dim of Orbifolds for Fermions do represent the **Gauge Bosons (and their Ghosts) of  $Cl(16)$  Physics:**

Gauge Bosons from  $1E_8, iE_8, jE_8,$  and  $kE_8$  parts of a D8 give  **$U(2,2)$  Conformal Gravity**

Gauge Bosons from  $EE_8$  part of a D8 give  **$U(2)$  Electroweak Force**

Gauge Bosons from  $IE_8, JE_8,$  and  $KE_8$  parts of a D8 give  **$SU(3)$  Color Force**



Each Deutsch chain of determination represents a World-Line of Particles / AntiParticles corresponding to a String of 26D String Theory such as the red line in this 64-element subset of Snapshots

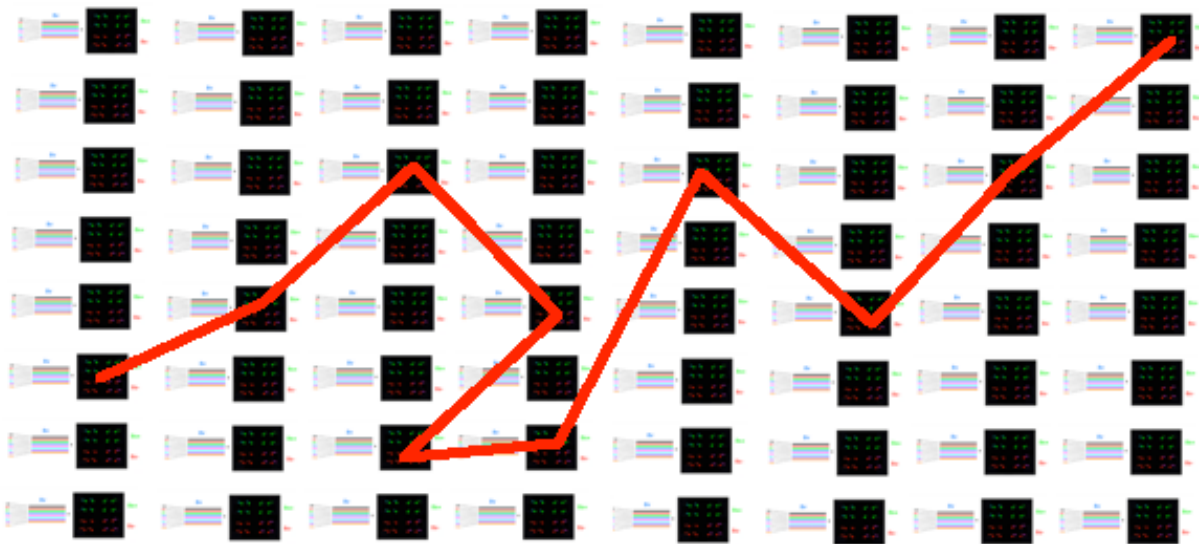

**26D String Theory is the Theory of Interactions of Strings = World-Lines.**

**Interactions of World-Lines can describe Quantum Theory**

according to Andrew Gray ( arXiv quant-ph/9712037 ): "... probabilities are ... assigned to entire fine-grained histories ... base[d] ... on the Feynman path integral formulation ...

The formulation is fully relativistic and applicable to multi-particle systems.

It ... makes the same experimental predictions as quantum field theory ...".

Green, Schwarz, and Witten say in their book "Superstring Theory" vol. 1 (Cambridge 1986)

"... For the ... closed ... bosonic string [ **26D String Theory** ] .... The first excited level ... consists of ... the ground state ... tachyon ... and ... a scalar ... 'dilaton' ... and ...

SO(24) ... little group of a ...[26-dim]... massless particle ... and ...

**a ... massless ... spin two state ...".**

Closed string tachyons localized at orbifolds of fermions produce virtual clouds of particles / antiparticles that dress fermions.

Dilatons are Goldstone bosons of spontaneously broken scale invariance that (analogous to Higgs) go from mediating a long-range scalar gravity-type force to the nonlocality of the Bohm-Sarfatti Quantum Potential.

The SO(24) little group is related to the Monster automorphism group that is the symmetry of each cell of Planck-scale local lattice structure.

**The massless spin 2 state = Bohmion = Carrier of the Bohm Force of the Bohm Quantum Potential.**

Roderick Sutherland (arXiv 1509.02442) gave a Lagrangian for the Bohm Potential saying: "... This paper focuses on interpretations of QM in which the underlying reality is taken to consist of particles have definite trajectories at all times ... An example ... is the Bohm model ... This paper ... provid[es]... a Lagrangian ...[for]... the unfolding events ... ... describing more than one particle while maintaining a relativistic description requires the introduction of final boundary conditions as well as initial, thereby entailing retrocausality ...

In addition ... the Lagrangian approach pursued here to describe particle trajectories also entails the natural inclusion of an accompanying field to influence the particle's motion away from classical mechanics and reproduce the correct quantum predictions. In so doing, it is ... providing a physical explanation for why quantum phenomena exist at all ... the particle is seen to be

the source of a field which alters the particle's trajectory via self-interaction ...

The Dirac case ... each particle in an entangled many-particle state will be described by an individual Lagrangian density ... of the form:

$$\mathcal{L} = \text{Re} \left[ \frac{1}{\langle f|i \rangle} \left( -i\bar{\Psi}_f \gamma^\alpha \partial_\alpha \Psi_i + m\bar{\Psi}_f \Psi_i \right) \right] \mp \sigma_0 \rho_0 \left| \mathbf{u}_\alpha \mathbf{u}^\alpha \right|^{1/2} + \sigma_0 \mathbf{u}_\alpha \mathbf{j}^\alpha$$

... the ...[first]... term ...[is]... the ... Lagrangian densities for the PSI field alone ...

... sigma\_o is the rest density distribution of the particle through space ... j is the current density ...

... rho\_o and u are the rest density and 4-velocity of the probability flow ...".

Jack Sarfatti extended the Sutherland Lagrangian to include Back-Reaction entanglement.

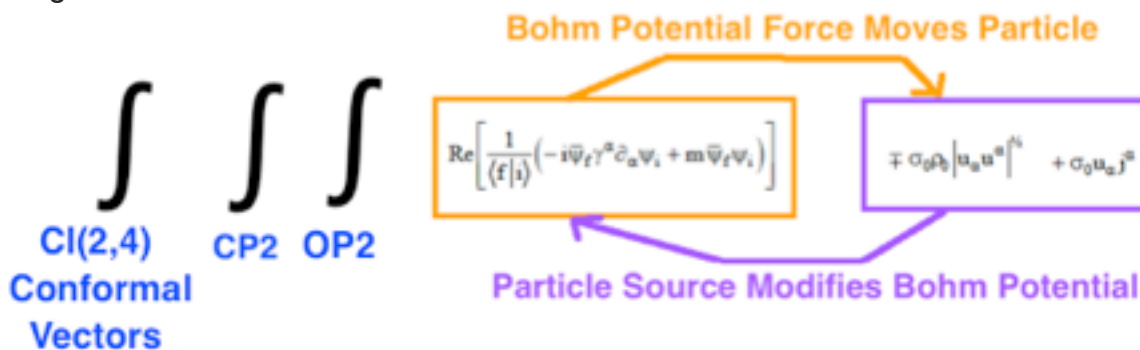

where a, b and VM4 form CI(2,4) vectors and VCP2 forms CP2 and S+ and S- form OP2 so that

26D = 16D orbifolded fermions + 10D and 10D = 6D Conformal Space + 4D CP2 ISS (ISS = Internal Symmetry Space and 6D Conformal contains 4D M4 of Kaluza-Klein M4xCP2)

saying (linkedin.com Pulse 13 January 2016): "... the reason entanglement cannot be used as a direct messaging channel between subsystems of an entangled complex quantum system, is the lack of direct back-reaction of the classical particles and classical local gauge fields on their shared entangled Bohmian quantum information pilot wave ... Roderick. I. Sutherland ... using Lagrangian field theory, shows how to make the original 1952 Bohm pilot-wave theory completely relativistic,

and how to avoid the need for configuration space for many-particle entanglement.

The trick is that final boundary conditions on the action

as well as initial boundary conditions influence what happens in the present.

The general theory is "post-quantum" ... and it is non-statistical ...

There is complete two-way action-reaction between quantum pilot waves

and the classical particles and classical local gauge fields ...

orthodox statistical quantum theory, with no-signaling ...[is derived]... in two steps,

first arbitrarily set the back-reaction (of particles and classical gauge field on their pilot

waves) to zero. This is analogous to setting the curvature equal to zero in general

relativity, or more precisely in setting  $G$  to zero.

Second, integrate out the final boundary information, thereby adding the statistical Born

rule to the mix. ...

the mathematical condition for zero post-quantum back-reaction of particles and

classical fields (aka "beables" J.S. Bell's term) is exactly de Broglie's guidance

constraint. That is, in the simplest case, the classical particle velocity is proportional to

the gradient of the phase of the quantum pilot wave. It is for this reason, that the

independent existence of the classical beables can be ignored in most quantum

calculations.

However, orthodox quantum theory assumes that the quantum system is

thermodynamically closed between strong von Neumann projection measurements that

obey the Born probability rule.

The new post-quantum theory in the equations of Sutherland, prior to taking the limit of

orthodox quantum theory, should apply to pumped open dissipative structures. Living

matter is the prime example. This is a clue that should not be ignored. ...".

Jack Sarfatti (email 31 January 2016) said: "... Sabine [Hossenfelder]'s argument ...

"... two types of fundamental laws ... appear in contemporary theories.

One type is deterministic, which means that the past entirely predicts the future.

There is no free will in such a fundamental law because there is no freedom.

The other type of law we know appears in quantum mechanics and has an

indeterministic component which is random. This randomness cannot be influenced by

anything, and in particular it cannot be influenced by you, whatever you think "you" are.

There is no free will in such a fundamental law because there is no "will" - there is just

some randomness sprinkled over the determinism.

In neither case do you have free will in any meaningful way."

... However ...[ There is a Third Way ]...

post-quantum theory with action-reaction between

quantum information pilot wave and its be-able is compatible with free will. ...".

**The Creation-Annihilation Operator structure of the Bohm Quantum Potential of 26D String Theory** is given by the

Maximal Contraction of  $E_8$  = semidirect product  $A_7 \times h_{92}$   
 where  $h_{92} = 92+1+92 = 185$ -dim Heisenberg algebra and  $A_7 = 63$ -dim  $SL(8)$

The Maximal  $E_8$  Contraction  $A_7 \times h_{92}$  can be written as a 5-Graded Lie Algebra

$$28 + 64 + (SL(8,R) + 1) + 64 + 28$$

$$\text{Central Even Grade } 0 = SL(8,R) + 1$$

The 1 is a scalar and  $SL(8,R) = Spin(8) + \text{Traceless Symmetric } 8 \times 8 \text{ Matrices}$ ,  
 so  $SL(8,R)$  represents a local 8-dim SpaceTime in Polar Coordinates.

$$\text{Odd Grades } -1 \text{ and } +1 = 64 + 64$$

Each =  $64 = 8 \times 8 = \text{Creation/Annihilation Operators for 8 components of 8 Fundamental Fermions}$ .

$$\text{Even Grades } -2 \text{ and } +2 = 28 + 28$$

Each = Creation/Annihilation Operators for 28 Gauge Bosons of Gravity + Standard Model.

The  $8 \times 8$  matrices linking one  $D_8$  to the next  $D_8$  of a World-Line String  
 give  $A_7 \times R = U(8)$  representing **Position x Momentum**

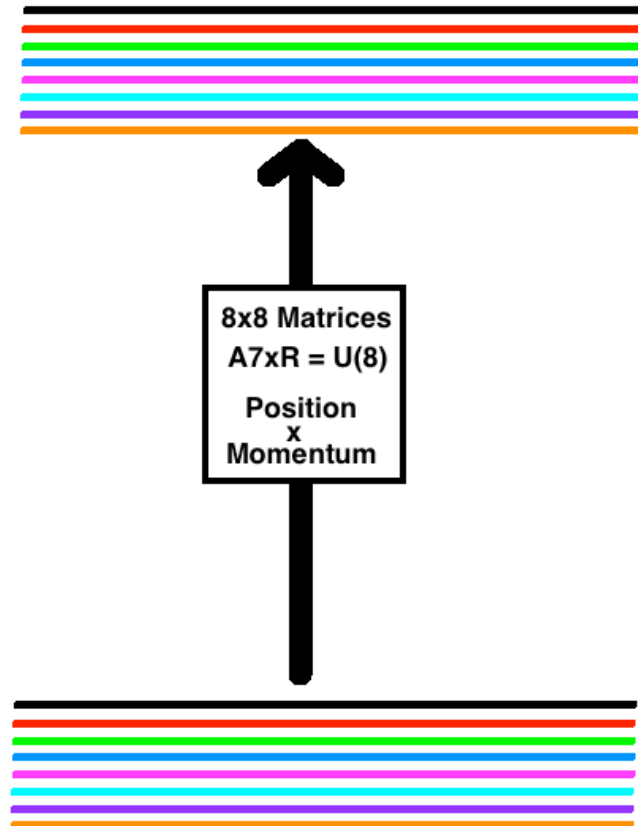

The Algebraic Quantum Field Theory ( AQFT ) structure of the Bohm Quantum Potential of 26D String Theory is given by the Cl(16) Physics Local Lagrangian

$$\int_{8\text{-dim SpaceTime}} \text{Gauge Gravity} + \text{Standard Model} + \text{Fermion Particle-AntiParticle}$$

and by 8-Periodicity of Real Clifford Algebras,  
as the **Completion of the Union of all Tensor Products of the form**

$$\text{Cl}(1,25) \times \dots (\text{N times tensor product}) \dots \times \text{Cl}(1,25)$$

which is analogous to Fock Space Hyperfinite II1 von Neumann factor algebra that is based on 2-Periodicity of Complex Clifford Algebras.

For  $N = 2^8 = 256$  the copies of Cl(1,25) are on the 256 vertices of the 8-dim HyperCube



For  $N = 2^{16} = 65,536 = 4^8$  the copies of Cl(1,25) fill in the 8-dim HyperCube as described by William Gilbert's web page: "... The n-bit reflected binary Gray code will describe a path on the edges of an n-dimensional cube that can be used as the initial stage of a Hilbert curve that will fill an n-dimensional cube. ...".

The vertices of the Hilbert curve are at the centers of the  $2^8$  sub-8-HyperCubes whose edge lengths are 1/2 of the edge lengths of the original 8-dim HyperCube

**As N grows**, the copies of Cl(1,25) continue to fill the 8-dim HyperCube of E8 SpaceTime

using higher Hilbert curve stages from the 8-bit reflected binary Gray code subdividing the initial 8-dim HyperCube into more and more sub-HyperCubes.

If edges of sub-HyperCubes, equal to the distance between adjacent copies of Cl(1,25), remain constantly at the Planck Length, then the

**full 8-dim HyperCube of our Universe expands as N grows to  $2^{16}$  and beyond**

similarly to the way shown by this 3-HyperCube example for  $N = 2^3, 4^3, 8^3$

from William Gilbert's web page:

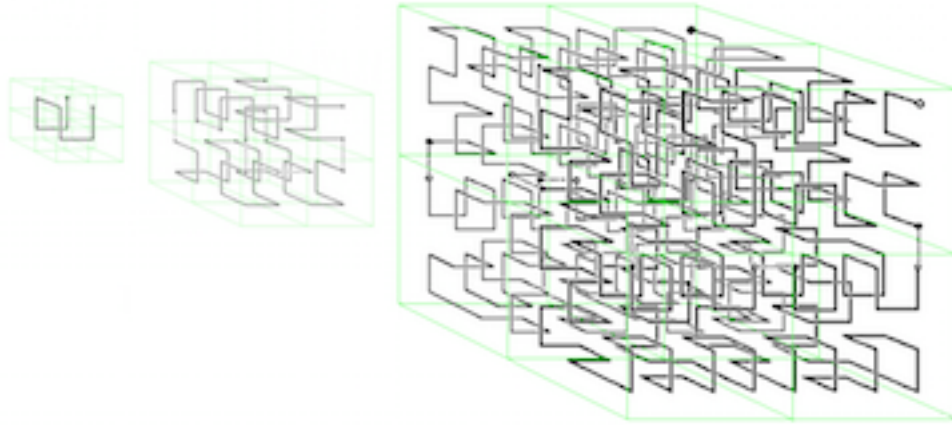

The Union of all  $Cl(1,25)$  tensor products is  
 the Union of all subdivided 8-HyperCubes  
 and  
 their Completion is a huge superposition of 8-HyperCube Continuous Volumes  
 which Completion belongs to the Third Grothendieck Universe.

26D String Theory Structure is

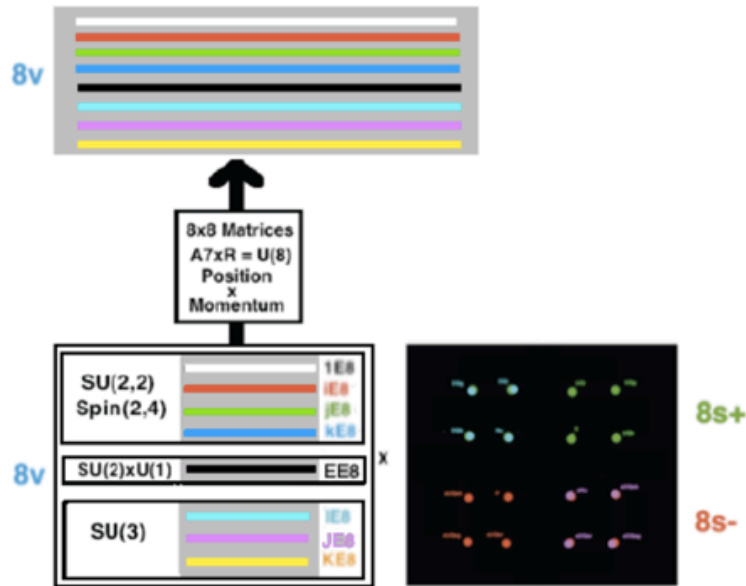

Green, Schwartz, and Witten, in "Superstring Theory" vol. 1, describe 26D String Theory saying "... The first excited level ... consists of ...

the ground state ... **tachyon** ...

and ... a scalar ... **'dilaton'** ...

and ... **SO(24)** ... **little group of a ...[26-dim]... massless particle** ...

and ... a ... **massless ... spin two state** ...".

Tachyons localized at orbifolds of fermions produce virtual clouds of particles / antiparticles that dress fermions by filling their Schwinger Source regions.

Dilatons are Goldstone bosons of spontaneously broken scale invariance that (analogous to Higgs) go from mediating a long-range scalar gravity-type force to the nonlocality of the Bohm-Sarfatti Quantum Potential.

The SO(24) little group is related to the Monster automorphism group that is the symmetry of each cell of Planck-scale local lattice structure.

**The massless spin 2 state = Bohmion = Carrier of the Bohm Force of the Bohm Quantum Potential.**

**Similarity of the spin 2 Bohmion to the spin 2 Graviton accounts for the Bohmion's ability to support Penrose Consciousness with Superposition Separation Energy Difference  $G m^2 / a$**

where, for a Human Brain,  $m$  = mass of electron and  $a$  = 1 nanometer in Tubulin Dimer

**"... Bohm's Quantum Potential can be viewed as an internal energy of a quantum system ..."**

according to Dennis, de Gosson, and Hiley ( arXiv 1412.5133 )

and

**Bohm Quantum Potential inherits Sarfatti Back-Reaction from its spin-2 structure similar to General Relativity**

Peter R. Holland says in "The Quantum Theory of Motion" (Cambridge 1993):

"... the total force ... from the quantum potential ... does not ... fall off with distance ... because ... the quantum potential ... depends on the form of ...[the quantum state]... rather than ... its ... magnitude ...".

**Penrose-Hameroff-type Quantum Consciousness is due to Resonant Quantum Potential Connections among Quantum State Forms.**

The Quantum State Form of a Conscious Brain is determined by the configuration of a subset of its  $10^{18}$  to  $10^{19}$  Tubulin Dimers described by a large Real Clifford Algebra.

Paola Zizzi in gr-qc/0007006 describes the Octonionic Inflation Era of Our Universe as a Quantum Consciousness Superposition of States ending with Self-Decoherence after 64 doublings of Octonionic Inflation, at which time Our Universe is

"... a superposed state of quantum ... [ qubits ].

the self-reduction of the superposed quantum state is ... reached at the end of inflation ...[at]... the decoherence time ... [ Tdecoh =  $10^9$  Tplanck =  $10^{(-34)}$  sec ] ... and corresponds to a superposed state of ... [  $10^{19} = 2^{64}$  qubits ]. ...".

64 doublings to  $2^{64}$  qubits corresponds to the Clifford algebra

$$Cl(64) = Cl(8 \times 8) = Cl(8) \times Cl(8) \times Cl(8) \times Cl(8) \times Cl(8) \times Cl(8) \times Cl(8) \times Cl(8)$$

By the periodicity-8 theorem of Real Clifford algebras, Cl(64) is the smallest Real Clifford algebra for which we can reflexively identify each component Cl(8)

with a basis vector in the Cl(8) vector space.

This reflexive identification causes our universe to decohere at  $N = 2^{64} = 10^{19}$ .



Octonionic Quantum Processes are Not Unitary and so can produce Fermions.

(see Stephen Adler's book "Quaternionic Quantum Mechanics ..." at pages 50-52 and 561).

At the end of 64 Unfoldings, Non-Unitary Octonionic Inflation ended having produced about  $(1/2) 16^{64} = (1/2) (2^4)^{64} = 2^{255} = 6 \times 10^{76}$  Fermions.

At the End of Inflation Our Universe had Temperature / Energy  $10^{27} \text{ K} = 10^{14} \text{ GeV}$  so each of the  $10^{77}$  Fermions had energy of  $10^{14} \text{ GeV}$  and collisions among them would for each of the  $10^{77}$  Fermions produce jets containing about  $10^{12}$  particles of energy 100 GeV or so so that the total number created by Inflation was about  $10^{89}$ .

The End of Inflation time was at about  $10^{(-34)} \text{ sec} = 2^{64} \text{ Tplanck}$  and

the size of our Universe was then about  $10^{(-24)} \text{ cm}$

which is about the size of a Fermion Schwinger Source Kerr-Newman Cloud.

The  $2^{64}$  qubits created by Inflation is roughly  $10^{19}$  which is roughly the number of Quantum Consciousness Tubulins in the Human Brain.

Therefore

**the Human Brain Quantum Consciousness has evolved in Our Universe to be roughly equivalent to the Maximum Consciousness of Our Inflationary Era Universe.**

Further,

each cell of E8 Lagrangian Spacetime corresponds to 65,536-dim  $Cl(16)$  which contains 248-dim E8 = 120-dim D8 bivectors + 128-dim D8 half-spinors Human Brain Microtubules 40 microns long have 65,536 Tubulin Dimers



( image adapted from 12biophys.blogspot.com Lecture 11 )

and so

can have Bohm Quantum Resonance with  $Cl(16)$  Spacetime cells so that at any and all Times

the State of Consciousness of a Human is in exact resonant correspondence with a subset of the cells of E8 Classical Lagrangian Spacetime

Therefore

**E8 Lagrangian Spacetime (as a Nambu-Jona-Lasinio Condensate) is effectively the Spirit World**

**in which the Human States of Consciousness = Souls exist.**

After the death of the Human Physical Body the Spirit World interactions with its Soul are no longer constrained by Physical World interactions with its Body so that the Spirit World can harmonize the individual Soul with the collective Universal Soul.

**A Single Cell of E8 26-dimensional Bosonic String Theory,  
in which Strings are physically interpreted as World-Lines,  
can be described by taking the quotient of its 24-dimensional O+, O-, Ov  
subspace modulo the 24-dimensional Leech lattice.  
Its automorphism group is the largest finite sporadic group, the Monster Group,  
whose order is  
8080, 17424, 79451, 28758, 86459, 90496, 17107, 57005, 75436, 80000, 00000 =  
= 2^46 .3^20 .5^9 .7^6 .11^2 .13^3 .17.19.23.29.31.41.47.59.71  
or about 8 x 10^53.**

“... Bohm’s Quantum Potential can be viewed as an internal energy of a quantum system ...” according to Dennis, de Gosson, and Hiley ( arXiv 1412.5133 ) and Peter R. Holland says in "The Quantum Theory of Motion" (Cambridge 1993): "... the total force ... from the quantum potential ... does not ... fall off with distance ... because ... the quantum potential ... depends on the form of ...[the quantum state]... rather than ... its ... magnitude ...".

**Penrose-Hameroff-type Quantum Consciousness is due  
to Resonant Quantum Potential Connections among Quantum State Forms.**

The Quantum State Form of a Conscious Brain is determined by  
the configuration of a subset of its 10^18 to 10^19 Tubulin Dimers  
with math description in terms of a large Real Clifford Algebra:

Resonance is discussed by Carver Mead in “Collective Electrodynamics“ ( MIT 2000 ):  
"... we can build ... a resonator from ... electric dipole ... configuration[s] ...



[ such as Tubulin Dimers ]

Because there are charges at the two ends of the dipole, we can have a contribution to the electric coupling from the scalar potential ... as well [as] from the magnetic coupling ... from the vector potential ... electric dipole coupling is stronger than magnetic dipole coupling ... the coupling of ... two ... configurations ... is the same, whether retarded or advanced potentials are used. Any ... configuration ... couples to any other on its light cone, whether past or future. ... The total phase accumulation in a ... configuration ... is the sum of that due to its own current, and that due to currents in other ... configurations ... far away ...

The energy in a single resonator alternates between the kinetic energy of the electrons (inductance), and the potential energy of the electrons (capacitance). With the two resonators coupled, the energy shifts back and forth between the two resonators in such a way that the total energy is constant ... The conservation of energy holds despite an arbitrary separation between the resonators ... Instead of scaling linearly with the number of charges that take part in the motion, the momentum of a collective system scales as the square of the number of charges! ... The inertia of a collective system, however, is a manifestation of the interaction, and cannot be assigned to the elements separately. ... Thus, it is clear that collective quantum systems do not have a classical correspondence limit. ...”.

**For the  $10^{18}$  Tubulin Dimers of the human brain,**  
the resonant frequencies are the same and exchanges of energy among them  
act to keep them **locked in a Quantum Protectorate collective coherent state.**

Philip W. Anderson in cond-mat/0007287 and cond-mat/007185 said:

"... Laughlin and Pines have introduced the term "Quantum protectorate" as a general descriptor of the fact that certain states of quantum many-body systems exhibit properties which are unaffected by imperfections, impurities and thermal fluctuations. They instance ... flux quantization in superconductors, equivalent to the Josephson frequency relation which again has mensuration accuracy and is independent of imperfections and scattering. ...

... the source of quantum protection is a collective state of the quantum field involved such that the individual particles are sufficiently tightly coupled that elementary excitations no longer involve a few particles but are collective excitations of the whole system, and therefore, macroscopic behavior is mostly determined by overall conservation laws ... a "quantum protectorate" ... [ is ]... a state in which the manybody correlations are so strong that the dynamics can no longer be described in terms of individual particles, and therefore perturbations which scatter individual particles are not effective ...".

Mershin, Sanabria, Miller, Nawarathna, Skoulakis, Mavromatos, Kolomenskii, Scheussler, Ludena, and Nanopoulos in physics/0505080 "Towards Experimental Tests of Quantum Effects in Cytoskeletal Proteins" said:



Classically, the various dimers can only be in the ... [ ]... conformations. Each dimer is influenced by the neighboring dimers resulting in the possibility of a transition. This is the basis for classical information processing, which constitutes the picture of a (classical) cellular automaton.

If we assume ... that each dimer can find itself in a QM superposition of ... [ those ]... states, a quantum nature results. Tubulin can then be viewed as a typical two-state quantum mechanical system, where the dimers couple to conformational changes with  $10^{(-9)} - 10^{(-11)}$  sec transitions, corresponding to an angular frequency  $\sim 10^{10} - 10^{12}$  Hz. In this approximation, the upper bound of this frequency range is assumed to represent (in order of magnitude) the characteristic frequency of the dimers, viewed as a two-state quantum-mechanical system ... [

The Energy Gap of our Universe as superconductor condensate spacetime is from  $3 \times 10^{(-18)}$  Hz (radius of universe) to  $3 \times 10^{43}$  Hz (Planck length). Its RMS amplitude is  $10^{13}$  Hz = 10 THz = energy of neutrino masses = critical temperature  $T_c$  of BSCCO superconducting crystal Josephson Junctions ]... large-scale quantum coherence ... [ has been observed ]... at temperatures within a factor of three of biological temperatures. MRI magnets contain hundreds of miles of superconducting wire and routinely carry a persistent current. There is no distance limit - the macroscopic wave function of the superfluid condensate of electron pairs, or Cooper pairs, in a sufficiently long cable could maintain its quantum phase coherence for many thousands of miles ... there is no limit to the total mass of the electrons participating in the superfluid state. The condensate is "protected" from thermal fluctuations by the BCS energy gap at the Fermi surface ... The term "quantum protectorate" ... describe[s] this and related many-body systems ...".

The Human Brain has about  $10^{11}$  Neuron cells, each about 1,000 nm in size.  
 The cytoskeleton of cells, including neurons of the brain, is made up of Microtubules

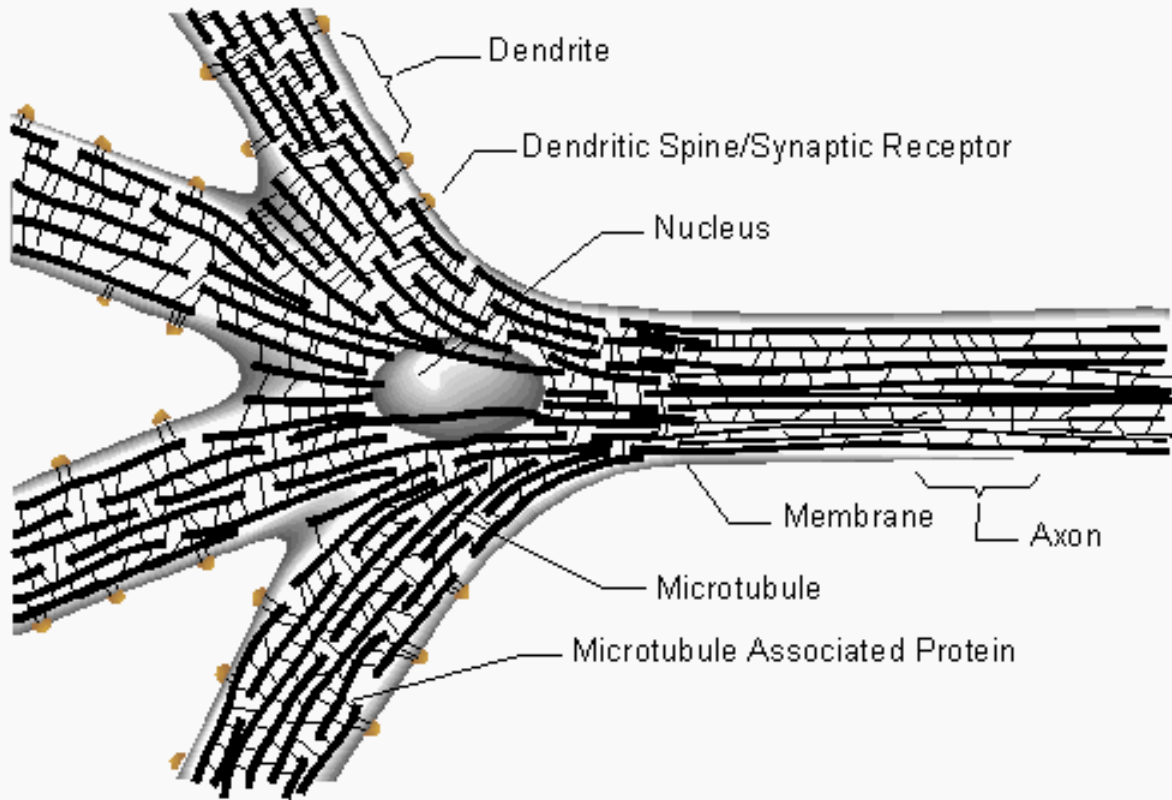

( image from "Orchestrated Objective Reduction of Quantum Coherence in Brain Microtubules: The "Orch OR" Model for Consciousness" by Penrose and Hameroff )

Each Neuron contains about  $10^9$  Tubulin Dimers, organized into Microtubules some of which are organized by a Centrosome. Centrosomes contain a pair of Centrioles.

A Centriole is about 200 nm wide and 400 nm long. Its wall is made up of 9 groups of 3 Microtubules, reflecting the symmetry of 27-dim  $J(3,0)$

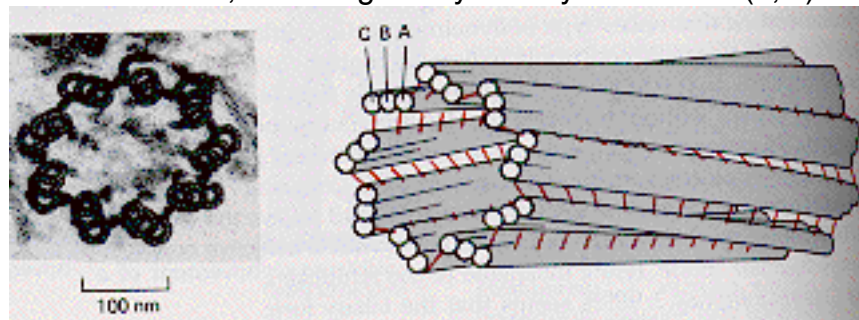

Each Microtubule is a hollow cylindrical tube with about 25 nm outside diameter and 14 nm inside diameter, made up of 13 columns of Tubulin Dimers

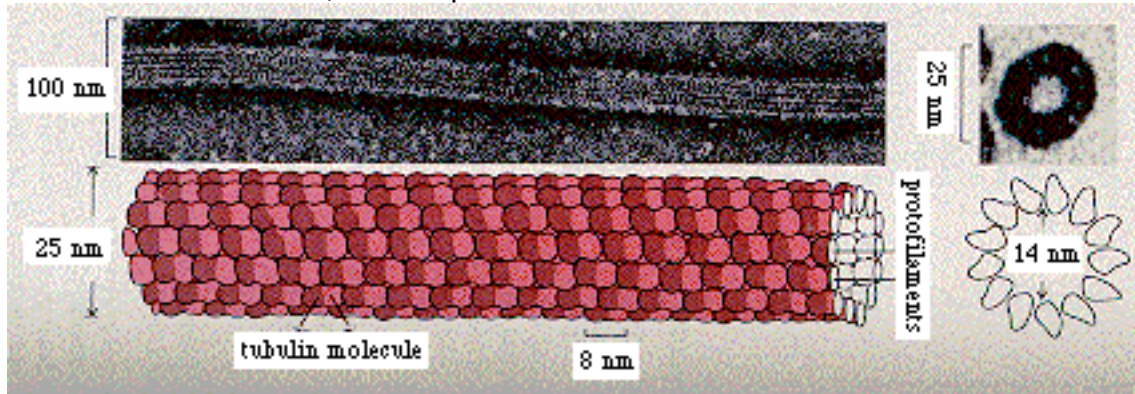

( illustrations and information about cells, microtubules, and centrioles are from Molecular Biology of the Cell, 2nd ed, by Alberts, Bray, Lewis, Raff, Roberts, and Watson (Garland 1989) )

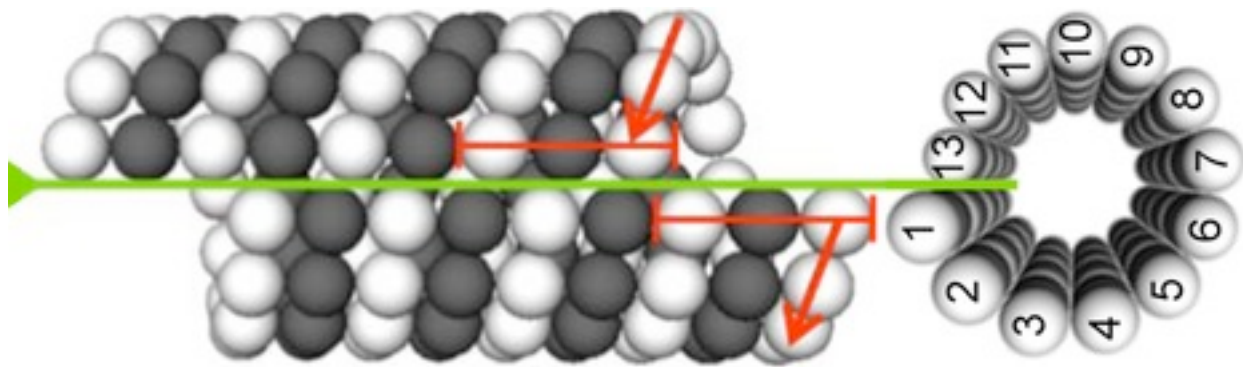

( image from Wikipedia on Microtubule )

Each Tubulin Dimer is about 8 nm x 4 nm x 4 nm, consists of two parts, alpha-tubulin and beta-tubulin ( each made up of about 450 Amino Acids, each containing roughly 20 Atoms )  
 A Microtubule 40 microns = 40,000 nm long contains  $13 \times 40,000 / 8 = 65,000$  Dimers



( images adapted from [nonlocal.com/hbar/microtubules.html](http://nonlocal.com/hbar/microtubules.html) by Rhett Savage )

The black dots indicate the position of the Conformation Electrons.

There are two energetically distinct configurations for the Tubulin Dimers:

Conformation Electrons Similarly Aligned (left image) - State 0

Conformation Electrons Maximally Separated (right image) - State 1

The two structures - State 0 ground state and State 1 higher energy state - make Tubulin Dimers the basis for a Microtubule binary math / code system.

**Microtubule binary math / code system corresponds  
to Clifford Algebras  $Cl(8)$  and  $Cl(8) \times Cl(8) = Cl(16)$   
containing 16-dim  $V_{16}$  (magenta) and  
120 (inside purple outline) + 128-dim (yellow green red) = 248-dim  $E_8$  and  
560 (inside black outline) 10 copies of 56-dim  $Fr_3(O)$ :**

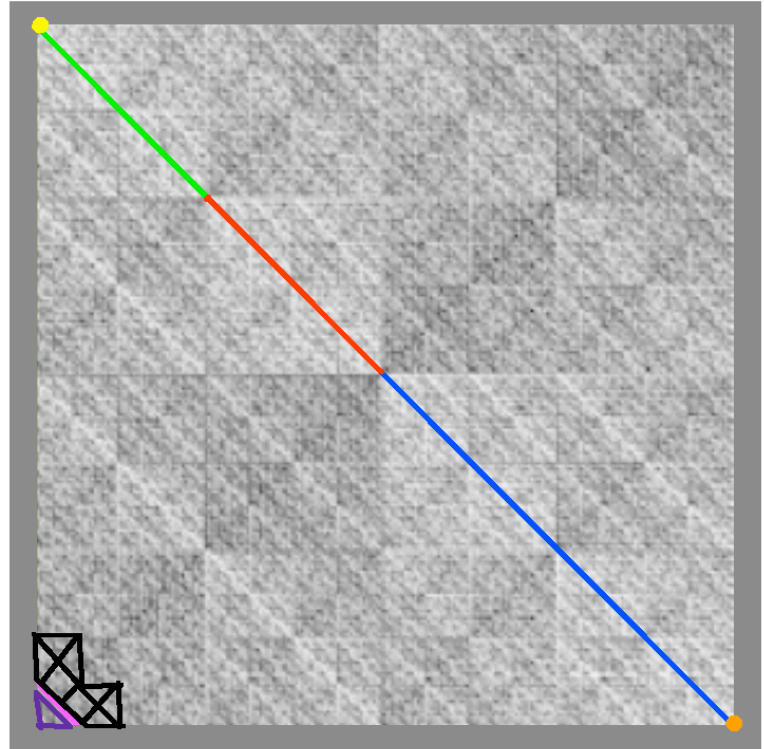
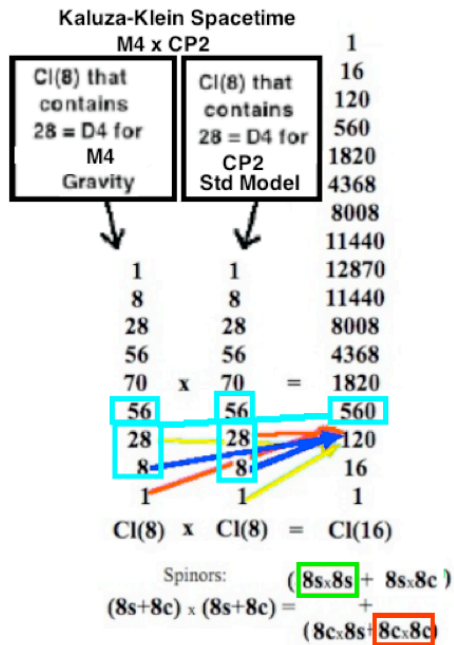

That leaves 1 (orange) + and 127 (blue) = 128-dim Mirror Fermion half-spinors and  $65,536 - 256 - 560 - 120 - 16 = 64,584$  elements of  $Cl(16)$  available to carry information in the processes of Quantum Consciousness.

According to [12biophys.blogspot.com](http://12biophys.blogspot.com) Lecture 11 Microtubule structure is dynamic: "... One end of the microtubule is composed of stable (GTP) monomers while the rest of the tubule is made up of unstable (GDP) monomers. The GTP end comprises a cap of stable monomers. Random fluctuations either increase or decrease the size of the cap.

This results in 2 different dynamic states for the microtubule.

Growing: cap is present Shrinking: cap is gone ...

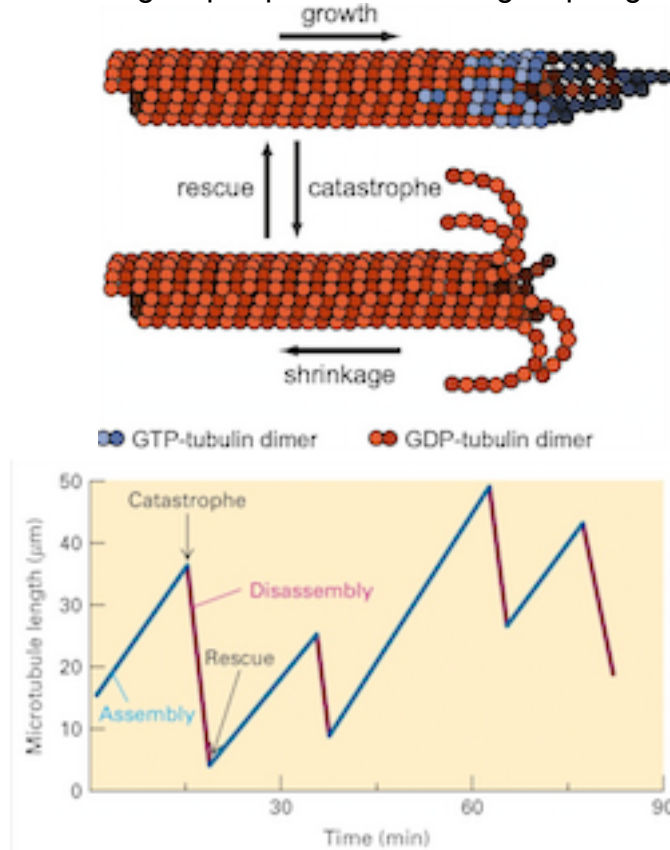

...”.

Microtubules spend most of their lives between 10 microns and 40 microns, sizes that can represent E8 as half of the Even Part (half) of CI(16) ( 10 microns ) or as the Even Part (half) of CI(16) ( 20 microns ) or as full CI(16) ( 40 microns ).

In a given Microtubule

the 128 CI(8) Half-Spinor part  is represented by a line of 128 Dimers in its stable GTP region and

the 120 CI(16) BiVector part  by a 12 x 10 block of Dimers in its stable GTP region  
The 560 CI(16) TriVector part is represented similarly.

( image adapted from 12biophys.blogspot.com Lecture 11 )



## How do the Microtubules communicate with each other ?

Consider the Superposition of States State 0 and State 1 involving one Tubulin Dimer with Conformation Electron mass  $m$  and State1 / State 0 position separation  $a$  .

**The Superposition Separation Energy Difference is the internal energy**

$$E_{\text{ssediff}} = G m^2 / a$$

that can be seen as **either the energy of 26D String Theory spin two gravitons** or the **Bohm Quantum Potential internal energy**, equivalently.

Communication between two Microtubules is by the Bohm Quantum Potential between their respective corresponding Dimers with the correspondence being based on connection between respective E8 and Fr3(O) subsets

## How is information encoded in the Microtubules ?

Each Microtubule contains E8 and Fr3(O), allowing Microtubules to be correlated with each other. The parts of the Microtubule beyond E8 and Fr3(O) are in Cl(16) for 40 micron Microtubules, or the Even Subalgebra of Cl(16) for 20 micron Microtubules, or half of the Even Subalgebra of Cl(16) for 10 micron Microtubules so since by 8-Periodicity of Real Clifford Algebras  $Cl(16) = Cl(8) \times Cl(8)$  and since Cl(8) information is described by the Quantum Reed-Muller code  $[[ 256, 0, 24 ]]$  **the information content** of Cl(16) and its Subalgebras **is described by the Tensor Product Quantum Reed-Muller code  $[[ 256, 0, 24 ]]$  x  $[[ 256, 0, 24 ]]$**

## What about information in the Many Microtubules of Human Consciousness ?

The information in one Microtubule is based on Cl(16) which is contained in the Cl(1,25) of 26D String Theory E8 Physics

How does this give rise to Penrose-Hameroff Quantum Consciousness ?

Consider the Superposition of States State 0 and State 1 involving one Tubulin Dimer with Conformation Electron mass  $m$  and State1 / State 0 position separation  $a$  . The Superposition Separation Energy Difference is the internal energy

$$E_{\text{ssediff}} = G m^2 / a$$

that can be seen as the energy of 26D String Theory spin two gravitons which physically represent the Bohm Quantum Potential internal energy.

For a given Tubulin Dimer  $a = 1$  nanometer =  $10^{-7}$  cm so that

$$T = h / E_{\text{electron}} = ( \text{Compton} / \text{Schwarzschild} ) ( a / c ) = 10^{26} \text{ sec} = 10^{19} \text{ years}$$



Now consider the case of N Tubulin Dimers in Coherent Superposition connected by the Bohm Quantum Potential Force that does not fall off with distance. Jack Sarfatti defines coherence length L by  $L^3 = N a^3$  so that the Superposition Energy  $E_N$  of N superposed Conformation Electrons is

$$E_N = G M^2 / L = N^{(5/3)} E_{ssediff}$$

**The decoherence time for the system of N Tubulin Electrons is**

$$T_N = h / E_N = h / N^{(5/3)} E_{ssediff} = N^{(-5/3)} 10^{26} \text{ sec}$$

so we have the following rough approximate Decoherence Times  $T_N$

Number of Involved Tubulin Dimers	Time $T_N$
$10^{(11+9)} = 10^{20}$	$10^{(-33 + 26)} = 10^{(-7)} \text{ sec}$ $10^{11}$ neurons x $10^9$ TD / neuron $10^{20}$ Tubulin Dimers in Human Brain
$10^{16}$	$10^{(-27 + 26)} = 10^{(-1)} \text{ sec} - 10 \text{ Hz}$ Human Alpha EEG is 8 to 13 Hz Fundamental Schumann Resonance is 7.8 Hz Time of Traverse by a String World-Line Quantum Bohmion of a Quantum Consciousness Hamiltonian Circuit of $10^{16}$ TD separated from nearest neighbors by 10 nm is $10^{16} \times 10 \text{ nm} / c = (10^{16} \times 10^{(-6)}) \text{ cm} / c = 10^{10} \text{ cm} / c = 0.3 \text{ sec}$

Each cell of E8 Classical Lagrangian Spacetime corresponds to 65,536-dim Cl(16) which contains 248-dim E8 = 120-dim D8 bivectors +128-dim D8 half-spinors

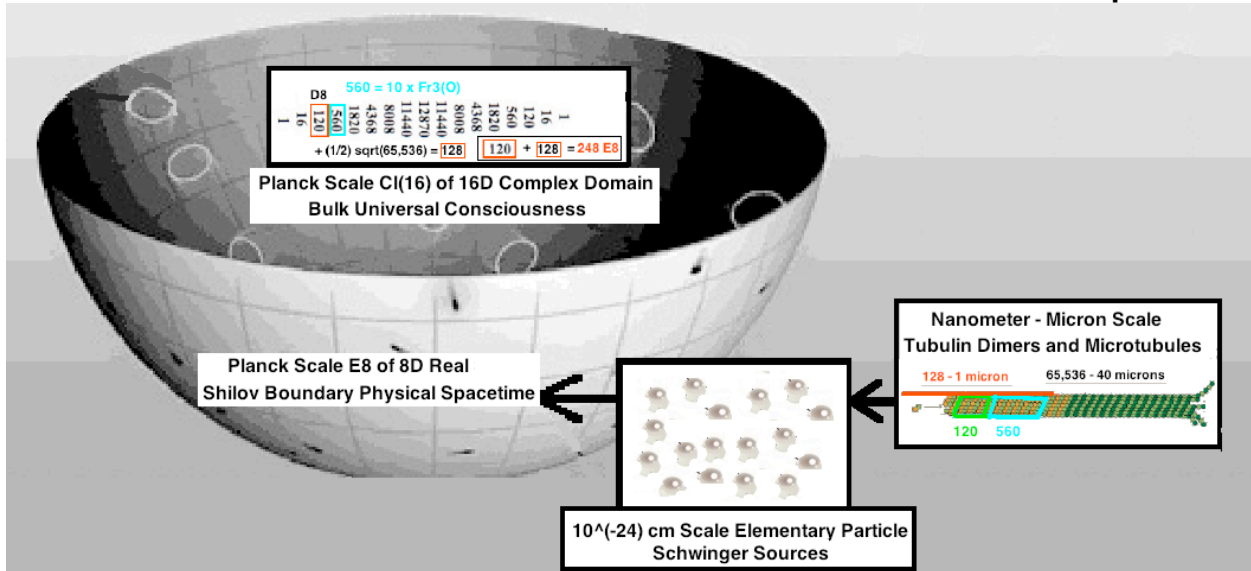

In E8 Physics ( viXra 1602.0319 )

**Spacetime is the 8-dimensional Shilov Boundary  $RP^1 \times S^7$**

**of the Type IV8 Bounded Complex Domain Bulk Space**

of the Symmetric Space  $Spin(10) / Spin(8) \times U(1)$

which **Bulk Space** has 16 Real dimensions

and is the Vector Space of the Real Clifford Algebra  $Cl(16)$ .

By 8-Periodicity,

$Cl(16) =$  tensor product  $Cl(8) \times Cl(8) =$  Real 256x256 Matrix Algebra  $M(R,256)$

and so has  $256 \times 256 = 65,536$  elements.

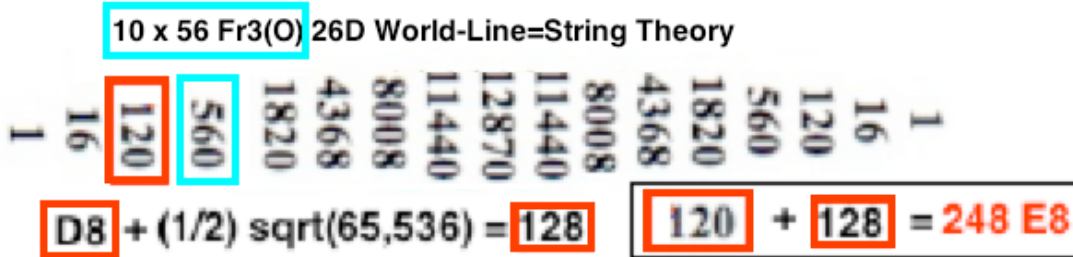

$Cl(8)$  has 8 Vectors, 28 BiVectors, and 16 Spinors with  $8+28+16 = 52 = F4$  Lie Algebra.

$Cl(16)$  has 120 BiVectors and 128 Half-Spinors for  $120+128 = 248 = E8$  Lie Algebra giving a Lagrangian for the Standard Model and for Gravity - Dark Energy.

$Cl(16)$  has 560 TriVectors for 10 copies of  $Fr3(O)$  and  $Cl(1,25)$  AQFT

so  $65,536 - 248 - 560 = 64,728$  elements of  $Cl(16)$  are for Consciousness Information.

The Complex Bulk Space  $Cl(16)$

contains the Maximal Contraction of E8 which is  $H92 + A7$

a generalized Heisenberg Algebra of Quantum Creation-Annihilation Operators with graded structure

$$28 + 64 + ((SL(8,R)+1) + 64 + 28)$$

Human Brain Microtubules 40 microns long have 65,536 Tubulin Dimers

128 - 1 micron

65,536 - 40 microns

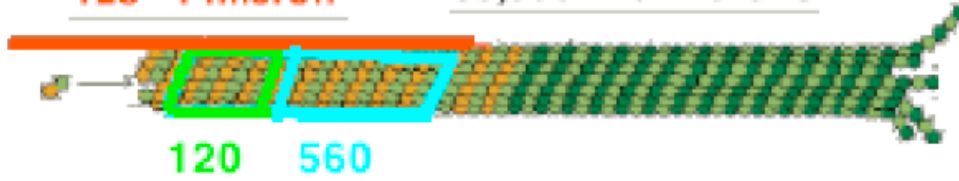

( image adapted from 12biophys.blogspot.com Lecture 11 )

and so

can have Bohm Quantum Resonance with Cl(16) Spacetime cells

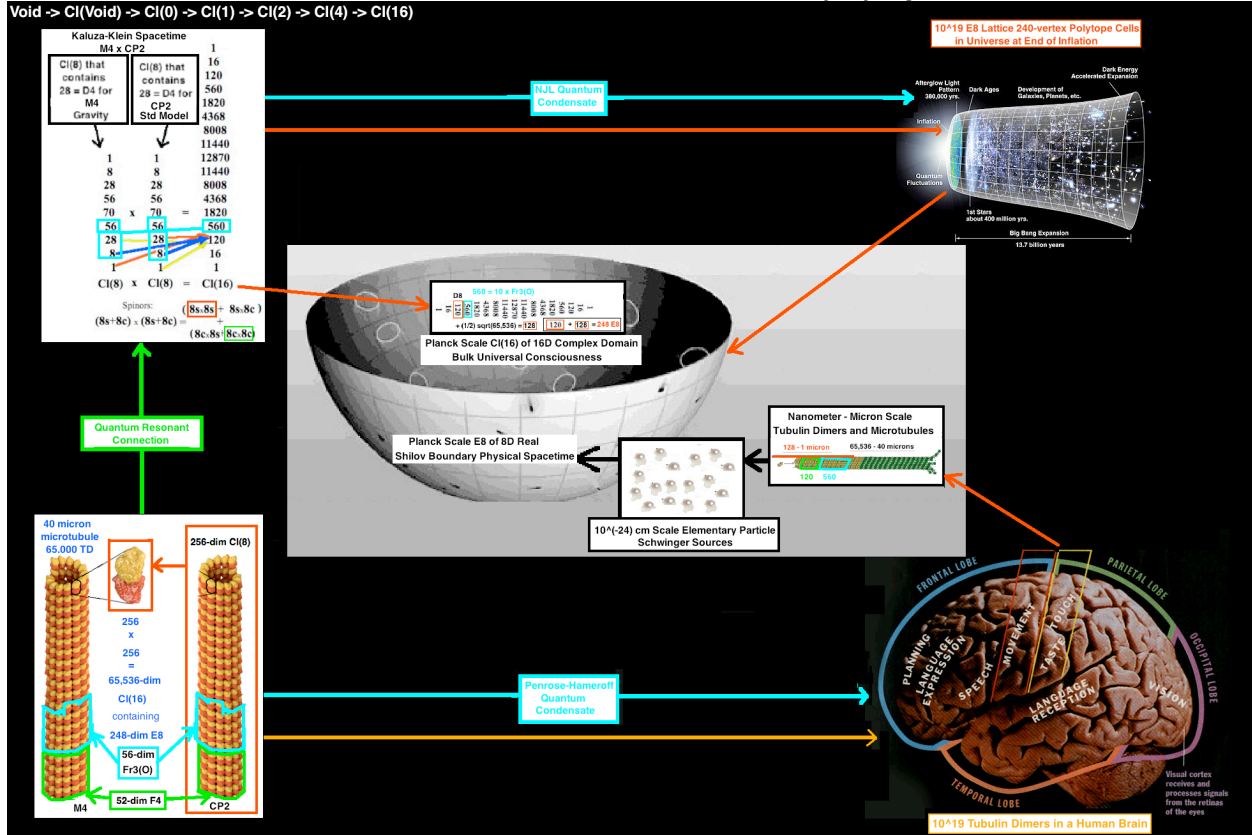

so that at any and all Times  
the State of Consciousness of a Human  
is in exact resonant correspondence with  
a subset of the cells of E8 Classical Lagrangian Spacetime

Therefore

**E8 Classical Lagrangian Spacetime NJL Condensate** is effectively the **Spirit World** in which the Human States of Consciousness = Souls exist. After the death of the Human Physical Body the Spirit World interactions with its Soul are no longer constrained by Physical World interactions with its Body so that the Spirit World can harmonize the individual Soul with the collective Universal Soul. **William Kingdon Clifford**, who invented **Real Clifford Algebras**, called them “mind-stuff”, saying: “...  
When matter takes the complex form of a living human brain,  
the corresponding mind-stuff takes the form of a human consciousness ...”.

# Some of my Ancestors

Frank Dodd (Tony) Smith, Jr. - 2017  
**Paternal Y-DNA**

**Maternal Mitochondrial M-DNA and**



show that my Mother's side Maternal ancestors U5 migrated out of Africa about 150,000 years ago to Finland

and that my Father's side Paternal ancestors E3b1= E-V13 migrated out of Africa about 50,000 years ago to Roman Legions and on to Britain.

As to Individual Ancestors, my Mother's side goes back to Angus McIntosh born 1715 in Inverness and **John Whistler, born in Africa, husband of Ann McIntosh, daughter of Angus.** John and Ann are my 5-Great Grandparents (7th Generation back).

( 22nd Generation has  $2^{22} = 4,194,304$  Grandparents. Earth population 1300 was about 400,000,000 )  
 My Father's family has a Brewster branch (Y-DNA M-253) to my **20-Great Grandfather (22nd Generation back) John Brewster I of Suffolk born 1279** and a Taylor branch (Y-DNA R1b) to my 35-Great Grandfather Frankish Aristocrat, born 697 and his son, my **34-Great Grandfather Gerold Von Vinzgau, born circa 725**, Graf im Kraichgau und Anglachgau, whose daughter Hildegard married King Charlemagne in 771.

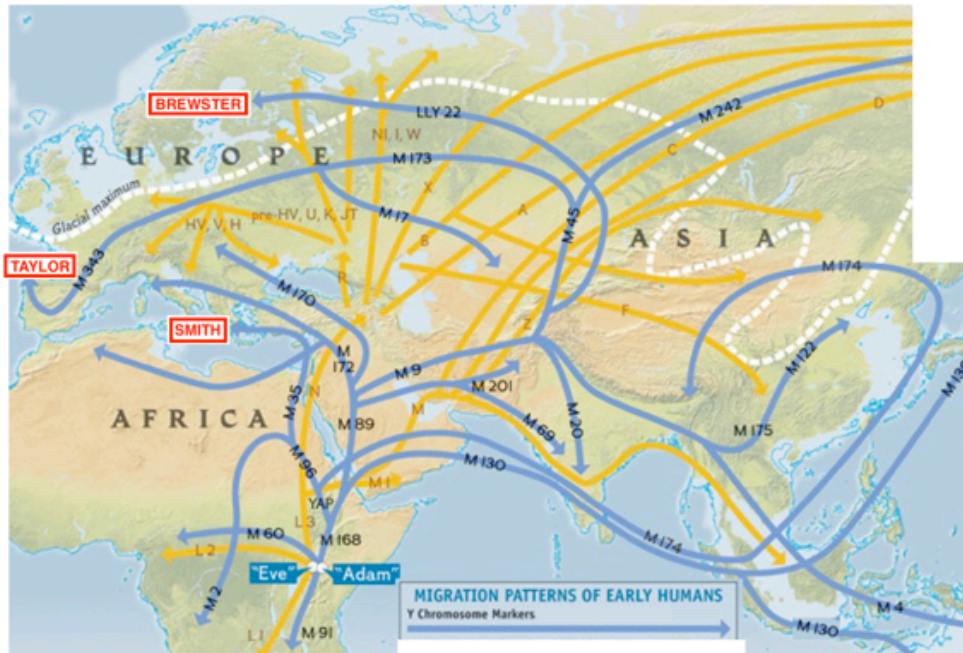

Material herein is taken from various sources, including but not limited to  
Wikipedia, ancestry.com, geni.com, fabpedigree.com, werelate.org,  
Burkes Landed Gentry, Alumni Cantabrigienses, U. Cambridge from Earliest Times to 1535

## **Paris and Cambridge around 1300**

Around 1300 Scholasticism and Empiricism were being developed at the University of Paris, then the world's leading University, and Cambridge and Oxford Universities which were getting organized based on Paris. Developers of Scholasticism and Empiricism included:

Doctor Mirabilis = Roger Bacon (1219-1292) who advocated Aristotelian Empiricism,  
Doctor Angelicus = Thomas Aquinas (1225-1274) also an advocate of Aristotle.  
Doctor Illuminatus = Ramon Llull (1232-1315) who produced a system of Logic and a mathematical Art based on what is now known as the Clifford Algebra  $Cl(16)$  and the 120 dimensional Lie algebra  $Spin(16)$ . 700 years ago the details of that mathematics were not known, nor was it known that the math structure of the Art gives a realistic representation of E8 Physics of the Standard Model and Gravity along with its Algebraic Quantum Field Theory. (see viXra 1602.0319)  
Doctor Subtilis = John Duns Scotus (1266-1308) who developed Llull's system of Logic into sophisticated Scholasticism, but did not have the math and physics knowledge to show that the mathematical Art of Doctor Illuminatus gives a realistic physics model.

A Second Scholasticism began in 1540 when Ignatius Loyola under Pope Paul III founded the Jesuits, who joined with the Franciscans (Bacon, Llull and Scotus) and the Dominicans (Aquinas) in developing Scholasticism but, without the ability to experimentally measure the relative strengths of the forces of the Standard Model and Gravity and the relative masses of the elementary fermion particles and to compare those observations with the physics model of Llull's mathematical Art, by 1700 Scholasticism had been displaced by the Enlightenment of Descartes et al.

Although I can trace my Brewster Line ancestry back to 1279 birth of John Brewster I, the earliest connection that I have found of them with Cambridge Scholasticism is Robert Brewster of Scrooby (1440-1505) Cambridge MA 1468-9. Most of my Brewster Line family connections with Cambridge were 1588 to 1624, the Golden Age of Second Scholasticism.

However, my Taylor ancestry goes back further, including  
20-Great Grandfather Aymer d'Angouleme, comte d'Angouleme, born 1160  
19-Great Grandfather Count D'Agouleme William Taillefer born 1200  
brother of Isabelle of Angouleme, Queen Consort of England  
as wife of King John of England from 1200 to his death in 1216 shortly  
after the Magna Carta had been initially signed with rebel barons.

In 1209 three Oxford clerks were arrested in connection with the death of a townswoman and King John ordered their death. After their hanging, many Oxford clerks fled Oxford and some of them founded Cambridge.

After King John's death in 1216 Isabelle returned to Angouleme and married Hugh X of Lusignan. Their son William de Valence (1225-1296) was the first Earl of Pembroke (3rd creation). His son Aymer de Valence, 2nd Earl of Pembroke (1275-1324) married Marie de St. Pol. Apocryphal legend: Marie was maiden, wife, and widow all on her wedding day when her husband was killed in front of her in a friendly jousting match. Fact: Marie founded Pembroke College Cambridge with license from Edward III on Christmas Eve 1347.

## 1647 Brewster-Taylor New Haven Phantom Ship

1480 - Robert Bacon born; John Taylor, Jr., triplet #1, my 13-Great Grandfather, born  
1573 - Francis Bacon, Grandson of Robert Bacon, adm Fel-Cmnr Trinity Cambridge  
Francis Brewster I born  
1617 - Francis Brewster II adm Fel Cmnr Pembroke Cambridge



1619 - Comet - African Slaves to Jamestown  
1624 - Francis Brewster II MA Cambridge  
1632 - Francis Brewster I dies  
1642 - Nathaniel Brewster, 4-Great Grandfather of Abraham Lincoln, AB Harvard

1647 - Nathaniel Bacon, 3-Great Grandson of Robert Bacon, born  
**New Haven Phantom Ship**

Francis Brewster II my 9-Great Grandfather

John Taylor V (not of the triplets family) 4-Great Grandfather of William Tecumseh Sherman  
also 4th cousin of my 10-Great Grandfather Thomas Taylor, Jr. (of the triplets family)  
who was father of my 9-Great Grandfather John Taylor I the immigrant born 1607

1649 - Cromwell signs Charles I death warrant  
1650 - John Taylor I (of the triplets family) and son James Taylor immigrants to Virginia  
1651 - John Taylor I dies  
1653 - Cromwell is Lord Protector  
1658 - Oliver Cromwell dies  
1660 - Charles II, restored Stuart, chartered slave shipment directly from Africa  
1661 - Nathaniel Bacon adm Fel Cmnr St. Catherines Cambridge  
1665 - Nathaniel Brewster first minister of the Presbyterian Church at Setauket  
1667 - Nathaniel Bacon MB Cambridge  
1674 - Nathaniel Bacon immigrant to Virginia  
1675 - Comet  
1676 - Bacon's Rebellion burns Jamestown, Bacon dies, Charles II puts it down  
1690 - Nathaniel Brewster dies

From scrapbookyourfamilytree.com isaacs-story "... **"Vision of the Phantom Ship,"** ...  
by Jesse Talbot in 1850, recalls ... **a New Haven vessel lost at sea in [1647]** ...  
... merchants at New Haven ... built or had built a ship in Rhode Island (about 150 tons)  
to be used in trade with England and other countries ... sailors and ship builders called  
this ship 'crank sided and walty' (or in terms we understand today, very unstable) ...  
In the winter of 1645/46 the "Great Shippe" was chartered by "The Company of  
Merchants of New Haven" with Captain George Lambertson in command. ...Because ...

loading ... was delayed, it was not ready to sail until ... about the middle of January 164[7], **seventy persons boarded the ship**, among them were ...



George Lamberton ...

[ and my 9-Great Grandfather **Francis Brewster II**, ancestor of Abraham Lincoln and **John Taylor V** (not of the triplets family) 4-Great Grandfather of William Tecumseh Sherman and 3-Great Grandson of my 15-Great Grandfather William Taylor, II, born 1429, who was common ancestor of James Madison, Jr., Zachary Taylor and William Tecumseh Sherman ] ...

**The vessel was iced in so solidly at its pier, that in order to get to Sea every able man and boy had to help hand-chop a three mile channel out of Long Island Sound. Then the ship had to be towed stern-first through the ice out to the waters of the North Atlantic. This was a chillingly bad omen, and the crew members almost mutinied because of it. ... The ship's master, George Lamberton, an experienced mariner, predicted many times that the "walty" ship would "prove their grave." ...**

The ship was never heard from again ...

Six months later ... On a humid June afternoon, heavy thunderstorms descended upon New Haven harbor. Excitement overtook the town as person after person saw their `Great Shippe´ emerging from the cloudbanks and sailing into the harbor. However, it

was sailing against the winds and above the waves - in the fogged clouds and not touching the waters below. As it approached the shore, and as dusk fell, the main topmast broke off, fell and entangled other sails on the deck. Pieces of the ship seemed to break off. Many watching from the harbor saw a human figure on the bow, sword raised and pointing to the sea, just before the ship, ragged, broken and haunted, rolled over on her side and disappeared into the mists ...  
No debris-wood, casks, sails - from the ship was ever found.  
The water calmed and the mists lifted. The ship had vanished. ...”.

From colonialwarsct.org “... Henry Wadsworth Longfellow's The Phantom Ship

In Mather's Magnalia Christi, Of the old colonial time,  
May be found in prose the legend That is here set down in rhyme.  
A ship sailed from New Haven, And the keen and frosty airs,  
That filled her sails at parting, were heavy with good men's prayer.  
"O Lord if it be thy pleasure" - Thus prayed the old divine -  
"To bury our friends in the ocean, Take them, for they are thine!"  
But Master Lamberton muttered, And under his breath said he,  
"This ship is so crank and walty, I fear our grave she will be!"  
And the ships that came from England, When the winter months were gone,  
Brought no tidings of this vessel Nor of Master Lamberton.  
This put the people to praying that the Lord would let them hear  
What in his greater wisdom He had done with friends so dear.  
And at last their prayers were answered: It was in the month of June,  
An hour before the sunset Of a windy afternoon,  
When, steadily steering landward, A ship was seen below,  
And they knew it was Lamberton, Master, Who sailed long ago.  
On she came, with a cloud of canvas, Right against the wind that blew  
Until the eye could distinguish The faces of the crew.  
Then fell her straining topmasts, Hanging tangled in the shrouds,  
And her sails were loosened and lifted, And blown away like the clouds.  
And the masts, with all their rigging, Fell slowly, one by one,  
And the hulk dilated and vanished, As sea-mist in the sun!  
And the people who saw this marvel Each said unto his friend,  
That this was the mould of their vessel, And thus her tragic end.  
And the pastor of the village Gave thanks to God in prayer,  
That, to quiet their troubled spirits, He had sent this Ship of Air.

...”



## The Brewster Line and Taylor Branch of ancestry intersected in 1780 and give Common Ancestry with Madison, Taylor, Lincoln and Sherman

### Brewster Ancestry Line:

20-Great Grandfather Sir John Brewster I born 1279 died 1299  
19-Great Grandfather Sir John Brewster II born 1299 died 1325  
18-Great Grandfather Sir John Brewster III born 1325 died 1379  
17-Great Grandfather Galfridus Brewster I born 1350 died 1410  
he was also 17-Great Grandfather to HRH Charles and to Lady Diana  
16-Great Grandfather John Brewster born 1380 died 1441  
15-Great Grandfather Humphrey Brewster born 1410 died 1443  
14-Great Grandfather **Robert Brewster of Scrooby** born 1440 (Cambridge MA 1468-9) died 1505  
At Cambridge in the Scholastic Era he could have learned about Ramon Llull (1232-1315)  
13-Great Grandfather William Brewster of Rushmere born 1470 died 1521  
12-Great Grandfather Robert Brewster born 1494 died 1540  
his brother William Brewster of Hatfield b 1510 (B.Can.L. Cambridge 1532-3).  
11-Great Grandfather Humphrey Clearke Brewster born 1526 died 1593  
his son Humphrey Jr matric pens St Johns Cambridge 1588 died 1613 age 44  
10-Great Grandfather **Francis Brewster I** born 1573 died 1632  
his Second Cousin William "Elder" Brewster was Pilgrim leader of Mayflower Compact  
his son John born 1600 adm pens Emmanuel Cambridge 1610  
his son Robert born 1599 matric Fel Cmnr Pembroke Cambridge 1617  
9-Great Grandfather **Francis Brewster II** born 1598 (adm Fel Cmnr Pembroke 1617 Cambridge MA 1624)  
he died 1647 on the New Haven Phantom Ship with John Taylor  
8-Great Grandfather **Nathaniel Brewster** born 1618 (Harvard AB 1642) died 1690  
**he was 4-Great Grandfather of President Abraham Lincoln**  
7-Great Grandfather Daniel Brewster born 1662 died 1748  
6-Great Grandfather John Brewster born 1705 died 1778  
5-Great Grandfather John Brewster born 1728 died 1816 in SC  
**4-Great Grandfather James Brewster b 1756 d 1804 in SC married Mildred Downs 1780 in NC**  
3-Great Grandmother Sarah Brewster b 1783 d 1857 in GA married James Dickerson  
2-Great Grandmother Mary Brewster Dickerson b 1819 d 1895 in GA  
she married Benjamin Franklin Smith b 1815 d 1893 in GA  
Great Grandfather James Madison Smith b 1841 d 1884 in GA  
Grandfather James Madison Smith b 1877 d 1932 in GA  
Father Frank Dodd Smith b 1906 d 1986 in GA  
Frank Dodd (Tony) Smith, Jr., born 1941

### My closest Common Ancestor with Abraham Lincoln is Nathaniel Brewster (Harvard AB 1642)

**Abraham Lincoln 4-Great Grandfather Nathaniel Brewster** born 1618 (Harvard AB 1642)  
Abraham Lincoln 3-Great Grandmother Sarah Brewster born 1656 married Jonathan Smith (son of Bull)  
Abraham Lincoln 2-Great Grandmother Abigail Smith born 1678 married Isaiah Harrison  
Abraham Lincoln Great Grandmother Abigail Harrison born 1710 married Alexander (Jr.) Herring  
Abraham Lincoln Grandmother Bethsheba Herring born 1742 married Abraham (Capt.) Lincoln  
Abraham Lincoln Father Thomas Lincoln born 1778  
Abraham Lincoln born 1809

### Taylor Ancestry Branch:

- 35-Great Grandfather Frankish Aristocrat, born 697
- 34-Great Grandfather Gerold Von Vinzgau, Graf im Kraichgau und Anglachgau, born circa 725  
his daughter Hildegard married King Charlemagne in 771
- 33-Great Grandfather Udalrich I, Graf in Breisgau, born circa 770
- 32-Great Grandfather Udalrich II, Graf im Breisgau, born 783
- 31-Great Grandfather Wulfhard Taillefer d'Angouleme, born circa 783
- 30-Great Grandfather Wulgrin Tallefer d' Angouleme, born circa 828
- 29-Great Grandfather Alduin, born circa 866
- 28-Great Grandfather William I "Taillefer" d'Angouleme, born circa 895
- 27-Great Grandfather Arnaud "Manzer" d'Angouleme, born circa 927
- 26-Great Grandfather William Taillefer d'Angouleme, born circa 978
- 25-Great Grandfather Geoffrey d'Angouleme, born 1014
- 24-Great Grandfather Foulques d'Angouleme, born 1015
- 23-Great Grandfather Guillaume V 'Taillifer' d'Angouleme, born 1067-1103
- 22-Great Grandfather Vulgrin II d' Angouleme, born 1070-1130
- 21-Great Grandfather Guillaume 'Taillefer' d'Angouleme, born circa 1115
- 20-Great Grandfather Aymer d'Angouleme, comte d'Angouleme, born 1160
- 19-Great Grandfather Count D'Agouleme William Taillefer born 1200  
brother of Isabelle of Angouleme, Queen Consort of England
- 18-Great Grandfather Baron Hanger Taylifer born 1256
- 17-Great Grandfather Sir John Taylor (Taylifer), Kt, born circa 1324
- 16-Great Grandfather William Taylor, I, born before 1377
- 15-Great Grandfather John Taylor, II, born 1403
- 14-Great Grandfather William Taylor, II, born 1429, Master of the Rolls of the Court of Chancery,  
father of triplets
- 13-Great Grandfather John Taylor, Jr., triplet #1, born 1480  
Doctor of Civil Law and Doctor of Canon Law at Cambridge in 1520
- 12-Great Grandfather Rowland Taylor, Archdeacon of Exeter, born 1510, burned at stake 1555  
Doctor of Laws degree from Cambridge in 1534
- 11-Great Grandfather Thomas Taylor, Sr., born 1548
- 10-Great Grandfather Thomas James Taylor, Jr., born 1574  
his 3-Great Granddaughter Elizabeth Bassett married Benjamin Harrison V who signed the  
Declaration of Independence. Their son **William Henry Harrison** and their Great Grandson  
**Benjamin Harrison** were Presidents
- 9-Great Grandfather John Taylor I, the Immigrant born 1607
- 8-Great Grandfather Col. James Taylor born 1633
- 7-Great Grandfather James Taylor II born 1675 had daughter Frances and son Zachary:  
James Madison Jr Grandmother Frances Taylor born 1700 married Ambrose Madison  
James Madison Jr Father Col. James Madison born 1723  
**James Madison Jr born 1751**  
Zachary Taylor Grandfather Zachary Taylor I born 1707  
Zachary Taylor Father Richard Taylor born 1744  
**Zachary Taylor born 1784**
- 6-Great Grandmother Martha Taylor born 1702 married Thomas Chew
- 5-Great Grandmother Frances Chew born 1730 married Henry Downs, Jr.
- 4-Great Grandmother Mildred Downs born 1760 married James Brewster 1780 in NC**
- 3-Great Grandmother Sarah Brewster born 1783 married James Dickerson
- 2-Great Grandmother Mary Brewster Dickerson born 1819 married Benjamin Franklin Smith born 1815
- Great Grandfather James Madison Smith born 1841
- Grandfather James Madison Smith born 1877
- Father Frank Dodd Smith born 1906
- Frank Dodd (Tony) Smith, Jr., born 1941

According to Wikipedia: "... In 848 Angoulême was sacked by the Viking chief Hastein. ...



... In 896 or 930 the city suffered another attack from invading Vikings but this time the Vikings faced an effective resistance. Guillaume I, third Count of Angoulême, at the head of his troops made them surrender in a decisive battle. During this engagement, he split open to the waist Stonius, the Norman chief, with a massive blow together with his helmet and breastplate. It was this feat that earned him the name Taillefer ... Latin: *Incisor ferri*, meaning "hewer of iron" ... which was borne by all his descendants until Isabella of Angoulême who was also known as Isabelle Taillefer, the wife of King John of England. The title was withdrawn from the descendants on more than one occasion by Richard Coeur-de-Lion then the title passed to King John of England at the time of his marriage to Isabella of Angoulême, daughter of Count Aymer of Angoulême ...".

My 19-Great Grandfather William Taillefer (1200-1274), younger brother of Isabella of Angouleme, was Count D'Angouleme. A successor Count of Angouleme (Count from 1496 to 1515) was King Francis I of France who was patron of Giovanni da Verrazano who first came to what is now **New York City** and who named it **New Angouleme** in 1524.

Later (1609 or so) the Dutch fur traders came there and in 1614 named the area New Netherland and New Angouleme became **New Amsterdam**. In 1664 it was traded to the English and renamed **New York**.

**My closest Common Ancestor with William Tecumseh Sherman is William Taylor II  
whose 3-Great Grandson John Taylor V  
died on the New Haven Phantom Ship with Francis Brewster II**

William Tecumseh Sherman 9-Great Grandfather William Taylor, II, born circa 1429  
Master of the Rolls of the Court of Chancery

William Tecumseh Sherman 8-Great Grandfather John I. Taylor I, born 1451

William Tecumseh Sherman 7-Great Grandfather John Taylor of Shadoxhurst, born circa 1480  
not of the triplets family

William Tecumseh Sherman 6-Great Grandfather John Taylor born 1522

William Tecumseh Sherman 5-Great Grandfather John Taylor IV born 1563

William Tecumseh Sherman 4-Great Grandfather John Taylor V born 1603 died Phantom Ship

William Tecumseh Sherman 3-Great Grandfather Thomas Taylor born 1642

William Tecumseh Sherman 2-Great Grandfather Nathan Taylor born 1681

William Tecumseh Sherman GreatGrandmother Mindwell Taylor born 1727 married Daniel Sherman

William Tecumseh Sherman Grandfather Taylor Sherman born 1759

William Tecumseh Sherman Father Charles R. Sherman born 1788

William Tecumseh Sherman born 1820.

## Francis Brewster I

12-Generation 10-Great Grandfather of Frank Dodd (Tony) Smith Jr  
Born 1566 in Suffolk England. Died 1644 in Somerset England.



**Suffolk**



**Scrooby**



**Somerset**

Suffolk and Somerset were Parliamentarian in the English Civil War.

The earliest Brewster to attend University was the 2-Great-Grandfather of Francis I  
**Robert Brewster, of Scrooby, b. 1440 d. 1505, MA Cambridge 1468-9.**

Francis I did not attend University  
but was able to send his three sons to Cambridge where his brother had matriculated  
and to send two of his grandsons to Cambridge and to Harvard.

How did Francis I make enough money to send children and grandchildren  
to Cambridge and Harvard ?

His father Humphrey Clearke Brewster (1526-1593) (according to Burke's Landed Gentry)  
"... purchased the manor and living of Wrentham, and in 1556, built the hall there, at  
which his descendants continued to reside until 1794 ... The income of the proprietors of  
Wrentham was derived from lands in more than twenty parishes in Suffolk and Norfolk.  
In the former county the Brewsters possessed leading influence,  
and in the great rebellion became partisans of the parliament ...  
Humphrey [ Clearke ] Brewster ... had ... sons ... [ William b. ca 1566 ] and

Francis [ I ] his heir ... b. in 1566 ... d. in 1644 ...[and]

**Humphrey [ Jr ]... [ who matriculated as Pensioner St. John's Cambridge in 1588;**  
admitted Middle Temple 1596 from New Inn, b. 1569 died 1613 at age 44 ] ...

and

four dau[ghter]s ... Elizabeth ... Susan ... Mary ... and Jane ...

The elder son and heir **Francis Brewster [ I ]**, Esq. of Wrentham Hall ...  
 an active parliamentarian during the rebellion as a magistrate and deputy-lieutenant ...  
 had ...[ sons **Francis II 1598-1647**, **Robert 1599-1663**, and **John b. 1600**  
 and daughters Gillian Brewster and Mary Garth ]

[ Fellow-commoner; the first of the three ranks in which students were matriculated  
 Pensioner; the second of the three ranks in which students were matriculated  
 Sizar. The third of these ranks. In old times sizars performed many menial services. ]

**John** ... b. in [ 1600 ]... d. in 1677 ...[ subscribed Oxford 1613 **admitted Pensioner Emmanuel Cambridge 1620** adm at Gray's Inn 1623 ]... was a member of the parliament committee formed for the preservation of the peace of the county of Essex ...

**Robert** ... b. in [ 1599 ]... d. in 1663 ... [ **matriculated as Fellow Commoner Pembroke Cambridge in 1617**; MP for Dunwich and for Suffolk ]... had two sons ...

**Francis** ... b. in 1623 ...[ **matriculated as Fellow Commoner St. Catherine's Cambridge in 1642** adm at Gray's Inn 1646 ]... d. 1671 ...

**Robert** ... b. in 1625 ... d. in 1681 ...

**Francis [ II ]**, of Wrentham, b. in [ 1598 ] ...[ **was admitted (age 17) as Fellow Commoner Pembroke Cambridge in 1617**; matriculated in 1618; received BA in 1620;



**received MA in 1624**. He was a Barber/Surgeon and a Puritan. ...

By the sixteenth century ... the Castle of Bristol ... had fallen into disuse, but the City authorities had no control over royal property and the precincts became a refuge for lawbreakers ... On 23 Aug 1626 ...[ **Francis II** ]... received a lease of the ... castle ... from King Charles I, for a period of 80 years ...

In 1630 the city bought the castle ...

In 1638 ...[ **Francis II** ]... was one of the original settlers of New Haven ...

the Civil War broke out [ in 1642 The overall outcome of the war was threefold: the trial and execution of Charles I (1649); the exile of his son, Charles II (1651); ... the replacement of English monarchy with ... the Commonwealth of England (1649-53) ... then the Protectorate under ... Oliver Cromwell (1653-58) and his son (1658-59) ]...

Around 1647 he died at sea aboard the Lombard Phantom Ship ]... having had issue ...[ daughters Mary French b. 1633 and Hannah Thompson and ? Herbert sons Nathaniel 1618-1690, John b. 1632 and Robert b. 1638 and Francis 1627-1694, Joseph b. 1628 and Benjamin b. 1644 ]

Mary, daughter of Francis II, testified at a 1654 New Haven witch trial  
Witchcraft officially became a crime in Connecticut in 1642 ...  
New Haven enacted its witchcraft law in 1655 ...  
almost all of alleged witches were hanged ... no witch was ever burned at the  
stake in Connecticut ( [www.damnedct.com/connecticut-witchcraft-trials](http://www.damnedct.com/connecticut-witchcraft-trials) and  
!The Witchcraft Delusion in Colonial Connecticut (1647-1697) by John M. Taylor ]

Nathaniel ... b. in [ 1618 d. 1690 ]...  
[ enrolled in Harvard in 1639 and was in Harvard's first graduating class,



receiving the AB degree in 1642, ... Nathaniel then moved to England and became a cleric in the Church of England. In 1644 Nathaniel married Abigail Reynes with whom he had 3 children. In 1653 Oliver Cromwell was made Lord Protector of England, Scotland, and Ireland. After Abigail's death in 1654 Nathaniel attended Trinity College in Dublin receiving the B.D. degree in 1656. While in Dublin Nathaniel married Sarah Ludlow with whom he had 7 children. The English Restoration Uniformity Act of 1662 drove Puritan ministers from the Church of England to Presbyterian and Congregational Churches. In 1663 Nathaniel moved to Boston. In 1665, the year of Isaac Newton's B.A. degree from Trinity College, Cambridge (which then closed for the 1665-1666 Great Plague), Nathaniel moved to Suffolk County, Long Island, becoming the first minister of the Presbyterian Church at Setauket (Brookhaven Twp.) ]...

This family had many ramifications;  
one offshot ... was established in the United States by William [ Elder ] Brewster ... the ruling elder and spritual guide of the Pilgrim Fathers who, in 1620, went out to America to avoid the religious persecutions to which they were exposed, and were the founders of New England ...[ He was born 1565 in Scrooby Nottinghamshire; matriculated as Pensioner Peterhouse College Cambridge 1580; Y-DNA Haplogroup I-M253; died 1644 Plymouth, **second cousin of Francis I** [ His father ]... William Brewster of Scrooby b. 1534 ... died in 1590 ... was appointed Receiver and Bailiff of the Archbishop's estates at Scrooby in 1575 for the duration of his lifetime. ...[ and ]... was succeeded by his son ... From 1606-7 [ Elder ] Brewster held Separatist meetings in the manor house. Around 1636-7 most of the manor house and its outbuildings were demolished following a demolition order granted by Charles I ( [www.scrooby.net/page/scroobyManorHouse](http://www.scrooby.net/page/scroobyManorHouse) ) ]

...[ Brewster ] Mottto - Verite soyet ma garde [ Truth be my shield ]...”.

## John Whistler

### 1700-1750

**In Scotland**, my 6-Great Grandfather Angus McIntosh of Inverness supported exiled Stuarts and participated in the Jacobite Rebellion to overthrow the House of Hanover. He and his daughter, my **5-Great Grandmother Ann McIntosh** were captured and she was shipped to Orange County VA as an Indentured Servant.

**In Africa**, my **5-Great Grandfather John Whistler** (or his ancestors) was captured and shipped to Orange County VA as a Slave.

### 1750-1800s

**In Virginia**, my **5-Great Grandparents John Whistler and Ann McIntosh** were effectively husband and wife as slave / servant of Arjalon Price in Orange County VA. In 1756 they had my **4-Great Grandmother Molly a/k/a Mary a/k/a Frankey McIntosh** who became property valued at 20 pounds.

**For that pregnancy Ann was banned from the church and whipped fifty lashes.**

In 1787 Molly gave birth to my **3-Great Grandmother Mary McIntosh** **who at age 16 in 1803 obtained a certificate** from David Jamison, a justice of the peace from Culpeper County, and produced it in the District of Columbia Court in Alexandria on 17 November 1803 **declaring that she was born free.**

She then moved to Richmond County NC and married John McKennon.

In 1810 they had my **2-Great Grandmother Margaret McKennon** who married Malcolm McKinnon. They moved to Echols County Georgia, and in 1843 had my **Great Grandmother Mary Frances McKinnon** who married William Jeremiah Absolom Ham and gave birth in 1875 to my **Grandfather George Clinton Ham**, father of my **Mother Willie Julia (Billie) Ham.**

The history of Britain's wars such as the Jacobite Rebellion and its use of Indentured Servitude to send war losers and poor people to America as servant labor substantially equivalent to slave labor is well known but

the history of the African Slave Trade is less well known:

Tim Hashaw in "The Birth of Black America" said:

"... Long before the birth of Jesus there had flourished in East Africa the magnificent city-state of Aksum. Ideally situated to control the long flow of trade passing from Asia and East Africa through the Red Sea to the Mediterranean, Aksum ... became [a] great cosmopolitan center... in the ancient world. By Roman times, the wealth and influence of Aksum was envied throughout the Mediterranean, and its people, the Ethiopians, were widely famed for piety, justice, hospitality, and a long, unbroken tradition of literature. In the fourth century A.D. ... Ethiopia under King Ezana ... established the world's first Christian state. ... The Christian rulers of Ethiopia had been tolerant of all religions, including Judaism and Buddhism. Because Christian Ethiopians had offered refuge to persecuted Muslims, the Prophet Muhammad, according to Islamic tradition, had instructed Muslim armies to leave Ethiopia in peace ...

on August 28, 1482 ... the Portuguese explorer Diogo Cao became the first European to reach the mouth of the great Congo (Zaire) River, six degrees south of the equator. Here he found unexpected evidence of an impressive advanced civilization; Africans unknown to the Mediterranean world yet refining gold, silver, copper, and iron and clothed in fine garments ...

This was ... [a] kingdom...[that] gave their kings the title of ngola (iron blacksmith), from which comes the name of the country, "Angola"

...

in the 1520s ... Somali Muslim warlord ... Ahmed Gran, son of an Ethiopian Christian priest and a Somali prostitute, invaded Ethiopia ... captured and burned Aksum ...

...

in 1616 ... at Jamestown ... the Virginia Company shifted its focus ... to social and economic ventures intended to create a permanent colony of consumers, producers, and manufacturers with whom company investors hoped to trade

...

at the latter end of 1618, King James's chronicler William Camden had reported the sudden appearance in the sky of a comet ... on December 7, 1618, as the corsairs White Lion and the Treasurer were preparing to leave for the West Indies, Camden reported **the comet visible at the latitude of Jamestown ... in 1619 ... the first Africans ... [were brought]... to English-speaking America from Angola**

... The Spanish slave frigate San Juan Bautista left Africa with 350 slaves and crossed the Atlantic to be captured in the Gulf of Mexico in the summer of 1619 by two English pirate ships - the White Lion ... and the Treasurer ... the first Africans in English North America were ... delivered to Jamestown ... in 1619 ...

two dozen ... by the White Lion and ... half dozen [by]... the Treasurer

...

In less than two decades after arriving, many of this skilled and intelligent first generation of Jamestown Africans were free and had established their own farms and communities in Tidewater Virginia ... From 1619 to 1676, one generation has a brief opportunity to bestow freedom upon its descendants

...

**Nearly sixty years [ after 1619 ], Virginians saw another comet in the latitude of Jamestown ...**

England in 1660 invited Charles II, grandson son of James I, to return to the throne and restore the Stuart dynasty. ... Charles II, among other things, that year gave the Royal African Company a charter to ship slaves directly from Africa. No longer would American plantations rely on freelance pirates raiding Spanish and Portuguese frigates for slaves. In 1660, slavery became a British industry, ... Britain sold Africans to the faraway colonies to do jobs that English peasants did not want to do. Between 1648 and 1681, the number of whites in Virginia increased by 5.2 percent, while the number of blacks in Virginia in the same time period increased by 10 percent, due in large part to imported Africans ... Thus began **Bacon's Rebellion** [ of 1676 ]...

Nathaniel Bacon, a planter and the first American populist. Bacon raised an army by promising freedom to every enslaved African and indentured Englishman who would run away and join him. ...



Six months later, Bacon's campaign ceased being a war against natives and became a war of the colonial underclass against Jamestown's ruling royalist elite. Free black and white farmers, plus runaway Angolan fugitives, marched to Jamestown to protest government abuses and cast Berkeley and his favorites out of power. Governor Berkeley fled and, at the high point of the attack, Bacon's army, by then largely African, seized the colonial capital and burned it to the ground.

In the ashes of Jamestown, Governor Berkeley appealed to the Stuart king of England, who gave him a fleet to put down the ... rebels. Bacon died of natural causes at this time and the rebellion, though as powerful as ever, had no capable leader. ...

The royalist elite returned and rebuilt Jamestown. They of course did not ignore the great number of Africans in the rebellion and took steps to prevent a future reoccurrence.

...

After 1660, as the number of imported Africans dramatically increased, issues involving the status of Africans passed from the local courts to the colonial legislature, particularly as a result of Bacon's Rebellion ... in 1691, the Virginia legislature ... outlawed mixed marriages and required that mixed children born out of wedlock to European women be bound as servants for thirty years ... European women and their offspring could not be enslaved ... in 1723, the Virginia Assembly took the last step and banned outright the freeing of slaves, unless they had performed some notable public service, such as reporting a planned slave rebellion ...”.

According to britannica.com “... Nathaniel Bacon, (born January 2, 1647, Suffolk ... died October 1676, Virginia ... leader of Bacon’s Rebellion (1676), the first popular revolt in England’s North American colonies.

A kinsman of the famous Sir Francis Bacon ...[ their closest common ancestor was Robert Bacon b 1480 d 1548 Grandfather of Francis Bacon b 1561 d 1626 an English philosopher, statesman, scientist, jurist, orator, and author known as the father of empiricism Adm Fell-Com Trinity 1573 Matric 1573 Adm at Gray’s Inn 1576 MA 1594 and 3-Great Grandfather of Nathaniel Bacon b 1647 d 1676 ]...

Nathaniel Bacon graduated from the University of Cambridge ...[ Adm Fell-Com at St Catherine’s 1661 adm at Gray’s Inn 1664 MB 1667 ]...”.

## Maternal Line at Garden of Eden

Overview: my Mother's side Maternal ancestors U5 migrated out of Africa about 150,000 years ago to Finland



( years ago = BP = Before Present )

150,000 BP - Mitochondrial Eve - Haplogroup L1

75,000 BP - Haplogroups L2 and L3 - went out of Africa across the Red Sea

50,000 BP - Haplogroup N branched off of L3 to Incubation Period in Garden of Eden



Cousins of my Maternal DNA Line:

Part of Haplogroup N were ancestors of Noah who went with the Persian Gulf Flood to the Yemini Coast to Ethiopia, home of Abraham and Moses who went up the Nile to Giza Paternal Line at Nile River



According to Y-DNA, Enoch = Boskop descendants moved up the Nile to Giza and across the Indian Ocean to Sunda, Japan, and Tibet. The corresponding M-DNA migration to Sunda was by Haplogroup M branching off of L3

## Paternal Line Cousins at Angkor Wat

Overview: my Father's side Paternal ancestors E3b1= E-V13 migrated out of Africa about 50,000 years ago to Britain with Roman Legions

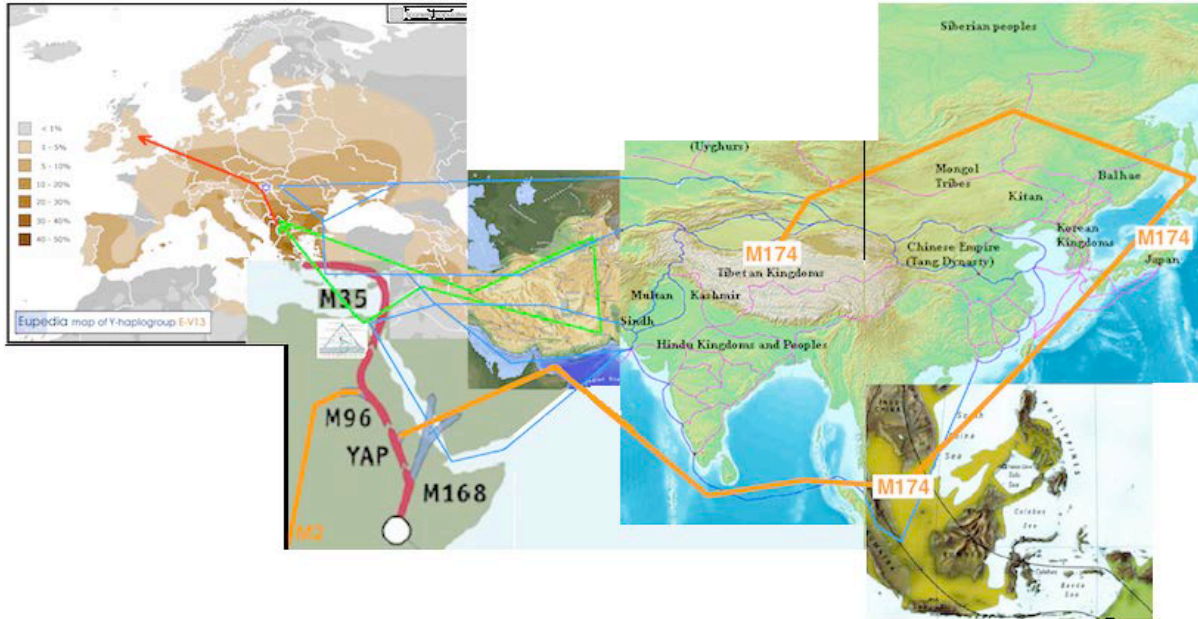

50,000 BP - Africa Haplogroup M168



50,000 - 40,000 BP - Africa Haplogroup YAP



Cousins of my Paternal Y-DNA Line:

50,000 BP - M174 leaves YAP from Africa to Sunda, Japan, Tibet



Tibet - I Ching 64 = E8 triality

Japan - Shinto Futomani 128 = E8-CI(16) half-spinor

Sunda - Origin of India-China Asia population (HUGO, Science 326 (2009) 1541- 1545)

Rg Veda - 240 E8RV Hindu - Sanskrit - Mt Meru 256 = CI(8) = CI(16) spinor

Angkor Wat (yellow) - Angkor Thom (red) - Phnom Bakheng (purple)



(tourismcambodia.com map)

Angkor Wat has 4 Inner Pillars and 4 Middle Pillars - IFA Tetragrams and M4xCP2

Angkor Thom has 8 Outer Pillars and 16 Middle Pillars - Fr3(O) Strings=World-Lines

and 1+12+4 Inner Pillars - Bohm Quantum Potential and Quarks and Leptons

Both have Outer 8-point squares - 8 IFA Opele Chain Elements -  $2^8 = 256$  IFA Odu

Both Centers have 8 layers -  $2^8 = 256$  IFA Odu = dim CI(1,7) = CI(8)

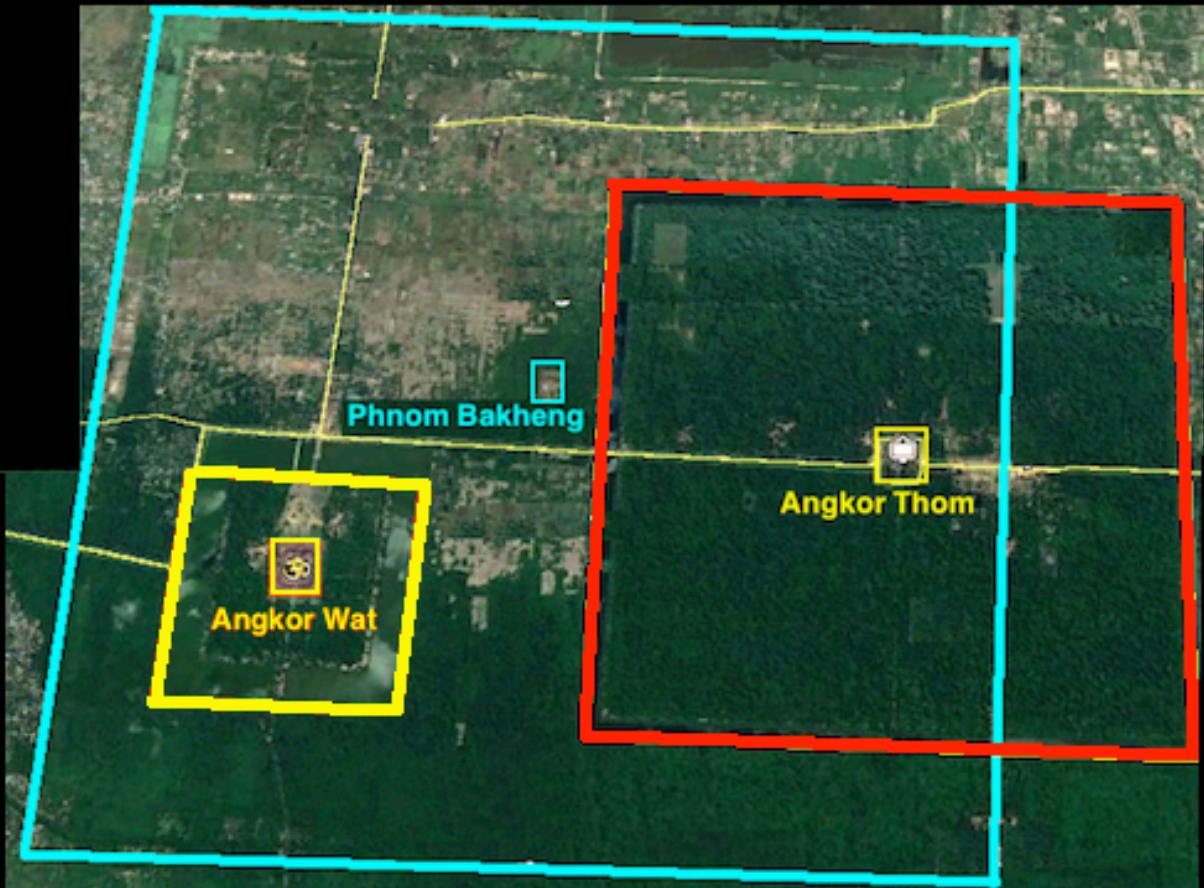

According to Wikipedia: "...Phnom Bakheng is a symbolic representation of Mount Meru ... a status emphasized by the temple's location atop a steep hill 65 m above the surrounding plain. The temple is built in a pyramid form of seven levels ... At the top level [are] five sandstone sanctuaries - [as in] Angkor Wat seen from Phnom Bakheng ...

... Originally, ... small towers were arrayed around the temple at ground level and on various of its tiers; most of them have collapsed ...".



(google earth images)

Phnom Bakheng has 3-mile square moat with area  $3^2 = 9$



Angkor Thom

has 2-mile square moat  $2^2 = 4$



Angkor Wat

has rectangular moat with 1-mile base

## Paternal Line at Nile River to Great Pyramid

40,000 BP - M96 leaves YAP and goes up Nile

Cousins of my Paternal Y-DNA Line:

M2 branch going back south to Boskop



36,000 BP - M96 continues up Nile to build the Great Pyramid

and during its construction to invent the efficient Hebrew Alphabet  
and the time of Late Wisconsin Glaciation

and the time that the shock wave of the Geminga Supernova hit the Earth  
and beginning of Manetho's Rule of Gods on Earth (36,000 to 22,000 BP)



The Builders of the Great Pyramid who had migrated throughout the length of the Nile along which substantially contiguous settlements enabled them to maintain enough contact to maintain the details of the oral traditions of IFA so that when they built the earliest of the pyramids, the Great Pyramid, they did not deface it with any writing but instead encoded the IFA Clifford Algebra in the structure of the Pyramid itself: The Great Pyramid is built of 203 layers (courses) plus a now-missing capstone represented by  $1+1 + 8+8 = 18$  for a total of 221 courses above ground level. The Subterranean Pit is as deep below ground level as Queen's Chamber is above it so the Subterranean Pit depth equivalent to 35 courses is dual to the Queen's Chamber height of 35 courses just as the 70 mid-grade grade 4 elements of the Cl(8) Clifford



Algebra are  $(35+35)$  35 elements plus 35 elements, dual to each other. When the Subterranean 35 courses are included, the total number Courses of the Great Pyramid is  $221 + 35 = 256 =$  number of IFA Odu and dimension of IFA Clifford Algebra  $Cl(8)$

$$Cl(8) = 1 + 8 + 28 + 56 + (35 + 35) + 56 + 28 + 8 + 1$$

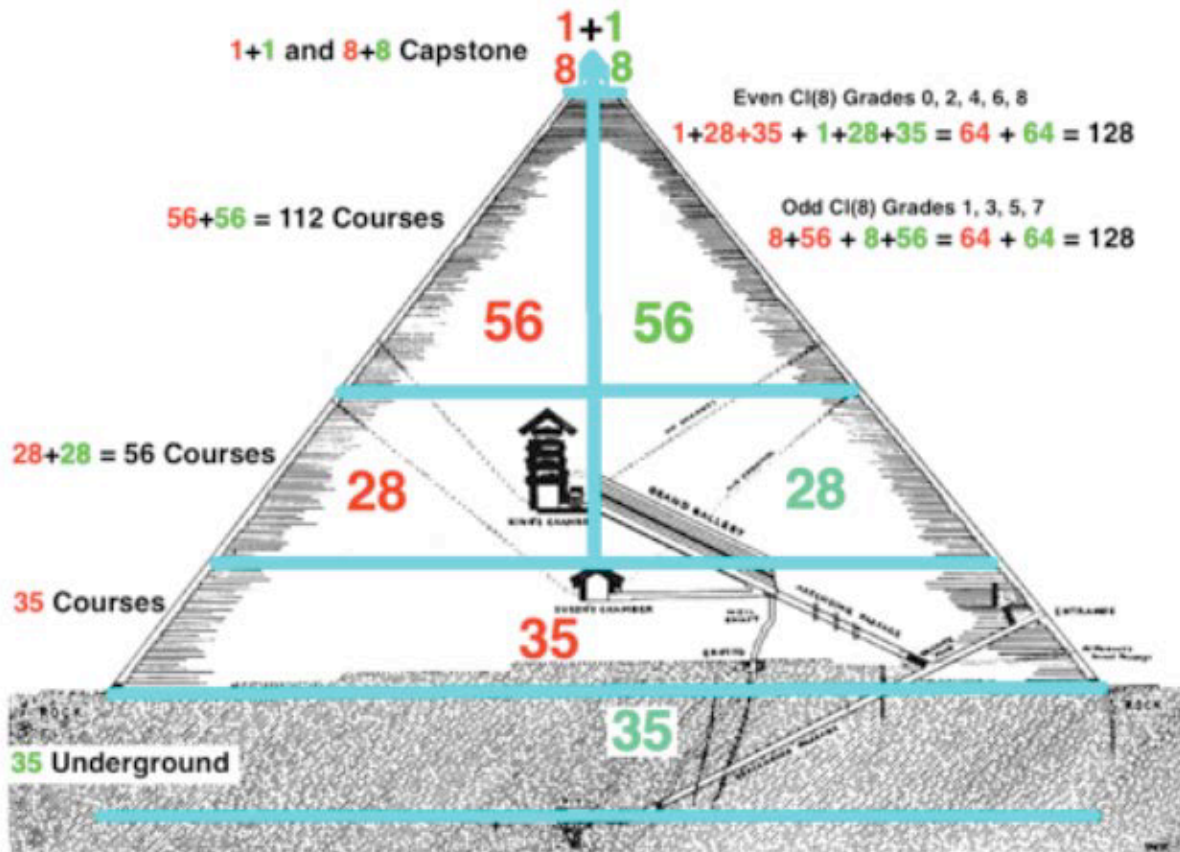

$$1 + 8 + 28 + 56 + (35 + 35) + 56 + 28 + 8 + 1$$

( image adapted from David Davidson image -  
 for a larger version of this image go to [tony5m17h.net/GreatPyrCl8.png](http://tony5m17h.net/GreatPyrCl8.png)  
 or [valdostamuseum.com/hamsmith/GreatPyrCl8.png](http://valdostamuseum.com/hamsmith/GreatPyrCl8.png) )  
 ( for more details about the Great Pyramid Geometry correspondences see viXra 1305.0060 )

1 and 4 and 9 are the top three components of the Square Pyramidal Number of order 8  
 $1+4+9+16+25+36+49+64 = 204 = 203 \text{ courses of Great Pyramid} + \text{Capstone}$

(chart from The Great Pyramid, by Peter Lemesurier, Element Books (1987))

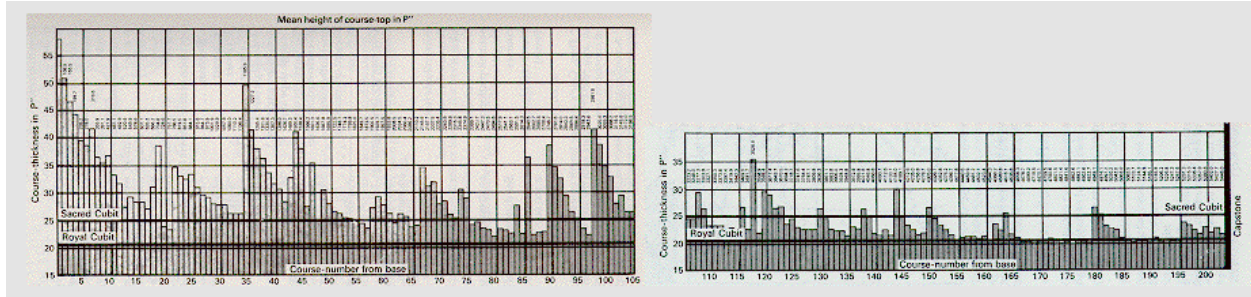

Mt. Meru corresponds to the Binomial Pyramid Triangle

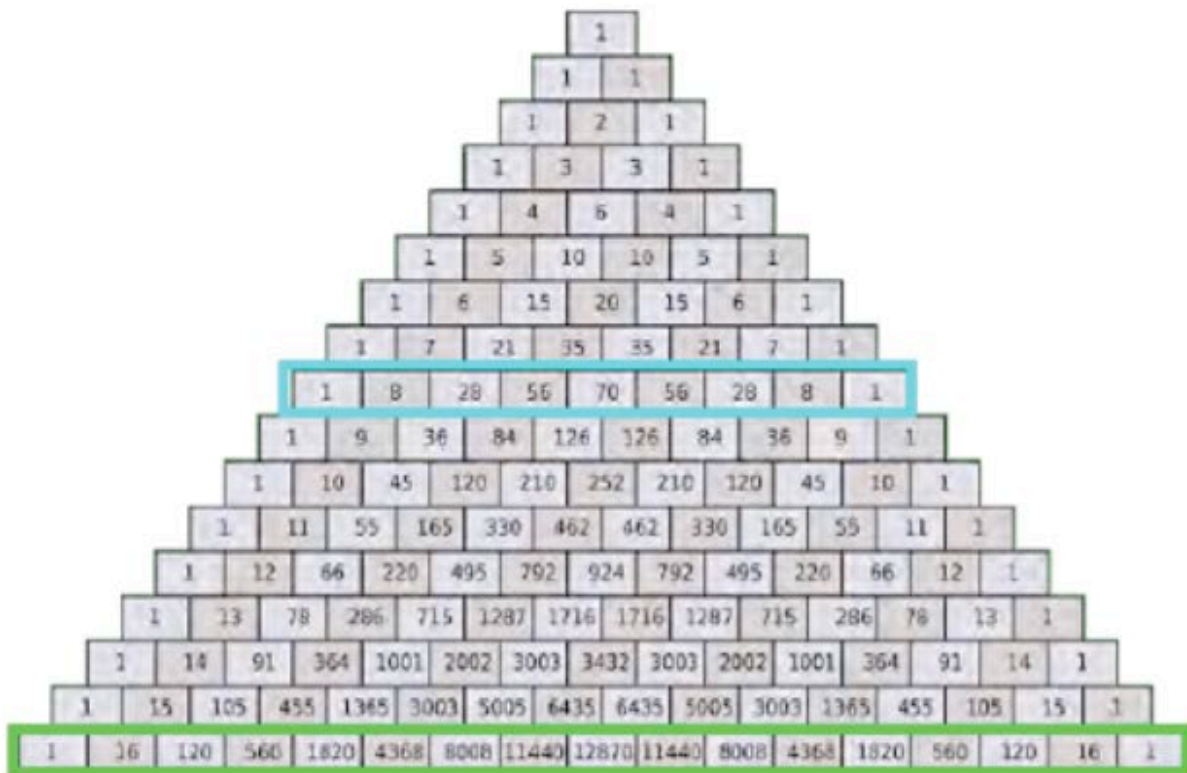

Square Pyramidal Number of order 16 = 1496 = 8 x 11 x 17

## Paternal Line and Cousins with Alexander the Great

22,000 BP - M35 leaves M96 and Africa to cross Mediterranean  
from the Nile Delta into the Middle East and Kosovo / Macedonia  
Manetho's Rule by Demigods and Spirits of the Dead (22,000 to 11,000 BP)  
ended after Ice Age when sea levels rose requiring agri-tech for survival  
Manetho's Rule of Mortal Humans began 11,000 BP  
which was about 25-26,000 years after the Geringa shock wave  
11,000 BP also had a supernova (Vela X) and the Sphinx was built.



8,000 BP - During Manetho's Rule of Mortal Humans (11,000 BP through now)  
330 BC - Cousins of my Paternal Y-DNA Line - Alexander the Great army goes East to  
India and South to Great Pyramid / Alexandria and then returns to Kosovo / Macedonia.

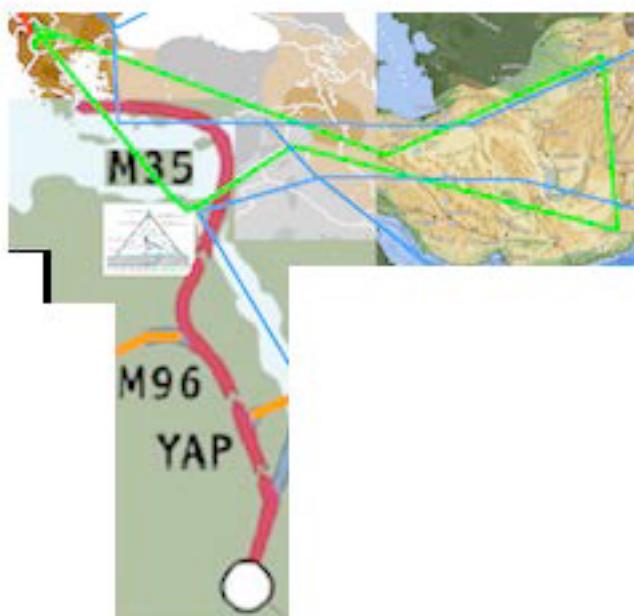

## Paternal Line Roman Legions, Radhanite Cousins, and End of Line

100 BC - Gaius Marius formed Roman Legions using Kosovars / Macedonians.

130 AD - Roman Legions controlled Danube / Rhine / Britain (up to Hadrian's Wall).

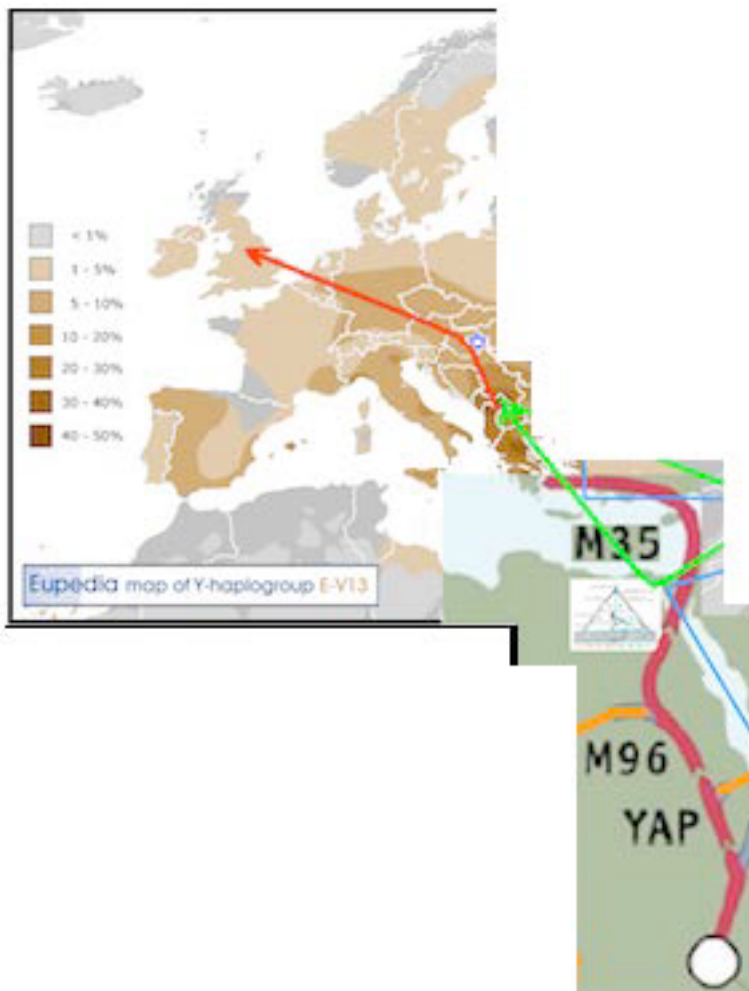

Cousins of my Paternal Y-DNA Line E-V13 that had evolved from M35:  
 300 AD - Hungarian Ashkenazim founded  
 500 AD - Ashkenazim in Hungary set up Radhanite Europe / Tang China trade

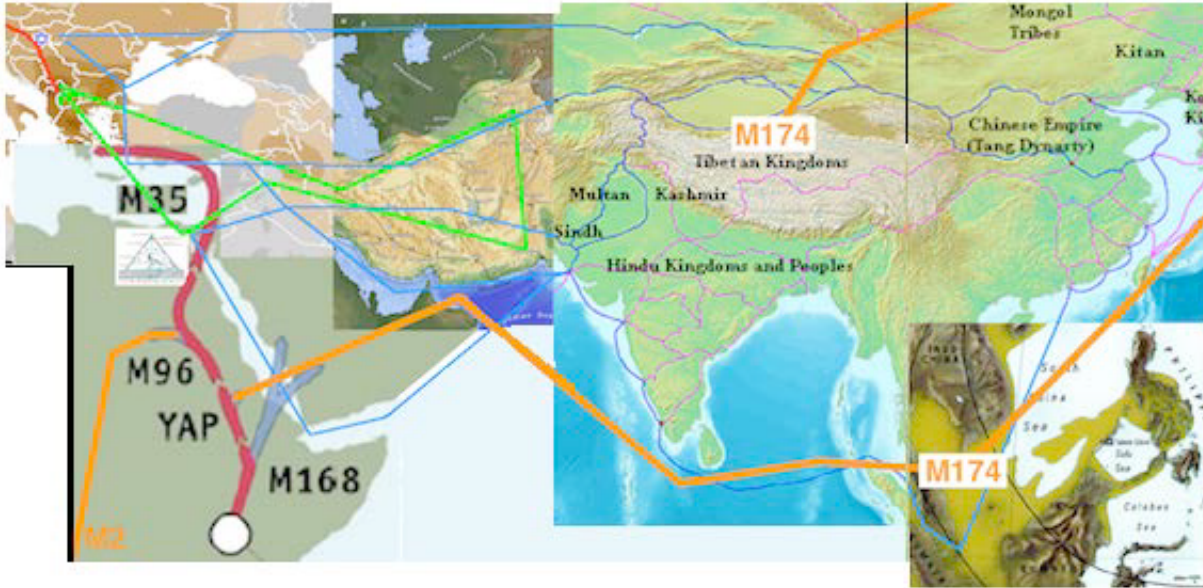

1000 AD - Tang Dynasty ended and Venice, Genoa, etc. succeeded Radhanites  
 1000-2000 AD - my European and African Ancestors came to America

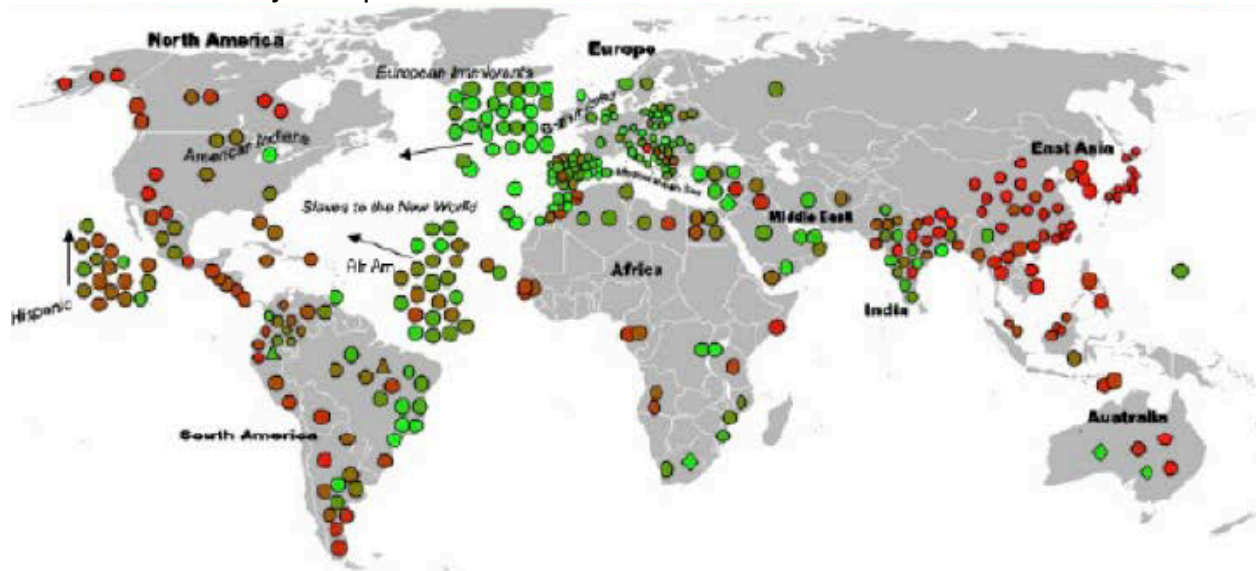

( my Michigan Native American Ancestors were already in America )

2017 AD - I Frank Dodd (Tony) Smith, Jr., am 76 years old, having been conceived on Shavuot, 6-7 Sivan, 5700 ( 12-13 June 1940 ) ( year of Metal and Dragon ) in the Braban Hotel in Cartersville, Georgia, USA,

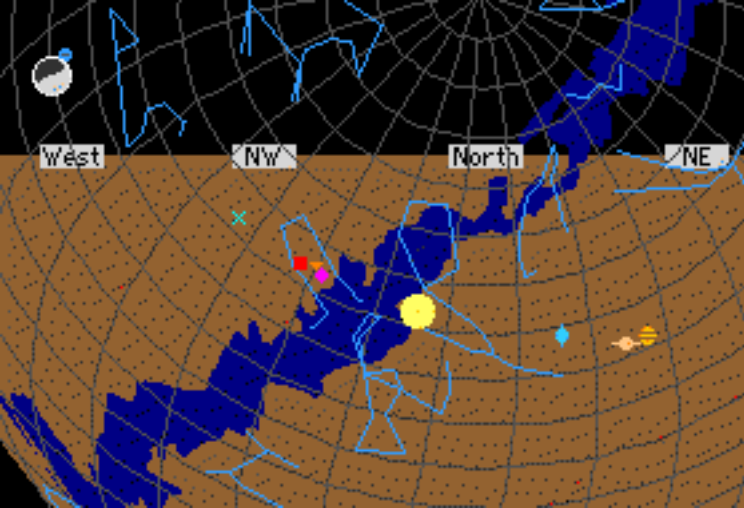

and born on Purim, 14 Adar, 5701 ( 13 March 1941 ) ( year of Metal and Snake ) in Cartersville, Georgia, USA, at about 1 AM Eastern Standard Time

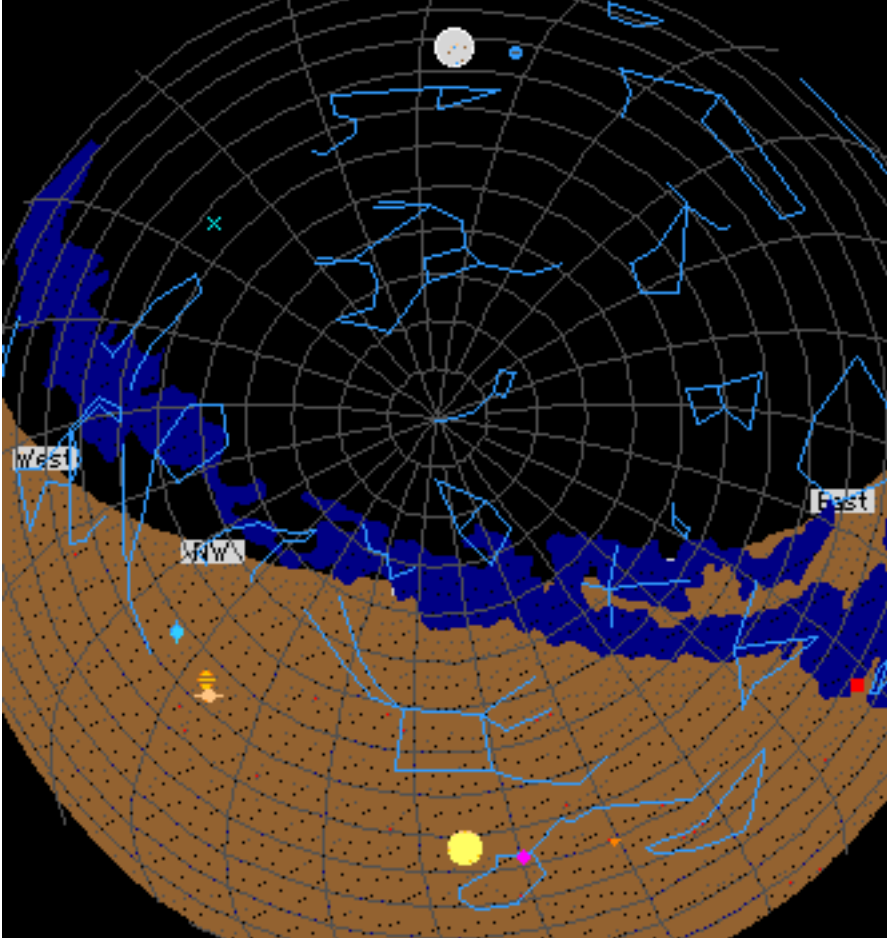

Since I have no issue,  
 my Paternal Y-DNA Line (and all my other Lines) ends with me  
 Frank Dodd (Tony) Smith, Jr. - AB Princeton 1963



Silver + Palladium

Ag = currency

Pd = Cold Fusion of  $D+D+D+D \rightarrow He + He + 48 \text{ MeV}$

Tiger Eye = Quartz  $SiO_2$  intergrown with

Goethite  $Fe_2O_3 \cdot H_2O$  = needle iron ore with Ferric  $Fe^{3+}$  Iron(III)  
 hydrated with  $nH_2O$  = Limonite

Iron = Steel Industry

Limonite =  $H_2O$  neutron absorption + Iron charged-particle absorption = Mike Shield



Operation Ivy  
 H-bomb Mike 82 tons 1 November 1952



### ADVANCED CALCULUS

by H. K. NICKERSON, D. C. SPENCER AND N. E. STEENROD  
 the honors course in Advanced Calculus ... Princeton University

#### TABLE OF CONTENTS

- I. THE ALGEBRA OF VECTOR SPACES
- II. LINEAR TRANSFORMATIONS OF VECTOR SPACES - leads to Lie Groups and Symmetric Spaces
- III. THE SCALAR PRODUCT
- IV. VECTOR PRODUCTS IN  $R^3$  - leads to Vector Products in  $R^7$
- V. ENDOMORPHISMS
- VI. VECTOR-VALUED FUNCTIONS OF A SCALAR
- VII. SCALAR-VALUED FUNCTIONS OF A VECTOR
- VIII. VECTOR-VALUED FUNCTIONS OF A VECTOR
- IX. TENSOR PRODUCTS AND THE STANDARD ALGEBRAS - leads to Clifford Algebras and Spinors
- X. TOPOLOGY AND ANALYSIS
- XI. DIFFERENTIAL CALCULUS OF FORMS
- XII. INTEGRAL CALCULUS OF FORMS
- XIII. COMPLEX STRUCTURE - leads to Potential Theory, Green's Functions, Bergman Kernels, Bounded Domains, and Schwinger Sources

This text has the basic background for my E8 Cl(16) Physics - viXra 1602.0319

# Cold Fusion - Deuterium in 147-atom Pd nanoclusters embedded in Zeolite Cages

Frank Dodd (Tony) Smith, Jr. - 2016 - viXra 1603.0098

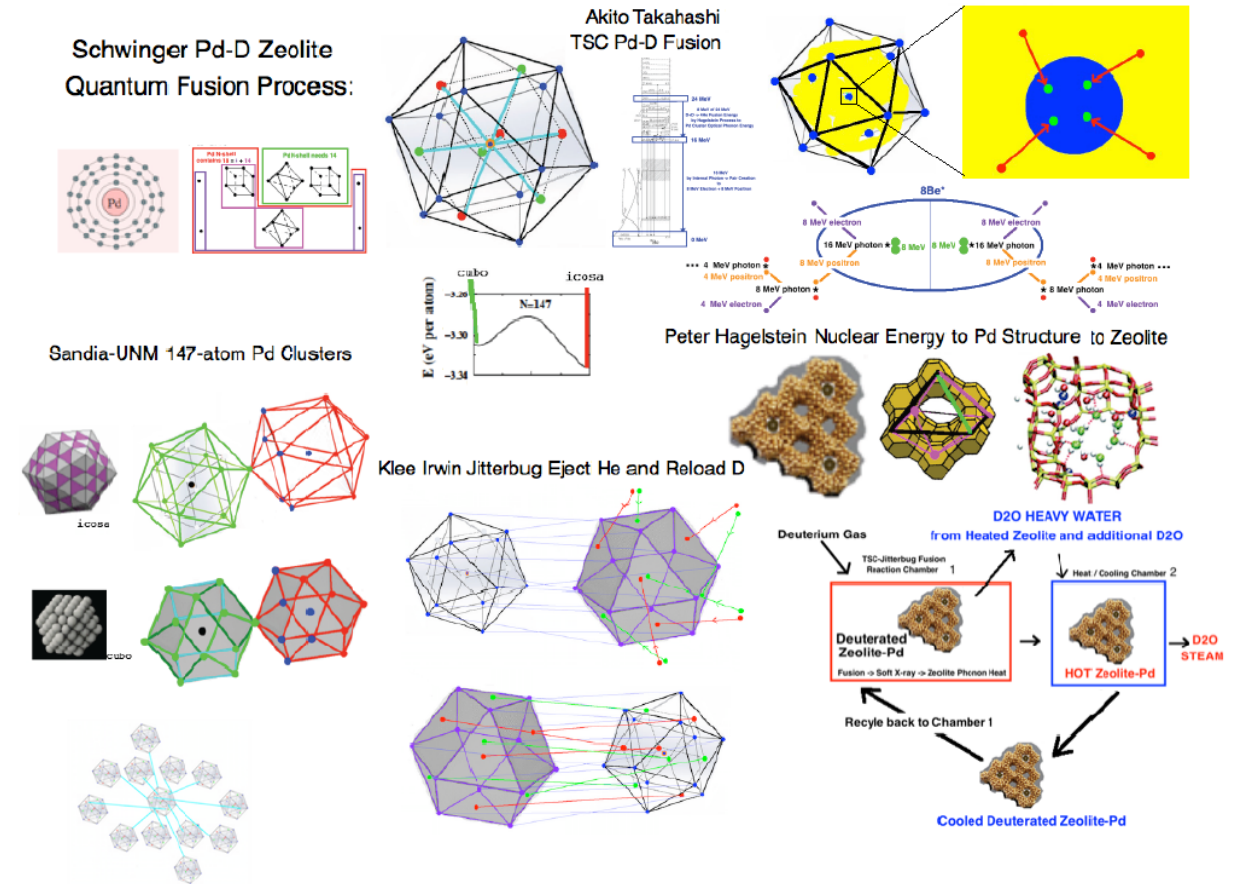

## Abstract:

147-atom Palladium clusters embedded in Zeolite cavities enable Cold Fusion when exposed to Deuterium gas by Klein Paradox Tunnelling of  $D+D+D+D$  producing  $He + He + 47.6$  MeV. Cold Fusion Energy goes to Optical Mode Phonons in the Pd clusters and then to the Zeolite where it is stored as Heat that is released by  $D_2O$  Heavy Water to produce useful energy. Ejection of  $He + He$  and reloading of  $D+D+D+D$  is done by Jitterbug transformation between Icosahedral Ground State and Cuboctahedral Metastable State of 147-atom Pd clusters. Synthesis of 147-atom Pd clusters has been done by Burton, Boyle, and Datye at Sandia / U. New Mexico, USA. Zeolite synthesis has been discussed by Sharma, Jeong, Han and Cho at Chungnam Nat. Un., Korea. Based on prior experimental results of Arata and Zhang (replicated by McKubre at SRI) and of Parchamazad the expected energy production is on the order of kilowatts per milligram of Palladium.



## Table of Contents:

How does Pd-D Cold Fusion Work ? ...	page 3
Why is Palladium uniquely useful for Deuterium Cold Fusion ? ...	page 4
What is the structure of the icosahedral 147-atom Pd cluster ? ...	page 7
In TSC Icosahedra of a Pd cluster 4 D form a Schwinger Coherent State ...	page 10
Schwinger State D nuclei go to the central Pd atom and by Klein Paradox Tunnelling 4 D nuclei undergo TSC Cold Fusion producing He + He + 47.6 MeV ...	page 11
47.6 MeV TSC Cold Fusion energy goes to Pd cluster Optical Phonons ...	page 15
Reloading D with Pd cluster Jitterbug from Icosahedron to Cuboctahedron ...	page 18
How much energy does TSC Cold Fusion produce ? ...	page 23
Zeolite Structure ...	page 24
Transfer of Energy from Pd Cluster Structure to Zeolite Structure ...	page 29
Extraction of Cold Fusion Energy from Zeolite Structure ...	page 30
Synthesis of 147-atom Pd clusters and Embedding into Zeolite ...	page 35
Global Energy and TSC-Jitterbug-Zeolite Fusion machines ...	page 37
Appendix A: Details of Structure of 147-atom Pd clusters ...	page 40
Appendix B: Graphene and Klein Paradox Quantum Tunnelling ...	page 47

## How does Pd-D Cold Fusion Work ?

Julian Schwinger in 1990 lecture at Universite de Bourgogne said:

**“... in the very low energy cold fusion, one deals essentially with a single state, described by a single wave function, all parts of which are coherent ...”.**

**Akito Takahashi proposed a process Tetrahedral Symmetric Condensation (TSC) that for 4 Deuterons (D) in an icosahedral cluster of Palladium (Pd) atoms produces a Schwinger coherent quantum state**

**that effectively distributes the electron population among deuterons** so that the Coulomb barrier is eliminated and the four Deuterium (D) nuclei can simultaneously interact and fuse, forming two  $4\text{He}$  nuclei plus 47.6 MeV energy.

Peter Hagelstein used phonon models for Relativistic Coupling Between Lattice Vibrations and Nuclear Excitation, enabled by break-down of Foldy-Wouthuysen transformation due to 8-15 THz Lattice Vibration Modes, to show direct transfer of the 47.6 MeV energy of Cold Fusion to the Pd lattice as excited optical phonon modes.

**The only Cold Fusion experiments producing heat consistently and reproducibly are the detections of heat using Pd Clusters and Deuterium gas**

**by Arata and Zhang ( replicated by McKubre at SRI ) and by Iraj Parchamazad.**

Arata and Zhang ( and SRI ) used Palladium black with initial cluster sizes distributed around 5 nm so that a substantial number of Pd clusters had diameter 1.5 nm.

However, clumping increased the cluster size to around 40 nm at which size Takahashi et al said, based on their similar work, the “heat-power level drop[ped]... drastically”.

( see Current Science 108 (25 Feb 2015) LENR Special Section Preface )

Iraj Parchamazad and Melvin Miles avoided the clumping problem by growing the Pd clusters within Zeolite cavities. Using Sodium Zeolite Y whose cavity size is around 1.2 nm ( but capable of expansion by about a factor of 2 ), they produced Pd clusters of 1.5 nm size size which were dispersed within the Zeolite cavities thus preventing clumping. Upon exposure of his Pd clusters in Zeolite to Deuterium gas, he produced heat in 10 out of 10 experiments with

**Cold Fusion Energy on the scale of kiloWatts per milligram of Palladium.**

( see [coldfusionnow.org/iraj-parchamazad-lenr-with-zeolites/](http://coldfusionnow.org/iraj-parchamazad-lenr-with-zeolites/) )

**1.5 nm diameter Pd clusters have 147 atoms and can be in two states: an Cuboctahedral Metastable State and an Icosahedral Ground State**

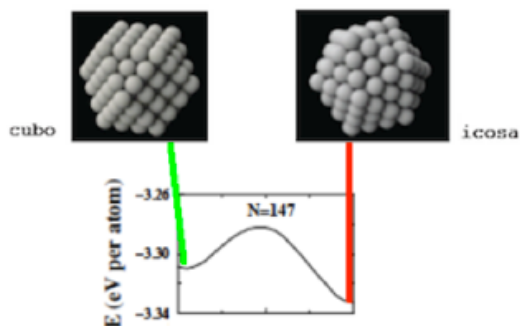

**that can transform into each other by a Fuller Jitterbug Transformation.**

# Why is Palladium uniquely useful for Deuterium Cold Fusion ?

Pd has uniquely closed electron shell structure.

Wikipedia says (I added red material specifically about Pd): “...

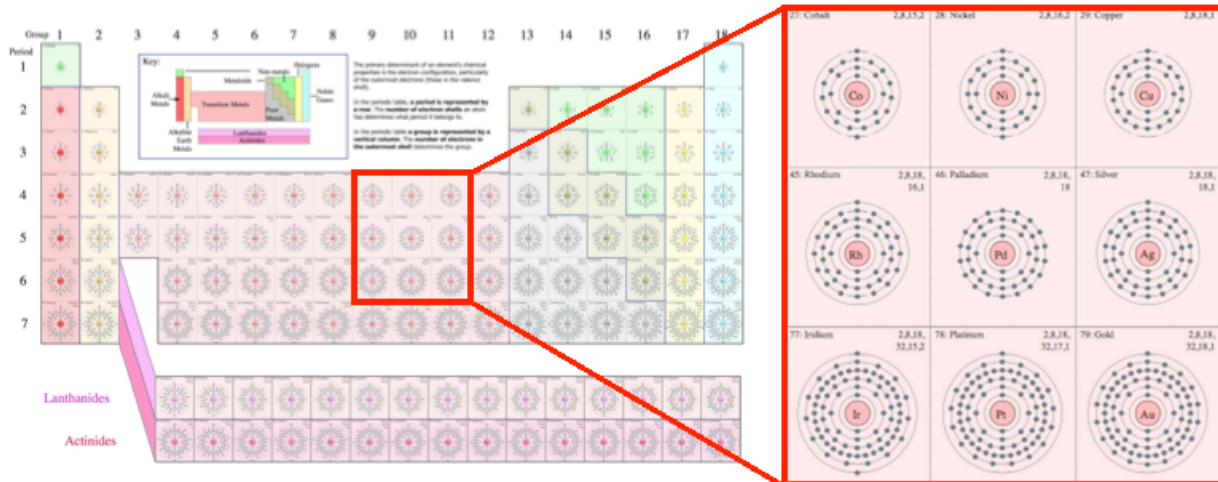

... Each s subshell holds at most 2 electrons  
 Each p subshell holds at most 6 electrons  
 Each d subshell holds at most 10 electrons  
 Each f subshell holds at most 14 electrons  
 Each g subshell holds at most 18 electrons ...

Shell name	Subshell name	Subshell max electrons	Shell max electrons
K	1s	2	2
L	2s	2	2 + 6 = 8
	2p	6	
M	3s	2	2 + 6 + 10 = 18
	3p	6	
	3d	10	
N	4s	2	2 + 6 + 10 + 14 = 32
	4p	6	
	4d	10	
	4f	14	

## Palladium

2

2+6 = 8

2+6+10 = 18

2+6+10 = 18



... palladium (atomic number 46) has no electrons in the fifth shell, unlike other atoms ...[in its periodic table neighborhood]...”

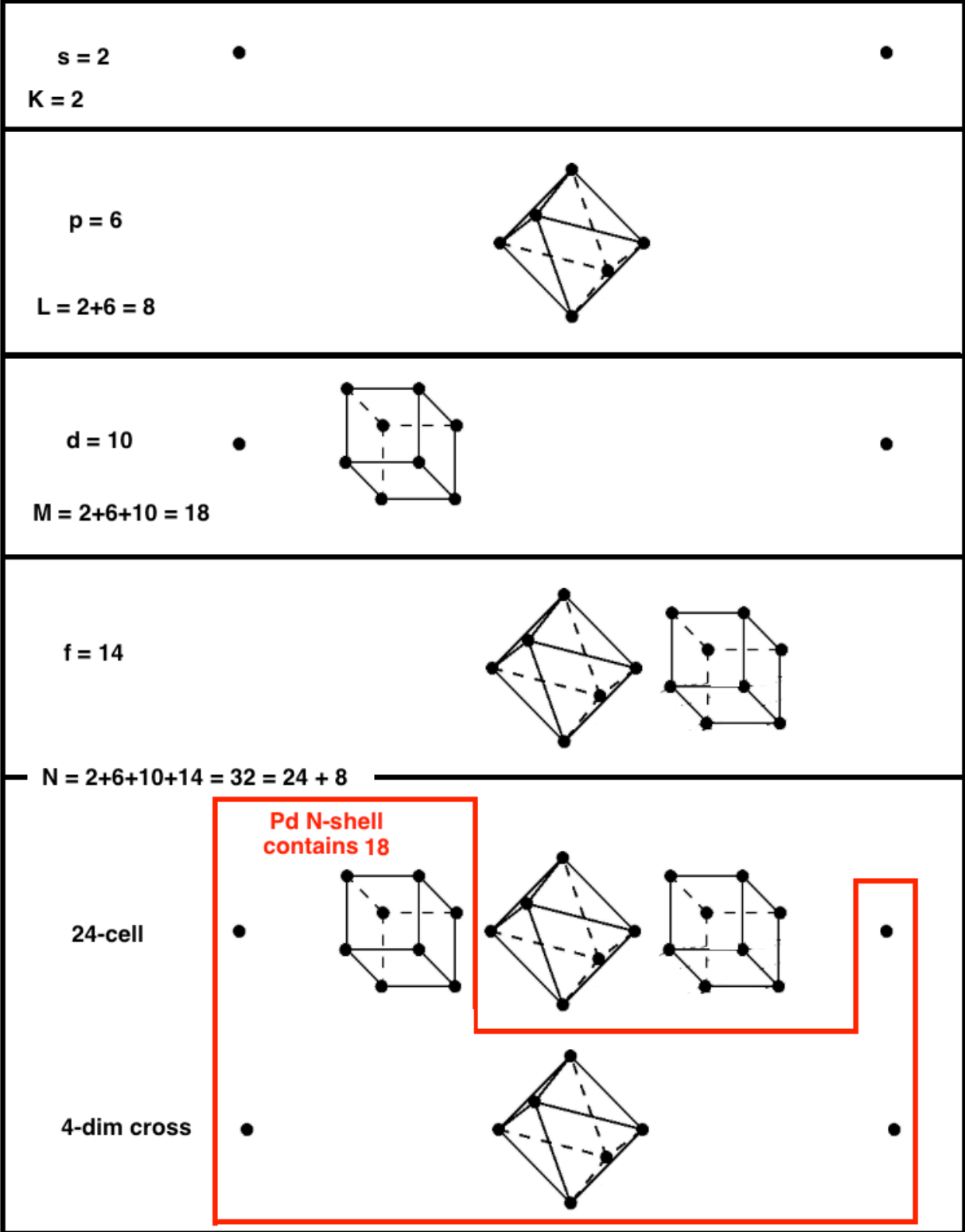

( 24-cell image from John Baez review of "On Quaternions and Octonions" by Conway and Smith )

Geometrically:

2 of the First Shell correspond to the Root Vectors of  $B_1 = \text{Spin}(3)$

8 of the Second Shell correspond to the Root Vectors of  $B_2 = \text{Spin}(5)$

18 of the Third Shell correspond to the Root Vectors of  $B_3 = \text{Spin}(7)$

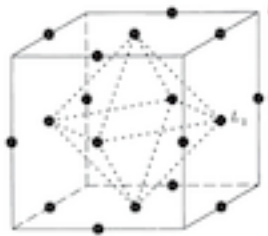

( image from Representation Theory by Fulton and Harris )

The  $B_3$  Root Vectors live in 3-dim space, which is where Element Electron Shells live.

32 of the Fourth Shell correspond to the Root Vectors of  $B_4 = \text{Spin}(9)$

**Palladium is the only element whose outer shell has more electrons than the 8 electrons of noble gases beyond Helium.**

**The 18 electrons in the outer shell of Palladium replicate the full state of the Third Shell ( M shell ).**

## What is the structure of the icosahedral 147-atom Pd cluster ?

The icosahedral 147-atom ground state has 12 exterior icosahedra and a central icosahedron with 12 interior vertices which are the innermost vertices of 12 exterior TSC Fusion site icosahedra:

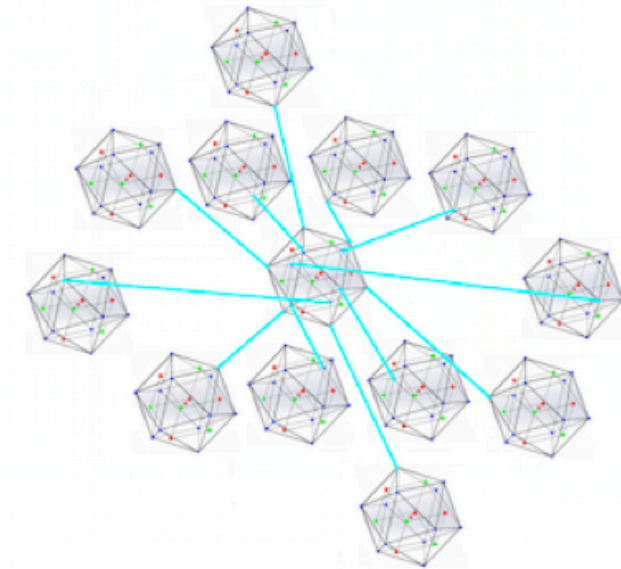

The 12 exterior icosahedra each have outer faces on the outer boundary of the 147-atom cluster.

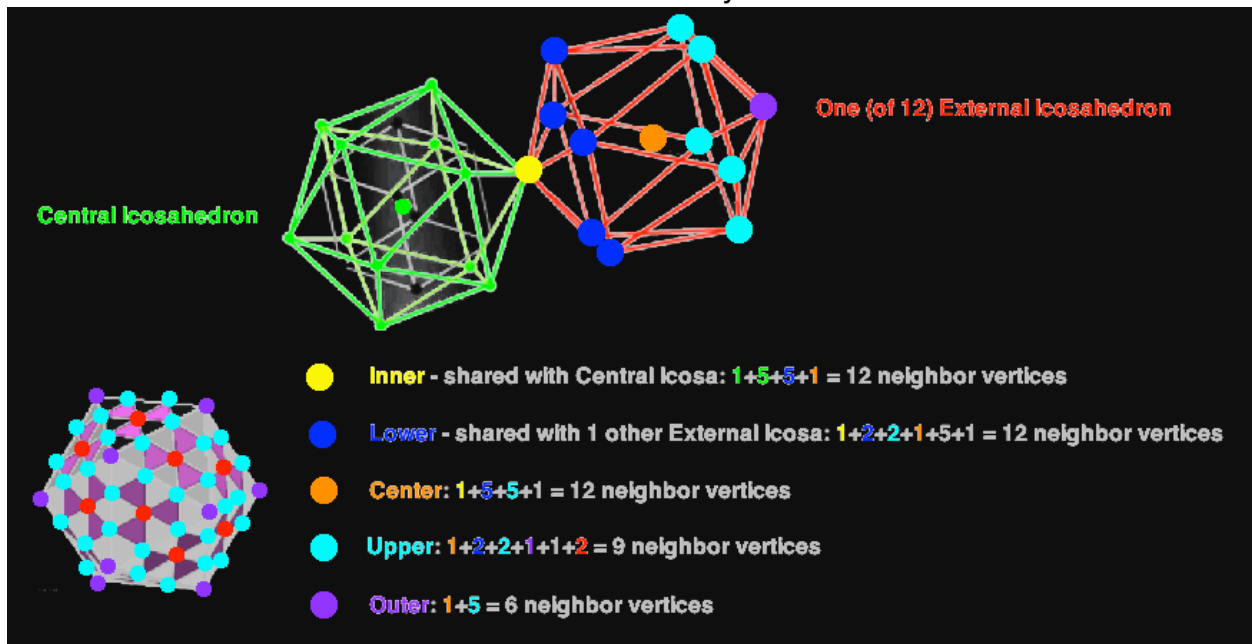

$$147 = 1+12+30+12+72+20:$$

1 atom is at the cluster center

12 atoms surround the cluster center

$5 \times 12 / 2 = 30$  atoms are in the next layer out

12 atoms are at centers of exterior icosahedra

$12 \times 6 = 72$  atoms are on outer surface of exterior icosahedra

20 atoms are on outer surface between exterior icosahedra

The 20 Exterior-Face-Center Pd atoms each have  $3+6 = 9$  neighbors.

Each of the 12 exterior icosahedra of the 147-atom cluster has 13 Pd atoms:

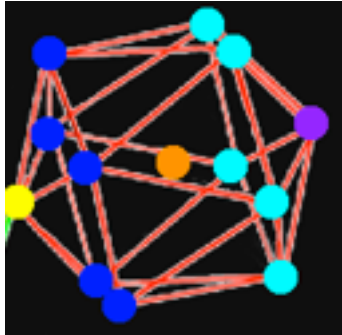

How do the Palladium atoms in a cluster interact with each other ?

The interaction is primarily through the outer shell of electrons ( N-shell for Palladium ).

A full N-shell has  $s + p + d + f = 2 + 6 + 10 + 14 = 32$  electrons.

Palladium N-shell has  $2 + 6 + 10 = 18$  electrons and “holes” to receive 14 electrons:

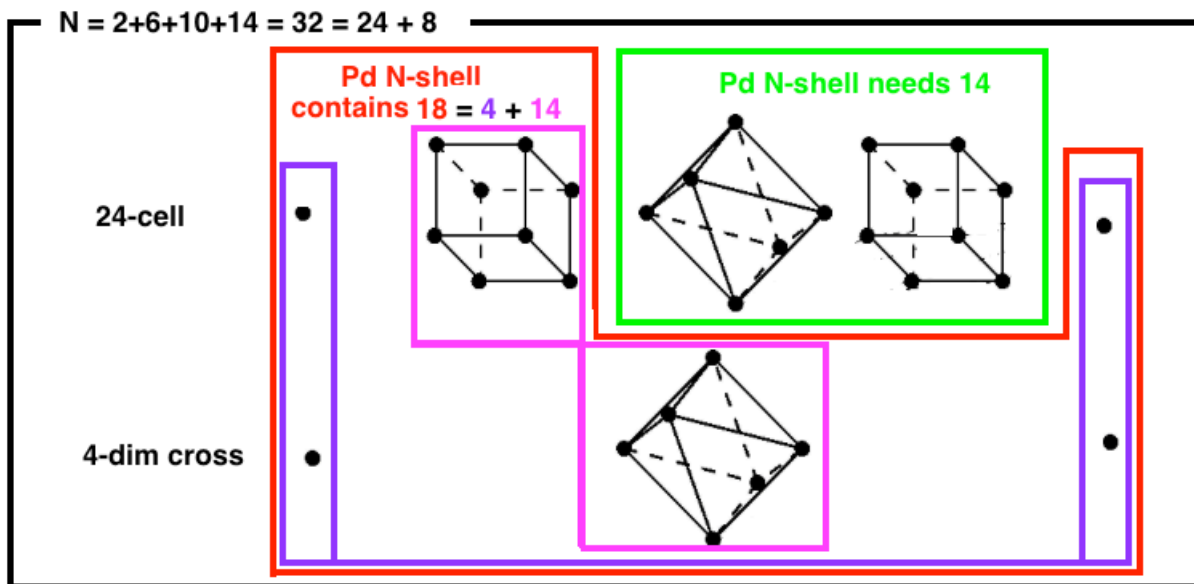

Each Palladium atom has  $18-14 = 4$  N-shell electrons that can interact with 4 electrons of 4 Deuterium atoms absorbed into a Pd cluster, helping them to participate in a Schwinger coherent quantum state for TSC Fusion.

Further, each Palladium atom has 14 N-shell electrons 12 to fill needs of other Pd atoms and 2 for a Dirac Fermion Band for Klein Paradox Tunnelling.

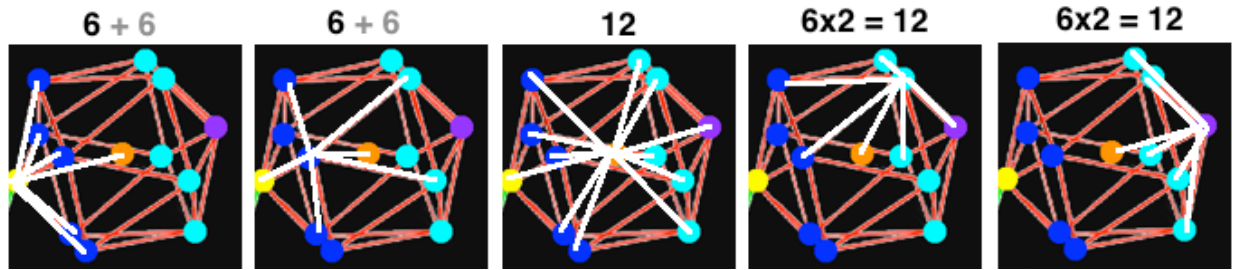

**6x2 = 12:** For the **1** exterior vertex Pd with 6 neighbors, all 6 of which are in the icosahedron, 12 electrons go 2 to each icosahedron neighbor and  $14-12 = 2$  electrons go to a Dirac Fermion Band for Klein Paradox Tunnelling. It receives 12 electrons, 2 from each of its **1**+5 = 6 icosahedron neighbors leaving 2 holes related to Dirac Fermion Band for Klein Paradox Tunnelling.

**6x2 = 12:** For each of the **5** exterior surface Pd with 9 neighbors, **2**+**1**+**2**+**1** = 6 of which are in the icosahedron, 12 electrons go 2 to each icosahedron neighbor and  $14-12 = 2$  electrons go to a Dirac Fermion Band for Klein Paradox Tunnelling. It receives 12 electrons, 2 from each of its **2**+**1**+**2**+**1** = 6 icosahedron neighbors leaving 2 holes related to Dirac Fermion Band for Klein Paradox Tunnelling.

**12:** For the **1** central Pd with 12 neighbors, all 12 of which are in the icosahedron, 12 electrons go 1 to each icosahedron neighbor and  $14-12 = 2$  electrons go to a Dirac Fermion Band for Klein Paradox Tunnelling. It receives 12 electrons, one from each of its **1**+**5**+**5**+**1** = 12 icosahedron neighbors leaving 2 holes related to Dirac Fermion Band for Klein Paradox Tunnelling.

**6 + 6:** For each of the **5** interior Pd shared with 1 other icosahedron and with 12 neighbors, **1**+**2**+**1**+**2** = 6 of which are in the icosahedron, 6 electrons go 1 to each icosahedron neighbor and  $14-6 = 8$  electrons go 2 to a Dirac Fermion Band for Klein Paradox Tunnelling and 6 to the other icosahedron. It receives  $6+6 = 12$  electrons, 1 from each of its **1**+5 = 6 icosahedron neighbors and 6 from the other icosahedron, leaving 2 holes related to Dirac Fermion Band for Klein Paradox Tunnelling.

**6 + 6:** For the **1** interior Pd shared with the central icosahedron and with 12 neighbors, **5**+**1** = 6 of which are in the icosahedron, 6 electrons go 1 to each icosahedron neighbor and  $14-6 = 8$  electrons go 2 to a Dirac Fermion Band for Klein Paradox Tunnelling and 6 to the central icosahedron. It receives  $6+6 = 12$  electrons, 1 from each of its **5**+**1** = 6 icosahedron neighbors and 6 from the central icosahedron, leaving 2 holes related to Dirac Fermion Band for Klein Paradox Tunnelling.

**All 13 Pd atoms in the icosahedron have  $18-14 = 4$  electrons for TSC condensation guidance.**



## In TSC Icosahedra of a Pd cluster 4 D (D+D+D+D) form a Schwinger Coherent Quantum State

From a classical approximation point of view there are  $12+1 = 13$  Pd nuclei (blue) within which there is a 2-tetrahedral configuration of 4 D nuclei (red) and 4 D electrons (green)

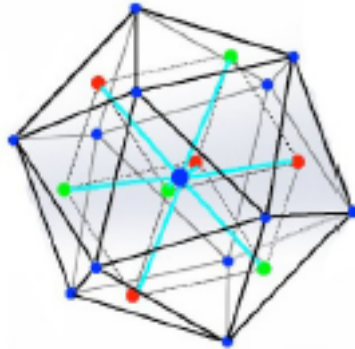

In the Schwinger coherent quantum state (yellow) the 4 D nuclei and 4 D electrons are smeared out all over the interior of the icosahedral TSC cell

and

the 4 D electrons screen out the positive charge of the 4 D nuclei making the Schwinger coherent quantum cloud effectively neutral with no Coulomb repulsion or attraction.

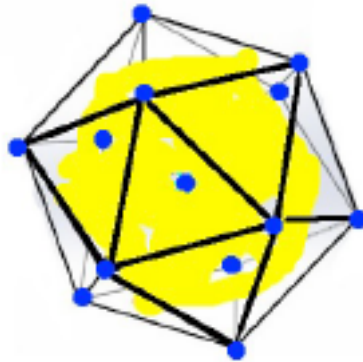

**The process of forming the Schwinger State which collapses to the central Pd atom**

**where Deuterium nuclei undergo Cold Fusion is called by Akito Takahashi Tetrahedral Symmetric Condensation (TSC).**

**The D Schwinger State nuclei go to the central Pd atom  
and by Klein Paradox Tunnelling 4 D nuclei undergo TSC Cold Fusion  
producing 4He + 4He + 47.6 MeV**

Now look at the central Pd atom in the TSC cell.

Its outer electron shell of 18 electrons has 4 free electrons

(14 of them being bound to the outer 12 Pd atoms plus 2 forming a Dirac Fermion Band)

which 4 free electrons pull the 4 D nuclei out of the Schwinger quantum cloud  
into the Central Pd Atom

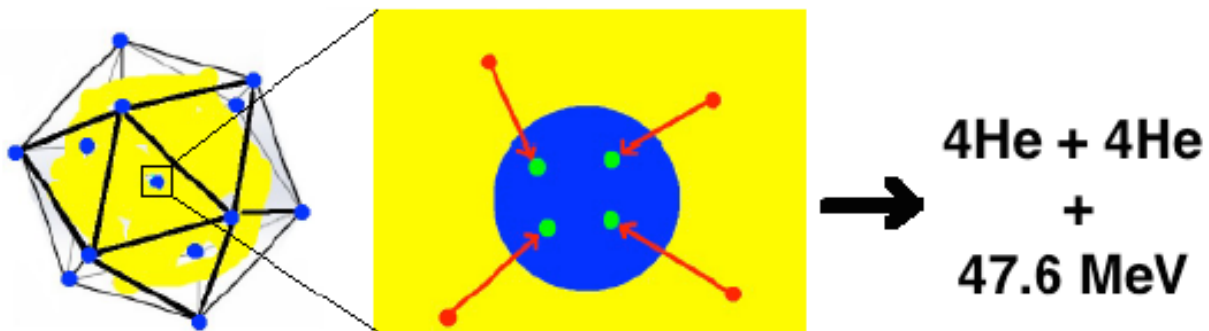

When the 4 D nuclei get into the small volume of the Central Pd Atom  
they “see” each other as repulsive like electrical charges  
resulting in a very high Coulomb barrier between them

but

that is when the Dirac Fermion Band takes effect  
and gets them to rapidly penetrate the barrier by Klein Paradox Tunnelling

( see Appendix for deescription of Klein Paradox Tunnelling )

and

then all 4 Deuterium nuclei undergo TSC Fusion to produce energy + 2 Helium nuclei  
which then pick up the left-over 4 Deuterium electrons to form 2 Helium atoms.

Takahashi said, about his TSC process  $4D \rightarrow 8Be^* \rightarrow 4He + 4He + 47.6 \text{ MeV}$ :

“... Immediately at ...  $8Be^*$  formation ...

4d-cluster shrinks to much smaller size (about 2.4 fm radius) of  $8Be^*$  nucleus,  
and four electrons should go outside due to the Pauli's repulsion for fermions.

Shortly in about few fs or less (note; Lifetime of  $8Be$  at ground state is 0.67 fs),

$8Be^*$  will break up into two  $4He$  particles . ...”

plus energy release of 47.6 MeV.

In more detail:

The  $D + D + D + D$  (two pairs of green dots) form an  $8\text{Be}$  nucleus.

The  $e + e + e + e$  (two pairs of red dots) form the electrons of an  $8\text{Be}$  atom.

All of them ( $D + D + D + D + e + e + e + e$ ) are in a single Coherent Quantum State.

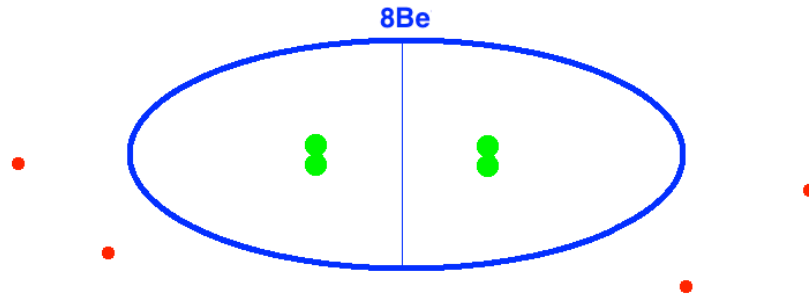

Two of the  $D$  ( one half of the  $8\text{Be}$  nucleus ) undergo TSC Fusion to produce about 24 MeV which excites the  $8\text{Be}$  nuclear state to  $8\text{Be}^*$  .

About 8 MeV goes from the  $8\text{Be}^*$  excited nuclear state by the Hagelstein Process to Pd Cluster Optical Phonon Energy.

About 16 MeV goes by Internal Photon Pair Creation to an 8 MeV Electron + 8 MeV Positron Pair.

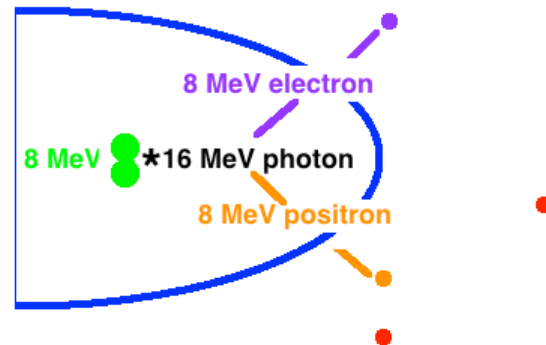

The 8 MeV Positron annihilates one of the coherent Electrons

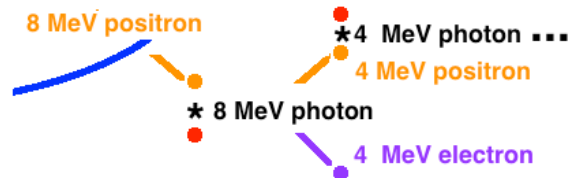

producing an 8 MeV photon which creates a 4 MeV Electron + 4 MeV Positron Pair with the 4 MeV Positron annihilating the other of the two relevant coherent Electrons.

Effectively the two zero kinetic energy coherent Electrons (red dots)

are replaced by an 8 MeV Electron + a 4 MeV Electron (purple dots)

whose 12 MeV kinetic energy becomes vibrational energy of the Pd Cluster.

The  $16 - 12 = 4$  MeV photon may continue the annihilation to vibrational energy process.

The other half of the  $8\text{Be}$  structure will undergo the TSC Fusion energy process in the same way at a slightly different time.

Here is a more detailed  $^8\text{Be}$  energy level chart:

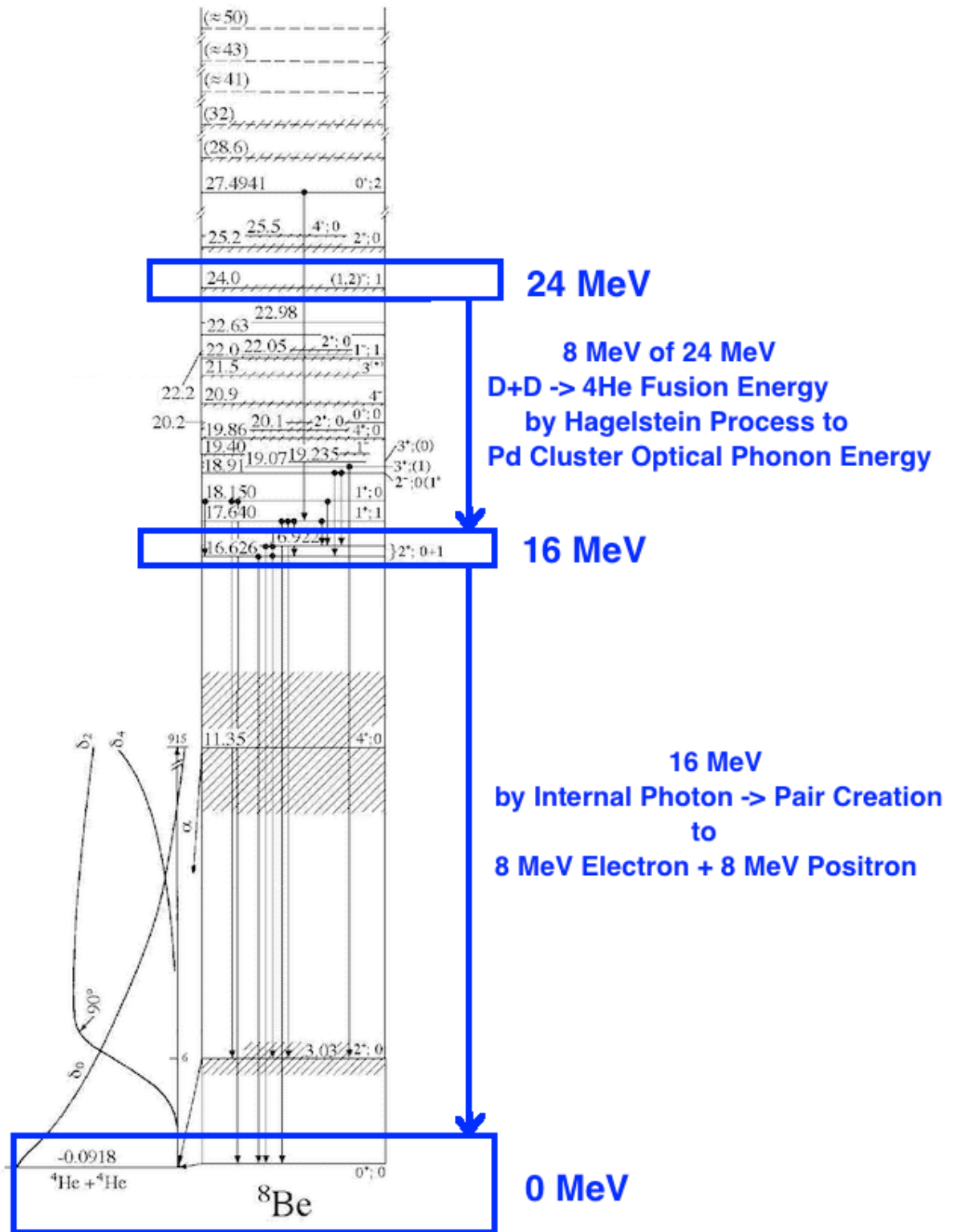

(image from "Energy Levels of Light Nuclei A = 8" by Tilley, Kelley, Godwin, Millener, Purcell, Sheu, and Weller 2012)

The overall process looks like this:

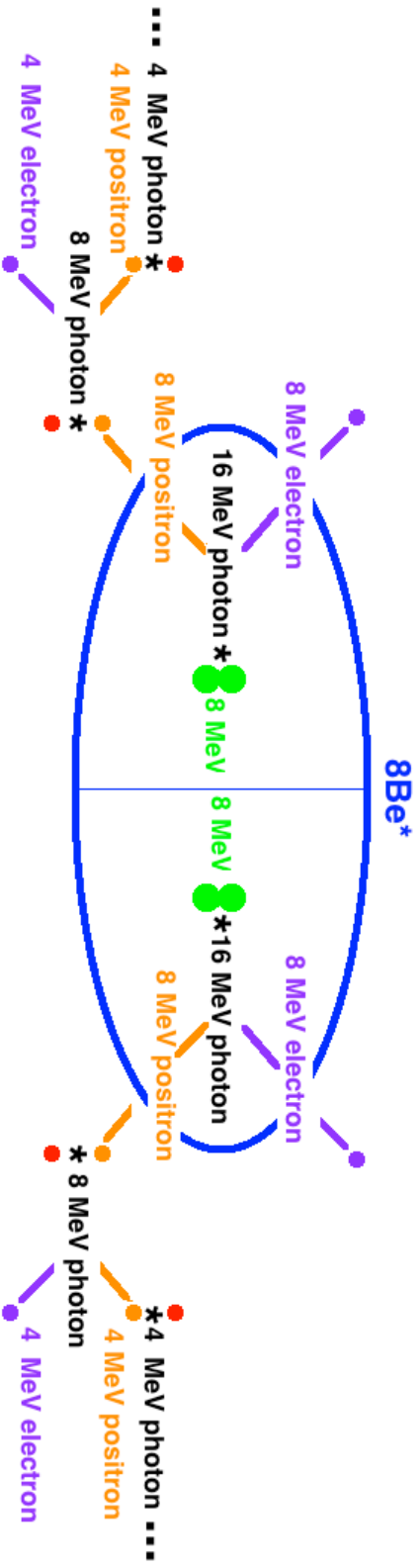

## 47.6 MeV TSC Cold Fusion energy goes to Pd cluster Optical Phonons

Hagelstein and Chaudhary in ICCF 18 (Missouri 2013) Poster:

**Relativistic Coupling Between Lattice Vibrations and Nuclear Excitation** said:

“... for relativistic dynamics ... the fundamental theory includes a very strong coupling between the center of mass momentum operator, and internal nuclear transitions.

This coupling is connected to changes in the internal structure of a composite when it moves (as a result of the Lorentz transform), compared to the rest frame wavefunction.

Under normal conditions a generalized Foldy-Wouthuysen transformation eliminates this strong coupling, which results in a model in the rotated frame with no residual first-order interaction. As a result, one would expect generally not expect any significant coupling to survive.

The conditions under which any residual coupling would be expected are the same conditions where the generalized Foldy-Wouthuysen rotation "breaks down" ...

in that it becomes very difficult to deal with the loss operator in the rotated picture.

Under conditions where the Foldy-Wouthuysen transformation "breaks down" in this sense due to the presence of a strong Brillouin-Wigner loss operator, there exists no useful general nonrelativistic limit. In this case,

**the strong coupling between the center of mass momentum and internal nuclear states remains, and can be used for coherent dynamical processes. ...”.**

Wikipedia says: “... **Optical phonons** are out-of-phase movements of the atoms in the lattice, one atom moving to the left, and its neighbour to the right. This occurs if the lattice basis consists of two or more atoms. They are called *optical* because in ionic crystals, like sodium chloride, they are excited by infrared radiation. The electric field of the light will move every positive sodium ion in the direction of the field, and every negative chloride ion in the other direction, sending the crystal vibrating. Optical phonons have a non-zero frequency at the Brillouin zone center and show no dispersion near that long wavelength limit. This is because they correspond to a mode of vibration where positive and negative ions at adjacent lattice sites swing against each other, creating a time-varying electrical dipole moment. Optical phonons that interact in this way with light are called *infrared active*. Optical phonons that are *Raman active* can also interact indirectly with light, through Raman scattering. Optical phonons are often abbreviated as LO and TO phonons, for the longitudinal and transverse modes respectively; the splitting between LO and TO frequencies is often described accurately by the Lyddane-Sachs-Teller relation.

When measuring optical phonon energy by experiment, optical phonon frequencies are sometimes given in spectroscopic wavenumber notation, where the symbol  $\omega$  represents ordinary frequency (not angular frequency), and is expressed in units of  $\text{cm}^{-1}$ . The value is obtained by dividing the frequency by the speed of light in vacuum. In other words, the frequency in  $\text{cm}^{-1}$  units corresponds to the inverse of the wavelength of a photon in vacuum, that has the same frequency as the measured phonon. The  $\text{cm}^{-1}$  is a unit of energy used frequently in the dispersion relations of both acoustic and optical phonons ...”.

Hagelstein and Chaudhary in Current Science 108 (25 Feb 2015): Low Energy Nuclear Reactions : Phonon Models for Anomalies in Condensed Matter Nuclear Science said: "... a... new physics model which addresses the fractionation of a large quantum; and a new fundamental Hamiltonian which describes the coupling between vibrations and internal nuclear degrees of freedom ...

the nuclear energy quantum is fractionated into much smaller quanta, which can go into vibrational modes.

For this to work in the model, the vibrational modes first need to be highly excited

...

deuterons are responsible in fractionating the nuclear quanta in operation with excited optical phonon modes, and the deuterons can accomplish this cleanly. However, THz acoustic mode excitation would also be expected to produce fractionation with participation of the host Pd nuclei, which do not fractionate cleanly (leading to disintegration of the Pd nuclei) ...

there is a strong coupling between the vibrational degree of freedom and internal nuclear degrees of freedom implicit in a relativistic model, but this coupling is normally eliminated by a generalized Foldy–Wouthuysen transformation ...

The fundamental relativistic Hamiltonian under discussion is

$$\hat{H} = \sum_j (Mc^2 + \mathbf{a} \cdot c\hat{\mathbf{p}})_j + \sum_k \frac{|\hat{\mathbf{p}}_k|^2}{2m} + \sum_{j < j'} \frac{Z_j Z_{j'} e^2}{4\pi\epsilon_0 |\mathbf{R}_j - \mathbf{R}_{j'}|} + \sum_{k < k'} \frac{e^2}{4\pi\epsilon_0 |r_k - r_{k'}|} - \sum_{jk} \frac{Z_j e^2}{4\pi\epsilon_0 |\mathbf{R}_j - \mathbf{r}_k|} \quad (5)$$

If we use a Born–Oppenheimer approximation, then the lattice nuclear problem that remains is

$$\hat{H} = \sum_j (Mc^2 + \mathbf{a} \cdot c\hat{\mathbf{p}})_j + \sum_{j < k} V(\mathbf{R}_j - \mathbf{R}_k) - \frac{i\hbar \hat{\mathbf{M}}(E)}{\hbar}, \quad (6)$$

where we have augmented the normal Born–Oppenheimer model with a loss term due to coupling with the electrons.

... we have in this a starting place to analyse coherent energy exchange between nuclei and vibrations under conditions of fractionation ...

phonon - nuclear coupling matrix element... in the case of the D2 / 4He transition ... is consistent in magnitude with what is needed to account for the rate at which excess heat is observed in experiments

...

Fractionation is easier when fewer oscillator quanta are involved, so we would expect the highest frequency vibrational modes to be involved (THz frequency vibrations).

There is only a weak coupling between vibrations and the D2 / 4He transition ...

the D2 / 4He transition occurs with a single phonon exchange with the large nuclear energy quantum transferred to other more strongly coupled transitions and subdivided (many nuclear excitations for a single D2 / 4He de-excitation),

and subsequently fractionated to optical phonons ...excess heat is basically 'silent' (in that there is nothing energetic emitted in the primary reaction) ...

The rate of fractionation without subdivision then has to match the energy release rate.

For example, if the system produces excess heat at the 1 W level,

then there are  $2.6 \times 10^{11}$  reactions/sec and it must take  $3.8 \times 10^{-12}$  sec for each of

the large 24 MeV quanta to be fractionated. If the optical phonon mode has an energy of 36 MeV, then the average time associated for the net transfer of a single phonon in connection with fractionation must be  $5.7 \times 10^{-21}$  sec. These numbers are consistent with the models we have studied over the years

...

If the nuclear system is treated relativistically, there is a very strong coupling present between the vibrational and internal nuclear degrees of freedom ...

there exists a unitary transformation that eliminates this very strong first-order coupling. Under conditions where this unitary transformation is useful, the vibrational and nuclear degrees of freedom are nearly independent ...

when the ... destructive interference ...[of]... the unitary transformation which eliminates the strong first-order coupling ... is spoiled ... there will be a[n]... enhanced rate for coherent energy exchange under conditions of fractionation ...

**a highly excited vibrational mode ... remove[s]... the destructive interference ...”.**

Letts in Current Science 108 (25 Feb 2015): Low Energy Nuclear Reactions : Dual Laser Stimulation says: “... PdD lattice vibrations might occur around 8 and 15 THz ...”.

8 - 15 THz Pd-D Fusion Frequency is interestingly coincident with:

Critical Temperature of BSCCO superconducting crystals

Beck - Mackey Dark Energy Josephson Junction Frequency

Energy of Neutrino Masses



## Reloading D with Pd cluster Jitterbug from Icosahedron to Cuboctahedron

Icosahedra and Cuboctahedra both have 12 vertices so that it is possible to transform them into each other. Buckminster Fuller called that transformation the Jitterbug

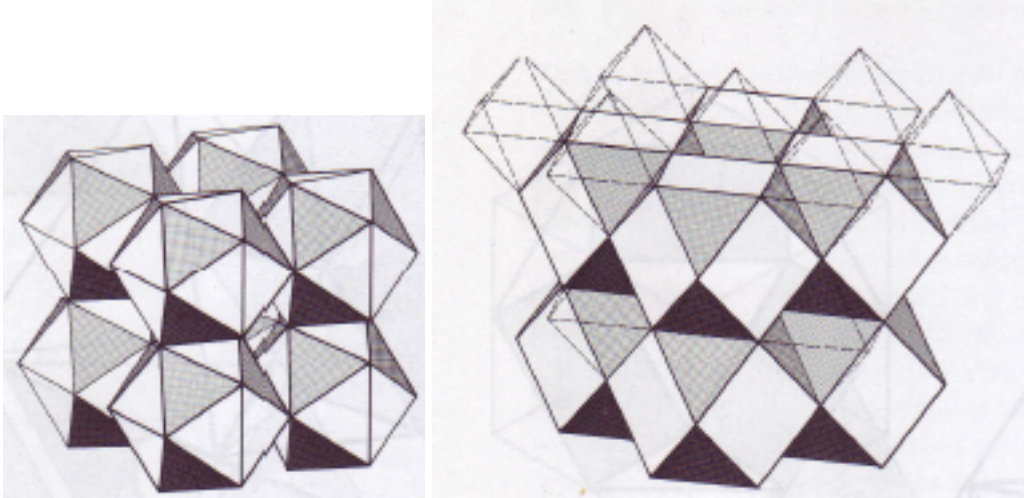

(images from Synergetics by Buckminster Fuller (Macmillan 1975, 1982))

To make Cuboctahedra (unit edge length) from Icosahedra (unit edge length) choose 6 pairs of Icosahedra triangle faces (white in the above images) and lengthen the common edge of each pair by a factor of  $\sqrt{2}$ . That expansion flattens each of the triangle pairs to produce 6 square faces of the Cuboctahedron. The other Icosahedral  $20 - 2 \times 6 = 8$  (shaded) triangle faces are rotated and become the other  $14 - 6 = 8$  triangle faces of the Cuboctahedron.

thus decreasing the number of faces from  $20 = 8 + (6 + 6)$  to  $8 + 6 = 14$  while keeping the number of vertices constant at 12.

The triangle faces of the Icosahedron/Cuboctahedron are rotated by a Golden Ratio

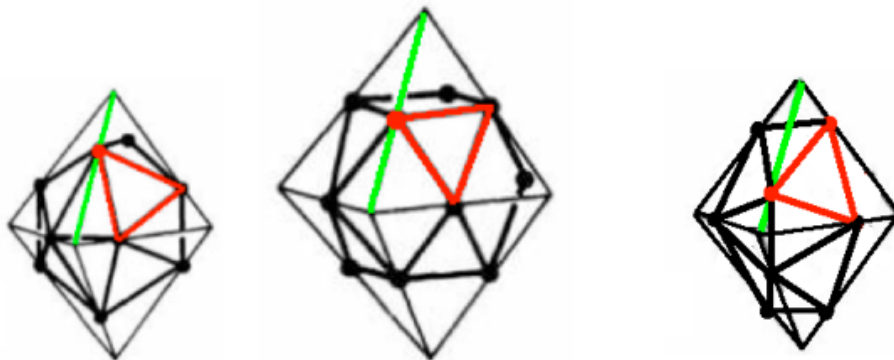

(images adapted from Geometrical Frustration by Sadoc and Mosseri (Cambridge 2006))  
angle defined by sliding Icosahedron vertices on the edges of a circumscribing Octahedron from points dividing edges into Golden Ratio segments to points dividing edges into two equal segments so that the Octahedron then circumscribes a Cuboctahedron. If the edge lengths of the Icosahedron/Cuboctahedron are kept the

same then the Octahedron surrounding the Cuboctahedron will be an expansion of the Octahedron surrounding the Icosahedron.

Just as in the choice of a Cuboctahedron square diagonal to be compressed, there are two ways in which the edge could be divided into Golden Ratio segments, corresponding to the two possible orientations of an Icosahedron. Choice of Golden Ratio segments for one edge forces (by requiring consistency) the choices for all other edges.

The time scale of such a Jitterbug Transformation of a Pd cluster may be on the order of a picosecond (compare Euro. Phys. J. D. 19 (2002) 333-337 by Pundt et al).

The volume expansion of the Jitterbug Transformation from Icosahedron (unit edge) to Cuboctahedron (unit edge) is:

$$\text{Icosahedron volume} = (5/12) ( 3 + \text{sqrt}(5) ) = 2.18169499$$

$$\text{Cuboctahedron volume} = (5/3) \text{sqrt}(2) = 2.3570226$$

$$\text{Icosahedron/Cuboctahedron volume ratio} = 0.9256147947$$

$$\text{Cuboctahedron/Icosahedron volume ratio} = 1.0803630254$$

The cuboctahedral configuration resulting from Fusion Energy Jitterbug is not only larger than the Icosahedral configuration, it has 6 large square openings allowing easier entry into the Pd cluster of the Deuterium Nuclei (red dots) and Electrons (green dots) as well as easy exit of the Fused Deuterium  $4\text{He} + 4\text{He}$  nuclei from the Pd cluster.

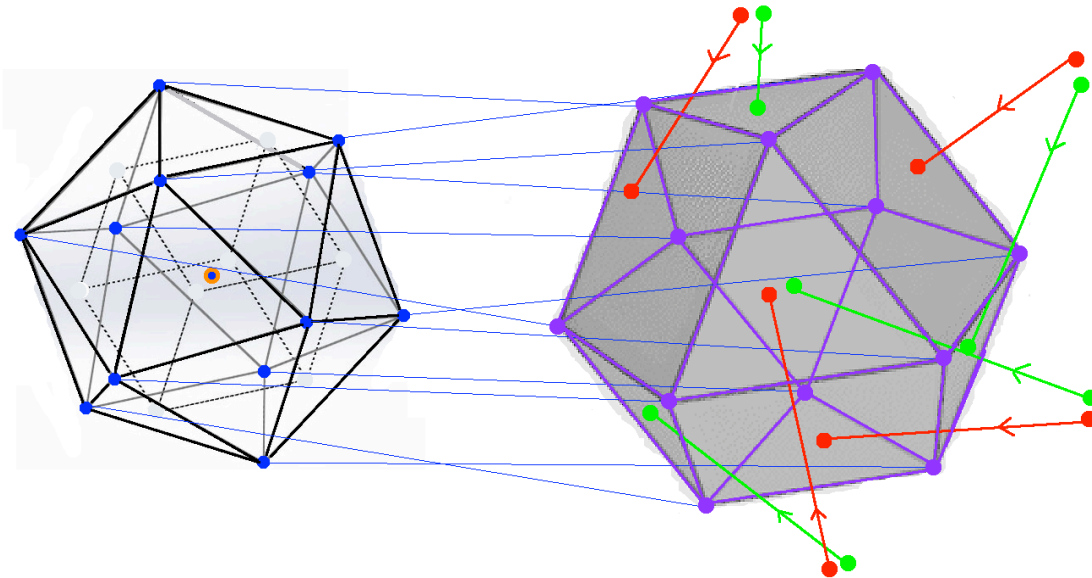

Also, the cuboctahedral configuration has 8 small triangle faces to which the 4 Nuclei and 4 Electrons of the Deuterium are attracted to form the Tetrahedral Symmetric Coherent Quantum State.

The size required for Jitterbug / TSC Fusion is a Palladium atomic cluster whose ground state is icosahedral and can easily Jitterbug Transform into a cuboctahedral state and whose size is large enough to contain several TSC Fusion Cluster sites, each of which is an icosahedron that can Jitterbug transform into a cuboctahedron.

The 13-atom Pd/Ni cluster (0.70 nm) is an icosahedron, for 1 TSC Fusion Cluster site.

The 2-shell 55-atom Pd/Ni cluster (1.13 nm) has two icosahedra that share a central vertex, for only TSC Fusion Cluster sites.

Clusters of between 56 and 147 atoms contain from 2 to 13 TSC Fusion Cluster sites by partially filling the 3rd shell of atoms.

The 3-shell 147-atom Pd/Ni cluster (1.56 nm) has 12 exterior TSC Fusion Cluster sites plus 1 central TSC Fusion Cluster sites, so it contains 13 TSC Fusion Cluster sites.

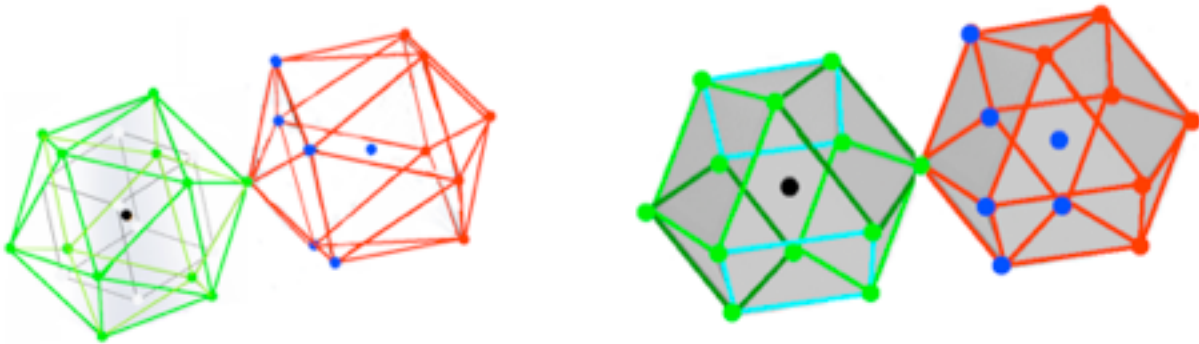

( see viXra 1502.0069 )

Clusters of between 147 and 309 atoms contain at least 13 TSC Fusion Cluster sites. The 4-shell 309-atom Pd/Ni cluster is 2.00 nm in size, so it is disfavored with respect to the 3-shell 147-atom cluster for use with Sodium Zeolite Y whose pore size is 0.74 nm expandable to 1.5 nm.

Most of the TSC Fusion Energy is carried to the Pd Cluster Structure by the  $4\text{He}+4\text{He}$  and the  $4e$  electrons of the TSC coherent quantum state according to the Hagelstein Coupling between Nuclear Excitation and Atomic Structure.

The Pd Structure Energy of Excited Optical Phonon Modes is carried by the Zeolite Cage Electrostatic Field ( on the order of  $3 \text{ V/nm}$  ) to be stored in the Zeolite as heat which Heat can be accessed by Zeolite-Water reaction.

## Each of the 13 TSC fusion icosahedra is capable of TSC fusion

Some of the TSC Fusion Energy goes to a Jitterbug transformation

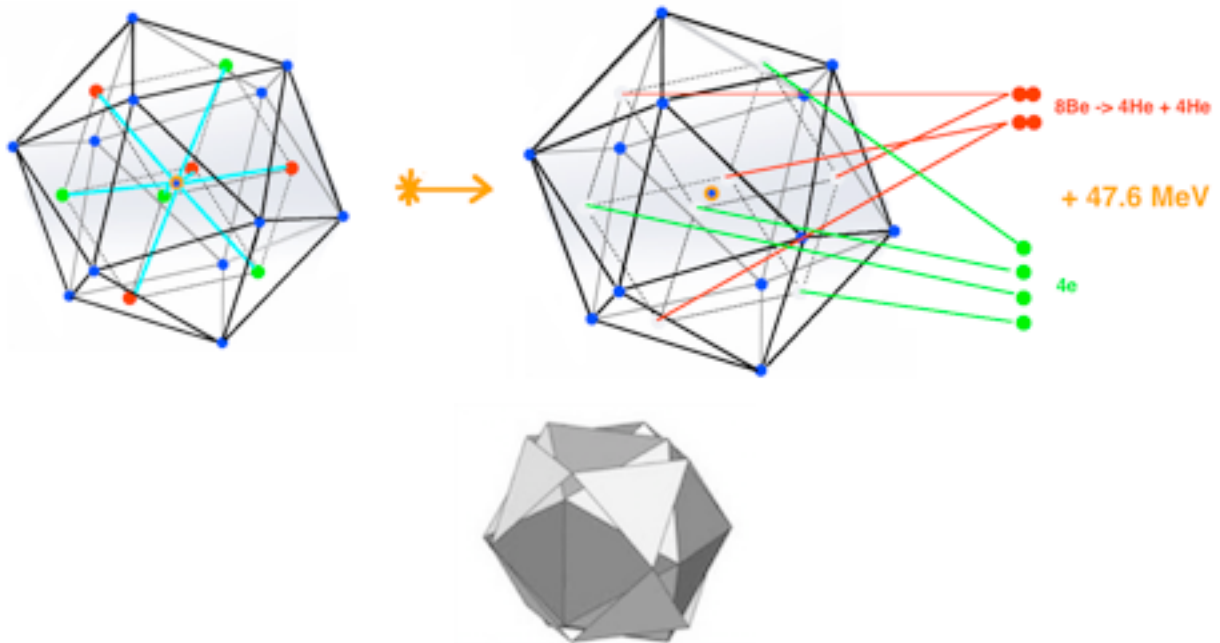

of the icosahedral Palladium, depleted of Deuterium fusion fuel,  
to a cuboctahedral configuration

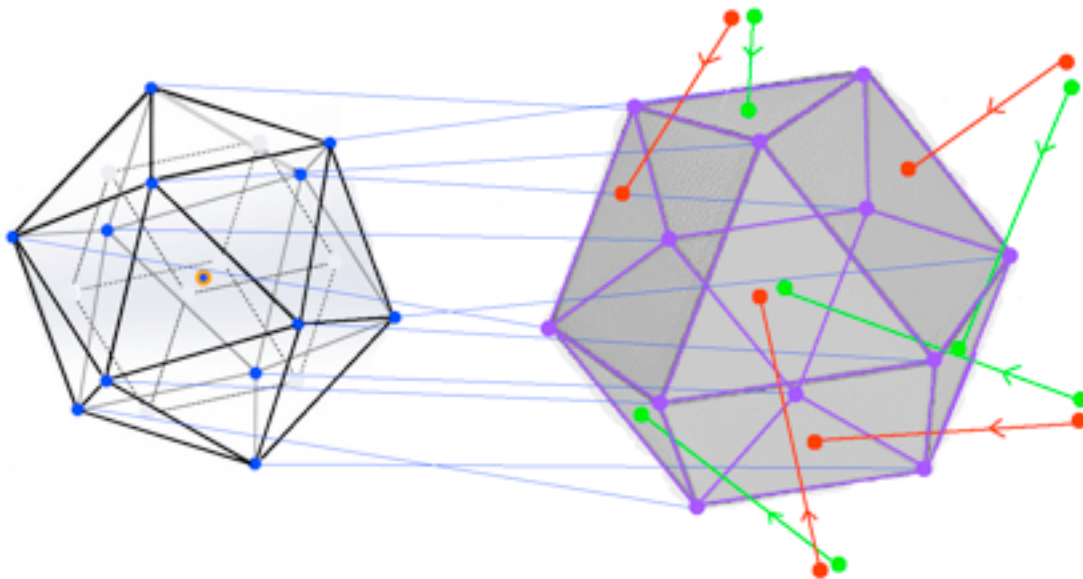

which has 6 large square openings through which  
the 4He TSC Fusion Product Ash can leave the Pd cluster  
and ambient Deuterium Fuel can enter to reload the Palladium cluster.  
Replacement is easier for the 12 outer TSC configurations than for  
the 1 central TSC configuration which is not directly exposed to ambient D gas

After entering the Palladium cluster the 4 Deuterium nuclei (red dots) and 4 electrons (green dots) form a Tetrahedral Symmetric Coherent Quantum State centered on the 8 triangular faces of the cuboctahedral configuration. Then, since the icosahedral configuration is the Palladium cluster ground state, another Jitterbug transformation

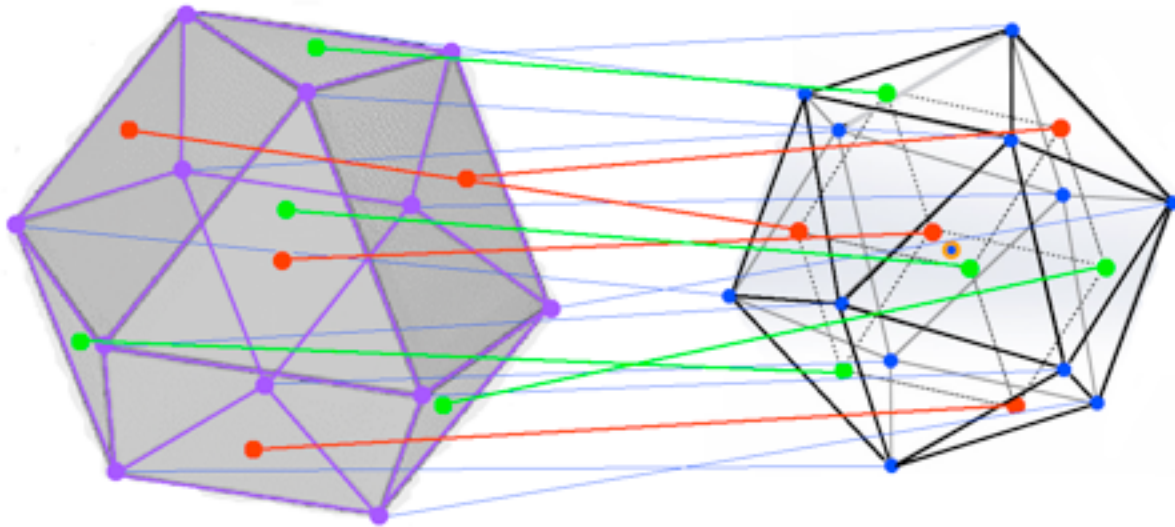

takes the Palladium cluster to an icosahedral configuration with the replenished Deuterium nuclei and electrons ready for another round of TSC fusion

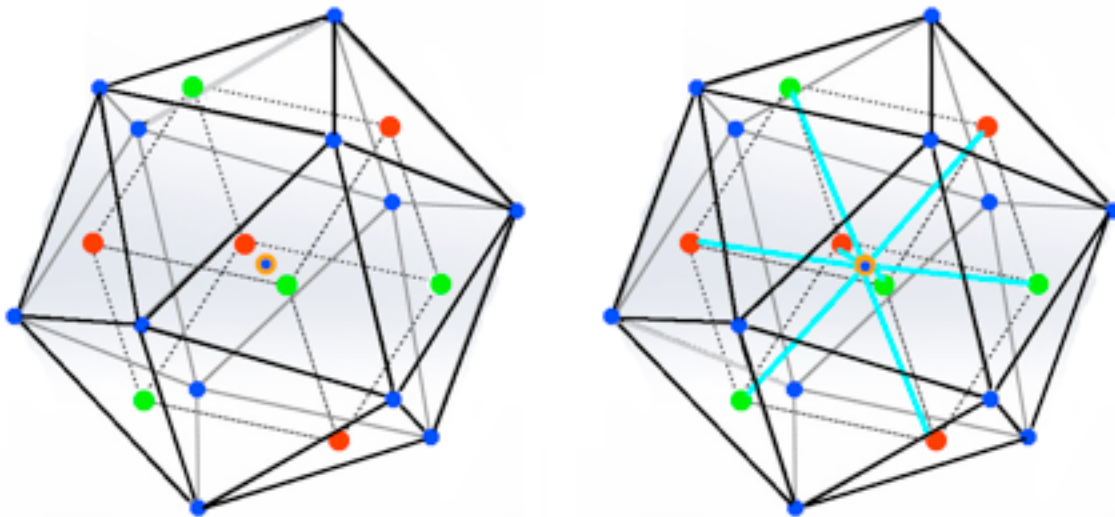

## How much energy does TSC Cold Fusion produce ?

According to Hagelstein's model for fusion energy going to excited optical phonons in the Pd cluster, instead of the "... four electrons ... go[ing] outside ...", the four electrons should remain part of Schwinger's "coherent ... single state" until after fusion when the four electrons and the two 4He nuclei would produce two 4He atoms, with most of the 47.6 MeV going to excited optical phonons in the Pd cluster.

If the Pd Clusters were embedded in Zeolite Cages, heat from the Pd Cluster would be transferred to the Zeolite, from which it could be extracted by the Zeolite-Water process.

A 3-shell 147-atom icosahedral Palladium atomic nanocluster contains 13 TSC Fusion Site Icosahedra and each TSC Fusion event produces 47.6 MeV  
 $47.6 \text{ MeV} \times 13 \text{ TSC Sites} / 147\text{-atom Pd Cluster} \times 4.45 \times 10^{(-17)} \text{ Watt-Hours} / \text{MeV} = 2.754 \times 10^{(-14)} \text{ Watt-Hours} / 147\text{-atom Pd Cluster}$  for each Jitterbug Cycle

Mass of 147-atom Pd Cluster  $147 \times 106 \times 1.66 \times 10^{(-21)} = 2.587 \times 10^{(-17)}$  milligrams  
so  
a milligram of 147-atom Pd Clusters gives about 1 KiloWatt-Hour each Cycle.

If 36 seconds = 1/100 hour is taken as the Cycle time then

**a TSC-Jitterbug Fusion device with 1 milligram of Palladium in the form of 147-atom Pd clusters with full D-Loading should produce 100 KiloWatt-Hours in an hour.**

## Zeolite Structure

The Zeolite Y Cavity has geometric symmetry related to an isometric trapezohedron = tetragonal trisoctahedron with the 4 holes corresponding to deleting 4 octahedral-type 3-face groups

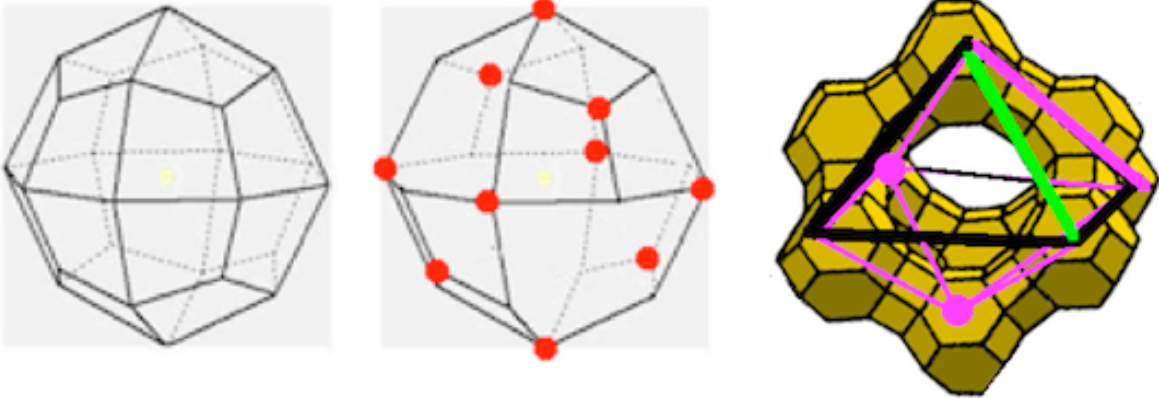

In the center image, the 10 red dots correspond to the 10 sodalite cages.  
In the right image, magenta is used for hidden lines and for the 2 hidden sodalite cages and  
the green octahedron edge corresponds to the green edge in these Jitterbug process images

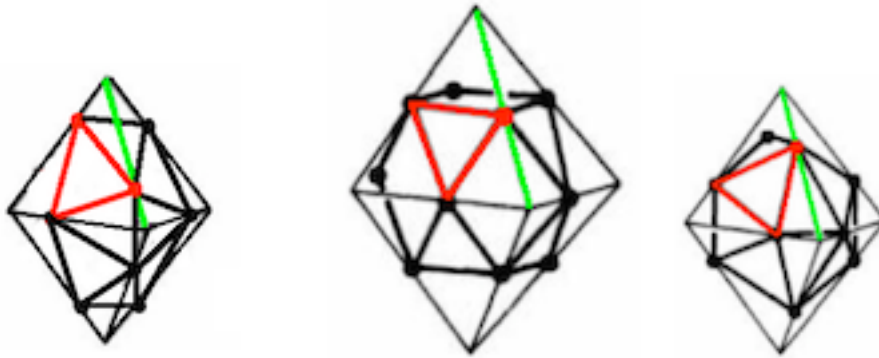

(images adapted from Geometrical Frustration by Sadoc and Mosseri (Cambridge 2006))

The green edge midpoint cuboctahedral vertex is at the widest point of the cavity mouth as expected for the larger cuboctahedron volume  
and  
the green edge Golden Ratio point icosahedral vertices are at narrower points of the cavity mouth as expected for the smaller icosahedral volume.

Each sodalite cage is a 24-vertex truncated octahedron as in this image from Wikipedia

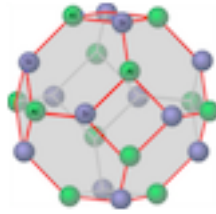

A more detailed view of a sodalite cage from

<http://som.web.cmu.edu/structures/S099-sodalite.html>

has red dots for Oxygen and pink spheres for OH and yellow spheres for Sodium and blue tetrahedra for Silicon and green tetrahedra for Aluminum

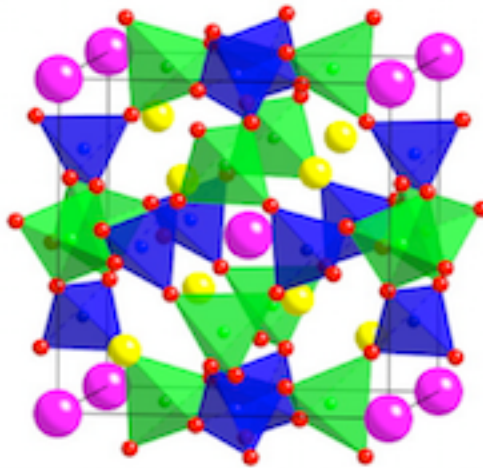

It shows that of the 24 vertices of the sodalite cage, 12 are Aluminum and 12 are Silicon so each Zeolite Cavity has  $10 \times 12 = 120$  Aluminum atoms.

Zeolite Cavities have Electrostatic Fields on the order of  $3 \text{ V / nm}$ .

R. A. van Santen and D. L. Vogel, in *Lattice Dynamics of Zeolites* ( *Advances in Solid-State Chemistry*, Vol. 1 (1989) 151-224 ), said: "... The vibrational spectrum of a zeolite may be visualized as the sum of three contributions,

the first of which which is given by the zeolite framework, the network formed by  $\text{SiO}_4$  and  $\text{AlO}_4$  tetrahedra sharing corners.

The second contribution originates from the ...[material]... located in the cages and channels formed by the framework ... The [material] vibrate[s] against the framework ...

The third contribution is given by the presence of hydroxyl groups and water molecules. Hydroxyl groups are either located in lattice vacancies, or present as isolated groups bound to the external zeolite surfaces, or internally bridging two tetrahedra. ... Due to the very high oscillator strength of the hydroxyl group, water and hydroxyl groups give rise to strong absorption bands between  $3200 \text{ cm}^{-1}$  and  $3750 \text{ cm}^{-1}$  (symmetric and antisymmetric stretching modes). ...".



Angela Di Lella, Nicolas Desbiens, Anne Boutin, Isabelle Demachy, Philippe Ungerer, Jean-Pierre Bellat, and Alain H. Fuchs, Phys. Chem. Chem. Phys. 8 (2006) 5396-5406 ) studied water in Zeolites, saying: "... We report ... Monte Carlo simulations of water



adsorption in [ Zeolite ] NaY ... faujasite ... The existence of cyclic water hexamers ... located in the 12-ring windows ... recently disclosed by neutron diffraction ...

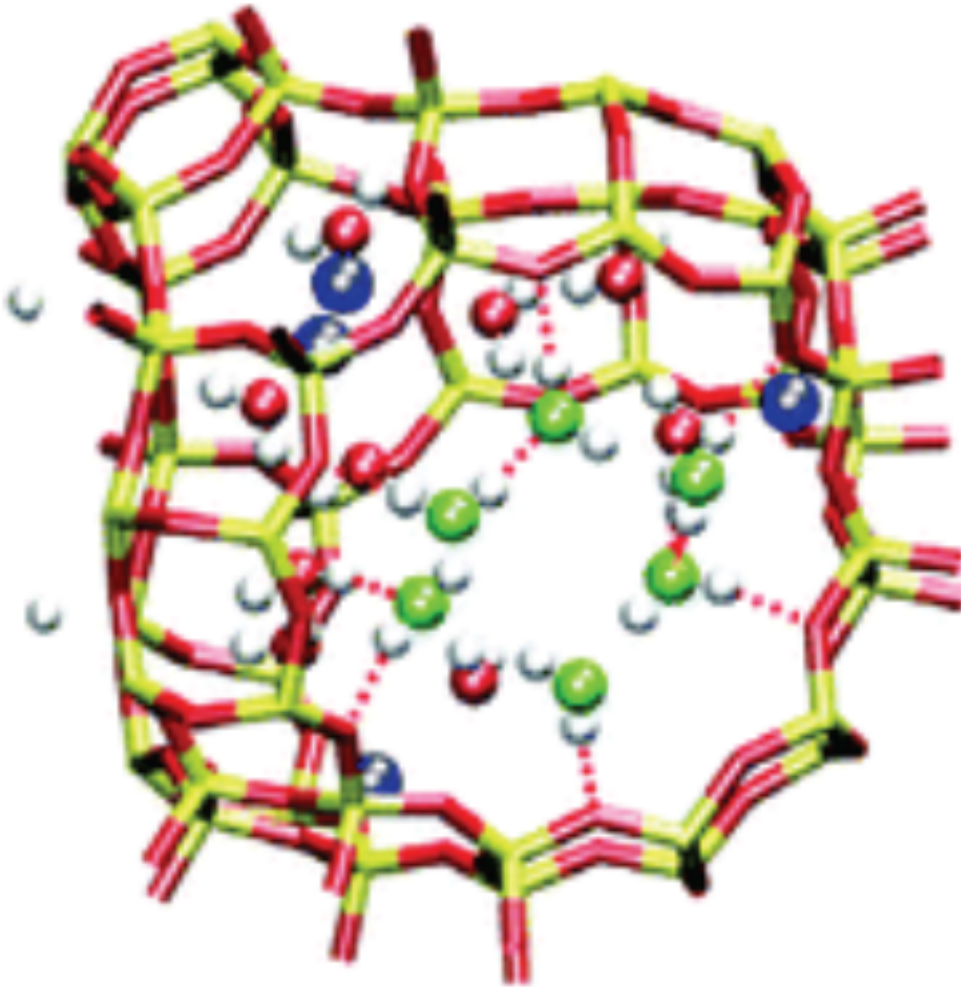

... experiments ... were ... observed in the case of NaY ...".

Dmitry Kopelevich and Chia-Yi Chen, in Phonon interactions in zeolites mediated by anharmonicity and adsorbed molecules ( Molecular Simulation 2008 ), said: "... thermal conductivity of nanoporous materials can be significantly affected by adsorption of guest molecules. These molecules serve as moving defects and provide additional scattering centers for heat-carrying phonons. ...

we perform molecular dynamics simulations of a model system, namely sodalite zeolite with small molecules ... encapsulated in its cages. We measure effects of sorbates ... such as correlations between different phonon modes and the phonon frequency and lifetime. ... The phonon lifetime often increases upon encapsulation of a sorbate into the zeolite which suggests that the sorbate-phonon interactions are qualitatively different from phonon scattering by point defects fixed in the lattice. ...”.

Iraj Parchamazad used Sodium Zeolite Y also known as faujasite.

The Wikipedia page for faujasite says:

“... The faujasite framework consists of sodalite cages which are connected through hexagonal prisms.

The pores are arranged perpendicular to each other.

The pore, which is formed by a 12-membered ring, has a relatively large diameter of 7.4 Å [ 0.74 nm ]

The inner cavity has a diameter of 12 Å [1.2 nm ] and is surrounded by 10 sodalite cages. ...”.

Ruby Carat and Melvin Miles interviewed Iraj Parchamazad of University of La Verne in 2012. In that video interview Iraj Parchamazad said that the Zeolite cavity size can oscillate and vary, enlarging up to about 2.4 nm.

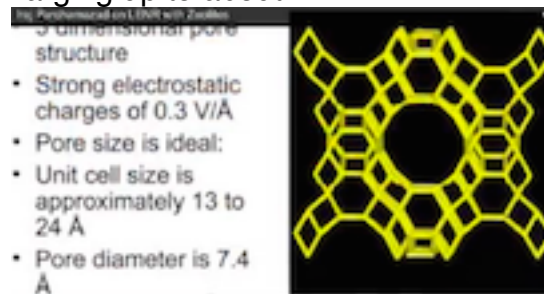

A corresponding enlargement of pore size is to about 1.5 nm which would permit a 3-shell 147-atom Palladium cluster to enter the Zeolite Cavity.

Iraj Parchamazad did not use Sandia’s 1.5 nm Palladium clusters in his Zeolite but

used an organometallic solution containing Palladium atoms.

After putting that into the Zeolite he heated the Zeolite

to burn off Carbon, Hydrogen, and Oxide

leaving a Zeolite and some Palladium.

Then he exposed the Zeolite/Palladium to Deuterium,

and got excess heat 10 out of 10 times, indicating fusion.

I would like to see experiments  
with Zeolite directly using Sandia 1.5 nm Palladium NanoClusters.

If there is difficulty with getting the Sandia Clusters  
to fit into the Sodium Zeolite Y  
then  
I would like to see experiments  
with Zeolite ITQ-37

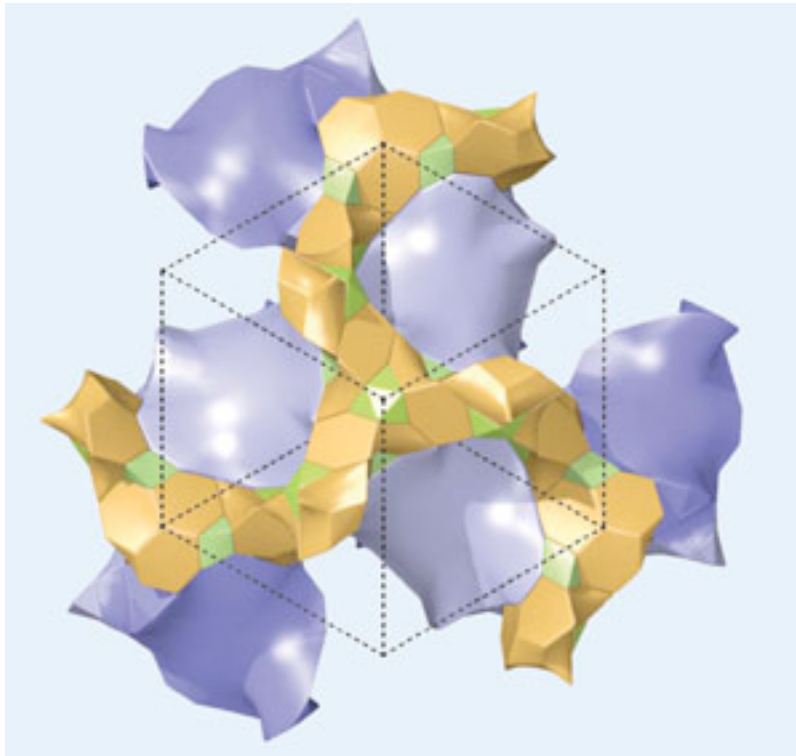

**which has pore size about 2 nanometers.**  
(Royal Society of Chemistry, 29 April 2009 and Sun et al, Nature 2009)

## **Transfer of Energy from Pd Cluster Structure to Zeolite Structure**

After TSC Fusion, by Hagelstein's process, the energy is stored in the Pd cluster as excited Optical Phonon modes.

The Pd Structure Energy of Excited Optical Phonon Modes is carried to the Zeolite in which the Pd cluster is caged to be stored as Zeolite heat.

Each Zeolite Y Cavity is surrounded by 10 sodalite cages which are arranged in a 3-dimensional Diamond network as shown in this image from

<http://www.vurup.sk/sites/vurup.sk/archivedsite/www.vurup.sk/english/products/molek/slovsit1/english.html>

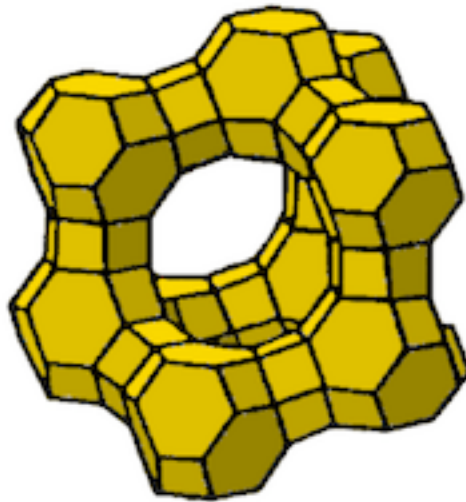

**The Pd Structure Energy of Excited Optical Phonon Modes is carried by the Zeolite Cage Electrostatic Field ( on the order of 3 V/nm ) to be stored in the Zeolite as heat which Heat can be accessed by Zeolite-Water reaction.**

## Extraction of Cold Fusion Energy from Zeolite Structure

According to a 7 June 2012 techthefuture.com web article by Tessel Renzenbrink: "... Zeolite is a mineral that can store up to four times more heat than water ... zeolite retains a hundred percent of the heat for an unlimited amount of time ... When water comes into contact with zeolite it is bound to its surface by means of a chemical reaction which generates heat. Reversely, when heat is applied the water is removed from the surface, generating large amounts of steam. The transference of heat to the material does not cause its temperature to rise. Instead, the energy is stored as a potential to adsorb water. The ... [ German Fraunhofer Institute ]... scientists used these particular properties to turn zeolite into a thermal storage system. They created a storage device and filled it with zeolite pellets. To charge the pellets, they exposed them to heat. To retrieve the energy they simply added water. ...".

Here is my design for a TSC-Jitterbug Zeolite Pd-D fusion heat engine:

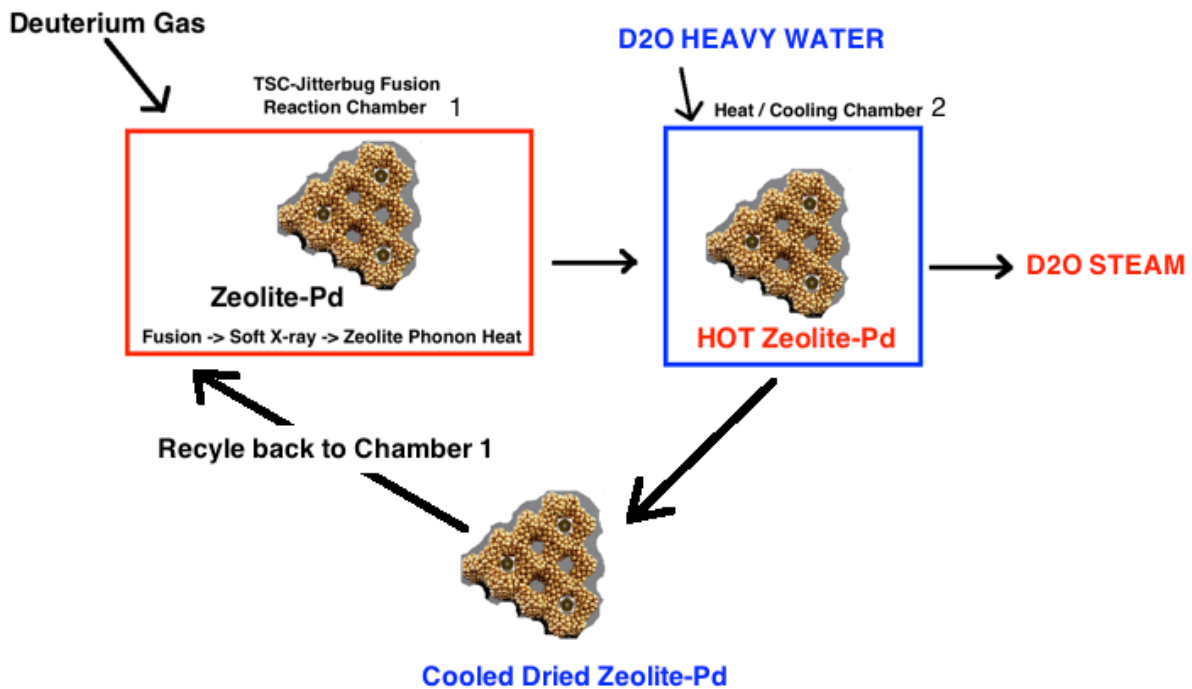

( Zeolite-Pd images adapted from Calvo and Carre in Nanotechnology 17 (2006) 1292-1299 and from <http://gwenbeads.blogspot.com/2014/04/infinite-skew-polyhedron-faujasite-4446.html> )

D2O Heavy Water is used to take heat from the Zeolite to make steam so that Hydrogen from H2O does not poison the TSC-Jitterbug process by replacing Deuterium in the Palladium nanoclusters, a possible problem pointed out by Melvin Miles. D2O heavy water from Fisher Scientific costs about \$1,000 per liter for 99.8 atom % D.

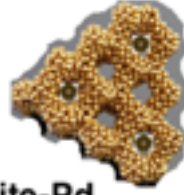

## Preparation of Zeolite-Pd

Sodium Zeolite Y has unit cell size about 2.5 nanometers which corresponds to the edge-length per cavity of its overall octahedral structure.

According to <http://www.google.com/patents/US20040047803>

“... Synthesis and stabilization of nanoscale zeolite particles ...

Zeolite Y is of great interest ... Zeolite crystals prepared under conventional synthesis conditions frequently have a mean particle size of between 1 and 5  $\mu\text{m}$ . ... it would ... be useful if the zeolite particles were sufficiently small to form a colloidal suspension ... Mono- or di-saccharides can be used to keep the crystal size of faujasite (zeolite X and Y) small

... Sucrose, dextrose or other saccharides are added to a conventional aluminium silicate reaction mixture obtained by mixing aqueous alkali metal silicate and alkali metal aluminate solutions at low temperatures, followed by ageing and hydrothermal synthesis. Crystal sizes of between about 30 and 40 nm are claimed ...”.

According to Journal of the Taiwan Institute of Chemical Engineers 50 (2015) 259–265 by PankajSharma, Su-JungJeong, Moon-HeeHan, and Churl-HeeCho

“... nanosized NaY zeolite crystals from clear solution using ... (TMAS) ... tetramethylammoniumsilicate ... yields particle of size around 50 nm but in aggregated form ...”.

According to a Journal of Catalysis article by Patrick D. Burton, Timothy J. Boyle, and Abhaya K. Datye, "Facile, surfactant-free synthesis of Pd nanoparticles for heterogeneous catalysts"

“... room temperature reduction of Pd(OAc)<sub>2</sub> in MeOH is slow enough to produce a suspension of ... metal-phase ... Pd NPs. ...

A Pd-NP/C catalyst was prepared by mixing the carbon support into the suspension of Pd NPs and evaporating the solvent. Aggregate formation was a concern, as there were no capping agents to prevent particle growth. Therefore, the nanoparticles were collected quickly before substantial aggregation could occur. ... this technique is general and can be extended to other powder supports. ...”.

An “other powder support” that would be useful for TSC-Jitterbug fusion energy would be 30-40 nanometer Zeolite Y Crystals in colloidal suspension.

As the Pd nanoclusters “... grow for 20 ... min ...” up to size 1.56 nm for the 147 atom size that is optimal for TSC-Jitterbug fusion,

they are small enough to fit into the Exterior Cavities of the Zeolite Y Crystals

( which are have average pore opening 0.74 nm and cavity size 1.2 nm

but which sizes can oscillate to be up to about twice those sizes )

Due to the open structure of the Zeolite Y Crystals, growth up to the 147 atom size can continue inside the Exterior Cavities of the Zeolite Y Crystals.

As soon as the Pd nanoclusters have grown to the 147 atom size the solvent can be evaporated and the powder of 30-40 nm Zeolite Y Crystals loaded with Palladium can be collected and placed in the TSC-Jitterbug Fusion Reaction Chamber for exposure to Deuterium gas and heating the Zeolite Y Crystals by fusion energy.

The Zeolite Y Crystal has octahedral structure

( images from

[news.chess.cornell.edu/articles/2011/OctahedralNanoparticles.html](http://news.chess.cornell.edu/articles/2011/OctahedralNanoparticles.html)

[mathworld.wolfram.com/SquarePyramidalNumber.html](http://mathworld.wolfram.com/SquarePyramidalNumber.html)

Journal of the Taiwan Institute of Chemical Engineers 50 (2015) 259–265 )

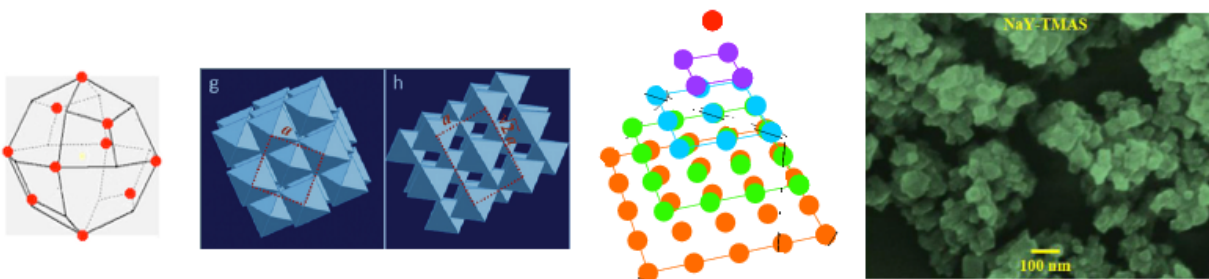

and each unit cell with 1 Cavity is 2.5 nanometers in diameter  
so an octahedral Zeolite Y Crystal with diameter 35 nanometers  
would have an edge length  $35 / \sqrt{2} = 25 \text{ nm} = 10 \text{ cells}$   
and the octahedron would have 19 square layers:

layer 1 = 1 external + 0 internal = 1 for total of 1 of which 1 is external

layer 2 = 4 external + 0 internal = 4 for total of 5 of which 5 are external

layer 3 = 8 external + 1 internal = 9 for total of 14 of which 13 are external

layer 4 = 12 external + 4 internal = 16 for total of 30 of which 25 are external

layer 5 = 16 external + 9 internal = 25 for total of 55 of which 41 are external

layer 6 = 20 external + 16 internal = 36 for total of 91 of which 61 are external

layer 7 = 24 external + 25 internal = 49 for total of 140 of which 85 are external

layer 8 = 28 external + 36 internal = 64 for total of 204 of which 113 are external

layer 9 = 32 external + 49 internal = 81 for total of 285 of which 145 are external

layer 10 = 36 external + 64 internal = 100

layers 11 through 19 are mirrors of 1 through 9, for a total of 285 with 145 external

so an octahedral Zeolite Y Crystal with diameter 35 nm would have

$285 + 100 + 285 = 670$  cavities with  $145 + 64 + 145 = 354$  ( 52.8 % ) external and

therefore relatively easily accessible to the Pd nanoclusters in the colloidal suspension.

Zeolite Y unit cell atomic mass is (from nptel.ac.in Introduction to Catalysis Lecture 36 Zeolites)

(  $56 \times 23 \text{ Na} + 56 \times 59 \text{ AlO}_2 + 136 \times 60 \text{ SiO}_2 + 264 \times 18 \text{ H}_2\text{O}$  ) = 17,504

for actual mass =  $17504 \times 1.66 \times 10^{(-21)} = 2.906 \times 10^{(-17)}$  milligrams

The atomic mass of a 147-atom Pd nanocluster is  $147 \times 106 = 15,582$

for actual mass =  $15,582 \times 1.66 \times 10^{(-21)} = 2.587 \times 10^{(-17)}$  milligrams

For 35 nm Zeolite Y Crystals only about 1/2 of their Cavities are External so it may be

**optimal to use Zeolite Y Crystal mass = 2 x Palladium mass in the colloid.**

## Zeolite Heat and Capacitor Electricity

According to a 26 January 2011 PhysOrg.com article by Lisa Zyga:

“... The unique 3D array of nanopores in zeolite-templated carbon ...

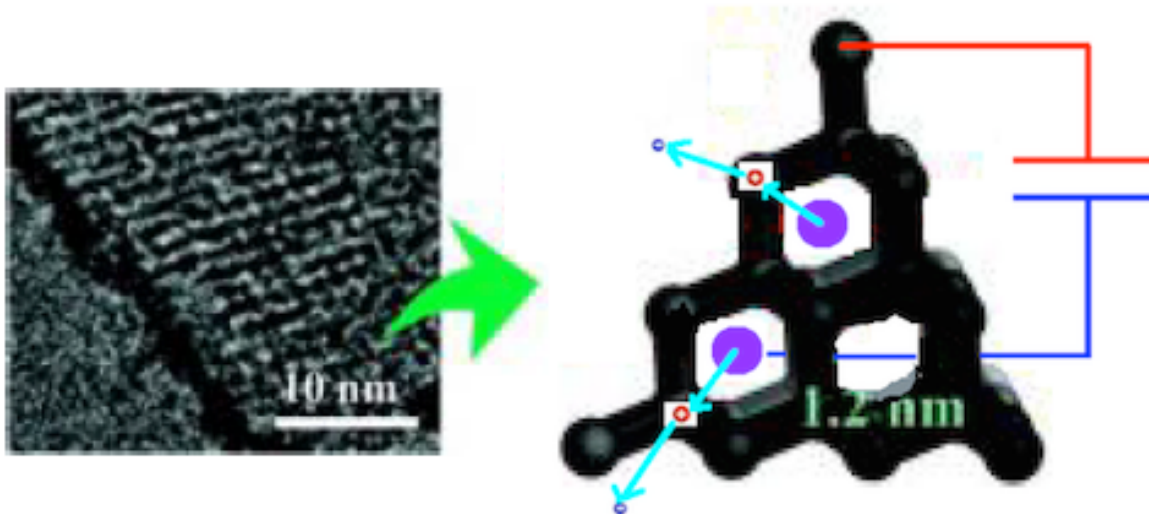

( image modified to show  
 Zeolite-Templated Carbon framework as Black, Palladium NanoClusters as Purple,  
 Ambient Fluid with Deuterium for TSC-Jitterbug Reloading as White,  
 Excited Optical Phonons from TSC-Jitterbug Fusion as Cyan arrows  
 ionize parts of the ZTC, ejecting electrons (Blue) into the Ambient Fluid  
 and leaving positive ions (Red) in the Zeolite-Templated Carbon  
 thus building up a Capacitance Voltage  
 between the Zeolite-Templated Carbon and the Ambient Fluid )

... enables it to be used as an electrode for high-performance supercapacitors that have a high capacitance and quick charge time ... The zeolite-templated carbon consists of nanopores that are 1.2 nm in diameter ... and that have a very ordered structure ...”.

### Synthesis of Zeolite-Templated Carbon

is described in the 2013 Caltech Ph.D. Thesis of Nicholas Stadie:

“... Zeolite-templated carbon (ZTC) materials were prepared ... by ... established methods ...

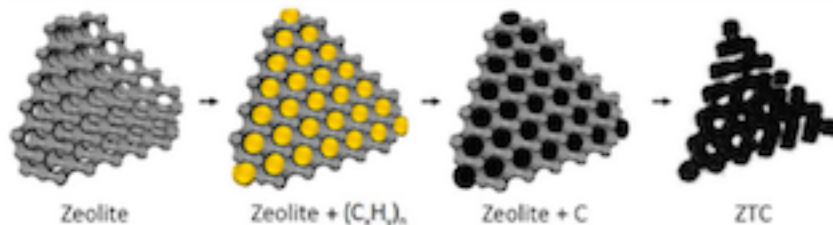

Figure 4.1. A schematic of template-carbonization in a porous zeolite framework, to produce zeolite-templated carbon (ZTC).

...”



The ZTC capacitor process converts TSC-Jitterbug fusion energy directly to electricity. Since it does not require the Zeolite-heat-water-steam chemical structure only the Zeolite Y Crystal geometric configuration is needed so all the Zeolite Y can be converted to ZTC carbon configurations attached to a single base carbon substrate that acts as a Capacitor Electrode.  
( It would be difficult to use separated Zeolite Y Crystals as an electrode. )

However,  
the ZTC has fewer Exterior Cavities than the colloidal free-floating Zeolite Y Crystals because  
each ZTC structure is attached to the carbon substrate by a base face,  
thus eliminating the Exterior Cavities on that base face  
so that  
for 35 nm ZTC structures only about 1/3 of their Cavities are External  
( as opposed to about 1/2 for free-floating 35 nm Zeolite Y )  
so it may be optimal  
for the number of ZTC Cavities to be 3 x the number of Pd 147-atom nanoclusters.

## Synthesis of 147-atom Pd clusters and Embedding into Zeolite

**147-atom Pd clusters have diameter about 1.5 nanometers.**

**1.5 nm Pd Clusters have been produced**

**at Sandia National Laboratories**

**and University of New Mexico Center for Micro-Engineered Materials**

according to a Journal of Catalysis article

"Facile, surfactant-free synthesis of Pd nanoparticles for heterogeneous catalysts"  
at

<http://www.flintbox.com/public/filedownload/2871/2011-038%20Science%20Direct%20Article>

by Patrick D. Burton, Timothy J. Boyle, and Abhaya K. Datye showing

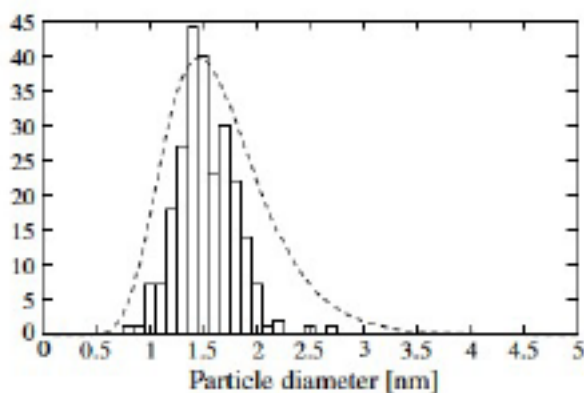

“ ... ”

Tim Boyle said in email October 2014:

“... We easily remade the Pd NP just need to get TEM to see what size they are.

If they come out good, we can go ahead and make some for you.

Couple of things.

This is very easy and ya'll may want to do it yourselves  
(esp after the next couple of comments).

Simply dissolve Pd-acetate in MeOH and stir for 5 min,  
let grow for 20 more and should have your size.

The problem is these will continue to grow and plate out onto the sides of the container,  
unless you use a substrate.

Would you want these on a substrate, then that'll need to be supplied.

If we make it, we'd have to send it as a solution ...

could you handle this and could you use it?

It won't be a powder, which I think is what you want.

We can dry it down to a powder but not sure what size that will be  
or how they'd cluster and how they'd redisperse or in what solvent.

we can try to deposit the materials on a number of surfaces and just let it dry.

Again, not sure how the clustering of these particles will occur.

A gram will take about 2.5 g of Pd(Oac)<sub>2</sub> which we have but will need replaced. ...”

## Sandia Pd Cluster Recipe

(updated June 2016 based on ideas of Arindom Saha of Quantum Gravity Research)

- 1 - 15 ml of methanol ( MeOH ) in a scintillation vial
- 2 - Add 5 mg palladium acetate ( Pd(OAc)<sub>2</sub> ) whose color is red-orange
- 3 - Reduce the Pd(OAc)<sub>2</sub> by MeOH to Pd atoms by stirring for 5 minutes with unobstructed exposure to room lighting.
- 4 - Add 10 mg of Zeolite substrate in colloidal suspension
- 5 - Place on elevated stir plate and allow to react undisturbed for 20 minutes.

During 20 minutes the Pd atoms form clusters that grow to size 1.5 nm (147 atoms)  
Initially the Pd atom clusters are very small (only a few atoms)

and will migrate into Zeolite cages and continue to grow  
to size 1.5 nm (147 atoms) at 20 minutes

Color of colloidal suspension changes from pale yellow to dark green over the 20 min

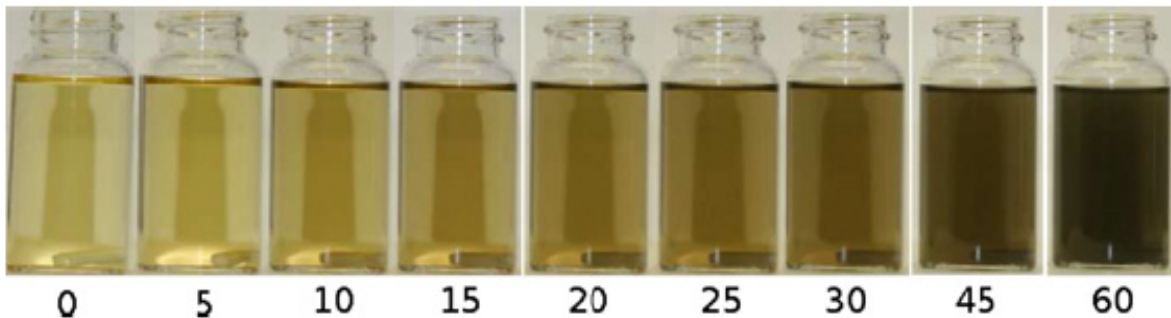

6 - At 20 minutes Pd-loaded substrate (and any remnant Pd still in colloidal suspension) are removed and the Pd-loaded substrate dried

7 - Pd-loaded substrate is placed in reaction chamber where it is exposed to Deuterium gas from tank and calorimeter measurements are taken to measure any heat that might be produced by TSC-Jitterbug fusion

( analogous to heat produced by Arata and Zhang (replicated by McKubre at SRI)  
with no external power input - only palladium powder + deuterium gas )

The substrate may be 30-40 nm Zeolite Crystals, such as Sodium Zeolite Y or ITQ-37.  
At 30-40 nm size each will have about 12 to 16 large Cavities per edge  
About half of the Cavities will be on the Exterior Surface of the Tetrahedral Crystal where they will be easily accessible by Pd atom clusters in the colloidal suspension

## Global Energy and TSC-Jitterbug-Zeolite Fusion machines

Can TSC-Jitterbug-Zeolite Fusion produce Abundant Cheap Energy so that Expensive Competition for geologically concentrated Cheap Oil



will become unnecessary ?

Using total Earth Energy Reserves in Terawatt-years, according to M. Taube, in his book Evolution of Matter and Energy on a Cosmic and Planetary Scale (Springer-Verlag 1985), the number of years that  $10^{10}$  people could consume energy at the present USA per capita rate, a consumption rate of about 1,000 Terawatt-years/year, is:

	Reserves (Terawatt-years)	Duration (years)
Oil	850	1
Gas	550	1
Methane	1,500	2
Coal	7,000	7
Uranium	$1.9 \times 10^9$ (1/1000 of Earth supply)	2,000,000
Thorium	$7.9 \times 10^9$ (1/1000 of Earth supply)	8,000,000
Deuterium	$1.9 \times 10^9$ (1/1000 of ocean supply)	2,000,000
Lithium	$1.9 \times 10^9$ (source of tritium)	2,000,000

As to solar energy, the total solar energy received by Earth is about 109,000 Terawatt-years/year so that  $10^{10}$  people could consume energy at the present USA per capita rate by using about 1% (one percent) of the solar energy received by Earth. This could be done, for example, by building a lot of orbiting solar energy collection dishes and beaming the energy to Earth.

The total geothermal heat flux is about 66 Terawatt-years/year, and the total tidal energy is about 3 Terawatt-years/year, so that those sources would be inadequate to support  $10^{10}$  people consuming energy at the present USA per capita rate.

For Everybody on Earth to be Happy, the Abundant Cheap Energy must provide a high Standard of Living (current USA standard) for a lot of people (10 billion), and:

last for a long time (more than decades) - rules out Oil, Gas, Methane, and Coal;

have no serious radioactive waste - rules out Uranium, Thorium, and Tritium (Lithium);

have realistically scalable capital cost - rules out Solar which would require Satellite collectors with area 1% of  $\pi \times 6,000^2 = 1,000,000 \text{ km}^2 = (1,000 \text{ km})^2$  or cloud-free collectors on Earth surface with the same area. Less than 100% efficiency would require correspondingly larger area of collectors.

**That leaves one possible source of Abundant Cheap Energy for 10 billion people:**

	<b>Reserves (Terawatt-years)</b>	<b>Duration years)</b>
<b>Deuterium</b>	<b>1.9 x 10<sup>9</sup> (1/1000 of ocean supply)</b>	<b>2,000,000</b>

**Since a gram of properly structured Palladium gives TSC-Jitterbug Pd-D Cold Fusion Energy on the scale of Megawatts:**

1 milligram of Palladium gives a 1 kiloWatt Machine, useful for “electric motors, tools, machines and heaters” (Wikipedia)  
Such small energy machines could use the ZTC Electric Capacitor technology.

1 gram of Palladium gives a 1 MegaWatt = 1340 HorsePower Machine, useful for “large electric motors; large warships such as aircraft carriers, cruisers, and submarines; large server farms or data centers; and some scientific research equipment such as supercolliders, and the output pulses of very large lasers. A large residential or commercial building may use several megawatts in electric power and heat. ... railway... electric locomotives ... typically have a peak power output of 5 or 6 MW, although ... Eurostar ... uses more than 12 MW, while heavy diesel-electric locomotives typically produce/use 3 to 5 MW ...” (Wikipedia)  
C-130 aircraft have 4 engines each with 4300 HorsePower (globalsecurity.org)  
so would need a  $4 \times 4300 / 1340 = 13$  grams of Pd  
Such mid-sized energy machines could use, depending on portability and site requirements, either Zeolite Steam or ZTC Electric Capacitor technology.

1 kg of Palladium gives a 1 GigaWatt Machine,  
useful for “large power plants ... HVDC converters have been built with power ratings up  
to 2 GW” (Wikipedia)

Such machines could use either Zeolite Steam or ZTC Electric Capacitor technology,  
using HVDC converters up to 2 GW to convert the ZTC Electric Capacitor DC into AC.

1,000 kg = 1 ton of Palladium gives 1 TeraWatt.

The total power used by Humans in 2006 was 16 TW.

The average lightning strike peaks at 1 TW, but lasts only 30 microseconds.

Powerful 20th century lasers produce TW, but only for nanoseconds. (Wikipedia)

1,000 tons of Palladium gives 1 PetaWatt.

The Lawrence Livermore Nova laser has power of 1.25 PW in a  $5 \times 10^{-13}$  sec pulse.

The total power of sunlight hitting the Earth is about 174 PW. (Wikipedia)

222 tons of Palladium were mined world-wide (based on 2006 and 2007 data, Wikipedia):

Russia produced 98 tons  
South Africa produced 89 tons  
Canada produced 13 tons  
USA produced 11 tons  
the rest of the world produced 11 tons

## Appendix A: Details of Structure of 147-atom Pd clusters

There are two basic structures that are Jitterbug Transforms of each other:

### Icosahedral and Cuboctahedral

n = number of shells

N = number of Pd atom vertices

d = diameter of icosahedral configuration in nm

C = number of cells in icosahedral phase

CT = number of tetrahedral cells in icosahedral phase

CO = number of octahedral cells in icosahedral phase

n	N	d	C = CT + CO		
0	1	0.27	0 = 0 + 0	icosahedral	cuboctahedral
1	13	0.70	20 = 20 + 0	icosahedral	cuboctahedral
2	55	1.13	100 = 80 + 20	icosa	cubo
3	147	1.56	280 = 200 + 80	icosa	cubo

(Images from: Polyhedral Clusters by Lord et al; Frank and Kasper in Acta Cryst. 11 (1958) 184-190; Mackay in Acta Cryst. 15 (1962) 1916-1918; vimeo.com/27662398 by Yan Liang (L2XY2) August 2011. Data for n, N, and d from Shtaya-Suleiman dissertation Gottingen 2003. )

## 147-atom Icosahedral Geometry

The 147-atom cluster is a central Palladium atom surrounded by 3 layers of Pd atoms:

Layer 1 = central 1 (black) + 12 icosahedral (green) = 13 vertices  
and 20 tetrahedral cells

It is a single icosahedron configuration that allows TSC fusion  
of 4 Deuterium nuclei (red dots) screened by their 4 electrons (green dots)  
condensing along symmetrical paths (cyan lines) to fusion at the center

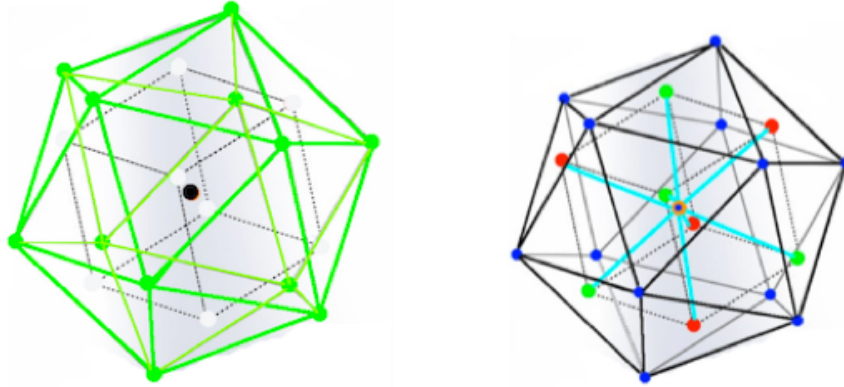

Layer 2 adds 42 vertices (blue) for total of 55  
and 60 tetrahedral + 20 cuboctahedral cells for total 80 tetra + 20 cubo = 100

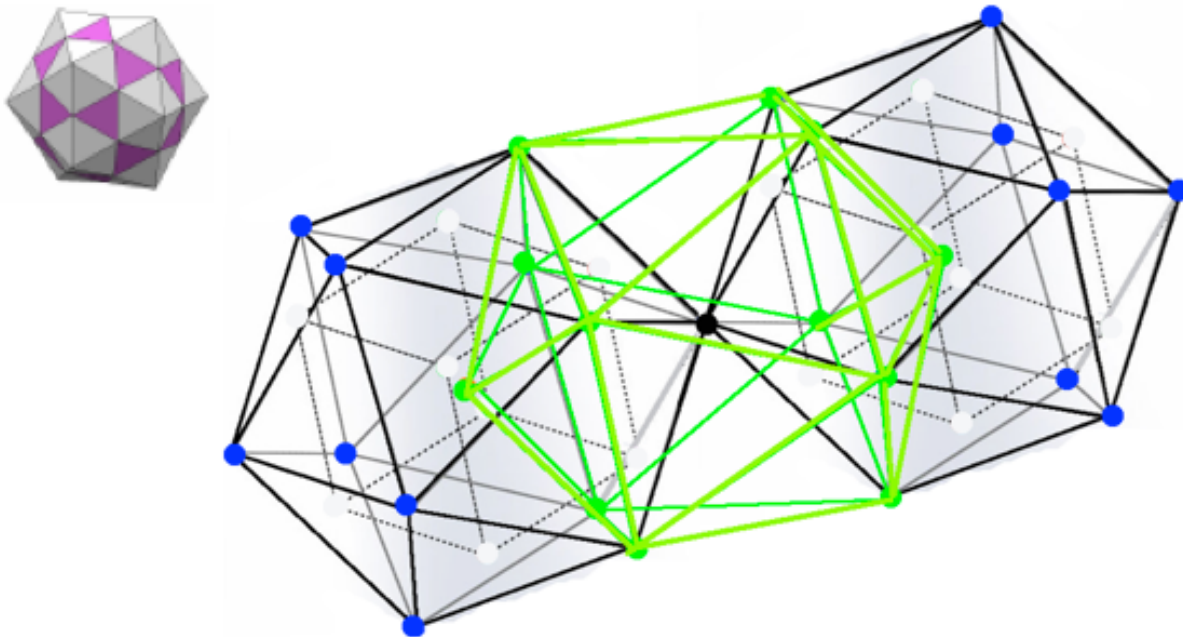

It is a configuration of 2 TSC fusion icosahedra sharing the central vertex  
with the remaining  $55 - (26-1) = 30$  vertices in 3 10-vertex bands



Layer 3 adds 92 vertices (red) for total of 147  
 and 120 tetrahedral + 60 cuboctahedral cells for total 200 tetra + 80 cubo = 280

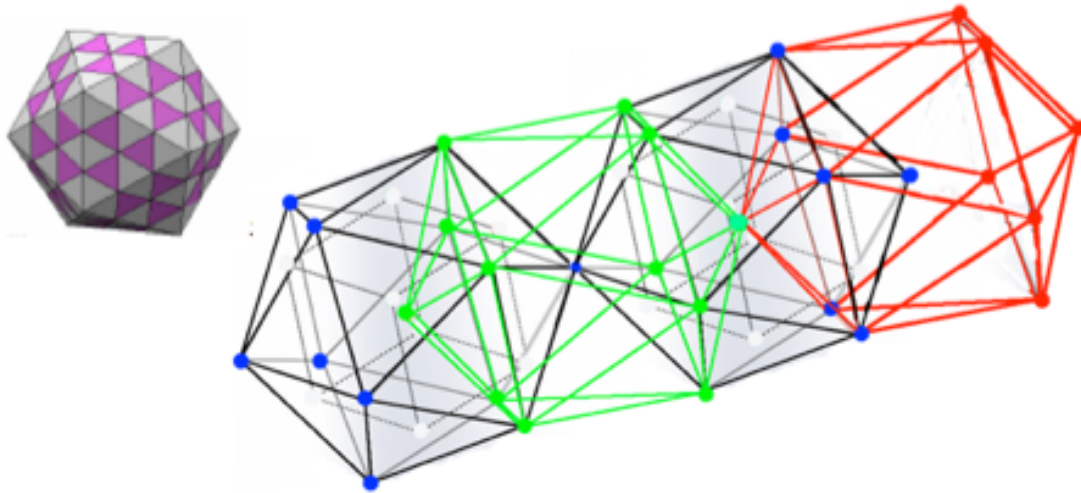

It is a configuration of 12 TSC fusion icosahedra

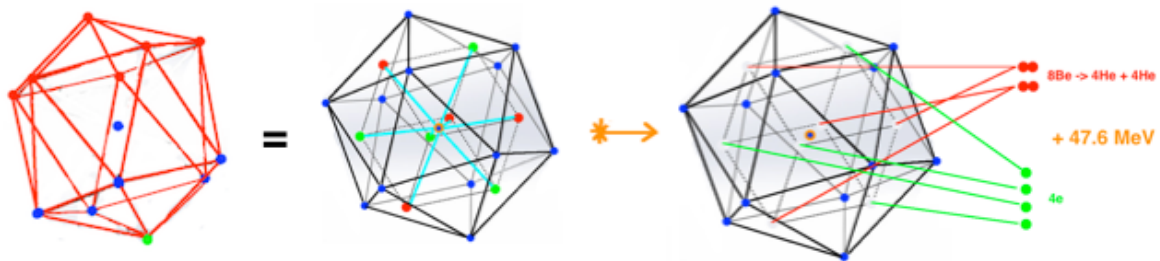

each of which shares a vertex with one of the 12 vertices of the Layer 1 icosahedron.

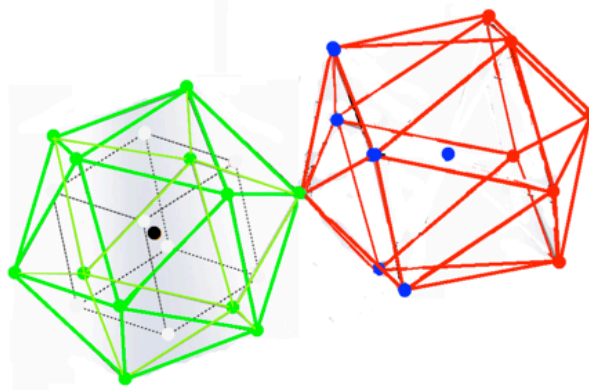

so that the entire 3-layer 147-atom configuration has 13 TSC fusion icosahedra:  
 12 outer icosahedra and 1 central icosahedron.  
 The 13 TSC configurations have  $13 \times 13 = 169$  vertices but  
 24 vertices are shared between an outer and the central TSC  
 and  $5 \times 12 = 60$  vertices are shared between two outer TSC  
 so  $169 - 24/2 - 60/2 = 127$  of the 147 vertices are in the 13 TSC  
 The remaining  $147 - 127 = 20$  vertices outside the 13 TSC are  
 at the centers of the triangle faces of the entire 147-atom icosahedron.

## 147-atom Cuboctahedral Geometry

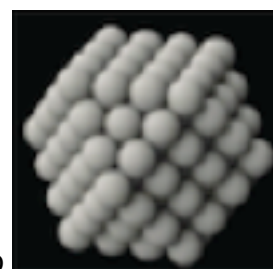

The 147-atom 3-layer icosah structure goes to a 3-layer cuboctahedral structure by Jitterbug transformation of all 147 atoms.

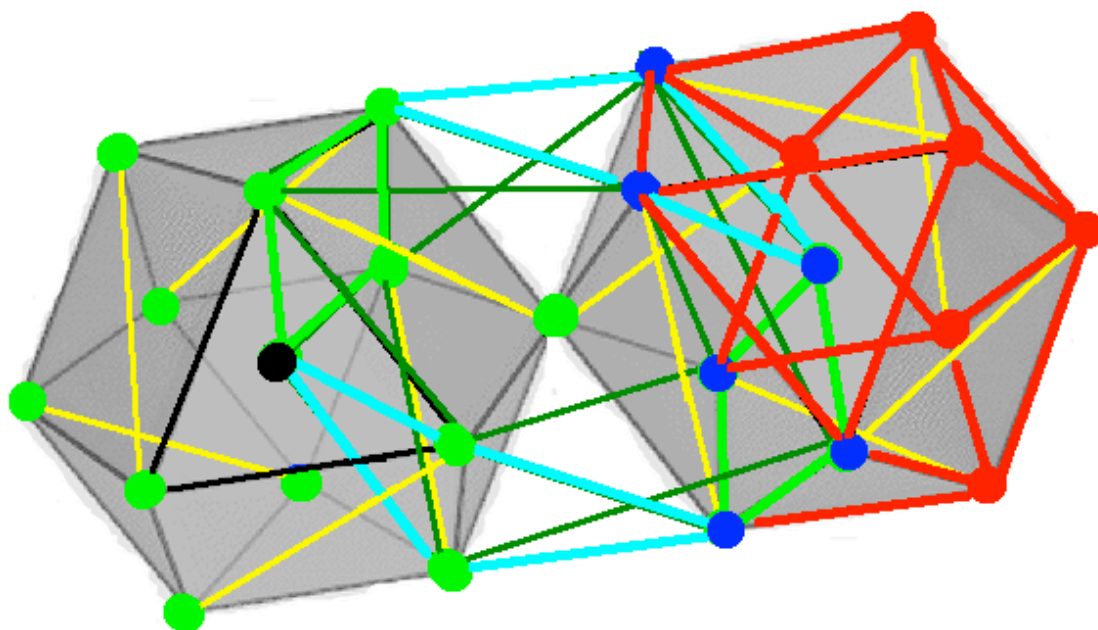

Like the icosah case, in the cubo case there is a central (black) vertex surrounded by 12 (green) cubo-configured vertices and a second layer (blue) forming an intermediate (distorted) cuboctahedron and a third layer (red) forming an outer (more regular) cuboctahedron.

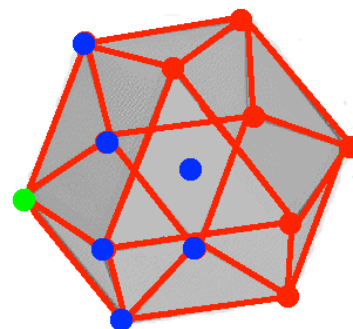
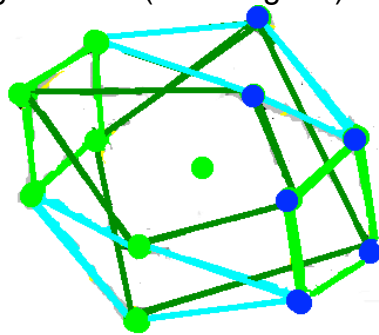
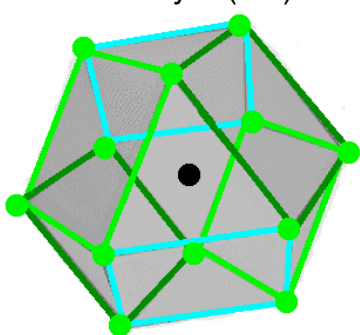

In the cubo case, there are also 12 outer TSC Jitterbug cuboctahedra plus a single central TSC Jitterbug cuboctahedron, so Jitterbug transformation of the entire 147-atom Pd cluster works consistently with individual Jitterbug transformations of the 13 TSC icosahedra and TSC Jitterbug cuboctahedra.

## How do the Icosahedral Clusters grow to 147 atoms ?

Eric A. Lord, Alan L. Mackay, and S. Ranganathan say in

"New Geometries for New Materials" (Cambridge 2006):

"... The Mackay icosahedron is obtained by packing tetrahedra and octahedra around an icosahedron [12 vertices +1 center = 13 vertices]...

if an octahedron is placed on every face of an icosahedron, the angular gap between neighboring octahedra can be closed by a very small deformation, to bring them into face contact [12 + 20 x (6-3)/2 = 42 vertices]...



... The concave regions of the resulting polyhedron can be filled by five-rings of tetrahedra [42 + 12 + 1 center = 55 vertices]...



... The [55]-atom Mackay cluster ...[triangles: dark = octahedra; light = tetrahedra]...

The process can be continued ...[with octahedra on each of the 12x5 = 60 outer cell faces of 5-rings thus adding 60 x (2/2 + 1/3) = 80 vertices and creating

2 TSC Fusion structures sharing a central vertex.

This also creates concave places for 30 pairs of tetrahedra adding no vertices plus 12 tetra-5-rings adding 12 vertices for a total of 54+80+12 + 1 center = 147.



**147-atom cluster**

**has 12+1 = 13 TSC Fusion sites]..."**

Lord et al use 12, 54, and 146 atoms for Mackay clusters

while Liang uses 13, 55, and 147 atoms.

The difference is whether or not the center vertex is counted, that is, not so much a real physical difference but a difference in math convention.

## How many D atoms can live in a 147-atom Pd cluster ?

F. Calvo and A. Carre say in Nanotechnology 17 (2006) 1292–1299

"Structural transitions and stabilization of palladium nanoparticles upon hydrogenation":  
"... Cuboctahedra ...[and]... icosahedra ... contain exactly the same number of atoms. ...  
In the case of ... the 147-atom Pd cluster ... the favoured structure in the pure metal is the three-layer icosahedron.

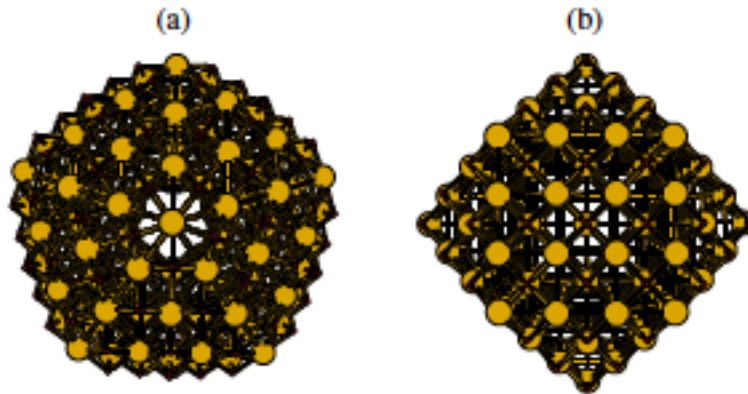

**Figure 1.** Palladium clusters fully loaded with hydrogen.

(a)  $\text{Pd}_{147}\text{H}_{200}$ ,  $I_h$  symmetry; (b)  $\text{Pd}_{147}\text{H}_{164}$ ,  $O_h$  symmetry.

Since the minimum full load for Icosa or Cubocta Pd/Ni 147-atom clusters is 164 D/H atoms, no more than 3 cycles of full TSC fusion (each consuming 56 D/H nuclei) can occur without replenishment of D/H from the surroundings of the clusters (such as immersion of the clusters in D/H gas).

## How long does it take Deuterium to load into Palladium ?

Wang, Hara, and Watanabe in Materials Transactions, Vol. 48, No. 3 (2007) pp. 560 to 565 say:  
"... Pure Pd, Pd-4 at%Pt and Pd-8 at%Pt ... powders smaller than 200 mesh ( $<74 \text{ nm}$ ) were prepared ... hydrogen absorption ...[by Pd-4 at%Pt]... was extremely fast and attained to equilibrium within tens of seconds. Hydrogen absorption by Pd and Pd-8 at%Pt was also very fast ...".

**Tens of seconds is much longer than the times for TSC Fusion and for Jitterbug** so it determines the time duration of one TSC-Jitterbug Fusion Cycle and

for the purpose of rough calculations it seems reasonable to take

**36 seconds = 1/100 hour = time duration of one TSC-Jitterbug Fusion Cycle.**

This time is much shorter than the usual loading time for old-type Cold Fusion experiments using Palladium rods, discs, much-larger-than 1.5 nm powder, etc because there are only 3 layers of Pd atoms in 1.5 nm 147-atom Pd clusters.

## What about more than 147 atoms ?

As more layers are added, the deformations of tetrahedra and octahedra accumulate and eventually destabilize the structures necessary for Jitterbug and TSC Fusion. The next Mackay cluster beyond 147 atoms has  $147+162 = 309$  atoms.

Barretau, Desjonqueres, and Spanjaard in Eur. Phys. J. D. 11 (2000) 395-402 say:

“... the icosahedron is the preferred structure at small sizes, and the critical size at which the relative stability becomes favorable to cuboctahedrons is  $N = 561$  for PdN clusters ...[for which]...

For  $N = 13$  the cuboctahedron is ... unstable.

For  $N = 55, 147,$  and  $309$  atoms the cuboctahedron is metastable and slightly distorted. Its transformation to a perfect icosahedral structure needs an activation energy of 12 meV for  $N = 55,$  28 meV for  $N = 147$  and 45 meV for  $N = 309.$

The activation energies involved in the inverse transformation are 61 meV for  $N = 55,$  51 meV for  $N = 147$  and 48 meV for  $N = 309.$

...[ compare 47.6 MeV for each TSC Fusion event ]...

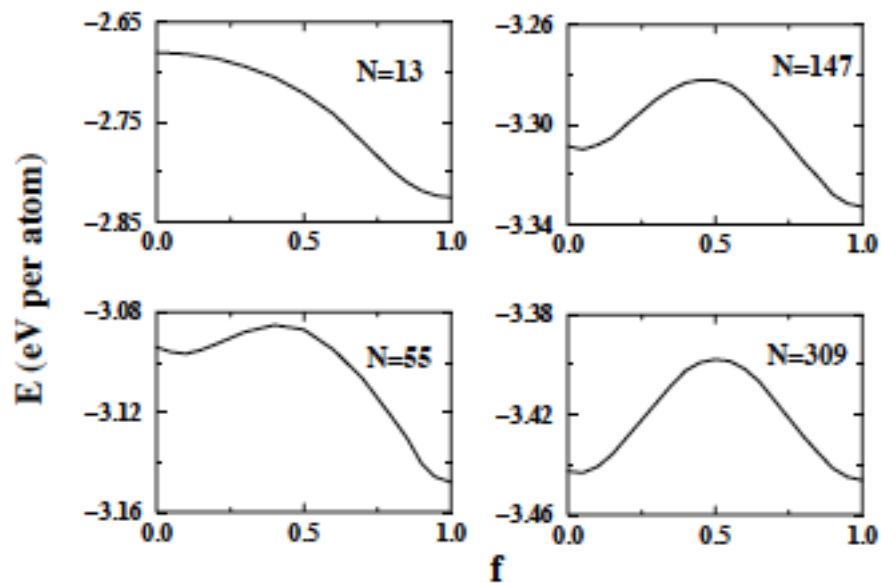

... The evolution of the potential energy profile of homogeneously relaxed ... PdN clusters during the Mackay [Jitterbug] transformation for increasing values of  $N$ .  $f$  is a fraction of the displacements ...  $f = 0$  and  $1$  correspond to the ... cuboctahedron and icosahedron, respectively ...”.

$N = 309$  is disfavored for TSC-Jitterbug Fusion with respect to  $N = 147$  for two reasons:  
energy levels are too close for rapid Jitterbug cubocta to icosah transition

$N = 309$  Pd Cluster is too large (2 nm) to fit  
through 1.5 nm expanded Sodium Zeolite Y pore

so

**147 atoms is optimal for Pd cluster Cold Fusion**

## Appendix B: Graphene and Klein Paradox Quantum Tunnelling

Consider the outer shell ( L-shell ) of Carbon:

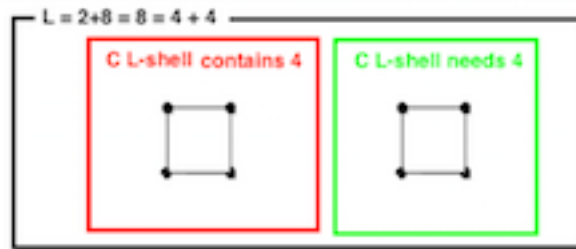

The useful chemistry of Carbon ( graphite, diamond, buckyballs, graphene, organics ) is due to the fact that

each Carbon atom has the 4 L-shell electrons that every other Carbon atom needs.

**If each Carbon atom is connected to 4 other Carbon atoms**

then the result is a 3-dim Diamond Packing with Tetrahedron Vertex Figure.

However, Diamond is only a metastable state. Graphene is a stable state.

P. B. Allen and B. K. Nolicic, in University of Delaware PHYS 824: Introduction to Nanophysics - Electronic band structure of graphene, said: "... Band structure of graphene ... originates from orbital hosting the fourth valence electron. The bands which correspond to the dispersion of bonding and antibonding molecular orbital (constructed from orbitals on two carbon atoms) are called pi and pi\* bands ...

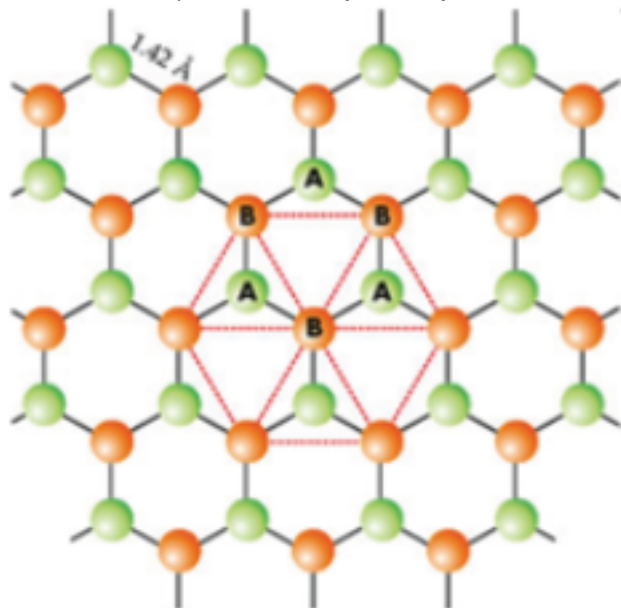

The honeycomb lattice of graphene ... is not a Bravais lattice. Instead, it can be viewed as bipartite lattice composed of two interpenetrating triangular sublattices ...

the single-particle electron states are ... two classes, called sigma and pi.

**The even sigma states are derived from carbon s and px , py orbitals** (i.e., their hybridized sp<sup>2</sup> orbitals ...),

while **the odd pi states are derived from carbon pz orbitals** ... electron and hole states in graphene should be interconnected, exhibiting properties analogous to the

charge-conjugation symmetry in quantum electrodynamics ... because graphene low-energy quasiparticles have to be described by two-component wave functions ... which are needed to define the relative contributions of the A and B sublattices in the quasiparticles make-up. The two-component description for graphene is very similar to the [ Dirac Equation ] spinor wave functions in QED...”.

I. Katsnelson, K. S. Novoselov & A. K. Geim, in Chiral tunnelling and the Klein paradox in graphene (arXiv cond-mat/0604323), said: The ... Klein paradox - unimpeded penetration of relativistic particles through high and wide potential barriers - ... can be tested ... using electrostatic barriers in single- and bi-layer graphene. Due to the chiral nature of their quasiparticles, quantum tunnelling ... becomes ... qualitatively different from ... normal, non-relativistic electrons. ...

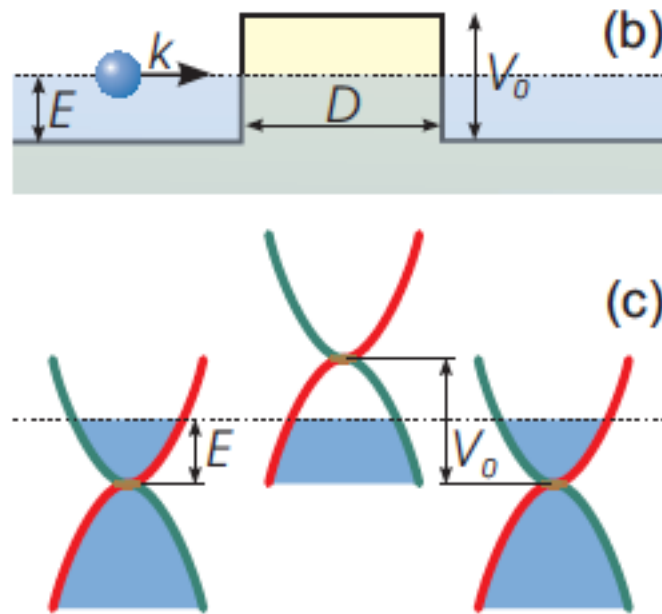

... Tunnelling through a potential barrier in graphene: ... (b) ... diagrams ... show the positions of the Fermi energy  $E$  across such a barrier. The Fermi level (dotted lines) lies in the conduction band outside the barrier and the valence band inside it. The blue filled areas indicate occupied states. The pseudospin ... is parallel (antiparallel) to the direction of motion of electrons (holes), which also ... keeps a fixed direction along the red and green branches of the electronic spectrum. (c) - Low-energy spectrum for quasiparticles in **bilayer graphene**. The spectrum is isotropic and, despite its parabolicity, also originates from the intersection of energy bands formed by equivalent sublattices, which ensures charge conjugation, similar to ... single-layer graphene. ... charge carriers in bilayer graphene ... are massive quasiparticles with a finite density of states at zero energy, similar to conventional nonrelativistic electrons. On the other hand, these quasiparticles are also chiral and described by spinor wavefunctions, similar to relativistic particles or quasiparticles in single-layer graphene ... the origin of the unusual energy spectrum can be traced to the crystal lattice of bilayer graphene with four equivalent sublattices. ... **the relevant QED-like effects appear to be more pronounced in bilayer graphene ...**”.

If each Palladium atom were to be connected to 14 other Palladium atoms then the result would be a 3-dim FCC Lattice with Rhombic Dodecahedron Vertex Figure

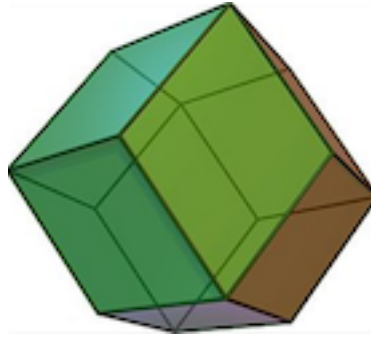

However, it may be that the Rhombic Dodecahedron FCC Lattice is only metastable and

more stable state may be based on its dual, the Cuboctahedron

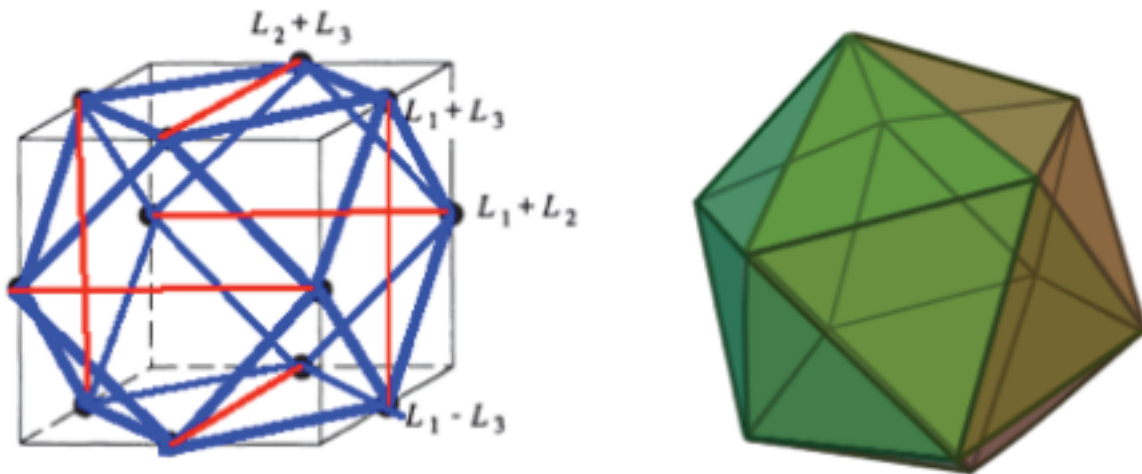

which can transform by Jitterbug Transformation into an Icosahedron.

**Just as Graphene directly uses 3 of the 4 Carbon electrons**  
the Cuboctahedron / Icosahedron directly uses 12 of the 14 Palladium electrons.

**Just as the 4th Carbon valence electron in Bilayer Graphene produces a Dirac Fermion band** with Klein Paradox Tunneling through Potential Barriers  
the  $14 - 12 = 2$  Palladium valence electrons produce a **Dirac Fermion band** which, using Klein Paradox Tunneling through Potential Barriers, enable TSC Fusion of Deuterium in Palladium Cluster structures.



# Overview of Cl(16) Physics with Pd-D Fusion

Frank Dodd (Tony) Smith, Jr. - 2018

## Abstract

This is a pdf file of 45 slides about the Basic Ideas of Cl(16) Physics with Pd-D Fusion. It is only an Overview of Basic Ideas. Details are in <http://vixra.org/pdf/1807.0166v3.pdf> and <http://vixra.org/pdf/1603.0098v2.pdf> and my viXra pages and my web sites including <http://valdostamuseum.com/hamsmith/>

The Slideshow in mov format is on the web at

<http://valdostamuseum.com/hamsmith/OverviewSlideshow.mov>

The mov slides have no audio narration because I think that audio would distract from video presentation of the slides.

## Table of Contents

page 1 ...	Table of Contents
page 2 ...	Void to Cl(16) Universe Creation and Evolution
pages 3, 8 ...	Cl(16) Vectors = 16-dim Lie Ball Complex Domain with 8-dim Lie Sphere Shilov Boundary $RP^1 \times S^7$
pages 3-14 ...	Cl(16) BiVectors + half-Spinors = E8 Lagrangian
pages 3, 8, 15-22 ...	Cl(16) TriVectors = Fr3(O) 26D String=World-Line AQFT
page 23 ...	Schwinger Source Constituent Quarks for Pd and D Nuclei
pages 24-35 ...	4 D to 2 He + 47.6 MeV Fusion in 147-atoms in Zeolite by Takahashi TSC and Klein Paradox Tunnelling
pages 36-42 ...	Giza Pyramids and Sphinx!
pages 43-45 ...	Ankgor Wat, Ankgor Thom, Phnom Bakheng - Rig Veda

All Universes begin as Quantum Fluctuations of the Empty Set = Void  
 by Quantum Fluctuation of Compact E8(-248) Real Form of E8  
 which is the First Grothendieck Universe and they all evolve according to  
 David Finkelstein's Iteration of Real Clifford Algebras:

$n = 0$	$\emptyset$	= Void
---------	-------------	--------

$n = 1$	$\{\emptyset\}$	= CI(0)
---------	-----------------	---------

$n = 2$	$\emptyset$ $\{\emptyset\}$	= CI(1)
---------	-----------------------------	---------

$n = 4$	$\emptyset$ $\{\{\emptyset\}\}$ $\{\emptyset \& \{\emptyset\}\}$ $\{\emptyset\}$	= CI(2)
---------	---	---------

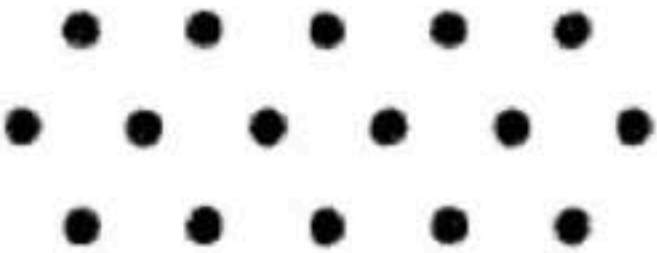
$n = 16$		= CI(4)
----------	--	---------

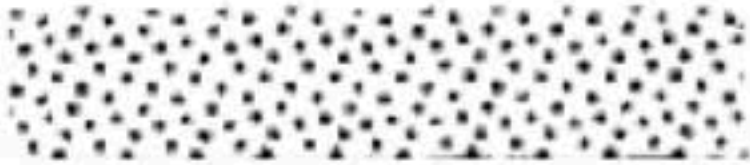
$n = 65,536$		= CI(2^4=16) = CI(16)
--------------	--	-----------------------

### Kaluza-Klein Spacetime

M4 x CP2

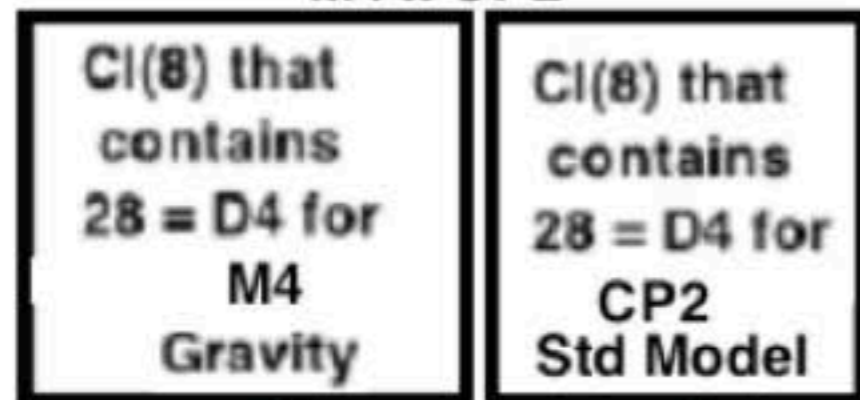

1	1	1
16	1	1
120	8	8
560	28	28
1820	56	56
4368	70	70
8008	56	56
11440	28	28
12870	8	8
11440	1	1

Cl(8) is M16(R)

=  
16 x 16 Matrix Algebra  
of Real Numbers.

<b>TriVectors</b>	56	56	560
<b>BiVectors</b>	28	28	120
<b>Vectors</b>	8	8	16

Cl(8) x Cl(8) = Cl(16)

8-Periodicity tensor product

**Cl(8) Spinors x Cl(8) Spinors = Cl(16) Spinors**

8-Periodicity tensor product

**Cl(8) Spinors = 8 S+ + 8 S-**

**8 S+ + 8 S- x 8 S+ + 8 S- =**

**= 8x8 S++ + 8x8 S+- + 8x8 S-+ + 8x8 S--**

**Cl(16) helicity consistent half-Spinors = 64 S++ + 64 S-- = 128**

Cl(16) is M256(R) = 256 x 256 Matrix Algebra of Real Numbers

with

Vectors = 16-dim IV(8) Complex Domain Lie Ball  
of Symmetric Space Spin(10) / Spin(8)xU(1)  
with Lie Sphere Shilov Boundary RP1 x S7

BiVectors with an antisymmetric Bracket Product form a Lie Algebra.  
120-dim Cl(16) BiVectors + 128-dim Cl(16) half-Spinors = 248-dim E8

TriVectors with a symmetric Jordan Product form a Jordan Algebra.  
560-dim Cl(16) TriVectors = 10 copies of 56-dim Fr3(O)  
Fr3(O) = Complexification of 27-dim J3(O)

560 = 56 + 8 x 28 + 28 x 8 + 56  
120 = 28 + 8 x 8 + 28

**Cl(8) structure is in African IFA divination through its  $16 \times 16 = 2^8 = 256$  Odu and is also represented by the 256 Elementary Cellular Automata**

the binary nature of which has its historical origin in Africa.

Ron Eglash (in his book "African Fractals" (Rutgers 1999) and on his web site) says:

**"... a historical path for base-2 calculation ... begins with African divination ..."**

**Cellular Automata (CA):**

**The 256 CAs correspond to the 256-dim Cl(8) Real Clifford Algebra:**

$$8+28+16 = 52 \text{ F4}$$

**16**

**Cl(8) Primitive Idempotent has 16 Terms**

$$f = (1/2)(1 + e_{1248})(1/2)(1 + e_{2358})(1/2)(1 + e_{3468})(1/2)(1 + e_{4578}) =$$

$$= (1/16)(1 + e_{1248} + e_{2358} + e_{3468} + e_{4578} + e_{5618} + e_{6728} + e_{7138} + e_{8357} + e_{4671} + e_{5712} + e_{6123} + e_{7234} + e_{1345} + e_{2456} + e_{3567})$$

corresponding to 16 of the 256 Cellular Automata

**Tensor Product Cl(8) x Cl(8) = Cl(16)**

$$(F4 \text{ in } Cl(8)) \times (F4 \text{ in } Cl(8)) =$$

$$= 8 \times 8 + 28 \times 1 + 1 \times 28 + 16 \times 16 =$$

$$= 120 \text{ Cl(16) BiVectors} + (128 + 128) \text{ Cl(16) Spinors}$$

$$120 \text{ Cl(16) BiVectors} + 128 \text{ Cl(16) Half-Spinors} = E8$$

**Cl(8) Triality**

- 8 half-spinors
- 8 half-spinors
- 8 vectors

**8**

**Grade 0**

**1**

**Grade 1**

**2**

**Grade 2**

**Grade 3**

**Grade 4**

**Grade 5**

**Grade 6**

**Grade 7**

**8**

# There are two D4 = Cl(8) BiVectors in the D8 = Cl(16) BiVectors that live in E8

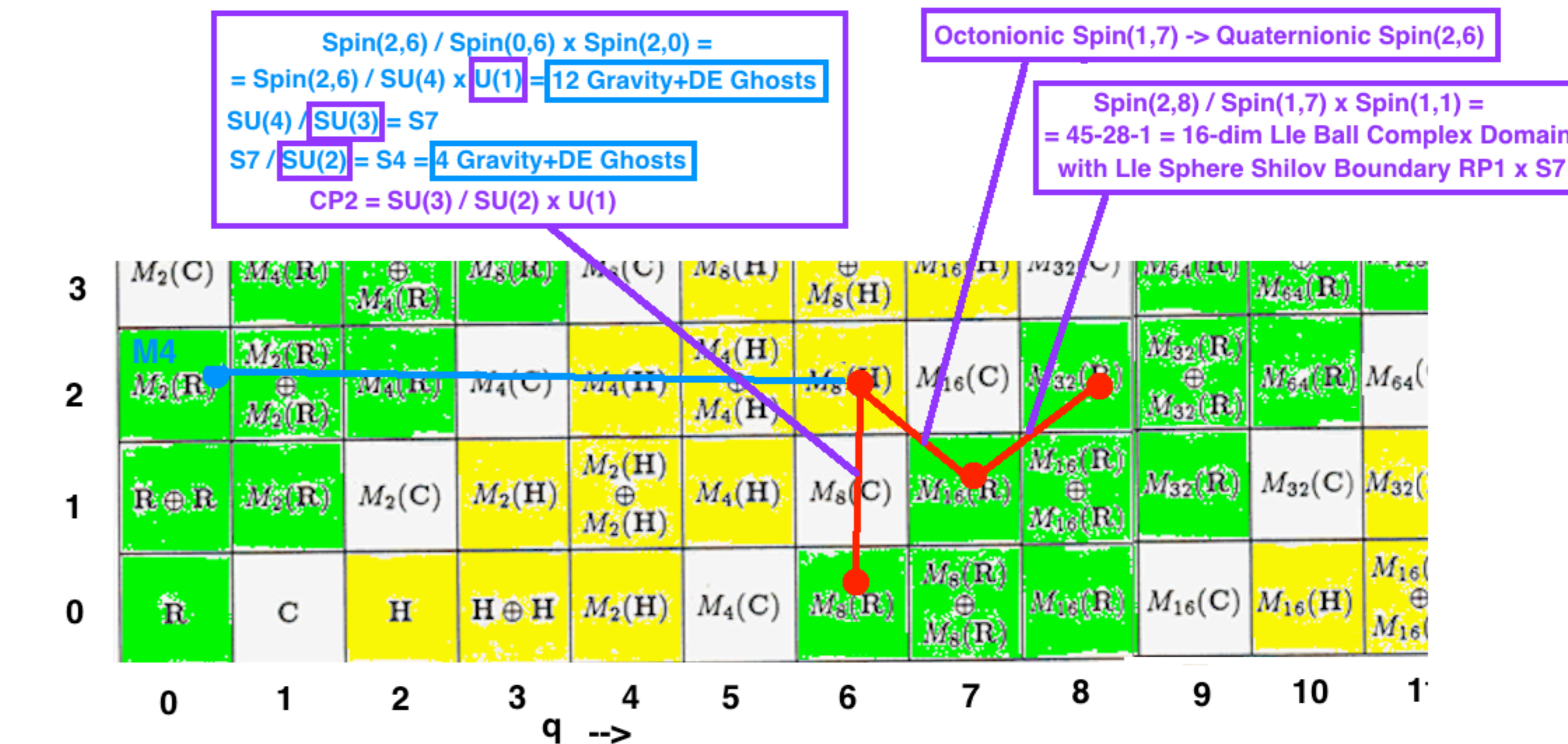
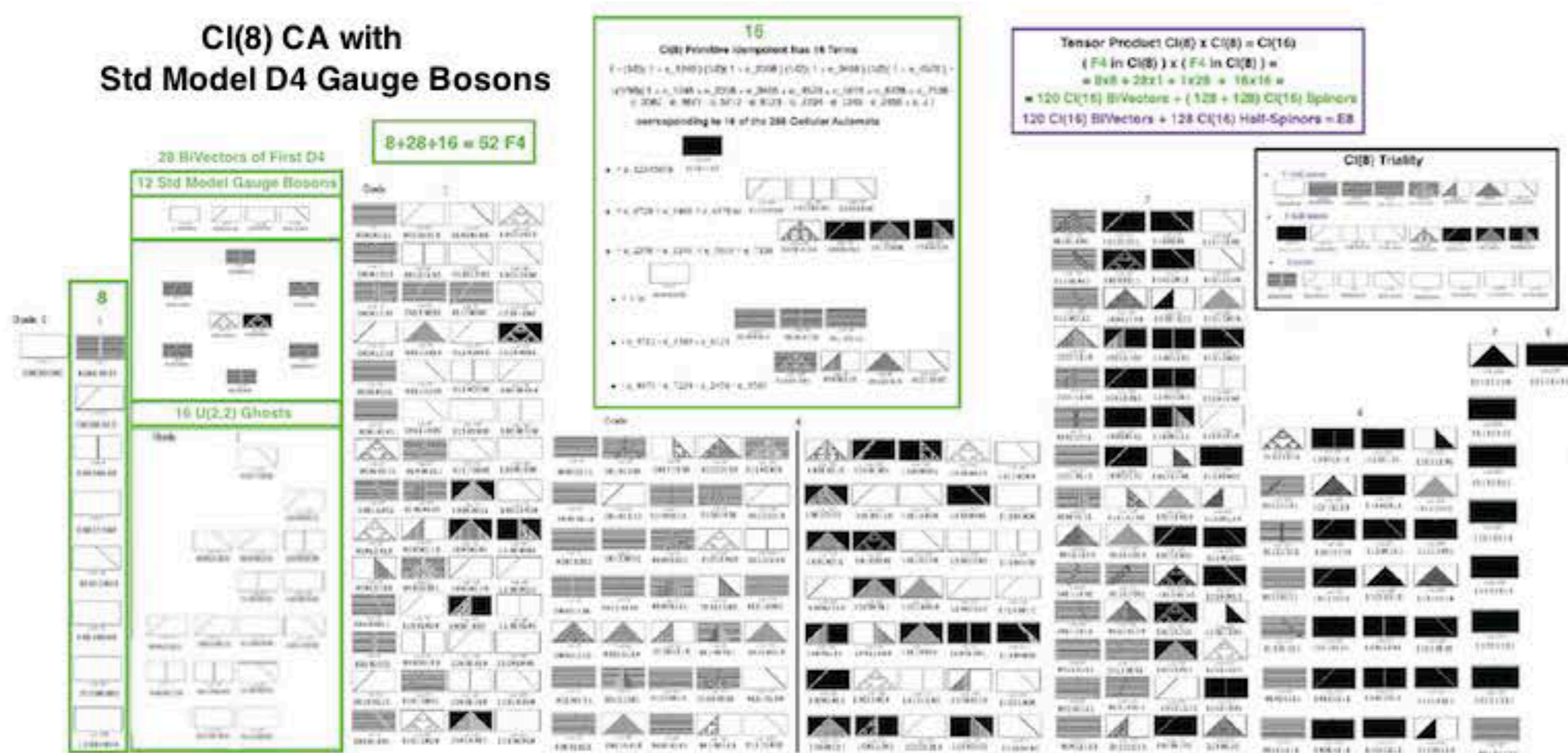
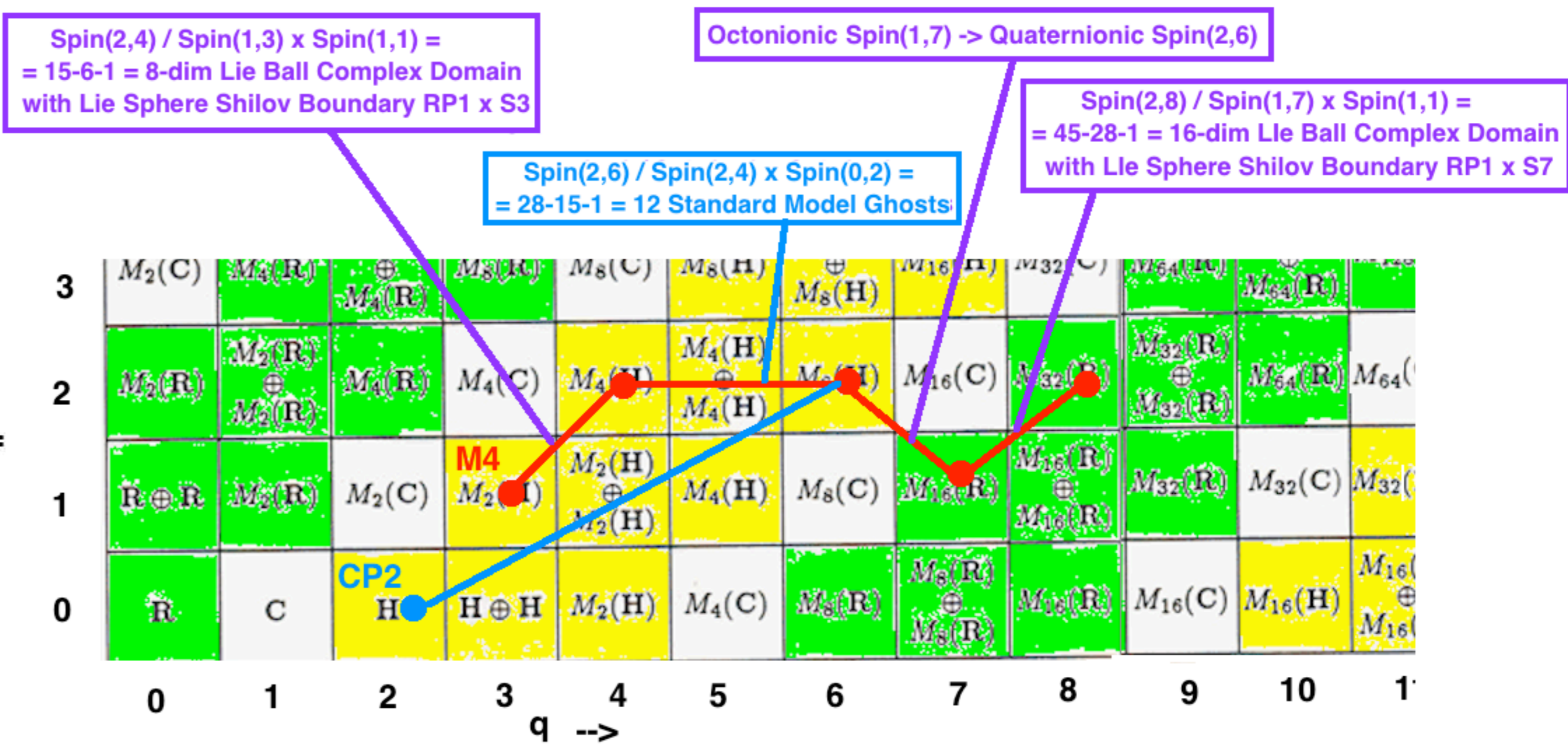
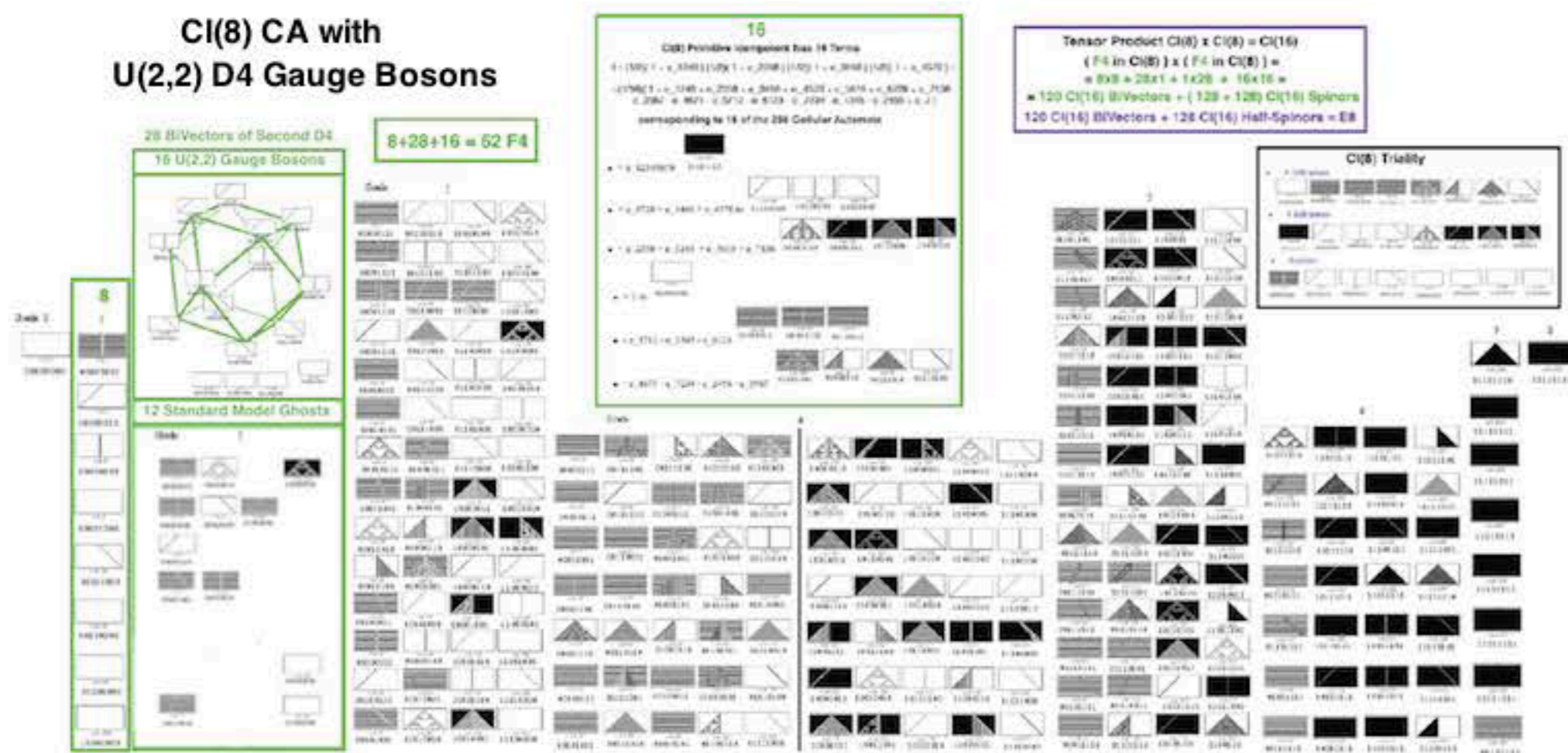

# Kaluza-Klein Spacetime M4 x CP2

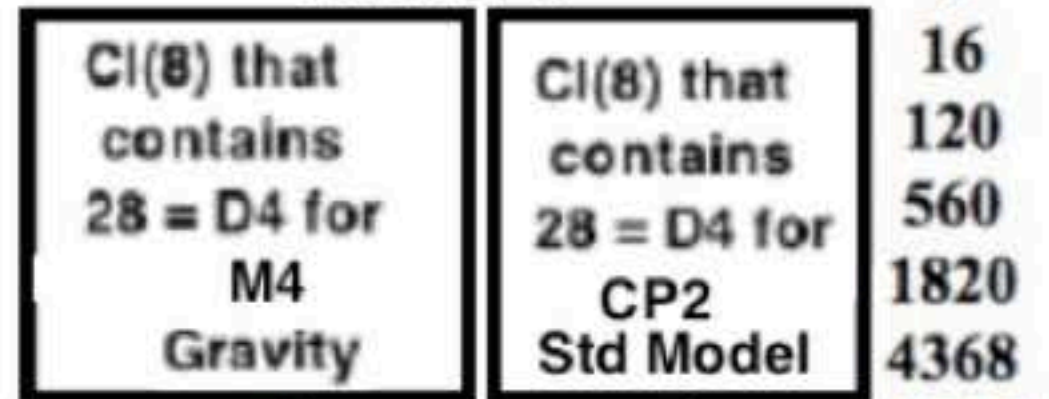

- 1
- 16
- 120
- 560
- 1820
- 4368
- 8008
- 11440
- 12870
- 11440
- 8008
- 4368
- 1820

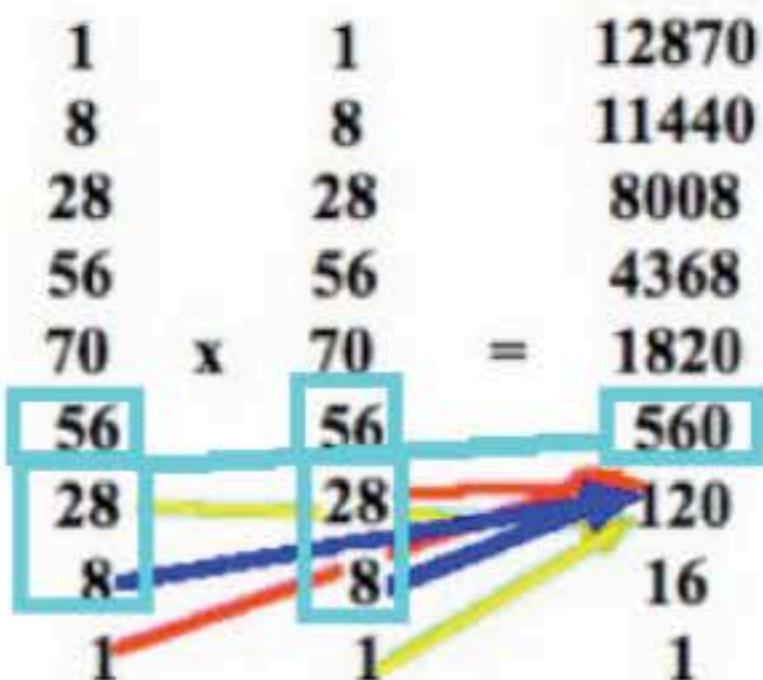

$Cl(8) \times Cl(8) = Cl(16)$

256 Spinors  $(8s \times 8s + 8s \times 8c)$   
 $(8s+8c) \times (8s+8c) = (8c \times 8s + 8c \times 8c)$

$(8s \times 8s + 8c \times 8c)$  128 half-Spinors + 120 D8 = 248 E8  
 with 240 Root Vectors

560 = 10 copies of 56 Fr3(O)

## Cl(8) CA with U(2,2) D4 Gauge Bosons

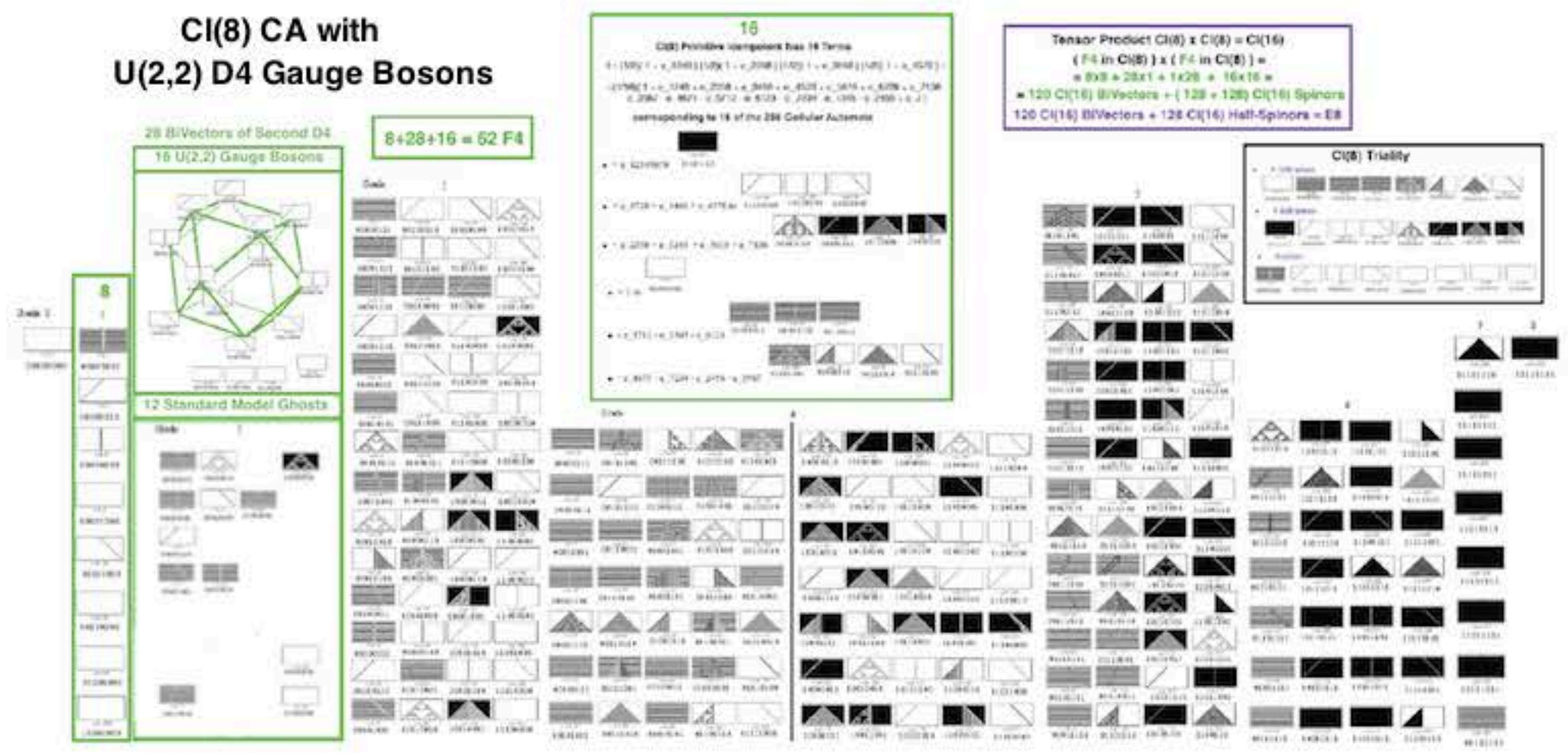

## Cl(8) CA with Std Model D4 Gauge Bosons

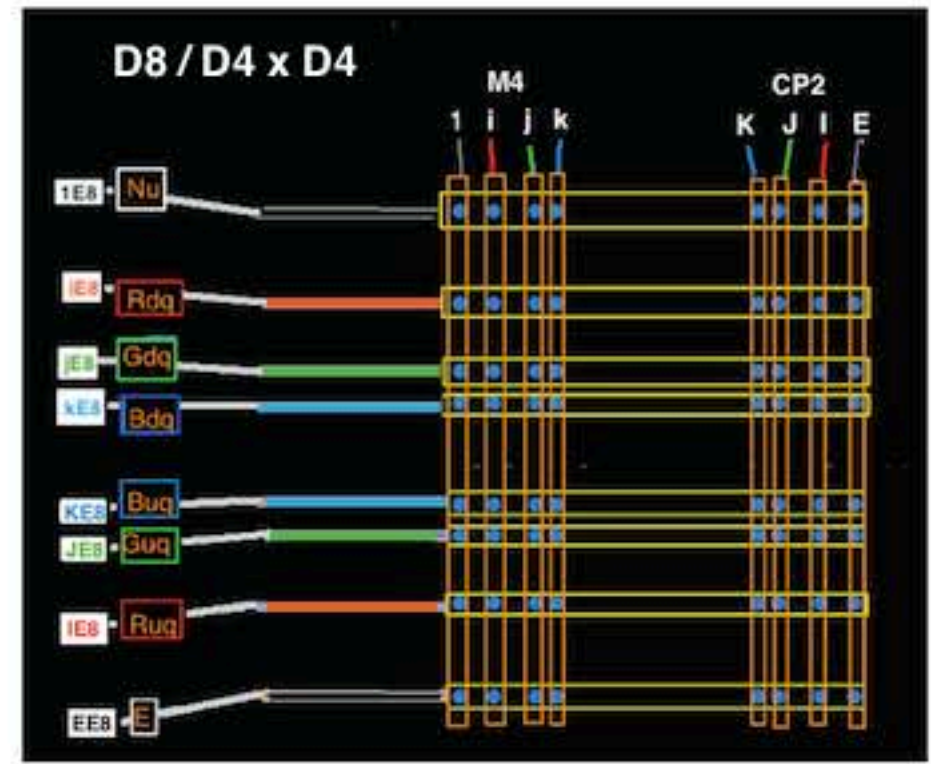
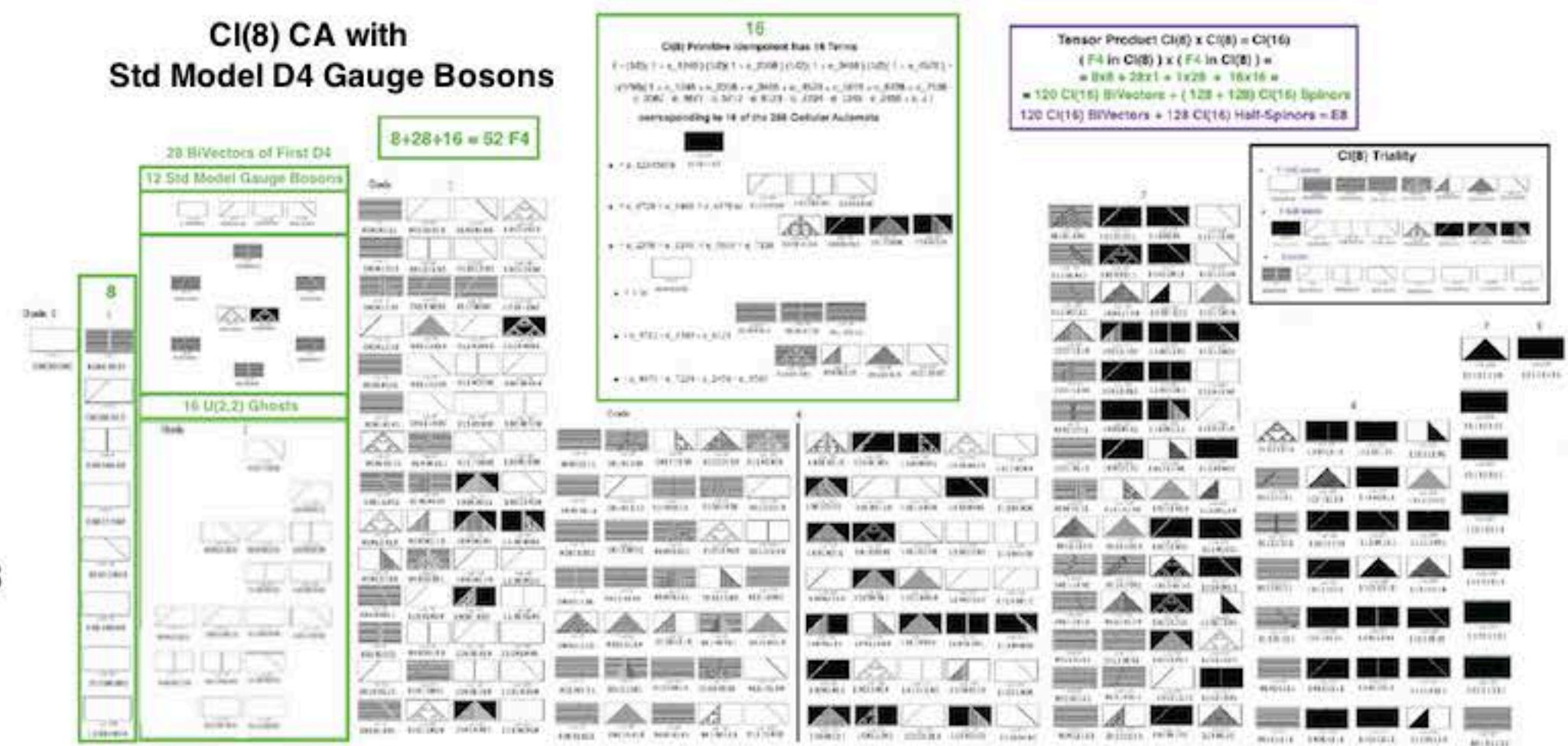

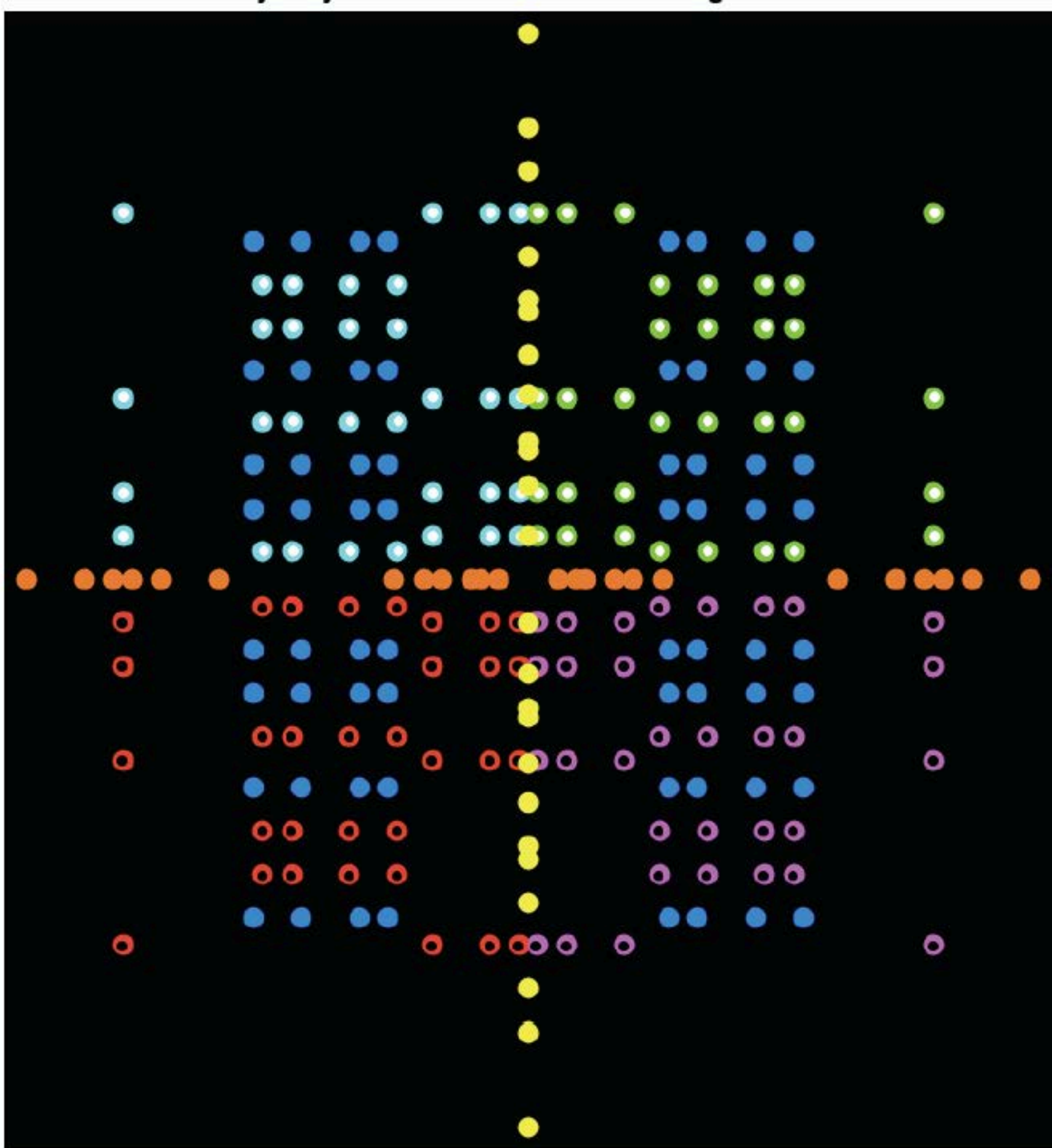

**240 E8 Root Vectors = 112 D8 Root Vectors + 128 D8 half-spinors**

**128 D8 half-spinors = 128 elements of E8 / D8**

**Green and Cyan dots with white centers (32+32=64 dots) = Fermion Particles**

**Red and Magenta dots with black centers (32+32=64 dots) = Fermion AntiParticles**

**112 D8 Root Vectors = 64 D8 / D4xD4 (blue) + 24 D4 (yellow) + 24 D4 (orange)**

In terms of 16x16 Matrices of CI(8) and 256x256 Matrices of CI(16)  
 ( Matrices of Real Numbers. CI(8) TriVectors = 2-color dots with dark blue outer part. )

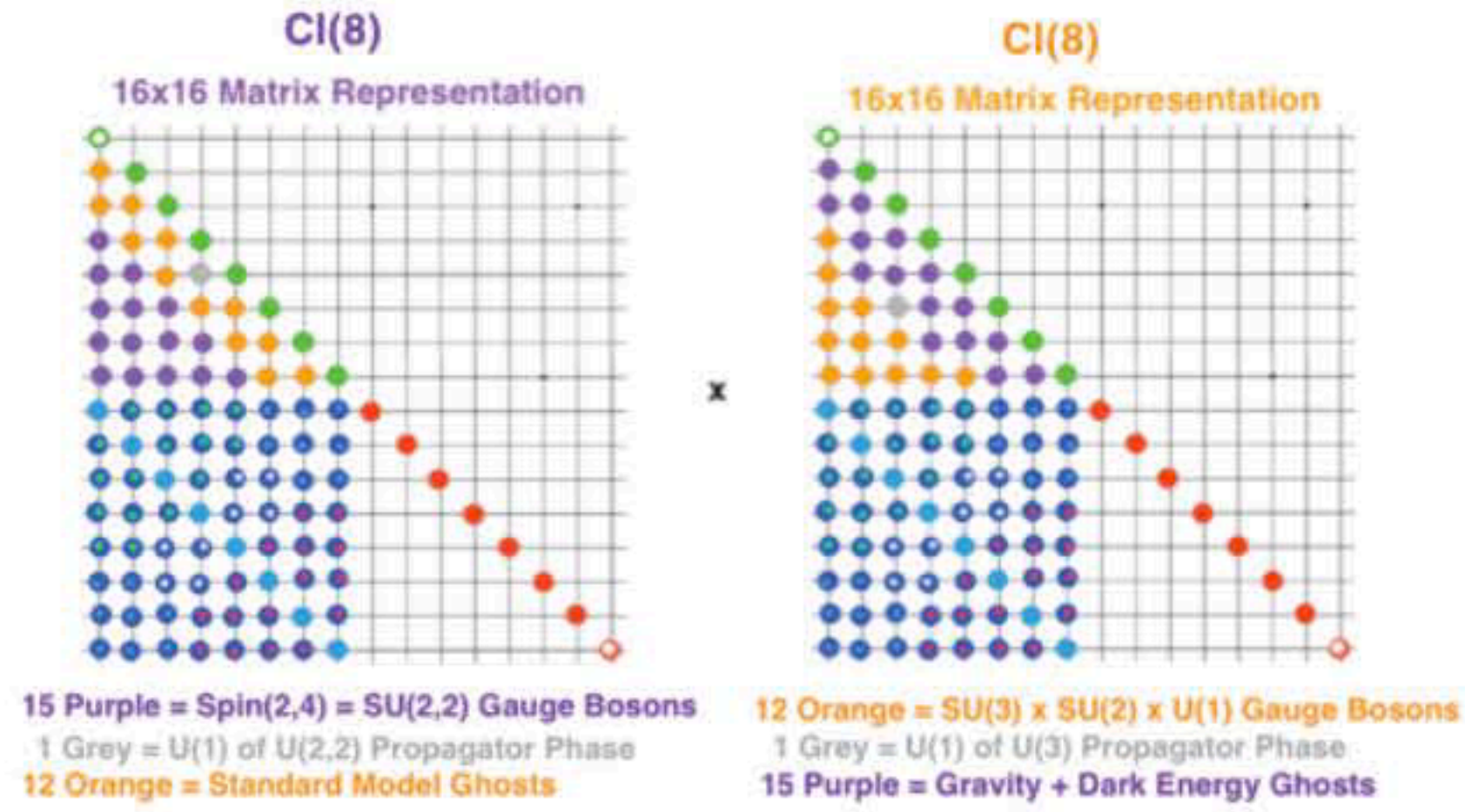

CI(16) 256x256 Matrix Representation

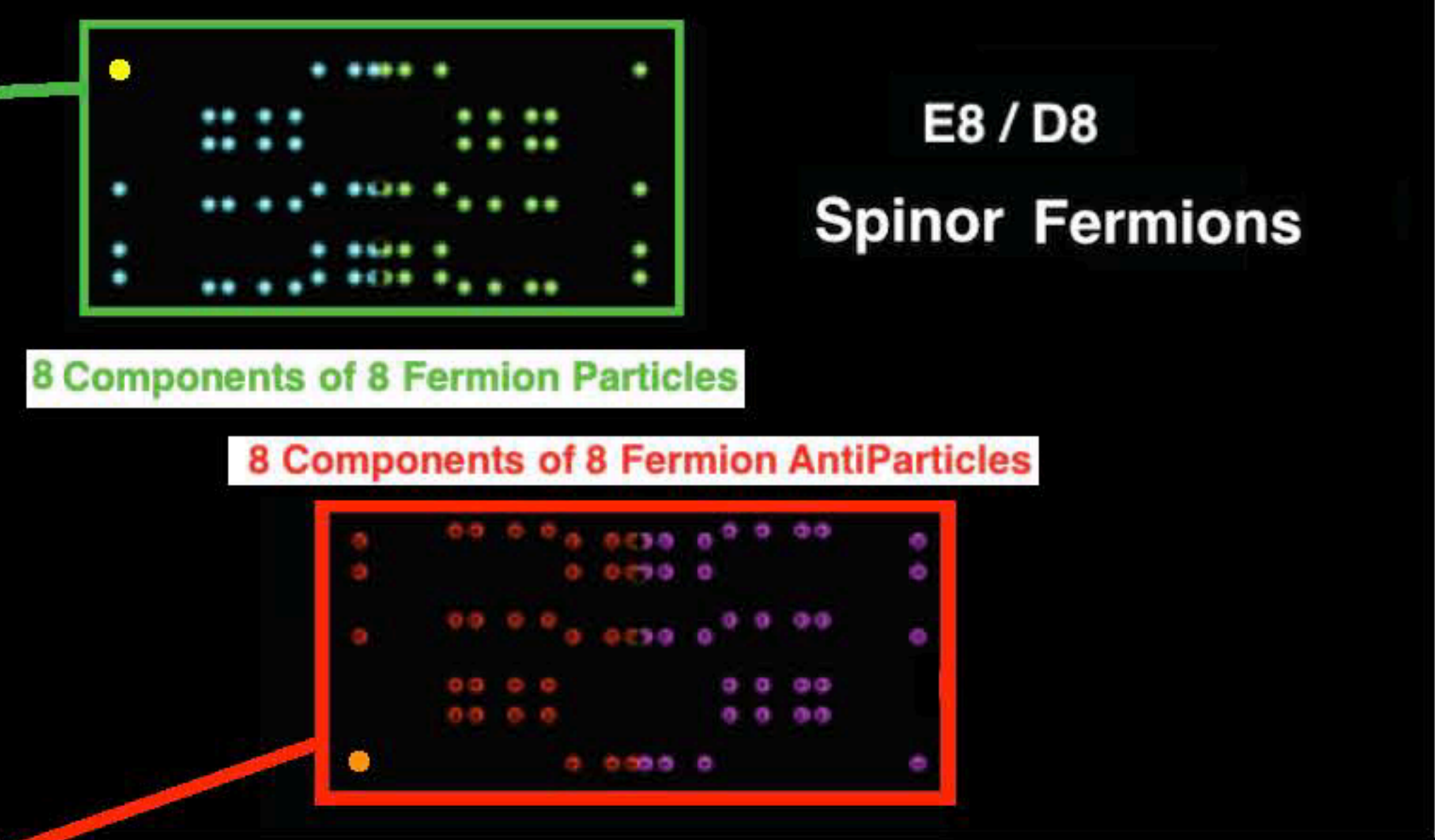
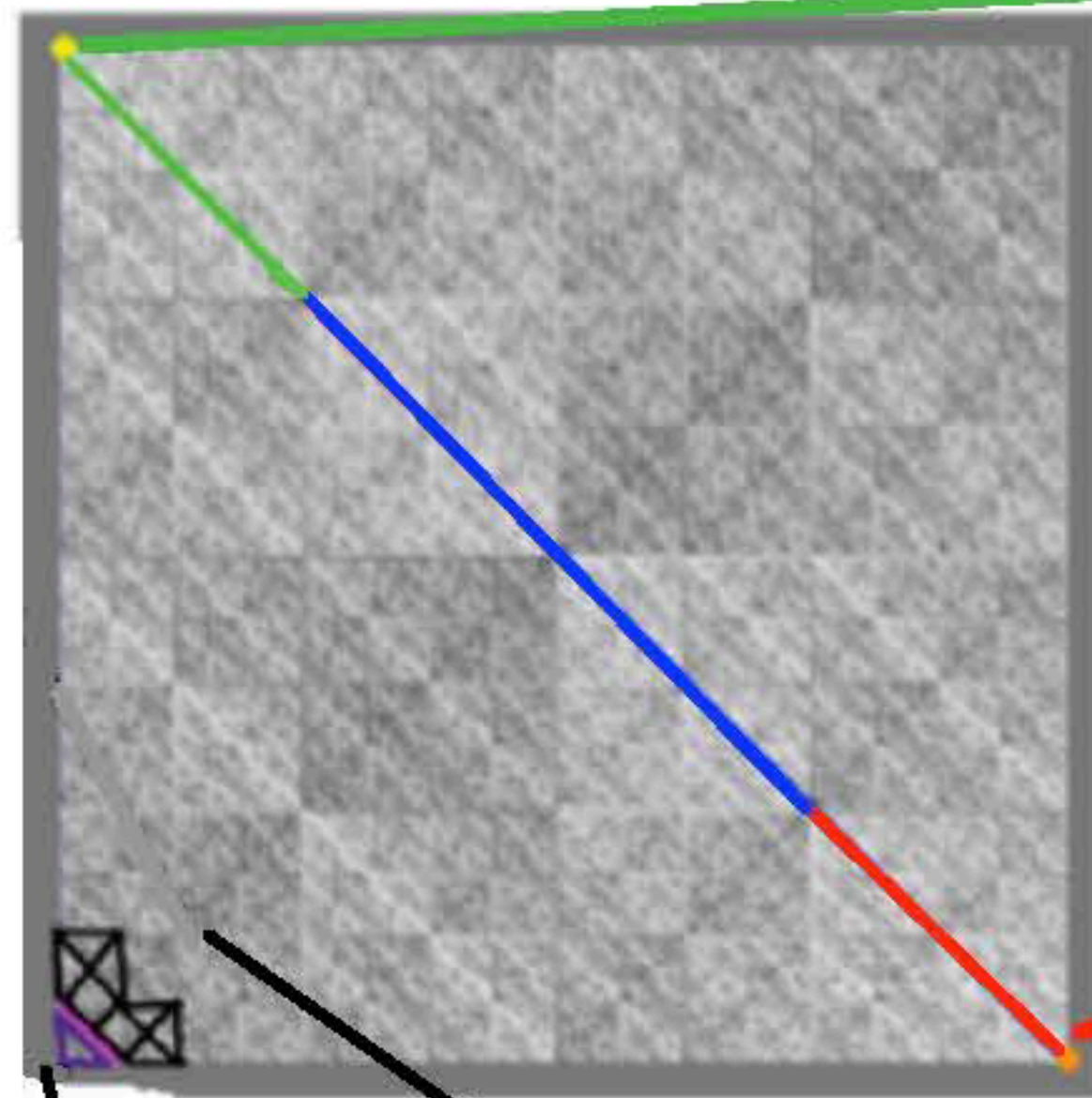

128 - 1 micron      65,536 - 40 microns

120    560

Human Brain Microtubules 40 microns = 65,536 Tubulin Dimers

**Physical Body contains Information**  
 CI(16) = 65,536  
 - 16 Vector Complex Domain  
 - 128 half-Spinor part of E8  
 - 120 BiVector part of E8  
 - 560 TriVector Fr3(O)  
 = 64,712 Ethereal Information

each Human Microtubule with 65,536 Tubulin Dimers can have a Bohm Quantum Resonant Connection with a Spirit World Unit Lattice Cell with 65,536-element CI(16) Structure

Planck Scale C(16) of 16D Complex Domain  
 LIE BALL  
 INTERIOR SPIRIT WORLD

Nanometer - Micron Scale  
 Tubulin Dimers and Microtubules  
 128 - 1 micron    65,536 - 40 microns

Planck Scale S(8) of 8D Real Shilov Boundary Physical Spacetime  
 PHYSICAL WORLD  
 SHILOV BOUNDARY  
 LIE SPHERE

The Earthly World is the 8-real-dim Lie Sphere Shilov Boundary  $RP^1 \times S^7$

The Spirit World is the interior of that Shilov Boundary which is the Type IV(8) Bounded Complex Domain corresponding to the Lie Ball Symmetric Space  $D_5 / D_4 \times U(1)$

**Second D4**

Standard Model Gauge Bosons  
 Gravity + Dark Energy Ghosts  
 propagator phase Ghost

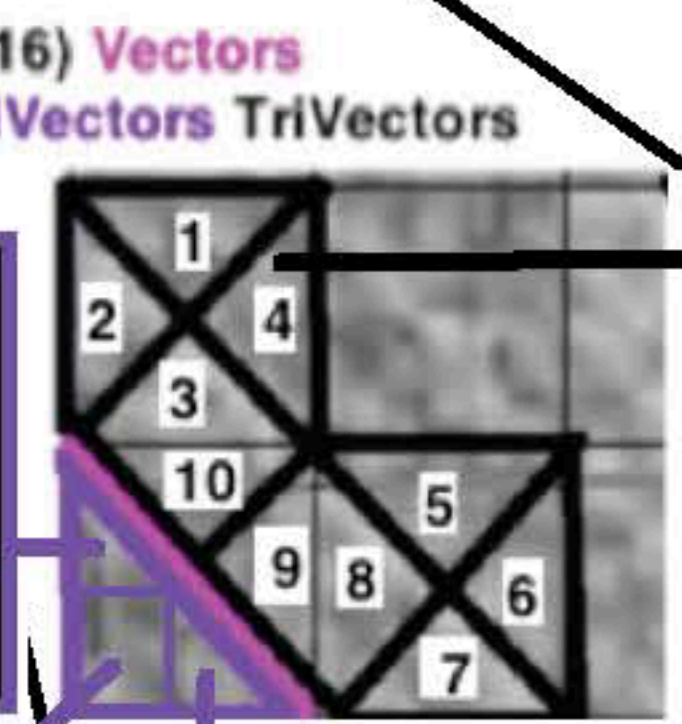

Fr3(O) is Zorn-type matrices  
 a,b,d,d',e,e',f,f' are Real Numbers  
 S+,S'+,V, V',S-,S'- are Octonions  
 \* = Conjugate

**M4 CP2**

**D8 / D4xD4**  
 Base Manifold

**First D4**

Gravity + Dark Energy Gauge Bosons  
 propagator phase  
 Standard Model Ghosts

16x16 Matrix Representation of CI(8)  
 CI(8) TriVectors (4 grey, 8 blue, 8 green, 8 red)  
 representing 56-dim Fr3(O)  
 which contains two copies of 27-dim J3(O)  
 Each J3(O) contains 26-dim traceless part J3(O)o  
 which represents a copy of 26DString Theory

a, b, d, d', e, e', f, f', S+, S'+, V, V', S-, S'-



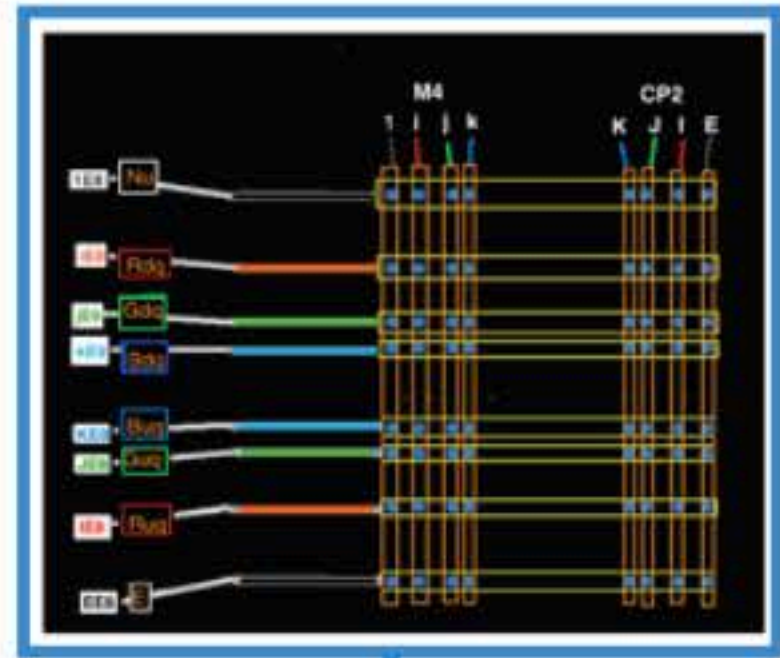

Base Manifold



Gravity + Dark Energy  
Gauge plus Bosons and Ghosts  
propagator phase



Standard Model  
Gauge Bosons and Ghosts

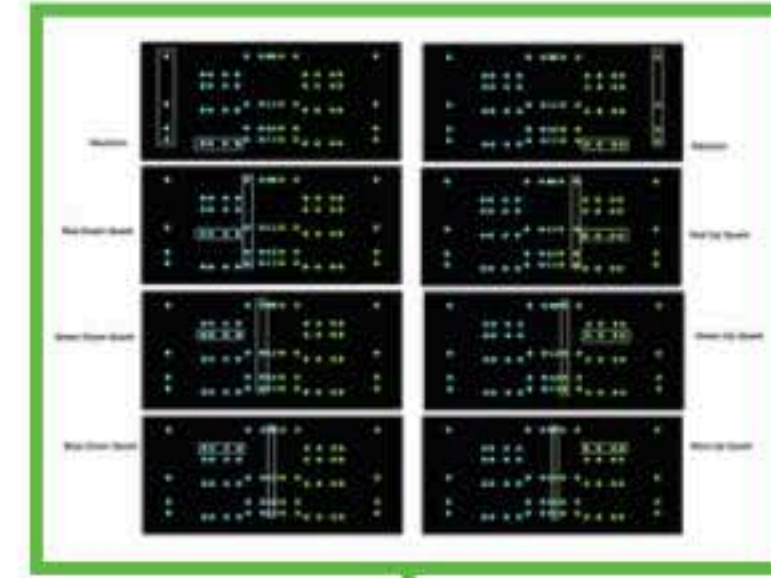

8 Components of 8 Fermion Particles

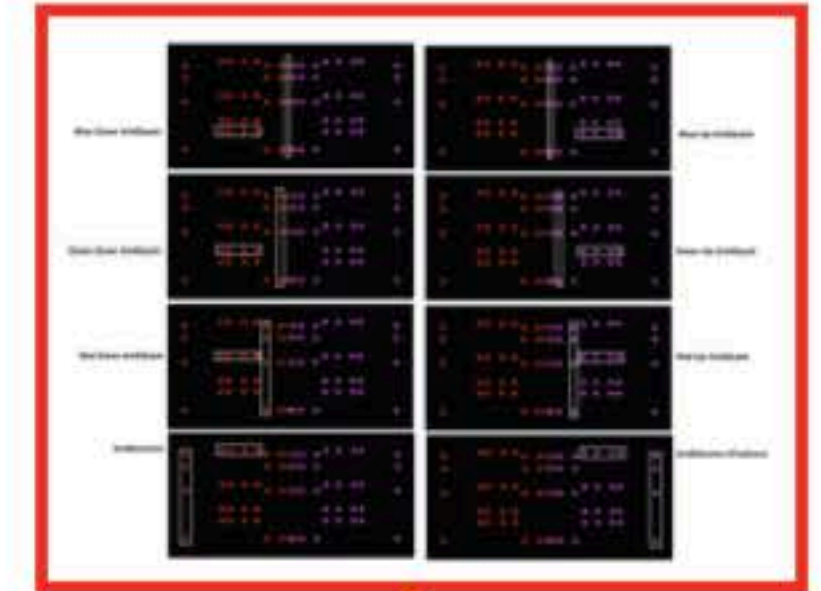

8 Components of 8 Fermion AntiParticles

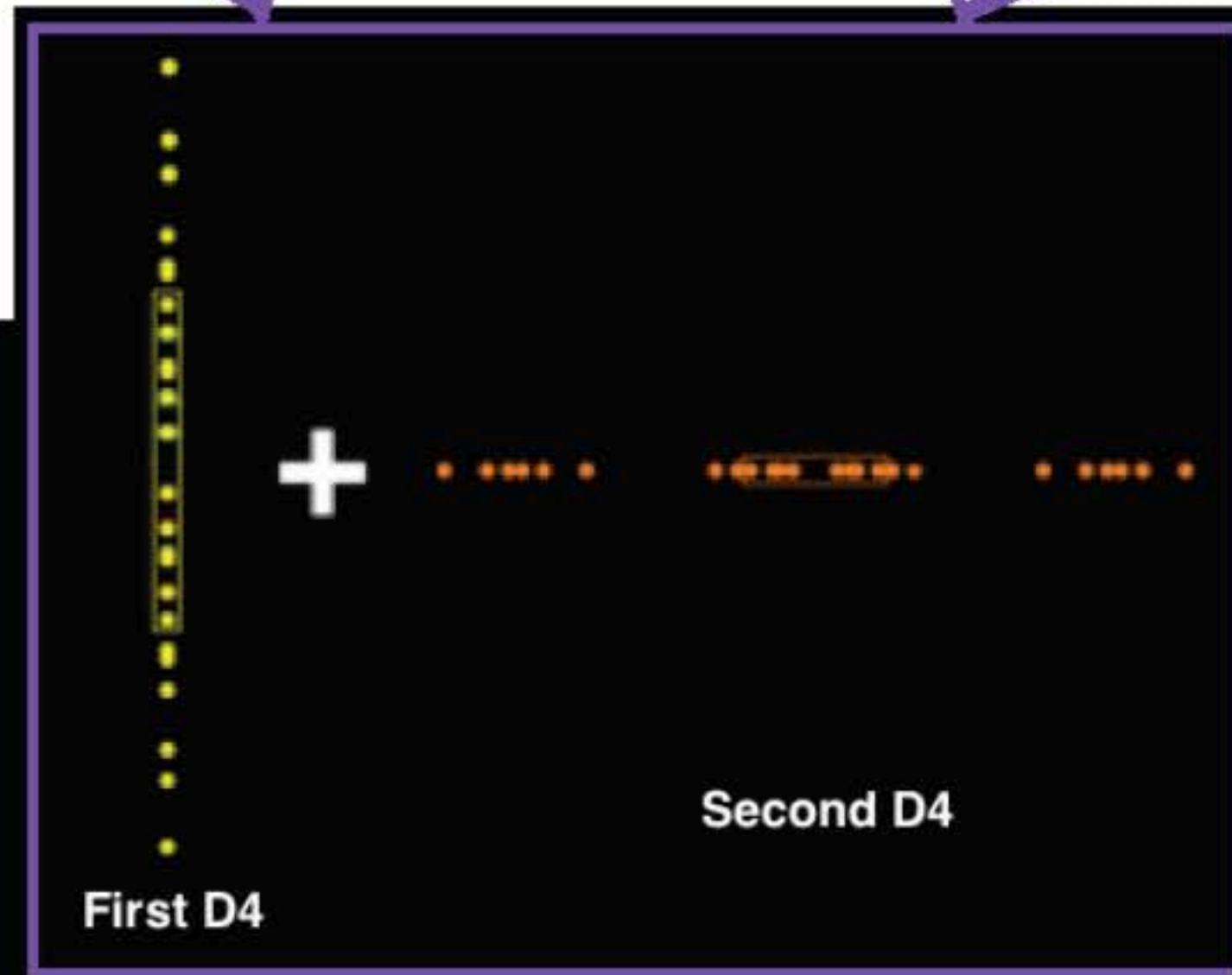

Gauge Bosons and Ghosts  
D4xD4

8D Lagrangian

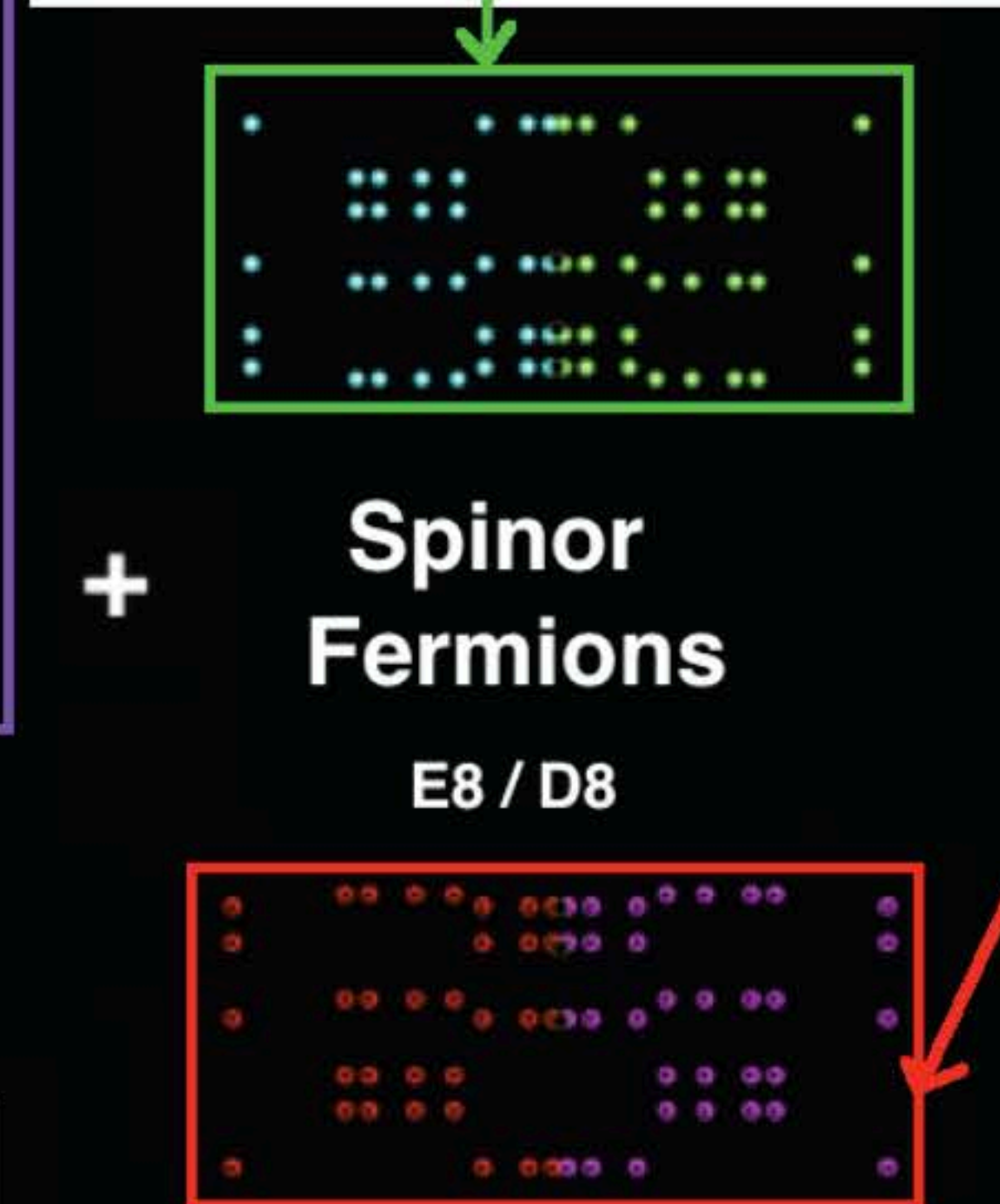

Spinor Fermions

E8 / D8

## The 8D-4D E8 Lagrangian System has these characteristics:

Lagrangian has 8-dim Lorentz structure satisfying Coleman-Mandula because its Fermionic fundamental spinor representations are built with respect to spinor representations for 8-dim Spin(1,7) spacetime - see Steven Weinberg, "The Quantum Theory of Fields" Volume III

Lagrangian is UltraViolet finite because each Fermionic Term Fermion has in 8-dim Spacetime units of  $\text{mass}^{(7/2)}$  and each Bosonic Gauge Boson + Ghost Term has units of  $\text{mass}^{(1)}$ , so, since  $(8+8) \times (7/2) = 56 = 28 + 28$  the Fermionic Terms cancel the Bosonic Terms - see Steven Weinberg "1986 Dirac Lectures Elementary Particles and the Laws of Physics"

Lagrangian is Chiral because E8 contains Cl(16) half-spinors (64+64) for a Fermion Generation but does not contain Cl(16) Mirror Fermion AntiGeneration half-spinors. Fermion +half-spinor Particles with high enough velocity are seen as left-handed. Fermion -half-spinor AntiParticles with high enough velocity are seen as right-handed.

Lagrangian obeys Spin-Statistics because the CP2 part of M4xCP2 Kaluza-Klein has index structure Euler number  $2+1 = 3$  and Atiyah-Singer index  $-1/8$  which is not the net number of generations because CP2 has no spin structure but you can use a generalized spin structure (Hawking and Pope (Phys. Lett. 73B (1978) 42-44)) to get (for integral m) the generalized CP2 index  $n_R - n_L = (1/2) m (m+1)$   
Prior to Dimensional Reduction:  $m = 1$ ,  $n_R - n_L = (1/2) \times 1 \times 2 = 1$  for 1 generation  
After Reduction to 4+4 Kaluza-Klein:  $m = 2$ ,  $n_R - n_L = (1/2) \times 2 \times 3 = 3$  for 3 generations  
Hawking and Pope say: "Generalized Spin Structures in Quantum Gravity ... what happens in CP2 ... one could replace the electromagnetic field by a Yang-Mills field whose group G had a double covering  $G_{\sim}$ . The fermion field would have to occur in representations which changed sign under the non-trivial element of the kernel of the projection ...  $G_{\sim} \rightarrow G$  while the bosons would have to occur in representations which did not change sign ...". For E8 physical gauge bosons are in the  $28+28=56$ -dim D4xD4 subalgebra. D4 = SO(8) is the Hawking-Pope G with double covering  $G_{\sim} = \text{Spin}(8)$ . The 8 fermion particles / antiparticles are D4 half-spinors represented within E8 by anti-commutators and so do change sign while the 28 gauge bosons are D4 adjoint represented within E8 by commutators and so do not change sign.

E8 Lagrangian inherits from F4 the property whereby its Spinor Part need not be written as Commutators but can also be written in terms of Fermionic AntiCommutators - see Pierre Ramond hep-th/0112261 -also, F4 lives in Cl(8) as Vectors + BiVectors + Spinors and by 8-Periodicity Cl(16) = tensor product Cl(8) x Cl(8) and E8 lives in Cl(16) as BiVectors + half-Spinors.

# Lagrangian

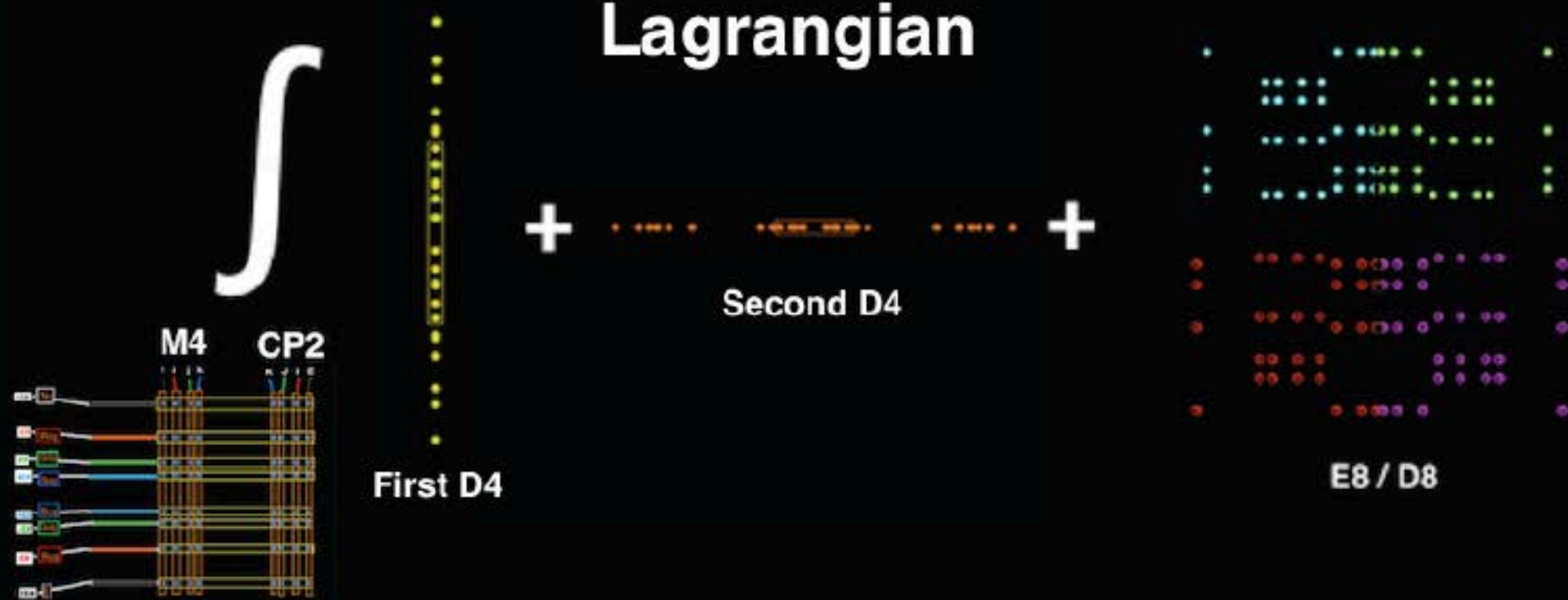

**Mayer Mechanism**

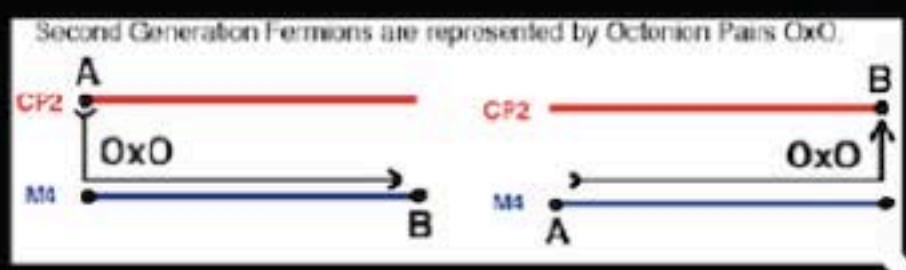
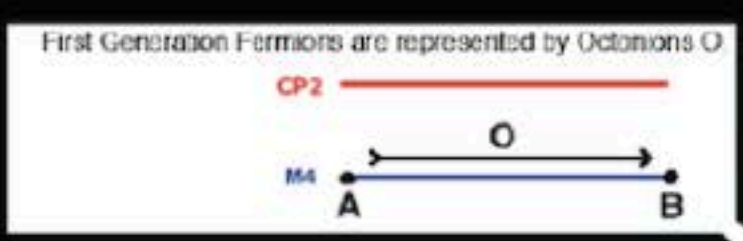

3 Kaluza-Klein Fermion Generations

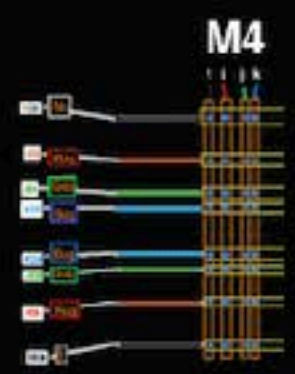

**NJL Higgs as Condensate of T T̄**

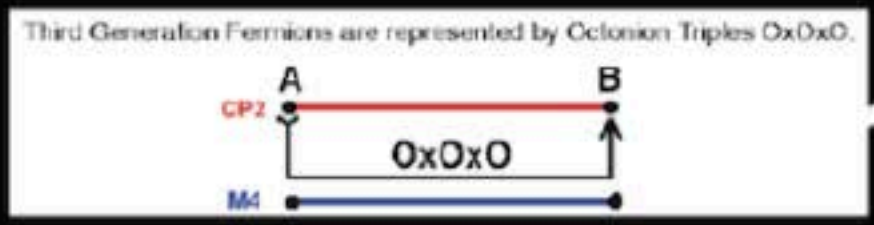

RGB Truth Quarks

RGB Truth AntiQuarks

The Real Form of E8 at Initial Big Bang is Compact E8(-248) with SO(16) Symmetry.

The Real Form of E8 during Inflation is E8(8) with SO(8,8) Symmetry. In the 8D Lagrangian the Base Manifold Spacetime is 8-dim Octonion with respect to which Quantum Processes are Non-Unitary so that during Inflation Particles are created.

After Inflation the Symmetry of Spacetime is broken from Octonion to Quaternion, the Real Form of E8 becomes E8(-24) with  $SO^*(16) = Sk(8,H)$  Symmetry, and the Base Manifold Spacetime becomes  $M4 \times CP2$  Kaluza-Klein (where  $M4 =$  Minkowski and  $CP2 = SU(3) / SU(2) \times U(1) =$  Internal Symmetry Space)

Breaking Spacetime and World-Lines of Particles into  $M4 \times CP2$  Kaluza-Klein produces Higgs (Mayer and Trautman in Acta Physica Austriaca, Suppl. XXIII (1981)) and Fermion Generations 2 and 3 which produces a Nambu - Jona-Lasinio System of Higgs and Truth Quarks (Yamawaki et al in hep-ph/9603293 and hep-ph/0311165 ) that has Higgs as Truth Quark-AntiQuark condensate and 3 mass states:

- Higgs at 125 GeV and Truth Quark at 130 GeV
- Higgs at 200 GeV and Truth Quark at 174 GeV
- Higgs at 250 GeV and Truth Quark at 220 GeV

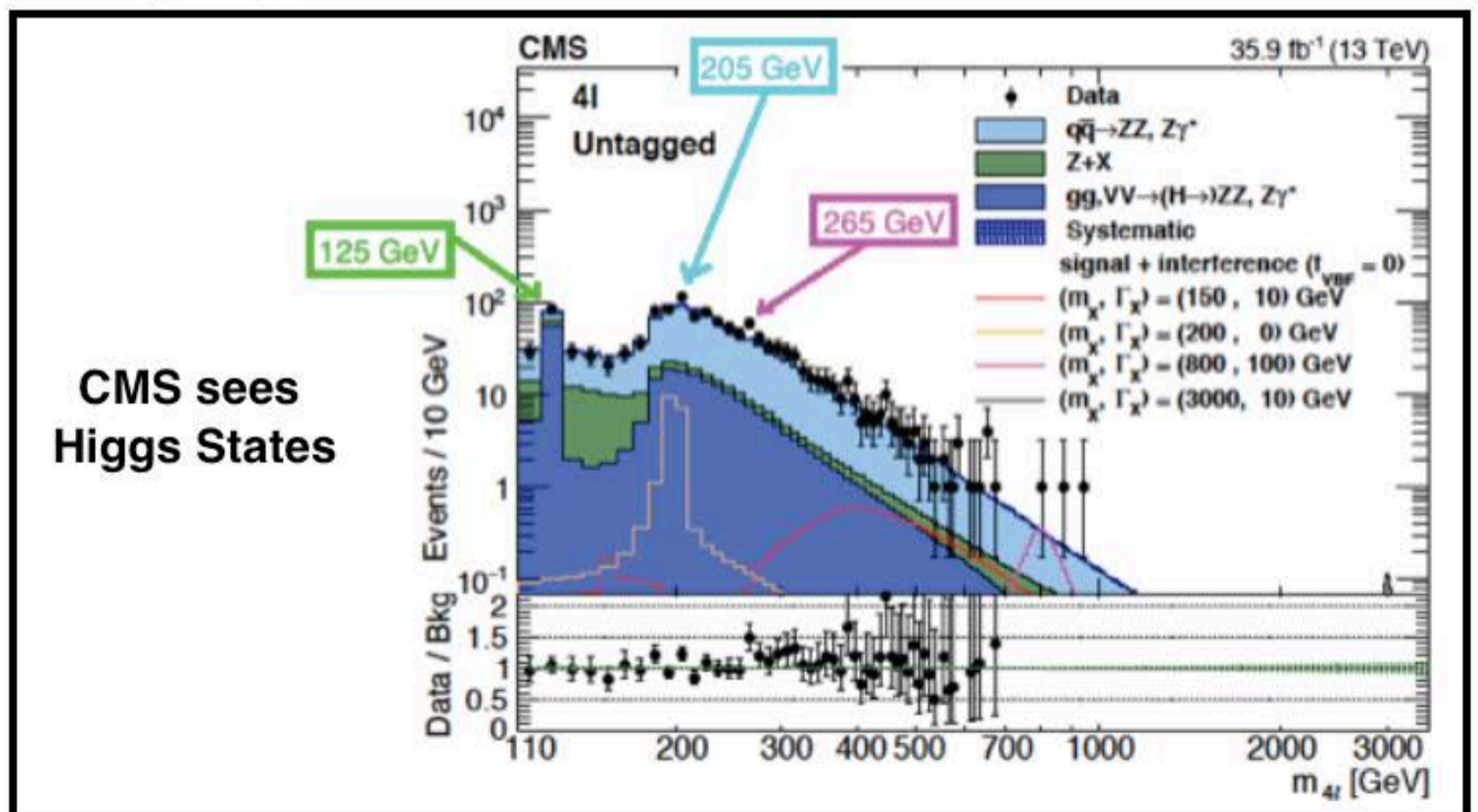
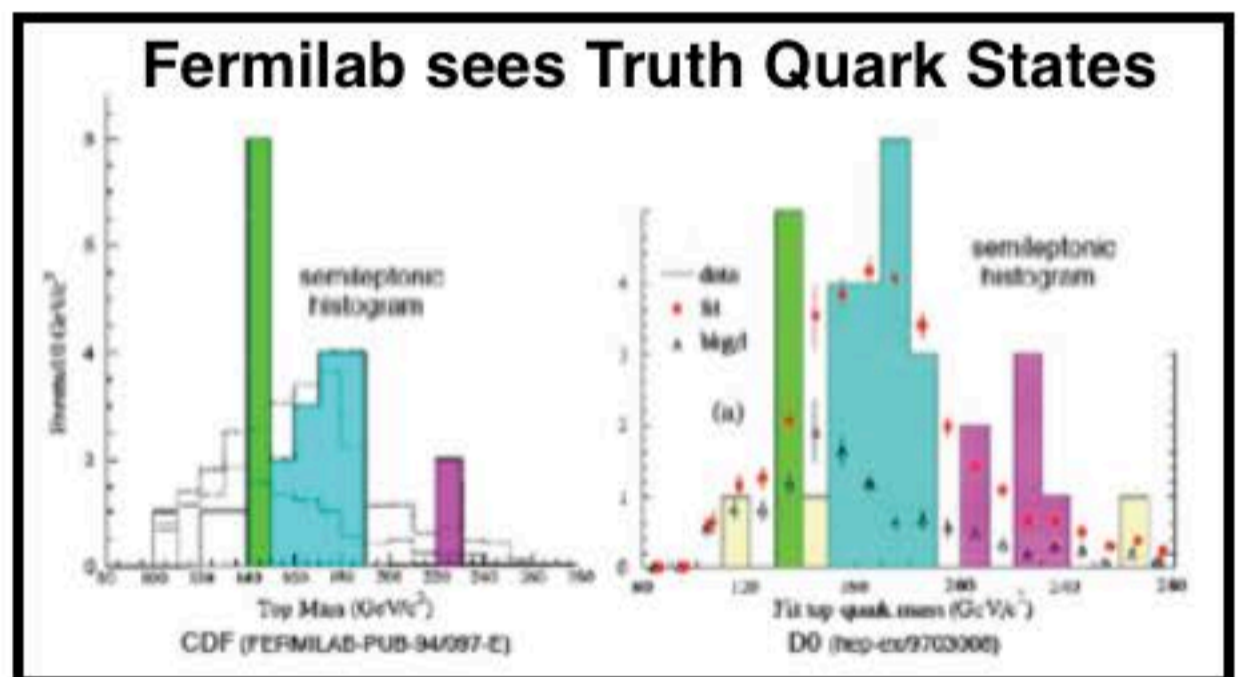
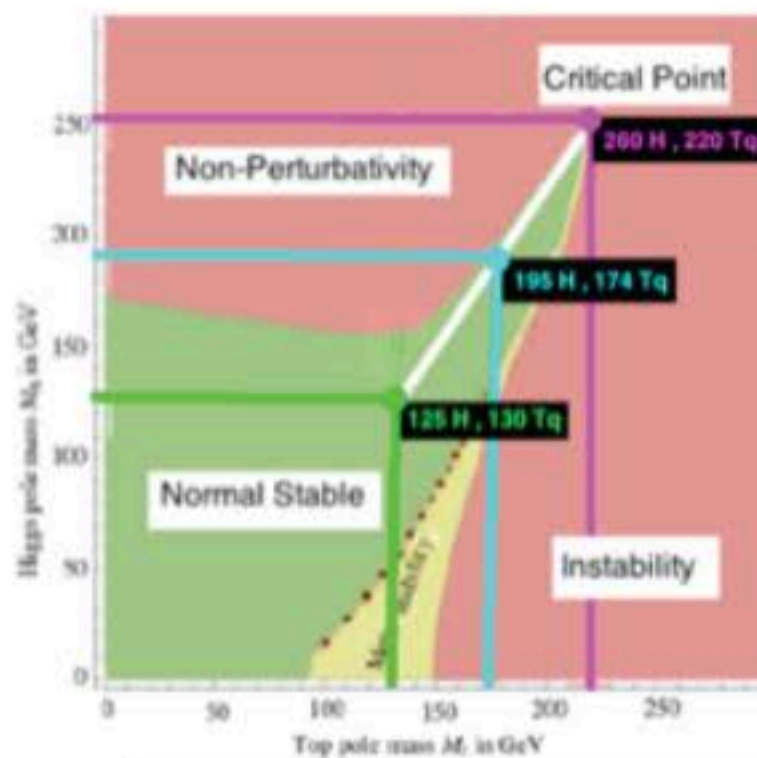

CMS sees Higgs States

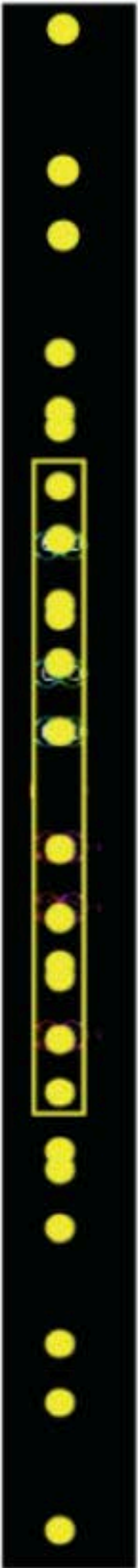

The 24 Yellow Root Vectors of the D4 of E8 Gravity + Standard Model Ghosts are on the Vertical Y-axis.

12 of them in the Yellow Box represent the 12 Root Vectors of the Conformal Gauge Group  $SU(2,2) = Spin(2,4)$  of Conformal Gravity + Dark Energy.

The 4 Cartan Subalgebra elements of  $SU(2,2) \times U(1) = U(2,2)$  correspond to the 4 Cartan Subalgebra elements of D4 of E8 Gravity + Standard Model Ghosts and to the other half of the 8 Cartan Subalgebra elements of E8.

The other  $24 - 12 = 12$  Yellow Root Vectors represent Ghosts of 12D Standard Model whose Gauge Groups are  $SU(3) SU(2) U(1)$ .

Gravity and Dark Energy come from its Conformal Subgroup  $SU(2,2) = Spin(2,4)$

- see Mohapatra "Unification and Supersymmetry section 14.6  
R. Aldrovandi and J. G. Peireira in gr-qc/9809061

$SU(2,2) = Spin(2,4)$  has 15 generators:

1 Dilation representing Higgs Ordinary Matter

4 Translations representing Primordial Black Hole Dark Matter

10 = 4 Special Conformal + 6 Lorentz representing Dark Energy

(see Irving Ezra Segal, "Mathematical Cosmology and Extragalactic Astronomy" (Academic 1976))

The basic ratio Dark Energy : Dark Matter : Ordinary Matter =  $10:4:1 = 0.67 : 0.27 : 0.06$

When the dynamics of our expanding universe are taken into account, the ratio is calculated to be **0.75 : 0.21 : 0.04**

### Ghosts correspond to Gauge Bosons:

Steven Weinberg in The Quantum Theory of Fields Volume II Section 15.7 said:

"... there is a beautiful geometric interpretation of the ghosts and the BRST symmetry ...

The gauge fields  $A_a^\mu$  may be written as one-forms  $A_a = A_{a\mu} dx^\mu$ , where  $dx^\mu$  are a set of anticommuting c-numbers. ... This can be combined with the ghost to compose a one-form  $A_a = A_a + w_a$  in an extended space.

Also, the ordinary exterior derivative  $d = dx^\mu d/dx^\mu$  may be combined with the BRST operator  $s$  to form an exterior derivative  $D = d + s$  in this space, which is nilpotent because  $s^2 = d^2 = sd + ds = 0$  ...".

The 24 Orange Root Vectors of the D4 of E8 Standard Model + Gravity Ghosts are on the Horizontal X-axis.



8 of them in the Orange Box represent the 8 Root Vectors of the Standard Model Gauge Groups SU(3) SU(2) U(1).

Their 4 Cartan Subalgebra elements correspond to the 4 Cartan Subalgebra elements of D4 of E8 Standard Model + Gravity Ghosts and to half of the 8 Cartan Subalgebra elements of E8.

The other 24-8 = 16 Orange Root Vectors represent Ghosts of 16D U(2,2) which contains the Conformal Group SU(2,2) = Spin(2,4) that produces Gravity + Dark Energy by the MacDowell-Mansouri mechanism.

Standard Model Gauge groups come from CP2 = SU(3) / SU(2) x U(1) (as described by Batakis in Class. Quantum Grav. 3 (1986) L99-L105)

Electroweak SU(2) x U(1) is gauge group as isotropy group of CP2.

SU(3) is global symmetry group of CP2 but due to Kaluza-Klein M4 x CP2 structure of compact CP2 at every M4 spacetime point, it acts as Color gauge group with respect to M4.

### Ghosts correspond to Gauge Bosons:

Jean Thierry-Mieg in J. Math. Phys. 21 (1980) 2834-2838 said:

“... The ghost and the gauge field:

The single lines represent a local coordinate system of a principal fiber bundle of base space-time.

The double lines are 1 forms.

The connection of the principle bundle  $\omega$  is assumed to be vertical.

Its contravariant components  $\phi^i$  and  $X^i$  are recognized, respectively, as the Yang-Mills gauge field and the Faddeev-Popov ghost form ...

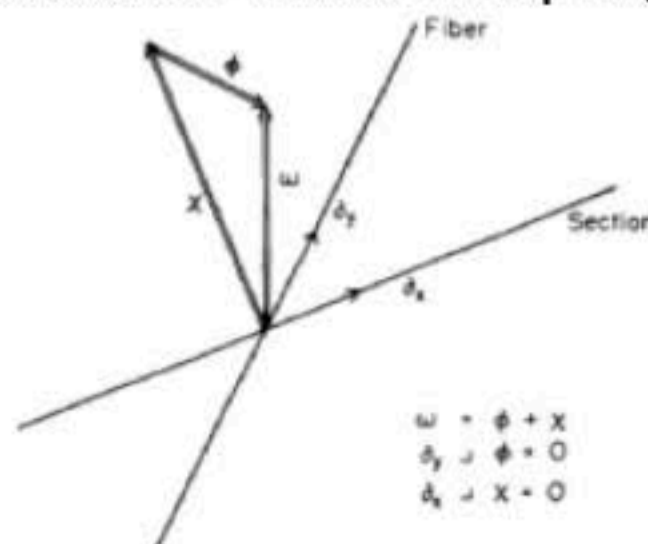

# 56 Cl(8) TriVectors correspond to Fr3(O) of 26D World-Line=String Theory

56 Cl(8) TriVectors

Circle 3

9000111	00101010	01010100	10010010
00101011	00101100	01011000	10010100
00101111	00110010	01100011	10110010
00101110	00110010	01100010	10100011
00101011	00110100	01100100	10100100
00101010	00110000	01100000	10100100
00101110	01000011	01110000	10101000
00110001	00100101	10000011	10110000
90011110	01000110	10000101	11000001
90011100	01001001	10000110	11000010
00100001	01001010	10001001	11000100
00100101	01001100	10001010	11000100
00100110	01010001	10001100	11010000
00101001	01010010	10001001	11010000

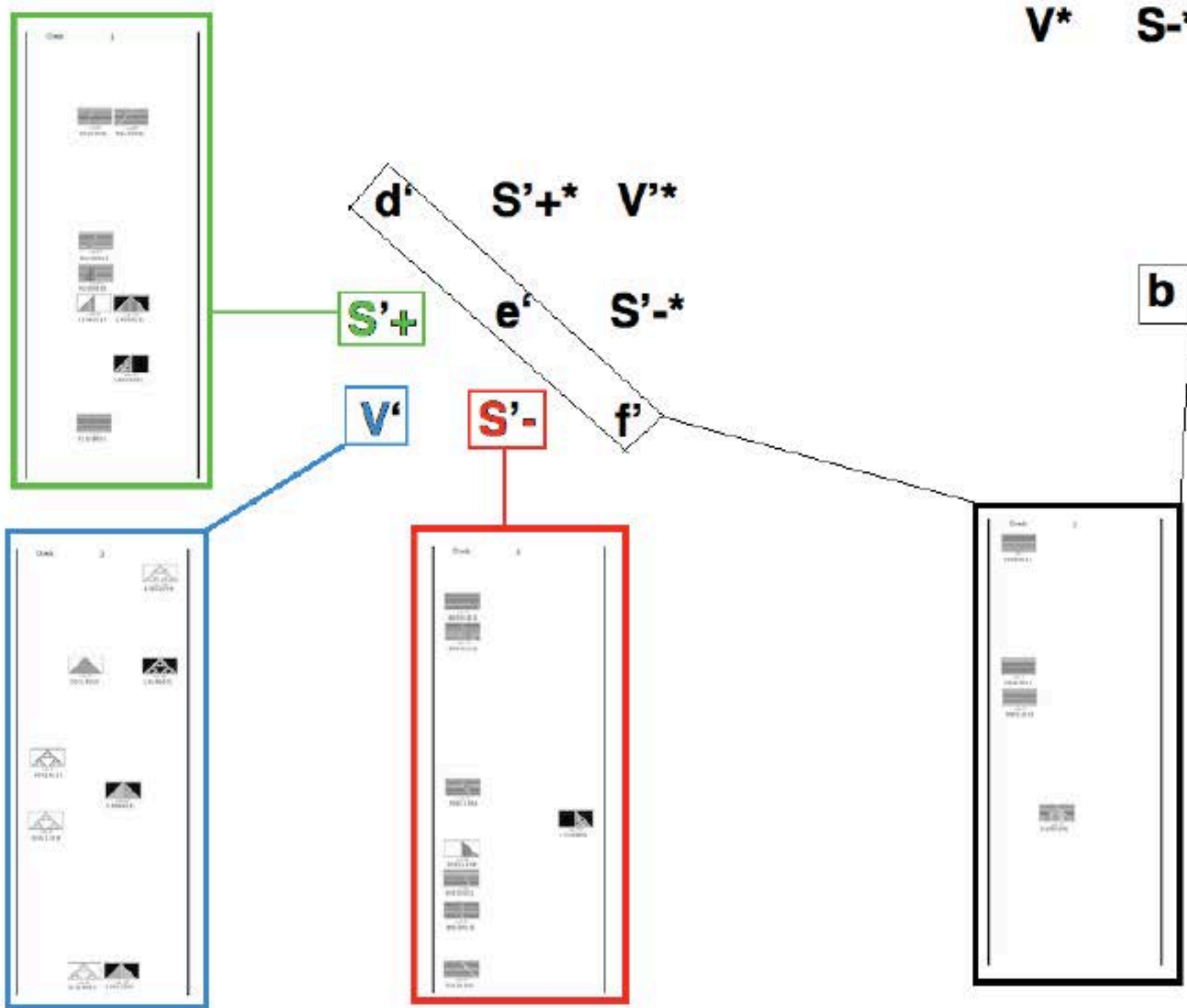
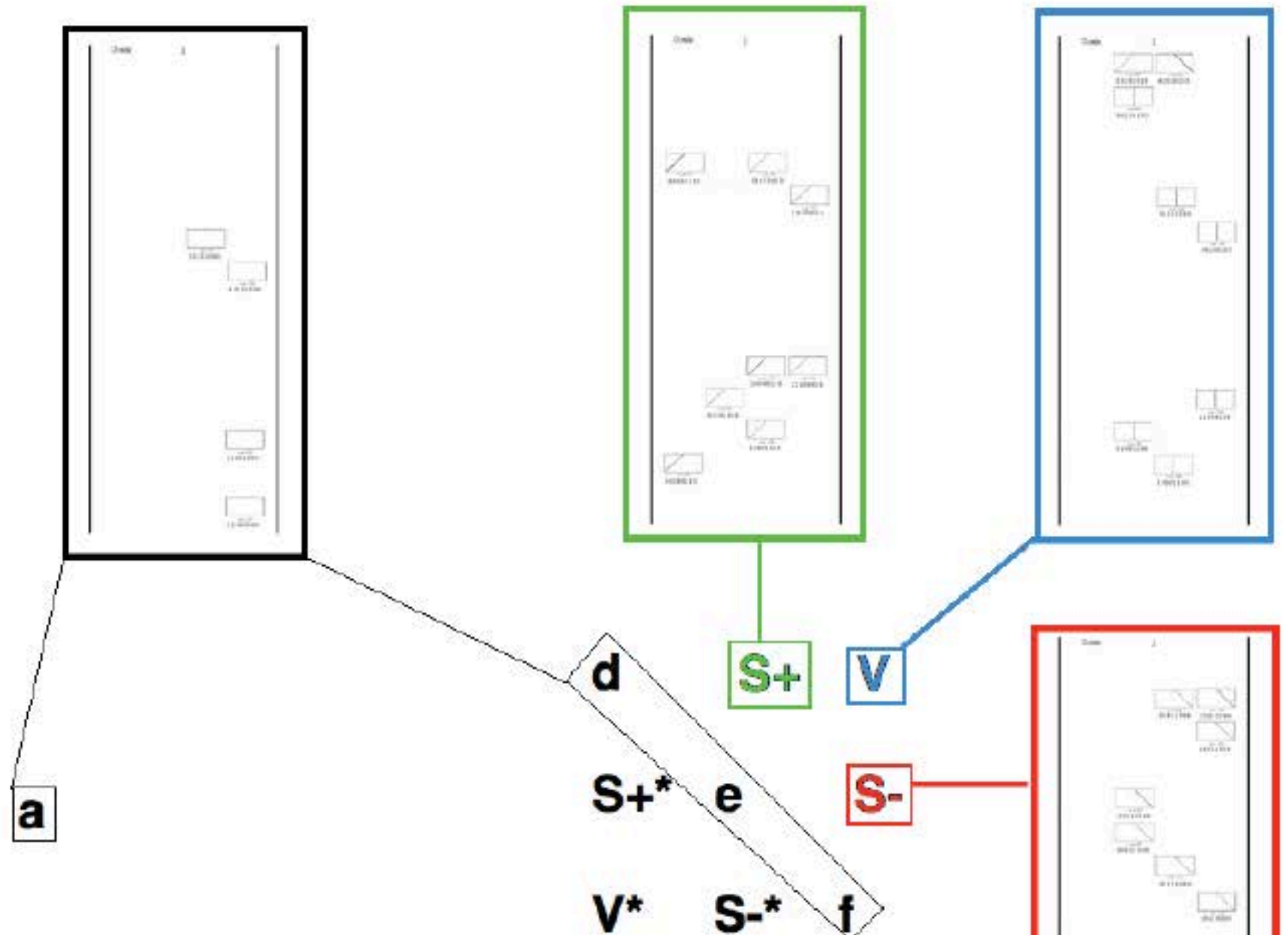

To see how  $Fr_3(O)$  gives String Theory look at one of the  $J_3(O)_o$  in  $Fr_3(O)$

	<b>d</b>	<b>S+</b>	<b>V</b>
<b>One of the two 26D traceless <math>J_3(O)_o</math> parts of <math>Fr_3(O)</math></b>	<b>S+*</b>	<b>-d-f</b>	<b>S-</b>
	<b>V*</b>	<b>S-*</b>	<b>f</b>

**S+** = 8 First-Generation Fermion Particles

**S-** = 8 First-Generation Fermion AntiParticles

**S+** and **S-** are Orbifolded in the 26D String Theory Space

leaving  $26 - 16 = 10$  dimensions of 8-dim **V** and 1-dim **d** and 1-dim **f**.

**d** and **f** act to make 10-dim **V+d+f** a Conformal Space over 8-dim **V**  
with Octonionic symmetries  $Spin(1,9) = SL_2(O)$  and  $Spin(0,8) = Spin(1,7)$   
due to the Clifford Algebra isomorphism  $Cl(0,8) = Cl(1,7) = M_{16}(R)$

Green, Schwartz, and Witten, in "Superstring Theory" vol. 1, describe 26D String Theory saying ".... The first excited level ... consists of ...

the ground state ... **tachyon** ...

and ... a scalar ... '**dilaton**' ...

and ... **SO(24)** ... **little group of a ...[26-dim]... massless particle** ...

and ... a ... **massless ... spin two state** ...".

Tachyons localized at orbifolds of fermions produce virtual clouds of particles / antiparticles that dress fermions by filling their Schwinger Source regions.

Dilatons are Goldstone bosons of spontaneously broken scale invariance that (analagous to Higgs) go from mediating a long-range scalar gravity-type force to the nonlocality of the Bohm-Sarfatti Quantum Potential.

The  $SO(24)$  little group is related to the Monster automorphism group that is the symmetry of each cell of Planck-scale local lattice structure.

**The massless spin 2 state = Bohmion = Carrier of the Bohm Force  
of the Bohm Quantum Potential.**

**Similarity of the spin 2 Bohmion to the spin 2 Graviton accounts for  
the Bohmion's ability to support Penrose Consciousness  
with Superposition Separation Energy Difference  $G m^2 / a$**

where, for a Human Brain,  $m$  = mass of electron and  $a$  = 1 nanometer in Tubulin Dimer



Andrew Gray ( quant-ph/9712037v2 ) said:

“... A new formulation of **quantum mechanics ... assign[s] ... probabilities ... to entire fine-grained histories ... [It] is fully relativistic and applicable to multi-particle systems ...[and]...**

makes the same experimental predictions as quantum field theory ...

consider space and time cut up into small volume elements

... and then take the limit as ... volume ...  $\rightarrow 0$  ...

get the final amplitude ... by considering all possible distributions at a time  $t$  earlier ...

for each such distribution the amplitude for it to occur [is] multiplied by the amplitude to

get ... the final distribution ... **the interference factor ... is a measure of how much**

**interference between the different possible histories that contain the distribution of interest there is at each time ... This result is the ...**

**Feynman amplitude squared times the product of all the interference factors ...”.**

Consider the Gray Fine-Grained History to be a World-Line String.



The Gray Fine-Grained History Quantum Theory is equivalent to

the Nambu-Goto action of 26D String Theory.

Nambu-Goto 24x24 traceless spin-2 particle

is

**Quantum Bohmion carrier of Bohm Quantum Potential**

Roderick I. Sutherland ( arXiv 1509.02442v3 ) has given a Lagrangian

for the Gray Fine-Grained Nambu-Goto Quantum Bohm Potential

that has been extended by Jack Sarfatti to include nonlinear Back-Reaction

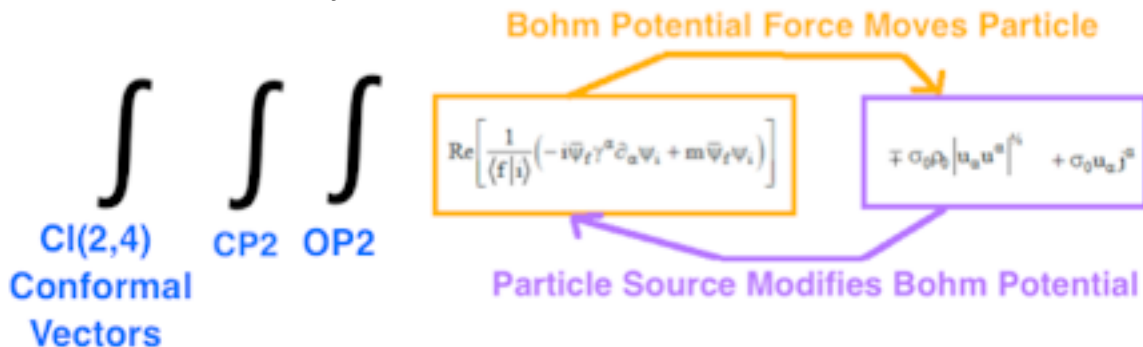

that enables Penrose-Hameroff Quantum Consciousness and Free Will, justifying Clifford's characterization of Real Clifford Algebras as

“... **mind-stuff tak[ing] the form of ... human consciousness ...”.**

**Tachyons localized at orbifolds of fermions  
produce virtual clouds of particles / antiparticles that dress fermions  
and so produce Schwinger Sources.**

**When a fermion particle/antiparticle appears in E8 spacetime it does not remain a single Planck-scale entity because Tachyons create a cloud of particles/antiparticles. The cloud is one Planck-scale Fundamental Fermion Valence Particle plus an effectively neutral cloud of particle/antiparticle pairs forming a Kerr-Newman black hole. That cloud constitutes the Schwinger Source. Its structure comes from the 24-dim Leech lattice part of the Monster Group which is**

**$2^{(1+24)}$  times the double cover of Co1, for a total order of about  $10^{26}$ .**

Since a Leech lattice is based on copies of an E8 lattice and since there are 7 distinct E8 integral domain lattices there are 7 (or 8 if you include a non-integral domain E8 lattice) distinct Leech lattices. The physical Leech lattice is a superposition of them, effectively adding a factor of 8 to the order.

The volume of the Kerr-Newman Cloud is on the order of  $10^{27}$  x Planck scale, so the Kerr-Newman Cloud Source should contain about  $10^{27}$  particle/antiparticle pairs and its size should be about  $10^{(27/3)} \times 1.6 \times 10^{(-33)}$  cm = roughly  $10^{(-24)}$  cm.

# Quantum Kernel Functions and Schwinger Source Green's Functions

Fock "Fundamental of Quantum Mechanics" (1931) showed that it requires Linear Operators "... represented by a definite integral [of a]... kernel ... function ...".

Hua "Harmonic Analysis of Functions of Several Complex Variables in the Classical Domains" (1958) showed Kernel Functions for Complex Classical Domains.

Schwinger (1951 - see Schweber, PNAS 102, 7783-7788) "... introduced a description in terms of Green's functions, what Feynman had called propagators ... The Green's functions are vacuum expectation values of time-ordered Heisenberg operators, and the field theory can be defined non-perturbatively in terms of these functions ...[which]... gave deep structural insights into QFTs; in particular ... the structure of the Green's functions when their variables are analytically continued to complex values ...".

Wolf (J. Math. Mech 14 (1965) 1033-1047) showed that the Classical Domains (complete simply connected Riemannian symmetric spaces) representing 4-dim Spacetime with Quaternionic Structure are:

$S^1 \times S^1 \times S^1 \times S^1 = 4$  copies of  $U(1)$

$S^2 \times S^2 = 2$  copies of  $SU(2)$

$CP^2 = SU(3) / SU(2) \times U(1)$

$S^4 = Spin(5) / Spin(4) =$  Euclidean version of  $Spin(2,3) / Spin(1,3)$

**Armand Wyler** (1971 - C. R. Acad. Sc. Paris, t. 271, 186-188) showed how to use **Green's Functions = Kernel Functions** of Classical Domain structures characterizing **Sources = Leptons, Quarks, and Gauge Bosons,** to calculate **Particle Masses and Force Strengths**

Cl(16) Physics constructs the **Lagrangian** integral such that the **mass m emerges as the integral over the Schwinger Source spacetime region** of its Kerr-Newman cloud of virtual particle/antiparticle pairs plus the Valence Fermion so that the volume of the Schwinger Source fermion defines its mass, which, being dressed with the particle/antiparticle pair cloud, gives **quark mass as constituent mass**.

**Armand Wyler used Harmonic Geometry to calculate:**

**Fermion masses** as a product of four factors:

$$V(Q_{\text{fermion}}) \times N(\text{Graviton}) \times N(\text{octonion}) \times \text{Sym}$$

$V(Q_{\text{fermion}})$  is the volume of the part of the half-spinor fermion particle manifold  $S^7 \times RP^1$  related to the fermion particle by photon, weak boson, or gluon interactions.

$N(\text{Graviton})$  is the number of types of Spin(0,5) graviton related to the fermion.

$N(\text{octonion})$  is an octonion number factor relating up-type quark masses to down-type quark masses in each generation.

Sym is an internal symmetry factor, relating 2nd and 3rd generation massive leptons to first generation fermions. It is not used in first-generation calculations.

**Force Strengths** are made up of two parts:

the relevant spacetime manifold of gauge group global action

the U(1) photon sees 4-dim spacetime as  $T^4 = S^1 \times S^1 \times S^1 \times S^1$

the SU(2) weak boson sees 4-dim spacetime as  $S^2 \times S^2$

the SU(3) weak boson sees 4-dim spacetime as  $CP^2$

the Spin(5) of gravity sees 4-dim spacetime as  $S^4$

and

the volume of the Shilov boundary corresponding to the symmetric space with local symmetry of the gauge boson. The nontrivial Shilov boundaries are:

for SU(2) Shilov =  $RP^1 \times S^2$

for SU(3) Shilov =  $S^5$

for Spin(5) Shilov =  $RP^1 \times S^4$

Schwinger Sources as described above are continuous manifold structures of Bounded Complex Domains and their Shilov Boundaries but the E8-Cl(16) model at the Planck Scale has spacetime condensing out of Clifford structures forming a Lorentz Leech lattice underlying 26-dim String Theory of World-Lines

with  $8 + 8 + 8 = 24$ -dim of fermion particles and antiparticles and of spacetime.

**The automorphism group of a single 26-dim String Theory cell modulo the Leech lattice is the Monster Group of order about  $8 \times 10^{53}$ .**

## Cl(1,25) Algebraic Quantum Field Theory ( AQFT )

26D String Theory has a Real Clifford Algebra Cl(1,25) constructed from

Cl(16) = Cl(8)xCl(8) -> Cl(8)xCl(8)xCl(8) = Cl(24)  
to get to the Leech Lattice 24-dim Vector Space

Conformal Structure of 2x2 matrices with entries in Cl(24)  
( Porteous, Clifford Algebras and the Classical Groups and  
Lounesto and Porteous, Lectures on Clifford (Geometric) Algebras and Applications )  
gives  $M(2, Cl(24)) = Cl(1,25)$  with Lorentz Leech Lattice Vector Space.

Since all the matrix entries are tensor product of 3 copies of Cl(0,8)  
8-Periodicity allows formation of the tensor products of copies of Cl(1,25)

$$Cl(1,25) \times \dots (N \text{ times tensor product}) \dots \times Cl(1,25)$$

For  $N = 2^8 = 256$  the copies of Cl(1,25) are on the 256 vertices  
of the 8-dim HyperCube

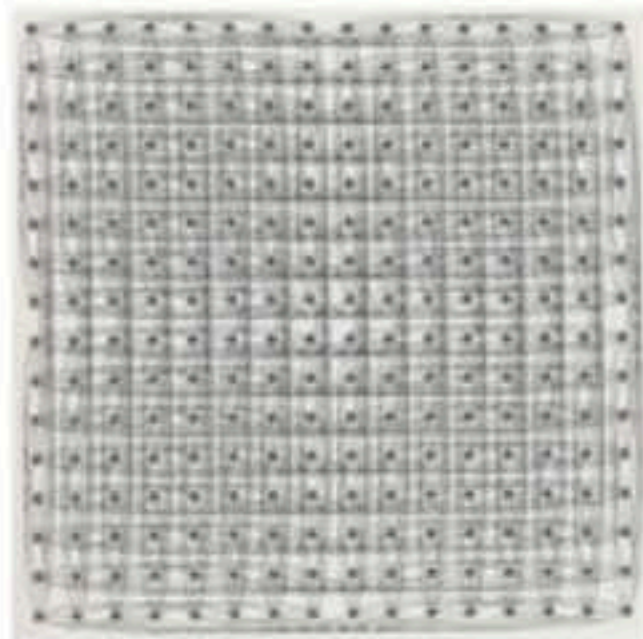

For  $N = 2^{16} = 65,536$  the copies of Cl(1,25) fill in the 8-dim HyperCube  
William Gilbert's web page says: "... The n-bit reflected binary Gray code  
will describe a path on the edges of an n-dimensional cube that can be  
used as the initial stage of a Hilbert curve that will fill an n-dim... cube. ...".

As N grows, the copies of Cl(1,25) continue to fill the 8-dim HyperCube of  
E8 SpaceTime using higher Hilbert curve stages from the 8-bit reflected  
binary Gray code subdividing the initial 8-dim HyperCube into more and  
more sub-HyperCubes.

If edges of sub-HyperCubes, equal to the distance  
between adjacent copies of Cl(1,25), remain constantly at the Planck  
Length, then the full 8-dim HyperCube of our Universe expands as N grows  
to  $2^{16}$  and beyond similarly to the way shown by this 3-HyperCube  
example for  $N = 2^3, 4^3, 8^3$  from William Gilbert's web page:

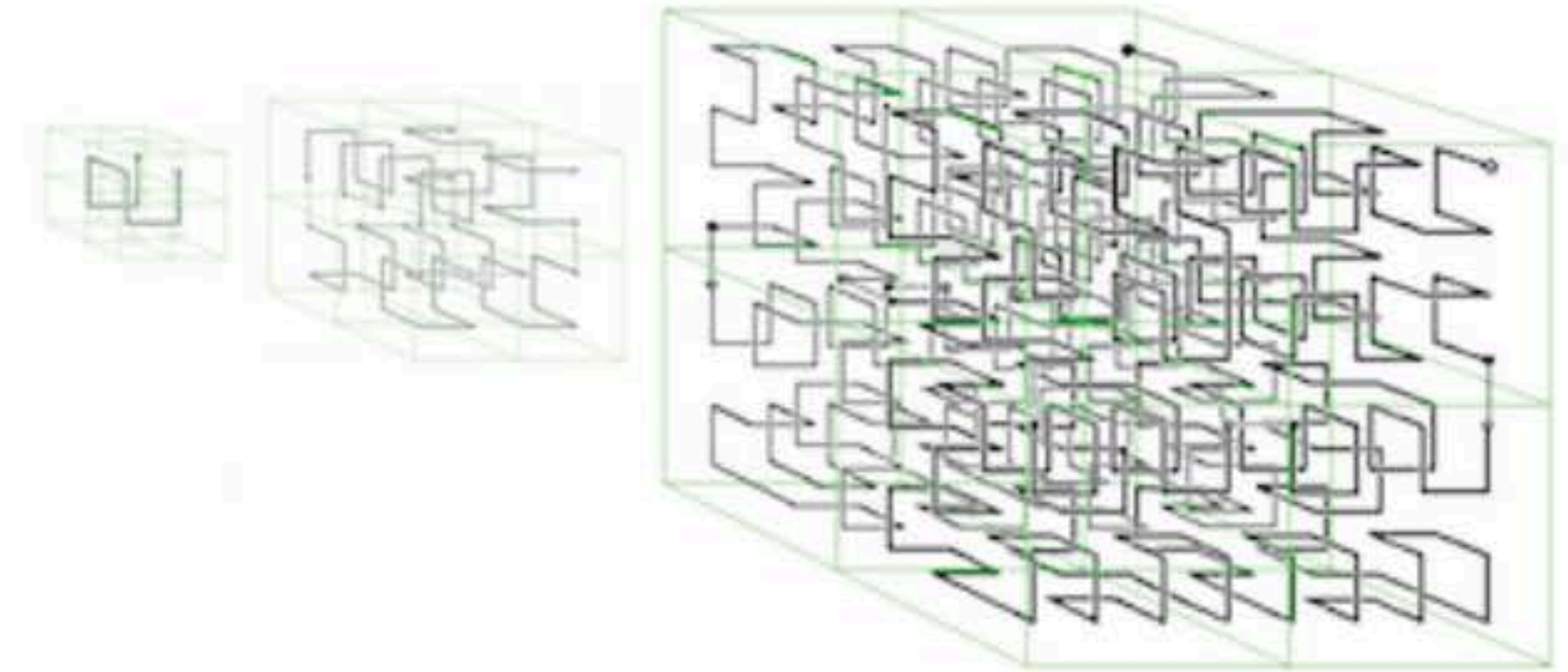

**Completion of Union of All Tensor Products of Cl(1,25) =  
= hyperfinite AQFT = Algebraic Quantum Field Theory =  
= the Third Grothendieck Universe**

The AQFT contains a copy of E8 within Cl(16) within each copy of Cl(1,25)  
**The E8 is a Recipe for a Realistic Physics Lagrangian  
so the AQFT has a natural realistic Lagrangian structure.**

The Vector Space of Cl(1,25) is the Spacetime of a 26D String Theory  
in which Strings are World-Lines of Particles  
and  
**the Massless Symmetric Spin 2 State is the Carrier  
of the Bohm Quantum Potential with Sarfatti Back-Reaction**

The Cl(1,25) AQFT being the completion of the union of all tensor products of Cl(1,25)  
it is the Real Clifford Algebra (8-Periodicity) analog  
of the completion of the union of all tensor products of the Complex Clifford Algebra  
(2-Periodicity) Cl(2;C) of 2x2 Complex Matrices = M2(C) of Spinor Fock Space that  
is the Hyperfinite II1 von Neumann factor algebra.

## Results of E8 Physics Calculations:

Here is a summary of E8 Physics model calculation results. Since ratios are calculated, values for one particle mass and one force strength are assumed. Quark masses are constituent masses. Most of the calculations are tree-level, so more detailed calculations might be even closer to observations.

Fermions as Schwinger Sources have geometry of Complex Bounded Domains with Kerr-Newman Black Hole structure size about  $10^{(-24)}$  cm.

( for calculation details see viXra 1804.0121 )

Dark Energy : Dark Matter : Ordinary Matter = 0.75 : 0.21 : 0.04

Particle/Force	Tree-Level	Higher-Order
e-neutrino	0	0 for nu_1
mu-neutrino	0	$9 \times 10^{(-3)}$ eV for nu_2
tau-neutrino	0	$5.4 \times 10^{(-2)}$ eV for nu_3
electron	0.5110 MeV	
down quark	312.8 MeV	charged pion = 139 MeV
up quark	312.8 MeV	proton = 938.25 MeV
		neutron - proton = 1.1 MeV
muon	104.8 MeV	106.2 MeV
strange quark	625 MeV	
charm quark	2090 MeV	
tauon	1.88 GeV	
beauty quark	5.63 GeV	
truth quark (low state)	130 GeV	(middle state) 174 GeV (high state) 218 GeV
W+	80.326 GeV	
W-	80.326 GeV	
W0	98.379 GeV	Z0 = 91.862 GeV
Mplanck	$1.217 \times 10^{19}$ GeV	
Higgs VEV (assumed)	252.5 GeV	
Higgs (low state)	126 GeV	(middle state) 182 GeV (high state) 239 GeV
Gravity Gg (assumed)	1	
(Gg)(Mproton <sup>2</sup> / Mplanck <sup>2</sup> )		$5 \times 10^{(-39)}$
EM fine structure	1/137.03608	
Weak Gw	0.2535	
Gw(Mproton <sup>2</sup> / (Mw+ <sup>2</sup> + Mw- <sup>2</sup> + Mz0 <sup>2</sup> ))		$1.05 \times 10^{(-5)}$
Color Force at 0.245 GeV	0.6286	0.106 at 91 GeV

Kobayashi-Maskawa parameters for W+ and W- processes are:

	d	s	b
u	0.975	0.222	0.00249 -0.00388i
c	-0.222 -0.000161i	0.974 -0.0000365i	0.0423
t	0.00698 -0.00378i	-0.0418 -0.00086i	0.999

The phase angle d13 is taken to be 1 radian.

The problem of the determination of the quark masses is not trivial. We can define as a “current” quark mass the mass entering in the Lagrangian (or Hamiltonian) representation of a hadron; this comes out to be of the order of some  $\text{MeV}/c^2$  for  $u, d$  quarks, and  $\sim 0.2 \text{ GeV}/c^2$  for  $s$  quarks. However, the strong field surrounds the quarks in such a way that they acquire a “constituent” (effective) mass including the equivalent of the color field; this comes out to be of the order of some  $300 \text{ MeV}/c^2$  for  $u, d$  quarks, and  $\sim 0.5 \text{ GeV}/c^2$  for  $s$  quarks. Current quark masses are almost the same as constituent quark mass for heavy quarks. Alessandro De Angelis · Mário Pimenta

Introduction to Particle and Astroparticle Physics Second Edition

Constituent Mass Quarks (Schwinger Sources)  
combine to form Nuclei for Atoms such as  
Deuterium and Palladium.

Wikipedia says (I added red material specifically about Pd): “...

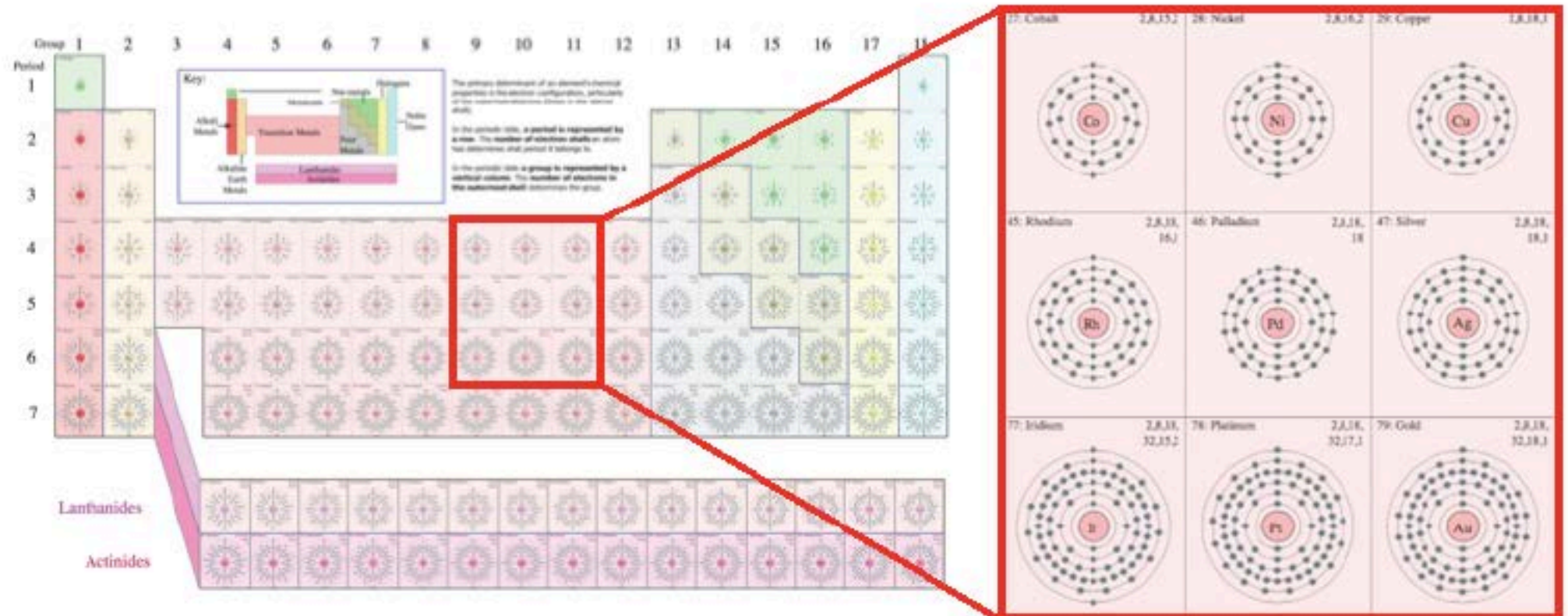

... Each s subshell holds at most 2 electrons Each p subshell holds at most 6 electrons  
 Each d subshell holds at most 10 electrons Each f subshell holds at most 14 electrons  
 Each g subshell holds at most 18 electrons ...

Shell name	Subshell name	Subshell max electrons	Shell max electrons
K	1s	2	2
L	2s	2	2 + 6 = 8
	2p	6	
M	3s	2	2 + 6 + 10 = 18
	3p	6	
	3d	10	
N	4s	2	2 + 6 + 10 + 14 = 32
	4p	6	
	4d	10	
	4f	14	

### Palladium

2  
 2+6 = 8  
 2+6+10 = 18  
 2+6+10 = 18

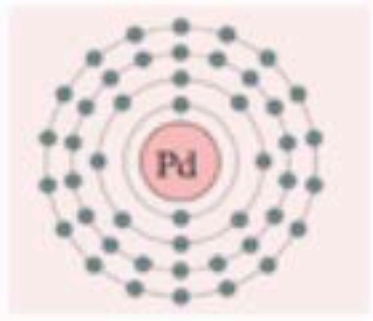

... palladium (atomic number 46) has no electrons in the fifth shell, unlike other atoms ...[in its periodic table neighborhood]...”.



A full N-shell has  $s + p + d + f = 2 + 6 + 10 + 14 = 32$  electrons.

Palladium N-shell has  $2 + 6 + 10 = 18$  electrons and “holes” to receive 14 electrons:

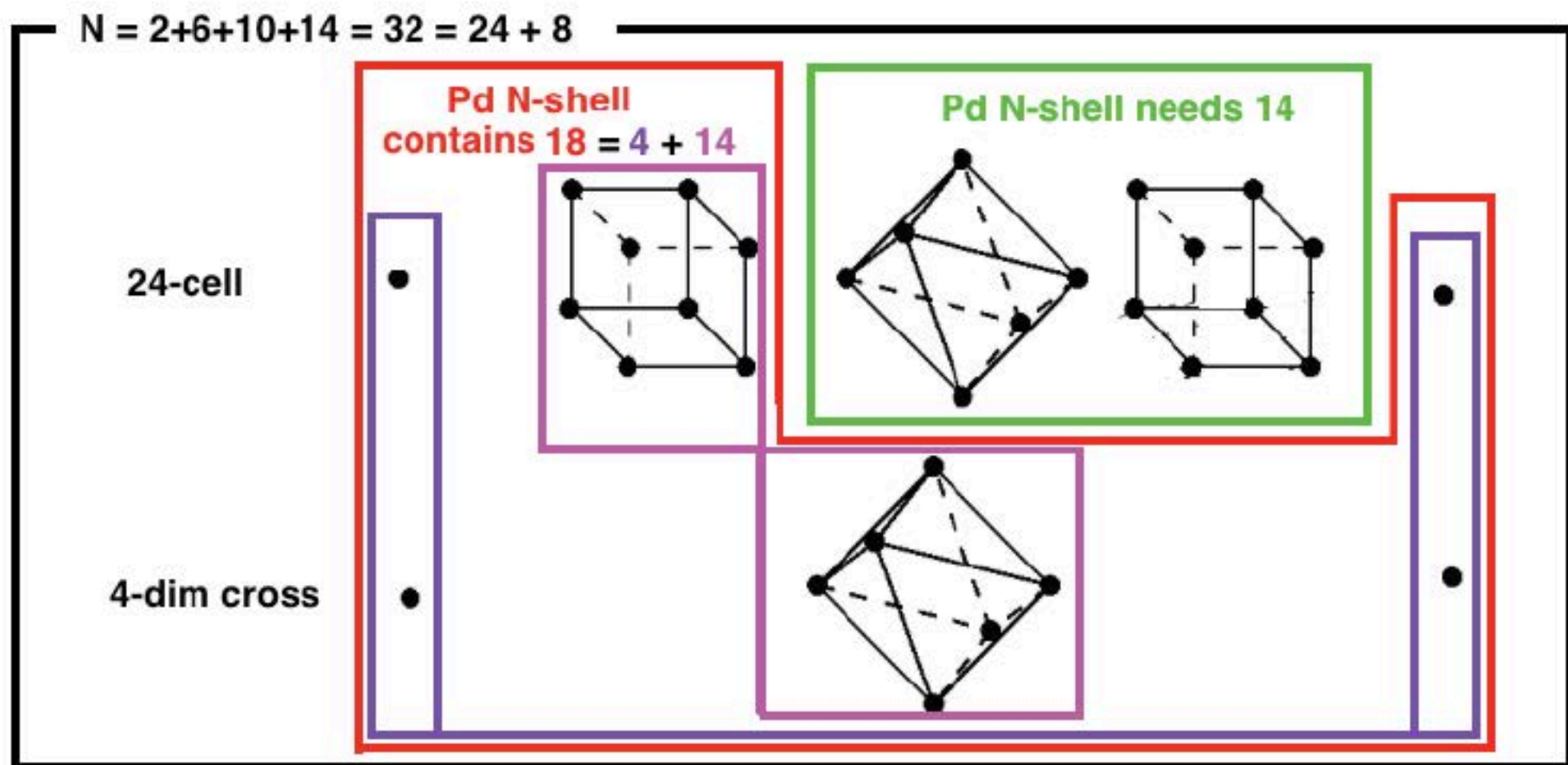

Each Palladium atom has  $18-14 = 4$  N-shell electrons that can interact with 4 electrons of 4 Deuterium atoms absorbed into a Pd cluster, helping them to participate in a Schwinger coherent quantum state for TSC Fusion.

Further, each Palladium atom has 14 N-shell electrons  
12 to fill needs of other Pd atoms  
and 2 for a Dirac Fermion Band for Klein Paradox Tunnelling.

# What is the structure of the icosahedral 147-atom Pd cluster ?

The icosahedral 147-atom ground state has 12 exterior icosahedra and a central icosahedron with 12 interior vertices which are the innermost vertices of 12 exterior TSC Fusion site icosahedra:

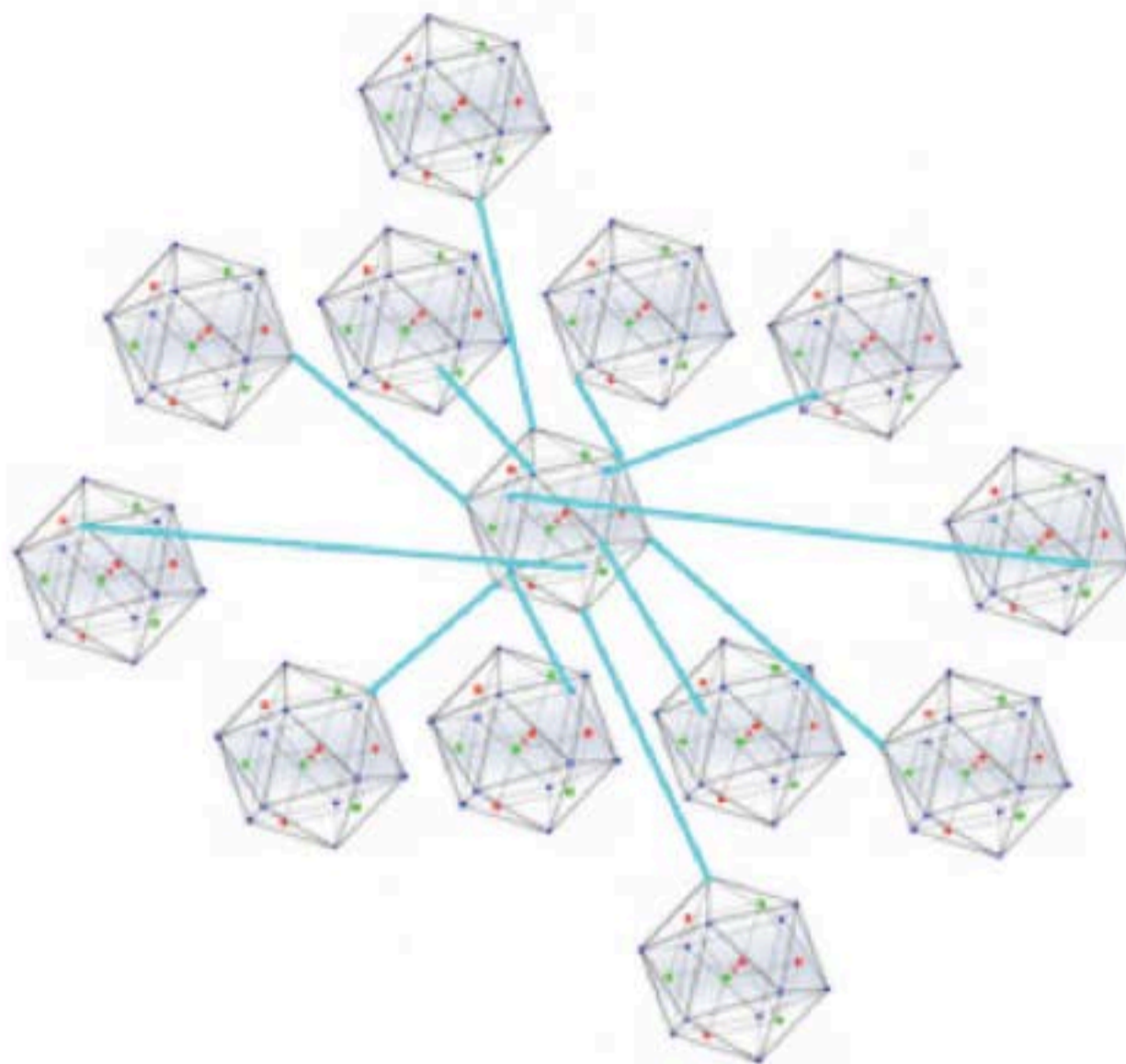

The 12 exterior icosahedra each have outer faces on the outer boundary of the 147-atom cluster.

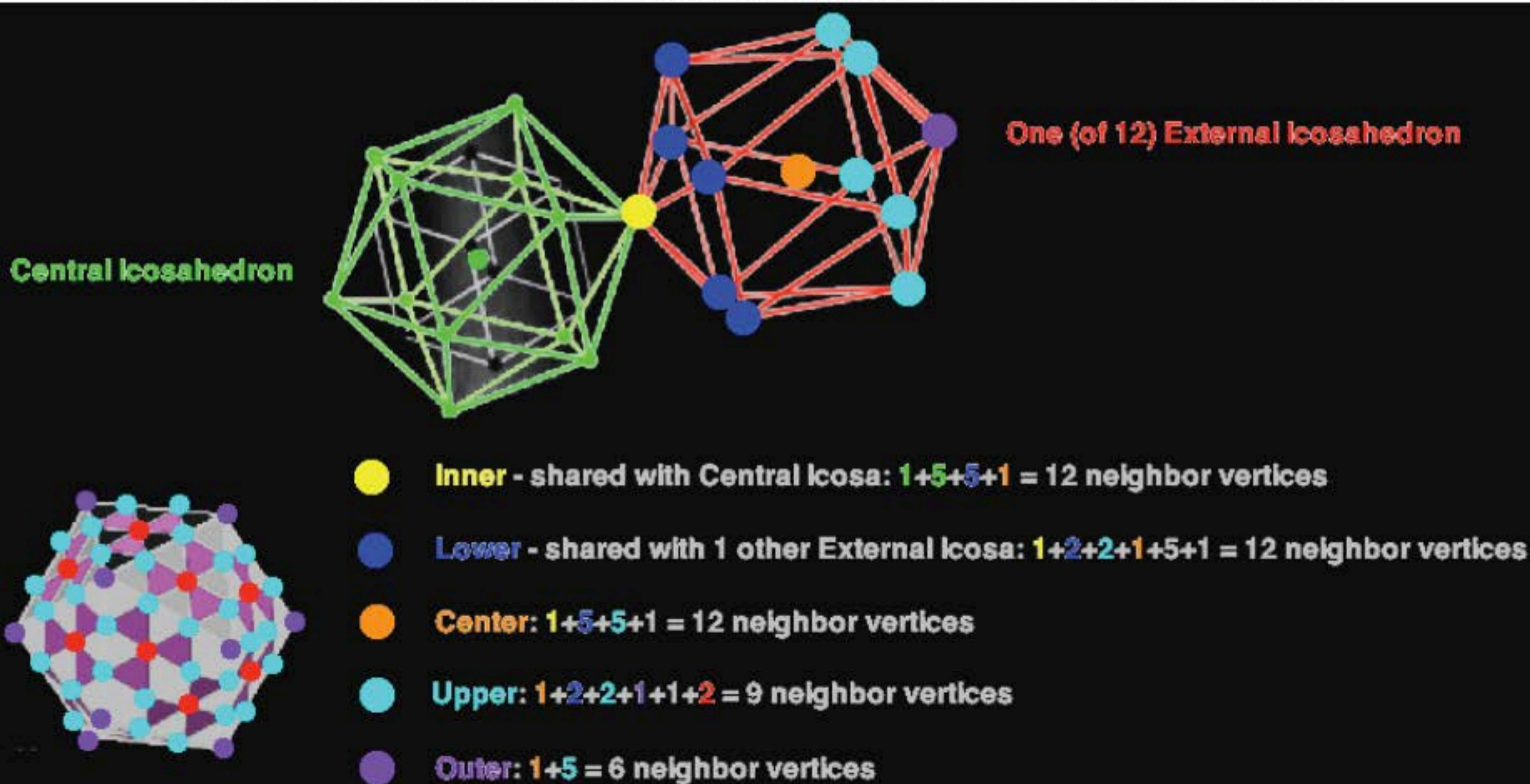

## In TSC Icosahedra of a Pd cluster 4 D (D+D+D+D) form a Schwinger Coherent Quantum State

From a classical approximation point of view there are  $12+1 = 13$  Pd nuclei (blue) within which there is a 2-tetrahedral configuration of 4 D nuclei (red) and 4 D electrons (green)

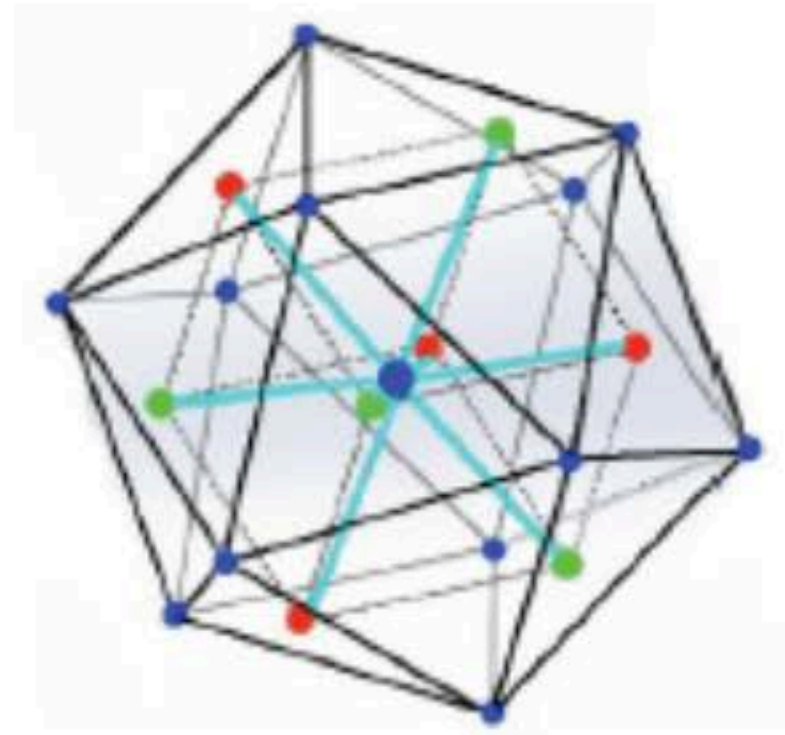

In the Schwinger coherent quantum state (yellow) the 4 D nuclei and 4 D electrons are smeared out all over the interior of the icosahedral TSC cell

and

the 4 D electrons screen out the positive charge of the 4 D nuclei making the Schwinger coherent quantum cloud effectively neutral with no Coulomb repulsion or attraction.

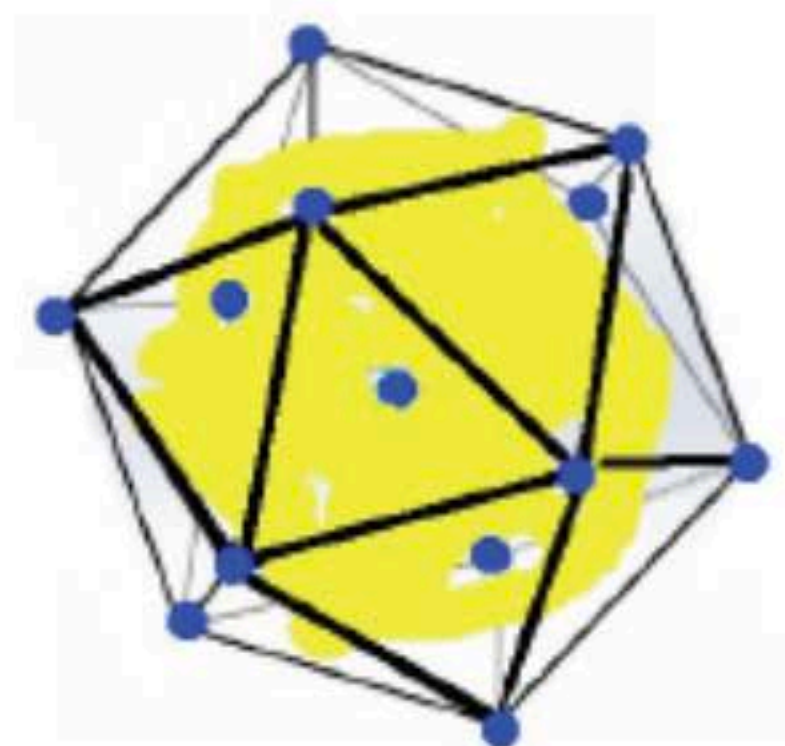

**The process of forming the Schwinger State which collapses to the central Pd atom where Deuterium nuclei undergo Cold Fusion is called by Akito Takahashi Tetrahedral Symmetric Condensation (TSC).**

**The D Schwinger State nuclei go to the central Pd atom  
and by Klein Paradox Tunnelling 4 D nuclei undergo TSC Cold Fusion  
producing  $4\text{He} + 4\text{He} + 47.6 \text{ MeV}$**

Now look at the central Pd atom in the TSC cell.

Its outer electron shell of 18 electrons has 4 free electrons

(14 of them being bound to the outer 12 Pd atoms plus 2 forming a Dirac Fermion Band)

which 4 free electrons pull the 4 D nuclei out of the Schwinger quantum cloud  
into the Central Pd Atom

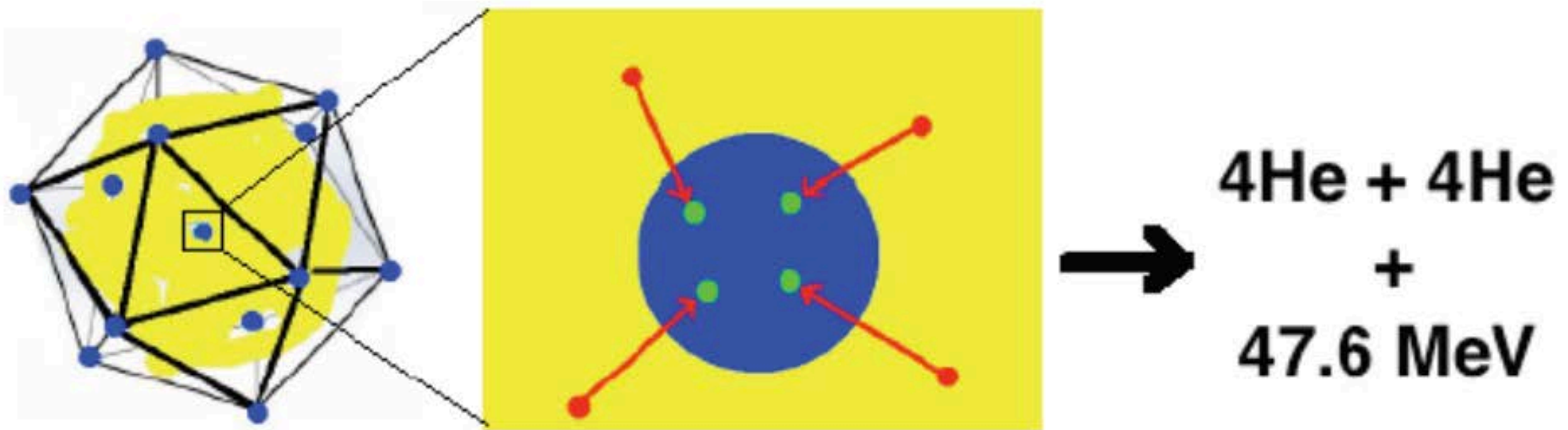

When the 4 D nuclei get into the small volume of the Central Pd Atom  
they “see” each other as repulsive like electrical charges  
resulting in a very high Coulomb barrier between them

but

that is when the Dirac Fermion Band takes effect  
and gets them to rapidly penetrate the barrier by Klein Paradox Tunnelling

Some of the TSC Fusion Energy goes to a Jitterbug transformation

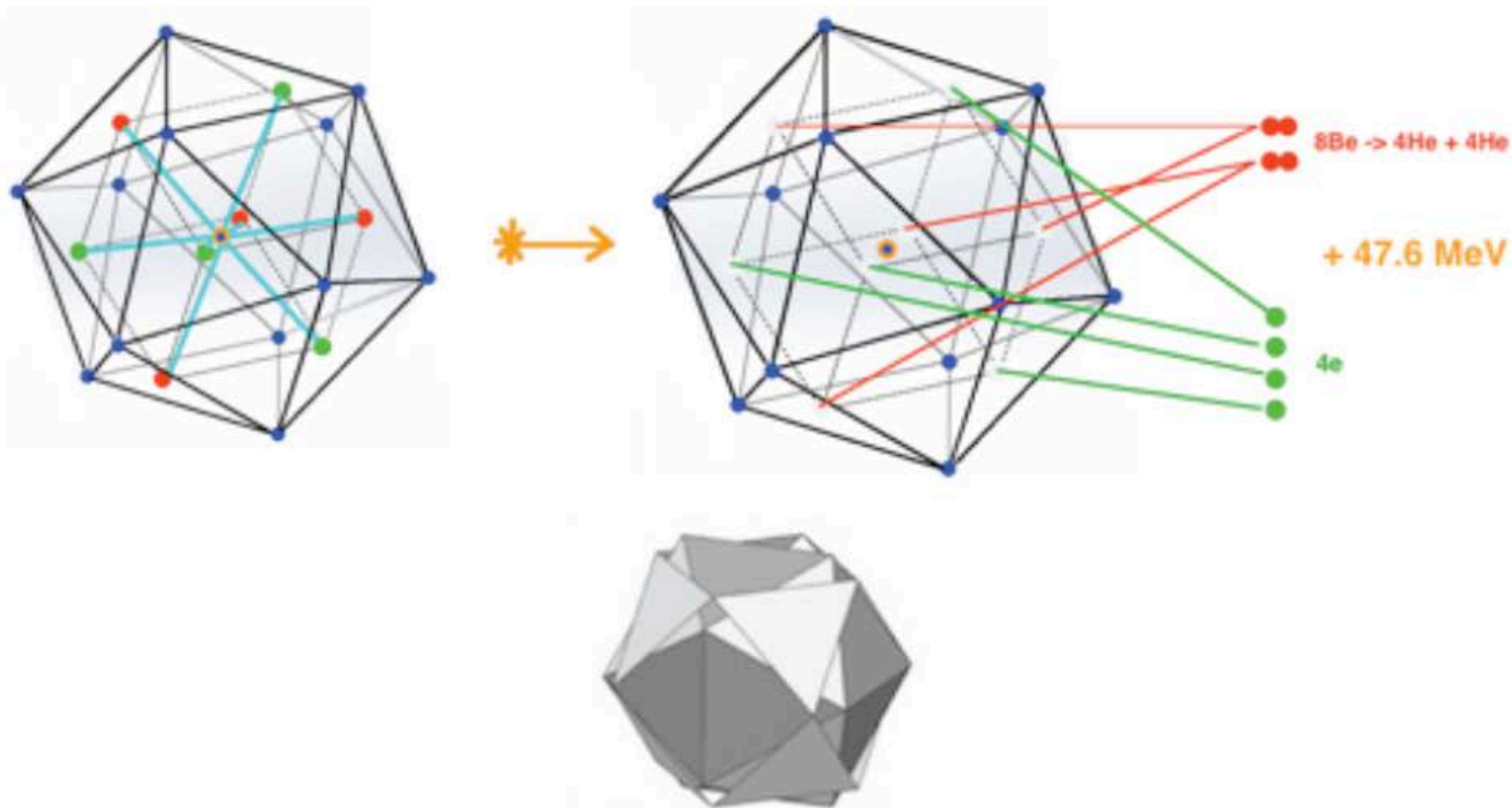

of the icosahedral Palladium, depleted of Deuterium fusion fuel,  
to a cuboctahedral configuration

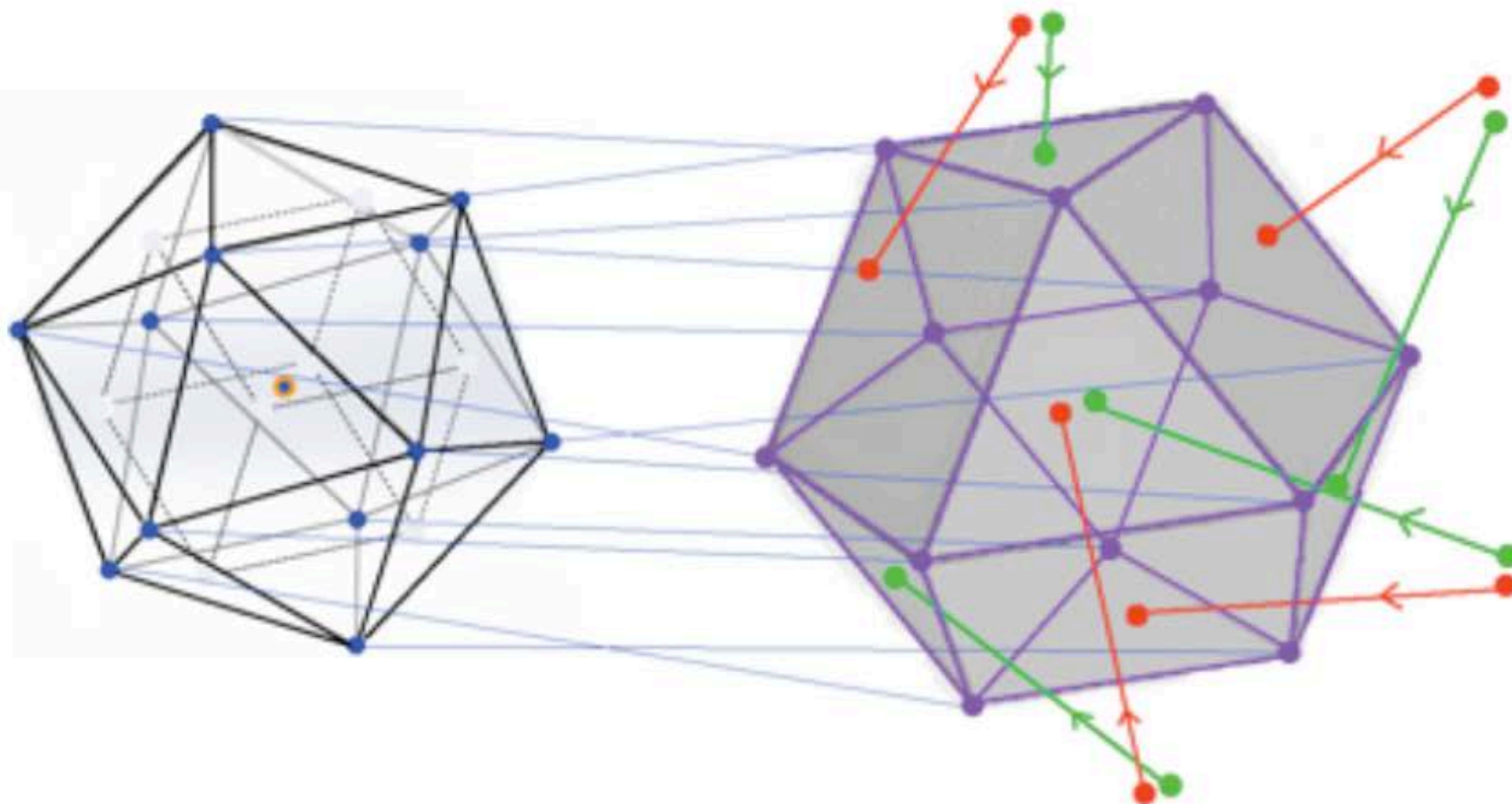

which has 6 large square openings through which  
the 4He TSC Fusion Product Ash can leave the Pd cluster  
and ambient Deuterium Fuel can enter to reload the Palladium cluster.

Then, since the icosahedral configuration is the Palladium cluster ground state, another Jitterbug transformation

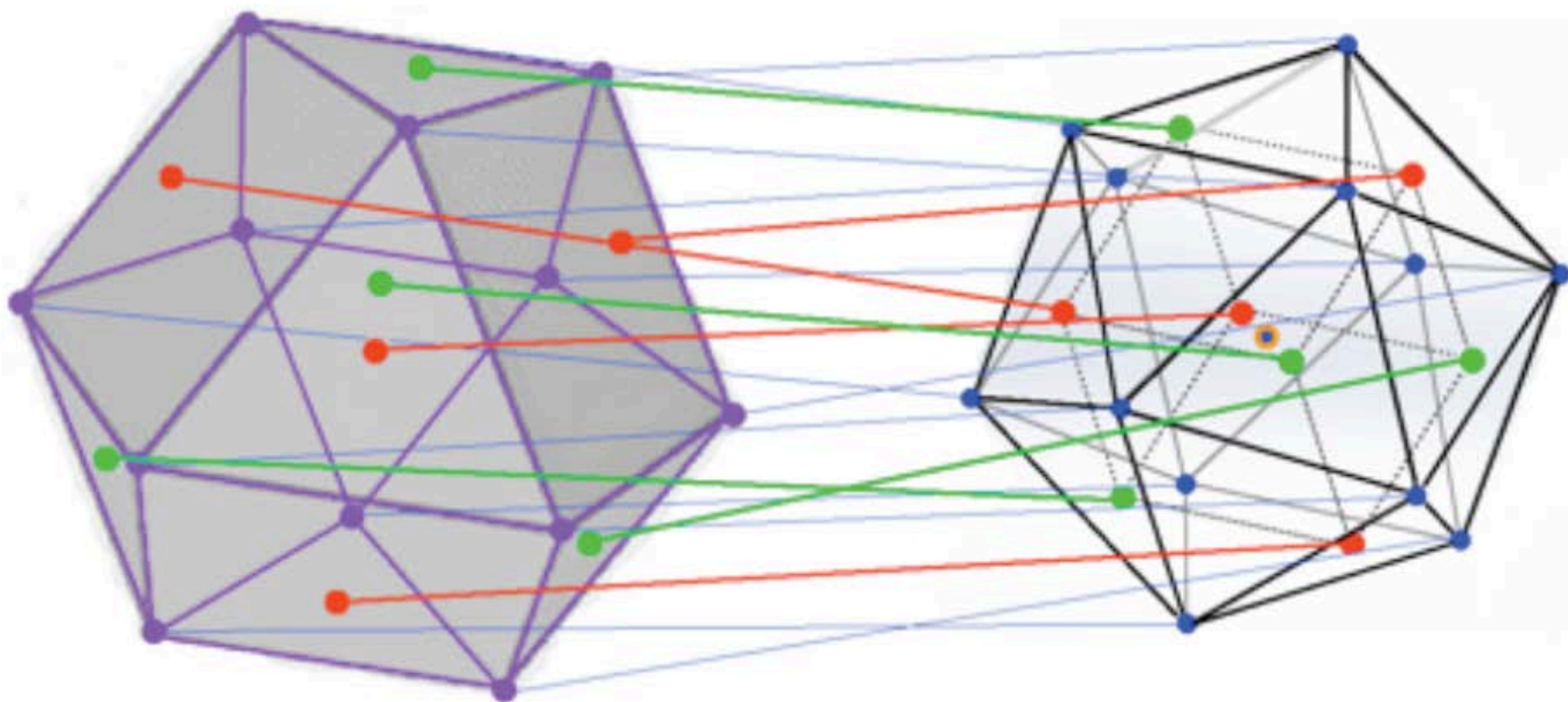

takes the Palladium cluster to an icosahedral configuration with the replenished Deuterium nuclei and electrons ready for another round of TSC fusion

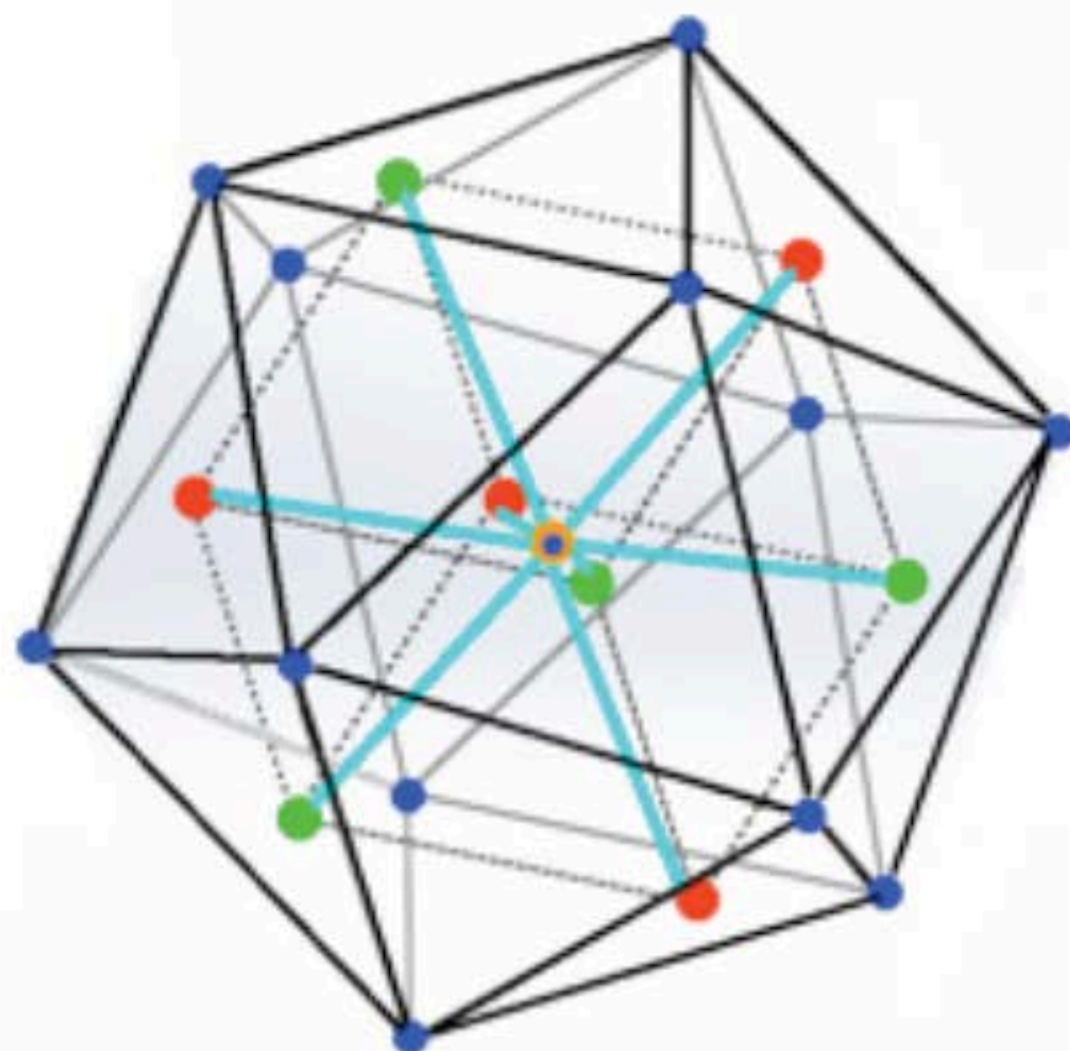
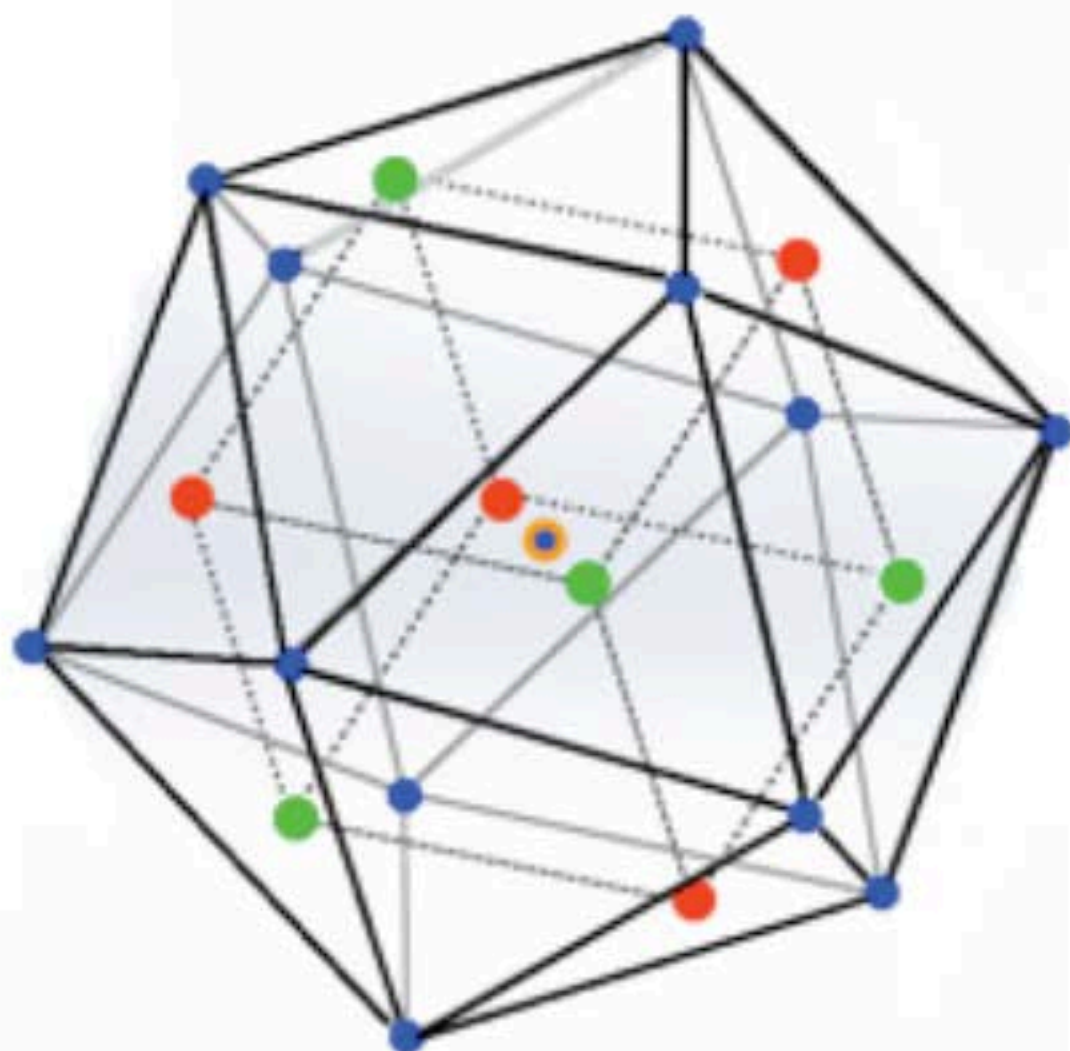

Deuterium Gas

D2O HEAVY WATER

TSC~Jitterbug Fusion  
Reaction Chamber 1

Heat / Cooling Chamber 2

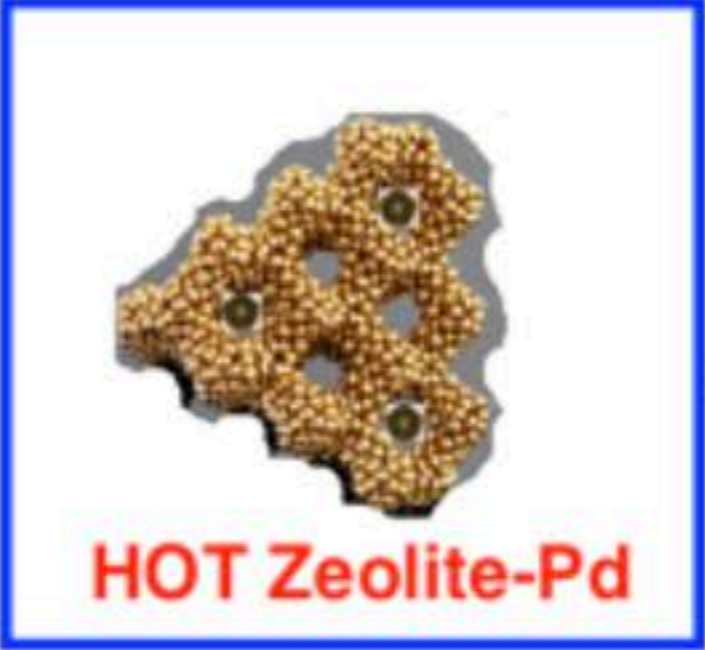
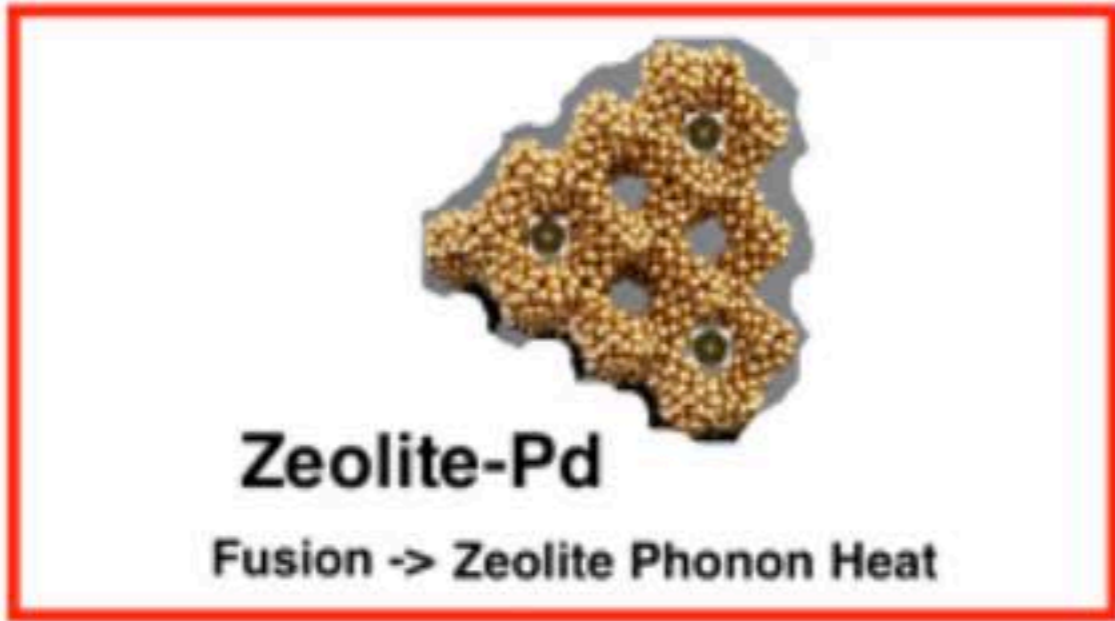

D2O STEAM

Recycle back to Chamber 1

Cooled Dried Zeolite-Pd

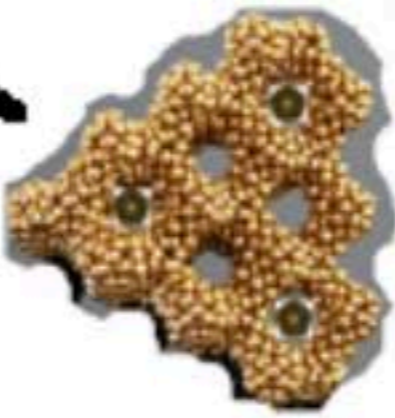

As more layers are added, the deformations of tetrahedra and octahedra accumulate and eventually destabilize the structures necessary for Jitterbug and TSC Fusion. The next Mackay cluster beyond 147 atoms has  $147+162 = 309$  atoms.

Barretau, Desjonqueres, and Spanjaard in Eur. Phys. J. D. 11 (2000) 395-402 say:

“... the icosahedron is the preferred structure at small sizes, and the critical size at which the relative stability becomes favorable to cuboctahedrons is  $N = 561$  for PdN clusters ...[for which]... For  $N = 13$  the cuboctahedron is ... unstable.

For  $N = 55, 147,$  and  $309$  atoms the cuboctahedron is metastable and slightly distorted. Its transformation to a perfect icosahedral structure needs an activation energy of  $12 \text{ meV}$  for  $N = 55,$   $28 \text{ meV}$  for  $N = 147$  and  $45 \text{ meV}$  for  $N = 309.$  The activation energies involved in the inverse transformation are  $61 \text{ meV}$  for  $N = 55,$   $51 \text{ meV}$  for  $N = 147$  and  $48 \text{ meV}$  for  $N = 309.$  ...[ compare  $47.6 \text{ MeV}$  for each TSC Fusion event ]...

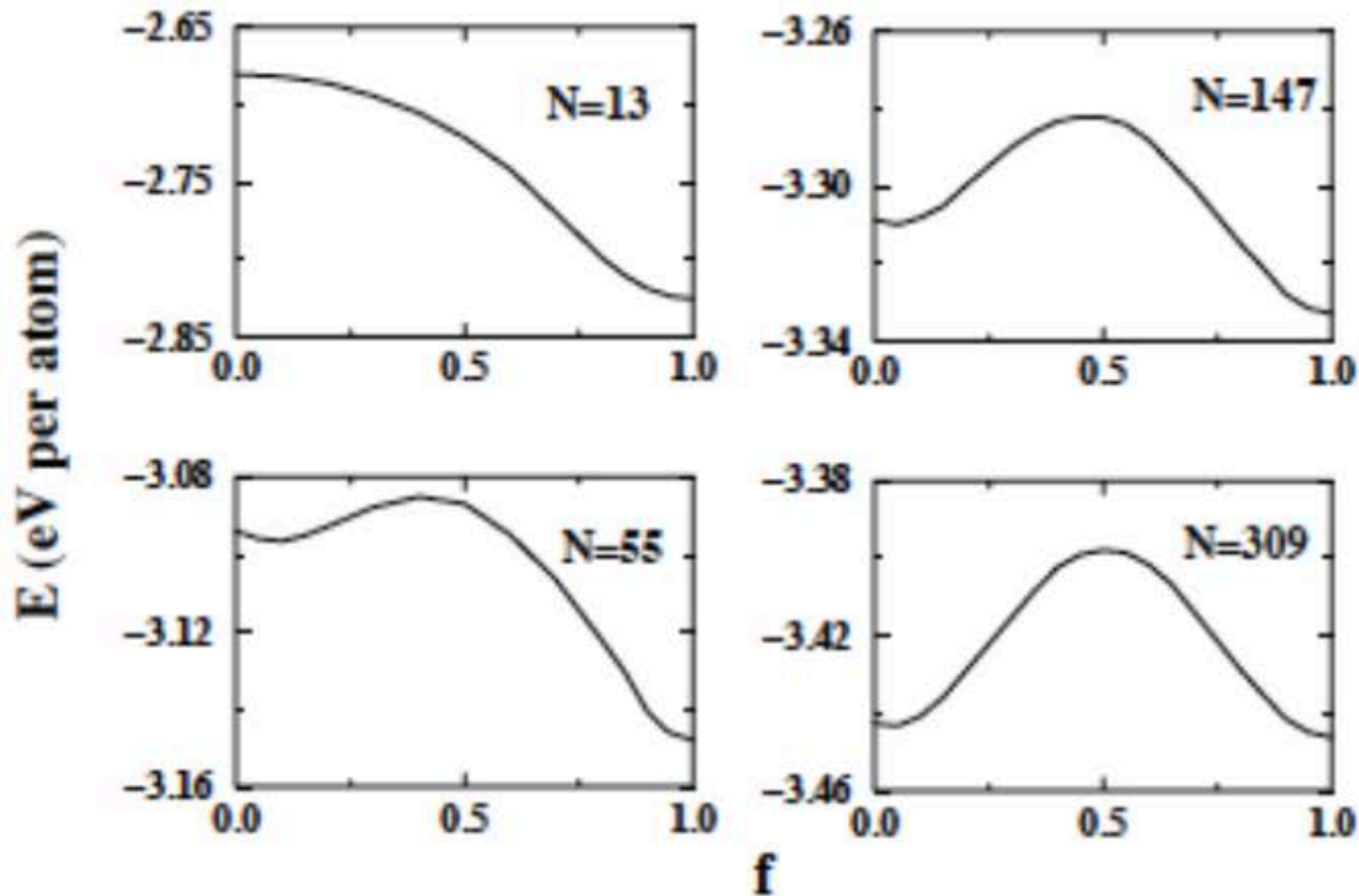

... The evolution of the potential energy profile of homogeneously relaxed ... PdN clusters during the Mackay [Jitterbug] transformation for increasing values of  $N.$   $f$  is a fraction of the displacements ...  $f = 0$  and  $1$  correspond to the ... cuboctahedron and icosahedron, respectively ...”.

$N = 309$  is disfavored for TSC-Jitterbug Fusion with respect to  $N = 147$  for two reasons: energy levels are too close for rapid Jitterbug cubocta to icosah transition

$N = 309$  Pd Cluster is too large (2 nm) to fit through 1.5 nm expanded Sodium Zeolite Y pore

so

**147 atoms is optimal for Pd cluster Cold Fusion**



**I would like to see experiments  
with Zeolite directly using Sandia 1.5 nm Palladium NanoClusters.**

**If there is difficulty with getting the Sandia Clusters  
to fit into the Sodium Zeolite Y  
then  
I would like to see experiments  
with Zeolite ITQ-37**

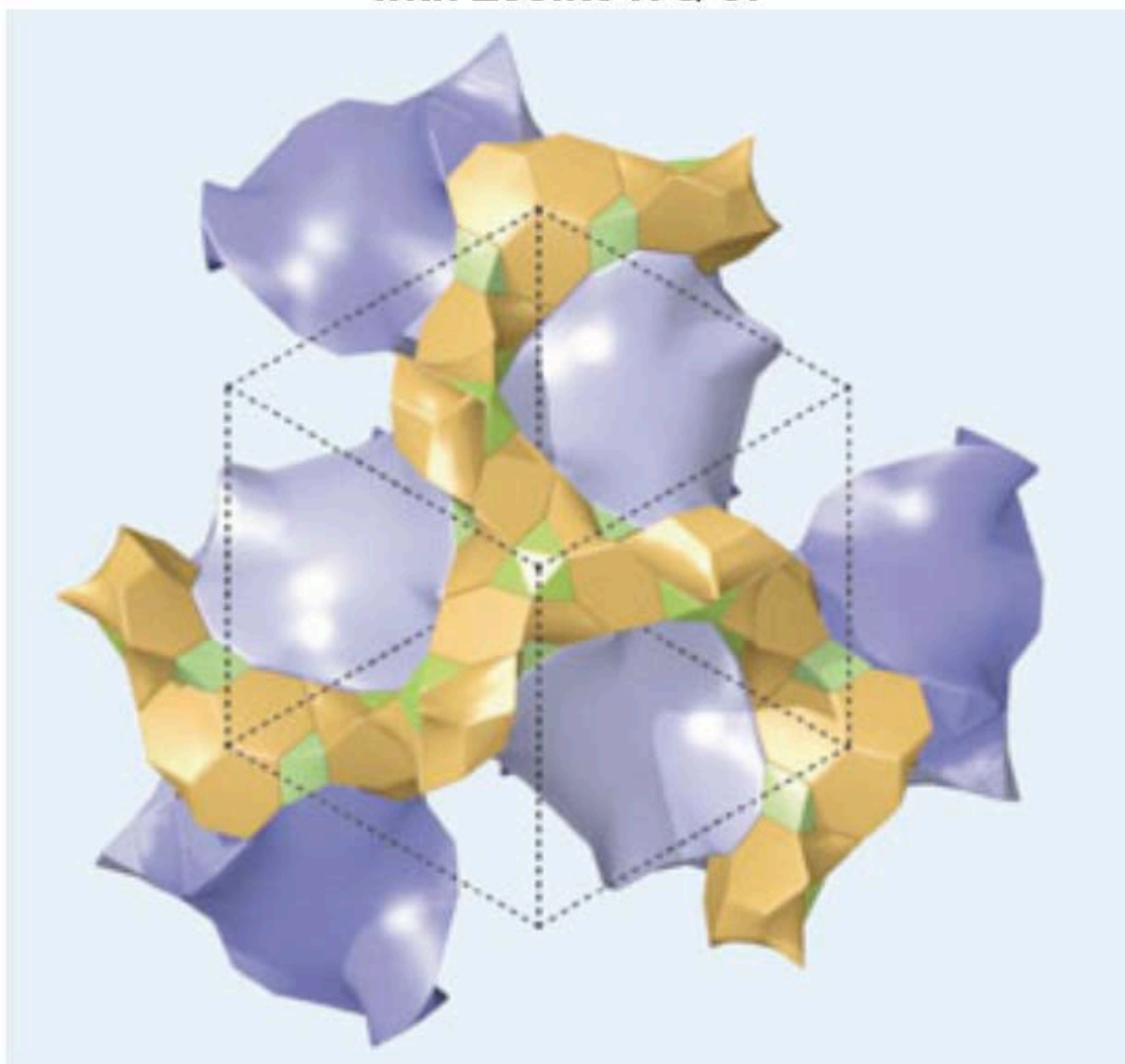

**which has pore size about 2 nanometers.**

(Royal Society of Chemistry, 29 April 2009 and Sun et al, Nature 2009)

Julian Schwinger in 1990 lecture at Universite de Bourgogne said:

**“... in the very low energy cold fusion, one deals essentially with a single state, described by a single wave function, all parts of which are coherent ...”.**

**Akito Takahashi proposed a process Tetrahedral Symmetric Condensation (TSC) that for 4 Deuterons (D) in an icosahedral cluster of Palladium (Pd) atoms produces a Schwinger coherent quantum state**

**that effectively distributes the electron population among deuterons** so that the Coulomb barrier is eliminated and the four Deuterium (D) nuclei can simultaneously interact and fuse, forming two  $4\text{He}$  nuclei plus 47.6 MeV energy.

Peter Hagelstein used phonon models for Relativistic Coupling Between Lattice Vibrations and Nuclear Excitation, enabled by break-down of Foldy-Wouthuysen transformation due to 8-15 THz Lattice Vibration Modes, to show direct transfer of the 47.6 MeV energy of Cold Fusion to the Pd lattice as excited optical phonon modes.

**The only Cold Fusion experiments producing heat consistently and reproducibly are the detections of heat using Pd Clusters and Deuterium gas**

**by Arata and Zhang ( replicated by McKubre at SRI ) and by Iraj Parchamazad.**

Arata and Zhang ( and SRI ) used Palladium black with initial cluster sizes distributed around 5 nm so that a substantial number of Pd clusters had diameter 1.5 nm.

However, clumping increased the cluster size to around 40 nm at which size Takahashi et al said, based on their similar work, the “heat-power level drop[ped]... drastically”.

( see Current Science 108 (25 Feb 2015) LENR Special Section Preface )

Iraj Parchamazad and Melvin Miles avoided the clumping problem by growing the Pd clusters within Zeolite cavities. Using Sodium Zeolite Y whose cavity size is around 1.2 nm ( but capable of expansion by about a factor of 2 ), they produced Pd clusters of 1.5 nm size size which were dispersed within the Zeolite cavities thus preventing clumping. Upon exposure of his Pd clusters in Zeolite to Deuterium gas, he produced heat in 10 out of 10 experiments with

**Cold Fusion Energy on the scale of kiloWatts per milligram of Palladium.**

( see [coldfusionnow.org/iraj-parchamazad-lenr-with-zeolites/](http://coldfusionnow.org/iraj-parchamazad-lenr-with-zeolites/) )

For Everybody on Earth to be Happy, the Abundant Cheap Energy must provide a high Standard of Living (current USA standard) for a lot of people (10 billion), and:

last for a long time (more than decades) - rules out Oil, Gas, Methane, and Coal;

have no serious radioactive waste - rules out Uranium, Thorium, and Tritium (Lithium);

have realistically scalable capital cost - rules out Solar which would require Satellite collectors with area 1% of  $\pi \times 6,000^2 = 1,000,000 \text{ km}^2 = (1,000 \text{ km})^2$  or cloud-free collectors on Earth surface with the same area. Less than 100% efficiency would require correspondingly larger area of collectors.

**That leaves one possible source of Abundant Cheap Energy for 10 billion people:**

	<b>Reserves (Terawatt-years)</b>	<b>Duration (years)</b>
<b>Deuterium</b>	<b><math>1.9 \times 10^9</math> (1/1000 of ocean supply)</b>	<b>2,000,000</b>

**Energy is only necessary, but not sufficient,  
for 10 billion humans to be happy in a harmonious society.**  
Humanity also needs (image from Doonesbury)

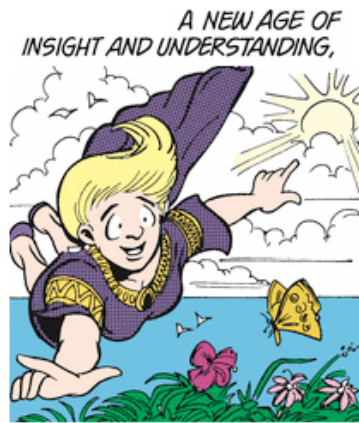

and  
to  
avoid



Nuclear Annihilation could occur if USA or Russia or China decided that a First Strike were in their best interest because the Other seemed to be preparing for Nuclear War and that Nuclear War could be survivable due to First Strike Suppression of Retaliation and historical facts such as Hiroshima has rebuilt, Nagasaki had no Firestorm, and the Kuwaiti Firestorm did not cause a Nuclear Winter. It could be avoided if **USA and Russia and China agreed to share Power over Earth just as Spain and Portugal did in 1494 in the Treaty of Tordesillas.**

“... Rudolf Steiner (1861-1925) ... was the founder of Anthroposophy, a philosophy and spiritual movement whose aim ... is to develop supersensible capacities that enable access to what Steiner described as a spiritual dimension underlying all of life ...  
“**Geisteswissenschaft**” ... **is the re-awakening of a spiritual awareness ...**”  
( Jennie Louise Cain - 2016 U. Michigan Ph.D. thesis )

Rudolf Steiner, in Cosmic Memory, said “... The Fourfold Man ... consists of ... the **physical** body, the **ether** ... body, the **astral** body and the “ I “ ...”.

In my view - see <http://vixra.org/pdf/1810.0365v2> -

Spirit World = Complex Domain Lie Ball  
Physical World = Shilov Boundary Lie Sphere

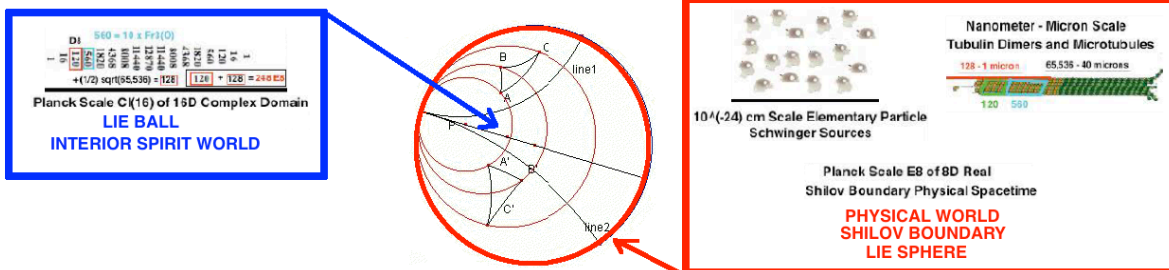

are related by Poisson Kernel and Bergman Kernel = Green's Function Propagator

**Physical Body** is constructed of 40-micron Microtubules = 65,536 Tubulin Dimers  
**Ether Body** is Quantum Consciousness Information = 64,712 elements per Microtubule

**Astral Body** is 26D World-Line Theory Lattice Cell with 65,536-dim Cl(16) Symmetry  
 “ I “ is Cl(16) Clifford Algebra Information = 64,712 elements per Lattice Cell

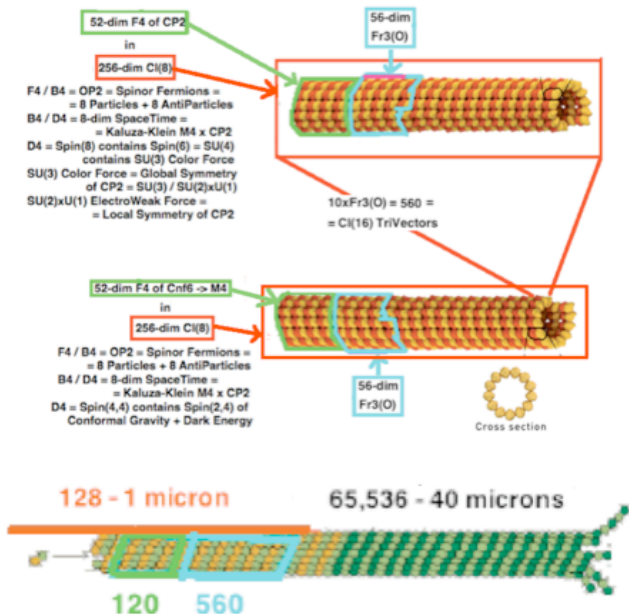

Human Brain Microtubules 40 microns = 65,536 Tubulin Dimers

- Physical Body** contains Information
- Cl(16) = 65,536
  - 16 Vector Complex Domain
  - 128 half-Spinor part of E8
  - 120 BiVector part of E8
  - 560 TriVector Fr3(O)
  - = 64,712 Ethereal Information

Kaluza-Klein Spacetime M4 x CP2		1
Cl(8) that contains 28 = D4 for M4 Gravity	Cl(8) that contains 28 = D4 for CP2 Std Model	16
		120
		560
		1820
		4368
		8008
		11440
1	1	12870
8	8	11440
28	28	8008
56	56	4368
70	70	1820
56	56	560
28	28	120
8	8	16
1	1	1
Cl(8) x Cl(8) = Cl(16)		
Spinors: (8s+8c) x (8s+8c) = (8s,8s) ++half-half-Spinors		
(8c,8s) -- half-half-Spinors		

TriVectors  
 BiVectors  
 Vectors

256 x 256 Real Matrices

**Astral Body** contains Information  
 Cl(16) = 65,536 - 16 - 128 - 120 - 560 =  
 = 64,712 Spirit Information

“... Steiner ... regards ...the ancient Egyptians ... as oriented toward connection and interaction with the outer world, and ... the greater astronomical cosmos ... the age of the Egyptian pyramids [was] the time of development of the “Empfindungsseele” ... the ability to experience the outer world internally ...”.

( Jennie Louise Cain - 2016 U. Michigan Ph.D. thesis )

**36,000 Years Ago - National Geographic Genographic YDNA -  
M168 - YAP - M96 - M35 Humans follow North Star Vega  
up the Nile to Giza and Mediterranean**

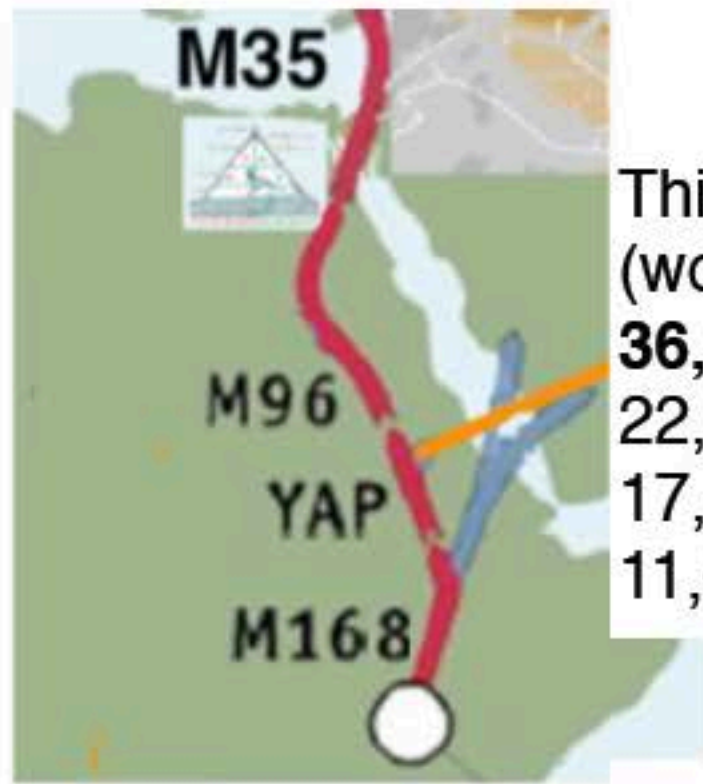

This coincided with the beginning of Egyptian History according to Manetho (working under Alexander's General and successor Ptolemy I):

- 36,525 years ago** - Rule of Gods - North Star Vega - Geminga Shock - Glaciation
- 22,625 years ago - Rule of Demigods - last Glacial Maximum
- 17,413 years ago - Rule of Spirits of the Dead - end of last Glacial Maximum
- 11,600 years ago - Rule of Mortal Humans - North Star Vega - Vela X - end of Ice Age

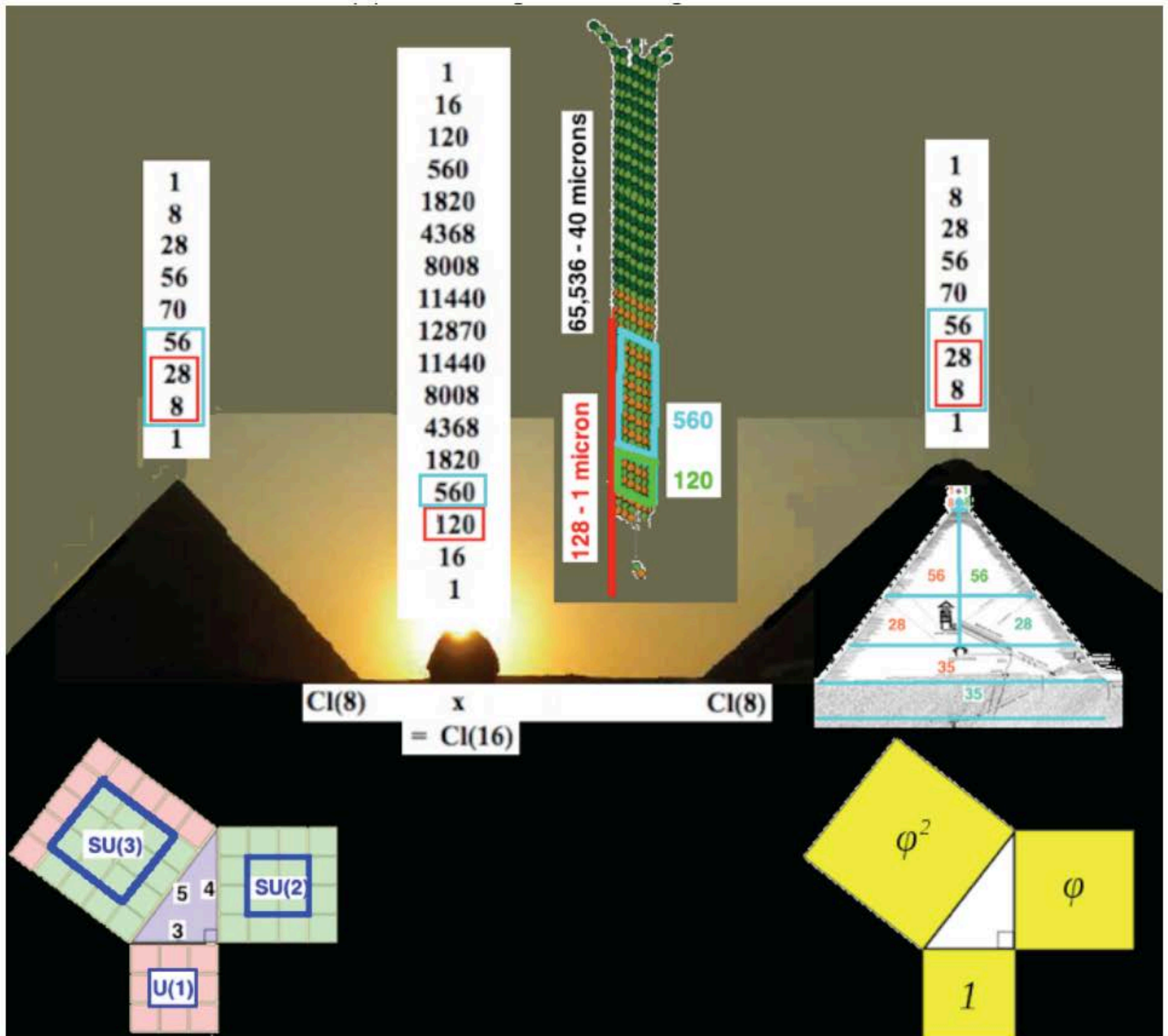

The Sphinx represents 65,536-dim  $Cl(16)$  containing 248-dim E8 as tensor product of 256-dim  $Cl(8)$  containing 52-dim F4sm of CP2 and 256-dim  $Cl(8)$  containing 52-dim F4gde of M4 of M4 x CP2

Clifford Algebras were not known to European mathematicians until Clifford in the 19th century and not known to European physicists until Dirac in the 20th century but it seems to me that their structure was known to Africans in ancient times. The courses of the Great Pyramid of Giza correspond to the graded structure of 256-dim  $Cl(8)$ :

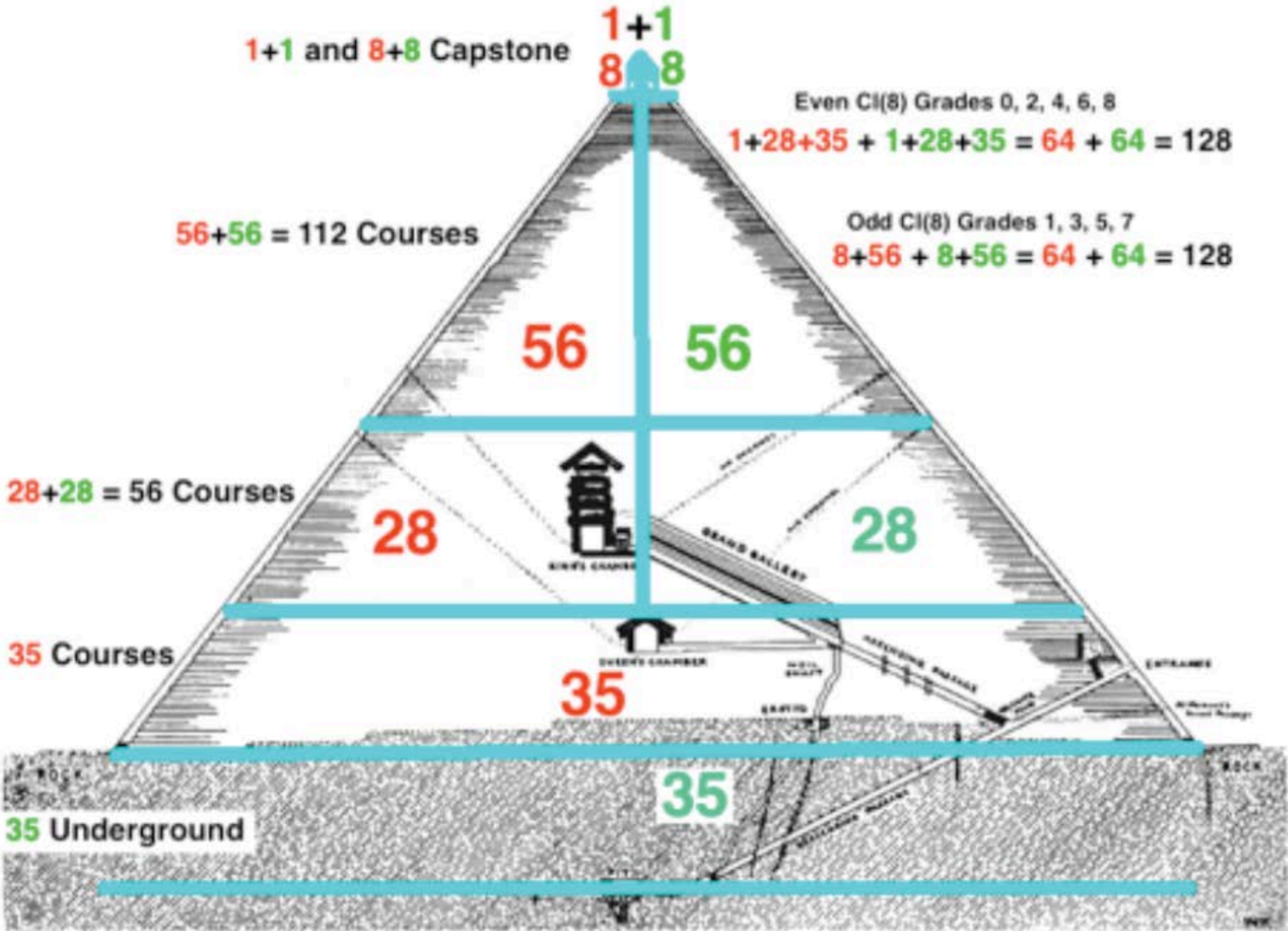

$$1 + 8 + 28 + 56 + ( 35 + 35 ) + 56 + 28 + 8 + 1$$

( image adapted from David Davidson image - for larger size see [tony5m17h.net/GreatPyrCl8.png](http://tony5m17h.net/GreatPyrCl8.png) )





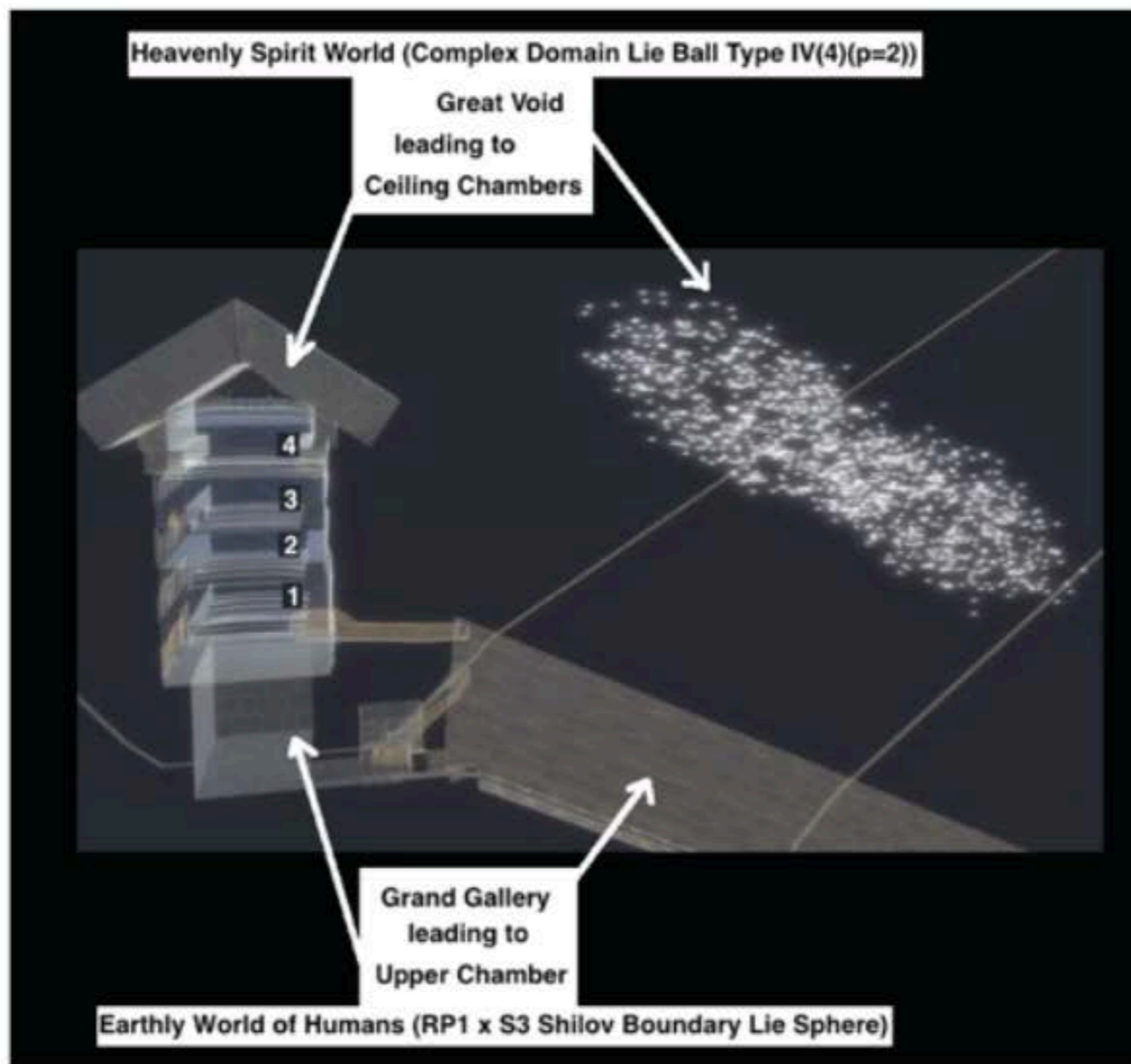

The Builders of the Great Pyramid represented the Real Shilov Boundary Physical world by the Grand Gallery and Upper Chamber that are easily accessible by Humans with Microtubule Quantum Consciousness and they represented the Imaginary Complex World of CI(16) Spacetime Cells mirroring the Human Microtubule World as Ceiling Chamber spaces and the Great Void that are more accessible to Souls of the Spirit World than to Physical Humans.

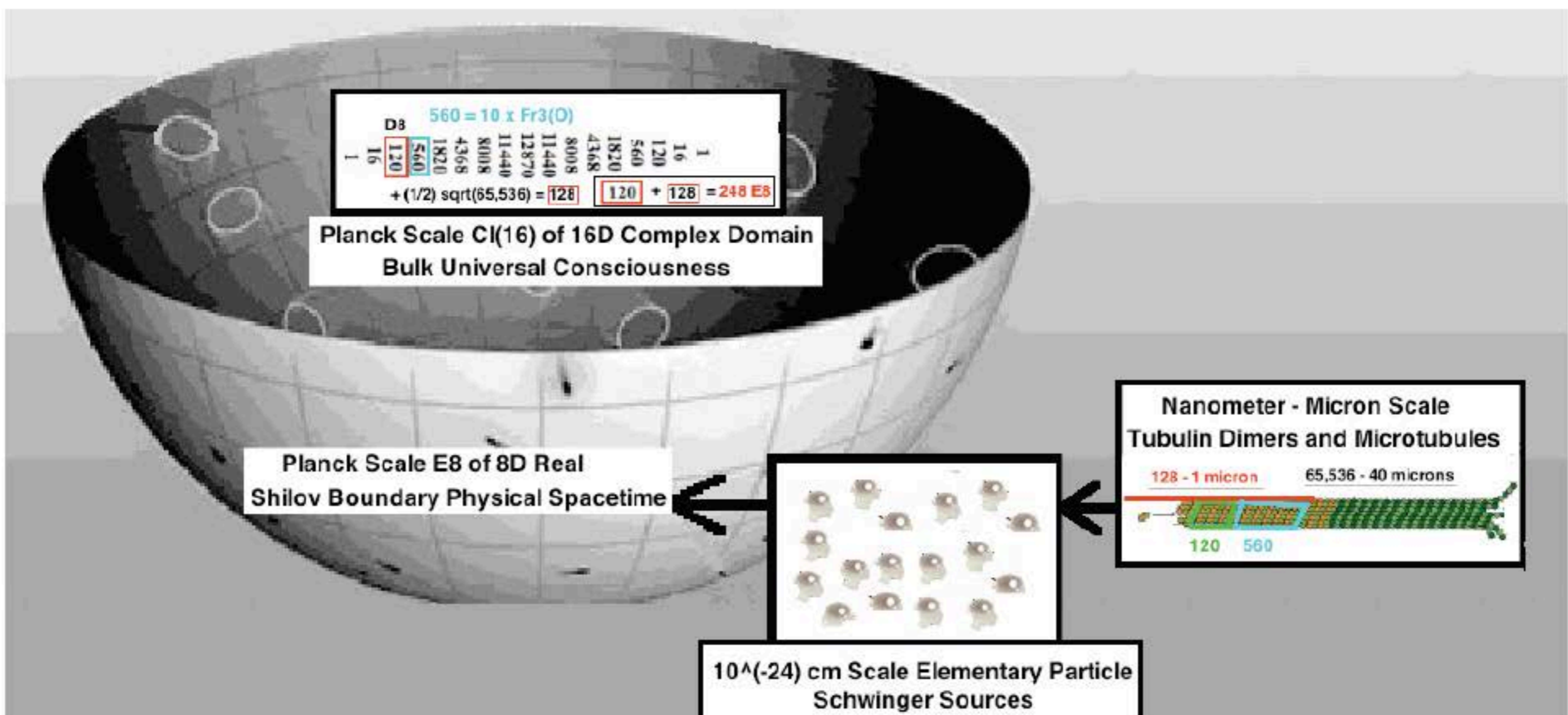

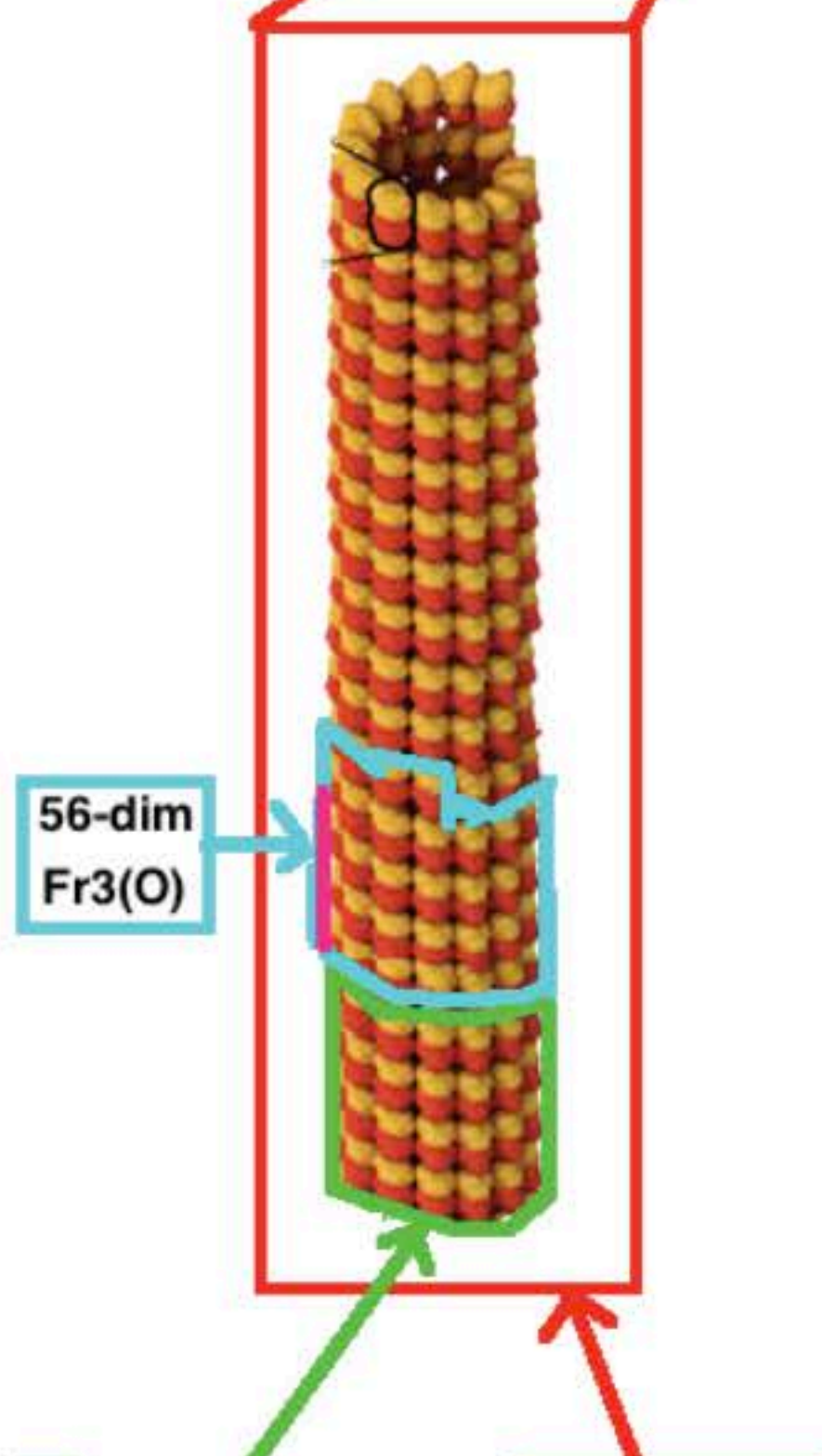

56-dim Fr3(O)

52-dim F4 of CP2 in 256-dim Cl(8)

F4 / B4 = OP2 = Spinor Fermions = 8 Particles + 8 AntiParticles  
 B4 / D4 = 8-dim SpaceTime = Kaluza-Klein M4 x CP2  
 D4 = Spin(8) contains Spin(6) = SU(4) contains SU(3) Color Force  
 SU(3) Color Force = Global Symmetry of CP2 = SU(3) / SU(2)xU(1)  
 SU(2)xU(1) ElectroWeak Force = Local Symmetry of CP2



**B4**  
28  
8

**CP2**  
+ sqrt(256) = 16 = 52 F4  
CP2 = SU(3) / SU(2)xU(1)

**D8** (Cnf6 -> M4) x CP2  
120 + (1/2) sqrt(65,536) = 128 = 248 E8

**B4**  
28  
8

**Cnf6 -> M4**  
+ sqrt(256) = 16 = 52 F4

1
8
28
56
70
56
28
8
1

128 - 1 micron

1
16
120
560
1820
4368
8008
11440
12870
11440
8008
4368
1820
560
120
16
1

65,536 - 40 microns

1
8
28
56
70
56
28
8
1

Cl(8) x Cl(8) = Cl(16)

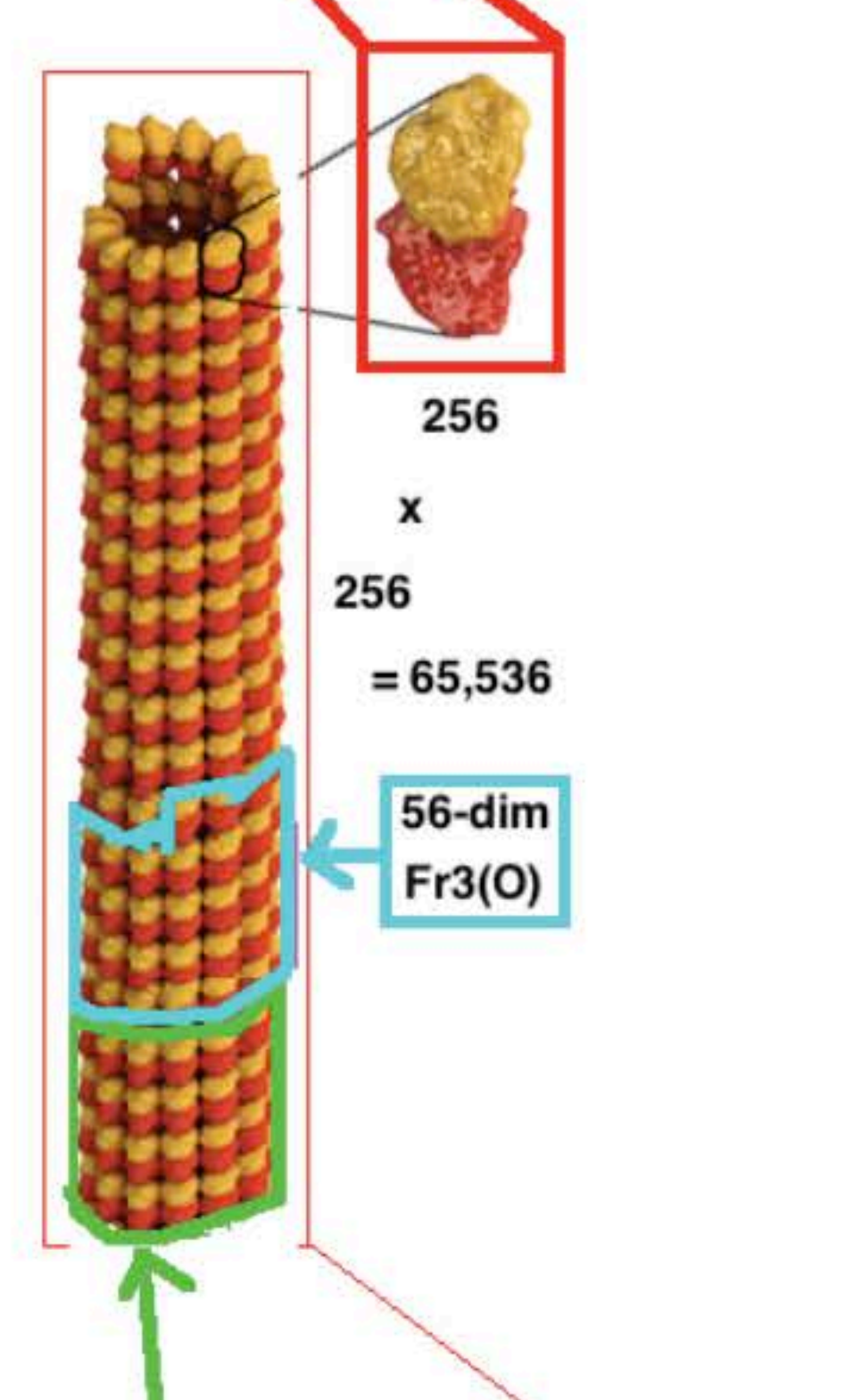

56-dim Fr3(O)

52-dim F4 of Cnf6 -> M4 in 256-dim Cl(8)

256 x 256 = 65,536

F4 / B4 = OP2 = Spinor Fermions = 8 Particles + 8 AntiParticles  
 B4 / D4 = 8-dim SpaceTime = Kaluza-Klein M4 x CP2  
 D4 = Spin(4,4) contains Spin(2,4) of Conformal Gravity + Dark Energy



**E8 Kaluza-Klein (Cnf6 -> M4) x CP2**

In ( Cl(8) of CP2 ) x ( Cl(8) of Cnf6 -> M4 ) = Cl(16) containing E8  
 at each of the 256 points of Cl(8) of Cnf6 -> M4 there are all 256 points of Cl(8) of CP2

**D8 = Cl(16) BiVectors = 120**

**E8 / D8 = 128-dim Fermion Spinor Space = 8 components of 8+8 Fermions**

**D8 / D4 x D4 = A7+1 = 64 = 8-dim position x 8-dim momentum**

**D4 containing D3 = Spin(2,4) = A3 = SU(2,2) for Conformal Gravity + Dark Energy**

**D4 containing D3 = SU(4) containing Color Force SU(3)**

**10xFr3(O) = Cl(16) TriVectors = 560**

# Rig Veda / Angkor Wat

About 50,000 years ago (National Geographic Genographic)  
 YAP and M174 went out of Africa to Sunda  
 (then dry land South of Angkor Wat  
 and SouthEast of India)  
 and on to Japan and Tibet

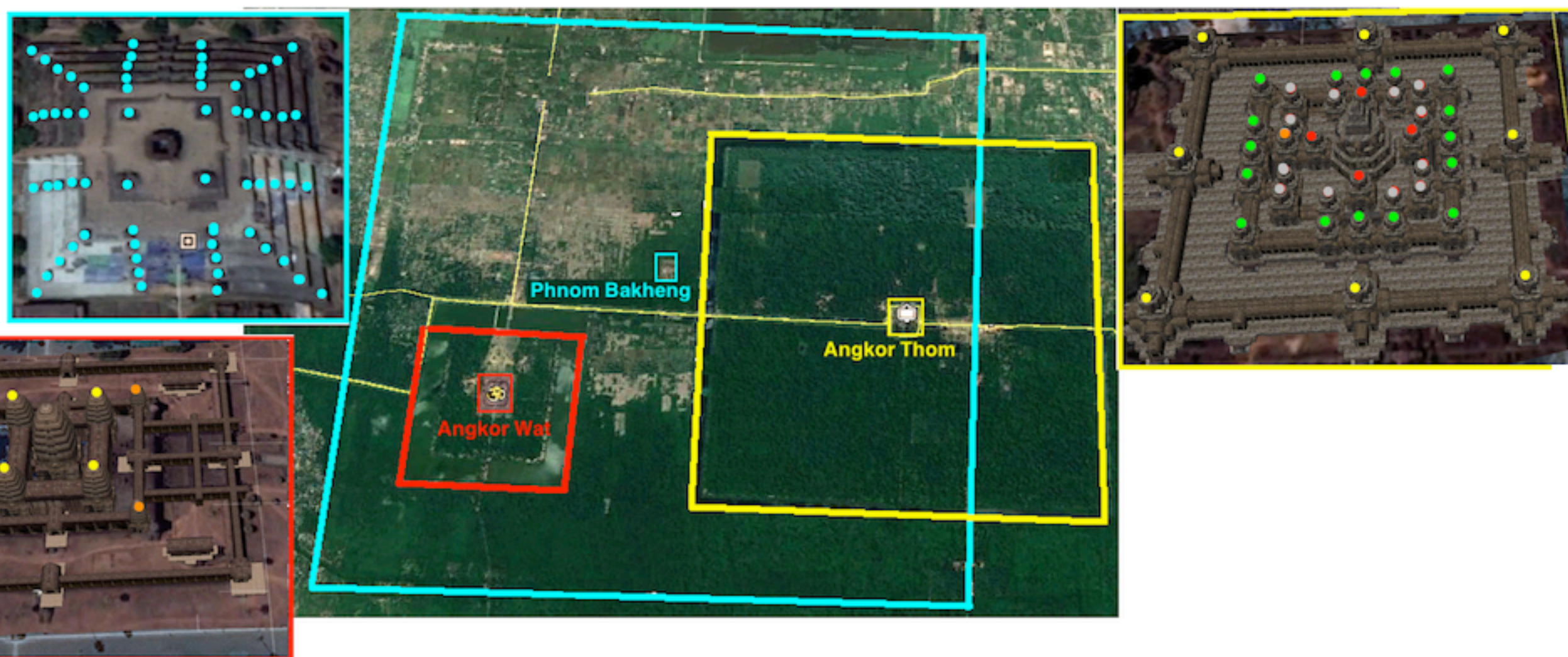
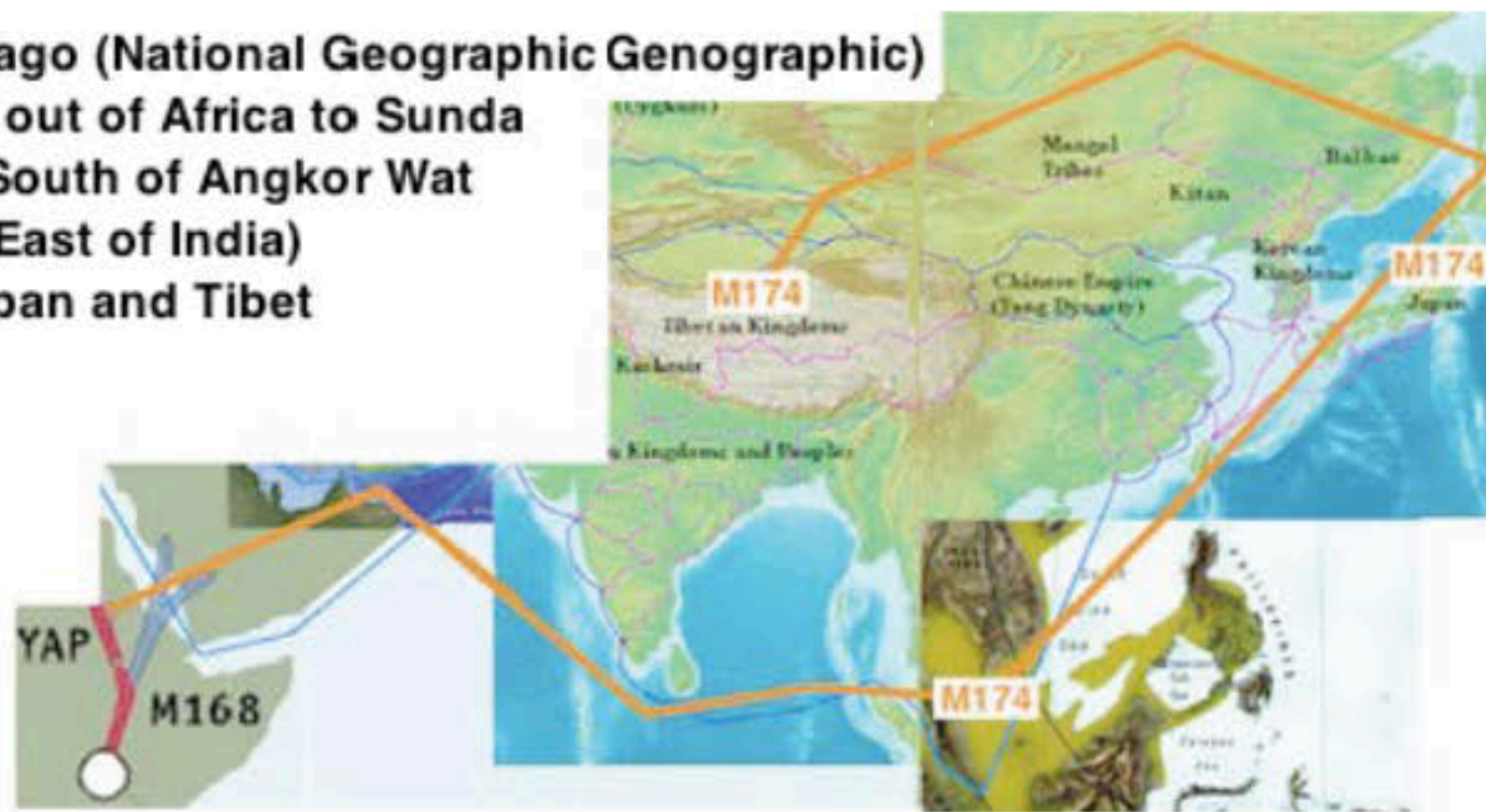

Angkor Thom, Angkor Wat, Phnom Bakheng

<-->

Giza Great Pyramid Cl(8) (D4gde), Second Pyramid Cl(8) (D4sm), Sphinx Cl(16) (E8 + Fr3(O))

Angkor Thom: 8 yellow Outer Towers + 16 green Middle Towers = 24-dim  $O \times O \times O$  of  $Fr_3(O)$  26-D String=World-Line Theory  
 1 orange Inner Tower = Bohm Quantum Potential from Cl(16) TriVectors  
 4 red + 12 gray Inner Towers = Fundamental Lepton + Quark Particles / AntiParticles from Cl(16) half-Spinors

Angkor Wat: 4 yellow Inner Towers = 4-dim Minkowski Physical Spacetime of Kaluza-Klein  $M_4 \times CP_2$  from Cl(16) BiVectors  
 4 orange Middle Towers = 4-dim  $CP_2 = SU(3) / SU(2) \times U(1)$  of Kaluza-Klein  $M_4 \times CP_2$  from Cl(16) BiVectors

Phnom Bakheng: 64 cyan Towers =  $D_8 / D_4 \times D_4 =$  by Cl(16) Triality = ++half-Spinor Fermion Particles  
 = --half-Spinor Fermion AntiParticles

++half-Spinor Fermion Particles + --half-Spinor Fermion AntiParticles =  $64+64 = 128 = E_8 / D_8$

**Rig Veda Mandala 1 encodes the 240 Root Vectors of E8 = 24 + 24 + 64 + 64 + 64**

Akankar	Buddhi	Manas	Akash	Vayu	Agni	Jal	Prithvi	Akankar	Buddhi	Manas	Akash	Vayu	Agni	Jal	Prithvi	Akankar	Buddhi	Manas	Akash	Vayu	Agni	Jal	Prithvi
अक	नि	मी	ळे	पु	रो	हि	तं	य	ज्ञ	स्यं	दे	व	मु	त्व	जम्	हो	ता	रं	रं	लु	धा	तं	मम्
AK	NI	MI	LE	PU	RO	HI	TAM	YA	GYA	SYA	DE	VA	MRI	TVI	JAM	HO	TA	RAM	RA	TNA	DHA	TA	MAM
अ	भिः	पू	वै	भिः	अ	भिः	प्रि	री	ड	सो	नू	तं	ने	इ	त	स	दे	वाँ	ए	ह	दं	च	ति
अ	भिः	नां	उ	भिः	भं	श्न	उ	त्वो	षं	शे	व	दि	वे	दि	वे	सु	श	सं	वो	र	वं	त	मम्
अ	भे	यं	यु	ज	मं	ध्व	रं	वि	श्च	कं	प	दि	पु	र	सिं	स	इ	दे	वे	धुं	ग	च्छ	ति
अ	भिर	हो	वां	क	वि	कं	रुः	सु	त्यश्	चि	त्र	श्रं	व	स्त	पः	दे	वो	दे	वे	भि	रा	गं	मव
य	ड	ङ्ग	दा	सु	षे	तु	वं	अ	गं	पु	इं	क	रि	प्य	त्रिं	त	वेत्	तत्	सु	त्व	मं	ङ्गि	रः
उ	पं	त्वा	शे	दि	वे	दि	वे	दो	र्षां	व	स्व	दी	दि	वि	पम्	न	मो	भ	रं	नु	ए	मं	सि
रा	वं	न्त	म	श्च	रा	शां	गो	पा	मु	त	स्व	दी	दि	वि	पम्	व	धै	मा	तुं	सु	वे	द	सं
स	नः	पि	ते	वं	सु	न	वे	अ	गं	सु	षा	पु	नो	भं	वं	स	वं	सु	आ	नः	स्व	स्त	यं

**24 First Richa Syllables + 24 First Richa Gaps = D4sm + D4gde (purple box)**

**8x8 = 64 Last-8 Syllables of Last 8 lines = D8 / D4sm x D4gde (blue box)**

**8x8 = 64 (red box) plus 8x8 = 64 (green box) give 128 = E8 / D8 = Fermions  
Middle-8 Syllables of Last 8 lines plus First-8 Syllables of Last 8 Lines**

According to Wikipedia and emails from John Small:

“... **The Rig Veda is composed of ten books (called mandalas in Sanskrit)**  
[that correspond to 10 Spacetime dimensions of 26D World-Line=String Theory] ...

The first book [RV1] is a collection of hymns from seers of different families  
[encapsulating the whole Rig Veda] ...

Seven of the books [RV2 through RV8] each relate primarily to one great seer  
[and represent the 7 imaginary Octonions] ...

The ninth book is [RV9] Soma hymns [and represent the Octonion Real Axis]  
Terence McKenna postulates that the most likely candidate for soma is the mushroom  
Psilocybe cubensis, a hallucinogenic mushroom that grows in cow dung ... the 9th  
mandala of the Rig Veda makes ... references to the cow as the embodiment of soma ...

The tenth book [RV10] [complements the first and fills in the gaps]...”.

RV2 through RV9 together represent  
the Octonion Structure of Spin(0,8) = Spin(1,7)  
and the RP1 x S7 Lie Sphere Shilov Boundary of Type IV(8) Complex Domain  
of Lie Ball Symmetric Space Spin(2,8) / Spin(8) x U(1)

RV1 and RV10 together represent  
the (1,1) Conformal Structure of Spin(1,9) = Spin(2,8) = SL(2,O)

Graham Hancock, in *Heaven's Mirror*, said "... Our current world age is Pisces because on the spring equinox ... Pisces rises just ahead of the sun ... because of precession ... ( 1 degree in 72 years) ... the sun spends around 2160 years [ 2160 = second layer vertices of all E8 Lie Algebra Lattices ] in each constellation - a complete revolution taking 26,000 years!  
 The great Hindu temple-complex ... spread over 200 square miles confirms that they correspond to the stars in the constellation of Draco, as they appeared in 10,500 BC! ...

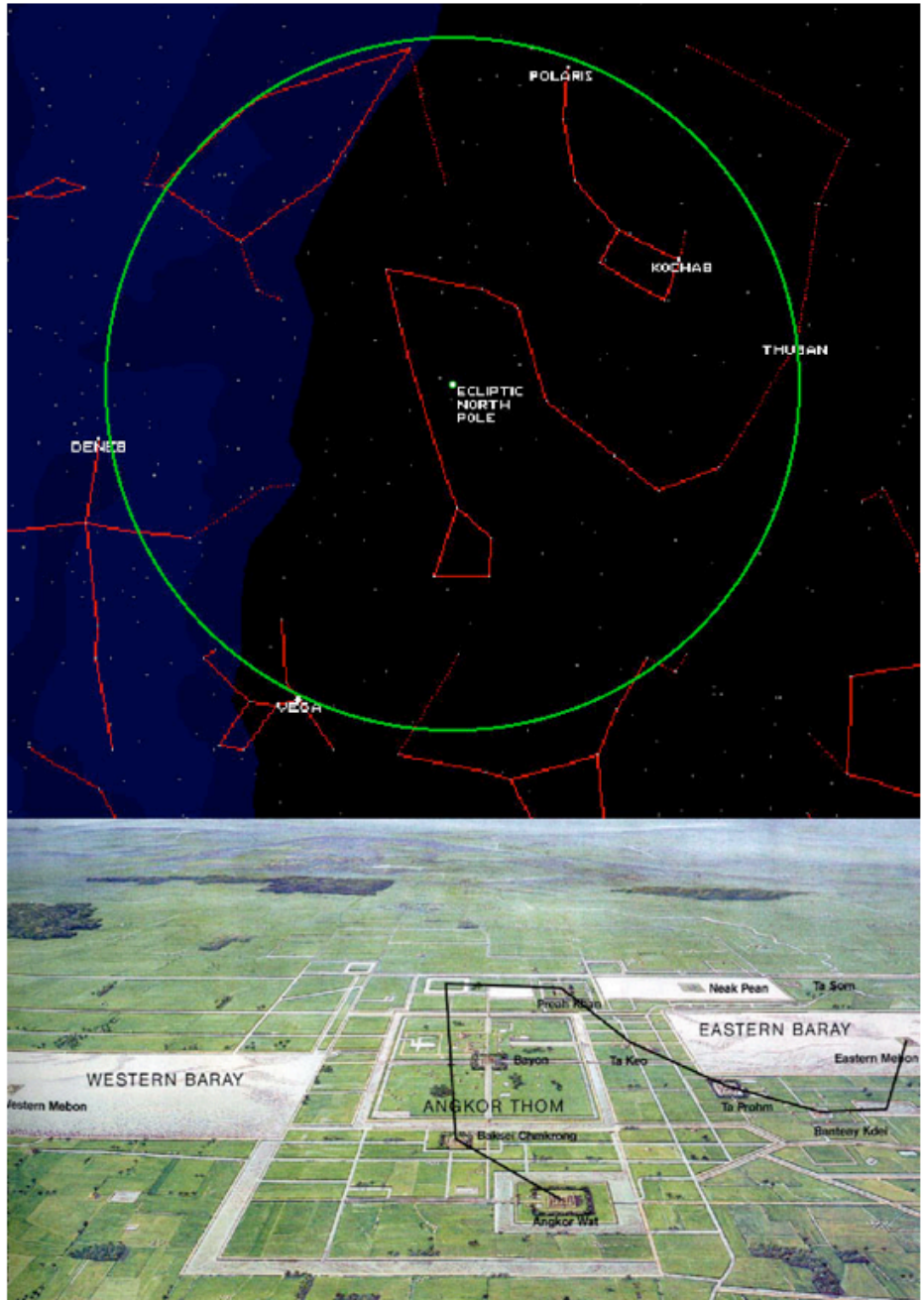

... "

The same star configuration of 10,500 BC = 12,500 years ago would have appeared in the previous precession period about 38,500 years ago, with Vega as North Star and Angkor Thom as the Ecliptic North Pole, about the time humans first arrived from Africa.