

# Matter and it's origin

<https://www.google.ca/search?q=space>



by Louis Rancourt

version may-2018

## **PREFACE**

Scientists agree that current theories in physics are incomplete because gravity can not be easily united to other theories.

We begin by looking at the current theories of matter and the limits of these theories. Certain facts can not be explained by these theories.

In the second part we look at three different experimental results, which allow us to find a new approach to meet expectations.

We first explain how an object with an excess of electrons can act at a distance.

We then examine the production of light and how light is transformed into matter and matter transformed back into light.

Finally, we look at the effect when light changes the gravitational force. We have over 1000 hours of scientific experiments on this effect.

It seems that light, gravity and what we call an electric field are intimately linked. These real results prompt us to look at new explanations because nothing in current theories predicted what we observed. Should we then reject the current theories? No, because in some areas they are sufficient to calculate the expected results. Instead, we need to take a fresh look at these results

CH 1 CURRENT THEORIES. PAGE 4

CH 2 STATIC ELECTRICITY. PAGE 7

CH 3 LIGHT. PAGE 16

CH 4 REDUCED GRAVITY. PAGE 23

CH 5 THE UNIVERSE. PAGE 40

CH 6 MATTER. PAGE 43

CH 7 SPACE AND TIME. PAGE 47

CH 8. IS LIGHT A WAVE OR A PARTICLE? PAGE 49

CH 9 GRAVITY DOES NOT EXERT A PUSH OR AN ATTRACTION. PAGE 49

CH 10 REPULSION ATTRACTION. PAGE 54

CH 11 WHEN WEIGHT IS DECREASED. PAGE 61

CH 12 THE BEGINNING OF THE UNIVERSE. PAGE 64

APPENDIX: DETECTOR FOR STATIC ELECTRICITY page 62

## Chapter 1

### Current theories

#### MATTER

Since the first human looked at the firmament, he wondered what this universe is made of. Theories are always refined with new discoveries. They will continue to be more precise. Let us see how science sees the universe today. All agree that solid matter is made of small units called atoms. Some devices can even show so much details that we see spheres that make up the surface of a metal.

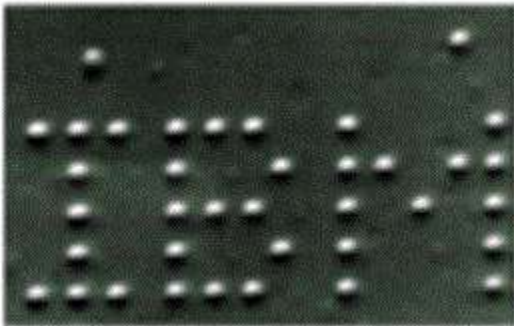

Here, IBM deposited atoms on a metal to write IBM.

[https://en.wikipedia.org/wiki/IBM\\_\(atoms\)](https://en.wikipedia.org/wiki/IBM_(atoms))

In 2009, another IBM team was able to photograph a molecule of nanographene;

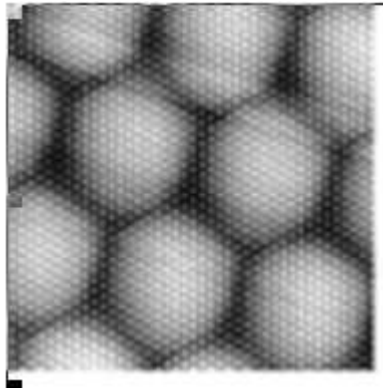

We see how the atoms in the molecule are arranged. You can see these pictures on the internet. [Http://e1.physik.uni-dortmund.de/ltstm\\_en](http://e1.physik.uni-dortmund.de/ltstm_en)

It seems therefore correct to say that matter is made of atoms. How are atoms made then? By examining their properties, we arrive at certain models of the structure of the atom.

Here are two different models that can be found on the Internet.

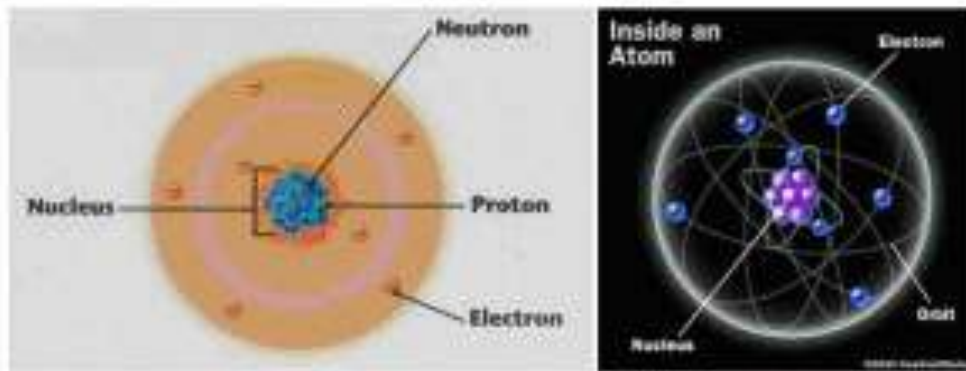

[Http://www.mediaanddestiny.org/a-meaningless-universe/](http://www.mediaanddestiny.org/a-meaningless-universe/)  
[Http://www.chs.d211.org/science/hausered/Chemistry/Inside%20an%20Atom.htm](http://www.chs.d211.org/science/hausered/Chemistry/Inside%20an%20Atom.htm)

**Atoms:** It is clear that atoms themselves are made of several parts. These parts are made of smaller parts. Are there parts so unique that they are not made of other smaller parts yet? Perhaps not, and this is what Planck's constant seems to suggest. When we look at electricity, we always get measurements that are multiples of something very small that we call the electron. There is no fraction of electron. Similarly it is possible that the smallest thing that exists is of the dimension required by the Planck constant (**h**) because all the measurements are multiples of **h** when we go at the level of the atoms and again towards smaller levels. We call them the last sub quanta or simply the quantas. The constant **h** is very small, about  $6.6 \times 10^{-34}$  joules-seconds.

This method of writing small numbers is useful in science. For example, to write a half millimeter, we write  $0.5 \times 10^{-3}$  m because  $\times 10^{-3}$  means 1 divided by 1000. The number of 0 in 1000 is the same as the ( $\times 10^{-3}$ ). One millimeter is 1000 times smaller than one meter.

The dimension of a hydrogen atom is then written as follows:  $1.06 \times 10^{-10}$  m. It would therefore take  $6 \times 10^{24}$  **h** to arrive close to the diameter of the hydrogen.  
 6000000000000000000000000000.

These atoms are everywhere in the universe. They are the basis of matter that we know on earth. Atoms seem to be formed in the stars like our sun. The Big Bang theory assumes that at first there was only one small point where all matter was concentrated. After an explosion of this point, the parts went in all directions. A force called gravity attracted them and the parts grouped together, forming larger systems and finally forming the atoms that we know. These atoms are grouped together and form the stars, the planets. The biggest problem of this theory is that there must be a force of attraction called gravity. If this force is not an attraction, the theory no longer holds.

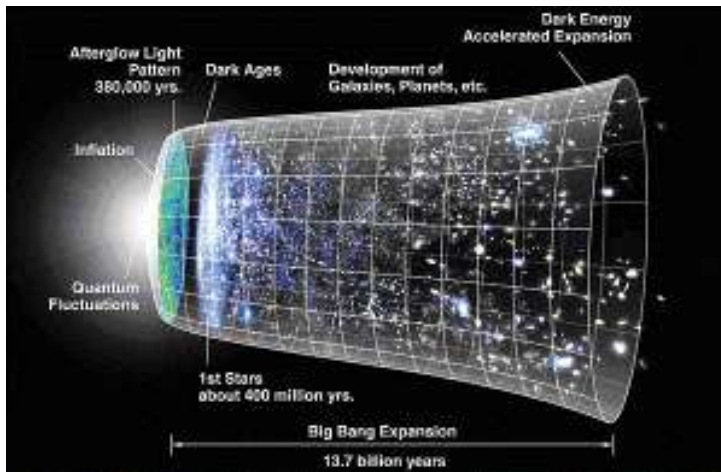

[Http://en.wikipedia.org/wiki/Universe](http://en.wikipedia.org/wiki/Universe)

Gravity seems to play an important role in the universe and on earth. However, the effects of gravity on earth seem to be different from effects in a galaxy because stars on the edge of galaxies do not follow the formulas used on earth. We have therefore invented strange concepts such as massive black holes in the middle of galaxies to explain these differences. We also had to invent dark matter and dark energy because our formulas can not explain what is happening in the universe. Several facts seem to confirm these theories, but other less far-fetched explanations give the same answers. Who is right?

Field theories are used to explain certain facts such as gravity and static electricity. Some observations in the laboratory can not be explained by current field theory. Some laboratories use high-frequency light to transform light into electrons, positrons, protons and antiprotons. The electron which unites with the proton makes a hydrogen atom.

The electrons that join the positrons are transformed into light. There is a direct relationship between atom and light. To understand atoms, we must first know what light is and to understand light, we must see what is called an electric field.

## Chapter 2 Static electricity

The current theory seems to have been spread by Maxwell with his 4 equations. It is said that as soon as an object has an excess of electric charge, a field exists everywhere in the universe. This field can now influence any charged object. If the charges are similar, a light object moves away and if the charges are different, a light object gets closer. The theory does not explain what substance makes that field: it exists...

<http://www2.csdm.qc.ca/garneau/Menus/6e/sciences3c/amelieshellie/electricite.html>

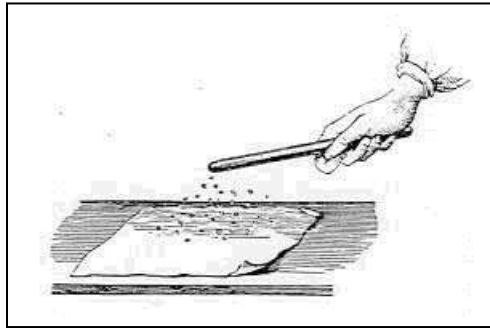

This object sensing the field can be anywhere in the vicinity of the charged object. All these places where the sensing object feels this charge are called the electric field. According to the definition of the field, this field exists instantaneously everywhere. This would mean that the field does not spread everywhere at a certain speed but exists everywhere, instantaneously. We already see that this concept is limited because it is not possible that an electric field is instantly everywhere in the universe when one makes an electron.

It is easy to find the limits of that theory in the lab. What we find is a little different from Maxwell's concept. One realizes then that a comb with an excess of electrical charge can be felt by a sensitive object but in addition, one can block this effect. An electroscope is used as a probe to determine whether an object has a surplus of electrons. A plastic comb rubbed into hair can capture hundreds of electrons as the electrons in the hair are pushed much more towards the atoms of the comb; some electrons of the hair jump and go on the comb.

A simple experiment shows that what is called electric field travels in a straight line from the charged object. Here's how to demonstrate it.

We use a rod made of ebonite (a sort of plastic) charged with surplus electrons. To charge it, we rub some fur on the ebonite rod. Many electrons leave the fur and jump on the ebonite rod.

A sensitive detector made with a NAND electronic chip and 2 LED can feel these surplus electrons over a distance of more than 3 meters. (Drawing in appendix). The circuit turns on a green LED with an excess of electrons and lights the red LED if there is a lack of electrons. The red LED and the green LED turn on together if the object is neutral, with as many electrons as protons. The detector is placed one meter and the electron-charged rod is moved. The detector can light a LED each time the rod is advanced. If the charged rod is advance at a frequency of 20 times per second, the LED will turn on 20 times per second as well.

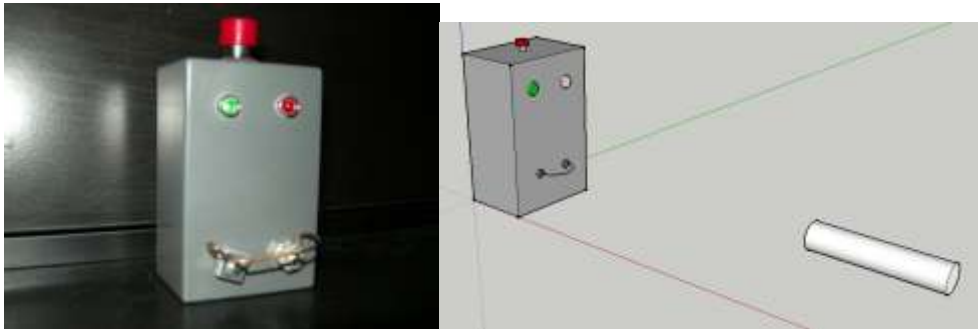

The sensitive detector is placed on the left. A rod is charged with an excess of electrons. The detector LED turns green to indicate the presence of an electrical charge in the vicinity.

A book of neutral charge is slipped between the sensor and the rod. If the electric field is everywhere, the presence of the book in between should not change what the detector perceives.

Here is the experimental result, easy to verify in the laboratory.

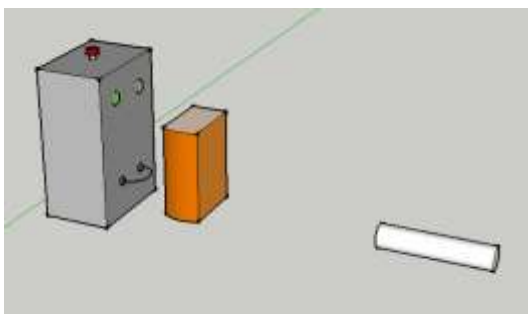

The LED is immediately turned off as if we had blocked what comes from the rod. If the book is removed, the LED is green again.

It seems that the book is blocking something that comes from the charged rod and goes to the detector



What is sent by the charged object travels in a straight line at the speed of light; this produces the electric field. We can not stop something that does not move. What leaves the rod is not a series of electrons because to send electrons over a distance of one meter, would take a thrust of thousands of volts. 120 volts can make a spark of a few millimetres only.

The rate of change of an electric field is the same as that of the change of the LED. If the rod is moved rapidly, the electric field varies in intensity at the same frequency and the detector feels it. This changing electric field is often referred to as an electromagnetic wave. It should rather be called pulsating field because there is no magnetism in the ebonite rod used.

The following drawing gives an idea of what is sent in all directions and can be blocked by a simple cardboard or book. The white circle represents the rod with an excess of electrons. The cloud that surrounds it represents what the rod sends in all directions. The density decreases with distance,

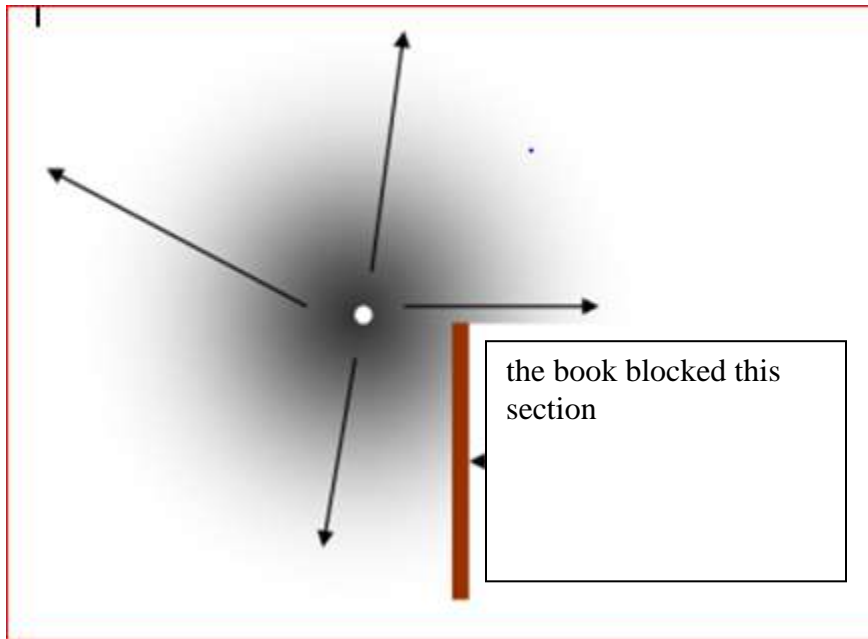

Field theory used in physics is useful mathematically but is not a real representation of what is happening. According to current theory, the field would be present everywhere, even on the other side of the cardboard. The facts show the opposite. The object charged with a surplus of electrons can thus produce an effect like light if it is moved from one side to the other, very quickly. The light emitted has the same frequency as the movement of the object.

There is not yet an official name for what the rod sends, but the properties associated with the many invented names do not completely correspond to what experience clearly demonstrates

Maurizio Micheli calls this micro quanta in his article: *A Flux of Micro Quanta Explains Relativistic Mechanics and Gravitational Interaction*.

Another name would be the last sub-quanta to indicate that it is the smallest parts that exist without being made of something even smaller.

Here is another experiment that demonstrates that objects with an excess of electrons send something around. A rod of ebonite is rubbed on fur. It quickly acquires thousands of electrons taken from the fur. The sensor will feel it and the green LED will light even if it is at a distance of 3 meters. The rod is moved toward the probe: the green LED stays on.

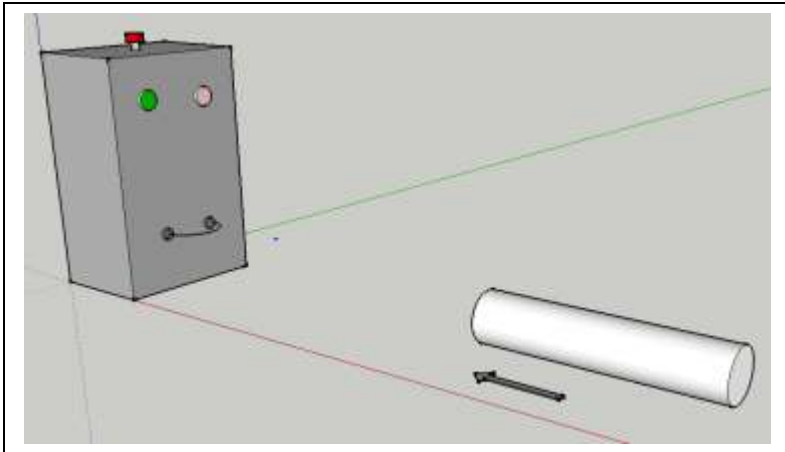

The rod is moved away from the probe: the green LED goes out and the red LED lights up.

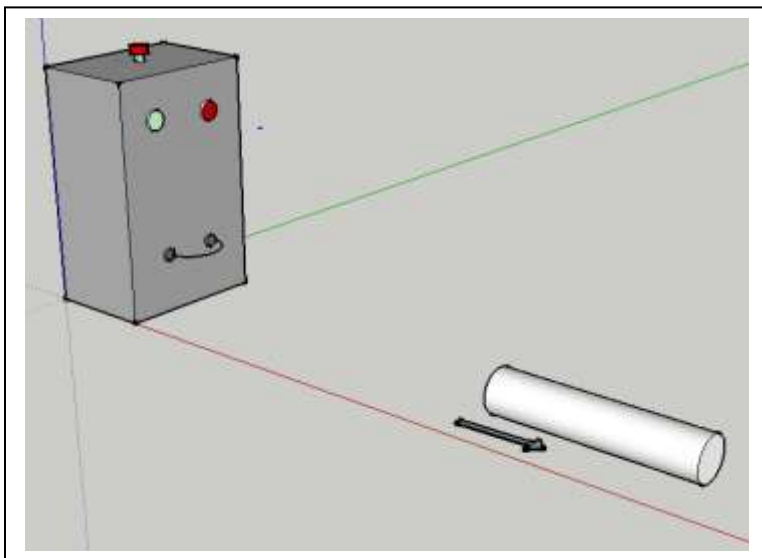

Normally, the red LED lights up in the presence of an object like fur that has lost electrons. Why does the red LED indicate that there is less electrons when the charged ebonite rod moves away because it still has an excess of electrons?

The most plausible answer is that all the objects in the room where this experiment is made have either a surplus of electrons or a lack of electrons or are neutral with as many electrons as protons. When the ebonite rod did not move with respect to the probe, the emission flow from the rod was constant and the LED did not change. When the charged rod approaches the probe, the intensity of this flow increases. If an object has a lack of electrons, the flow between the object and the probe is smaller than the normal average and the red LED lights up. Similarly, when the ebonite rod moves away, the emission from all objects around is now smaller and the probe perceives this as a lack of electrons and the red LED lights up.

The opposite happens if an object is used with a lack of electrons. At rest, the red LED lights up. If the object moves away from the probe, the green LED lights up as if there is an excess of electrons and the red LED goes out.

**Conclusion:** These facts demonstrate that an object that has an excess of electrons sends something in all directions, in a straight line, at the speed of light. The further one moves away from the object, the more it diminishes. It seems that if one triples the distance, the intensity decreases nine times.

The intensity seems to follow the following rule:  $\text{Intensity 2} = \text{Intensity 1} / (\text{distance})^2$ .

**A strange fact:** if the electrons send something around, why then is there no electric field around all the objects because all the objects have electrons?

When an object is neutral, with about the same number of electrons as protons, no electric field is felt. It seems, therefore, that at a certain distance the electric field of the electrons and protons cancel each other.

However, if a sensitive probe is used in a room, it sometimes indicates an excess of electrons and sometimes a lack. This is especially noticeable in winter, in dry weather. Overall, the room is neutral but in some places the electric charge is somewhat larger than in other places. Let us see some diagrams used to demonstrate the electric field according to Maxwell.

If we have an excess of electrons, we use the name given by Faraday by saying that the object has a negative charge. He believed that the ebonite rod he rubbed on the fur lost electricity, so he put a (-) sign on the ebonite. Later, we realized that the ebonite had gained electrons but we continued to put a minus sign (-) when there are more electrons and a plus (+) sign when there is less electron. An historical error of Faraday!

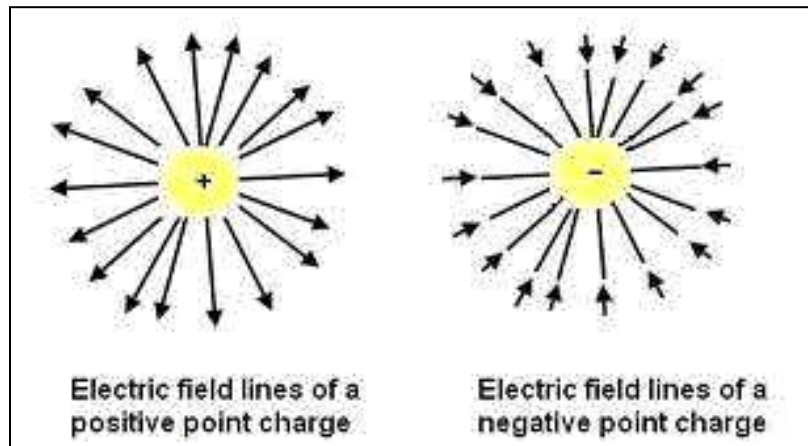

The arrows indicate the path taken by a small object with a lack of electron if placed there. So it moves away from a positive charge and approaches an object with an excess of electrons. The closer the lines are, the greater the force that moves the object.

In the following drawing, the lines again indicate the path taken by a small object with a lack of electron. The small object would follow this path by moving away from the charge + and going towards the negative charge.

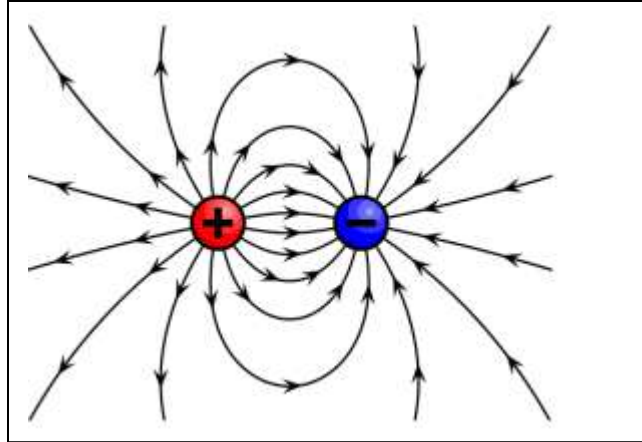

[http://solarwiki.ucdavis.edu/The\\_Science\\_of\\_Solar/1.\\_Basics/A.\\_Introductory\\_Physics\\_for\\_Solar\\_Application/II.\\_Electricity/1.\\_Charge\\_Carriers\\_and\\_the\\_Electric\\_Field](http://solarwiki.ucdavis.edu/The_Science_of_Solar/1._Basics/A._Introductory_Physics_for_Solar_Application/II._Electricity/1._Charge_Carriers_and_the_Electric_Field)

The biggest problem with these drawings is that there seems to be something starting from the object (+) and curving towards the object (-). This is false. What leaves the charge goes in a straight line and it seems to go at the speed of light. Curved lines are paths that an object would follow only. Moreover, nothing assures us that this starts from the object + or -. It will take other experiments to determine which one really sends something.

What is sent goes in all directions and the intensity decreases with distance, as shown in the drawing on the left. A charged object that moves will necessarily have a higher emission density level ahead of it. The small gray pixels indicate the intensity of what is emitted and the arrows, in which direction.

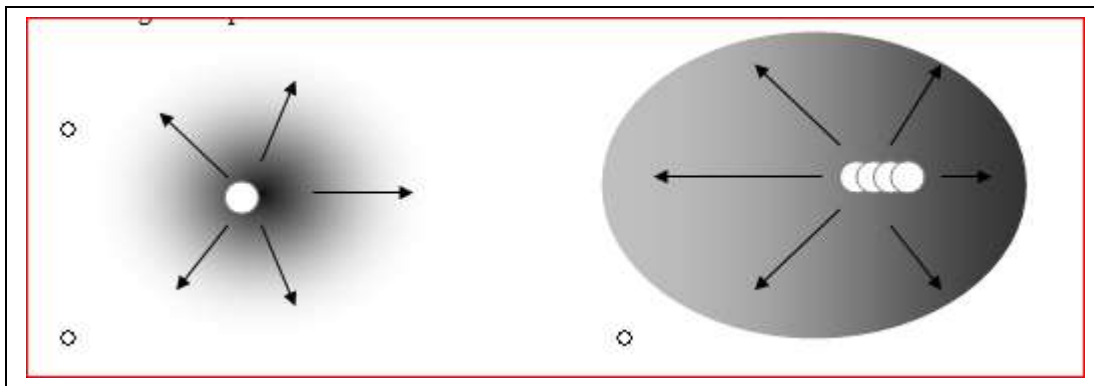

The drawing on the right tries to show how the electric field varies if a charged object has a rapid movement. The density is higher in front of the object.

The electric field moves away from the charged object at the speed of light. The intensity of this field changes depending on the direction of the moving charge.

If the charged object moves back and forth, a detector placed in front perceives these intensity differences as waves having a frequency and perceives this as visible light if the frequency is about  $10^{14}$  cycles per second. The field now has properties of frequency and of length as a wave.

Physics books name light an electromagnetic wave that does not need support to travel. It is true that light has a frequency and distance between layers, but it is not a wave like the sound wave or the water wave in a lake. This is a special case and the word wave here means something else because light does not need a support like a wave does.

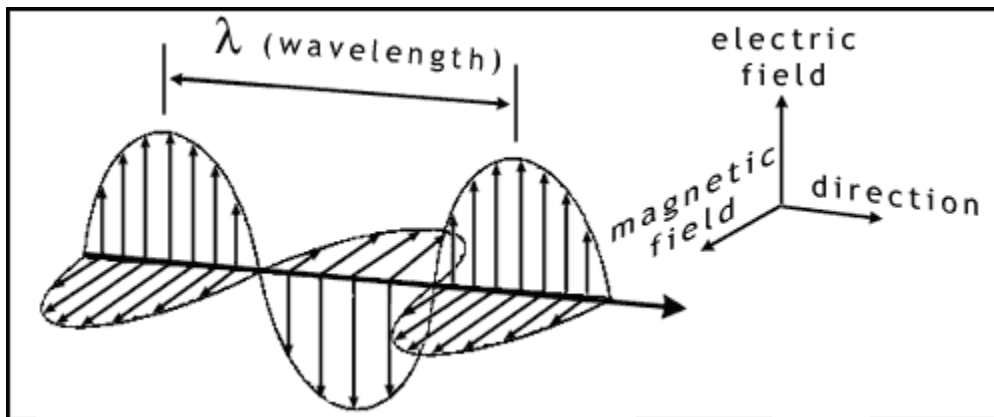

[van.physics.illinois.edu/qa/listing.php?id=16604](http://van.physics.illinois.edu/qa/listing.php?id=16604)

A drawing often shows an electric field of varying intensity at 90 degrees to the direction of light. Another field, magnetic this time is at 90 degrees with respect to the electric field and the direction of the light. The intensity of each layer of light is indicated by a vector. This vector does not represent a 90 degrees vibration with respect to the speed of light as some authors indicate, but it indicates the intensity of the field at this point. There is nothing that vibrates at 90 degrees in this wave. There is only a variation of intensity from layer to layer and it is this variation which has a frequency. The intensity depends on the source. It decreases with the square of the distance from the source

If the electron that emits light is itself composed of the same thing as light called the last sub-quanta, then these last sub-quanta travels at the speed of light in the electron and thus continually changes direction to remain in the electron. When the last sub-quanta leaves the electron, it continues at the same speed without giving an inverse thrust to the electron. There is no reaction force on the electron when it becomes the electric field.

To produce light, it takes energy from a system. Electrons can produce visible light. The relation between the energy of the system and the light is this:  
 $\text{energy} = \text{frequency} \times h$  where  $h$  is the Planck constant.

**Problem:** If the charged object continuously sends something in all directions, at some point it will be empty and can not send anything. Yet it still keeps sending everywhere. How is this possible? Let's look at what's going on around us. Every object made of atoms possess billions of electrons that emit something everywhere. If we could see these, we would see that there are some that go in all directions as indicated in the drawing. from the left.

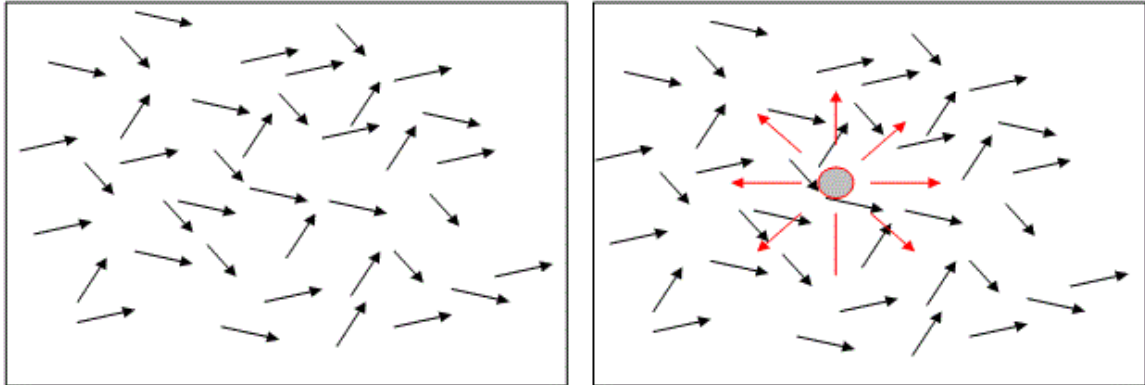

The second drawing shows a charged object that emits in all directions radially, that is, it seems to start from the center of the object. The object receives radiation from everywhere, in all directions, but seems to emit it radially outwards. Here, we put the arrows in red to show the difference in orientation. So the charged object can emit continuously because it receives from everywhere the same thing it emits. Some say it receives and emits photons. The description and properties of the photons is not quite that and we will come back to it later.

## Chapter 3 Light

What is the relationship between light and what is sent by an object with an excess of electrons? Let's see another experiment with the probe that detects an excess of electrons on an object.

One moves an ebonite rod with an excess of electrons and the probe lights a green LED. The frequency of motion of the charged rod is the same as the frequency seen on the probe.

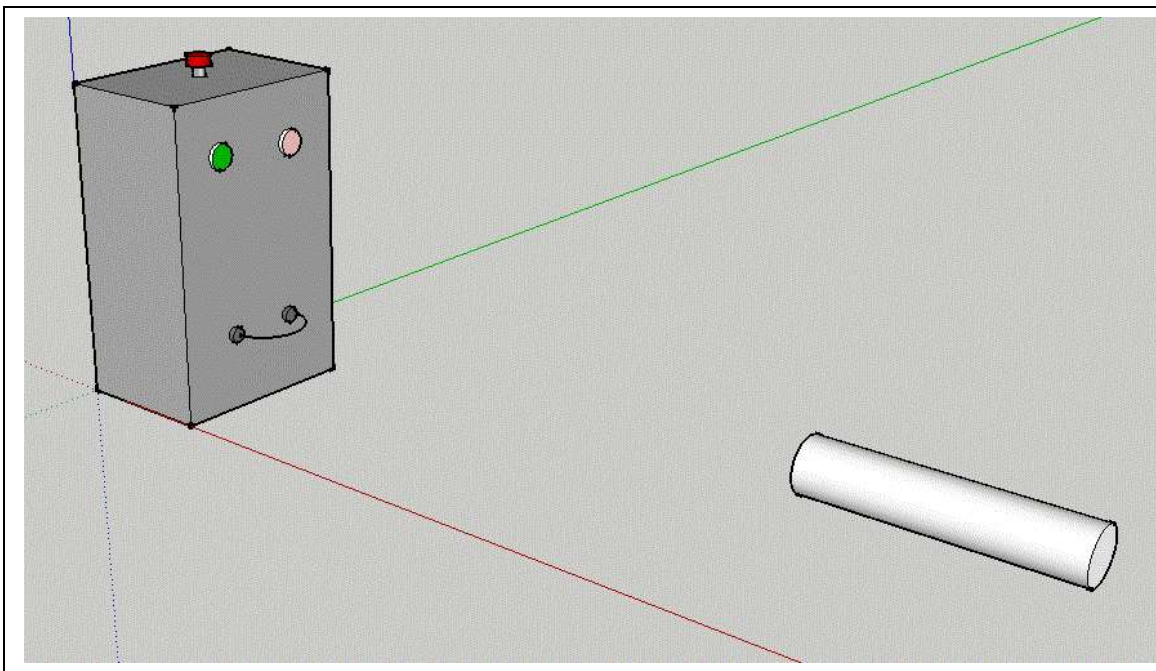

If the frequency of the movement changes, the frequency of the probe also changes. The probe can be activated by making a spark between two conductive wires. An electronic circuit can vary the frequency of sparks.

If the frequency is in the thousand times per second, it is said that what is sent is a radio signal in kilohertz. At higher frequency, we have the megahertz used for radio fm and tv. Even higher frequency, we have the radar wave used in microwave ovens. If the frequency is around exponent 14, there is visible light.

So if you could move the rod at a frequency of  $5 \times 10^{14}$  hertz, you would see the rod yellow.

Really the color of the visible light depends on the frequency.

In this document, the word light is used rather than electromagnetic wave for all the frequencies, from the radio wave to the gamma ray.



***Light is simply a very rapid variation in the intensity of emissions from objects having an electrical charge.***

For visible light, the source is always the excited electrons in the atoms of the object. Here is a drawing which allows to understand the variation of emission intensity as the ebonite rod moves back and forth from left to right. Each pixel represents what is sent as if you could take a picture of a snapshot. The white circles in the middle indicate the two positions of the rod coming and going. What is sent is actually light that can be perceived by the eye if the frequency is high.

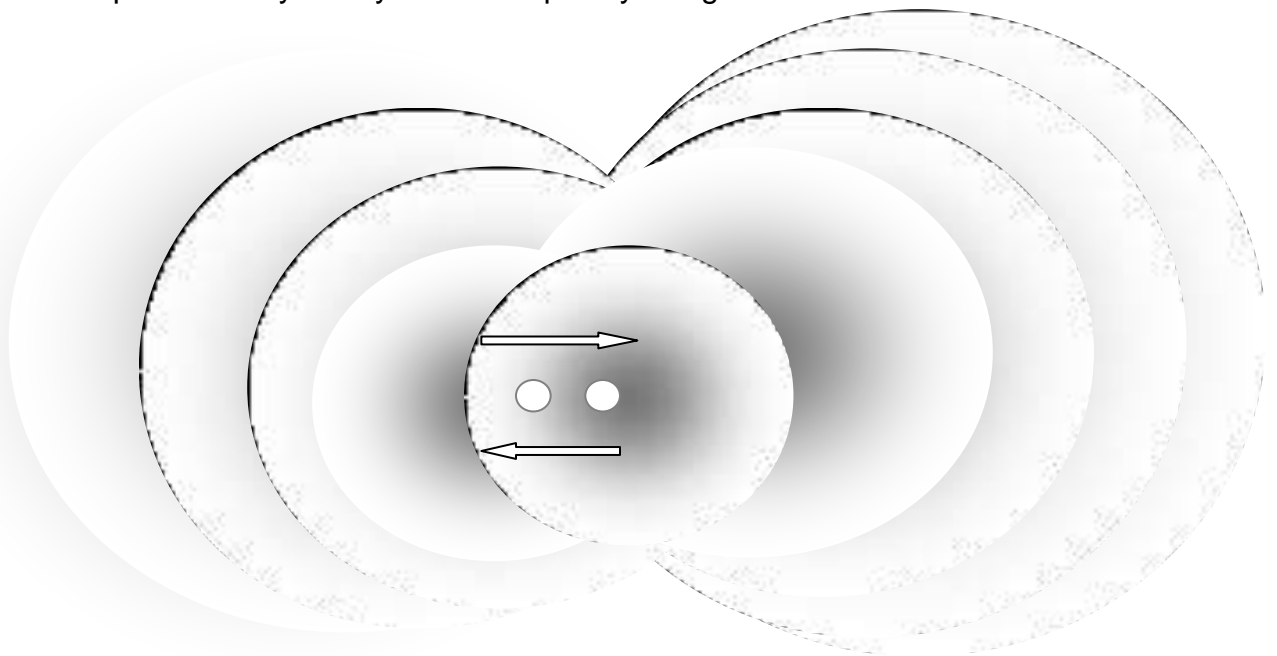

Truly it would be necessary to do the drawing in 3 dimensions

## PRODUCTION OF MATTER AND LIGHT

If one concentrates the high-frequency light and passes it through a thin sheet of gold or lead, the heavy atoms reorganize this field and make systems that are called electron and positron. We say that we have changed light itself into matter. Really we organized light into a system called electron. ( Google pictures)

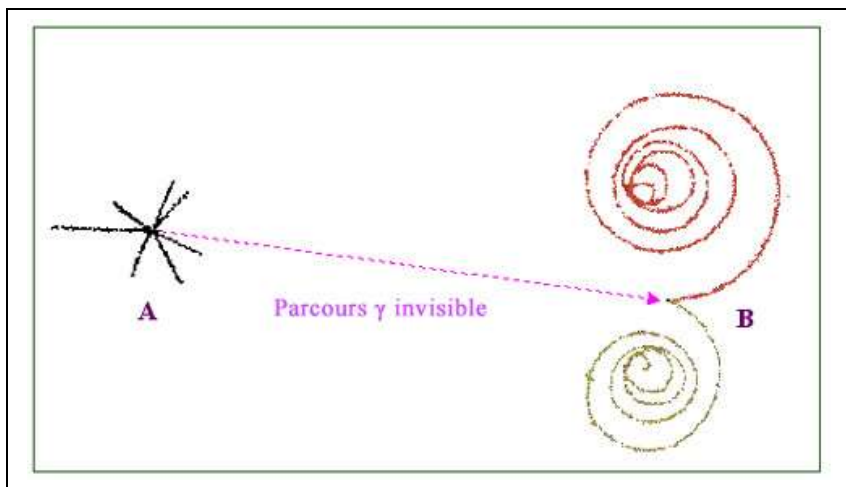
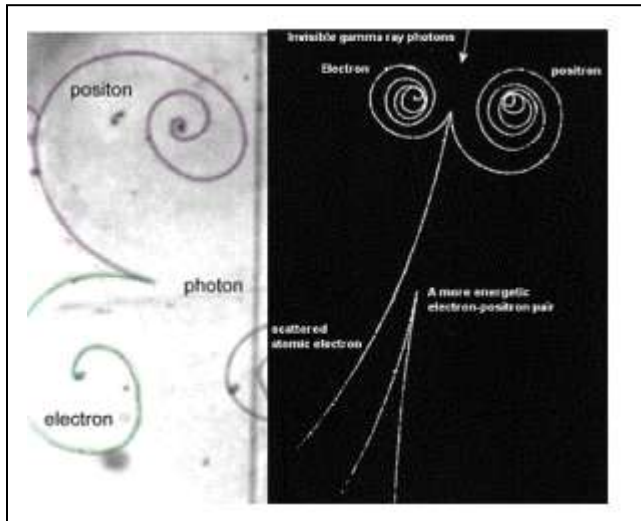

<http://www.laradioactive.com/site/pages/ParcoursGamma.htm>

Gamma light was produced at point A during a collision of a particle from a large accelerator. After traveling without interacting, the gamma interact with atoms and materializes at point B by becoming an electron and a positron. The presence of an intense magnetic field curves in the opposite direction the trajectory of the two particles. These lose speed by slowing down and spiralling before stopping. This cascade of events is observed in a bubble chamber

-Hence the formula attributed to Einstein

Energy = mass x (speed of light)<sup>2</sup>

Or even better because

Energy = frequency x constant h

$$hf = mc^2 \quad \text{where } h = (6.63 \times 10^{-34} \text{ J s})$$

Thus light becomes matter or system called electron to be more precise. The positron does not remain as a system for a very long time because as soon as it encounters an electron, it comes closer and everything again becomes light. It seems correct to say that solid matter and light are made of the same thing but organized otherwise.

Similarly, what is sent by all objects is also made of the same thing and it makes sense because it depends how the organization is done:

Stable system = atom, electrons, protons

System with a certain frequency = light, radio waves, etc.

Without frequency going radially = what is sent by the ebonite rod

Without frequency not going radially = gravity

### Emission of light:

For some atoms to react to light, many incoming layers of light are required to excite the electrons which then give a signal called light. This is how a detector can 'see' the light. Also it is important that many atoms are excited at the same time.

Our eyes have these detectors. A good example of this: if one looks at a distant luminous point through hair, one can see concentric circles illuminated even if the hair is not placed in a circle. Only the section of a hair that follows the exact curve of the light front will have enough excited electrons to emit light. Atoms that do not receive enough layers of light do not emit light. One often sees the same effect in a windshield in the evening in the countryside looking at a remote source of light.

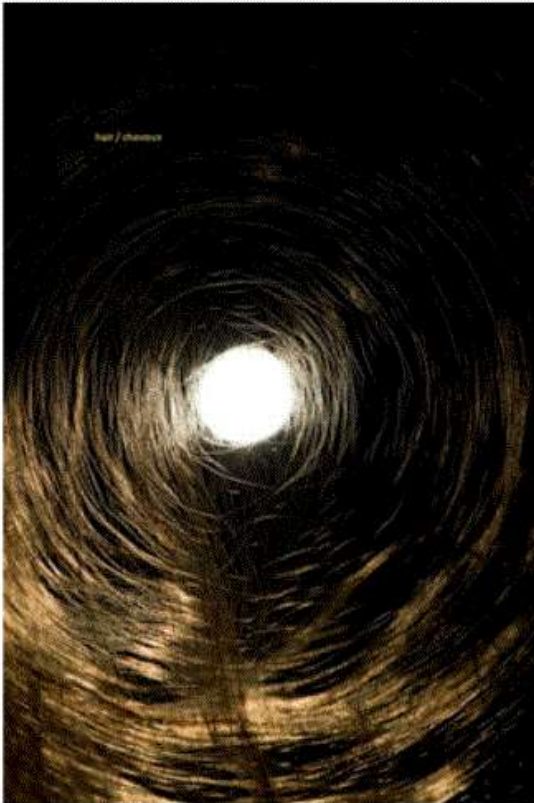

Looking at a bright light through long hair of Fleurange.

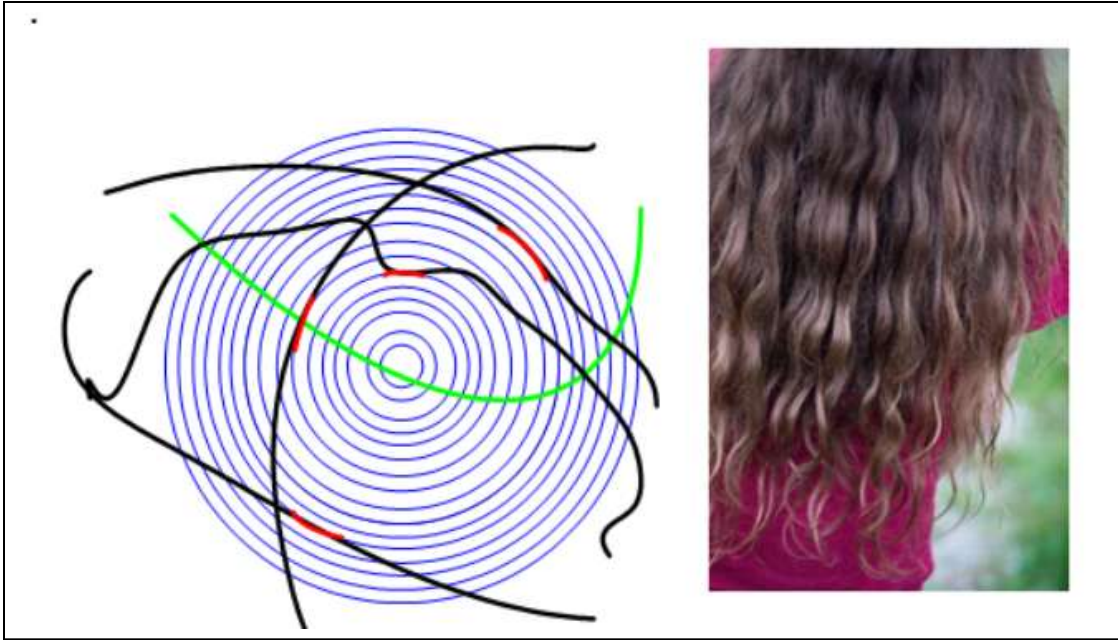

The concentric blue lines on the left drawing represent the layers of light that reach the hair. The small red lines show that only the section of a hair that follows the exact curve of the light front can be excited enough so that the electrons of the hair can in turn emit light. The large number of these small curves make the circles we see in the first photo.

The picture on the right shows how the hair was placed when we took a picture of intense light through these hair.

If matter and light are made from the same substance, this means that matter like atoms are complex systems made up of billions of small parts while light would be made of these substances but not organized into systems.

These substances would go at a speed of  $3 \times 10^8$  m / s, in a straight line. If they have a constant variable density this gives it its frequency and it is called light.

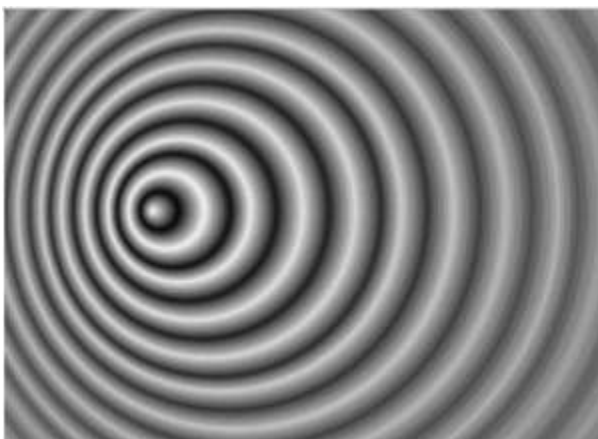

[http://ffden-.phys.uaf.edu/211\\_fall2010.web.dir/tony\\_mancuso\\_211webproj\\_Rev2/Electromagnetic%20Wave.htm](http://ffden-.phys.uaf.edu/211_fall2010.web.dir/tony_mancuso_211webproj_Rev2/Electromagnetic%20Wave.htm)

All these many real observations really suggest that there is something smaller than electrons and that this is what makes electrons, protons, neutrons and even light. As the current theories are not clear on this subject, we have named them the last sub quanta.

## CHAPTER 4 GRAVITY

Gravity is present everywhere and is still the part of physics that is the most controversial. Why? The theories of gravity have yet not be united to other theories. The main reason is perhaps that gravity is so different that we have to look at it in a new way.

We tried several experiments to discover the nature of gravity. An experiment gave results so surprising that it had to be done for nine months to try to find out if there was any error in the results obtained.

We therefore continue our discovery of the universe by a description of the facts and this will lead us to a new way of looking at the universe.

Here is a summary of the results of my research.

I have made many experiments on gravity without results. After reading what Podkletnov did in Finland with a wheel turning quickly, I tried to block gravity with a wheel but I did not observe anything. The idea came that if the wheel turns fast and blocks gravity, perhaps since light goes very fast, it could also block gravity.

I tried to bounce a laser beam between two mirrors and measure whether the gravity of a mass of 200 g changed once placed above the light. I have not found anything.

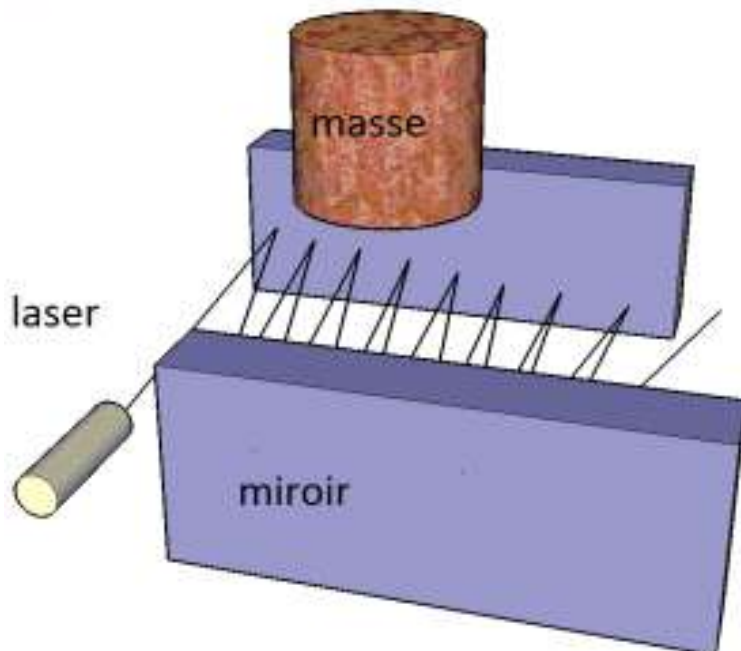

Instead of bouncing the light, I used a blade-shaped laser beam rather than a dot. The blade of light forms a straight line when arriving on a screen. Thus one can send the blade of light very close to a mass.

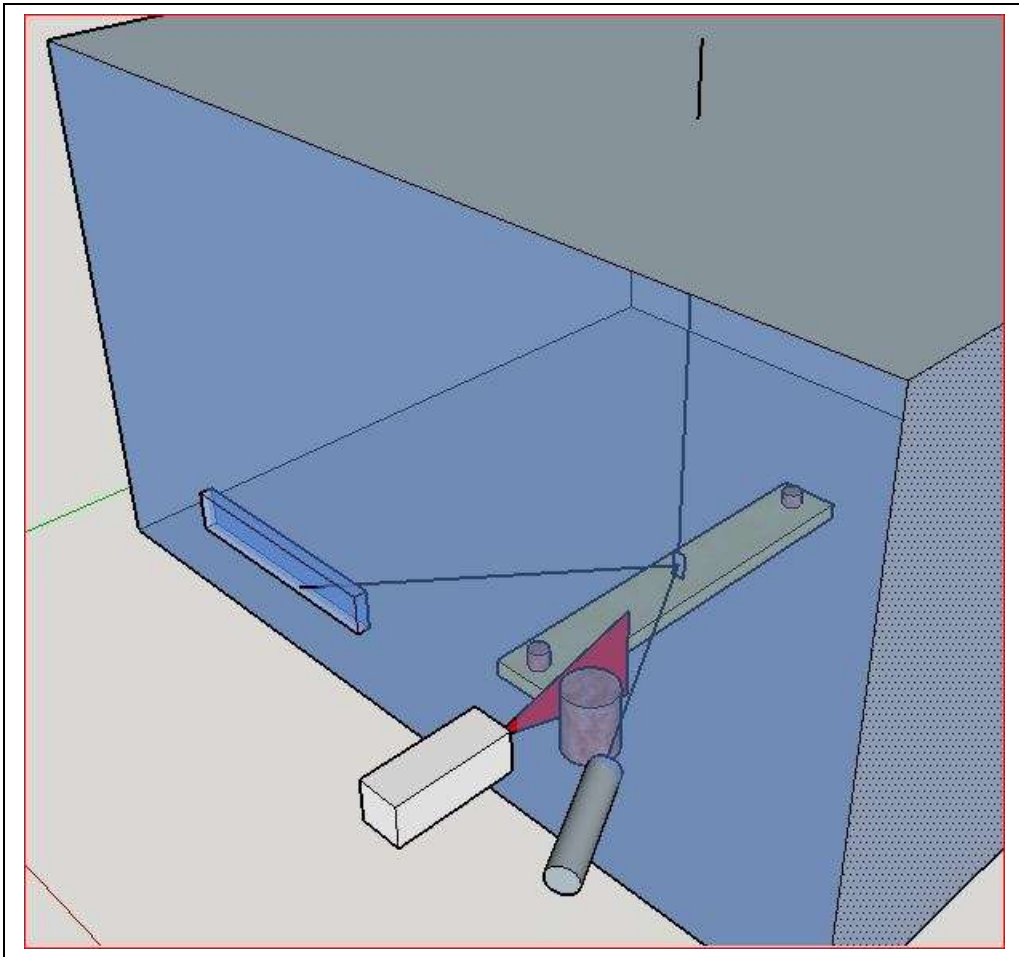

Another way to check this is to replace the metal masses with masses that are not affected by electromagnetic waves. We placed a large rock crystal (apatite) and a piece of rock called hematite on the pendulum. The effect is the same as with the bronze masses.

The earth rotates. Maybe the movement of the earth is enough to move the moving mass. The effect of the movement of the earth named Coriolis acts on the movements of air. To verify this, the pendulum is placed in different directions and locations.

The pendulum is brought to the Collège Boréal in a warehouse near a wall leaning against the rock. The same effect is still observed. Here is an example of the result obtained on March 2009 with the mobile mass and the fixed mass.



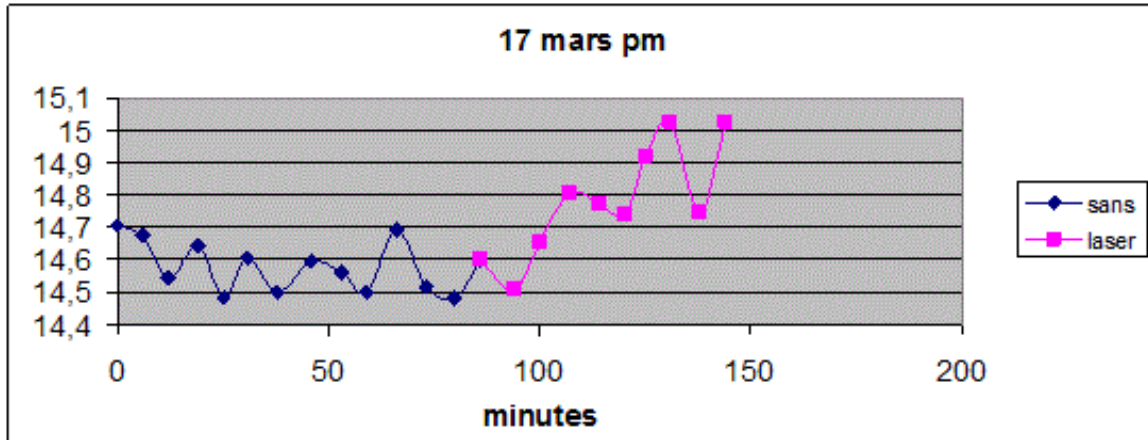

**Explanation of chart:** The horizontal axis indicates the time in minutes. The broken line indicates the position of the moving mass during this time. The pink line indicates when the light passed between the 2 masses. The vertical axis indicates the distance in cm of the red dot on the ruler.

**Observations:** At first, without light between the masses, the moving mass moves from side to side as indicated by the blue line. The light is sent between the two masses and the small mass approaches the fixed mass rapidly. This is indicated by the red dots going up on the graph.

**Conclusion:** The force of gravitational attraction seems to be greater in the presence of light. This is not foreseen by any current theory. This graph is only an example because many tests gave the same thing. After all these trials, we must accept that light can change what we call the gravity between two objects.

### Possible explanation:

If light interacts with gravity and blocks or deflects the trajectory of gravity, then light partially blocks gravity from outside as well. If the moving mass approaches the fixed mass, it is because the light has blocked more gravity coming from the outside; having less gravity between the masses, the moving object approaches as if attracted by the fixed mass. Actually, it is pushed from the outside towards the fixed mass. Here is a diagram of what happens when you put a ray of light between the masses.

In the next figure, without light between the masses, the moving mass is almost stable because the forces on each side are balanced. Left thrust = right thrust and thrust down = thrust from the top.

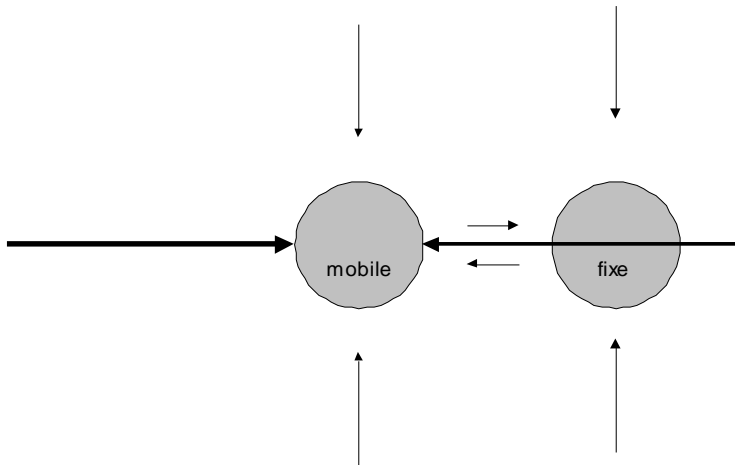

In the next figure, the light in red blocks the thrust coming from the right (the arrow which represents the force is shorter) and the mass is pushed a little more to the right; It approaches the fixed mass.

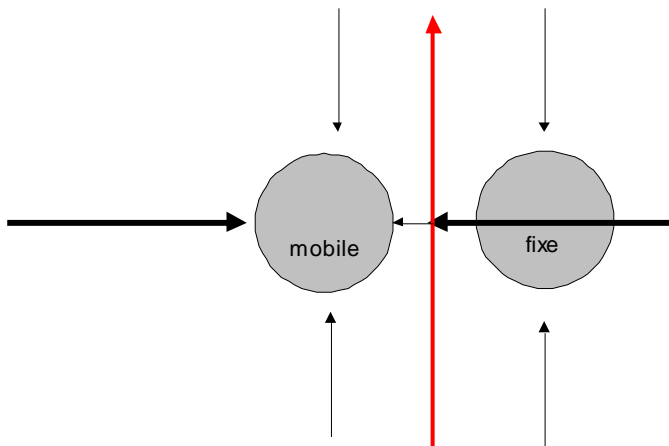

In March 2010, I stopped experimenting because the result were always the same. It was necessary to find an explanation of the phenomenon. I did not know any physical theory that could explain it. The idea that gravity was perhaps not something sent by one mass to the other mass came to me. I search the Internet and realize that others had thought about it but it was not taught in physics. Fabio and Lesage had mentioned it at Newton but Newton did not want to accept these theories.

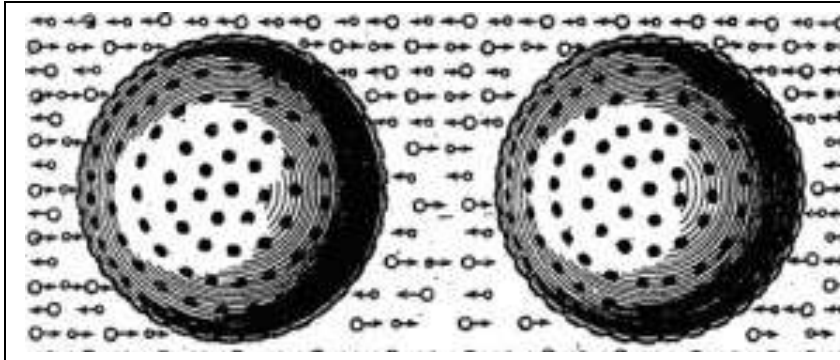

Drawing of Lesage on wiki:

In summary, his theory says that we bathe in an atmosphere of small parts that travel very fast; An example would be the air that surrounds us even if we do not see it. These small parts push the objects in one direction or the other. Currently, you are pushed left by air molecules on one side and right on the other side. As the two thrusts are equal, you go neither left nor right. If you could block part of what pushes you to the left, then the right thrust would be stronger and you would be pushed to the right. This happens when there is a lot of wind. The invisible air pushes you further on a side where the wind comes from. You feel a thrust by the wind. A good example is the air that pushes the aircraft wing upward has more force than the air that pushes the wing down; So the plane is pushed up.

I realized that if this theory were true, it could be verified by using the torsional pendulum without using a fixed mass. Nobody to date had verified the theory and in the 1920s ++, we had stopped talking about it. In recent years, some theorists have tried to revive it.

It is said that the space around us contains many non-visible parts like the neutrinos that pass through millions every second through us. In addition, there are particles emitted by the stars and the sun that bombard us. There are also radio waves, visible light, ultraviolet light and sometimes X-rays coming from space. There may be other things we have not yet discovered.

If light could act on what comes from space, it could change the thrust on objects. This would also mean that what makes light would be of the same nature as that which drives objects towards each other, as what drives the earth to turn round the sun; this was called gravity.

To verify this theory, it is necessary to place a torsion pendulum alone, without fixed mass nearby. Once it is stabilized, a beam of light is sent close to the left side close to the mass and one observes whether the mass moves in one direction or the other. We then place the light on the other side to check if there really is a change in the movement of the mass.

It sounds easy in theory but it takes patience to verify it. After hundreds of hours, I have enough results that show that light can affect the moving mass.

In the following drawing, it is seen that the light passes to the left of the moving mass. A screen stops the light so that it has no effect on the 2nd one at the other end.

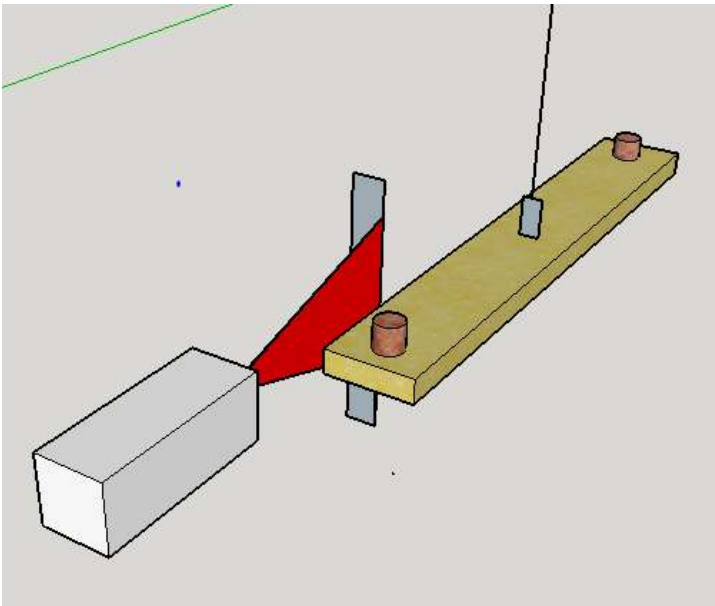

It seems that the pendulum oriented east-west is pushed on one side and the other by everything that comes from space. When the light is placed to the south of the mass, it is pushed to the south as if the thrust coming from the north is greater than the thrust coming from the south. What blocked part of the thrust coming from the south? It is light. If the light beam is changed and placed on the north side of the mass, it should now go north if the light can block what comes from the north. Yes, that happens.

The theory is verified by an experiment that all physics laboratories can check with a powerful enough laser. (N.B. The laser light must be laminar and not a small point).

The following graph clearly shows that the mass was pushed where the force of gravity was less on the side of the light. Excel software is used to record the time and position of the light spot on the ruler..

It must be remembered that the moving mass never stops moving from one side to the other. This movement at rest is only a few millimeters but can be seen very well with the luminous point of the small laser.

Here is what is recorded during a session. The blue curved line indicates the movement of the pendulum and the horizontal pink line indicates when light was directed near the mass. The red line indicates the average position of the moving mass.

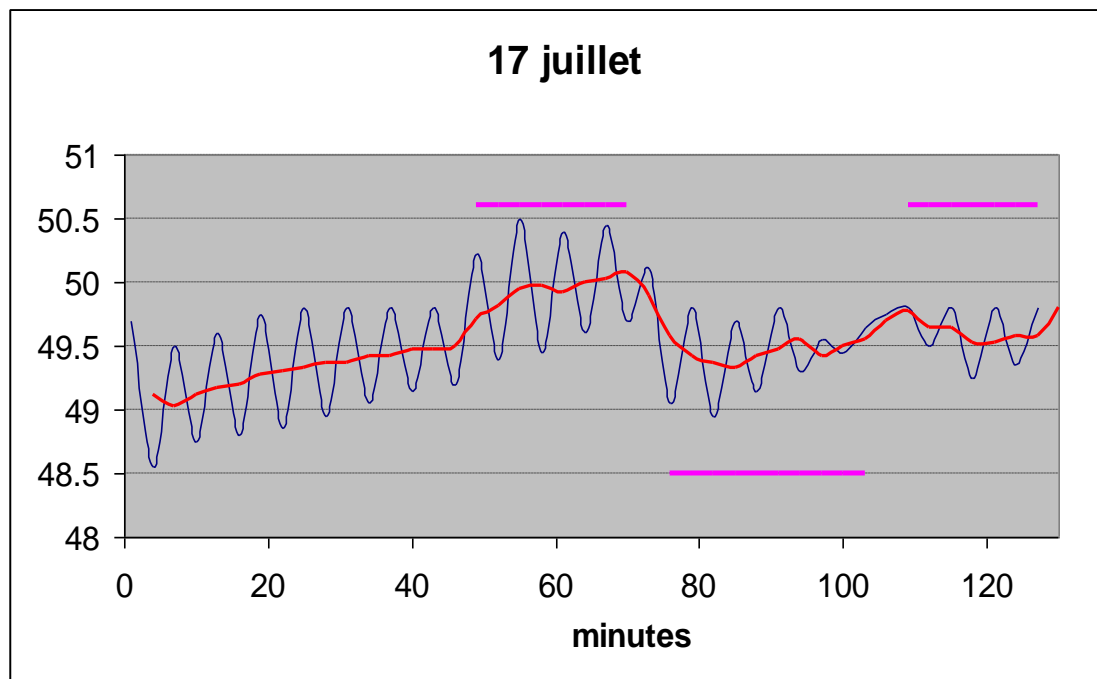

When a light beam is sent near the moving mass without having a fixed mass nearby, the moving mass is pushed towards the light because the horizontal gravitational thrust is less on the light side. It is proof that light blocks the gravitational thrust. As soon as the light is switched off, the mass returns to its rest position. This can be seen in the next following chart of April 16, 2012.

Before turning on the light, the mass moved slowly southward as indicated by the black line. That was probably caused by the sun moving south of the apparatus. The red line at the top indicates when the red laser light was activated close to the moving mass. The light is placed north of the mass; It immediately heads north and the red dot stabilizes around 630 mm. The light is cut off and the mass returns towards the south as indicated by the green line.

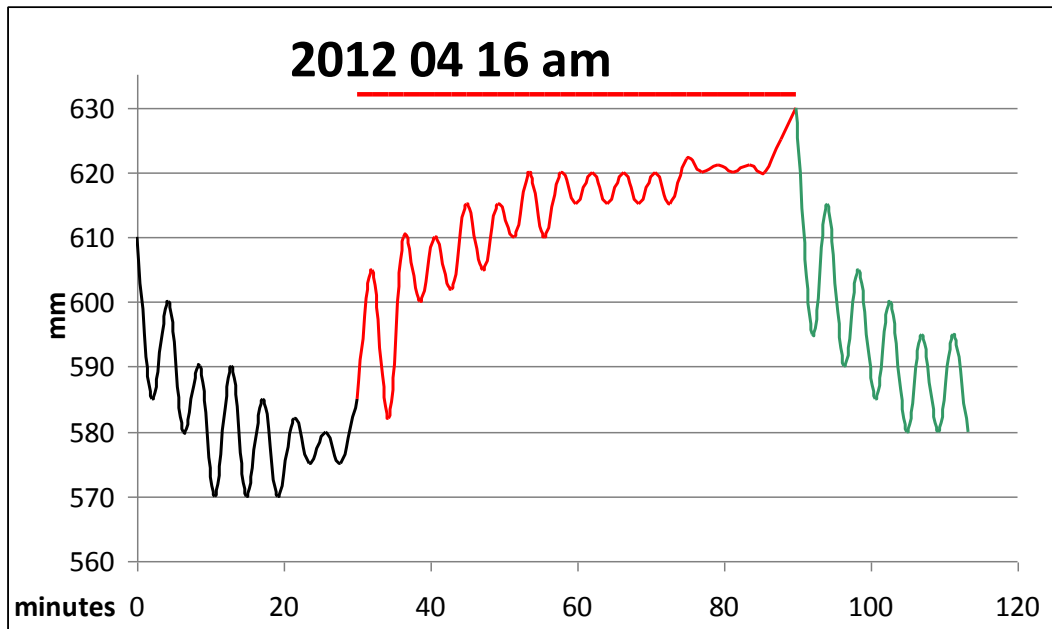

**Possible explanation based on actual results.** The green vector indicates the force coming from the north (right on this drawing) and the black vector indicates the force coming from the south. The two are equal. The two forces cancel each other and the mass remains fixed.

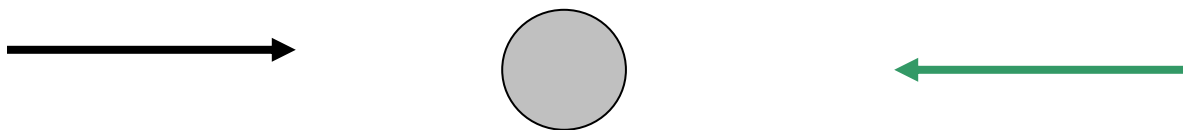

When the light (red arrow) passes on the north side of the mass, it blocks some force from the north. The thrust indicated by the shorter green arrow shows that the light blocked part of the thrust coming from the north. The total result of the two forces is indicated with the blue vector. The mass is pushed to the north.

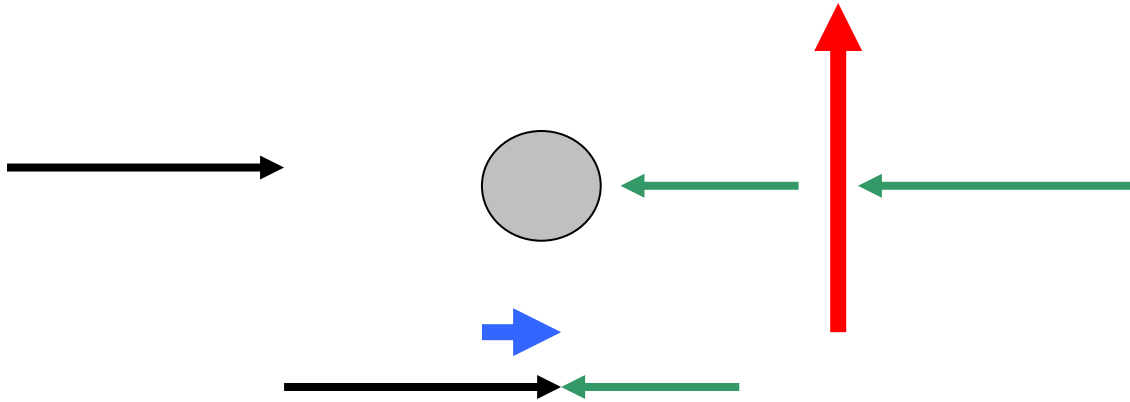

Current theories say that the large mass is the cause of the attraction of the small mass. Newton did not make that assumption but most people believe that. It is as if the big mass was actually sending the gravity that attracts the small mass. If the light blocks a part of the gravity coming from the large mass, then the attraction would be smaller and the small mass should move away a little. The opposite happens, although nothing in current theories predicted.

We have to accept the evidence and try to understand what is happening. If the large mass does not send gravity to the moving mass of 200 g, what moves it. An external force would have to push it. The small mass of 200 g moves towards the large mass placed to the north. If the small mass goes north, so a force pushes it from the south. When the laser beam is placed between the two masses, it passes to the north of the mass of 200 g. If the laser beam blocks a portion of the thrust coming from the north, the small 200 g mass will go north because the southern force would now be larger than the north force. This would be a possible explanation and the only one that makes sense.

## A second series of experiments

A second series of experiments confirms the first discoveries. We have built a box with polished aluminum sheets to hold light in order to place objects above or below the box and measure the weight changes of the object.

The box measures approximately 1.2 m by 1.2 m and 0.2 m high. Nine fluorescent bulbs send 63,000 lumen into the bottom partition of the box. Mirrors at the other end return the light to the partition above and so on. The light from the top partition is returned to the bottom partition. The interior design makes this clearer. A mass of 100 g is placed on a wooden support with one end placed under the box and the other end on the platen of a scale. Half of the force is therefore indicated on the scale. The reading indicates the force on the mass and on the wooden support. It is necessary to multiply the reading in grams per 1000 then by 9.8 to have Newtons.

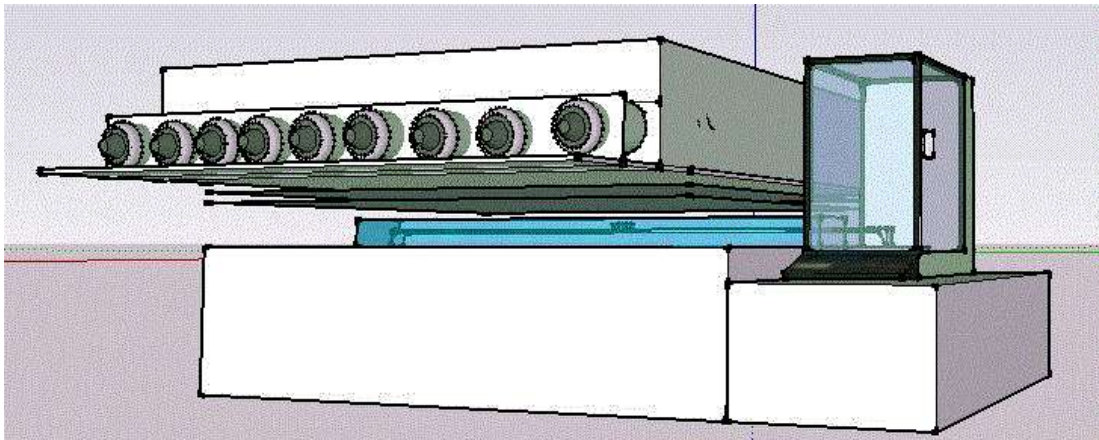
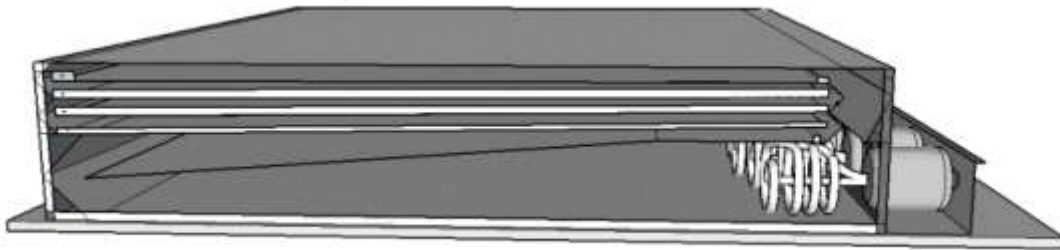



With the fluorescent bulbs which give about 63,000 lumen, one can see a change of gravity significant enough to make measurements. When the object is placed under the light, it loses weight. On the next graph, the red line indicates when the bulbs were lit from 50 minutes to 300 minutes and closed until 420 minutes.

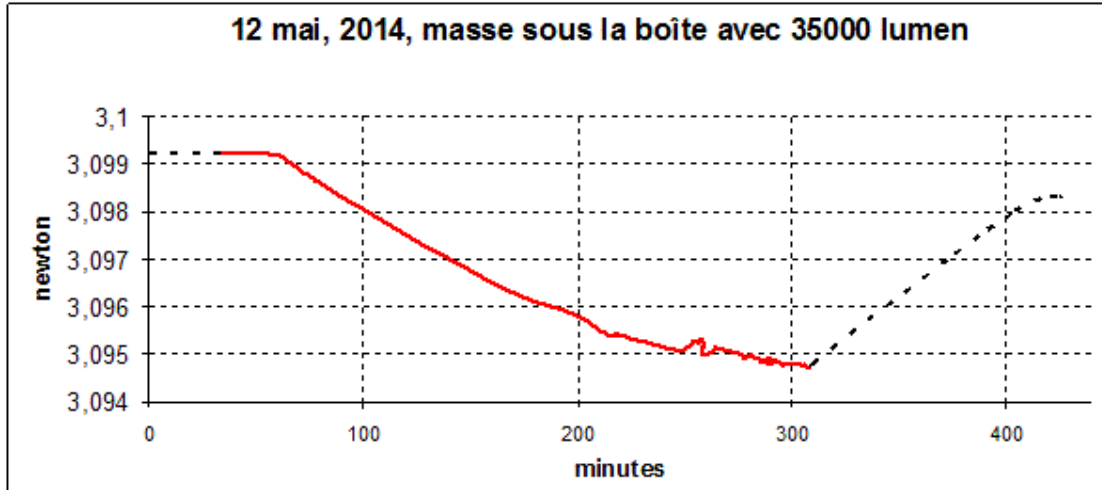

When the light was shut off, the weight slowly returns to its previous value.

The most surprising thing is that an object placed above the box gains weight even if its mass does not change. Verifications are made to ensure that there is no static electric field effect or air current caused by a change in temperature. Many graphs show that the more intense the light, the more the change of gravity increases. This change therefore depends on the light. On the next graph the violet line indicates when the bulbs were lit and the mass was located above the box and gained 0.06% weight.

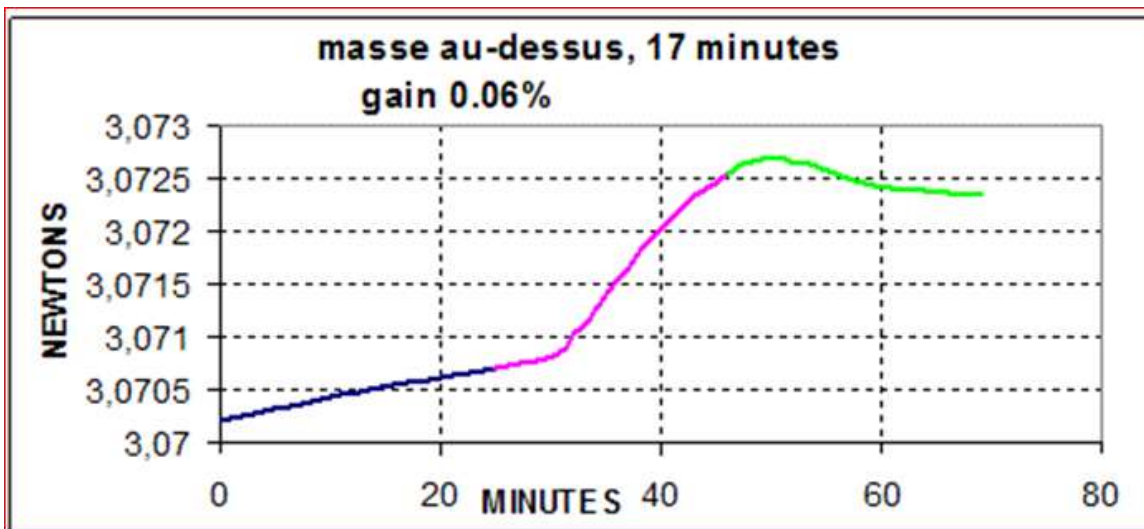

There may be another explanation. It must explain how it can sometimes increase the gravity and sometimes decrease it depending on where the mass is placed, above or below the box. A change of temperature can not do two opposite actions like that. Nobody to date has suggested a better way to explain this.

We must accept the evidence again. Light can block what causes gravity. In addition, this means that gravity exerts a push and not an attraction as was believed. When the big mass seemed to attract the 200 g mass, in reality the 500 g did not attract the 200 g. It blocked some of the gravitational thrust coming from behind, as light did. This means that all objects made of atoms block some of the gravitational thrust. The planet blocks much, so that the objects on the ground are pushed towards the ground because the thrust coming from the top is greater than the thrust coming from the bottom. The force of gravity is the 'response' or the result when two opposing and unequal forces are added together. The greatest force wins and this is called gravity.

If gravity is a force that pushes objects, what causes this force?

It is now known that the void between the stars or the sun is not empty. Space is filled with neutrinos that pass through us, billions per second. In addition there are all the radio waves that travel at the speed of light because these waves are a form of light with a frequency lower than the visible light. X-rays and gamma rays are everywhere. Particles emitted by stars move all over the universe. Some theories say there are virtual particles everywhere. Others say that there is a substance called black matter because it is not visible. Would the thrust of all this be the source of the thrusts called gravitational? Perhaps. There may still be something so small that it can not be detected. Some name this as tiny strings with strange properties.

Perhaps there are still even smaller things, so small that they have no dimensions, are not made of anything else, and always travel at the speed of light. It would be the last little things that exist. No smaller amount. These would be the last sub-quanta to use physics terms.

## CONCLUSIONS:

### 1. Light can interact with what causes gravity.

Facts do not lie. This does not, however, explain how light interacts. We must understand better what light is. As light blocks gravity, what makes up light and what makes gravity must have something in common in their nature. It may be that light and what causes gravity are made of the same parts but arranged in different ways. Future research can help us understand this.

### 2. The force of gravity seems to be repulsive and not attractive.

As the moving mass is set in motion when the light passes close by, this proves that a force acts on the mass. This force is called gravity. In physics, it is believed that any change in speed is caused by any force. Since this is not an attraction, it means that this force is a push. In truth, this simplifies our concept of gravity because it is very difficult to explain attraction at distance. Chapter 10 explains how a pushing forces seems to be attracting.

What does that mean? One has the impression by lifting a heavy rock that the earth attracts the rock downwards. Really, the rock is also pushed on all sides: left, right, forward, backward, from above and from below. The thrust which came from below crossed the planet Earth and part of this thrust coming from the bottom was blocked by the Earth. So the thrust coming from the bottom is smaller than the thrust coming from the top. The top thrust wins and the rock goes down. We are pushed towards the ground by the gravity coming from above, from space because gravity coming from below was blocked in part by planet earth. So the atoms of the earth can block some of the gravity. So our atoms in our bodies are pushed by gravity and thus block some of the radiation of gravity. What is not blocked continues through us.

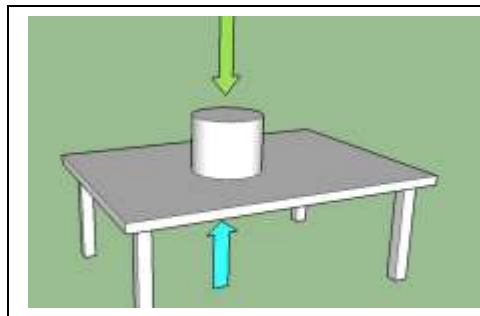

In this drawing, the arrow pointing downwards represents gravity and the arrow under the table represents the thrust given by the table to the object. If the two forces are equal, the object becomes stable on the table.

### **3. From the phenomena observed in the laboratory, it is asserted that matter, light and 'fields' are actually composed of the last sub quanta.**

The 4 basic properties of these small quanta are very simple: they are not made of other things even smaller, they have no dimension but have an interaction zone equal to the short length of Planck, about  $1.616229 \times 10^{-35}$  m. As they are the ultimate smaller entities and have no dimensions, they are recreated continually a little beside their current position so that they seem to go at the speed of light.

Since the last sub-quanta have no mass or frequency, only being and a velocity of  $3 \times 10^8$  m / s, they have no energy in the known sense in physics. Energy is only a concept that applies to interacting systems; Really, energy is summed up either with  $E = mc^2$  or  $E = hf$  or  $E = QV$ . Really one should remove the E and say simply that in the interactions, one can have this:  $mc^2 = hf = QV$ . The other formulas are contained in these.

Last sub quanta have no electric charge because charge is a property of a system just like the mass.

From the properties of the last sub-quanta one can probably discover all the laws of physics and explain how matter works at all its levels. But there is a limit : the number of calculations to be made to describe everything is too big; because a single electron seems to be made of more than millions of millions of millions of millions of millions of these parts. ( $10^{30}$ ) In addition these parts travel at the speed of light and interact with each other continuously.

### **4. Gravity is a push caused by the last sub-quantas.**

It is possible that the bombardment of the last sub-quanta is the causes of gravity. In the experiment described before, if the ray of light is also made of the last sub quanta advancing in a straight line, it interferes with those coming from the north and as the quantity from the north diminishes, those from the south push the object a little more than those coming from the north. This explanation is plausible and seems to be the only one valid to date.

If gravity is a thrust from the last sub quanta going to the speed of light from all sides, where do they come from?

The known universe is perhaps not the real limit of the universe. For example, if the current universe was as big as an 'apple' in the middle of a gymnasium (see drawing) and the whole gymnasium contained other galaxies and stars, in a gradual continuation from all sides of what we see, then the source of these last sub-quanta that comes to our universe would come from outside the 'apple' and also from the 'apple' itself. The amount that enters our universe seems a little smaller than what comes out because the universe grows a little bit.

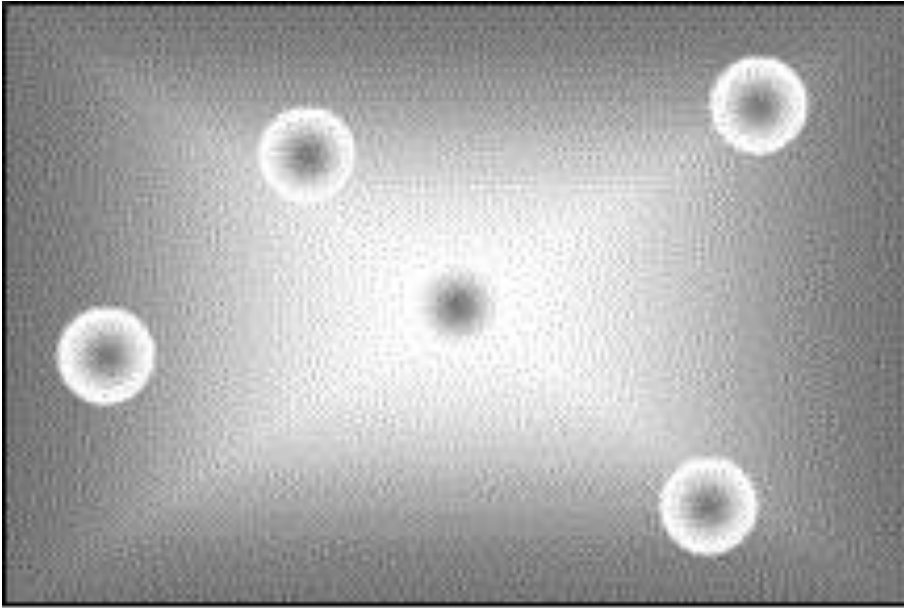

When a last sub-quanta enters in 'collision' with another, it only changes each direction as two billiard balls in a perfect collision. So, before and after, from the outside, it is as if they had passed one through the other.



However, if several meet in opposite directions, they can bounce back in new directions. The drawing is not to scale, it serves to demonstrate how 3 or more meet, so the direction taken by each may be different from the direction of origin and there is still conservation of the momentum. If this happens often and the density is very high, some special eddies form and some remain stable. The physics laws of the systems are preserved.

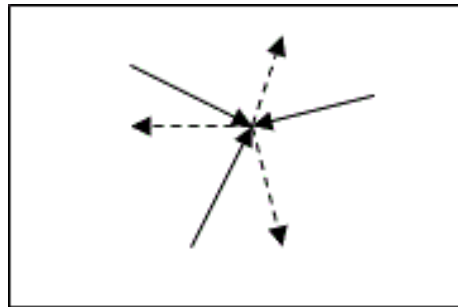

## **5. Possible explanation why light diminishes the gravitational effect.**

Fission of a uranium nucleus.

Each nucleus when it fissions also produces rays of the order of  $10^{22}$  hertz. This light is not visible. If the gravity is emitted by the nucleus and also some light at  $10^{22}$  hertz, it is possible that some emissions are without frequency like gravity that has no frequency.

What is emitted by the nuclei comes from the nucleus. How is it that the nucleus does not eventually disappear if it continually emits gravity. It is necessary to realize that it emits much but also that it receives much from space that surrounds it in various forms: light, gravity, neutrino, etc. The total amount of issuance is likely to be substantially equal to the receiving amount and the nucleus remains the same. What is emitted goes at the speed of light because light is made of what is emitted and has a frequency while gravity is the same thing but emitted continuously, without frequency.

Visible light is well known, but light used in microwave ovens is less well known. Its frequency is said to be smaller than that of visible light.

One should not consider the electrons and neutrons as small beads of matter but rather as complex systems comprising a very large number of last sub-quanta.

What is called missing matter in the universe would simply be the last sub-quanta emitted by all matter and going in all directions.

## Chapter 5

### THE UNIVERSE:

Precise and repeated experiments have shown that objects do not send gravity to other objects to attract them. Moreover, a ray of light passing between two objects increases the thrust from one object to the other. Light can act indirectly on what pushes the objects towards each other. Since the direction of light is at 90 degrees compared to the gravitational thrust, it must be concluded that the thrust comes from the outside of the objects and that light has blocked part of this thrust. This conclusion comes from vectors laws. For example, an eastbound force has no southern component.

The objects are then pushed from the outside, going towards each other.

That means gravity is not an attractive force between masses as needed to explain Big Bang.

If the Big Bang theory is not possible, how can we explain our universe?

Let us first see the atoms and the space that surrounds us. The objects around us are made of atoms. These atoms are made of small parts. Atoms are complex systems with different properties. It seems that the parts that make the atoms also complex systems made of even smaller parts. Small systems called neutrinos can be detected. They pass billions through us every second but it is rare that a neutrino touches what composes us. It is because our atoms seem empty for these neutrinos. They are so small that they pass through us without touching anything. To get a better idea why atoms are almost empty, we calculate the volume of a girl of 50 kg if the electrons of each atom were stuck on the nucleus. The person would occupy only  $1.3 \times 10^{-12} \text{ m}^3$ . In other words, it would take 1.3 million million people to occupy one cubic meter. We see that our matter is almost a perfect vacuum. It is for this reason that the neutrinos can pass through us without touching us.

An electron can be made by sending a ray of light through a sheet of thin metal. This ray of light changes into two electrons of opposite electric charge. They are called positrons and electrons. These two have similar properties but an opposite electrical charge. The positron travels quickly and as soon as it encounters another electron, they unite and become light again.

It seems then that what composes light and what makes up the electron is the same thing but organized otherwise. One can also make protons in the same way using higher frequency light, more powerful than X-rays. Protons and electrons would be made of the same thing as light ...

With your cell phone, you can send messages. These messages are transmitted from one telephone to the other by what is called radio waves. Really, these radio waves are a form of light too, but with a lower frequency. Microwaves are also light but our eyes do not see it because they are sensitive only to visible light. We do not



see the infrared, the ultra-violet, or the X-ray. Yet what composes all these frequencies of light is the same thing as that which makes up the atoms of our body.

Space in which we live is therefore not only filled with air but also with neutrino radiation and light from several frequencies. In addition space also contains what pushes objects to the ground and what drives the earth to rotate around the sun. In addition there are all the radiations that come from the sun and billions of stars. Space is not empty. What pushes objects is called gravity but it is not known exactly what it is made of. Many names were given, almost a name for each researcher. Everyone tries to guess the properties of what causes gravity. Most theories are not verified by laboratory experiments.

To date only one is verified by a series of experiments which always give the same result. Light from a laser beam blocks part of the gravitational thrust on a moving object. No physics theory predicted this possibility. If light acts on the gravitational force, it is because light and this force have something in common. A bit like electrons and visible light. Visible light is always produced by excited electrons. And this light can in turn become an electron. It is as if the electron was a complex system composed of billions of parts. All these parts of the system mean that the electron remains a stable system. It receives thousands of particles from everywhere. If it does not swell, it is either that these small parts pass through the electron without touching it, or that the system called electron ejects these parts all the time. In fact, an excited electron ejects light from a certain frequency, depending on the velocity of the electron.

So our universe is made of what?

When one observes the sky at night, one sees certain stars of our galaxy. The other luminous points outside the Milky Way are not stars but galaxies or clusters of galaxies. According to some calculations, the mass of the universe would be between  $10^{50}$  and  $10^{60}$  kg. It is known that one kilogram can contain about  $6 \times 10^{25}$  neutrons or protons. Our universe would then contain between  $10^{75}$  to  $10^{85}$  neutrons and protons. A calculation on the Internet says that an electron would contain perhaps  $10^{60}$  small parts. In all there would thus be about  $10^{104}$  last sub quanta in matter. This does not count all the last sub quanta that travel in space ...

Then, to sum up, the last sub quanta form systems called electrons, protons, neutrons; These form the atoms; The atoms form matter we see. Matter forms the stars, the planets, the parts of the universe. All last sub quantas that travel freely, without frequency would be the source of the gravitational force. Gravity is not a special force that attracts but the result of pushes coming from all over space, one no longer needs the famous theory of dark matter in the center of galaxies. This famous black matter is necessary in the theory of gravity attractive but is no longer necessary if gravity is not an attractive force.

The visible universe is limited to the light that arrives from space. If our universe has a certain age, light that comes from far away has not yet arrived at us and we can not see these distant stars. The latest discoveries say that our universe seems to extend like a swollen balloon. This means that beyond that which we see, there must also be matter that radiates in all directions, to our universe. The thrust of this radiation is not great enough to diminish the volume of our visible universe. Our galaxy seems to be moving to a place full of galaxies. However, by measuring the total mass of these galaxies, it seems that there is not enough mass at this location to explain the motion of our galaxy using the concept of gravitational attraction. If we use the concept of push effect rather than attraction, then there should be fewer stars on the opposite side to the movement of our galaxy. Each star blocks a bit of gravity and emits it radially. If at one side of the galaxy, there are fewer stars than the other side, then gravity is blocked a little less. We have even discovered a large, almost empty space on the other side as expected by our theory that gravity is not an attraction. These results are better explained by admitting that gravity is the result of contrary thrust coming from space.

No current theory predicts that gravitational force can be ***increased*** by using light. Yet this has indeed happened in the second series of experiments mentioned above.

The many examples given here really seem to indicate that the universe is made of something very small, sometimes organized into rather stable systems like atoms, stars, our earth, ourselves, sometimes in frequencies like visible light or not visible and sometimes without frequency like gravity. These can change shape, light becomes atom, atom emits light. The quantity of these small parts is so large that the human brain can not imagine it.

## CHAPTER 6

### Matter

First, let us distinguish between matter and non-matter, between what really exists and what is of the world of the imagination. What the authors of science fictions describe does not really exist but are images in the imagination. This is why the imaginary can not interact with matter because it does not exist. Humans really exist, we are not imaginary. Man belongs to the two worlds: that of matter and that of the spirit. The world of the mind is very complex but physics is not there to explain it. The only connection of physics with the world of the mind is that of the question about the origin of matter. Opinions differ on this issue. It seems that the world of matter is less perfect than the world of the spirit. It seems that matter was created and that time is a property of matter. The spirit world is outside time and matter or space because space and time are properties of matter. The material world must therefore have been made or fabricated by the spirit. This Spirit is called by the name of God in our Western world.

This means that God created matter and by doing this, time and space begin to exist. Before matter, there is no time. God, the Spirit, is outside time and space. The part of us that is spirit is imbricated in matter (our body and our morals) then our mind continues to be outside of our material body after death. In physics, we study the behaviour of matter to discover the laws that control this matter. For years, these discoveries have been deepened. We have not yet a complete theory which would explain all the phenomena connected with matter.

## Forms of matter:

It seems that matter is in several forms: we know visible matter like the fruits, the stars, our body. There is also light which is another form of matter having a constant velocity and capable of being transformed into solid matter. Solids can also be transformed by emitting visible or non-visible light. Another form of matter is felt when we fall to the ground because of the force of gravity. This gravitational field that helps to hold the moon around our planet is a form of matter because it comes from matter and also travels at the speed of light. It does not have the property named frequency because the density (or how many parts per volume) is almost constant. This density diminishes when one moves away. The farther the astronaut is from the ground, the less its gravity because the effect of the earth decreases with the square of the distance. Twice as far, the surface that receives the influence of gravity is 4 times larger, so it receives 4 times less influence and the gravity is 4 times smaller.

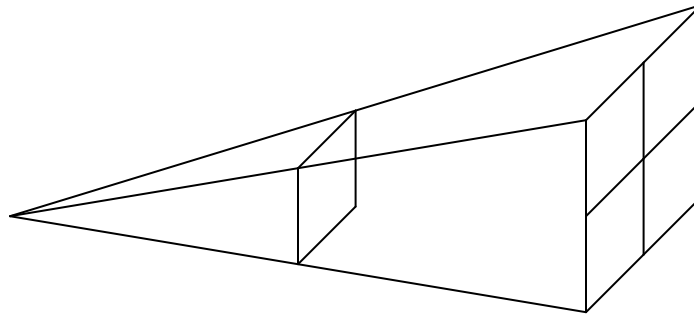

This drawing shows that as it moves away from the source to the left, the surface increases to the square. If we continue the drawing we will have 16 squares because  $4 \times 4 = 16$ .

There is also a field called electrical around an object that has an unbalanced electrical charge. This field comes from matter and also travels at the speed of light. It does not have the property named frequency because the density (or how many parts per volume) is almost constant. This density diminishes when one moves away. Twice as far, the surface that receives the influence is 4 times larger, so it receives 4 times less influence. This is why the perceived electric field also decreases with the square of the distance.

In summary, light and fields have a big difference with solid matter, liquid, gas or plasma (like the sun) because visible matter does not seem to go at the speed of light. If we could see inside this matter, these atoms, we would probably see that the parts that compose it go at the speed of light. These fast parts form complex systems called electrons, protons, neutrons, and these systems do not go at the speed of light. If we add the speed of the systems to the speed of the parts which compose them, we would probably have the speed of light. If these parts always go

at the speed of light, it is normal that once they leave the systems, they still go at the speed of light. This is why a lamp that advances and sends light, the speed of the lamp is not added to the speed of the light that leaves the lamp.

**Mass:** Because the last sub quanta are not made of anything else, they have no mass. The mass of a system would then be a property of the system and not of the last sub quanta. The mass is measured on earth in three possible ways: by a comparison of weight with an object of known mass, or by the force exerted on a spring by gravity on the object, or by what is termed the inertial mass. The last measure is indirect because one observes the interaction of the object with another object in motion and the change of movement makes it possible to calculate what is called the energy of the object. The inertial mass is then deduced there from. This mass therefore depends on two factors of the system being measured: the quantity of systems or the last sub-quanta and the internal organization of the system. A cannonball that spins quickly on itself will have a greater interaction than the one that advances without spinning. It is as if its mass was greater due to its rotation. In addition, some experiments show that a small system advancing near the speed of light acts as if it had a larger mass because of its speed. It is also because the parts of the system interact differently in the collision when it goes very quickly.

### **Emission and reception:**

In short, systems (such as atoms, stars, apples, etc.) are composed of small parts that interact with one another. The systems do not go at the speed of light but what makes them go at the speed of light.

The systems therefore emit these parts in all directions and receive them from the space that surrounds them. When they give more than they receive, they eventually emit, as when a star explodes. A balanced system emits substantially the same amount of last sub quanta it receives. We feel it by going out in the winter because we get less than we emit and our total temperature drops rapidly. Let us note that temperature is the sum total of the velocities of the parts which make up our body.

If a system emits many last sub-quanta with a certain frequency, that emission of light is called radio wave, visible light, ultraviolet, etc. This seems to be the case for the electrons around the nucleus. What is sent seems to form a spiral very close to the nucleus but in the distance it looks like circular waves as one finds on the water of a lake. This is what gives the frequency of the light wave.

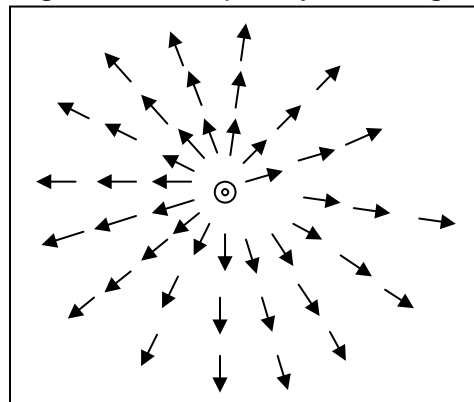

If the system transmits continuously, it is called a field. For a neutral object without electric charge therefore, it is called a gravitational field. For an object with an unbalanced electrical charge, it is called an electric field. An object in motion in this electric field perceives this field as the field coming from a magnet and is called a magnetic field although it is only an electric field. It was not possible to measure a gravitational field between the parts of an atom.

If a system emits a pulse of last sub quanta but this without frequency, one obtains solitons. These are groups of last sub quanta going at the speed of light but having no frequency. They have great difficulty interacting with matter because they have no frequency to come into resonance with the system. It seems that the neutrinos are made like that.

## CHAPTER 7 Space and time.

Imagine a single point that exists throughout the universe and nothing else. One can not say that it moves because there is no point of reference to see its movement. There is no space between this point and another because it is alone in existence. There is therefore no space or speed.

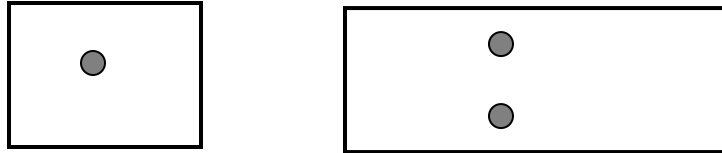

Let's put another point nearby. Automatically, there is a space between them. What we call space is not a physical reality but a concept in the mind of the thinking being who looks at these two points. For the concept of space to exist, there must be at least two points in the universe. If these two points always remain at the same distance from each other, they can not be said to have motion because they could move at the same speed in parallel line and the distance between them would not change. One can not yet speak of speed then but only of space between them. If one sees the distance between them change, then one can say that at least one moves with respect to the other. We have just had the concept of speed. Let us place a third point which also moves at the same constant velocity; We can predict the distance between them as they move away by inventing the concept of time.

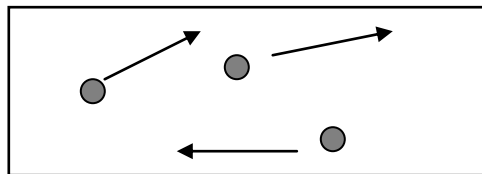

The speed equals the distance per second or per minute. Time is therefore the distance divided by the speed. If the speed is one unit per time, it is possible to exchange time by the distance because the time is therefore the distance divided by the speed. Similarly, it is sometimes said that the distance between two cities is two hours because one implies that we travel by car at a speed of about 100 km / hour. The distance between the stars is also measured in light years. The light year is a time that corresponds to the distance traveled by light in a year. Time is only a concept, an idea that makes it possible to predict the distance between moving objects. Time has no existence as such, and outside of the physical universe one can not speak of it. For the world of the spirit, there is no time as we understand it on earth.

Our physical space has three-dimensional concept: top, front and side. If an object moves in this space the concept of time appears but time does not exist as such. When we say that time is a fourth dimension, it is only a mathematical concept and it has no existence in itself. In mathematics, one can make equations and calculations with more than three dimensions. What we call the exponent as  $43 \text{ meters}^3$  represents three dimensions.  $43 \text{ meter}^2$  represent two dimensions.  $43 \text{ meters}^5$  represent five dimensions. Similarly, a mathematical equation with two unknowns,  $x$  and  $y$ , for example, can be represented by Cartesian two-dimensional coordinates. The unknowns  $x$  and  $y$  are parameters of the equation. One can have several parameters that affect the response. Ten parameters can then be seen as ten dimensions even if ten physical dimensions do not exist.



## Chapter 8

### IS LIGHT A WAVE OR A PARTICLE?

Because light has a property of frequency and distance between layers of light, one is tempted to compare it to physical waves such as sound. But sound is only a movement of particles in the air which propagates with a certain speed. The hotter the air, the faster the air molecules go and the faster the sound is propagated. Without air, there is nothing to propagate sound. Light is not propagated by something like sound; it advances in the void between stars.

Some people have suggested that an invisible substance was everywhere in a vacuum and that light would be a wave propagated by this substance. When a wave advances in a substance each part must move and strike the neighbour to propagate the movement. The stiffer the substance, the faster the movement. The sound travels faster in water than in air and faster in steel than in rubber. To have a velocity of 300,000,000 meters per second, the vacuum should be made of a substance much harder than steel ... And yet we are advancing in space on earth without effort, surely not in a substance harder than steel. Light that goes at 300,000,000 meters per second therefore does not seem to be a wave transmitted by a substance but something that advances directly at this speed, having a density that varies according to its frequency.

Since light has a velocity and a frequency, we can speak of the wavelength by analogy because we know that light is not a wave like sound. Light would be rather made of a series of layers, the density of which varies in space; this density is caused by what is sent by an electrically charged object that moves at a certain frequency. When the electrically charged object does not move, it is said that there is a stable electric field around and one can detect the presence of this field. When it moves back and forth at a certain frequency, this is called light because the density varies continuously.

**The photon:** It is said that light sometimes acts as a wave and sometimes as a particle, in the case of the photoelectric effect. It is then said that light is a photon.

To know that there is light, a sensitive sensor is needed which reacts in the presence of light. If the light is very weak, a very sensitive detector is required and if light becomes even weaker, nothing can detect it. It seems that what is called a photon is the smallest amount of detectable light. For example, if you have a laser beam that strikes a blank page and you see a red dot on the page and the light beam is cut quickly, the dot appears and disappears on the page. If you cut the light ray to measure one meter long, the point is visible. If this ray is shortened more and more, at a certain length, the point no longer appears because the atoms of the paper can not react enough to emit red light. This does not mean that there is

nothing striking the paper but the amount is not sufficient to excite the receiving atoms. The photon would then be the minimum amount to be able to detect light.

When two rays of light of the same frequency meet on a surface, they seem to be destroyed as if the light disappeared. What happens is that the density at this point becomes constant and the detector no longer feels any frequency. It no longer detects this change associated with frequency. There is no more resonance and therefore it seems that there is no more light. The best comparison is the encounter of two waves on the water where the hollow meets the top of the wave and the water at this place seems calm. The water does not disappear but no longer has the frequency of the wave.

The intensity of light represented by a curve.

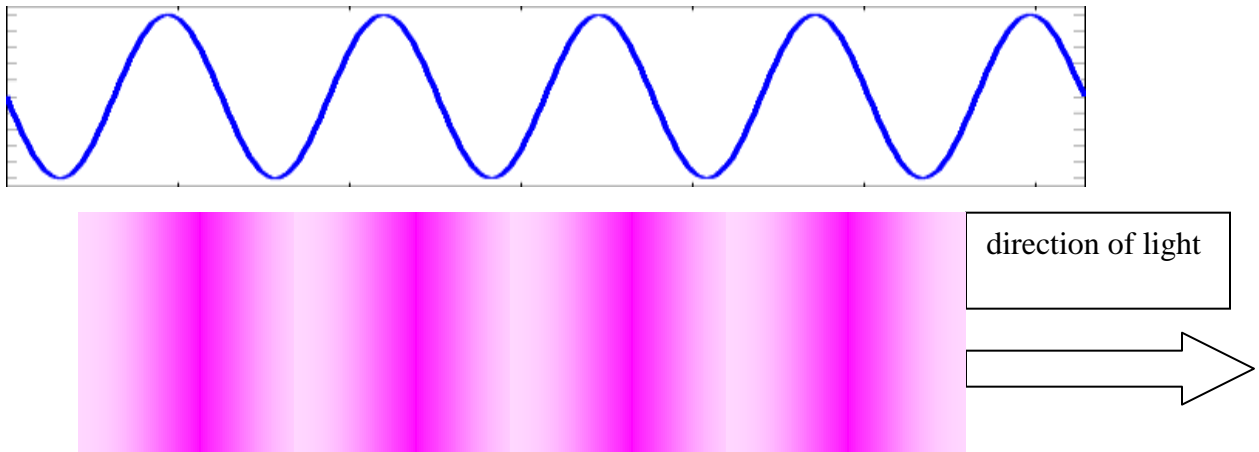

Two lights superimposed so as to have a constant intensity. A detector can 'feel' that there is light and the detector remains off.

Thus, light is neither a particle in the sense of the electron or the proton, nor a wave like sound but the effect of electric charges which have a frequency and which spread in space at the speed of light, for it is light.

## Chapter 9

### GRAVITY HAS AN EFFECT OF A PUSHING FORCE

Gravity that acts on an object does not push the object like a billiard ball that strikes another. Gravity that penetrates the nucleons becomes part of the nuclear system and the whole system is reorganized a little further.

The following drawings attempt to visualize what happens in a proton going east in space. The proton is seen as a stable and balanced complex system made of billions of last sub quanta whose total velocity is always that of light. This is true if we add the internal velocity in the proton with the velocity of the proton in space.

Space is filled with the last sub quanta going in all directions at the speed of light.

The drawing demonstrates an eastward proton in a space that has on average as much of the last sub quanta coming from all directions.

The second group demonstrates an eastward proton in a space that has more sub quanta coming from the west (left side of the drawing)

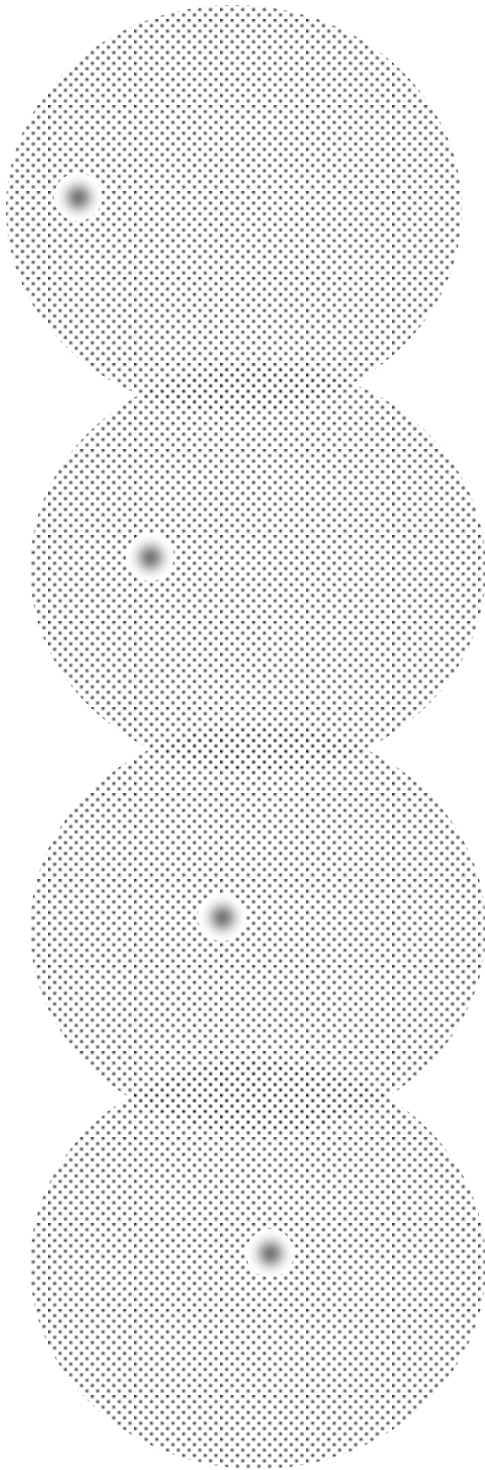

The middle spot on the left represents a proton. The small dots around represent many last sub quanta going in all directions in space. This proton is a complex balanced system made of billions of last sub quanta that interact with each other and with the medium in space full of last sub quanta. A proton goes east into space. It receives last sub quanta coming from all sides; These receptions are equal on average on each side. This system is stable and continually rebuilt and this gives the impression of an object going east. Its direction remains the same and it is always reorganized to the right, keeping on average the same number of last sub quanta in it. There are as many that are emitted as the number that penetrates and are integrated into the proton system.

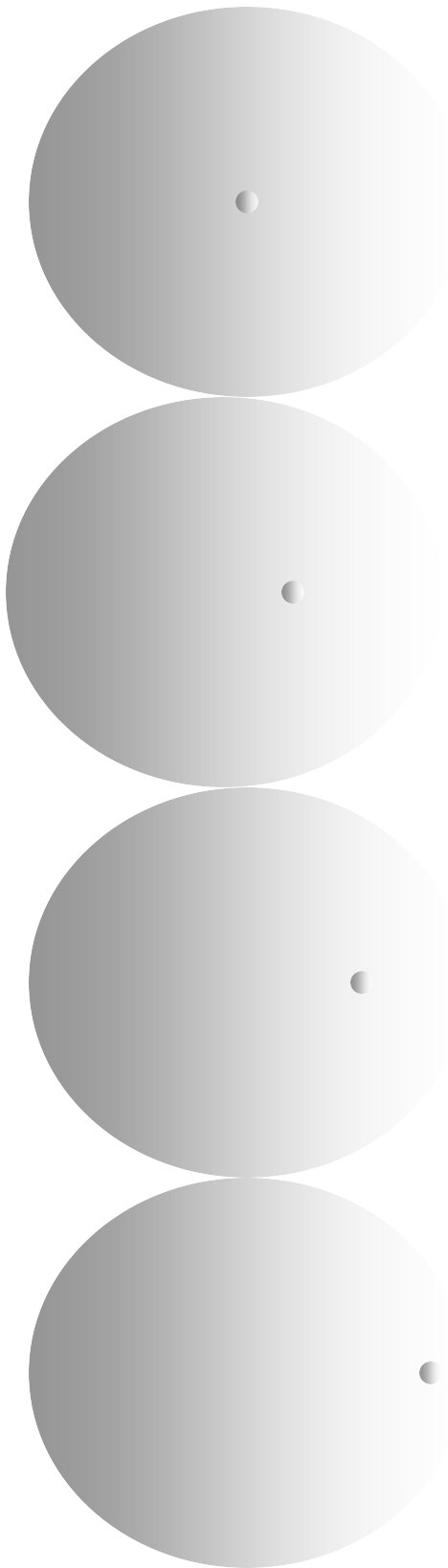

A proton goes east into space. It receives last sub quanta coming from all sides but these receptions are bigger coming from the west. This is represented by a darker coloration to the west. When many last sub quanta penetrate into the proton, there is now in the proton more last sub-quanta going towards the east. The total sum of vectors to the east is now larger. Its direction remains the same and it is always reorganized to the right, keeping on average the same number of last sub quanta in it. This constant reorganization means that the speed of the proton system is now greater towards the east. For an external observer, it seems that the last sub quanta coming from the west exerted a push on the proton. In reality there is no push but an internal reorganization which means that the total speed of the proton system has changed because the number of vectors of the last sub-quanta going east has increased. Gravity acts in the same way by reorganizing the nucleons that are always in motion with respect to space. It is not a push or an attraction but a change in the nucleon systems. There is therefore no increase in temperature as Feynman had foreseen,

## Chapter 10

### Attraction by repulsion

This title seems strange. But sometimes what seems to be an attraction is often an external push that causes objects to move towards each other as if they were attracted. We must really observe what happens when the velocity of an object is changed by an external force. Is it an attraction or a repulsion?

We affirm here a strange assertion: the real attraction in physics does not exist: it is always a phenomenon of pushing force coming from the outside.

#### **Gravity:**

For years, traditional teaching said that the masses were attracted by gravity and that the larger the mass, the greater the force of attraction. As the distance between the masses increases, the force decreases. This comes from Newton's formula which says that the force of gravity = a constant  $G$  x mass x mass divided by the distance to the square.

This can be checked in the laboratory easily. Yet nothing in the formula indicates that force is an attraction or a push. Newton himself did not believe it was an attraction but he could not prove it so he makes no assumption about the nature of this force.

The numerous results of experiments show that light can reduce the gravity of an object placed under the light and increase the gravity if the object is placed above the light. When one does this experiment, one does not change the quantity of mass of the object or the mass of the earth. Yet force varies and this is not in Newton's formula. Several scientists have tried to explain these results in different ways. Some theories must invent new unverifiable things. This resembles the scientific explanations of the Middle Ages with much magic and sorcery.

The only theory that is logical is this: throughout the universe, atoms receive and send something very small in all directions. When there is no frequency of emissions, this is called a field, as Maxwell said. However, the description of this field varies according to the scientist who explains it. It is said that this field is everywhere in the universe instantly because it is only a possibility that a detector can detect that the source emits something. A detector placed at one meter is activated at the same time as a detector placed at 15 light years. According to this theory, there is not something really emitted by the source because it would have to go at infinite speed and we do not like infinities. So the field is not a physical reality but rather a mathematical concept useful for calculations.

But in reality, there is something emitted by all objects and it seems that it is at the speed of light.

In summary, our experiments demonstrate that objects emit something in all directions. Then space in the universe would be filled with that going in all directions. We already know that space is filled with light and neutrino coming from all the stars. Nothing contradicts that there is also something smaller and without frequency that fills the space. Our theory asserts that space is filled with these little things going at the speed of light in all directions. In this text, I named it the last sub quanta or simply the quanta. With this assertion, it is now possible to demonstrate that attraction is really a kind of push.

When many of these ultimate small quanta advance in disorder, without a frequency being detected, this is called the field, a little different from the Maxwell field, for it is real. When many of these ultimate small quantas advance and a frequency is detected, this is called light. If the frequency is around  $10^{14}$  hertz, this light is in the visible region. When a large number of these last small quantas advance in a stable group, they are called neutrinos. If these groups have an internal structure organized as a stable system, this is called electrons and protons. The other groups are unstable and always end up partly mentioned above.

This effect can be seen in our solar system and also at the level of atoms such as hydrogen. The following drawings demonstrate an area around the sun and as the thrust in this area is almost equal on each side, an object becomes a sun satellite.

Here is a drawing that gives us a better idea how the last sub quanta are in space. You can see the animation on You Tube under the name of **dsq de Louis**

or go directly to <https://youtu.be/FMnQQqKjqUO>

Each small point represents a quanta going at the speed of light. Each quanta can change direction if it encounters another quanta. Here, there is no area that shows a frequency.

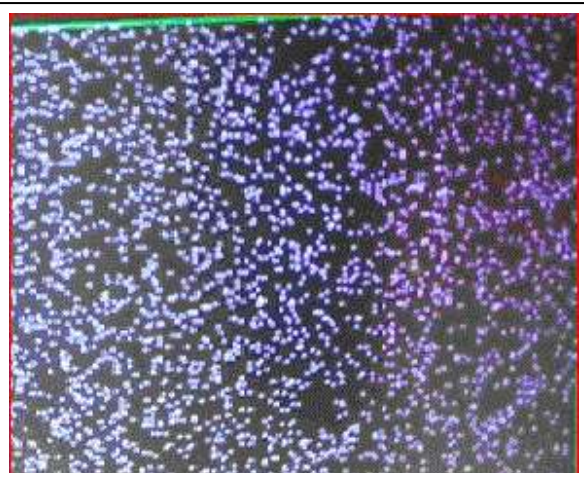

The sun blocks some of the emissions coming from all directions of space. Because of this blockage, there is a spherical area around the sun where there is a smaller density. At a certain distance, this effect is almost zero and the density resembles the average. In the drawing, each gray pixel represents a quanta going at the speed of light. The lighter area represents the places where the sun blocked emissions from the other side.

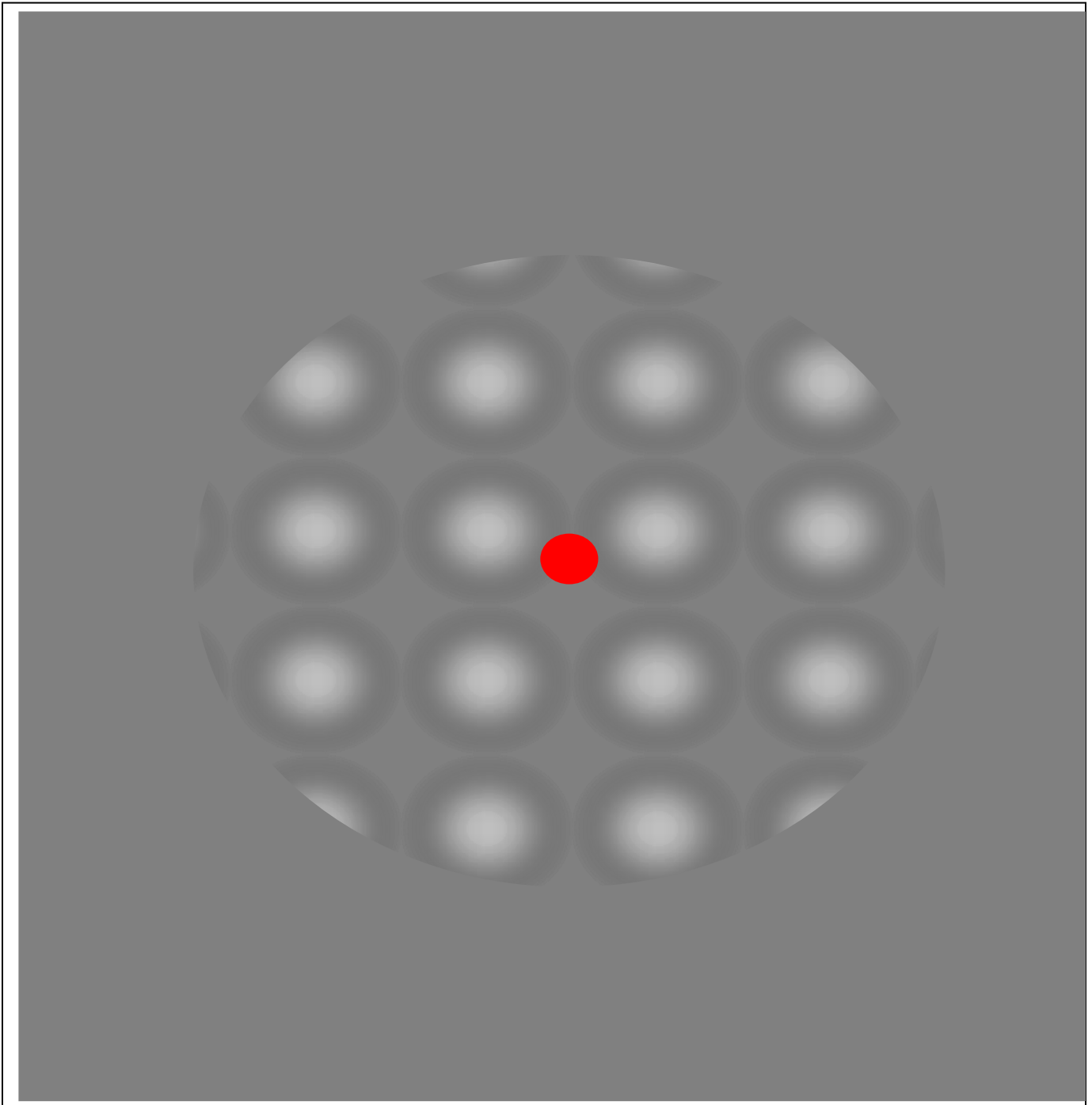



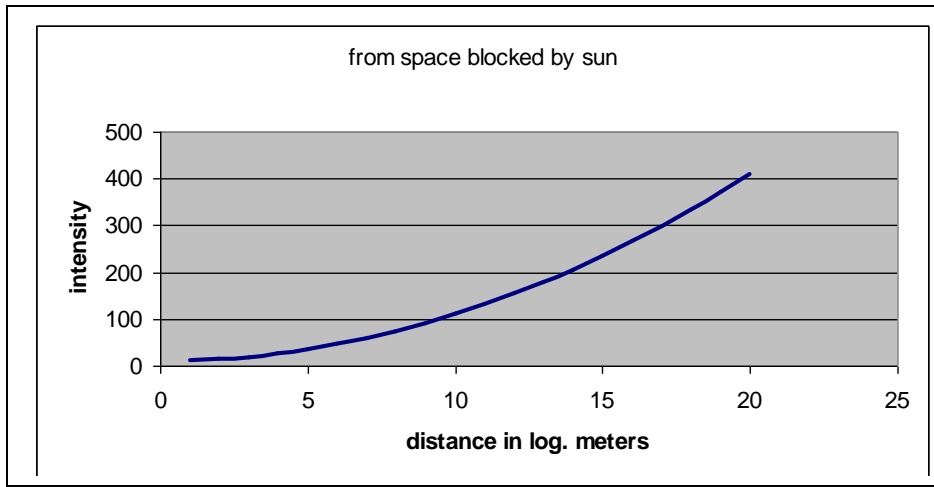

However, the sun also emits in all directions. The density of these emissions decreases with the square of the distance. This force is pushing objects away from the sun.

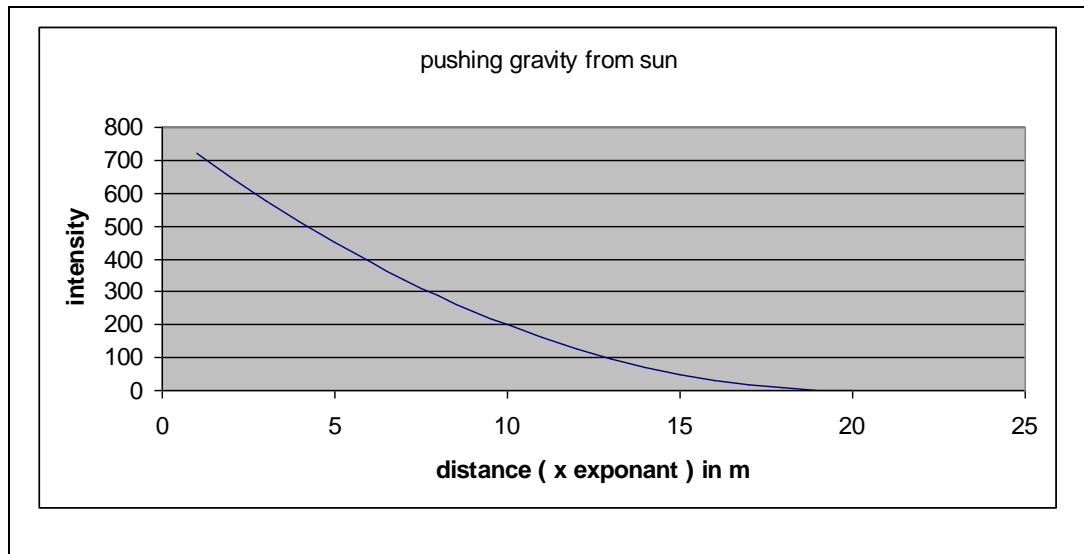
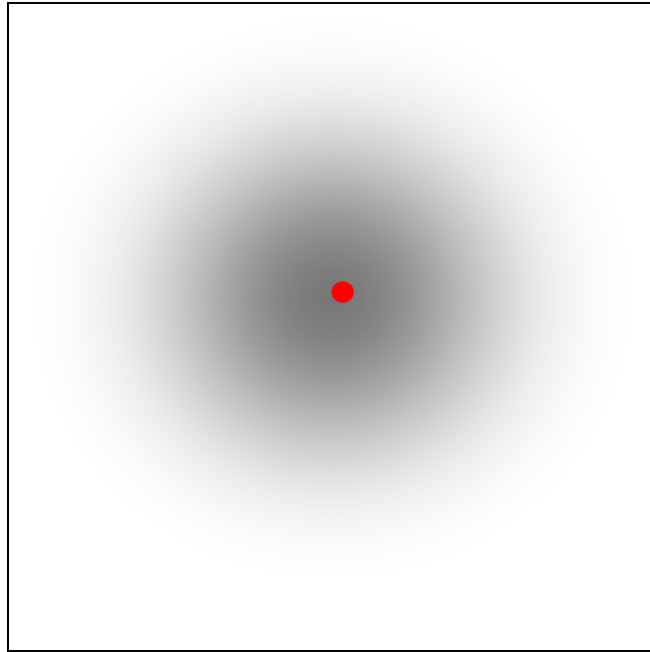

The sun receives a lot from space but also emits a lot and its mass remains almost constant. The total forces pushing objects toward the sun is indicated by the brown line.

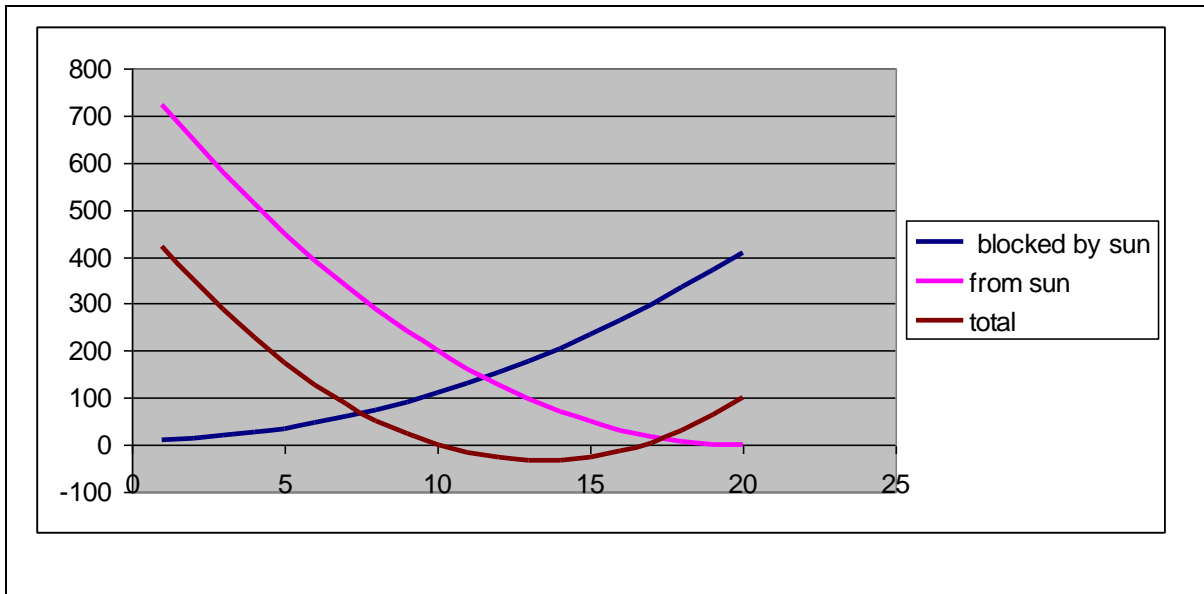

caused by the absorption of the sun, we obtain this: at a certain distance from the sun, we have a spherical zone where the density on each side is the same. An object in that region is not pushed on either side. It continues in a straight line. This trajectory pushes the object a little outside this place and it is now pushed towards the sun. In this area, a moving object (like the earth) becomes satellite of the sun because it is also pushed away from the sun and towards the sun. The two thrusts are equal. Depending on the speed of the object and its mass, it is in equilibrium at a certain distance from the sun. The small objects are currently in the asteroid belt that circulates around the sun. . Very close to the sun, the density is greater than the average. This is what causes a comet that approaches the sun to be pushed back by these high density regions.

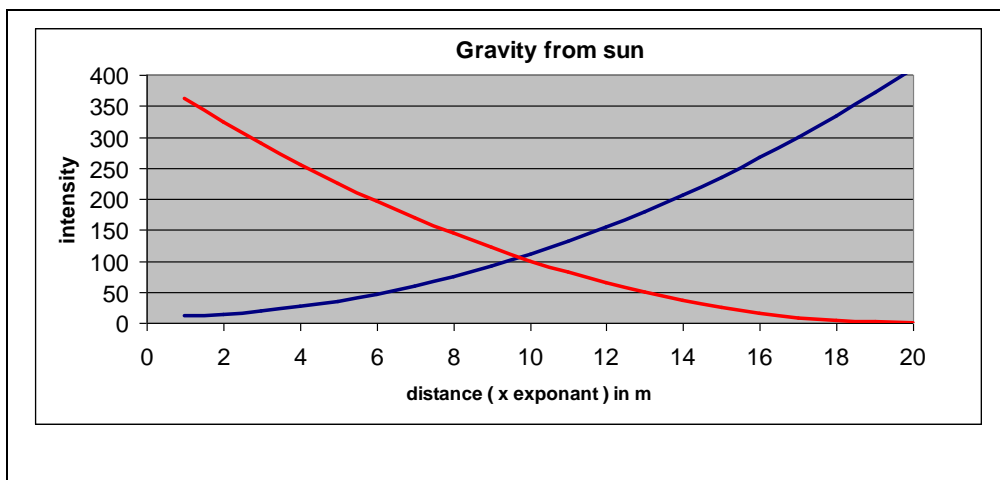
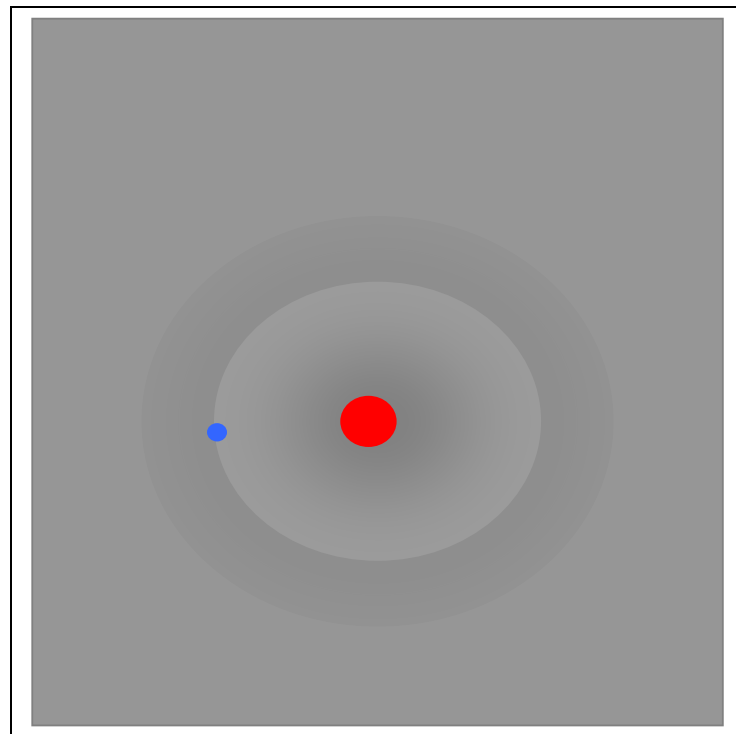

This effect occurs when the transmitter emits radially and the quanta coming from all directions go in all directions. This probably also happens at the atomic level. The proton having a mass of almost 2000 times the mass of the electron acts almost like the previous drawing. The electron of the hydrogen atom circulates in the zone where the thrust caused by the emissions of the proton is almost equal to the thrust of the quanta coming from space.

### **Interactions of quantas with matter.**

A quick calculation gives the ratio of the cross-section of the nucleus of an atom to that of the atom gives about 1 in 10,000,000.

This means that about 1 neutrino on  $10^7$  has a chance to hit a nucleus. Since they are neutral, the effect is minimal. If a last sub quanta is smaller than a neutrino, then how do they interact with a nucleus? To understand it, one must go down to the very small level of the nucleus and not compare to the macroscopic level, our level. The proton and the neutron are not steel balls that can be pushed by throwing another ball on it like billiards. They are complex systems, resembling clouds rather than a ball. The parts which compose them travel at the speed of light and interact in the nucleon. Since there is no hard surface to reflect, when a quanta reaches the outward surface, it continues in space. If the nucleon did not receive as much as it lost, it would disappear. We know that the proton is stable, it does not disappear. So it must on average receive as much as it emits.

It is also necessary to visualize that what goes into space in all directions means that the effects are not caused by a single interaction but by the difference of opposite interactions if the quantity on one side is different from the other. If the quantities are on average equal, the effect is canceled as two equal and opposite vectors cancel each other out.

It is fair to say that gravity does not push and attract but changes the direction of the movement of the nucleons of an object with respect to space by becoming part of the nucleons and interacting with the parts of the nucleons.

## Chapter 11

### What happens when we reduce gravity.

A cylinder of one kg is placed on a table. If it is at the equator, this location goes east at about 340 m/s as the earth makes a turn every 24 hours. In 24 hours, at this speed, the object will have traveled around the earth and will have returned almost to the same place. The drawing shows this object suspended from an elastic band. Because of gravity, the object has a weight of 9.8 Newtons. This force stretches the elastic band downward and the elastic must exert a force of 9.8 N upward. Thus, the object remains at the same height above the table. In this example it is 10 cm from the surface of the support.

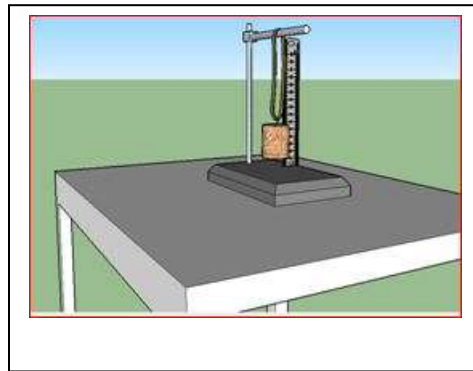

The speed of the object is always 340 m/s towards the east because the earth rotates. If no force was exerted down, on the mass, it would have continued in a straight line. The following drawing which is not to scale shows that the object would be away from the surface of the table and would be in space after a few minutes.

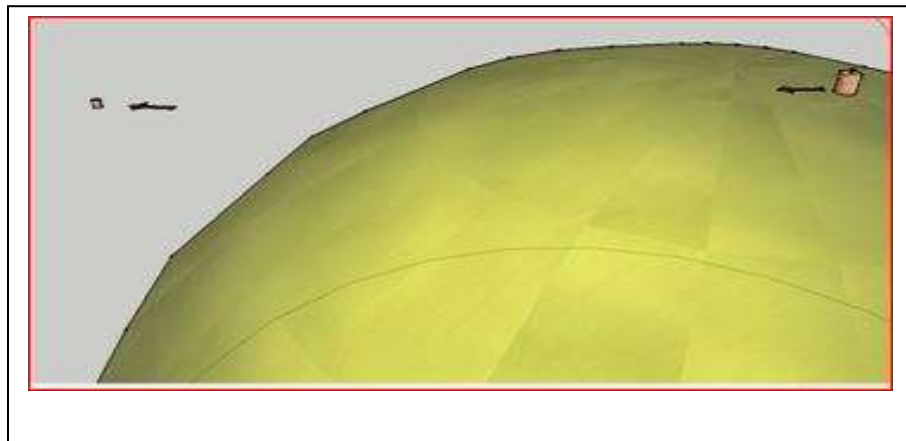

If the object after one second has traveled 340 m in space and is still above the table, it is because it has two directions in its speed. A horizontal direction that has a value of 340 m / s and the other vertical which has a value of about 5m / s. In physics this is demonstrated by arrows called vectors.



The arrow that is angled downwards is called the resulting speed when the two speeds are added together. The large arrow to the east represents the speed of 340 m / s and the down arrow represents the speed of 5 m / s. This drawing is not to scale because we would not see the small arrow down.

If one sends a lot of light horizontally above the object, its gravity decreases and the force of the elastic returns it a little higher, towards 20 cm. This means that the downward velocity vector has decreased a little and the other vector has a smaller angle.

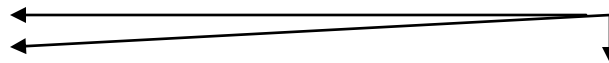

We continue to send light above and gravity decreases. The object is now 30 cm from the table, then at 40 cm and finally at 50 cm. It does not rise higher because it is in a state of levitation. Its final speed vector makes it float above the table and the elastic could be removed as it exerts no more force upwards. It is said that the object is in orbit above the earth or is geostationary.

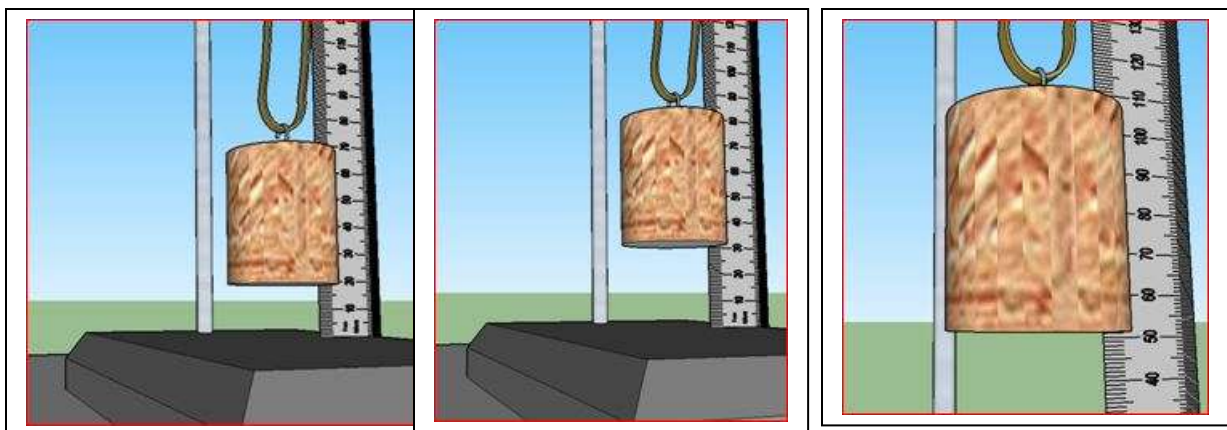

Really what happens when one decreases the force of gravity down on an object, it changes the direction of the object in space and becomes geostationary like the high satellites in space.

When the light source is closed, the downward force changes the angle of the resulting velocity and the original weight returns slowly.

If the light is left above the object longer, the force of gravity coming from below will lift the object and it will stick to the ceiling. Its speed vector points a little upwards. The light can be shut off and the object will remain up. It goes down only when the speed vector points down. The fact that the object remains in levitation state after the light is shut off proves the space time curvature theory is wrong.

## Chapter 12

### The beginning of the universe

If the Big Bang theory is not possible, how did our universe appear? A simple answer is possible if we admit the existence of the last sub quanta which are the basis of our matter, of light, electricity, gravity and other physical phenomena.

#### **FACTS:**

We know that matter is made of electrons, protons and neutrons and that these can be produced in the lab with high-frequency light.

We know that all frequencies of light are really successive layers of billions of quantas emitted by a source.

We know that in the stars the atoms of helium are produced by the fusion of smaller atoms, and that the larger atoms are also made by the fusion of smaller atoms.

We see in the universe clusters of hydrogen that gather and make stars.

#### **SO**

It is easy to predict that by having an immense amount of quantas going at the speed of light they can interact with each other. Air molecules are often seen to set in motion and form small or very large vortices such as cyclones.

In a similar way, the very large number of quanta that interact with each other sometimes form more or less stable groups. A group called electron and a group named proton seems to be so stable that we do not know what their half-life is. This is because they interact with what comes from space by using these quantas and integrating them into their system. They remain stable because they emit on average as much as they receive. These systems are grouped to form the other atoms and thus all the known material is manufactured. In addition the emissions of these systems are at the origin of what we call gravitational field and electric field as well as the fields having a frequency that we call electromagnetic wave or simply light. The formation of these systems is continuous in space and observed by the telescope. As the speed light is slow compared to the size of the universe, only one section of the universe can be seen. The quanta that arrive from everywhere often come from outside of what is known to our universe.

You can also see the other two videos.

<https://www.youtube.com/watch?v=BY1hvSLuO3A&feature=youtu.be#t=157.970222>

<https://www.youtube.com/watch?v=ecYS0NUZet4&t=3s>



## Appendix:

### A detector that is sensitive to static electricity.

Uses a CMOS 4000 chip dual 3-input NOR gate and inverter and makes this circuit. When the detector is near an object with excess electron, the green LED lights up. Red LED will light up when it is near an object that has lost electrons. Both light up when the object is neutral. The resistors are 320 and 1200 ohms. This circuit was mistakenly discovered by a student and it works very well.

I used this chip: HEF4000BPB

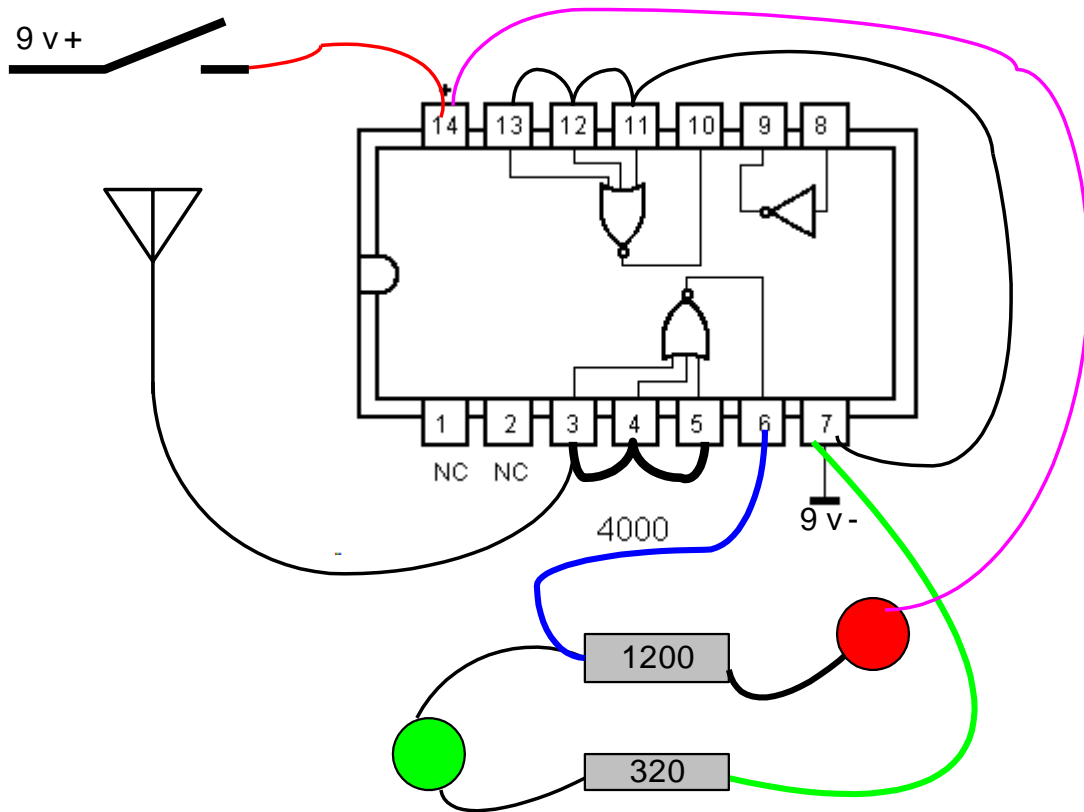

This book is a vulgarization of the discoveries that led to the development of the theory of the last sub quanta. These sub quanta would be what makes up atoms, light, electric field, gravity, in short, our universe.

I could quote many references that support this document and also many that prove that this is not possible. I therefore only quote my findings and each one has to decide.

Scientific reports can be found at:

Effect of light on gravitational attraction

Article in Physics Essays 24 (4): 557- • December 2011

DOI: 10.4006 / 1.3653936

And Applied Physics Research; Flight. 7, No. 4; 2015,

[Further Experiments Demonstrating the Effect of Light on Gravitation](#)

Louis Rancourt, Philip J. Tattersall