

Contents [page]: Spheroid theory of everything: Charges [1], Nuclei [3], Magnets [6], Light [30], Gravity [80], Mathematical Proofs [91], Rules [106], List of properties [108], Particles [112]

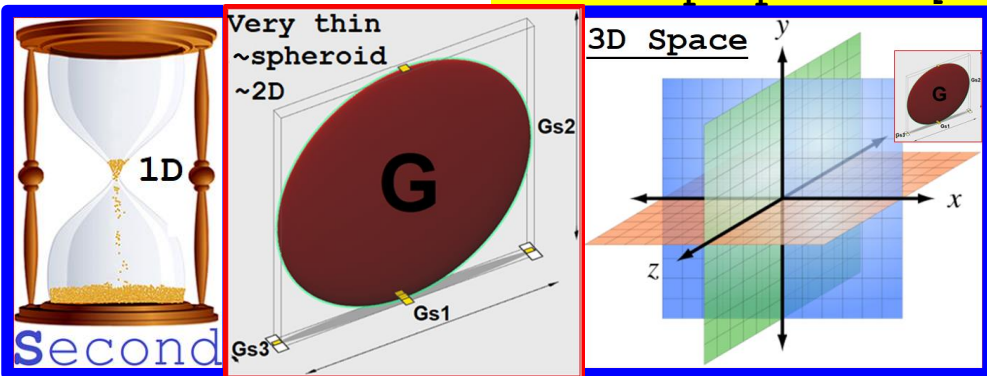

**Postulates:**

**Time**=the quantity of seconds that pass (1D quantity).

**G particle**=G=an almost perfectly smooth very thin spheroid (~2D).

**Space**=The quantity of G particle's diameter ( $Gs1=Gs2$ ) in every direction (3D)

Spheroid theory of everything (by Guy Abitbol):

The universe is just space filled with G particles that are oriented, translated, rotated & clustered in specific ways; Its true because if we assume so, we can derive/explain all properties of the universe as follow:

- If an individual G particle doesn't rotate we will call it G; G can translate with any  $v$ , orient in any direction & it's the most common particle in space;

Charges:

- If a cluster of  $\sim 10^{24}$  G's (standing very close, see picture) rotates (together) mainly (mean also most powerfully) about its y axis ( $\omega(2)$ ) we call it electron (e);

- If this e rotates mainly in opposite direction we call it positron ( $e^+$ )

- If G rotates mainly in the direction of  $e^+$  & translate we call it  $Ge$ ;

- If G rotates mainly in the direction of e & translate we call it  $Ge^+$ ;

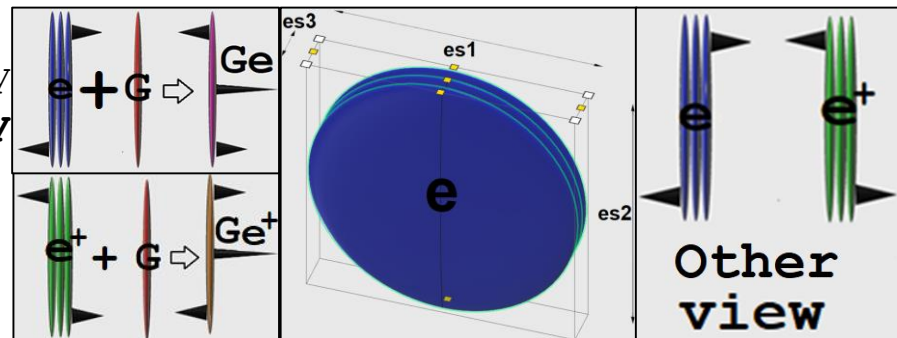

**Rule 1: Electric field generation:** If e collide with G (G particles fly in space with every orientation & every velocity) it will transform the G mainly (usually & most powerfully) into  $Ge$  (see rule 1 proof); By symmetry  $e^+$  will transform any colliding G mainly into  $Ge^+$  particle; We call  $Ge$  &  $Ge^+$  electric field.

**Rule 2: Attraction:** If  $Ge^+$  collide with  $e$  particle it will usually attract it; (see rule 2 proof){by symmetry  $Ge$  colliding with  $e^+$  usually attract it}

**Rule 3: Repulsion:** If  $Ge$  collide with  $e$  it will usually repel it; (see rule 3 proof) {by symmetry  $Ge^+$  particle colliding with  $e^+$  usually repel it}

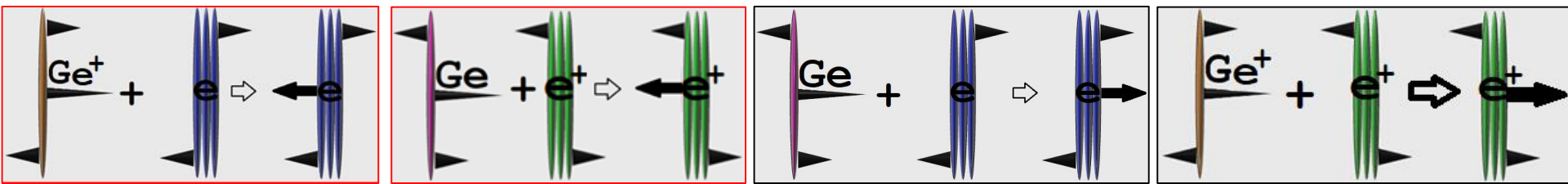

- All particles can translate but only G particle can orient in any direction;
- So,  $e^+$  &  $e$  attract each other; and  $e^+$  &  $e^+$  or  $e$  &  $e$  repel each other; {This is true no matter what position these particles take in space because G particles translate in every direction & orientation and fill up most space}
- Thus, the angular velocity ( $\omega(2)$ ) of  $e^+$  &  $e$  particle is what we call charge. {same as temperature is translational velocity}.

**Property 1:** Electric force on  $q_1 = Fe_1 = (c^2 * 10^{-7} * q_1 * q_2 * r_{21}) / |r_{21}|^3$ .  $c = \text{speed of light} = 299,792,458 \text{ [m/s]}$ ; { $q_1 \& q_2 = \text{non overlapping spheres stationary with respect to each other}$ }  $q = \text{charge [C]}$ ; **Explanation 1:** The description of charge as  $\omega(2)$  of  $e^+$  &  $e$  particles &  $Ge^+$  &  $Ge$  as intermediate particles explain why the force reduce with distance by  $1/|r|^2$ ; its because  $Ge^+$  &  $Ge$  spread out in 3D (sphere surface =  $4 * \pi * |r|^2$ );  $q = \text{indicate number of } e^+ \text{ or } e \text{ particles}$ ; (the more  $e$  particles the more  $Ge$  & more attraction or repulsion);

**Video 1**

Only collisions that create high speed rotating G's are important

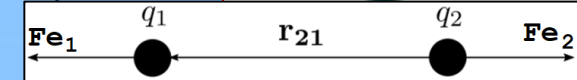
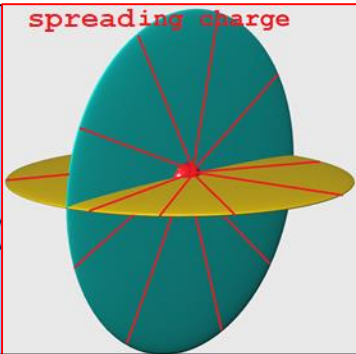
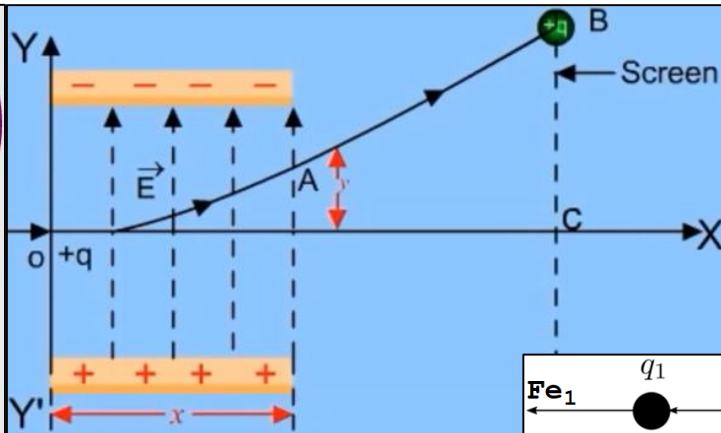
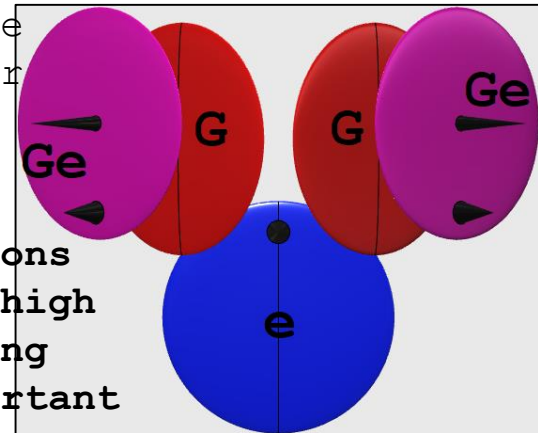

## Nuclei:

- **Proton creation:** If  $e^+$  collide with another  $e^+$  at their edges they can **combine** (by inserted a little into each other) **to create a non stable form** (Intermediate axis rotation is not stable, see Mathematical proofs or my collision truths book) **that over time & collision with G particles transform into a stable form & finally after more collisions like this p particle is formed** (so, p is a cluster of  $\sim 1836 e^+$ ). **p size along its y axis is  $\sim 1000 \cdot es1$** ; where  $es1$  is  $e$  size along its x axis; **p size along x is  $es1$  & p size along its z axis is  $es3$** ; **Because Angular momentum(L) is conserved** (it's not a law of nature, but a truth that can be derive from the definition of space & time, see my collision truths book) **if:  $e^+L=L$  of  $e^+$ ; &  $pL=L$  of p;  $1836 \cdot e^+L=pL$ ; and thus  $p\omega(2)=\omega(2)$  of  $p=-e\omega(2)=-\omega(2)$  of  $e$ ;  $\{e^+L=e^+I \cdot e^+\omega = [e^+I1, 0, 0; 0, e^+I2, 0; 0, 0, e^+I3] \cdot e^+\omega = eI1 \cdot e\omega(1) - eI1 \cdot e\omega(2) + eI3 \cdot e\omega(3) = -eI1 \cdot e\omega(2) = -em \cdot (Gs1^2 + es3^2) / 5 \cdot e\omega(2)$ ;  $pL=pm \cdot (Gs1^2 + es3^2) / 5 \cdot p\omega(2)$ ;  $pm = \text{mass of } p = 1836 \cdot em (\text{mass of } e)\}$ ;**
- **p will transform any colliding G mainly into Gp particle ( $Gp = Ge^+$ );**
- **p&e attract each other; p&p repel each other** (see proof of rule 1,2,3);
- **Because  $e, e^+, Ge, Ge^+, Gp$  have axis of symmetry & because p don't rotate on its intermediate axis, the L of these particles will preserve, while they translate & they will have a periodic motion; and because their main  $\omega$  component is so huge, there will be need a huge force to completely change the direction of their L;**

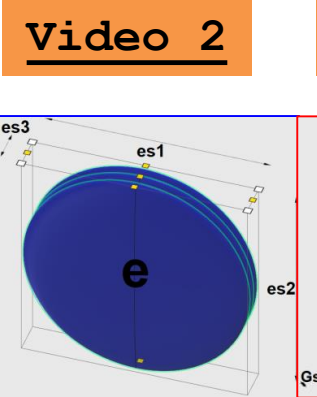
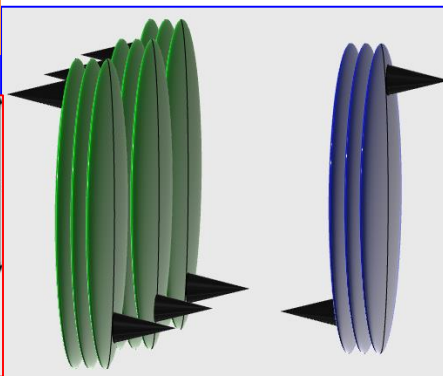
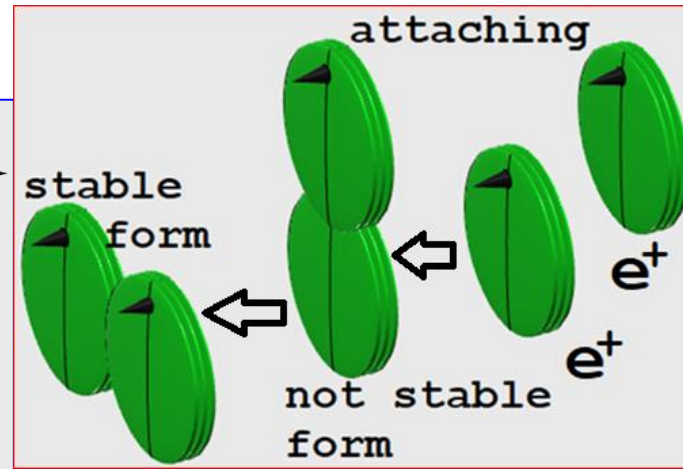
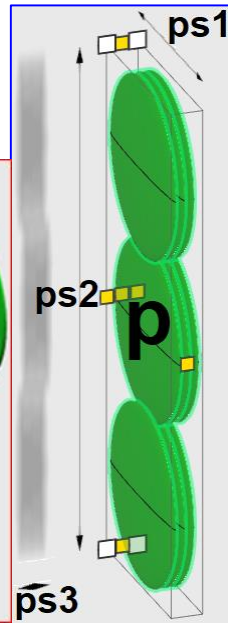

Video 3

Video 2

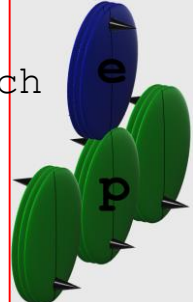

**Property 2:** electron captured; **Explanation 2:** If p particle collide with e particle at their edges they can combine (by inserted a little into each other) to create non stable form (Intermediate axis rotation isn't stable see mathematical proofs) that over time & collision with G particles transform into a stable form that we call neutron (n); n has  $\omega(2)=0$ ; {during this collision some G's brake out & we call them neutrino};

**Property 3:** Beta emission: n particle in the nucleus can emit electron (beta-decay) & transform into proton (L preserved) while emitting also antineutrino.

**Explanation 3:** If neutron slide in the nucleus it may be collided with the nucleus & a part of it (electron) is released (e particle has same  $\omega$  direction like Gp), now in order to preserve L, n began to contribute to the  $\omega$  of the nucleus and effectively transformed into p particle, the released antineutrino is just another G that brake out from the neutron during this process.

- Last 2 processes that change p to n or n to p are what we call weak forces;

**Property 4:** nuclear fusion; **Explanation 4:** If p particle collide with another p at their edges they can combine (by inserted a little into each other) to create what we call Deuteron (contain 1 p & 1 n) {during this process 1 positron & 1 G(v) brake out}; If p particle collide with deuteron at their edges they can combine to create He<sup>3</sup> (contain 2 p & 1 n) If 2 He<sup>3</sup> collide at their edges they can combine & then brake up into 2 p & He (contain 2 p & 2 n); He also called  $\alpha$  particle; & we call this process nuclear fusion (it happened in the sun);

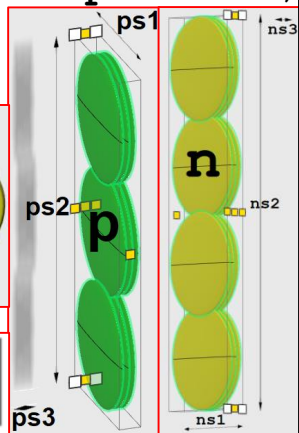
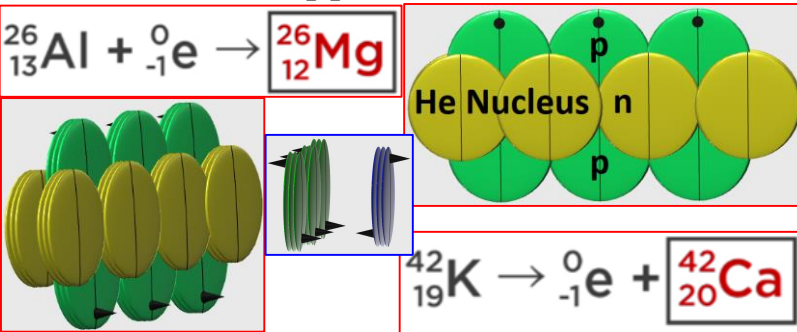

**NUCLEAR FUSION in the sun**

${}^1_1\text{H}$	+	${}^1_1\text{H}$	$\rightarrow$	${}^2_1\text{H}$	+	${}^0_{+1}\text{e}$	+	${}^0_0\text{V}$
${}^1_1\text{H}$	+	${}^1_1\text{H}$	$\rightarrow$	${}^2_1\text{H}$	+	${}^0_{+1}\text{e}$	+	${}^0_0\text{V}$
${}^2_1\text{H}$	+	${}^1_1\text{H}$	$\rightarrow$	${}^3_2\text{He}$				
${}^2_1\text{H}$	+	${}^1_1\text{H}$	$\rightarrow$	${}^3_2\text{He}$				
${}^3_2\text{He}$	+	${}^3_2\text{He}$	$\rightarrow$	${}^4_2\text{He}$	+	$2\ {}^1_1\text{H}$		

$4\ {}^1_1\text{H} \rightarrow {}^4_2\text{He} + 2\ {}^0_{+1}\text{e} + 2\ {}^0_0\text{V} + Q(\text{energy})$

starting mass of four protons =  $4 \times 1.0078 = 4.0312$  amu

final mass of Helium nucleus =  $4.002604 - 2 \times m_e = 4.001506$  amu

$\therefore$  Loss of mass =  $4.0312 - 4.001506 = 0.0297$  amu.



- This little insertion of particles into each other & their mutual rotation is what hold them together and what we call the strong force (in order to explain how same charged particles hold together in tiny place).

**Property 5:** Alpha emission & spontaneous fission; **Explanation 5:** if the nucleus is too big a whole He particle (or even bigger part for fission) can slide out or brake as a result of collision with many unphase Ge's due to unstable rotation (due to rotation about intermediate axis);

**Property 6:** positron emission; **Explanation 6:** If a part ( $e^+$ ) of proton in the nucleus is released (e.g. by slipping) the proton  $\omega$  will become zero to preserve L, so it is effectively transformed into n particle, during this process G particle (neutrino) brake out;

**Property 7:** The more protons the atom has (until 26 protons), the more difficult is to pull proton away from the atom. **Explanation 7:** The more p's, the nucleus is more massive and will resist collision better, but when there are more then 26 p's the shape become less stable (in a big nucleus the rotation is still not about intermediate axis, but the difference from the rotated axis to the intermediate axis become less and less significant and any

tiny movement can change the rotated axis into an intermediate axis & makes the rotation unstable)

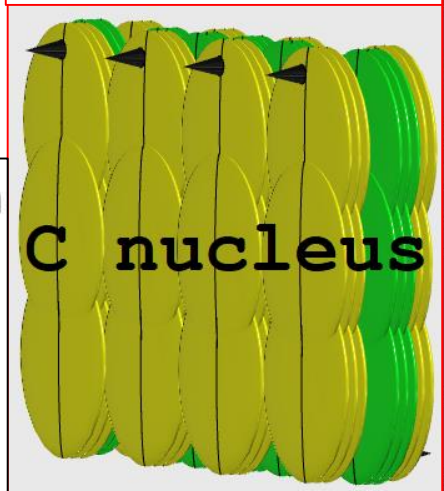
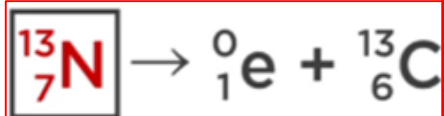
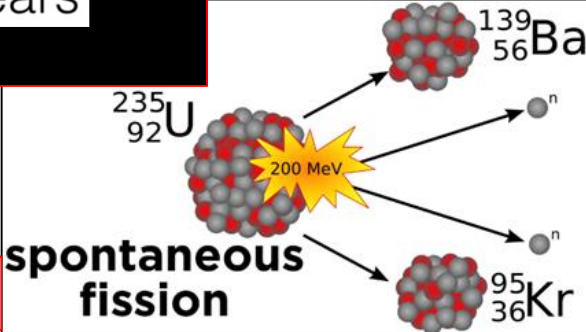
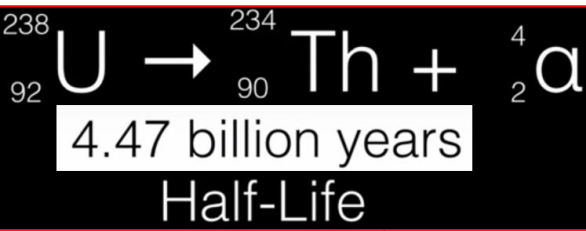

**too many protons**

**positron emission**

$$\text{proton} \rightarrow \text{neutron} + \text{positron} + \text{neutrino}$$

**electron capture**

$$\text{proton} + \text{electron} \rightarrow \text{neutron}$$

the electron comes from 1 of the inner orbitals of the atom

**too many neutrons**

**beta emission**

$$\text{neutron} \rightarrow \text{proton} + \text{electron} + \text{antineutrino}$$

**too big**

alpha emission/spontaneous fission

## Magnets:

**Rule 4a: Moving charge create magnetic field:** If a charge move, when it hit G it will not only rotate it due to its  $\omega(2)$ , but it also push it due to its velocity, so it creates  $G_e/G_{e^+}$  & also  $G_n/G_s$  particles which are perpendicular to  $G_e/G_{e^+}$  we call them magnetic field(B); ( $G_n$ =north pole;  $G_s$ =south pole; B's direction=from  $G_n$  to  $G_s$ ); **property 8:** If charge moves with constant velocity it will create magnetic field at point r:  $B=10^{-7} * q * (v \times r) / |r|^3$ ; Thus, 2 currents in same direction attract each other; & 2 currents in opposite direction repel each other; **Explanation 8 option 1:** The main mechanism is in the figures (opposite charges gives opposite B; Opposite movement direction gives opposite B; |B| is

not depend on the identity of the particle (true also for p); Each type of e give same B (see next pages); When v increase more  $G_n$ 's,  $G_s$ 's formed; The more perpendicular  $v$  &  $r$  more  $G_n, G_s$  formed there);

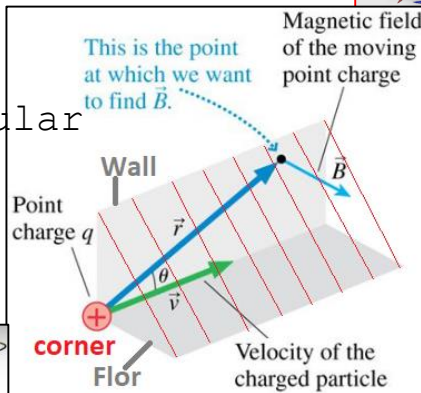
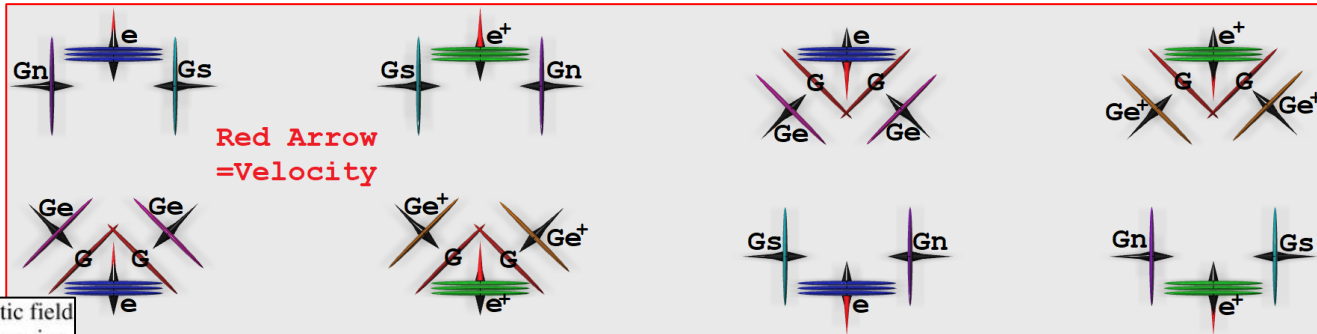

Other view point

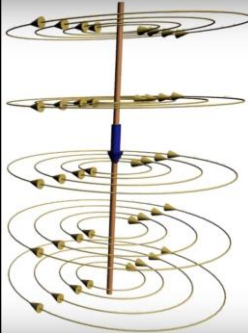
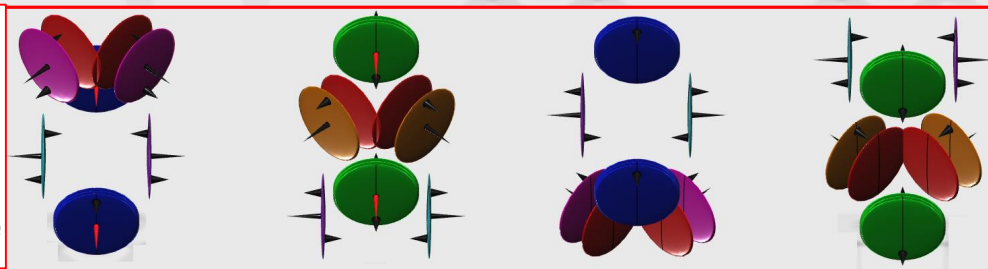
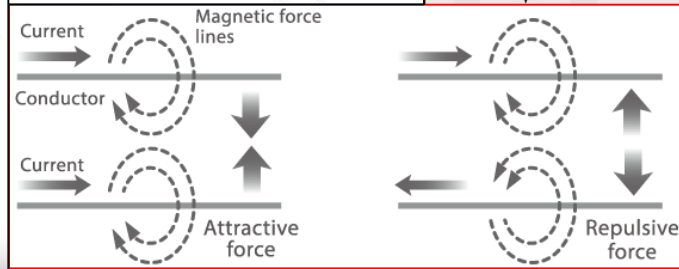
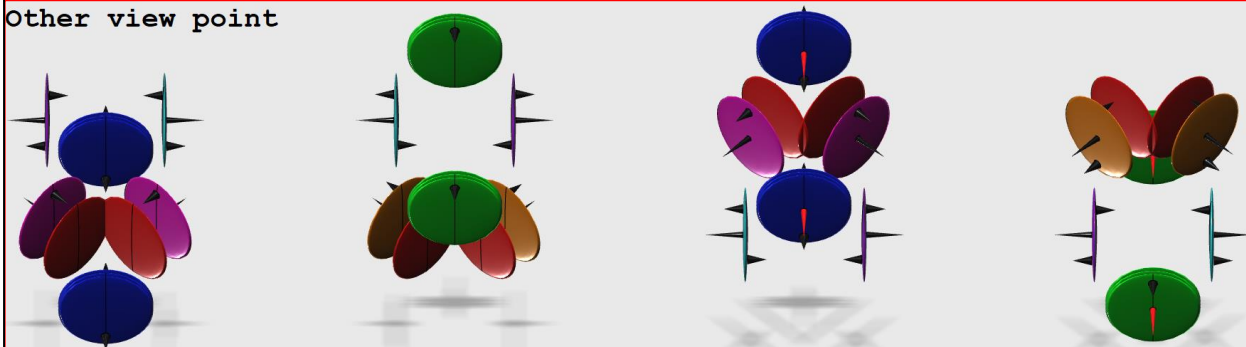

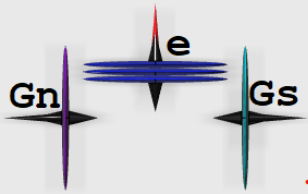

Red Arrow  
=Velocity

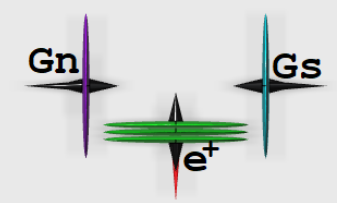
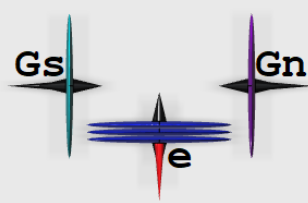
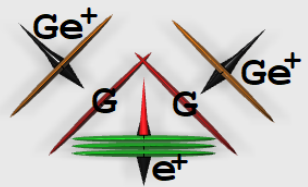
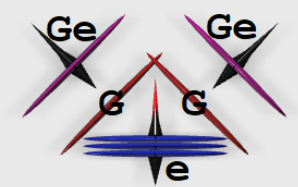
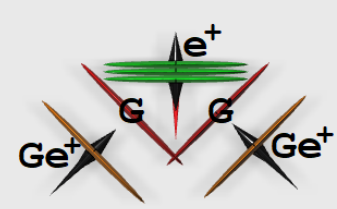
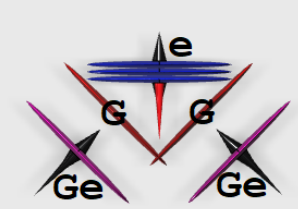
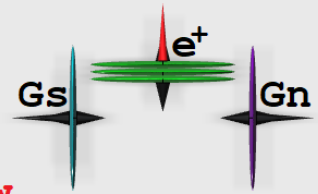

Other view point

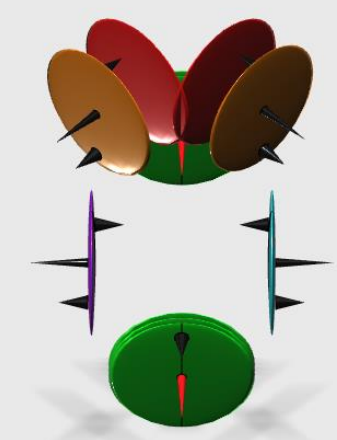
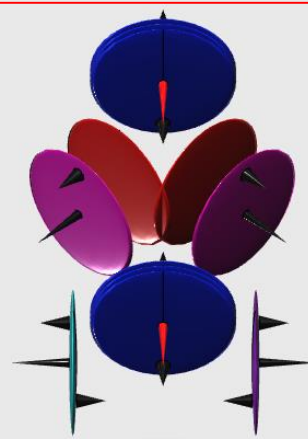
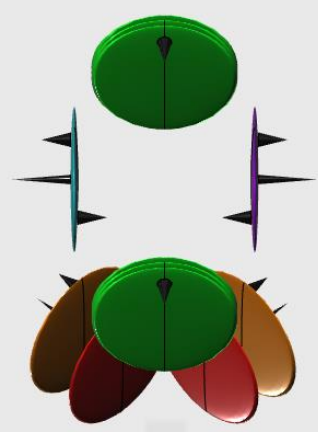
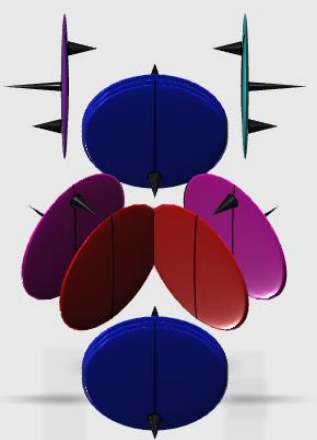

3D  
Fig

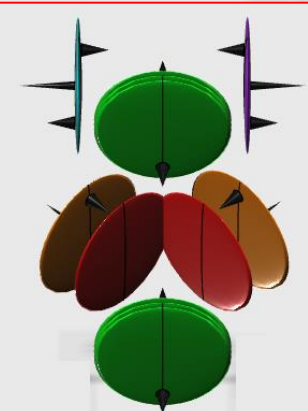
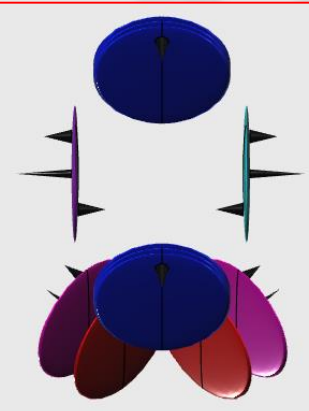
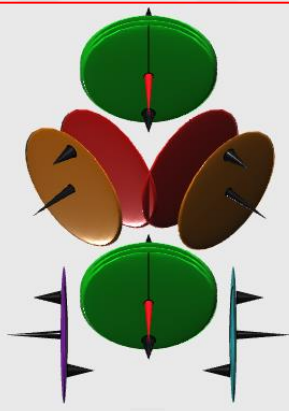
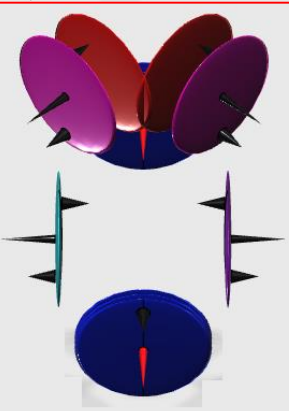

For 3D  
image  
use the  
free:  
AUTODESK  
123D  
DESIGN



**Explanation8 option 2: The main mechanism is in the figures:**

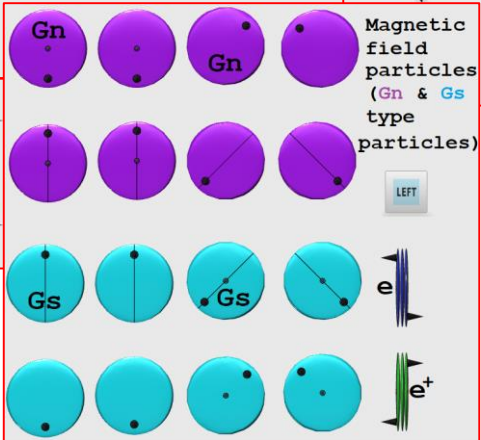
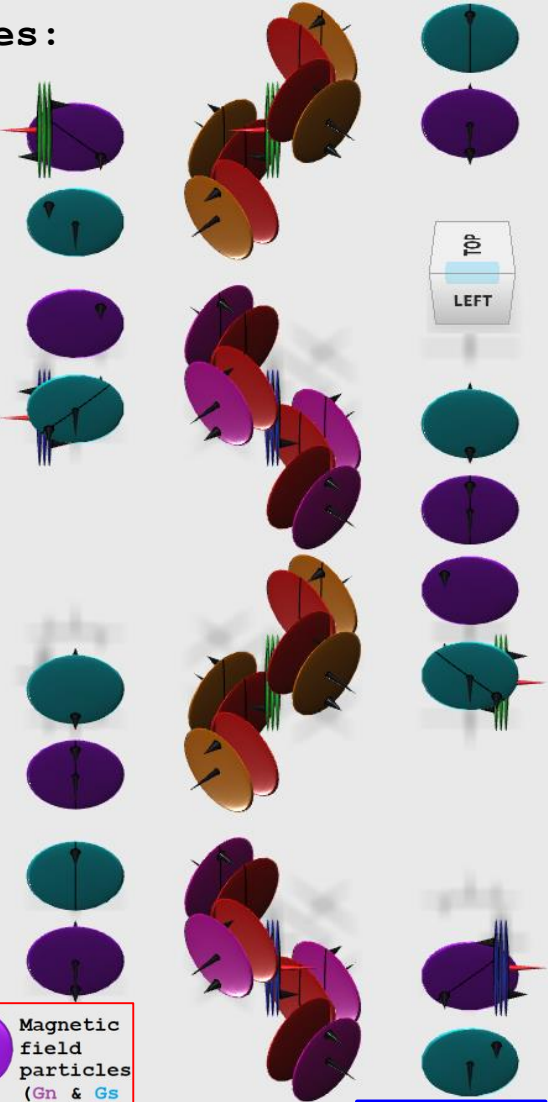
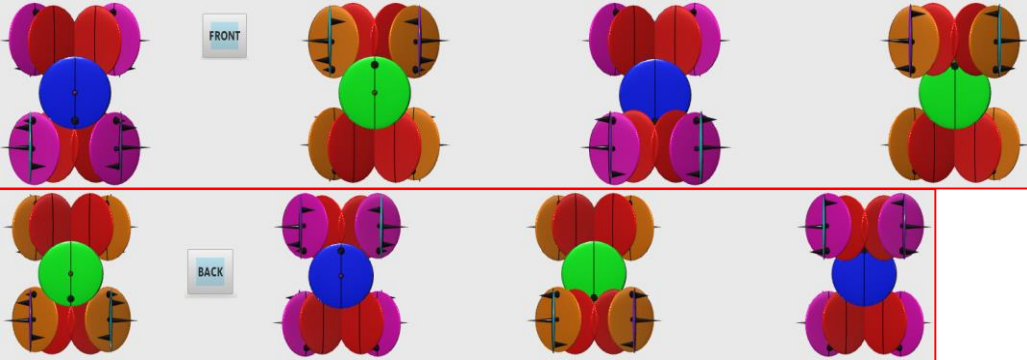
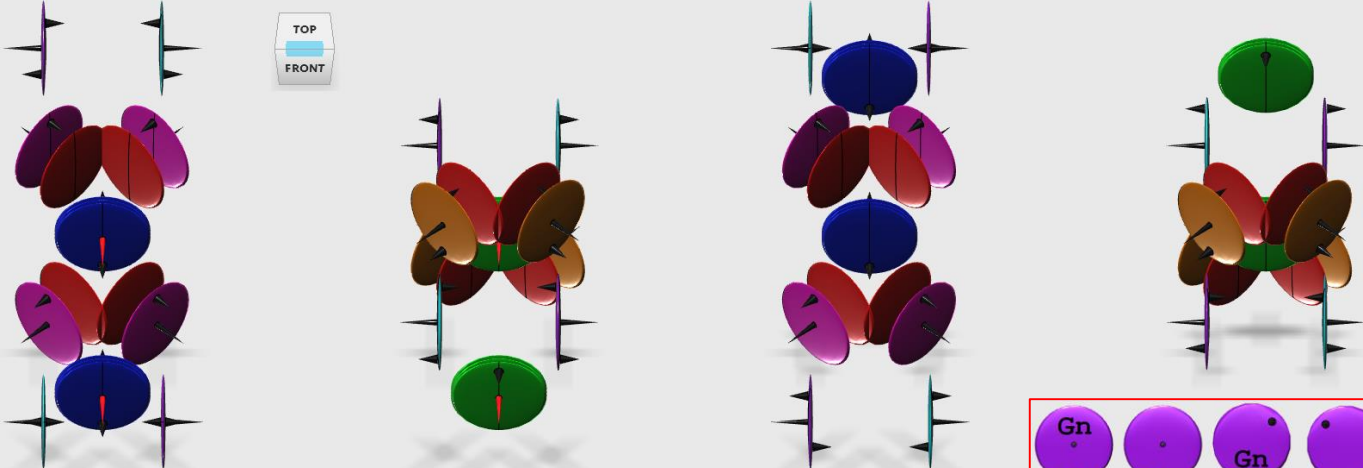
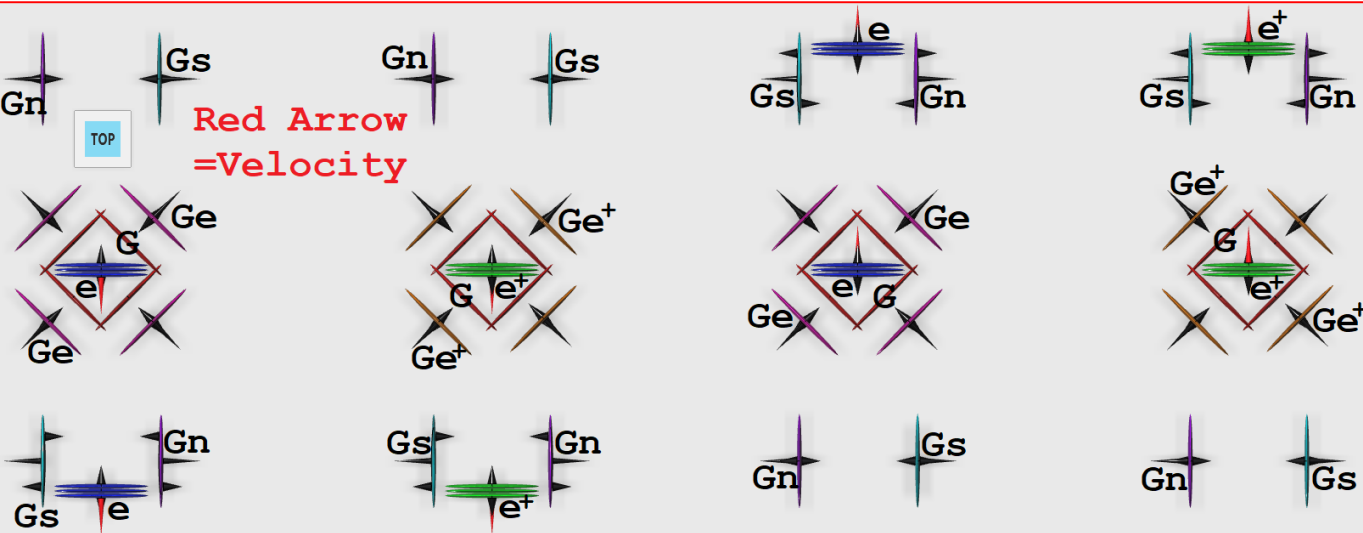

**Explain why above & below current there are opposite B**

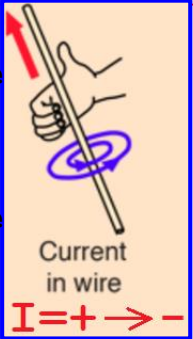



Note that the magnetic field particles in option 2 mechanism have a specific directional velocity, which is used to defined their type (like the left handed neutrino);

In option 2 mechanism when a charge hit G in the direction of its motion, it will push it (align it perpendicular to e) and rotate it in an angle (or cause  $\omega(3)$ , in contrast to option 1 mechanism); in addition the charge will also hit G in to other side (the side that is opposite to its motion), but in this side it will rotate it without any angle;

In option 1 and in option 2, for each different charge movement there will be formed different Gn/Gs type particles; and different Gn/Gs type particle will also formed in each direction (for a specific charge movement);

In order to understand exactly which option is correct (can be other options also), and how Gn/Gs particles really look like exactly, the only way is to run my simulation, with different collisions of moving charge(e) and G's; and then to find the most predominant (the most common and the most powerful) particle that formed(see proof of rule 1,2,3) and that have the properties of a magnetic field particle;

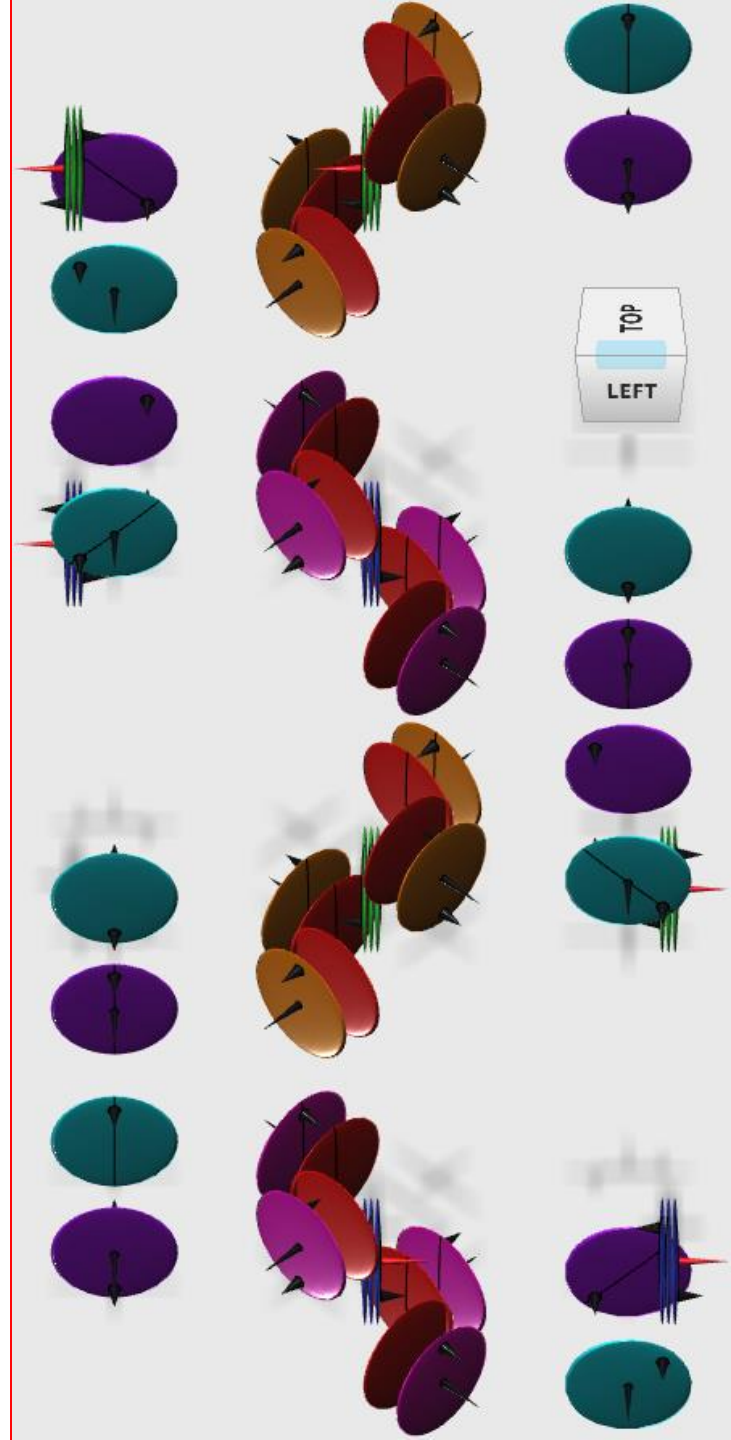

- When e & p attract, e will never stand perfectly in front of p (by chance), so when p attract e over time, the many Gp particles will rotate e about X & Z axes (produce  $\omega(1)$  &  $\omega(3)$  respectively);  $\omega(3)$  cause e to precess (it's possible because the G particles that compose e, p are not perfectly smooth spheroid & because sometime few G's can slide out from the cluster form) If e is located in the other side of p these rotation & precession will be opposite in direction.

- These  $\omega(1)$  &  $\omega(3)$  components of the electron  $\omega$ , is what we call electron spin; if  $\omega(3) > 0$  we call it spin up (Eu); & if  $\omega(3) < 0$  we call it spin down (Ed);

**Rule 5: The internal energy of each electron is constant:** The internal energy of each electron is its rotational motion; each electron collide with many G's (Ge, Gp, ..) some enforce its rotation and other reduce it, but overall its rotation energy remain constant; & its  $= e\omega \bullet eI \bullet e\omega / 2 = e\omega \bullet M / 5 \bullet [(Gs1^2 + es3^2), 0, 0; 0, (Gs1^2 + es3^2), 0; 0, 0, 2 \bullet Gs1^2] \bullet e\omega / 2 = e\omega(1)^2 \bullet M / 10 \bullet (Gs1^2 + es3^2) + e\omega(2)^2 \bullet 2 \bullet M / 10 \bullet (Gs1^2 + es3^2) + e\omega(3)^2 \bullet M / 10 \bullet (2 \bullet Gs1^2) = \text{constant}$ ; so  $(e\omega(1)^2 + e\omega(2)^2) \bullet (Gs1^2 + es3^2) + e\omega(3)^2 \bullet (2 \bullet Gs1^2) = \text{constant}$ ;

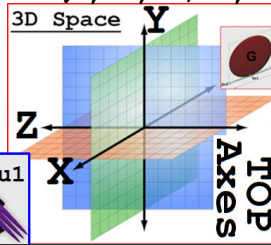

<p>TOP</p>	<p>Gp rotates e about its X axis</p>	<p>Gp rotates e about its Z axis causing e to precess</p>	<p>Final e conformation transforms it into Eu1</p>
	<p>Gp rotates e about its X axis</p>	<p>Gp rotates e about its Z axis causing e to precess</p>	<p>Final e conformation transforms it into Ed2</p>

initial side view

Eu1, e, Ed1

e, es1, es2, es3

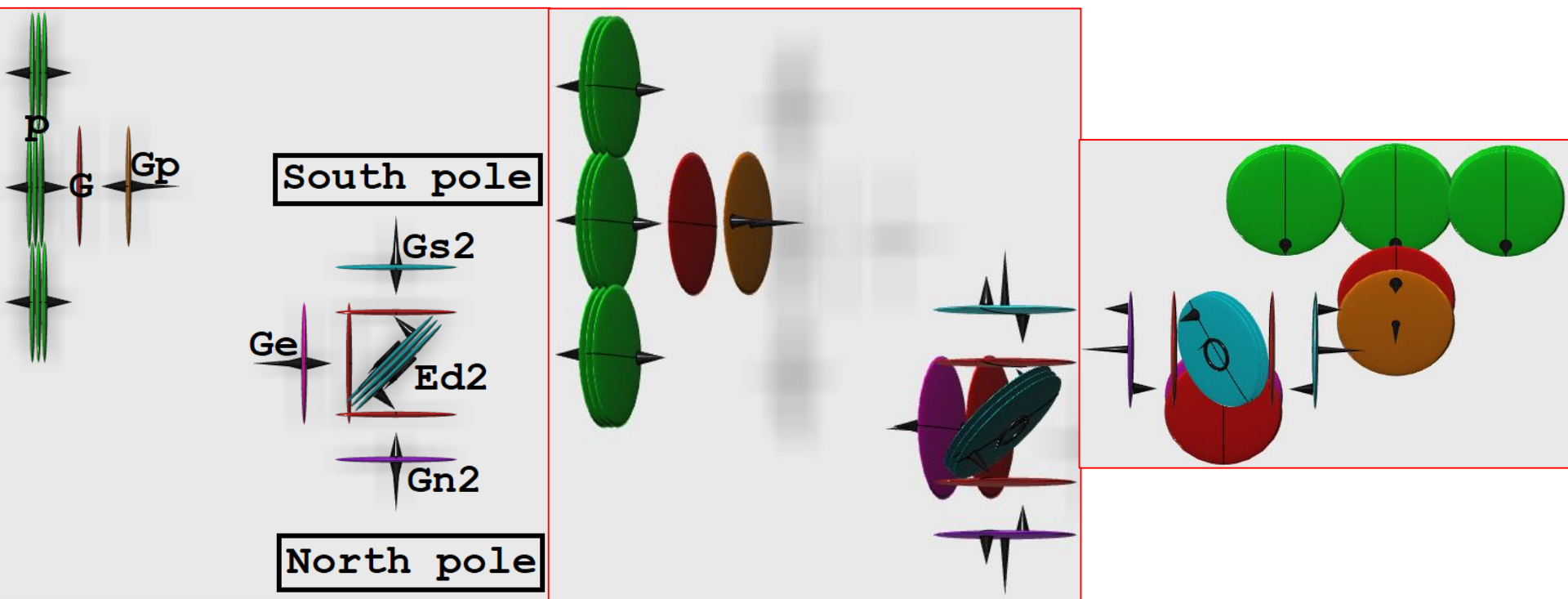
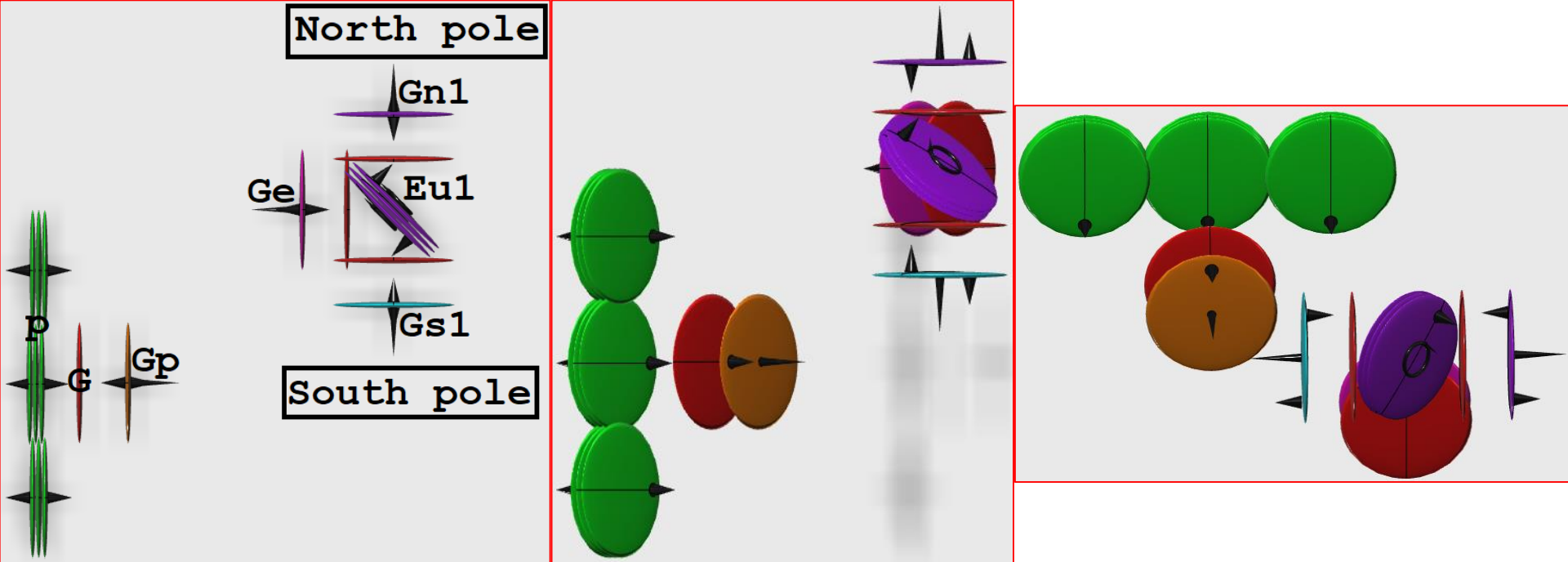

**Rule 6: Different electrons different spins, but same spin magnitude:** What we call spin magnitude= $\omega(1)^2 * (Gs1^2 + es3^2) + e\omega(3)^2 * 2 * Gs1^2 = \text{constant}$ ; is the part of the electron internal energy that is influenced by the spin; This spin magnitude is constant because if the first Gp rotates e about its Z axis, then for the next Gp's it will be harder to rotate e about its X axis; and if the first Gp rotates e about its X axis, then for the next Gp's it will be harder to rotate e about its Z axis; so when  $\omega(1)$  big  $\omega(3)$  small and when  $\omega(1)$  small  $\omega(3)$  big; in addition the farther e upward, the Gp effect on these rotations is more drastic, but e will get less Gp (because distance, & because e & p will play give & take with less G particles as there will be less options for G's collision angles), so overall, the spin magnitude will be constant; For a specific electron the spin direction can change only between up & down, because it can only be up or down with respect to the nucleus; different heights will be changed immediately to preferred heights by the local Ge, Gp; For different electrons the preferred heights can be different, so their spins will have different  $\omega(1)$  &  $\omega(3)$  values; in addition for different electrons there can be different Ge, Gp numbers that coming from different angles which can increase  $\omega(1)$ , but they will also decrease  $\omega(3)$ ; so spin magnitude remain constant.

- So in the universe there are many type of Eu (Eu1, Eu3, Eu5..) and many type of Ed (Ed2, Ed4, Ed6..), each having different  $\omega(1)$  &  $\omega(3)$  values; but for each The spin magnitude is constant; & the spin of Eux = -spin of Ed(x+1); (e.g. spin of Eu1 = -spin of Ed2); Eux & Ed(x+1) are 2 options for a specific electron in a specific location (because of symmetry) (if  $\omega(1)$  &  $\omega(3)$  are the value for Eux, - $\omega(1)$  & - $\omega(3)$  will be the value for Ed(x+1));



- Because of this process there are no pure e particles in the universe but only Eu & Ed type particles, and from now on when we say e we mean Eu or Ed.
- When p attract e over time, it throw e from side to side by Gp's, as p is much more heavy and will move much less by Ge's; we call them Hydrogen atom.
- Note, that angles X1,Z1 in the pictures are huge only for explanation, in reality they are tiny, and only  $\omega(1)$  &  $\omega(3)$  can be big (but smaller then  $\omega(2)$ );

**Rule 4b: Magnetic field generation:** If Eu(Eu1) [or Ed2] collide with G it can transform it to Ge but also to Gn & Gs (Gn1&Gs1) [or Gn2&Gs2] depend in the side of collision (because Eu precess clockwise in one side and anticlockwise in the other side).  $[Eu1+G \rightarrow Ge, Gn1, Gs1; Ed2+G \rightarrow Ge, Gn2, Gs2]$  {Gn, Gs are the most common & most powerful form of G's that e create after Ge, to understand the process of their creation, use my simulation, and the proof of rule 1}

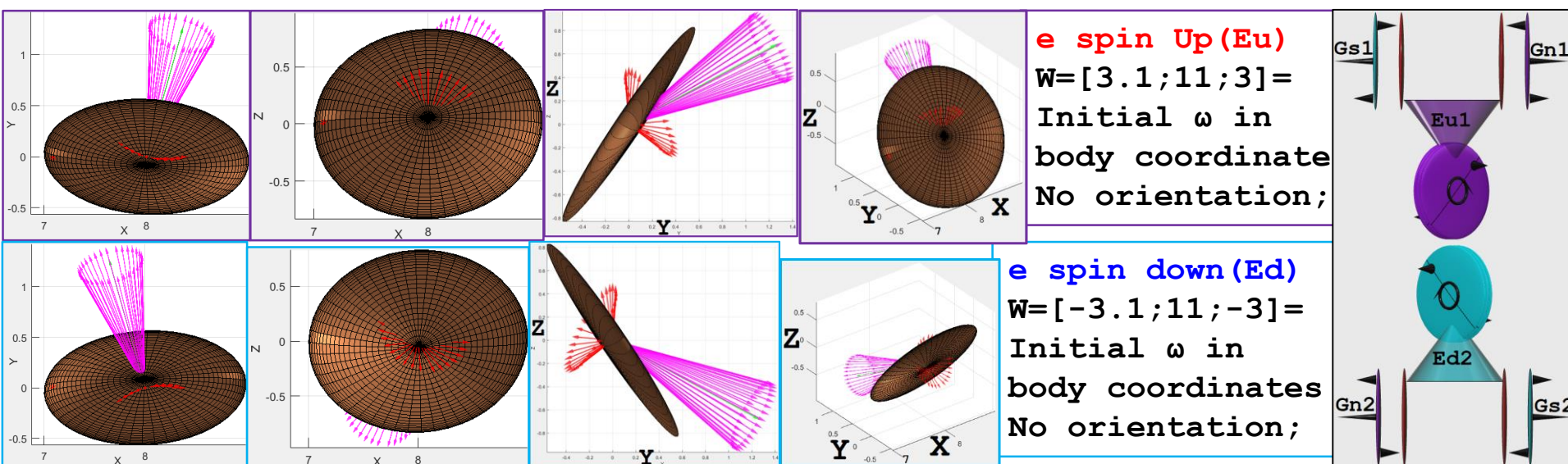

In the pictures: Sphere size=[1;1;0.1];  $L$ =Angular momentum.  $\omega$ =Angular velocity in world coordinates.  $z'$ =vector along axis of symmetry. Are drawn for many time points. {see section Spheroid precession in mathematical proof}

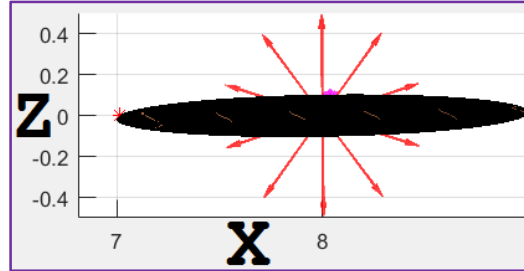
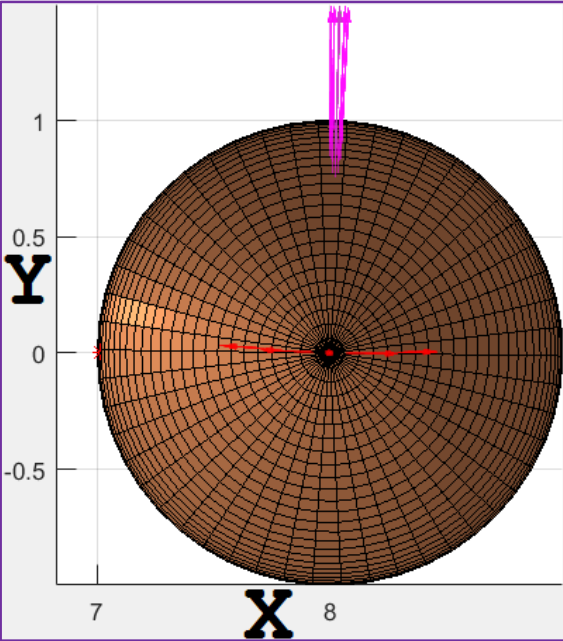

Video 4

Video 5

More realistic  
e spin Up (Eu)  
 $W=[3.1;110;3]=$   
Initial  $\omega$  in  
body coordinates  
No orientation;

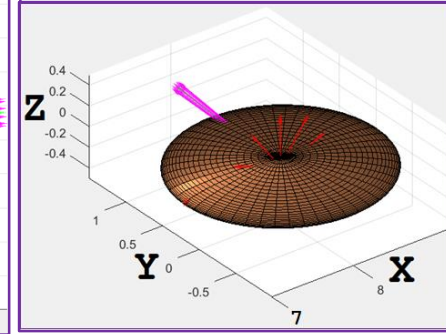
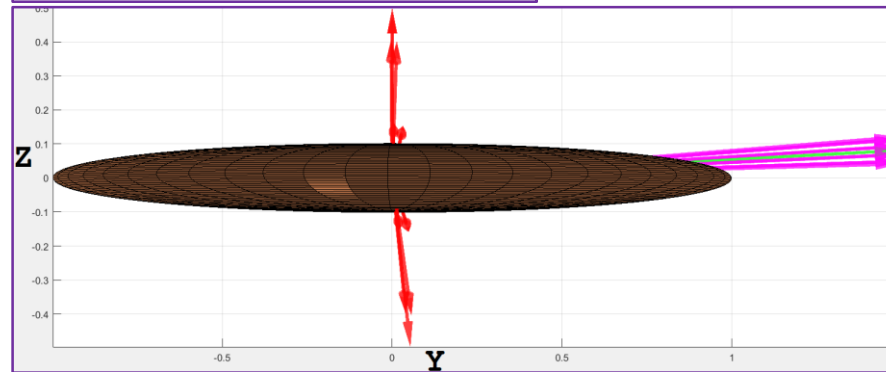

In the pictures: Sphere size=[1;1;0.1];  $L$ =Angular momentum.  $\omega$ =Angular velocity in world coordinates.  $z'$ =vector along axis of symmetry. Are drawn for many time points. {see section Spheroid precession in mathematical proof}

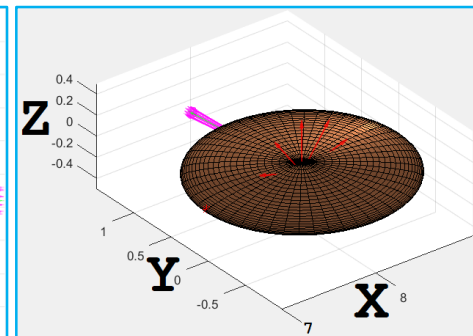
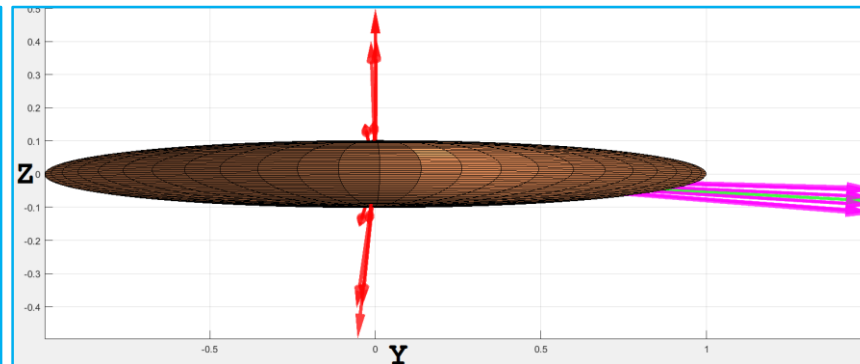
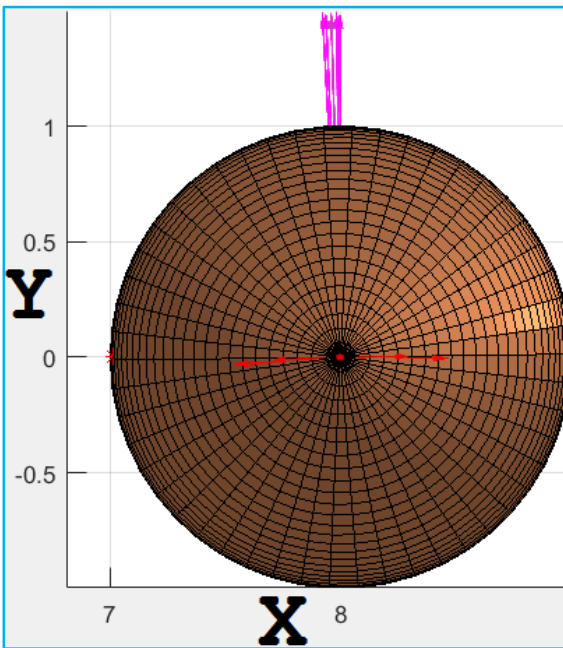

Video 6

At the end  
its:  $L$  &  $z'$

More realistic  
e spin down (Ed)  
 $W=[-3.1;110;-3]=$   
Initial  $\omega$  in  
body coordinates  
No orientation;

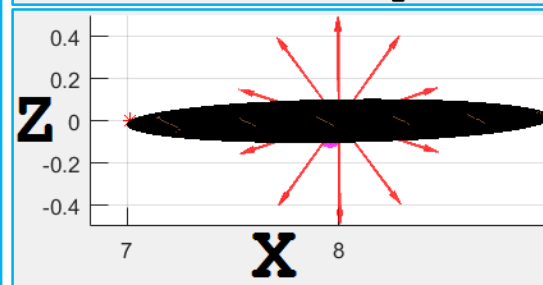

**Rule 7,8: Magnetic Attraction & Repulsion :**

The e side that emit Gn will be attracted by Gs & repelled by Gn;  
 The e side that emit Gs will be attracted by Gn & repelled by Gs;  
 [Gs1 or Gn1 attracts any Eu; Gs2 or Gn2 attracts any Ed];  
 [Gs1 or Gn1 repel any Ed; Gs2 or Gn2 repel any Eu];  
 - Nuclei get spin by Ge; because they heavy their  $\omega(1) & \omega(3)$  are smaller, thus they create few Gn,Gs; (rule 5,6 are true also for each nuclei); but their spin magnitude can be the same or higher as  $ps2 > es2$  & p spin magnitude =  $p\omega(1)^2 * (ps2^2 + es3^2) + p\omega(3)^2 * (ps2^2 + es1^2) = \text{constant}$ ;  
 - So there are also no p in the universe but only Pu&Pd type particle (from now when we say p we mean Pu&Pd)  
 - Likewise electron also p or nucleus can be only up or down for each atom (it can be only Pu3 or Pd4 in one atom & only Pu5 or Pd6 in other atom; these are its prefer configurations because of symmetry); **My model for:**

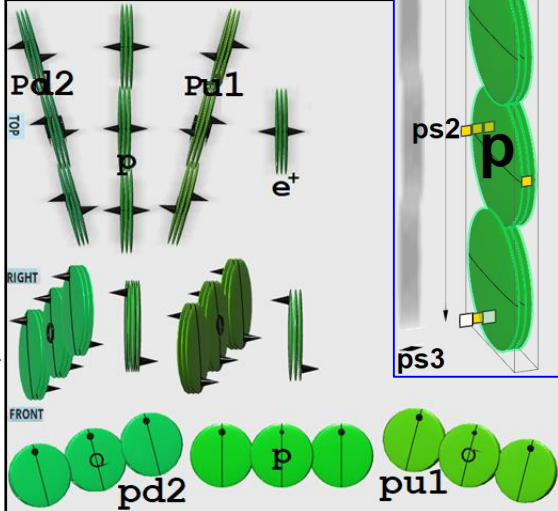
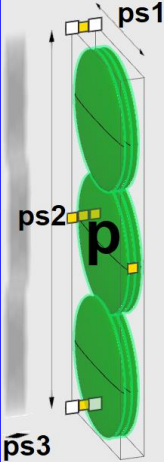
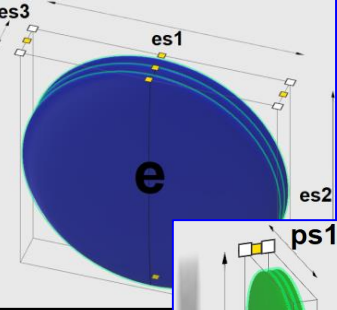

**Hydrogen Atom option 1**

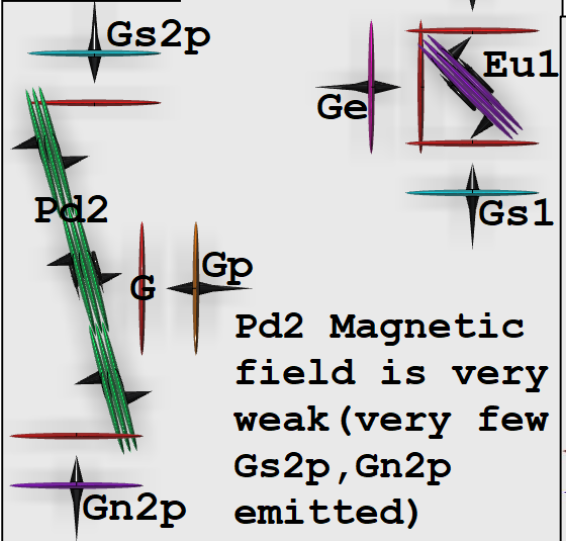

**The magnetic field that p create is opposite;**

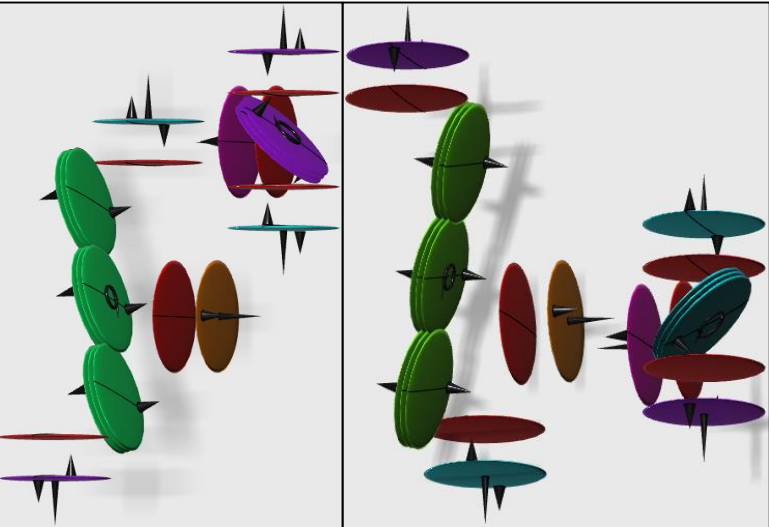

**Hydrogen Atom option 2**

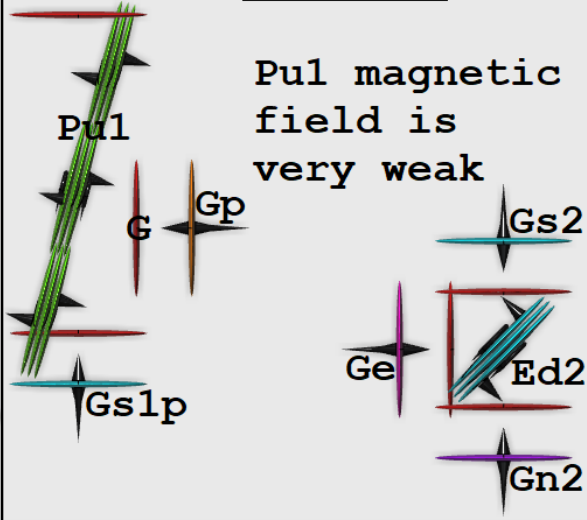

Hydrogen Atom  
option 1

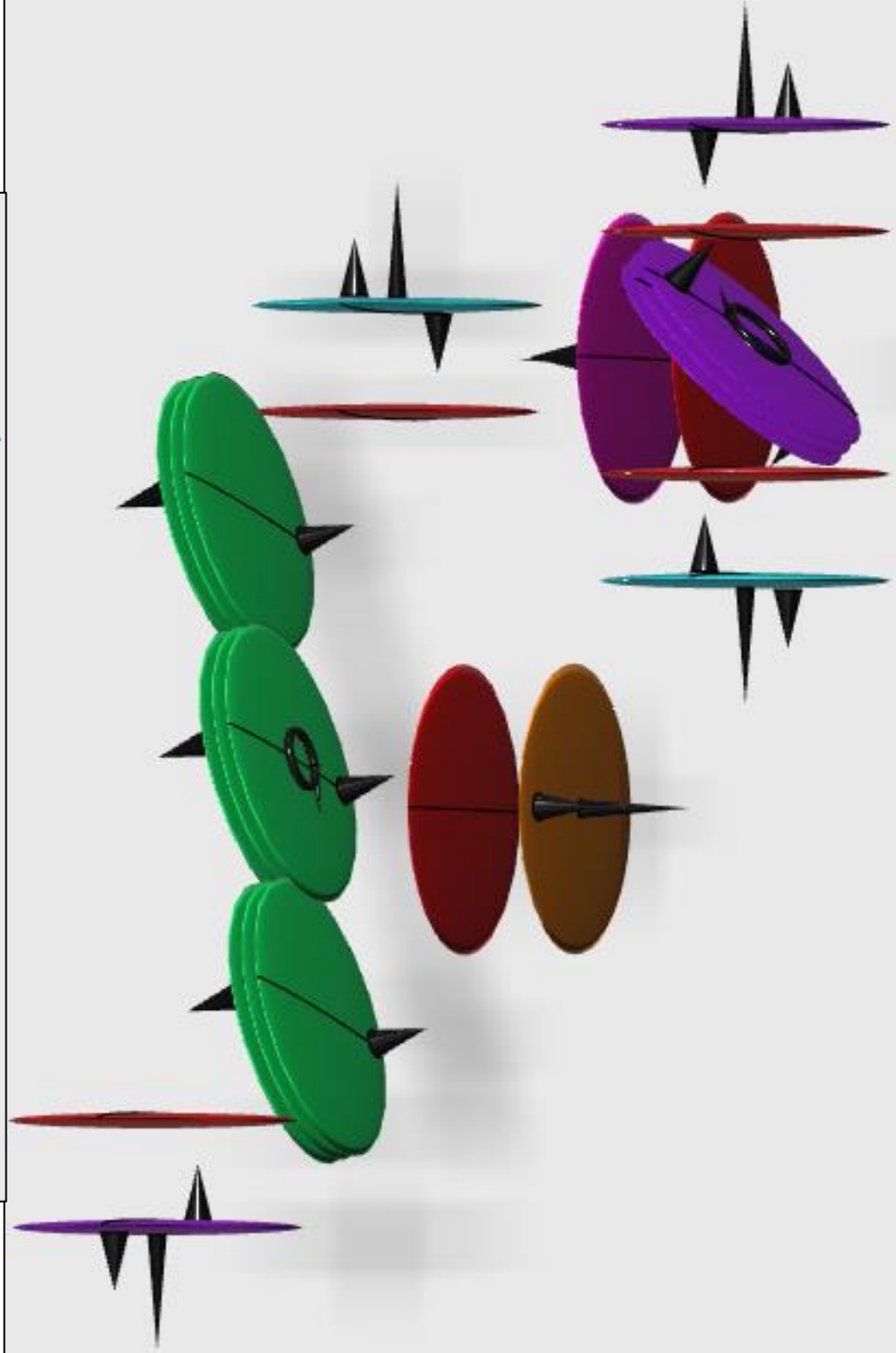
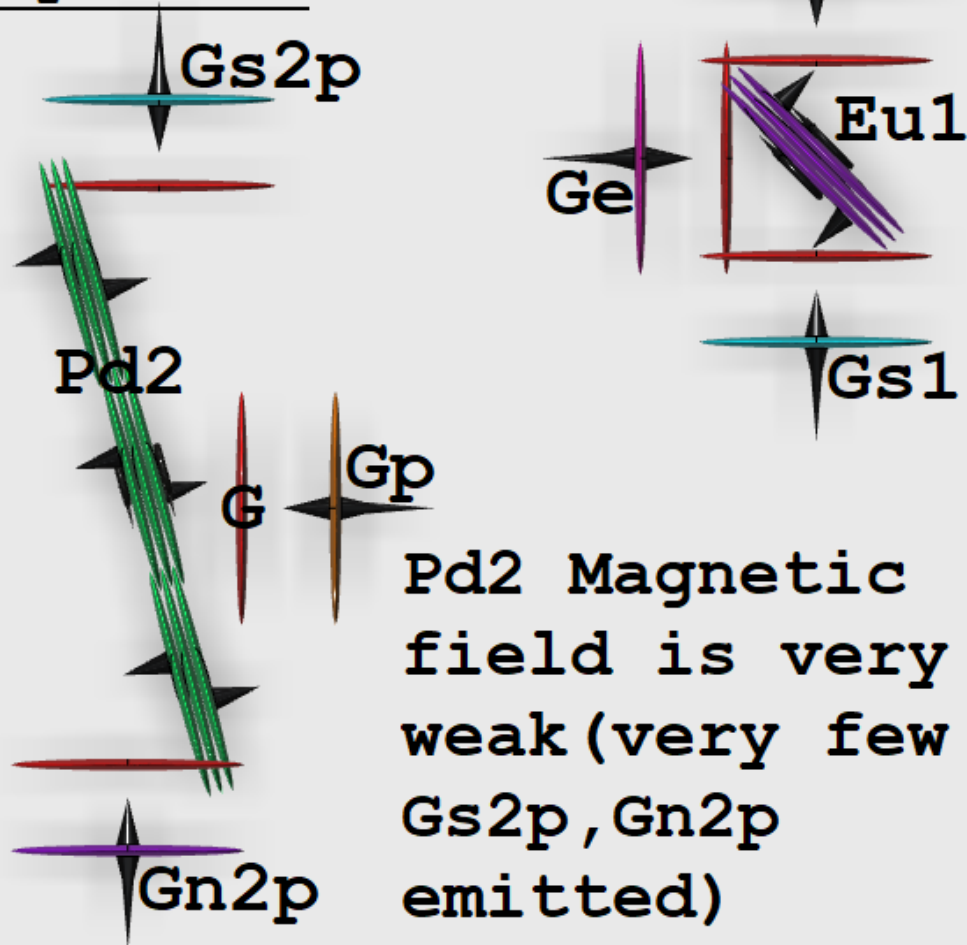



- Particles orientation &  $\omega$  (Gn1p~Gn1;Gs1p~Gs1;Gn2p~Gn2;Gs2p~Gs2) ;

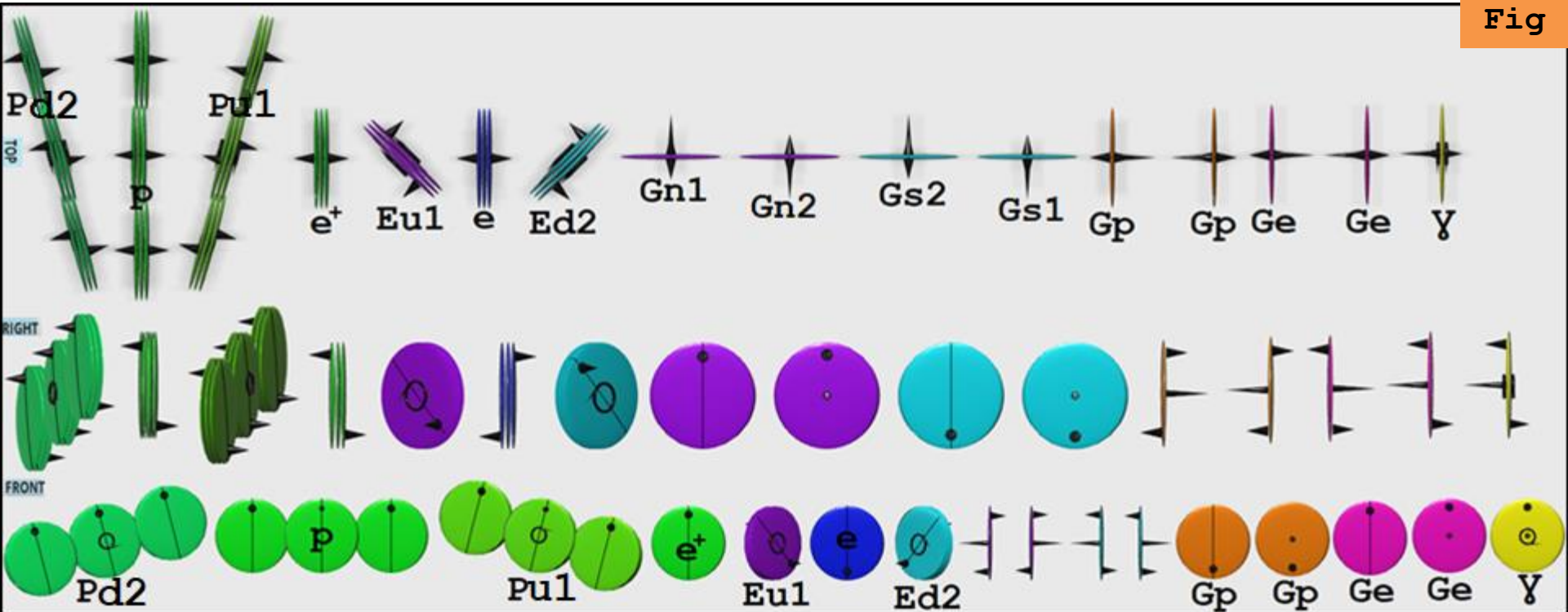

\* The electron (Eu & Ed) precess because we can arrange its spin pointing to any direction; so it must have a z & x components; and if the electron gets hit that rotates it in the z axis, it will continue to rotate about z (and not just change angle); in addition the calculation of  $\mu$  implies so also;

\* Another (less probable) option for rule 4b,7,8 is that each up or down electron generates predominantly only 1 type of particles from each side and that in a magnet the electron spin up stands all the time upper to the electron spin down, so the particles emitted between them hit these electrons and enforce them; and if there is only one free electron in the atom, it will generate just few magnetic field particles (only Gn or Gs type);

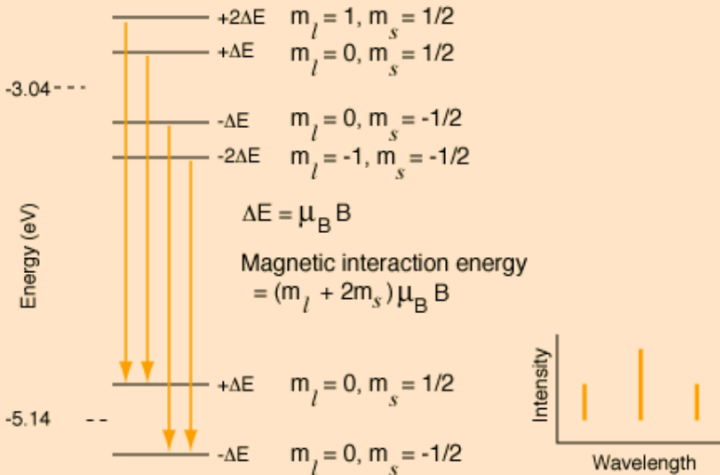

A characteristic of the collection of protons and neutrons (which are **fermions**) is that a nucleus of odd mass number A will have a half-integer spin and a nucleus of even A will have integer spin. The suggestion that the angular momenta of nucleons tend to form pairs is supported by the fact that all nuclei with even Z and even N have nuclear spin I=0. For example, in the nuclear data table for [iron](#) below, all the even A nuclides have spin I=0 since there are even numbers of both neutrons and protons. The half-integer spins of the odd-A nuclides suggests that this is the nuclear spin contributed by the odd neutron.

$$\omega_{electron\ spin} = \frac{2\mu_e B}{h} = \frac{2 \cdot 2 \cdot \frac{1}{2} (5.79 \times 10^{-5} eV / T)(1T)}{6.58 \times 10^{-16} eV \cdot s} = 1.7608 \times 10^{11} s^{-1}$$

$$v = \frac{\omega}{2\pi} = 28.025\ GHz \quad \text{Larmor frequency}$$

$$\omega_{proton\ spin} = \frac{2\mu_p B}{h} = \frac{2(2.79)(3.15 \times 10^{-8} eV / T)(1T)}{6.58 \times 10^{-16} eV \cdot s} = 2.6753 \times 10^8 s^{-1}$$

$$v = \frac{\omega}{2\pi} = 42.5781\ MHz \quad \text{Larmor frequency}$$

Neutron:  $g = -3.8260837 \pm 0.0000018$

Nuclide	Nuclear spin I	Magnetic moment $\mu$ in $\mu_N$
n	1/2	-1.9130418
p	1/2	+2.7928456
<sup>2</sup> H(D)	1	+0.8574376
<sup>17</sup> O	5/2	-1.89279
<sup>57</sup> Fe	1/2	+0.09062293
<sup>57</sup> Co	7/2	+4.733
<sup>93</sup> Nb	9/2	+6.1705

**- e, p & other nucleus have different masses so the magnitude of their spin is different;**

**- For neutron  $\omega(2)=0$ ; but it has  $\omega(1)$  &  $\omega(3)$  values & thus spin;**

Z	A	Atomic Mass (u)	Nuclear Mass(GeV/c <sup>2</sup> )	Binding Energy(MeV)	Spin	Natural Abund.	Half-life	Decay	Q MeV
26	54	53.939613	50.2315	471.77	0	0.059	stable	...	...
26	55	54.938296	51.1618	481.07	3/2	...	2.7y	EC	0.23
26	56	55.934939	52.0902	492.26	0	0.9172	stable	...	...
26	57	56.935396	53.0221	499.91	1/2	0.021	stable	...	...
26	58	57.933277	53.9517	509.96	0	0.0028	stable	...	...
26	60	59.934077	55.8154	525.35	0	...	1.5My	b-	0.24

Particle	Spin	$\omega_{Larmor/B}$ s <sup>-1</sup> T <sup>-1</sup>	v/B
Electron	1/2	1.7608 x 10 <sup>11</sup>	28.025 GHz/T
Proton	1/2	2.6753 x 10 <sup>8</sup>	42.5781 MHz/T
Deuteron	1	0.4107 x 10 <sup>8</sup>	6.5357 MHz/T
Neutron	1/2	1.8326 x 10 <sup>8</sup>	29.1667 MHz/T
<sup>23</sup> Na	3/2	0.7076 x 10 <sup>8</sup>	11.2618 MHz/T
<sup>31</sup> P	1/2	1.0829 x 10 <sup>8</sup>	17.2349 MHz/T
<sup>14</sup> N	1	0.1935 x 10 <sup>8</sup>	3.08 MHz/T
<sup>13</sup> C	1/2	0.6729 x 10 <sup>8</sup>	10.71 MHz/T
<sup>19</sup> F	1/2	2.518 x 10 <sup>8</sup>	40.08 MHz/T

Z	A	Atomic Mass (u)	Nuclear Mass(GeV/c <sup>2</sup> )	Binding Energy(MeV)	Spin	Natural Abund.	Half-life	Decay	Q MeV
27	56	55.939841	52.0943	486.92	4	...	77.7d	b+	4.57
27	57	56.936294	53.0225	498.29	7/2	...	271d	EC	0.84
27	59	58.933198	54.8826	517.32	7/2	1.00	stable	...	...
27	60	59.933820	55.8147	524.81	5	...	5.272y	b-	2.82

- If the atom is in a big molecule (or crystal) when we rotate this molecule at first p & Eu & Ed2 particles won't be rotated, just move in space (because conservation of angular momentum) but then they will feel different attraction & repulsion forces (by Gp & Ge from the other p,e particles) and they will now rotates about their X & Z axes differently, creating other directions of spin: Eu3,Ed4,Eu5,Ed6,.. (each spin is still a little bit more in the up direction or in the down direction, as the probability to get a perfectly horizontal spin is zero) and their spin magnitude remain the same by rule 6;

- If in atom the number of Eu and Ed type electrons is not equal, then it will emit more Gn particle to one direction & more Gs particle to the other direction, we call them north and south pole and we call this atom magnet (ferromagnet), the bigger the difference in the number of Eu & Ed, the stronger the magnet.

3D Fig

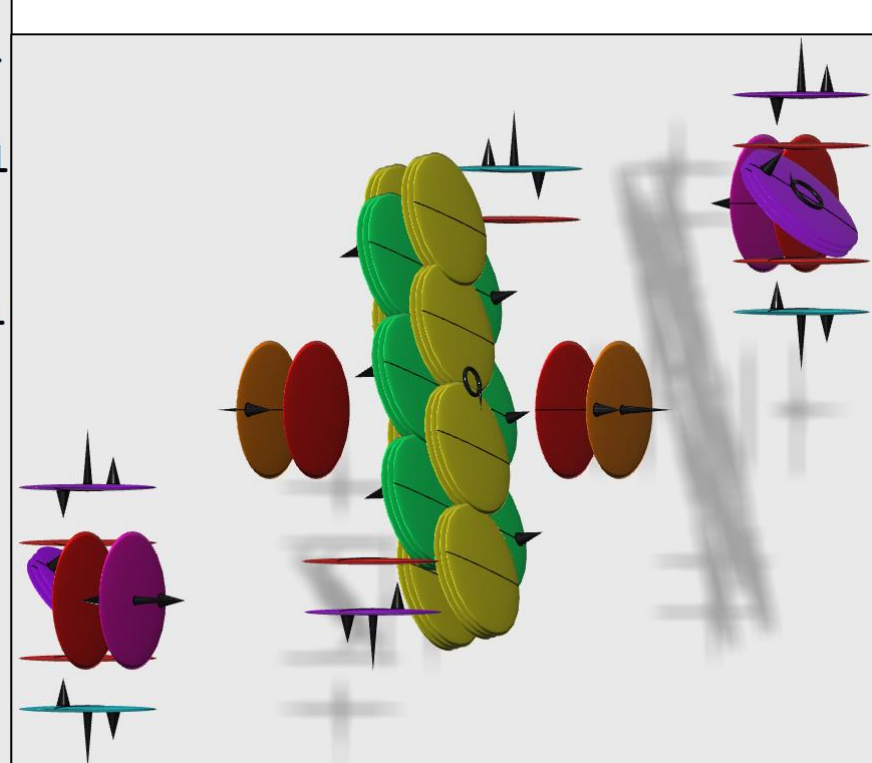
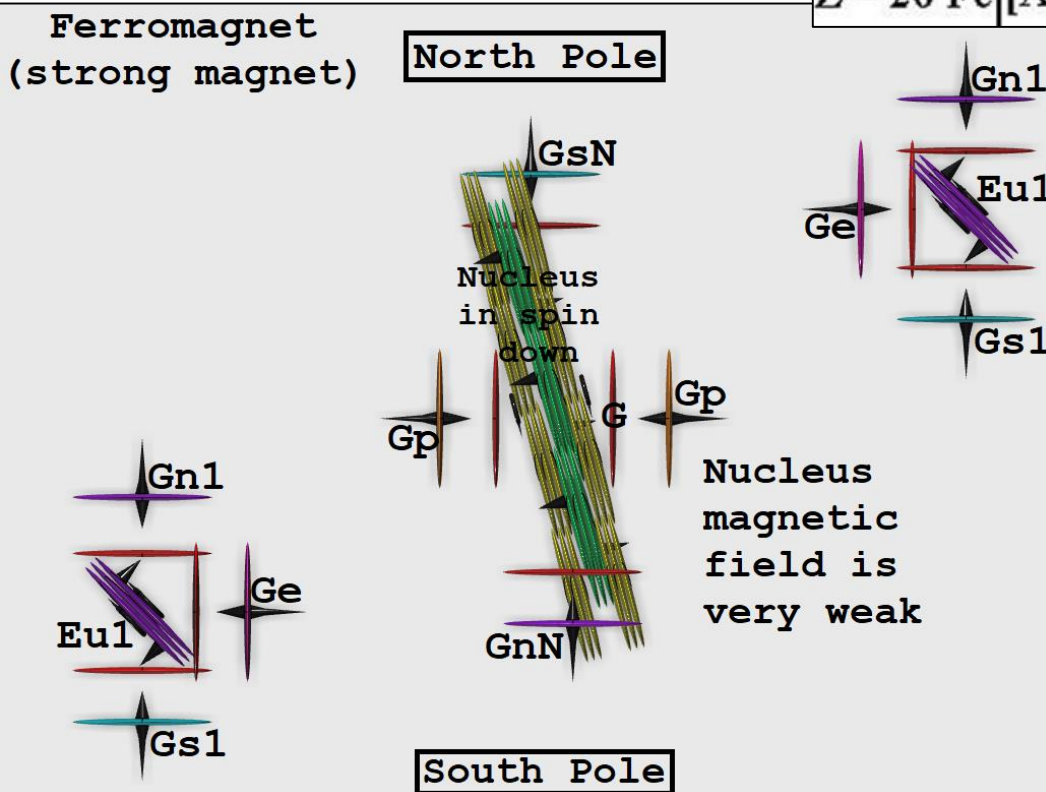
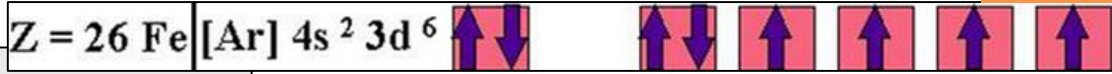

- The magnetic field generated by the moving electron in the atom will be canceled, because the electron are thrown from side to side, thus only this intrinsic magnetic field that is generated by the electron spin contribute the magnetic field of any magnet;

**Property 9:** We can't separate magnetic poles, they always come in North & South;

**Explanation 9:** North & South poles are  $G_n$  and  $G_s$  type particles; each spin up (or spin down) electron generate  $G_n$  type particles from one side and  $G_s$  type particles from its other side (when collide with  $G$  in certain side and angles), because the electron precess so each side see different direction of precessional rotation (clockwise or counter-clockwise);

**Property 10:** A beaten/heated magnet losses its magnetic properties;

**Explanation 10:** In a beaten/heated magnet the electrons move & collide, so they can change their location & by this their precession direction (or spin), and this process is random, so over time there will be equal up electrons and down electrons, so the magnet destroy.

**Property 11:** The magnetic force is the strongest at the ends of the magnet.

**Explanation 11:**  $E_{u1}$  will emit more  $G_{n1}, G_{s1}$  to the direction perpendicular to  $G_e$ ; and other  $E_u$  will emit  $G_{n1}, G_{s1}$  mainly to other direction;



Magnet has two poles – These are the ends of a magnet where magnetic force is strongest.



Poles always exist in pairs. They cannot be separated.

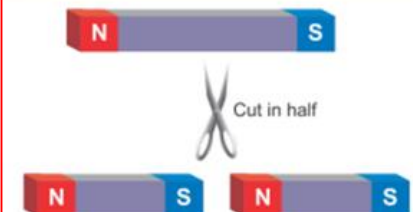



- If in atom the number of Eu & Ed type electrons is equal, then the effect of Gn & Gs will cancel each other & it won't be a magnet, we call it non magnet.
- If in an atom 2 electrons (e.g. Eu1&Ed2) are paired, it means that they throw G particles (e.g. Gs1&Gs2) continuously and very often on each other and that they are perfectly synchronize in this give and take game, in addition these continuous hitting change their orientation into\* (into Eu1\*, Ed2\* respectively and their G's into Gs1\* & Gs2\* respectively).
- If in atom an electron get only few Gp, Ge, Gn, Gs particles per second it will be more free to move and we call this atom conductor. If in atom all electrons get a lot of Gp, Ge, Gn, Gs particles per second, we call this atom insulator.

**Rule 9a: Magnet transform unpaired e:** If we place a strong magnet close to atom many Gx will be emitted (e.g. Gn1) towards the atom. If this atom has unpaired electron (e.g. Ed2) overtime it can be changed by these collision with Gx into the electron that create these Gx (e.g. Eu1) {so:  $Gn1 + Ed2 \rightarrow Eu1$ }

- If some electrons in non magnet atom are not paired we call it paramagnet & it will attract any

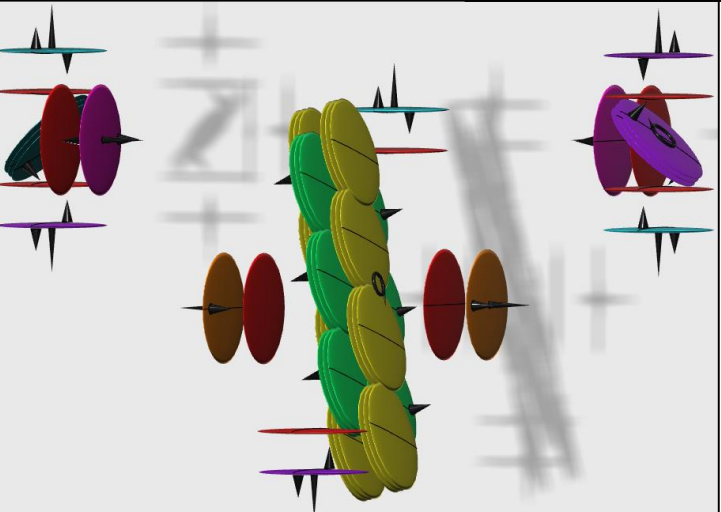
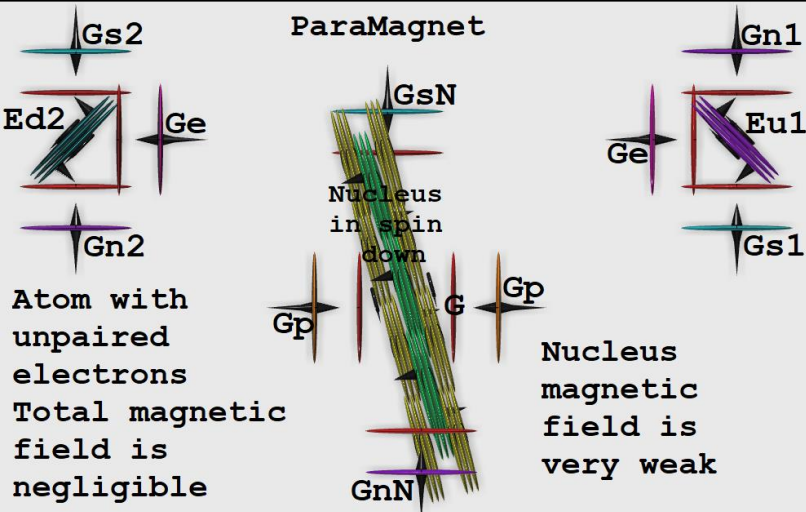
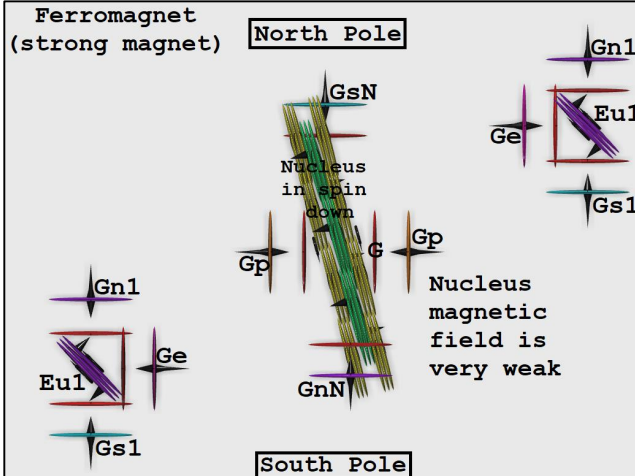

strong magnet in any direction {e.g. tungsten, lithium} by rule 9a.

**lithium**  
[He] 2s<sup>1</sup>  
2, 1

**tungsten**  
[Xe] 4f<sup>14</sup> 5d<sup>4</sup> 6s<sup>2</sup>  
2, 8, 18, 32, 12, 2

**Property12:** In stern Gerlach experiment: When we fire silver atoms or nuclei of some atoms through an inhomogeneous magnetic field, we get only 2 spots;

**Explanation12:** The silver atom contain 47 p & e, but only 1 e is unpaired, so rest paired e spin up and down cancel each other, and this e can be only up or down with specific angles; the nuclei of atoms can be only up or down for each atom with specific angles; in inhomogeneous magnetic field( $G_{s2}, G_{n2}$ ), the number of  $G_{n2} >$  number of  $G_{s2}$  so  $E_u$  will go down and  $E_d$  will go up & we get 2 spots;

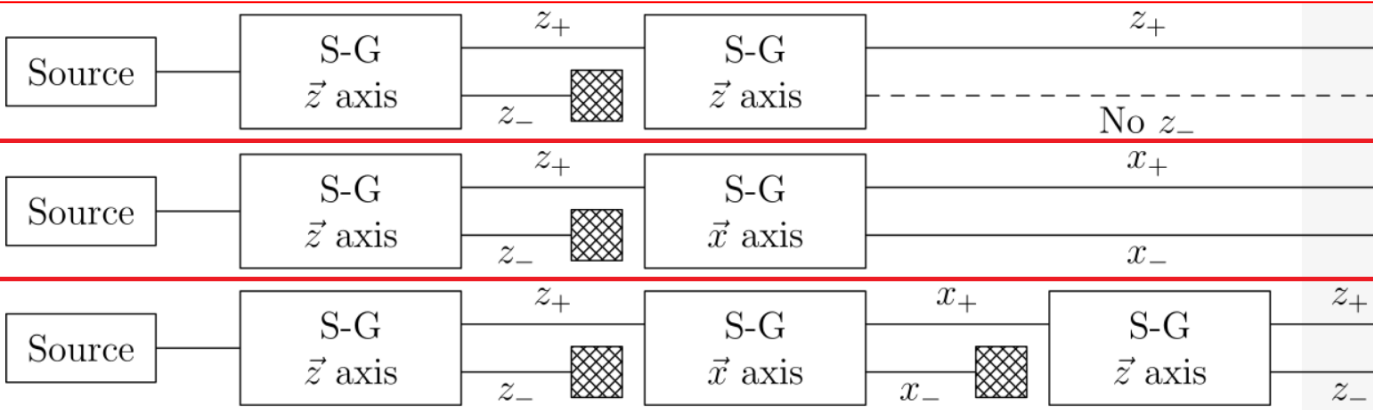

**silver**  
 $[Kr] 4d^{10} 5s^1$   
 2, 8, 18, 18, 1

Stern-Gerlach experiment: electrically neutral silver atoms

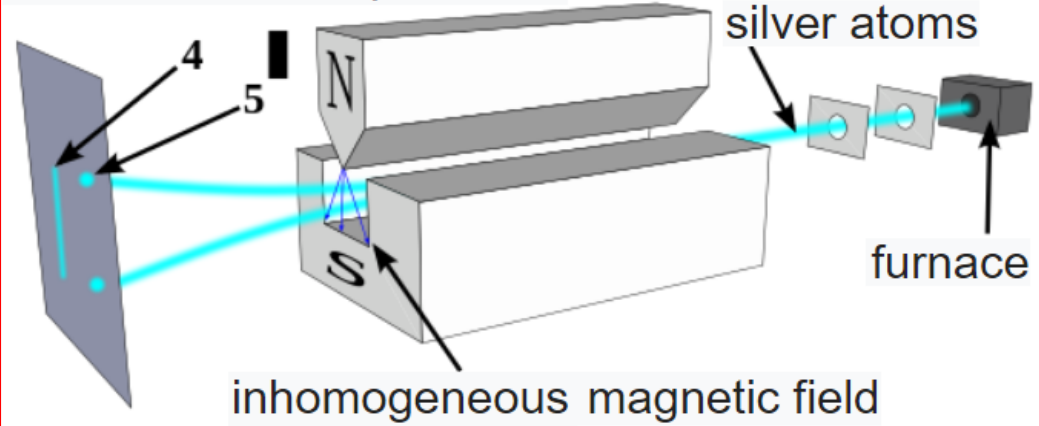

4: expected result. 5: what was actually observed  
 Taylor reproduced the effect using hydrogen atoms in their ground state

## Charging an Insulator

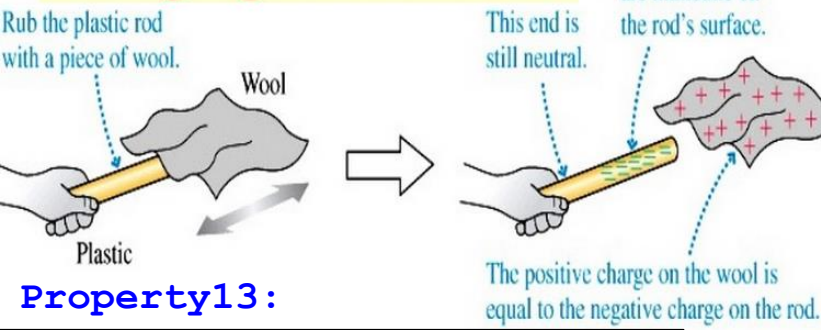

Property14:

Conductors cannot be charged by friction.

However, charge can be transferred to a conductor by contact with a charged object.

The charges arriving at the conductor stay on the outer surface and distribute themselves over that surface so that they are as far away as possible from the repulsive forces of the other charges.

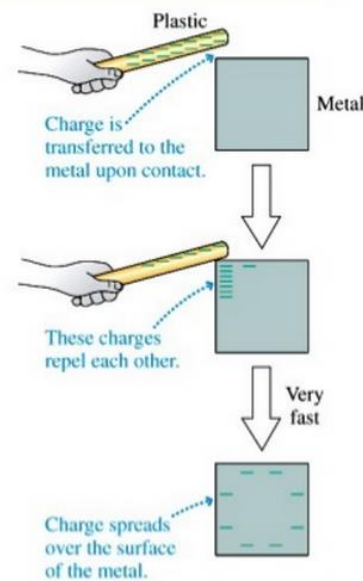

Metals, Nonmetals, and Metalloids																		He
H																		He
Li	Be																	
Na	Mg																	
K	Ca	Sc	Ti	V	Cr	Mn	Fe	Co	Ni	Cu	Zn	Ga	Ge	As	Se	Br	Kr	
Rb	Sr	Y	Zr	Nb	Mo	Tc	Ru	Rh	Pd	Ag	Cd	In	Sn	Sb	Te	I	Xe	
Cs	Ba	La	Hf	Ta	W	Re	Os	Ir	Pt	Au	Hg	Tl	Pb	Bi	Po	At	Rn	
Fr	Ra	Ac	Rf	Db	Sg	Bh	Hs	Mt	Ds	Rg	Uub	Uuq						

copper, Cu  
**Electron configuration**  
 $[Ar] 3d^{10} 4s^1$

**Explanation13:** In conductor atom (e.g. metal, Cu) the outer electron is more free to move because it get very few G's (Gp, Ge, Gn, Gs) per second. But in insulator material (e.g. nonmetal) the outer electron get a lot of G's per second so it is not free to move; (metalloid has properties between metal & nonmetal) When we rub an insulator, the atoms collision eject electron far from an atom, now this electron is on a neutral atom, so it can move to the other neutral atom, which we use for the rubbing, and stay there, and by that charge these both materials. But if we rub conductor, even if we eject the electron far from the atom, the outer electron of all the atoms from the ejected electron to the atom that miss that electron will be pushed in line (each electron only move from its atom to its neighbor atom) & the conductor won't be charged.

**Explanation14:** Charged atom has not equal number of p & e; when a charge atom has contact with conductor, the free to move electrons in the conductor will move to the insulator, or electrons will move to the conductor;

**Rule 10: Magnet transform paired e:** If we place a strong magnet close to an atom that has only paired electrons, the paired electron (e.g.  $Eu1^*$ ) will be changed by the  $Gx$  (e.g.  $Gn1$ ) emitted from the strong magnet & by the  $G$ 's emitted from its paired electron (e.g.  $Gs2^*$ ) into the opposite electron of the electron that emit  $Gx$  (e.g.  $Ed2$ ) { $Gn1 + \text{paired } Eu1 (Eu1^*) \rightarrow Ed2$ } {its because immediately after the collision with  $Gx$  there will be another collision with  $Gs2^*$  but now they aren't synchronized}

- If all electrons in a non magnet atom are paired, we call this atom DiaMagnet (e.g. He, superconductor) & it will repel any strong magnet in any direction by rule 10.

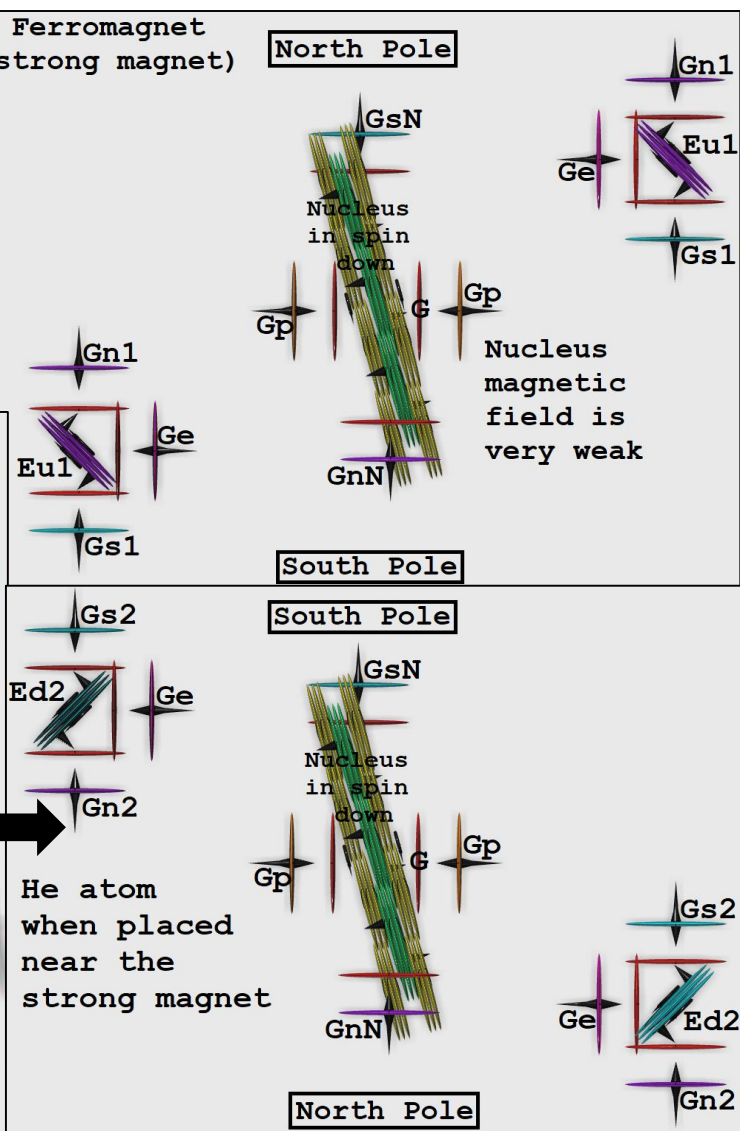
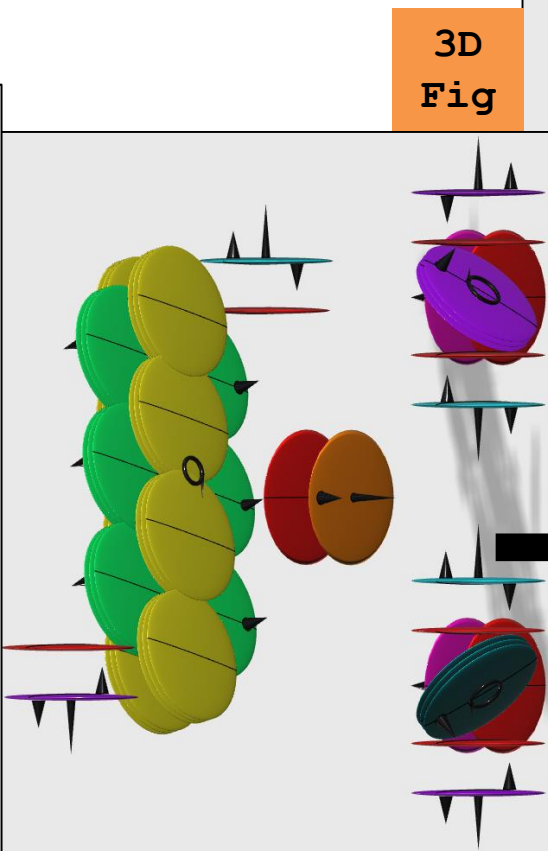
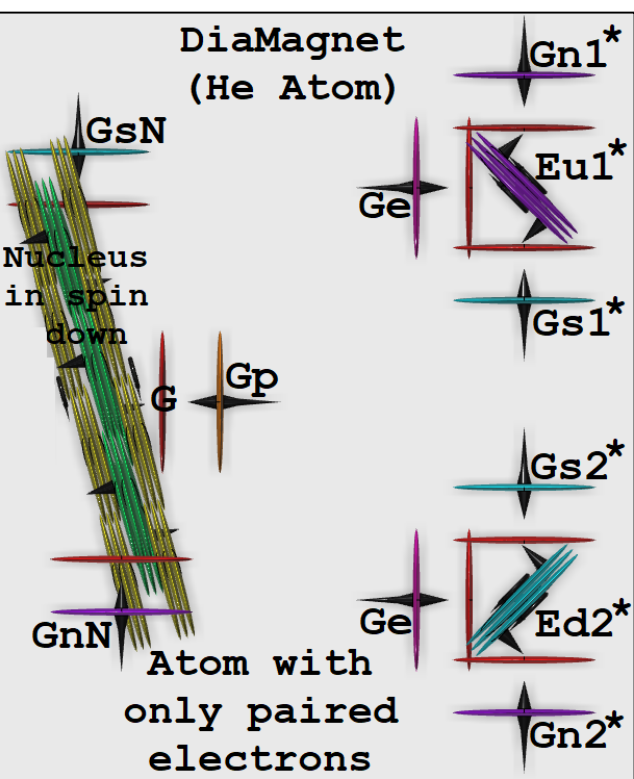



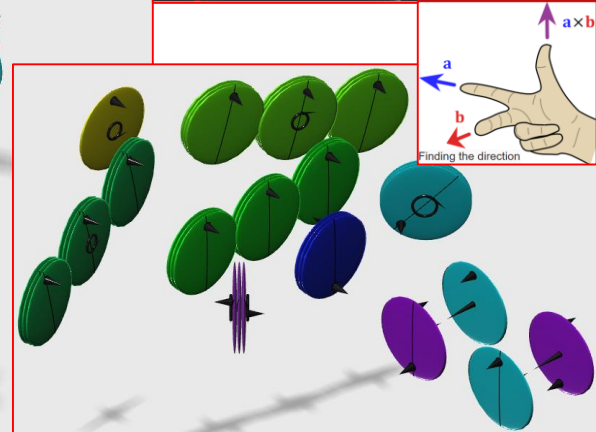
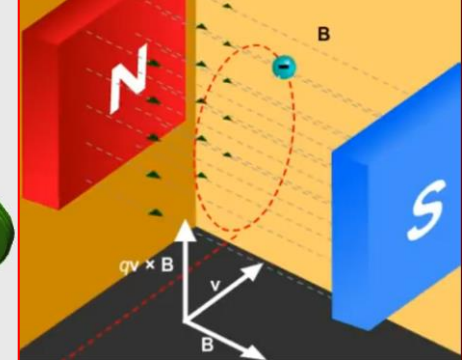
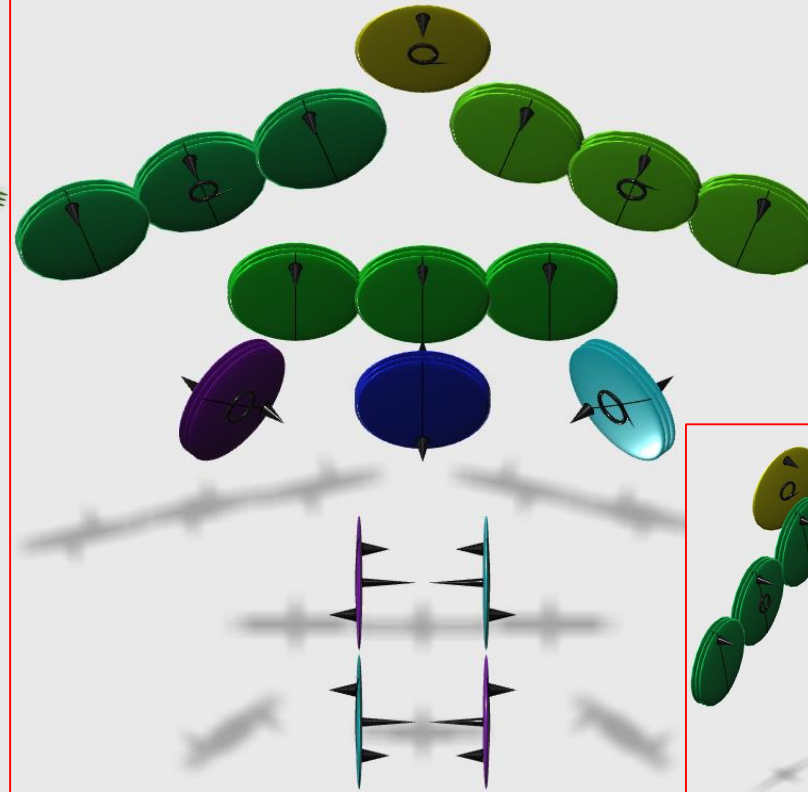
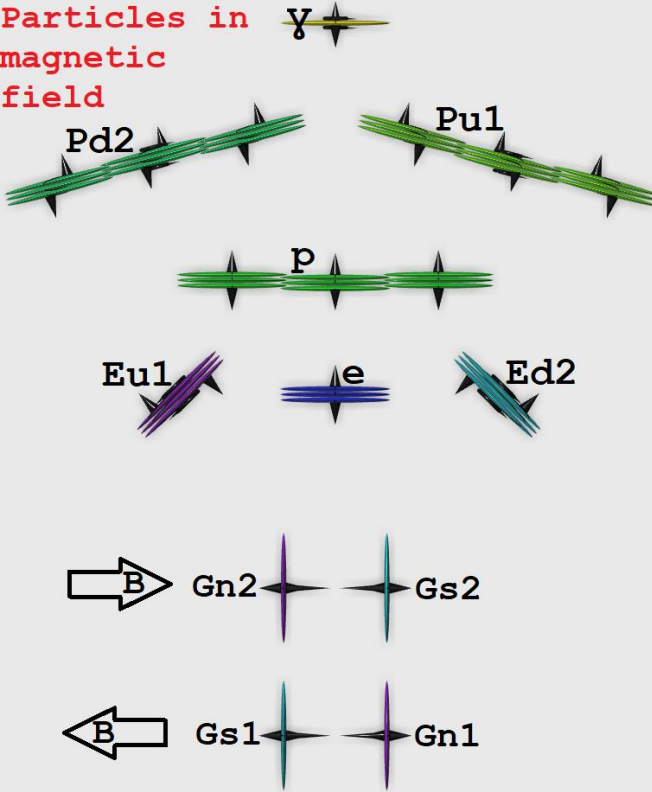

**Rule 15:** The magnetic force ( $F_m$ ) on a charge ( $q$ ) moves ( $v$ =velocity) through a magnetic field ( $B$ )  $F_m = q \cdot v \times B$ ; {For Eu&Ed: $q=-1$ ; For Pu&Pd: $q=1$ ; bigger  $q$  indicate more charges;  $B$  give notion of how many  $G_n, G_s$  traveling & what direction); {this rule can be visualized by field interactions of rule 4a & 4b; direct visualization is harder because this rule involves 2 steps: moving charge create  $B$  by rule 4a and  $B$  change charge spin by rule 9b; the correct way to prove and understand this rule is to use my simulation};

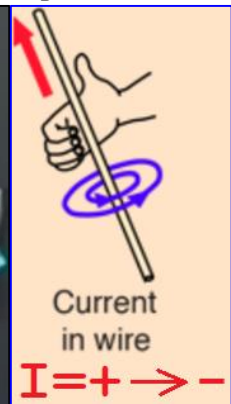
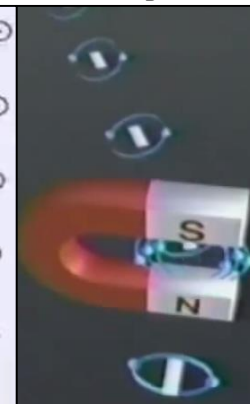
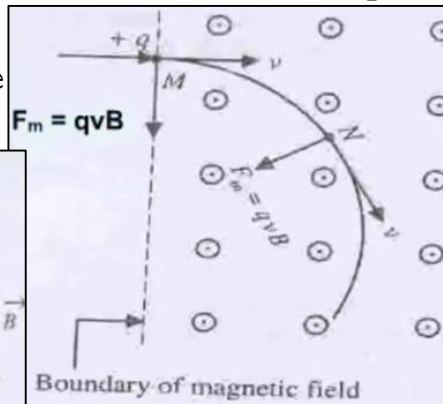
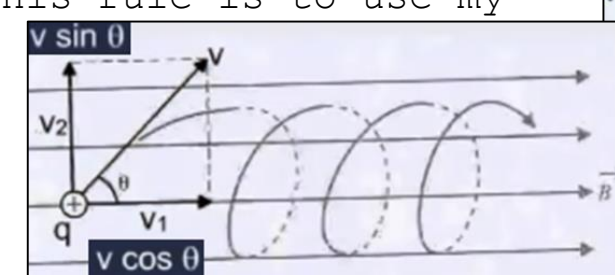

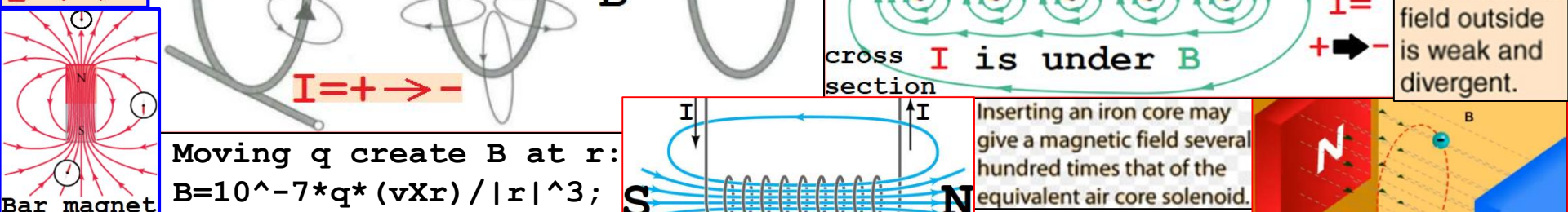
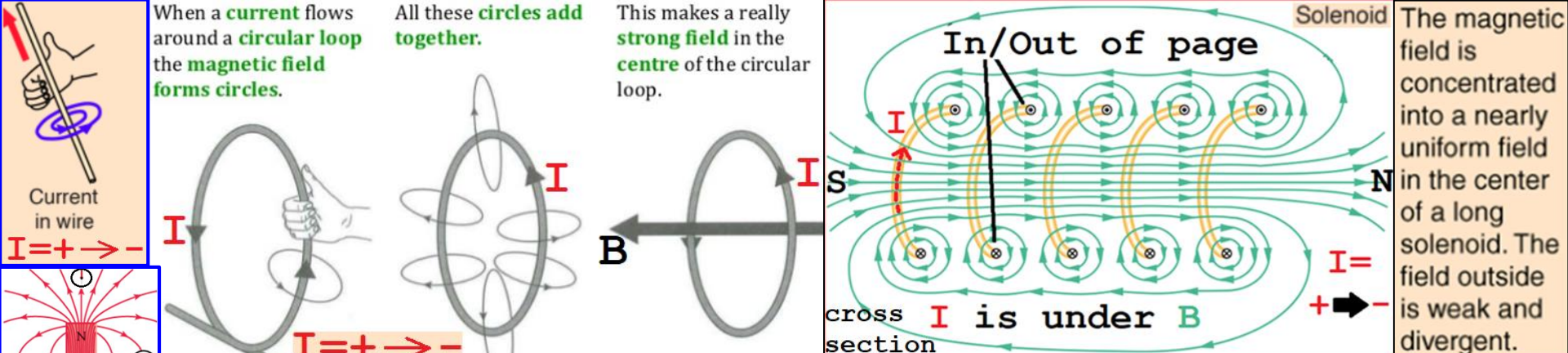

**Property 15:** Current & Magnetic field properties; **Explanation 15:** these 4 properties can be explained by rules 15 & 4a, 4b (upper left)

The current induced by a moving magnet is explained by  $F = q * v \times B$ ;

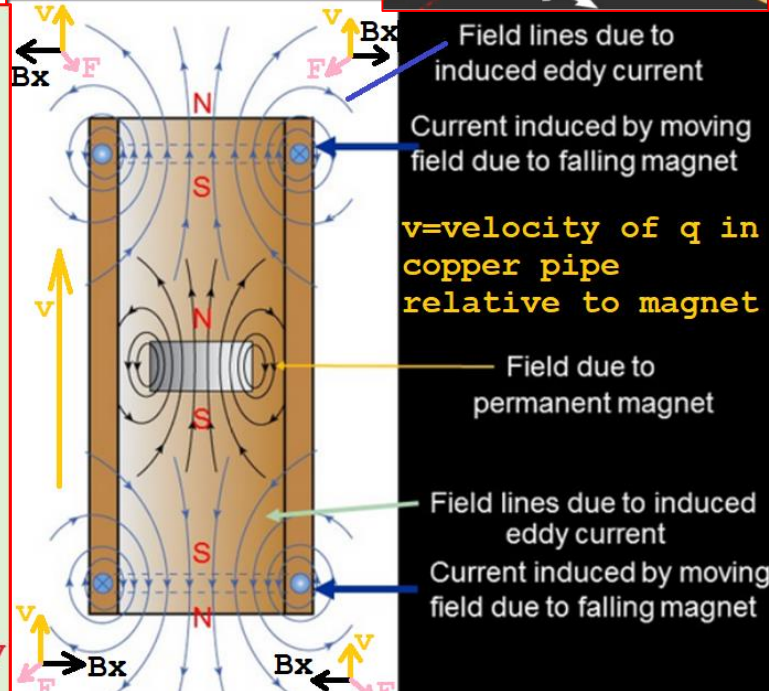
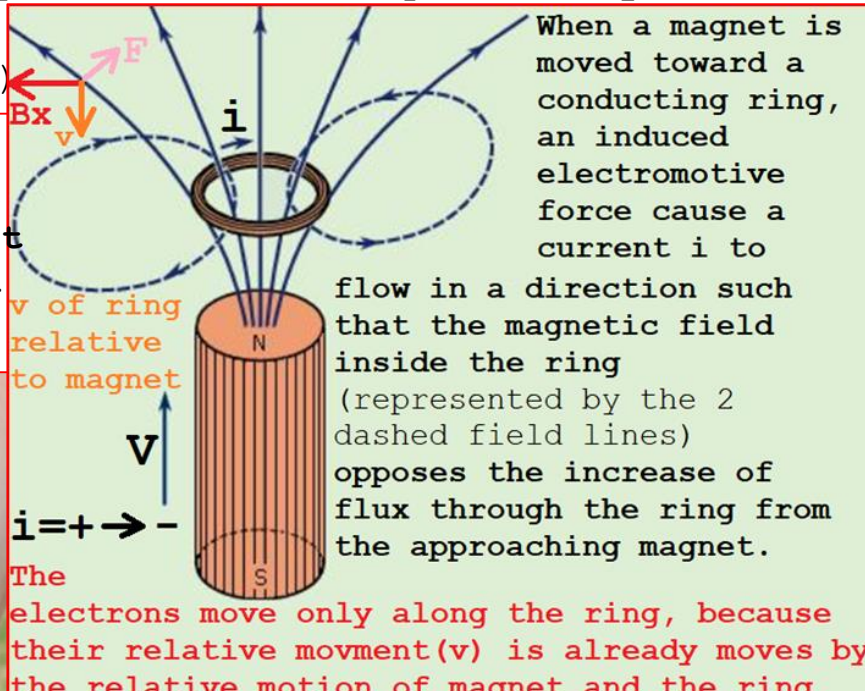



**Property16:** Superconductor stay locked in space, when put near magnet;

**Explanation16:** In superconductor the temperature is very low (we have to cool it with liquid nitrogen) so the atoms don't vibrate and the free electrons can move without colliding with other electrons; So if we place it next to magnet if the magnet will move, a strong current will flow immediately in the superconductor to oppose that movement (by creating B that attract or repel the magnet to oppose its movement, see former page property) thus their relative motion will be cancel and the superconductor will be locked in place; but the superconductor can move on a magnetic rail or to rotate about a round magnet, because by these movements there is no change in the magnetic field;

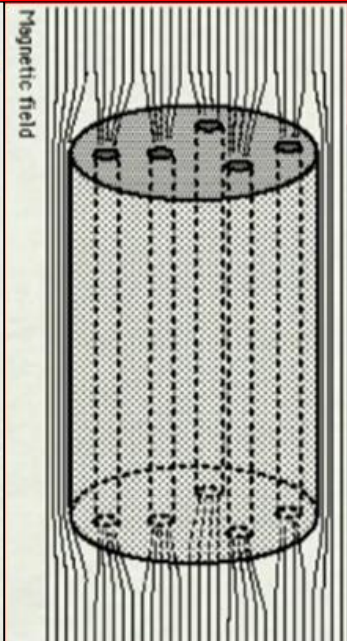
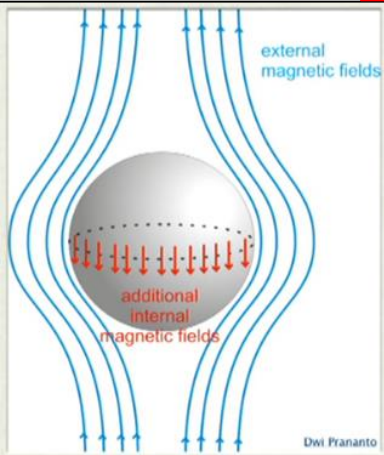
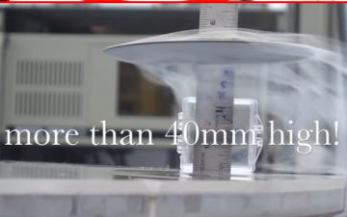
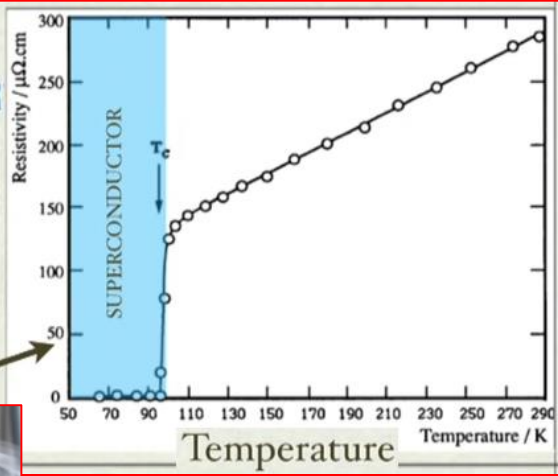
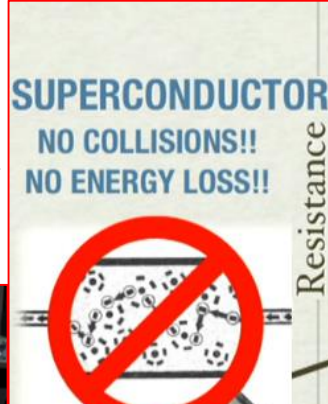

DISCRETE MAGNETIC FIELD LINES PICTURED FROM ABOVE

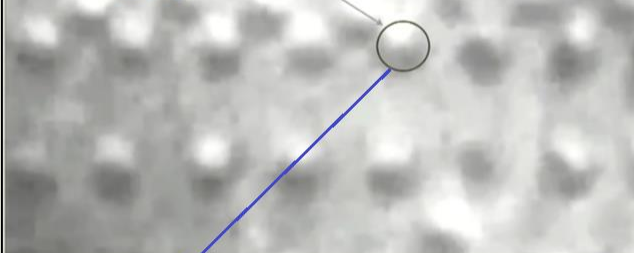

Magnetic field is QUANTIZED inside the superconductor.

This is actually e particle currents around  $\Phi_n$  or  $\Phi_s$

**WHAT IS IT MADE OF?**

**SAPPHIRE**

A CERAMIC COMPOUND OF RARE EARTH METAL (YTRIUM), BARIUM, COPPER AND OXYGEN

SUBSTRATE: SAPPHIRE      TRANSITION TEMPERATURE: 88K (-196°C)

**THE THIN SUPERCONDUCTOR HOLDS MORE THAN 70,000 TIMES ITS WEIGHT !!!!**



**Property17:** Mirror reverse arrangement can have different properties: Co is decay into Ni by beta emission (see beta emission, in this process 2 gamma ray also emitted and their emission is not effected by the nuclear spin). By lowering the temperature to 0.01K and by applying a strong magnetic field, the Co nuclei spins were align either upwards or downwards; then the directions of the emitted electrons were measured; more electrons were emitted in the direction opposite to the magnetic field & thus opposite to the nuclear spin; Thus mirror experiments don't act the same, so parity was violated.

**Explanation17:** In beta emission neutron slide from the nucleus and a piece of it collides with the nucleus & released (this is the emitted electron) because L preserved, the neutron is now proton. So it is more likely that the electron will be emitted mostly from one side of the nucleus spin;

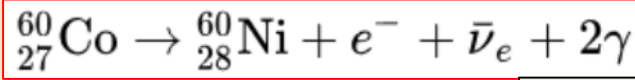
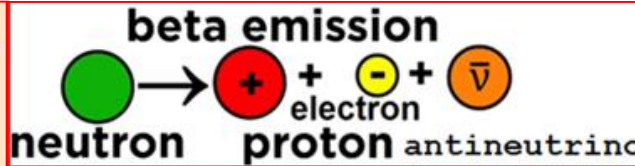
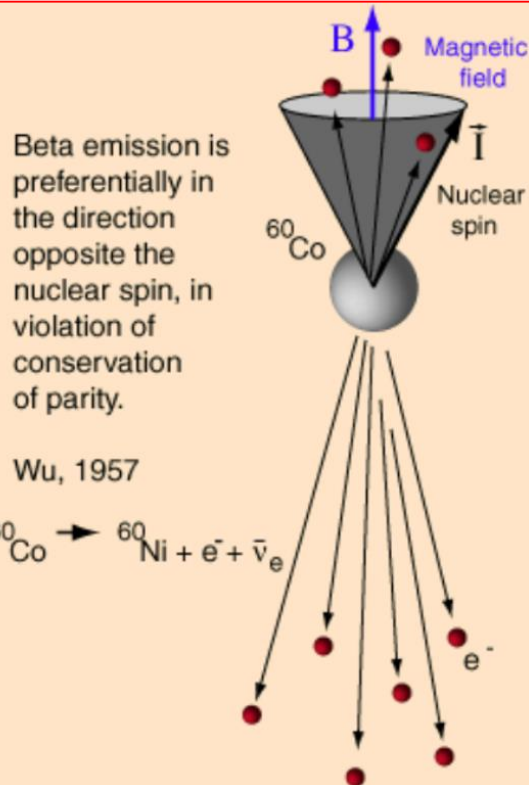

cobalt 27 <b>Co</b> 58.933	nickel 28 <b>Ni</b> 58.693
-------------------------------------	-------------------------------------

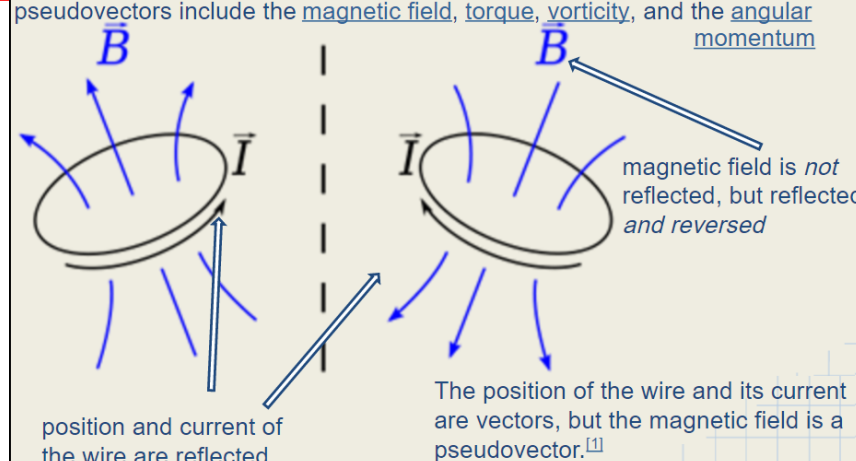
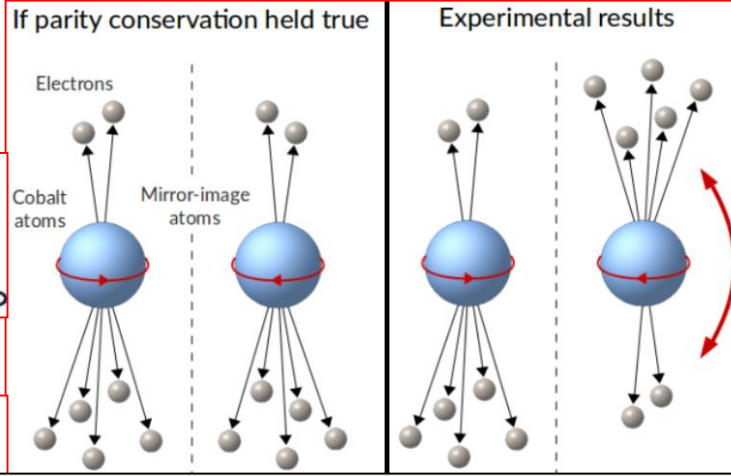



**Property18:** The earth has a magnetic field{earth radius=6,378km, earth core radius=3,478 km & it's made of iron(Fe)&nickel(Ni)} and it flipped every 0.5 million years (few hundreds years before it's gradually decreased); The earth north magnetic pole is not directly related to the rotating axis of the earth.

**Explanation18:** The magnetic field in Fe atom can be flipped if the electron moves (by collision with electron or photon) to the other side of the nucleus, there it will get spin that will transform it into a dipole and then it can influence the other electrons and the nucleus to flip also; then this atom can influence other nearby Fe atoms to flip their magnetic field and eventually most of the earth core will be flipped, the probability of this chain reaction to build up is low but it will happen by chance every 0.5 million years;

The following magnetic properties can be derived from previous properties:

- The atoms in a magnet align themselves in the same direction.
- Cu(copper) is not a permanent magnet, but if we pass an electric current through any metal it becomes a magnet.
- Electromagnet(iron covered by a current carrying wire) remains magnet only as long as current passes through the wire. Electromagnet is a stronger magnet than a current carrying wire without an iron core.
- The strength of the electromagnet is depending on the: strength of the current; number of turns of the coil; the material forming the core.
- When the electromagnet core is made of steel(iron+carbon) instead of iron the electromagnet retains some of its magnetism after current is switched off.

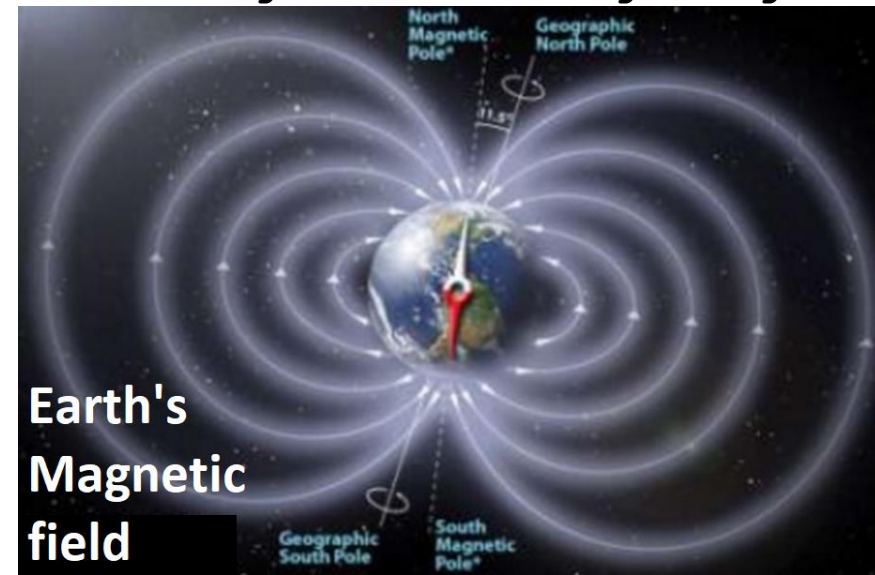

## Light

- If  $e$  (Eu1, Ed2..) accelerated (not only in the direction of its  $z$  axis) & hit  $G$  the result  $G$  will have both angular velocity component along its symmetry axis & along any other axis (it's  $\omega$  will not be in a primary axis) {because  $G$  is not perfectly smooth} and it will also translate, we call it photon ( $\gamma$ ). Because it's  $\omega$  component along the symmetry axis is much smaller than its other  $\omega$  component its motion is:

Draw angular velocity ( $\omega$ ) & angular momentum ( $L$ ) in world coordinates & vector along the symmetry axis ( $z'$ ) for many time points:

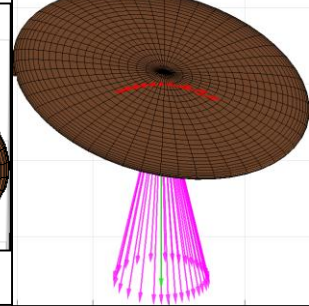
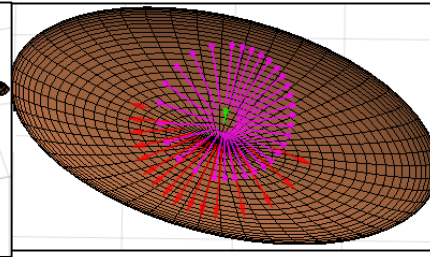
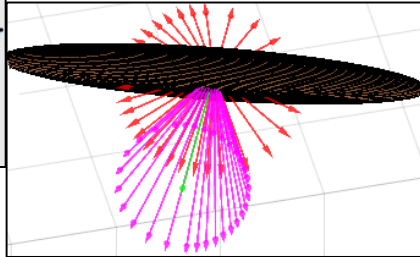
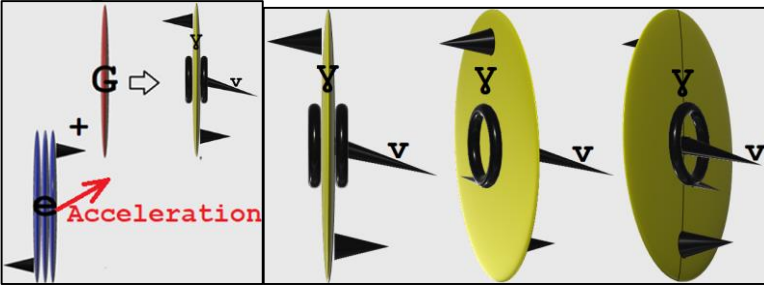

Observer in world frame would see the  $z'$ -axis (&  $\omega$ ) trace out a cone as it precesses about  $L$ ; the body cone ( $z'$  center) rolling along the space cone;  $\omega$  is the line where the 2 cones touch;  $\omega$  also precess about  $z'$ ;

- If the translation vector is perpendicular to  $L$  then we call  $\gamma$  linear polarized light.

- If the translation vector is in the direction of  $L$  then we call  $\gamma$  circular polarized light.

- If the translation vector is in any other direction, we call  $\gamma$  elliptical polarized Light

-  $\omega$  changes with time. when  $\omega$  is in the direction of the  $\omega$  of Ge/Gp particle we say that electric field is max/min; when  $\omega$  is in the direction of the  $\omega$  of Gn/Gs particle we say that Magnetic Field is max/min; as Ge/Gp perpendicular to Gn/Gs.

When one in it's max/min the other in 0;

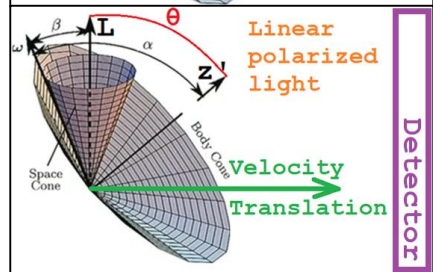
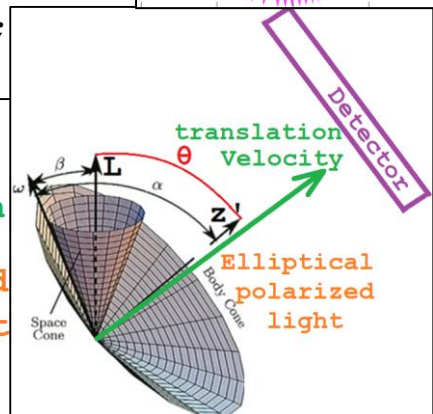
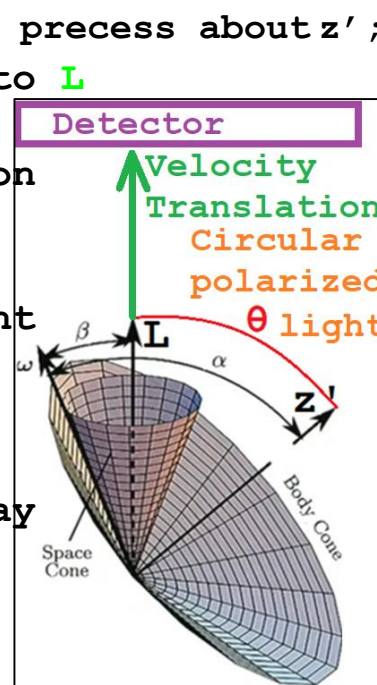

O123=Rotating frame;  
 Oxyz=World frame;

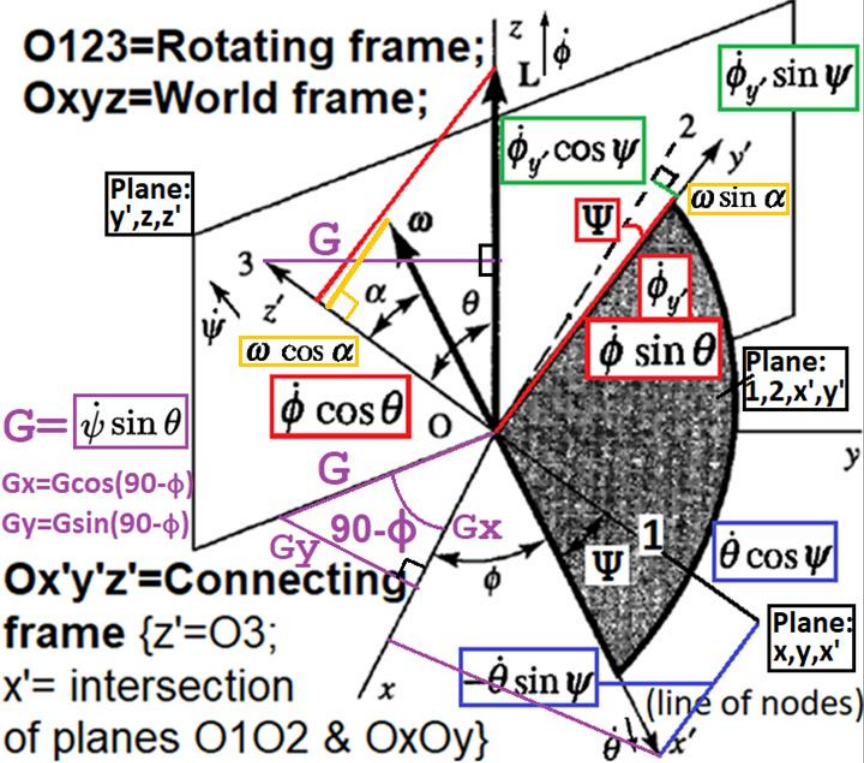

$G = \dot{\psi} \sin \theta$   
 $G_x = G \cos(90 - \phi)$   
 $G_y = G \sin(90 - \phi)$

Ox'y'z'=Connecting frame {z'=O3; x'= intersection of planes O1O2 & OxOy}

z' or 3 axes is  $\Upsilon$  symmetry axis;  
 $\Upsilon$  center of mass is at the origin (O);  
 $\omega_3(t) = \omega_3(0) = \text{constant} = \Upsilon$  spin rate about its symmetry axis in rotating frame [radian/s];  
 -  $\Upsilon$  Frequency =  $f = \text{Cycles/s} = \omega_3(0) / (2 * \pi)$ ; [Hz]  
 -  $\Upsilon$  Period =  $T = t / \text{Cycles} = 2 * \pi / \omega_3(0)$ ;  
 - 2 photons are at phase if their electric fields are at max at the same time point.  
 - Because  $\Upsilon$  is created by e, its main  $\omega$  is in  $\omega(2)$  (like  $G_e, G_p = \text{electric field}$ ); & its perpendicular component that is in  $G_n, G_s$  direction (magnetic field) is **c fold smaller** (c=observe speed of light = 299,792,458 [m/s]);

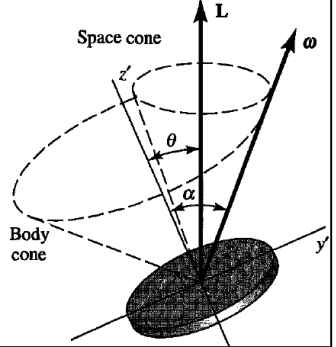

- **Polarizer** can change  $\Upsilon$  as a result of collisions. And when  $\Upsilon$  passes through polarizer it can one time hit e particle and in the other time not because of its precession (it can miss it).
- The bigger  $\omega_3(0)$  the **more space**  $\Upsilon$  will occupy due to its rotation;

- **Sunlight** = many different colored photon = many  $\Upsilon$  particles with different  $\omega$ .
- **Led** = one color but not in phase = many  $\Upsilon$  particles, each with same  $\omega$ , but their initial  $\omega$  and orientation is different.
- **Laser** = one color and in phase = many  $\Upsilon$  particles, each with same  $\omega$ , and their initial  $\omega$  and orientation is the same.

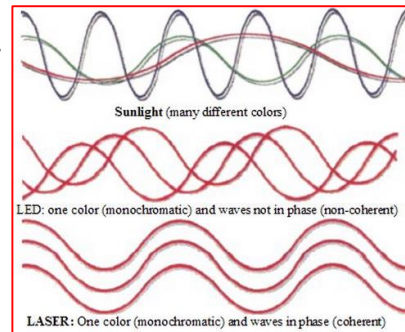



**Property19:** Accelerated charge produce light at  $r$ :  $E(r,t)=-Q*ap(t')*10^{-7}/|r|$ ;  
 $B(r,t)=\hat{r}XE(r,t)/c$ ;  $\{t'=t-|r|/c$ =time before reach us;  $ap$ =a perpendicular to  $r$ =  
 $a-(a \text{ parallel to } r)=a-a\cdot\hat{r}\cdot\hat{r}$ ;  $\hat{r}$ =unit vector of  $r$ ;  $F_{el}$ =electric force on  $q_1$ =  
 $(c^2*10^{-7}*q_1*q_2*r_{21})/|r_{21}|^3$ .  $E_1$ =electric field at position of  $q_1$ = $F_{el}/q_1$ \};

**Explanation19:**  $F_{el}$  &  $E_1$  reduced by  $1/|r|^2$  because they spread in both  $xy$  &  $xz$  planes; but the intensity of light is reduced by  $1/|r|$ , because it spread only in the  $xz$  plane, (if the acceleration is in the  $y$  axis), because the electron moves up and down in  $y$  axis, producing many light particles in all directions in that axis. The higher the acceleration in the direction perpendicular to  $r$  the more chance that  $G$  will be rotated also in it's symetry axis (becuase it is not perfectly smooth) ( $r$  is dictated by the electron charge, so the electron must have an acceleration component perpendicular to  $r$ ) & more photon are created. if we have progressive electromagnetic wave in vacuum:  $|E|/|B|=c$ ; the  $|B|$  component is  $c$  fold smaller then  $|E|$  because  $\gamma$  particle is created by accelerating  $e$  particle so most of the collision hit is in the direction of the main  $\omega$  of  $e$  particle ( $\omega(2)$ , like  $Ge, Gp$ (electric field)) & much less in the direction of  $Gn, Gp$ (magnetic field);  $Q$ =number of  $e$  or  $p$  particles; (the bigger more photons are created & the intensity increased)

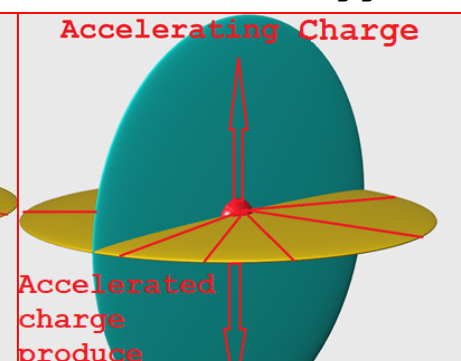
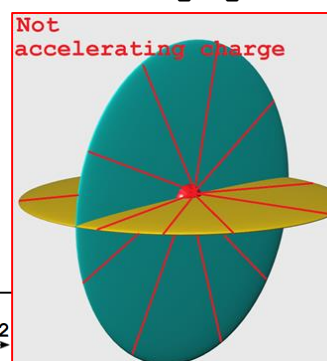
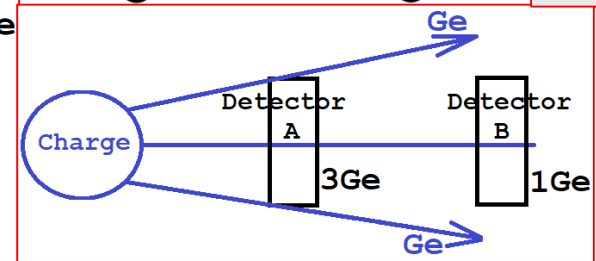
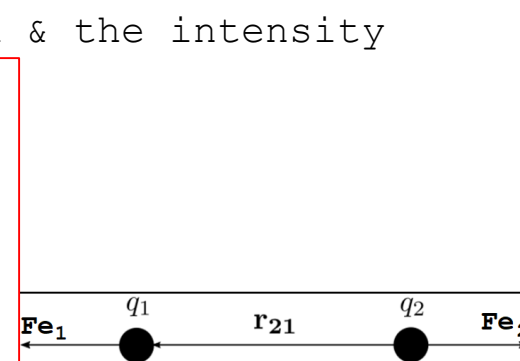
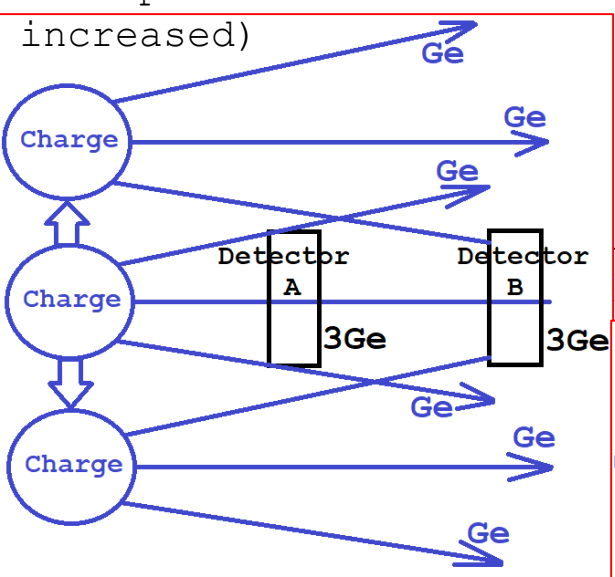

Accelerated charge produce light at  $r$ :  
 $E(r,t)=-q*ap(t')*10^{-7}/|r|$ ;  
 $B(r,t)=\hat{r}XE(r,t)/c$ ;  
 $\{t'$ =time before reach us;  
 $ap$ =acceleration perpendicular to  $r$ \}  
 Light reduced by  $1/|r|$



**Property20:** In vacuum:  $\nabla \cdot \mathbf{E} = 0$ ; &  $\nabla \cdot \mathbf{B} = 0$ ;  $\nabla \times \mathbf{E} = -\partial \mathbf{B} / \partial t$ ;  $\nabla \times \mathbf{B} = 1/c^2 \cdot \partial \mathbf{E} / \partial t$ ;

**Explanation20:**  $\nabla \cdot \mathbf{E} = 0$ ; &  $\nabla \cdot \mathbf{B} = 0$ ; mean that the flow of the electric field (E) ( $G_e$ ,  $G_p$ ) & magnetic field (B) ( $G_n$ ,  $G_s$ ) components of photon don't behaves like a source (or a minus source) at any point; as my theory predict;

$\nabla \times \mathbf{E} = -\partial \mathbf{B} / \partial t$ ; mean that when arrows of E seem to be forming a loop around some region the magnetic field will be increasing inside that region perpendicular to the plane of the loop; as my theory predict (see Spheroid precession part);

$\nabla \times \mathbf{B} = 1/c^2 \cdot \partial \mathbf{E} / \partial t$ ; mean that a loop in B correspond to a change in the E within it perpendicular to the plane of the loop. as my theory predict;

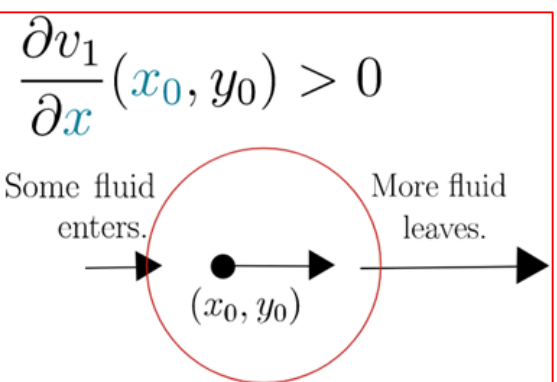

$$\vec{v}(x, y, z) = \begin{bmatrix} v_1(x, y, z) \\ v_2(x, y, z) \\ v_3(x, y, z) \end{bmatrix} \quad \nabla \cdot \vec{v} = \frac{\partial v_1}{\partial x} + \frac{\partial v_2}{\partial y} + \frac{\partial v_3}{\partial z}$$

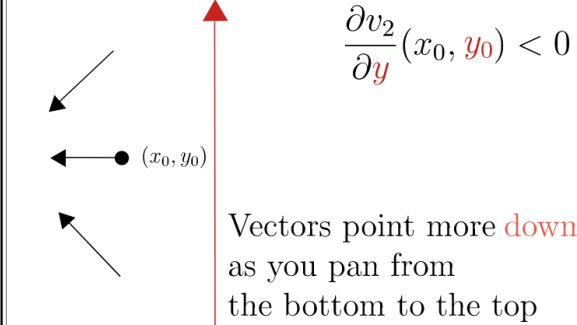
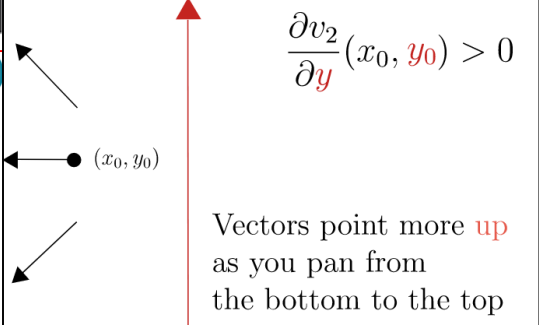
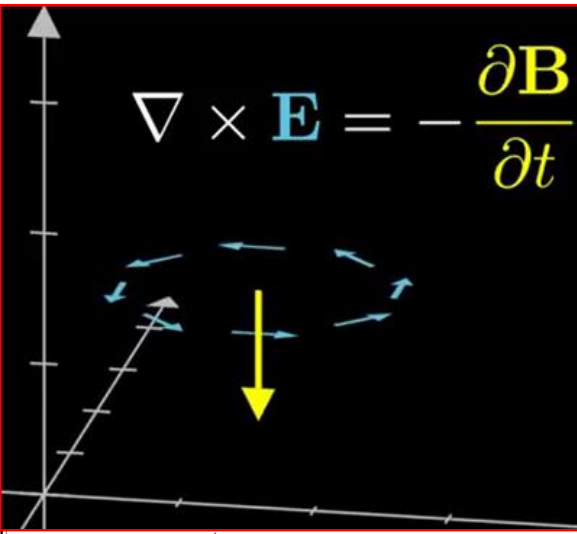
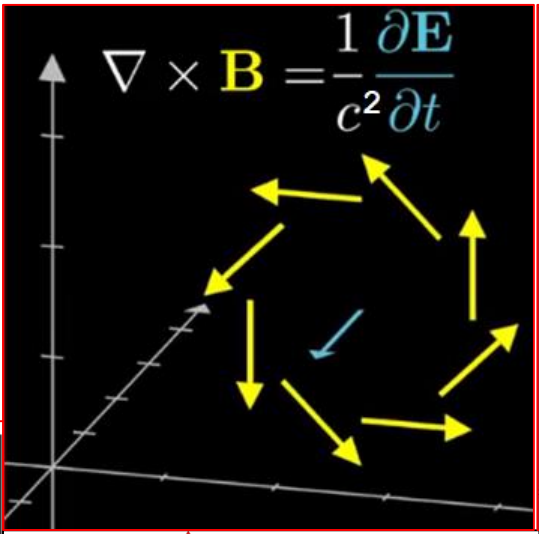
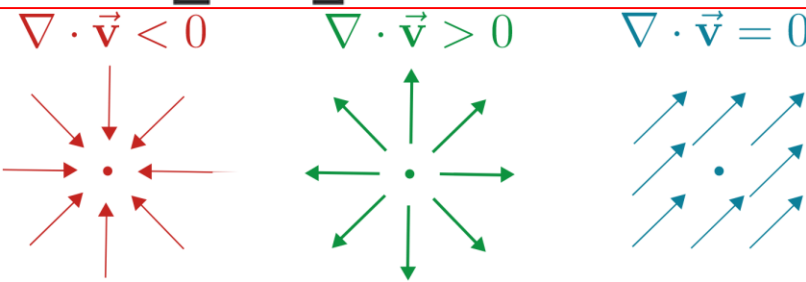

**Rule 11: If the energy of 2 γ equal, their frequency is also equal:** The reason for this lay in the structure of the G particle; when accelerated e collide with G, it will give him big ω(2) but also small ω(1) and tiny ω(3); ω(3) is a rotation about G symmetry axis and the reason it's created is because G is not perfectly smooth spheroid; so there will be need a huge force to create this ω(3); & there will be a strong connection between ω(3) to ω(1)&ω(2)&av

Class	λ [m]	E [eV]	f[Hz] [1/s]	ω(3) [rad/s]	(actual velocity of γ) {the bigger ω(3), the bigger also ω(1) & ω(2) & av}
Gamma ray*	10 <sup>-12</sup>	1.24*10 <sup>6</sup>	3*10 <sup>20</sup>	π*6*10 <sup>20</sup>	
X-ray*	10 <sup>-10</sup>	12.4*10 <sup>3</sup>	3*10 <sup>18</sup>	π*6*10 <sup>18</sup>	
Ultraviolet*	10 <sup>-8</sup>	124	3*10 <sup>16</sup>	π*6*10 <sup>16</sup>	*Ionizing light;
Blue**	495*10 <sup>-9</sup>	2.5	606*10 <sup>12</sup>	π*1212*10 <sup>12</sup>	**Visible;
Green**	570*10 <sup>-9</sup>	2.17	526*10 <sup>12</sup>	π*1052*10 <sup>12</sup>	γ's f=ω(3)/(2*π);
Red**	750*10 <sup>-9</sup>	1.65	400*10 <sup>12</sup>	π*800*10 <sup>12</sup>	h=6.626X10 <sup>-34</sup>
Infrared	10 <sup>-5</sup>	124*10 <sup>-3</sup>	30*10 <sup>12</sup>	π*60*10 <sup>12</sup>	[J*s] [m <sup>2</sup> *kg/s];
Microwave	10 <sup>-2</sup>	124*10 <sup>-6</sup>	30*10 <sup>9</sup>	π*60*10 <sup>9</sup>	Gm=1.78*10 <sup>-54</sup> kg;
Radio	10 <sup>3</sup>	1.24*10 <sup>-9</sup>	300*10 <sup>3</sup>	π*600*10 <sup>3</sup>	c=299,792,458m/s;
ELF	10 <sup>8</sup>	12.4*10 <sup>-15</sup>	3	π*6	h=4.135667662*10 <sup>-15</sup> [eV*s];

**Photon rotational energy**=Gω•GI\*Gω/2=Gω•GM/5\* [(Gs1<sup>2</sup>+Gs3<sup>2</sup>), 0, 0; 0, (Gs1<sup>2</sup>+es3<sup>2</sup>), 0; 0, 0, 2\*Gs1<sup>2</sup>] \*Gω/2=Gω(1)<sup>2</sup>\*GM/10\*(Gs1<sup>2</sup>+Gs3<sup>2</sup>)+Gω(2)<sup>2</sup>\*GM/10\*(Gs1<sup>2</sup>+Gs3<sup>2</sup>)+Gω(3)<sup>2</sup>\*GM/10\*(2\*Gs1<sup>2</sup>)=  
**GM/10\*{ (Gω(1)<sup>2</sup>+Gω(2)<sup>2</sup>) \* (Gs1<sup>2</sup>+Gs3<sup>2</sup>)+Gω(3)<sup>2</sup>\*2\*Gs1<sup>2</sup>}**  
**Photon total energy**=GM\*GV<sup>2</sup>/2+GM/10\*{ (Gω(1)<sup>2</sup>+Gω(2)<sup>2</sup>) \* (Gs1<sup>2</sup>+Gs3<sup>2</sup>)+Gω(3)<sup>2</sup>\*2\*Gs1<sup>2</sup>}  
 =GM/10\* [5\*GV<sup>2</sup>+ (Gω(1)<sup>2</sup>+Gω(2)<sup>2</sup>) \* (Gs1<sup>2</sup>+Gs3<sup>2</sup>)+Gω(3)<sup>2</sup>\*2\*Gs1<sup>2</sup>]  
 ~~~GM/10\* [5\*GV<sup>2</sup>+Gs1<sup>2</sup>\* (Gω(1)<sup>2</sup>+Gω(2)<sup>2</sup>+Gω(3)<sup>2</sup>\*2) ]=GM/10\* [5\*GV<sup>2</sup>+Gs1<sup>2</sup>\* (|Gω|<sup>2</sup>+Gω(3)<sup>2</sup>) ]  
 ~~~GM/2\*GV<sup>2</sup>=GM/2\*function(Gω(3))<sup>2</sup>=h\*f; Gs3→0; 5\*GV<sup>2</sup>>>Gs1<sup>2</sup>\* (|Gω|<sup>2</sup>+Gω(3)<sup>2</sup>) ;  
**and by rule 11:GV=Actual γ velocity=function(Gω(3))=(2\*h\*ω(3)/(GM\*2\*π))<sup>(1/2)</sup>=**  
 10,885,309,412.37\*ω(3)<sup>(1/2)</sup>; m/s

**Rule 9b:** Magnet transform electron(not in atom) & emit same  $\gamma_0$  with an increased probability as the e spin & magnet directions differ: Examples:  $[Gn1+Ed2 \rightarrow Eu1+\gamma_0(100\%)]$   $[Gn1+Eu1 \rightarrow Eu1+\gamma_0(0\%)]$   $[Gn1+Ed4 \rightarrow Eu1+\gamma_0(30\%)]$   $[Gn7+Ed4 \rightarrow Eu7+\gamma_0(80\%)]$

Because of rule 5 the internal energy of each e is constant1 & because each  $Gn, Gs$  is produced by collision between rotating e and G, the energy of each  $Gn, Gs$  is also constant2; so the elastic collision between:  $Energy\_constant2 + Energy\_constant1 \rightarrow Energy\_constant1 + \gamma_0$ ; Thus the energy of  $\gamma_0$  must be also constant( $Gn1$  is transformed to  $\gamma_0$ ); & by Rule 11(which is the reason for:  $E=h \cdot f$ );  $\gamma_0$  frequency is also constant; The reason for the probability to create  $\gamma_0$ , lay in the structure of G, in order to cause rotation about G symmetry axis, e must either accelerate towards G from the  $Gn-Gs$  direction or the collision should be in certain angles, the chance to create these angles increased as the difference between the spin direction and the magnetic field direction increased (as the chance to head to head collision increase for more similar oriented particle) it's a matter of probability, as  $Gn1$  can come in many angles; explanation for particle transformation is in rule 9a; The stronger the magnetic field the more  $Gn$  particles emitted & the faster  $Eu1$  transformed.

**property21:** If we prepare electron with spin in  $S1$  direction and we put it in magnetic field in  $S2$  direction, where  $\theta$  is the angle between  $S1$  &  $S2$ ; the electron spin will change to  $S2$ ; & the probability that it will not emit photon =  $(\cos(\theta/2))^2$ ; if emitted the photon frequency will be always the same regardless  $S1$  or  $S2$ ; **Explanation21:** rule9b;

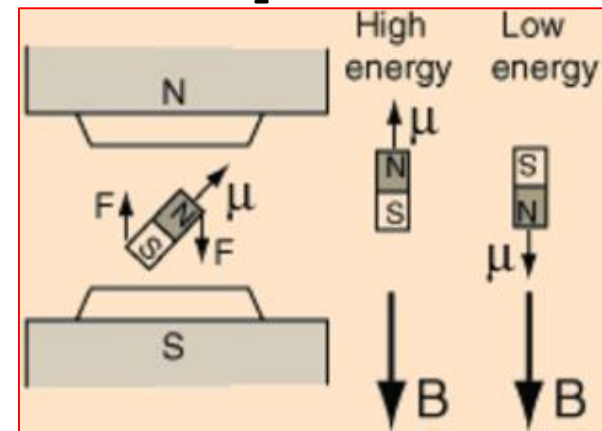

- we can't measure the y & x component of the electron ( $E_{y1}$ ) spin because when we measure the x component we use magnetic field  $G_{nx}$  that change  $E_y$  into  $E_{yx}$ .

**Rule 12: In atom, The total energy of each electron is different:** In atom the electron is thrown from one side of the nucleus to its other side by  $G_p$  particles, and because the electron and nucleus angular velocities are periodically, the electron will visit approximately the same places, we call these places the probability cloud or orbitals; the orbital shape can be different for different electrons; some shape of orbital give the electron more extra energy than other orbital, because the electron velocity or orbital angular momentum increased their, or because the electron is more far from the nucleus so its potential energy increases (the electron will transfer its potential energy into kinetic energy when accelerated toward the nucleus, which increase its velocity) (the internal energy of each electron remain the same and its depend only on its  $\omega$ );



**Rule 13:** Gn<sub>x</sub> can be created in any atom in few numbers & in specific locations only; The nucleus & the electrons in the atom throw many Gp & Ge particles, the common orientation and rotation of them and the most powerful are as described; but very few of them, may look like Gn; these particles come with angles so they will be usually in specific location in the atom; they will collide with the electron there in phase, and if another electron will come to this location they will transform it to the natural electron in this location; - By rule 9b: Eux transform Gny(or Gsy) to Y only if x & y are different; (In order to create the rotation about the symmetry axis of Gny the collision must be in certain angles);

**Property22:** Photon absorption & emission in atom in gas or other material;

**Explanation22:** If Y collide with electron that is in atom, the electron will change its  $\omega$  & will be thrown farther from the nucleus; The higher  $|\omega|$  of the Y, the farther the electron will be thrown from the nucleus, and by Rule 12 the total energy this electron get increases; Because the electron  $\omega$  changed by this collision its spin is transformed (e.g.  $\Upsilon^3 + Ed^2 \rightarrow Eu^3$ ); Then (far from nucleus) e will collide with Gp's and start accelerate toward the nucleus, getting higher and higher velocity (and kinetic energy), when the electron reach its natural location, it will collide with Gn, Gs (Gn<sup>2</sup>) there transform its spin back and give this Gn the access energy and transform it into Y; (so the all process is:  $\Upsilon^3 + Ed^2 \rightarrow Eu^3[v^3]$ ;  $v^3 = \text{velocity}$ ;  $Eu^3[v^3] + Gp's \rightarrow Eu^3[0]$ ;  $Eu^3[0] = 0$  velocity but far location;  $Eu^3[0] + Gp's \rightarrow Eu^3[-v^3]$ ;  $Eu^3[-v^3] + Gn^2 \rightarrow Ed^2 + \Upsilon^3$ ) (Gp's can throw the electron from side to side, such that its max velocity is  $|-v^3|$  or  $|+v^3|$ , until it reach its natural place and collide with Gn<sup>2</sup>); if this process happened we say that the electron is not absorbed; if the electron stay in its new location when it is  $Eu^3[0]$  (because many Ge's hit him and make him stay there) we say the electron is absorbed; afterwards if Ge miss the electron it may collide with Gp & start accelerate to its natural place & there hit Gn<sup>2</sup> and transform to its natural spin while transforming Gn<sup>2</sup> to  $\Upsilon^3$

(give him all the access kinetic energy; energy always conserved, it's not a nature law but a mathematical true that can be proven from the definition of space and time, see my collision truths book); **this process can be also a multistep process** (While coming back the electron can hit Gn5 in different orbital & transform it to  $\gamma_2$  and stay there and only then come back); If the atom is not in gas(solid or liquid) there are many Ge's from the atoms around, and if the coming back electron will collide with these Ge's it will lose its kinetic energy before hitting Gn5, so when hitting Gn5, it will not transform it into the original photon(let's call this process black absorption); **Because the internal energy of each electron is the same, only its kinetic energy[v] determine the photon energy;**

**Examples:**

1-non absorption process:  $\gamma_4 + \text{Eu}_5 \rightarrow \text{Ed}_4[v_4]$ ;  $\text{Ed}_4[v_4] + \text{Gp}'s \rightarrow \text{Ed}_4[0]$ ;  
 $\text{Ed}_4[0] + \text{Gp}'s \rightarrow \text{Ed}_4[-v_4]$ ;  $\text{Ed}_4[-v_4] + \text{Gn}_5 \rightarrow \text{Eu}_5 + \gamma_4$ ;

2-Absorption process:  $\gamma_4 + \text{Eu}_5 \rightarrow \text{Ed}_4[v_4]$ ;  $\text{Ed}_4[v_4] + \text{Gp}'s \rightarrow \text{Ed}_4[0]$ ;  
 ( $\text{Ed}_4[0] + \text{Ge}'s \rightarrow \text{Ed}_4[+\delta]$ ; &  $\text{Ed}_4[+\delta] + \text{Gp}'s \rightarrow \text{Ed}_4[0]$ ;  $\delta$ =low velocity; this repeat many times);  $\text{Ed}_4[0] + \text{Gp}'s \rightarrow \text{Ed}_4[-v_4]$ ;  $\text{Ed}_4[-v_4] + \text{Gn}_5 \rightarrow \text{Eu}_5 + \gamma_4$ ;

3-Multistep absorption process:  $\gamma_4 + \text{Eu}_5 \rightarrow \text{Ed}_4[v_4]$ ;  $\text{Ed}_4[v_4] + \text{Gp}'s \rightarrow \text{Ed}_4[0]$ ;  
 $\text{Ed}_4[0] + \text{Gp}'s \rightarrow \text{Ed}_4[-v_1]$ ;  $\text{Ed}_4[-v_1] + \text{Gn}_3 \rightarrow \text{Eu}_3[0] + \gamma_1$ ;  $\text{Eu}_3[0] + \text{Gp}'s \rightarrow \text{Eu}_3[-v_3]$ ;  
 $\text{Eu}_3[-v_3] + \text{Gn}_5 \rightarrow \text{Eu}_5 + \gamma_3$ ; {energy preserve so energy of  $\gamma_1 + \gamma_3 = \gamma_4$ }

4-black absorption process:  $\gamma_4 + \text{Eu}_5 \rightarrow \text{Ed}_4[v_4]$ ;  $\text{Ed}_4[v_4] + \text{Gp}'s \rightarrow \text{Ed}_4[0]$ ;  
 $\text{Ed}_4[0] + \text{Gp}'s \rightarrow \text{Ed}_4[-v_4]$ ;  $\text{Ed}_4[-v_4] + \text{Ge}'s \rightarrow \text{Ed}_4$ ;  $\text{Ed}_4 + \text{Gn}_5 \rightarrow \text{Eu}_5$ ;

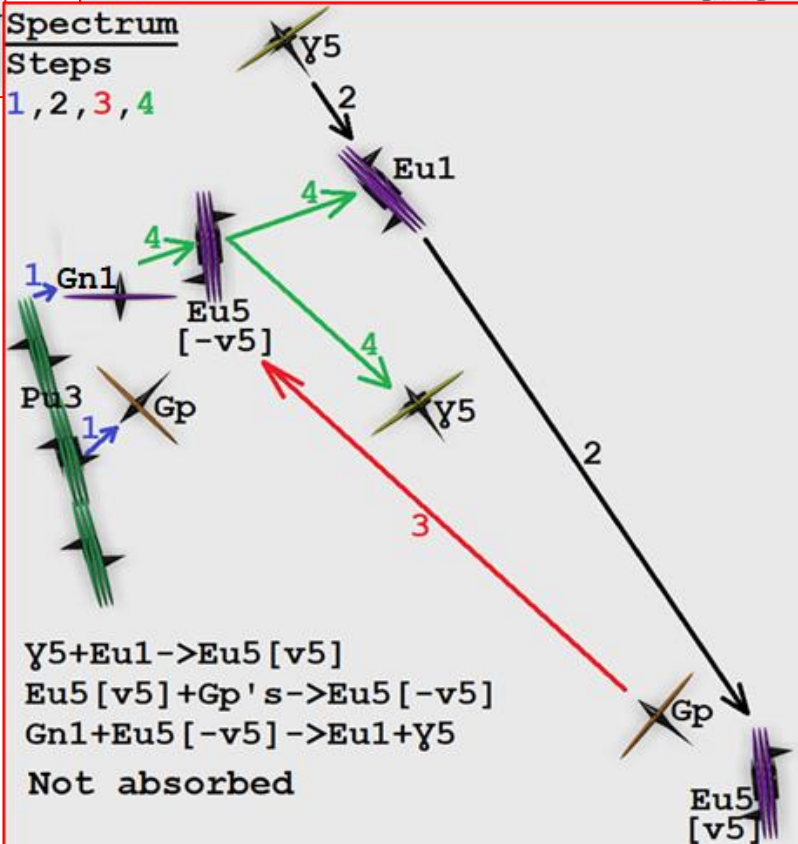
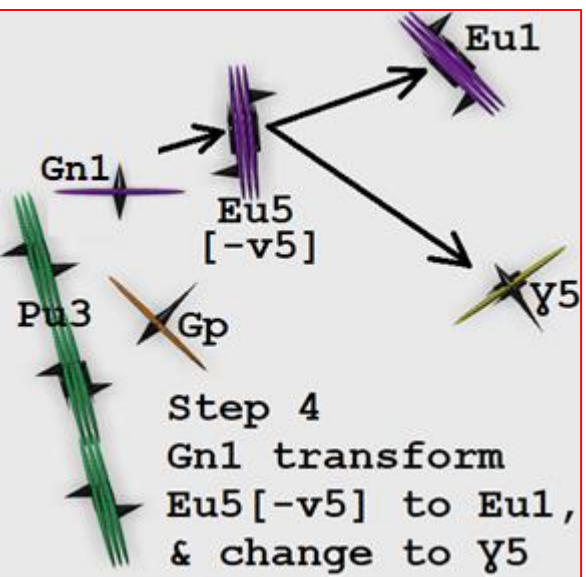
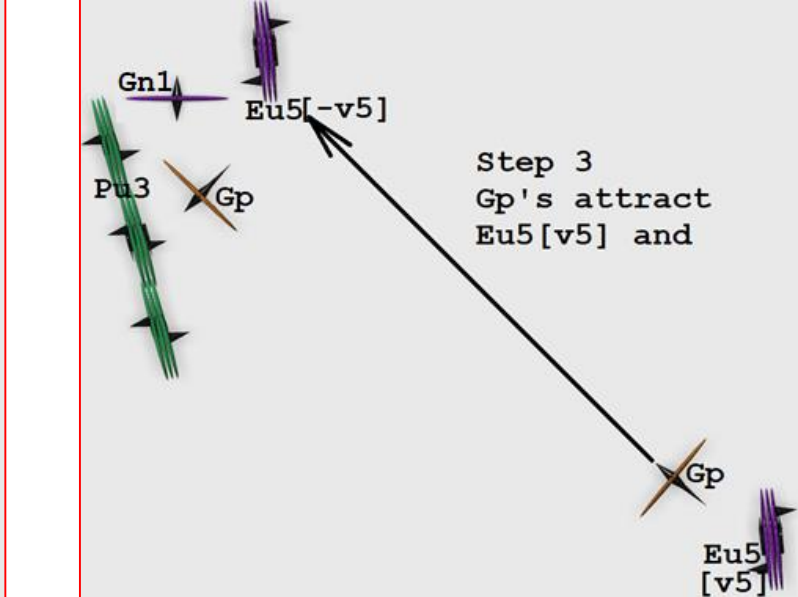
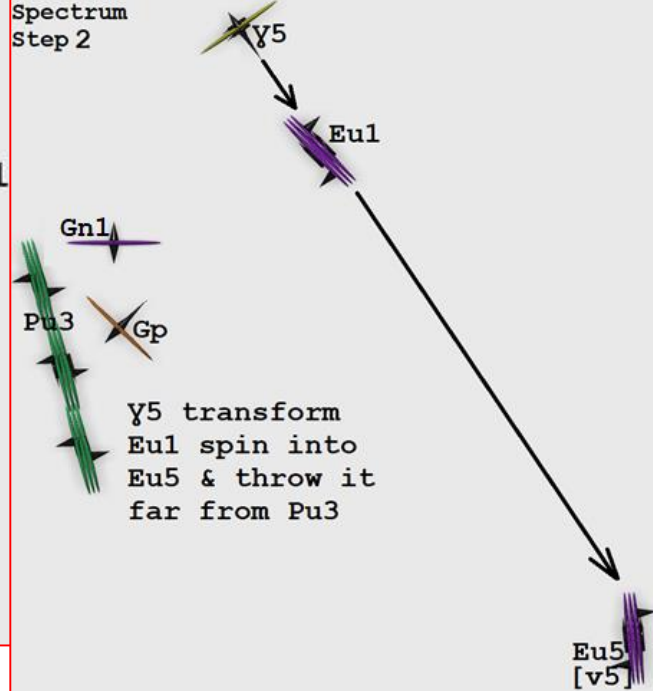
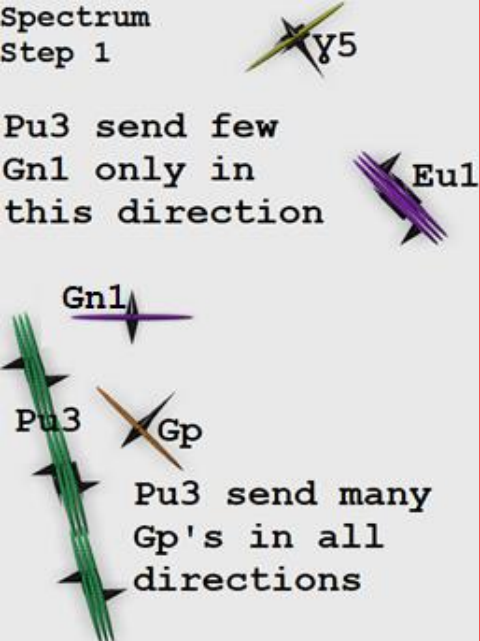

### Spectrum B

Steps

- 1, 2, 3  
4, 5, 6

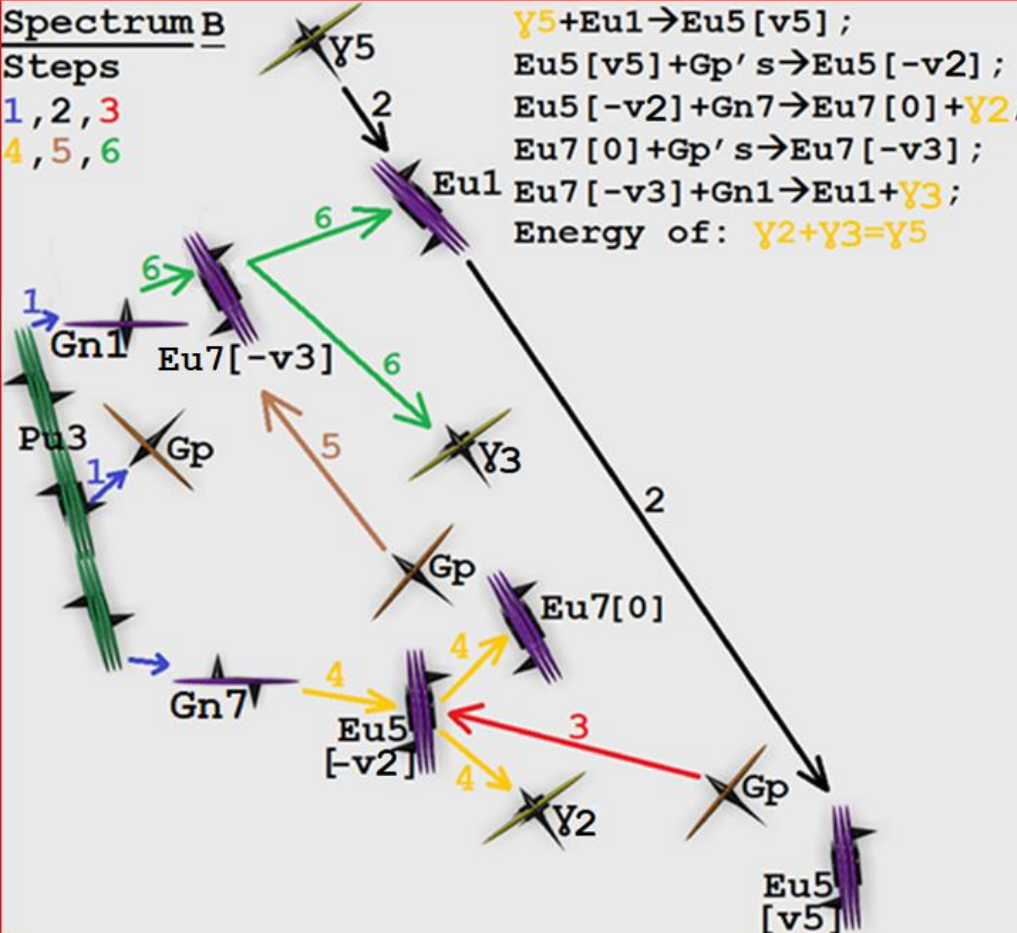

### Spectrum C

Steps

- 1, 2, 3, 4, 5

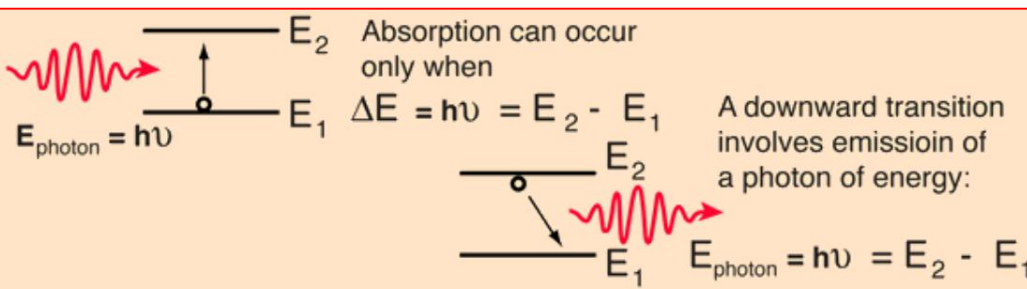
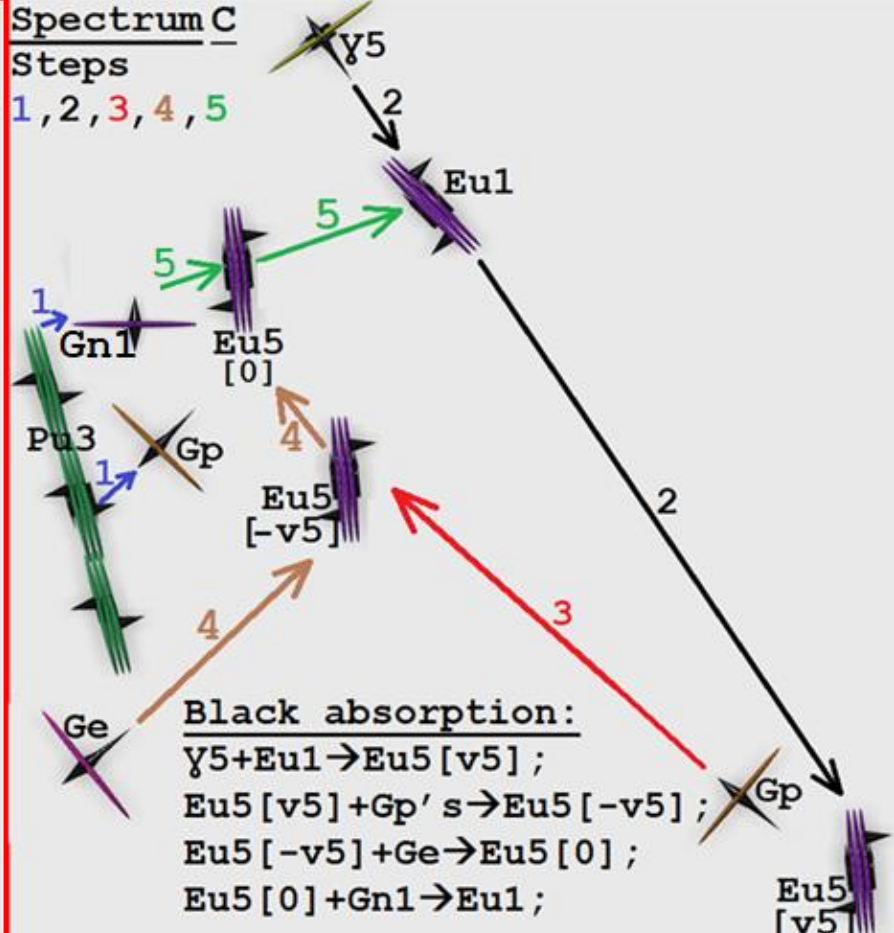

# Absorption Spectra



# Fluorescence

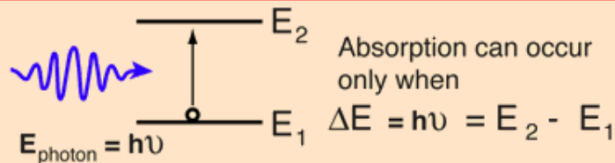

It is possible for the absorbing atom or molecule to lose some energy to the crystal lattice or by collisional processes, so that now the excited electron is in a lower energy level.

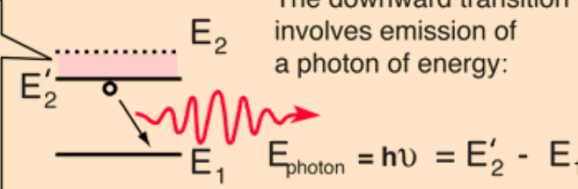

Fluorescence is always at a lower quantum energy and longer wavelength than the originally absorbed photon, a requirement for conservation of energy.

## Fluorescence

Steps  
1, 2, 3, 4, 5

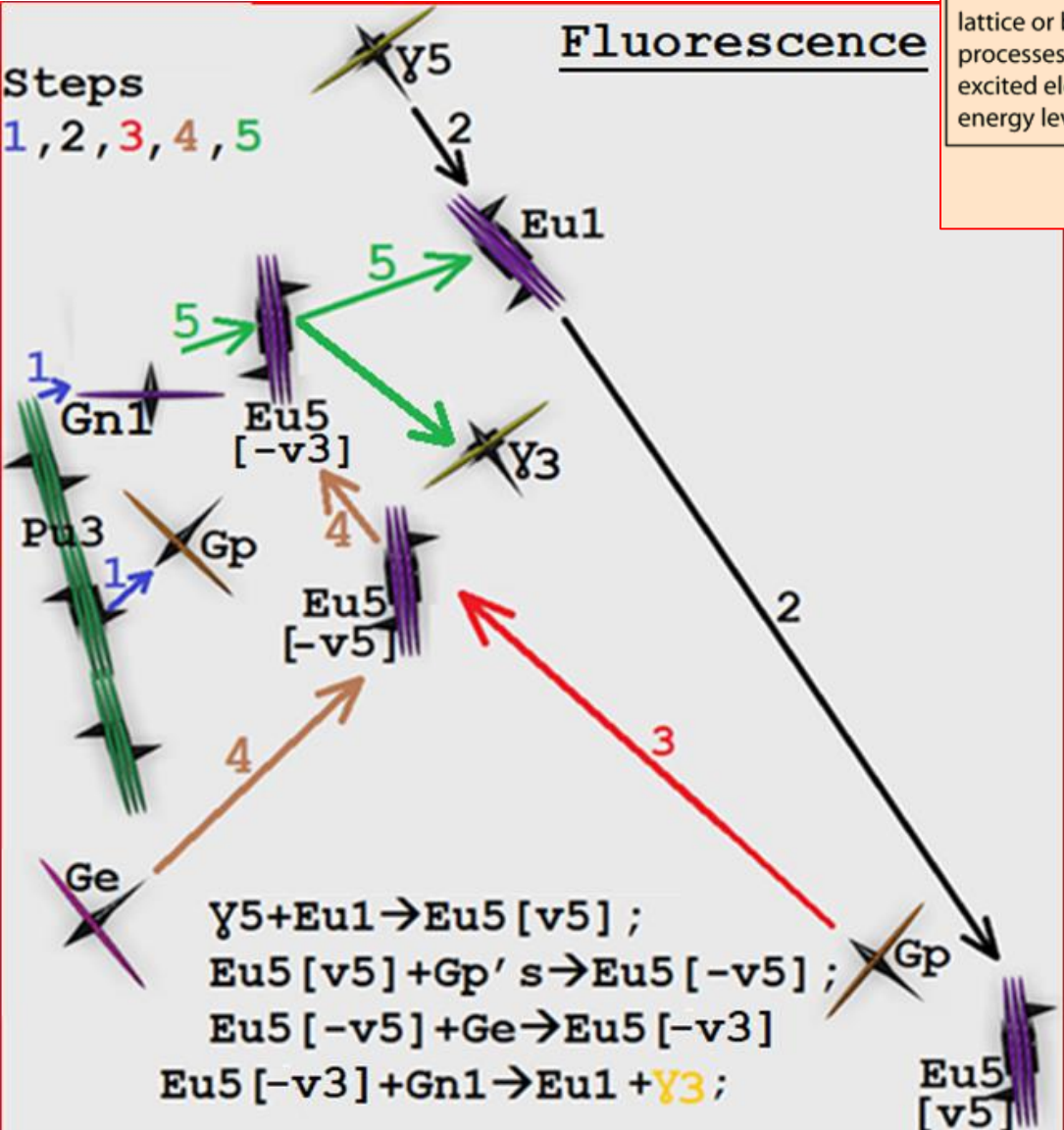

**Property23: Fluorescence;**  
**Explanation23:**  $\gamma_5$  hit Eu1 (for example) & transform it to Eu5[v5]; Gp attract it, but now on the way back to its natural position Ge hit him and reduce its velocity from Eu5[-v5] to Eu5[-v4] so now when it hit Gn1 it will transform it to  $\gamma_4$  and not to  $\gamma_5$ ;

$[\gamma_5 + \text{Eu1} \rightarrow \text{Eu5} [v_5]$  ;  
 $\text{Eu5} [v_5] + \text{Gp} \rightarrow \text{Eu5} [-v_5]$  ;  
 $\text{Eu5} [-v_5] + \text{Ge} \rightarrow \text{Eu5} [-v_4]$  ;  
 $\text{Eu5} [-v_4] + \text{Gn1} \rightarrow \text{Eu1} + \gamma_4$  ;

**Property24:** Stimulated emission; **Explanation24:**  $\gamma_5$  hit Eu1 (for example) & transform it to Eu5[v5] and throw it to farther orbital, but there is already excited electron/s (electron that this place is not its natural position) in this orbital, so they hit each other with Ge, and come back each to its natural position but because they all located in the same orbital now (same distance from nucleus & same orbital angular momentum & same spin) they will have the same velocity when reach their natural orbital, which is also the same for all of them but with lower n (closer to nucleus), so when they collide with their Gn (each with different Gn1, Gn3..) they will emit same  $\gamma_5$  (because the internal energy of each electron is the same and only the energy of its velocity (KE) is transformed to photon) exactly in the same time

so the  $\gamma_5$ 's are in phase;  $[\gamma_5 + \text{Eu1} \rightarrow \text{Eu5}[\text{v5}]]$ ;  
 $\text{Ge (from Eu5}[\text{v5}]) + \text{Eu7} + \text{Gp} \rightarrow \text{Eu7}[-\text{v5}]$ ;  
 $\text{Ge (from Eu7)} + \text{Eu5}[\text{v5}] + \text{Gp} \rightarrow \text{Eu5}[-\text{v5}]$ ;  
 $\text{Eu7}[-\text{v5}] + \text{Gn3} \rightarrow \text{Eu3} + \gamma_5$ ;  $\text{Eu5}[-\text{v5}] + \text{Gn1} \rightarrow \text{Eu1} + \gamma_5$ ;

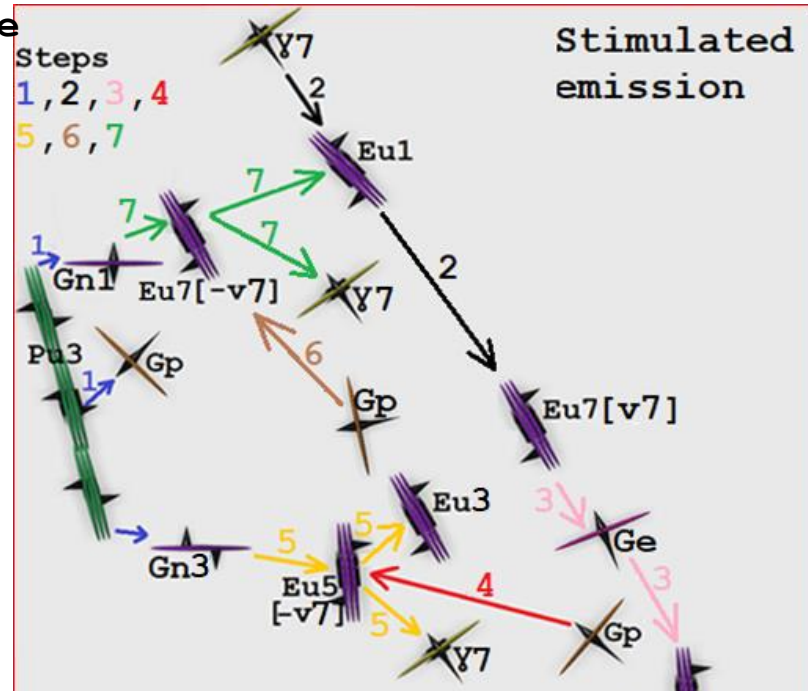

$\gamma_7 + \text{Eu1} \rightarrow \text{Eu7}[\text{v7}]$ ;  
 $\text{Ge (of Eu7}[\text{v7}]) + \text{Eu5}[\text{0}] + \text{Gp} \rightarrow \text{Eu5}[-\text{v7}]$ ;  
 $\text{Eu7}[\text{v7}] + \text{Gp} \rightarrow \text{Eu7}[-\text{v7}]$ ;  
 $\text{Eu5}[-\text{v7}] + \text{Gn3} \rightarrow \text{Eu3} + \gamma_7$ ;  
 $\text{Eu7}[-\text{v7}] + \text{Gn1} \rightarrow \text{Eu1} + \gamma_7$ ;

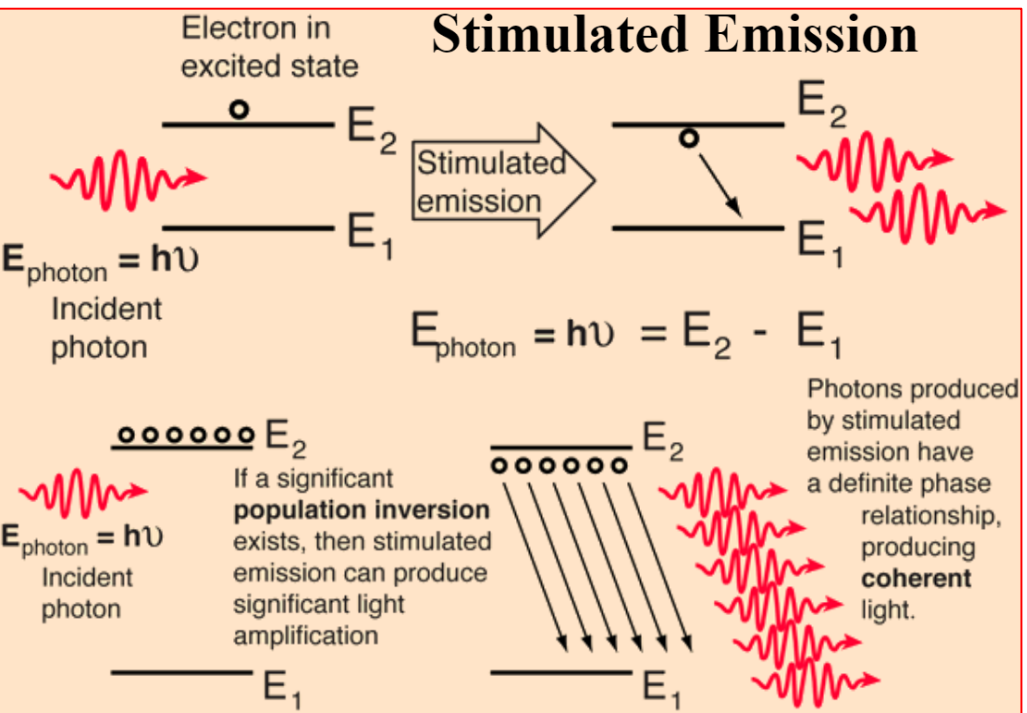

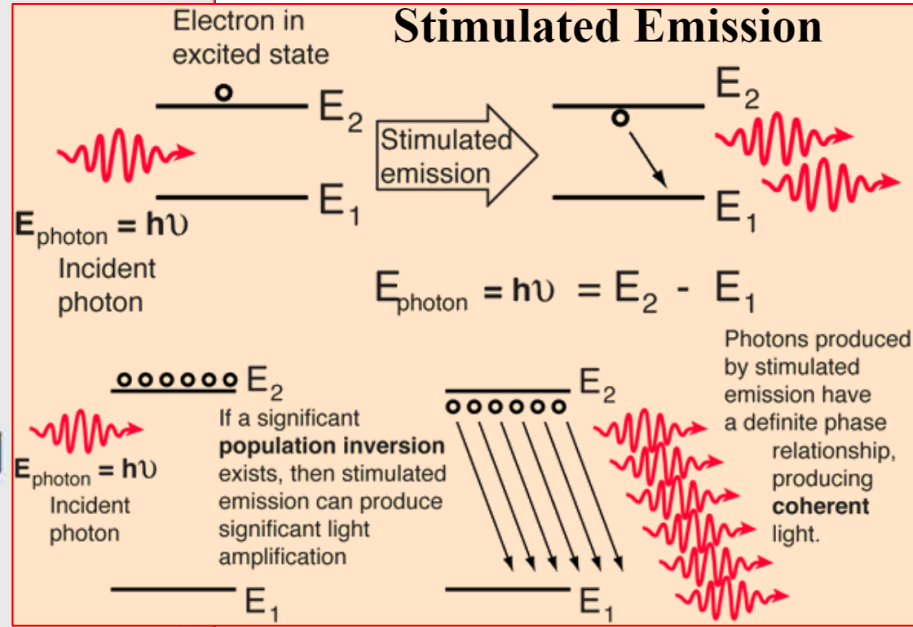
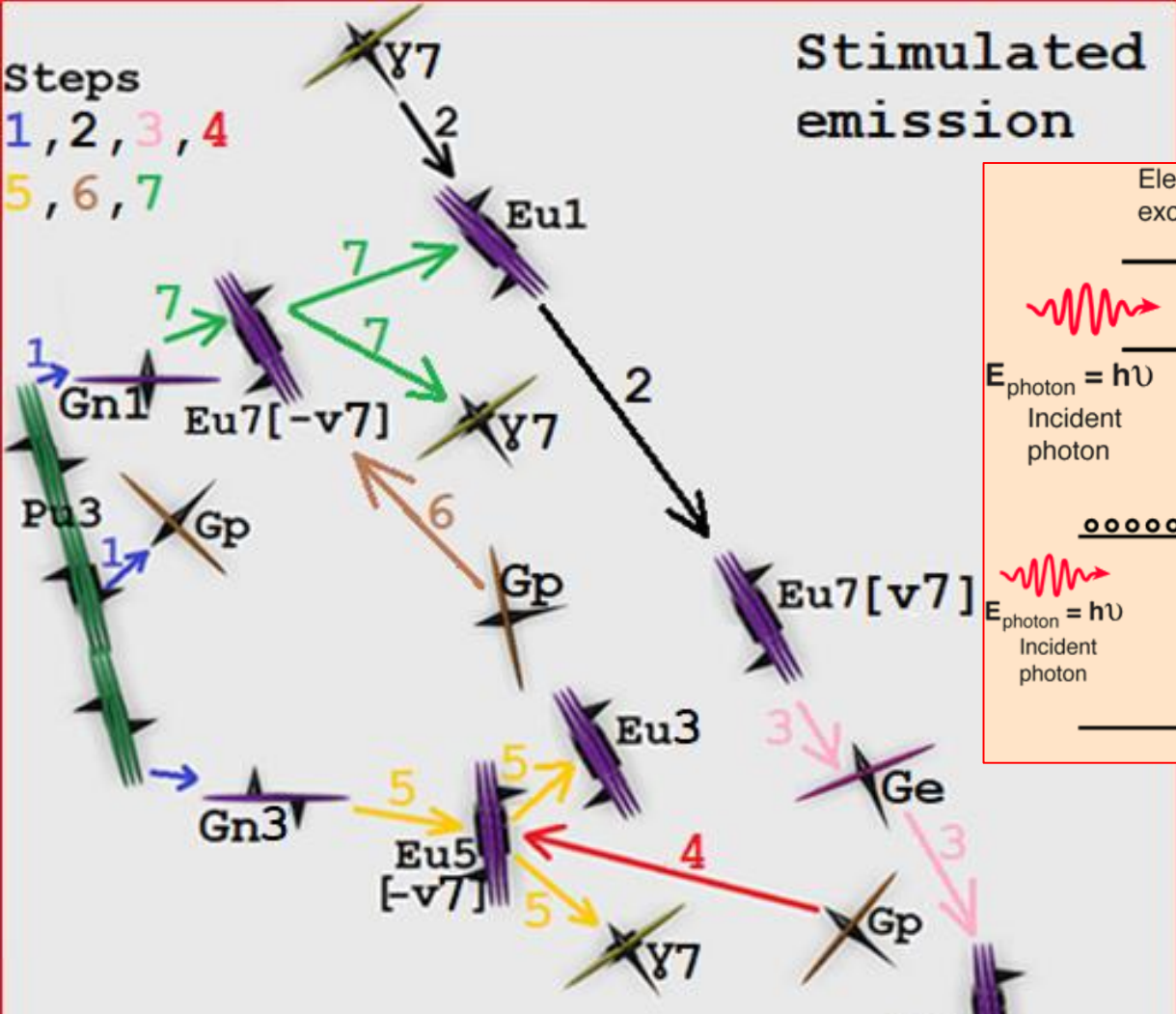

with mirrors stimulated emission process is used to create laser.

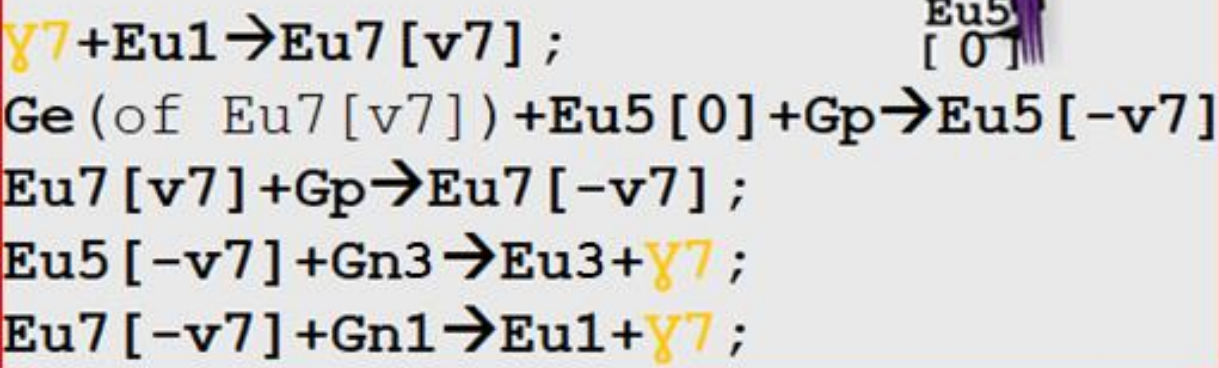



**Property25:** Transparency of glass;

**Explanation25:** not absorb most photon because, when  $\gamma_1$  hit e there is no other free place in any orbital for the ejected electron, so it will not get other  $G_n$ , but get  $G_e, G_p$  until it returns to its original place, there it will collide with its  $G_n$  and emit  $\gamma_1$ ; the reflected direction is dictated by the crystal structure (many photon emitted in other directions but they will cancel each other out).

**Property26:** Mirror property of Li;

**Explanation26:** there is no other free place in any orbital for the ejected electron, so it go back to its place, faster then in glass, because the electrons in this atom are more ordered and will send  $G_s$  from both direction of  $Eu_3$  to get him back on place faster so angle of incidence equal angle of reflection;

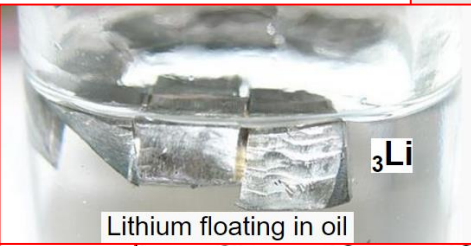
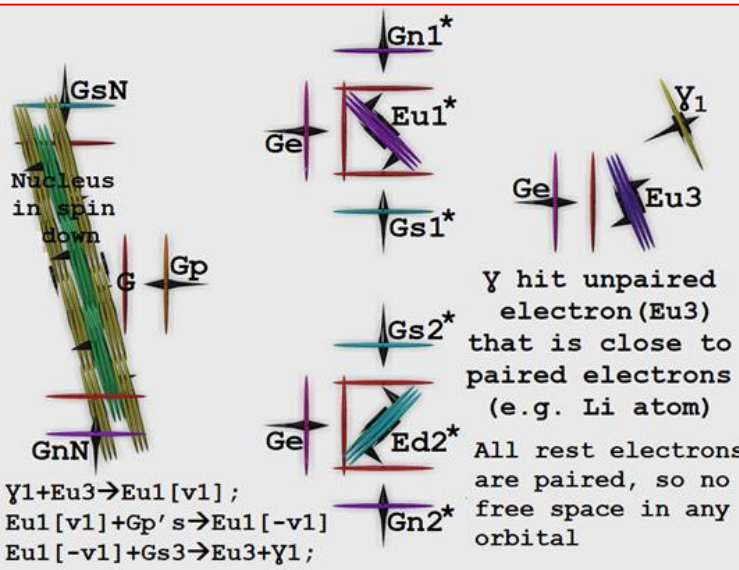
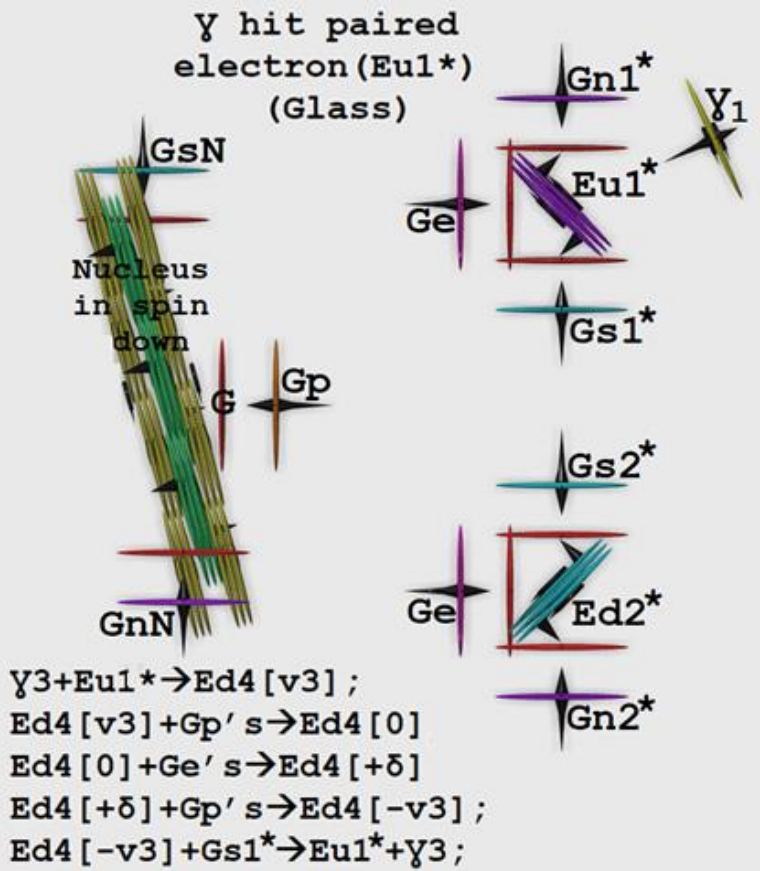

Beam splitter splits beam into 2 (made of glass+ small pieces of aluminum)

aluminium, Al  
 $[Ne] 3s^2 3p^1$

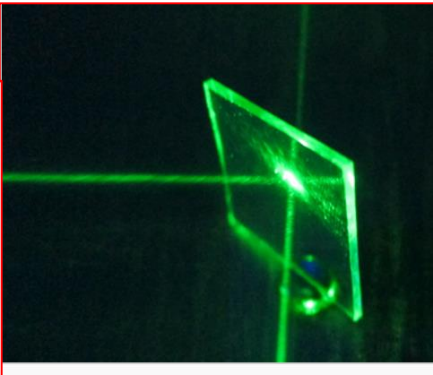
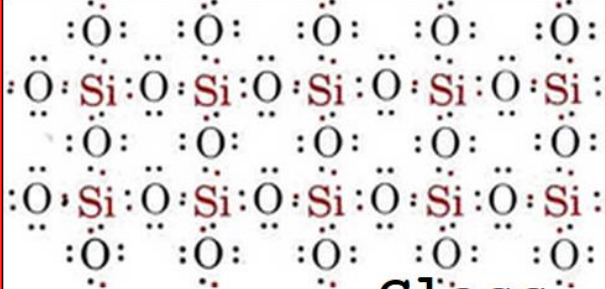

**Glass**



**Property27:** Red material absorb all other visible photon but not red; green laser makes a hole in red balloon but not in green balloon;

**Explanation27:** In red material, if red photon hit e, it's not absorbed (see not absorbed process), but if other visible colored photon hit e, we get black absorption (see black absorption process) and in this process the energy of the photon is transferred by the colliding Ge into atomic movements, vibration, heat; this heat can make a hole in a balloon; Thus green laser will be transfer to heat in red balloon (making a hole) and not in green balloon;

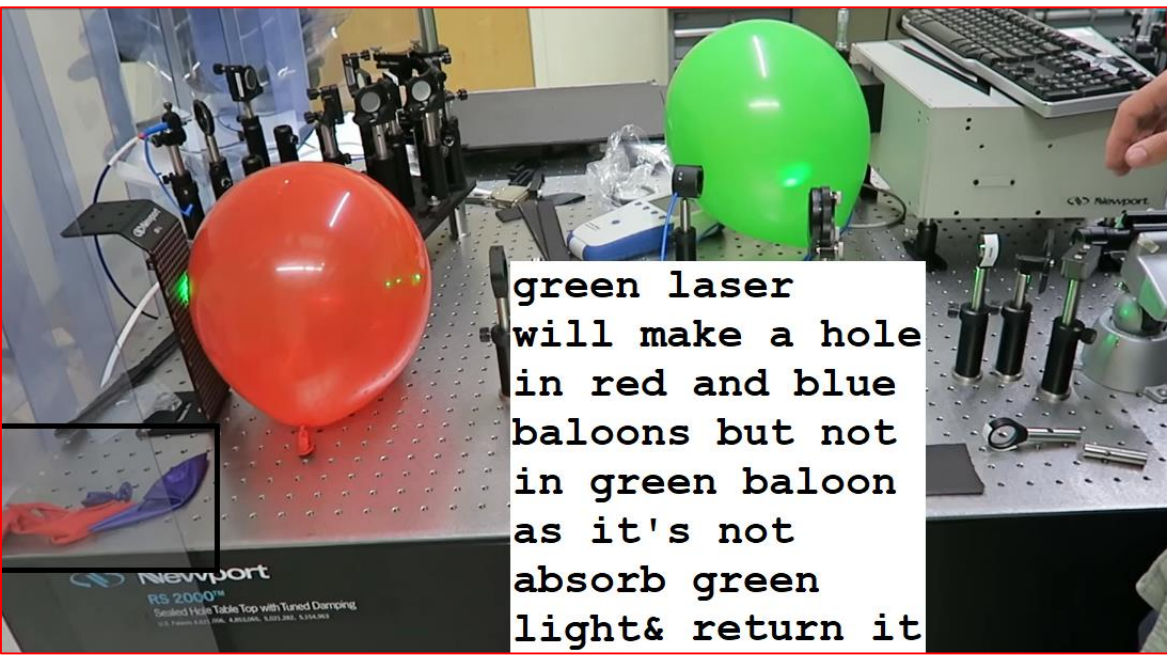

**Property28:** Increasing temperature increase the: number of photon emitted & the most common frequency; **Explanation28:** In higher temperature the atoms move faster, and the colliding electron will get bigger push farther and farther from the nucleus. But their push is by many Ge, so the electron will not change its spin(or  $\omega$ ), but its total energy increases as it get farther from nucleus; there, if it collides with Gp it will return to its natural position, and there collide with Ge or Gn and give it the extra energy; but it will not emit photon (as its not change its spin) in this process we say that the electron is not absorbed; ( $Eu1+Ge's \rightarrow Eu1[v1]$ ;  $Eu1[v1]+Gp's \rightarrow Eu1[0]$ ;  $Eu1[v1]+Gp's \rightarrow Eu1[-v1]$ ;  $Eu1[-v1]+Gn1 \rightarrow Eu1$ ); if the electron hit Gn5 for example on its way back in different orbital it will transformed to Eu5(changing its spin) & stay there for a while, then when collides with Gp's it will come back to its natural place and there collide with Gn1 & transformed its spin & transform this Gn1 into a photon(by transferring its kinetic energy to Gn1 and rotate it about its z axis, which now will happened because the electron has different spin & it accelerate); So the allowed collision energy for releasing photon are quantized; When the electron does release photon the farther it moved (the higher the temperature) the higher the frequency of the photon it release;

& the higher the temperature, the more collisions & more photon released so intensity increased.

**Examples:1-non absorption process**

Ge's (from heat, approaching electron) + Eu5  $\rightarrow$  Eu5[v1];  
 Eu5[v1] + Gp's  $\rightarrow$  Eu5[0];  
 Eu5[0] + Gp's  $\rightarrow$  Eu5[-v1];  
 Eu5[-v1] + Gn5  $\rightarrow$  Eu5;

**2-Absorption process:** Ge's (from heat) + Eu5  $\rightarrow$  Eu5[v1];  
 Eu5[v1] + Gp's  $\rightarrow$  Eu5[0];  
 Eu5[0] + Gp's  $\rightarrow$  Eu5[-v1];  
 Eu5[-v1] + Gn7  $\rightarrow$  Eu7[0] +  $\gamma$ 7;  
 Eu7[0] + Gp's  $\rightarrow$  Eu7[-v2];  
 Eu7[-v2] + Gn5  $\rightarrow$  Eu5 +  $\gamma$ 5;

$$E(\lambda, T) = \frac{2hc^2}{\lambda^5} * \frac{1}{e^{\frac{hc}{\lambda kT}} - 1}$$

$h = 6.626 * 10^{-34} \text{ J} * \text{s}$      $\lambda(\text{m})$   
 $c = 2.997925 * 10^8 \text{ m / sec}$   
 $k = 1.381 * 10^{-23} \text{ J/K}$      $T(\text{K})$

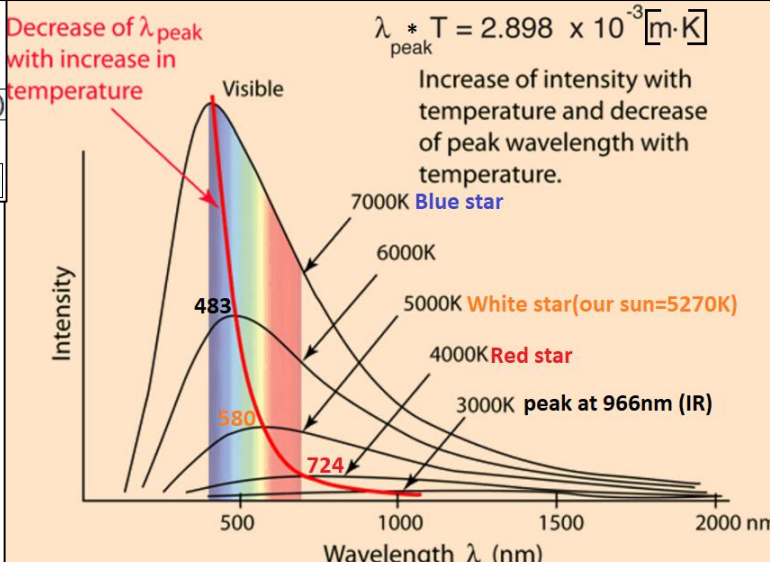

# Emission Spectra

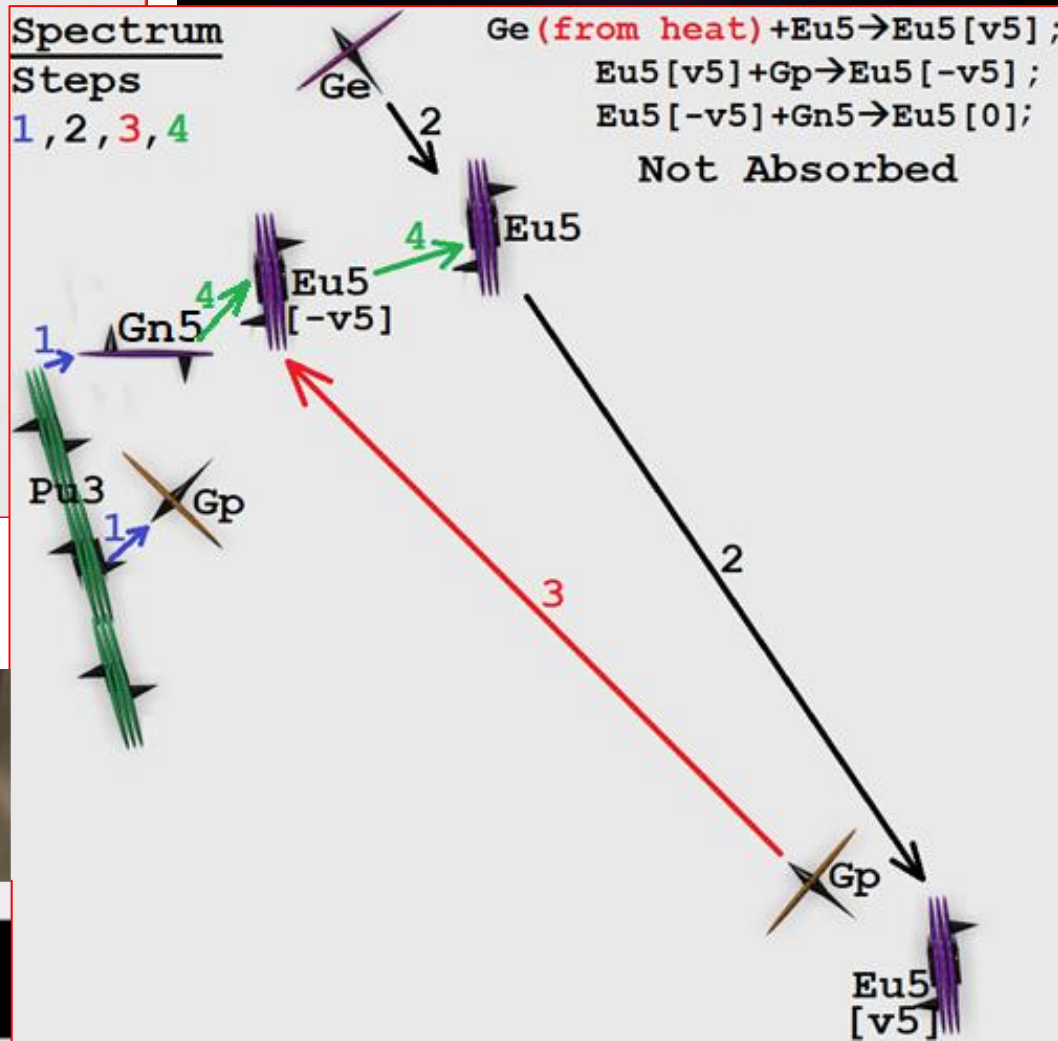
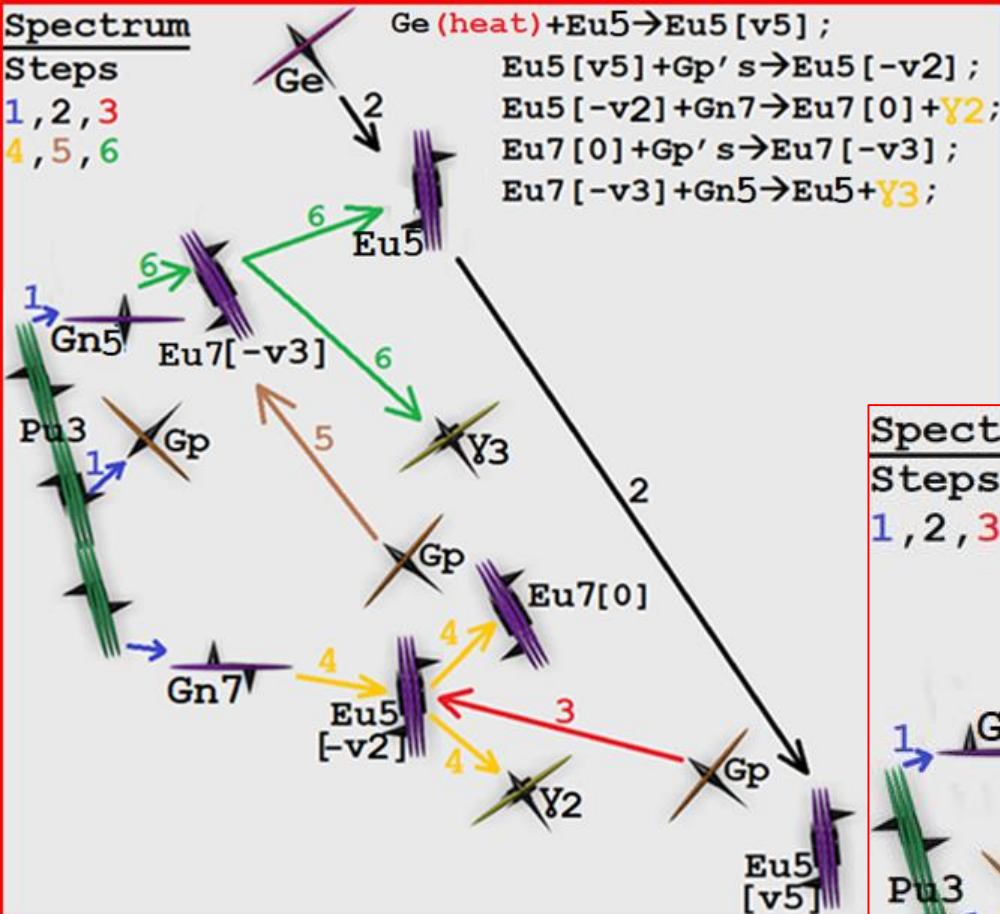

**Property28:** Increasing temperature increase the: number of photon emitted & the most common frequency;





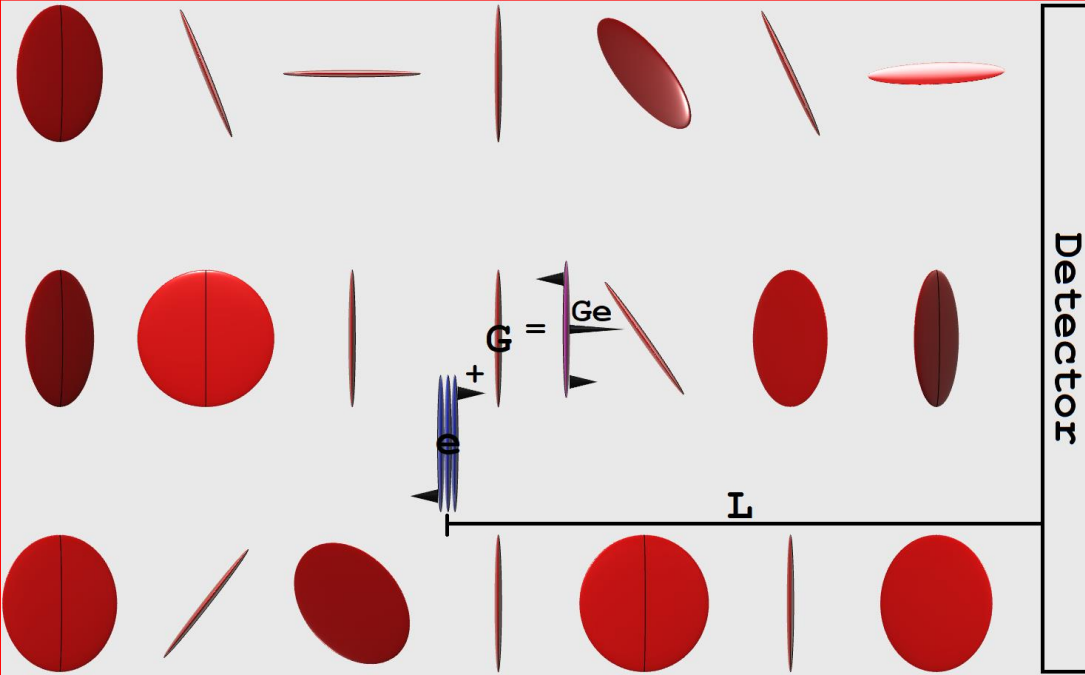

**Property29:** Speed of light constant; **Explanation29:**

- The universe is filled with many G particles located in random position & orientation & travel at random direction & speed
- If we place e particle in specific location, it will transform the G that hit him mainly into Ge.
- The actual velocity ( $av$ ) of Ge is very high ( $Geav \rightarrow \infty$ ).
- Thus G particles move randomly in and out of the pathway to the

detector, but if Ge hits G they will always thrown out off the pathway to the detector. Thus over time the pathway to the detector will be more and more clear & finally Ge particle will reach the detector.

- The time ( $dt$ ) that take for e particle to remove all the disturbing G's from 1 unit of pathway is a function of |e's  $\omega$ | ( $eW$ ), G's density ( $Gd$ ) & G's average velocity magnitude ( $|Gv|$ ) in the universe & thus it's constant

$$\{dt=f(eW, Gd, |Gv|)=\text{constant}\}$$

- The time that take for e to remove all the disturbing Gs from  $L=dt*L$ ;
- Thus the measured velocity ( $mv$ ) of  $Ge=Gemv=L/(dt*L)=1/dt=\text{constant}$ .
- As we know  $Gemv=c=1/dt=299792458\text{m/s}$ .  $dt=1/c=3.3356409519815204957557671447492*10^{-9}\text{s}$ .
- If e is accelerated it will produce  $\gamma$  instead of Ge, so this also true for  $\gamma$
- $Gemv$  is independent of the movement of e as  $Geav \rightarrow \infty$ .
- There are more G's around e then in space, as it play give & take with e,p;
- Because the speed of light constant all result of special relativity holds;



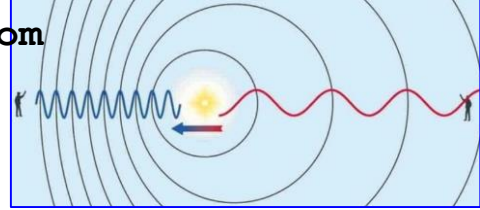

**Property30:** blue/red shift of light from source coming to/from the detector; **Explanation30:**  $\omega$  of  $\gamma$  is created by movement of  $e$ , thus if  $e$  move to/from the detector  $\omega$  of  $\gamma$  increase/decrease respectively;

**Property31:** blue/red shift of light seen (experienced) by a moving observer; **Explanation31:** An electron that is moving to/from  $\gamma$ , will get a higher/lower hit when they collide, and thus experience a higher/lower  $\omega$  of  $\gamma$  respectively; (this principle is used in doppler laser cooling method);

**Property32:** Malus's law; **Explanation32:** The higher (from  $0^\circ$  to  $90^\circ$ ) the angle between the polarizer to the  $\gamma$  precession angle, the more chance that  $\gamma$  will collide with  $e$  in the polarizer & not pass to the other side (intensity decrease);

**Property33:** Standing electromagnetic wave; **Explanation33:** When  $\gamma$  hit  $e$  in a perfect conductors that are located in both of it sides, these  $e$  emit  $\gamma$  back (see not absorption process) in the same direction but with other phase (rotation timing changed, but rotation pattern remains) so we see oscillation;

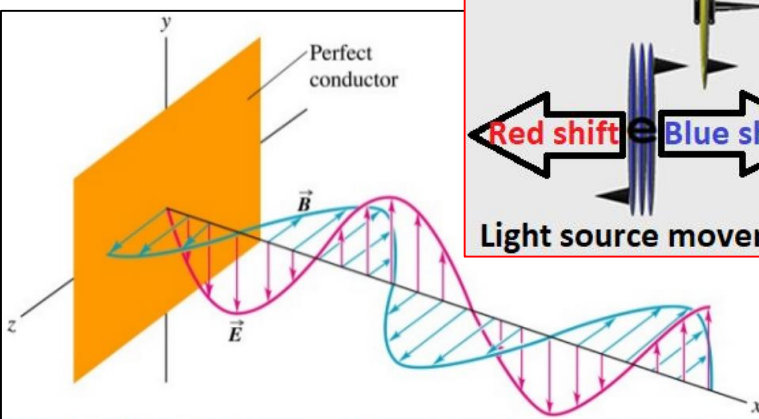

A **standing** electromagnetic wave does not propagate along the x-axis; instead, at every point on the x-axis the  $E$  and  $B$  fields simply oscillate.

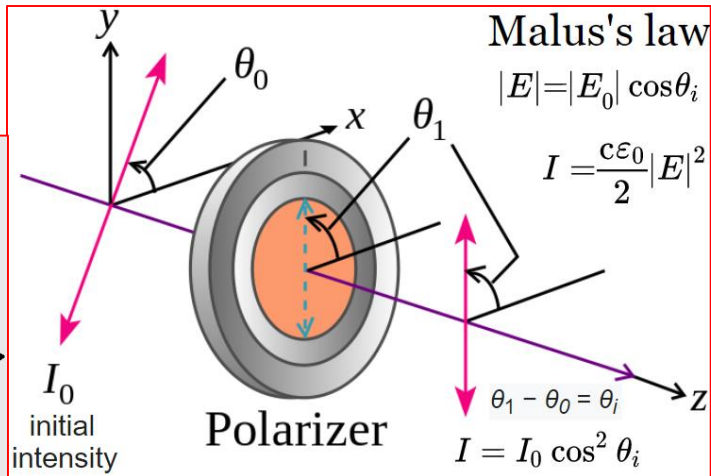
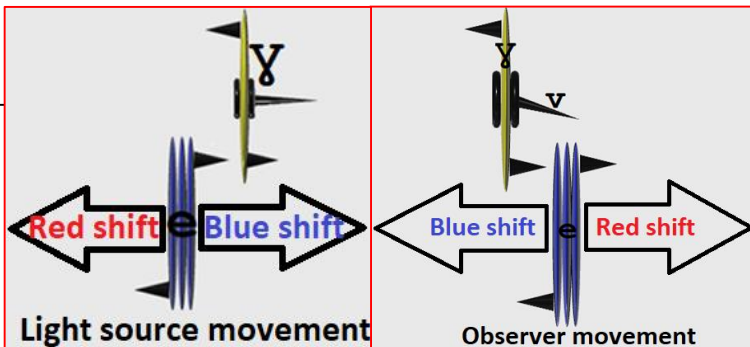

$v$  is *negative* if the observer and the source are moving *towards* each other  
 $f_s$  is the frequency of the wave the source emitted, stationary frequency

$$\text{observed frequency } f_o = f_s \sqrt{\frac{1 - v/c}{1 + v/c}}$$

$$\text{if } v \ll c \quad f_o = \left(1 - \frac{v}{c}\right) f_s$$

**Property34:** Doppler laser cooling;

**Explanation34:** If the photon is absorbed, the electron that get it, will be longer time in different locations (then its natural location), these different locations are farther from the nucleus in the direction of the photon, so this electron will attract the nucleus to these directions; but if the photon is not absorbed the e that get it will go almost immediately to its natural place and won't change the velocity of the atom to any direction (because it will be in wrong place only for short time); in doppler laser cooling we adjust the photon frequency to be just slightly below the frequency that is absorbed, so only if the atom move toward the laser it will feel the necessary frequency to absorbed it (see blue shift property) and it will slow down;

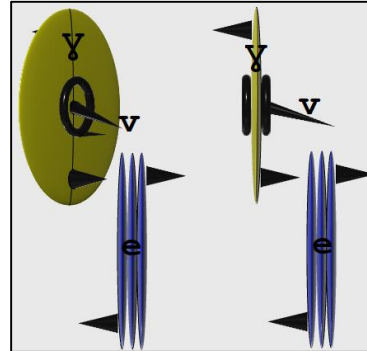

3.1 An atom moving towards the laser sees it blue-shifted and absorbs the photon, slowing the atom.

3.2 The photon excites the atom, moving an electron to a higher quantum state.

3.3 The atom re-emits a photon. As its direction is random, there is no net change in momentum over many absorption-emission cycles.

Simplified principle of Doppler laser cooling:

1 A stationary atom sees the laser neither red- nor blue-shifted and does not absorb the photon.

2 An atom moving away from the laser sees it red-shifted and does not absorb the photon.

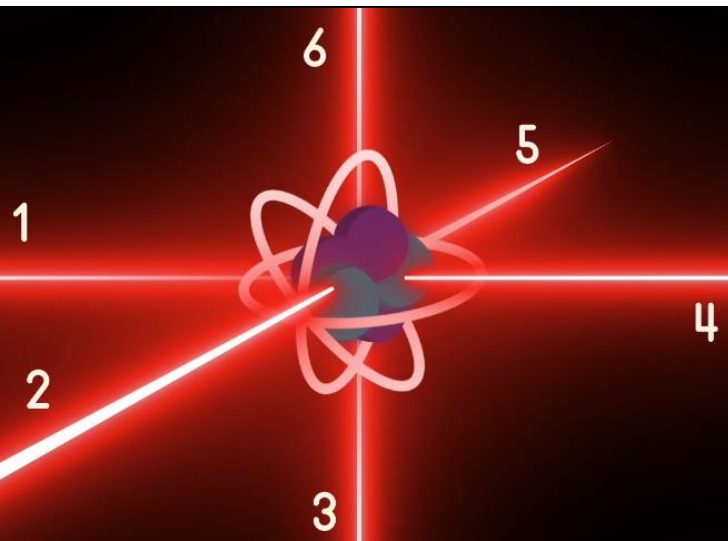

**Property35:** Bremsstrahlung principle: firing a high energy electron into a piece of metal yield electromagnetic radiation (photons) that is almost entirely in the x-ray region. the greater the kinetic energy of the incoming electron the higher the frequency of the outgoing photon;

**Explanation35:** If e particle colliding with another e particle in atom, the faster the first e particle the more far the other e particle will thrown, and by rule 12, it will gain more total energy, thus when come back to its natural place, it will hit its Gn faster and create  $\gamma$  with bigger  $\omega$ .

**Property36:** Magnetic field can change the polarization of a photon;

**Explanation36:** Gn,Gs particles from the magnet can hit the photon and change its precession (or  $\omega$ ).

**Property37:** Tunnel effect; **Explanation37:** A barrier prevent the passing of electrons by the Ge's that it emit, if the barrier is very thin it will emit less Ge's, an incoming electron can change its position very rapidly by colliding with Gp's (that are sent from the barrier) close to its end, thus in rare event the electron can pass through a thin barrier before interacting with the Ge that are sent from the barrier.

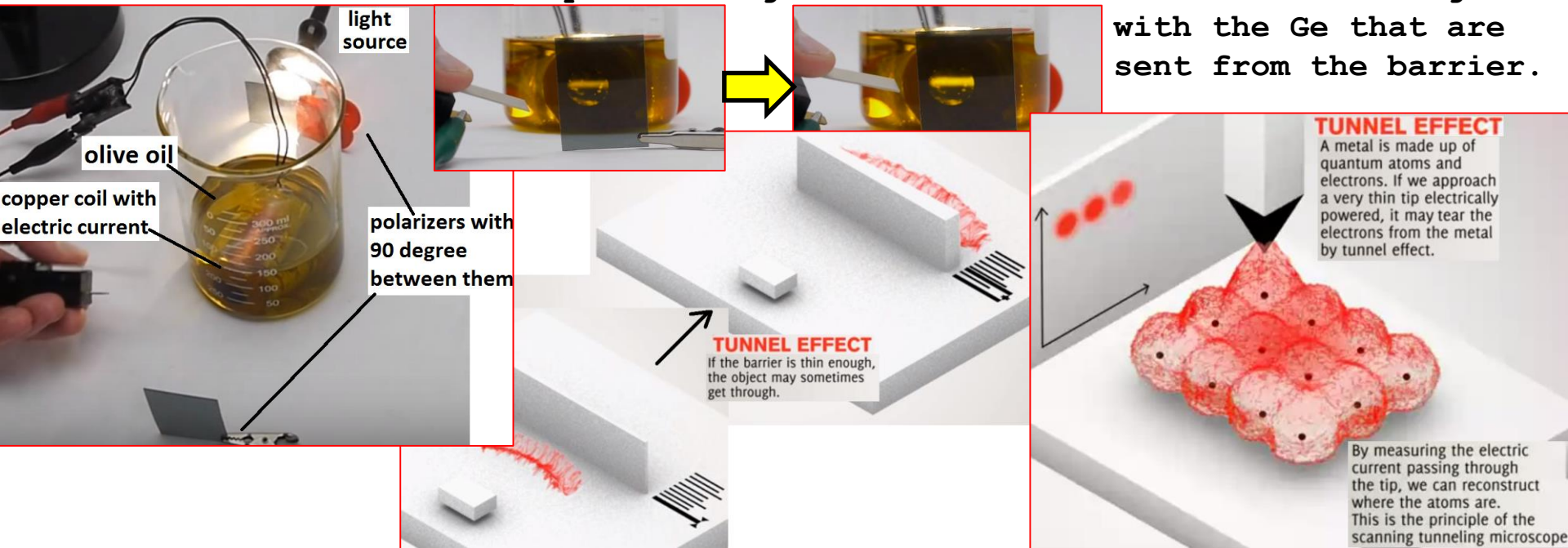



- Entangled  $e^-$  &  $e^+$ :  $n$  or  $p$  particle can eject electron & positron at same time if they get very high frequency photon, that brake these pieces of them (total  $L$  preserved), when created they will be also opposite in their spin (total  $L$  preserved) for example if the electron is  $E_{u1}$  the positron is  $E_{d2^+}$  and they will throw  $G$  particles (e.g.  $G_{s1}$  &  $G_{s2}$ ) in a speed of almost  $\infty$  (this is the actual speed of any  $G_x/\gamma$  particle, in contrast to the observed speed, see speed of light section) continuously and very often on each other (so the path between them is clear) and in perfect synchronization (playing give and take with many  $G$  particles) we call them entangled particles.

**Rule 14: Magnet transform entangled  $e^-$  &  $e^+$ :** If we change an entangled  $e^-$  to up spin, its entangled  $e^+$  will be changed immediately to down spin. If we put  $E_{u3}$  near the entangled  $E_{u1}$  particle it will transform it into  $E_{u3}$  (by  $G_{n3}$ ), but then immediately this  $E_{u3}$  will send  $G_{n3}$  particle into the entangled  $E_{d2^+}$  and transform it to  $E_{d4^+}$  because they are opposite in charge (in the main  $\omega$  component,  $\omega(2)$ ).

$\{G_{n3} + \text{entangled}[E_{u1} \& E_{d2^+}] \rightarrow \text{entangled}[E_{u3} \& E_{d4^+}]\}$

(we call a particle spin up or spin down by the magnetic field that it generates, not by its orientation)

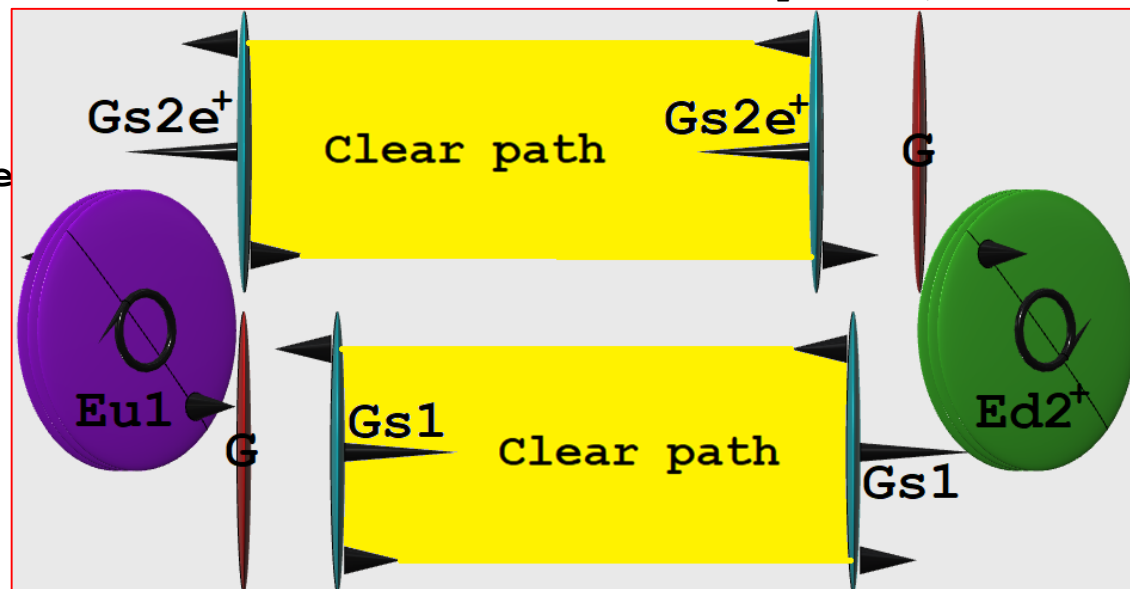

Entangled electron & positron:  
They create a clear pathway that contain no disturbing  $G$ 's so they transfer  $G$ 's at very high speed (faster than  $c$ )



**Property38:** photons combining; If we shine 2 green photon into a non-linear crystal we can get 1 uv photon and use it to make uv laser beam;

**Explanation38:** the first green photon hit an electron in its original place and the second photon hit e in its new place (or on its way to there), then when e come back to its original place it will emit uv photon (twice energetic);

**Property39:** photon entanglement; If we shine a photon at beta barium borate crystal (non-linear crystal) it can split it into 2, this happened only for  $\sim 1/(10B)$  photons, the energy of the incoming photon is equal to the total energies of the outgoing photons; and the momentum is conserved (so the angles of the outgoing photons with respect to the incoming photon should be with opposite direction but with same magnitude and the photons have to kick back the crystal) and the spin is conserved; 1/500 of these photon pairs will be entangled (we can use this process to create a single photon with a known property, as we use 1 & measure the other) we can couple each of these entangled photons into a separate optical fiber and take them anywhere, then we can measure their polarization and see that the polarization of 1 influence the polarization of the other; **Explanation39:**  $\gamma_2$  collide with a nucleus on its edge (or with G that slide a little of the cluster) releasing G's from its cluster, one of them & the incoming  $\gamma_2$  are transformed into  $\gamma_1$  particles (these are the entangled photons); when the first  $\gamma_1$  pass through the polarizer & hit the electron in the detector, the electron, immediately after, hit also one of the G's that released from the nucleus cluster, this G flying all the way back to the nucleus and collide with it and flying all the way to the other detector influencing the result of the entangled particle. The speed of this G is the actual speed of light (much faster than c, see speed of light property), its possible because the rotational speed of these particles is crazily fast and these distances are nothing in comparison, everything is synchronize because these particles formed together & energy still conserved because, this G collides with the nucleus. The fiber optic won't change this process as G can jump from one e to the other in almost 0 time (picture next page)

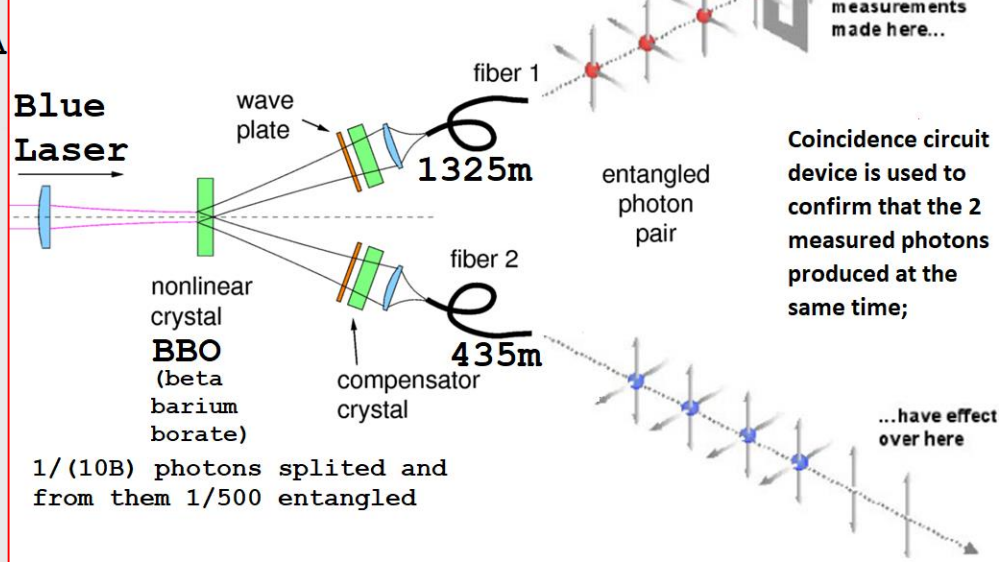
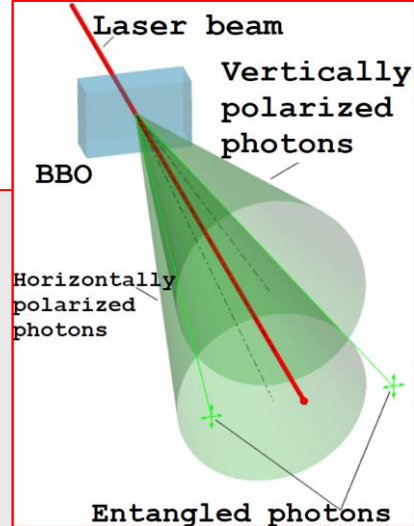
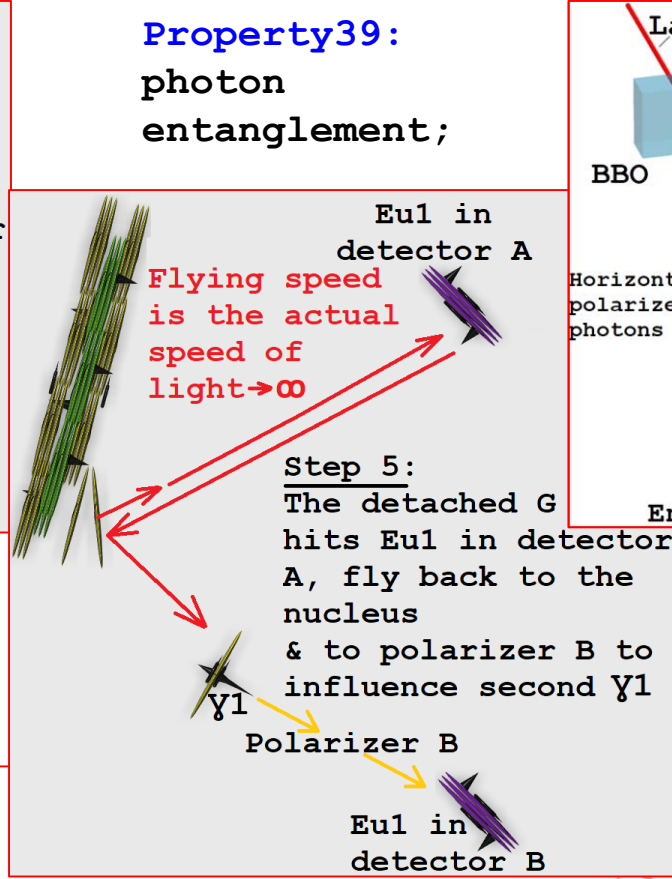
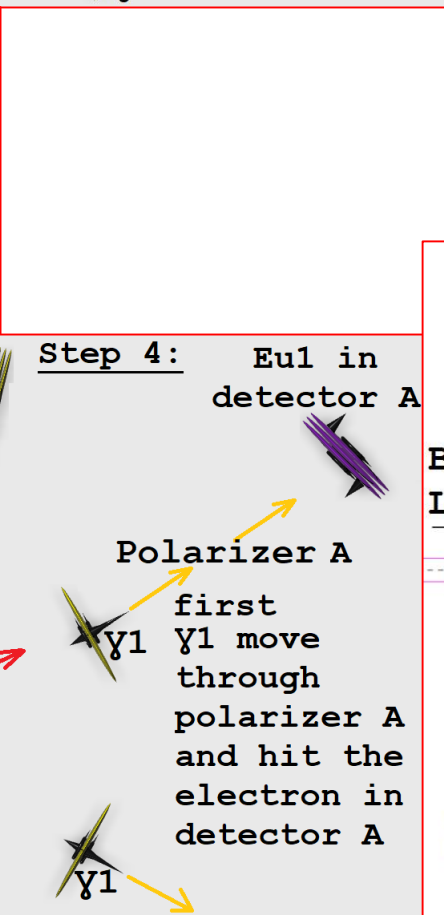
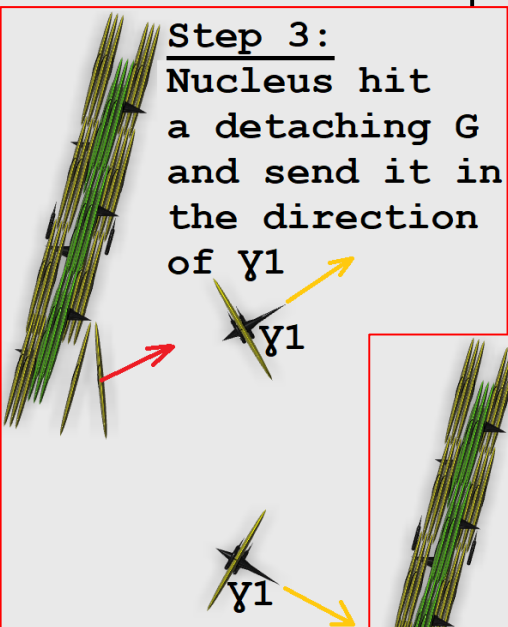
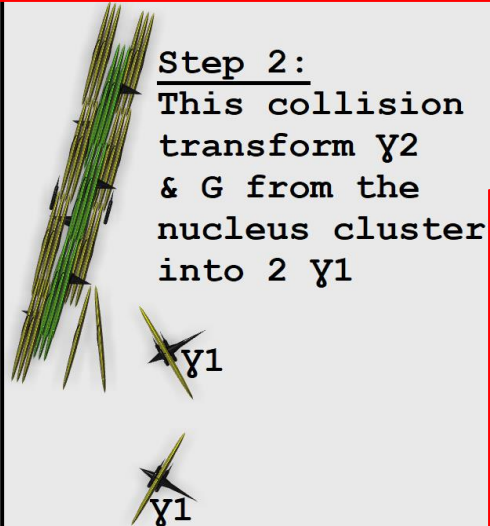
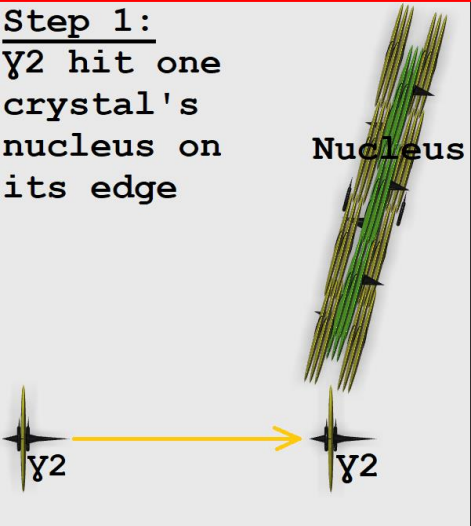

**Property40:** Left/Right handed particle: A neutrino always has its spin pointed in the direction opposite its velocity ( $c$ ). Anti-neutrinos have their spins parallel to their velocity ( $c$ );

**Explanation40:** Neutrino and antineutrino are just pieces that brake from a nucleus, so the direction of the collision that cause their brake dictate their spin direction and velocity; this Left/Right handed characterization is not meaningful for other particles that don't travel at the speed of light, because they will be seen Left/Right handed by someone who travel faster in their/opposite direction (the observer will see the same spin but opposite velocities); but for neutrino, any observer can't travel faster then light; and it gives us a good evidence that this theory is correct and any opposite charge or anti particle is just rotated oppositely (to notice that we should look at these 2 particles together and not separately);

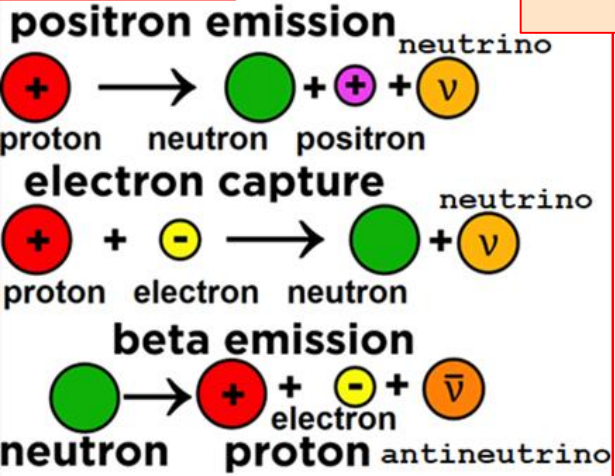
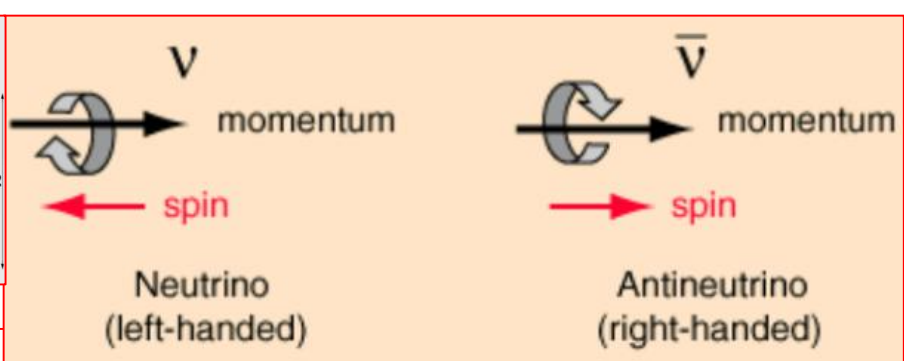
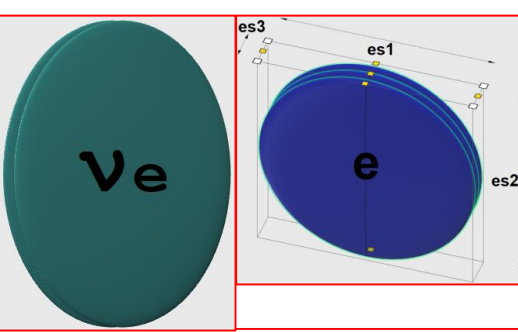

Electron cluster contains 232,272 fold more G's then neutrino; neutrino  $\omega(2)=0$ ; (no charge); thus it won't interact with ordinary matter & it's almost undetectable; but it has  $\omega(1)$  &  $\omega(3)$ , so it has spin & it travels at  $c$ ; it's produced by the sun in vast quantity;

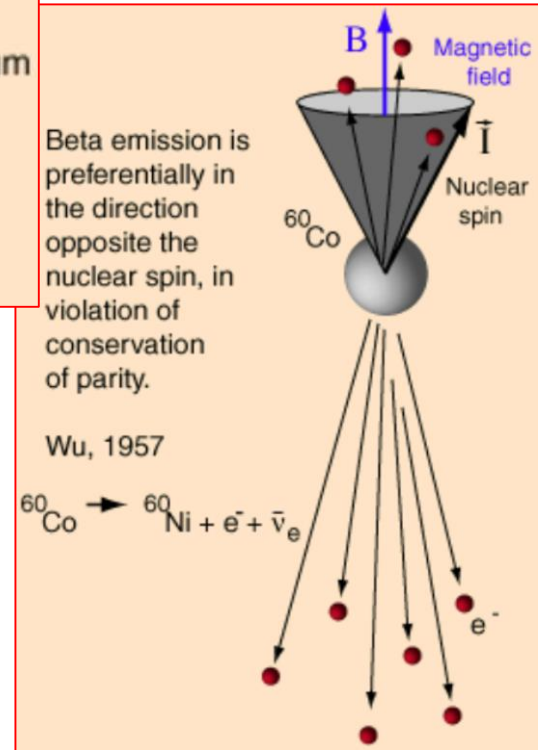

Beta emission is preferentially in the direction opposite the nuclear spin, in violation of conservation of parity.

Wu, 1957

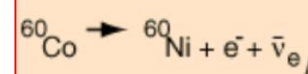



# Derivation of Scattering Formula

$$\Delta\lambda = \lambda' - \lambda = \frac{h}{m_e c} (1 - \cos\theta)$$

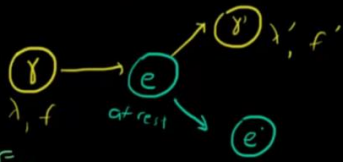

Conservation of Energy:

$$E_\gamma = hf \quad E_e = m_e c^2$$

$$E_{\gamma'} = hf' \quad E_{e'} = \sqrt{(p_{e'} c)^2 + (m_e c^2)^2}$$

$$hf - hf' = \sqrt{(p_{e'} c)^2 + (m_e c^2)^2} - m_e c^2$$

$$hf - hf' + m_e c^2 = \sqrt{(p_{e'} c)^2 + (m_e c^2)^2}$$

**Property 41:** electron & photon collision: Compton Scattering **Explanation 41:** Compton calculate the collision result of photon and electron by treating them as particles (using conservation of energy & momentum) it works so it imply that light can be particle. In this calculation if compton would have taken the photon and electron as a sphere particle he would get a wrong result (as the angle between them after any collision will be 90 degrees) implying that photon and electron are not spheres.

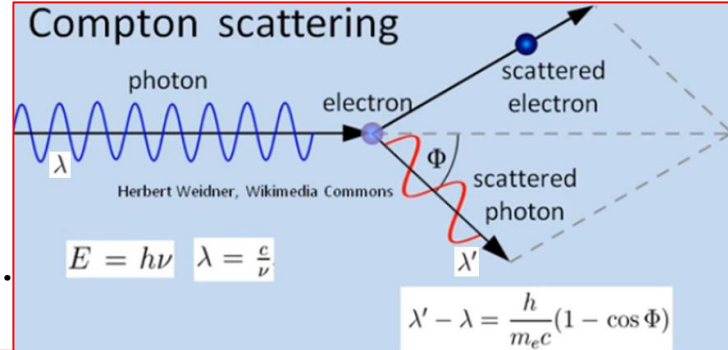

Conservation of Momentum:

$$p_\gamma + p_e = p_{\gamma'} + p_{e'}$$

$$p_{e'} = p_\gamma - p_{\gamma'}$$

$$p_{e'}^2 = p_\gamma^2 + p_{\gamma'}^2 - 2p_\gamma p_{\gamma'} \cos\theta$$

$$p_{e'}^2 c^2 = p_\gamma^2 c^2 + p_{\gamma'}^2 c^2 - 2c^2 p_\gamma p_{\gamma'} \cos\theta$$

$$p_\gamma = \frac{hf}{c}$$

$$p_{\gamma'}^2 c^2 = \frac{h^2 f^2}{c^2} c^2 + \frac{h^2 f'^2}{c^2} c^2 - 2c^2 \left(\frac{hf}{c}\right) \left(\frac{hf'}{c}\right) \cos\theta$$

$$p_{e'}^2 c^2 = h^2 f^2 + h^2 f'^2 - 2h^2 f f' \cos\theta$$

$$(hf - hf' + m_e c^2)^2 - m_e^2 c^4 = h^2 f^2 + h^2 f'^2 - 2h^2 f f' \cos\theta$$

$$h^2 f^2 - h^2 f f' + h^2 f m_e c^2 - h^2 f f' + h^2 f'^2 - h f' m_e c^2 + h f m_e c^2 - h f' m_e c^2 + m_e^2 c^4 - m_e^2 c^4 = h^2 f^2 + h^2 f'^2 - 2h^2 f f' \cos\theta$$

$$-2h^2 f f' + 2h f m_e c^2 - 2h f' m_e c^2 = -2h^2 f f' \cos\theta$$

$$2h f m_e c^2 - 2h f' m_e c^2 = 2h^2 f f' - 2h^2 f f' \cos\theta$$

$$2h m_e c^2 (f - f') = 2h^2 f f' (1 - \cos\theta)$$

Divide by  $2h f f' m_e c$ :

$$\frac{c(f - f')}{f f'} = \frac{h(1 - \cos\theta)}{m_e c}$$

$$\frac{c}{f'} - \frac{c}{f} = \frac{h}{m_e c} (1 - \cos\theta)$$

$$\frac{c}{f'} - \frac{c}{f} = \frac{h}{m_e c} (1 - \cos\theta)$$

$$c = \lambda f = \lambda' f'$$

$$\frac{\lambda f'}{\lambda'} - \frac{\lambda f}{f} = \frac{h}{m_e c} (1 - \cos\theta)$$

$$\lambda' - \lambda = \frac{h}{m_e c} (1 - \cos\theta)$$

In atom, because of the many Ge's, Gp's all the gamma energy is used to transform the e spin & velocity; like head to head /plastic collision

$\lambda$  = wavelength of absorbed light  
 $\lambda'$  = wavelength of emitted light

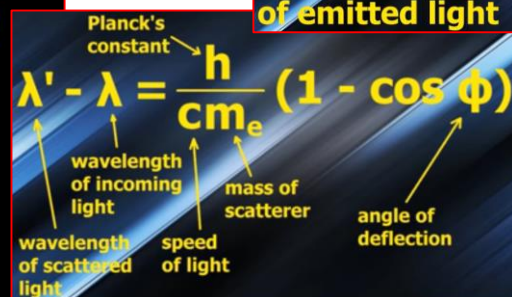



**Property42:**The sky are blue&cloud are more red(except at mid day);

**Explanation42:**

- The  $\omega(3)$  of  $\gamma$ ( $\gamma$  frequency) particle(light) can be low=red<green<blue<violet=high. A higher  $\omega p$   $\gamma$  particle will take up more space while moving (see precession mathematical background).
- The sun emitt  $\gamma$  particles mostly in the visible  $\omega p$ (& more blue then violet).
- Our eyes contain cones that are more sensitive for blue  $\omega p$  then for violet  $\omega p$  (or higher  $\omega p$ ).
- We see the sky blue because blue  $\gamma$   $\omega p$  particles will collide more often with small particles like air molecules, then red  $\gamma$   $\omega p$  particles (as blue  $\gamma$   $\omega p$  particles take up more space while moving).
- Cloud droplet are big particle, so the chance that a low  $\omega p$   $\gamma$  will miss them is almost equal to the chance that high  $\omega p$   $\gamma$  miss them, so we see them more red as rest  $\omega p$   $\gamma$  already collide before, with the air molecule, but in mid day(where the sun is up), we see the cloud white, because there is very little scattering when the sun up (less gas to collide on the way to our eyes and we see more direct emitted light then scattered light, because its direction).

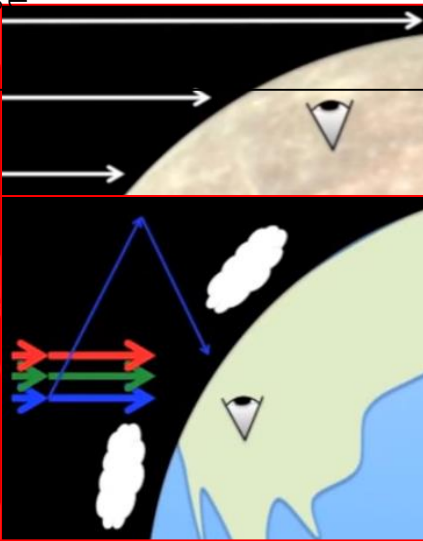
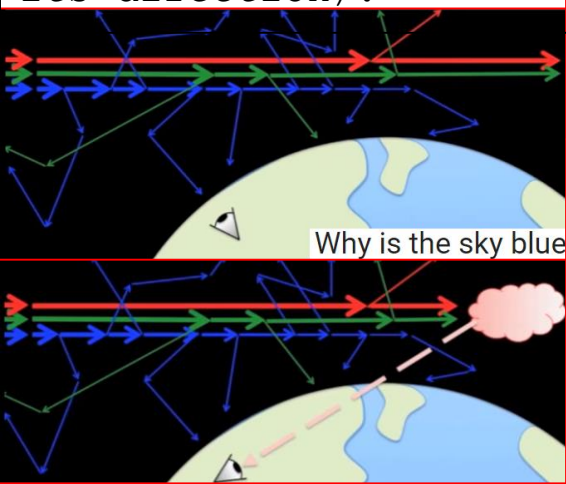
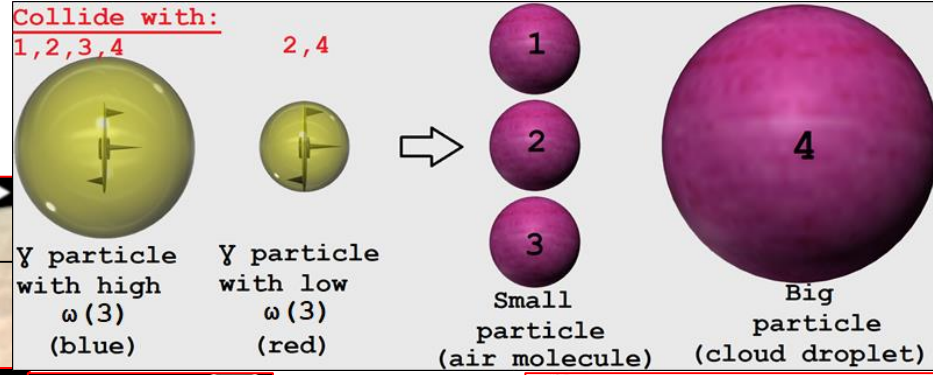

Intensity  $\propto \frac{1}{\lambda^4}$

"proportional to"

wavelength  $\uparrow$

intensity  $\downarrow$

| Color | Wavelength | Relative intensity |
|-------|------------|--------------------|
| Red   | 700 nm     | 1.00               |
| Green | 550 nm     | 2.62               |
| Blue  | 450 nm     | 5.86               |

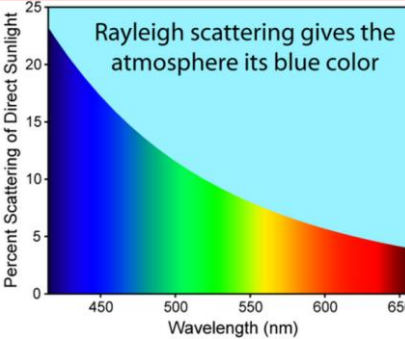

**Property43:** The more dense the material the slower (apparent velocity, which is the observed velocity in different materials) light travel in it; **Explanation43:** the more dense the material the more electrons in it & more collision with  $\gamma$  {explain prisma & Lens}

**Property44:** The higher the  $\gamma$  frequency the more slowly it will travel in a material.

**Explanation44:** the higher the frequency ( $\omega$ ) of  $\gamma$  the more space it occupy (due to its  $\omega(3)$ ), so it will collide more times;

**Property45:** If light is polarized parallel to the plane of incidence there will be no reflection;

**Explanation45:** this collision change e's  $\omega$  downwards, so when it collide with  $G_n$  or  $G_s$  it will emit  $\gamma$  downwards.

**Property46:** The reflected light of an unpolarized incident light is partially or fully polarized, when fully polarized it is always in the direction perpendicular to the plane of incidence; **Explanation46:** the

many  $G_e$ 's &  $G_p$ 's from the plane will effect the electron orientation, and this will effect the collision result with  $\gamma$

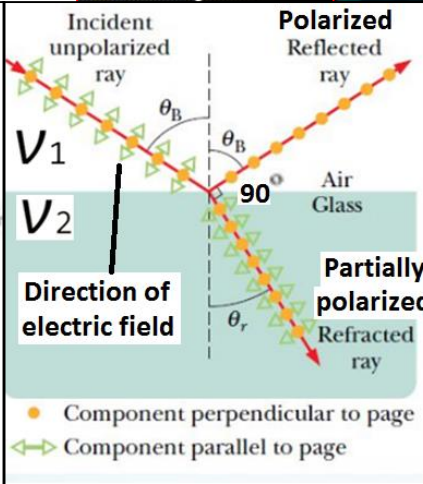
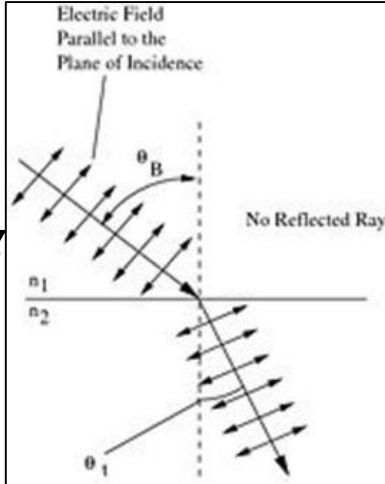
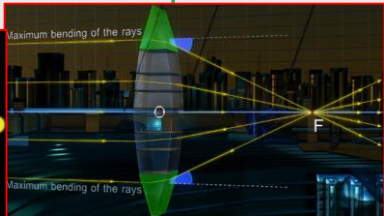
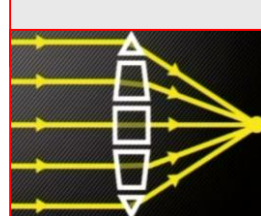
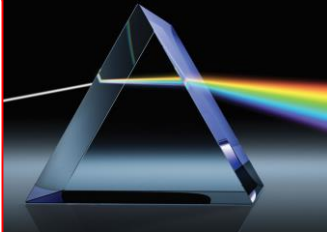
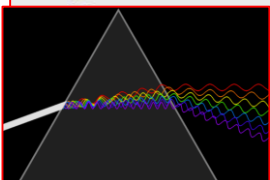
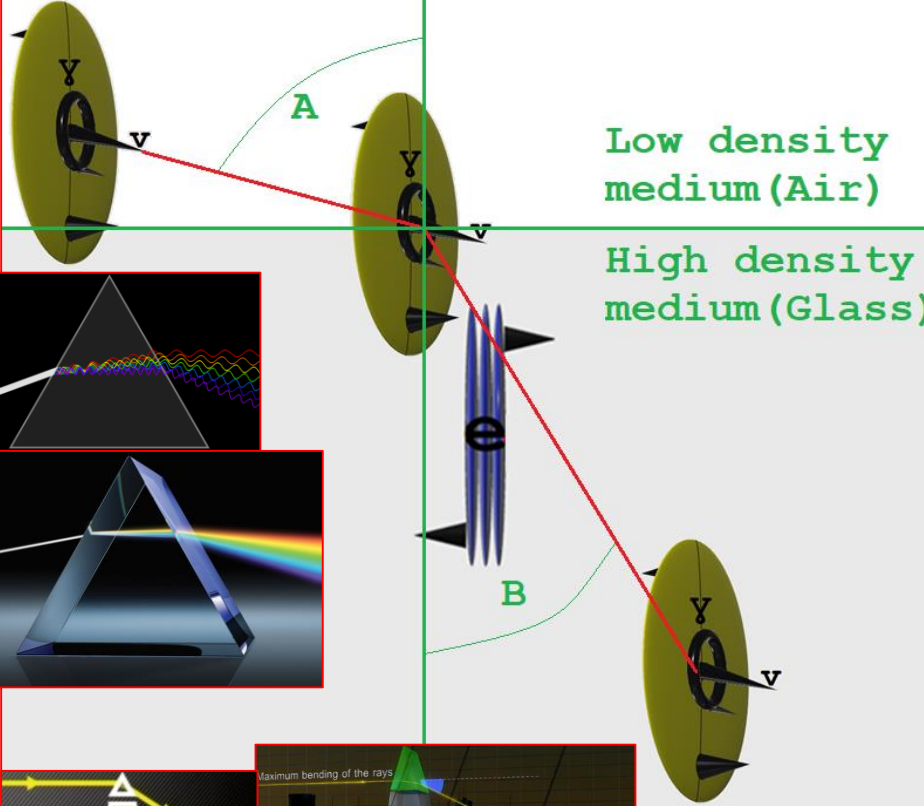

The reflected light of an unpolarized incident light is partially or fully polarized. When it is fully polarized (always in the direction perpendicular to the plane of incidence), the incidence angle is called the Brewster angle. In such a case, the reflected and refracted lights are perpendicular to each other.

$$\text{Brewster angle} = \theta_B = \tan^{-1} \frac{v_1}{v_2}$$

**Property47:** Fermat's principle: If a beam of Light travels from point A to B, it does so along the fastest path possible; thus  $\sin(A)/v_1 = \sin(B)/v_2$ ;

{because If  $v_1 \& v_2$  = apparent velocity in upper & bottom medium; the travel time:  $t(x) = (h_1^2 + x^2)^{1/2} / v_1 + ((w-x)^2 + h_2^2)^{1/2} / v_2$ ; t is minimum when:  $t'(x) = x / (v_1 * (h_1^2 + x^2)^{1/2}) - (w-x) / (v_2 * ((w-x)^2 + h_2^2)^{1/2}) = 0$ ; or  $x / (v_1 * (h_1^2 + x^2)^{1/2}) = (w-x) / (v_2 * ((w-x)^2 + h_2^2)^{1/2})$ ;  $\sin(A)/v_1 = \sin(B)/v_2$ ;

In this picture light travel more slowly in the upper medium as  $B > A$ ; **But light is not smart, the real Explanation47:** \*This type of collision will throw the electron downward to  $\gamma$  velocity vector (mathematical truth); therefore: the more dense the material, the more electrons  $\gamma$  collide, and the more the emitted  $\gamma$  will directed downward\*, and the smaller B angle will be; and the smaller  $v_2$  will be;

Thus when  $V_2$  become smaller angle B also become smaller. By:  $\sin(A)/v_1 = \sin(B)/v_2$ ;

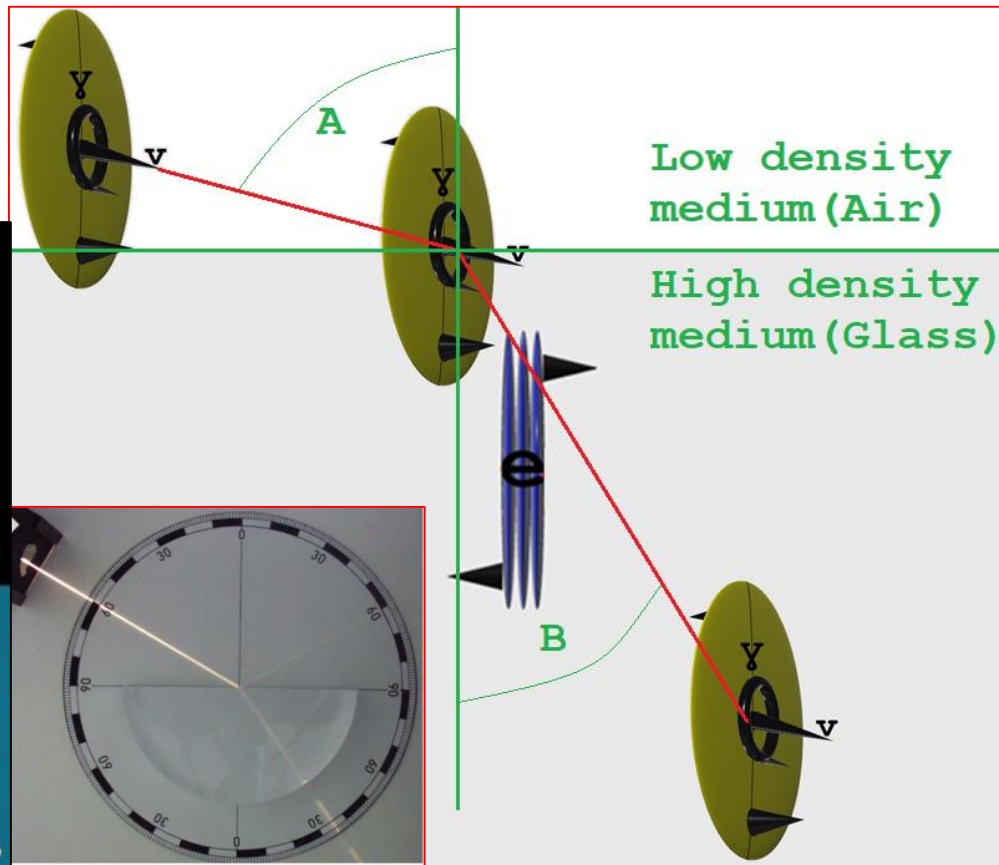
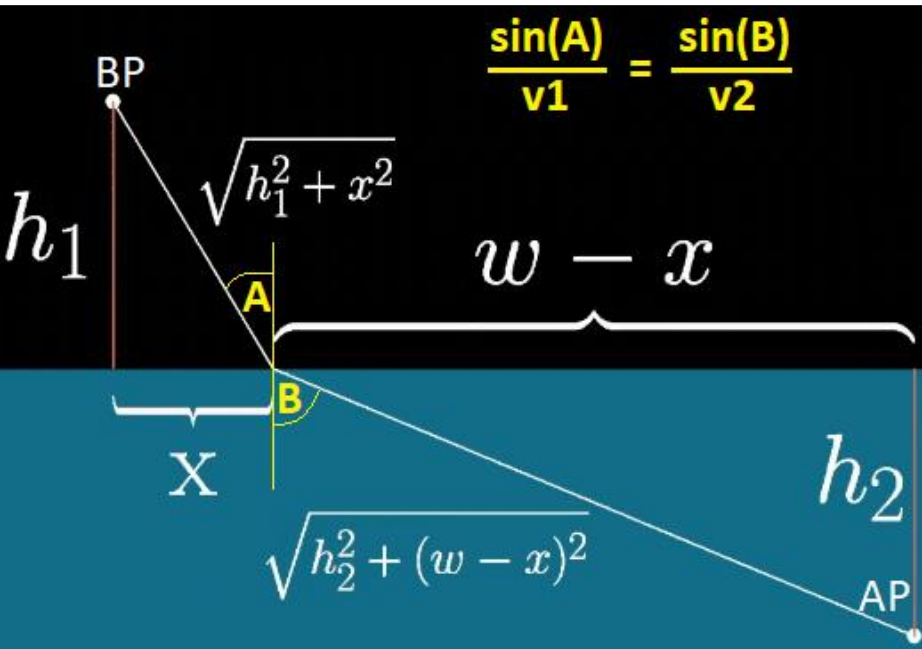



**Property48:** Photoelectric effect (see picture); If you take a metal and shine uv light at it, electrons will emerge from the metal with different kinetic energy that we can measure, a graph of the maximum of this kinetic energy as the frequency of radiation will have a slope that is equal to plank constant= $h=6.626 \times 10^{-34}$  [J\*s] [ $m^2 \cdot kg/s$ ];  $h=4.135667662 \times 10^{-15}$  [eV\*s];

**Explanation48:** If  $\gamma$  particle with high  $\omega$  (frequency) collide with e particle it may eject it from the atom depending on  $\omega$  of  $\gamma$ . not on the number of  $\gamma$  because the collision is between 1  $\gamma$  to 1 e and the energy of  $\gamma=h \cdot f$ ; by rule 11.

**Property49:** Constructive and Destructive interference.

**Explanation49:** If  $\gamma$  particle hit e particle & then after  $n \cdot \text{period}$  ( $n=1,2,3..$ ) second identical  $\gamma$  particle also hit that e particle (so they are at distance  $n \cdot \lambda$ ) the effect on e particle is double, because they hit e in the same position and angles (Constructive interference), but if the second  $\gamma$  particle hit that e particle only after  $n \cdot \text{period}/2$  (so they are at distance  $n \cdot \lambda/2$ ) the effect on e particle is canceled because it hit e in other position; The actual velocity of different  $\gamma$  is different,

but it's a function of  $\omega(3)$ ;

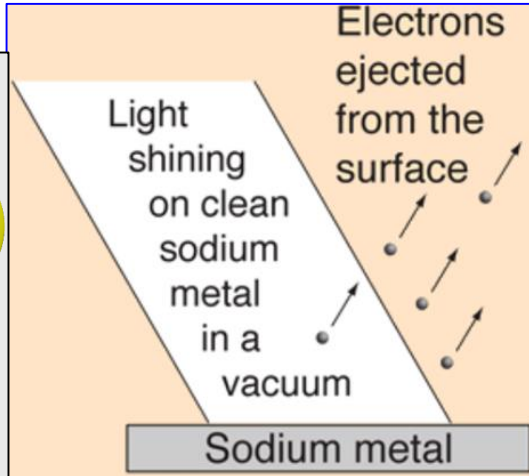
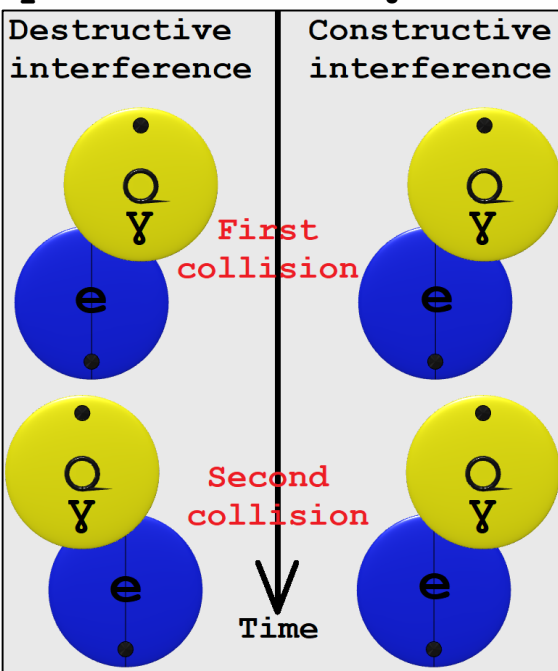

1. The electrons were emitted immediately - no time lag!
2. Increasing the intensity of the light increased the number of photoelectrons, but not their maximum kinetic energy!
3. Red light will not cause the ejection of electrons, no matter what the intensity!
4. A weak violet light will eject only a few electrons, but their maximum kinetic energies are greater than those for intense light of longer wavelengths

the energy of the ejected electrons was proportional to the frequency of the illuminating light. the ejection energy was independent of the total energy of illumination showed that the interaction must be like that of a particle which gave all of its energy to the electron!

Photon energy  
 $E = hf$

**Property50:** shining photons at increasingly thicker glass create a periodic reflection pattern: If we shine red photons to a very thin glass we will measure (using detector A & B) that 0% photons are reflected back to detector A. if we will do this experiment again with a little thicker glass we will measure that 1% of the photons are reflected back to detector A. & if we will continue to do this experiment with a progressively thicker & thicker glass we will measure that: 2%, 3%, 4%, ... 16%, 0%, 1%, 2%, ... 16%, 0%, 1%, 2%, ... 16%, 0%, 1%, 2%, ... of the photons are reflected back to detector A. so we always just add glasses and the percent of the reflected photons are goes from 0, 1, 2, ... 16, 0, 1, 2, ... 16, 0, 1, 2, ... in a continues cycle. If in the experiment we will use different color of light ( $\gamma$  particle with different  $\omega$ ) the thickness of glass that give 0% reflection will be changed but this pattern will repeat. **Explanation50:** when we add more glasses there are more atoms & the electron move to different energy level, the e particle place itself in different shell, as there are now more Ge&Gp particles from the other atoms, so now the e particle that get excited (get precession) by the collision of  $\gamma$  particle, will hit  $G_n$  & create  $\gamma$  particle that will be thrown more to the direction of the detector. If we add more glass the e particle will move to a shell with properties (how many Ge&Gp get to e) that similar to the first case (with the thinner glass) and it will throw less  $\gamma$  particle to the direction of the detector. The e particle shells change periodically as the  $\omega$  of e&p particle is constant (Ge particle can enforce p so the total  $\omega$  of p preserved, same for e).

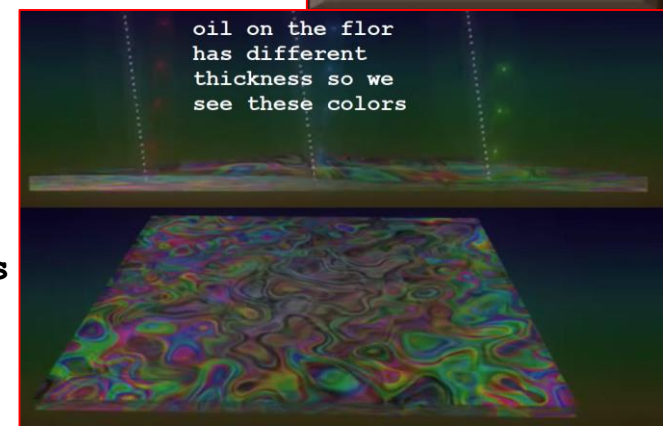
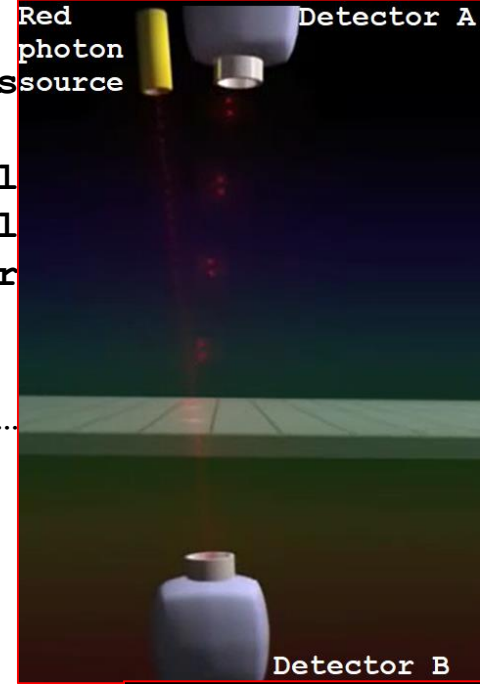

**Property51:** Each part of the mirror reflect light: If we shine light from a source (like lamp, not focus light) into a mirror we can see that the detector will measure photons from every part of the mirror but mostly from the middle (where the angle of incident equal the angle of reflection).

**Explanation51:** This is because  $\gamma$  particle will hit e particle in all the mirror, and each e particle has some probability to throw  $\gamma$  in any direction depending the position of collision.

- Computation using QED get around the complicated collision calculation like the Fermat principle of least action does. But its not the way the universe works.

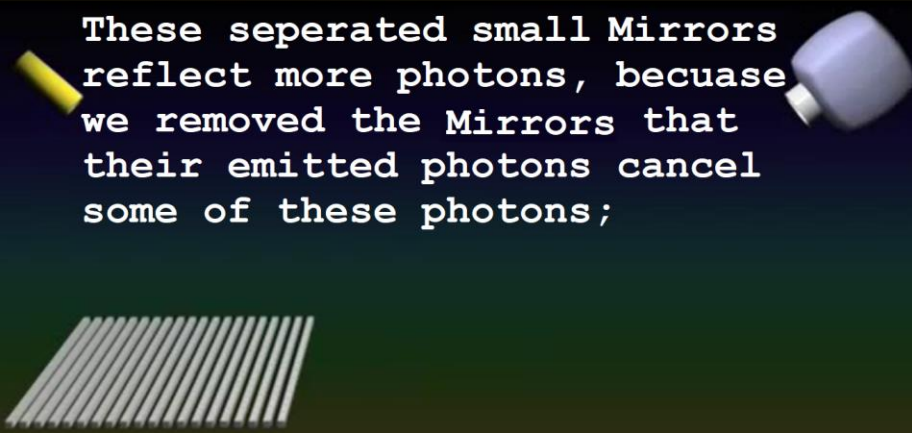
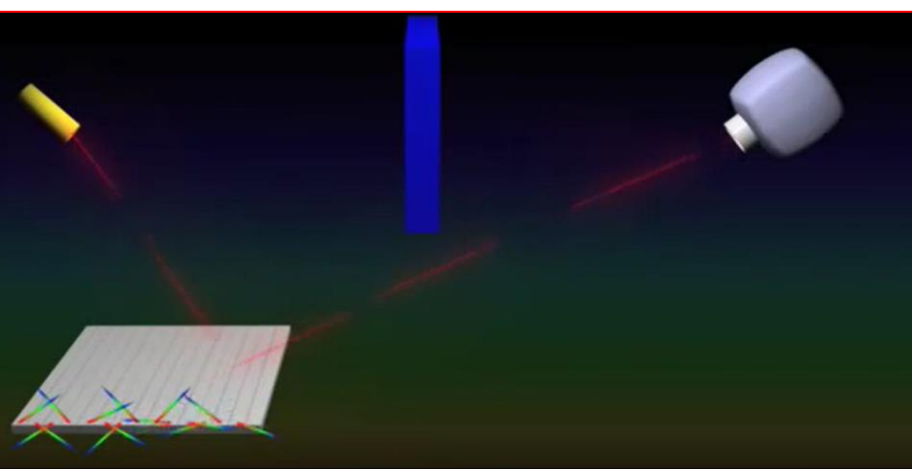



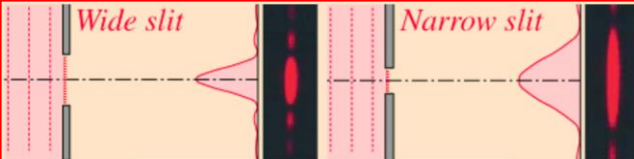

slit is smaller then 1/100 inch wide

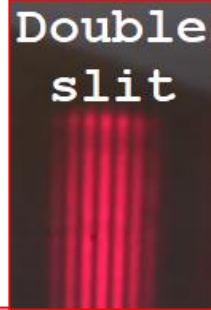

**Property52:** behavior of light passing through single & double slit; **Explanation52:**  $\gamma$  particle has speed ( $v$ ) and frequency ( $f$ ) so we can calculate also  $\lambda = v/f$ ; for him. & 2  $\gamma$  are in phase if their electric fields are at max at the same time point. So the current explanation of single & double slit experiments hold also if light =  $\gamma$  particle;

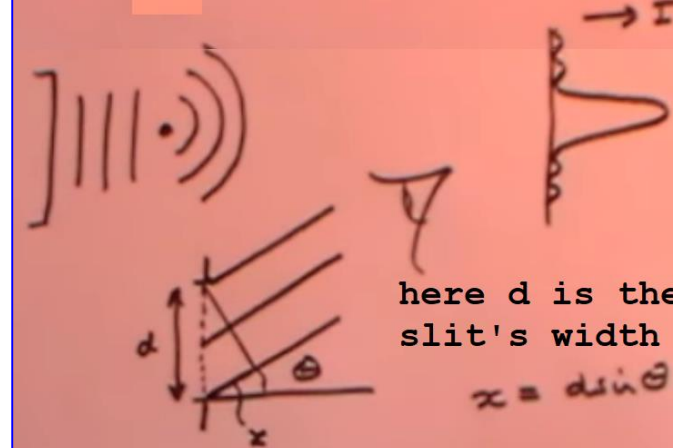
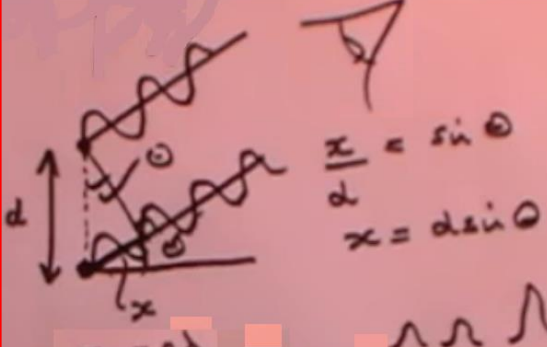
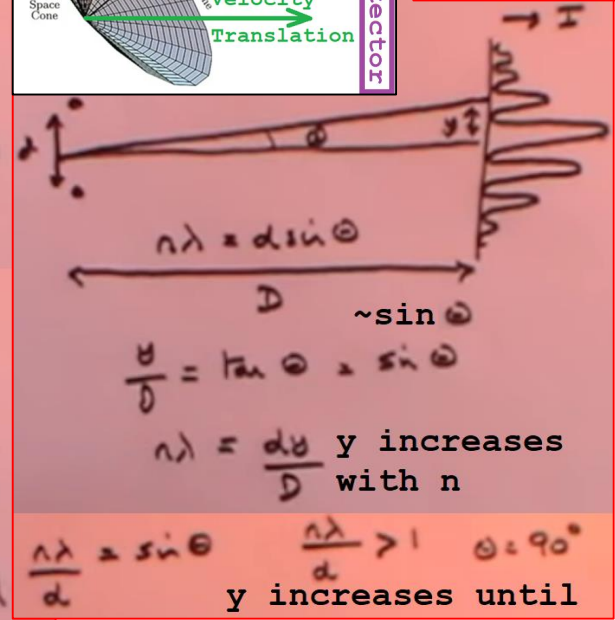
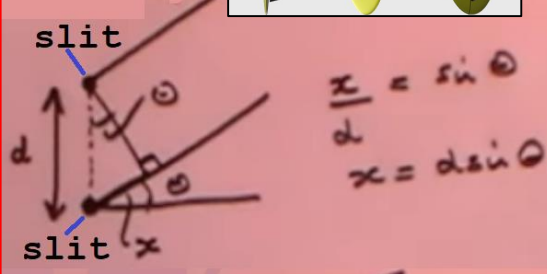
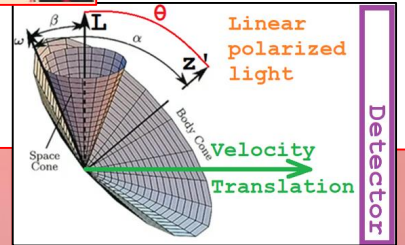
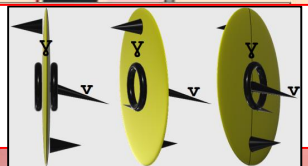

$x = \frac{\lambda}{2}$  or  $(2n-1) \frac{\lambda}{2}$

$(2n-1) \frac{\lambda}{2} = d \sin \theta$

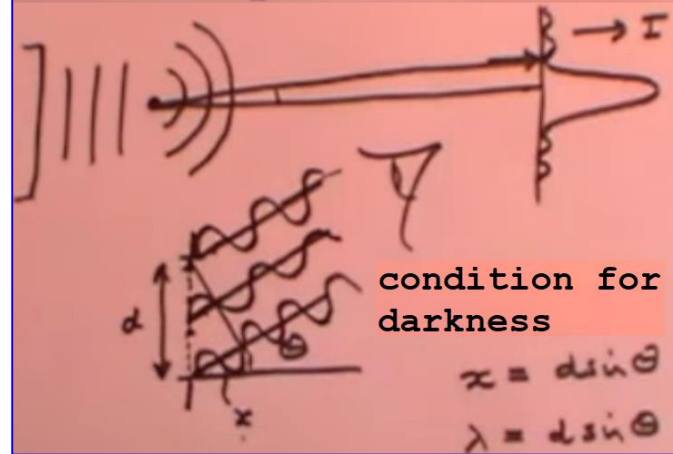
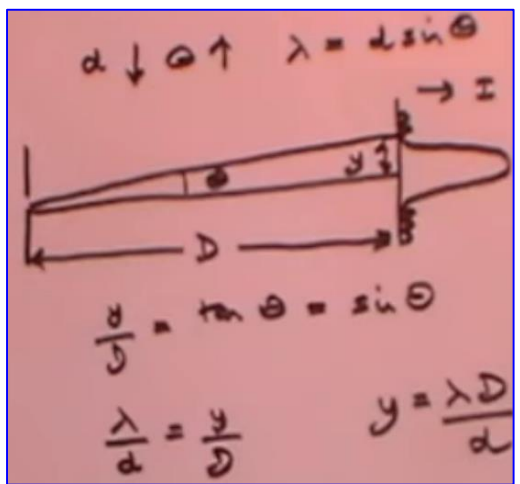

$n=1,2,3\dots$ ; I=intensity;  $D \gg d$ ; so slit consider as single dot;  $D \gg y$  so  $\tan \theta \sim \sin \theta$ ;

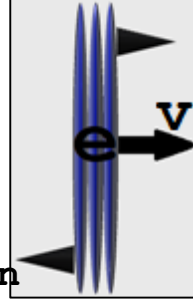

**Property53:** behavior of electron passing through single & double slit;

**Explanation53:** The electron ( $E_u$  &  $E_d$ ) rotates mainly about its y axis and precesses so we can assign period, frequency & wavelength for it the same way we did for  $\gamma$ ; and 2 e's are at phase if they orient the same at the same time point; so the current explanation of single and double slit experiments hold also for electron; the double slit experiment works even if we shoot one electron at a time because this electron can collide with Ge particles emitted from the edge of the slits apparatus & be interfered with them (when we put a detector to see from which slit it passes, the magnetic field of the detector prevents the electrons in the edge from interfering with the passing electron);

**Property54: light can increase/decrease magnet strength:** Arthur Epstein from Ohio State University built a magnet from plastic by mixing 2 chemicals (vanadium hexacarbonyl  $[V(CO)_6]$  and tetracyanoethylene [TCNE]). Blue light increases this magnet strength by 150%; and green light reduces this magnet strength by 60%. **Explanation54:** When  $\gamma$  hits e, it transforms its spin direction (can be also from up to down) and moves it farther from the nucleus, there it can also stay for long time; in this material (there are more up spin electrons)  $\gamma_1$  may transform unpaired  $E_d^2$  to  $E_u^1$  and by this increases the total number of up spin electrons in the atom and increases its strength;  $\gamma_4$  may transform unpaired  $E_u^7$  to  $E_d^4$  and by this reduces the number of up spin electrons and reduces the magnet strength;

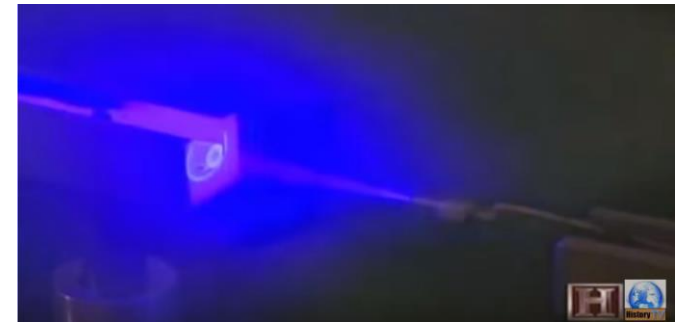
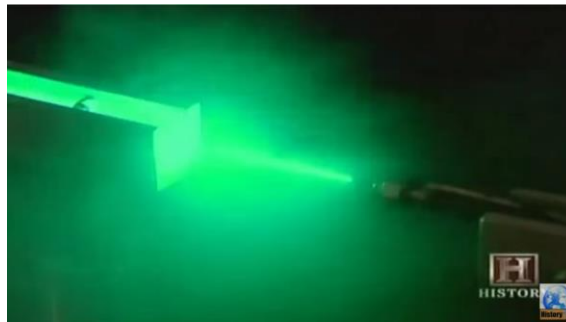

**Property55:** Annihilation & pair production: If electron & positron collide they annihilate each other & produce a photon with a specific frequency (gamma ray). this photon can produce them again (pair production).

**Explanation55:** If  $e^+$  &  $e$  collide at their edges they can brake apart to all of the G components that make them while transforming 1 of these G's into photon with  $\omega$  in the gamma ray;  $e^+$  &  $e$  pair production may occur by braking a proton or neutron using this photon. Same mechanism may used to other particles.

**Property56:** Gamma emission;

**Explanation56:** If the nucleus collide with very high  $\omega$  photon, it can get other precession, and then returning to its original precession by a colliding Ge. this Ge brake a piece (G) from the nucleus & emit it (so this piece (gamma photon, is rotated like the nucleus or like Ge).

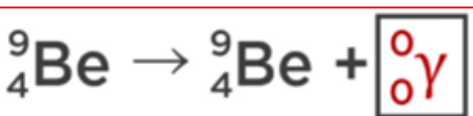

2.6 minutes  
Half-Life

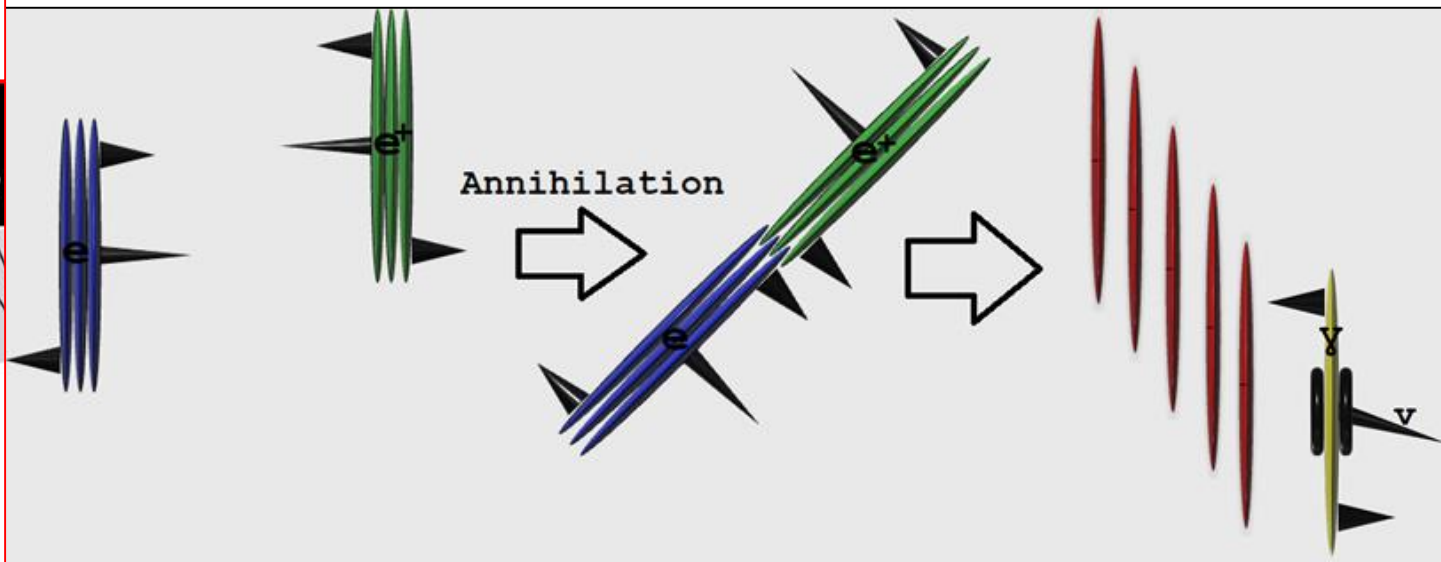
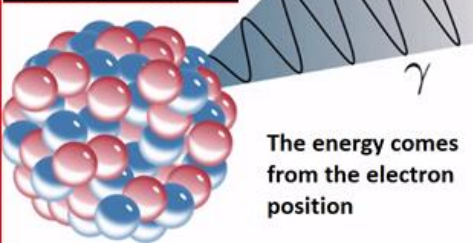





**Property58:** Precisely half full orbital gives stability (don't want to loss e)

**Explanation58:** In a precisely half full orbital all the electrons send many Ge, Gn, Gs particles to each other, thus it will be more hard to eject one of these electrons, because the many Ge, Gn, Gs will return him to its place.

**Property59:** Hund's rule: Hund's rule says that for electrons in the same energy level, we put 1 electron in each orbital first before doubling them up.

**Explanation59:** In order for 2 electrons to be paired, they have to stand vertically with respect to the nucleus, in order to send and receive Gn, Gs particles; and they need to move together, so a lot of order is needed, and when the orbital is not half filled there is less order; in addition when the orbital is precisely half filled the electrons interact with each other and the next electron will be send to its paired location.

**Property60:** Aufbau principle: Aufbau principle tell us the order in which an atom will fill up its orbitals, it will fill up first the orbital with lower potential energy (closer to nucleus);

**Explanation60:** Because the attraction at the beginning (of the filling process) is more intensive, because there is no shielding effect, the electron gets more Gp and less Ge at the beginning.

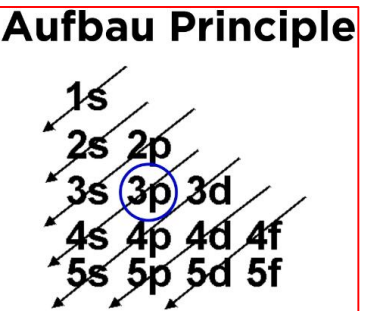
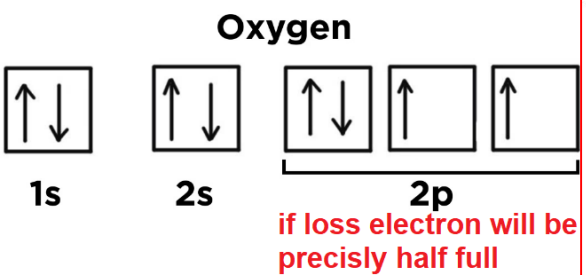
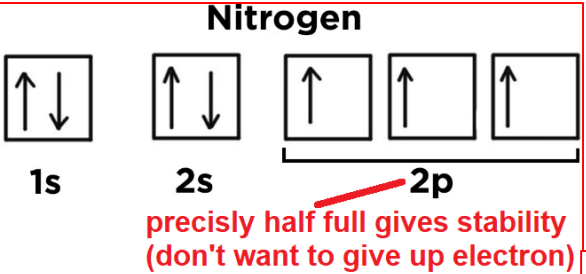

## orbital diagram

|           |    |                  | 1s                   | 2s                   | 2p   |   |
|-----------|----|------------------|----------------------|----------------------|--|---|
| Lithium   | Li | $1s^2 2s^1$      | $\uparrow\downarrow$ | $\uparrow$           | $\square \square \square$                                  | ← |
| Beryllium | Be | $1s^2 2s^2$      | $\uparrow\downarrow$ | $\uparrow\downarrow$ | $\square \square \square$                                  | ← |
| Boron     | B  | $1s^2 2s^2 2p^1$ | $\uparrow\downarrow$ | $\uparrow\downarrow$ | $\uparrow \square \square$                                 | ← |
| Carbon    | C  | $1s^2 2s^2 2p^2$ | $\uparrow\downarrow$ | $\uparrow\downarrow$ | $\uparrow \uparrow \square$                                | ← |
| Nitrogen  | N  | $1s^2 2s^2 2p^3$ | $\uparrow\downarrow$ | $\uparrow\downarrow$ | $\uparrow \uparrow \uparrow$                               | ← |
| Oxygen    | O  | $1s^2 2s^2 2p^4$ | $\uparrow\downarrow$ | $\uparrow\downarrow$ | $\uparrow\downarrow \uparrow \uparrow$                     | ← |
| Fluorine  | F  | $1s^2 2s^2 2p^5$ | $\uparrow\downarrow$ | $\uparrow\downarrow$ | $\uparrow\downarrow \uparrow\downarrow \uparrow$           | ← |
| Neon      | Ne | $1s^2 2s^2 2p^6$ | $\uparrow\downarrow$ | $\uparrow\downarrow$ | $\uparrow\downarrow \uparrow\downarrow \uparrow\downarrow$ | ← |

**paramagnetic**  
**diamagnetic**

**Property61:** Elements in same group behave similarly because they have same number of valence electrons (electrons in the outermost shell);

**Explanation61:** The e particle in the outermost shell get less Ge, Gp, Gn, Gs then more inner electrons and thus they are more free to react;

**Property62:** Ionization energy (the amount of energy it take to pull electron away, it will always be electron from outermost shell) trend (see table);

**Explanation62:** The factors that dictate the ionization energy trend hold also in my theory. Nuclear larger charge=more Gp particles; Shielding effect=inner e particles that emit outwards Ge, Gn, Gs particles; The greater the radius, the less Gp particles (reduced by  $1/R^2$  as it's a particle). If the sublevel is full it mean that all the electron there are paired and thus they get in addition to Gp, Ge also Gn or Gs (and thus need extra energy to remove them). All deviation from this trend can be explained by the stability of half full shell

**successive ionization energies (kJ/mol)**

|        | Na     | Mg     | Al     | Si     | P      | S      | Cl     | Ar     |
|--------|--------|--------|--------|--------|--------|--------|--------|--------|
| 1st IE | 496    | 738    | 578    | 787    | 1,012  | 1,000  | 1,251  | 1,520  |
| 2nd IE | 4,562  | 1,451  | 1,817  | 1,577  | 1,903  | 2,251  | 2,297  | 2,665  |
| 3rd IE | 6,912  | 7,733  | 2,745  | 3,231  | 2,912  | 3,361  | 3,822  | 3,931  |
| 4th IE | 9,543  | 10,540 | 11,575 | 4,356  | 4,956  | 4,564  | 5,158  | 5,770  |
| 5th IE | 13,353 | 13,630 | 14,830 | 16,091 | 6,273  | 7,013  | 6,540  | 7,238  |
| 6th IE | 16,610 | 17,995 | 18,376 | 19,784 | 22,233 | 8,495  | 9,458  | 8,781  |
| 7th IE | 20,114 | 21,703 | 23,293 | 23,783 | 25,397 | 27,106 | 11,020 | 11,995 |

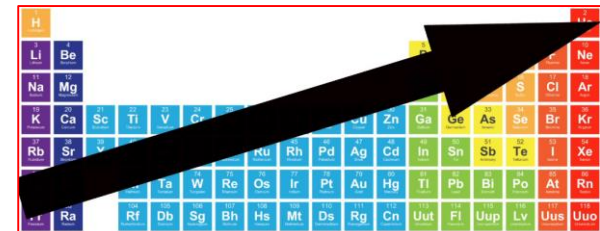
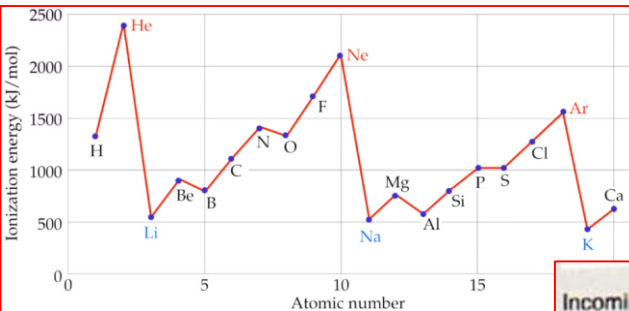

**ionization energy increases up and right**

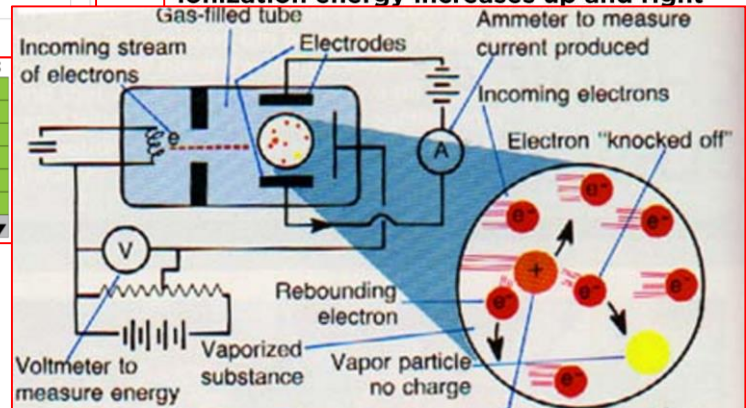
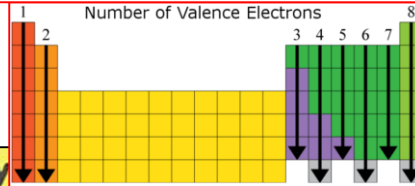

**FIGURE 12-1.** Ionization energy is determined by monitoring the energy of the incoming stream of electrons. When ionization occurs, a current will be detected by the ammeter. Positive ion formed as a result of the collision of an uncharged particle with an electron

**Factors Affecting Ionization Energy**

- Nuclear charge**—the larger the nuclear charge, the greater the ionization energy.
- Shielding effect**—the greater the shielding effect, the less the ionization energy.
- Radius**—the greater the distance between the nucleus and the outer electrons of an atom, the less the ionization energy.
- Sublevel**—an electron from a full or half-full sublevel requires additional energy to be removed.



**Property63: Electron affinity** [how much an atom wants to gain electron. disregarding the noble gases (full shells), F has the highest electron affinity will get full shell, Na, Mg don't want to gain electron and rather loss them to get full shell. exception to this trend can be explain also with precisely half full shells] **and Electronegativity** [the ability of an atom to hold electrons tightly. smaller atom like F with more protons for its energy levels (higher effective nuclear charge) will hold electron best (disregarding the noble gasses)] **trend; Explanation63: Same**

**difference in electronegativity > 2.0**

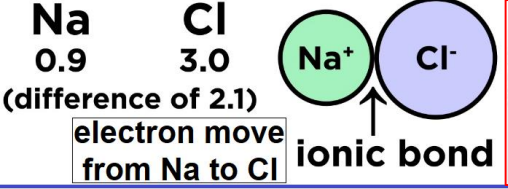

**as ionization energy;**

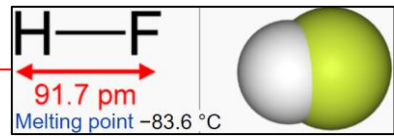
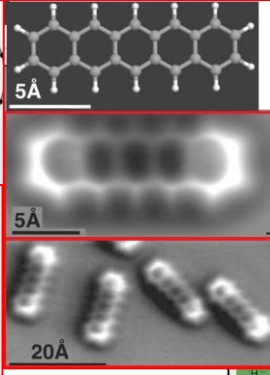
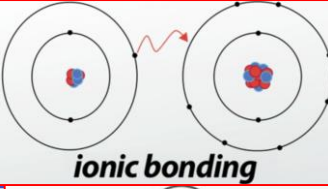

**difference in electronegativity < 1.7**

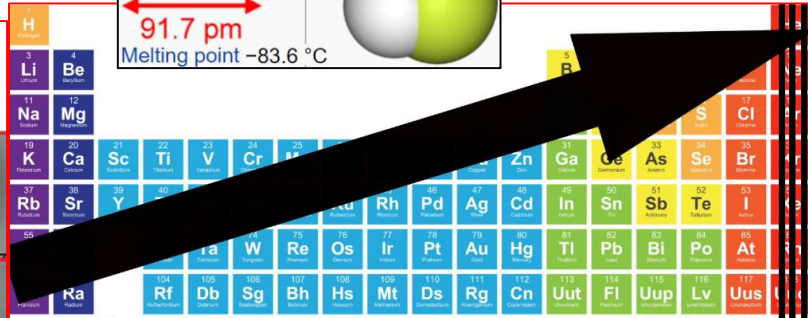
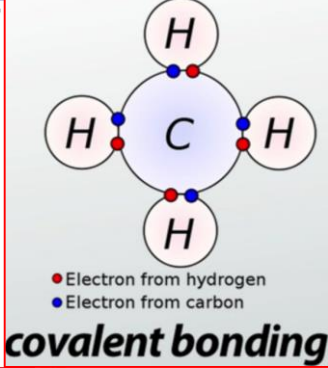
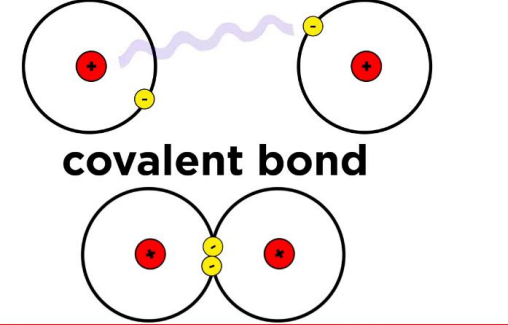

**difference in electronegativity 0.5 to 1.7**

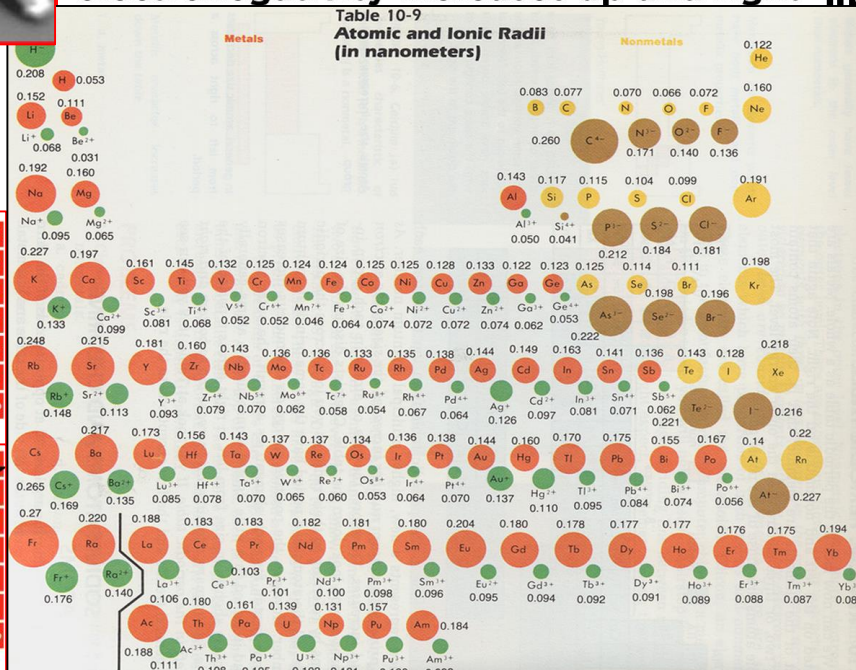
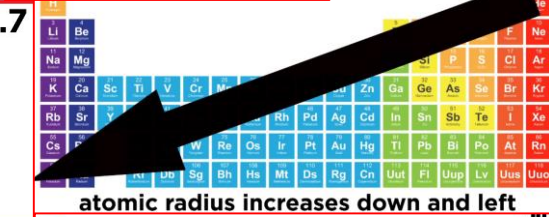
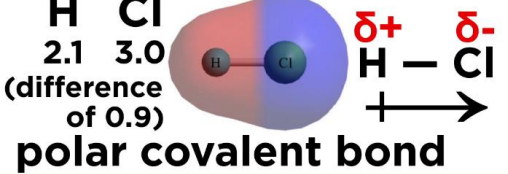

**difference in electronegativity < 0.5**

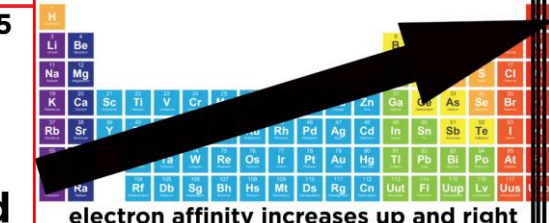
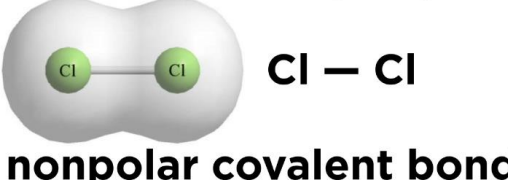

**Property64:** At very high temperatures the electromagnetic force and the weak force become the same force (electroweak force) and at even higher temperature, the electroweak force and the strong force become a single unified force.

**Explanation64:** By this theory all of these forces just describe G particles (or cluster of G particles) collisions, so it make sense that they can be unified.

**Property65:** There is almost only matter and no antimatter in the universe (e and not  $e^+$  and p and not  $p^+$ ).

**Explanation65 option 1:** G particle are not perfect spheroid, they contain an attaching structure in one side only; so only  $e^+$  and  $p^+$  contain this attaching structure in the direction of their rotation, and thus when  $e^+$  collide with itself it create p but if e collide with itself it won't create any stable form (if  $p^+$  collide with itself it create tau particle) and if matter and antimatter collide they annihilate each other;

**Explanation65 option 2:** When the black hole brakes into many pieces due to intermediate axis rotation at the big bang (see properties 73,74) when pieces get hit by its rotation they become electrons and when pieces just slide out they become protons; their shape and number of G's is in the most stable form for these processes;

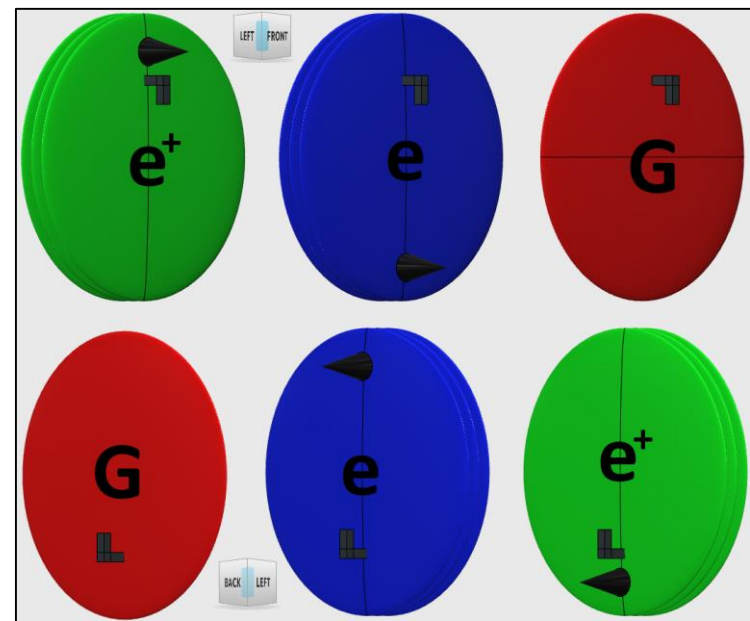
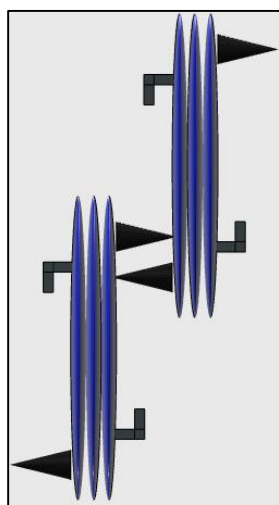
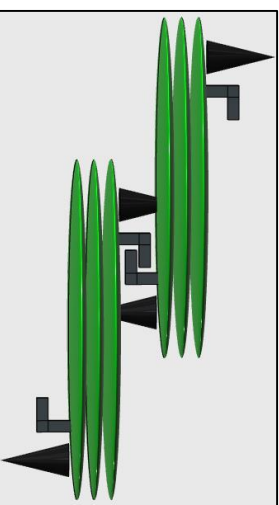

- In my theory I have provided a mechanism that explain why the speed of light is constant regardless the motion of the observer or the light source (see Property: Speed of light constant), {The core principle of this mechanism is that if e generate Ge particle every t1 seconds; and if in every meter there are n1 disturbing G's; and if the actual speed of Ge  $\rightarrow \infty$  as e rotates super fast; then the time taken to remove all the disturbing G's from L (the length between the light source to detector) is  $(n1*L)*t1=(total\ disturbing\ G's)*time$  need to generate 1 Ge; and thus the measured speed of light= $L/((n1*L)*t1)=1/(n1*t1)=constant=c$ ; the motion of the observer or the light source will not influence the result because the actual speed of Ge  $\rightarrow \infty$  and any motion is much less}; the theory of relativity take this as postulate, so it's correct and all of its conclusion correct, include time dilation and length contraction.

**Property66: Time dilation;**

**Explanation66:** In a stationary atom the traveling distance for Ge to reach p is shorter then in a moving atom and because the speed of light is constant, also the time that Ge need to reach p will be shorter in a stationary atom; & thus an astronaut that leave earth, and move faster then its brother on earth, will age slower, & when return it will be younger, because all the chemical process are determined by the exchange of Ge,Gp,Gn,Gs particles between e&p particle; {this equation is used in satellite clocks; If we travel 1year in  $v=c*0.99999$ ; on earth pass 223 years}[ $T_0$ =proper time=measured by observer that is at rest (for decay particle the clock traveling with the particle)];

| Speed of:               | v=m/s       | $(1 - (v/c)^2)^{-1/2}$ |
|-------------------------|-------------|------------------------|
| Fastest running human   | 10          | 1.0000000000000000     |
| Sound in air            | 343         | 1.0000000000000650     |
| water molecule at 100°C | 660         | 1.0000000000002420     |
| Fastest spacecraft      | 73,611      | 1.000000030144910      |
| Earth in space          | 390,000     | 1.000000846171440      |
| electricity             | 287,800,759 | 3.571428472234590      |
| Fastest Proton at LHC   | 299,792,455 | 7,068.621505916400000  |
| Light=c                 | 299,792,458 |                        |

$$\text{Time Dilation } T = \frac{T_0}{\sqrt{1 - \frac{v^2}{c^2}}}$$

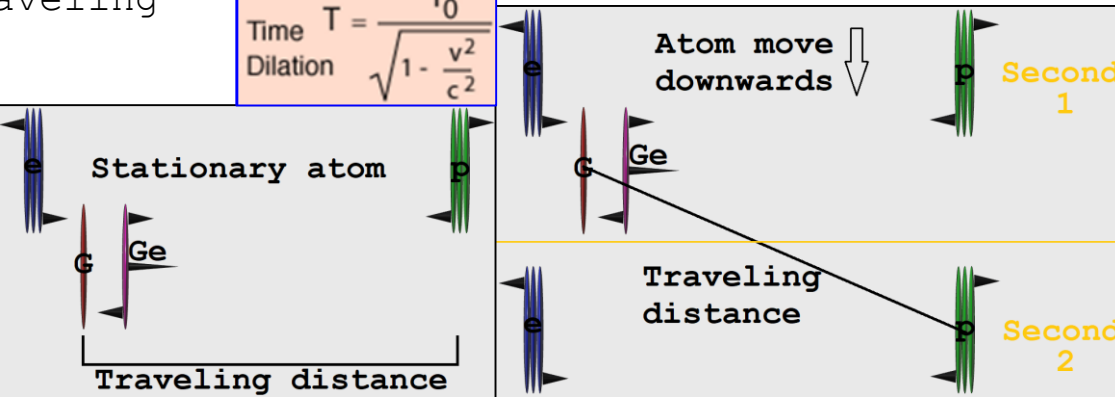



- photon travel at  $c$ , so it experience zero time ( $T_0=0$ ) {if an astronaut travel at  $v \rightarrow c$ , even for a second, it will not experience any time changed and when come back to earth, he will see that  $\infty$  years pass here}

**Property67:** Length contraction: Both astronaut & earth observers will agree on their relative velocity, but each measure different span of time for the event, so they must also measure different distances;  $L_0$ =proper length= measured by observer that is at rest;  $L$ =contracted length=at faster speeds objects and distances appear shorter; {an astronaut inside a spacecraft, moving at  $0.85 \cdot c$ , measures the length of the ship as being 100m, how long does it look to an earth observer?  $L_0=100$ ;  $L=L_0 \cdot (1-0.85^2)^{(1/2)}=52.7\text{m}$ ; A muon travels 10,400km in earth's reference frame when it travels at  $0.998 \cdot c$  How far does it travel in its own reference frame?  $L_0=10,400$ ;  $L=10,400 \cdot (1-(0.998)^2)^{(1/2)}=657$ ; photon travel at  $c$ , so for us it seen that it has no sizes (space doesn't exist to a photon)}

**Explanation67:** In contrast to time dilation, length contraction is not an actual contraction in the physical length, the length only seen contracted for observer that is not at rest with respect to this physical length; because both observers agree on their relative velocity, but each measure different span of time for an event; so if a rest observer measure the time that took to the right side of a tennis ball reach a point in space and then he measure the time that took to the left side of this ball to reach the same point in space, and then by knowing the velocity (that they both agreed on) and by looking at its watch (which run faster then the ball's watch) he can calculate the length and get shorter and shorter length with the increase of speed;

$$L = L_0 \sqrt{1 - \frac{v^2}{c^2}}$$

Length contraction

$$\text{Time Dilation } T = \frac{T_0}{\sqrt{1 - \frac{v^2}{c^2}}}$$

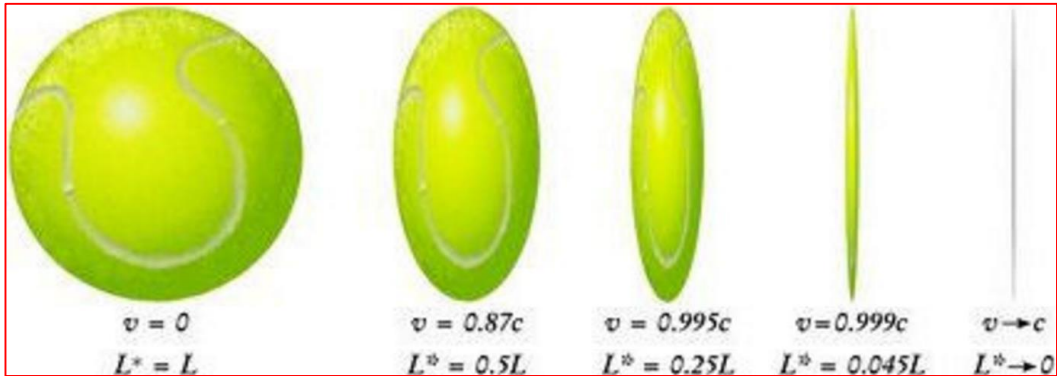

**Property68:** Increased mass at high speed: If we accelerates {at  $-271^{\circ}\text{C}$  (absolute zero= $-273^{\circ}\text{C}$ ) in LHC using super conductors magnets} 2 protons at opposite direction to speed of 99.9999991% of the speed of light, each one of them will have 7000 times more mass and when they collide they can create something that is 14,000 times heavier than a proton; (at the collision point, LHC has a 3D digital camera that take 14 million pictures per second); example 1 of such formed heavy particle is the higgs, which is 134 times heavier then a proton; higgs live for only  $10^{-24}$  seconds , it's created and disintegrated instantly into 2 gamma rays that fly from the collision point.

**Explanation68:** When a proton travel so fast it collect G particles by inserting them in between the G's that compose its clustered structure; but this heavier proton doesn't live longer, because it is unstable, because this newly created particle will rotate about its intermediate axis (see mathematical proof last chapter), so it will brake soon after the creation and 2 of the broken pieces of G's will fly and rotate fast, we call them gamma rays photons (and they are being used in the process of discover this and other new particles);

- What we call electron neutrino is a cluster of 2,199,995,720,977,971,152 G's P (em/232272.7) that its  $\omega(2)=0$ ; (no charge); thus it won't interact with ordinary matter & it's almost undetectable; but it has  $\omega(1)$  &  $\omega(3)$ , so it has spin, with magnitude like the electron; & it travel at c; it produced by the sun in vast quantity or as a product of collision in LHC;



**Property69:** The 2<sup>nd</sup>, 3<sup>rd</sup> generation particles in the standard model have the same properties like the 1<sup>st</sup> generation particles {electron neutrino, electron, Down&Up Quark (that make proton & neutron)}, but they are more massive and not stable {e.g. if we create muon (like electron but 207 times more massive) on particle accelerator it will quickly decay into electron and neutrinos}.

**Explanation69:** These heavier particles are formed by the process described in the former property; and therefore retain the original particle ω (charge & spin); (the neutrinos in the example are formed when the G particles components of the muon are getting closer together again, thus emitting the neutrino that has velocity of c and spin but no ω(2));

**Property70:** Mass increased formula; **Explanation70:** This formula was derived, using the constant of the measured velocity of light as a postulate; and therefore its derivation still hold in my theory; (this derivation may be the key to derive the density of G particle in the universe and their average velocity);

Velocity 0.99986 c    0.999999996 c

Mass 60 m<sub>0</sub>    11,180 m<sub>0</sub>

relativistic mass:  $m = \frac{T_0}{\sqrt{1 - \frac{v^2}{c^2}}} = \gamma m_0$

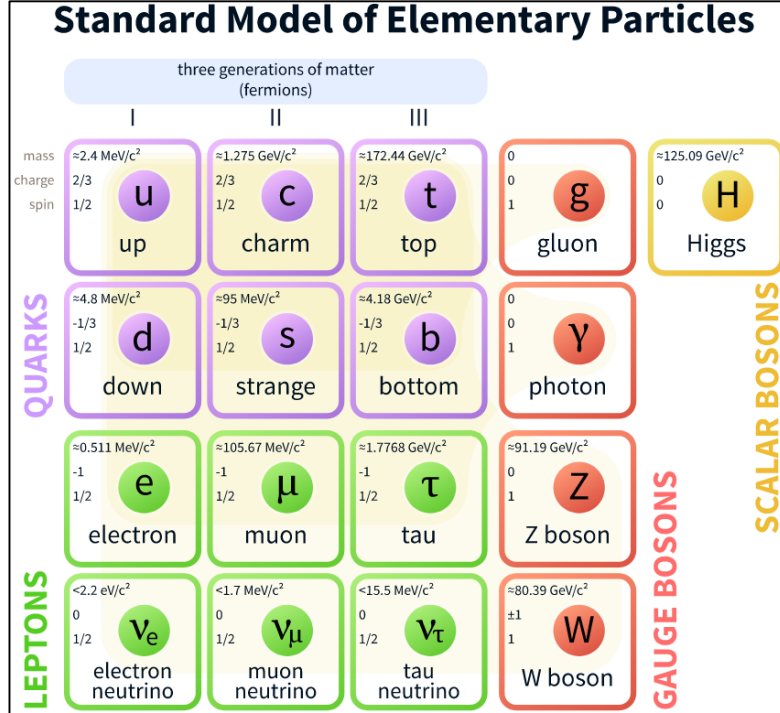



The following atomic bond properties can be derived from previous properties:

- Atoms that are bonded in covalent bond can come closer than atoms that are not bonded. The stronger the bond the shorter the bond. Bonds are weaker and longer between larger atoms.
- C atom(6p) forms 4 bonds, H atom(p) forms 1 bond, O atom(8p) forms 2 bonds...
- The strength of bond between 2 atoms increases with the difference in electronegativities.
- Ionic compounds are characterized by high melting points & the ability to conduct electricity in the molten/gas state (but not in solid state). They tend to be soluble in water and usually crystallize as sharply defined particles.
- Covalent compounds typically have low melting points, do not conduct electricity, and are fragile.

The following metal properties can be derived from previous properties:

- In metal (element with low ionization energy) the outer electrons are shared between many atoms (Metallic bond).
- A metal element is typically hard, conduct electricity in all phases, opaque, shiny, and has good thermal conductivity. Metals are generally malleable, that is, they can be hammered or pressed permanently out of shape without breaking or cracking - as well as fusible (able to be fused or melted) and ductile (able to be drawn out into a thin wire) {because the atoms in metal have freedom to move around each other}. Metal have high melting point and high boiling point {because its hard to pull a individual atom because of the huge attraction from the sea of E}.
- Nonmetals (element with high ionization energy) tend to be easily vaporized, have low elasticity, & are good insulators of heat and electricity. Nonmetals tend to have high electronegativity & gain or share electrons when they react with other elements or compounds.
- Metalloid (element with medium ionization energy) has properties that are a mixture of metals and nonmetals.

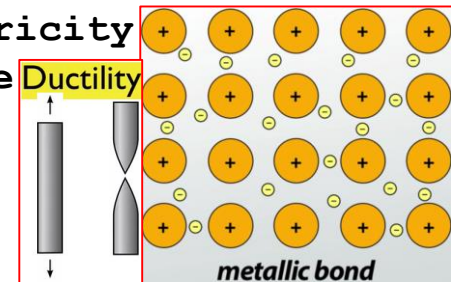

## The following electric properties can be derived from previous properties:

- When a current carrying wire is split into 2 wires, the sum of the currents of these 2 wires is equal to the current of the original wire.
- Copper can carry more current than iron, thus when we transfer a lot of current from copper to iron the iron will melt (the 4 outer electrons in iron will collide during the movement, copper has only 1 outer electron).
- AC=current that reverses direction periodically & continuously vary in magnitude.
- When we hold an electric cable with 2 hands without touching the ground, the current will pass only through the cable and we stay alive (electron in the cable are more free to move).
- When we hold electric cable with 2 hands without touching the ground & cut the cable between our hands the current will pass through our body & kill us.
- When we hold an electric cable with 1 hand and with the other hand we hold the ground, the current will pass through our body and kill us (the ground can make the outer electrons in some of the atoms in our body more free to move, even in comparison with the cable (because it contains many atoms & thus many options of electron movement), so some current will flow that way).
- Capacitor is a passive two-terminal electrical component used to store electrical energy temporarily in an electric field. The larger the surface area of the "plates" and the narrower the gap between them, the greater the capacitance is (because the opposite charges will stabilize each other and allow the accumulation of more charge).
- When 2 clouds collide many electrons move to one of the clouds & then the electrons will travel as lightning to the ground, because in electricity electrons move by the power of repulsion, and thus it needs a place to move to, and the ground has many electrons that can easily move to other atoms.

The following light properties can be derived from previous properties:

- If we rotate the antenna to be parallel to the ground, we will see the electric field oscillating left and right and the electromagnetic wave will be horizontally polarized.
- In the wings of some butterfly there are layers that are separated at a distance equal to the wavelength of green light. these layers reflect light of all colors, but the waves of green light lined up together making the green more intense, & all the other colors cancel themselves out & we see it green.
- Sun burning require only specific wavelength or shorter to brake the C-C bond, longer wavelength won't brake it even if many photons of it hit the body.
- When an electron deflect due to the positively charge nucleus of an atom in the anode, the deflecting electron will slow down (decelerate) and therefore loss energy and this energy will be radiated in the X-ray wavelength (accelerated charge emit photons).
- Water molecule is polar (contain 2 different charges), thus, when a microwave photon hit a water molecule it will rotate it back and forth and cause heat.
- When a compound is subjected to varied frequency of IR radiation, some frequency are absorbed. The absorbed frequency correspond to the natural vibration frequency of the molecule (bending, wagging, stretching, twisting) & it can be used to identify the compound.

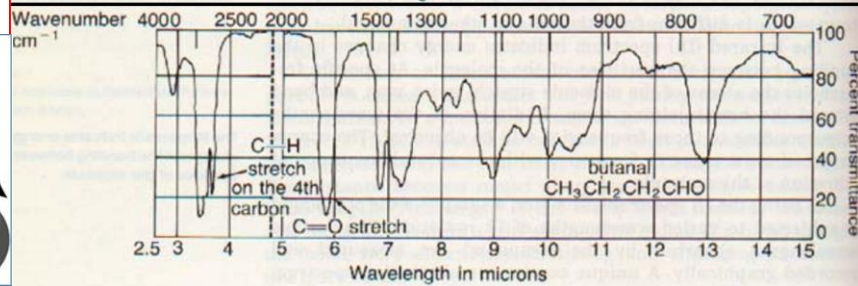
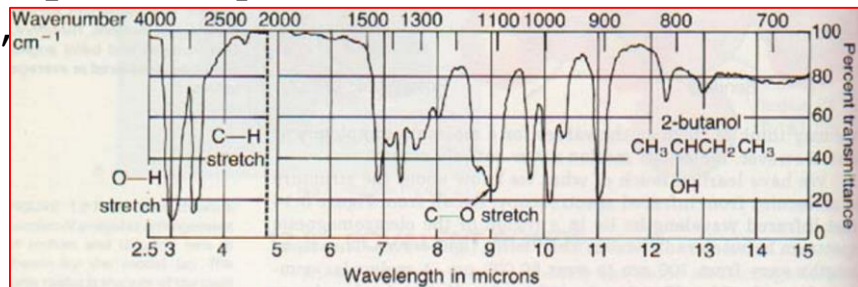
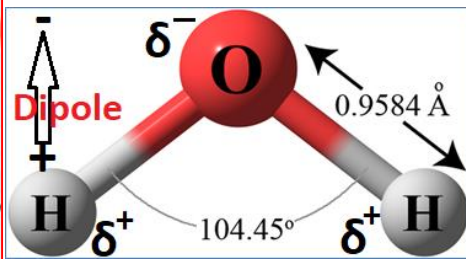
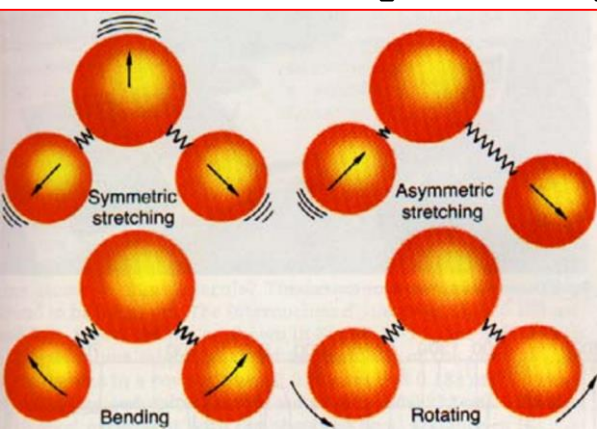

- Doppler-free spectroscopy: is a set-up that enables the precise determination of the transition frequency of an atom without having to cool the sample down to temperatures at which the Doppler broadening is no longer relevant (few millikelvins). Both laser beams are at the same frequency. If the atom doesn't move in the x-direction there is no Doppler shift and both beams will interact with the same electron in the atom. The not chopped beam has more intensity, thus it will elevate all the electrons and then the chopped beam will have no electron to interact with so it will be absorbed and re-emitted immediately, so its intensity is unchanged. But if the atom is moving in the x direction both beams will interact with different electrons and the intensity of the chopped beam will be reduced as it will be absorbed and not re-emitted immediately but after some time, and some portion of the elevated electron will be returned without emitting photon but due to collision with other atom. So when the chopped beam is returned in the highest intensity (and it happened only with the not chopped beam) it's due to the fact that both photons interact with the same electron in an atom that is not moving, thus no Doppler broadening.

For hydrogen gas at 300 K, the rms velocity is about 2700 m/s. This speed corresponds to a Doppler shift of about 4 GHz, or a line broadening of twice that. This would effectively obscure the Lamb shift, since it is only 1.057 GHz.

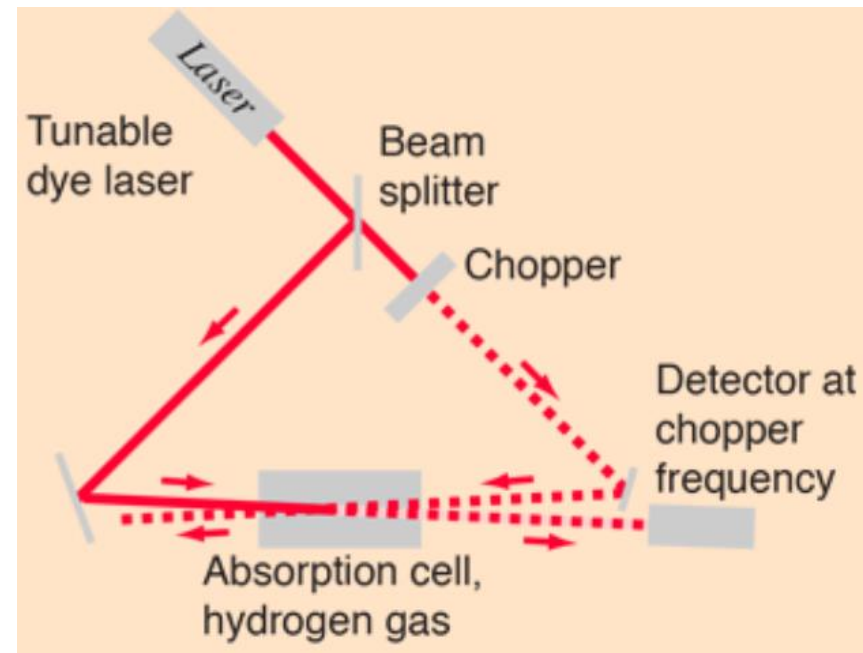



- **Holography:** the reference beam(A) is coherent(light waves are in phase) and the object beam(B) is not coherent; the reference & object beams create interference pattern on the film(C) that contain both intensity and phase information about the object;  $A+B=C$ ; to see the image, we shine A on from the back of C;  $(C-A=B)$ ; if we cut the film to many pieces each piece will still show the whole object because photons from each part of the object will reach each part of the film; because the film contain phase information also we can see 3D (from behind and with dept);

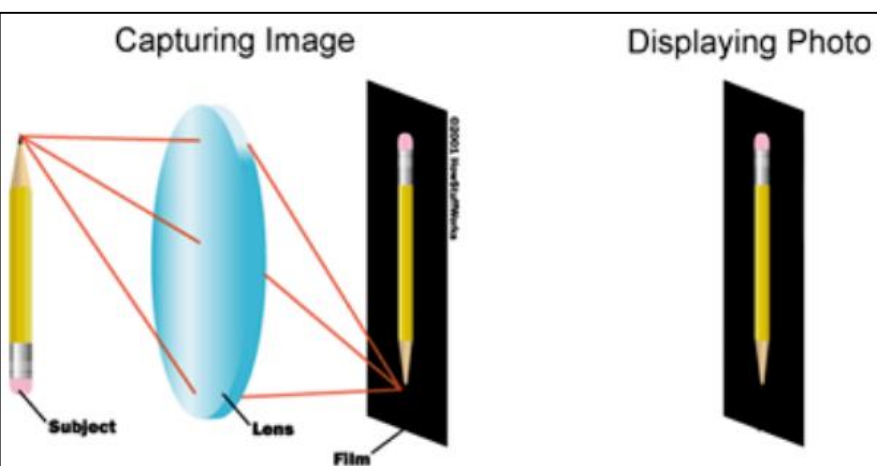

**DIFFERENCE BETWEEN A PHOTOGRAPHY & HOLOGRAPHY**

| S.No | photography  | Holography  |
|------|--|---|
| 1.   | Photography is a 2-dimensional recording process   | Holography is a 3-dimensional recording process                           |
| 2.   | Ordinary light can be used for recording           | Only laser beam should be used for recording (or) constructing a hologram |
| 3.   | It is based on lens systems                        | It is a lensless systems  |
| 4.   | Amplitude alone can be recorded                    | Both Amplitude and phase can be recorded                                  |
| 5.   | Image is recorded totally                          | Image is recorded bit by bit  |
| 6.   | Image has poor resolution                          | Image has very high solution  |
| 7.   | To get the positive of the image it needs printing | To get the positive of the image it needs printing                        |
| 8.   | No need of vibration less table                    | Needs of vibration less table   |

**How Holograms Work Basic Setup**

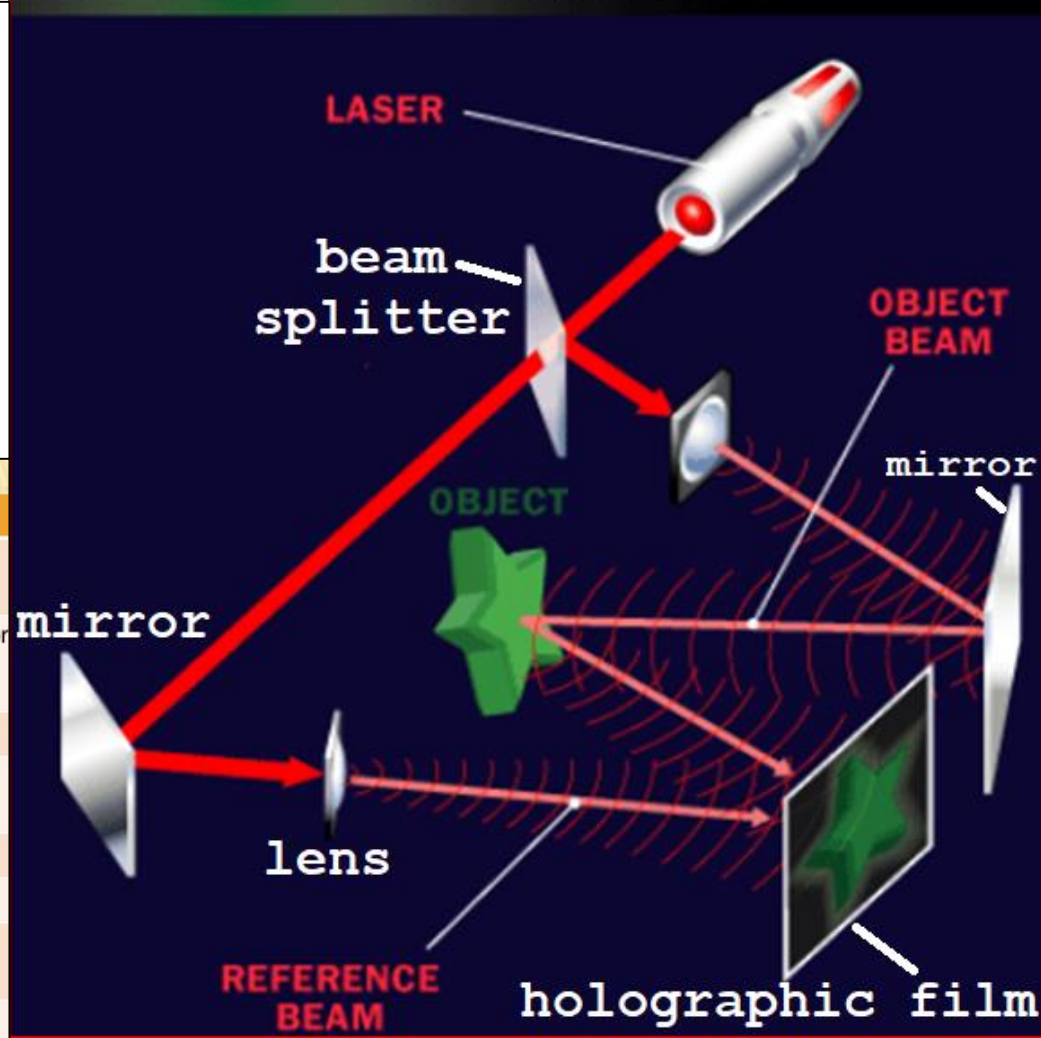

**Gravity option 1: (most probable)**

While the particles of the magnetic field ( $G_n, G_s$ ) rotate mainly perpendicular to the particles of the electric field ( $G_e, G_p$ ), the particles of gravitational field ( $G_l, G_r$ ) rotate mainly perpendicular to both of them; So the electron/proton produce many  $G_e/G_p$ , few  $G_n&G_s$  and very few  $G_r&G_l$ ; and both  $G_r&G_l$  attract  $e, p$ ;

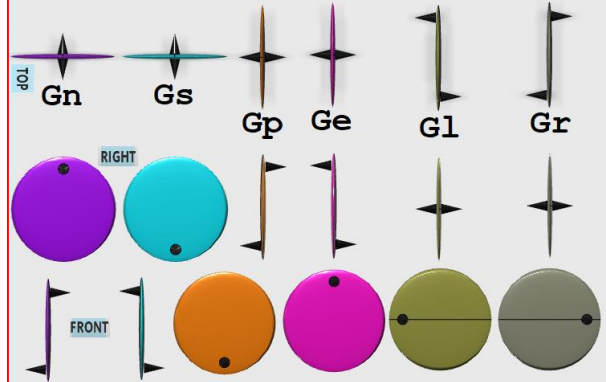

So if option 1 correct, there will be 2 new rules:

- Rule 16:** Gravitational field generation:  $[E_{u1}+G \rightarrow G_e, G_{s1}, G_{n1}, G_r, G_l;$   
 $E_{d2}+G \rightarrow G_e, G_{s2}, G_{n2}, G_r, G_l;$   $P_{u1}+G \rightarrow G_p, G_{s1p}, G_{n1p}, G_r, G_l;$   $P_{d2}+G \rightarrow G_p, G_{s2p}, G_{n2p}, G_r, G_l];$
- Rule 17:** Attraction:  $G_r$  attracts  $e$ ;  $G_l$  attracts  $e$ ;  $G_r$  attracts  $p$ ;  $G_l$  attracts  $p$ ;  
 {use my collision simulation to prove these rules; e.g. proof of rule 1,2}

**Property71:** The gravitational force is  $10^{36}$  fold weaker than electromagnetic force. **Explanation71:** Only very few  $G_r, G_l$  particles formed by  $p, e$  and their effect on  $e, p$  is very weak;

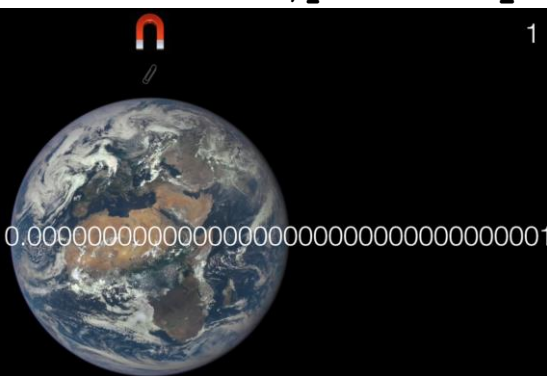

| Fundamental Forces |                         |                                 |   |   |
|--------------------|-------------------------|---------------------------------|---|---|
| <i>Strong</i>      |                         | Strength<br><b>1</b>            | Range (m)<br>$10^{-15}$<br>(diameter of a medium sized nucleus) | Particle<br>gluons,<br>$\pi$ (nucleons)   |
|                    | <i>Electro-magnetic</i> |                                 | Strength<br>$\frac{1}{137}$                                     | Range (m)<br>Infinite   |
| <i>Weak</i>        |                         | Strength<br>$10^{-6}$           | Range (m)<br>$10^{-18}$<br>(0.1% of the diameter of a proton)   | Particle<br>Intermediate vector bosons<br>$W^+, W^-, Z_0,$<br>mass > 80 GeV<br>spin = 1 |
| <i>Gravity</i>     |                         | Strength<br>$6 \times 10^{-39}$ | Range (m)<br>Infinite   | Particle<br>graviton ?<br>mass = 0<br>spin = 2  |

| Interaction  | Gravitational                  | Electromagnetic      |
|--|--------------------------------|----------------------|
| Property   |                                |                      |
| Acts on:   | Mass - Energy                  | Electric Charge      |
| Particles experiencing:                                    | All                            | Electrically charged |
| Particles mediating:                                       | Graviton<br>(not yet observed) | $\gamma$             |
| Strength relative to electromag for two protons in nucleus | $10^{-36}$                     | 1                    |

Gravity option 2:

- when e particle accelerate very fast and hit G particle exactly at its edge, it creates a  $\gamma_g$  particle which is  $\gamma$  particle with a very high  $|\omega(2)|$ ; This  $\gamma_g$  particle will cause the attraction of any p particle or nucleus (like Ge), so we call it gravity, when  $\gamma_g$  hit e particle in any atom it will repel it so much that this e particle will be thrown out of the atom very fast, leaving the atom without 1 electron but in its original place. This event is very rare therefore gravity is a very weak force that effect only large objects. For object in our scale the loose of electron will be shortly compensate by getting new electron from the air or environment.

Gravity option 3:

Each atom emit many Ge &  $\gamma$  particles in all direction, if they hit p article in far atom it will be attracted, but if they hit the e particle (probability much smaller as it much smaller in size) of the far atom usually they won't be absorbed (only specific frequency absorbed), so that far atom won't move (see Doppler laser cooling property); the electron that get Ge/ $\gamma$  will come back to its place almost immediately by the many Gp's; but if the nucleus get these Ge/ $\gamma$  it will move & the electrons won't bring it back to its natural position as fast, because they are interacting also with each other (by Ge, Gn, Gs);

- Saying: "masses attracted because they warp spacetime" is equal of saying: "masses attracted because masses attracted"; becuae curving 3D space about time create velocity. This is not an explanation;

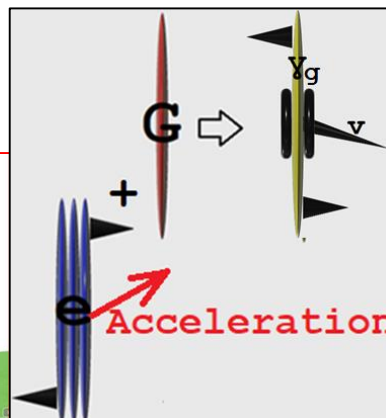
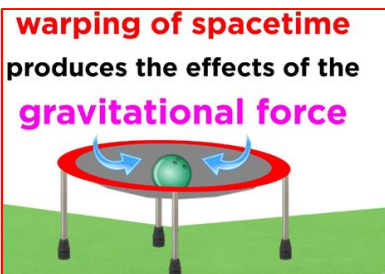

- Mass is just the number of G particle in the cluster particle;

**Property72:** Neutron star. Neutron star result from the gravitational collapse of a massive star after a supernova. Neutron stars are the densest and smallest stars known to exist. their radius is 11km and their mass is twice of our Sun. Neutron stars are composed almost entirely of neutrons. their surface temperature is  $\sim 6 \times 10^5$  K. and their density is  $\sim 5 \times 10^{17}$  kg/m<sup>3</sup> (density of an atomic nucleus is  $3 \times 10^{17}$  kg/m<sup>3</sup>). Some neutron stars rotate very rapidly, up to 716 times a second and emit beams of electromagnetic radiation. There are thought to be around 100 million neutron stars in the galaxy.

**Explanation72:** Neutron star formed when a big nucleus attached more and more protons and other nuclei and also electrons (see proton creation & electron capture process), because it attached many electrons it loosed most of its positive charge ( $\omega(2)$ ), it still has some rotation but its negligible compared to the intensity of  $\omega(2)$  & it's mostly in the direction of spin ( $\omega(1), \omega(3)$ );

**Property73:** Black holes; while the maximum observed mass of neutron stars is about 2 solar (sun) masses. The smallest observed mass of a stellar black hole is about 5 solar masses. **Explanation73:** Black hole formed when a big nucleus attached more and more protons and other nuclei and then also little bit electrons, in contrast to neutron star, a black hole attached more protons and nuclei at the beginning, so it is capable of growing to a bigger structure;

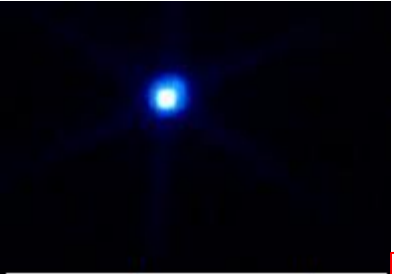

neutron star 1 solar mass =  $1.9891 \times 10^{30}$  kilograms

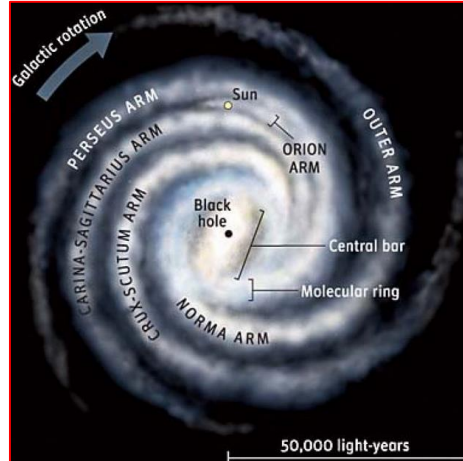



**Property74:** The expansion of the universe appears to be accelerating. The velocity of galaxy away from earth[km/s]=The distance of the galaxy from earth[km]\*26\*10^-19. **Explanation74:** When a black hole grow it attract a lot of stars that attract a lot of planets, so there are a lot of material around him; as a black hole is just a huge nucleus that rotate with  $\omega(2)$ , at a critical point of its growing, its rotation become a rotation about its intermediate axis and thus it become unstable and brake apart and all of its braking parts are now also rotate about their intermediate axis, so they also braks and this chain reaction is what we call the big bang; as there were a lot of material around the black hole; there is now a lot of material around the center of the big bang; thus when this centered material cool down and form galaxies, they will be

accelerated outward, and the farther the galaxy from the center of the big bang the faster it move outwards because it is closer this old material that were around the black hole;



Universe expansion accelerating

How fast it's moving away from us

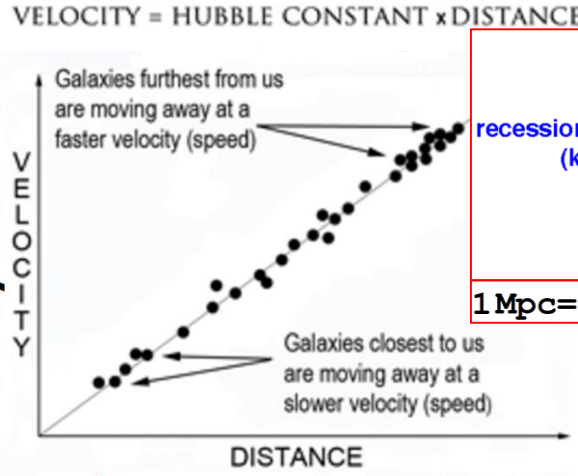

$$V = Hd$$

recessional velocity (km/s)      distance (Mpc)

- H is the Hubble constant
- H = 80 km/s/Mpc

$$1 \text{ Mpc} = 3.08567758 \times 10^{22} \text{ meters}$$

How far away the galaxy is

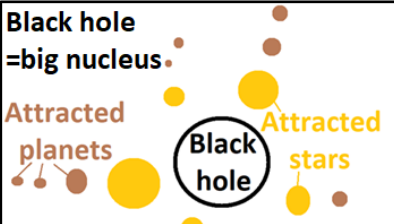
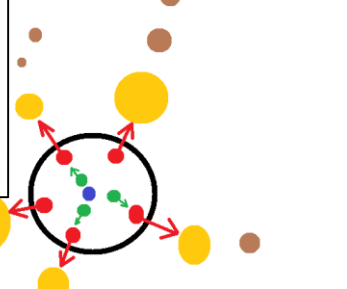

**Step 1:**  
Black hole Attract material that attract more material  
The black hole which is a huge nucleus grows and grows

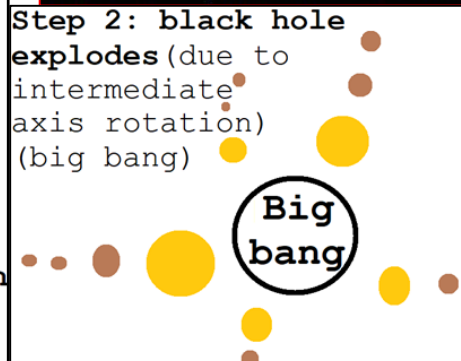

**Step 2:** black hole explodes (due to intermediate axis rotation) (big bang)

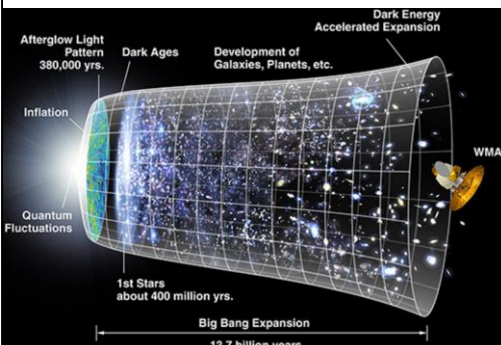

**Step 3:**  
Galaxies formed, the farther the galaxy from the big bang center, the more close it to the old material and the more it will be attracted, thus the more it will accelerate away from earth

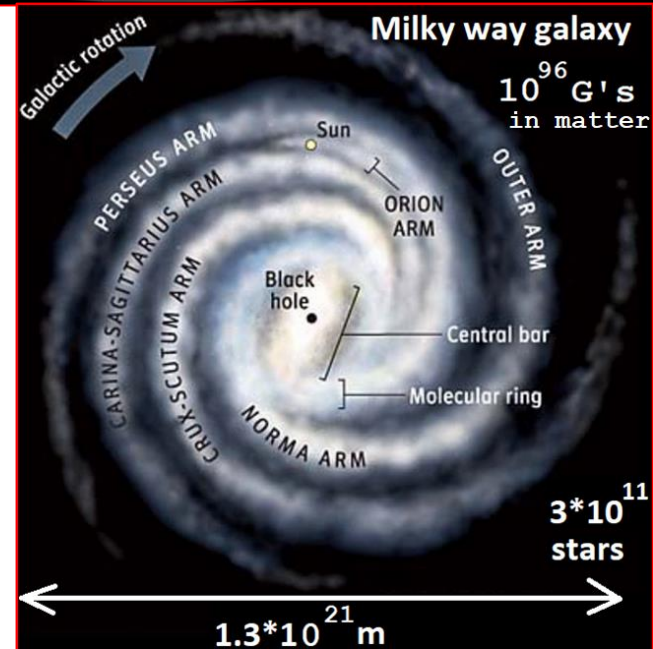
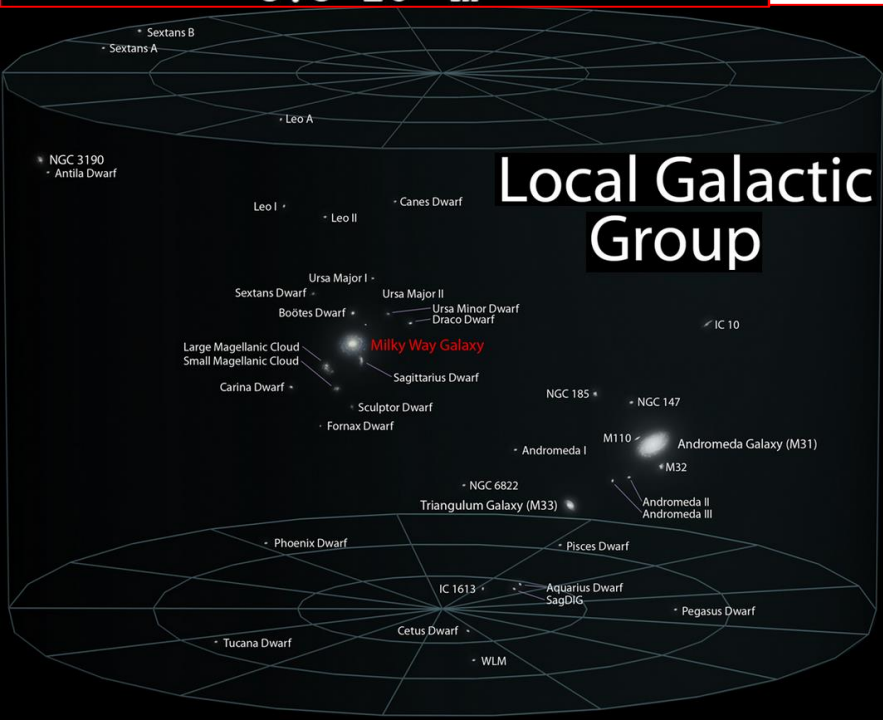
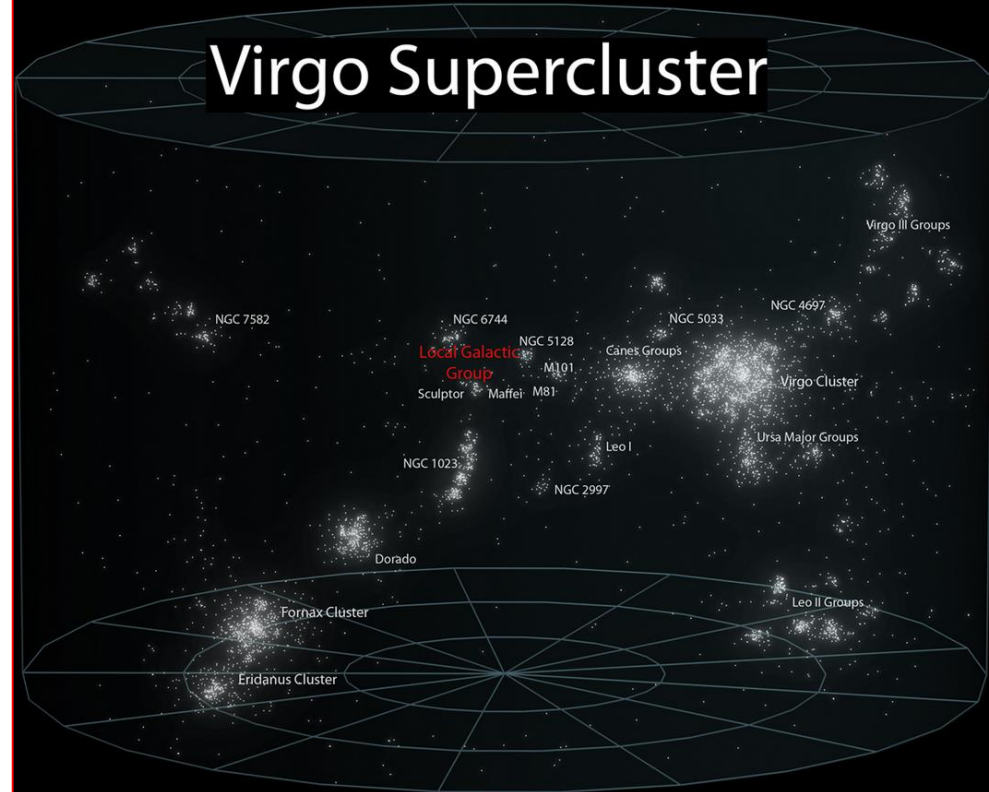





- **Dark energy**(a proposed repulsive force that causes the universe to expand in an ever-increasing rate) **is not exist, see former property .**

**Property75:** Dark matter; Invisible forms of matter make up much of the mass observed in galaxies & clusters of galaxies; dark matter is invisible because it doesn't reflect absorb or emit light(it's electrically neutral);

**Explanation75:** The most abundant particle in the universe is G; most of it doesn't rotate and only translate; but some G particles can have some tiny, negligible rotation (compared to the huge  $\omega(2)$  of the electron), this small rotation produce some Gr,Gl particles that are responsible for the extra mass observed;



**Property76:** CMB (cosmic microwave background radiation); CMB light (strongest in the microwave wavelength region) glows almost exactly the same in all directions and is not associated with any star, galaxy, or other object.

**Explanation76:** Immediately after the Big Bang there were no atoms so the formed photons just fly away or hit electron or proton and disappear; 378,000 years after, hydrogen atoms formed and now the photons can jump from one atom to the other, the temperature at this moment was 3000K so the photon wavelength peak was  $\lambda=9.67 \times 10^{-7}$ ; (Wien's law:  $\lambda=0.0029/T$ ; the atoms were close at that moment so they collide and create light) these hydrogen atoms are the first atoms that fly outward from the big bang center; earth is located more close to the big bang center, so where ever we look in the sky there are these hydrogen atoms and they still send this old photons to each other and to us, but because they are moving faster then us (see property universe expansion accelerating) we see this photon red shifted as  $\lambda=0.001064$ ; which is the microwave region; (even if some of these old photons hit the material that made earth just after the creation of the first hydrogen, these old photons will escape outwards over time, so the CMB that we see today coming from the far hydrogen cloud that move faster then us; it's more probable that this CMB light goes many times between the earth & this cloud during the past 13.8B years)

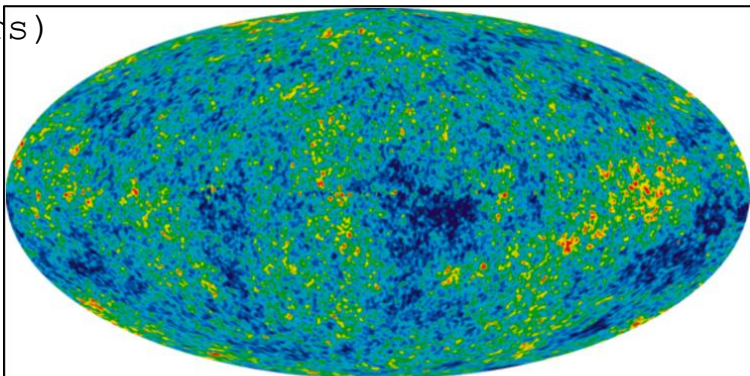

All-sky map of the CMB

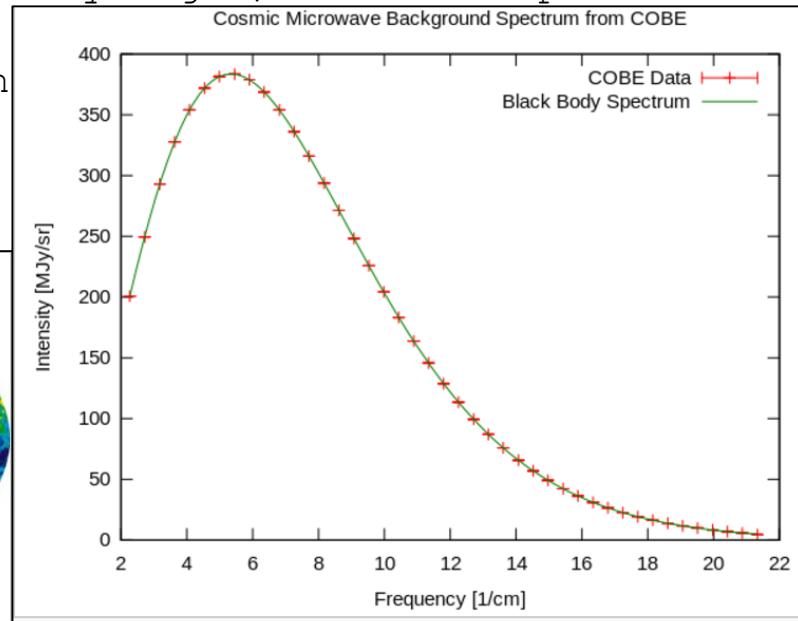

the most precisely measured black body spectrum

Step 1:

Immediately after big bang, there are no atoms so any created  $\gamma$  will disappear by collision with e,p or by going outwards;

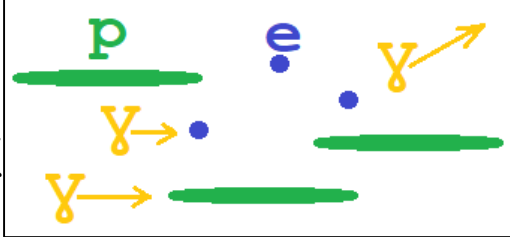

CMB (cosmic microwave background radiation); glows the same in all directions and not associated with any object. Suppose to be  $\lambda=9.67 \times 10^{-7}$ ; but we see it as  $\lambda=0.001064$ ;

Step 2:

Hydrogen atoms formed & are close together, temperature 3000K, so by their collisions they form  $\gamma$  of  $\lambda=9.67 \times 10^{-7}$ ; that now can be jump from one atom to the other and preserved;

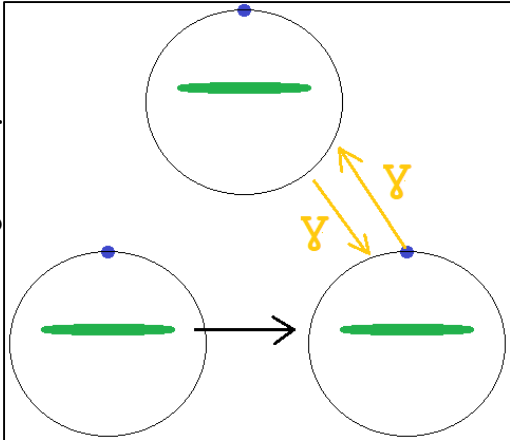

Step 3:

Hydrogen atoms (clouds) thrown farther from the big bang center in all directions and the distance between them increase (no more collision or other  $\gamma$  creation);

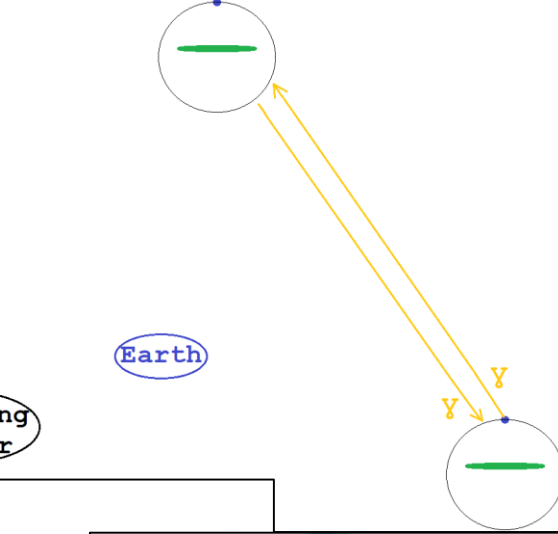
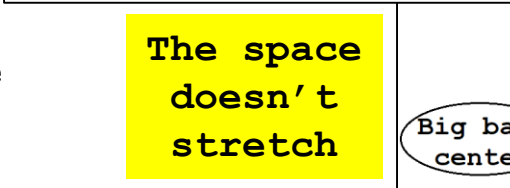

Step 4:

These  $\gamma$  of  $\lambda=9.67 \times 10^{-7}$ ; are going back and forth between earth and the hydrogen clouds, but because these clouds are located farther from the big bang center their velocity is higher and the  $\lambda$  of  $\gamma$  thrown to earth become longer and longer each time; so now 13.8B years after the big bang we see  $\lambda=0.001064$ ;

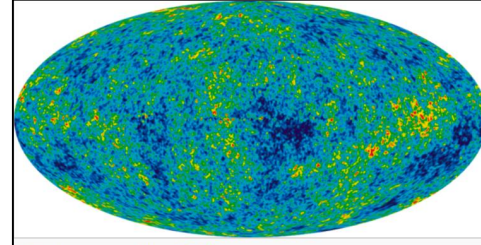
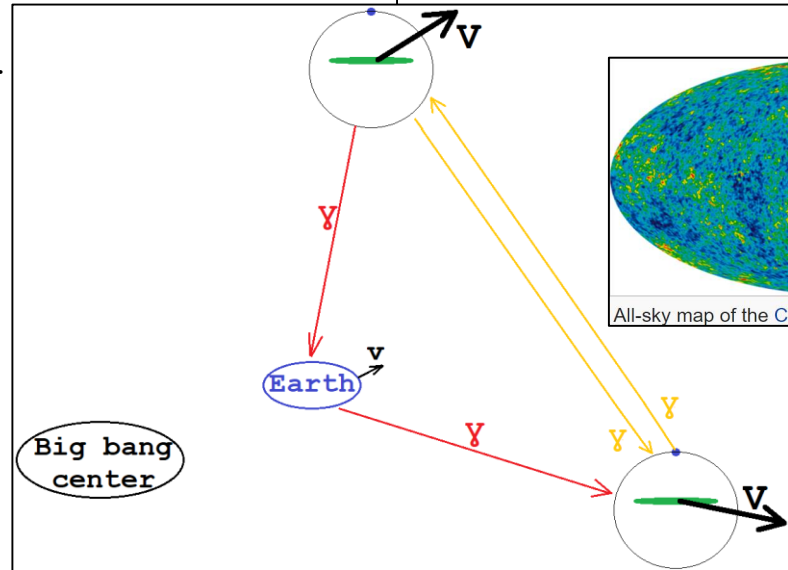

All-sky map of the CMB

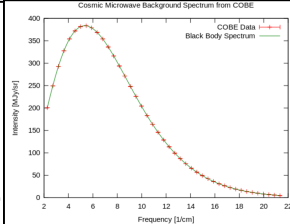

the most precisely measured black body spectrum

- The photon  $\lambda$  peak for 3000[K] body is  $\lambda_s = 9.67 \cdot 10^{-7}$  [m]; (Wien's law:  $\lambda_s = 0.0029 / T$ ); & its frequency =  $f_s = 310023224405377.45$  [1/s] ( $f_s = c / \lambda_s = 299792458 / (9.67 \cdot 10^{-7})$ );

Option 1: (more probable)

The hydrogen gas cloud is located much closer to us (then  $1.15304601059e+23$  km) and the CMB light is going many times back and forth between earth and this cloud for the past 13.8B years, & each time its  $\lambda$  become longer and longer;

Option 2:

The hydrogen gas cloud is located  $1.153046010596450e+23$  km away from us (at the edge of the observable universe) so its velocity ( $v$ ) away from us by the Hubble law ( $v$  [km/s] =  $d$  [km] \*  $26 \cdot 10^{-19}$ ) is 99.99983% of the observed speed of light ( $c$ );  $v/c = 0.999998348040753$ ; So by the red shift law {observed\_frequency = stationary\_frequency \*  $((1 - v/c) / (1 + v/c))^{1/2}$ } we see this light in observed frequency = **281759828947.37**; (microwave region)  
{A photon of  $\lambda_o = 0.001064$ ; have frequency of  $f_o = 281759828947.37$  [1/s] ( $f_o = c / \lambda_o$ )};

- In general, galaxy or star that is farther from the big bang center, is formed earlier, it is moving faster outward, and its light is more red shifted not only because of its higher velocity, but also because its light is more old so it has more opportunity to bounce between this galaxy to other and in each bouncing the light become more and more red shifted; (these 2 reasons explain all red shifted phenomena and the explanation of an expanding or stretching space should be abandoned);

**Property77:** Gravity force= $Fg(r)=-g*m1*m2*r/|r|^3$ ; [N]  $g=6.67259*10^{-11}$  [N\*m<sup>2</sup>/kg<sup>2</sup>]; **Explanation77:** The more mass, the more e,p particles and more  $\Upsilon g/(Gr,Gl,Ge)$  produced; the force is reduced by  $1/|r|^2$ ; as Gr,Gl,Ge are particles and  $\Upsilon g$  is produced by one event of acceleration and not by continues periodic acceleration (which create regular light);

**Property78:** Gravity waves are predicted to have  $\lambda=10^{-20}m$  (frequency= $3*10^{28}$ );

**Explanation78:** The frequency of  $\Upsilon g$  is expected to be very high; Gr,Gl particles may also have high spin and thus high frequency;

**Property79:** Gravitational collapse after supernova of a massive star that result in neutron star; **Explanation79:** During supernova many high frequency photon & many Gr,Gl,Ge created;

**Property80:** Photon is affected by gravity: When a photon leaves a massive mass, in order to overcome its gravitational force it losses energy and therefore its wavelength is increased, its speed remain the speed of light.

**Explanation80:** The massive mass attract the atom that contain the electron that emit the photon, so the electron moves in opposite direction and emit red shifted photon.

**Property81:** Gravitational lensing;

**Explanation81:** When the gravitational particles  $\Upsilon g$  or (Gr,Gl,Ge) hit  $\Upsilon$  it can attract it or repel it depending on the collision angle; we see only the  $\Upsilon$  that get attracted as gravitational lensing;

Example of gravitational lensing:

```

Ce=1; AM=1; BM=1; As=[1,1,0.1]; Bs=[1,1,0.1];
%For Spheroid A,B: M=mass,s=size(s(1))s(2)),
V=Velocity in world frame,AV=[9;0;0]; BV=[0;-9;0];
AW=[-22;0;0]; BW=[3;0;20];
AOIv=[0;pi/2;0]; BOIv=[0;pi/2;0];
Dg=[2.6;4;0]; %W=initial angular velocity
  
```

Other collision results don't reach us.

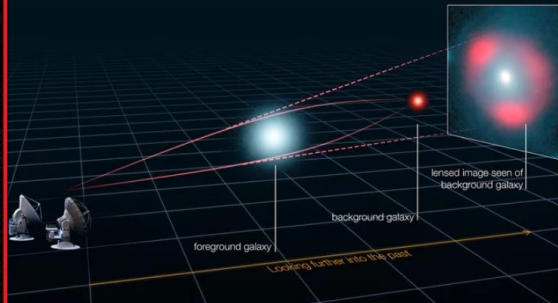
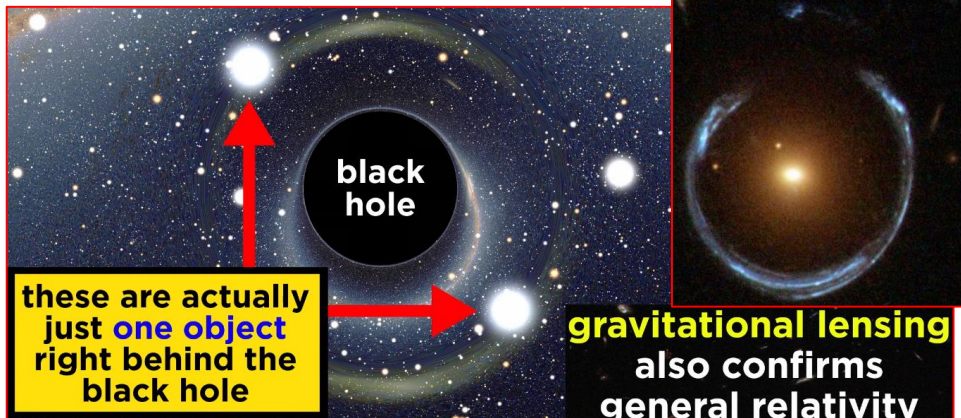



Mathematical Proofs:  
My Mathematical discovery

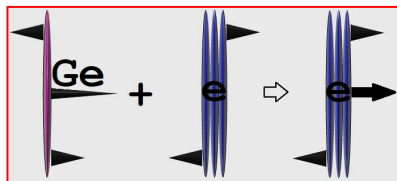
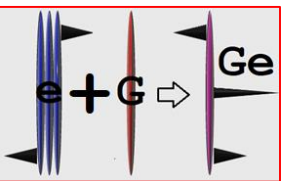
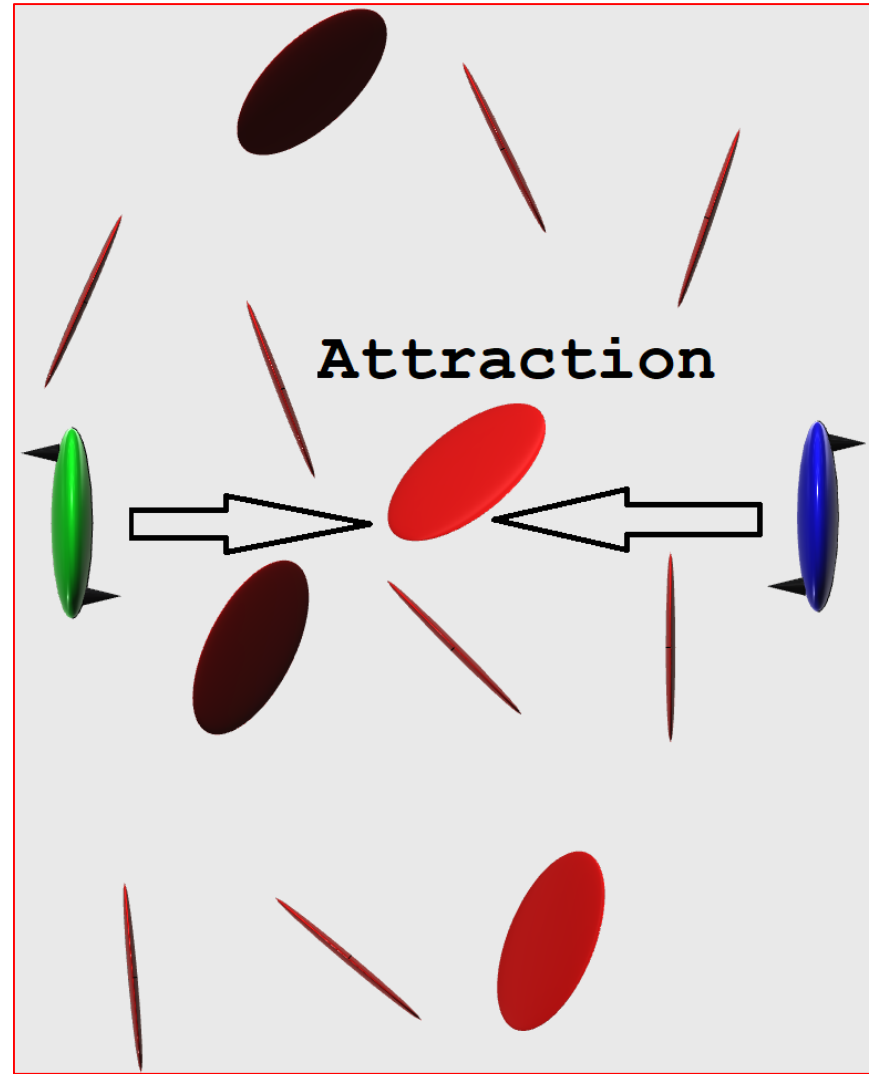
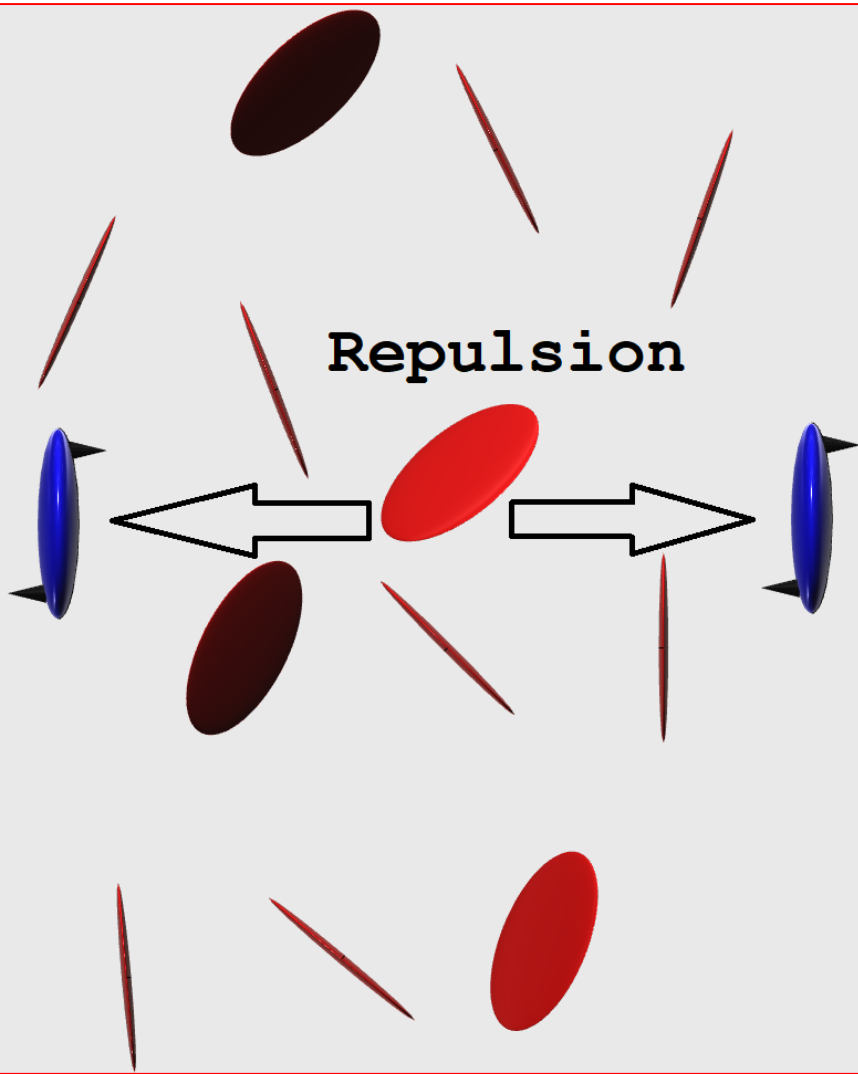

Video 1

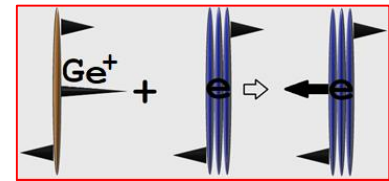
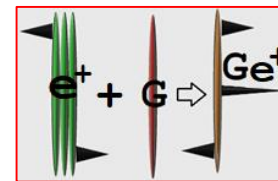

## Simulations parameters for visual demonstration

In order to visualize the collision rules run in matlab: test140.m with the following input parameters (second & third line in test140.m): [it'll generate: CollisionsData.txt (that can be open in excel for viewing the collision result parameters) & SimulationData.txt (this is used by the c program: main.c; so after running test140.m you should run main.c in c++)] (these parameter are not the optimal parameters, but parameters that can be visualize)

### **e+G→Ge:**

```
Ce=1; AM=10; BM=1; As=[1;1;0.25]; Bs=[1;1;0.025]; %For Spheroid A,B: M=mass,s=size(s(1)=s(2)),V=Velocity in world frame,
AV=[0;0;0]; BV=[-1;0;0]; AW=[10;0;0]; BW=[0;0;0]; AOIv=[0;pi/2;0]; BOIv=[0;pi/2;0]; Dg=[5;1.65;0]; %W=initial angular
```

### **p+G→Gp:**

```
Ce=1; AM=10; BM=1; As=[1;1;0.25]; Bs=[1;1;0.025]; %For Spheroid A,B: M=mass,s=size(s(1)=s(2)),V=Velocity in world frame,
AV=[0;0;0]; BV=[-1;0;0]; AW=[-10;0;0]; BW=[0;0;0]; AOIv=[0;pi/2;0]; BOIv=[0;pi/2;0]; Dg=[5;-1.65;0]; %W=initial angular
```

### **Gp+e→attracted e:**

```
Ce=1; AM=1; BM=10; As=[1;1;0.025]; Bs=[1;1;0.25]; %For Spheroid A,B: M=mass,s=size(s(1)=s(2)),V=Velocity in world frame,
AV=[2.18;0;0]; BV=[0;0;0]; AW=[14.05;0;0]; BW=[10;0;0]; AOIv=[0;pi/2;0]; BOIv=[0;pi/2;0]; Dg=[5;-1.65;0]; %W=initial angular
```

### **Ge+e→repeled e:**

```
Ce=1; AM=1; BM=10; As=[1;1;0.025]; Bs=[1;1;0.25]; %For Spheroid A,B: M=mass,s=size(s(1)=s(2)),V=Velocity in world frame,
AV=[2.18;0;0]; BV=[0;0;0]; AW=[-14.05;0;0]; BW=[10;0;0]; AOIv=[0;pi/2;0]; BOIv=[0;pi/2;0]; Dg=[5;-1.65;0]; %W=initial angular
```

For running the C++ use the free code::blocks 10.05

## My collision rules

**Rule 1:** If  $e$  particle collide with  $G$  particle (coming from the right in the same initial  $e$  orientation but in any heights & from any distance) it will transform the  $G$  particle mainly into  $Ge$ .

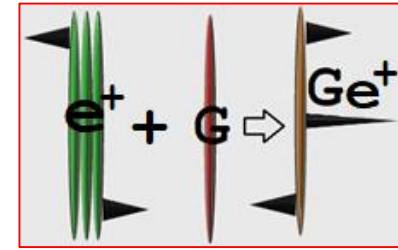
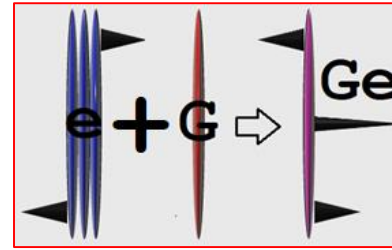

For numerical proof see next page. {by symmetry the same is true for  $e^+$  colliding with  $G$ , which transform it mainly into  $Ge^+$ }

**Rule 2:** If many  $Ge^+$  particles (one  $Ge^+$  after the other) collide with  $e$  particle (at any heights) they will attract the  $e$

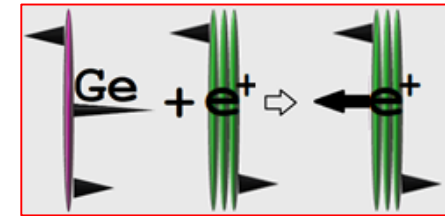
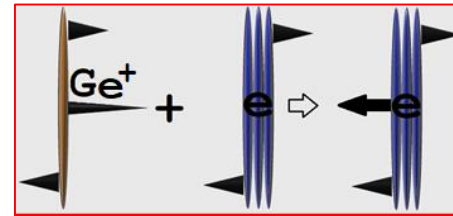

For numerical proof see 3 page forward.

{by symmetry, many  $Ge$  particles colliding with  $e^+$  particle also attract it}

**Rule 3:** If many  $Ge$  particles (one  $Ge$  after the other) collide with  $e$  particle (at any heights) they will repel the  $e$ .

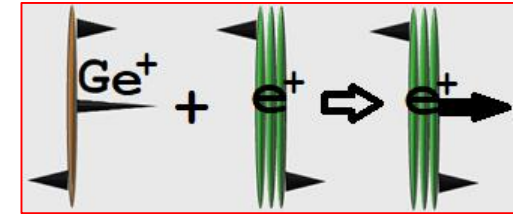
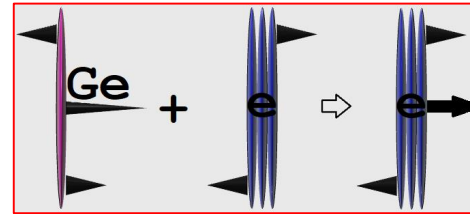

For numerical proof see 4 page forward. {by symmetry, many  $Ge^+$  particles colliding with  $e^+$  particle will also repel it}

These set of rules were proved numerically using my collision simulation program that run each time with different positioned particles, taking each particle as a spheroid & assign higher mass to  $e, e^+$  particles then  $G$  particle;  $Ge, Ge^+$  are  $G$  particle after the collision. Center arrow indicate velocity. Hollow arrow indicate collision result. rest arrow indicate rotational motion. The  $\omega$  of  $e$  and  $e^+$  particles remain almost unchanged after the collision because of their higher mass.

| hit time | AWw(1) | AWw(2) | AWw(3)  | BWw(1) | BWw(2) | BWw(3) | Dg(1)    | Dg(2)   | Dg(3) | AV(1) | AV(2) | AV(3) | BV(1)   | BV(2)   | BV(3) |
|----------|--------|--------|---------|--------|--------|--------|----------|---------|-------|-------|-------|-------|---------|---------|-------|
| 0        | 0      | 0      | -28,000 | 0      | 0      | 0      | 8        | -1.9    | 0     | 0     | 0     | 0     | -1      | 0       | 0     |
| 7.564602 | 0      | 0      | -27,944 | 0      | 0      | 50,169 | 0.435398 | -1.9    | 0     | 10    | 5     | 0     | -10,035 | -5,157  | 0     |
| 7.400335 | 0      | 0      | -27,932 | 0      | 0      | 53,752 | 0.599665 | -1.8    | 0     | 11    | 8     | 0     | -10,751 | -8,485  | 0     |
| 0        | 0      | 0      | -28,000 | 0      | 0      | 0      | 8        | -1.7    | 0     | 0     | 0     | 0     | -1      | 0       | 0     |
| 7.286223 | 0      | 0      | -27,916 | 0      | 0      | 57,208 | 0.713777 | -1.7    | 0     | 11    | 12    | 0     | -11,443 | -12,190 | 0     |
| 0        | 0      | 0      | -28,000 | 0      | 0      | 0      | 8        | -1.6    | 0     | 0     | 0     | 0     | -1      | 0       | 0     |
| 7.200161 | 0      | 0      | -27,895 | 0      | 0      | 60,512 | 0.799839 | -1.6    | 0     | 12    | 17    | 0     | -12,103 | -17,228 | 0     |
| 0        | 0      | 0      | -28,000 | 0      | 0      | 0      | 8        | -1.5    | 0     | 0     | 0     | 0     | -1      | 0       | 0     |
| 7.134183 | 0      | 0      | -27,870 | 0      | 0      | 62,270 | 0.865817 | -1.5    | 0     | 12    | 23    | 0     | -12,455 | -22,940 | 0     |
| 0        | 0      | 0      | -28,000 | 0      | 0      | 0      | 8        | -1.4    | 0     | 0     | 0     | 0     | -1      | 0       | 0     |
| 7.083577 | 0      | 0      | -27,833 | 0      | 0      | 61,050 | 0.916423 | -1.4    | 0     | 12    | 31    | 0     | -12,211 | -31,199 | 0     |
| 0        | 0      | 0      | -28,000 | 0      | 0      | 0      | 8        | -1.3    | 0     | 0     | 0     | 0     | -1      | 0       | 0     |
| 7.046098 | 0      | 0      | -27,786 | 0      | 0      | 52,213 | 0.953902 | -1.3    | 0     | 10    | 42    | 0     | -10,444 | -41,658 | 0     |
| 0        | 0      | 0      | -28,000 | 0      | 0      | 0      | 8        | -1.2    | 0     | 0     | 0     | 0     | -1      | 0       | 0     |
| 7.020289 | 0      | 0      | -27,754 | 0      | 0      | 39,821 | 0.979711 | -1.2    | 0     | 8     | 49    | 0     | -7,965  | -48,565 | 0     |
| 0        | 0      | 0      | -28,000 | 0      | 0      | 0      | 8        | -1.1    | 0     | 0     | 0     | 0     | -1      | 0       | 0     |
| 7.005138 | 0      | 0      | -27,728 | 0      | 0      | 18,618 | 0.994862 | -1.1    | 0     | 4     | 54    | 0     | -3,725  | -54,236 | 0     |
| 0        | 0      | 0      | -28,000 | 0      | 0      | 0      | 8        | -1      | 0     | 0     | 0     | 0     | -1      | 0       | 0     |
| 6.999973 | 0      | 0      | -28,000 | 0      | 0      | -349   | 1.000027 | -1      | 0     | 0     | 0     | 0     | 69      | -1      | 0     |
| 0.004754 | 0      | 0      | -27,989 | 0      | 0      | 22,758 | 1.327526 | -1.003  | 0     | 0     | 5     | 0     | -346    | -4,884  | 0     |
| 0        | 0      | 0      | -28,000 | 0      | 0      | 0      | 8        | -0.9    | 0     | 0     | 0     | 0     | -1      | 0       | 0     |
| 6.999861 | 0      | 0      | -28,000 | 0      | 0      | -627   | 1.000139 | -0.9    | 0     | 0     | 0     | 0     | 137     | 0       | 0     |
| 0.002509 | 0      | 0      | -27,989 | 0      | 0      | 22,264 | 1.343051 | -0.9004 | 0     | 0     | 5     | 0     | 132     | -5,065  | 0     |
| 0        | 0      | 0      | -28,000 | 0      | 0      | 0      | 8        | -0.8    | 0     | 0     | 0     | 0     | -1      | 0       | 0     |
| 6.999749 | 0      | 0      | -28,000 | 0      | 0      | -526   | 1.000251 | -0.8    | 0     | 0     | 0     | 0     | 129     | 0       | 0     |
| 0.002736 | 0      | 0      | -27,997 | 0      | 0      | 11,408 | 1.353706 | -0.8002 | 0     | 0     | 2     | 0     | 455     | -2,376  | 0     |
| 0.000213 | 0      | 0      | -27,975 | 0      | 0      | 34,607 | 1.450899 | -1.3078 | 0     | 2     | 6     | 0     | -2,120  | -6,364  | 0     |

Simulate collisions:Ce=1;  
Dg=[8;i;0];%for i=-2:0.1:2  
AM=1000; As=[1;1;0.0005];  
BM=1; Bs=[1;1;0.0005];  
AV=[0;0;0]; AW=[28000;0;0];  
BV=[-1;0;0]; BW=[0;0;0];  
AOIv=[0;pi/2;0]; BOIv=[0;pi/2;0];  
%For Spheroid A,B:M=mass, s=size(s(1)=s(2)),V=Velocity in world frame,  
W=initial angular velocity in rotating frame,OIv=Orientation Axis& Angle|OIv| from rotating to world frame,Dg=from A mass center to B;AWw=AW in world frame

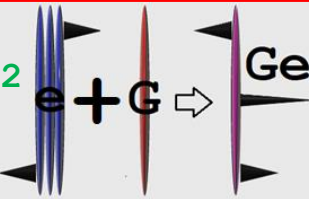

| hit time | AWw(1) | AWw(2) | AWw(3)  | BWw(1) | BWw(2) | BWw(3) | Dg(1)    | Dg(2)   | Dg(3) | AV(1) | AV(2) | AV(3) | BV(1)  | BV(2)   | BV(3) |
|----------|--------|--------|---------|--------|--------|--------|----------|---------|-------|-------|-------|-------|--------|---------|-------|
| 0        | 0      | 0      | -28,000 | 0      | 0      | 0      | 8        | -0.7    | 0     | 0     | 0     | 0     | -1     | 0       | 0     |
| 6.999748 | 0      | 0      | -28,000 | 0      | 0      | -821   | 1.000252 | -0.7    | 0     | 0     | 0     | 0     | 229    | 0       | 0     |
| 0.001719 | 0      | 0      | -27,989 | 0      | 0      | 21,373 | 1.394227 | -0.7002 | 0     | -1    | 5     | 0     | 1,057  | -5,118  | 0     |
| 0        | 0      | 0      | -28,000 | 0      | 0      | 0      | 8        | -0.6    | 0     | 0     | 0     | 0     | -1     | 0       | 0     |
| 6.999636 | 0      | 0      | -28,000 | 0      | 0      | -513   | 1.000364 | -0.6    | 0     | 0     | 0     | 0     | 168    | 0       | 0     |
| 0.002507 | 0      | 0      | -27,998 | 0      | 0      | 10,581 | 1.421083 | -0.6002 | 0     | -1    | 2     | 0     | 813    | -2,182  | 0     |
| 0.000202 | 0      | 0      | -27,975 | 0      | 0      | 34,447 | 1.585053 | -1.0406 | 0     | 1     | 7     | 0     | -1,243 | -6,735  | 0     |
| 0        | 0      | 0      | -28,000 | 0      | 0      | 0      | 8        | -0.5    | 0     | 0     | 0     | 0     | -1     | 0       | 0     |
| 6.999636 | 0      | 0      | -28,000 | 0      | 0      | -733   | 1.000364 | -0.5    | 0     | 0     | 0     | 0     | 286    | 0       | 0     |
| 0.001715 | 0      | 0      | -27,993 | 0      | 0      | 17,808 | 1.490843 | -0.5001 | 0     | -2    | 4     | 0     | 1,546  | -3,877  | 0     |
| 0        | 0      | 0      | -28,000 | 0      | 0      | 0      | 8        | -0.4    | 0     | 0     | 0     | 0     | -1     | 0       | 0     |
| 6.999636 | 0      | 0      | -28,000 | 0      | 0      | -860   | 1.000364 | -0.4    | 0     | 0     | 0     | 0     | 415    | 0       | 0     |
| 0.001485 | 0      | 0      | -27,984 | 0      | 0      | 26,382 | 1.617324 | -0.4001 | 0     | -2    | 6     | 0     | 2,159  | -5,751  | 0     |
| 0        | 0      | 0      | -28,000 | 0      | 0      | 0      | 8        | -0.3    | 0     | 0     | 0     | 0     | -1     | 0       | 0     |
| 6.999524 | 0      | 0      | -28,000 | 0      | 0      | -101   | 1.000476 | -0.3    | 0     | 0     | 0     | 0     | 66     | 0       | 0     |
| 0        | 0      | 0      | -28,000 | 0      | 0      | 0      | 8        | -0.2    | 0     | 0     | 0     | 0     | -1     | 0       | 0     |
| 6.999524 | 0      | 0      | -28,000 | 0      | 0      | -255   | 1.000476 | -0.2    | 0     | 0     | 0     | 0     | 247    | 0       | 0     |
| 0        | 0      | 0      | -28,000 | 0      | 0      | 0      | 8        | -0.1    | 0     | 0     | 0     | 0     | -1     | 0       | 0     |
| 6.999524 | 0      | 0      | -28,000 | 0      | 0      | -187   | 1.000476 | -0.1    | 0     | 0     | 0     | 0     | 350    | 0       | 0     |
| 0        | 0      | 0      | -28,000 | 0      | 0      | 0      | 8        | 0       | 0     | 0     | 0     | 0     | -1     | 0       | 0     |
| 6.999524 | 0      | 0      | -28,000 | 0      | 0      | -14    | 1.000476 | 0       | 0     | 0     | 0     | 0     | 391    | 0       | 0     |
| 0        | 0      | 0      | -28,000 | 0      | 0      | 0      | 8        | 0.1     | 0     | 0     | 0     | 0     | -1     | 0       | 0     |
| 6.999524 | 0      | 0      | -28,000 | 0      | 0      | 166    | 1.000476 | 0.1     | 0     | 0     | 0     | 0     | 355    | 0       | 0     |
| 0        | 0      | 0      | -28,000 | 0      | 0      | 0      | 8        | 0.2     | 0     | 0     | 0     | 0     | -1     | 0       | 0     |
| 6.999524 | 0      | 0      | -28,000 | 0      | 0      | 246    | 1.000476 | 0.2     | 0     | 0     | 0     | 0     | 252    | 0       | 0     |
| 0        | 0      | 0      | -28,000 | 0      | 0      | 0      | 8        | 0.3     | 0     | 0     | 0     | 0     | -1     | 0       | 0     |
| 6.999524 | 0      | 0      | -28,000 | 0      | 0      | 100    | 1.000476 | 0.3     | 0     | 0     | 0     | 0     | 66     | 0       | 0     |
| 0        | 0      | 0      | -28,000 | 0      | 0      | 0      | 8        | 0.4     | 0     | 0     | 0     | 0     | -1     | 0       | 0     |
| 6.999636 | 0      | 0      | -28,000 | 0      | 0      | 854    | 1.000364 | 0.4     | 0     | 0     | 0     | 0     | 441    | 0       | 0     |
| 0.001545 | 0      | 0      | -27,899 | 0      | 0      | 58,293 | 1.682693 | 0.40014 | 0     | -15   | 16    | 0     | 14,603 | -15,511 | 0     |

| hit time | AWw(1) | AWw(2) | AWw(3)  | BWw(1) | BWw(2) | BWw(3) | Dg(1)    | Dg(2)   | Dg(3) | AV(1) | AV(2) | AV(3) | BV(1)  | BV(2)   | BV(3) |
|----------|--------|--------|---------|--------|--------|--------|----------|---------|-------|-------|-------|-------|--------|---------|-------|
| 0        | 0      | 0      | -28,000 | 0      | 0      | 0      | 8        | 0.5     | 0     | 0     | 0     | 0     | -1     | 0       | 0     |
| 6.999636 | 0      | 0      | -28,000 | 0      | 0      | 737    | 1.000364 | 0.5     | 0     | 0     | 0     | 0     | 301    | 0       | 0     |
| 0.001762 | 0      | 0      | -27,846 | 0      | 0      | 57,726 | 1.531309 | 0.50015 | 0     | -26   | 19    | 0     | 26,226 | -19,078 | 0     |
| 0        | 0      | 0      | -28,000 | 0      | 0      | 0      | 8        | 0.6     | 0     | 0     | 0     | 0     | -1     | 0       | 0     |
| 6.999636 | 0      | 0      | -28,000 | 0      | 0      | 517    | 1.000364 | 0.6     | 0     | 0     | 0     | 0     | 174    | 0       | 0     |
| 0.002543 | 0      | 0      | -27,798 | 0      | 0      | 51,547 | 1.443003 | 0.60016 | 0     | -36   | 20    | 0     | 36,328 | -20,030 | 0     |
| 0        | 0      | 0      | -28,000 | 0      | 0      | 0      | 8        | 0.7     | 0     | 0     | 0     | 0     | -1     | 0       | 0     |
| 6.999748 | 0      | 0      | -28,000 | 0      | 0      | 835    | 1.000252 | 0.7     | 0     | 0     | 0     | 0     | 243    | 0       | 0     |
| 0.001643 | 0      | 0      | -27,788 | 0      | 0      | 50,662 | 1.399724 | 0.70019 | 0     | -39   | 18    | 0     | 39,056 | -17,967 | 0     |
| 0        | 0      | 0      | -28,000 | 0      | 0      | 0      | 8        | 0.8     | 0     | 0     | 0     | 0     | -1     | 0       | 0     |
| 6.999749 | 0      | 0      | -28,000 | 0      | 0      | 533    | 1.000251 | 0.8     | 0     | 0     | 0     | 0     | 134    | 0       | 0     |
| 0.002763 | 0      | 0      | -27,816 | 0      | 0      | 55,489 | 1.370839 | 0.80024 | 0     | -35   | 14    | 0     | 35,023 | -14,493 | 0     |
| 0        | 0      | 0      | -28,000 | 0      | 0      | 0      | 8        | 0.9     | 0     | 0     | 0     | 0     | -1     | 0       | 0     |
| 6.999861 | 0      | 0      | -28,000 | 0      | 0      | 637    | 1.000139 | 0.9     | 0     | 0     | 0     | 0     | 143    | 0       | 0     |
| 0.002426 | 0      | 0      | -27,823 | 0      | 0      | 58,478 | 1.346566 | 0.90033 | 0     | -34   | 12    | 0     | 33,754 | -12,452 | 0     |
| 0        | 0      | 0      | -28,000 | 0      | 0      | 0      | 8        | 1       | 0     | 0     | 0     | 0     | -1     | 0       | 0     |
| 6.999973 | 0      | 0      | -28,000 | 0      | 0      | 244    | 1.000027 | 1       | 0     | 0     | 0     | 0     | 48     | 0       | 0     |
| 0.006688 | 0      | 0      | -27,842 | 0      | 0      | 61,148 | 1.323427 | 1.00123 | 0     | -30   | 10    | 0     | 30,135 | -10,297 | 0     |
| 0        | 0      | 0      | -28,000 | 0      | 0      | 0      | 8        | 1.1     | 0     | 0     | 0     | 0     | -1     | 0       | 0     |
| 7.005131 | 0      | 0      | -28,000 | 0      | 0      | 4,305  | 0.994869 | 1.1     | 0     | -1    | 0     | 0     | 861    | 8       | 0     |
| 0.00041  | 0      | 0      | -27,904 | 0      | 0      | 57,563 | 1.348389 | 1.1033  | 0     | -19   | 7     | 0     | 19,029 | -7,268  | 0     |
| 0        | 0      | 0      | -28,000 | 0      | 0      | 0      | 8        | 1.2     | 0     | 0     | 0     | 0     | -1     | 0       | 0     |
| 7.020274 | 0      | 0      | -27,998 | 0      | 0      | 8,560  | 0.979726 | 1.2     | 0     | -2    | 0     | 0     | 1,712  | 30      | 0     |
| 0        | 0      | 0      | -28,000 | 0      | 0      | 0      | 8        | 1.3     | 0     | 0     | 0     | 0     | -1     | 0       | 0     |
| 7.046189 | 0      | 0      | -27,996 | 0      | 0      | 13,285 | 0.953811 | 1.3     | 0     | -3    | 0     | 0     | 2,657  | 44      | 0     |
| 0        | 0      | 0      | -28,000 | 0      | 0      | 0      | 8        | 1.4     | 0     | 0     | 0     | 0     | -1     | 0       | 0     |
| 7.08366  | 0      | 0      | -27,993 | 0      | 0      | 17,962 | 0.91634  | 1.4     | 0     | -4    | 0     | 0     | 3,593  | 61      | 0     |
| 0        | 0      | 0      | -28,000 | 0      | 0      | 0      | 8        | 1.5     | 0     | 0     | 0     | 0     | -1     | 0       | 0     |
| 7.134258 | 0      | 0      | -27,989 | 0      | 0      | 22,730 | 0.865742 | 1.5     | 0     | -5    | 0     | 0     | 4,547  | 71      | 0     |
| 0        | 0      | 0      | -28,000 | 0      | 0      | 0      | 8        | 1.6     | 0     | 0     | 0     | 0     | -1     | 0       | 0     |
| 7.200339 | 0      | 0      | -27,984 | 0      | 0      | 27,412 | 0.799661 | 1.6     | 0     | -5    | 0     | 0     | 5,484  | 89      | 0     |
| 0        | 0      | 0      | -28,000 | 0      | 0      | 0      | 8        | 1.7     | 0     | 0     | 0     | 0     | -1     | 0       | 0     |
| 7.286167 | 0      | 0      | -27,978 | 0      | 0      | 32,022 | 0.713833 | 1.7     | 0     | -6    | 0     | 0     | 6,405  | 125     | 0     |
| 0        | 0      | 0      | -28,000 | 0      | 0      | 0      | 8        | 1.8     | 0     | 0     | 0     | 0     | -1     | 0       | 0     |
| 7.400044 | 0      | 0      | -27,973 | 0      | 0      | 35,652 | 0.599956 | 1.8     | 0     | -7    | 0     | 0     | 7,130  | 418     | 0     |
| 0        | 0      | 0      | -28,000 | 0      | 0      | 0      | 8        | 1.9     | 0     | 0     | 0     | 0     | -1     | 0       | 0     |
| 7.564522 | 0      | 0      | -27,963 | 0      | 0      | 41,475 | 0.435478 | 1.9     | 0     | -8    | 0     | 0     | 8,296  | 205     | 0     |

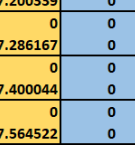



# C code simulation

```
int main() {
    // Simulation parameters
    double dt = 0.01; // Time step
    double t_end = 10; // Total time
    double x0 = 0; // Initial position
    double v0 = 0; // Initial velocity
    double a = 1; // Acceleration

    // Arrays for position and velocity
    double x[t_end/dt];
    double v[t_end/dt];

    // Initial conditions
    x[0] = x0;
    v[0] = v0;

    // Time loop
    for (int i = 1; i < t_end/dt; i++) {
        // Update velocity
        v[i] = v[i-1] + a*dt;

        // Update position
        x[i] = x[i-1] + v[i-1]*dt + 0.5*a*dt*dt;
    }

    // Output data
    // Save to SimulationData.txt
    // Save to CollisionsData.txt
}
```

# Matlab test134.m return SimulationData.txt for C & CollisionsData.txt for excel

```
% Simulation parameters
dt = 0.01; % Time step
t_end = 10; % Total time
x0 = 0; % Initial position
v0 = 0; % Initial velocity
a = 1; % Acceleration

% Arrays for position and velocity
x = zeros(1, t_end/dt);
v = zeros(1, t_end/dt);

% Initial conditions
x(1) = x0;
v(1) = v0;

% Time loop
for i = 2:t_end/dt
    % Update velocity
    v(i) = v(i-1) + a*dt;

    % Update position
    x(i) = x(i-1) + v(i-1)*dt + 0.5*a*dt*dt;
end

% Output data
% Save to SimulationData.txt
save('SimulationData.txt', 'x', 'v');

% Save to CollisionsData.txt for excel
save('CollisionsData.txt', 'x', 'v');
```

```

Simulate collisions: Ce=1; Dg=[8;i;0]; %for i=-2:0.1:2
AM=1; As=[1;1;0.0005]; AV=[26103;0;0]; AW=[62270;0;0]; AOIv=[0;pi/2;0];
BM=1000; Bs=[1;1;0.0005]; BV=[0;0;0]; BW=[28000;0;0]; BOIv=[0;pi/2;0];
%For Spheroid A,B:M=mass, s=size(s(1)=s(2)), V=Velocity in world frame, W=initial
angular velocity in rotating frame, OIv=Orientation Axis& Angle|OIv| from rotating
to world frame, Dg=from A body mass center to B body; AWw=AW in world frame

```

| tfcollide | AWw(1) | AWw(2) | AWw(3)  | BWw(1) | BWw(2) | BWw(3)  | Dg(1)    | Dg(2)    | Dg(3)    | AV(1)   | AV(2)   | AV(3)   | BV(1) | BV(2) | BV(3) | tfcollide | AWw(1) | AWw(2)  | AWw(3) | BWw(1) | BWw(2)  | BWw(3)   | Dg(1)    | Dg(2)  | Dg(3)    | AV(1)   | AV(2) | AV(3) | BV(1) | BV(2) | BV(3) |      |
|-----------|--------|--------|---------|--------|--------|---------|----------|----------|----------|---------|---------|---------|-------|-------|-------|-----------|--------|---------|--------|--------|---------|----------|----------|--------|----------|---------|-------|-------|-------|-------|-------|------|
| 0         | 0      | 0      | -62,270 | 0      | 0      | -28,000 | 8        | -1.9     | 0        | 26,103  | 0       | 0       | 0     | 0     | 0     | 0         | 0      | -62,270 | 0      | 0      | -28,000 | 8        | -1.9     | 0      | 26,103   | 0       | 0     | 0     | 0     | 0     |       |      |
| 0.000281  | 0      | 0      | 25,965  | 0      | 0      | -28,028 | 0.671811 | -0.2     | 0        | 26,228  | 17,991  | 0       | 0     | -18   | 0     | 1.26E-05  | 0      | -29,114 | 0      | 0      | -27,946 | 0.341232 | -0.42699 | 5E-11  | 23,956   | 36,231  | 0     | 2     | -36   | 0     |       |      |
| 0         | 0      | 0      | -62,270 | 0      | 0      | -28,000 | 8        | -1.7     | 0        | 26,103  | 0       | 0       | 0     | 0     | 0     | 0         | 0      | 0       | 0      | 0      | -28,000 | 8        | -1.7     | 0      | 26,103   | 0       | 0     | 0     | 0     | 0     |       |      |
| 0         | 0      | 0      | -62,270 | 0      | 0      | -28,000 | 8        | -1.6     | 0        | 26,103  | 0       | 0       | 0     | 0     | 0     | 0         | 0      | 0       | 0      | 0      | -28,000 | 8        | -1.6     | 0      | 26,103   | 0       | 0     | 0     | 1     | -19   | 0     |      |
| 0         | 0      | 0      | -62,270 | 0      | 0      | -28,000 | 8        | -1.5     | 0        | 26,103  | 0       | 0       | 0     | 0     | 0     | 7.94E-06  | 0      | -27,949 | 0      | 0      | -27,909 | 0.519882 | -0.2481  | 0      | 21,505   | 43,097  | 0     | 5     | -43   | 0     |       |      |
| 0         | 0      | 0      | -62,270 | 0      | 0      | -28,000 | 8        | -1.4     | 0        | 26,103  | 0       | 0       | 0     | 0     | 0     | 0         | 0      | 0       | 0      | 0      | -28,000 | 8        | -1.4     | 0      | 26,103   | 0       | 0     | 0     | 0     | 0     |       |      |
| 0.000315  | 0      | 0      | -38,689 | 0      | 0      | -27,904 | -0.22014 | -1.4     | 0        | 45,320  | 13,373  | 0       | -19   | -13   | 0     | 0.000277  | 0      | 34,559  | 0      | 0      | -28,023 | 0.766402 | 0        | 0      | 24,269   | 19,330  | 0     | 2     | -19   | 0     |       |      |
| 0         | 0      | 0      | -62,270 | 0      | 0      | -28,000 | 8        | -1.3     | 0        | 26,103  | 0       | 0       | 0     | 0     | 0     | 4.24E-06  | 0      | -17,655 | 0      | 0      | -27,873 | 0.663496 | -0.08205 | 0      | 19,120   | 49,503  | 0     | 7     | -50   | 0     |       |      |
| 0.000311  | 0      | 0      | -25,921 | 0      | 0      | -27,938 | -0.11661 | -1.3     | 0        | 42,552  | 14,388  | 0       | -16   | -14   | 0     | 0.000275  | 0      | 39,048  | 0      | 0      | -28,019 | 0.810043 | 0.1      | 0      | 23,245   | 20,075  | 0     | 3     | -20   | 0     |       |      |
| 0         | 0      | 0      | -62,270 | 0      | 0      | -28,000 | 8        | -1.2     | 0        | 26,103  | 0       | 0       | 0     | 0     | 0     | 9.13E-07  | 0      | 5,089   | 0      | 0      | -27,855 | 0.788812 | 0.081643 | 0      | 17,948   | 52,419  | 0     | 8     | -52   | 0     |       |      |
| 0.000307  | 0      | 0      | -17,197 | 0      | 0      | -27,965 | -0.01854 | -1.2     | 0        | 39,681  | 14,660  | 0       | -14   | -15   | 0     | 0         | 0      | 0       | 0      | 0      | -28,000 | 8        | 0.2      | 0      | 26,103   | 0       | 0     | 0     | 0     | 0     |       |      |
| 0         | 0      | 0      | -62,270 | 0      | 0      | -28,000 | 8        | -1.1     | 0        | 26,103  | 0       | 0       | 0     | 0     | 0     | 0.000272  | 0      | -87,667 | 0      | 0      | -27,706 | 0.892346 | 0.2      | 0      | 7,344    | 56,032  | 0     | 19    | -56   | 0     |       |      |
| 0.000304  | 0      | 0      | -10,959 | 0      | 0      | -27,984 | 0.073173 | -1.1     | 0        | 37,273  | 14,729  | 0       | -11   | -15   | 0     | 3.3E-06   | 0      | -39,220 | 0      | 0      | -27,712 | 0.868145 | 0.014711 | 0      | 6,002    | 65,682  | 0     | 20    | -66   | 0     |       |      |
| 0         | 0      | 0      | -62,270 | 0      | 0      | -28,000 | 8        | -1       | 0        | 26,103  | 0       | 0       | 0     | 0     | 0     | 0.00027   | 0      | -59,971 | 0      | 0      | -27,608 | 0.959982 | 0.3      | 0      | -10,982  | 70,466  | 0     | 37    | -70   | 0     |       |      |
| 0.0003    | 0      | 0      | -6,013  | 0      | 0      | -27,998 | 0.158618 | -1       | 0        | 35,331  | 14,809  | 0       | -9    | -15   | 0     | 0         | 0      | 0       | 0      | 0      | -28,000 | 8        | 0.4      | 0      | 26,103   | 0       | 0     | 0     | 0     | 0     |       |      |
| 0         | 0      | 0      | -62,270 | 0      | 0      | -28,000 | 8        | -0.9     | 0        | 26,103  | 0       | 0       | 0     | 0     | 0     | 0.000268  | -0.2   | -21,521 | 0      | 0      | -27,559 | 1.010879 | 0.4      | 0      | -25,718  | 74,794  | 0     | 52    | -75   | 0     |       |      |
| 0.000297  | 0      | 0      | -1,708  | 0      | 0      | -28,008 | 0.238235 | -0.9     | 0        | 33,739  | 14,961  | 0       | -8    | -15   | 0     | 0         | 0      | 0       | 0      | 0      | -28,000 | 8        | 0.5      | 0      | 26,103   | 0       | 0     | 0     | 0     | 0     |       |      |
| 0         | 0      | 0      | -62,270 | 0      | 0      | -28,000 | 8        | -0.8     | 0        | 26,103  | 0       | 0       | 0     | 0     | 0     | 0.000266  | 0      | 18,221  | 0      | 0      | -27,550 | 1.051539 | 0.5      | 0      | -34,802  | 71,878  | 0     | 61    | -72   | 0     |       |      |
| 0.000295  | 0      | 0      | 2,293   | 0      | 0      | -28,016 | 0.312546 | -0.8     | 0        | 32,389  | 15,196  | 0       | -6    | -15   | 0     | 0         | 0      | 0       | 0      | 0      | -28,000 | 8        | 0.6      | 0      | 26,103   | 0       | 0     | 0     | 0     | 0     |       |      |
| 0         | 0      | 0      | -62,270 | 0      | 0      | -28,000 | 8        | -0.7     | 0        | 26,103  | 0       | 0       | 0     | 0     | 0     | 0.000265  | 0      | 52,777  | 0      | 0      | -27,570 | 1.085059 | 0.6      | 0      | -38,363  | 64,781  | 0     | 64    | -65   | 0     |       |      |
| 0.000292  | 0      | 0      | 6,167   | 0      | 0      | -28,021 | 0.382058 | -0.7     | 0        | 31,203  | 15,509  | 0       | -5    | -16   | 0     | 0.000264  | 0      | -62,270 | 0      | 0      | -28,000 | 8        | 0.7      | 0      | 26,103   | 0       | 0     | 0     | 0     | 0     |       |      |
| 0         | 0      | 0      | -62,270 | 0      | 0      | -28,000 | 8        | -0.6     | 0        | 26,103  | 0       | 0       | 0     | 0     | 0     | 0         | 0      | 0       | 0      | 0      | -28,000 | 8        | 0.8      | 0      | 26,103   | 0       | 0     | 0     | 0     | 0     |       |      |
| 0.000289  | 0      | 0      | 10,011  | 0      | 0      | -28,025 | 0.447228 | -0.6     | 0        | 30,124  | 15,891  | 0       | -4    | -16   | 0     | 0.000263  | 0      | 97,994  | 0      | 0      | -27,647 | 1.137316 | 0.8      | 0      | -34,693  | 47,485  | 0     | 61    | -47   | 0     |       |      |
| 0         | 0      | 0      | -62,270 | 0      | 0      | -28,000 | 8        | -0.5     | 0        | 26,103  | 0       | 0       | 0     | 0     | 0     | 2.14E-05  | 0      | -85,123 | 0      | 0      | -27,851 | 1.882288 | -0.21888 | 8E-13  | -40,181  | 6,950   | 0     | 66    | -7    | 0     |       |      |
| 0.000287  | 0      | 0      | 13,883  | 0      | 0      | -28,027 | 0.508457 | -0.5     | 0        | 29,112  | 16,336  | 0       | -3    | -16   | 0     | 0         | 0      | 0       | 0      | 0      | -28,000 | 8        | 0.9      | 0      | 26,103   | 0       | 0     | 0     | 0     | 0     |       |      |
| 0         | 0      | 0      | -62,270 | 0      | 0      | -28,000 | 8        | -0.4     | 0        | 26,103  | 0       | 0       | 0     | 0     | 0     | 0.000262  | 0      | 110,079 | 0      | 0      | -27,688 | 1.158082 | 0.9      | 0      | -30,387  | 39,776  | 0     | 56    | -40   | 0     |       |      |
| 0.000285  | 0      | 0      | 17,819  | 0      | 0      | -28,028 | 0.566099 | -0.4     | 0        | 28,139  | 16,837  | 0       | -2    | -17   | 0     | 2.09E-05  | 0      | -98,298 | 0      | 0      | -27,858 | 1.795081 | 0.06691  | 1E-13  | -33,148  | -2,524  | 0     | 59    | 3     | 0     |       |      |
| 3.12E-05  | 0      | 0      | -8,172  | 0      | 0      | -28,015 | -0.31267 | -0.9263  | -9E-10   | 27,534  | 22,842  | 0       | -1    | -23   | 0     | 0         | 0      | 0       | 0      | 0      | -28,000 | 8        | 1        | 0      | 26,103   | 0       | 0     | 0     | 0     | 0     |       |      |
| 0         | 0      | 0      | -62,270 | 0      | 0      | -28,000 | 8        | -0.3     | 0        | 26,103  | 0       | 0       | 0     | 0     | 0     | 0.000261  | 0      | 117,299 | 0      | 0      | -27,725 | 1.176169 | 1        | 0      | -25,708  | 33,229  | 0     | 52    | -33   | 0     |       |      |
| 0.000283  | 0      | 0      | 21,841  | 0      | 0      | -28,029 | 0.62046  | -0.3     | 0        | 27,183  | 17,390  | 0       | -1    | -17   | 0     | 2.12E-05  | 0      | -90,337 | 0      | 0      | -27,901 | 1.721826 | 0.295434 | -8E-14 | -28,124  | -11,734 | 0     | 54    | 12    | 0     |       |      |
| 1.92E-05  | 0      | 0      | -23,325 | 0      | 0      | -27,981 | 0.097548 | -0.63485 | 1E-11    | 26,021  | 29,701  | 0       | 0     | -30   | 0     | 0.000261  | 0      | 121,126 | 0      | 0      | -27,758 | 1.192046 | 1.1      | 0      | -21,127  | 27,819  | 0     | 47    | -28   | 0     |       |      |
| 0         | 0      | 0      | -62,270 | 0      | 0      | -28,000 | 8        | 0        | 0        | 26,103  | 0       | 0       | 0     | 0     | 0     | 2.2E-05   | 0      | -71,714 | 0      | 0      | -27,952 | 1.658526 | 0.486526 | 0      | -24,026  | -19,680 | 0     | 50    | 20    | 0     |       |      |
| 0         | 0      | 0      | -62,270 | 0      | 0      | -28,000 | 8        | 1.2      | 0        | 26,103  | 0       | 0       | 0     | 0     | 0     | 0.00026   | 0      | 122,681 | 0      | 0      | -27,786 | 1.206079 | 1.2      | 0      | -16,873  | 23,405  | 0     | 43    | -23   | 0     |       |      |
| 2.35E-05  | 0      | 0      | -29,752 | 0      | 0      | -28,014 | 1.604184 | -28,014  | 0.648622 | -1E-11  | 21,256  | -25,821 | 0     | 47    | 26    | 0         | 0      | 0       | 0      | 0      | -28,000 | 8        | 1.3      | 0      | 26,103   | 0       | 0     | 0     | 0     | 0     |       |      |
| 0         | 0      | 0      | -62,270 | 0      | 0      | -28,000 | 8        | 1.3      | 0        | 26,103  | 0       | 0       | 0     | 0     | 0     | 0.00026   | 0      | 122,762 | 0      | 0      | -27,810 | 1.218558 | 1.3      | 0      | -13,032  | 19,816  | 0     | 39    | -20   | 0     |       |      |
| 0.00026   | 0      | 0      | -62,270 | 0      | 0      | -28,000 | 8        | 1.4      | 0        | 26,103  | 0       | 0       | 0     | 0     | 0     | 0.000259  | 0      | 121,912 | 0      | 0      | -27,830 | 1.229711 | 1.4      | 0      | -9,619   | 16,887  | 0     | 36    | -17   | 0     |       |      |
| 0         | 0      | 0      | -62,270 | 0      | 0      | -28,000 | 8        | 1.5      | 0        | 26,103  | 0       | 0       | 0     | 0     | 0     | 0         | 0      | 0       | 0      | 0      | -28,000 | 8        | 1.5      | 0      | 26,103   | 0       | 0     | 0     | 0     | 0     |       |      |
| 0.00031   | 0      | 0      | 77,485  | 0      | 0      | -27,676 | -0.0989  | 1.5      | 0        | -32,286 | -53,103 | 0       | 58    | 53    | 0     | 0.00031   | 0      | 77,485  | 0      | 0      | -27,676 | -0.0989  | 1.5      | 0      | -32,286  | -53,103 | 0     | 58    | 53    | 0     |       |      |
| 0         | 0      | 0      | -62,270 | 0      | 0      | -28,000 | 8        | 1.6      | 0        | 26,103  | 0       | 0       | 0     | 0     | 0     | 0         | 0      | 0       | 0      | 0      | -28,000 | 8        | 1.6      | 0      | 26,103   | 0       | 0     | 0     | 0     | 0     |       |      |
| 0.000311  | 0      | 0      | 78,990  | 0      | 0      | -27,571 | -0.12523 | 1.6      | 0        | -40,723 | -57,578 | 0       | 67    | 58    | 0     | 0.000311  | 0      | 78,990  | 0      | 0      | -27,571 | -0.12523 | 1.6      | 0      | -40,723  | -57,578 | 0     | 67    | 58    | 0     |       |      |
| 0         | 0      | 0      | -62,270 | 0      | 0      | -28,000 | 8        | 1.7      | 0        | 26,103  | 0       | 0       | 0     | 0     | 0     | 0         | 0      | 0       | 0      | 0      | -28,000 | 8        | 1.7      | 0      | 26,103   | 0       | 0     | 0     | 0     | 0     |       |      |
| 0         | 0      | 0      | -62,270 | 0      | 0      | -28,000 | 8        | 1.8      | 0        | 26,103  | 0       | 0       | 0     | 0     | 0     | 0         | 0      | 0       | 0      | 0      | -28,000 | 8        | 1.8      | 0      | 26,103   | 0       | 0     | 0     | 0     | 0     |       |      |
| 0         | 0      | 0      | -62,270 | 0      | 0      | -28,000 | 8        | 1.9      | 0        | 26,103  | 0       | 0       | 0     | 0     | 0     | 0         | 0      | 0       | 0      | 0      | -28,000 | 8        | 1.9      | 0      | 26,103   | 0       | 0     | 0     | 0     | 0     |       |      |
|           |        |        |         |        |        |         |          |          |          |         |         |         |       |       |       |           |        |         |        |        |         |          |          |        | Sum=     |         |       |       |       |       |       | -999 |
|           |        |        |         |        |        |         |          |          |          |         |         |         |       |       |       |           |        |         |        |        |         |          |          |        | Average= |         |       |       |       |       |       | -12  |

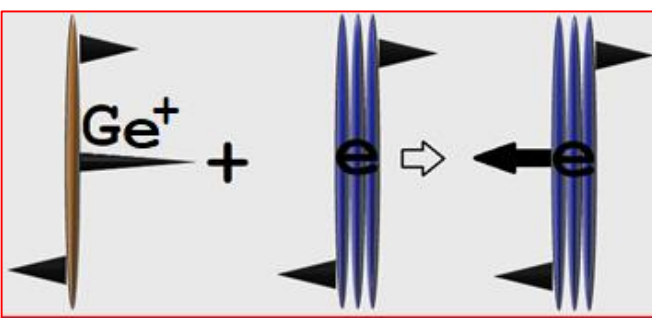

If many of these collisions happened, e will be moved down and then another of these collisions will take it to the left.

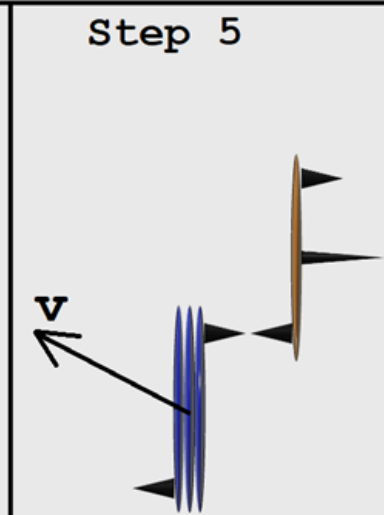
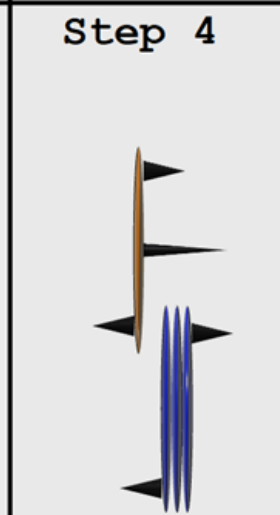
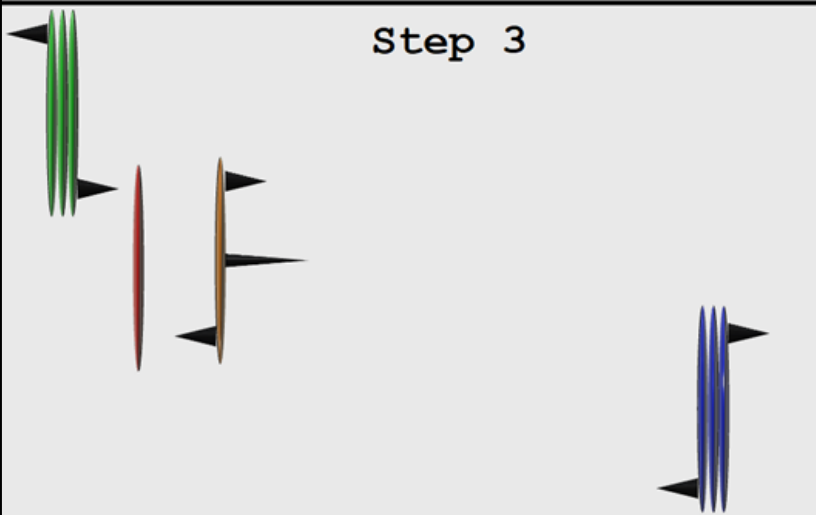
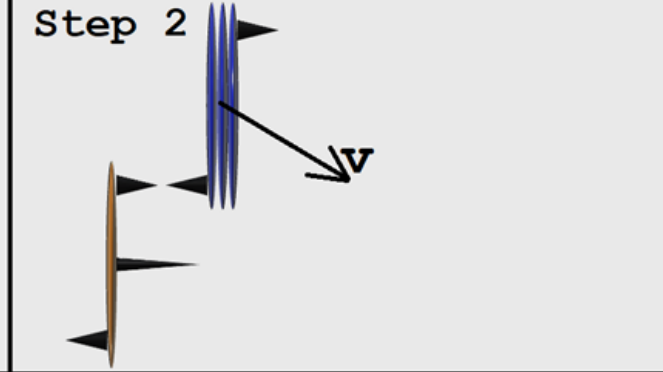
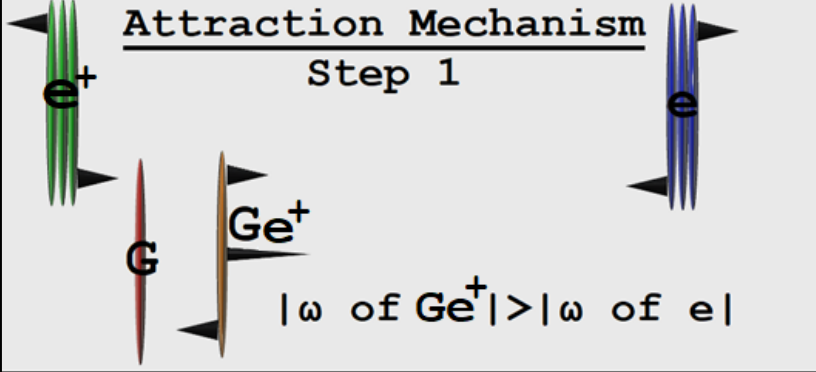

Note that some collisions enforce the electron  $\omega$  and some decrease it, so overall  $\omega$  will remain unchanged;

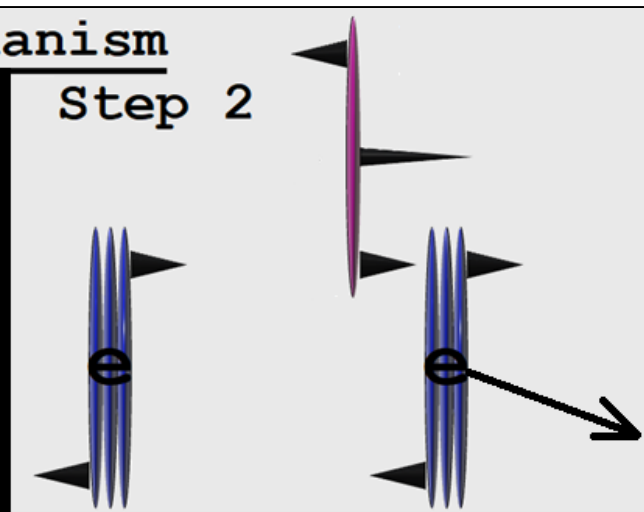
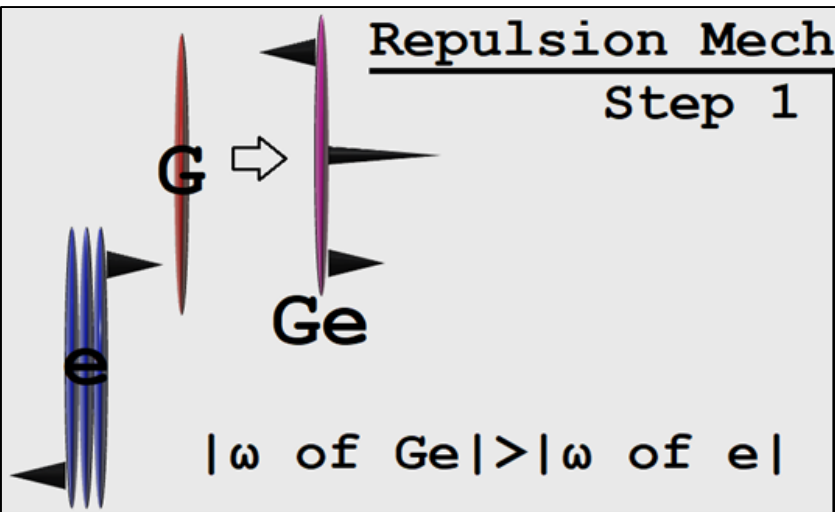

See next page for the repulsion mechanism numerical proof





## Mathematical Proofs: Spheroid precession

If a spheroid with dimension  $[s_1; s_2; s_3]$   $s_1=s_2$  and  $s_3 < s_1$ ; rotates with angular velocity ( $\omega$  in rad/second; in body frame):  $[W_1; W_2; 0]$  or  $[0; 0; W_3]$  there will be no precession, as the direction of the angular momentum  $L$  (in world frame) is equal to the direction of  $\omega$  for each time point. {because the moment of inertia tensor ( $I$ ) of the spheroid is  $I = M/5 * [s_1^2 + s_3^2, 0, 0; 0, s_1^2 + s_3^2, 0; 0, 0, 2*s_1^2]$ ; where  $M$  is its mass and  $L = I * \omega = M/5 * [\omega_1 * (s_1^2 + s_3^2); \omega_2 * (s_1^2 + s_3^2); \omega_3 * 2*s_1^2]$ }; But if the spheroid  $\omega$  is in any other direction, then the direction of  $L$  will be different from the direction of  $\omega$  and the spheroid will precess (it's  $\omega$  will change with time) {the reason lay on the spheroid shape which is not a sphere and that upon rotation while each point in it want to move in strait line it impose a force that change  $\omega$  and that unlike sphere it's not canceled by the other points}

**Example-1:** spheroid with  $s = [1; 1; 0.1]$ ;  $\omega = [2; 0; 0.5]$ ; will have the following motion:

In the pictures:

$\omega$  = Angular velocity in world coordinates.

$L$  = Angular momentum.

$z'$  = vector along axis of symmetry. Are drawn for many points in time.

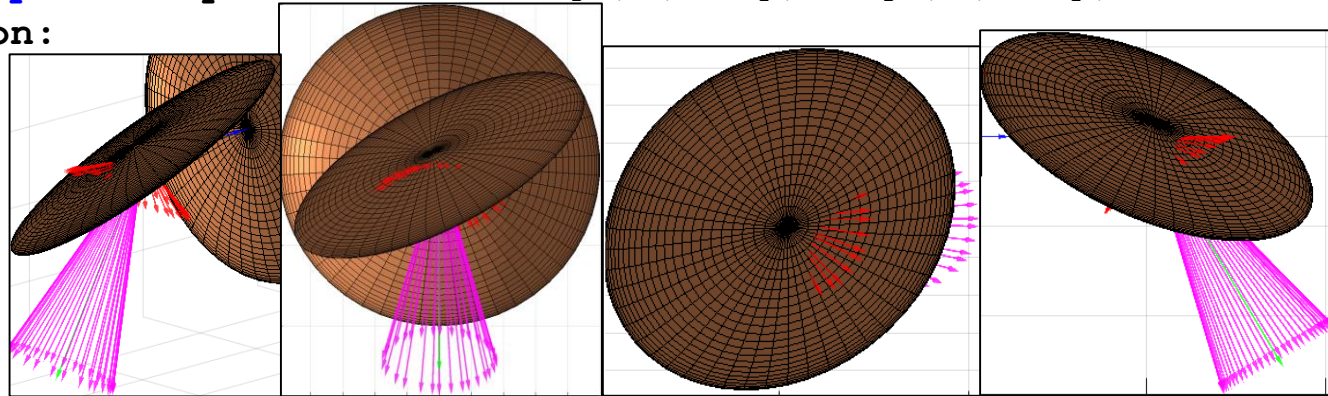

**Example-2:** motion of spheroid with  $s = [1; 1; 0.1]$ ; and  $\omega = [2; 0; 0.1]$ ;

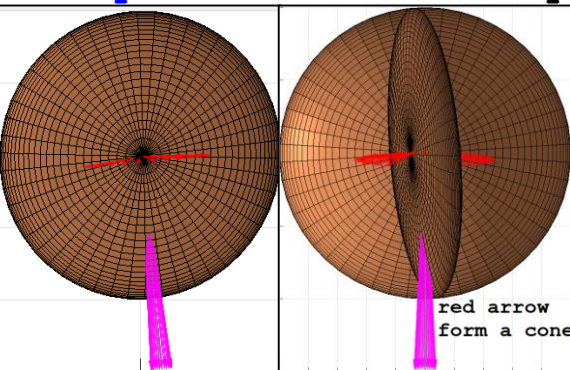

In general, observer in world frame would see  $z'$  axis (&  $\omega$ ) trace out a cone as it precesses about  $L$ ; the body cone ( $z'$  center) rolling along space cone;  $\omega$  is line where the 2 cones touch;  $\omega$  also precess about  $z'$ ;

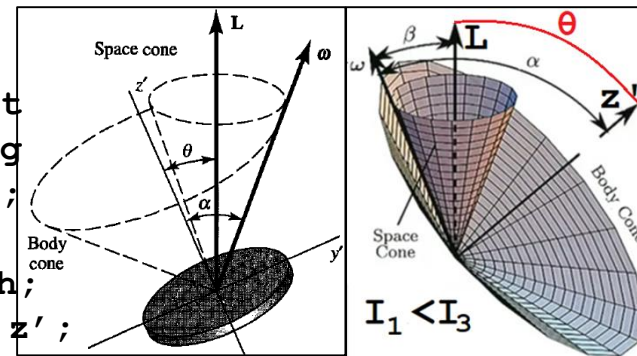

To view this motion run the following matlab code:

```
clear all;
close all;
% Parameters
m = 1; % mass
l = 1; % length
g = 9.81; % gravity
% Initial conditions
theta0 = pi/4; % initial angle
omega0 = 0; % initial angular velocity
% Time step and range
dt = 0.01; % time step
t = 0:dt:2; % time range
% Numerical solution
theta = theta0;
omega = omega0;
for i = 1:length(t)-1
    % Angular acceleration
    alpha = -g/l*cos(theta);
    % Update angular velocity
    omega = omega + alpha*dt;
    % Update angle
    theta = theta + omega*dt;
end
% Plot
figure;
plot(t, theta, 'b');
hold on;
plot(t, omega, 'r');
axis([0 2 -1 1]);
title('Angular displacement and velocity vs time');
xlabel('Time (s)');
ylabel('Angle (rad) / Angular velocity (rad/s)');
legend('theta', 'omega');
```

Or run the following matlab code: & then the right bottom c code:

```
clear all;
close all;
% Parameters
m = 1; % mass
l = 1; % length
g = 9.81; % gravity
% Initial conditions
theta0 = pi/4; % initial angle
omega0 = 0; % initial angular velocity
% Time step and range
dt = 0.01; % time step
t = 0:dt:2; % time range
% Numerical solution
theta = theta0;
omega = omega0;
for i = 1:length(t)-1
    % Angular acceleration
    alpha = -g/l*cos(theta);
    % Update angular velocity
    omega = omega + alpha*dt;
    % Update angle
    theta = theta + omega*dt;
end
% Plot
figure;
plot(t, theta, 'b');
hold on;
plot(t, omega, 'r');
axis([0 2 -1 1]);
title('Angular displacement and velocity vs time');
xlabel('Time (s)');
ylabel('Angle (rad) / Angular velocity (rad/s)');
legend('theta', 'omega');
```

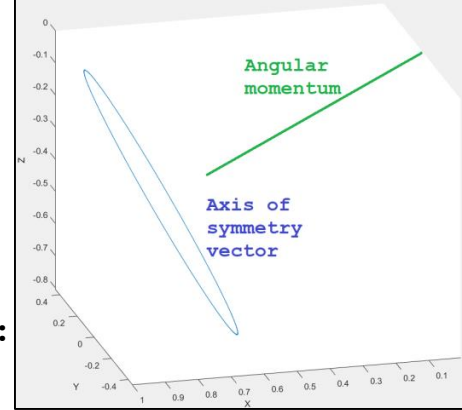

```
clear all;
close all;
% Parameters
m = 1; % mass
l = 1; % length
g = 9.81; % gravity
% Initial conditions
theta0 = pi/4; % initial angle
omega0 = 0; % initial angular velocity
% Time step and range
dt = 0.01; % time step
t = 0:dt:2; % time range
% Numerical solution
theta = theta0;
omega = omega0;
for i = 1:length(t)-1
    % Angular acceleration
    alpha = -g/l*cos(theta);
    % Update angular velocity
    omega = omega + alpha*dt;
    % Update angle
    theta = theta + omega*dt;
end
% Plot
figure;
plot(t, theta, 'b');
hold on;
plot(t, omega, 'r');
axis([0 2 -1 1]);
title('Angular displacement and velocity vs time');
xlabel('Time (s)');
ylabel('Angle (rad) / Angular velocity (rad/s)');
legend('theta', 'omega');
```

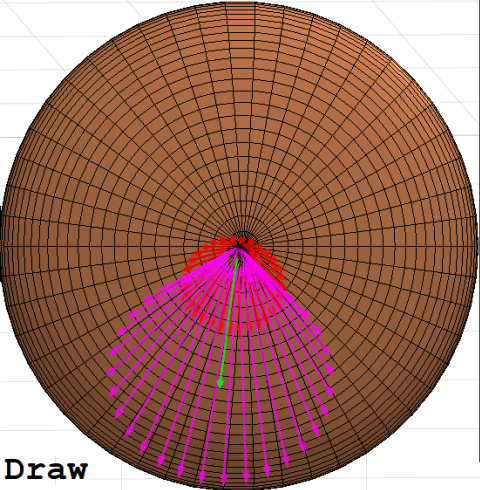

Draw  
 Angular velocity in  
 world coordinate  
 Vector along axis  
 of Symmetry  
 Angular momentum vector  
 For many points in time

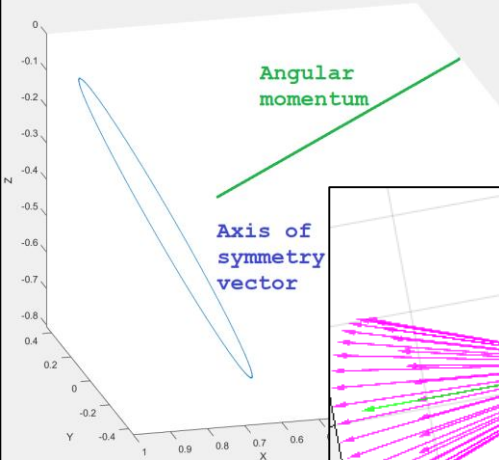

```

% Example 3: Spheroid with s=[1;1;0.1];
% wo=[1;0;1]; % initial omega in object frame;
% Qi=[0;pi/2;0]; % Orientation Axis & angle |OIv| from rotating to world frame;
% ... (rest of the code)
  
```

**Example-3:** spheroid with  $s=[1;1;0.1]$ ;  
 $\omega_0=[1;0;1]$ ; %initial  $\omega$  in object frame;  
 $Q_i=[0;\pi/2;0]$ ; %Orientation Axis &  
 angle  $|OIv|$  from rotating to world frame;

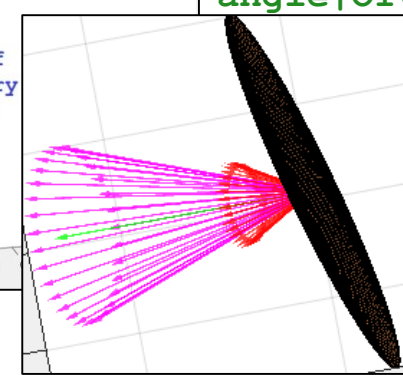

$\omega$   
 $L$   
 $z'$

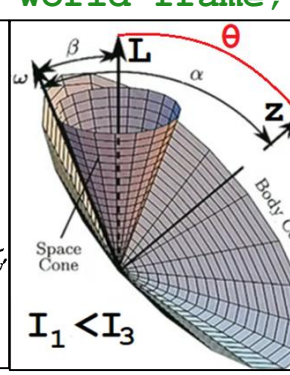
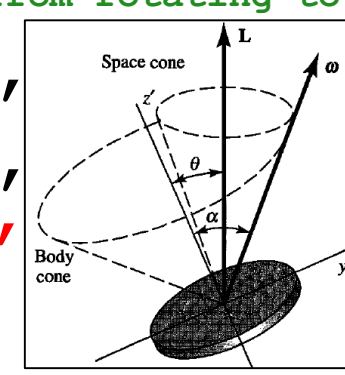

Observer in world frame would see the  $z'$ -axis (&  $\omega$ ) trace out a cone as it precesses about  $L$ ; the body cone ( $z'$  center) rolling along the space cone;  $\omega$  is the line where the 2 cones touch;  $\omega$  also precess about  $z'$ ;

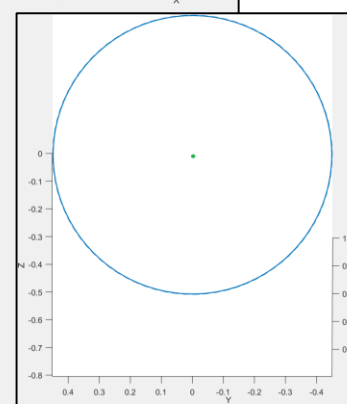
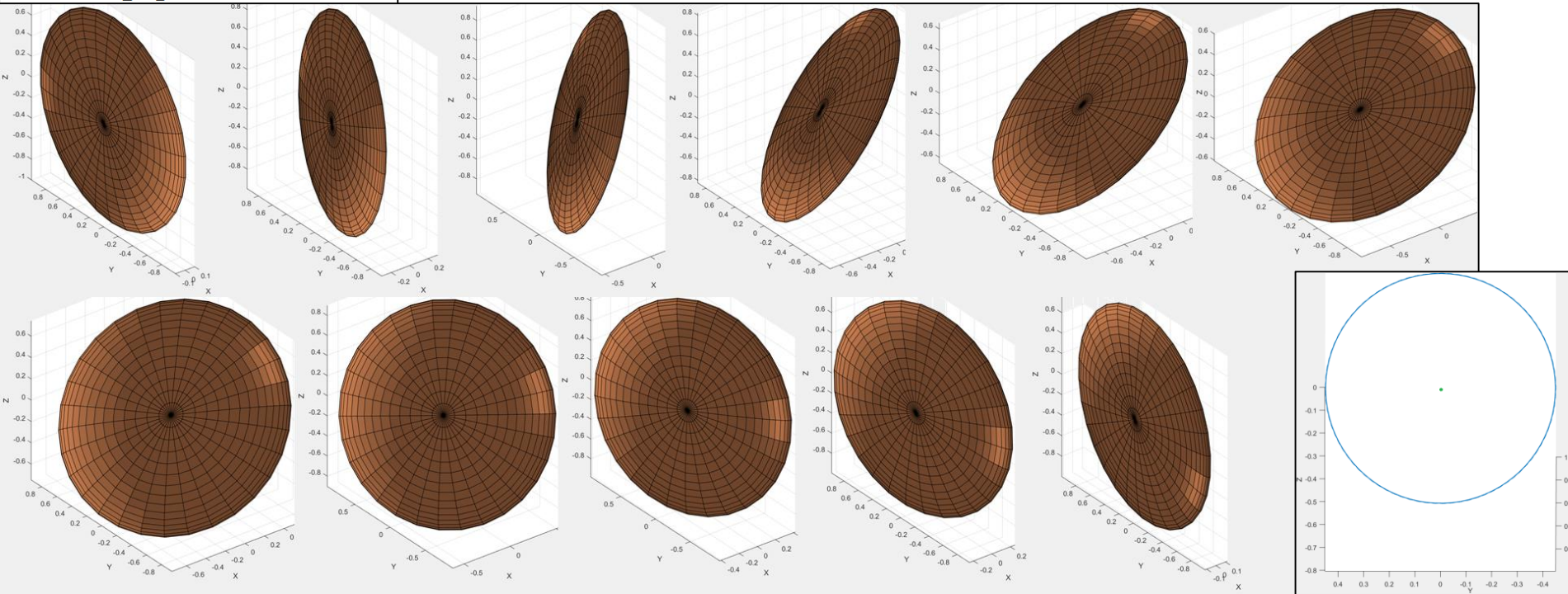



# Mathematical Proofs: Intermediate axis of rotation

$$\left(\frac{dv}{dt}\right)_{fixed} = \left(\frac{dv}{dt}\right)_{rot} + \omega \times v = \left(\frac{d}{dt}\right)_{rot} (v' + \omega \times r') + \omega \times (v' + \omega \times r') =$$

$$\left(\frac{dv'}{dt}\right)_{rot} + \left(\frac{d\omega}{dt}\right)_{rot} \times r' + \omega \times \left(\frac{dr'}{dt}\right)_{rot} + \omega \times v' + \omega \times (\omega \times r') =$$

$$\mathbf{a} = \mathbf{a}' + \dot{\omega} \times \mathbf{r}' + \underline{2\omega \times v'} + \underline{\omega \times (\omega \times r')}$$

*transverse*   *Coriolis*   *centripetal*   acceleration

$\mathbf{F} = m\mathbf{A}_0 + m\mathbf{a}'$    Taking the first and second time derivatives gives

$$\mathbf{F}' = \mathbf{F} - m\mathbf{A}_0 = m\mathbf{a}'$$

$-m\mathbf{A}_0 =$  inertial or fictitious force

force not due to interactions with other bodies, rather, stem from the acceleration of the reference system.

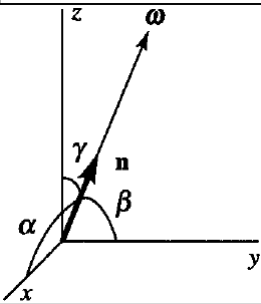
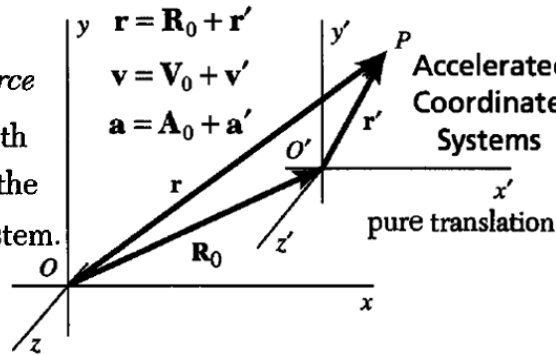

$\tilde{\mathbf{n}}$  means "n transpose."

$$I = \tilde{\mathbf{n}} \mathbf{I} \mathbf{n} = \begin{pmatrix} I_{xx} & I_{xy} & I_{xz} \\ I_{yx} & I_{yy} & I_{yz} \\ I_{zx} & I_{zy} & I_{zz} \end{pmatrix} \begin{pmatrix} \cos \alpha \\ \cos \beta \\ \cos \gamma \end{pmatrix}$$

$$I = I_{xx} \cos^2 \alpha + I_{yy} \cos^2 \beta + I_{zz} \cos^2 \gamma + 2I_{yz} \cos \beta \cos \gamma + 2I_{zx} \cos \gamma \cos \alpha + 2I_{xy} \cos \alpha \cos \beta$$

moment of inertia about an axis aligned with the vector  $\mathbf{n}$

$$\mathbf{v} = \mathbf{v}' + \omega \times \mathbf{r}'$$

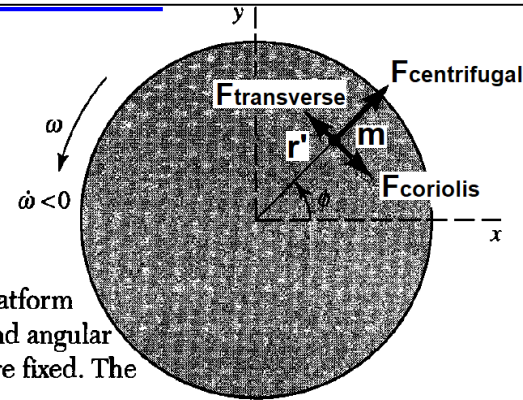

Inertial forces acting on a mass  $m$  moving radially outward on a platform rotating with angular velocity  $\omega$  and angular acceleration  $\dot{\omega} < 0$ . The  $xy$ -axes are fixed. The direction of  $\omega$  is out of the paper.

real, physical force   inertial or fictitious forces

$$\mathbf{F}' = \mathbf{F} - m\mathbf{A}_0 - \underline{2m\omega \times v'} - \underline{m\dot{\omega} \times r'} - \underline{m\omega \times (\omega \times r')} = m\mathbf{a}'$$

*inertial*   *Coriolis*   *transverse*   *centrifugal*   force

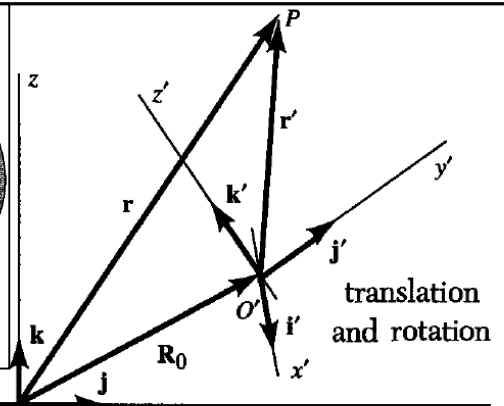
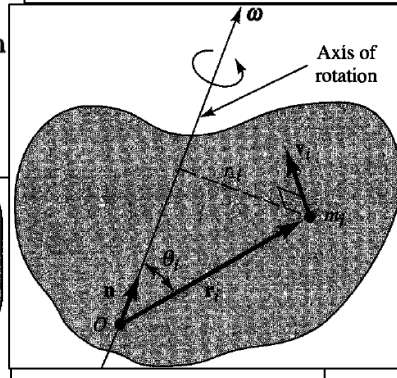

$$\mathbf{v} = \mathbf{v}' + \omega \times \mathbf{r}' + \mathbf{V}_0$$

$$\mathbf{a} = \mathbf{a}' + \dot{\omega} \times \mathbf{r}' + \underline{2\omega \times v'} + \underline{\omega \times (\omega \times r')} + \mathbf{A}_0$$

*transverse*   *Coriolis*   *centripetal*

The components of  $\omega$  in the rotating frame aren't zero because when one writes these

components, one isn't referring to measurements of the motions of the particles in the rotating frame (because, of course, the particles are stationary in this frame). Instead, one is referring to  $\omega$  as measured in the world frame but whose components have simply been written with respect to a time-varying basis that is rotating with the body.



in inertial coordinate system,  $\mathbf{N} = \frac{d\mathbf{L}}{dt}$  If we employ a coordinate system that is fixed in the body and rotates with it, the angular velocity of the body & the angular velocity of the coordinate system are one & the same;

$$\mathbf{i} \frac{dx}{dt} + \mathbf{j} \frac{dy}{dt} + \mathbf{k} \frac{dz}{dt} = \mathbf{i}' \frac{dx'}{dt} + \mathbf{j}' \frac{dy'}{dt} + \mathbf{k}' \frac{dz'}{dt} + \boldsymbol{\omega} \times (\mathbf{i}'x' + \mathbf{j}'y' + \mathbf{k}'z')$$

$$\left(\frac{d\mathbf{L}}{dt}\right)_{\text{fixed}} = \left(\frac{d\mathbf{L}}{dt}\right)_{\text{rot}} + \boldsymbol{\omega} \times \mathbf{L}$$

$$\mathbf{N} = \left(\frac{d\mathbf{L}}{dt}\right)_{\text{rot}} + \boldsymbol{\omega} \times \mathbf{L}$$

$$\begin{pmatrix} N_1 \\ N_2 \\ N_3 \end{pmatrix} = \begin{pmatrix} I_1 \dot{\omega}_1 \\ I_2 \dot{\omega}_2 \\ I_3 \dot{\omega}_3 \end{pmatrix} + \begin{pmatrix} \omega_2 \omega_3 (I_3 - I_2) \\ \omega_3 \omega_1 (I_1 - I_3) \\ \omega_1 \omega_2 (I_2 - I_1) \end{pmatrix}$$

components of  $\boldsymbol{\omega}$  are taken along the principal axes of the body.

G94: If  $\mathbf{a}'(t) = -\boldsymbol{\omega}(t) \times \mathbf{a}(t)$ ; then  $|\mathbf{a}(t_1)| = |\mathbf{a}(t_2)| = \text{constant}$ ;

{If  $\mathbf{a}'(t) = -\boldsymbol{\omega}(t) \times \mathbf{a}(t)$ ; then  $|d\mathbf{a}(t)| = |dt * \mathbf{a}'(t)| = |-dt * \boldsymbol{\omega}(t) \times \mathbf{a}(t)| = dt * |\boldsymbol{\omega}(t)| |\mathbf{a}(t)| \sin\phi = d\theta * H * |\mathbf{a}(t)| \sin\phi = d\theta * H * y$ ; & if  $|d\mathbf{a}(t)| = d\theta * y$ ;  $|d\mathbf{a}(t)|$  is an arc of a circle with radius  $y$ ; &  $z$  is also radius &  $z = y$ ;  $z^2 = y^2 = |\mathbf{a}(t+dt)|^2 - |\mathbf{a}(t)|^2 \cos^2(\phi) = |\mathbf{a}(t)|^2 \sin^2(\phi)$ ;  $|\mathbf{a}(t+dt)|^2 = |\mathbf{a}(t)|^2 * (\cos^2(\phi) + \sin^2(\phi)) = |\mathbf{a}(t)|^2$ ;  $|\mathbf{a}(t+dt)| = |\mathbf{a}(t)|$ };

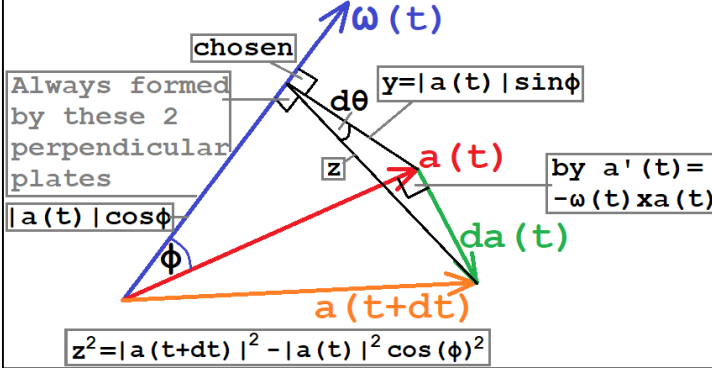

If torque = [0;0;0] in world frame; and components of  $\mathbf{L}, \mathbf{I}, \boldsymbol{\omega}$  taken along the principal axes of the body (in the rotating frame):  $[0;0;0] = \mathbf{L}'(t) + \boldsymbol{\omega}(t) \times \mathbf{L}(t)$ ;  $\mathbf{L}'(t) = -\boldsymbol{\omega}(t) \times \mathbf{L}(t)$ ;  $|\mathbf{L}(t_1)| = |\mathbf{L}(t_2)| = \text{constant}$ ; {By G94} &  $|\mathbf{L}(t)|^2 = \text{constant} = R^2 = L_x(t)^2 + L_y(t)^2 + L_z(t)^2 = \text{sphere radius } R$ ;  $R = \sqrt{[I_x^2 \omega_x(t_1)^2 + I_y^2 \omega_y(t_1)^2 + I_z^2 \omega_z(t_1)^2]}$ ;

$\boldsymbol{\omega}(t_1) \cdot \mathbf{L}(t_1) = \boldsymbol{\omega}(t_2) \cdot \mathbf{L}(t_2) = \text{constant} = 2T$ ;  $\{\{\boldsymbol{\omega}(t) \cdot \mathbf{L}(t)\}' = \{\boldsymbol{\omega}(t) \cdot \mathbf{I} \boldsymbol{\omega}(t)\}' = \{I_x \omega_x(t)^2 + I_y \omega_y(t)^2 + I_z \omega_z(t)^2\}' = 2I_x \omega_x(t) \omega_x'(t) + 2I_y \omega_y(t) \omega_y'(t) + 2I_z \omega_z(t) \omega_z'(t) = 2\boldsymbol{\omega}(t) \cdot \mathbf{L}'(t) = 2\boldsymbol{\omega}(t) \cdot \{-\boldsymbol{\omega}(t) \times \mathbf{L}(t)\} = 2\boldsymbol{\omega}(t) \cdot \{\text{perpendicular to } \boldsymbol{\omega}(t)\} = 0$ ; G30};  $2T = \boldsymbol{\omega}(t) \cdot \mathbf{L}(t) = \boldsymbol{\omega}(t) \cdot \mathbf{I} \boldsymbol{\omega}(t) = I_x \omega_x(t)^2 + I_y \omega_y(t)^2 + I_z \omega_z(t)^2 = L_x(t)^2 / I_x + L_y(t)^2 / I_y + L_z(t)^2 / I_z$ ;

$1 = L_x(t)^2 / (2TI_x) + L_y(t)^2 / (2TI_y) + L_z(t)^2 / (2TI_z) = \text{Ellipsoid}$   
 $\mathbf{a} = \sqrt{[(I_x \omega_x(t_1)^2 + I_y \omega_y(t_1)^2 + I_z \omega_z(t_1)^2) * I_x]}$ ;  $\mathbf{b} = \sqrt{[(I_x \omega_x(t_1)^2 + I_y \omega_y(t_1)^2 + I_z \omega_z(t_1)^2) * I_y]}$ ;  $\mathbf{c} = \sqrt{[(I_x \omega_x(t_1)^2 + I_y \omega_y(t_1)^2 + I_z \omega_z(t_1)^2) * I_z]}$ ; In the rotating frame  $\mathbf{I}$  is constant, but  $\boldsymbol{\omega}, \mathbf{L}$  may vary;

The allowed  $\mathbf{L}(t)$  values (allowed motions), lay in the intersection points between this sphere & ellipsoid; If  $I_x > I_y > I_z$  &  $\boldsymbol{\omega}(t_1) = [\omega_x; \delta\omega_y; \delta\omega_z]$  ( $\delta \rightarrow 0$ ) then  $R \approx a$ ; &  $R > b$ ; &  $R > c$ ;

If  $I_x > I_y > I_z$  &  $\boldsymbol{\omega}(t_1) = [\delta\omega_x; \delta\omega_y; \omega_z]$  then  $R \approx c$ ; &  $R < b$ ; &  $R < a$ ;

If  $I_x > I_y > I_z$  &  $\boldsymbol{\omega}(t_1) = [\delta\omega_x; \omega_y; \delta\omega_z]$  then  $R \approx b$ ; &  $R < a$ ; &  $R > c$ ;

Thus, if  $\boldsymbol{\omega}$  is in the Intermediate  $\mathbf{I}$  direction the motion can do a flip, Else the motion is stable;

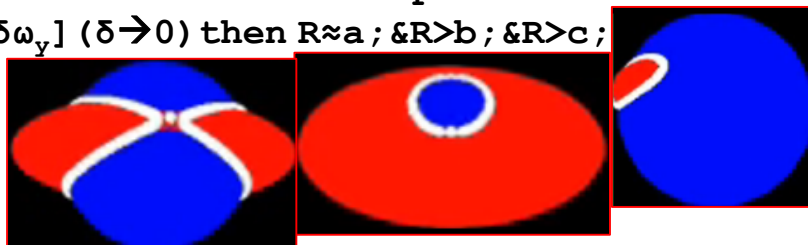

{if  $\omega(t)$ =continuous,  $L(t)=I_x\omega_x(t)+I_y\omega_y(t)+I_z\omega_z(t)$ ; also; So  $L(t)$  has no path to flip in first 2 cases};

$\tau=I\omega'+\omega \times I\omega=[I_x\omega_x'+(I_z-I_y)\omega_y\omega_z; I_y\omega_y'+(I_x-I_z)\omega_x\omega_z; I_z\omega_z'+(I_y-I_x)\omega_y\omega_x]$ ;  $\tau$  in world frame &  $\omega, I$  in the rotating frame; If  $\tau=[0;0;0]: I_x\omega_x'+(I_z-I_y)\omega_y\omega_z=0; I_y\omega_y'+(I_x-I_z)\omega_x\omega_z=0; I_z\omega_z'+(I_y-I_x)\omega_y\omega_x=0$ ; If we rotate the object mainly about  $\omega_z$ :  $\omega_x, \omega_y$  are very small and  $\omega_x*\omega_y$  even smaller, we assume  $\omega_x*\omega_y \approx 0$ ; so  $\omega_z'=\omega_y\omega_x(I_x-I_y)/I_z \approx 0$ ;

$I_x\omega_x'+(I_z-I_y)\omega_y\omega_z=0; I_x\omega_x''+(I_z-I_y)\omega_y'\omega_z+(I_z-I_y)\omega_y\omega_z' = I_x\omega_x''+(I_z-I_y)\omega_y'\omega_z=0$ ;  
 $\omega_x''=\omega_y'\omega_z(I_y-I_z)/I_x; I_y\omega_y'+(I_x-I_z)\omega_x\omega_z=0; \omega_y'=\omega_x\omega_z(I_z-I_x)/I_y$ ;  
 $\omega_x''=\omega_x\omega_z^2(I_y-I_z)(I_z-I_x)/(I_yI_x); \{I_x, I_y, I_z = \text{positive}\}$

If the main rotation ( $\omega_z$ ) is around an intermediate axis  $\{I_x > I_z > I_y \text{ or } I_y > I_z > I_x\}$ :

$\omega_x''=G^2\omega_x; \{\omega_x''=\omega_x(+)(-)(-)/(+); \text{ or } \omega_x''=\omega_x(+)(+)(+)/(+); G \in \text{real}\};$  &  
 $\omega_x=\omega_x(t)=ke^{Gt}; G=\pm\sqrt{[\omega_z^2(I_y-I_z)(I_z-I_x)/(I_yI_x)]}; \{(ke^{Gt})''=(kGe^{Gt})'=kG^2e^{Gt}\}$

Else  $\{I_x > I_y > I_z \text{ or } I_z > I_y > I_x \text{ or } I_y > I_x > I_z \text{ or } I_z > I_x > I_y\}: \omega_x''=-Q^2\omega_x; \{\omega_x''=\omega_x(+)(+)(-)/(+);$   
 or  $\omega_x''=\omega_x(+)(-)(+)/(+); \text{ or } \omega_x''=\omega_x(+)(+)(-)/(+); \text{ or } \omega_x''=\omega_x(+)(-)(+)/(+);$   
 $Q \in \text{real}\}; \& \omega_x=\omega_x(t)=K\cos(Qt); \text{ or } \omega_x(t)=K\sin(Qt); Q=\pm\sqrt{[\omega_z^2(I_z-I_y)(I_z-I_x)/(I_yI_x)]};$   
 $\{(K\cos(Qt))''=(-KQ\sin(Qt))'=-KQ^2\cos(Qt); (K\sin(Qt))''=(KQ\cos(Qt))'=-KQ^2\sin(Qt)\};$

Thus, if we rotate object mainly about  $\omega_z$  & this is axis with smallest or largest  $I$ , rotation is stable ( $\omega_x(t)$  goes from  $-K$  to  $K$  only), but if  $\omega_z$  axis is the axis with intermediate  $I$ , rotation is unstable ( $\omega_x(t)$  increased rapidly with time);

If there is no gravity, this Rotation (in intermediate axis) causes spontaneous flipping;

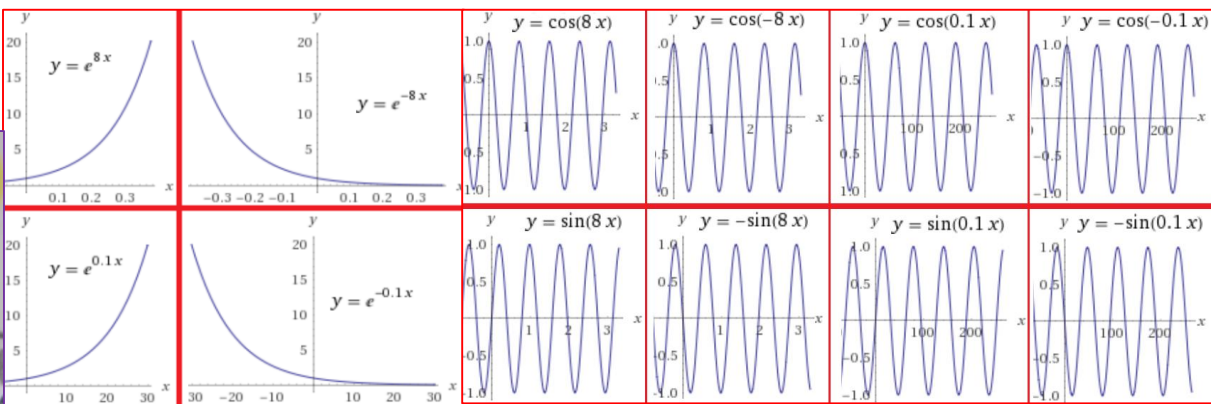

In a general torque free motion, we have to solve these 3, first order, coupled differential equations numerically; with initial conditions:  $[W1(0); W2(0); W3(0)] = [1; 1; 1]$ ; & time interval  $[0-3.3\pi]$  the matlab code is:

```
[t,W]=ode45(@vdp1,[0 3.3*pi],[1; 1; 1]); %ode45(W',tspan,W0);
plot3(W(:,1),W(:,2),W(:,3));
function dWdt=vdp1(t,W)
    I1=pi; I2=2*pi; I3=8.168;
    dWdt=[W(2)*W(3)*(I2-I3)/I1;W(3)*W(1)*(I3-I1)/I2;W(1)*W(2)*(I1-I2)/I3]; end
```

$$\begin{pmatrix} N_1 \\ N_2 \\ N_3 \end{pmatrix} = \begin{pmatrix} I_1 \dot{\omega}_1 \\ I_2 \dot{\omega}_2 \\ I_3 \dot{\omega}_3 \end{pmatrix} + \begin{pmatrix} \omega_2 \omega_3 (I_3 - I_2) \\ \omega_3 \omega_1 (I_1 - I_3) \\ \omega_1 \omega_2 (I_2 - I_1) \end{pmatrix}$$

components of  $\omega$  are taken along the principal axes of the body.

The kinetic energy and the magnitude of the angular momentum are constant of the motion and they constrains the angular velocity vector to terminate on 2 ellipsoidal surfaces intersection shown; {value of T & |L| determined by the initial conditions of W}

$$\frac{\omega_1^2}{(2T/I_1)} + \frac{\omega_2^2}{(2T/I_2)} + \frac{\omega_3^2}{(2T/I_3)} = 1$$

$$\frac{\omega_1^2}{(LI_1)^2} + \frac{\omega_2^2}{(LI_2)^2} + \frac{\omega_3^2}{(LI_3)^2} = 1$$

$$\dot{\omega}_1 = \omega_2 \omega_3 (I_2 - I_3) / I_1$$

$$\dot{\omega}_2 = \omega_3 \omega_1 (I_3 - I_1) / I_2$$

$$\dot{\omega}_3 = \omega_1 \omega_2 (I_1 - I_2) / I_3$$

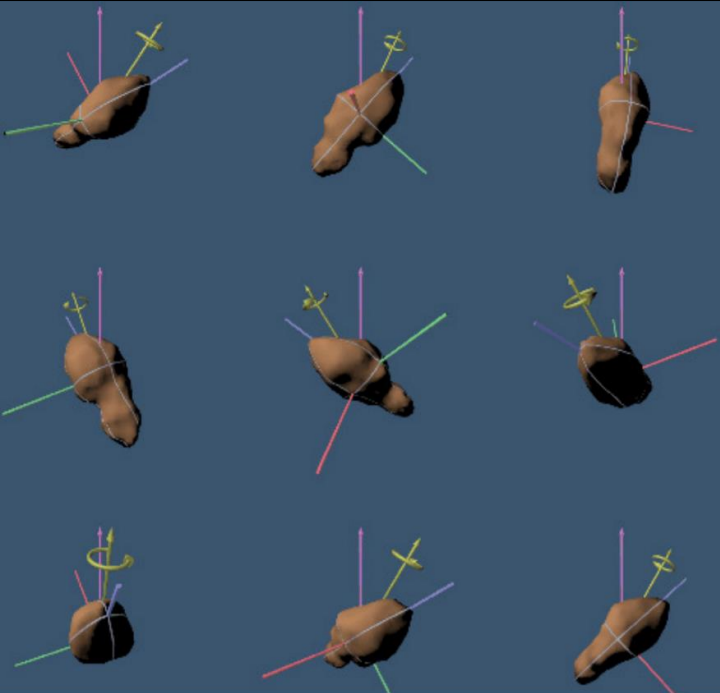
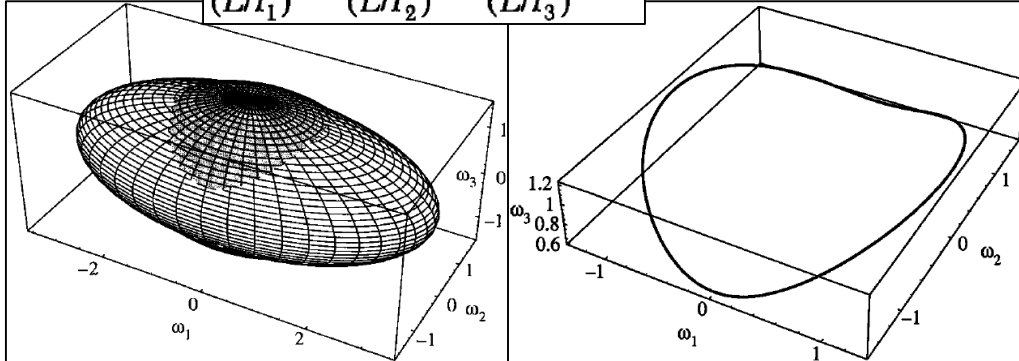

The three principal axes are shown in red, green and blue (without arrows). The angular momentum  $L$  is the vertical, purple arrow. The angular velocity  $\omega$  is the circled, yellow arrow.

**G95:  $f \bullet (w \times r) = (r \times f) \bullet w$** ; {proof by matlab: syms fx fy fz wx wy wz rx ry rz real r=[rx;ry; rz]; w=[wx;wy;wz]; f=[fx;fy;fz]; cc=expand(dot(f,cross(w,r))-dot(cross(r,f),w)) ans=0}

$W = \sum W_i = \sum [\int F_i(r_i(t)) \bullet r_i'(t) dt] = \sum [\int F_i(r_i(t)) \bullet (v_T(t) + v_{R_i}(t)) dt] = \sum [\int F_i(r_i(t)) \bullet v_T(t) dt] + \sum [\int F_i(r_i(t)) \bullet (\omega(t) \times r_i(t)) dt] = \sum [m_i \int a_i(t) \bullet v_T(t) dt] + \sum [\int (r_i(t) \times F_i(r_i(t))) \bullet \omega(t) dt] = \sum [\frac{1}{2} m_i \int (|v_T(t)|^2)' dt] + \sum [\int \tau_i(r_i(t)) \bullet \omega(t) dt] = \frac{1}{2} M |v_T(t_2)|^2 - \frac{1}{2} M |v_T(t_1)|^2 + \sum \omega(t_2) \bullet I(t_2) \omega(t_2) - \sum \omega(t_1) \bullet I(t_1) \omega(t_1);$

# Rules

- Rule 1:** Electric field( $\omega(2)$ ) generation:  $[e+G \rightarrow Ge; e^++G \rightarrow Ge^+; p+G \rightarrow Gp]$  ~Proved;
- Rule 2:** Attraction:  $[Ge^+$  attracts  $e$ ;  $Ge$  attracts  $e^+$ ;  $p$  attracts  $e]$ ; ~Proved;
- Rule 3:** Repulsion:  $[Ge$  repels  $e$ ;  $Ge^+$  repels  $e^+$ ;  $p$  repels  $p]$ ; ~Proved;

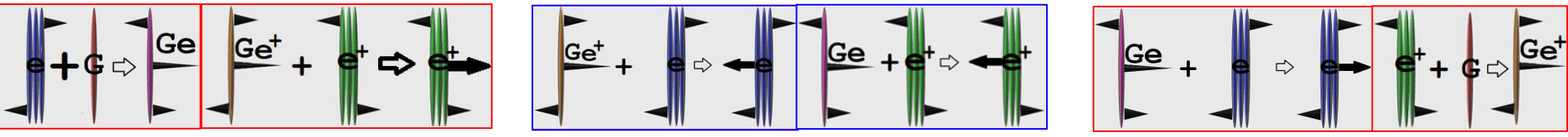

- Rule 4a:** Moving charge create magnetic field:  $[(\text{moving } e)+G \rightarrow Ge+Gn+Gs; (\text{moving } e^+)+G \rightarrow Ge^++Gn+Gs; (\text{moving } p)+G \rightarrow Gp+Gn+Gs]$ ;

- Rule 4b:** Magnetic field generation:  $[Eu1+G \rightarrow Ge, Gn1, Gs1; Ed2+G \rightarrow Ge, Gn2, Gs2]$

- Rule 5:** The internal energy of each electron is constant; Internal electron energy =  $(e\omega(1)^2 + e\omega(2)^2) * eM/5 * (Gs1^2 + es3^2) + e\omega(3)^2 * eM/5 * (2 * Gs1^2) = \text{constant}$ ;

- Rule 6:** Different electrons different spins ( $e\omega(1), e\omega(3)$ ), but same spin magnitude; spin magnitude =  $e\omega(1)^2 * (Gs1^2 + es3^2) + e\omega(3)^2 * 2 * Gs1^2 = \text{constant}$ ;

- Rule 7:** M.Attraction:  $[Gs1$  or  $Gn1$  attracts any  $Eu$ ;  $Gs2$  or  $Gn2$  attracts any  $Ed]$ ;

- Rule 8:** M.Repulsion:  $[Gs1$  or  $Gn1$  repels any  $Ed$ ;  $Gs2$  or  $Gn2$  repels any  $Eu]$ ;

- Rule 9a:** Magnet transform unpaired e:  $[Gn1+Ed2 \rightarrow Eu1; Gn2+Ed6 \rightarrow Ed2; Gn1+Eu5 \rightarrow Eu1]$

- Rule 9b:** Magnet transform electron(not in atom)&emit same  $\gamma_0$  with an increased probability as the e spin & magnet directions differ:  $[Gn1+Ed2 \rightarrow Eu1+\gamma_0(100\%)]$   
 $[Gn1+Eu1 \rightarrow Eu1+\gamma_0(0\%)]$   $[Gn1+Ed4 \rightarrow Eu1+\gamma_0(30\%)]$   $[Gn7+Ed4 \rightarrow Eu7+\gamma_0(80\%)]$

- Rule 10:** Magnet transform paired e:  $[Gn1+\text{paired } Eu1(Eu1^*) \rightarrow Ed2; Gn2+Ed4^* \rightarrow Eu1]$

- Rule 11:** If energy of 2  $\gamma$  equal, their frequency is also equal:  $\gamma$  Frequency =  $\text{Cycles}/t = (\omega(1)^2 + \omega(2)^2 + \omega(3)^2 * (2 * Gs1^2 / (Gs1^2 + Gs3^2))^{1/2}) / (2 * \pi)$ ;

- Rule 12:** In atom, The total energy of each electron is different;

- Rule 13:** Few  $Gnx$  can be created in any atom only in specific locations;

- Rule 14:** Magnet transform entangled e& $e^+$ :  $[Gn3+\text{entangled}(Eu1 \& Ed2^+) \rightarrow \text{entangled}(Eu3 \& Ed4^+)]$

- Rule 15:** The magnetic force( $Fm$ ) on a charge( $q$ ) moves( $v$ =velocity) through a magnetic field( $B$ ) =  $Fm = q * v * B$ ;



**Rule 16:** Gravitational field generation:  $[Eu1+G \rightarrow Ge, Gs1, Gn1, Gr, G1;$   
 $Ed2+G \rightarrow Ge, Gs2, Gn2, Gr, G1; Pu1+G \rightarrow Gp, Gs1p, Gn1p, Gr, G1;$   
 $Pd2+G \rightarrow Gp, Gs2p, Gn2p, Gr, G1];$

**Rule 17:** Attraction: Gr attracts e; G1 attracts e; Gr attracts p; G1 attracts p;  
{use my collision simulation to prove these rule; e.g. proof of rule 1,2}

## The properties of the universe:

**Property 1:** Electric force on  $q_1 = F_{e1} = (c^2 \cdot 10^{-7} \cdot q_1 \cdot q_2 \cdot r_{21}) / |r_{21}|^3$ .

**Property 2:** electron captured;

**Property 3:** Beta emission;

**Property 4:** nuclear fusion;

**Property 5:** Alpha emission & spontaneous fission;

**Property 6:** positron emission;

**Property 7:** The more protons the nucleus has (until 26 protons), the more difficult is to pull proton away from the nucleus.

**property 8:** Moving charge creates B at point r:  $B = 10^{-7} \cdot q \cdot (v \times r) / |r|^3$ ;

**Property 9:** We can't separate magnetic poles, they always come in North & South;

**Property10:** A beaten/heated magnet loses its magnetic properties;

**Property11:** The magnetic force is the strongest at the ends of the magnet.

**Property12:** In Stern Gerlach experiment: When we fire silver atoms or nuclei of some atoms through an inhomogeneous magnetic field, we get only 2 spots;

**Property13:** Insulator can be charged by friction but conductor can't;

**Property14:** Charge can be transferred to conductor by contact;

**Property15:** Current & Magnetic field properties;

**Property16:** Superconductor stay locked in space, when put near magnet;

**Property17:** Mirror reverse arrangement can have different properties;

**Property18:** The earth has a magnetic field & it flipped every 0.5 million years

**Property19:** Accelerated charge produce light at r:  $E(r, t) = -Q \cdot a_p(t') \cdot 10^{-7} / |r|$ ;

$B(r, t) = \hat{r} \times E(r, t) / c$ ;  $\{t' = t - |r|/c = \text{time before reach us; } a_p = a \text{ perpendicular to } r\}$

**Property20:** In vacuum:  $\nabla \cdot E = 0$ ; &  $\nabla \cdot B = 0$ ;  $\nabla \times E = -\partial B / \partial t$ ;  $\nabla \times B = 1/c^2 \cdot \partial E / \partial t$ ;

**property21:** Magnet transform electron (not in atom) & electron emit same  $\gamma_0$  with an increased probability as the e spin & magnet directions differ;

**Property22:** Photon absorption & emission in atom in gas or other material;

**Property23:** Fluorescence;

**Property24:** Stimulated emission;

- Property25:** Transparency of glass;
- Property26:** Mirror property of Li;
- Property27:** Red material absorb all other visible photon but not red; green laser makes a hole in red balloon but not in green balloon;
- Property28:** Increasing temperature increase the: number of photon emitted & the most common frequency;
- Property29:** Speed of light constant;
- Property30:** blue/red shift of light from source coming to/from the detector;
- Property31:** blue/red shift of light seen(experienced) by a moving observer;
- Property32:** Malus's law;
- Property33:** Standing electromagnetic wave;
- Property34:** Doppler laser cooling;
- Property35:** Bremsstrahlung principle;
- Property36:** Magnetic field can change the polarization of a photon;
- Property37:** Tunnel effect;
- Property38:** photons combining;
- Property39:** photon entanglement;
- Property40:** Left/Right handed particle;
- Property41:** electron & photon collision: Compton Scattering;
- Property42:** The sky are blue&cloud are more red(except at mid day);
- Property43:** The more dense the material the slower light travel in it;
- Property44:** The higher the  $\gamma$  frequency the more slowly it travels in material.
- Property45:** If light is polarized parallel to the plane of incidence there will be no reflection;
- Property46:** The reflected light of an unpolarized incident light is partially or fully polarized, when fully polarized it is always in the direction perpendicular to the plane of incidence;
- Property47:** Fermat's principle: If a beam of Light travels from point A to B, it does so along the fastest path possible;

- Property48: Photoelectric effect;
- Property49: Constructive and Destructive interference.
- Property50: shining photons at increasingly thicker glass create a periodic reflection pattern;
- Property51: Each part of the mirror reflect light;
- Property52: behavior of light passing through single& double slit;
- Property53: behavior of electron passing through single& double slit;
- Property54: light can increase/decrease magnet strength;
- Property55: Annihilation & pair production;
- Property56: Gamma emission;
- Property57: Most probable location for electron in atom;
- Property58: Precisely half full orbital give stability;
- Property59: Hund's rule;
- Property60: Aufbau principle;
- Property61: Elements in same group behave similarly;
- Property62: Ionization energy trend;
- Property63: Electron affinity and Electronegativity trend;
- Property64: Force unification in very high temperatures;
- Property65: There is almost only matter and no antimatter in the universe;
- Property66: Time dilation;
- Property67: Length contraction;
- Property68: Increased mass at high speed;
- Property69: Properties of 2<sup>nd</sup>, 3<sup>rd</sup> generation particles in the standard model;
- Property70: Mass increased formula;
- Property71: Gravitational force is  $10^{36}$  fold weaker then electromagnetic force
- Property72: Neutron star;
- Property73: Black holes;
- Property74: The expansion of the universe appears to be accelerating.
- Property75: Dark matter;



**Property76:** CMB (cosmic microwave background radiation);

**Property77:** Gravity force =  $-g \cdot m_1 \cdot m_2 \cdot r / |r|^3$ ; [N]  $g = 6.67259 \cdot 10^{-11}$  [N\*m<sup>2</sup>/kg<sup>2</sup>];

**Property78:** Gravity waves are predicted to have  $\lambda = 10^{-20}$ m;

**Property79:** Gravitational collapse after supernova of a massive star that result in neutron star;

**Property80:** Photon is affected by gravity;

**Property81:** Gravitational lensing;

# Particles parameters:

3D  
Fig

In the picture 3 different view points of each type of particle;

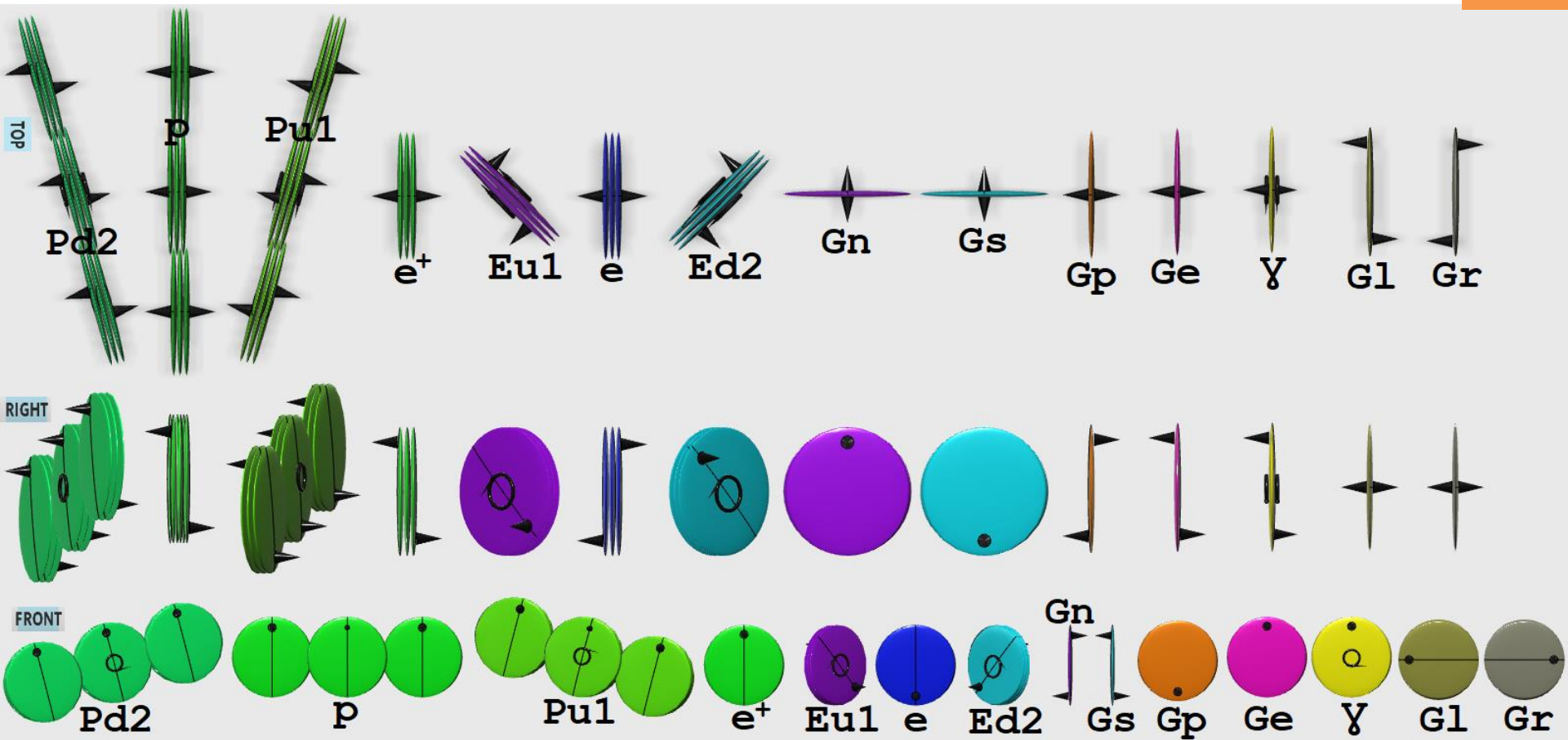

Mass of  $G = G_m = 1.78 \times 10^{-54}$  [kg];  $G_{s1} = 2.4 \times 10^{-18}$  [m];  $G_{s3} = 0.0 \times 10^{-18}$  [m];  
 Size of  $G = [G_{s1}; G_{s1}; G_{s3}]$ ; Orientation to world coordinates (Front in picture)  
 [rad];  $\omega =$  in body coordinates [rad/s];  $\sigma =$  small number (+/-)  $\{|\sigma| < |G_e W|\}$ ;  $v =$  observed  
 |velocity| [m/s];  $G_v =$  Average  $v$  of  $G$ ;  $c = 299792458$  [m/s];  $G$  based particles:

| Particle | Field                 | Mass & Size   | Orientation     | $\omega$                         | $v$   |
|----------|-----------------------|---------------|-----------------|----------------------------------|-------|
| G        |                       | $G_m$ & $G_s$ | Any             | [0;0;0]                          | $G_v$ |
| $G_n$    | Magnetic (North pole) | $G_m$ & $G_s$ | $[\pi/2; 0; 0]$ | $[0; - G_n W ; 0]$               | $c$   |
| $G_s$    | Magnetic (South pole) | $G_m$ & $G_s$ | $[\pi/2; 0; 0]$ | $[0;  G_n W ; 0]$                | $c$   |
| $G_p$    | Electric (+)          | $G_m$ & $G_s$ | [0;0;0]         | $[0;  G_p W ; 0]$                | $c$   |
| $G_e$    | Electric (-)          | $G_m$ & $G_s$ | [0;0;0]         | $[0; - G_e W ; 0]$               | $c$   |
| $G_l$    | Gravitational         | $G_m$ & $G_s$ | [0;0;0]         | $[ G_l W ; 0; 0]$                | $c$   |
| $G_r$    | Gravitational         | $G_m$ & $G_s$ | [0;0;0]         | $[- G_l W ; 0; 0]$               | $c$   |
| $\gamma$ | Light                 | $G_m$ & $G_s$ | [0;0;0]         | $[\sigma_1; - G_e W ; \sigma_3]$ | $c$   |

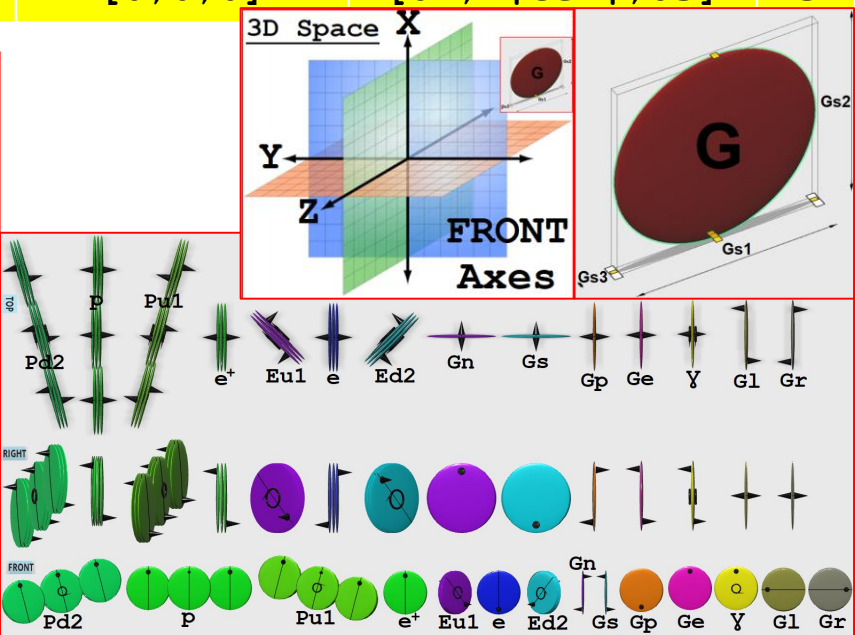
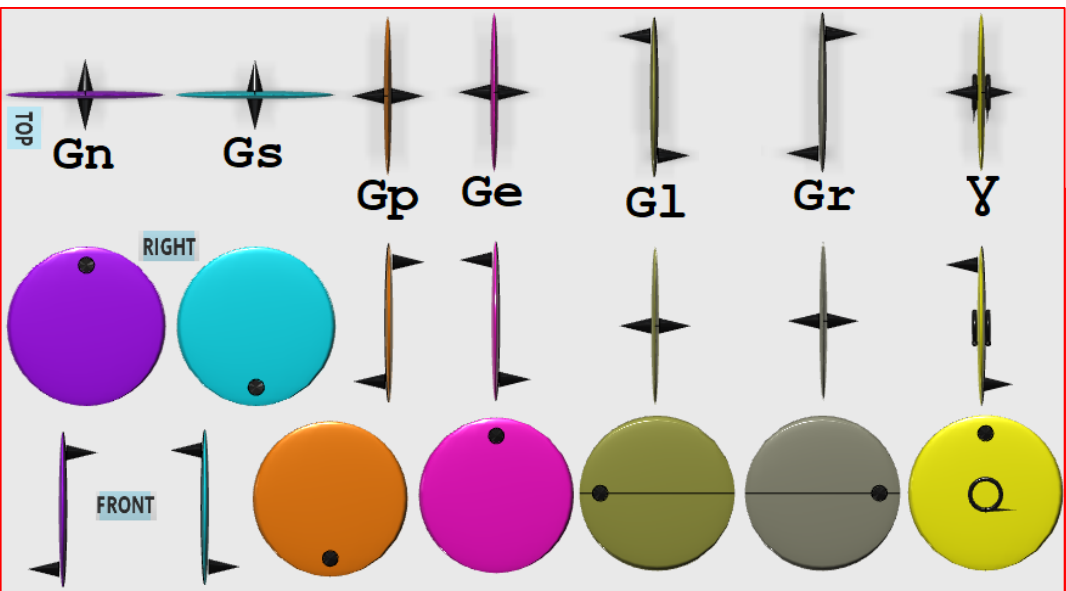

Mass of  $e=em=Gm*0.51*10^{24}$ ; Mass of  $p=pm=em*1836.15$ ; Size of  $e=es=[Gs1;Gs1;Gs3*0.51*10^{24}]$ ; Size of  $p=ps=[Gs1;2.4*10^{-15};es3]$ ; Orientation to world coordinates (Front in picture) [rad];  $\omega$ =in body coordinates [rad/s];  $\epsilon$ =smaller numbers ( $\epsilon>0$ );  $\delta$ =smallest numbers ( $0<\delta$ );  $\{|G_{ew}|>|e_{w}|>|p_{w}|$  } e based particles:

| Particle | Description          | Mass & Size | Orientation | $\omega$                         | $v$ |
|----------|----------------------|-------------|-------------|----------------------------------|-----|
| G        |                      | Gm & Gs     | Any         | [0;0;0]                          | Gv  |
| Pd2      | proton (spin down)   | pm & ps     | [0;0;0]     | $[\delta1; - eW ; \delta3]$      | 0   |
| p        | proton (idealized)   | pm & ps     | [0;0;0]     | $[0; - eW ; 0]$                  | 0   |
| Pu1      | proton (spin up)     | pm & ps     | [0;0;0]     | $[-\delta1; - eW ; -\delta3]$    | 0   |
| e+       | positron (idealized) | em & es     | [0;0;0]     | $[0; - eW ; 0]$                  | 0   |
| Eu1      | Electron (spin up)   | em & es     | [0;0;0]     | $[\epsilon1;  eW ; \epsilon3]$   | 0   |
| e        | Electron (idealized) | em & es     | [0;0;0]     | $[0;  eW ; 0]$                   | 0   |
| Ed2      | Electron (spin down) | em & es     | [0;0;0]     | $[-\epsilon1;  eW ; -\epsilon3]$ | 0   |

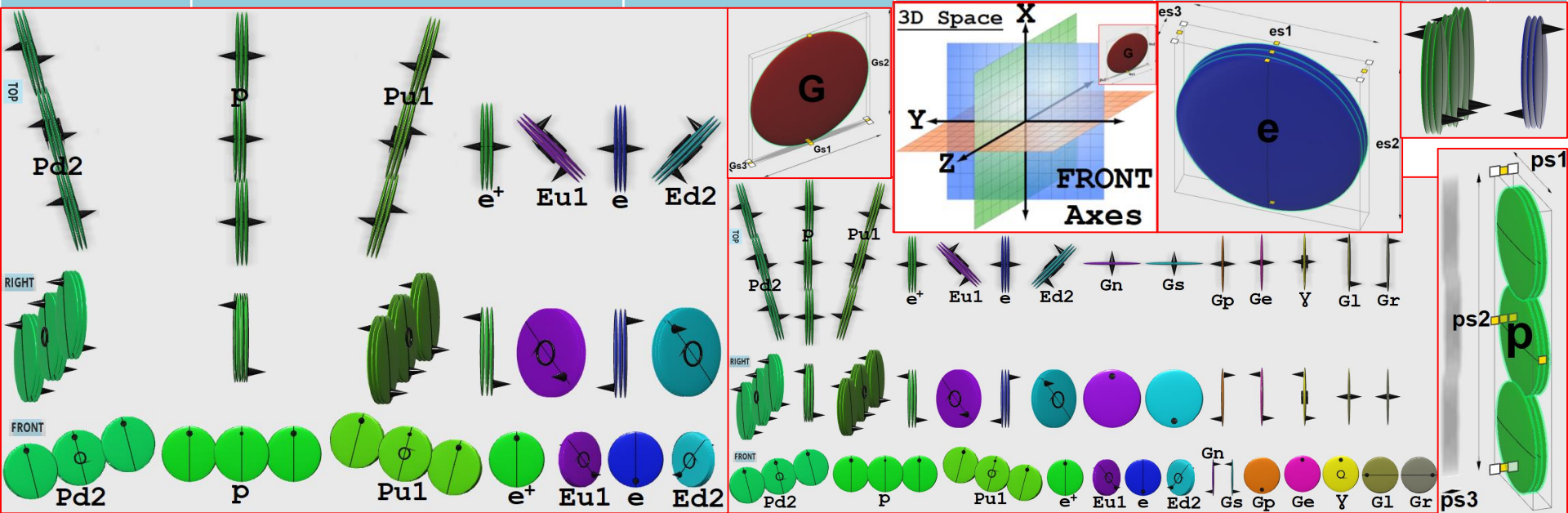



Size of Neutron(n)=ns=[Gs1;ps2+Gs1;es3];  $\alpha$ s=[2\*Gs1;ns2;3\*es3]; Size of ve (electron neutrino)=ves=[Gs1;Gs1;es3/232272.7];  $\nu_{\mu}$ s=[Gs1;Gs1;es3\*3.33];  $\nu_{\tau}$ s=[Gs1;Gs1;es3\*30.33]; Mass of ve=vem=em/232272.7; Orientation to world coordinates (if it was in the big picture);

| Particle        | Description            | Mass & Size                      | Orientation | $\omega$                             | $\mathbf{v}$ |
|-----------------|------------------------|----------------------------------|-------------|--------------------------------------|--------------|
| nd2             | Neutron (spin down) *  | $\sim (pm+em) \ \& \ ns$         | [0;0;0]     | $[\delta 1; 0; \delta 3]$            | 0            |
| nu1             | Neutron (spin up) *    | $\sim (pm+em) \ \& \ ns$         | [0;0;0]     | $[-\delta 1; 0; -\delta 3]$          | 0            |
| αd2             | He Nucleus (spin down) | $\sim (4pm+2em) \ \& \ \alpha s$ | [0;0;0]     | $[\delta 4;  \alpha W ; \delta 5]$   | 0.05c        |
| αu1             | He Nucleus (spin up)   | $\sim (4pm+2em) \ \& \ \alpha s$ | [0;0;0]     | $[-\delta 4;  \alpha W ; -\delta 5]$ | 0.05c        |
| ved2            | Neutrino (spin down)   | $\nu_{em} \ \& \ ves$            | [0;0;0]     | $[-\epsilon 4; 0; -\epsilon 5]$      | c**          |
| veu1            | Neutrino (spin up)     | $\nu_{em} \ \& \ ves$            | [0;0;0]     | $[\epsilon 4; 0; \epsilon 5]$        | c**          |
| $\nu_{\mu}$ d2  | Muon Neutrino (s.down) | $3.33*em \ \& \ \nu_{\mu}s$      | [0;0;0]     | $[-\epsilon 4; 0; -\epsilon 5]$      | c**          |
| $\nu_{\mu}$ u1  | Muon Neutrino (s.up)   | $3.33*em \ \& \ \nu_{\mu}s$      | [0;0;0]     | $[\epsilon 4; 0; \epsilon 5]$        | c**          |
| $\nu_{\tau}$ d2 | Tau Neutrino (s.down)  | $30.33*em \ \& \ \nu_{\tau}s$    | [0;0;0]     | $[-\epsilon 4; 0; -\epsilon 5]$      | c**          |
| $\nu_{\tau}$ u1 | Tau Neutrino (s.up)    | $30.33*em \ \& \ \nu_{\tau}s$    | [0;0;0]     | $[\epsilon 4; 0; \epsilon 5]$        | c**          |

\*Neutron lifetime=920sec;  
 \*\*the direction of c is opposite to the direction of its spin;  
 - Mass can be threatened as the quantity of G particles;

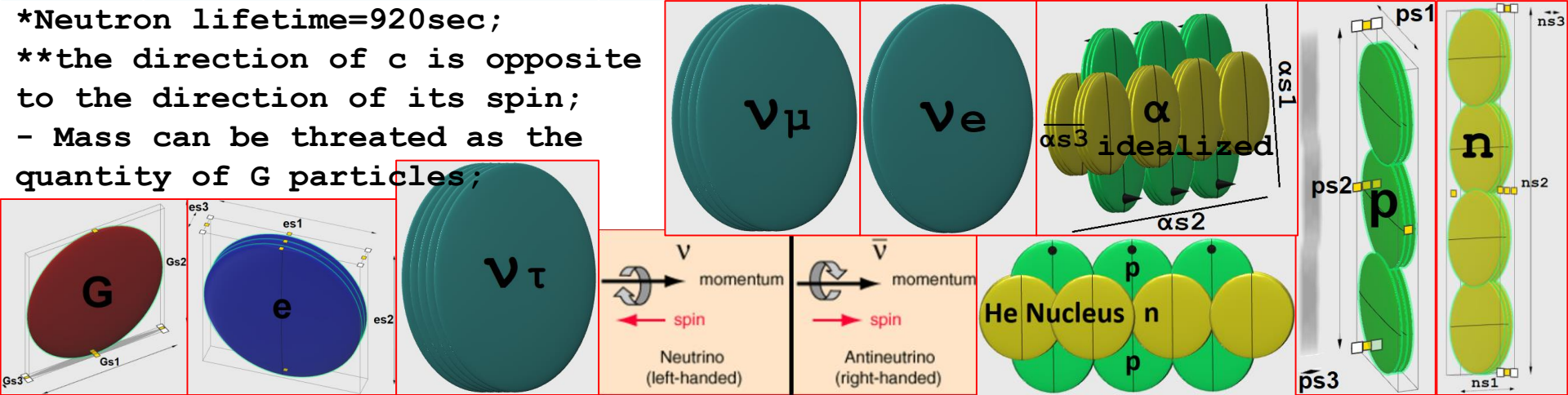

## Contribute to the exploration & proofing of this theory:

- 1- By proofing any of rules 4-17 (use my attached simulation & books);
- 2- By transfer any money amount to my PayPal account:  
abitbolguy5@gmail.com <https://paypal.me/abitbolguy>

It will give us complete understanding of how the universe work,  
how it was created and why,  
open the age of space exploration and  
help us build new tools that will be necessary to the survival of  
our species, that in the last 120 years start to arouse interest  
in the universe.

You also welcome to contact me directly at: [abitbolguy5@gmail.com](mailto:abitbolguy5@gmail.com)