

New Interpretation and Analysis of Michelson-Morley Experiment, Sagnac Effect, and Stellar Aberration by Apparent Source Theory

HenokTadesse, Electrical Engineer, BSc. Ethiopia, Debrezeit, P.O Box 412

Tel: +251 910 751339 or +251 912 228639

email: entkidmt@yahoo.com or wchmar@gmail.com

01 November 2018

Abstract

I have already proposed a new theory known as Apparent Source Theory (AST) that has been highly successful in explaining the hitherto enigmatic and apparently contradictory light speed experiments. For example, to this date, there is no known, accepted theory of the speed of light that *truly* reconciles the 'null' result of the Michelson-Morley experiment and the fringe shift in the Sagnac effect. Apparent Source Theory is formulated as follows: the effect of absolute motion for co-moving light source and observer is to create an apparent change in position of the light source relative to (as seen by) the observer. Therefore, in the Michelson-Morley experiment (MMX), there will be an apparent change in position of the light source as seen from the point of light detection. There will be only a small fringe shift due to *apparent* change of source position for the same reason that there will be only a small fringe shift if the position of the light source was *actually/physically* changed. The ether doesn't exist, as disproved by the Michelson-Morley experiment, but absolute motion does exist, as proved by the Silvertooth and other experiments. Apparent Source Theory has successfully explained the conventional and modern Michelson-Morley experiments, the Sagnac effect, the enigmatic Silvertooth experiment, the Venus radar ranging experiment anomaly (as analyzed by Bryan G Wallace), the Marinov experiment, the Roland De Witte experiment and moving source and moving mirror experiments. In this paper, I will present a new analysis and interpretation of the Michelson-Morley experiment, the Sagnac effect and the phenomenon of stellar aberration. There have been two interpretations of the Michelson-Morley experiment (MMX) within the physics community: the 'null' interpretation and the non-null interpretation. From the point of view of stationary ether theory, the MMX result is essentially null because the observed fringe shift is much smaller than the expected value. On the contrary, the MMX result is non-null from the perspective of relativity theories, mainly the classical emission theory and the Special Relativity Theory (SRT) because there were always small but significant fringe shifts observed, as in the Miller experiments. Therefore, the MMX disproves not only the ether theory, but also the emission theory and SRT. A correct theory of the speed of light, therefore, should account not only for the 'null' interpretation, but also for the non-null interpretation. To this date there is no such known, accepted theory of light. Apparent Source Theory (AST) has resolved this century old puzzle by explaining the small fringe shifts observed in MM experiments. In this paper it will be shown that AST predicts a maximum fringe shift of about 0.013 fringes for the 1881 Michelson experiment. Michelson measured a maximum fringe shift of about 0.018 fringes! The discrepancy may be reduced if more details of the dimensions of the original Michelson apparatus are obtained. For example, slight variation of the dimensions have resulted in a fringe shift of 0.02125 fringes. AST has successfully resolved the enigmatic contradiction between the Michelson-Morley experiment and the Sagnac effect. No known existing theory of light, including SRT, has achieved this. AST also explains why conventional Michelson-Morley experiments gave small fringe shifts, but modern Michelson-Morley experiments using optical cavity resonators give almost a complete null result. Despite all these successes, AST is found to be in conflict with stellar aberration, a simple analysis I overlooked for years. This was a serious problem that made me resort to speculative ideas*. This contradiction has been resolved at last in my other recent paper that gives a new interpretation to the phenomenon of stellar aberration.

Introduction

According to the principle of relativity, no experiment (optical, electromagnetic or mechanical) exists that can detect absolute motion. This presumption has already been conclusively disproved experimentally, such as by the Silvertooth experiment. The failure of conventional first and second order experiments to detect absolute motion of the Earth was not because absolute motion doesn't exist, but because the experimental setups or their understanding were flawed or the sensitivity of the experiments was very small.

I have already developed a new theoretical frame work[1], of which Apparent Source Theory (AST) is one component, that can explain the outcomes of many light speed experiments that have succeeded or failed to detect absolute motion. Apparent Source Theory has successfully explained[1] the classical and modern Michelson-Morley experiments, the Sagnac effect, moving source and moving mirror experiments, the Marinov, the Silvertooth, the Roland De Witte experiments. AST also explained for the first time the Venus planet radar ranging experiment, which gave 'anomalous' results conforming to the classical emission/ballistic theory, as reported by Bryan G Wallace. The speed of light behaves according to ether theory in some experiments and according to emission theory in other experiments. Apparent Source Theory is the first theory ever to resolve this centuries old puzzle.

Despite the successful application of Apparent Source Theory to many light speed experiments and electrostatic and gravitational phenomena, some problems persisted. Some of these were:

- The explanation of Sagnac effect by Apparent Source Theory was not complete and convincing enough
- The explanation of Mercury's perihelion advance also seemed to be incomplete
- A contradiction existed between Apparent Source Theory with the phenomenon of stellar aberration (or conventional understanding of it).
- There was a conceptual problem with the application of Apparent Source Theory to a charge and observer in independent motions.

Moreover, so far I gave only a qualitative explanation of the Michelson-Morley experiment (MMX) in my previous papers[1].

In this paper, we will address some of these shortcomings of AST. The main purpose of this paper is to give a quantitative analysis of the 1881 Michelson-Morley experiment, to show the procedure of analysis of experiments in which accelerated motions are involved, such as the Sagnac effect, and to propose some possible experiments to detect absolute motion.

Apparent Source Theory (AST)

The new theory[1], Apparent Source Theory (AST), of the speed of light that successfully reconciled the Sagnac effect and the Michelson-Morley experiment is formulated below.

The effect of absolute motion for co-moving light source and observer/detector is to create an apparent change in position of the source relative to (as seen by) the observer. The apparent change in position of the source depends on the direct source-observer distance and the orientation of the source-observer line relative to the absolute velocity vector and the magnitude of the absolute velocity. The procedure of analysis of light speed experiments is:

1. Replace the real light source by an apparent light source
2. Analyze the experiment by assuming that the speed of light is constant relative to the apparent source. In other words, once the real source is replaced by the apparent source, we just assume conventional emission (ballistic) theory to analyze the experiment.

A comprehensive description of AST is found in my previous papers[1].

We will see that this theory (AST) can easily explain the Michelson-Morley experiment null result.

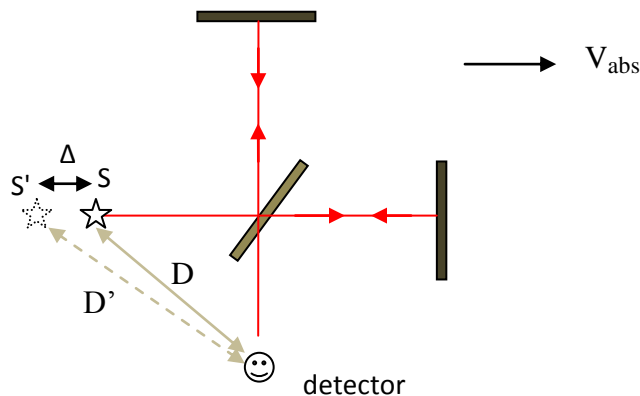

According to Apparent Source Theory, there will be an apparent change in position of the light source as seen by the detector. The apparent change in source position is determined by the source-detector direct distance D , the magnitude and direction of the absolute velocity V_{abs} .

As shown in the above figure, for absolute velocities directed to the right, the apparent change in source position (which is to the left) will not result in any fringe shift for the same reason that no fringe shift will occur if the source position was *actually, physically* shifted slightly because both the longitudinal and transverse (virtual) light beams would be affected (delayed or advanced) identically. We can see that, according to AST, for absolute velocities directed to the right or to the left, the Michelson-Morley experiment result is literally null.

In general, there may be small but significant fringe shifts for other directions of absolute velocities. For example, for absolute velocity directed downwards, there will be an apparent change of source position upwards as shown below. There will be difference in change of path length of the two light beams, the red and the blue. The path lengths are calculated by assuming an actual/physical change of source position from S to S', which should result in a small fringe shift. The actual calculation of the difference of the two path lengths is a straightforward, elementary optics problem, but somewhat involved. Note that the law of reflection (angle of incidence equals angle of reflection) applies to the virtual light rays as for real light rays.

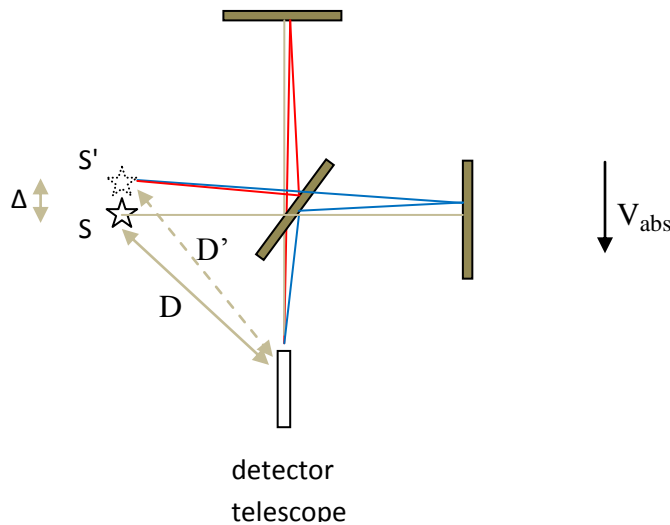

We can see from the diagram above that, according to AST, the effect of absolute motion is not only to create a change in path difference but also misalignment of the two light beams.

Next we will attempt to calculate the fringe shift in the 1881 Michelson ether drift experiment.

$$L1 = 1.2m , L2 = 1.2m , H1 = 20cm , H2 = 10cm , \lambda = 575 \text{ nm}$$

The values for H1 and H2 are just guessed. We will also assume the absolute velocity of the Solar System, which is about 390 Km/s .

The distance D is calculated as:

$$D = \sqrt{H1^2 + H2^2} = 10\sqrt{5} \text{ cm} = 22.36 \text{ cm}$$

From my previous paper[1] Δ can be approximated by

$$\Delta \cong \frac{V_{abs}}{c} D = \frac{390 \text{ Km/s}}{300000 \text{ Km/s}} * 22.36 \text{ cm} = 290.68 \mu m$$

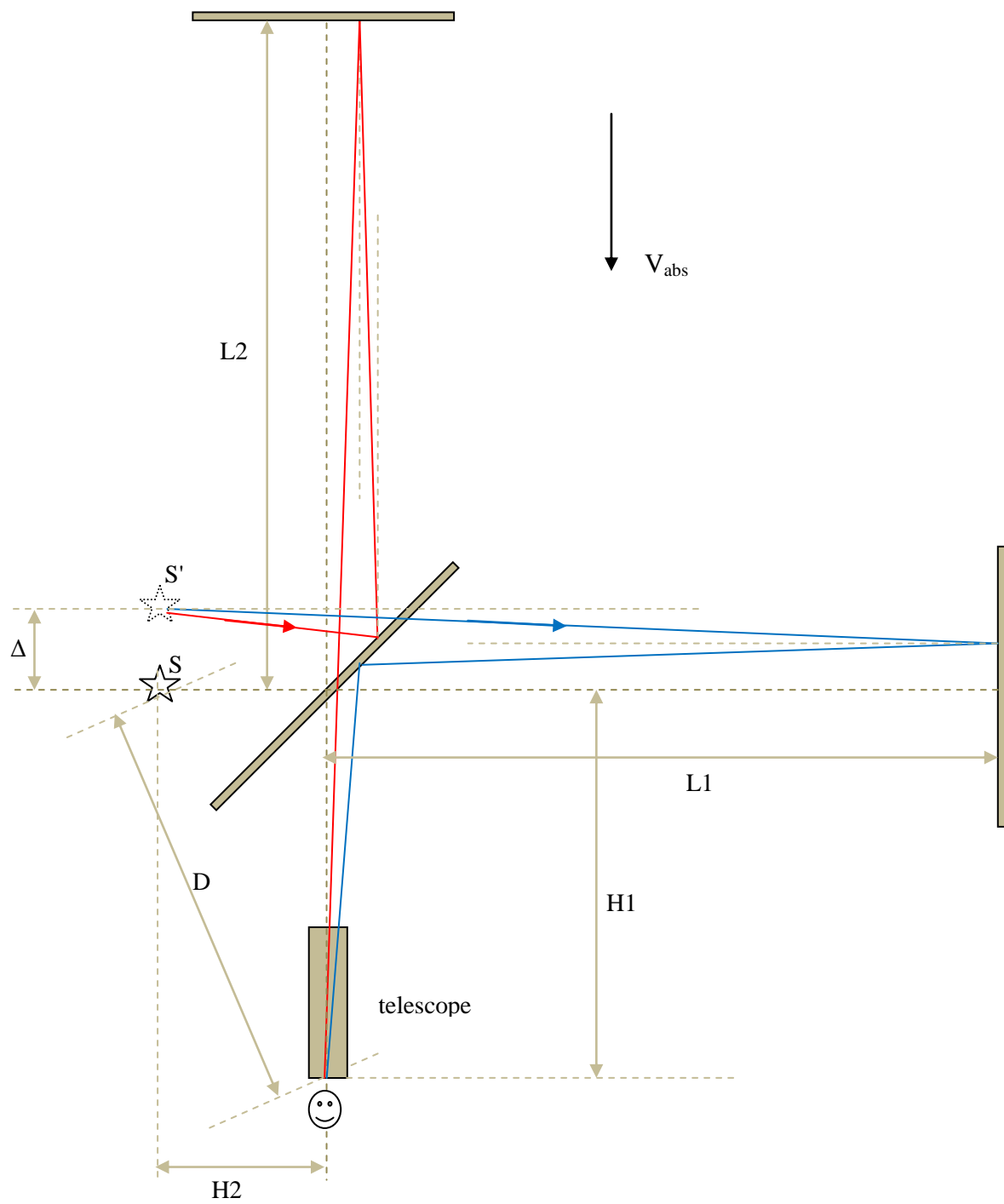

Next we determine the path length of the red light beam.

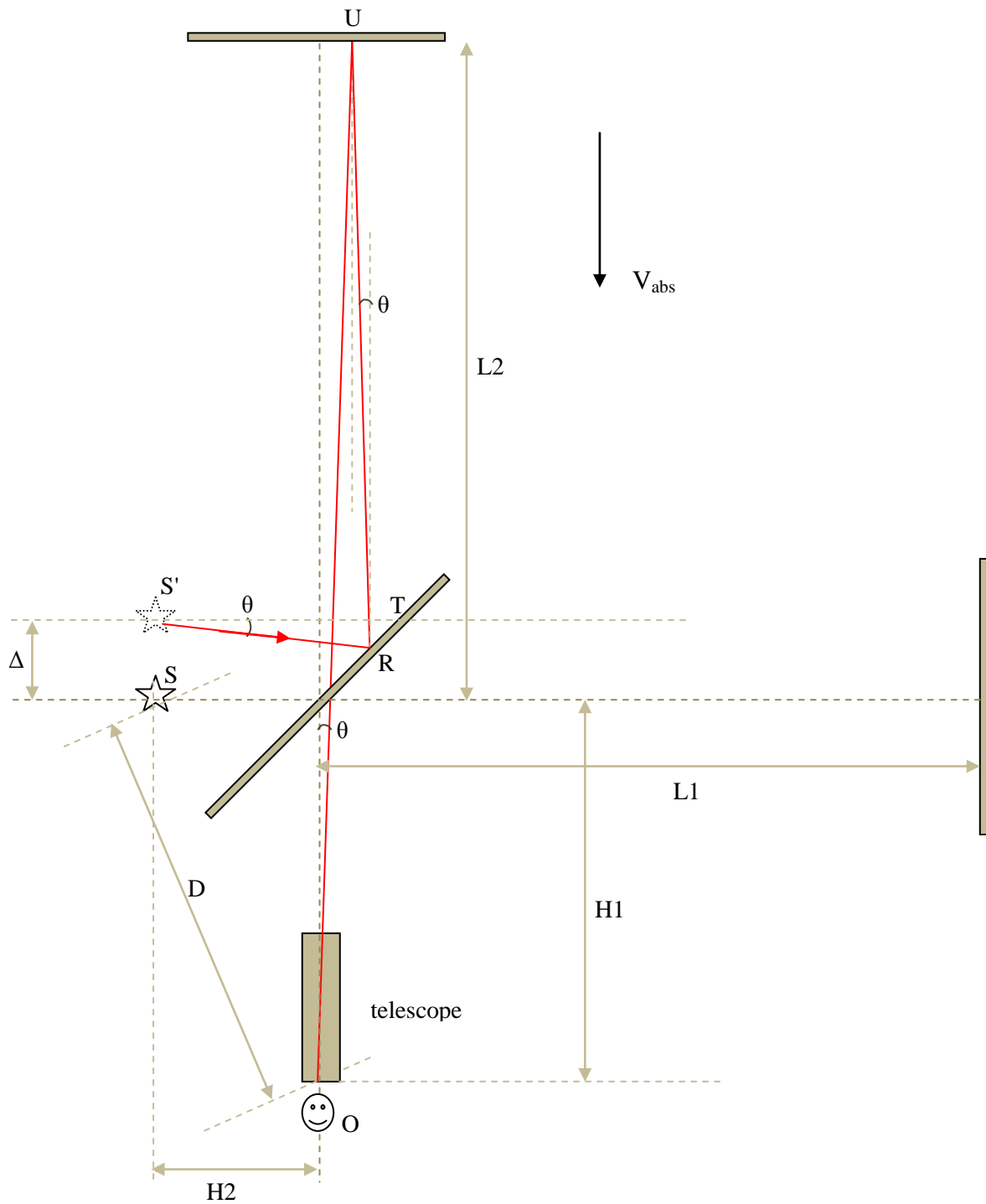

Note that the angles marked θ in the above diagram can be easily shown to be equal.

Consider the triangle S'TR .

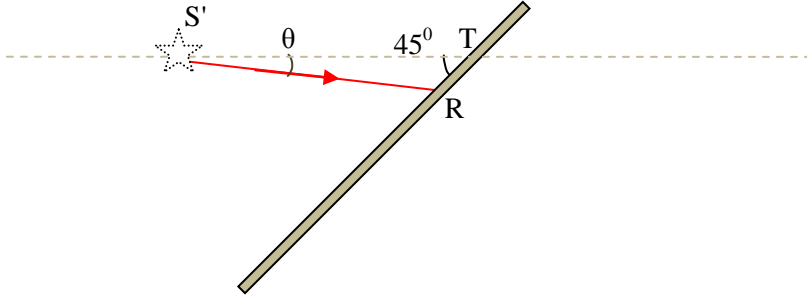

We can determine the length of the red light beam, i.e. side S'R of the triangle as follows.

$$\frac{\sin(180^\circ - 45^\circ - \theta)}{S'T} = \frac{\sin 45^\circ}{S'R}$$

But

$$S'T = H2 + \Delta \tan 45^\circ$$

Substituting this value in the previous equation:

$$S'R = \sin 45^\circ * \frac{S'T}{\sin(180^\circ - 45^\circ - \theta)} = \sin 45^\circ \frac{S'T}{\sin(135^\circ - \theta)}$$

From the previous diagram it is easy to figure out that:

$$(S'R \sin \theta + (L2 - \Delta)) \tan \theta + (L2 + H1) \tan \theta = S'R \cos \theta - H2$$

Substituting the previous value of S'R in the above equation:

$$\left(\frac{S'T}{\sin(135^\circ - \theta)} \sin \theta \sin 45^\circ + (L2 - \Delta) \right) \tan \theta + (L2 + H1) \tan \theta = \frac{S'T}{\sin(135^\circ - \theta)} \cos \theta \sin 45^\circ - H2$$

Since S'T is known (given H2 and Δ), the only unknown in the above equation is θ . Once θ is determined, the lengths of all the component parts (S'R , RU , UO) of the red light beam can be calculated as follows.

Again from the diagram it can be seen that:

$$RU = S'R \sin \theta + (L2 - \Delta) \text{ and}$$

$$UO = \frac{L2 + H1}{\cos \theta}$$

We will not use analytical method here as it is very tedious; we will use Excel to solve the above equations.

Next we make these calculations for the blue light beam. Note again that the angles marked β can be easily shown to be equal.

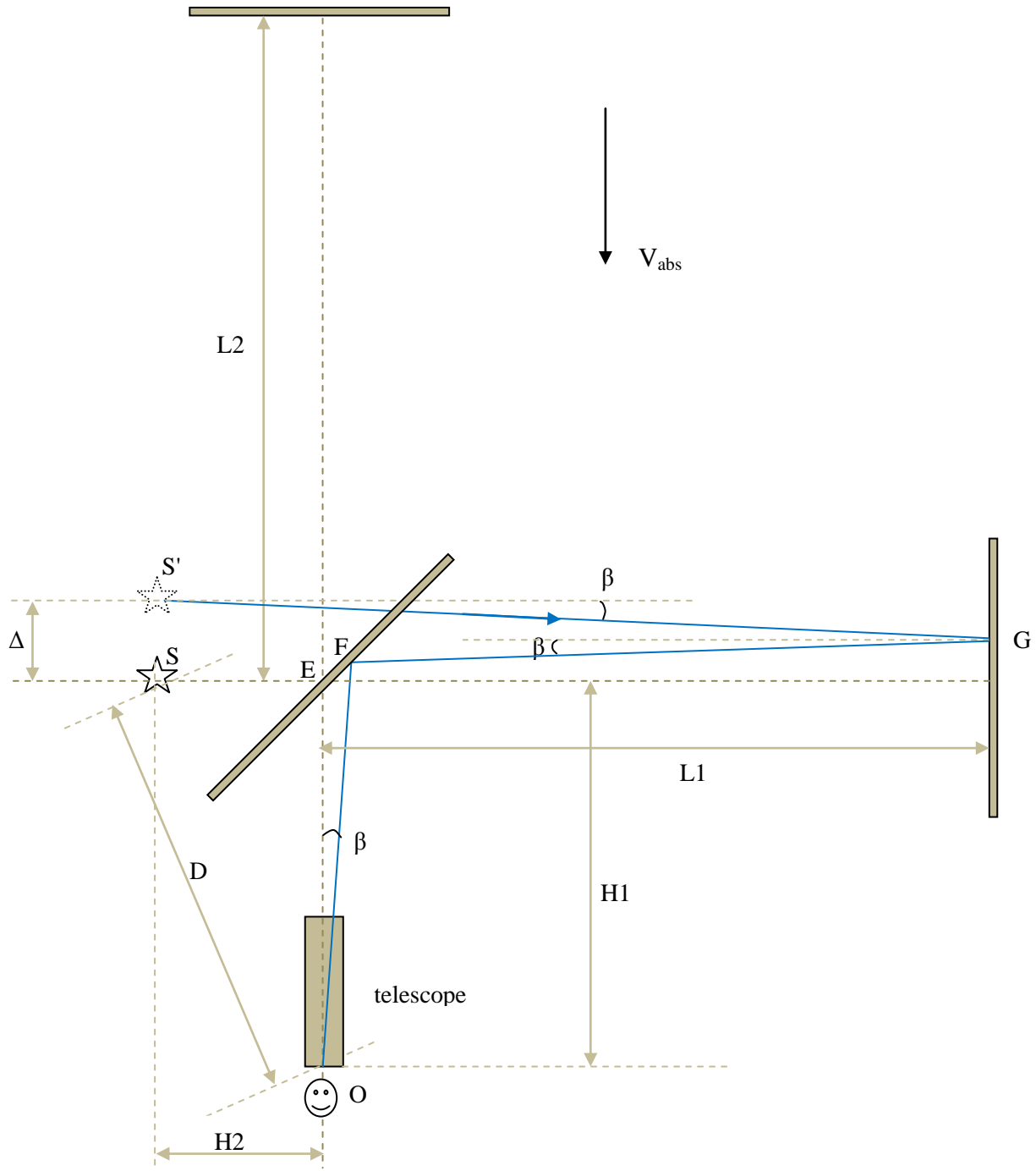

Consider the triangle OEF below.

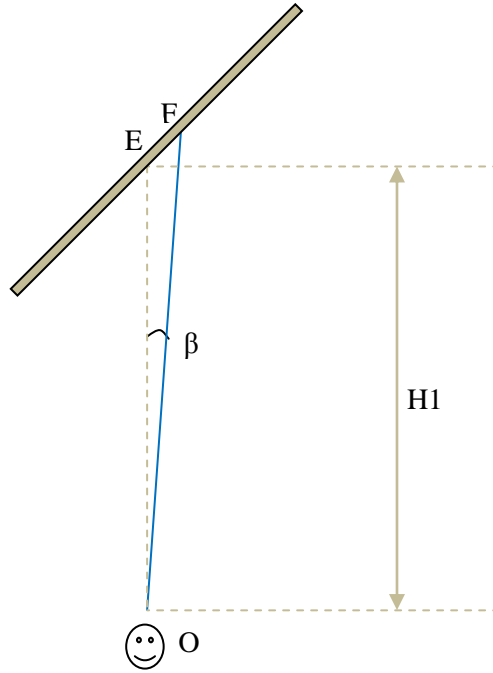

We can easily see that angle E is equal to 135° (because the beam splitter has 45° inclination). Therefore, angle F will be equal to $180^{\circ} - 135^{\circ} - \beta = 45^{\circ} - \beta$.

To determine the length of the light ray OF we use the relationship:

$$\frac{\sin(45^{\circ} - \beta)}{H1} = \frac{\sin 135^{\circ}}{OF}$$

From which

$$OF = \frac{H1}{\sin(45^{\circ} - \beta)} \sin 135^{\circ}$$

With some thought we can see that:

$$(L1 - OF \sin \beta) \tan \beta + (L1 + H2) \tan \beta = (H1 + \Delta) - OF \cos \beta$$

We substitute the value of OF in the above equation:

$$\left(L1 - \frac{H1}{\sin(45^{\circ} - \beta)} \sin 135^{\circ} \sin \beta \right) \tan \beta + (L1 + H2) \tan \beta = (H1 + \Delta) - \frac{H1}{\sin(45^{\circ} - \beta)} \sin 135^{\circ} \cos \beta$$

The only unknown in the above equation is β .

Once β is determined, the lengths of all the three components of the blue ray (OF , FG , S'G) can be determined.

$$FG = \frac{L1 - OF \sin \beta}{\cos \beta}$$

Substituting the value of OF in the above equation:

$$FG = \frac{L1 - \frac{H1}{\sin(45^\circ - \beta)} \sin 135^\circ \sin \beta}{\cos \beta}$$

And

$$S'G = \frac{L1 + H2}{\cos \beta}$$

We will use Excel to solve the above equations.

Once the path lengths of the red and blue light beams is determined, we can calculate the fringe shift from the difference in path lengths.

I used Excel to solve the equations for θ and β .

$$\left(\frac{S'T}{\sin(135^\circ - \theta)} \sin \theta \sin 45^\circ + (L2 - \Delta) \right) \tan \theta + (L2 + H1) \tan \theta = \frac{S'T}{\sin(135^\circ - \theta)} \cos \theta \sin 45^\circ - H2$$

$$\left(L1 - \frac{H1}{\sin(45^\circ - \beta)} \sin 135^\circ \sin \beta \right) \tan \beta + (L1 + H2) \tan \beta = (H1 + \Delta) - \frac{H1}{\sin(45^\circ - \beta)} \sin 135^\circ \cos \beta$$

By substituting the values of the dimensions for L1, L2, H1, H2 we assumed earlier, i.e.

L1 = 1.2m, L2 = 1.2m , H1 = 20cm , H2 = 10cm, $\lambda = 575 \text{ nm}$, $\Delta = 290.68 \mu\text{m}$

I obtained the values of θ and β using Excel.

$\theta = 0.0001211 \text{ radians}$ and $\beta = 0.00012638 \text{ radians}$

from which I calculated the path lengths of components of the red and the blue light.

The components of the red light beam are:

$$S'R = 0.100280271247555 \text{ m} \quad RU = 1.1997197292927 \text{ m} \quad UO = 1.4000000075424 \text{ m}$$

The total path length of the red light beam will be the sum of the above three components:

redlight ray total path length = 2.70000000808265m

The components of the blue light beam are:

$$OF = 0.200021534877466m \quad FG = 1.19997847323555m \quad S'G = 1.30000000753352m$$

The total path length of the blue light beam will be the sum of the above three components:

bluelight ray total path length = 2.70000001564654 m

The difference in path lengths of the red and blue light beams will be:

path difference caused by absolute motion = 7.56388907063865 nm

The fringe shift will be:

$$\text{fringe shift} = \text{path difference} / \text{wavelength} = 7.56388907063865 \text{ nm} / 575 \text{ nm}$$

= 0.01315 fringes

Note that Michelson in his 1881 experiment measured a maximum average fringe shift of 0.018 fringes ! The discrepancy may be because we used roughly estimated values for H1 and H2 .

For example if H1 = 20cm and H2 = 20 cm , I found that the path difference will be 12.125nm , and the fringe shift will be:

$$12.125 \text{ nm} / 575 \text{ nm} = 0.0211 \text{ fringes.}$$

Note that the dimensions H1 and H2 are irrelevant in ether theory and Special Relativity.

I would like to refer the reader to a modified Michelson-Morley experiment I proposed [3] which is many orders of magnitude more sensitive than conventional MMX.

For the sake of completeness, we will repeat the above analysis for absolute velocity directed upwards.

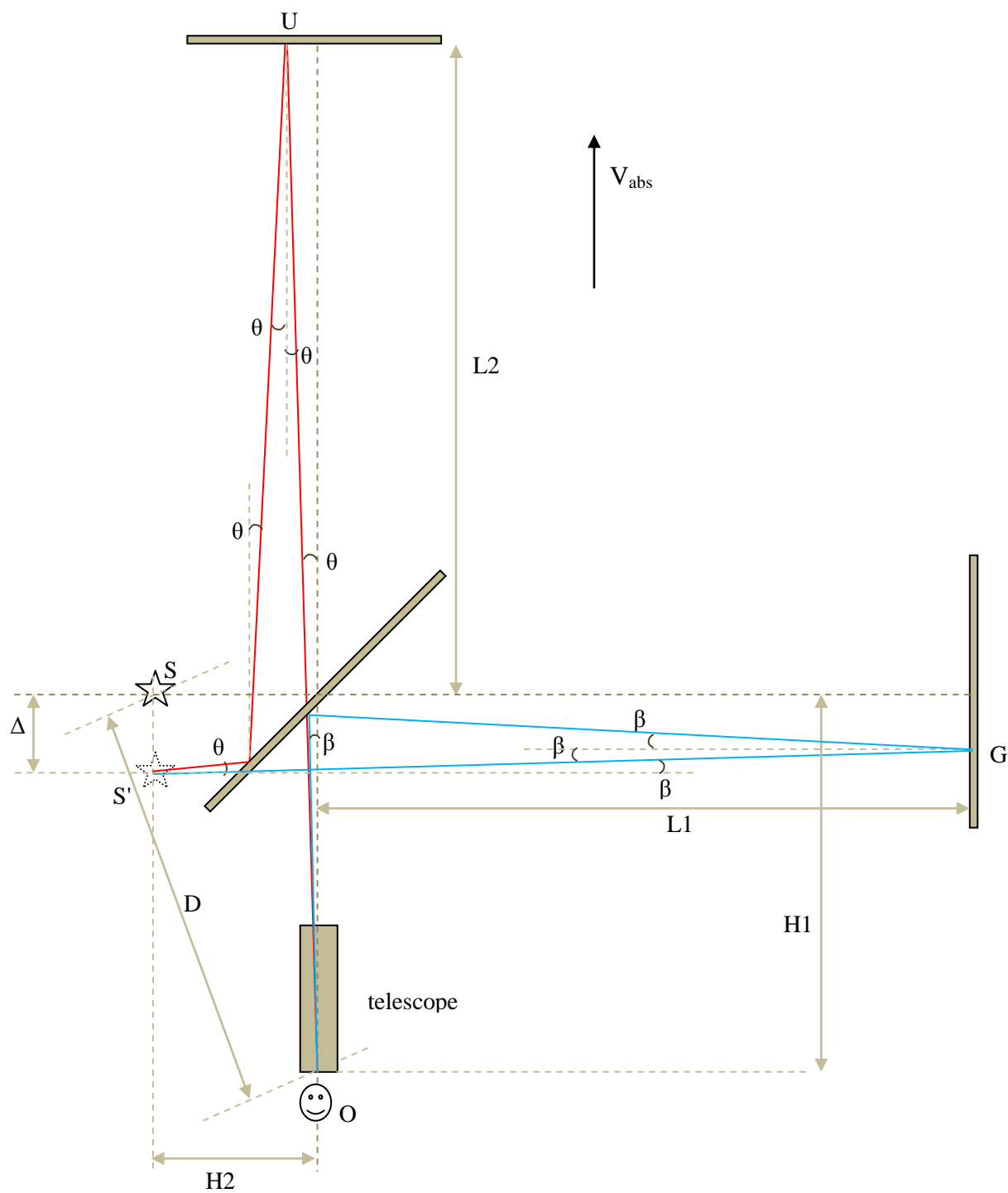

From triangle S'RT below

$$\frac{\sin(180^\circ - 135^\circ - \theta)}{S'T} = \frac{\sin 135^\circ}{S'R}$$

$$\Rightarrow \frac{\sin(45^\circ - \theta)}{S'T} = \frac{\sin 135^\circ}{S'R}$$

$$\Rightarrow S'R = \frac{S'T}{\sin(45^\circ - \theta)} \sin 135^\circ$$

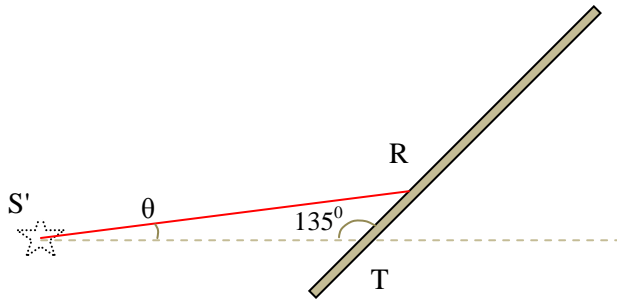

But

$$S'T = H2 - \Delta$$

Substituting this value in the previous equation:

$$\Rightarrow S'R = \frac{S'T}{\sin(45^\circ - \theta)} \sin 135^\circ = \frac{H2 - \Delta}{\sin(45^\circ - \theta)} \sin 135^\circ$$

From the previous diagram it is easy to figure out that:

$$S'R \cos \theta + (L2 + \Delta - S'R \sin \theta) \tan \theta + (L2 + H1) \tan \theta = H2$$

Substituting the previous value of S'R in the above equation:

$$\left(\frac{H2 - \Delta}{\sin(45^\circ - \theta)} \sin 135^\circ \right) \cos \theta + (L2 + \Delta - \left(\frac{H2 - \Delta}{\sin(45^\circ - \theta)} \sin 135^\circ \right) \sin \theta) \tan \theta + (L2 + H1) \tan \theta = H2$$

Since $H2$ and Δ are given, the only unknown in the above equation is θ . Once θ is determined, the lengths of all the component parts ($S'R$, RU , UO) of the red light beam can be calculated as follows.

Again from the diagram it can be seen that:

$$RU = (L2 + \Delta) - S'R \sin \theta \quad \text{and}$$

$$UO = \frac{L2 + H1}{\cos \theta}$$

We will not use analytical method here as it is very tedious; we will use Excel to solve the above equations by numerical method.

Next we analyze the path and path length of the blue virtual light beam.

Consider the triangle OEF below.

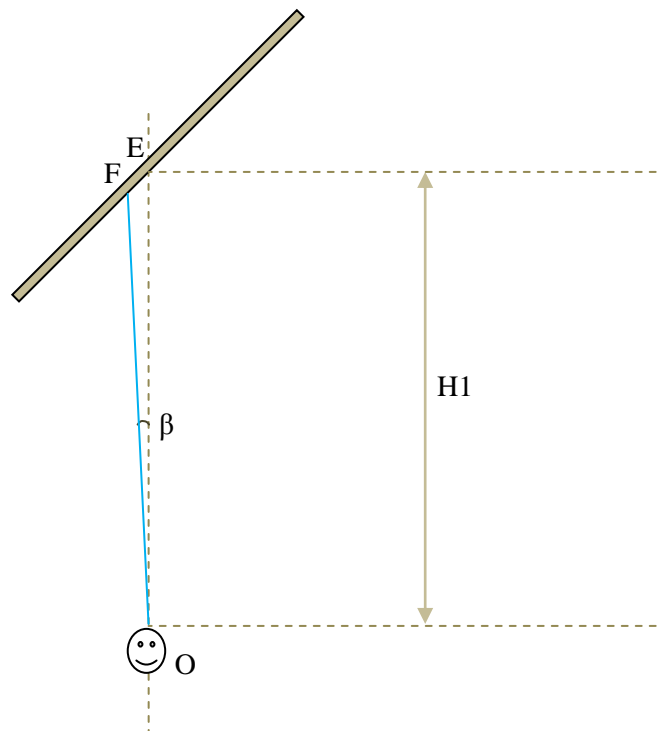

Angle E is equal to 45° (because the beam splitter has 45° inclination).

Therefore, angle F will be equal to $180^{\circ} - 45^{\circ} - \beta = 135^{\circ} - \beta$.

To determine the length of the light ray OF we use the relationship:

$$\frac{\sin(135^{\circ} - \beta)}{H1} = \frac{\sin 45^{\circ}}{OF}$$

From which

$$OF = \frac{H1}{\sin(135^{\circ} - \beta)} \sin 45^{\circ}$$

With some thought we can see that:

$$(L1 + OF \sin \beta) \tan \beta + (L1 + H2) \tan \beta = \Delta - (H1 - OF \cos \beta)$$

We substitute the value of OF in the above equation:

$$(L1 + (\frac{H1}{\sin(135^{\circ} - \beta)} \sin 45^{\circ}) \sin \beta) \tan \beta + (L1 + H2) \tan \beta = \Delta - (H1 - (\frac{H1}{\sin(135^{\circ} - \beta)} \sin 45^{\circ}) \cos \beta)$$

$$[(L1 + (\frac{H1}{\sin(135^{\circ} - \beta)} \sin 45^{\circ}) \sin \beta) + (L1 + H2)] \tan \beta = \Delta - (H1 - (\frac{H1}{\sin(135^{\circ} - \beta)} \sin 45^{\circ}) \cos \beta)$$

The only unknown in the above equation is β .

Once β is determined, the lengths of all the three components of the blue ray (OF , FG , S'G) can be determined.

$$FG = \frac{L1 + OF \sin \beta}{\cos \beta}$$

Substituting the value of OF in the above equation:

$$FG = \frac{L1 + (\frac{H1}{\sin(135^{\circ} - \beta)} \sin 45^{\circ}) \sin \beta}{\cos \beta}$$

And

$$S'G = \frac{L1 + H2}{\cos \beta}$$

We will use Excel to solve the above equations by numerical method.

Once the path lengths of the red and blue light beams is determined, we can calculate the fringe shift from the difference in path lengths.

I used Excel to solve the equations for θ and β .

$$\left(\frac{H2 - \Delta}{\sin(45^\circ - \theta)} \sin 135^\circ\right) \cos \theta + (L2 + \Delta - \left(\frac{H2 - \Delta}{\sin(45^\circ - \theta)} \sin 135^\circ\right) \sin \theta) \tan \theta + (L2 + H1) \tan \theta = H2$$

$$(L1 + \left(\frac{H1}{\sin(135^\circ - \beta)} \sin 45^\circ\right) \sin \beta) \tan \beta + (L1 + H2) \tan \beta = \Delta - (H1 - \left(\frac{H1}{\sin(135^\circ - \beta)} \sin 45^\circ\right) \cos \beta)$$

By substituting the values of the dimensions for L1, L2, H1, H2 we assumed earlier, i.e.

$$L1 = 1.2\text{m}, L2 = 1.2\text{m}, H1 = 20\text{cm}, H2 = 10\text{cm}, \lambda = 575 \text{ nm}, \Delta = 290.68\mu\text{m}$$

I obtained the values of θ and β using Excel.

$$\theta = 0.0001076593 \text{ radians} \quad \text{and} \quad \beta = 0.0001076593 \text{ radians}$$

from which I calculated the path lengths of components of the red and the blue light.

The components of the red light beam are:

$$S'R = 0.0997200563693479 \text{ m} \quad RU = 1.20027994420856 \text{ m} \quad UO = 1.40000000811337\text{m}$$

The total path length of the red light beam will be the sum of the above three components:

$$\text{redlight ray total path length} = \mathbf{2.70000000869127 \text{ m}}$$

The components of the blue light beam are:

$$OF = 0.1999784716167 \text{ m} \quad FG = 1.20002153649667\text{m} \quad S'G = 1.30000000753384 \text{ m}$$

The total path length of the blue light beam will be the sum of the above three components:

$$\text{bluelight ray total path length} = \mathbf{2.70000001564721\text{m}}$$

The difference in path lengths of the red and blue light beams will be:

path difference caused by absolute motion = 6.95593715960285 nm

The fringe shift will be:

fringe shift = path difference / wavelength = **6.95593715960285nm / 575 nm**

= 0.012097 fringes

The fringe shift for absolute velocity directed upwards was 0.01315 fringes and the fringe shift for absolute velocity directed downwards is 0.012097fringes. Therefore, the maximum fringe shift occurs when the direction of absolute velocity is upwards. For absolute velocities directed to the right or to the left, the fringe shift is nil.

Note that the effect of absolute motion is not only to create a change in path difference, but also misalignment of the longitudinal and transverse light beams

The 1887 Michelson-Morley experiment

So far we have analyzed the 1881 Michelson experiment. The failure of the 1881 Michelson experiment to detect the ether prompted Michelson (and Morley) to undertake the construction of an apparatus that they thought would be much more "sensitive" and accurate than the 1881 experiment. They considerably increased the path length of light (about ten times the path length in the 1881 experiment) by using folded light beams that were created by multiple reflections from mirrors.

With the equations for θ and β already derived, it has been revealed in this paper that, for fixed values of $H1$ and $H2$, the sensitivity of the apparatus to absolute motion decreases with increasing $L1$ and $L2$. The fringe shift and the arm length are inversely related!

Next we will determine the fringe shift to be expected in the 1887 experiment. The arm length of light in the 1887 Michelson-Morley experiment was about 11 meters.

Therefore, by using

$L1 = 11 \text{ m}$, $L2 = 11 \text{ m}$, $H1 = 65\text{cm}$, $H2 = 65\text{cm}$, $\Delta = 1195\mu\text{m}$, $\lambda = 575 \text{ nm}$

in the formulas for θ and β , we will determine the fringe shift by numerical method by using Excel.

As before, we just guessed the values for $H1$ and $H2$. We will also assume the absolute velocity of the Solar System, which is about 390 Km/s .

$$\left(\frac{S'T}{\sin(135^\circ - \theta)} \sin \theta \sin 45^\circ + (L2 - \Delta) \tan \theta + (L2 + H1) \tan \theta = \frac{S'T}{\sin(135^\circ - \theta)} \cos \theta \sin 45^\circ - H2 \right.$$

$$\left. (L1 - \frac{H1}{\sin(45^\circ - \beta)} \sin 135^\circ \sin \beta) \tan \beta + (L1 + H2) \tan \beta = (H1 + \Delta) - \frac{H1}{\sin(45^\circ - \beta)} \sin 135^\circ \cos \beta \right.$$

Note that the above formulas are for absolute velocity directed downward.

The path difference will be 15.33 nm. The corresponding fringe shift for $\lambda = 500$ nm is 0.031 fringes. The observed fringe shift was about 0.01 fringes.

In the Miller experiments, the arm length was 32m.

Therefore,

$$L1 = L2 = 32m \quad , \quad H1 = H2 \cong 2m$$

The difference in path lengths of the two light beams arising from the absolute motion of the apparatus is found to be, by using numerical method by Ms Excel, 49.7 nm. The corresponding fringe shift is, by assuming $\lambda = 575$ nm in the Miller experiments:

$$fringe\ shift = \frac{49.7\ nm}{575\ nm} = 0.0995\ fringes$$

The fringe shift actually observed was about 0.088 fringes, in one of the mount Wilson Miller experiments.

The fringe shifts predicted by Apparent Source Theory is of the same order of magnitude as the observed fringe shift. The discrepancies could be due to uncertainty of the dimensions H1 and H2, and due to uncertainty of the component of Earth's absolute velocity in the plane of rotation of the interferometer at the time of the experiments.

Proposed experiment to test absolute motion and Apparent Source Theory

As we have seen above, Apparent Source Theory has revealed the century old mystery of the Michelson-Morley experiment: *increasing the arm length made the apparatus less sensitive to absolute motion*. Moreover, the dimensions H1 and H2 turned out to determine the fringe shift. Note that H1 and H2 are irrelevant in ether theory and Special Theory of Relativity.

Therefore, to make the apparatus more sensitive to absolute motion, the arm lengths $L1$ and $L2$ should be decreased. It turns out that $H1$ and $H2$ must be long, whereas $L1$ and $L2$ must be short if the instrument is to be sensitive at all.

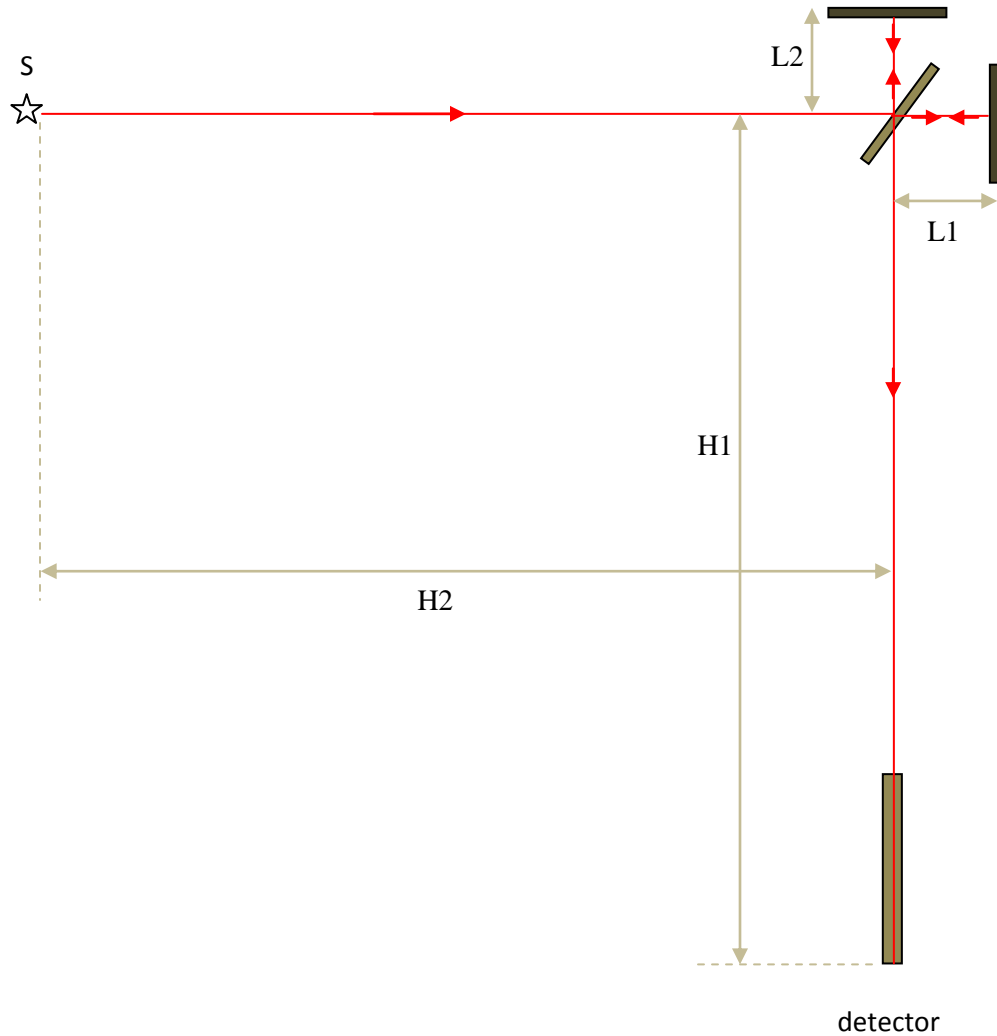

Again I used Excel to check the fringe shift for the following parameters.

$$V_{abs} = 390 \frac{Km}{s} , \quad H1 = 1m , \quad H2 = 1m , \quad D = \sqrt{H1^2 + H2^2} = 1m ,$$

$$\Delta = D \frac{V_{abs}}{c} = 0.0013m , \quad L1 = 10 \text{ cm} , \quad L2 = 10 \text{ cm}$$

The resulting path difference was 210.78 nm , and the corresponding fringe shift for $\lambda = 575$ nm is 0.366572 fringes !

For comparison, I also checked the fringe shift for:

$$H1 = 2 \text{ cm} , \quad H2 = 1 \text{ cm} , \quad D = \sqrt{H1^2 + H2^2} = 1.732 \text{ cm} ,$$

$$\Delta = D \frac{V_{abs}}{c} = 0.00225 \text{ cm} , \quad L1 = 10 \text{ cm} , \quad L2 = 10 \text{ cm}$$

The resulting path difference was 37.55 nm , and the corresponding fringe shift for $\lambda = 575$ nm is 0.065 fringes.

Proposed experiment with the 1881 Michelson and 1887 Michelson-Morley interferometers

Since the analysis of the 1887 Michelson-Morley experiment is too complicated due to the complexity of the light path (multiple reflections from slightly inclined mirrors, and folded beam paths), I propose an alternative method. This is to build the 1881 and the 1887 Michelson-Morley interferometer experiments with a slight modification to enable the adjustment (change) of the position of the light source, within a range of about 1mm in different directions. By slightly changing the position of the light source and observing its effect on the fringe position, it is possible to test the prediction of Apparent Source Theory. The main reason that discouraged Michelson and Morley in their 1887 experiment was that the observed fringe shift was much smaller than the expected fringe shift. Even though the path length of light for the 1887 experiment was about ten times the path length for the 1881 Michelson experiment, they did not observe a corresponding increase in fringe shift. Therefore, this experiment will reveal why there was no corresponding increase in fringe shift if it is found that slight actual/physical adjustment of the light source in each experiment by equal amounts does not create much fringe shift and the 1887 interferometer is not significantly more sensitive to slight changes in source position when compared to the 1881 Michelson experiment.

Now, let us assume the 1881 Michelson interferometer experiment. We determine the apparent source positions [1] for two given orientations of the apparatus relative to the absolute velocity vector, according to Apparent Source Theory, by assuming an absolute velocity of 390 Km/s . For example, in one orientation the axis of the apparatus is assumed to be directed towards Leo and in the second orientation the axis is assumed to be directed 90^0 away from Leo.

Then the source position is adjusted *physically*, first to the same position as the apparent source position computed by assuming that the instrument axis is directed towards Leo, and the fringe positions are noted and recorded. Then the source position is adjusted *physically* again to the same position as the apparent position of the source that was computed by assuming that the instrument axis is in the direction 90^0 away from Leo. The positions of the interference fringes is

then noted and recorded. Then the fringe shift is determined by comparing the positions of the fringes in the two cases. The above experiment should be performed in such a way that Earth's absolute velocity will not affect the experiment, for example, in a shielded room. There are reports indicating that shielding will nullify the effect of absolute motion. Note that there is no physical rotation of the apparatus required in this case. There is only *physical* adjustment of light source positions, in the same way as predicted by Apparent Source Theory by assuming an absolute velocity of 390 Km/s, and assuming two orientations of the apparatus in space: with the axis of the apparatus directed towards Leo and with the axis of the apparatus directed towards a direction 90^0 away from Leo.

Then the experimental apparatus is actually exposed to Earth's absolute motion (the shields are removed) and the fringe shift is observed for two different actual/physical orientations of the apparatus, as follows. The position of the light source is returned to its initial (unadjusted) position. First the axis of the apparatus is directed towards Leo and the fringe positions observed. Then the axis of the apparatus is directed towards a direction 90^0 away from Leo and the fringe positions noted. The fringe shift is determined by comparing the fringe positions for each orientation of the apparatus.

Thus, we have two fringe shifts. The first one is due to *actual/physical* change (adjustment) of the position of the light source. The second one is due to *apparent* change of source position, which arises due to change in orientation of the experimental apparatus in space. If these two fringe shifts are equal, then Apparent Source Theory is confirmed.

The above experiment is based on the theory that *apparent* change in source position is equivalent to corresponding *actual/physical* change of source position. However, it should be noted that Apparent Source Theory applies to point sources. This means that changing the position of a real light source with finite size is not strictly the same as apparent change in source position. For finite size sources, AST is applied to each infinitesimal light source. However, I guess that this may not significantly affect the above experiment and conclusion.

In the above experiment we assumed the 1881 Michelson interferometer. It would be useful if the experiment is repeated for the 1887 Michelson-Morley interferometer, especially with regard to the Miller experiments, in which the light path is complicated.

The Sagnac effect

Despite the fact that I got the initial insight of AST while pondering the Sagnac effect, for years I found it hard to apply AST to the Sagnac effect as formulated above. The key problem was that I could not conceive of any idea how to determine the apparent position of the light source in the case of a rotating Sagnac device. Using the direct source-observer distance as in the Michelson-Morley experiment would lead to wrong and complicated result which is not compatible with the simple Sagnac formula we know.

I finally found that the Sagnac effect, unlike the Michelson-Morley experiment, should be seen as a general case of accelerated translational motion. In the case of the Michelson-Morley experiment and other experiments such as the Silvertooth experiment only uniform translational (unaccelerated) motion is involved. The Sagnac effect is therefore only a translational motion problem in which acceleration is involved. In this paper, I have abandoned the idea in previous versions of this paper that the Sagnac effect arises from distinction between translational and rotational motions.

In my recent paper [4] I have proposed a general theoretical framework to analyze any light speed experiment, which is presented briefly as follows.

1. There is an apparent change in the point where light was emitted in the reference frame of an **absolutely** moving inertial observer. For an observer in uniform absolute motion, light behaves as if it was emitted from the *apparent past position* of the source, not from the *actual/physical past position* of the source. I have interpreted this[4] as apparent contraction or expansion of space relative to an inertial observer in absolute motion.
2. The light speed experiment is analyzed by assuming that light was emitted from apparent past position of the source, not from the actual/physical past position of the source. This apparent change in past position applies only to the light source and not to the mirrors, beam splitters and other parts of the experiment.
3. For an observer in accelerated motion, we cannot use the reference frame of such observer because he/she is accelerating. The problem is solved for an imaginary inertial observer who happens to be at the same point as the accelerating observer and moving with the same velocity as the instantaneous velocity of the accelerating observer, at the instant that he/she (the inertial observer) is just detecting the light emitted by the source. This means that the accelerating observer and the imaginary inertial observer will detect the light at the same instant of time, at the same point of space and while moving at the same instantaneous velocity. Therefore, by solving the problem for the imaginary inertial observer, we automatically solve the problem for the accelerating observer. The path and path length of light, the time of flight and the phase of

light detected is determined for the imaginary inertial observer. These will automatically apply for the accelerated observer.

To illustrate the above theory, let us consider a simple system of light source and observer rotating about a common center.

Consider a light source S and observer O rotating about a common center in a circular path in the counter-clockwise direction, both attached to the two ends of a rigid rod, as shown in the next figure. The problem is to determine the path, path length, time of flight and phase of light detected by the observer O .

According to the above theoretical framework, we cannot use the reference frame of the co-rotating observer/detector O because he/it is in accelerated motion. Therefore, we will solve the problem in the reference frame of an imaginary inertial observer O' , as described above.

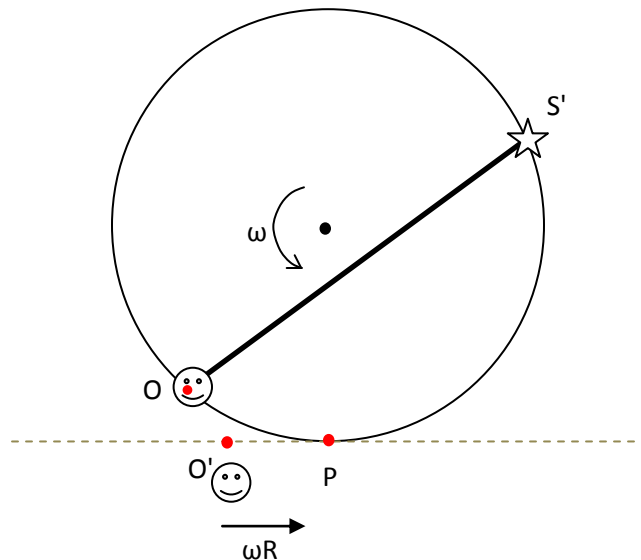

Suppose that real observer O and imaginary inertial observer O' are at points O and O' at the instant of light emission, at $t = 0$. Suppose again that imaginary inertial observer O' will detect the light at point P . The accelerating real observer O will also be just passing through point P at the instant of light detection by imaginary observer O' . Therefore, as stated earlier, both O and O' will arrive at point P simultaneously and detect the light at point P . At the time instant that O and O' are passing through point P , they will have equal instantaneous velocities, both in magnitude and direction, which is ωR to the right.

The problem can now be solved from these requirements. The first requirement is, therefore, the time taken by observer O to move from point O to point P is equal to the time taken by imaginary inertial observer O' to move from point O' to point P. The time taken by observer O will be equal to the length of arc OP divided by the tangential speed of observer O, which is equal to ωR , where R is the radius of the circular path. Therefore, we get the expression for the time taken by observer O as follows:

$$t = \frac{\text{length of arc } OP}{\omega R} = \frac{L}{\omega R} = \frac{2\pi R \frac{\alpha}{360}}{\omega R} = \frac{2\pi \frac{\alpha}{360}}{\omega}$$

where α is the angle in degrees subtended by arc OP.

What about the expression of time taken by imaginary inertial observer O' ? Since the velocity of the imaginary observer is equal to the instantaneous velocity of the real observer at point P, which is equal to ωR to the right, the velocity of O', therefore, is ωR to the right. The expression for the time taken by observer O' to move from point O' to point O, will be:

$$t = \frac{\text{length of line } O'P}{\omega R} = \frac{M}{\omega R}$$

Since the time taken by accelerating real observer O to move from point O to point P is equal to the time taken by imaginary inertial observer O' to move from point O' to point P, we equate the two time expressions given above.

$$\frac{2\pi \frac{\alpha}{360}}{\omega} = \frac{M}{\omega R}$$

In the above equations we have two unknowns: M and α .

The other requirement is that the time taken by light to travel from source to the observer O' is equal to the time taken by observer O' to move from point O' to point P, which is the same time t in the above equations. As we have stated above, we use the apparent point of light emission, and not the actual/physical point of light emission, in the reference frame of imaginary inertial observer O' , in order to determine the time of flight, the path and path length of light.

The apparent position (S') of light emission in the reference frame of imaginary observer O' is determined according to the principles of AST explained in [1] .

Therefore,

$$t = \frac{D'}{c}$$

Since D' can be expressed in terms of L and M , all the variables can now be obtained by using this equation in combination of the previous equations.

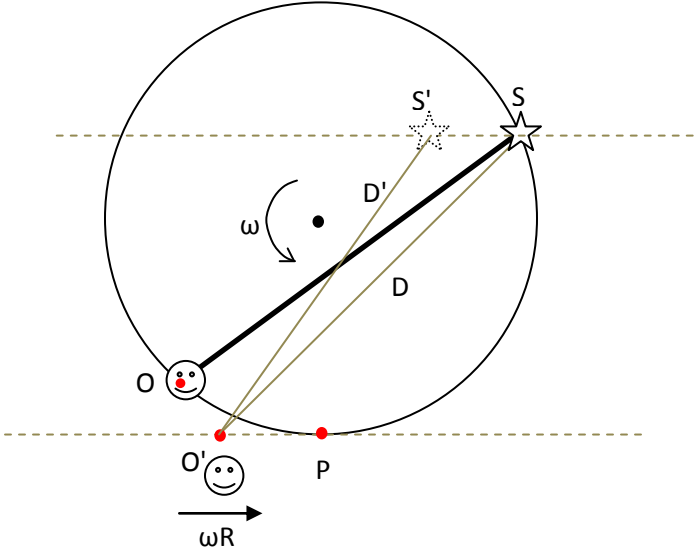

The above setup is more general in which the source and observer are rotating about a center that is not on the line connecting them and requires more involved analysis. A simpler case in which the center of rotation is on the middle point of line OS , as shown below.

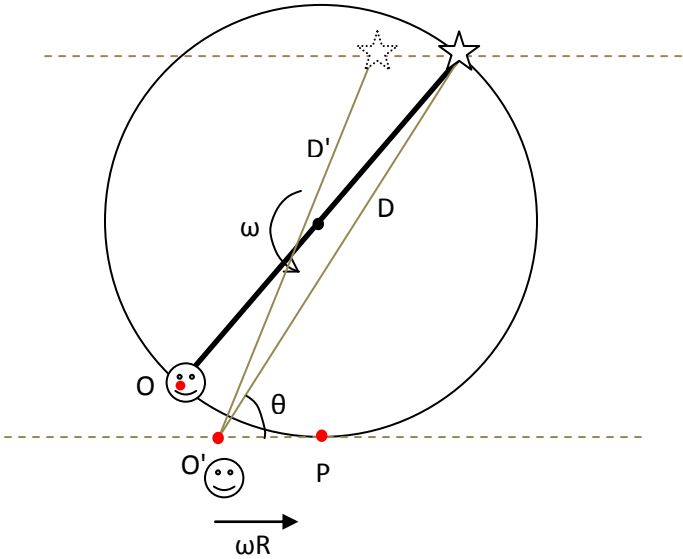

We first need to determine angle α in terms L andM . Once the expression for α is obtained, we can get the expression of D' , as analyzed in my paper [1].

$$\Rightarrow D' \approx D - \frac{DV_{abs}}{c} \cos\theta \quad , \quad \text{for } \frac{V_{abs}^2}{c^2} \approx 0$$

Substituting in the previous equation:

$$t = \frac{D'}{c} = \frac{D - \frac{DV_{abs}}{c} \cos\theta}{c} = \frac{D}{c} \left(1 - \frac{V_{abs}}{c} \cos\theta \right)$$

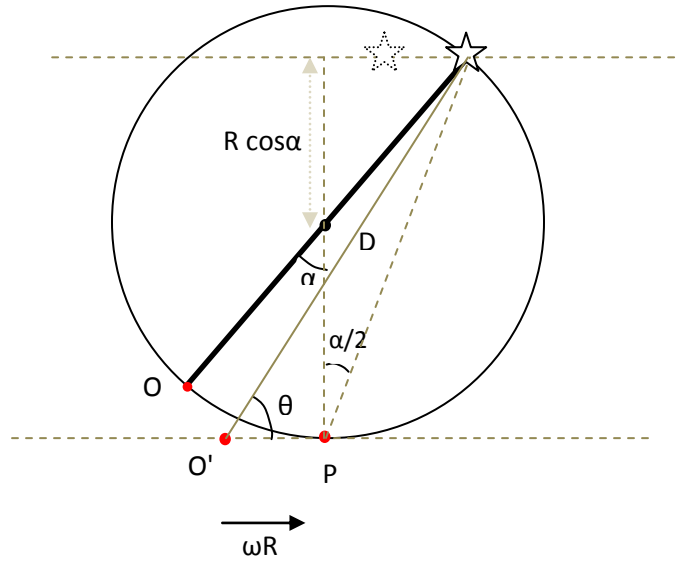

From the above diagram, it can be shown that:

$$\sin\theta = \frac{2R \cos\alpha + (R - R\cos\alpha)}{D} = \frac{R(\cos\alpha + 1)}{D}$$

$$\Rightarrow \cos\theta = \frac{\sqrt{D^2 - R^2(1 + \cos\alpha)^2}}{D}$$

Therefore,

$$\Rightarrow D' \approx D - \frac{DV_{abs}}{c} \cos\theta = D - \frac{DV_{abs}}{c} \left(\frac{\sqrt{D^2 - R^2(1 + \cos\alpha)^2}}{D} \right)$$

$$\Rightarrow D' \approx D - \frac{V_{abs}}{c} \sqrt{D^2 - R^2(1 + \cos\alpha)^2}$$

Now we need to express D in terms of α .

From the last figure:

$$\begin{aligned} \frac{\sin(90^\circ + \frac{\alpha}{2})}{D} &= \frac{\sin(180^\circ - (\theta + 90^\circ + \frac{\alpha}{2}))}{M} \\ \Rightarrow \frac{\cos(\frac{\alpha}{2})}{D} &= \frac{\sin(90^\circ - (\theta + \frac{\alpha}{2}))}{M} \\ \Rightarrow \frac{\cos(\frac{\alpha}{2})}{D} &= \frac{-\cos(\theta + \frac{\alpha}{2})}{M} \\ \Rightarrow -\frac{M}{D} \cos(\frac{\alpha}{2}) &= \cos\theta \cos\frac{\alpha}{2} - \sin\theta \sin\frac{\alpha}{2} \end{aligned}$$

Substituting the previous values of $\sin\theta$ and $\cos\theta$:

$$\begin{aligned} \Rightarrow -\frac{M}{D} \cos(\frac{\alpha}{2}) &= \frac{\sqrt{D^2 - R^2(1 + \cos\alpha)^2}}{D} \cos\frac{\alpha}{2} - \frac{R(\cos\alpha + 1)}{D} \sin\frac{\alpha}{2} \\ \Rightarrow -M \cos(\frac{\alpha}{2}) &= \sqrt{D^2 - R^2(1 + \cos\alpha)^2} \cos\frac{\alpha}{2} - R(\cos\alpha + 1) \sin\frac{\alpha}{2} \\ \Rightarrow R(\cos\alpha + 1) \sin\frac{\alpha}{2} - M \cos(\frac{\alpha}{2}) &= \sqrt{D^2 - R^2(1 + \cos\alpha)^2} \cos\frac{\alpha}{2} \\ \Rightarrow \frac{R(\cos\alpha + 1) \sin\frac{\alpha}{2} - M \cos(\frac{\alpha}{2})}{\cos\frac{\alpha}{2}} &= \sqrt{D^2 - R^2(1 + \cos\alpha)^2} \\ \Rightarrow \sqrt{\frac{R(\cos\alpha + 1) \sin\frac{\alpha}{2} - M \cos(\frac{\alpha}{2})}{\cos\frac{\alpha}{2}} + R^2(1 + \cos\alpha)^2} &= D \end{aligned}$$

Now substituting the value of D in the previous equation for D' :

$$\Rightarrow D' \approx D - \frac{V_{abs}}{c} \sqrt{D^2 - R^2(1 + \cos\alpha)^2}$$

$$\Rightarrow D' \approx \sqrt{\frac{R(\cos\alpha + 1) \sin\frac{\alpha}{2} - M\cos(\frac{\alpha}{2})}{\cos\frac{\alpha}{2}} + R^2(1 + \cos\alpha)^2} - \frac{V_{abs}}{c} \sqrt{\left(\frac{R(\cos\alpha + 1) \sin\frac{\alpha}{2} - M\cos(\frac{\alpha}{2})}{\cos\frac{\alpha}{2}} + R^2(1 + \cos\alpha)^2\right) - R^2(1 + \cos\alpha)^2}$$

Now we can substitute the above value of D' in the expression for t :

$$t = \frac{D'}{c}$$

So far we have three expressions for t . Since we have three unknown variables (α , M , t) , we can solve the simultaneous equations for these unknowns, where t is the time of flight of light from source to observer. The path length of light is D' and can be obtained once α and M are determined.

In addition to the path, path length and time of flight, we need to determine the phase of detected light relative to emitted light, which is relevant in interference experiments.

$$\Delta\phi = 2\pi f * \frac{\text{path length}}{c}$$

Since the distance between source and observer is constant in this case, there will be no Doppler effect. Therefore, $f' = f$.

$$\Delta\phi = 2\pi f * \frac{D'}{c}$$

The above analysis shows how involved the analysis is even for such a simple problem.

Basically the same procedure applies to the Sagnac experiment, but the actual analysis is prohibitively complicated. However, we will make only a qualitative and approximate analysis which is accurate enough for all practical purposes. Here we will show the procedure for the exact analysis of the Sagnac effect. We will not undertake the actual analysis, however.

Suppose that the Sagnac apparatus is in the position shown above at the instant of light emission, at $t = 0$, in the **absolute reference frame** . Assume that observer O will detect the light at point P . The problem is to determine the path, path length and time of flight of light detected by observer O .

As before, observer O is in accelerated motion, so we cannot use the reference frame of observer O . Instead we solve the problem for an imaginary inertial observer O' , who happens to be at

point P at the instant of light detection, and who is moving with a constant velocity equal to the instantaneous velocity (magnitude and direction) of observer O at point P.

As in the previous example, we need three equations for time t , where t is the time of flight of light from the source to the observer.

The first expression for t is obtained from the time taken by observer O to move from point O to point P.

$$t = \frac{\text{length of arc } OP}{\omega R}$$

where R is the radius of rotation of observer O.

$$\Rightarrow t = \frac{2\pi R \frac{\alpha}{360}}{\omega R}$$

where α is the angle subtended by the arc OP.

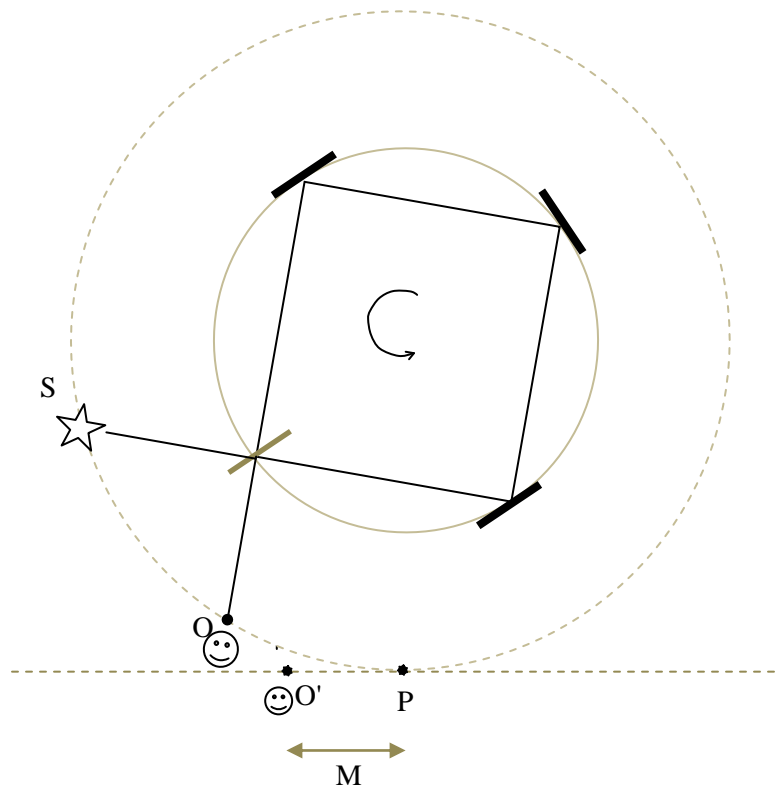

The second expression for t is obtained from the requirement that imaginary inertial observer O' will also move from point O' to point P during this time interval, t .

Since the instantaneous velocity of real observer is ωR to the right at point P , the imaginary inertial observer O' will also have a constant velocity of ωR to the right.

$$t = \frac{M}{\omega R}$$

where M is length of path $O'P$.

The third requirement is that, during time interval t , light will travel from *apparent point of emission* (*apparent past position* of the source), in the reference frame of imaginary inertial observer O' , to the observer O' . Note that we are talking about *direct* light ray from S to O' . Even if there is no direct light coming from the source to the observer O' , we just assume there is. The light reaching the observer after reflection from mirrors has nothing to do with the determination of apparent past position of the source (*apparent point of emission*).

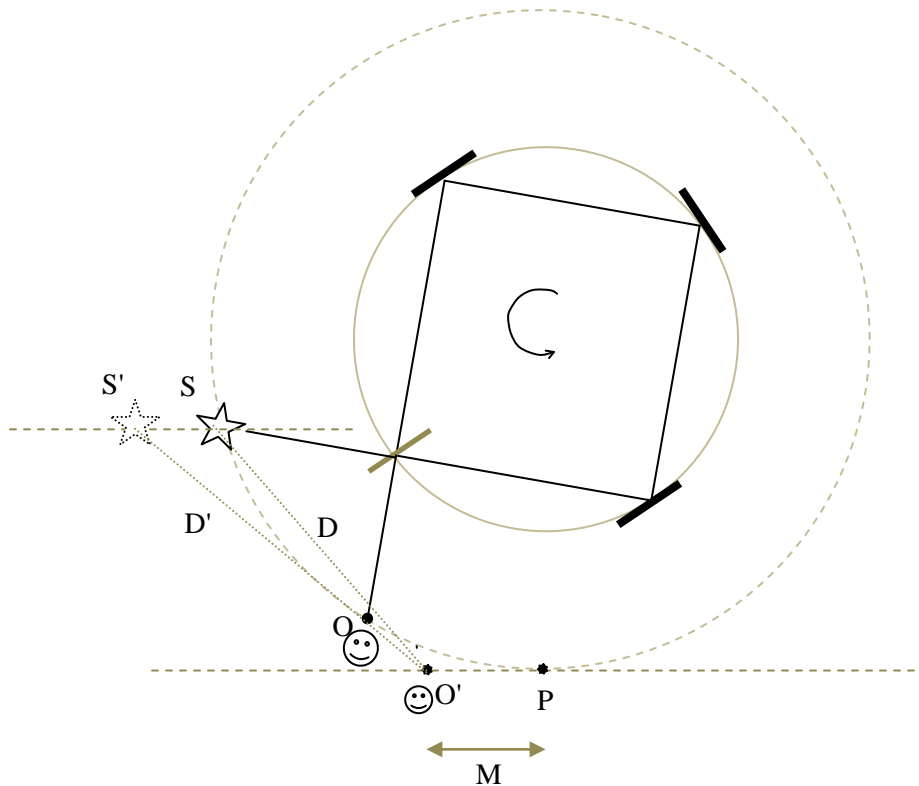

We get the apparent point of emission (S') in the reference frame of inertial observer O' . Once we get the expression for the apparent point of emission, we solve the problem in the reference frame of the imaginary inertial observer O'. This requires describing the positions and motions of the mirrors and the beam splitter in the reference frame of inertial observer O'. We then solve the problem by assuming that the *group* velocity of light depends on mirror velocity, in the conventional way, i.e. ballistic hypothesis. The actual analysis will be prohibitively complicated because the initial positions and the translational and rotational motions of the beam splitter and the mirrors should be considered in the analysis.

From this analysis we get a third expression for time t .

From the three equations for t so far, the time of flight t is determined, the path and path length of light is determined. The phase of the detected light is determined from the path length and *constant* phase velocity c .

$$\Delta\phi = 2\pi f * \frac{\text{path length}}{c}$$

Note that the analysis is made for both light beams, for the clockwise and for the counterclockwise propagating beams. Both light beams start from S' in the reference frame of inertial observer O'.

So far we have been concerned only with the imaginary inertial observer O' . This is because the solution for the inertial observer O' is the same as the solution for accelerated observer O. This is because we have started with the assumption that both observer O and O' will be at point P , moving with equal instantaneous velocities at the instant of light detection.

Since the exact analysis of Sagnac effect is complicated, we will devise an approximate analysis that will be accurate enough for all practical purposes.

We have already stated that the *preferred reference frame* for the analysis of the Sagnac effect (for any experiment in which acceleration of the observer is involved) is the reference frame of an imaginary *inertial* observer O' who happens to be at the same point in space, and moving with the same velocity as the instantaneous velocity of the accelerating observer O at the instant of light detection. This means that observers O and O' detect the light at the same point in space and at the same instant of time, while moving with equal instantaneous absolute velocities. However, the additional assumption is that light is assumed to have been emitted not from the actual point of emission, but from the apparent point of emission, in the reference frame of the imaginary inertial observer O'.

Since imaginary inertial observer O' is moving to the right with constant velocity ωR in the above case, we can say that observer O' is in translational motion relative to whole apparatus. We assume that the Sagnac apparatus is not in translational motion as a whole, as this would

complicate the problem even more. We assume that the Sagnac device is only in rotational motion as a whole and has not translational motion as a whole.

Therefore, the inertial observer O' is in absolute translational motion to the right where as the Sagnac device is not in translational motion as a whole, which means that the inertial observer O' and the Sagnac apparatus as a whole are in relative translational motion. So we can also say that the imaginary observer is at rest and the Sagnac device is in translational motion to the left.

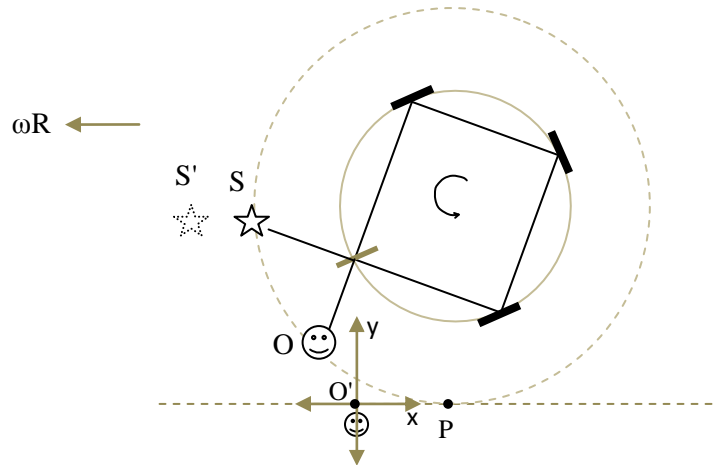

The problem is therefore solved in the reference frame of imaginary inertial observer O' . For this, as already mentioned, the positions and motions of the beam splitter and the mirrors should be described in the reference frame of observer O' . Note that, the motion of the beam splitter and the mirrors in the reference frame of O' is a combination of translational and rotational motions.

However, a question arises at this point: we need to know distance $O'P$ which can be obtained only through the procedure of exact analysis discussed above. However, even in the exact analysis, we can guess that the apparent change of point of emission (i.e. the position of S') does not have any significant effect on the fringe shift. This is simply because slight physical change in position of the light source in the Sagnac device will not have any significant effect on the interference fringes because both the clockwise (CW) and counterclockwise (CCW) beams will be affected (delayed or advanced) almost equally. We may also guess that only the rotational motion determines the fringe shift in Sagnac effect and translational motion of the apparatus as a whole does not have any significant effect on the fringe shift.

Therefore, we can use any inertial reference frame moving to the right with velocity ωR can be used to analyze the Sagnac experiment. From our argument above that translational motion of the Sagnac device as a whole will not have significant effect on the interference fringes, we don't need an inertial frame moving to the right with velocity ωR . Since only rotational motion determines the fringe shift, we can analyze the experiment in the rest frame of the device, i.e. in the reference frame in which the device is rotating.

To further clarify this argument, consider a light source that is at absolute rest and a Sagnac device that is in rotational motion. Assume that the Sagnac device is only in rotational motion, and has no translational motion as a whole.

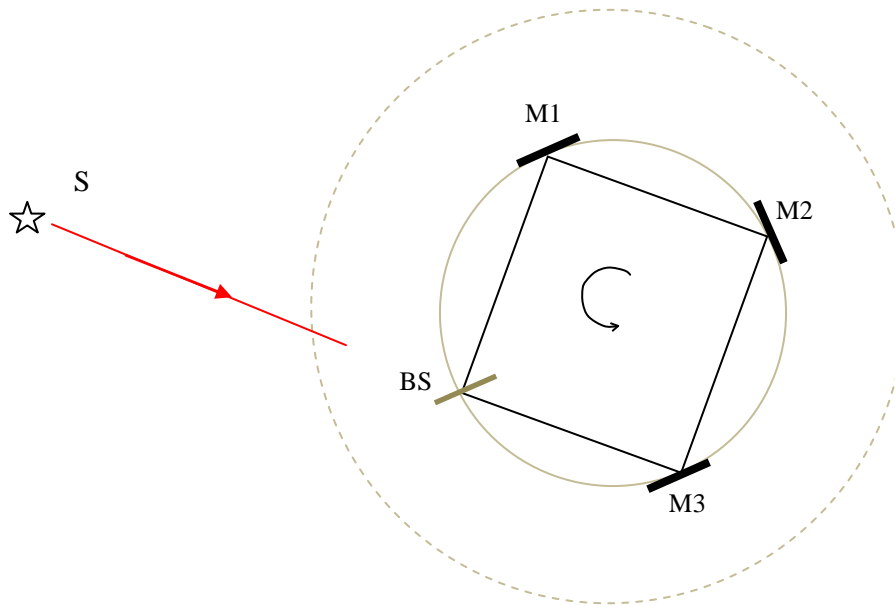

Light is emitted by the stationary source just at the right instant so that the light beam will be incident on the beam splitter at the right angle and at the right point, so that the light will propagate in the two opposite directions to form interference fringes at the detector. Since we have postulated that the *group* velocity of light depends on the mirror velocity (according to the ballistic hypothesis), once the light hits the beam splitter or the mirror it will attain a component of the velocity of the respective mirror. Imagine an observer sitting on the beam splitter. Relative to this observer, the *group* velocities of the CW and CCW beams is equal. Both groups will arrive at the observer simultaneously. Therefore, rotation of the device does not create difference in group delays of the two light beams.

Then how does a fringe shift arise in the Sagnac effect.

In this paper we will analyze the Sagnac effect based on two assumptions.

1. The group velocity of light is independent of source velocity, but varies with mirror velocity.
2. The phase velocity of light is always constant irrespective of source, observer or mirror velocity.

Therefore, the Sagnac effect is a manifestation of distinction between phase velocity and group velocity of light.

Although the time of flight (group delay) of the CW and CCW beams is equal, their path lengths are different and this is what gives rise to a fringe shift in the Sagnac effect.

As we have already stated, the phase of observed light relative to emitted light is:

$$\Delta\phi = 2\pi f \frac{\text{path length}}{\text{phase velocity}} = 2\pi f \frac{\text{path length}}{c}$$

Consider a Sagnac interferometer rotating in the counterclockwise direction, as shown below. The blue lines represent the path of the light beam emitted in the backward direction.

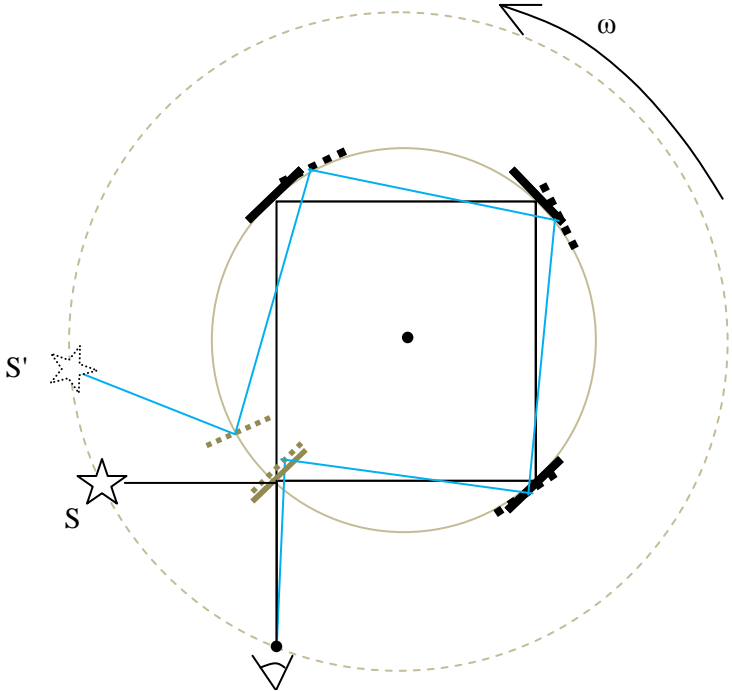

The red lines represent the path of the light beam emitted in the forward direction, as shown below.

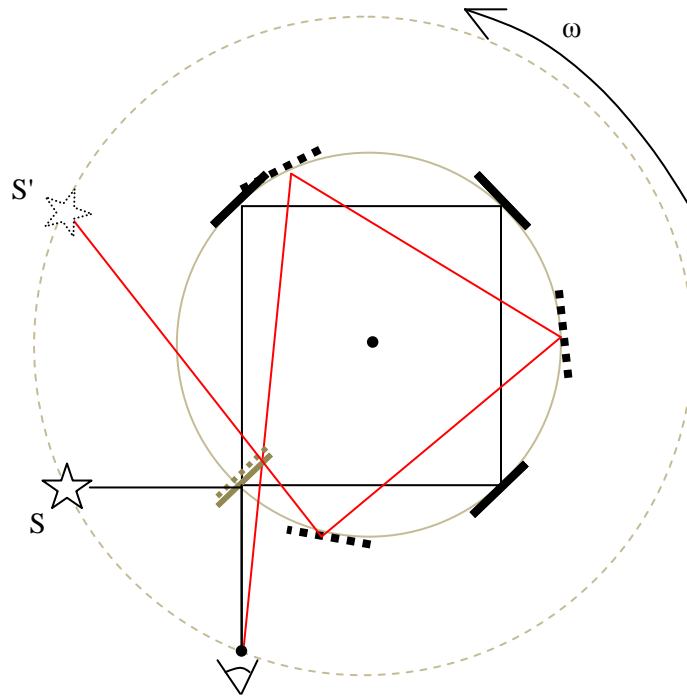

We can see that the light emitted in the forward direction (redrays) travels longer distance than the light emitted in the backward direction (blue rays) . As discussed already there will be no difference in time of flight of the forward and backward beams. In fact, the time of flight of both beams will be the same as when the device is at rest. However, the light emitted in the forward direction will have to travel longer distance (red path) than the light emitted in the backward direction, which would result in a fringe shift.

The Sagnac effect is a consequence of distinction between phase velocity and group velocity of light: the phase velocity is independent of mirror motion, whereas the group velocity depends on mirror velocity.

Contradiction between Apparent Source Theory and the phenomenon of stellar aberration

I have recently discovered a contradiction between Apparent Source Theory and the phenomenon of stellar aberration, which I overlooked for years. Since AST has a firm logical and experimental foundation, this contradiction is seen here as the incompleteness of AST, rather than as a disproof of AST.

Contradiction of AST with stellar aberration

Imagine absolutely co-moving light source S and observer O. Assume also another observer A who is at absolute rest.

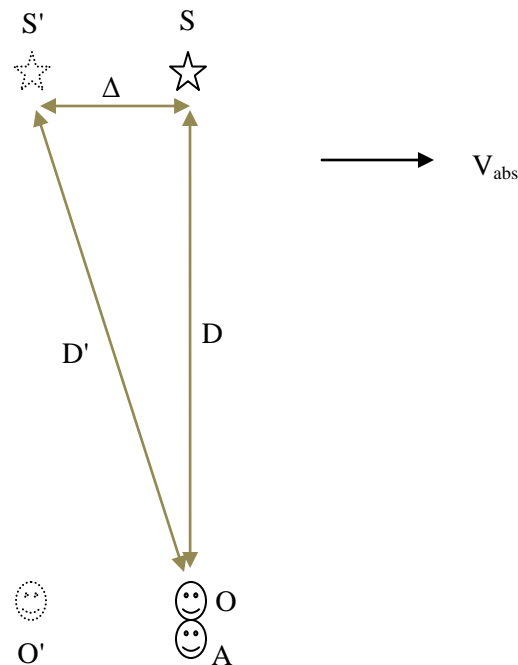

Assume that the source emits light at the instant when it is at position S' and the co-moving observer is at position O'. The observer A is always at absolute rest at position A. Assume that moving observer O detects the light just at the instant that he/she is passing through the location of stationary observer A. According to Apparent Source Theory (AST), the co-moving observer O has to point his telescope towards point S' to see the light, due to apparent change in position of the light source for absolutely co-moving source and observer[1]. Since moving observer O and stationary observer A are at the same point at the instant of light detection, observer A will also detect the light at that instant. However, we know that the stationary observer A should also point his telescope in the direction of S', the point in space where light was emitted. We see that both the stationary observer and the moving observer would point their telescopes in the same

direction to see the light. This is in contradiction with the phenomenon of stellar aberration and is a real challenge to Apparent Source Theory, because, according to the theory of stellar aberration, co-moving observer should point his telescope towards current position (S) of the source, which contradicts AST.

As another related contradiction, suppose that at the instant of light detection, the co-moving observer O instantaneously starts moving to the left with velocity V_{abs} relative to the source. This would make observer O to be stationary at the point where observer A is located because the forward absolute velocity V_{abs} of observer O to the right will be cancelled by the backward velocity V_{abs} of O relative to the source. Since observer A and observer O are now both stationary at almost the same point in space, both should observe the light in exactly the same way. We know that stationary observer A has to point his telescope towards point S', the point where the source was at the instant of emission. But, according to the theory of light aberration, if observer O had to point his/her telescope towards S' when co-moving with the source, he should point to the direction of S'' when moving relative to S (relative to S'), as shown below. Although observers A and O are at the same point in space and also both at absolute rest (therefore, at rest relative to each other), observer A has to point his telescope in the direction of S', while observer O has to point his telescope towards direction S'', which is a contradiction.

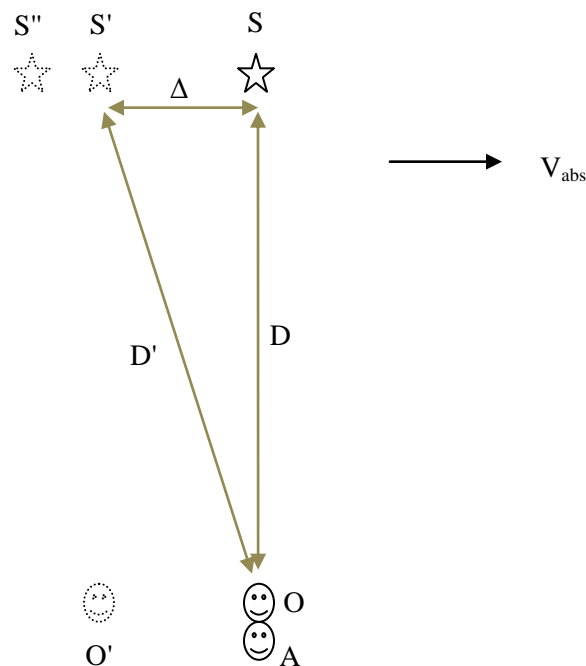

Since both observers are at the same point in space and are at rest relative to each other, the light should come from the same direction for both observers. Which direction is correct ?

Astronomical observations of binary stars shows that stellar aberration depends only on the absolute velocity of the observer and is independent of absolute velocity of the light source[2]. This disproves the theory that observer O will see light coming from direction of S".

This is another related contradiction of AST with the phenomenon of stellar aberration.

New interpretation of the phenomenon of stellar aberration

This contradiction has been resolved in my recent paper[4], by giving a new interpretation of stellar aberration.

The solution to this problem is to abandon conventional understanding of the phenomenon. The current understanding of stellar aberration is based on the classical explanation,

According to conventional, universally accepted knowledge, the apparent change in position of a star relative to a moving observer is towards the direction of motion. AST reveals that the apparent position of the star is opposite to the direction of observer velocity!!!

In my other paper[4], I have proposed a new interpretation : the phenomenon of stellar aberration is due to contraction (expansion) of space in front of (behind) an absolutely moving observer.

Therefore, the traditional, intuitive analogy between stellar aberration and a man running in rain is wrong. According to this analogy, the man running in the rain has to hold his umbrella slightly forward even though the rain drops are falling vertically relative to a stationary observer.

Current, universally
accepted understanding of
stellar aberration

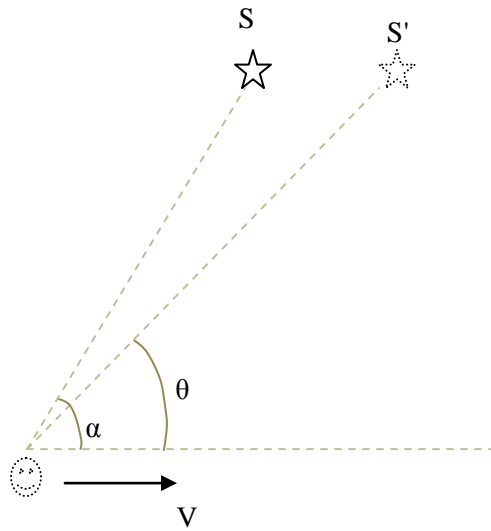

New interpretation of
stellar aberration according
to Apparent Source Theory

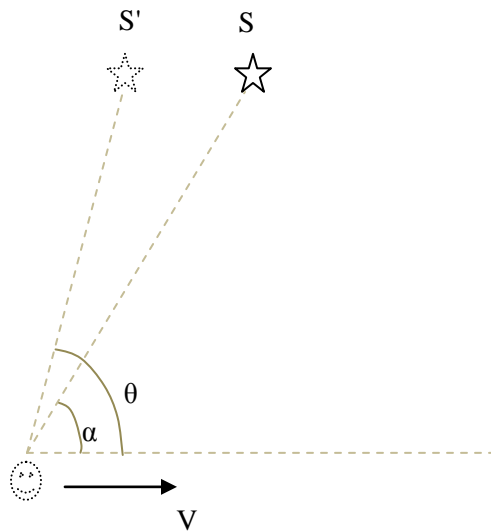

Proposed experiment to test Apparent Source Theory

The following two experimental setups are proposed to test Apparent Source Theory. The experiment is to be performed when Leo is just on the horizon, with the axis of the experimental setup directed towards Leo. We know that the Earth moves with absolute velocity of about 390 Km/s towards constellation Leo, as discovered by the Silvertooth experiment and the NASA CMBR experiment.

There are two experimental arrangements. The results of the two experiments, which is the reading of a counter in each setup, are compared. If the predicted difference is observed between the readings of the two counters, then this will confirm absolute motion and Apparent Source Theory.

The first setup consists of a light source and a detector located close to each other, so that they can be considered to be at the same point in space, which will diminish the effect of absolute motion to nil[1]. A counter is also installed to count the number of pulses detected.

The experiment works as follows. Initially the light detector unit triggers the light source and the source emits a very short light pulse towards the mirror. The detector then detects the reflected light. Upon detecting the reflected light, the detector unit triggers the source again, the source emits a short light pulse again, and so on. A counter counts the number of pulse received (or emitted).

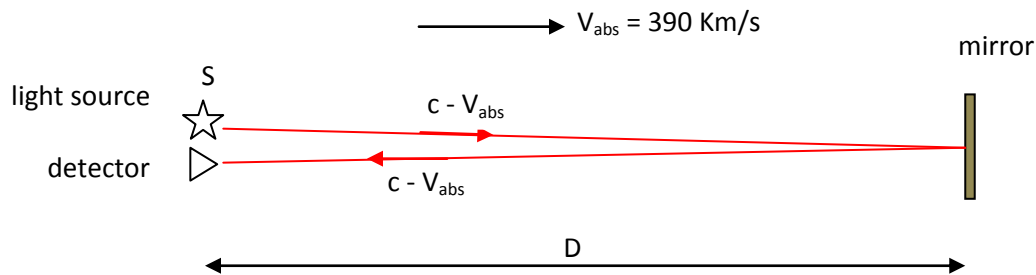

According to Apparent Source Theory, since the source and the detector are located almost at the same point in space, absolute motion of the system will not have any effect[1], and we simply apply emission theory regarding the group velocity, which is relevant in this experiment, because this is a time of flight experiment.

Therefore, the round trip time will be [1]:

$$\frac{2D}{c}$$

The counter value after time T will be:

$$C_1 = \frac{T}{\left(\frac{2D}{c}\right)}$$

The second experimental setup consists of two light sources and two detectors, as shown below.

Initially, detector unit d1 triggers light source S1, which emits a short light pulse towards detector d2. Upon detecting the light pulse, detector d2 triggers light source S2, which emits a short light pulse towards detector d1. Detector d1, upon detecting the light pulse, triggers source S1 again, which emits light pulse towards detector d2 again, and so on. A counter counts the number of light pulses received (oremitted).

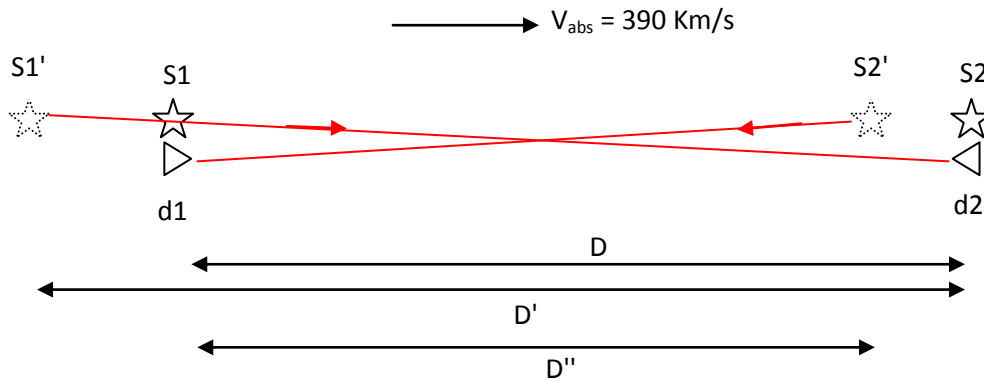

According to Apparent Source Theory, D' is the distance of apparent source S1' relative to detector d2 and D'' is the distance of apparent source S2' relative to detector d1, and

$$D' = D \frac{c}{c - V_{abs}}$$

and

$$D'' = D \frac{c}{c + V_{abs}}$$

The time of flight from S1' to detector d2 will be:

$$t_1 = \frac{D'}{c} = \frac{D \frac{c}{c-V_{abs}}}{c} = \frac{D}{c - V_{abs}}$$

The time of flight from S2' to detector d1 will be:

$$t_2 = \frac{D''}{c} = \frac{D \frac{c}{c+V_{abs}}}{c} = \frac{D}{c + V_{abs}}$$

The round trip time will be:

$$t_1 + t_2 = \frac{D}{c - V_{abs}} + \frac{D}{c + V_{abs}} = D \frac{2c}{c^2 - V_{abs}^2}$$

The value of the counter in time period T will be:

$$C_2 = \frac{T}{D \frac{2c}{c^2 - V_{abs}^2}}$$

The value of the counter C_1 in time period T was, as determined previously:

$$C_1 = \frac{T}{\frac{2D}{c}}$$

The difference in the two counter values will be:

$$C_1 - C_2 = \frac{T}{\frac{2D}{c}} - \frac{T}{D \frac{2c}{c^2 - V_{abs}^2}} = \frac{T}{2D} \frac{V_{abs}^2}{c}$$

Let $D = 10 \text{ m} = 0.01 \text{ Km}$, $T = 100 \text{ s}$, $V_{abs} = 390 \text{ Km/s}$, $c = 300000 \text{ Km/s}$

$$C_1 - C_2 = \frac{T}{2D} \frac{V_{abs}^2}{c} = \frac{100}{2 * 0.01} \frac{390^2}{300000} = 2535 \text{ counts}$$

Therefore, according to AST, the difference between the two counter values will reach 2535 in a time period of 100 seconds.

To determine the required number of bits for the counters, we use the round trip time of C_1 :

$$\frac{T}{\frac{2D}{c}} = \frac{100}{\frac{2*0.01}{300000}} = 15 * 10^8$$

If we use the round trip time of counter C_2 :

$$D \frac{\frac{T}{2c}}{c^2 - V_{abs}^2} \cong \frac{T}{D \frac{2c}{c^2}} = \frac{T}{\frac{2D}{c}} = \frac{100}{\frac{2*0.01}{300000}} = 15 * 10^8$$

which is almost the same as the value for C_1 .

This will require a counter of 31 bits.

$$2^{31} = 2147483648$$

However, practically, it is also possible to use 16-bit counters, store the difference in their values just before one counter resets to zero, reset the other counter simultaneously and start the counting from zero and repeat the above procedure. Of course, all this is done automatically, electronically. After the system has run for sufficiently long time, the system will be stopped and the stored differences of the two counters will be added together.

The required speed of the counters is:

$$\frac{1}{\text{round trip time}} = \frac{1}{\frac{2D}{c}} = \frac{1}{\frac{2*0.01}{300000}} = 15 \text{ MHz}$$

Note that the above analysis is only theoretical and in the actual experiment other factors need to be considered. For example, the detection of light by the detector, the triggering of the source by the detector unit and emission of light by the source all introduce a finite time delay, which needs to be considered in the design and analysis of the experiment.

Discussion

The new analysis of the Michelson-Morley experiment has revealed the logical flaws in the traditional analysis, which will have a serious consequence for the theory of relativity. Since the Lorentz transformation and Special Relativity Theory are based on such fallacious analysis, this will undermine their validity[5].

From its beginning in 1905, the Special Theory of Relativity was in a vulnerable position because it was founded on the presumption that it is impossible to detect absolute motion. Einstein just assumed (postulated) the principle of relativity and hoped that there is no experiment that would

violate it [6]. However, even a 0.00000001 fringe shift would disprove relativity. But we have seen that the classical analysis of the Michelson-Morley experiment, on which the Lorentz Transformation and Special Relativity are based, is flawed and it will be impossible to get a null fringe shift even if the known Lorentz transformation is applied [5]. Modifying the Lorentz equations is impossible either [5].

One of the main experiments that is cited for the Special Theory of Relativity are the modern Michelson-Morley experiments that give almost a complete null result. Apparent Source Theory has successfully explained the null results of these experiments.

So far there is no known theory of the speed of light that successfully treats both the Michelson-Morley and the Sagnac experiments within the same theoretical framework. Apparent Source Theory is the first theory ever to achieve this. As we have seen, the exact analysis of the Sagnac effect will give a complicated result, but which may be approximated with the simple Sagnac formula we know, and this will be a problem for the theory of relativity again.

Conclusion

In this paper, a quantitative analysis of the 1881 and 1887 Michelson interferometer experiments have been presented. The result shows agreement with the Michelson experimental result. This is a success for Apparent Source Theory. No known theory of light has ever achieved this. The mystery of the Michelson-Morley experiment has been revealed in this paper: increase in arm length made the apparatus less sensitive to absolute motion. We have also presented an analysis of the Sagnac effect, within the same theoretical framework as the Michelson-Morley experiment. The Sagnac effect has been treated as a general case in which acceleration is involved. A profound consequence of Apparent Source Theory has also been proposed: the direction of apparent change in star position in the phenomenon of stellar aberration is not in the same direction as the (absolute) velocity of the observer, as universally thought, but in the direction opposite to the observer's absolute velocity! Apparent Source Theory has explained almost all known light speed experiments. But a new theory, however successful it is in explaining known experiments, should make new predictions and those predictions must be tested and confirmed by physical experiments, to get acceptance by the scientific community. Accordingly, some experiments to test Apparent Source Theory have been proposed in this paper.

Thanks to God and the Mother of God, Our Lady Saint Virgin Mary

References

1. Absolute/Relative Motion and the Speed of Light, Electromagnetism, Inertia and Universal Speed Limit c - an Alternative Interpretation and Theoretical Framework, by Henok Tadesse, vixra:1508.0178
2. Stellar Aberration and Einstein's Relativity, by Paul Marmet
3. An Interferometer Experiment that can be Many Orders of Magnitude More Sensitive than the Michelson-Morley Experiment, by Henok Tadesse, vixra:1604.0347
4. Apparent Contraction and Expansion of Space Relative to Absolutely Moving Observer - New Explanation of the Phenomenon of Stellar Aberration, Doppler Effect and Mercury Anomalous Perihelion Advance, by Henok Tadesse, vixra:1811.0007
5. The Michelson-Morley Experiment and Classical Analysis of Reflection of Light From a Moving Mirror-Implications for the Lorentz Transformation Equations, by Henok Tadesse, vixra:1810.0341
6. Why Einstein did not receive the Nobel Prize for his theory of relativity, Conrad Ranzan, Physics Essays

Notes

* 'Intrinsic absolute motion' was a theory I speculated years ago. I abandoned it when I discovered Apparent Source Theory. Recently, I resorted to this speculative idea again, after I found contradiction between Apparent Source Theory and the conventional understanding of stellar aberration. At the time of writing of this paper, I have already solved this puzzle by giving stellar aberration a new interpretation that conforms to Apparent Source Theory. Therefore, I have abandoned the 'intrinsic absolute motion' idea.