

**Alexander G. Kyriakos**

# **The nonlinear quantum field theory**

**Athens  
2018**

The author proposes a special nonlinear quantum field theory. In a linear approximation, this theory mathematically can be presented in the form of the Standard Model (SM) theory. The richer physical structure of this nonlinear theory makes it possible to exceed the limits of SM and remove its known incompleteness. We show that nonlinearity of the field is critical for the appearance of charges and masses of elementary particles, for confinement of quarks, and many other effects, whose description within the framework of SM causes difficulties. In this case, the mechanism of generation of masses is mathematically similar to Higgs's mechanism, but it is considerably simpler. The proposed theory does not examine the theory of gravity, but give the base to build Lorentz-invariant gravitation theory. The book is intended for undergraduate and graduate students studying the theory of elementary particles, as well as for specialists working in this field.

## CONTENTS

Chapter 1. Introduction. The axiomatic approach versus heuristic	(4)
Chapter 2. Choice of axiomatics and mathematical apparatus of theory	(12)
Chapter 3. The photon theory	(25)
Chapter 4. The intermediate bosons and mass generation theory	(36)
Chapter 5. The electron and positron equations (linear approach)	(48)
Chapter 6. Electrodynamic sense of the quantum forms of Dirac electron theory	(66)
Chapter 7. Classical nonlinear electron theories and their connection with QED	(81)
Chapter 8. Nonlinear quantum electron equation	(98)
Chapter 9. Physical vacuum and its effect on elementary particles and their interactions	(109)
Chapter 10. The theory of massive neutrino	(130)
Chapter 11. On the structure and theory of hadrons	(142)
Chapter 12. The interaction description	(166)
Chapter 13. On elementary particles' spectra	(185)
Chapter 14. On calculation of elementary particles' masses	(198)
Chapter 15. The non-linear theory as string theory of Compton wavelength scale	(210)
Chapter 16. On photon and electron structure	(220)
Chapter 17. The mass origin theory	(250)
Bibliography	(278)

### Note:

- 1) In each Chapter numeration of sections is independent from others Chapters.
- 2) In text the of present book the theory name is:  
**Nonlinear Theory of Elementary Particles**, or briefly **NTEP**

# Chapter 1. Introduction.

## The axiomatic approach versus heuristic

### 1.0. Crisis in Physics

A considerable number of prominent scientists says about the crisis in fundamental physics, which is reflected in the fact that the last 40 years in this field of science there are no new results (Smolin, 2006; Woit, 2007; Seth, 2007; Schroer, 2008; Schroer, 2009; Horgan, 1996; etc)..

So, well-known physicist Lee Smolin in his book (Smolin, 2006) notes:

*“The story I will tell could be read by some as a tragedy. To put it bluntly – and to give away the punch line – we have failed. We inherited a science, physics that had been progressing so fast for so long that it was often taken as the model for how other kinds of science should be done. For more than two centuries, until the present period, our understanding of the laws of nature expanded rapidly. But today, despite our best effort, what we know for certain about these laws is no more than what we knew back in the 1970s.*

*How unusual is it for three decades to pass without major progress in fundamental physics? Even if we look back more than two hundred years, to a time when science was the concern mostly of wealthy amateurs, it is unprecedented. Since at least the late eighteenth century, significant progress has been made on crucial questions every quarter century”...*

*Why is physics suddenly in trouble? And what can we do about it? These are the central questions of my book...”*

The presence of the crisis is also confirmed by the philosophers:

(Popper, 1982) *“Today, physics is in a crisis. Physical theory is unbelievably successful; it constantly produces new problems, and it solves the old ones as well as the new ones. And part of the present crisis—the almost permanent revolution of its fundamental theories—is, in my opinion, a normal state of any mature science. But there is also another aspect of the present crisis: it is also a crisis of understanding.*

*This crisis of our understanding is roughly as old as die Copenhagen interpretation of quantum mechanics. It is thus a little older than die original edition of The Lope of Scientific Discovery. In this part of die Postscript I have tried to make again a number of proposals intended to clarify what underlies this crisis of understanding”.*

The question arises about the causes of the crisis of fundamental science.

### 2.0. Which of our basic assumptions are wrong?

Although they use different terminology, physicists and philosophers converge to the same reason. Here is what Popper says (Popper, 1982):

*“In my view, the crisis is, essentially, due to two things:*

- (a) *the intrusion of subjectivism into physics; and*
- (b) *the victory of the idea that quantum theory has reached complete and final truth.*

*Subjectivism in physics can be traced to several great mistakes. One is the positivism or idealism of Mach. It spread to the British Isles (where it had been originated by Berkeley) through Russell, and to Germany through the young Einstein (1905). This view was rejected by Einstein in his forties (1926), and it was deeply regretted by the mature Einstein (1950). Another is the subjectivist interpretation of the calculus of probability, which is far older and which became a central dogma of the theory of probability through the work of Laplace”.*

Let us consider what the reasons are consistent with this in science.

Simplistically, we can say that science is a method of obtaining the answer to a question in order to gain some benefit for people.

Since Nature is only one, only one answer to each question must exist as well as one picture of each phenomenon. Such an answer is usually called true or correct. Methods that are used in order to obtain only one answers from Nature are named the methodology of science. In practice, methodology of science is a number of regulations.

The basis of methodology of scientific theory is nowadays a law (which conditionally can be named “**Francis Bacon law of science methodology**” (SEPh, 2003):

**«Scientific community has taken that any theory is true, if it is in agreement with experimental results when these experiments are invariant with respect to the space, time, experimentalists, technical means and some other conditions».**

In other words, to announce a verdict about the truth of the theory, the experiments should give identical results in Moscow, Los Angeles, on the Moon or Aldebaran; a hundred years ago, today, tomorrow, after a thousand years; by experimentalists from USA, Argentines, Mars or Venus; by means of any device, which is fit for a given experiment; and the results of the experiment must be mathematically processed and presented by known methods.

Assuming all of this, the Bacon law can be summarized as follows: “*The coincidence of theoretical results with experimental results is the truth in science*”.

This law is regularly worked until the early 20th century. But, as the science development shows, there is some incompleteness in the Bacon law: this law says nothing about the method of construction of theory and about theory structure. As it turned out, the absence of this indication also leads to a crisis in science. In particular, we assume that one of the main causes of the current crisis is precisely this point. What grounds are there for such a statement?

Historically, there are two aspects of mathematics. Proof-based mathematics is not the only form (Davis and Hersh, 1982).

*"The mathematics of Egypt, of Babylon, and of the ancient Orient was all of the algorithmic type. Dialectical mathematics -- strictly logical, deductive mathematics -- originated with the Greeks. But it did not displace the algorithmic. In Euclid, the role of dialectic is to justify a construction-i.e., an algorithm. It is only in modern times that we find mathematics with little or no algorithmic content. [ . . . ] Recent years seem to show a shift back to a constructive or algorithmic view point."*

It turned out that this difference is also characteristic for physics of XX-XXI centuries. Richard Feynman caught the attention of physicists on this particularity . In a series of lectures "The Character of Physical Law " (Feynman, 1964), he analyzed these issues in detail. The following are typical excerpts from his book:

*"...there are two kinds of ways of looking at mathematics, which for the purpose of this lecture I will call the Babylonian tradition and the Euclidean or Greek tradition. In Babylonian schools in mathematics the student would learn by doing a large number of examples until establishing the general rule... Tables of numerical quantities were available so that they could solve elaborate equations.*

*Under the Babylonian system, everything was prepared for calculating things out. But Euclid (under the Greek mathematical system) discovered that there was a way in which all of the theorems of geometry could be ordered from a set of axioms that were simple. The Babylonian mathematics is that you know all of the various theorems and many of the connections in between..."*

The next step is then the guessing of physical equations, which, Feynman argues, facilitates the guessing of new physical laws in a way that common-sense feeling, philosophical principles, or models cannot.

Feynman (Feynman, 1964) argued that, *"In physics, we need the Babylonian method, and not the Euclidian or Greek method."*

The Babylonian tradition and the Euclidean or Greek tradition in the framework of physics and mathematics can be named “algorithmic approach” and “axiomatic approach”; following Karl Popper (Popper, 1982), they can be called "instrumentalism" and "realism"; recalling the T. Kuhn analysis (Kuhn, 1962), we can also name these methods “Babylonian paradigm” and “Greek paradigm”; or “neo-positivistic approach” and “classical approach” (Mach, 1897; Holton, 1968)).

In framework of “Babylonian approach” (see, for example, the mathematical cuneiform tablets of Mesopotamia, Egypt papyri, the Ptolemy astronomy theory) the theory is formulated in the form of regulations, rules, recipes of calculations found in any way, including through trial and error or the method of fitting. It is clear that the number of these regulations, rules and prescriptions should be almost as great as the number of questions to be answered. Any mathematic apparatus can be invented here to obtain the result, without understanding its connection with other part of theory.

In contrast, according to “Greek approach” for each area of science must exist one of the equivalent systems of axioms, and all mathematic results of the theory must follow consecutively from this axiom system (for examples see the Euclid geometry and classical mechanics of Newton).

Although both approaches are not against the Bacon law, it is difficult to disagree with the fact that a scientific theory, which enjoys a huge number of practical recipes and instructions, found by means of trial and error method, contradicts to our intuitive understanding of the unity of the world picture (Planck, 1910).

*"Is the physical picture of the world, only more or less an arbitrary creation of our mind, or, conversely, we have to admit that it reflects a real, totally independent from us, phenomena of nature? ...*

*If, on the basis of the above, I answer affirmatively this question, I am well aware that the answer lies in a certain contradiction with the direction of the philosophy of nature, which is headed by Ernst Mach and which now enjoys great sympathy among scientists. According to this doctrine, in nature there is no other reality other than our own feelings, and every study of nature is, ultimately, only the economical adaptation of our thoughts to our feelings, to which we come under the influence of the struggle for existence. The difference between the physical and mental is purely practical and conventional; i.e. the unique elements of world - this is our experience.*

*Although I am firmly convinced that in the Mach system, if it is consistently held, there is no self-contradiction, it seems to me no less significant that its value is, in essence, purely formal and does not concern the foundations of science. The reason for this is that the Mach system is completely alien to the most important attribute of any natural science research: the desire to find a permanent, independent of change of times and the people, world picture ...*

*The goal does not lie in the complete adaptation of our ideas towards our sensations, but in the complete liberation of the physical picture of the world from the individuality of the creative mind. This is a more precise statement of what I described above as the exemption from anthropomorphic elements.*

*When the great creators of the exact science - Copernicus ..., Kepler ..., Newton ..., Huygens..., Faraday, ... - introduced their ideas to science, surely none of these scientists have relied on the economic point of view in the fight against the inherited beliefs and overwhelming authority. The support of all their activities was the unshakable belief in the reality of their world view. In view of this undoubted fact, it is difficult to get rid of the fear that the train of thoughts of leading minds would be violated, the flight of imagination weakened, and the development of science would be fatally delayed, if the principle of economy of Mach really became the focal point of the theory of knowledge. Maybe it will actually be more "economical" if we give the principle of economy a more modest place?"*

After 40 years, in 1952, E. Schrodinger even more clearly expressed dissatisfaction with algorithmic (Babylonian, neopositivistic) development of modern physics (Schrödinger, 1952):

(Quotes from Part I) *“The innovations of thought in the last o years, great and momentous and unavoidable as they were, are usually overrated compared with those of the preceding century; and the disproportionate foreshortening by time-perspective, of previous achievements on which all our enlightenment in modern times depends, reaches a disconcerting degree according as earlier and earlier centuries are considered... A theoretical science, where this is forgotten, and where the initiated continue musing to each other in terms that are, at best, understood by a small group of close fellow travellers, will necessarily be cut off from the rest of cultural mankind; in the long run it is bound to atrophy and ossify, however virulently esoteric chat may continue within its joyfully isolated groups of experts...”*

*The disregard for historical connectedness, nay the pride of embarking on new ways of thought, of production and of action, the keen endeavour of shaking off, as it were, the indebtedness to our predecessors, are no doubt a general trend of our time...*

*There is, however, so I believe, no other nearly so blatant example of this happening as the theories of physical science in our time...*

*There have been ingenious constructs of the human mind that gave an exceedingly accurate description of observed facts and have yet lost all interest except to historians. I am thinking of the theory of epicycles”.*

(Quotes from Part II) *“There is, of course, among physicists a widely popular tenet, informed by the philosophy of Ernst Mach, to the effect that the only task of experimental science is to give definite prescriptions for successfully foretelling the results of any future observations from the known results of previous observations.*

*If our task is only to predict precisely and correctly by any means whatsoever, why not by false mathematics?”*

### **3.0. Algorithmic mathematics vs. axiomatic**

#### **3.1. Why is the modern theory of elementary particles called the Standard Model?**

Modern theoretical physics does not pretend to explain how something really happens in nature. Theoretical physics only claims that it can offer mathematical models that describe phenomena well, on the basis of which it is possible to make predictions, and then to test them experimentally.

Therefore, nothing restricts the mathematics that is needed for theoreticians to build models. For example, it is acceptable to use complex numbers if it turns out that with the help of complex numbers, it is possible to describe something that was not possible to describe with the help of real numbers; or, if it turns out that in order to describe the electrical and magnetic interactions of bodies it is convenient to introduce the notion of an electromagnetic field that is somehow "spilled" in space, then it is acceptable to do so. If it turns out that it is more effective as far as explanations and predictions are concerned, to use curved space-time to describe gravity, this is also acceptable.

The transition from one mathematical model to another does not necessarily have to be smooth, but can be accomplished abruptly. For example, we have a set of experimental facts that can not be described by the previous theory (say, classical mechanics). In addition it is not possible at a principled level; i.e., in classical mechanics there is simply no place for such phenomena. In this case we have to invent another mathematical formalism, in which the main role will be played by other objects.

For example, quantum mechanics is the kind of formalism that does not transition smoothly from classical mechanics, but is based on another basis. If some strange variants appear in the course of the development of a theory, they should be used if this mathematical model with its unusualness better describes the reality than any other models.

The same is true for the transition from quantum mechanics to quantum field theory. There, too, the rules of the game change: other objects become key-objects, and the formalism of working with them becomes more difficult. Most importantly, this theory should successfully describe and predict phenomena that could not be described by quantum mechanics.

In other words, modern theoretical physics does not represent an aggregation of knowledge in which all results follow consistently from a limited set of statements. It is rather a collection of disparate recipes – mathematical description models, poorly connected with each other and accepted by agreement by the majority of the scientists of the world.

Hence the name of the modern theory of matter: **Standard Model**.

Further we will examine the structure of the contemporary theory of elementary particles - Standard Model - and will note its “Babylonian” difficulties.

#### 4.0. Difficulties of quantum field theory

The quantum field theory (QFT), (in particular, in the form of the Standard Model (SM)), is the contemporary theory of elementary particles and their interactions. Its predictions agree with experiments. But it has very strange peculiarities.

The most peculiar features of quantum mechanics are quantum nonlocality, indeterminism, interference of probabilities, quantization, wave function collapse during measurement. They and some others are basic principles of quantum mechanics that are generally accepted and called “The Copenhagen interpretation” :

1. A system is completely described by a wave function,
2. The description of nature is essentially probabilistic. The probability of an event related to the square of the amplitude of the wave function.
3. The wave function represent the state of the system, which grows gradually with time but, upon measurement, collapses suddenly to its original size.
4. Heisenberg's uncertainty principle: it is not possible to know the value of all the properties of the system at the same time; those properties must be described by probabilities.
5. Wave-particle duality. An experiment can show both the particle-like and wave-like properties of matter; in some experiments both of these complementary viewpoints must be invoked to explain the results, according to the complementarity principle of Niels Bohr.
6. Since measuring devices are essentially classical devices, it can measure only classical properties.

These peculiarities can not be explained on basis of quantum theory. Copenhagen interpretation describes the nature of the Universe as being much different then the world we observe.

The question arises, what grounds exist for the adoption of these concepts? It turns out that there are no bases, apart from the general agreement of physicists. As Niels Bohr (Bohr, 1962) said:

*"After a short period of ideological disorder and the disagreements, caused by short term of restriction of "presentation", the consensus about replacement of concrete images with abstract mathematical symbols, for example as  $\psi$ , has been reached. In particular, the concrete image of rotation in three-dimensional space has been replaced by mathematical characteristics of representation of group of rotation".*

Many physicists have subscribed to the instrumentalist (or, according to R. Feynman, Babylonian) interpretation of quantum mechanics, a position, which is often equated with denial all interpretation. It is summarized by the sentence "Shut up and calculate!".

*"While expounding as the undisputed leader of the Copenhagen school, his peculiar mixture of positivism, realism, and existentialism, Bohr unfortunately did not anticipate the long-range*



*effects of his teachings on future generations of physicists who lacked the philosophical training or the sophistication required to distinguish between subtle philosophical nuances and their gross over-simplifications. Such physicists condensed Bohr's entire philosophy into simplified enunciations of the principles of complementarity, wave-particle duality and the purportedly "classical nature" of the "apparatus," and simply ignored the rest. Indeed, what Karl Popper calls the "third group of physicists," who emerged right after World War II and soon became the overwhelming majority, is described by him as follows (Prugovecki, 1992):*

*"It consists of those who have turned away from discussions [concerning the confrontation between positivism and realism in quantum physics] they regard them, rightly, as philosophical, and because they believe, wrongly, many younger physicists who have grown up in a period of over-specialization, and in the newly developing cult of narrowness, and the contempt for the non-specialist older generation: a tradition which may easily lead to the end of science and its replacement by technology." (Popper, 1982, p. 100).*

#### **4.1. What does the algorithmity of modern theories lead to?**

Briefly and meaningfully about this peculiarity of QFT spoke one of the creators of SM, the Nobel laureate Murray Gell-Mann. (Gell-Mann, 1981):

*"Quantum mechanics, that mysterious, confusing discipline, which none of us really understands but which we know how to use. It works perfectly, as far as we can tell, in describing physical reality, but it is a 'counter-intuitive discipline', as social scientists would say. Quantum mechanics is not a theory, but rather a framework, within which we believe any correct theory must fit."*

According to (Anthony, 1985): *"The quantum mechanics ... says nothing about the nature of the particles, forming the Universe, and about forces, which operate between them. More likely, it is the set of rules, with help of which it is possible to find, what will take place according to the given dynamic theory under certain conditions"*

Steven Weinberg in his book *"Dreams of the Final Theory (1993) Chap. 4." Quantum Mechanics and Its Discontents* writes:

*"A year or so ago, while Philip Candelas (of the physics department at Texas) and I were waiting for an elevator, our conversation turned to a young theorist who had been quite promising as a graduate student and who had then dropped out of sight. I asked Phil what had interfered with the ex-student's research. Phil shook his head sadly and said, "He tried to understand quantum mechanics."*

In his *"Lectures on Quantum Mechanics (2nd ed., 2015), Ch. 3 : General Principles of Quantum Mechanics"* he explained this remark in more detail:

*"My own conclusion is that today there is no interpretation of quantum mechanics that does not have serious flaws. This view is not universally shared. Indeed, many physicists are satisfied with their own interpretation of quantum mechanics. But different physicists are satisfied with different interpretations. In my view, we ought to take seriously the possibility of finding some more satisfactory other theory, to which quantum mechanics is only a good approximation"*

It is necessary to recognize that such structure of theory is completely acceptable for the technical applications. But at the same time, for this reason, SM does not answer many questions that are entitled to be asked by any inquisitive mind (in framework of the QFT the answers are either separate postulates, or claims that our ability to know the micro-world is limited due to some of its features).

Among these, for example, are: what is the origin of the mass; why fundamental particles - electron and quarks - don't have size (i.e., are point); why the wave function has not a physical sense.

We do not know the physical meaning of quantization; uncertainty principle of Heisenberg; a wave-particle dualism; non-commutativity of dynamic variables; the operator form of QM; statistical interpretation of wave function; phase and gauge invariance; four-dimensional world; Pauli exclusion principle;

The theory does not explain elementariness of the charge; the charge and fine structure constant values; the “charges” of weak and strong interactions; universality of electron charge; existing of plus and minus charge of the particles; particle spin; helicity; the existing of different kinds of particles: intermediate bosons, leptons, mesons, baryons; and why other particles don't exist; confinement of the quarks; the stability and instability of the elementary particles; existence of particles and antiparticles; spontaneous breaking of symmetry; zitterbewegung; etc.

We do not know the physical sense of the mathematical characteristics of Dirac's electron equation: why the spinor equation does contain two equations, and the bispinor - four equations? Why into the Dirac equations the matrices are used, which in the classical theory describe the rotation? Why do the Pauli and Dirac matrices form groups? Why the mathematical theory of groups is the basis for the search for invariants of physical theories? Why there are many equivalent forms of the Dirac electron equation that transform into each other through formal transformations of matrices and the wave function? Etc..

The understanding of the fact that “quantum mechanics is not a theory, but rather a framework, within which we believe any correct theory must fit”, cause the desire to construct within the framework of existing theory the completely axiomatic theory of elementary particles.

#### 4.2. Is it possible to move to a different paradigm?

A question arises, of whether the contemporary quantum field theory is already on that stage, when it can be formulated axiomatically (Smilga, 2001):

*“In his well-known popular lectures R. (Feynmann, 1964) reflects on the way physical theories are built up and distinguishes two such ways or, rather, two stages in the process of their construction: (i) the “Babylonian” stage and (ii) the “Greek” stage.*

*It is not difficult to guess that the term “Babylonian” refers to ancient Babylon and the corresponding physical theory is just, geometry. A Babylonian geometer (the words “mathematician” or “physicist” were not yet coined) knew many facts about circles, triangles, and other figures, and his understanding was not purely empirical because he could also relate different such facts with each other... In other words, his theory described the observed experimental facts well and had direct practical applications.*

*Our Babylonian colleague was lacking, however, a, consistent structured system in which a set of basic simple facts are chosen as axioms and all others are rigorously derived as theorems... Feynman writes that a modern physicist is a Babylonian rather than a Greek in this respect: he does not care too much about Rigor, and his God and ultimate Judge is Experiment.*

*Strictly speaking, this is not quite correct. Some branches of classical and also of quantum physics have now quite reached the Greek stage.*

*Regarding ... quantum field theory in general, we are living now in interesting times when we go over from the Babylonian to the Greek stage.”*

Therefore, we can not exclude an opportunity of existence of other paradigm, which are not breaking the mathematical apparatus of quantum mechanics, but give the essentially other theory. "Is it possible to make differently?" - the analysis of this question from known followers of de Broglie (Andrade and Loshak, 1972) leads to following statement of a question:

*"From the point of view of the sensible scientific approach, here there is no talk about whether postulates of the Copenhagen school correct or false are. The discourse goes simply about that any philosophical postulates have itself no evidential force, even if their logic connection with quantum mechanical calculations was perfect and the great discoveries on its basis were made. Hence, we should set for ourselves a problem: to establish, whether it is possible, proceeding from other postulates, to construct other interpretation of quantum mechanics and, thus, to come*

*to the theory, which are distinct from those, which we know, and bringing new results. In other words, whether it is possible to make differently or even better?*

*From the most general point of view this question seems quite pertinent and it would be very much desirable to answer it so that, since no way should remain without use, the similar enterprise will justify the efforts, spent for it".*

As examples of successful physical axiomatic theories serve, e.g., Newton's mechanic and classical electrodynamics. In these theories on the basis of several postulates (or, which is the same, axioms) all formulas, necessary for calculating of the physical values in these area of science, are derived.

We propose as such a theory to consider the axiomatic **nonlinear theory of elementary particles (NTEP)**. In framework of this theory, it can be shown that all the peculiarities of modern quantum field theory arise due to the fact that it is artificially treated as a linear theory. The mathematics of the nonlinear theory in the linear approximation is identical to the mathematics of existing QFT.

At the same time, all abovementioned features of modern quantum field theory in the nonlinear theory have a natural physical explanation and do not require artificial interpretations. Moreover, it appears that all the items of the Copenhagen interpretation are a mathematical consequence of the theory itself, thus, justifying Andrade and Loshak's hope.

## References

- Andrade e Silva Zh and Loshak Zh. (1972). Fields, particles, quanta. Moscow, Science ,
- Anthony, Simon. (1985). Superstrings: a Theory of Everything?// New Scientist. 29 August 1985. P. 34-36.
- Bohr, Nils. (1962). The theoretical physics of XX century. Collection of article translations from English to Russian, (1962).
- Davis, P. J. and Hersh, R. (1982) The mathematical experience. Houghton Mifflin Company
- Feynman, R. (1964) *The Character of Physical Law*. Messenger Lectures, 1964.
- Feynman, R.P. (1987). The reason for Antiparticles/Elementary particles and the laws of physics: the 1986 Dirac Memorial Lectures/. Cambridge University Press, 1987. – Pp. 1-59.
- Gell-Mann, M. (1981). Questions for the future. Series Wolfson College lectures; 1980. Oxford University Press, 1981.
- Gerald Holton. Mach, Einstein, and the Search for Reality. Daedalus, Vol. 97, No. 2, Historical Population Studies (Spring, 1968), pp. 636-673).
- Goenner, H. F. M. (2004.) Living Reviews Relativity, 7, (Online Article: <http://www.livingreviews.org/lrr-2004-2>).
- Horgan John. (1996) The End of Science: Facing the Limits of Science in the Twilight of the Scientific Age. Broadway Books, 1996.
- Mlodinow, L. (2003). *Feynman's Rainbow: a Search for Beauty in Physics and in Life*. Warner Books.
- Planck, Max. (1910) Die Stellung der neueren Physik zur mechanischen Naturanschauung, Leipzig: S.Hirzel.
- Popper K.R. (1982). Quantum theory and the schism in physics. – London; New York,
- Prugovecki, Eduard. (1992) Realism, Positivism, Instrumentalism, and Quantum Geometry. Foundation of Physics, Vol. 22, No.2.
- Schrödinger, E. (1952) Are there quantum jumps ? Part I. The British Journal for the Philosophy of Science, Vol. 3, No. 10 (Aug., 1952), pp. 109-123 <http://www.jstor.org/stable/685552> ); Part II. Vol. 3, No. 11 (Nov., 1952), pp. 233-242 (<http://www.jstor.org/stable/685266> )
- Schroer Bert. (2008) String theory, the crisis in particle physics and the ascent of metaphoric arguments. <http://arxiv.org/abs/0805.1911>
- Schroer Bert. (2009). A critical look at 50 years particle theory from the perspective of the crossing property. <http://arxiv.org/abs/0905.4006>
- SEPh (Stanford Encyclopedia of Philosophy). (2003). Francis Bacon. <http://plato.stanford.edu/entries/francis-bacon/>
- Seth Suman. (2007) Crisis and the construction of modern theoretical physics. The British Journal for the History of Science (2007), 40:1:25-51 Cambridge University Press.
- Smilga, A.V. (2001). Lectures on quantum chromodynamics. World Scientific Publishing Company.
- Smolin, L. (2006). *The trouble with physics: the rise of string theory, the fall of a science, and what comes next*. Houghton Mifflin, Boston, 2006.
- Woit Peter. (2007). String Theory and the Crisis in Particle Physics. Gulbenkian Foundation Conference on Is Science Near Its Limits?, 25-26 October 2007 . Columbia University.

## Chapter 2. Choice of axiomatics and mathematical apparatus of theory

### 1.0. The peculiarities of the Standard Model theory, which lie in the basis of the axiomatic theory

The modern theory of elementary particles is called the Standard Model Theory or simply Standard Model (SM). More specifically, SM consists of the quantum field theories of photons, leptons, intermediate bosons, hadrons and their interactions.

All these theories are wave theories, in the sense that all particles are described by wave equations relative to the appropriate wave functions of particles. The wave function was introduced as a phase wave, which, as L. de Broglie showed, always accompanies particle motion. The physical meaning of this wave was not discovered.

At the initial stage of development of quantum theory, it was shown that the wave function of the electron cannot be compared with the linear electromagnetic waves of Maxwell's theory. Since no other sense for this function could be established, scientists agreed that the quantum wave function has no physical sense. In order to use it in calculations, it was postulated that the square of the wave function determines the probability of finding the particle at a given point of space at a given moment. This interpretation was assumed to be the basis of quantum theory, since experimental verification showed its complete correctness.

In contemporary quantum field theory, the state of a system is described by elements of Hilbert space. Hilbert space is a generalization of linear Euclidean vector space to the infinite-dimensional case. In other words, Hilbert space is a special case of a linear space. Due to this fact, quantum field theory is considered to be a linear theory.

In order to expand the theory's applicability, attempts to introduce nonlinearity into quantum mechanics were made since a long time ago. These attempts did not achieve the desired result. But the development of quantum field theory led unexpectedly to the appearance of the nonlinearity.

The connection of contemporary theories with nonlinear electromagnetic theory was known a long time ago. According to modern ideas (Ryder, 1985), the observed substance of the Universe consists of photons, leptons and quarks. Besides electromagnetic interactions, there are strong and weak interactions. All of these interactions are described by the unified theory, which is a substantial generalization of Maxwell's theory. Instead of vectors of the usual electrical and magnetic fields  $\vec{E}$  and  $\vec{B}$ , the modern theory contains several similar field vectors  $\vec{E}_i$  and  $\vec{B}_i$ , and in a natural way, the waves of these vectors are strictly nonlinear.

The first such generalization of Maxwell's theory was made by C. Yang and R. Mills in 1954. All similar theories are therefore called the Yang-Mills theories. Let us emphasize that the nonlinearity is so deeply embedded into the nature of the Yang-Mills fields: "*The generalization of the Maxwell theory is the theory of the Yang-Mills fields or non-Abelian gauge fields. Its equations are nonlinear. In contrast to this, the equations of Maxwell are linear, in other words, Abelian*" (I. Nambu); (a detailed derivation of the Yang-Mills equations in the form of Maxwell's equations can be found in the book of Ryder (Ryder, 1985)).

Thus, Yang-Mills theory can be considered as the ***quantum nonlinear electromagnetic theory, in which the nonlinear electromagnetic field is not Maxwellian***. Therefore, nonlinearity and electromagnetics are the essential aspect of the contemporary theory of elementary particles. In connection with this arises the question, why is it possible to examine the contemporary quantum field theory within the framework of linear paradigm, as we have noted previously.

This approach unavoidably leads to the fact that the nonlinearity must play an essential role in the Universe (Ryder, 1985): *“Now it turns out that non-linear field theories possess extended solutions, commonly known as solitons, which represent stable configurations with a well-defined energy which is nowhere singular. May this be of relevance to particle physics? Since non-Abelian gauge theories are non-linear, it may well be, and the last ten years have seen the discovery of vortices, magnetic monopoles and ‘instantons’, which are soliton solutions to the gauge-field equations in two space dimensions (i.e. a ‘string’ in 3- dimensional space), three space dimensions (localized in space but not in time) and 4-dimensional space-time (localized in space and time). If gauge theories are taken seriously then so must these solitons be”.*

The idea that elementary particles are electromagnetic solitons, or soliton-like objects, is an idea with a rich history. For instance, we can recall Kelvin’s theory of vortex atoms, developed in the middle of the 19th century: here the particles are closed strings (solitons), and their mass depends on the frequency of their vibrations as in the modern string theory.

At the end of the 19th and at the beginning of the 20th centuries, realistic soliton-like models were proposed by H. Lorentz for the electron within the framework of a linear approximation (Lorentz, 1952). His proposal was that the electron consists of an electromagnetic field in the limited space. This idea was further supported by two substantial results: Lorentz derived the known Lorentz transformations, and found the relationship between the electron mass and energy with a coefficient different from 1; this result was corrected in 1922 by E. Fermi and others (Fermi, 1922, Jackson, 1999) and has not been disproved yet (Feynman, Leighton and Sands, 1964; chap. 28, “Electromagnetic mass”): *“We only wish to emphasize here the following points: 1) the electromagnetic theory predicts the existence of an electromagnetic mass, but it also falls on its face in doing so, because it does not produce a consistent theory – and the same is true with the quantum modifications; 2) there is experimental evidence for the existence of electromagnetic mass; and 3) all these masses are roughly the same as the mass of an electron. So we come back again to the original idea of Lorentz – may be all the mass of an electron is purely electromagnetic, maybe the whole 0.511 MeV is due to electrostatics. Is it or isn’t it? We haven’t got a theory, so we cannot say.”*

In 1912, the German physicist Gustav Mie (Pauli, 1958; Tonnela, 1959) found a remarkable nonlinear generalization of Maxwell’s theory in which electromagnetic waves were nonlinear. In Mie’s theory, the electron appeared as soliton-like particle of small and finite dimension, in which the final electromagnetic energy was stored. Later, as an application of this theory, the well-known nonlinear Born-Infeld theory was developed (Pauli, 1958; Tonnela, 1959), and encouraging numerical results were obtained.

The obvious deficiencies in all these preliminary attempts of “solitonization” of the elementary particles were that they did not consider the requirements of quantum theory, expressed in the relationships of the quantization of Planck and de Broglie.

The nonlinear non-Maxwellian electromagnetic (EM) field lies in the basis of the proposed nonlinear theory of elementary particles (NTEP). We will show that nonlinearity is needed to understand all special features of wave functions of elementary particles within the framework of the Copenhagen interpretation of Quantum Mechanics. Furthermore, it will follow from this theory that nonlinearity is crucial for understanding all differences which separate classical physics from quantum.

On the basis of above-enumerated results we will select the following axiomatics.

## 2.0. Axiomatics of the non-linear theory of elementary particles

The axiomatic basis of the offered theory is made with 6 postulates, the first 4 of which are postulates of the modern field theory. Postulates 5 and 6 express specificity of present theory; they do not follow from modern physics, but supported by it. In research the Gauss unit system is used..

**1. A postulate of fundamentality of an electromagnetic field: *Maxwell's equation for the field without sources:***

$$\frac{1}{c} \frac{\partial \vec{E}}{\partial t} - \text{rot} \vec{H} = 0, \quad (2.2.1)$$

$$\frac{1}{c} \frac{\partial \vec{H}}{\partial t} + \text{rot} \vec{E} = 0, \quad (2.2.2)$$

$$\text{div} \vec{E} = 0, \quad (2.2.3)$$

$$\text{div} \vec{H} = 0, \quad (2.2.4)$$

*are fundamental independent equations of motion of fields.*

where  $\vec{E}$  and  $\vec{H}$  electric and magnetic strengths of EM fields;  $c$  is velocity of light

**Definition 1:** the consequence of Maxwell equations are self-propagated in space, alternated electric and magnetic fields, which is called electromagnetic (EM) wave.

**2. Postulate of quantization of electromagnetic waves: *electromagnetic waves are superposition of the elementary wave fields named photons, which have the certain energy and zero rest mass.***

**3. A postulate of dualism of photons: *photons exist as real independent objects, which have***

a) the wave properties described by Maxwell equations (2.2.1) - (2.2.4) and by the wave equation, following from them:

$$\left( \frac{\partial^2}{\partial t^2} - c^2 \nabla^2 \right) \vec{F} = 0, \quad (2.2.5)$$

where  $\vec{F}$  is the electromagnetic wave fields  $\vec{E}$  and  $\vec{H}$ .

b) quantum properties, i.e. photons have certain, not deduced from Maxwell theory, but also not contradicting to it, the numerical characteristics determined by a below-mentioned postulate of Planck.

**4. Planck's postulate: *Connections between energy, frequency and wavelength of a photon is set by the following formulas:***

$$\varepsilon = h\nu = \hbar\omega, \quad (2.2.6)$$

$$\lambda = \frac{h}{p} = \frac{hc}{\varepsilon}, \quad (2.2.7)$$

where  $\varepsilon$ ,  $\nu$ ,  $\omega$ ,  $\lambda$ ,  $p$ ,  $c$  are an energy, linear frequency, circular frequency, length of a wave, momentum and velocity of a photon, and  $h$ ,  $\hbar$  are Planck's usual and bar constant accordingly.

**5. A postulate of quantization of wavelength of a photon: *In framework of our theory the photon contains one wavelength, which corresponds to his energy according to Planck's formula (1.7).***

The basis for this postulate is the proof of the nonlocality of the photon (for details, see Chapter 3. Photon Theory. p.30, paragraph 1.3.2 of this book) According to the analysis of Landau and Peierls (1930) and others, the wave function of a photon is inherently nonlocal. It is not determined by the value of the field at the same point, but depends on the distribution of the field in a certain region whose dimensions are of the order of the wavelength of the photon.

**Definition 1:** the object, which, on the one hand, submits to the wave equation, and on the other hand, has the limited length, as is known, refers to as a string. Thus, in framework of CWED a photon as the elementary electromagnetic wave, mathematically represents a string. To not confuse it to strings of modern "theory of strings" we will name it "an electromagnetic string" or briefly "EM-string".

**6. A postulate of formation of massive electromagnetic particles: in frameworks CWED under the certain external conditions the elementary electromagnetic wave (EM-string) can start to move on the closed curvilinear trajectory (it is bend), forming relatively stable construction - an electromagnetic particle (EM-particle).**

The basis for this postulate is the idea of a modern theory of elementary particles about the presence in the nature of gauge symmetries (see Chapter 2 (page 12), paragraph 3.2.2., Physical sense of the complexity of the functions; page.20 of the present book). Rotation can be connected with the role that has the gauge transformation.

As is known, the curvature of a trajectory of an electromagnetic wave at the motion in external strong electromagnetic field.

At the same time, it is obvious, that due to the quantum nature of a photon (EM-string) the formed particles should possess, at least, a rest mass and the angular momentum (spin). We do not consider the question, if this system of axioms is complete. Moreover, judging by the formulation of other axiomatic theories, it is possible to use another system of axioms. We considered the simplest (minimal) of them, which is necessary and sufficient for describing of all known fundamental elementary particles.

Below we consider the mathematical formulation of axiomatics of theory and physical sense of mathematical description of theory.

### **3.0. Mathematical apparatus of the nonlinear theory of elementary particles**

Mathematical apparatus of NTEP does not differ in its form from the mathematical apparatus of SM. But within the framework of NTEP special consideration is given to physical content and physical interpretation of the elements of mathematics. Below we will examine briefly some important for the development of nonlinear theory cases.

#### **3.1. Mathematical forms of writing of Maxwell's equations and their physical sense**

First of all, let us note that the physical sense of mathematical expressions is an invariant relative to mathematical symbols and it is fixed only with the determination of their physical values. This means that the choice of mathematical symbols is arbitrary and is dictated only by the convenience and tradition.

Let us enumerate some mathematical forms of Maxwell's equations without the sources (for details see (Jackson, 1999; Akhiezer and Berestetskii, 1965; Schiff, 1955; Cronin, Greenberg, Telegdi, 1967; and others) with minimum explanations.

##### **a) the scalar form**

$$\frac{\partial E_x}{\partial x} + \frac{\partial E_y}{\partial y} + \frac{\partial E_z}{\partial z} = 0,$$

$$\frac{\partial H_x}{\partial x} + \frac{\partial H_y}{\partial y} + \frac{\partial H_z}{\partial z} = 0,$$

$$\begin{cases}
\frac{1}{c} \frac{\partial E_x}{\partial t} - \left( \frac{\partial H_z}{\partial y} - \frac{\partial H_y}{\partial z} \right) = 0, \\
\frac{1}{c} \frac{\partial H_x}{\partial t} + \left( \frac{\partial E_z}{\partial y} - \frac{\partial E_y}{\partial z} \right) = 0, \\
\frac{1}{c} \frac{\partial E_y}{\partial t} + \left( \frac{\partial H_z}{\partial x} - \frac{\partial H_x}{\partial z} \right) = 0, \\
\frac{1}{c} \frac{\partial H_y}{\partial t} - \left( \frac{\partial E_z}{\partial x} - \frac{\partial E_x}{\partial z} \right) = 0, \\
\frac{1}{c} \frac{\partial E_z}{\partial t} - \left( \frac{\partial H_y}{\partial x} - \frac{\partial H_x}{\partial y} \right) = 0, \\
\frac{1}{c} \frac{\partial H_z}{\partial t} + \left( \frac{\partial E_y}{\partial x} - \frac{\partial E_x}{\partial y} \right) = 0
\end{cases} \quad (2.3.1)$$

Let us note that in a number of cases (especially in case of the electrodynamics of waves of high frequencies) the field functions and the electrodynamic parameters of equations (2.3.1) are considered as complex functions. This makes it possible to solve more simply the problems of generation and propagation of EM waves.

The system of equations (2.3.1) is a most detailed writing of Maxwell's equations in a form, suitable for the solution of concrete practical problems. Further enumerated forms, with respect to this, are different kinds of compactification of record.

**b) the vector form, expressed through the vector of the strength of the EM field:**

$$\begin{aligned}
\frac{1}{c} \frac{\partial \vec{E}}{\partial t} - \text{rot} \vec{H} &= 0 \\
\frac{1}{c} \frac{\partial \vec{H}}{\partial t} + \text{rot} \vec{E} &= 0, \\
\text{div} \vec{E} &= 0 \\
\text{div} \vec{H} &= 0
\end{aligned} \quad (2.3.2)$$

**b) the vector form, which uses the potentials:**

$$\begin{aligned}
\bar{\nabla}^2 \vec{A} - \frac{1}{c^2} \frac{\partial^2 \vec{A}}{\partial t^2} &= 0, \\
\bar{\nabla}^2 \varphi - \frac{1}{c^2} \frac{\partial^2 \varphi}{\partial t^2} &= 0
\end{aligned} \quad (2.3.3)$$

The field strengths are expressed here through potentials by the relationships:

$$\vec{E} = -\bar{\nabla} \varphi - \frac{\partial \vec{A}}{\partial t}, \quad \vec{H} = \text{rot} \vec{A}$$

**b') the 4-dimensional form, which uses the 4-potential:**

$$\partial^2 A_\mu / \partial t^2 - \Delta A_\mu = 0, \quad (2.3.4)$$

or through d'Alembert operator:

$$\square A_\mu = 0, \quad (2.3.4')$$

where the Greek index  $\mu$  takes the values: 1,2,3,4.

**c) the tensor form**

Introducing the following tensor of electromagnetic field:

$$F_{\mu\nu} = \frac{\partial A_\mu}{\partial x_\nu} - \frac{\partial A_\nu}{\partial x_\mu},$$



where the Greek indices  $\lambda, \mu, \nu$ , take the values: 1,2,3,4, it is possible for all the equations of Maxwell to be written down in the form of two tensor equations:

$$\frac{\partial F_{\mu\nu}}{\partial x_\lambda} + \frac{\partial F_{\nu\lambda}}{\partial x_\mu} + \frac{\partial F_{\lambda\mu}}{\partial x_\nu} = 0, \quad \frac{\partial F_{\mu\nu}}{\partial x_\nu} = 0, \quad (2.3.5)$$

or, more briefly:

$$\partial_\mu F_{\nu\lambda} + \partial_\nu F_{\lambda\mu} + \partial_\lambda F_{\mu\nu} = 0, \quad \partial_\nu F^{\mu\nu} = 0, \quad (2.3.5')$$

where the rule of summation over the repetitive indices is used, as well as the reduced record of differentiation).

**d) the bivector form:**

$$\frac{1}{c} \frac{\partial \vec{F}}{\partial t} - \text{rot} \vec{F} = 0, \quad (2.3.6)$$

where  $\vec{F} = \vec{E} + i\vec{H}$ ,  $\vec{F}^* = \vec{E} - i\vec{H}$  are the complex-conjugate bivectors.

**f) the bivector operator- matrix form, adequate to Dirac's equation form**

$$i \frac{1}{c} \frac{\partial \vec{F}}{\partial t} - (\hat{S} \cdot \hat{p}) \vec{F} = 0, \quad (2.3.7)$$

where  $\vec{F}$  is the bivector;  $\hat{p} = -i\hbar\vec{\nabla}$  is the operator of momentum;  $\hat{S} = \{\hat{S}_1, \hat{S}_2, \hat{S}_3\}$  are, the so-called, spin matrices of photon, which are the generators of rotation in the 3D-space:

$$\hat{S}_0 = I, \hat{S}_1 = \begin{pmatrix} 0 & 0 & 0 \\ 0 & 0 & -i \\ 0 & i & 0 \end{pmatrix}, \hat{S}_2 = \begin{pmatrix} 0 & 0 & i \\ 0 & 0 & 0 \\ -i & 0 & 0 \end{pmatrix}, \hat{S}_3 = \begin{pmatrix} 0 & -1 & 0 \\ 1 & 0 & 0 \\ 0 & 0 & 0 \end{pmatrix},$$

where  $I \equiv \hat{S}_0$  is a single 3 x 3 matrix. Comparing the cases d) and e) it is not difficult to see that they differ only by the form of the record of rotation of fields:  $\text{rot} \vec{F} = (\hat{S} \cdot \hat{p}) \vec{F}$ .

It is possible to easily ascertain that the matrices  $S$  are subordinated to commutation relationships for the momentum  $[\vec{S}, \vec{S}] = i\vec{S}$  and moreover, that  $S^2 = S_1^2 + S_2^2 + S_3^2 = 2I$ . From this follows that the equation (2.3.7.) describes the particle with spin 1, for which  $S^2 = S(S+1)I$ . This means that this particle spin  $S$  is equal to one some as for photon.

**g) equations in the quantum form:**

$$\begin{aligned} (\hat{\alpha}_0^{(6)} \hat{\varepsilon} - c \cdot \hat{\alpha}^{(6)} \hat{p}) \psi &= 0 \\ \psi^+ (\hat{\alpha}_0^{(6)} \hat{\varepsilon} + c \cdot \hat{\alpha}^{(6)} \hat{p}) &= 0 \end{aligned} \quad (2.3.8)$$

where  $\hat{\varepsilon} = i\hbar \frac{\partial}{\partial t}$ ,  $\hat{p} = -i\hbar\vec{\nabla}$  are operators of energy and momentum;  $\hat{\alpha}^{(6)}$  are 6 x 6 - matrices of the following form:

$$\hat{\alpha}^{(6)} = \begin{pmatrix} \hat{0} & \hat{S} \\ \hat{S} & \hat{0} \end{pmatrix}, \hat{\alpha}_0^{(6)} = \begin{pmatrix} \hat{S}_0 & \hat{0} \\ \hat{0} & \hat{S}_0 \end{pmatrix}, \hat{\alpha}_4^{(6)} \equiv \hat{\beta}^{(6)} = \begin{pmatrix} \hat{S}_0 & \hat{0} \\ \hat{0} & -\hat{S}_0 \end{pmatrix};$$

where  $\hat{0}$  is 3 x 3- zero matrix; wave function  $\psi = \begin{pmatrix} \vec{E} \\ i\vec{H} \end{pmatrix}$  and Hermitian-conjugated to it function  $\psi^+ = (\vec{E} \quad -i\vec{H}) = (E_x \quad E_y \quad E_z \quad iH_x \quad iH_y \quad iH_z)$  are 6 x 1 and 1 x 6 matrices, respectively.

Let us note that these equations are similar to Dirac's equation without the mass term and describe two antisymmetric systems of Maxwell equations (which can be considered as equations in the right and left handed system of coordinates). It is not difficult to verify that the given above 6x6 matrices give correct expressions for the energy density:  $\psi^+ \hat{\alpha}_0^{(6)} \psi = \vec{E}^2 + \vec{H}^2 = 8\pi U$ , for the vector of Poynting (and for momentum density, respectively):  $\vec{S}_p = \frac{1}{8\pi} \psi^+ \vec{\alpha}^{(6)} \psi$ , and also for Lagrangian of the EM field:  $\psi^+ \hat{\alpha}_4^{(6)} \psi = \vec{E}^2 - \vec{H}^2 = 8\pi I_1$ .

Let us emphasize that this form, although identical to the usual equations of Maxwell, has a richer sense. As we will show subsequently, it reflects the connection of electrodynamics with quantum mechanics.

### 3.2. The forms of the record of field equations and parameters

Besides enumerated above forms, there are also other forms: quaternion, biquaternion, algebraic and others. A great number of record forms of equation in different systems of coordinates (including curvilinear) should be added. Moreover, not only the equations of electromagnetism, but almost all equations of physics can be written down in a set of forms.

Are these forms physically significant? Or in other words, are some of them capable of giving additional results in comparison with other forms? It is not difficult to understand that all enumerated above forms of the equations of EM field from a) to g) are almost (with some exceptions, which we will mention below) equal: no additional results can any of them give in comparison to others. As proof of this assertion serves the fact that from any form we can pass to the form a). Furthermore, in order to obtain of the real solution of a problem we must pass from any form to such form, in which all the equation quantities can be measured.

But frequently an exceptional sense is given to the choice of one or another form. Here the position is complicated by the fact that many judgments and conclusions, which are recognized as obvious but are not reinforced by proofs, were accumulated. This leads sometimes to conclusions, which are not justified in any way, and even to difficulties in the theories, which we will note below.

At the same time, the different mathematical forms of writing of equations are not useless: each form has some physical sense. If we characterize the usefulness of forms by one general property, it is possible to say that each form facilitates a solution of a specific problem. It is not difficult to see that each form is invented and introduced into the practice in order to reflect some characteristic of a physical object. Actually these characteristics (as EM field strengths and EM potentials, energy - momentum and frequency - wave vector, etc) are connected together one-to-one or with an accuracy to the values, which do not affect measurements. Therefore we can formulate equations, separating in each case some parameters and leaving others in a latent state.

Thus there is connection between the force and the energy. In particular, due to this connection, at least two forms of the equations - energy and force forms exist. Depending on initial conditions and requirements of task, it is more easy to solve it in one or the other equation form.

Below we will examine in greater detail the physical sense of some mathematical forms, which play an important role in the theory of elementary particles.

#### 3.2.1. Choice of the wave functions

As is known (Akhiezer and Berestetskii, 1969; Levich, Vdovin and other, 1971; Gottfried and Weisskopf, 1984), the wave theory of photon is the quantized theory of the electromagnetic waves of classical electrodynamics.

In the literature of recent decades can be found the assertion that the 4-potential of electromagnetic field is the quantum wave function of photon. Accordingly, in this case the equations of electrodynamics, expressed through the 4-potential of electromagnetic field, serve as base for the introduction of the quantum equation of photon.

Unfortunately, the authors, who use this approach, usually forget to mention that this is not the only choice of wave functions and equations of photon. Moreover, at the initial stage of development of the theory the strength of electromagnetic field most served frequently as wave functions of photon theory (Akhiezer and Berestetskii, 1969; Levich, Vdovin and other, 1971). Most clearly this possibility is manifested in the operator-matrix form f), where the matrices of photon are clearly present.

As we noted above, in this case the choice of one or the other form cannot destroy the theory, since the potentials of electromagnetic field can be expressed through its strengths. But as is known, in this case the correspondence between the field strengths and its potentials is determined with an accuracy to some arbitrary functions. On one hand, this makes it possible to select the different gauge transformation of potentials, which facilitates solution of problems. But on the other hand, this makes the theory ambiguous. Unfortunately, in the contemporary theory, in which the gauge transformation plays the basic role, this leads to a significant complication of the theory.

In the proposed theory we reject this ambiguity, and as wave functions and wave equations we use only the strength vectors of electromagnetic field. In this case it is possible to avoid some difficulties, which appear in the theory of Standard Model.

### 3.2.2. *Physical sense of the complexity of the functions*

The complex form of record plays a very important role in the quantum theory of elementary particles. As is known, complexity is the inherent property of the equations of quantum mechanics and theory of elementary particles. In the quantum field theory the physical characteristics of field (energy, momentum and so forth) are determined by bilinear forms from the wave functions. A probabilistic interpretation would encounter great difficulties, if the wave functions of elementary particles were real. But namely because of this interpretation, the complexity of equations and wave functions does not have a physical sense in the framework of modern quantum theory.

On the other hand, since the wave function describes elementary particles, i.e. the real physical objects, it would be very strange, if the complexity of wave functions did not have a physical sense.

A complex quantity can be expressed in various mathematical forms, each of which reflects some physical property. The record:  $z = x + iy$  (where  $x$  and  $y$  are real numbers, and symbol  $i$  shows independence of  $x$  and  $y$ ), in the geometric sense reflects the position of material point on the plane in the system of rectangular coordinates  $x$  and  $y$ . In this case the value  $z$  can be compared with the radius-vector of point  $(x, y)$  with length  $r = |z| = \sqrt{x^2 + y^2}$ .

If we express actual  $x$  and imaginary  $y$  parts of the complex value through the module  $r = |z|$  and argument  $\phi$  so that  $x = r \cos \phi$ ,  $y = r \sin \phi$ , any complex number  $z$ , except zero, can be written down in the trigonometric form:  $z = r(\cos \phi + i \sin \phi)$ .

The physical sense of the *exponential* form, connected with the *trigonometric* form through the Euler formula  $e^{i\phi} = \cos \phi + i \sin \phi$ , consists in the rotation of vector  $r$  to the angle  $\phi$ . If rotation is accomplished with the angular velocity  $\omega$ , the indicated form of record describes the rotation of vector  $r$  with the angular velocity  $\omega$ .

Comparing trigonometric and exponential forms, it is not difficult to conclude that the complex form describes also two mutually perpendicular oscillations along the axes  $x$  and  $y$  with the angular frequency  $\omega$ . In connection with this, let us note an additional important property of the exponential form.

The general equation of circle in the Cartesian coordinates (with the center at the origin of coordinates) is written in the form of the **nonlinear** equation  $x^2 + y^2 = R^2$ , where  $R$  is radius of a circle. At the same time, this circle can be described with the system of two **linear**

parametric equations:  $x = R \cos \omega t$ ,  $y = R \sin \omega t$ , or in the form of one linear parametric equation:  $z = R \cdot e^{i\omega t}$ .

An important conclusion follows from this: *the complex form of record reflects the identity of the **nonlinear** circular motion (rotation) of point to the sum of **two linear** harmonic oscillations along mutually perpendicular axes.*

As it is known the possibility of complex record of the equations and their parameters is inherent in Maxwell's theory.

Actually, in the basis of electromagnetic theory lies the description of the motion of three vectors: electrical  $\vec{E}$ , magnetic  $\vec{H}$  and Poynting's vector  $\vec{S}_p = \frac{1}{4\pi} [\vec{E} \times \vec{H}]$ , which reflect the connection between the electromagnetic and mechanical values of theory. These three vectors are mutually perpendicular. In the tasks of emission and propagation of waves they are described by harmonic functions. Moreover, in the majority of physical tasks these functions can be decomposed in the Fourier series according to the trigonometric or exponential functions

$$f(t) = \sum_{\omega=-\infty}^{+\infty} f_{\omega} e^{i\omega t} = \sum_{\omega=-\infty}^{+\infty} f_{\omega} (\cos \omega t + i \sin \omega t).$$

As far as quantum theory is concerned, as it is known, the solutions of the equations of quantum field theory are the harmonic waves, recorded in the complex form:

$$\psi = B \exp\left(-\frac{i}{\hbar}(\varepsilon t - \vec{p}\vec{r})\right), \quad (2.3.9)$$

where  $B = be^{i\phi}$ ; amplitude  $b$  is the number, and  $\phi$  is the initial phase of wave. Function (2.3.9) is the eigenfunction of the operator of energy-momentum, where  $\varepsilon$  and  $\vec{p}$  are the eigenvalues of energy and momentum respectively. At any point of space this wave describes harmonic oscillation with respect to time, which is possible to interpret also as the rotation:

$$\psi = C \exp\left(-\frac{i}{\hbar}\varepsilon t\right) = C \exp(-i\omega t) \quad (2.3.10)$$

where  $\varepsilon = \hbar\omega$ . This interpretation can be connected with the role that has the gauge transformation theory in physics of elementary particles. As is known, the gauge transformations of the wave function, which are the transformations of its phase, make it possible to describe all interactions of elementary particles. *From a physical point of view these transformations consist in the rotation of own field particles.*

We can assume that in connection with quantum theory of elementary particles these interpretations of complex function correspond to the behavior of the objects of these theories. *In other words, by means of the complex form of record the **nonlinear** nature of the objects of the quantum field theory can be described in the **linear** form.*

We will examine the descriptions of two types of rotation, characteristic in the classical and quantum theory (Rayder, 1985). This will allow us to draw a number of important conclusions.

## 1) Description of arbitrary rotation in the three-dimensional space

### 1a) Description with the use of mathematical apparatus of classical mechanics

In general form for the arbitrary rotation in the space it is possible to write it down as:

$$\begin{pmatrix} x' \\ y' \\ z' \end{pmatrix} = (R) \begin{pmatrix} x \\ y \\ z \end{pmatrix}$$

where the 3-- -matrix of rotation is the orthogonal 3 X. Arbitrary rotation in the space is composed of rotations around each of the axes, each of which is described by conformable matrix. Matrix  $R$  is the work of these three matrices, which form the group, designated by  $O(3)$ . Using trigonometry, it is possible to find these matrices:

$$R_z(\theta) = \begin{pmatrix} \cos \theta & \sin \theta & 0 \\ -\sin \theta & \cos \theta & 0 \\ 0 & 0 & 1 \end{pmatrix}, R_x(\phi) = \begin{pmatrix} 1 & 0 & 0 \\ 0 & \cos \phi & \sin \phi \\ 0 & -\sin \phi & \cos \phi \end{pmatrix}, R_y(\chi) = \begin{pmatrix} \cos \chi & 0 & -\sin \chi \\ 0 & 1 & 0 \\ \sin \chi & 0 & \cos \chi \end{pmatrix}$$

The three angles (in this case, Euler) are called parameters of rotation. Matrices do not commute between themselves. It is possible to express torque tel. through the matrices indicated

### 1b) Description with the use of mathematical apparatus of quantum field theory

In the group theory, which is the mathematical apparatus of the quantum field theory, in order to obtain the rotation on final angle infinitesimal rotations are used to infinitely small angle. Their matrices are expressed as follows:

$$R_z(\delta\theta) = 1 + iJ_z\delta\theta, R_x(\delta\phi) = 1 + iJ_x\delta\phi, R_y(\delta\chi) = 1 + iJ_y\delta\chi,$$

where  $J_z, J_x, J_y$  are called generators of rotations, which are determined as follows,:

$$J_z = \frac{1}{i} \frac{dR_z}{d\theta} \Big|_{\theta=0} = \begin{pmatrix} 0 & -i & 0 \\ i & 0 & 0 \\ 0 & 0 & 0 \end{pmatrix}, J_x = \begin{pmatrix} 0 & 0 & 0 \\ 0 & 0 & -i \\ 0 & i & 0 \end{pmatrix}, J_y = \begin{pmatrix} 0 & 0 & i \\ 0 & 0 & 0 \\ -i & 0 & 0 \end{pmatrix}$$

It is possible to express the angular momentums of classical bodies through the rotation generators.

It is not difficult to show that the matrix of rotation to the final angle is expressed as the complex function:

$$R_z(\theta) = e^{iJ_z\theta}, R_x(\phi) = e^{iJ_x\phi}, R_y(\chi) = e^{iJ_y\chi}$$

It is easy to ascertain that this corresponds to the matrices, given above:

$$e^{iJ_z\theta} = 1 + iJ_z \frac{\theta}{1!} - iJ_z^2 \frac{\theta^2}{2!} - iJ_z^3 \frac{\theta^3}{3!} + \dots = \begin{pmatrix} 1 & 0 & 0 \\ 0 & 1 & 0 \\ 0 & 0 & 1 \end{pmatrix} + \theta \begin{pmatrix} 0 & 1 & 0 \\ -1 & 0 & 0 \\ 0 & 0 & 0 \end{pmatrix} + \frac{\theta^2}{2!} \begin{pmatrix} -1 & 0 & 0 \\ 0 & -1 & 0 \\ 0 & 0 & 0 \end{pmatrix} + \frac{\theta^3}{3!} \begin{pmatrix} 0 & -1 & 0 \\ 1 & 0 & 0 \\ 0 & 0 & 0 \end{pmatrix} + \dots = \begin{pmatrix} \cos \theta & \sin \theta & 0 \\ -\sin \theta & \cos \theta & 0 \\ 0 & 0 & 1 \end{pmatrix} = R_z(\theta)$$

and so forth.

## 2) Description of arbitrary rotation in the spinor space

It is not difficult to show (Rayder, 1985), that the  $SU(2)$ -transformation above the spinor

$\begin{pmatrix} \sigma_1 \\ \sigma_2 \end{pmatrix}$  is completely similar to the  $O(3)$ -transformation above the vector  $\begin{pmatrix} x \\ y \\ z \end{pmatrix}$ . In other words, all

mathematical formulas occur for  $SU(2)$ -transformation, which are given above for  $O(3)$ -transformation, recorded in the mathematical form of both classical mechanics and the quantum theory. If we designate the matrix of the  $SU(2)$ -transformation through  $U$ , then we have the following correspondence between spinor and vector fields for a rotation relative to any axis  $\vec{n}$  to the angle  $\theta$ :

$$U = e^{i\vec{\sigma}\vec{n}\theta/2} = \cos(\theta/2) + i\vec{\sigma}\vec{n}\sin(\theta/2) \leftrightarrow R = e^{i\vec{j}\vec{n}\theta}$$

where  $\vec{\sigma}$  are the Pauli spinor matrices. From this correspondence follows that the transformation describes the turning of spinor to half of that angle, to which the vector turns. In the quantum theory the wave functions of fermions actually possess such special feature (see the theory of electron). It appears that  $\vec{J}$  and  $\vec{\sigma}$  can be written down also as differential operators (not only as matrix). They will, of course, obey the same commutation relations.

So we will obtain for the rotation in the 3-dimensional space (3x3 matrices)  $\hat{J} = [\hat{r} \times \hat{p}]$ ,

where  $\hat{r} = \{x, y, z\}$ ,  $\hat{p} = -i\hbar\vec{\nabla}$ . Applied to the wave function, this operator will give the value of angular momentum.

Depending on the stated goal we can use various forms of description. In this case, description in the form of classical physics gives to us the visual physical interpretation of mathematics, utilized in the quantum theory.

### 3.2.3. Physical sense of the four-dimensional forms

There is the opinion that the 4-space-time record of the equations of Maxwell and other equations makes fundamental sense and contains much additional information. In particular, with 4-dimensional form of electrodynamics is connected the covariance of equations of EM field relative to the transformations of Poincare-Lorentz group. The existence of a 4-dimensional form of record is understood sometimes as an independent existence of 4-dimensional space-time. Frequently the writing of the laws of physics in four-dimensional form identifies with the relativity. The assertion that only the four-dimensional form of record is correct is even encountered.

The 4-dimensional form of record actually has a great physical sense, but not the one that is enumerated above. The best thing about this was said by R. Feynman (Feynman, Leighton, Sands, 1964):

*“This equation, together with the conservation of charge, gives us the fundamental law of the electromagnetic field:*

$$\partial^2 A_\mu / \partial t^2 - \Delta A_\mu = j_\mu / \epsilon_0, \quad \nabla_\mu j_\mu = 0 \quad (25.29)$$

*There, in one tiny space on the page, are all of the Maxwell equations - beautiful and simple. Did we learn anything from writing the equations this way, besides that they are beautiful and simple? In the first place, is it anything different from what we had before when we wrote everything out in all the various components? Can we from this equation deduce something that could not be deduced from the wave equations for the potentials in terms of the charges and currents? The answer is definitely no. The only thing we have been doing is changing the names of things - using a new notation...*

*What then is the significance of the fact that the equations can be written in this simple form? From the point of view of deducing anything directly, it doesn't mean anything. Perhaps, though, the simplicity of the equations means that nature also has a certain simplicity...*

*It is therefore absolutely obvious that a simple notation that just hides the complexity in the definitions of symbols is not real simplicity. It is just a trick...*

*However, there is more to the simplicity of the laws of electromagnetism written in the form of Eq. (25.29)... The fact that the electromagnetic equations can be written in a very particular notation which was designed for the four-dimensional geometry of the Lorentz transformations - in other words, as a vector equation in the four-space - means that it is invariant under the Lorentz transformations...*

*The fact that the Maxwell equations are simple in this particular notation is not a miracle, because the notation was invented with them in mind. But the interesting physical thing is that every law of physics must have this same invariance under the same transformation”.*

Obviously, there is no need to rewrite the theory in the 4-dimensional designations in order to prove its Lorentz-covariance. The covariance of Maxwell's equations relative to the transformations of Poincare-Lorentz was proven before the 4-dimensional form of record was introduced into physics. Moreover, Maxwell's equations are relativistic-invariant not only in the 4-dimensional record, but in any correct record.

Nevertheless, the question remains why most common forms of physical equations can be recorded in the 4-dimensional form (or differently: which physical reason exists for the fact that “every law of physics must have this same invariance under the same transformation”?). It is possible to say that Lorentz transformations appear as the reflection of some unified beginning of nature. Then the question can be reformulated as: what unified beginning of nature does the existence of the Lorentz transformations reflect?

From a formal point of view “four-dimensionality of world” consists in the fact that all “correct”, i.e. relativistic equations of nature must contain, conditionally speaking, both time and space coordinates in the same degree.

Then the question arises: is there such unified physical quantity, which does contain simultaneously both time and space coordinates and makes equations relativistic, and the world “four-dimensional”?

It occurs that such value exists. Let us name this function as theta ( $\mathcal{G}$ ) and let us enumerate the requirements, which it must satisfy:

- 1) for describing the material particles, it must enter a de Broglie phase wave (2.3.9):
- 2) it must describe gauge transformation, i.e. it must be phase invariance;
- 3) it must contain the pair of canonical variables “time - space coordinates” and it must not have a sense with respect to separate components of this pair;
- 4) it must be physical, i.e. it must contain values, which can be measured directly.
- 5) it must be dimensionless in order to be invariant relatively to the choice of units.

Obviously, only the phase of wave (2.3.9) is such value “theta”:

$$\mathcal{G} = \frac{1}{\hbar}(\varepsilon t - \vec{p}\vec{r}) = (\omega t - \vec{k}\vec{r}), \quad (2.3.11):$$

It satisfies all requirements enumerated above and offers explanation of many facts. Actually, comparing the 4-vectors we see that, in spite of apparent variety, they are connected with each other with the completely specific relationships, out of which this association has no sense. It is moreover, not difficult to show that all canonical dual variables can be expressed through the function “theta”.

Now it is possible to answer the question, why the transformations of Poincare-Lorentz determine, in a certain sense, the physics of our world: the wave, which describes matter, must not change from rotations and displacement of the coordinate system

The Lorentz transformations corresponds to invariance with respect to the rotation in the 4- dimensional space, which are described by the mathematical expressions, similar to the ones given above.

As is known, on the basis of Noether theorem, the conservation laws follow from the invariance relative to transformations.

In particular, from the invariance relative to the transformations of Poincare follow the conservation laws of energy and momentum. But it is not difficult to obtain these laws also from the function of theta.

The invariance of the function of theta relative to shift in the time means that  $\partial\mathcal{G}/\partial t = const1$ , while the invariance relative to shift in the space means that  $grad \mathcal{G} = const2$ . Actually, it follows from (3.11):

$$\frac{\partial \mathcal{G}}{\partial t} = \varepsilon/\hbar, \quad grad \mathcal{G} = -\vec{p}/\hbar, \quad (2.3.12)$$

From this follows that  $\varepsilon = \hbar \cdot const1$  and  $\vec{p} = \hbar \cdot const2$ , or in the case of EM wave:  $\varepsilon = \hbar \cdot \omega$  and  $\vec{p} = \hbar \cdot \vec{k}$  ( $\vec{k} = \vec{k}^0/\lambda$  is the wave vector,  $\lambda = \lambda/2\pi$  is the shortened wavelength).

As we see,, although the values (3.12) compose the 4-vector, the presence of the conservation laws is not connected to this fact.

Moreover, the function of “theta” gives the possibility of describing not only different parameters of particles, but it can also serve as the basis of the construction of theory.

In the case of EM wave we obtain:

$$\left(\frac{1}{c} \frac{\partial \mathcal{G}_{pl}}{\partial t}\right)^2 - (grad \mathcal{G}_{pl})^2 = 0, \quad (2.3.13)$$

i.e. Hamilton-Jacobi equation, which describes the propagation of the front of plane EM wave. It is also obvious that this equation is simultaneously a dispersion equation of EM wave:

$$\omega^2 - c^2 \vec{k}^2 = 0.$$

As is known in the case of nonlinear waves this relationship takes the form:

$$\omega^2 - c^2 \vec{k}^2 = \omega_0^2, \quad (2.3.14)$$

where  $\omega_0$  is constant. Comparing with the equation of energy-momentum conservation, which describes massive particle (for example, electron):

$$\varepsilon^2 - c^2 \vec{p}^2 = m^2 c^4, \quad (2.3.15)$$

it is not difficult to ascertain that it corresponds namely to nonlinear waves. Moreover, this equation, expressed through the function of theta:

$$\left( \frac{1}{c} \frac{\partial \mathcal{G}}{\partial t} \right)^2 - (\text{grad } \mathcal{G})^2 = \hbar^2 m^2 c^2, \quad (2.3.16)$$

corresponds to Hamilton-Jacoby equation, if the action according to Hamilton was chosen in the form

$$S_H = \hbar^2 \mathcal{G}, \quad (2.3.17)$$

Let us recall that the  $\psi$  - function of the Schroedinger equation is introduced by him (Schroedinger, 1926) by the expression, which coincides to (2.3.9). Namely, he assumed:

$$\psi = \psi_0 \exp\left(i \frac{S_H}{\hbar}\right), \quad (2.3.18)$$

From the stated above follows that the invariance relative to phase actually corresponds to the invariance of the Lagrangian and action relative to phase (gauge) transformations. Furthermore, we see that the function of “theta” actually makes it possible to formulate a theory in the 4-dimensional form. But it is not difficult to understand that physics in the four-dimensional form gives no new results in comparison with physics, which uses separately these values, since they are always measured independently one from the other.

The only thing that the 4-dimensional approach confirms, is that the material objects are built from waves.

### 3.2.4. Physical sense of the choice of coordinates for writing of the equations

The laws of conservation are known from Newton's times. In our time the presence of the laws of conservation is connected with the symmetry of task, since mathematically the presence of symmetry is equivalent to conservation of some value. This connection (Noether theorem) was discovered only at the end of XIX centuries and has been used since the beginning of XX centuries. Thus, although the connection of symmetry with the conservation laws is interesting itself, this fact should not given a superfluous sense.

However, using this connection, we can explain the advantages of the appropriate choice of the coordinate system. It known for a long time that the choice of coordinates, which corresponds to the symmetry of task, considerably facilitates the solution of problem. It follows from above that the choice of the coordinate system to be symmetrical for this task automatically considers the appropriate laws of conservation, and in other words reduces the number of unknown parameters of the problem.

For example, the motion of two bodies in the gravitational field (Kepler's task, solved by Newton) are characterized by twelve variables - three coordinates and three projections of momentum. In this case Newton's equations are subordinated to 10 laws of conservation. Using the suitable coordinate system, that automatically considers some of these laws, it is possible to reduce the number of unknown variables and to facilitate the solution of problem.



## Chapter 3. The photon theory

### 1.0. Basic ideas and the results of the contemporary quantum theory of the photon

The quantum theory of the photon is part of the theory of quantum electrodynamics (QED) (Akhiezer and Berestetskii, 1969). Let us briefly look at its fundamental notions, which are necessary to understand the place of photon theory in the proposed nonlinear field theory.

#### 1.1. Foundations of the theory of photons in QED

There are several approaches to constructing the quantum theory of photons, but they all originate from the same source, Maxwell's equations, and give us identical results.

We will follow some of the earliest ideas, which are not less consistent than later approaches. At the same time, these earliest ideas allow us to unify different physical representations of elementary particles.

The simplest task of quantum field theory (Akhiezer and Berestetskii, 1969) is to describe the state of a free particle. In this case, the wave function of the particle is a field in three-dimensional space. Let us examine how the wave function of the photon is introduced, and its wave equation is built.

Within the framework of QED (Akhiezer and Berestetskii, 1969; Gottfried, and Weisskopf, 1984), it is natural to consider the Maxwell equations as field equations which describe the quantum mechanical state of photons or a photon system. It is not difficult to show that this assumption, along with Planck's relationship  $\varepsilon = \hbar\omega$ , is sufficient to build the theory of the photon and its interaction with other particles (here,  $\varepsilon$  is the photon energy,  $\omega$  is an angular frequency,  $\hbar$  is the Planck constant). Within this approach, the quantized electric and magnetic fields are the wave function of a photon.

Maxwell equations with the sources that take into account the effect of media, are called Maxwell-Lorentz equations. They are the most general equations of electrodynamics (Jackson, 1999; Tonnelat, 1959). According to the first postulate of NTEP the Maxwell equations without the sources are the initial equation of our theory:

$$\frac{1}{c} \frac{\partial \vec{E}}{\partial t} - \text{rot} \vec{H} = 0, \quad (3.1.1)$$

$$\frac{1}{c} \frac{\partial \vec{H}}{\partial t} + \text{rot} \vec{E} = 0, \quad (3.1.2)$$

$$\text{div} \vec{E} = 0, \quad (3.1.3)$$

$$\text{div} \vec{H} = 0, \quad (3.1.4)$$

where  $\vec{E}$  and  $\vec{H}$  are the vectors of strength of electrical and magnetic fields.

It is not difficult to show (Longmire, 1963) that with respect to time-dependent problems Maxwell-Lorentz equations are in some sense more than complete. Equations (3.1.1) and (3.1.2) determine electrical and magnetic fields for any moment of time based on their initial values. This proves that it is possible to examine the equations (3.1.3) and (3.1.4) as initial conditions.

Also, note the following. In the general case, all four vector equations of Maxwell are used, but in the case of harmonic waves (which will be basic in our theory) the system of these equations is reduced to first two. In this case, the other two equations, which are the generalization of Gauss' laws for electrical and magnetic fields, follow from the two previous ones.

We know that it is possible to obtain the wave equations from Maxwell equations, in which wave functions are vectors of the electromagnetic (EM) field:

$$\begin{cases} \Delta \vec{E} - \frac{1}{c^2} \frac{\partial^2 \vec{E}}{\partial t^2} = 0 \\ \Delta \vec{H} - \frac{1}{c^2} \frac{\partial^2 \vec{H}}{\partial t^2} = 0 \end{cases}, \quad (3.1.5)$$

Thus, the Maxwell theory predicts the existence of electromagnetic waves.

Let us examine how the transition from the classical equations of the EM wave to quantum equations of the photon is accomplished within the framework of QED

## 1.2. Contemporary point of view to the nature of EM waves

According to contemporary ideas, photons are the elements (quanta) of an EM wave, and an EM wave is a flow of photons. Similar to all other elementary particles, photons simultaneously have both wave and corpuscular properties. These properties do not contradict each other.

We will briefly list the results obtained and verified by experiments in the classical and quantum theories.

### 1.2.1. Classical EM description of a wave

An electromagnetic wave is the propagated in the space disturbance of interconnected electrical and magnetic fields. According to Fourier's theorem, an electromagnetic wave of any form can be decomposed into elementary components - the harmonic EM waves of the type  $\vec{F} = \vec{F}_0 \sin(\omega t - \vec{k} \cdot \vec{r})$  or, in a complex form:  $\vec{F} = \vec{F}_0 e^{i(\omega t - \vec{k} \cdot \vec{r})}$ , where  $\vec{F} = \{\vec{E}, \vec{H}\}$  is any vector of an electrical  $\vec{E}$  or a magnetic  $\vec{H}$  field,  $\vec{F}_0$  is the wave amplitude,  $\omega$  is an angular frequency,  $t$  is time,  $\vec{k}$  is a wave vector,  $\vec{r}$  is the radius-vector of the propagating wave.

An electromagnetic wave has an energy density equal to  $u = \frac{1}{8\pi} (\vec{E}^2 + \vec{H}^2) = \frac{1}{4\pi} \vec{E}^2 = \frac{1}{4\pi} \vec{H}^2$ . The energy flow density (or intensity)  $I$  is the EM energy transferred by the wave in one unit of time through a unit of surface. The energy flow density can be presented in the form of Poynting's vector:  $\vec{S} = \frac{c}{4\pi} [\vec{E} \times \vec{H}]$ . Its absolute value can be expressed as follows:  $I = u \cdot c$ , where  $c$  is the velocity of light.

The vector of the energy flow density allows us to introduce the density of the mechanical momentum of an EM wave as follows:  $\vec{g} = \frac{\vec{S}}{c^2}$ . The presence of the linear momentum makes it possible to conditionally introduce the concept of density of EM mass as the value  $\rho_{EM} = \frac{g}{c} = \frac{u}{c^2}$ . The mass-energy relationship of EM field follows from this as  $u = \rho_{EM} \cdot c^2$ , which agrees with SRT, and leads to a conclusion about the EM origin of matter.

It is interesting that the use of these transformations for the wave train or wave packet (Becker, 1933) leads to a formula analogous to Planck's formula. Namely, the energy of the wave packet becomes equal to the following:  $\varepsilon_z = C \cdot \omega$ , where  $C$  is a constant with the dimensionality of action, which is not difficult to associate with Planck's constant. This analysis also agrees with the conclusion about the EM origin of matter.

### 1.2.2. Quantum description of the EM wave

According to Planck and Einstein (Akhiezer and Berestetskiy, 1969; Frauenfelder and Henley, 1974), a monochromatic electromagnetic (EM) wave consists of  $N$  monoenergetic photons, each of which has zero mass, an energy  $\varepsilon$ , a momentum  $\vec{p}$ , and a wavelength  $\lambda$ . It is remarkable that all photon characteristics are in one-to-one relationships, that is  $\varepsilon = \hbar \omega$ ,  $\vec{p} = \hbar \vec{k}$ ,  $\varepsilon = cp$ ,  $\varepsilon = c \hbar k$ ,  $\vec{k} = 2\pi \vec{k}^0 / \lambda$  (here,  $\vec{k}^0$  is a unit vector of the wave vector).

The number of photons in an EM wave is such that their total energy is equal to  $\varepsilon_{tot} = N\varepsilon = N\hbar\omega$ . Photons are bosons and coherent photons are capable of condensing in an EM wave (for example, in the form of a laser beam), which has a specific frequency.

The relationship between the classical and quantum descriptions is given by the probabilistic interpretation of an EM wave as a photon system.

### 1.2.3. A probabilistic interpretation of the EM wave

Obviously, the energy density of  $N$  photons with a given frequency  $\omega$ , which are in a volume  $\tau$  at a given moment, is equal to  $u = \frac{N\hbar\omega}{\tau}$ . On the other hand,  $u = \frac{1}{4\pi}\bar{E}^2 = \frac{1}{4\pi}\bar{H}^2$ . The comparison of these expressions leads to the conclusion that the number of photons per unit of volume is proportional to the square of the strength of the EM wave field:  $\frac{N}{\tau} \sim E^2$ .

If the average density of photons during a fixed time interval is large, then two different interpretations of the energy density – the wave and corpuscular ones – lead to the same observed values for the energy density. The difference is caused by the fact that in the first interpretation we consider this energy as the energy of EM wave, stored in the fields, while in the other case we look at it as the total energy of the photons that are located in a volume.

The general relationship between the wave and corpuscular views is explained by the examination of an EM wave of very small intensity. When the value  $E^2$  is so small that the average number of photons (proportional to  $E^2$ ) per unit of volume becomes less than one, then the value  $E^2$  is interpreted as the probability  $P$  of finding a photon in the given volume  $\tau$ . In this case, we can write  $P \sim E^2\tau$ ;  $P/\tau \sim E^2$  is called the probability density of the photon distribution.

Based on this approach, Max Born eventually proposed the probabilistic interpretation of the wave function of an electron in quantum mechanics.

Indication of the physical sense of the probabilistic interpretation of wave function consists in the comparison of theory of radiation of electromagnetic waves by atoms in the classical and quantum description. As is known (Physical encyclopedia 1962. V. 2, p.129. Radiation theory) “*the sequential quantum theory of emission is built on basis of QED. But if we do not consider the small effects (so-called radiation corrections), then the quantum theory of radiation leads to the same results as the classical theory. In this case it sufficient to replace in the formulas of the classical amplitudes the electrical and magnetic moments of different order with the appropriate matrix elements of electrical or magnetic moments, which are taken with respect to the wave functions of the quantum system states, between which occurs the transition*”.

In this case from the EM energy, radiated per unit time, it is possible to pass to the probabilities of radiation of the photon of the same frequency by division of EM energy by the photon energy.

As we will show further, namely such relative value determines the probabilistic interpretation of wave function, both in the case of the electrons and other elementary particles.

### 1.3. The wave function of the photon

Recall that a photon is the quantum of an EM wave, and in classical theory of the EM wave, it is described by a wave equation of the second order, which is a consequence of Maxwell's equations. Here, the EM field vectors  $\vec{E}$  and  $\vec{H}$  are wave functions.

Thus, from a physical point of view, the most simple and consistent way to introduce the wave function of a photon is through quantization of the EM field vectors  $\vec{E}$  and  $\vec{H}$  (Akhiezer and Berestetskiy, 1969).

Since the electric vector can be expressed through the magnetic vector, we can use only the generalized electric vector  $\vec{\mathcal{E}}(\vec{r}, t)$ .

### 1.3.1. Wave function of a photon in a momentum space

According to (Akhiezer and Berestetskiy, 1969; Levich, Myamlin, Vdovin, 1973), the wave function of a photon can be introduced as follows.

Quanta of light or photons are the elementary particles, as the distinctive special feature of which serves the fact that their rest mass is equal to zero. Therefore they always move with speed  $c$  in vacuum. This fact leads to some important features in the method of describing their behavior. Specifically, the connection between energy and momentum of photon is defined by the general formula

$$\varepsilon = cp = \hbar ck, \quad (3.1.6)$$

If we replace the momentum of photon with an operator, then the operator of energy in the momentum representation takes the form  $\hat{H} = c\hat{p} = \hbar c\hat{k}$ , (3.1.7) Respectively it is possible to write the Schrodinger equation in the momentum representation

$$i\hbar \frac{\partial \psi}{\partial t} = \hat{H} \psi_p, \quad (3.1.8)$$

where  $\psi_p$  is the wave function of photon in the momentum representation.

Operator  $\hat{H}$  is connected with the photon energy with the general formula

$$\varepsilon = \int \psi_p^+ \hat{H} \psi_p d\vec{p} = \hbar c \int \psi_p^+ \hat{k} \psi_p d\vec{p}, \quad (3.1.9)$$

From the other side, it is possible to consider that the photon is adequate to the EM field, which exists in the entire space. Its energy is:

$$\varepsilon = \int \frac{\vec{E}^2 + \vec{H}^2}{8\pi} d\tau = \frac{1}{4\pi} \int \vec{E}^2 d\tau, \quad (3.1.10)$$

It is natural to identify the photon energy with the energy of EM field. Both field vectors satisfy Maxwell's equations, which are reduced to the form

$$\Delta \vec{F} - \frac{1}{c^2} \frac{\partial^2 \vec{F}}{\partial t^2} = 0, \quad (3.1.11)$$

where the vector  $\vec{F}$  corresponds to the electrical and magnetic vectors:  $\vec{F} = \{\vec{E}, \vec{H}\}$ .

Decomposing  $\vec{F}$  into the Fourier integral

$$\vec{F}(\vec{r}, t) = \int \vec{F}(\vec{k}, t) e^{i\vec{k}\vec{r}} d\vec{k}, \quad (3.1.12)$$

we obtain for Fourier's components  $\vec{F}(\vec{k}, t)$  the equation

$$\frac{\partial^2 \vec{F}(\vec{k}, t)}{\partial t^2} + k^2 \vec{F}(\vec{k}, t) = 0, \quad (3.1.13)$$

or

$$\left[ \frac{\partial \vec{F}(\vec{k}, t)}{\partial t} - ikF(\vec{k}, t) \right] \left[ \frac{\partial \vec{F}(\vec{k}, t)}{\partial t} + ikF(\vec{k}, t) \right] = 0, \quad (3.1.14)$$

Since EM field is real quantity, the condition must be satisfied:

$$\vec{F}(\vec{k}) = \vec{F}(-\vec{k}), \quad (3.1.15)$$

Let us introduce instead of Fourier's  $\vec{k}$  component  $\vec{F}(\vec{k}, t)$  the new function  $\vec{f}(\vec{k}, t)$  by the specific relationships

$$\begin{cases} \vec{F}(\vec{k}, t) = N(k) [\vec{f}(\vec{k}, t) + \vec{f}^+(-\vec{k}, t)] \\ \dot{\vec{F}}(\vec{k}, t) = -ikN(k) [\vec{f}(\vec{k}, t) + \vec{f}^+(-\vec{k}, t)] \end{cases} \quad (3.1.16)$$

where  $N$  is the proportionality factor. The dot is used in order to mark the differentiation with respect to time.

It is not difficult to see that condition (3.1.15) is satisfied automatically with this representation of  $\vec{F}(\vec{k}, t)$ .

Substituting values  $\vec{F}(\vec{k}, t)$  and  $\dot{\vec{F}}(\vec{k}, t)$  in (3.1.14), we come to two equations:

$$\begin{cases} i \frac{\partial \vec{f}}{\partial t} = k \vec{f} \\ -i \frac{\partial \vec{f}^+}{\partial t} = k \vec{f}^+ \end{cases}, \quad (3.1.17)$$

Let us emphasize that the equations (3.1.17) are nothing else except for another writing form of Maxwell's equations.

Multiplying (3.1.17) on  $\hbar$ , we obtain

$$\begin{cases} i\hbar \frac{\partial \vec{f}}{\partial t} = p \vec{f} \\ -i\hbar \frac{\partial \vec{f}^+}{\partial t} = p \vec{f}^+ \end{cases}, \quad (3.1.18)$$

As we see, function  $\vec{f}(\vec{k}, t)$  satisfies the equation (3.1.18), which by its form is identical with the Schroedinger equation. If we replace  $p$  with operator  $\hat{H}$ , then function  $\vec{f}(\vec{k}, t)$  should be identified with the wave function of photon in  $k$ -representation.

Proportionality factor  $N$ , which remained, until now, arbitrary, can be determined from the comparison of (3.1.9) and (3.1.10).

Substituting in (3.1.10) the decomposition (3.1.16), we obtain after the appropriate conversions:

$$\varepsilon = 4\pi^2 \int N^2(k) f(\vec{k}) f^+(\vec{k}) d\vec{k}, \quad (3.1.19)$$

With  $N = \sqrt{\frac{ck\hbar}{4\pi^2}}$  the energy of EM field and photon energy are proved to be identical. Thus,

in the  $k$ -representation photon is described by the wave function

$$\psi(\vec{k}, t) = \vec{f}(\vec{k}, t)$$

moreover the following condition is satisfied

$$\int \vec{f}^+ \vec{f} d\vec{k} = 1, \quad (3.1.20)$$

In this case Maxwell's equations for the EM field of simple harmonic wave is proved to be identical with the Schroedinger equations for the separate photon. Introducing explicit dependence on the time, it is possible to write

$$\psi(\vec{k}, t) = f_0(\vec{k}) \exp(-i\omega t) = f_0(\vec{k}) \exp\left(-\frac{i}{\hbar} \varepsilon t\right), \quad (3.1.21)$$

Let us emphasize that since Maxwell's equations are relativistic-invariant, the Schroedinger equation for the photon is also relativistic-invariant

The vectors of the EM field  $\vec{E}$  and  $\vec{H}$  are considered as classical wave functions. After representing  $\vec{E}$  and  $\vec{H}$  in the form of a Fourier integral or sum, we can pass to complex wave vectors  $\vec{f}_{\vec{k}}$ . These vectors correspond to the wave vector  $\vec{k}$ , and represent a certain generalization of vectors of the EM field.

Using the EM wave equation, it is easy to show that  $\vec{f}_{\vec{k}}$  also satisfies a similar wave equation. Representing this wave equation as a product of two equations for the advanced and retarded waves, we obtain a system of two linear equations with respect to the wave function  $\vec{f}_{\vec{k}}$ .

For the quantization of the function  $\vec{f}_{\vec{k}}$ , we postulate that in a monochromatic solution of the function  $\vec{f}_{\vec{k}}$ , namely  $\vec{f}_{\vec{k}} = \vec{f}_0(\vec{k})e^{-i\omega t}$ , the frequency  $\omega$  obeys Planck's formula  $\varepsilon = \hbar\omega$ ; hence it can be represented through the wave number  $\omega = ck$ .

In the case of one photon, the function  $\vec{f}_{\vec{k}}$  satisfies the condition  $\int \vec{f}_{\vec{k}}^* \vec{f}_{\vec{k}} d^3k = 1$ , which can be considered to be a normalization condition. We can then interpret the square of wave function  $|\vec{f}_{\vec{k}}|^2$  as the probability density of the photon with a linear momentum, equal to  $\hbar\vec{k}$ . In this case, the expressions for the energy and momentum of a photon, represented through the wave function  $\vec{f}_{\vec{k}}$ , acquire the meaning of the usual quantum mechanical expressions for the average values of energy and momentum. Thus, according to the above, the function  $\vec{f}_{\vec{k}}$  can be interpreted as a quantum wave function of the photon in the *momentum space*.

It is quite clear, based on results in (Akhiezer and Berestetskiy, 1969), that the equation of this function is equivalent to the system of Maxwell's equations. For this reason, it is possible to consider Maxwell's equation as the equation of one photon (Gersten, 2001).

### **1.3.2. Insurmountable difficulty in the introduction of photon wave function in a coordinate representation. Space nonlocality of photon**

However, the attempt to introduce the function of a photon in a *coordinate representation* revealed an insurmountable difficulty (Akhiezer and Berestetskiy, 1969; Bialynicki-Birula, 1994). According to the analysis of Landau and Peierls (Landau and Peierls, 1930), and later Cook (Cook, 1982a; 1982b) and Inagaki (Inagaki, 1994), the *wave function of a photon is nonlocal by its nature*.

After performing an inverse Fourier transform of the above function  $\vec{f}_{\vec{k}}$ , we obtain (Landau and Peierls, 1930):  $\frac{1}{(2\pi)^3} \int \vec{f}_{\vec{k}} e^{i\vec{k}\vec{r}} d^3k = \vec{f}(\vec{r}, t)$ . It seems that it is possible to define  $\vec{f}(\vec{r}, t)$  as the wave function of photon in a coordinate representation. In fact, because of the normalization condition for  $\vec{f}_{\vec{k}}$ , the function  $\vec{f}(\vec{r}, t)$  can also be normalized by the usual method:  $\int |\vec{f}(\vec{r}, t)|^2 d^3x = 1$ . However, the value  $|\vec{f}(\vec{r}, t)|^2$  can no longer be interpreted as the probability density of finding the photon at a given point of space.

It is known that the presence of a photon can be established only by its interaction with charges. This interaction is determined by values of the EM field vectors  $\vec{E}$  and  $\vec{H}$  at a given point. However, these fields are not determined by the value of the wave function  $\vec{f}(\vec{r}, t)$  at the same point, because they are defined by its values in the entire space.

In fact, components of the Fourier field vectors expressed by  $f_{\vec{k}}$  contain the factor  $\sqrt{k}$ . This can formally be written in the following form:

$$\vec{\mathcal{E}}(\vec{r}, t) = \sqrt{-\Delta} \vec{f}(\vec{r}, t), \quad (3.1.22)$$

where  $\Delta$  is the Laplace operator. However,  $\sqrt{-\Delta}$  is an integral operator, and therefore the relationship between the  $\vec{\mathcal{E}}(\vec{r}, t)$  and  $\vec{f}(\vec{r}, t)$  is not local but integral. In other words,  $\vec{f}(\vec{r}, t)$  is not determined by the field value  $\vec{E}(\vec{r}, t)$  at the same point, but depends on the field distribution in a certain region, *which has the size on the order of wavelength*.

This means that the *localization of a photon in a smaller region is impossible* and, therefore, the *concept of a probability density distribution that could be used to find the photon at a fixed point of space does not make sense*.

With respect to this fact, it is remarkable that the accuracy of all experiments with light is limited by the wavelength of electromagnetic waves. The same conclusion follows from the theory.

Let us also note that the probability density distribution, according to Lorenz's transformation, must behave as a temporary component of the four-dimensional vector. However, its divergence is equal to zero. At the same time, it is not possible to compose a bilinear combination from the vectors of an electromagnetic field; this combination forms a four-dimensional vector whose divergence can be equal to zero.

The reason for this is grounded in the fact that the values of energy density  $u = \frac{1}{8\pi}(\vec{E}^2 + \vec{H}^2)$ , and the momentum density of the field  $\vec{S} = c^2 \vec{g} = \frac{c}{4\pi}[\vec{E} \times \vec{H}]$ , which satisfy the continuity equation, do not form a four-dimensional vector (the four-dimensional vector is formed only by the energy-momentum of an EM field).

Thus (Blokhintsev, 1982), in the case of a free electromagnetic field, it is not possible to construct a value that could play the role of the probability density of finding the photon in one or another point of space at a given moment of time. However, this value can be constructed, relying on the integral values - energy and momentum, which compose 4- vector and can be related to any chosen part of space.

## 2.0. Linear EM wave equation in matrix form

Within the framework of the proposed nonlinear theory of elementary particles (NTEP), the photon is considered as an object of QED described by a known linear wave equation. The only differences of our theory from the QED relate to the form of equations and the interpretation of their characteristics.

### 2.1. Wave equation of a photon in matrix form

Let us consider the general case of a circularly polarized electromagnetic (EM) wave that is moving, for instance, along the  $y$  - axis. This wave is the superposition of two plane-polarized waves with mutually perpendicular vectors of the EM fields:  $\vec{E}_x, \vec{H}_z$  and  $\vec{E}_z, \vec{H}_x$ . The electric and magnetic wave fields can be written in a complex form as follows:

$$\begin{cases} \vec{E} = \vec{E}_o e^{-i(\omega t - ky)} + \vec{E}_o^* e^{i(\omega t - ky)} \\ \vec{H} = \vec{H}_o e^{-i(\omega t - ky)} + \vec{H}_o^* e^{i(\omega t - ky)} \end{cases}, \quad (3.2.1)$$

An electromagnetic wave propagating in any direction can have two plane polarizations; it contains only four field vectors. For example, in the case of  $y$  -direction, we have:

$$\vec{\Phi}(y) = \{E_x, E_z, H_x, H_z\}, \quad (3.2.2)$$

and  $E_y = H_y = 0$  for all transformations. Here, note that the Dirac bispinor also has only four components.

The EM wave equation has the following known form (Jackson, 1999):

$$\left( \frac{\partial^2}{\partial t^2} - c^2 \vec{\nabla}^2 \right) \vec{\Phi}(y) = 0, \quad (3.2.3)$$

where  $\vec{\Phi}(y)$  is any of the above electromagnetic wave field vectors (3.2.2). In other words, this equation represents four equations: one for each vector of the electromagnetic field.

We can also write this equation in the following operator form:

$$\left(\hat{\varepsilon}^2 - c^2 \hat{p}^2\right) \Phi(y) = 0, \quad (3.2.4)$$

where  $\hat{\varepsilon} = i\hbar \frac{\partial}{\partial t}$ ,  $\hat{p} = -i\hbar \vec{\nabla}$  are correspondingly the operators of energy and momentum;  $\Phi$  is a matrix which consists of the four components  $\vec{\Phi}(y)$ .

Taking into account that  $(\hat{\alpha}_o \hat{\varepsilon})^2 = \hat{\varepsilon}^2$ ,  $(\hat{\alpha} \hat{p})^2 = \hat{p}^2$ , where  $\hat{\alpha}_o = \begin{pmatrix} \hat{\sigma}_0 & 0 \\ 0 & \hat{\sigma}_0 \end{pmatrix}$ ;  $\hat{\alpha} = \begin{pmatrix} 0 & \hat{\sigma} \\ \hat{\sigma} & 0 \end{pmatrix}$ ;  $\hat{\beta} \equiv \hat{\alpha}_4 = \begin{pmatrix} \hat{\sigma}_0 & 0 \\ 0 & -\hat{\sigma}_0 \end{pmatrix}$  are Dirac's matrices and  $\hat{\sigma}_0, \hat{\sigma}$  are Pauli's matrices, equation (3.2.4) can also be represented in a matrix form:

$$\left[ (\hat{\alpha}_o \hat{\varepsilon})^2 - c^2 (\hat{\alpha} \hat{p})^2 \right] \Phi = 0, \quad (3.2.5)$$

Recall that in case of a photon  $\omega = \varepsilon/\hbar$  and  $k = p/\hbar$ . From equation (3.2.5), using (3.2.1), we obtain  $\varepsilon = cp$ , which is the same as for a photon. Therefore, we can consider the wave function  $\Phi$  of the equation (3.2.5) both as that of an EM wave and (taking into account its quantization) of a photon.

Factoring (3.2.5) and multiplying it on the left by the Hermitian-conjugate function  $\Phi^+$ , we get:

$$\Phi^+ (\hat{\alpha}_o \hat{\varepsilon} - c \hat{\alpha} \hat{p}) (\hat{\alpha}_o \hat{\varepsilon} + c \hat{\alpha} \hat{p}) \Phi = 0, \quad (3.2.6)$$

Equation (3.2.6) may be broken down into two Dirac-like equations without mass:

$$\begin{cases} \Phi^+ (\hat{\alpha}_o \hat{\varepsilon} - c \hat{\alpha} \hat{p}) = 0 \\ (\hat{\alpha}_o \hat{\varepsilon} + c \hat{\alpha} \hat{p}) \Phi = 0 \end{cases}, \quad (3.2.7)$$

Note that the system of equations (3.2.7) is identical to the equation (3.2.5), and can be represented (Akhiezer and Berestetskiy, 1969; Levich, Myamlin and Vdovin, 1973) as a system of quantum equations for a photon in Hamilton's form. At the same time in the electromagnetic interpretation they are the equations of EM waves.

Actually, it is not difficult to show that only in the case when the  $\Phi$ -matrix has the form:

$$\Phi = \begin{pmatrix} E_x \\ E_z \\ iH_x \\ iH_z \end{pmatrix}, \quad \Phi^+ = (E_x \quad E_z \quad -iH_x \quad -iH_z), \quad (3.2.8)$$

the equations (3.2.7) are the right Maxwell-like equations of the retarded and advanced electromagnetic waves. Using (3.2.8), and substituting it into (3.2.7), we obtain:



$$\left\{ \begin{array}{l} \frac{1}{c} \frac{\partial E_x}{\partial t} - \frac{\partial H_z}{\partial y} = 0 \\ \frac{1}{c} \frac{\partial H_z}{\partial t} - \frac{\partial E_x}{\partial y} = 0 \\ \frac{1}{c} \frac{\partial E_z}{\partial t} + \frac{\partial H_x}{\partial y} = 0 \\ \frac{1}{c} \frac{\partial H_x}{\partial t} + \frac{\partial E_z}{\partial y} = 0 \end{array} \right. , \quad (3.2.9') \quad \left\{ \begin{array}{l} \frac{1}{c} \frac{\partial E_x}{\partial t} + \frac{\partial H_z}{\partial y} = 0 \\ \frac{1}{c} \frac{\partial H_z}{\partial t} + \frac{\partial E_x}{\partial y} = 0 \\ \frac{1}{c} \frac{\partial E_z}{\partial t} - \frac{\partial H_x}{\partial y} = 0 \\ \frac{1}{c} \frac{\partial H_x}{\partial t} - \frac{\partial E_z}{\partial y} = 0 \end{array} \right. , \quad (3.2.9'')$$

For waves of any other direction the same results can be obtained by cyclic transposition of indices, or by a canonical transformation of matrices and wave functions.

We will further conditionally name each of (3.7) equations the linear semi-photon equations, remembering that it was obtained by division of one wave equation of a photon into two equations of the electromagnetic waves: retarded and advanced.

Let us make two important remarks.

1) To describe the circularly polarized EM wave, as is known, two pairs of mutual-perpendicular vectors are required: electric vectors (in our case,  $E_x, E_z$ ) and magnetic vector ( $H_x, H_z$ ). To this corresponds the fact that the system of four equations (3.2.9) describes one photon with circular polarization.

In the case of plane polarization there are two separate photons, that move along the  $y$ -axis (in our case with the vectors  $E_x, H_z$  and  $E_z, H_x$ ), which are described by two independent systems of equations:

$$\left\{ \begin{array}{l} \frac{1}{c} \frac{\partial E_x}{\partial t} \mp \frac{\partial H_z}{\partial y} = 0 \\ \frac{1}{c} \frac{\partial H_z}{\partial t} \mp \frac{\partial E_x}{\partial y} = 0 \end{array} \right. , \quad (3.2.10)$$

and

$$\left\{ \begin{array}{l} \frac{1}{c} \frac{\partial E_z}{\partial t} \pm \frac{\partial H_x}{\partial y} = 0 \\ \frac{1}{c} \frac{\partial H_x}{\partial t} \pm \frac{\partial E_z}{\partial y} = 0 \end{array} \right. , \quad (3.2.11)$$

It is possible to say that system (3.2.9) includes this pair of photons; i.e., it is the general case of describing photons of different polarization. As we will see in the following chapters, this has an important physical meaning.

2) At present as the wave vector of photon is more frequently used the 4- vector potential  $A_\mu = \{i\varphi, A_i\}$  of EM of field, and the system of four equations is used as the initial wave equations:

$$\left. \begin{array}{l} \bar{\nabla}^2 \bar{A} - \frac{1}{c^2} \frac{\partial^2 \bar{A}}{\partial t^2} = 0 \\ \bar{\nabla}^2 \varphi - \frac{1}{c^2} \frac{\partial^2 \varphi}{\partial t^2} = 0 \end{array} \right\} , \quad (3.2.12)$$

which undergoes quantization in this or in another way.

There is an essential difference between systems (3.2.9) and (3.2.12). Wave functions in the first case are the characteristics of the field of EM of wave, and a quantity of equations is determined by the polarization of EM of wave. In the second case the potentials are auxiliary mathematical characteristics, and a number of equations is determined by the formal association of the physical values.

In connection with this let us recall (Bethe, 1964) that the bispinor equation of Dirac also has 4 wave functions and 4 equations for them; moreover this is in no way connected with the 4-dimensional space-time. As we will be convinced, this has a straight succession with the theory of photon and a deep physical sense.

### 3.0. Normalized and non-normalized representation of the wave function of the photon

Above within the framework of NTEP we used the wave function of photon, which is the strength of electromagnetic field.

The particular interpretation of wave function is one of the special features of quantum mechanics in comparison with the classical electrodynamics. The physical sense of quantum wave function consists in the fact that its square (but more precisely, the product of wave function to its conjugate function) is the probability of finding the particle in some point of space in this instant. In this case the normalization of wave function is presented by one of the basic requirements of wave mechanics.

It is understandable that this meaning of wave function is more mathematical, than physical. But this probabilistic interpretation is confirmed by all experimental data. Thus, we must show that in the framework of NTEP the representation of the wave function in the form of the strengths of electromagnetic field does not contradict the probabilistic representation.

The wave function of photon must satisfy the requirements of the energy conservation law:

$$\int_0^{\infty} \frac{1}{8\pi} (\vec{E}^2 + \vec{H}^2) d\tau = \varepsilon, \quad (3.3.1.)$$

where in this case  $\varepsilon$  is photon energy. Taking into account that  $\Phi^+ \Phi = (\vec{E}^2 + \vec{H}^2)$ , we obtain:

$$\int_0^{\infty} \Phi^+ \Phi d\tau = 8\pi\varepsilon, \quad (3.3.2.)$$

For the passage to the probabilistic representation of wave function we will use the indication, given above in paragraph 1.2.3. "The probability interpretation of EM of wave": "*From the EM energy, radiated per unit time, it is possible to pass to the probabilities of radiation of the photon by division of EM energy by the photon energy*". It is not difficult to see that if we write down the wave function of photon in the form:

$$\Psi(\vec{r}, t) = \frac{\Phi(\vec{r}, t)}{\sqrt{8\pi\varepsilon}}, \quad (3.3.3.)$$

we will obtain wave function in the probabilistic representation. Actually, the value

$$P(\vec{r}, t) = \Psi^+ \Psi = \frac{\Phi^+ \Phi}{8\pi\varepsilon}, \quad (3.3.4.)$$

is the dimensionless quantity, having the sense of probability density. In this case

$$\int_0^{\infty} \Psi^+ \Psi d\tau = 1, \quad (3.3.5.)$$

As far as one photon is considered, the value  $P$  will determine the portion of energy from the photon energy at the particular point of space-time. When we have many photons in a given volume of space,  $\varepsilon$  should be understand as the total electromagnetic energy of these photons. In

this case the formula (3.3.5.) will determine the probability of finding the photon at the particular point of the volume of space at the given point of time. Obviously, in both cases the following normalization conditions are satisfied. Depending on the convenience, the one or the other normalization can be selected, taking into account that the energy of photon  $\varepsilon$  is a normalized constant, similar to unit.

We will dedicate the following parts of theory to the description of the generation of massive elementary particles. We will ascertain that the physical sense of the wave function of massive particles remains the same (with the only difference that, besides energy, in this case it is possible to use the mass of particles according to Einstein's formula  $\varepsilon = mc^2$ ).

Let us note that since energy, momentum, wave vector, frequency and wavelength of photon are one-to-one connected among themselves, it is possible to speak about normalization in relation to any of these characteristics. Of course in this case it is necessary to use a wave function in the appropriate representation.

One additional question, connected with the normalization of wave function, is, what volume of the space of integration the formula (3.3.5) contains. Usually the infinite space is understood here. On this base it is said that the photon is spread on the infinite space.

As we have seen above, accordingly to QED a photon is a nonlocal object with size, characterized by its wavelength. Since photon is neutral and does not possess external infinite field, physically, integration on infinity is thoughtless. Then a question arises: why the integration for formula (3.3.5) does not cause difficulty in the physics calculations.

Let us assume that photon occupies the limited volume  $\tau_{ph}$ . It is not difficult to see that:

$$\int_0^{\infty} \Phi^+ \Phi d\tau = \int_0^{\infty - \tau_{ph}} \Phi^+ \Phi d\tau + \int_0^{\tau_{ph}} \Phi^+ \Phi d\tau = \int_0^{\tau_{ph}} \Phi^+ \Phi d\tau = 8\pi\varepsilon, \quad (3.3.6.)$$

since the integral on the space  $\tau = \infty - \tau_{ph}$ , where the photon is absent, is equal to zero.

# Chapter 4. The intermediate bosons and mass generation theory

## 1.0. The postulate of generation of massive elementary particles

The purpose of this chapter is to describe the mechanism of generation of massive elementary particles on the basis of the hypotheses, accepted in the chapter 2. Here, the mass-free particle, the photon, i.e. a quantum of an electromagnetic field, serves as a “billet” for the generation of a massive particle. In this case, the appearance of the mass of a particle is identical to the generation of the massive particle itself.

There is a mechanism in the theory of Standard Model (SM) that ensures the generation of currents of elementary particles. This mechanism is known as the gauge (or phase) transformation of particles' field (let's recall that the particle's field in QFT is the particle's wave function).

In the SM there is also a mechanism that ensures the generation of masses of elementary particles. Here, all particles do not have a mass at the initial stage. In the SM, the mass-free particles acquire mass because of the spontaneous breakdown of the gauge symmetry of vacuum. This mechanism is called Higgs's mechanism.

In the framework of axiomatic nonlinear elementary particle theory we accepted the following basic postulates, which ensure the generation of massive particles:

1) *In the proposed theory, in contrast to SM, only a quantum of an electromagnetic wave (photon) does not have mass.*

2) *The fields of an electromagnetic wave quantum (photon) can under specified conditions undergo a rotation transformation and initial symmetry breaking, which generate different massive elementary particles.*

It follows from these hypothesis that the equations of elementary particles must be nonlinear modifications of the equations of quantized electromagnetic (EM) waves. The detailed analysis presented in the following chapters shows that because of the rotation transformation and different types of symmetry breaking of the initial photon, such elementary particles can have mass, electric charge, spin (which is a multiple of 1 and 1/2), helicity, chirality, and all other characteristics of existing elementary particles.

In this chapter we will show that this transformation is accomplished through the massive intermediate boson by means of the rotation transformation and the spontaneous symmetry breaking of mass-free photon. Here the simplest type of intermediate boson - neutral boson - will be examined (subsequently we will examine the more complex cases of generation of the charged intermediate bosons).

Note that the mathematical description of mass generation of elementary particles in NTEP and in SM according with Higgs's mechanism has many similarities. We will look at how nonlinear theory makes it possible to explain many features of this mechanism.

## 2.0. Photon as a gauge field

As one of the simplest examples of the generation of massive fields (particles) we can consider the photoproduction of the electron-positron pair:

$$\gamma + p \rightarrow e^+ + e^- + p, \quad (4.2.1)$$

Actually, the photon  $\gamma$  is a mass-free gauge vector boson. The EM field of proton  $p$  (or some atom nucleus) initiates its transformation into two massive particles: electron and positron, *but its EM field does not disappear, similarly to Higgs's field*. The fields of the electron and positron  $e^+, e^-$  are spinors, which are not transformed like vector fields. *Thus, we can say that the reaction*

(4.2.1) describes the process of symmetry breaking of the initial mass-free vector field in order to generate the massive spinor particles.

Let us examine the Feynman diagram of the above reaction of a pair production (Fig. 4.1):

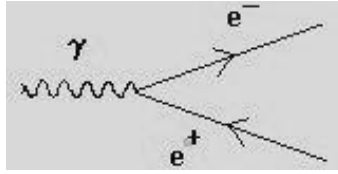

Fig. 4.1

It is known that using Feynman's diagrams within the framework of SM, we can precisely calculate all characteristics of particles with the exception of charge and mass. Nevertheless, the reaction (4.2.1) remains mysterious: we do not know, for example, how the process of transformation of the mass-free boson field into the massive fields happens, and how the electrical charge appears.

Within the framework of SM the interaction of the particles' currents takes place in the vertex of the diagram. However, it is obvious that here, before the electron-positron production occurs, the transformation of a mass-free photon into massive electron-positron pair begins. This means that the interaction, which here occurs between the photon field and the proton (or nuclear) field, is the origin of this transformation. We ask, what kind of transformation could this be? There are several considerations that allow us to answer this question.

In order to allow this transformation, Higgs's theory states that the intermediate (massive) bosons must participate. In other words, we can assume that the generation of electron and positron masses in this scenario occurs through some virtual intermediate massive photon.

On the other hand it is known that the propagation of EM wave in the strong electromagnetic fields is accompanied by nonlinear effects. On this base it is possible to assume that the photon must undergo a certain nonlinear transformation. And as we postulated above, this is a transformation of rotation.

Based on this evidence, let us assume that in the vertex of the Feynman's diagram the rotation transformation of the "linear" photon (in the sense that it obeys a linear wave equation) into the "nonlinear" photon (which obeys a nonlinear wave equation), which acquires rest mass, is achieved.

Thus, during the first stage, the rotation transformation of the mass-free photon into the intermediate boson (i.e. into a special "massive" photon) must occur in the strong EM field of the proton. Then during the second stage (which we will consider in the following chapter), the transformation of massive boson into two massive fermions must take place. Obviously, in this case the initial symmetry of the photon will be broken, since two massive "nonlinear" spinor particles are "born" from the mass-free "linear" vector photon.

These ideas can be translated into mathematical language. Let us now describe the rotation transformation of a photon.

### 3.0. The rotation transformation of electromagnetic wave quantum

First, we recall the quantum equation of a "linear" photon, obtained in the previous chapter .

#### 3.1. Quantum equation of the photon

For certainty, we will examine the same circularly polarized photon moving along the  $y$  - axis. The Feynman diagram's lines of the photon (i.e. the "linear" electromagnetic quantum)  $\gamma$  correspond to linear wave equations (3.2.5) of the previous chapter:

$$\left[ (\hat{\alpha}_o \hat{\varepsilon})^2 - c^2 (\hat{\alpha} \hat{p})^2 \right] \Phi = 0, \quad (a)$$

or, to the equivalent system (3.2.7) of the same chapter:

$$\begin{cases} \Phi^+ (\hat{\alpha}_0 \hat{\varepsilon} - c \hat{\alpha} \hat{p}) = 0 \\ (\hat{\alpha}_0 \hat{\varepsilon} + c \hat{\alpha} \hat{p}) \Phi = 0 \end{cases}, \quad (b)$$

where  $\hat{\varepsilon} = i\hbar \frac{\partial}{\partial t}$ ,  $\hat{p} = -i\hbar \vec{\nabla}$  are the operators of energy and momentum, correspondingly,  $\{\hat{\alpha}_0, \hat{\alpha}\}$  are Dirac's matrixes and  $\vec{\Phi}(y)$  is the matrix (3.2.8), which contains the components of wave function of photon:

$$\Phi = \begin{pmatrix} \Phi_1 \\ \Phi_2 \\ \Phi_3 \\ \Phi_4 \end{pmatrix} = \begin{pmatrix} E_x \\ E_z \\ iH_x \\ iH_z \end{pmatrix}, \quad (c)$$

### 3.2. The rotation transformation of photon fields

The rotation transformation of the “linear” photon wave to a “curvilinear” one can be conditionally written in the following form:

$$\hat{R}\Phi \rightarrow \Phi', \quad (4.3.1)$$

where  $\hat{R}$  is the rotation operator for the transformation of a photon wave from linear state to curvilinear state, and  $\Phi'$  is some final wave function:

$$\Phi' = \begin{pmatrix} \Phi'_1 \\ \Phi'_2 \\ \Phi'_3 \\ \Phi'_4 \end{pmatrix} = \begin{pmatrix} E'_x \\ E'_z \\ iH'_x \\ iH'_z \end{pmatrix}, \quad (4.3.2)$$

which appears after the nonlinear transformation (4.3.1); here,  $(E'_x, E'_z, -iH'_x, -iH'_z)$  are electromagnetic field vectors after the rotation transformation, which correspond to the wave functions  $\Phi'$ .

It is known that the transition of vector motion from linear to curvilinear state is described by differential geometry (Eisenhart, 1960). Note also that this transition is mathematically equivalent to a vector transition from flat space to curvilinear space, which is described by Riemann geometry. In relation to this, let us remind ourselves that the Pauli matrices, as well as the photon matrices, are the space rotation operators – 2-D and 3-D accordingly (Ryder, 1985).

### 3.3. The rotation transformation description in differential geometry

We do not know the real structure of a photon as a quantum of an EM wave. However, we have an idea about the description of the structure of its fields and their motion. Therefore, in the following, the word “photon” should be understood only in the sense of the known mathematical description of photon fields' characteristics.

Let us consider a plane-polarized EM wave, which has the field vectors  $(E_x, H_z)$  (see fig. 4.2):

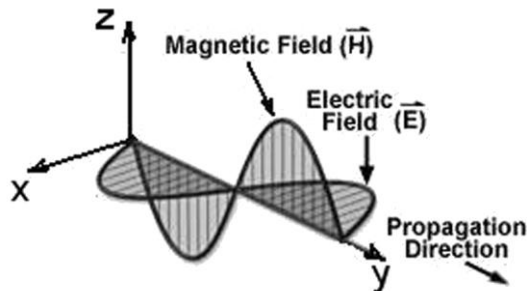

Fig. 4.2

Let this wave is rotated, by some radius  $r_p$ , in the plane  $(X', O', Y')$  of a fixed co-ordinate system  $(X', Y', Z', O')$  around the axis  $Z'$ , so that  $E_x$  is parallel to the plane  $(X', O', Y')$ , and  $H_z$  is perpendicular to this plane (fig. 4.3).

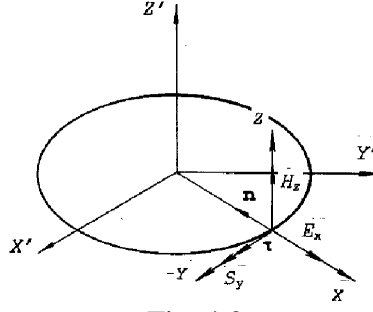

Fig. 4.3

According to Maxwell (Jackson, 1999), the following term of equations (b)

$$\hat{\alpha}_0 \hat{\epsilon} \Phi = i\hbar \frac{\partial \Phi}{\partial t}$$

contains the Maxwell's displacement current, which is defined by the expression:

$$\vec{j}_{dis} = \frac{1}{4\pi} \frac{\partial \vec{E}}{\partial t}, \quad (4.3.3)$$

The electrical field vector  $\vec{E}$  above, which moves along the curvilinear trajectory (assume its direction is from the center), can be written in the form:

$$\vec{E} = -E \cdot \vec{n}, \quad (4.3.4)$$

where  $E = |\vec{E}|$ , and  $\vec{n}$  is the normal unit-vector of the curve, directed to the center. Then, the derivative of  $\vec{E}$  can be represented as follows:

$$\frac{\partial \vec{E}}{\partial t} = -\frac{\partial E}{\partial t} \vec{n} - E \frac{\partial \vec{n}}{\partial t}, \quad (4.3.5)$$

Here, the first term has the same direction as  $\vec{E}$ . The existence of the second term shows that at the rotation transformation of the wave an additional displacement current appears. It is not difficult to show that it has a direction tangential to the ring:

$$\frac{\partial \vec{n}}{\partial t} = -v_p K \vec{\tau}, \quad (4.3.6)$$

where  $\vec{\tau}$  is the tangential unit-vector,  $v_p \equiv c$  is the electromagnetic wave velocity,  $K = \frac{1}{r_p}$  is

the curvature of the trajectory, and  $r_p$  is the curvature radius. Thus, the displacement current of the plane wave moving along the ring can be written in the following form:

$$\vec{j}_{dis} = -\frac{1}{4\pi} \frac{\partial E}{\partial t} \vec{n} + \frac{1}{4\pi} \omega_p E \cdot \vec{\tau}, \quad (4.3.7)$$

where  $\omega_p = \frac{m_p c^2}{\hbar} = \frac{v_p}{r_p} \equiv cK$  is an angular velocity. Furthermore, here,  $m_p c^2 = \epsilon_p$  is photon energy, where  $m_p$  is some mass, corresponding to the energy  $\epsilon_p$ .

Obviously, the terms  $\vec{j}_n = \frac{1}{4\pi} \frac{\partial E}{\partial t} \vec{n}$  and  $\vec{j}_\tau = \frac{\omega_p}{4\pi} E \cdot \vec{\tau}$  are the normal and tangent components of the displacement current of the rotated electromagnetic wave accordingly. Thus:

$$\vec{j}_{dis} = \vec{j}_n + \vec{j}_\tau, \quad (4.3.8)$$

This is a remarkable fact that the currents  $\vec{j}_n$  and  $\vec{j}_\tau$  are always mutually perpendicular, so that we can write (4.3.8) in complex form as follows:

$$j_{dis} = j_n + ij_\tau, \quad (4.3.8')$$

where  $j_n = \frac{1}{4\pi} \frac{\partial E}{\partial t}$  is the absolute value of the normal component of the displacement current, and

$$j_\tau = \omega_p \frac{1}{4\pi} E \equiv \frac{m_p c^2}{\hbar} \frac{1}{4\pi} E \equiv \frac{v_p}{r_p} \frac{1}{4\pi} E \equiv K \frac{c}{4\pi} E, \quad (4.3.9)$$

is the absolute value of the tangential component of the displacement current.

*Thus, the appearance of the tangent current leads to origination of the imaginary unit in a complex form of particles' equation. So, we can assume that the appearance of the imaginary unit in the quantum mechanics is tied to the appearance of tangent currents.*

### 3.4. A description of the rotation transformation in curvilinear space of Riemann geometry

We can consider the Maxwell-like wave equations (b) with the wave function (c) as Dirac's equation without mass. The generalization of the Dirac equation on the curvilinear (Riemann) geometry is connected to the parallel transport of the spinor in curvilinear space (Fock, 1929a,b; Fock and Ivanenko, 1929; Van der Waerden, 1929; Schroedinger, 1932; Infeld und Van der Waerden, 1933; Goenner, 2004).

In order to generalize the Dirac equation in the form of Riemann geometry, we replace the usual derivative  $\partial_\mu \equiv \partial / \partial x_\mu$  (where  $x_\mu$  are the co-ordinates in the 4-space) with the covariant derivative, which will be sufficient:

$$D_\mu = \partial_\mu + \Gamma_\mu, \quad (4.3.10)$$

where  $\mu = 0, 1, 2, 3$  are the summing indices, and  $\Gamma_\mu$  is the analogue of Christoffel's symbols in the case of spinor theory, which are called Ricci symbols (or connection coefficients).

When a spinor moves along a straight line, all the symbols  $\Gamma_\mu = 0$ , and we have the usual derivative. However, if the spinor moves along the curvilinear trajectory, not all  $\Gamma_\mu$  are equal to zero, and in this case an additional term appears.

Typically, the last term is not the derivative, but is equal to a product of the spinor itself with some coefficient  $\Gamma_\mu$ , which is an increment in the spinor. It is easy to see that the tangent current  $j_\tau$  corresponds to the Ricci connection coefficients (symbols)  $\Gamma_\mu$ .

According to the general theory (Sokolov and Ivanenko, 1952), we can obtain as an additional term of equations (b) the following term:  $\hat{\alpha}_\mu \Gamma_\mu = \hat{\alpha}_i p_i + i \hat{\alpha}_0 p_0$ , where  $p_i$  and  $p_0$  are real values. Since the increment in spinor  $\Gamma_\mu$  has the form and the dimension of the energy-momentum 4-vector, it is logical to identify  $\Gamma_\mu$  with a 4-vector of the energy-momentum of the photon's electromagnetic field:

$$\Gamma_\mu = \{\varepsilon_p, c\vec{p}_p\}, \quad (4.3.11)$$

where  $\varepsilon_p$  and  $p_p$  are the photon's energy and momentum respectively (not the operators). In other words, we have:

$$\hat{\alpha}_\mu \Gamma_\mu = \hat{\alpha}_0 \varepsilon_p + \vec{\hat{\alpha}} \vec{p}_p, \quad (4.3.12)$$



Taking into account that according to the law of conservation of energy  $\hat{\alpha}_0 \varepsilon_p \mp \vec{\hat{\alpha}} \cdot \vec{p}_p = \pm \hat{\beta} m_p c^2$ , we can see that the additional term contains mass of the transformed wave as a tangential current (4.3.9).

### 3.5. Physical sense of the rotation transformation

Let us examine what meaning the rotation transformation can have in contemporary physics.

In quantum field theory (Ryder, 1985; see first chapter of this book), it is shown that the rotation transformation of the particle's internal symmetry (which is also taking place in our case) is equivalent to a gauge transformation, which generates the gauge fields. Recall also (Ryder, 1985) that the matrices of gauge transformation are rotation matrices in the internal space of particles.

We can easily show the identity of both transformations if we represent the energy and momentum of the intrinsic field in equation (4.3.12), using the 4-potentials  $A_\mu$ , which is the gauge field within the framework of SM:

$$\hat{\alpha}_\mu \Gamma_\mu = \hat{\alpha}_0 \varepsilon_p + \vec{\hat{\alpha}} \cdot \vec{p}_p = e \alpha_\mu A^\mu \quad (4.3.13)$$

Our conclusion is also confirmed by the fact that the matrices of Pauli and Gell-Mann, that are generators of the gauge transformation of groups  $SU(2)$  and  $SU(3)$  respectively, describe rotations in 2- and 3-dimensional space accordingly.

Thus, the transformation  $\hat{R}$ , described by the relationship (4.3.1), can be referred to as the gauge transformation, and the connection coefficients (symbols) of Ricci (or, in a general case, Christoffel's coefficients) are the gauge fields.

Thus, we can say that within the framework of NEPT the mass-free boson obtains its mass due to rotation (or gauge) transformation of particle fields. Let us note with regard to SM that in this case the role of the Higgs's boson serves the electromagnetic nuclear field. Moreover, this transformation simultaneously leads to the generation of an internal current in particle.

### 4.0. An equation of the massive intermediate photon

As it follows from the previous sections, some additional terms  $K = \hat{\beta} m_p c^2$ , corresponding to tangent components of the displacement current, must appear in equation (a) due to a curvilinear motion of the electromagnetic wave:

$$\left( \hat{\alpha}_0 \hat{\varepsilon} - c \vec{\hat{\alpha}} \cdot \hat{p} - K \right) \left( \hat{\alpha}_0 \hat{\varepsilon} + c \vec{\hat{\alpha}} \cdot \hat{p} + K \right) \Phi' = 0, \quad (4.4.1)$$

Thus, in the case of the curvilinear transformation of the electromagnetic fields of a photon, we obtain the following Klein-Gordon-like equation with mass (Schiff, 1955), instead of equation (a):

$$\left( \hat{\varepsilon}^2 - c^2 \hat{p}^2 - m_p^2 c^4 \right) \Phi' = 0, \quad (4.4.2)$$

This is remarkable that due to a rotation transformation of the initial photon the tangential current is formed. At the same time, the current characteristics are unambiguously related to the mass of transformed photon. This mass is equal to its energy divided by a square of the speed of light. This, by the way, explains why mass divergence in electron theory is always connected with the divergence of its electrical charge.

Equation (4.4.2) is similar to the Klein-Gordon equation. However, the latter describes the **scalar** field, i.e. the massive boson with zero spin of the type of the hypothetical Higgs boson (let us also recall that Higgs's mechanism of mass generation is based on the scalar equation of Klein-Gordon). It is not difficult to prove, using an electromagnetic form that (4.4.2) is an equation of a massive **vector** particle.

As we can see, the  $\Phi'$ -function that appears after the transformation of the electromagnetic wave, and that satisfies equation (4.4.2), is not identical to the  $\Phi$ -function before the transformation. The  $\Phi$ -function is a classical linear electromagnetic wave field that satisfies the

wave equation (a). At the same time, the  $\Phi'$ -function is a non-classical curvilinear electromagnetic wave field that satisfies equation (4.4.2).

Moreover, equation (4.4.2), whose wave function is a  $4 \times 1$ -matrix with electromagnetic field components, *cannot be a scalar field equation*. Let us analyze the objects, which this equation describes.

It follows from the Maxwell's equations that each of the components  $E_x, E_z, H_x, H_z$  of vectors of the EM wave fields  $\vec{E}, \vec{H}$  is included into the same scalar wave equations. In the case of a linear wave, all field components are independent. So, studying each of  $\vec{E}, \vec{H}$  vector components, we can consider the vector field as scalar. However, we cannot proceed to scalar theory after the curvilinear transformation when a tangential current appears. In fact, the components of vector  $\vec{E}'$  are not independent functions, as it follows from the condition (which is the Maxwell law)  $\vec{\nabla} \cdot \vec{E}' = \frac{4\pi}{c} \vec{c}^0 \cdot \vec{j}$ , where  $\vec{c}^0$  is a unit vector of wave velocity.

With this regard, this equation plays a role of the Procá equation. The Procá equation can be recorded in a form, similar to equation (4.4.2)

$$\left( \hat{\mathcal{E}}^2 - c^2 \hat{p}^2 - m_p^2 c^4 \right) A_\mu = 0, \quad (4.4.3)$$

As it is known (Ryder, 1985), this equation is considered in SM as equation of intermediate bosons. The Procá equation is an equation for a four-dimensional vector potential, which can be used to describe a massive particle with spin equal to one.

The difference of (4.4.3) from the equation (4.4.2) lies in the fact that the free term of Procá equation is written through the 4-potential and is not gauge invariant in the case when  $m_p$  is a particle mass. In our case the mass term is expressed through the field strengths, i.e., through the wave function itself, and does not disrupt the invariance of the equations. In order to avoid difficulties of the designation, we will call the equation (4.4.2) the equation of “nonlinear photon” or the “equation of intermediate massive photon”.

According to the results presented above, we need to assume that the more detailed Feynman's diagram of photoproduction of an electron-positron pair must include a massive intermediate photon. So, the diagram must have the following form (Fig. 4.4):

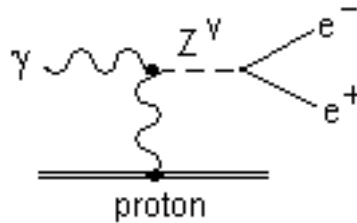

Fig. 4.4.

where we designated the nonlinear photon  $Z^\gamma$  like as an neutral intermediate massive  $Z^0$ -boson, described by the electro-weak theory within the framework of the Standard Model

## 5.0. Massive intermediate photon and the $Z^0$ -boson

### 5.1. Appearance of the $Z^0$ -boson in the Standard Model theory

The reaction of the electron-positron pair production is purely an electromagnetic process. In future we will examine the nonlinear representation of the electron and positron equations of Dirac and will ascertain that the weak interactions also relate to the class of electromagnetic processes. Therefore the appearance of an intermediate neutral boson in the electromagnetic process does not contradict the nonlinear theory.

In connection with this the question arises: is it possible to identify the “nonlinear photon”  $Z^\gamma$  with the neutral intermediate  $Z^0$ -boson? In the reaction Fig. 4.1 its rest mass must be equal to  $2m_e c^2$ , where  $m_e$  is the rest mass of electron. In other words, with these energies massive boson  $Z^\gamma$  practically coincides with electron-positron pair at the moment of their generation. It is possible to say that it is a dipole  $e^+e^-$ , comprised of these particles. This means that its lifetime is extremely small and that boson  $Z^\gamma$  cannot be experimentally registered. It is possible to say that it is in a virtual state.

As is known (Dawson, 1999; Quigg, 2007; Practicum, 2004), the same occurs for the boson  $Z^0$ . Let us examine this question in more detail, since it is directly coupling with the description of the mechanism of the generation of the masses of elementary particles in SM.

## 5.2. Generation and breaking of $Z^0$ - boson

In the framework of Standard Model it is assumed that there is some additional field, which is not practically separated from the empty space. It is conventionally designated as the Higgs scalar field. It is considered that mass-free particles acquire a mass by interaction with it.

First of all it was possible to explain the generation of massive intermediate bosons and calculate their masses. It turned out that taking into account their generation, it is possible to use in the theory the same coupling constant – electromagnetic fine structure constant – for weak and electromagnetic interactions. The experimental detection of massive intermediate bosons was the triumph of Higgs's theory.

From the SM theory point of view, intermediate bosons (neutral and charged) can be generated by annihilation of fermion with anti-fermion (both leptons and quarks).

The neutral intermediate  $Z^0$ -boson was fixed first. For the first time  $Z^0$ - bosons were observed in 1983 on the accelerator SppS of CERN in the collision of beams of protons and antiprotons ( $Z^0$ - bosons were formed with the annihilation of the quark of proton with the antiquark of antiproton; see diagram Fig. 4.5 ).

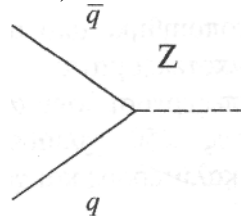

Fig. 4.5

This diagram is analogous to the diagram of the annihilation of electron-positron pair into the photon (Fig. 4.6 ).

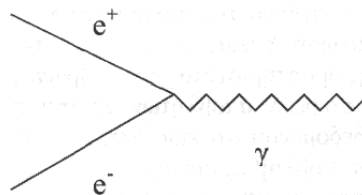

Fig. 4.6.

In this process during the specific choice of energies of the colliding electrons, the  $Z^0$  - boson can be a real, not a virtual, particle. The diagram of generation of  $Z^0$  - boson in the electron-positron annihilation is shown in Fig. 4.7:

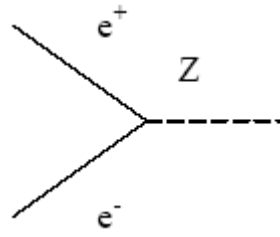

Fig.. 4.7.

On the LEP collider the energies of electron and positron beams were chosen in such way that in their sum would be equal to the mass of  $Z^0$  - boson. In this case the cross-section of  $Z^0$  - boson formation rises in several orders in comparison with the cross-sections of the formation of any other particles (resonance effect).

The intermediate bosons have a large mass. They are rapidly decomposed (or, equivalently, they have large widths of decay). The  $Z^0$  - boson has many different modes (channels) of decay, and each decay mode decreases its lifetime. Formation of  $Z^0$  - bosons can be most simply observed on the colliding beams in the reaction  $e^+e^-$  - annihilation  $e^+ + e^- \rightarrow Z^0$ .

In Fig. 4.8 are shown the different diagrams of the decays of intermediate bosons.

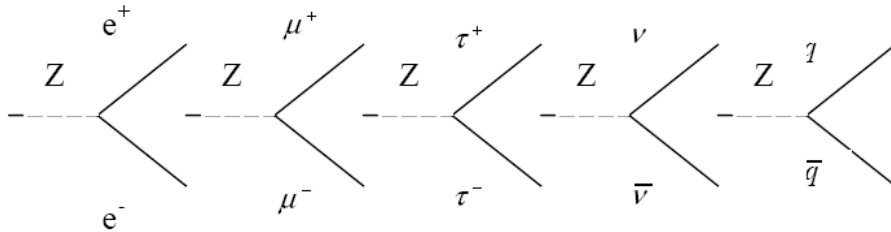

Fig. 4.8.

In electro-weak interactions the exchange is accomplished by generation and absorbance of the massive virtual particles - intermediate bosons  $W^+$ ,  $W^-$  and  $Z^0$ . Using values of the masses of intermediate bosons, it is possible to give an estimation of the radius of weak interactions.

In the unified theory of electro-weak interaction the masses of  $W$  -bosons (masses of  $W^+$  and  $W^-$  are equal) and  $Z^0$  - bosons can be computed and expressed through the Fermi constant  $G_F$  of weak interaction and Weinberg angle  $\theta_W$  :

$$m_W = \frac{1}{\sin \theta_W} \frac{\pi \alpha}{\sqrt{2} G_F} = \frac{37,3}{\sin \theta_W} [GeV], \quad m_{Z^0} = \frac{m_W}{\cos \theta_W}$$

where  $\alpha=1/137$  is fine structure constant. The angle of Weinberg  $\theta_W$  and the boson masses  $m_W, m_{Z^0}$  are measured in independent experiments. Therefore the validity of the given relationships serves as a very substantial argument in favor of the theory of electro-weak interaction.

Mass ( $m_W$ ) and width ( $\Gamma_W$ ) of the charged  $W$ -bosons are equal to  $80,6 \pm 0,4$  GeV and  $2,25 \pm 0,14$  GeV respectively; mass ( $m_{Z^0}$ ) and width ( $\Gamma_{Z^0}$ ) of neutral  $Z^0$  - boson are equal to  $91,161 \pm 0,031$  GeV and  $2,534 \pm 0,027$  GeV.

Let us estimate, using an uncertainty principle, the maximum distance between the fermions, which are exchanged by virtual intermediate boson  $Z^0$ . For the virtual particle the energy uncertainty is equal to its rest energy:  $\Delta \varepsilon \approx m_{Z^0} c^2$ . Let the rest energy of  $Z^0$ -boson be approximately 91 GeV. This leads to a very small radius of weak interactions:

$$\Delta\varepsilon \cdot \Delta t \approx \hbar \rightarrow R_{Z^0} \leq c\Delta t \approx \hbar c / m_{Z^0} \approx 0,2[GeV \cdot fm] / 91[GeV] \approx 2,2 \cdot 10^{-16} cm$$

Using this value, it is not difficult to estimate the time of the exchange by the intermediate boson:  $\Delta t \approx \frac{R_{Z^0}}{c} = 0,7 \cdot 10^{-26}$  s.

The obtained results explain the fact that the created by E. Fermi in the 30<sup>th</sup> years of XX century weak-interaction theory, as a theory of point interaction of four fermions, explained very well the experimental data of  $\beta$ -decay. This result explains also the impossibility of detecting the neutral boson in the reaction of the pair  $e^+e^-$  photoproduction, from which we began our analysis.

It remains to add that according to QED, the photon (see chapter 3) is a nonlocal particle with the characteristic size of one wavelength. This allows to conclude that the  $Z'$ -boson is also a nonlocal particle with the same characteristic size. (To avoid misunderstanding let us recall that within the framework of the nonlinear theory, all particles represent the field formation, which in view of the continuity of field cannot have precise boundaries. Therefore the ‘‘characteristic size’’ is not the particle’s size, but only a value, which characterizes the energy field distribution of the particle (we will analyze this question in more detail in future).

## 6.0. Photon fields self-interaction as the reason for the appearance of the mass. Nonlinear equation of intermediate boson

Let us analyze in greater detail the equation of the intermediate massive photon (4.4.2)  $(\hat{\varepsilon}^2 - c^2 \hat{p}^2 - m_p^2 c^4) \Phi' = 0$  and try to explain the reason for the appearance of mass  $m_p$ .

As it was shown above, due to the rotation transformation and symmetry breaking of fields of particle itself the Ricci symbols (or connection coefficients)  $\Gamma_\mu$  appeared, which can be expressed by energy and momentum of photon by relationship (4.3.12)  $\hat{\alpha}_\mu \Gamma_\mu = \hat{\alpha}_0 \varepsilon_p + \hat{\vec{\alpha}} \vec{p}_p$ . Taking into account that (in the general case)  $\hat{\alpha}_0 \varepsilon_p \mp \hat{\vec{\alpha}} \vec{p}_p = \pm \hat{\beta} m_p c^2$ , we can obtain the energy-momentum conservation law for massive particle, expressed by means of own or internal (‘‘in’’) fields of particle:

$$m_p^2 c^4 = (\varepsilon_{in}^2 - c^2 \vec{p}_{in}^2), \quad (4.6.1)$$

The energy  $\varepsilon_{in}$  and momentum  $p_{in}$  of particle inner fields can be here expressed, using the ‘inner’ energy density  $u_{in}$  and ‘inner’ momentum density  $\vec{g}_{in}$  of EM wave:

$$\varepsilon_{in} = \int_0^\tau u_{in} d\tau, \quad (4.6.2)$$

$$\vec{p}_{in} = \int_0^\tau \vec{g}_{in} d\tau, \quad (4.6.3)$$

assuming that the upper limit of integration for the volume  $\tau$  is variable:  $0 \leq \tau \leq \infty$ .

Taking into account the EM form of  $\Phi'$ - function (4.3.2), we can obtain the quantum forms of  $u_{in}$  and  $\vec{g}_{in}$ :

$$u_{in} = \frac{1}{8\pi} (\vec{E}'^2 + \vec{H}'^2) = \frac{1}{8\pi} \Phi'^+ \hat{\alpha}_0 \Phi', \quad (4.6.4)$$

$$\vec{g}_{in} = \frac{1}{4\pi c} [\vec{E}' \times \vec{H}'] = -\frac{1}{8\pi c} \Phi'^+ \hat{\vec{\alpha}} \Phi', \quad (4.6.5)$$

Substituting the expression (4.6.2) and (4.6.3) to the electron equation (4.4.2) and taking into account (4.6.4) and (4.6.5), we will obtain the *non-linear integro-differential equation of intermediate photon in both electromagnetic or quantum forms*.

An idea about the structure of nonlinear term can be obtained as a first approximation, taking into account that the solution of the photon equation is the plane wave:

$$\Phi = \Phi_0 \exp[i(\omega t - ky)], \quad (4.6.6)$$

In this case we can write (4.6.2) and (4.6.3) in the next approximate form:

$$\varepsilon_{in} = u\Delta\tau = \frac{\Delta\tau}{8\pi} \Phi'^+ \hat{\alpha}_0 \Phi', \quad (4.6.7)$$

$$\vec{p}_{in} = \vec{g}\Delta\tau = -\frac{\Delta\tau}{8\pi c} \Phi'^+ \hat{\vec{\alpha}}\Phi', \quad (4.6.8)$$

where  $\Delta\tau$  is the volume, which contain the main part of energy of the twirled photon. Then the approximate form of the equation (4.6.1) will be following:

$$m_p^2 c^4 = \frac{\Delta\tau}{8\pi} \left[ (\Phi'^+ \hat{\alpha}_0 \Phi')^2 - 4(\Phi'^+ \hat{\vec{\alpha}}\Phi')^2 \right], \quad (4.6.9)$$

Obviously, this nonlinear term corresponds to the self-action of the “nonlinear photon” fields.

The presence of the nonlinear term of particles’ field interaction means that the stability of this particle is ensured by self-interaction of particle fields.

In other words, we can assert that those conditions of the appearance of the massive particle, which we assumed as hypothesis, can actually be achieved. The mass-free photon, as a result of the transformations of its fields in the strong electromagnetic field of proton, begins to move (rotate) in a limited volume of space. Its relative stability is ensured by self-interaction of photon fields. Conditionally speaking, the “nonlinear photon” creates quasi-walls for itself, which act similar to the waveguide or resonator walls. When observed outside the volume, inside which photon moves, this photon looks as massive particle in rest.

## 6.2. Comparison of the description of intermediate boson in the nonlinear theory and in the Standard Model

Let us compare the results, obtained above within the framework of nonlinear quantum field theory, with those we have in the theory of Standard Model (CM).

In SM the additional scalar field of Higgs is introduced, in order to generate of the mass of intermediate bosons. The passage from it to the 4-vector equation of Procá for the massive particles requires the use of complex mathematical procedures on the basis of gauge transformation. In the proposed nonlinear theory the real vector EM field of photon is used, which in the general case four-component is (but it is not 4-vector !). Therefore, the passage to the equation of massive intermediate photon (analog of Procá equation) requires nothing, except the transformation of rotation.

As we noted, gauge transformation is mathematically the transformation of rotation. The difference consists in the fact that in NTEP the transformation of rotation has the direct physical sense of transformation of fields. At the same time, in the SM the gauge transformation is a mathematical procedure. For this reason in SM the passage from one Lagrangian to another occurs on the basis of special assumptions and prescriptions.

Another serious difference lies in the fact that in SM the intermediate bosons remains mass-free after gauge transformation in order not to disrupt the renormalization. One of the reasons for this is the fact that in SM the vector potential is used as the wave function of photon and massive bosons, rather than the strength of EM fields. Therefore, Higgs's mechanism is required for the particles to obtain masses. In the nonlinear theory the mass of intermediate photon appears as kinetic photon energy, “stopped” as a result of self-interaction of fields of the photon.

As addition let us examine briefly some correspondences of mathematical description of mass production in both theories.

In the framework of SM (Dawson, 1999; Quigg, 2007) the Lagrangian of the interaction and propagation of the scalar field is

$$L_{scalar} = (D^\mu \phi)^\dagger (D_\mu \phi) - V(\phi^\dagger \phi), \quad (4.6.10)$$

where  $D_\mu$  the gauge-covariant derivative is. The potential of Higgs interaction has the form

$$V(\phi^\dagger \phi) = \mu^2 (\phi^\dagger \phi) + \lambda (\phi^\dagger \phi)^2, \quad (4.6.11)$$

In NTEP the Lagrangian of interaction of photon with proton we can write down in form:

$$L = \Phi^\dagger (\hat{\alpha}_0 \hat{\varepsilon} - c \hat{\alpha} \cdot \hat{p}) (\hat{\alpha}_0 \hat{\varepsilon} + c \hat{\alpha} \cdot \hat{p}) \Phi + L(\Phi, N(\vec{r}, t)) + L(N(\vec{r}, t)), \quad (4.6.12)$$

where  $\Phi$  is photon wave function (c);  $N = N(\vec{r}, t)$  is the nuclear field, which detail description we don't know in the area, closed to nucleus themselves; the term  $L(N(\vec{r}, t))$  is the nucleus Lagrangian in conditional form and  $L(\Phi, N(\vec{r}, t))$  is the photon-nucleus interaction Lagrangian.

After a photon transformation into the massive boson, the Lagrangian of the vector massive boson of equation (4.4.2) will be the following:

$$L = \Phi'^\dagger (\hat{\alpha}_0 \hat{\varepsilon} - c \hat{\alpha} \cdot \hat{p} + m_p c^2) (\hat{\alpha}_0 \hat{\varepsilon} + c \hat{\alpha} \cdot \hat{p} - m_p c^2) \Phi' + L(N(\vec{r}, t)), \quad (4.6.13)$$

Without the Lagrangian of nucleus (which doesn't work now), equation (4.6.13) can be recorded in the form:

$$L = D_\mu \Phi'^\dagger D^\mu \Phi' = \partial_\mu \Phi'^\dagger \partial^\mu \Phi' - \Phi'^\dagger m_p^2 c^4 \Phi', \quad (4.6.14)$$

where the term

$$\Phi' m_p^2 c^4 \Phi' = \frac{\Delta \tau}{8\pi} \Phi' \left[ (\Phi'^\dagger \hat{\alpha}_0 \Phi')^2 - 4 (\Phi'^\dagger \hat{\alpha} \Phi')^2 \right] \Phi', \quad (4.6.15)$$

describes in the nonlinear theory the energy of self-interaction, which directly contains the mass of intermediate boson.

It is not difficult to see that the expression (4.6.15) has a similarity with Higgs's potential (4.6.11). We did not investigate in detail this parallelism, because the analysis, carried out above, indicates the possibility of describing of the particle mass production by means of intermediate boson, but without the presence of Higgs's boson.

In the following chapters we will examine the question of the generation of mass of leptons - electron and neutrino - on the basis of the presented above theory of particle fields' self-interaction.

## Chapter 5. The electron and positron equations (linear approach)

### 1.0. Introduction. Nonlinear non-Maxwellian electromagnetic field and Dirac equation

The Dirac equation is a relativistic quantum mechanical wave equation, which provides a description of elementary spin-1/2 particles - leptons. It is the relativistic generalization of the Schrödinger equation.

At present Dirac's equation is written in several identical forms. The usual one equation form is following:

$$\frac{1}{c} \frac{\partial \psi}{\partial t} + \hat{\alpha} \cdot \vec{\nabla} \psi = i \hat{\beta} \frac{m_e c}{\hbar} \psi, \quad (5.1.1)$$

where  $\psi$  is the four-component wavefunction

$$\psi = \begin{pmatrix} \psi_1 \\ \psi_2 \\ \psi_3 \\ \psi_4 \end{pmatrix}, \quad \psi^+ = (\psi_1 \quad \psi_2 \quad \psi_3 \quad \psi_4), \quad (5.1.2)$$

$m_e$  is the rest mass of the electron,  $c$  is the speed of light,  $\hat{\alpha}$  and  $\hat{\beta}$  are the  $\alpha$ -set of 4×4 Dirac's matrices,

$$\hat{\alpha}_0 = \begin{pmatrix} \hat{\sigma}_0 & 0 \\ 0 & \hat{\sigma}_0 \end{pmatrix}; \quad \hat{\alpha} = \begin{pmatrix} 0 & \hat{\sigma} \\ \hat{\sigma} & 0 \end{pmatrix}; \quad \hat{\beta} \equiv \hat{\alpha}_4 = \begin{pmatrix} \hat{\sigma}_0 & 0 \\ 0 & -\hat{\sigma}_0 \end{pmatrix}, \quad (5.1.3)$$

where  $\hat{\sigma}_0, \hat{\sigma}$  are Pauli's matrices. The most detailed form is the following:

$$\begin{cases} \frac{1}{c} \frac{\partial \psi_1}{\partial t} - \frac{\partial \psi_4}{\partial y} = -i \frac{m_e c}{\hbar} \psi_1 \\ \frac{1}{c} \frac{\partial \psi_4}{\partial t} - \frac{\partial \psi_1}{\partial y} = i \frac{m_e c}{\hbar} \psi_4 \\ \frac{1}{c} \frac{\partial \psi_2}{\partial t} + \frac{\partial \psi_3}{\partial y} = -i \frac{m_e c}{\hbar} \psi_2 \\ \frac{1}{c} \frac{\partial \psi_3}{\partial t} + \frac{\partial \psi_2}{\partial y} = i \frac{m_e c}{\hbar} \psi_3 \end{cases}, \quad (5.1.4)$$

Taking into account the fact that  $r_C = \frac{\hbar}{m_e c}$  is the Compton wavelength, Dirac's equation can be rewritten in the form

$$\frac{1}{c} \frac{\partial \psi}{\partial t} + \vec{\alpha} \cdot \vec{\nabla} \psi = i \hat{\beta} \frac{1}{r_C} \psi, \quad (5.1.5)$$

The Dirac equation in the form, which is near to originally proposed by Dirac, is:

$$\left( \hat{\alpha}_0 \hat{\varepsilon} + c \vec{\alpha} \hat{p} \right) \psi = \hat{\beta} m_e c^2 \psi, \quad (5.1.6)$$

where  $\hat{\varepsilon} = i\hbar \frac{\partial}{\partial t}$  and  $\hat{p} = -i\hbar \vec{\nabla}$  are the operators of energy and momentum.



Frequently the term from the right side of equation is called the “mass term” or “free term” of Dirac’s equation.

At present time the explicitly covariant form of the Dirac equation (employing the Einstein summation convention) is often used:

$$-\hbar\hat{\gamma}^\mu\partial_\mu\psi = m_e c\psi, \quad (5.1.7)$$

where the  $\gamma$ -set of the Dirac matrices is used. But here  $\hat{\gamma}_4$  is Hermitian, and the  $\hat{\gamma}_k$  are anti-Hermitian, with the definition  $\hat{\gamma}_4 = \hat{\beta}$ ,  $\hat{\gamma}_k = \hat{\gamma}_4\hat{\alpha}_k$  ( $k=1,2,3$ ); in this case (Madelung, 1943)  $\hat{\gamma}_\mu\frac{\partial}{\partial x_\mu}$  is not Hermitian; instead the operator  $\hat{\gamma}_4\hat{\gamma}_\mu\frac{\partial}{\partial x_\mu}$  is. Therefore more rationally to write Dirac's equation in the form (using  $x_\mu = \{\vec{r}, ict\}$  and Compton wavelength  $r_C$ ):

$$\left(\sum_\mu\hat{\gamma}_4\hat{\gamma}_\mu\frac{\partial}{\partial x_\mu} + \hat{\gamma}_4\frac{1}{r_C}\right)\psi = 0, \text{ which is identical with (5.1.5) and (5.1.6).}$$

Note (Fermi, 1960) that in order for the Dirac electron equation to obey to the relativistic momentum-energy relation  $\varepsilon^2 - \vec{p}^2c^2 - m^2c^4 = 0$ , the any set of Dirac’s matrices must satisfy the requirements:

$$\begin{aligned} \hat{\delta}_1^2 = \hat{\delta}_2^2 = \hat{\delta}_3^2 = \hat{\delta}_4^2 = 1 \\ \hat{\delta}_\mu\hat{\delta}_\nu + \hat{\delta}_\nu\hat{\delta}_\mu = 0 \text{ for } \mu \neq \nu \end{aligned} \quad (5.1.8)$$

where  $\mu, \nu = 1, 2, 3, 4$ . “One finds that the lowest order matrices for which (5.1.8) can be fulfilled is the 4<sup>th</sup>. For order four there are many solutions that are essentially equivalent. One can prove that all the physical consequences of Dirac’s equation do not depend on the special choice (5.1.3) of  $\hat{\alpha}_1, \hat{\alpha}_2, \hat{\alpha}_3, \hat{\beta}$ . They would be the same if a different set of four 4x4 matrices with the specifications (5.1.8) had been chosen. In particular it is possible by unitary transformation to interchange the roles of the four matrices, so that their differences are only apparent”.

The connection of contemporary theory of elementary particles with nonlinear electromagnetic (EM) theory is known many years. According to modern ideas (Ryder, 1985; Philipov, 1990), the observed substance of the Universe consists of photons, intermediate bosons, leptons and quarks. Besides electromagnetic interactions, there are strong and weak interactions. All of these interactions are described by the unified theory, which is a substantial generalization of Maxwell's theory. Instead of vectors of the usual electrical and magnetic fields  $\vec{E}$  and  $\vec{B}$ , the modern theory contains several similar field vectors  $\vec{E}_i$  and  $\vec{B}_i$ , and in a natural way, the waves of these vectors are strictly nonlinear.

The first such generalization of Maxwell's theory was made by C. Yang and R. Mills in 1954 (Nambu, 1982): “The generalization of the Maxwell theory is the theory of the Yang-Mills fields or non-Abelian gauge fields. Its equations are nonlinear. In contrast to this, the equations of Maxwell are linear, in other words, Abelian”. A sufficiently detailed derivation of the Yang-Mills equations in the form of Maxwell's equations can be found in the book of Ryder (Ryder, 1985). According to one of its creators M.Gell-Mann, «practically, the result of the field theory development was only the generalisation of the quantum electrodynamics» (Gell-Mann, 1983)

It is necessary to note that the possibility of a formal representation of the Schrödinger and Dirac electron equations in a form of linear Maxwell equations was also mentioned in several articles and books (Schrödinger, 1927; Archibald, 1955; Akhiezer and Berestetskii, 1965; Koga, 1975; Campolattoro, 1980; Rodrigues, 2002). But up to now all these EM representations of Dirac's equation were examined as the random, curious coincidence of mathematical forms. In these studies no attempts were done to examine the EM forms of Dirac's equation as quantum-mechanical equations, which describe massive fermions. The traditional view (Gspöner, 2002),

“which consists in the fact that the particles of spin 1 and spin  $\frac{1}{2}$  belong to different irreducible representations of the Poincare group, so that no connection exists between the Maxwell and Dirac equations, describing the dynamics of particles” probably played a role in this.

Indeed, the Dirac equations cannot be equivalent to the classical linear equations of Maxwell, and a spinor cannot be equivalent to a vector. However, the unified theory of electromagnetic and weak interaction, described by the Yang-Mills theory, makes it possible to assume that a connection exists between the electromagnetic non-Maxwellian, nonlinear equations and the Dirac equations. In other words, we can assume that Dirac’s equation is a quantized nonlinear non-Maxwellian electromagnetic equation, described in linear form.

In the present chapter we will derive the linear quantum equation of electron – the Dirac electron equation - and give the numerous proofs of its electromagnetic origin.

## 2.0. The equations of particles, generated from the breaking of intermediate massive photon

### 2.1. Derivation of equations

Our analysis of an initial stage of photoproduction of electron-positron pair, made in the previous chapter, shows that an intermediate photon can be divided into two parts, in order to produce an electron and a positron. Let us describe this process mathematically in order to find equations for these particles.

Let us begin with the equation of an intermediate photon (see equation (4.4.2) of the previous chapter):

$$\left(\hat{\varepsilon}^2 - c^2 \hat{p}^2 - K^2\right)\Phi' = 0, \quad (4.4.2)$$

Here as it follows from the previous sections, the term  $K = \hat{\beta} m_p c^2$  corresponds to the tangent displacement current (4.3.9):

$$j_\tau = \omega_p \frac{1}{4\pi} E \equiv \frac{m_p c^2}{\hbar} \frac{1}{4\pi} E \equiv \frac{v_p}{r_p} \frac{1}{4\pi} E \equiv K \frac{c}{4\pi} E,$$

where  $K = 1/r_p$  is the curvature of the fields’ motion trajectory,  $v_p = c$  is wave field velocity,

$r_p = \frac{\hbar}{m_p c}$  is the curvature radius,  $\omega_p = \frac{m_p c^2}{\hbar} = \frac{v_p}{r_p} \equiv cK$  is an angular velocity. Furthermore,

here,  $m_p c^2 = \varepsilon_p$  is intermediate photon own energy, where  $m_p$  is intermediate boson mass, corresponding to the energy  $\varepsilon_p$ .

Factorizing (4.4.2) and multiplying it on the left side by  $\Phi'^+$ , we obtain:

$$\Phi'^+ \left( \hat{\alpha}_o \hat{\varepsilon} - c \hat{\alpha} \cdot \hat{p} - K \right) \left( \hat{\alpha}_o \hat{\varepsilon} + c \hat{\alpha} \cdot \hat{p} + K \right) \Phi' = 0, \quad (5.2.1)$$

or

$$\Phi'^+ \left( \hat{\alpha}_o \hat{\varepsilon} - c \hat{\alpha} \cdot \hat{p} - \hat{\beta} m_p c^2 \right) \left( \hat{\alpha}_o \hat{\varepsilon} + c \hat{\alpha} \cdot \hat{p} + \hat{\beta} m_p c^2 \right) \Phi' = 0, \quad (5.2.1')$$

Now, we can separate the intermediate photon equation (5.2.1) into two transformed waves, *advanced* and *retarded*, in order to obtain two new equations for the massive particles:

$$\left[ \left( \hat{\alpha}_o \hat{\varepsilon} + c \hat{\alpha} \cdot \hat{p} \right) + \hat{\beta} m_p c^2 \right] \psi = 0, \quad (5.2.2')$$

$$\psi^+ \left[ \left( \hat{\alpha}_o \hat{\varepsilon} - c \hat{\alpha} \cdot \hat{p} \right) - \hat{\beta} m_p c^2 \right] = 0, \quad (5.2.2'')$$

where

$$\psi = \begin{pmatrix} \psi_1 \\ \psi_2 \\ \psi_3 \\ \psi_4 \end{pmatrix} = \begin{pmatrix} E_x \\ E_z \\ iH_x \\ iH_z \end{pmatrix}, \quad \psi^+ = (E_x \quad E_z \quad iH_x \quad iH_z), \quad (5.2.3)$$

is some new transformed EM wave function which appears after the intermediate photon breaking. Further, in this connection, we will conditionally name the equations (5.2.2) as *semi-photon equations*, and the passage from (4.4.2) to (5.2.2) as the *symmetry breaking* of an intermediate photon).

Now, we will analyze the peculiarities of equations (5.2.2). We can see that the latter are similar to the Dirac electron and positron equations. However, instead of electron mass  $m_e$ , equations (5.2.2) contain the intermediate photon mass  $m_p$ . The question is, what type of particles do equations (5.2.2) describe?

In the case of an electron-positron pair production, it must be  $m_p = 2m_e$ . So, we have from (5.2.2):

$$\left[ (\hat{\alpha}_o \hat{\varepsilon} + c \hat{\alpha} \hat{p}) + 2\hat{\beta} m_e c^2 \right] \psi = 0, \quad (5.2.4')$$

$$\psi^+ \left[ (\hat{\alpha}_o \hat{\varepsilon} - c \hat{\alpha} \hat{p}) - 2\hat{\beta} m_e c^2 \right] = 0, \quad (5.2.4'')$$

and after the breaking of the intermediate photon, the non-charged massive particle must be divided into two charged massive semi-photons, the positively and negatively charged particles acquire electric fields. At the same moment each particle begins to move in the field of the other. In order to become independent (i.e. free) particles, the electron and positron must be drawn sufficiently far away from each other (Fig. 5.1):

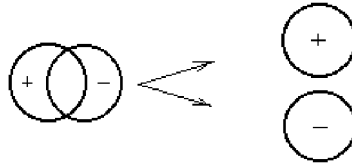

Fig. 5.1.

Therefore, the equations, which originate after the breaking-up of the intermediate photon, cannot be free positive and negative (electron and positron) particle equations, but they have to be the particle equations with an external field. In this case, the energy must be expended to the charged particles begin move apart. This is the energy that creates an electric field.

In fact, if the particles are combined, the system won't have an electric field (Fig. 5.1). At a very small distance, the particles will create the dipole field (see Fig. 5.2)

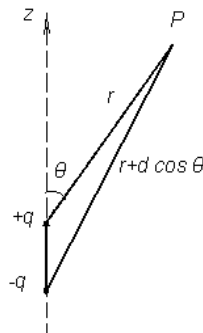

Fig. 5.2

At a distance much greater than the particle size, the positive and negative particles (plus and minus particles of Fig. 5.1) acquire full electric fields. It is known (Jackson, 1999) that the potential  $V_p$  of positive and negative charges at point  $P$  is defined as follows:

$$V_p = \frac{e}{4\pi} \left( \frac{1}{r} - \frac{1}{r + d \cos \theta} \right), \quad (5.2.5)$$

where  $\pm e$  are dipole charges,  $d$  is the distance between the charges, and  $\theta$  is the angle between the axes and radius-vector of the plus particle. When  $d = 0$ , we have  $V_p = 0$ . When  $d \rightarrow \infty$ , we obtain, as the limit case, the Coulomb potential for each free particle:

$$\lim_{d \rightarrow \infty} V_p = \frac{1}{4\pi} \frac{e}{r}, \quad (5.2.6)$$

Thus, during the breaking process, the particle charges appear. If the particles are moved apart to an infinite distance, the work to be done against the attraction forces is as follows:

$$\varepsilon_{rel} = \oint e V_p dV = \frac{1}{4\pi} \oint \frac{e^2}{r} dV, \quad (5.2.7)$$

The external field of particles defines the amount of work, so that the release energy is the field's production energy, and at the same time this is annihilation energy. Therefore, due to the law of energy conservation, this value of energy for each particle must be equal to  $\varepsilon_{rel} = m_e c^2$ .

So, equations (5.2.2) can be written in the following form:

$$\left[ (\hat{\alpha}_0 \hat{\varepsilon} + c \hat{\alpha} \hat{p}) + \hat{\beta} m_e c^2 + \hat{\beta} m_e c^2 \right] \psi = 0, \quad (5.2.8')$$

$$\psi^\dagger \left[ (\hat{\alpha}_0 \hat{\varepsilon} - c \hat{\alpha} \hat{p}) - \hat{\beta} m_e c^2 - \hat{\beta} m_e c^2 \right] = 0, \quad (5.2.8'')$$

Using a linear equation for the description of the law of energy conservation, we can write:

$$\pm \hat{\beta} m_e c^2 = -\varepsilon_{ex} - c \hat{\alpha} \vec{p}_{ex} = -e \varphi_{ex} - e \hat{\alpha} \vec{A}_{ex}, \quad (5.2.9)$$

where “ $ex$ ” means “external”. Substituting (5.2.9) into (5.2.8), we obtain the Dirac equations with an external field:

$$\left[ \hat{\alpha}_0 (\hat{\varepsilon} \mp \varepsilon_{ex}) + c \hat{\alpha} \cdot (\hat{p} \mp \vec{p}_{ex}) + \hat{\beta} m_e c^2 \right] \psi = 0, \quad (5.2.10)$$

which at  $d \rightarrow \infty$  gives the Dirac free - plus and minus - particle equations:

$$\left[ (\hat{\alpha}_0 \hat{\varepsilon} + c \hat{\alpha} \hat{p}) + \hat{\beta} m_e c^2 \right] \psi = 0, \quad (5.2.11')$$

$$\psi^\dagger \left[ (\hat{\alpha}_0 \hat{\varepsilon} - c \hat{\alpha} \hat{p}) - \hat{\beta} m_e c^2 \right] = 0, \quad (5.2.11'')$$

Some interesting consequences follow from the above analysis:

1. an intermediate photon is not an absolutely neutral particle before the breaking-up, but a dipole; therefore, it must have a dipole moment (its experimental detection would give confirmation of the nonlinear theory).

2. the relationship (5.2.9) shows that in NTEP the mass is not equivalent to energy, but to a 4-vector of the energy-momentum; it follows from this that in NTEP the energy has a kinetic origin.

3. the following formula is valid within the framework of NTEP for the free term of the particle equation:

$$\pm \hat{\beta} m_e c^2 = -\varepsilon_{in} - c \hat{\alpha} \vec{p}_{in} = -e \varphi_{in} - e \hat{\alpha} \vec{A}_{in}, \quad (5.2.12)$$

where “ $in$ ” means “internal”. In other words, values  $(\varepsilon_{in}, \vec{p}_{in})$  describe the inner fields and values  $(\varepsilon_{ex}, \vec{p}_{ex})$  of the external fields of the electron-positron particles. When we consider an electron particle from a large distance, the fields  $(\varepsilon_{in}, \vec{p}_{in})$  act as the mass, then we will have linear Dirac equations of particles. Inside the electron, the term  $(\varepsilon_{in}, \vec{p}_{in})$  is required for the detailed

description of the inner fields of the particle, which characterize the self-interaction of the particle's parts (it is shown in a further chapter) that this term transforms to a nonlinear equation of the particle).

4. An important additional conclusion following from the above is that the charge, mass and interaction between the particles appear simultaneously in the process of the rotation transformation and division of the "linear" photon.

5. Subsequently we will show that, although the choice of Dirac's matrices does not influence the solutions of Dirac's equation, it has the physical sense.

## 2.2. Electromagnetic representation of Dirac's equations

Using the electromagnetic representation (5.2.3) of the semi-photon wave function  $\psi$  and the displacement electric tangential currents (4.3.7) from previous chapter  $\vec{j}_{dis}^e = \frac{1}{4\pi} \omega_p \mathbf{E} \cdot \vec{\tau}$ , we obtain an electromagnetic form of equations (5.2.11).

$$\left\{ \begin{array}{l} \frac{1}{c} \frac{\partial E_x}{\partial t} - \frac{\partial H_z}{\partial y} = -i \frac{4\pi}{c} j_x^e \\ \frac{1}{c} \frac{\partial H_z}{\partial t} - \frac{\partial E_x}{\partial y} = i \frac{4\pi}{c} j_z^m \\ \frac{1}{c} \frac{\partial E_z}{\partial t} + \frac{\partial H_x}{\partial y} = -i \frac{4\pi}{c} j_z^e \\ \frac{1}{c} \frac{\partial H_x}{\partial t} + \frac{\partial E_z}{\partial y} = i \frac{4\pi}{c} j_x^m \end{array} \right. , \quad (5.2.13') \quad \left\{ \begin{array}{l} \frac{1}{c} \frac{\partial E_x}{\partial t} + \frac{\partial H_z}{\partial y} = -i \frac{4\pi}{c} j_x^e \\ \frac{1}{c} \frac{\partial H_z}{\partial t} + \frac{\partial E_x}{\partial y} = i \frac{4\pi}{c} j_z^m \\ \frac{1}{c} \frac{\partial E_z}{\partial t} - \frac{\partial H_x}{\partial y} = -i \frac{4\pi}{c} j_z^e \\ \frac{1}{c} \frac{\partial H_x}{\partial t} - \frac{\partial E_z}{\partial y} = i \frac{4\pi}{c} j_x^m \end{array} \right. , \quad (5.2.13'')$$

Let us note that for the symmetry we included in the equations the displacement magnetic tangential currents (4.3.7)  $\vec{j}_{dis}^m = \frac{1}{4\pi} \omega_p \mathbf{H} \cdot \vec{\tau}$ . It is known that the existence of the magnetic current  $\vec{j}^m$  does not contradict to quantum theory (see Dirac's theory of a magnetic monopole (Dirac, 1931)). In case of the plane polarized wave (see previous chapters), the magnetic currents are equal to zero (but not for other polarizations, as we will see further).

According to the results of the previous chapter of the book, the current terms of Dirac's equation are own electrical and magnetic currents of electron. Let us write down them in different identical representations:

$$\begin{aligned} j_j^e &= \frac{1}{2} \frac{1}{4\pi} \omega_p E_l \equiv \frac{1}{4\pi} \frac{m_e c^2}{\hbar} E_l \equiv \frac{1}{2} \frac{c}{4\pi r_p} E_l \equiv \frac{1}{2} \frac{c}{4\pi} \mathbf{K} E_l \\ j_j^m &= \frac{1}{2} \frac{1}{4\pi} \omega_p H_l \equiv \frac{1}{4\pi} \frac{m_e c^2}{\hbar} H_l \equiv \frac{1}{2} \frac{c}{4\pi r_p} H_l \equiv \frac{1}{2} \frac{c}{4\pi} \mathbf{K} H_l \end{aligned} , \quad (5.2.14)$$

where the subscript  $l$  in general case are  $l = (x, y, z)$ .

Using the currents' representation with electrical conductivity  $\omega_p = 2\omega_e = 2m_e c^2 / \hbar$  (which has the CGSE units of inverse second ( $s^{-1}$ )), we obtain the following electromagnetic form of Dirac equations:

$$\left\{ \begin{array}{l} \frac{1}{c} \frac{\partial E_x}{\partial t} - \frac{\partial H_z}{\partial y} = -i \frac{1}{c} \omega_e E_x \\ \frac{1}{c} \frac{\partial H_z}{\partial t} - \frac{\partial E_x}{\partial y} = i \frac{1}{c} \omega_e H_z \\ \frac{1}{c} \frac{\partial E_z}{\partial t} + \frac{\partial H_x}{\partial y} = -i \frac{1}{c} \omega_e E_z \\ \frac{1}{c} \frac{\partial H_x}{\partial t} + \frac{\partial E_z}{\partial y} = i \frac{1}{c} \omega_e H_x \end{array} \right. , (5.2.15') \quad \left\{ \begin{array}{l} \frac{1}{c} \frac{\partial E_x}{\partial t} + \frac{\partial H_z}{\partial y} = -i \frac{1}{c} \omega_e E_x \\ \frac{1}{c} \frac{\partial H_z}{\partial t} + \frac{\partial E_x}{\partial y} = i \frac{1}{c} \omega_e H_z \\ \frac{1}{c} \frac{\partial E_z}{\partial t} - \frac{\partial H_x}{\partial y} = -i \frac{1}{c} \omega_e E_z \\ \frac{1}{c} \frac{\partial H_x}{\partial t} - \frac{\partial E_z}{\partial y} = i \frac{1}{c} \omega_e H_x \end{array} \right. , (5.2.15'')$$

As it is easily see, the currents' forms (5.2.13) and (5.2.15) of the electron equation is similar to Maxwell-Lorentz's equations with complex fields, which is frequently used in the classical theory of electromagnetic waves (especially in the theory of ultra-high frequency EM waves). Moreover, beginning from O. Heaviside, magnetic currents are introduced into the complex Maxwell's equations for the symmetry of equations and facilitation of problem solutions. The essential difference between equations (5.2.15) and the Maxwell-Lorentz equations is that the electrical conductivity  $\omega_p$  contains the Planck constant..

Using the currents' representation with  $m_e$ , we obtain the other electromagnetic form of Dirac equations:

$$\left\{ \begin{array}{l} \frac{1}{c} \frac{\partial E_x}{\partial t} - \frac{\partial H_z}{\partial y} = -i \frac{m_e c}{\hbar} E_x \\ \frac{1}{c} \frac{\partial H_z}{\partial t} - \frac{\partial E_x}{\partial y} = i \frac{m_e c}{\hbar} H_z \\ \frac{1}{c} \frac{\partial E_z}{\partial t} + \frac{\partial H_x}{\partial y} = -i \frac{m_e c}{\hbar} E_z \\ \frac{1}{c} \frac{\partial H_x}{\partial t} + \frac{\partial E_z}{\partial y} = i \frac{m_e c}{\hbar} H_x \end{array} \right. , (5.2.16') \quad \left\{ \begin{array}{l} \frac{1}{c} \frac{\partial E_x}{\partial t} + \frac{\partial H_z}{\partial y} = -i \frac{m_e c}{\hbar} E_x \\ \frac{1}{c} \frac{\partial H_z}{\partial t} + \frac{\partial E_x}{\partial y} = i \frac{m_e c}{\hbar} H_z \\ \frac{1}{c} \frac{\partial E_z}{\partial t} - \frac{\partial H_x}{\partial y} = -i \frac{m_e c}{\hbar} E_z \\ \frac{1}{c} \frac{\partial H_x}{\partial t} - \frac{\partial E_z}{\partial y} = i \frac{m_e c}{\hbar} H_x \end{array} \right. , (5.2.16'')$$

which means that the electron has electromagnetic origin and its mass is generated as circular electromagnetic field. Thus, the derivation of Dirac's equation on the basis of quantized electromagnetic equations proves Lorentz's hypothesis about the electromagnetic origin of the electron. (Subsequently we will prove the same relatively to all leptons and hadrons).

Note also that the forms of source term (5.2.14) with curvature radius or curvature

$$j_j^e = \frac{1}{2} \frac{c}{4\pi} \frac{1}{r_p} E_l \equiv \frac{1}{2} \frac{c}{4\pi} K E_l, \quad j_j^m = \frac{1}{2} \frac{c}{4\pi} \frac{1}{r_p} H_l \equiv \frac{1}{2} \frac{c}{4\pi} K H_l,$$

the electron equation is similar to Gilbert-Einstein gravitational equation, but here the mass-energy term appear due to curvilinearity of field, not of space-time).

At the same time there are essential differences between the classical and quantum form of electromagnetic equations.

- In the nonlinear theory the quantization of the energy-momentum of electromagnetic field is introduced, whereas in the classical theory this limitation is absent.

- In the nonlinear theory the complex forms have literal physical sense: they describe the fields' rotation (in other words, they ensure passage from linear forms to nonlinear forms of theory). In the classical theory complex forms are convenient for calculation, but as final results is considered only one of the projections of rotary motion - the so-called, real part of the complex number. Thus, the complex form of the equations of nonlinear theory is the generalization of the linear theory of Maxwell-Lorentz.

- In the classical theory there are no magnetic currents and charges. At the same time, as we will show subsequently, in the theories of neutrino and quarks, magnetic currents actually exist. But they are not found out of the particles because of the mutual compensation for magnetic currents inside the particles and therefore they do not create magnetic monopoles. On one hand, this explains, why the introduction of magnetic currents does not disrupt the classical results, but on the other hand, it explains, why magnetic currents and charges in it are absent.

### 2.3. The “field diagram” of the photoproduction of the electron-positron pair

Using the results, obtained above and in the previous chapter, we can give Feynman's diagram of the electron-positron pair photoproduction (see the figs of 4.1 and 4.4 of previous chapter) more real physical sense. Thus we correspond to each element of this diagram the graphical representation of wave fields of the corresponding elementary particles. Let us name this diagram “**field diagram**” of interaction of particles.

Thus, we can conditionally represent the transformation of photon fields during the process of electron-positron pair photoproduction as following *field diagram* (Fig. 5.3):

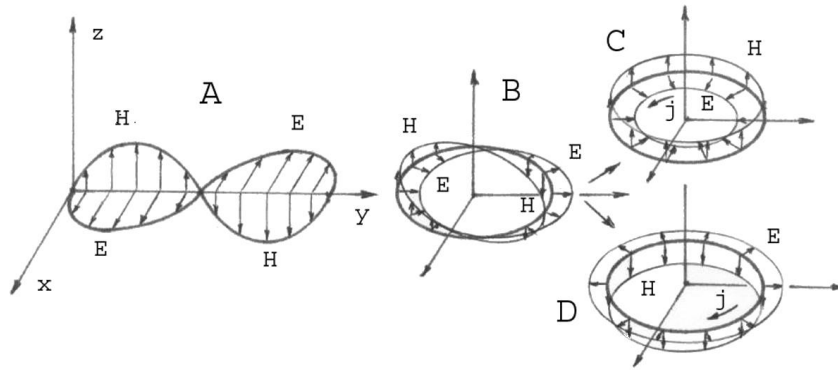

Fig. 5.3.

The part A here represents a “linear” photon (that obeys the linear equation); part B depicts the intermediate massive boson (“nonlinear” photon); and parts C and D represent the electron and positron.

We can make some conclusions from this field diagram without calculations.

a) It is clear that the intermediate photon breakdown process, according to Fig. 5.3, corresponds to the process of particle-antiparticle pair production. Closed currents  $j = \rho_e \vec{v}$  (where in our case  $v = c$ ), that emerge in this case, create electrical charges of particle  $e = \int_{\tau} \rho_e d\tau$ , where  $\tau$  is volume. This means that the field diagram Fig. 5.3 actually describes the generation of the charged particles.

Note that in the electromagnetic interpretation for understandable reasons the free term of Dirac's equation can be called “a source” of electric field of electron. The electric charge appears here as the gauge coupling constant, like as in Standard Model theory.

b) It follows from Fig. 5.3 that parts C and D (two ‘semi-photons’) contain currents of opposite directions. Thus, we can assume, that *the cause of an intermediate photon breaking is a mutual repulsion of oppositely directed currents*.

It is not difficult to see that in both parts C and D (electron and positron) magnetic and electric forces appear, which have reciprocal directions that is necessary to ensure the equilibrium of particle.

c) Note also that the “daughter” semi-photons C and D, i.e. electron and positron, are completely anti-symmetric, and one cannot be transformed into the other by any co-ordinate transformation (if this transformations are not accompanied by the change of fields' directions).

d) From the above also follows that the angular momentum of the intermediate photon is equal to:

$$\sigma_p = p_p \cdot r_p = 2m_e c \cdot \frac{\hbar}{2m_e c} = \hbar,$$

In accordance with the law of conservation of angular momentum, we have  $\sigma_s^+ + \sigma_s^- = \sigma_p$ , where  $\sigma_s^+, \sigma_s^-$  are the spins of the plus and minus semi-photons (i.e. of the electron and positron). Then, we obtain the known value for the angular momentum of the electron:

$$\sigma_s = \frac{1}{2} \sigma_p = \frac{1}{2} \hbar,$$

e) It is interesting that *both the semi-photons' and intermediate photons' radii must be the same*. Since  $\sigma_s = p_s \cdot r_s$ , where  $r_s$  is the semi-photon (electron) radius, and  $p_s = m_e c$  is the inner semi-photon (electron) linear momentum, we have:

$$r_s = \frac{\sigma_s}{p_s} = \frac{1}{2} \frac{\hbar}{m_e c} = \frac{\hbar}{2m_e c} = r_p,$$

Thus, *the torus size of the intermediate photon doesn't change after its breaking*.

f) Using this result, we can show that during the breaking *the angular velocity (angular frequency) also does not change*:

$$\omega_s = \frac{c}{r_s} = \frac{2m_e c^2}{\hbar} = \omega_p.$$

g) Linear velocity of rotation of fields' of intermediate boson and electron are equal to speed of light:

$$v = \omega_p \cdot r_p = \omega_s \cdot r_s = c$$

h) Magnetic moment of ring electron accordingly with definition is  $\mu_s = I \cdot S_I$ , where  $I$  is electron ring current and  $S_I$  is the current ring square. In our case we have

$$I = q_s \frac{\omega_s}{2\pi} = q_s \frac{1}{2\pi} \frac{2m_e c^2}{\hbar}, \quad S_I = \pi r_s^2 = \pi \left( \frac{\hbar}{2m_e c} \right)^2. \text{ Using these formulae, we find:}$$

$$\mu_s = \frac{1}{2} \frac{q\hbar}{2m_e c},$$

If we put  $q_s = e$ , the value is equal to half of the experimental value of the magnetic momentum of the electron. Taking into account the Thomas's precession (Thomas, 1926) we obtain the experimental value of the electron magnetic momentum.

The breakdown of the intermediate photon makes it possible to explain some fundamental experimental results:

**1) the origin of the law of charge conservation:** a total electric charge of an isolated system remains constant regardless of the changes within the system itself. Since there are the same numbers of plus and minus half-periods of photons in nature, the sum of all created or destroyed charges must be equal to zero.

**2) the difference between the positive and negative charges:** this difference follows from the asymmetry of fields and the difference in directions of tangent currents of semi-photons after the pair production.

**3) the explanation of "Zitterbewegung":** E. Schroedinger showed in his well-known articles about the relativistic electron (Schrödinger, 1929;1930;1931a;1931b;1932; Bethe, 1964) that the



rest electron has a special inner motion "Zitterbewegung", which has a frequency  $\omega_z = \frac{2m_e c^2}{\hbar}$ , an amplitude  $r_z = \frac{\hbar}{2m_e c}$ , and velocity of light  $v = c$ . The attempts to explain this motion within

the framework of QED did not produce results. However, if the electron is a semi-photon, then we receive a simple explanation of Schroedinger's analysis.

4) *the difference between the bosons and fermions*: the bosons contain an even number, while the fermions contain an odd number of semi-photons.

5) in nonlinear theory the problem of the *infinite electron energy* does not exist, because the space distribution of particle field is continuous.

6) The characteristic feature of quantum theory is the non-commutativity of canonical variables. This is easily explained by the fact that non-commutativity appears as the consequence of motion of vectors along the curvilinear trajectory.

7) In this case the optics-mechanical analogy of Hamilton, from which all quantum theory began, finds its substantiation (actually NTEP is the optics of nonlinear waves, which simultaneously can describe the motion of the material objects).

8) The occurrence of Pauli's matrixes, which describe the rotation in classical mechanics in 2D space in the Dirac electron and positron equations, receives an explanation as well as the occurrence of Gell-Mann matrixes in the Yang-Mills equations, which describe the rotation in 3D space.

9) The necessity of a nucleus electromagnetic field receives an explanation: it serves as the medium with the big refraction number, leaning on which the light string bents (obviously this requirement is identical to the requirement of conservation of system momentum).

10) The formed EM particles are simultaneously both waves and particles (i.e. the wave - particle dualism is inherent to them).

11) Since the twirled photon has integer spin (i.e., it is a boson), but the twirled semi-photons have spin half (i.e., they are fermions), we automatically receive an explanation of division of all elementary particles into bosons and fermions.

12) It is easy to see, that the fig. 4 reflects the process of spontaneous symmetry breakdown of an initial photon and occurrence of mass of elementary particles, which have place in presence of a nucleus field, as some catalyst of the reaction (playing here the role of Higgs boson).

13) If in the theory of static spherical electron of Lorentz classical theory there are no the electromagnetic forces, capable to constrain the repulsion of electron parts from each other and it is necessary to enter Poincare's forces of non electromagnetic origin, then it is easy to see, that here, owing to presence of a current, there is the magnetic part of full Lorentz force directed against electrostatic forces of repulsion and counterbalancing them. Thus, such electron does not demand the introduction of extraneous forces of an unknown origin and is stable.

### 3.0. Analysis of the free electron's equation solution from EM point of view

According to the above results, an electromagnetic form of a solution of the free electron Dirac equation must be a transformed electromagnetic wave.

As we saw above, for the appearance of electric current and, as a result, charge, it is necessary that the electric vector moved in the trajectory plane of the motion of electromagnetic wave.

If this supposition is correct, then two solutions must exist for the  $y$ -direction of a photon:

1) for the wave rotated around the  $OZ$ -axis development of electromagnetic theory

$${}^{oz}\psi = \begin{pmatrix} E_x \\ 0 \\ 0 \\ iH_z \end{pmatrix} = \begin{pmatrix} \psi_1 \\ 0 \\ 0 \\ \psi_4 \end{pmatrix}, \quad (5.3.1)$$

2) for the wave rotated around the  $OX$  -axis

$${}^{ox}\psi = \begin{pmatrix} 0 \\ E_z \\ iH_x \\ 0 \end{pmatrix} = \begin{pmatrix} 0 \\ \psi_2 \\ \psi_3 \\ 0 \end{pmatrix}, \quad (5.3.2)$$

For clarity, we will depict both orientations of the original photon in one figure 5.4, as it corresponds to classical electrodynamics:

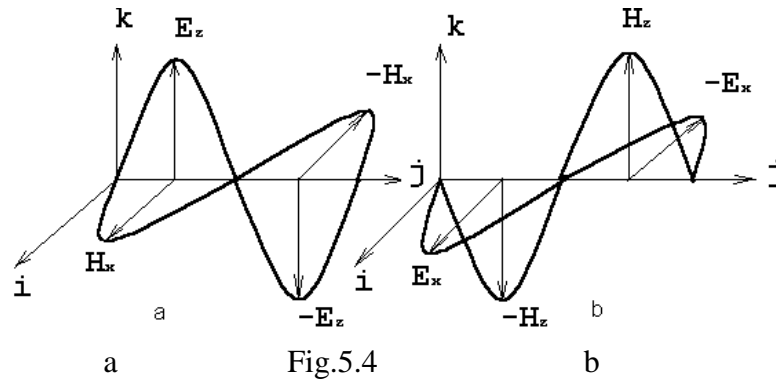

Fig.5.4

The  $\psi$  - functions (5.3.1) and (5.3.2), as solutions of equations (5.2.11), must have the same expressions as solutions of the Dirac's equation for an electron (Schiff, 1955). Let us analyze solutions of the Dirac's wave equation for an electron from the NTEP point of view.

It is known (Schiff, 1955) that the solution of the Dirac free electron's equation (5.2.1) has a form of a plane wave:

$$\psi_j = B_j \exp\left(-\frac{i}{\hbar}(\varepsilon t - \vec{p}\vec{r})\right), \quad (5.3.3)$$

where  $j = 1, 2, 3, 4$ ;  $B_j = b_j e^{i\phi}$ ; amplitudes  $b_j$  are numbers, and  $\phi$  is the initial wave phase. Functions (5.3.3) are eigenfunctions of energy-momentum operators, where  $\varepsilon$  and  $\vec{p}$  are the energy-momentum eigenvalues. Here, for each  $\vec{p}$ , the energy  $\varepsilon$  has either positive or negative values according to equation, representing the law of energy-momentum's conservation  $\varepsilon_{\pm} = \pm\sqrt{c^2\vec{p}^2 + m^2c^4}$ .

We have two linear-independent sets of four orthogonal normalizing amplitudes for  $\varepsilon_+$ :

$$1) B_1 = -\frac{cp_z}{\varepsilon_+ + mc^2}, B_2 = -\frac{c(p_x + ip_y)}{\varepsilon_+ + mc^2}, B_3 = 1, B_4 = 0, \quad (5.3.4)$$

$$2) B_1 = -\frac{c(p_x - ip_y)}{\varepsilon_+ + mc^2}, B_2 = \frac{cp_z}{\varepsilon_+ + mc^2}, B_3 = 0, B_4 = 1, \quad (5.3.5)$$

Accordingly, for  $\varepsilon_-$ :

$$3) B_1 = 1, B_2 = 0, B_3 = \frac{cp_z}{-\varepsilon_- + mc^2}, B_4 = \frac{c(p_x + ip_y)}{-\varepsilon_- + mc^2}, \quad (5.3.6)$$

$$4) B_1 = 0, B_2 = 1, B_3 = \frac{c(p_x - ip_y)}{-\varepsilon_- + mc^2}, B_4 = -\frac{cp_z}{-\varepsilon_- + mc^2}, \quad (5.3.7)$$

Each of these four solutions (Schiff, 1955) can be normalized by multiplying it by normalization factor:

$$\kappa = \left[ 1 + \frac{c^2 \vec{p}^2}{(\varepsilon_+ + m_e c^2)^2} \right]^{-\frac{1}{2}},$$

which gives  $\psi^\dagger \psi = 1$ .

Let us discuss these results.

1) The existence of two linear independent solutions corresponds to two independent orientations of electromagnetic wave vectors, and gives a unique logical explanation for this fact.

2) Since  $\psi = \psi(y)$ , we have  $p_x = p_z = 0$ ,  $p_y = mc$ , and we obtain for field vectors the following: for the "positive" energy from (5.2.4) and (5.2.5) :

$$B_+^{(1)} = \begin{pmatrix} 0 \\ b_2 \\ b_3 \\ 0 \end{pmatrix} \cdot e^{i\phi}, \quad B_+^{(2)} = \begin{pmatrix} b_1 \\ 0 \\ 0 \\ b_4 \end{pmatrix} \cdot e^{i\phi}, \quad (5.3.8)$$

For the "negative" energy, we obtain from (5.2.6) and (5.2.7):

$$B_-^{(1)} = \begin{pmatrix} b_1 \\ 0 \\ 0 \\ b_4 \end{pmatrix} \cdot e^{i\phi}, \quad B_-^{(2)} = \begin{pmatrix} 0 \\ b_2 \\ b_3 \\ 0 \end{pmatrix} \cdot e^{i\phi}, \quad (5.3.9)$$

which corresponds exactly to (5.3.1) and (5.3.2).

3) Calculating correlations between the components of the field vectors. Substituting  $\phi = \frac{\pi}{2}$  for  $\varepsilon_+ = mc^2$  and  $\varepsilon_- = -mc^2$ , we obtain accordingly:

$$B_+^{(1)} = \begin{pmatrix} 0 \\ \frac{1}{2} \\ i \cdot 1 \\ 0 \end{pmatrix}, \quad B_+^{(2)} = \begin{pmatrix} -\frac{1}{2} \\ 0 \\ 0 \\ i \cdot 1 \end{pmatrix}, \quad (5.3.10)$$

$$B_-^{(1)} = \begin{pmatrix} i \cdot 1 \\ 0 \\ 0 \\ -\frac{1}{2} \end{pmatrix}, \quad B_-^{(2)} = \begin{pmatrix} 0 \\ i \cdot 1 \\ \frac{1}{2} \\ 0 \end{pmatrix}, \quad (5.3.11)$$

Obviously, the imaginary unit in these solutions indicates that the field vectors  $\vec{E}$  and  $\vec{H}$  are mutually orthogonal.

Also, we see that the amplitude of an electric field is two times less than the magnetic field amplitude. This fact demonstrates that the electromagnetic field's values, which correspond to solution of Dirac equation, are different in comparison to the fields of a linear wave of Maxwell's theory, where  $\vec{E} = \vec{H}$ . (We can show that this result provides an electron's stability).

4) It is easy to show that in electromagnetic form, the solution of Dirac's equation is a standing wave. Actually, whenever the wave rotates on a circle, we have  $\vec{p} \perp \vec{r}$  and, therefore,  $\vec{p} \cdot \vec{r} = 0$ . Then, instead of (5.2.2), we obtain the standing wave:

$$\psi_j = b_j \exp\left(-\frac{i}{\hbar} \varepsilon t\right), \quad (5.3.12)$$

5) According to Euler's formula  $e^{i\varphi} = \cos \varphi + i \sin \varphi$ , the solution of Dirac's equation (5.3.12) describes a circle. This corresponds to our theory.

6) Let us calculate the normalization factor  $\kappa$ , substituting  $p = mc, \varepsilon = mc^2$ :

$$\kappa = \left(\frac{5}{4}\right)^{-\frac{1}{2}}, \quad (5.3.13)$$

Now, we will compare it with the normalization factor, which is obtained from the electromagnetic representation of the theory. In view of the fact that the electric field is twice as small as the magnetic field, the energy density of a semi-photon will be equal to:

$$W_{s-ph} = \frac{1}{8\pi} (E_{s-ph}^2 + H_{s-ph}^2) = \frac{1}{8\pi} \left[ \left(\frac{1}{2} H_{s-ph}\right)^2 + H_{s-ph}^2 \right] = \frac{1}{8\pi} \frac{5}{4} H_{s-ph}^2, \quad (5.3.14)$$

Using the non-normalized expression for the wave function:

$$\psi_j = B_0 B_j e^{i(\vec{k}\vec{r} - \omega t)} = B_0 \begin{pmatrix} 0 \\ i\frac{1}{2} \\ 1 \\ 0 \end{pmatrix} e^{i(\vec{k}\vec{r} - \omega t)}, \quad (5.3.15)$$

(where  $B_0$  is some constant, generally dimensional), and the Hermitian-conjugate function:

$$\psi_j^+ = B_0 B_j^+ e^{-i(\vec{k}\vec{r} - \omega t)} = B_0 \begin{pmatrix} 0 & -i\frac{1}{2} & 1 & 0 \end{pmatrix} e^{-i(\vec{k}\vec{r} - \omega t)}, \quad (5.3.16)$$

for the field energy, we obtain the following expression:

$$W = \frac{1}{8\pi} \psi_j^+ \psi_j = \frac{1}{8\pi} \cdot \frac{5}{4} \cdot B_0^2, \quad (5.3.17)$$

which precisely corresponds to the result of quantum theory.

#### 4.0. An equation of the electron field motion

Within the framework of NEPT, the 4-vector  $\left\{ e\varphi, \frac{e}{c} \vec{A} \right\}$  is a 4-vector of the energy-momentum of curvilinear wave field  $\{\varepsilon, \vec{p}\}$ . Therefore, a well-known analysis of the Dirac's electron equation in external field can be used to analyze equations of the inner semi-photon field, if we use the following:

$$\frac{e}{c} \vec{A} = \vec{p}, \quad e\varphi = \varepsilon, \quad (5.4.1)$$

As it is known (Akhiezer and Berestetskii, 1965; Schiff, 1955), an equation of the electron's motion in the external field can be found from the next operator equation that has Poisson brackets:

$$\frac{d\hat{O}}{dt} = \frac{\partial \hat{O}}{\partial t} + \frac{1}{i\hbar} (\hat{O}\hat{H} - \hat{H}\hat{O}), \quad (5.4.2)$$

where  $\hat{O}$  is a physical value operator whose variation we want to find, and  $\hat{H}$  is the Hamilton operator of Dirac's equation, which in general case is equal to (Akhiezer and Berestetskii, 1965; Bethe, 1964; Schiff, 1955):

$$\hat{H} = -c\hat{\alpha}\hat{P} - \hat{\beta}mc^2 + \varepsilon, \quad (5.4.3)$$

where  $\hat{P} = \hat{p} - \vec{p}_p$  is a full momentum of a semi-photon.

Let us note that since the mass is an integral characteristic of an electron, it cannot participate in the internal motion of matter of electron, and must be assumed equal to zero.

If we assume  $\hat{O} = \vec{r}$ , then we obtain on the basis (5.4.2) and (5.4.3):

$$\dot{\vec{r}} = \frac{d\vec{r}}{dt} = c\hat{\alpha}$$

which means that the eigenvalue of electron velocity is equal to  $\pm c$ . In quantum theory (Fock, 1932), "a question about does have this paradox result physical sense, it remains open". V. Fock and others "proposed to see here the defect of Dirac's theory". In NEPT, this result will be completely precise if the velocity of fixed electron is not the speed of a whole particle, but the speed of the electron's wave field along a curvilinear trajectory.

For  $\hat{O} = \hat{P}$ , we have the motion equation:

$$\frac{d\hat{P}}{dt} = \left[ -grad(e\varphi) - \frac{e}{c} \frac{\partial \vec{A}}{\partial t} \right] + \frac{e}{c} [\vec{v} \times rot \vec{A}], \quad (5.4.4)$$

Substituting  $\vec{v} = c\hat{\alpha}$ , where  $\vec{v}$  - velocity of the electron matter, we obtain the Newton's law for the motion of electrical charge:

$$\frac{d\vec{P}}{dt} = e\vec{E} + \frac{e}{c} [\vec{v} \times \vec{H}] = f, \quad (5.4.5)$$

where  $f$  is the Lorentz's force. Since for a motionless electron  $\frac{d\hat{P}}{dt} = 0$ , then it follows from (5.4.5):

$$\left( \frac{\partial \vec{p}}{\partial t} + grad \varepsilon \right) - [\vec{v} \times rot \vec{p}] = 0, \quad (5.4.6)$$

Assuming that (5.4.6) is correct for any small volume of the particle  $\Delta\tau$ , we can pass to the densities of EM fields of electron:

$$\vec{g} = \frac{d\vec{p}}{d\tau}, \quad u = \frac{d\varepsilon}{d\tau}, \quad (5.4.7)$$

Then we obtain the equation of matter motion of a semi-photon:

$$\left( \frac{\partial \vec{g}}{\partial t} + grad u \right) - [\vec{v} \times rot \vec{g}] = 0, \quad (5.4.8)$$

Let us analyze a physical meaning of (5.4.8). Let's remember the motion equation of an ideal liquid in the form of Lamb's-Gromek's equation (Lamb, 1931). In the case when the external forces are absent, this equation is as follows:

$$\left( \frac{\partial \vec{g}_l}{\partial t} + grad u_l \right) - [\vec{v} \times rot \vec{g}_l] = 0, \quad (5.4.9)$$

where  $u_l$ ,  $\vec{g}_l$  are the energy and momentum density of an ideal liquid.

Comparing (5.4.8) and (5.4.9), it is not difficult to see their mathematical identity. An interesting conclusion follows from this result: *the EM wave's field motion may be interpreted as a motion of ideal liquid.*

Additionally, according to (5.4.5) and (5.4.6), we have from (5.4.9)

$$\frac{\partial \vec{g}}{\partial t} + \text{grad } u = \vec{f}, \quad (5.4.10)$$

As it is known, the term  $[\vec{v} \times \text{rot } \vec{g}]$  in (5.4.9) is responsible for the centripetal acceleration. Probably, we have the same in (5.4.8). If the "photon liquid" moves along the ring with radius  $r$ , then the angular velocity  $\omega$  of the ring motion of field is tied to  $\text{rot } \vec{v}$  by expression:

$$\text{rot } \vec{v} = 2\vec{\omega} = 2\omega \vec{e}_z, \quad (5.4.11)$$

and the centripetal acceleration is

$$\vec{a}_n = \frac{1}{2} \vec{v} \times \text{rot } \vec{v} = \frac{v^2}{r} \vec{e}_r = c\omega \vec{e}_r, \quad (5.4.12)$$

where  $\vec{e}_r$  is a unit radius-vector,  $\vec{e}_z$  is a unit vector of  $OZ$ -axis. As a result, the equation (5.4.25) has a form of Newton's law:

$$\rho \vec{a}_n = \vec{f}, \quad (5.4.13)$$

The results (5.4.5) and (5.4.13) can be considered (Shiff, 1955) as a representation of the Ehrenfest theorem for the motion of electron's inner fields. These results show also that within the framework of NEPT the electron is a stable object.

Relatively to centripetal acceleration  $a_n$  it is possible to come to an additional interesting conclusion.

As it follows from the previous paragraph, the total acceleration of the EM field of convoluted semi-photon is centripetal it, i.e., has only a radial component.

Using expression (8.2) for describing the change in quantum values (Fock, 1932), it is not difficult to obtain the expression for the centripetal acceleration in NTEP. According to determination, the total acceleration is written as follows:  $\vec{a} = \frac{d^2 \vec{r}}{dt^2}$ . Since  $\frac{dr}{dt} = c \hat{\alpha}$ , we have

$$\vec{a} = \frac{d}{dt} (c \hat{\alpha}) = \frac{c}{i\hbar} [\hat{\alpha}, \hat{H}], \quad (5.4.14)$$

Substituting the expression for the Hamiltonian and taking into account that the spin matrices  $\hat{\sigma}$  are connected with the  $\hat{\alpha}$ -matrices by the relationships:

$$\begin{cases} \hat{\sigma}_1 = -i\hat{\alpha}_2\hat{\alpha}_3 \\ \hat{\sigma}_2 = -i\hat{\alpha}_3\hat{\alpha}_1, \\ \hat{\sigma}_3 = -i\hat{\alpha}_1\hat{\alpha}_2 \end{cases} \quad (5.4.15)$$

we will obtain after calculations the formula, which expresses the connection of acceleration with pulse and spin of twisted semi-photon:

$$\hat{a} = \frac{2c^2}{\hbar} \left[ \hat{P}_{ph} \times \hat{\sigma} \right], \quad (5.4.16)$$

It is not difficult to see that (5.4.16) gives the right direction for the acceleration (see Fig. 5.5)

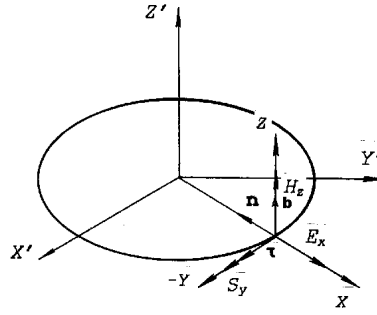

Fig. 5.5

Actually, since the direction of  $\hat{P}_{ph}$  coincides with the direction of Poynting's vector (in the figure:  $-\vec{S}_y$ ), and  $\hat{\sigma}$  is directed along the rotational axis, the acceleration is directed along a radius towards center. It, naturally, follows from this that the acceleration is perpendicular to the speed of the motion of field  $\vec{a}_n \perp \vec{v}$  ( $v=c$ ), and therefore the scalar product of acceleration to the speed is equal to zero:  $\vec{a}_n \cdot \vec{v} = 0$ .

Thus, according to our calculations, the velocity of fixed electron (in reality, of its fields) is equal to the speed of light and is directed tangentially toward the circular path, and the product of its acceleration to the speed is equal to zero. These special features of the motion of fixed electron can explain some results of the 4-dimensional kinematics of the theory of relativity. There we have two mysterious results (Landau and Lifshitz, 1977): 1) the square of 4-speed (in units of the speed of light) is equal to one; and 2) the product of 4-speed for the 4-acceleration is equal to zero. From the comparison with the obtained above results we can assume that the kinematics of the theory of relativity correspond to the kinematics of the theory of elementary particles. Subsequently we will examine this fact in more detail.

## 5.0. The physical and mathematical differences between vector and spinor wave functions

From the theory it follows that the wave functions of photon and intermediate boson are vectors, whereas the wave functions of electron is spinor. What are the physical and mathematical differences between these two objects? We can see that these differences appear during the breaking of an intermediate photon and the production of an electron-positron pair because of the change of the transformation properties of electromagnetic fields.

Let us attempt to describe the differences between the electromagnetic fields  $\{E'_x, E'_z, H'_x, H'_z\}$  of the vector  $\Phi'$ -wavefunction of an intermediate photon and electromagnetic fields  $\{E_x, E_z, H_x, H_z\}$  of the spinor  $\psi$ -wavefunction of semi-photon (i.e. electron) from different points of view.

### 5.1. The topological differences

The spinor's invariant transformation has the form (Ryder, 1987; Gottfried & Weisskopf, 1984):

$$\psi' = U\psi, \quad (5.5.1)$$

where

$$U(\vec{n}\theta) = \cos \frac{1}{2}\theta - i\vec{n} \cdot \vec{\sigma}' \sin \frac{1}{2}\theta, \quad (5.5.2)$$

is the transformation operator,  $\vec{n}$  is a unit vector on some axis,  $\theta$  is the angle of rotation around this axis, and  $\vec{\sigma}' = (\sigma'_x, \sigma'_y, \sigma'_z)$  is a spin vector. The rotation matrix (5.5.2) possesses a remarkable property. If the angle of rotation is  $\theta = 2\pi$  (that is returning to the initial reference system), then  $U = -1$ , instead of  $U = 1$ , as we would otherwise expect. In other words, the state

function of a system with a half spin in the usual three-dimensional space returns to its initial state only after turning by  $4\pi$ .

This result can be explained only if we assume that the *electron and positron are plus and minus half-cycles( halves of wave period) of an intermediate photon, and, therefore, their fields need to be rotated twice to return to the initial state.* This confirms the fact that the semi-photon is a transformed half-cycle of the photon. Thus in the framework of nonlinear electromagnetic representation of theory we can name the spinor wave function as “electromagnetic spinor”.

## 5.2. The differences from the tensor representation point of view

The Dirac spinor cannot be equivalent to vector. But already in the early articles it was noted that between them there is a specific correspondence. Therefore, previously (A. Sokolov, D. Ivanenko, 1952; Goenner, 2004) the spinors were also called “half-vectors” (or tensors of half rank), and the equation of Dirac - “half-vector equation”. The spinors obtained this name because of the comparison of their transformation law with the transformation law of the vectors. Let us describe briefly this comparison (in detail see bibliography).

In Dirac's theory the 4-vectors are some bispinor constructions. For example, let us find transformation law for the 4-vector of energy-momentum density  $\{u, \vec{g}\}$  of electron

$$u = \psi^+ \hat{\alpha}_0 \psi = \psi^+ \psi, \quad \vec{g} = \psi^+ \hat{\vec{\alpha}} \psi, \quad (5.5.3)$$

where  $\psi$  is a spinor (or bispinor),  $\hat{\alpha}_0, \hat{\vec{\alpha}}$  are Dirac's matrices. Using the correlation (5.2.3) we can obtain the electromagnetic representation of above relations:

$$\psi^+ \hat{\alpha}_0 \psi = \vec{E}^2 + \vec{H}^2 = 8\pi u, \quad (5.5.4)$$

$$\psi^+ \hat{\vec{\alpha}} \psi = 2\vec{E} \times \vec{H} = 8\pi c \vec{g}, \quad (5.5.5)$$

which actually correspond to relations of electromagnetic theory.

The rotation transformation law in the  $xt$ -plane (the Lorentz transformation) for Dirac wave function can be write in the form:

$$\psi' = \left( ch \frac{\gamma}{2} - \alpha_1 sh \frac{\gamma}{2} \right) \psi, \quad \psi = \left( ch \frac{\gamma}{2} + \alpha_1 sh \frac{\gamma}{2} \right) \psi', \quad (5.5.6)$$

where  $\gamma$  is the imaginary angle of rotation. Let us find now transformation law for the 4- vector of energy-momentum:

$$u = \psi^+ \psi, \quad g_x = \psi^+ \hat{\alpha}_1 \psi, \quad (5.5.7)$$

In this case, using (5.5.6), we can write:

$$\psi = \Omega_{xt} \psi'; \quad \psi^+ = \psi'^+ \Omega_{xt}^+, \quad (5.5.8)$$

where

$$\Omega_{xt} = \Omega_{xt}^+ = ch \frac{\gamma}{2} + \hat{\alpha}_1 sh \frac{\gamma}{2}, \quad (5.5.9)$$

are operators of the transformation of the Dirac wave function. Then, substituting (5.5.8) into (5.5.7) we obtain, using (5.5.9):

$$u = u' ch \gamma + g'_x sh \gamma,$$

$$g_x = g'_x ch \gamma + u' sh \gamma,$$

as it must be in this case.

Since

$$\psi^+ \psi = \psi'^+ \Omega_{xt}^2 \psi = \psi'^+ Q_{xt} \psi', \quad (5.5.10)$$

the operator



$$Q_{xt} = ch\gamma + \hat{\alpha}_1 sh\gamma, \quad (5.5.11)$$

can be considered as the transformation operator of the vectors. Thus, we have:

$$\Omega_{xt} = \sqrt{Q_{xt}}, \quad (5.5.12)$$

Consequently, the Dirac wavefunction is not tensor in the usual sense; however, the observed physical quantities, which are quadratic combinations from the wavefunctions, are real tensors.

According to above we can name the transformation law for the wavefunctions as the half-vector transformation law, and the equation, to which they obey - the “half-vector equation”

Thus, there are no foundations to doubts that the special (non-Maxwellian) electromagnetic field can organize objects with the spin  $\frac{1}{2}$ .

### 5.3. The differences from a point of view of the group theory

It is known that the vector fields of a photon are transformed as elements of the group  $O(3)$ . At the same time, the spinor fields of the Dirac equation are transformed as elements of the group  $SU(2)$ , and (Ryder, 1987) two spinor transformations correspond to one vector transformation.

## Chapter 6. Electrodynamic sense of the quantum forms of Dirac electron theory

### 1.0. Introduction. The spinor and bispinor equations of photon

On the basis of the previous chapters we will show here that all the mathematical particularities of the Dirac electron theory have the known electrodynamics meaning.

As is known (Akhiezer and Berestetskiy, 1965), there are many identical mathematical representations of the equation of electron. Since, according to the nonlinear theory of elementary particles (NTEP), an electron has electromagnetic origin, it can be assumed that all these representations have a base in nonlinear electrodynamics. In particular, they must be based on the linear equations of photon and nonlinear equation of intermediate massive photon (see previous chapters). Let us examine the special features of these equations, which must also be reflected in the equations of electron.

As we noted in chapter 3, the quantum equation of photon can be recorded in the form of Maxwell-Lorentz equations, taking into account the quantization of energy according to Planck. In particular, these equations can be written down in the spinor and bispinor form.

The Maxwell-Lorentz equations for a photon, as quantum of electromagnetic wave, in the spinor form looks as follows:

$$\begin{cases} \hat{\varepsilon} \Xi + c \hat{\sigma} \hat{p} X = 0, \\ \hat{\varepsilon} X + c \hat{\sigma} \hat{p} \Xi = 0, \end{cases} \quad (6.1.1)$$

where  $\hat{\varepsilon} = i\hbar \frac{\partial}{\partial t}$  and  $\hat{p} = -i\hbar \vec{\nabla}$  are the operators of energy and momentum;  $\hat{\sigma}$  are the spin

matrices of Pauli:  $\hat{\sigma}_1 = \begin{pmatrix} 0 & 1 \\ 1 & 0 \end{pmatrix}$ ,  $\hat{\sigma}_2 = \begin{pmatrix} 0 & -i \\ i & 0 \end{pmatrix}$ ,  $\hat{\sigma}_3 = \begin{pmatrix} 1 & 0 \\ 0 & -1 \end{pmatrix}$ ,  $\hat{\sigma}_0 = \begin{pmatrix} 1 & 0 \\ 0 & 1 \end{pmatrix}$ ;  $\Xi$  and  $X$  are the wave functions of an photon in the spinor form, described by means of the following matrices:

$$\Xi = \begin{pmatrix} \Xi_1 \\ \Xi_2 \end{pmatrix}, \quad X = \begin{pmatrix} X_1 \\ X_2 \end{pmatrix}, \quad (6.1.2)$$

Let us examine the photons, which move in the fixed coordinate system  $X, Y, Z$  along the  $y$ -axis. For such photons, according to electrodynamics, the relationship  $E_y = H_y = 0$  takes place, which is invariant, relative to the Lorentz transformations. Therefore they are described only by two vectors, perpendicular to  $y$ -axis.

If we connect the Frenet trihedron  $\{\vec{n}, \vec{b}, \vec{\tau}\}$  to the electrical, magnetic and Poynting vectors  $\{\vec{E}, \vec{H}, \vec{S}\}$  respectively, then the latter will be collinear with the  $y$ -axis (here  $\vec{n}$  is a normal unit vector to the trajectory of the photon,  $\vec{b}$  is the unit vector of binormal and  $\vec{\tau}$  is the unit vector of tangent to the trajectory of photon (with the rectilinear motion, this vector coincides with the trajectory of the motion of photon, and with the curvilinear it is directed tangentially toward the curve). Additionally the electrical and magnetic vector can be turned relatively to  $y$ -axis to any angle  $\varphi$  in the limits  $0 \leq \varphi \leq 2\pi$ , without changing the physical characteristics of photon. Taking into account this, one should conclude that in the general case there is an infinite number of such photons.

Obviously any linearly polarized photon can be represented as the sum of two photons with mutually perpendicular vectors  $\{E_x, H_z\}$  and  $\{E_z, H_x\}$  with a different absolute value. In that case vectors are harmonic functions, this sum is the elliptically-polarized or circularly polarized photon. Since according to the Bose-Einstein theory the monochromatic electromagnetic wave is

Bose-condensate of the photons of one frequency, we can present photons as EM wave, and vice versa.

Figure 6.1 depicts a change in the electric field of photon, which moves along the  $y$ -axis, the polarization plane of which composes the angle  $\varphi < \pi/2$  with the plane  $ZOY$ . The figure also shows the projections of the motion of electric vector on the plane  $ZOY$  and  $XOY$ , which illustrate the photons with its field components  $\{E_x, H_z\}$  and  $\{E_z, H_x\}$ :



Рис. 6.1.

Further we will have in mind the general case of two separate photons  $\{E_x, H_z\}$  and  $\{E_z, H_x\}$ , or one circularly polarized photon composed of this pair of EM field vectors (Fig. 6.2):

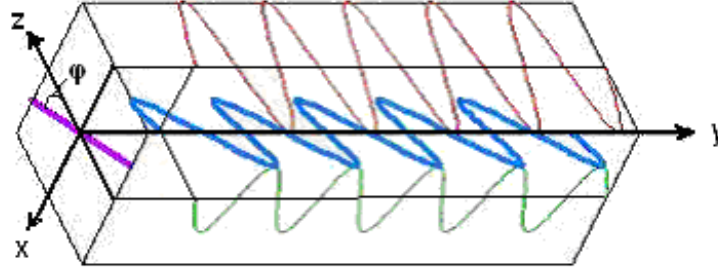

Рис. 6.2.

Introducing spinors in the form:

$$\Xi = \begin{pmatrix} E_x \\ E_z \end{pmatrix}, \quad X = i \begin{pmatrix} H_x \\ H_z \end{pmatrix}, \quad (6.1.3)$$

and taking into account that  $\Xi = \Xi(y)$ ,  $X = X(y)$ , we will obtain the Maxwell equations of two electromagnetic waves or photons (in the case of the quantization of their energy):

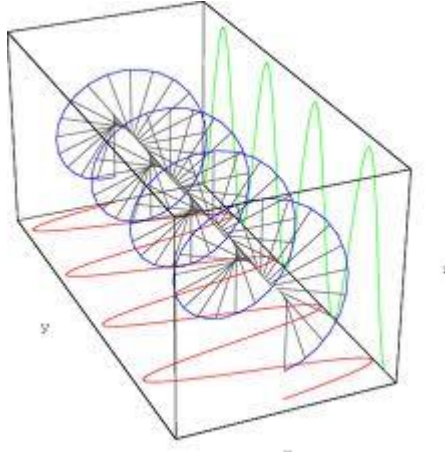
$$\begin{cases} \frac{1}{c} \frac{\partial E_x}{\partial t} - \frac{\partial H_z}{\partial x} = 0, & (a) \\ \frac{1}{c} \frac{\partial E_z}{\partial t} + \frac{\partial H_x}{\partial x} = 0, & (b) \\ \frac{1}{c} \frac{\partial H_x}{\partial t} + \frac{\partial E_z}{\partial x} = 0, & (c) \\ \frac{1}{c} \frac{\partial H_z}{\partial t} - \frac{\partial E_x}{\partial x} = 0, & (d) \end{cases}, \quad (6.1.4)$$

It is not difficult to see that two equations (6.1.1) can be recorded in the form of one equation. Actually, introducing a wave function  $\Phi$ , called bispinor, by means of the following matrix:

$$\Phi = \begin{pmatrix} \Xi \\ \mathbf{X} \end{pmatrix} = \begin{pmatrix} \Xi_1 \\ \Xi_2 \\ \mathbf{X}_3 \\ \mathbf{X}_4 \end{pmatrix} = \begin{pmatrix} \Phi_1 \\ \Phi_2 \\ \Phi_3 \\ \Phi_4 \end{pmatrix} = \begin{pmatrix} E_x \\ E_z \\ i\mathbf{H}_x \\ i\mathbf{H}_z \end{pmatrix}, \quad (6.1.5)$$

two spinor equations can be rewritten as one equation:

$$\hat{\alpha}\Phi + c\hat{\alpha}\hat{\beta}\Phi = 0, \quad (6.1.6)$$

where  $\hat{\alpha}$ ,  $\hat{\beta}$  are the Dirac matrices:

$$\hat{\alpha}_0 = \begin{pmatrix} \hat{\sigma}_0 & 0 \\ 0 & \hat{\sigma}_0 \end{pmatrix}, \quad \hat{\alpha} = \begin{pmatrix} 0 & \hat{\sigma} \\ \hat{\sigma} & 0 \end{pmatrix}, \quad \hat{\beta} \equiv \hat{\alpha}_4 = \begin{pmatrix} \hat{\sigma}_0 & 0 \\ 0 & -\hat{\sigma}_0 \end{pmatrix}.$$

It is not difficult to prove that using bispinor  $\Phi$ , we will obtain the same EM equations (6.1.4).

The equations (6.1.4) *a* and *d* correspond to the polarized in the plane *XOY* photon. Equations (6.1.4) *b* and *c* correspond to the polarized in the plane *ZOY* photon. Physically these photons are identical in view of uniformity and isotropism of empty space. But the mathematical record must consider the special features of their propagation depending on the choice of coordinates. The direction of propagation of electromagnetic wave is determined by the Poynting vector and in the Gauss system units takes the form:

$$\vec{\mathbf{S}}_P = \frac{c}{4\pi} [\vec{\mathbf{E}} \times \vec{\mathbf{H}}], \quad (6.1.7)$$

For the wave along the *y*-axis we have:

$$\vec{\mathbf{S}}_P = -\vec{j}(E_x H_z - E_z H_x), \quad (6.1.8)$$

where  $\vec{j}$  is the unit vector of *y*-axis. As we see, the photon  $\{E_x, H_z\}$  moves against the direction of *y*-axis and the equation of field components in this case must be written in the form:

$$\begin{cases} \vec{\mathbf{E}} = \vec{\mathbf{E}}_o e^{i(\omega t - ky)} \\ \vec{\mathbf{H}} = \vec{\mathbf{H}}_o e^{i(\omega t - ky)} \end{cases}, \quad (6.1.9)$$

Photon  $\{E_z, H_x\}$  moves along the direction of *y*-axis and the equation of its components must be written in the form:

$$\begin{cases} \vec{\mathbf{E}} = \vec{\mathbf{E}}_o e^{i(\omega t + ky)} \\ \vec{\mathbf{H}} = \vec{\mathbf{H}}_o e^{i(\omega t + ky)} \end{cases}, \quad (6.1.10)$$

As it follows from the previous chapter, for the formation of electron the photon must, first of all, experience the transformation of rotation in the plane  $(\vec{n}, \vec{\tau})$ . Obviously, the eventual result of transformation does not depend on the turning of the coordinate system. This means that the transformations, which describe a passage from one Cartesian system to any other, must exist without a change in the result of the rotatory transformation of photon.

By twisting the photon can form a ring either in the plane *XOY* or in the plane *YOZ*. In the process of rotation transformation the ring currents are formed:  $\vec{j}_\tau^e = \frac{\omega}{4\pi} |\vec{\mathbf{E}}| \vec{\tau}$ ,  $\vec{j}_\tau^m = \frac{\omega}{4\pi} |\vec{\mathbf{H}}| \vec{\tau}$ , and “linear” mass-free photon is converted into the massive intermediate boson, which we conditionally call intermediate massive photon. The electric charge of this photon is equal to zero, since it contains alternating current. A question arises of how are fields directed in the intermediate massive photon?

The rotation of photon can be accomplished clockwise and counter-clockwise (looking from the end of the magnetic vector) (Fig. 6.3):



Рис. 6.3

The result will be somehow different if both photons form a circularly polarized photon. We will examine this case in the chapter, dedicated to neutrino.

It follows from above that both the intermediate photons and electrons and positrons must have a set of forms of representations, which do not change the physical sense of equations and particles' characteristics.

## 2.0. The electrodynamics and quantum forms of Dirac's equation

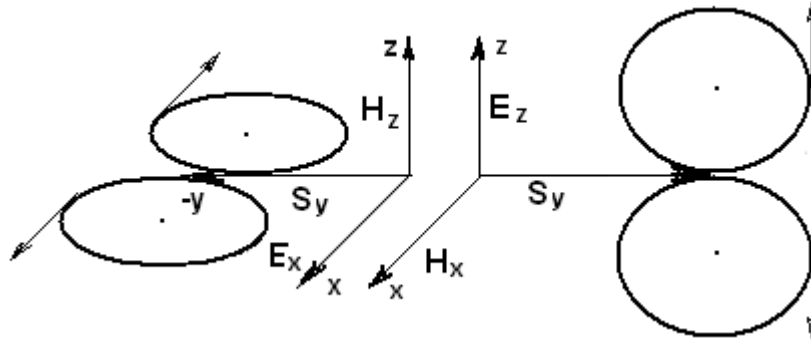
As we showed in the previous chapter 4, massive photon can experience spontaneous breaking of symmetry and can be divided into two half-periods – two semi-photons: electron and positron. Accordingly we obtained the equations of these particles. They are known as spinor and bispinor forms.

### 2.1. The spinor electron equation

For the appearance of the charged particle - electron it is necessary that the rotation of photon occurred in the plane, which contains the electric vector and the vector of Poynting. After the breaking of intermediate photon into semi-photons, they can form rings either in the plane  $XOY$  or in the plane  $YOZ$ . In this case magnetic currents are not formed. But for the symmetry we will

examine the general case of existence of both electric and magnetic currents:  $\vec{j}_\tau^e = \frac{\omega}{4\pi} |\vec{E}| \vec{\tau}$ ,

$\vec{j}_\tau^m = \frac{\omega}{4\pi} |\vec{H}| \vec{\tau}$ , taking into account that for the electron and positron the magnetic currents are equal to zero.

Introducing  $\varphi$  and  $\chi$  as the wave functions of an electron in the spinor form by means of the following matrices:

$$\varphi = \begin{pmatrix} \varphi_1 \\ \varphi_2 \end{pmatrix} = \begin{pmatrix} E_x \\ E_z \end{pmatrix}, \quad \chi = \begin{pmatrix} \chi_1 \\ \chi_2 \end{pmatrix} = i \begin{pmatrix} H_x \\ H_z \end{pmatrix}, \quad (6.2.1)$$

we obtain Dirac's equation in the spinor form:

$$\begin{cases} \hat{\epsilon}\varphi + c\hat{\sigma}\hat{p}\chi + mc^2\varphi = 0, \\ \hat{\epsilon}\chi + c\hat{\sigma}\hat{p}\varphi - mc^2\chi = 0, \end{cases} \quad (6.2.2)$$

Taking into account that  $\varphi = \varphi(y)$ ,  $\chi = \chi(y)$ , we will obtain Maxwell's equations in the complex form with electrical and magnetic currents:

$$\left\{ \begin{array}{l} \frac{1}{c} \frac{\partial E_x}{\partial t} - \frac{\partial H_z}{\partial x} + i \frac{\omega}{c} E_x = 0, \\ \frac{1}{c} \frac{\partial E_z}{\partial t} + \frac{\partial H_x}{\partial z} + i \frac{\omega}{c} E_z = 0, \\ \frac{1}{c} \frac{\partial H_x}{\partial t} + \frac{\partial E_z}{\partial x} - i \frac{\omega}{c} H_x = 0, \\ \frac{1}{c} \frac{\partial H_z}{\partial t} - \frac{\partial E_x}{\partial z} - i \frac{\omega}{c} H_z = 0, \end{array} \right. , \quad (6.2.3)$$

where  $\omega/c = mc/\hbar$ . In the quantum form this system is more conveniently written in the form of one bispinor equation of Dirac.

## 2.2. The bispinor electron equation (Dirac's electron equation)

Dirac's equation more frequently is written in a bispinor form. Introducing a wave function by means of the following matrix:

$$\psi = \begin{pmatrix} \varphi \\ \chi \end{pmatrix} = \begin{pmatrix} \psi_1 \\ \psi_2 \\ \psi_3 \\ \psi_4 \end{pmatrix} = \begin{pmatrix} E_x \\ E_z \\ iH_x \\ iH_z \end{pmatrix} , \quad (6.2.4)$$

two spinor equations of electron can be rewritten as one Dirac's electron equation:

$$\hat{\varepsilon}\psi + c\hat{\alpha}\hat{p} + \hat{\beta}mc^2\psi = 0, \quad (6.2.5)$$

## 2.3. Quantum forms of Dirac's electron and positron equations

There are two bispinor Dirac equations (Akhiezer and Berestetskii, 1965; Bethe, 1964; Schiff, 1955; Fermi, 1960):

$$\left[ (\hat{\alpha}_o \hat{\varepsilon} + c\hat{\alpha}\hat{p}) + \hat{\beta}mc^2 \right] \psi = 0, \quad (6.2.6)$$

$$\left[ (\hat{\alpha}_o \hat{\varepsilon} - c\hat{\alpha}\hat{p}) - \hat{\beta}mc^2 \right] \psi = 0, \quad (6.2.7)$$

which correspond to two signs of relativistic expression of an electron energy:

$$\varepsilon = \pm \sqrt{c^2 \vec{p}^2 + m^2 c^4}, \quad (6.2.8)$$

Moreover, for each sign of expression (6.2.8), there are two Hermitian-conjugate Dirac equations. Thus, there are two Hermitian-conjugate equations corresponding to a minus sign of the expression (6.2.8):

$$\left[ (\hat{\alpha}_o \hat{\varepsilon} + c\hat{\alpha}\hat{p}) + \hat{\beta}mc^2 \right] \psi = 0, \quad (6.2.9')$$

$$\psi^+ \left[ (\hat{\alpha}_o \hat{\varepsilon} + c\hat{\alpha}\hat{p}) + \hat{\beta}mc^2 \right] = 0, \quad (6.2.9'')$$

and two equations that correspond to plus signs of (6.2.8):

$$\left[ (\hat{\alpha}_o \hat{\varepsilon} - c\hat{\alpha}\hat{p}) - \hat{\beta}mc^2 \right] \psi = 0, \quad (6.2.10')$$

$$\psi^+ \left[ (\hat{\alpha}_o \hat{\varepsilon} - c\hat{\alpha}\hat{p}) - \hat{\beta}mc^2 \right] = 0, \quad (6.2.10'')$$

We will further use the wave function of a circular-polarized EM wave that is moving as in the previous chapters along the  $y$  - axis:

$$\psi = \begin{pmatrix} E_x \\ E_z \\ iH_x \\ iH_z \end{pmatrix}, \quad \psi^+ = (E_x \quad E_z \quad -iH_x \quad -iH_z), \quad (6.2.11)$$

## 2.4. EM forms of Dirac's electron equation

Let us consider first two Hermitian-conjugate equations, corresponding to a minus sign of expression (6.2.8):

Using (6.2.11), we obtain from (6.2.9') and (6.2.9''):

$$\left\{ \begin{array}{l} \frac{1}{c} \frac{\partial E_x}{\partial t} - \frac{\partial H_z}{\partial y} = -\vec{j}_x^e \\ \frac{1}{c} \frac{\partial H_z}{\partial t} - \frac{\partial E_x}{\partial y} = \vec{j}_z^m \\ \frac{1}{c} \frac{\partial E_z}{\partial t} + \frac{\partial H_x}{\partial y} = -\vec{j}_z^e \\ \frac{1}{c} \frac{\partial H_x}{\partial t} + \frac{\partial E_z}{\partial y} = \vec{j}_x^m \end{array} \right\}, \quad (6.2.12'), \quad \left\{ \begin{array}{l} \frac{1}{c} \frac{\partial E_x}{\partial t} - \frac{\partial H_z}{\partial y} = \vec{j}_x^e \\ \frac{1}{c} \frac{\partial H_z}{\partial t} - \frac{\partial E_x}{\partial y} = -\vec{j}_z^m \\ \frac{1}{c} \frac{\partial E_z}{\partial t} + \frac{\partial H_x}{\partial y} = \vec{j}_z^e \\ \frac{1}{c} \frac{\partial H_x}{\partial t} + \frac{\partial E_z}{\partial y} = -\vec{j}_x^m \end{array} \right\}, \quad (6.2.12'')$$

where

$$\vec{j}^e = i \frac{\omega}{4\pi} \vec{E} = i \frac{1}{4\pi} \frac{c}{r_C} \vec{E}, \quad (6.2.13')$$

$$\vec{j}^m = i \frac{\omega}{4\pi} \vec{H} = i \frac{1}{4\pi} \frac{c}{r_C} \vec{H}, \quad (6.2.13'')$$

are complex currents.

Thus, the equations (6.2.9') and (6.2.9'') are Maxwell's equations with complex currents, where *Hermitian-conjugate equations* (6.2.12) and (6.2.13) differ by current directions.

Let us consider now equations that correspond to a plus signs of (6.2.8). An electromagnetic form of equation (6.2.10') is:

$$\left\{ \begin{array}{l} \frac{1}{c} \frac{\partial E_x}{\partial t} + \frac{\partial H_z}{\partial y} = -\vec{j}_x^e \\ \frac{1}{c} \frac{\partial H_z}{\partial t} + \frac{\partial E_x}{\partial y} = \vec{j}_z^m \\ \frac{1}{c} \frac{\partial E_z}{\partial t} - \frac{\partial H_x}{\partial y} = -\vec{j}_z^e \\ \frac{1}{c} \frac{\partial H_x}{\partial t} - \frac{\partial E_z}{\partial y} = \vec{j}_x^m \end{array} \right\}, \quad (6.2.14)$$

Obviously, an electromagnetic form of equation (6.2.10'') will have the opposite signs of currents with regard to (6.2.14). Comparing (6.2.14) and (6.2.12), we can consider *equation* (6.2.14) *as the Maxwell's equation of the retarded wave in relation to Maxwell's equation of advanced wave* (6.2.12).

So, if we do not want to use the retarded wave, we can transform the wave function of the retarded wave to the following form:

$$\psi_{ret} = \begin{pmatrix} E_x \\ -E_z \\ iH_x \\ -iH_z \end{pmatrix}, \quad (6.2.15)$$

Then, contrary to the system (6.2.14), we get the system (6.2.12). The transformation from the function  $\psi_{ret}$  to the function  $\psi_{adv}$  is called a charge conjugation operation. Thus, we can say that the electron and positron wave functions can be considered as retarded and advanced waves.

Note that the above result relates to the theory of advanced waves of Wheeler and Feynman (Wheeler and Feynman, 1945; Wheeler, 1957). (See also the Dirac's work on time-symmetric classical electrodynamics (Dirac, 1938) and Konopinski's book on the same topic (Konopinski, 1980).

### 3.0. Electrodynamics' meaning of bilinear forms

This is well known that there are 16 Dirac matrices of 4x4 dimensions. We exploit the same set of matrices used by Dirac, and name it as  $\alpha$ -set.

The values  $O = \psi^+ \hat{\alpha} \psi$ , where  $\hat{\alpha}$  is any of the Dirac's matrices, are called bilinear forms of Dirac's electron theory.

It can be shown that the tensor dimension of a bilinear form follows from the tensor's nonlinear electrodynamics forms. Let us enumerate the Dirac's matrices as follows (Akhiezer and Berestetskii, 1965; Bethe, 1964; Schiff, 1955):

$$1) \hat{\alpha}_4 \equiv \hat{\beta}, \quad (6.3.1)$$

$$2) \hat{\alpha}_\mu = \{\hat{\alpha}_0, \hat{\alpha}\} \equiv \{\hat{\alpha}_0, \hat{\alpha}_1, \hat{\alpha}_2, \hat{\alpha}_3, \hat{\alpha}_4\}, \quad (6.3.2)$$

$$3) \hat{\alpha}_5 = \hat{\alpha}_1 \cdot \hat{\alpha}_2 \cdot \hat{\alpha}_3 \cdot \hat{\alpha}_4, \quad (6.3.3)$$

$$4) \hat{\alpha}_\mu^A = \hat{\alpha}_5 \cdot \hat{\alpha}_\mu, \quad (6.3.4)$$

$$5) \hat{\alpha}_{\mu\nu} = -\hat{\alpha}_{\nu\mu} = \begin{cases} i\hat{\alpha}_\nu \hat{\beta} \hat{\alpha}_\mu, & \mu \neq \nu \\ 0, & \mu = \nu \end{cases}, \quad (6.3.5)$$

Here we have: 1) scalar, 2) 4-vector, 3) pseudoscalar, 4) 4-pseudovector, 5) antisymmetrical tensor of a second rank.

Let us calculate electrodynamics values corresponding to the above matrices using  $\psi$  according to (6.2.11).

1)  $\psi^+ \hat{\alpha}_4 \psi = (E_x^2 + E_z^2) - (H_x^2 + H_z^2) = \vec{E}^2 - \vec{H}^2 = 8\pi I_1$ , where  $I_1$  is the *first scalar* (invariant) of Maxwell theory; it is also Lagrangian of an electromagnetic field in vacuum;

2)  $\psi^+ \hat{\alpha}_0 \psi = \vec{E}^2 + \vec{H}^2 = 8\pi u$ , where  $u$  is the *energy density* of the electromagnetic field;

$$\psi^+ \hat{\alpha}_y \psi = -\frac{8\pi}{c} \vec{S}_{Py} = -8\pi c \vec{g}_y, \text{ where } \vec{g}_y \text{ is a } \textit{momentum density} \text{ of an electromagnetic}$$

wave's field moving along the  $Y$ -axis. As it is well known, the value  $\left\{ \frac{1}{c} u, \vec{g} \right\}$  is a 4-vector of the energy-momentum.

3)  $\psi^+ \hat{\alpha}_5 \psi = 2(E_x H_x + E_z H_z) = 2(\vec{E} \cdot \vec{H})$  is a *pseudoscalar* of electromagnetic field, and  $(\vec{E} \cdot \vec{H})^2 = I_2$  is the second scalar (invariant) of electromagnetic field theory. We will show subsequently that this bilinear form is related to spirality of particles.

$$4) \psi^+ \hat{\alpha}_5^A \psi = 2(E_x H_x + E_z H_z) = 2(\vec{E} \cdot \vec{H})$$



$$\psi^+ \hat{\alpha}_5 \hat{\alpha}_1 \psi = -2i(E_x E_z - H_x H_z),$$

$$\psi^+ \hat{\alpha}_5 \hat{\alpha}_2 \psi = 0,$$

$$\psi^+ \hat{\alpha}_5 \hat{\alpha}_3 \psi = -i(E_x^2 - E_z^2 - H_x^2 + H_z^2).$$

In quantum mechanics, three-dimensional components of the spin's tensor are expressed through these matrices (Sokolov and Ivanenko, 1952).

5) Tensor  $\psi^+ \hat{\alpha}_{\mu\nu} \psi$  can be presented in a compact form as follows:

$$(\alpha_{\mu\nu}) = \begin{pmatrix} 0 & E_x^2 - E_z^2 + H_x^2 - H_z^2 & 0 & -2(E_x H_z + E_z H_x) \\ - (E_x^2 - E_z^2 - H_x^2 + H_z^2) & 0 & 2(E_x E_z - H_x H_z) & 0 \\ 0 & -2(E_x E_z - H_x H_z) & 0 & -2(E_x H_x - E_z H_z) \\ 2(E_x H_z + E_z H_x) & 0 & 2(E_x H_x - E_z H_z) & 0 \end{pmatrix}$$

In quantum mechanics, tensor  $\hat{\alpha}_{\mu\nu}$  (Levich, 1969) describes magnetic and electric moments of an electron. In our theory, the bilinear form of this tensor describes also the Lorentz's force acting to an electron.

#### 4.0. On statistical interpretation of the wave function

In non-relativistic quantum theory the term *wave function* refers to a complex  $n$ -components function  $\vec{\psi}$  as an element in a complex Hilbert space. In non-relativistic theory a *wave function* refers to a one-component complex function. In relativistic theory a wave function is a vector  $\vec{\psi}$  with  $n$  components, which is usually described as following matrix:

$$\vec{\psi} = \begin{bmatrix} c_1 \\ \vdots \\ c_n \end{bmatrix}$$

In the quantum theory a wave function, itself, does not have a physical sense, and it is considered as a certain mathematical model (mapping) of a real elementary particle. The real function, obtained from the wave function via its squaring, has here a physical sense. In the non-relativistic case the quadrature ensues from multiplication of wave function by its complex conjugate function. In the relativistic case product of the Hermitian-conjugated wave functions is used. In the quantum theory it is accepted that the square of wave function (in the sense, indicated above), which is normalized by unit, describes the probability density of finding the particle in the given place in given time.

In the case of nonlinear theory, (see previous chapters), the components of the non-normalized wave function are the projection on the selected system of coordinates of the vectors of nonlinear electrical and magnetic field of elementary particle (photon, electron and others). Nonlinearity is described in this case with complex functions. The basic measurable parameters of the elementary particle are its energy, momentum, angular momentum and so forth, which are expressed in electrodynamics through the squares of the components of the vectors of the EM field (see above). Therefore for obtaining such real values it is necessary to get rid of the complexity and obtain a certain real function or number. Exactly for this case the product of the Hermitian-conjugated matrices is necessary. In the non-normalized form this product is equal to the energy density of particle. Normalization, in regard to the total energy of particle or its mass, turns the energy density into a fraction in the range from zero to one, which can be treated as the probability density to find the particle in the given place of space at the given instant.

For confirmation of this assertion we will additionally examine the probability continuity equation of electron theory.

As it is well known, the probability continuity equation can be obtained from the Dirac's equation (Akhiezer and Berestetskii, 1965; Bethe, 1964; Schiff, 1955; Fermi, 1960):

$$\frac{\partial P_{pr}(\vec{r}, t)}{\partial t} + \text{div } \vec{S}_{pr}(\vec{r}, t) = 0, \quad (6.4.1)$$

Here,  $P_{pr}(\vec{r}, t) = \psi^+ \hat{\alpha}_0 \psi$  is the probability density, and  $\vec{S}_{pr}(\vec{r}, t) = -c \psi^+ \hat{\alpha} \psi$  is the probability flux density. Using the above results, for non-normalized wave function we can obtain:  $P_{pr}(\vec{r}, t) = 8\pi u$  and  $\vec{S}_{pr} = c^2 \vec{g} = 8\pi \vec{S}$ . Then, an electromagnetic form of equation (6.3.15) can be presented in the following form:

$$\frac{\partial u}{\partial t} + \text{div } \vec{S} = 0, \quad (6.4.2)$$

which is the form of *law of energy conservation* of electromagnetic field.

## 5.0. Electrodynamical meaning of matrices' choice

According to Fermi (Fermi, 1960) "it can prove that all the physical consequences of Dirac's equation do not depend on the special choice of Dirac's matrices... In particular it is possible to interchange the roles of the four matrices by unitary transformation. So, their differences are only apparent".

The matrix sequence  $(\hat{\alpha}_1, \hat{\alpha}_2, \hat{\alpha}_3)$  agrees with an electromagnetic wave that has  $-y$ -direction. The question arises: how to describe the waves that have  $x$  and  $z$  - directions?

Introducing the axes' indexes that indicate the direction of an electromagnetic wave, we can write three groups of matrices each of which corresponds to one, and only one, wave direction:

$$(\hat{\alpha}_{1_x}, \hat{\alpha}_{2_y}, \hat{\alpha}_{3_z}), (\hat{\alpha}_{2_x}, \hat{\alpha}_{3_y}, \hat{\alpha}_{1_z}), (\hat{\alpha}_{2_z}, \hat{\alpha}_{1_y}, \hat{\alpha}_{3_x}).$$

Let us choose now the wave function forms which give correct Maxwell equations for  $x$  and  $z$  - directions. Taking into account (6.2.11) as an initial form of the  $-y$  - direction, we will get other forms from it by means of indexes' transposition around the circle (see. Fig. 6.4).

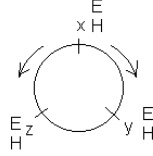

Fig. 6.4.

Since in this case the Poynting vector has the minus sign, we can assume that the transposition must be counterclockwise. Let us examine this supposition checking the Poynting vector's values:

The sets  $(\hat{\alpha}_{1_x}, \hat{\alpha}_{2_y}, \hat{\alpha}_{3_z}), (\hat{\alpha}_{2_x}, \hat{\alpha}_{3_y}, \hat{\alpha}_{1_z}), (\hat{\alpha}_{2_z}, \hat{\alpha}_{1_y}, \hat{\alpha}_{3_x})$  correspond to wave functions

$$\psi(y) = \begin{pmatrix} E_x \\ E_z \\ iH_x \\ iH_z \end{pmatrix}, \quad \psi(x) = \begin{pmatrix} E_z \\ E_y \\ iH_z \\ iH_y \end{pmatrix}, \quad \psi(z) = \begin{pmatrix} E_y \\ E_x \\ iH_y \\ iH_x \end{pmatrix}$$

and to non-zero Poynting vectors

$\psi^+ \hat{\alpha}_{2_y} \psi = -2[\vec{E} \times \vec{H}]_y$ ,  $\psi^+ \hat{\alpha}_{2_x} \psi = -2[\vec{E} \times \vec{H}]_x$ ,  $\psi^+ \hat{\alpha}_{2_z} \psi = -2[\vec{E} \times \vec{H}]_z$  respectively. As we can see, we obtained a correct result.

We can assume now that the wave functions will describe electromagnetic waves by a clockwise indexes' transposition. These wave functions move in a positive direction along the different co-ordinate axes. Let us prove this:

The sets  $(\hat{\alpha}_{1_x}, \hat{\alpha}_{2_y}, \alpha_{3_z})$ ,  $(\hat{\alpha}_{2_x}, \hat{\alpha}_{3_y}, \hat{\alpha}_{1_z})$ ,  $(\hat{\alpha}_{2_z}, \hat{\alpha}_{1_y}, \hat{\alpha}_{3_x})$  correspond to wave functions

$$\psi(y) = \begin{pmatrix} E_z \\ E_x \\ iH_z \\ iH_x \end{pmatrix}, \quad \psi(x) = \begin{pmatrix} E_y \\ E_z \\ iH_y \\ iH_z \end{pmatrix}, \quad \psi(z) = \begin{pmatrix} E_x \\ E_y \\ iH_x \\ iH_y \end{pmatrix}$$

and to non-zero Poynting vectors

$$\psi^+ \hat{\alpha}_{2_y} \psi = 2[\vec{E} \times \vec{H}]_y, \quad \psi^+ \hat{\alpha}_{2_x} \psi = 2[\vec{E} \times \vec{H}]_x, \quad \psi^+ \hat{\alpha}_{2_z} \psi = 2[\vec{E} \times \vec{H}]_z \text{ respectively. As we can see, once again, we get correct results.}$$

Now, we will prove that the above choice of matrices and wave functions gives correct electromagnetic equation forms. If we use, for instance, equation (6.2.10') and transpose the indexes clockwise, then we correspondingly obtain for the positive direction of electromagnetic wave the following results for  $x, y, z$ -directions:

$$\left\{ \begin{array}{l} \frac{1}{c} \frac{\partial E_y}{\partial t} + \frac{\partial H_z}{\partial x} = -j_y^e \\ \frac{1}{c} \frac{\partial H_z}{\partial t} + \frac{\partial E_y}{\partial x} = j_z^m \\ \frac{1}{c} \frac{\partial E_z}{\partial t} - \frac{\partial H_y}{\partial x} = -j_z^e \\ \frac{1}{c} \frac{\partial H_y}{\partial t} - \frac{\partial E_z}{\partial x} = j_y^m \end{array} \right\}, \quad \left\{ \begin{array}{l} \frac{1}{c} \frac{\partial E_z}{\partial t} + \frac{\partial H_x}{\partial x} = -j_z^e \\ \frac{1}{c} \frac{\partial H_x}{\partial t} + \frac{\partial E_z}{\partial x} = j_x^m \\ \frac{1}{c} \frac{\partial E_x}{\partial t} - \frac{\partial H_z}{\partial x} = -j_x^e \\ \frac{1}{c} \frac{\partial H_z}{\partial t} - \frac{\partial E_x}{\partial x} = j_z^m \end{array} \right\}, \quad \left\{ \begin{array}{l} \frac{1}{c} \frac{\partial E_x}{\partial t} + \frac{\partial H_y}{\partial x} = -j_x^e \\ \frac{1}{c} \frac{\partial H_y}{\partial t} + \frac{\partial E_x}{\partial x} = j_y^m \\ \frac{1}{c} \frac{\partial E_y}{\partial t} - \frac{\partial H_x}{\partial x} = -j_y^e \\ \frac{1}{c} \frac{\partial H_x}{\partial t} - \frac{\partial E_y}{\partial x} = j_x^m \end{array} \right\}, \quad (6.5.1)$$

Therefore, we have obtained three equation groups each of which contains four equations, *as this is necessary for description of all electromagnetic wave's directions*. In the same way, analogous results can be obtained for all other forms of Dirac equation.

Obviously, it is also possible, using canonical transformations, to choose the Dirac matrices in such a way that electromagnetic wave will have any direction. Let us show this.

#### 4.1. EM meaning of canonical transformations of Dirac's matrices and bispinors

The choice of the  $\alpha$ -set matrices is not unique (Akhiezer and Berestetskii, 1965; Schiff, 1955; Fock, 1932). As it is well known, there is a free transformation of a kind of  $\alpha = S \alpha' S^+$  (where  $S$  is a unitary matrix called a canonical transformation operator), to which the wave transformation of functions  $\psi'$  corresponds:  $\psi = S \psi'$ . This does not change the results of the theory.

If we choose matrices  $\alpha'$  as

$$\hat{\alpha}'_1 = \begin{pmatrix} \hat{\sigma}_x & 0 \\ 0 & \hat{\sigma}_x \end{pmatrix}, \quad \hat{\alpha}'_2 = \begin{pmatrix} \hat{\sigma}_y & 0 \\ 0 & -\hat{\sigma}_y \end{pmatrix}, \quad \hat{\alpha}'_3 = \begin{pmatrix} \hat{\sigma}_z & 0 \\ 0 & \hat{\sigma}_z \end{pmatrix}, \quad \hat{\alpha}'_4 = \begin{pmatrix} 0 & -i\hat{\sigma}_y \\ i\hat{\sigma}_y & 0 \end{pmatrix}, \quad (6.5.2)$$

then the functions  $\psi$  will be associated with functions  $\psi'$  according to the relationships:

$$\psi_1 = \frac{\psi'_1 - \psi'_4}{\sqrt{2}}, \quad \psi_2 = \frac{\psi'_2 + \psi'_3}{\sqrt{2}}, \quad \psi_3 = \frac{\psi'_1 + \psi'_4}{\sqrt{2}}, \quad \psi_4 = \frac{\psi'_2 - \psi'_3}{\sqrt{2}}, \quad (6.5.3)$$

A unitary matrix  $S$ , which corresponds to this transformation, is equal to:

$$S = \frac{1}{\sqrt{2}} \begin{Bmatrix} 1 & 0 & 0 & -1 \\ 0 & 1 & 1 & 0 \\ 1 & 0 & 0 & 1 \\ 0 & 1 & -1 & 0 \end{Bmatrix}, \quad (6.5.4)$$

It is not difficult to verify, that by means of this transformation we will also obtain equations of Maxwell theory. In fact, it is easy to get the following using (6.2.11) and (6.5.3):

$$\frac{\psi'_1 - \psi'_4}{\sqrt{2}} = E_x, \quad \frac{\psi'_2 + \psi'_3}{\sqrt{2}} = E_z, \quad \frac{\psi'_1 + \psi'_4}{\sqrt{2}} = iH_x, \quad \frac{\psi'_2 - \psi'_3}{\sqrt{2}} = iH_z, \quad (6.5.5)$$

whence:

$$\psi' = \frac{\sqrt{2}}{2} \begin{pmatrix} E_x + iH_x \\ E_z + iH_z \\ E_z - iH_z \\ -E_x + iH_x \end{pmatrix}, \quad (6.5.6)$$

Substituting these functions into the Dirac's equation, we will obtain correct Maxwell equations for electromagnetic waves in double quantity. It is possible to assume that functions  $\psi'$  correspond to an electromagnetic wave moving at angle of 45 degrees to both coordinate axes.

Thus, it follows from the above result that *every choice of Dirac matrices defines only the direction of an initial electromagnetic wave*. Obviously, *this is a physical reason why "the physical consequences of the Dirac's equation do not depend on the special choice of Dirac's matrices"* (Fermi, 1960).

## 6.0. An electromagnetic form of the electron theory's Lagrangian

The Lagrangian of the Dirac theory can have the following form (Schiff, 1955):

$$L = \psi^+ (\hat{\varepsilon} + c \hat{\alpha} \hat{p} + \hat{\beta} mc^2) \psi, \quad (6.6.1)$$

If an electromagnetic wave is moving along the  $(-y)$ -axis, then equation (6.6.1) can be rewritten as follows:

$$L = \frac{1}{c} \psi^+ \frac{\partial \psi}{\partial t} - \psi^+ \hat{\alpha}_y \frac{\partial \psi}{\partial y} - i \frac{mc}{\hbar} \psi^+ \hat{\beta} \psi, \quad (6.6.2)$$

Transforming each term in (6.6.2) to electrodynamics form, we obtain an electromagnetic form of Lagrangian of Dirac's theory:

$$L = \frac{\partial u}{\partial t} + \text{div } \vec{S} - i \frac{\omega}{4\pi} (\vec{E}^2 - \vec{H}^2), \quad (6.6.3)$$

(Note that in a case of variation procedure we must distinguish the complex conjugate field vectors  $\vec{E}^*$ ,  $\vec{H}^*$  and  $\vec{E}$ ,  $\vec{H}$ ). Using complex electrical and "magnetic" currents (6.2.13') and (6.2.13''), we have:

$$L = \frac{\partial u}{\partial t} + \text{div } \vec{S} - (\vec{j}^e \vec{E} - \vec{j}^m \vec{H}), \quad (6.6.4)$$

It is interesting that since  $L = 0$  due to (6.2.11), we can take the following equation:

$$\frac{\partial u}{\partial t} + \text{div } \vec{S} - (\vec{j}^e \vec{E} - \vec{j}^m \vec{H}) = 0, \quad (6.6.5)$$

which has a form of the law of conservation of energy-momentum for Maxwell equation with current.

## 7.0. An expression of Lorentz force in EM representation

According to our theory, the force that is perpendicular to the trajectory of motion of EM fields must appear to provide stability of EM particles. However, the tangential force (by our choice – along the  $y$ -axis) must be absent in this case, since it would provoke a tangential acceleration of electric charge.

As it is known from (Jackson, 1999), an expression of Lorentz's force in a vector form is described by the expression:  $\vec{F} = e\vec{E} + \frac{e}{c}\vec{v} \times \vec{H}$ , where  $\vec{v}$  is the charge velocity. Introducing the charge density  $\rho = de/d\tau$ , it is possible to rewrite this expression in a form:

$\vec{F} = \int_{(\tau)} \left( \rho\vec{E} + \frac{1}{c}\vec{j} \times \vec{H} \right) d\tau$ , where  $\tau$  is the volume occupied by charge. The expression in

brackets is called a Lorentz force's density  $\vec{f} = \frac{d\vec{F}}{d\tau} = \rho\vec{E} + \frac{1}{c}\vec{j} \times \vec{H}$ , which acts to any part of the charge (electron) itself. Since  $\vec{j} = \rho\vec{v}$  (where, in case of NEPT,  $|\vec{v}| = c$  inside the electron), then we can rewrite this expression as  $\vec{f} = \frac{1}{c}j\vec{E} + \frac{1}{c}\vec{j} \times \vec{H}$ .

If a photon undergoes the rotation transformation around the  $OZ$  axis, we obtain:

$${}^{OZ} f_x = \frac{1}{c} j(E_x + H_z)$$

If a photon undergoes the rotation transformation around the  $OX$  axis, we obtain:

$${}^{OX} f_z = \frac{1}{c} j(E_z - H_x)$$

(the upper left index shows the spinning axis  $OZ$  or  $OX$ ).

The Lorentz's force density in classical electrodynamics can be expressed through the symmetrical energy-momentum tensor of electromagnetic field  $\tau_\mu^\nu$  (Tonnelat, 1959; Ivanenko and Sokolov, 1949):

$$f_\mu = -\frac{1}{4\pi} \frac{\partial \tau_\mu^\nu}{\partial x^\nu} \equiv -\frac{1}{4\pi} \partial_\nu \tau_\mu^\nu, \quad (6.7.1)$$

where  $\tau_\mu^\nu$  is determined by the following expressions:

$$\tau_{ij} = -(\mathbf{E}_i \mathbf{E}_j + \mathbf{H}_i \mathbf{H}_j) + \frac{1}{2} \delta_{ij} (\vec{\mathbf{E}}^2 + \vec{\mathbf{H}}^2),$$

$$\tau_{i4} = 4\pi S = [\vec{\mathbf{E}} \times \vec{\mathbf{H}}]_i,$$

$$\tau_{44} = 4\pi u = \frac{1}{2} (\vec{\mathbf{E}}^2 + \vec{\mathbf{H}}^2),$$

Here, indices  $\mu, \nu = 1, 2, 3, 4$ ,  $i, j = 1, 2, 3$ ;  $\delta_{ij} = 0$ , when  $i = j$  and  $\delta_{ij} = 1$  for  $i \neq j$ . Moreover, a 4-vector of the space-time has the form  $x_\mu = \{x_i, x_4\} = \{\vec{r}, x_4\} = \{x, y, z, ict\}$ .

Using (6.7.1), the force components can be written as:

$$f_x = f_z = 0, \quad f_y \equiv -\left( \frac{\partial \vec{g}}{\partial t} + \text{grad } U \right), \quad (6.7.2)$$

$$f_4 = -\left( \frac{1}{c} \frac{\partial u}{\partial t} + c \text{div } \vec{g} \right), \quad (6.7.3)$$

Here, first three components describe the Lorentz force density vector, and the fourth component corresponds to law of energy conservation.

As we can see, if we use a symmetrical energy-momentum tensor, then we do not obtain the needed components of the force. Actually, in our case, the components  $f_x$  and  $f_y$  must be equal to zero, but the  $f_z$  component not.

It appears that the right result can be obtained if we use antisymmetrical tensor  $\alpha_{\mu\nu}$  (6.3.5). Then, we have:

$$f_\mu = -\frac{1}{4\pi} \frac{\partial \alpha_\mu^\nu}{\partial x^\nu} \equiv -\frac{1}{4\pi} \partial_\nu \alpha_\mu^\nu, \quad (6.7.4)$$

Or, using the tensor components:

$$\begin{cases} f_x = -\left( \frac{\partial \alpha_{12}}{\partial x_2} + \frac{\partial \alpha_{14}}{\partial x_4} \right) \\ f_y = 0 \\ f_z = -\left( \frac{\partial \alpha_{32}}{\partial x_2} + \frac{\partial \alpha_{34}}{\partial x_4} \right) \\ f_0 = 0 \end{cases}, \quad (6.7.5)$$

Using (6.2.11) and (6.3.5), we obtain components of the Lorentz's force:

$$\begin{aligned} 2\pi f_x &= E_x \left( \frac{1}{c} \frac{\partial H_z}{\partial t} - \frac{\partial E_x}{\partial y} \right) + H_z \left( \frac{1}{c} \frac{\partial E_x}{\partial t} - \frac{\partial H_z}{\partial y} \right) + \\ &+ H_x \left( \frac{\partial E_z}{\partial t} + \frac{\partial H_x}{\partial y} \right) + E_z \left( \frac{1}{c} \frac{\partial H_x}{\partial t} + \frac{\partial E_z}{\partial y} \right) \\ f_y &= 0, \end{aligned} \quad (6.7.6)$$

$$\begin{aligned} 2\pi f_x &= E_x \left( \frac{1}{c} \frac{\partial H_x}{\partial t} - \frac{\partial E_z}{\partial y} \right) - H_z \left( \frac{1}{c} \frac{\partial E_z}{\partial t} - \frac{\partial H_x}{\partial y} \right) + \\ &+ H_x \left( \frac{\partial E_x}{\partial t} + \frac{\partial H_z}{\partial y} \right) - E_z \left( \frac{1}{c} \frac{\partial H_z}{\partial t} + \frac{\partial E_x}{\partial y} \right) \\ f_4 &= 0, \end{aligned}$$

(Note that we obtained here the double number of brackets since bispinor (6.2.11) contains two plane polarized waves of the same direction, which turn around the different axes).

For a "linear" photon, all expressions in brackets in (6.7.6) are equal to zero according to Maxwell equation. It means that no forces appear in the linear EM wave quantum. When photon rotates around any axis which are perpendicular to  $y$ -axis, we will get additional current terms

$$\vec{j} = i\omega\vec{E} \quad (6.7.7)$$

where the imaginary unit indicates that the tangential current is perpendicular to electric vector of wave.

For the transformed photon  $(E_x, H_z)$ , the force components are:

$${}^{oz} f_x = i \frac{1}{4\pi} \frac{\omega}{c} E_x (E_x + H_z) = \frac{1}{c} j_\tau \cdot (E_x + H_z), \quad (6.7.8)$$

For the transformed photon  $(E_z, H_x)$ , we have:

$${}^{ox} f_z = -i \frac{1}{4\pi} \frac{\omega}{c} E_z (E_z - H_x) = -\frac{1}{c} j_\tau \cdot (E_z - H_x), \quad (6.7.9)$$

$$f_y = 0, \quad (6.7.10)$$

$$f_4 = 0, \quad (6.7.11)$$

As we can see, the results (6.7.8) – (6.7.11) correspond to our representations of dynamics of a semi-photon.

## 8.0. EM and QM representation of the interaction Lagrangian and Hamiltonian of nonlinear theory

The Hamiltonian and Lagrangian of NEPT, considered as a nonlinear theory, must contain all possible invariants of nonlinear electromagnetic field theory. Thus, we can assume that the Lagrangian must be some function of field invariants:

$$L = f_L(I_1, I_2), \quad (6.8.1)$$

where  $I_1 = (\vec{E}^2 - \vec{H}^2)$ ,  $I_2 = (\vec{E} \cdot \vec{H})$ .

Hamiltonian is fully defined by the Lagrangian. Thus, if function (6.8.1) is known, then it is easy to calculate the Hamiltonian using formulas (1.13), which will be now functions of various powers of electromagnetic field vectors:

$$H = f_H(\vec{E}, \vec{H}), \quad (6.8.2)$$

Apparently, the functions  $f_L$  and  $f_H$  must have its special form for each problem. This form is unknown before the problem's solution. As it is known, an approximate form of function  $f_H$  can be found on the basis of Schroedinger's or Dirac's wave equations using the so-called perturbation method. Here, we assume that there is an expansion of function  $f_H$  in the Taylor–MacLaurent power series with unknown expansion coefficient. Then, the problem is reduced to calculation of these coefficients. The solution is searched for each term of the expansion separately, starting from the first. Usually, this is a problem for a free particle, whose solution is already known. Then, using an equation with two first terms, we find the coefficient of the second term. Using further an equation for the first three terms, we find the coefficient for the third term of expansion, etc. In many cases, it is possible to obtain the solution by this method with any desirable accuracy.

In case of function of two variables  $\xi = f(x, y)$ , the Taylor – MacLaurent power series in the vicinity of the point  $(x_0, y_0)$  is:

$$f(x, y) = f(x_0, y_0) + \sum_{k=1}^n \frac{1}{k!} \left( (x-x_0) \frac{\partial}{\partial x} + (y-y_0) \frac{\partial}{\partial y} \right)^k f(x_0, y_0) + O(\rho^n), \quad (6.8.3)$$

where  $\rho = \sqrt{(x-x_0)^2 + (y-y_0)^2}$ ,

$$\left( (x-x_0) \frac{\partial}{\partial x} + (y-y_0) \frac{\partial}{\partial y} \right) f(x_0, y_0) \equiv (x-x_0) \frac{\partial f(x_0, y_0)}{\partial x} + (y-y_0) \frac{\partial f(x_0, y_0)}{\partial y}, \quad (6.8.4)$$

$$\begin{aligned} \left( (x-x_0) \frac{\partial}{\partial x} + (y-y_0) \frac{\partial}{\partial y} \right)^2 f(x_0, y_0) &\equiv (x-x_0)^2 \frac{\partial^2 f(x_0, y_0)}{\partial x^2} + \\ &+ 2(x-x_0)(y-y_0) \frac{\partial^2 f(x_0, y_0)}{\partial x \partial y} + (y-y_0)^2 \frac{\partial^2 f(x_0, y_0)}{\partial y^2}, \end{aligned} \quad (6.8.5)$$

etc. (In case when  $x_0 = 0$ ,  $y_0 = 0$ , we obtain the MacLaurent series).

Obviously, for the most types of functions  $f_L(I_1, I_2)$ , the expansion contains approximately the same set of terms that differ only by constant coefficients, any of which can be equal to zero (as an example, see expansions of quantum electrodynamics Lagrangian for a particle in the presence of physical vacuum (Akhiezer and Berestetskii, 1965; Schwinger, 1951; Weisskopf, 1936). In general, the expansion will look like:

$$L_M = \frac{1}{8\pi} (\vec{E}^2 - \vec{B}^2) + L', \quad (6.8.6)$$

where

$$L' = \alpha (\vec{E}^2 - \vec{B}^2)^2 + \beta (\vec{E} \cdot \vec{B})^2 + \gamma (\vec{E}^2 - \vec{B}^2) (\vec{E} \cdot \vec{B}) + \xi (\vec{E}^2 - \vec{B}^2)^3 + \zeta (\vec{E}^2 - \vec{B}^2) (\vec{E} \cdot \vec{B})^2 + \dots, \quad (6.8.7)$$

is the part which is responsible for the nonlinear interaction (here,  $\alpha, \beta, \gamma, \xi, \zeta, \dots$  are constants).

The corresponding Hamiltonian will be defined as follows:

$$H = \sum_i E_i \frac{\partial L}{\partial E_i} - L = \frac{1}{8\pi} (\vec{E}^2 + \vec{B}^2) + \bar{H}', \quad (6.8.8)$$

where the Hamiltonian part responsible for the nonlinear interaction is:

$$\hat{H}' = \alpha (\vec{E}^2 - \vec{B}^2) (3\vec{E}^2 - \vec{B}^2) + \beta (\vec{E} \cdot \vec{B})^2 + \xi (\vec{E}^2 - \vec{B}^2) (5\vec{E}^2 + \vec{B}^2) + \zeta (3\vec{E}^2 - \vec{B}^2) (\vec{E} \cdot \vec{B})^2 + \dots, \quad (6.8.9)$$

It is not difficult to obtain a quantum representation of the Hamiltonian (6.8.9) of nonlinear theory. Replacing vectors of electromagnetic wave field by quantum wave function, we will obtain the series of the following type:

$$\hat{H} = (\psi^\dagger \hat{\alpha}_0 \psi) + \sum c_{1i} (\psi^\dagger \hat{\alpha}_i \psi) (\psi^\dagger \hat{\alpha}_j \psi) + \sum c_{2i} (\psi^\dagger \hat{\alpha}_i \psi) (\psi^\dagger \hat{\alpha}_j \psi) (\psi^\dagger \hat{\alpha}_k \psi) + \dots, \quad (6.8.10)$$

where  $\hat{\alpha}_i, \hat{\alpha}_j, \hat{\alpha}_k$  are Dirac's matrixes,  $c_i$  are coefficients of expansion.

As we can see, the terms of Lagrangian and Hamiltonian series contain the same elements, such as  $(\vec{E}^2 + \vec{B}^2)$ ,  $(\vec{E} \cdot \vec{B})^2$ ,  $(\vec{E}^2 - \vec{B}^2)$ , and some others. It is possible to assume that each element of series has some particular physical meaning. In this case, it is possible to see analogy with the expansion of fields of electromagnetic moments (2.23), and also with the decomposition of S-matrix on the elements (Akhiezer and Berestetskii, 1965), each of which corresponds to particularities of interaction of separate particles.



# Chapter 7. Classical nonlinear electron theories and their connection with QED

## 1.0. Introduction

In the previous chapters we showed that a question about the formation of elementary particles and the appearance of its characteristics, in particular, mass and charge, is inseparably connected with the self-action of field of a particle. The self-action requires nonlinear description. The physicists arrived not immediately at these conclusions.

The theory of charge, mass and other characteristics of electron has arisen originally on the basis of classical electrodynamics and was developed by W. Kelvin, J. Larmor, H. Lorentz, M. Abraham, A. Poincare, and many others (see the reviews: (Pauli, 1958; Ivanenko and Sokolov, 1949)).

The first example of a theory (Coll. of articles, 1959) which unified electrodynamics and mechanics was H. A. Lorentz's attempt to explain the inertia of an electron on the basis of classical (linear) electrodynamics. Here, the electron was presented as a "clot" of electromagnetic field. The purpose of the theory was to show that the equation of an electron's motion follows from the equation which describes the field of the electron.. Important results have been achieved within the framework of this theory. However, the description of an electron required the introduction of an additional non-electromagnetic field. Alternatively, self-action fields inside the electron could be introduced, but this requires the creation of a nonlinear theory of the electron.

The idea of nonlinearity appeared as answer to the difficulties, emergent in the linear theory of electron (which was the first elementary particle).

### 1.1. The general results and difficulties of the classical electron theory

According to the hypothesis, which has been put forward in the end of the 19<sup>th</sup> century by J.J. Thomson and advanced by H. Lorentz, M. Abraham, A. Poincare, etc. (Lorentz, 1916; Ivanenko and Sokolov, 1949), the electron's own energy (or its mass) is completely caused by the energy of the electromagnetic field of electron. In the same way it is supposed that the electron momentum is obliged to the momentum of the field. Since electron, as any mechanical particle, possesses the momentum and energy, which are together the 4-vector of the generalized momentum, the necessary condition of success of the theory will be the proof that the generalized momentum of an electromagnetic field is a 4-vector.

Thus, for the success of the field mass theory the following conditions should be satisfied at least:

**At first**, it is necessary to receive final value of the field energy, generated by a particle, which could be precisely equated to final energy of a particle (i.e. product of the mass by the square of the light speed).

**At second**, the value of a momentum of the field, generated by a particle, must not only be final, but also has the proper correlation with energy, forming with the last a four-dimensional vector.

**Thirdly**, the theory should manage to deduce the equation of movement of electron.

**Fourthly**, it is necessary to obtain of electron spin, as a spin of a field (that needs the quantum generalization of the theory of field mass, since a spin is quantum effect).

All the parameters in classical electrodynamics can be expressed through the symmetrical energy-momentum tensor of electromagnetic field  $\tau_{\mu}^{\nu}$  (Tonnelat, 1959; Ivanenko and Sokolov, 1949)  $\tau_{\mu}^{\nu}$  is determined by the following expressions:

$$\tau_{ij} = -(\mathbf{E}_i \mathbf{E}_j + \mathbf{H}_i \mathbf{H}_j) + \frac{1}{2} \delta_{ij} (\vec{\mathbf{E}}^2 + \vec{\mathbf{H}}^2), \quad (7.1.1)$$

$$\tau_{i4} = 4\pi S = [\vec{\mathbf{E}} \times \vec{\mathbf{H}}]_i, \quad (7.1.2)$$

$$\tau_{44} = 4\pi u = \frac{1}{2}(\vec{E}^2 + \vec{H}^2), \quad (7.1.3)$$

were, indices  $\mu, \nu = 1, 2, 3, 4$ ,  $i, j = 1, 2, 3$ ;  $\delta_{ij} = 0$ , when  $i = j$  and  $\delta_{ij} = 1$  for  $i \neq j$ . Moreover, a 4-vector of the space-time has the form  $x_\mu = \{x_i, x_4\} = \{\vec{r}, x_4\} = \{x, y, z, ict\}$ .

The analysis shows, that there are two conditions, by which the generalized field momentum  $G_\mu$  is a 4-vector.

In case of space without charges the size

$$G_\mu = \frac{i}{c} \int \tau_{\mu 4} (dr), \quad (7.1.4.)$$

will represent a 4-vector if divergence of energy tensor of a field turns into zero:

$$\frac{\partial \tau_{\mu\lambda}}{\partial x_\lambda} = 0, \quad (7.1.5.)$$

For example, the electromagnetic field, which is located in a space without charges, satisfies similar conditions. In particular, due to this fact, in the photon theory, EM field is characterized not only by energy, but also by momentum.

2) The condition, by which the energy and momentum of an electromagnetic field form a 4-vector at the presence of charges, is formulated by the Laue theorem. According to the last, at the presence of charges the size  $G_\mu$  is a 4-vector only in the case when in the coordinate system, relatively to which electron is in rest, for all the energy tensor components the following parity is observed

$$\int \tau_{\mu\nu}^0 (d\vec{r}_o) = 0, \quad (7.1.6.)$$

except for the component  $T_{44}^0$ , the integral of which is a constant and is equal to full energy of the field, generated by particle (here  $(d\vec{r}_o)$  is elementary volume in reference system, in which the electron is in rest). The equality (1.3) expresses a necessary condition, by which the whole particle charge should be in balance.

We can equate this field energy to the particle's own energy, expressing in this way the basic idea of a field hypothesis. According to the last:

$$m_e = \frac{\varepsilon_e}{c^2} = \frac{1}{c^2} \int \tau_{44}^0 (d\vec{r}_o), \quad (7.1.7.)$$

Thus, the mass of a particle from the field point of view can be defined in two ways:

1) proceeding from EM momentum of a field  $G_1$  it is possible to define mass as factor of proportionality between a field momentum and three-dimensional speed of a particle.

2) if we consider the electron's own energy as equal or conterminous to the energy of a field, and mass as the ratio of a field energy  $\frac{c}{i} G_4$ , to a square of light speed (i.e. as the fourth component of a generalized momentum).

The attempts to execute this program, proceeding from classical linear Maxwell theory, have led to difficulties. In particular, it was not possible to prove the Laue theorem (Tonnelat, 1959). In the classical theory the dynamics (mechanics) and electrodynamics are completely independent from each other. Electromagnetic actions are characterized by component  $T_0^0$  of an energy-momentum tensor of an electromagnetic field. It does not include the energy and momentum of the substance, which should be subsequently inserted. The attempts of Lorentz and Poincare to coordinate the theory on the basis of the assumption that energy of substance has an electromagnetic origin, have not led to a positive result. In Lorentz electron theory (linear in essence) existence of charges it is possible to explain only by introduction of forces of non-electromagnetic origin.

Nevertheless (Sokolov and Ivanenko, 1949), there were also a number of successes, which carried a hope to solve this problem by some change of the theory. The most perspective change of Maxwell-Lorentz theory appeared to be its non-linear generalization by Gustav Mie..

## 2.0. The Gustav Mie non-linear electron theory

Within the framework of classical physics, the first completely successful nonlinear theory was created by Gustav Mie (Mie, 1912a, 1912b, 1913, 2007; Pauli, 1958; Tonnella, 1959; Sommerfeld, 1964). The most widely known variant of this theory was obtained by M. Born and L. Infeld (Born and Infeld, 1934b). Similar variant was also obtained by E. Schrödinger and others.

Gustav Mie took the first step in the direction of the generalization of Maxwell's equations and to the theory of the elementary particles in 1912 in his famous papers' "Foundations of a Theory of Matter". Their goal is no less than the generalisation of the Maxwell equations so that they include the *existence of the electron*. This generalisation is subjected from the start to the principle of relativity and derived from a "world function" (Lagrange function), which may depend only on Lorentz-invariant quantities. Here a distinction is made possibly for the first time in a consistent fashion - between entities of intensity and entities of quantity, i.e. the difference between  $F = (\vec{B}, -i\vec{E})$  and  $A_\mu = (\vec{A}, i\varphi)$ , on the one hand, and  $f = (\vec{H}, -i\vec{D})$  and  $j_\mu = (\rho\vec{v}, i\rho)$  on the other. Mie tested the invariants, which may be set up with the entities of intensity and the entities of quantity respectively.

Mie set himself the task to generalize the field equations and the energy-momentum tensor in the Maxwell-Lorentz theory in such a way that the Coulomb repulsive forces in the interior of the electrical elementary particles are held in equilibrium by other, equally electrical, forces, whereas the deviations from ordinary electrodynamics remain undetectable in regions outside the particles. In other words Mie introduced a uniform view of the field and substance, and got rid of Poincare-Lorentz forces, which have a non-electromagnetic origin.

### 2.1. The G. Mie theory Lagrangian

Mie was the first who suggested that the theory should be constructed on the basis of a Lagrangian that depends on fundamental invariants.

It is possible to make some general statements about the form of the Lagrangian  $L$ , which is often called the world function. Independent invariants, which can be formed from the bivector  $F_{\mu\nu}$  (where  $F_{\mu\nu}$  are the tensor components of EM field strengths) and the vector-potential  $A_\mu = (i\varphi, \vec{A}) = (i\varphi, A_i) = (A_4, A_i)$  of an EM field, are the following:

1. A square of the bivector  $F_{\mu\nu}$ :  $I_1 = \frac{1}{4} F_{\mu\nu} F^{\mu\nu}$ ;
2. A square of the pseudo-vector  $I_2 = \frac{1}{4} F_{\mu\nu} F^{*\mu\nu}$  (where  $F^{*\mu\nu}$  is dual electromagnetic tensor).
3. A square of a 4-vector of EM potential  $A_\mu$ :  $I_3 = A_\mu A^\mu$ ;
4. A square of the vector  $F_{\mu\nu} A^\nu$ :  $I_4 = F_{\mu\rho} A_\sigma F^{\mu\sigma} A^\rho$ ;
5. A square of the vector  $F_{\mu\nu}^* A^\nu$ :  $I_5 = F_{\mu\rho}^* A_\sigma F^{*\mu\sigma} A^\rho$ .

Therefore,  $L$  can depend only on these five invariants. If  $L$  is equal to the first of these, the field equations are the ordinary equations of EM theory for a space without charges. Thus,  $L$  can differ substantially from  $I_1$  only inside material particles. Invariant 2 can be included into  $L$  only when squared, in order not to break the invariance related to spatial reflections. Invariants 3-5 break the gauge invariance.

We cannot make further statements about the world function  $L$ . Thus, there is an infinite number of ways in which we can select  $L$ .

Mie supposed that only the invariants (1) and (3) need to be considered for the description of quasistationary processes and construct a world function (Lagrangian), such that at large distance

from the electron the ordinary Maxwell equations apply, whereas the equations are modified at the electron and in its immediate neighbourhood. The entities of intensity are obtained from Mie's world function by differentiation with respect to the entities of quantity. The Lagrangian is to be integrated over an arbitrary region of the four-dimensional world and to be varied in suitable manner.

G. Mie accepted the following Lagrangian as the initial one:

$$L_{Mi} = \frac{1}{4} F_{\mu\nu} F^{\mu\nu} - f\left(\pm \sqrt{A_\mu A^\mu}\right), \quad (7.2.1')$$

or

$$L_{Mi} = \frac{1}{8\pi} (E^2 - H^2) - f\left(\pm \sqrt{A_\mu A^\mu}\right), \quad (7.2.1'')$$

where  $f$  is some function, and  $\vec{E}$ ,  $\vec{H}$  are the strength vectors of the electric and magnetic fields, respectively.

Using this Lagrangian, Gustav Mie obtained the final energy (or mass) of a charged particle as a value completely determined by the energy of the particle's field. In this theory, Laue's theorem of particle stability is satisfied, and the proper correlation between the energy and momentum of the particle is achieved.

An attempt by Weyl should be mentioned here, in which he tries to make the asymmetry between the two kinds of electricity understandable from the point of view of Mie's theory. If world function  $L$  is not rational function of  $\sqrt{A_\mu A^\mu}$ , we can put

$$L^+_{Mi} = \frac{1}{4} F_{\mu\nu} F^{\mu\nu} - f\left(+\sqrt{A_\mu A^\mu}\right), \quad (7.2.2')$$

$$L^-_{Mi} = \frac{1}{4} F_{\mu\nu} F^{\mu\nu} - f\left(-\sqrt{A_\mu A^\mu}\right), \quad (7.2.2'')$$

where  $f$  denotes any function which is not even. For the statical case the field equations will not remain invariant for an interchange of electrostatic potential  $\varphi$  with  $-\varphi$  (positive and negative electricity). Thus, if  $L$  is a multiple-valued function of the invariants, mentioned above, then it is possible to choose various single branches of this function as world function for positive electricity, and another for negative electricity.

## 2.2. The Mie theory difficulties

Mie assumes (Pauli, 1958) the field of the stationary electron to be static and spherically symmetry. But the latter assumption is admittedly not justified by our experimental knowledge alone, but recommends itself for its simplicity. We will then have to look for those solutions of the field equations which are regular everywhere — for  $r = 0$  as well as for  $r = \infty$ .

A much more serious difficulty is caused by a fact already noticed by Mie. Once we have found a solution for the electrostatic potential  $\varphi$  of a material particle of the required kind,  $\varphi + \text{const.}$  will not be another solution, because the field equations of Mie's theory contain the absolute value of the potential. A material particle will therefore not be able to exist in a constant external potential field. This seems to constitute a very weighty argument against Mie's theory. In the theories which we are going to discuss in the following sections, this kind of difficulty does not arise.

## 3.0. Born-Infeld nonlinear theory

The Born-Infeld field (Born and Infeld, 1934a, 1934b; Pauli, 1958; Tonnella, 1959; Ivanenko and Sokolov, 1949) theory can be considered as a revival of the old idea of the electromagnetic origin of mass. This non-linear field theory (Born, 1953) "is a modification of Maxwell's electrodynamics in which the self-energy of the electron is finite. Mie had shown already in 1912

that the equations of the electromagnetic field can be formally generalized by replacing the linear relations between the two pairs of field vectors  $E, B$  and  $D, H$  by non-linear ones. Yet he did not specify these relations, and thus his formalism remained empty”.

The idea which Born applied to Mie plan is, as he note, “*a special case of what Whittaker has called the principle of impotence. If research leads to an obstacle which in spite of all efforts cannot be removed, theory declares it as insurmountable in principle... Examples are relativity, where the impossibility of material and signal velocities larger than the velocity of light is declared, and the uncertainty relations of quantum mechanics, which forbid the simultaneous determination of position and velocity and of similar pairs.*

*In the case of the electromagnetic field the self-energy can be made finite by prohibiting the increase of  $E$  the electric vector beyond a certain limit, the absolute field. This can be done by imitating relativity where the classical Lagrangian of a free particle  $L = \frac{1}{2}mv^2$  is replaced by*

$$L = mc^2 \left[ 1 - \left( 1 - v^2/c^2 \right)^{1/2} \right], \quad (7.3.1)$$

*from which  $v < c$  follows. In a similar way the Lagrangian density of Maxwell's electrodynamics can be replaced by a square root expression. Thus a finite self-energy of a point charge is obtained which represents not only the inertial mass but also, as Schrödinger has shown, the gravitational mass”.*

To obtain the laws of nature Born and Infeld use a variation principle of least action of the form

$$\delta \int L d\tau' = 0, \quad (d\tau') = dx^1 dx^2 dx^3 dx^4, \quad (7.3.2)$$

and postulate that the action integral has to be an invariant. The problem to find the form of  $L$  satisfying this condition arises here.

Born and Infeld consider a covariant tensor field  $a_{kl}$ . The question is to define  $L$  to be such a function of  $a_{kl}$  that (7.3.2) is invariant. The well-known answer is that  $L$  must have the form

$$L = \sqrt{|a_{kl}|}; \quad (|a_{kl}| = \text{determinant of } a_{kl}), \quad (7.3.3)$$

If the field is determined by several tensors of the second order,  $L$  can be any homogeneous function of the determinants of the covariant tensors of the order  $1/2$ .

Each arbitrary tensor  $a_{kl}$  can be split up into a symmetrical and anti-symmetrical part:

$$a_{kl} = g_{kl} + f_{kl}; \quad g_{kl} = g_{lk}; \quad f_{kl} = -f_{lk}, \quad (7.3.4)$$

The simplest simultaneous description of the metrical and electromagnetic field is the introduction of *one* arbitrary (unsymmetrical) tensor  $a_{kl}$ ; it can be identified its symmetrical part  $g_{kl}$  with the metrical field, its antisymmetrical part with the electromagnetic field.

The quotient of the field strength expressed in the conventional units divided by the field strength in the natural units may be denoted by  $b$ . This constant of a dimension of a field strength may be called the *absolute field*.

The Born-Infeld field equations are formally identical with Maxwell's equations for a substance which has a dielectric constant and a susceptibility, being certain functions of the field strength, but without a spatial distribution of charge and current.

As Born and Infeld in the summary write (Born-Infeld, 1934b), “*The new field theory can be considered as a revival of the old idea of the electromagnetic origin of mass. The field equations derive from the postulate that there exists an "absolute field"  $b$  which is the natural unit for all field components and the upper limit of a purely electric field. The field equations have the form of Maxwell's equations for a polarizable medium for which the dielectric constant and the magnetic susceptibility are special functions of the field components. The conservation laws of*

energy and momentum can be derived. The static solution with spherical symmetry corresponds to an electron with finite energy (or mass); the true charge can be considered as concentrated in a point, but it is also possible to introduce a free charge with a spatial distribution law. The motion of the electron in an external field obeys a law of the Lorentz type where the force is the integral of the product of the field and the free charge density”.

### 3.1. Born-Infeld field and Lagrangian

As in Maxwell's electromagnetism the Born-Infeld field  $F_{\mu\nu}$  is derived from a potential  $F_{\mu\nu} = \partial_\mu A_\nu - \partial_\nu A_\mu$ . This condition cancels the rotor of the electric field  $\vec{E}$  and the divergence of die magnetic field  $\vec{B}$ :

$$\partial_\nu F_{\lambda\mu} + \partial_\mu F_{\nu\lambda} + \partial_\lambda F_{\mu\nu} = 0, \quad (7.3.5)$$

The Born-Infeld field differs from the Maxwell field in the dynamic equations, which are written in terms of the tensor

$$\tilde{F}_{\mu\nu} = \frac{F_{\mu\nu} - \frac{I_2}{b^2} {}^*F_{\mu\nu}}{\sqrt{1 + \frac{2I_1}{b^2} - \frac{I_2^2}{b^4}}}, \quad (7.3.6)$$

where  $S$  and  $P$  are the scalar and pseudoscalar field invariants:

$$I_1 = \frac{1}{4} F_{\mu\nu} F^{\mu\nu} = \frac{1}{2} \left( |\vec{B}|^2 - |\vec{E}|^2 \right), \quad (7.3.7)$$

$$I_2 = \frac{1}{4} {}^*F_{\mu\nu} F^{\mu\nu} = \vec{E} \cdot \vec{B}, \quad (7.3.8)$$

( ${}^*F_{\mu\nu}$  is the dual field tensor, i.e. the tensor resulting from exchanging the roles of  $\vec{E}$  and  $-\vec{B}$ ). Born-Infeld dynamical equations are

$$\partial_\nu F^{\mu\nu} = 0, \quad (7.3.9)$$

which is obtained from the Born-Infeld Lagrangian

$$L = -\frac{b^2}{4\pi} \left( 1 - \sqrt{1 + \frac{2I_1}{b^2} - \frac{I_2^2}{b^4}} \right), \quad (7.3.10)$$

or:

$$L_{BI} = \frac{b^2}{4\pi} \left( 1 - \sqrt{1 - \frac{\vec{E}^2 - \vec{B}^2}{b^2} - \frac{(\vec{E} \cdot \vec{B})^2}{b^4}} \right), \quad (7.3.11)$$

The constant  $b$  in equations (7.3.6), (7.3.10) and (7.3.11) is a new universal constant with units of held that controls the scale for passing from Maxwell's theory to the nonlinear Born-Infeld theory, in the same way as the light speed  $c$  is the velocity scale that indicates the range of validity of Newtonian mechanics. The Maxwell Lagrangian and its related dynamical equations are recovered in the limit  $b \rightarrow \infty$ , or in regions where the held is small compared with  $b$ . Besides. Born-Infeld solutions having  $S = 0 = P$  ('free waves') also solve Maxwell's equations. As it follows from Born-Infeld solution the constant  $b$  is a maximum electric field of an electron  $b \equiv E_0$ . Thus, if we consider  $E$  and  $B$  as wave functions, then the ratios  $E/b$  and  $B/b$  can be considered as the normalized wave functions.

### 3.2. The point and non-point solutions of Born-Infeld's nonlinear theory

The results presented above led them to the following Lagrangian considered as a function of invariants  $I_1$  and  $I_2$ :

$$L_{BI} = \frac{E_0^2}{4\pi} \left( 1 - \sqrt{1 - \frac{E^2 - H^2}{E_0^2} - \frac{(\vec{E} \cdot \vec{H})^2}{E_0^4}} \right), \quad (7.3.12)$$

where  $E_0$  is a maximum electric field of an electron.

Using  $\vec{H} = 0$ ,  $\vec{E} = -\text{grad}\varphi$ ,  $\rho(\vec{x} - \xi) = \delta(\vec{r})\delta(t - s)$ , where  $\delta$  is the Dirac function, we can find the following Lagrangian form:

$$L_n = \frac{E_0^2}{4\pi} \left( 1 - \sqrt{1 - \frac{E_r^2}{E_0^2}} \right) - e\varphi\delta(\vec{r})$$

Then, with the help of the variation principle, we can obtain:

$$-\frac{1}{4\pi} \frac{\partial D_r}{\partial E_r} - \frac{\partial L}{\partial \varphi} = 0$$

where  $\vec{D}$  is an electrical induction vector (D-field):

$$D_r = 4\pi \frac{\partial L}{\partial E_r} = \frac{E_r}{\sqrt{1 - \frac{E_r^2}{E_0^2}}}$$

which corresponds to equation:

$$\text{div}\vec{D}_r = 4\pi e\delta(\vec{r})$$

Solution of this equation, which corresponds to linear Maxwell theory, is as follows:

$$D_r = \frac{e\vec{r}}{r^3}, \quad (7.3.13)$$

As we can see, *from the point of view of D-field, the electron should be considered as a point particle.*

For the electric field (E-field), we obtain:

$$\vec{E}_r = \frac{\vec{D}_r}{\sqrt{1 + \frac{D_r^2}{E_0^2}}} = \frac{e\vec{r}}{r\sqrt{r^4 + r_0^4}}, \quad (7.3.14)$$

where  $r_0 = \sqrt{\frac{e}{E_0}}$ . Thus, *from the point of view of electric field (E-field), the electron is not the point particle.*

In comparison to a linear theory, these results present very important specifics of a nonlinear theory. This can explain why experiments on dispersion of electron can be interpreted so that the non-point electron can look as a point particle.

We can obtain the potential's value at the center of a particle as follows:

$$\varphi_0 = \int_0^\infty E_r dr = 1.8541... \frac{e}{r_0}$$

The charge's density distribution of the non-point electron can be found in the following way:

$$\rho = \frac{\text{div}E}{4\pi} = \frac{er_0^4}{2\pi r(r^4 + r_0^4)^{3/2}}, \quad (7.3.15)$$

For  $r \gg r_0$ ,  $\rho \propto r^{-7}$ , therefore diminishing very rapidly as  $r$  increases. For  $r < r_0$ ,  $\rho \propto 1/r$ , therefore  $\rho \rightarrow \infty$ , but  $r^2\rho \rightarrow 0$ . It easy to verify that the space integral of  $\rho$  is equal to  $e$ . For a full charge we have:

$$\int \rho d\tau = \frac{1}{4\pi} \int \text{div}\vec{E}d\tau = \frac{1}{4\pi} \oint E ds = \lim_{r \rightarrow \infty} r^2 E(r) = e$$

The charge can be considered as distributed in a sphere of radius  $r_0$ , since, because of the condition  $r \gg r_0$ , the density will quickly go to zero. Therefore, the size  $r_0$  can be considered as an effective radius of an electron.

The value of an electromagnetic mass of an electron can be found based on the equality condition:

$$m_{EM} = \frac{\int \tau_{44} d\tau}{c^2} = \frac{2}{3} \frac{e\varphi_0}{c^2} = 1.2361... \frac{e^2}{c^2 r_0}$$

Using experimental values for the mass and the charge of an electron, it is possible to obtain for an effective electron radius the value of  $r_0 = 2,28 \cdot 10^{-13}$  cm, which is practically equal to the classical radius of an electron. In this case, we have for the electron energy  $\varepsilon = \int \tau_{44} d\tau = m_{EM} c^2$ .

Also, it is easy to find the maximal field of an electron, which is in the center of an electron at  $r=0$ :

$$E_0 = \frac{e}{r_0^2} = 9,18 \cdot 10^{15} \text{ CGS} = 2,75 \cdot 10^{20} \frac{\text{V}}{\text{m}}.$$

As is known two types of fields and two definitions for the charge density, corresponding to them, present in theory of dielectrics. The ratio of  $\vec{D}$  to  $\vec{E}$  can be considered as a dielectric constant  $\delta_d$ :

$$\delta_d = \frac{D}{E} = \sqrt{\frac{r^4 + r_0^4}{r^4}}, \quad (7.3.16)$$

which in this case is the function of a position. On large distances from the charge, when  $\frac{r_0}{r} \rightarrow 0$ ,

$\delta_d$  is equal to one, the same as in conventional electrodynamics. We can say that instead of the energy expression  $\frac{e^2}{r^2}$  the value of  $\frac{e^2}{\delta_d r^2}$  is used, and that the reduction of  $r$  is compensated by the increase of  $\delta_d$ , so that the full energy remains final.

Thus, we proved that it is possible to obtain the final self-energy (or the mass) of the charged particle as a value completely conditioned by the energy of the field of this particle, when one uses a certain formally irreproachable hypothetical nonlinear generalization of electrodynamics as the basis. Furthermore, the Laue theory of stability is valid within this theory, so that a correct relationship between the energy and the particle's momentum is established.

Thus, basing on some formal hypothetical nonlinear generalization of electrodynamics, it appeared possible (Ivanenko and Sokolov, 1949):

1. to prove the theorem of stability, i.e. to prove, that in the nonlinear theory the electron is stable without introduction of forces of non-electromagnetic origin;
2. to receive the final energy (mass) of a particle;
3. to receive the final size of an electric charge;



4. to receive the final size of an electromagnetic field.

#### 4.0. Schrödinger variant of Born-Infeld theory without root

As E. Schrödinger has noted (Schrödinger, 1935), Born's theory starts from describing the field by two vectors (or a "six-vector"),  $\vec{B}, \vec{E}$ , the magnetic induction and electric field-strength respectively. A second pair of vectors (or a second six-vector)  $\vec{H}, \vec{D}$ , is introduced, merely an abbreviation, if you please, for the partial derivatives of the Lagrange function with respect to the components of  $\vec{B}$  and  $\vec{E}$  respectively (though with the negative sign for  $\vec{E}$ ).  $\vec{H}$  is called magnetic field and  $\vec{D}$  dielectric displacement. It was pointed out by Born that it is possible to choose the independent vectors in different ways. *Four* different and, to a certain extent, equivalent and symmetrical representations of the theory can be given by combining each of the two "magnetic" vectors with each of the two "electric" vectors to form the set of six independent variables. Every one of these four representations can be derived from a variation principle, using, of course, entirely different Lagrange functions physically different, that is, though their analytic expressions by the respective variables are either identical or very similar to each other.

In studying Born's theory E. Schrödinger came across a further representation, which is entirely different from all the aforementioned, and presents curious analytical aspects. The idea is to use two complex combinations of  $\vec{B}, \vec{E}, \vec{H}, \vec{D}$  as independent variables, but in such a way that their "conjugates," *i.e.*, the partial derivatives of  $\tilde{L}$ , equal their *complex* conjugates. Choosing the following pair of independent variables

$$\tilde{F} = \vec{B} - i\vec{D}, \quad \tilde{G} = \vec{E} + i\vec{H}, \quad (7.4.1)$$

(which form a true six-vector) the appropriate Lagrangian works out

$$L = \frac{\tilde{F}^2 - \tilde{G}^2}{(\tilde{F}\tilde{G})}, \quad (7.4.2)$$

and one has

$$\tilde{F}^* = \frac{\partial L}{\partial \tilde{G}}, \quad \tilde{G}^* = \frac{\partial L}{\partial \tilde{F}}, \quad (7.4.3)$$

The \* indicates the complex conjugate. The derivative with respect to a vector is short for: a vector, of which the components are the three derivatives with respect to the components of that vector. The units are "natural" units, Born's constant  $b$  being equalled to 1 (in other units  $\tilde{L}$  would take the factor  $b^2$ ).

What is so very surprising with E. E. Schrödinger's idea (Schrödinger, 1935) is that the square root, which is so characteristic for Born's theory, has disappeared. The Lagrangian is not only rational, but homogeneous of the zeroth degree.

As Schrödinger show, the treatment of the field by the Lagrangian (7.4.2) is entirely equivalent to Born's theory. Therefore it cannot yield any new insight which could not, virtually, be derived from Born's original treatment as well. Moreover, for actual calculation the use of imaginary vectors will hardly prove useful. Yet for certain theoretical considerations of a general kind I am inclined to consider the present treatment as the standard form on account of its extreme simplicity, the Lagrangian being simply the *ratio* of the two invariants, whereas in Maxwell's theory it was equal to one of them.

It is not difficult to observe that the 10 components of  $\tau_{\mu\nu}$  (see above) are identical in form with the components of Maxwell's vacuum tensor,  $\tilde{F}, \tilde{G}$  being substituted for  $\vec{H}, \vec{E}$ .

By investigating the transformations of the real tensor  $\tau_{\mu\nu}$ , it is easy to find a frame of reference, in which the physical meaning of our "condition of conjugateness" is readily disclosed. What distinguishes a Maxwell tensor from the general symmetrical tensor is only that its roots or

eigenvalues have the form  $\pm \rho$ , each double. The first part of  $\tau_{\mu\nu}$ , viz.,  $\frac{i\tau_{\mu\nu}}{(\tilde{F}\tilde{G})}$  is precisely of this type. At that the value  $\rho$  works out to

$$\rho = \pm \sqrt{\left(\frac{i}{2}\tilde{L}\right)^2 - 1}, \quad (7.4.4)$$

by considering that in Maxwell's case  $\rho$  is known to be  $\pm \frac{1}{2}\sqrt{(\vec{H}^2 - \vec{E}^2)^2 + 4(\vec{H}\vec{E})^2}$  (see the proof in (Lightman, A.P., et al., 1975)).

#### 4.1. Other Lagrangians of nonlinear theories

It was noted (Ivanenko and Sokolov, 1949), that various and arbitrary variants of formal nonlinear electrodynamics lead to close values of coefficients, if we take into account that the electron radius is equal to a classical radius of an electron. For example, in this way E. Schrödinger obtained similar results using the following Lagrangian:

$$L_{Sch} = \frac{E_0^2}{8\pi} \ln\left(1 + \frac{E^2 - H^2}{E_0^2}\right), \quad (7.4.5)$$

The only serious deficiency in these nonlinear theories is that they are not quantum.

## 5.0. The vacuum polarization as cause of formation of electron

As is known (Wikipedia, Vacuum polarization; Peskin and Schroeder, 1995) in quantum field theory, and specifically quantum electrodynamics, vacuum polarization describes a process in which a background electromagnetic field produces virtual electron-positron pairs that change the distribution of charges and currents that generated the original electromagnetic field. It is also sometimes referred to as the self energy of the gauge boson (photon). Vacuum polarization was observed experimentally in 1997 using the TRISTAN particle accelerator in Japan.

According to quantum field theory, the ground state of a theory with interacting particles is not simply empty space. Rather, it contains short-lived "virtual" particle-antiparticle pairs which are created out of the vacuum and then annihilate each other.

Some of these particle-antiparticle pairs are charged; e.g., virtual electron-positron pairs. Such charged pairs act as an electric dipole. In the presence of an electric field, e.g., the electromagnetic field around an electron, these particle-antiparticle pairs reposition themselves, thus partially counteracting the field (a partial screening effect, a dielectric effect). The field therefore will be weaker than would be expected if the vacuum were completely empty. This reorientation of the short-lived particle-antiparticle pairs is referred to as *vacuum polarization*.

The vacuum polarisation firstly was discussed 1912 by G. Mie in his classical nonlinear electromagnetic theory of electron. One of the first a student of Werner Heisenberg and Arnold. Sommerfeld - Dr. Erich Bagge - connected the task of the forming the elementary particle (in particular, electron) with the polarization of physical vacuum

In the simplest case the formulation of problem of formation of an (spherical) electron looks as follows (Bagge, 1951).

The fact of the formation of the electron pairs by high energy light quanta can be considered as deep polarization of vacuum that leads to the breaking of the electric dipole under the action of EM field of light wave. This makes it possible to examine the presence of this polarization also in the case, when field energetically cannot cause a pair formation. This leads to interaction of light by light, as this showed Heisenberg, Euler and Kockel (Euler and Kockel, 1935; Euler, 1936; Heisenberg and Euler, 1936) in quantum field theory.

Maybe Peter Debye (Debye, 1934) was first, who note, that this approach can be developed also in the framework of Dirac's theory: "If Dirac's picture of pair production in 'hole theory' is

correct, then at lower energies a kind of vacuum polarisation should be prepared similar to the polarisation effect in a dielectric medium shortly before an electric discharge occurs."

E. Bagge has shown (Bagge, 1951; 1988; 1990, 1993) that with the reasonable choice of the function  $\delta_V(r, t)$  it is possible to describe the rest spherical electron within the framework of Dirac's relativistic theory of particles as electro-magnetic stable, spheroidal particles. Their properties, especially their spins and their magnetic momentum, are exactly those, which have been measured at first and later on derived by Dirac.

This concept theoretically can be realised by the help of the formula for the media dispersion constants of optical resonance effects, allowing the calculation a polarisation function  $\varepsilon_V(\vec{r}, t)$  of the vacuum. In this case the ratio of  $\vec{D}$  to  $\vec{E}$  can be considered as a "dielectric constant (permeability) of vacuum":  $\delta_V(r, t) = \frac{\vec{D}}{\vec{E}}$ .

It is natural therefore to represent in this case the equations of field in that form, which they have for the polarization medium. This means that in particular the dielectric constant  $\delta_V$  must be considered as the function of space.

This fact naturally constrains the field in the environment of electron, which automatically leads to end value for the self-energy of electron.

Considering the dielectric constant of vacuum with particles  $\delta_V(r)$  not as constant, but as the function of three-dimensional variables and field (in simplest case, of scalar potential  $\varphi$ ), we must replace the known Laplace equation for the empty space

$$\Delta\varphi_1 = 0, \quad (7.5.1)$$

by the equation, which considers the inconstancy of dielectric constant:

$$\frac{\partial}{\partial x} \left( \delta_V \frac{\partial \varphi}{\partial x} \right) + \frac{\partial}{\partial y} \left( \delta_V \frac{\partial \varphi}{\partial y} \right) + \frac{\partial}{\partial z} \left( \delta_V \frac{\partial \varphi}{\partial z} \right) = 0, \quad (7.5.2)$$

This equation already can not have the infinite solution for the field of spherical charge. Actually, if  $\delta_V = \delta_V(r)$ ,  $\varphi = \varphi(r)$ ,

then the differential equation (7.5.2) takes the form:

$$\frac{d^2 \varphi}{dr^2} + \frac{2}{r} \frac{d\varphi}{dr} + \frac{d(\ln \delta_V)}{dr} \frac{d\varphi}{dr} = 0, \quad (7.5.4)$$

If a dielectric constant is constant, the equation (7.5.4) has a solution in the form of the Coulomb potential:  $\varphi_C = \frac{e}{r}$ .

It is obvious that we must obtain this expression at a great distance from the electron, whereas in the limits of the basic volume, which contains the basic energy (mass) of electron, the solution must not give the divergent result.

By analogy with the dispersion formulas of optical theory Bagge proposed the following expression for the dielectric constant (without taking into account a damping):

$$\delta_V = \frac{C}{(\varepsilon_r - \varepsilon)^2}, \quad (7.5.5)$$

where  $C$  is a constant, which must be determined;  $\varepsilon_r$  ( $\sim \hbar\omega_r$ ) is the resonance energy ( $\varepsilon = 2m_e c^2$ ), which is determined by photon energy;  $\varepsilon$  ( $\sim \hbar\omega$ ) is certain energy of the fields (which can be identified with the energy of electron-positron, which compose the dipole of intermediate photon (see Kiryakos, 2010a). It is natural to assume  $\varepsilon = e\varphi$ ; then for the dielectric constant we obtain the expression:

$$\delta_V = \frac{C}{(\varepsilon_r - e\varphi)^2}, \quad (7.5.6)$$

Using (7.5.6), we will obtain from (7.5.4) the following expression:

$$\frac{d^2\varphi}{dr^2} + \frac{2}{r} \frac{d\varphi}{dr} + \frac{2e}{\varepsilon_r - e\varphi} \left( \frac{d\varphi}{dr} \right)^2 = 0, \quad (7.5.7)$$

Considering that the strength of the field of electron has an finite maximum quantity, we must to assume that the resonance energy, which corresponds to this strength, is the constant, which can be expressed in the form:  $\varepsilon_r = \frac{e^2}{r_0}$ , so that if  $\varepsilon_r = 2mc^2$ , then  $r_0 = \frac{e^2}{2mc^2}$  is a radius of the charged sphere, whose charge is distributed uniformly by the volume. Then from (7.5.7) we obtain the nonlinear differential equation:

$$\frac{d^2\varphi}{dr^2} + \frac{2}{r} \frac{d\varphi}{dr} + \frac{2e}{e/r_0 - e\varphi} \left( \frac{d\varphi}{dr} \right)^2 = 0, \quad (7.5.8)$$

The general solution of this nonlinear differential equation of the second order, as it is not difficult to verify (Bagge, 1951), takes the form:

$$\varphi = \frac{e}{r_0} \frac{Ar_0 + (B-1)r}{Ar_0 + Br}, \quad (7.5.9)$$

where  $A$  and  $B$  are constants of the integrations, which can be found from the limiting conditions:

- a)  $\varphi = 0$  with  $r \rightarrow \infty$ , which gives  $B=1$ , b)  $\varphi \rightarrow \frac{e}{r}$  with  $r \gg r_0$ , which gives  $A=1$ ,

Thus, the potential of spherically symmetrical electron upon consideration of self-action can be recorded in the form:

$$\varphi = \frac{e}{r+r_0}, \quad (7.5.10)$$

As we see, potential  $\varphi$  at point  $r=0$  does not go to infinity, but is taken the specific value:  $\varphi = \frac{e}{r_0}$ , which corresponds to the maximum value of field.

Solution (7.5.10) makes it possible to calculate also strength  $E$  and electrical displacement  $D$  of field, and also energy  $\varepsilon_e$  of spherical charge.

From (7.5.10), according to the connection of scalar potential and strength of electric field, we obtain for the value:

$$\vec{E} = -grad\varphi = \frac{e}{(r+r_0)^2} \frac{\vec{r}}{r}, \quad (7.5.11)$$

From this the maximum value of field will be equal to:

$$\vec{E} = -grad\varphi = \frac{e}{(r_0)^2} \frac{\vec{r}}{r}, \quad (7.5.11')$$

Using (7.5.10), from (7.5.6) we obtain for the dielectric constant:

$$\delta_V = \frac{Cr_0^2 (r+r_0)^2}{e^4 r^2}, \quad (7.5.12)$$

and for the displacement:

$$\vec{D} = \delta_V \vec{E} = \frac{Cr_0^2}{e^3} \frac{\vec{r}}{r^3}, \quad (7.5.13)$$

Equation (7.5.13) gives the possibility to establish the connection between  $C$  and  $r_0$ . From one side:

$$\oint \vec{D} d\vec{S} = 4\pi e = 4\pi \frac{Cr_0^2}{e^3}, \quad (7.5.14)$$

From the other side

$$\frac{1}{8\pi} \int \vec{E} \vec{D} d\tau = m_0 c^2 = \frac{Cr_0}{2e^2}, \quad (7.5.15)$$

It follows from (7.5.14) and (7.5.15):

$$\varepsilon_r = \frac{e^2}{r_0} = 2m_0 c^2, C = \frac{e^4}{r_0^2} = 4m_0^2 c^4,$$

Substituting, we obtain complete expression for the dielectric constant the expression:

$$\delta_V = \frac{4m_0^2 c^4}{(2m_0 c^2 - e\varphi)^2}, \quad (7.5.16)$$

which completely satisfies to the physical conditions of the electron-positron pair production: taking into account  $\varphi \rightarrow 0$  we obtain  $\delta_V \rightarrow 1$ , while the energy  $e\varphi = 2mc^2$ , which is necessary for the appearance of pair, gives for the dielectric constant the infinite value, which corresponds to the breaking of photon to two parts. Both conclusions correspond precisely to physical statement of problems.

Following E. Bagge (Bagge, 1951), let us note also that in the general case the problem must be placed and be solved, taking into account all fields and their precise configuration. In this case the dielectric constant will be not the simple function of potential, but the tensor, determined by the electrical and magnetic fields of the intermediate photon and nucleus.

It was noted (Ivanenko and Sokolov, 1949), that various and, as was outlined, from the physical point of view, arbitrary variants of formal nonlinear electrodynamics lead to close values of coefficients, if to take into account, that the electron radius is equal to classical radius of electron.

It was also noted, that the basic defect of these theories, as well as of Mie theory, was the arbitrary choice of Lagrangian, which had no connection with the quantum theory, in particular, with Dirac theory, and did not take into account properties of electron, revealed by the last.

We will show that these theories can be considered as approach of the NTEP and that they are mathematically connected to the Dirac electron theory.

## 6.0. Nonlinear classical theories as approximations of NEPT

### 6.1. A connection of G. Mie's theory with Born-Infeld theory and NEPT

Let us show that the Mie Lagrangian, after some additions, can be represented as a Lagrangian that is similar to the Lagrangian of NEPT (and, consequently, QED).

Recall the Mie Lagrangian (7.2.1):

$$L_{Mi} = \frac{1}{4} F_{\mu\nu} F^{\mu\nu} - f\left(\pm \sqrt{A_\mu A^\mu}\right) \quad \text{or} \quad L_{Mi} = \frac{1}{8\pi} (E^2 - H^2) - f\left(\pm \sqrt{A_\mu A^\mu}\right)$$

As we know (Pauli, 1958; Sommerfeld, 1964), the charge density is not an invariant with respect to Lorentz transformations. However, the charge is an absolute invariant with respect to Lorentz transformations. It is also known that the square of the 4-potential, i.e.  $I_3 = A_\mu A^\mu$ , is an

invariant with respect to Lorentz transformations. However, it is not an invariant with respect to gauge transformations.

It appears that the product of the square of charge and  $I_3$  will be invariant with respect to both Lorentz and gauge transformations.

### 6.1.1. Larmor – Schwarzschild's invariant

According to (Pauli, 1958) and (Sommerfeld, 1964), R. Schwarzschild (Schwarzschild, 1903), introduced the value

$$S_w = \varphi - \frac{\vec{v}}{c} \cdot \vec{A}, \quad (7.6.1)$$

which he called "electrokinetic potential". He showed that this value, when multiplied by the density of charge, forms a relativistic invariant:

$$L' = \rho(\varphi - \frac{\vec{v}}{c} \cdot \vec{A}) = -\frac{1}{c} j_\mu \cdot A^\mu = \rho S_w, \quad (7.6.2)$$

where  $j_\mu = \{ic\rho, \rho\vec{v}\}$  is a 4-current density,  $A^\mu = \{\varphi, \vec{A}\}$  is a 4-potential. Further, Schwarzschild forms the Lagrange function by integration with respect to space

$$\bar{L} = \frac{1}{2} \int (H^2 - E^2) dV + \int \rho(\varphi - \frac{\vec{v}}{c} \cdot \vec{A}) dV \quad (7.6.3)$$

He then obtains the action function by integration with respect to time.

Thus, in four dimensions, the Lagrange function density (or Lagrangian) can be written as follows:

$$L = \frac{1}{4} F_{\mu\nu} F^{\mu\nu} - \frac{1}{c} j_\mu A^\mu, \quad (7.6.4)$$

while the Lagrange function will be:

$$\bar{L} = \frac{1}{4} \int F_{\mu\nu} F^{\mu\nu} d\tau - \frac{1}{c} \int j_\mu A^\mu d\tau, \quad (7.6.5)$$

(In note 10 to his book (Pauli, 1958) Pauli noted that before Schwarzschild, the same Lagrangian has been suggested by J.J. Larmor (Larmor, 1900)).

### 6.1.2. The Mie variant of gauge-invariant theory

We will now consider the radicand function in Mie's Lagrangian:

$$A_\mu^2 \equiv A_\mu A_\mu = -\varphi^2 + A_i^2, \quad (7.6.6)$$

Multiplying it by the square of an electron's charge, we obtain:

$$e^2 A_\mu^2 = -(e\varphi)^2 + (e\vec{A})^2, \quad (7.6.7)$$

Since the value:

$$\varepsilon_e = e\varphi, \quad (7.6.8)$$

is the energy of electron interaction, and the value:

$$p_{ei} = \frac{1}{c} eA_i, \quad (7.6.9)$$

is the momentum of electron interaction, we obtain from (7.6.9):

$$e^2 A_\mu^2 = -\varepsilon_e^2 + (c\vec{p}_e)^2, \quad (7.6.10)$$

Taking into account that  $(\hat{\alpha}_o \varepsilon)^2 = \varepsilon^2$ ,  $(\hat{\alpha} \vec{p})^2 = \vec{p}^2$ , these expressions can also be written as:

$$e^2 A_\mu^2 = -(\varepsilon_e^2 - c^2 p_{ei}^2) = -\left( (\hat{\alpha}_0 \varepsilon_e)^2 - c^2 (\hat{\alpha} \vec{p}_e)^2 \right), \quad (7.6.11)$$

Using the above results, we will accept the following expression for the nonlinear part of Mie's Lagrangian  $L_{Mie}^N = f(\pm \sqrt{A_\mu A^\mu})$ :

$$L_{Mie}^N = e \left( \pm \sqrt{\varphi^2 - c^2 \vec{A}^2} \right), \quad (7.6.12)$$

Using the properties of Dirac matrices, it is easy to obtain the following decomposition:

$$\sqrt{e^2 A_\mu^2} = \mp \left( \hat{\alpha}_0 \varepsilon_e \pm c \hat{\alpha} \vec{p}_e \right), \quad (7.6.13)$$

which results in the following expression for the nonlinear part of the Lagrangian:

$$L_{Mie}^{Ne} = \mp \left( \hat{\alpha}_0 \varepsilon_e \pm c \hat{\alpha} \vec{p}_e \right), \quad (7.6.14)$$

Taking into account that

$$\hat{\beta} mc^2 = \mp \left( \hat{\alpha}_0 \varepsilon_e \pm c \hat{\alpha} \vec{p}_e \right), \quad (7.6.17)$$

we see that we can put the mass term of Dirac's equation into Mie's Lagrangian.

The usage of these expressions leads to Dirac's equations of electron and positron, and gives the basis to Weyl's attempt to interpret an asymmetry of both types of electricity not with regard to a mass, but with respect to the difference between the particle and antiparticle.

Also, this way we can relate the Mie's Lagrangian to Born-Infeld's Lagrangian. We can write using (7.6.11) the following:

$$(eA_\mu)^2 = - \left[ \left( \int_0^{+\infty} u d\tau \right)^2 - c \left( \int_0^{+\infty} \vec{g} d\tau \right)^2 \right] = - \left[ \int_0^{+\infty} (u - c\vec{g}) d\tau \int_0^{+\infty} (u + c\vec{g}) d\tau \right], \quad (7.6.18)$$

Then, using the approximation in the previous chapter, we have:

$$(eA_\mu)^2 = -(u^2 - c^2 \vec{g}^2) (\Delta\tau)^2, \quad (7.6.19)$$

Thus, in approximate form, the Mie's Lagrangian can be written in the following form:

$$L_{Mi} = \frac{1}{8\pi} (E^2 - H^2) + (\Delta\tau) \sqrt{(u^2 - c^2 \vec{g}^2)}, \quad (7.6.20)$$

Recalling electromagnetic representation of the Fierz identity:

$$\begin{aligned} (8\pi)^2 (u^2 - c^2 \vec{g}^2) &= (8\pi)^2 (u^2 - \vec{S}^2) = \\ &= (\vec{E}^2 + \vec{H}^2) - 4[\vec{E} \times \vec{H}]^2 = (\vec{E}^2 - \vec{H}^2) - 4(\vec{E} \cdot \vec{H})^2, \end{aligned} \quad (7.6.21)$$

we can write an approximation of the Mie Lagrangian as

$$L_{Mi} = \frac{1}{8\pi} (E^2 - H^2) + 8\pi \Delta\tau \sqrt{(\vec{E}^2 - \vec{H}^2) - 4(\vec{E} \cdot \vec{H})^2}, \quad (7.6.22)$$

As it is not difficult to see this approximation is similar to Born-Infeld Lagrangian. Moreover, in the following chapter we will show that Mie's Lagrangian can be transformed into the form of the Lagrangian of nonlinear field theory, which corresponds to the electron theory of NEPT (see the following chapter "NTEP. 8. Nonlinear quantum electron theory").

## 7.0. Nonlinear classical theories as approximations of NTEP. General statement of problem

As we has shown already, the condition of quantization in NTEP is caused by the introduction of relationships of the energy (according to Planck) and momentum (according to de Broglie) quantization. Therefore, the classical nonlinear theories, in which the requirement of noncommutativity is valid because of the specific nonlinearity (caused by cyclic transport of field vectors), can be considered as quantum theories if they are supplemented with this condition.

Obviously, the NTEP can include all possible invariants of electromagnetic field. Therefore, its Lagrangian can be written as some function of the field invariants  $I_1 = (\vec{E}^2 - \vec{H}^2)$  and  $I_2 = (\vec{E} \cdot \vec{H})$ :

$$L = f_L(I_1, I_2), \quad (7.7.1)$$

Apparently, the function  $f_L$  can have a specific form for each particular problem. However, an expansion of the function  $f_L(I_1, I_2)$  in Taylor–Mac-Laurent power series must exist in every case. In general case, these expansions must contain the same set of terms that will differ only by constant coefficients, some of which can be equal to zero (see examples of such expansions in (Akhiezer and Berestetskii, 1965; Weisskopf, 1936; Schwinger, 1951).

Therefore, in general, the expansion will look as follows:

$$L_M = \frac{1}{8\pi} (\vec{E}^2 - \vec{B}^2) + L', \quad (7.7.2)$$

where

$$L' = \alpha (\vec{E}^2 - \vec{B}^2)^2 + \beta (\vec{E} \cdot \vec{B})^2 + \gamma (\vec{E}^2 - \vec{B}^2) (\vec{E} \cdot \vec{B}) + \xi (\vec{E}^2 - \vec{B}^2)^3 + \zeta (\vec{E}^2 - \vec{B}^2) (\vec{E} \cdot \vec{B})^2 + \dots, \quad (7.7.3)$$

is the part responsible for nonlinear interaction (here,  $\alpha, \beta, \gamma, \xi, \zeta, \dots$  are constant coefficients).

On the other hand, the Born-Infeld Lagrangian can be expanded into a series with small parameters  $a^2 E^2 \ll 1$  and  $a^2 B^2 \ll 1$ , where  $a^2 = \frac{1}{E_0^2}$ :

$$L_{BI} = -\frac{1}{8\pi} (\vec{E}^2 - \vec{B}^2) + \frac{a^2}{32\pi} \left[ (\vec{E}^2 - \vec{B}^2)^2 + 4(\vec{E} \cdot \vec{B})^2 \right] + \sum O(\vec{E}^2, \vec{H}^2), \quad (7.7.4)$$

where  $\sum O(\vec{E}^2, \vec{H}^2)$  is the series remainder with the terms, containing vectors of electromagnetic field in powers greater than four. Obviously, at a large distance from the center of a particle (where the maximal field is), under the conditions  $a^2 E^2 \ll 1$  and  $a^2 B^2 \ll 1$ , the terms of these series quickly converge. However, the terms with higher powers must be taken into account at a small distance from the particle center.

In the following chapter we will show that the first approximation of Lagrangian of NTEP can be represented in EM form as:

$$L_N = -\frac{1}{8\pi} (\vec{E}^2 - \vec{B}^2) + A \left[ (\vec{E}^2 - \vec{B}^2) + 4(\vec{E} \cdot \vec{B})^2 \right], \quad (7.7.5)$$

where  $A$  is some constant. Thus, taking into account (7.7.4), we can write:

$$L_N \approx L_{BI}, \quad (7.7.6)$$

Then, within the framework of NTEP, an approximate solution of the electron equation will be similar to the solution of the Born-Infeld theory. Obviously, this assertion will be also correct for other nonlinear theories.

Having this, it is not difficult to answer the question, why the various variants of formal nonlinear electrodynamics lead to close values of coefficients: the expansions of nonlinear Lagrangian (7.7.3) are approximately similar for various variants and consequently they produce close results.

At the same time, since the Lagrangian and equations of NTEP completely coincide with the Lagrangian and equations of quantum electrodynamics, the Mie theory and its variant - the Born-Infeld theory, are closely related to Dirac's electron theory.

In the following chapter we will show that the Dirac electron equation can be expressed in form of nonlinear equation, which in the electromagnetic form is similar to classical nonlinear



equations, considered above, and in the quantum form is similar to known nonlinear quantum field equations.

## Chapter 8. Nonlinear quantum electron equation

### 1.0. Introduction. Unified nonlinear theories

Nonlinear theories of elementary particles originated in an attempt to unify the descriptions of motion with intrinsic characteristics of particles (first of all, of electron).

#### 1.1. From classical to quantum nonlinear electron theory

In the electron theory before Mie's (Bialynicki-Birula, 1983), the electron was not considered to be a purely electromagnetic entity. Its description, for example, contained Poincaré stresses and a mechanical mass. The first attempt to set up a theory, which can give a solution of this and other problems, was made by the German physicist Gustav Mie. Later, as an application of this theory, the well-known nonlinear Born-Infeld theory was developed (Born and Infeld, 1934), and encouraging numerical results were obtained. But the non-quantum nature was the basic defect of these theories.

G. Mie wanted the electromagnetic field only to be responsible for all properties of the electron. In particular, he wanted the electromagnetic current to be a consequence of electrodynamics postulates. In order to achieve this goal, Mie assumed that the four-vector potential must be directly included into the Lagrangian. Actually, this approach allows to achieve the generation of current. However, the potentials in Mie's theory acquired a physical meaning, and gauge invariance was lost. Other physicists found these properties unacceptable, and as a result of this, Mie's theory has been shelved for many decades.

In fact, gauge non-invariance and the non-quantized nature were serious defects of Mie's theory. However, in the next chapter, we will show that both deficiencies can be overcome on the basis of later results.

Another approach to the description of elementary particles - an theory of composite particles - has its origin in the neutrino theory of light of L. de Broglie. He assumed that the photon is a pair of "fusion" neutrinos (therefore, the theory is also known as the "theory of fusion"). The neutrino has an electric charge equal to zero, and spin equal to  $\frac{1}{2}$ . Its resting mass was formerly considered to be zero. In the process of fusion, two neutrinos thus could form a neutral particle with zero mass and spin 1, as is the case with a photon. It was possible to obtain other particles with the spin a multiple of  $\frac{1}{2}$  through the fusion of several neutrinos.

By way of a solution to all these difficulties (Ivanenko, 1958), many authors have proposed that the nonlinear spinor equation be made the basis of the field theory. As indicated many times, Heisenberg and his associates were able to attain most noticeable successes in this direction (Coll. of articles, 1959; Heisenberg, 1957). First, the reciprocal transformation of the particles clearly indicates that they are excited states of some general substance. In accordance with the arguments of de Broglie, the simplest basic field, from which it is possible to construct all the others, should be a spinor field of Dirac particles with spin  $s = \frac{1}{2}$ . A clear example of the method of "joining" is the idea of construction of the neutrino theory of light by de Broglie (developed by Kronig, Jordan, A. A. Sokolov, and others).

If we generalize these ideas and adopt the point of view of a unified theory, then, obviously, its base should be some sort of nonlinear generalization of the Dirac equation. In fact, to yield excited states, the fundamental world spinor field should interact with something, but in the unified theory it can interact only with itself. Later D. Ivanenko (Ivanenko, 1938), established the form of all possible nonlinear generalizations of Dirac's equation, not including the derivatives, on which Heisenberg indeed leans in his papers. In his papers (see also the book (Heisenberg, 1966) Heisenberg expounded on the principal ideas and advances of unified nonlinear theory of matter. Let us summarize the principal achievements of this theory.

Taking into account the invariance under Pauli and Salam-Touschek transformations (from the neutrino theory), Heisenberg arrives at the Lagrangian

$$L_{NL} = \psi^+ \gamma_\nu \frac{\partial}{\partial \psi_\nu} \psi \pm \frac{l^2}{2} \sum_\mu (\psi^+ \gamma_\nu \gamma_5 \psi)^2, \quad (8.1.1)$$

from which he obtains the fundamental nonlinear spinor equation of matter

$$\gamma_\mu \partial_\mu \psi \pm \lambda (\psi^+ \gamma_5 \gamma_\nu \psi) \gamma_5 \gamma_\nu \psi = 0, \quad (8.1.2)$$

where  $l$  is the fundamental minimal length,  $\lambda = hc l^2$  is the interaction constant,  $\gamma_5$  and  $\gamma_\nu$  are Dirac's matrices.

After establishing the fundamental nonlinear equation, it is necessary to consider the rules of quantization of the field. In this connection Heisenberg made a very bold and original step, by modifying the commutation rules through introducing a Dirac indefinite metric in Hilbert space so that these equations come into agreement with the new nonlinear equation.

Among the results of Heisenberg and his associates, let us recall their derivation of the fermion state with mass  $k = 7.426/l$  (where  $k = mc/h$ ), determined by the interaction constant (when the calculations are made with the new nonlinear term, the coefficient is 7.08 in the first approximation and 6.67 in the second approximation)  $\lambda = hc l^2$  and several excited states with series of masses. It became also possible to obtain a value for the fine-structure constant in the

$$\text{form } \alpha = \frac{2\pi e^2}{hc} \cong \frac{1}{267}.$$

Unfortunately, final mathematically solving of Heisenberg's equation proved to be a difficult problem. On the other hand, some ideas of Heisenberg were shown to be of special importance, and consequently deeply influenced the development of modern quantum field theory.

## 1.2. Unified quantum nonlinear Heisenberg's theory of matter and spontaneous symmetry breakdown

W. Heisenberg's goal was the description of all particles as bound states of a different number of some primary particles. In order to obtain all necessary particle spins, the primary particles must have spin  $\frac{1}{2}$ . According to Heisenberg's supposition, the fundamental equation must have the highest possible symmetry. However the mass term in Dirac's equation disrupts the invariance of this equation in relation to a series of transformations (of transformation  $\psi \rightarrow \gamma_5 \psi$ , where  $\gamma_5$  is the fifth matrix of Dirac; of scale transformation  $x \rightarrow \theta x$ ,  $\psi \rightarrow \theta^{-1/2} \psi$ , where  $\theta$  is a certain number, and others). W. Heisenberg considered that the mass of particles should appear in the theory automatically in the course of its decision. Therefore he proposed a nonlinear equation (8.1.2) without particle mass. Since the equation (8.1.2) has not a term with particle mass, it possess the highest possible symmetry. However it is very well known that the interactions of elementary particles are characterized by different symmetries (isotopic symmetry is lost upon transfer from the strong interaction to the electromagnetic, upon the subsequent transfer to the weak interaction the law of parity conservation ceases to work, etc). It is understandable that it is impossible to create a simple fundamental equation which will automatically have these different symmetries.

The theory of ferromagnetism, the author of which was Heisenberg, showed him a way to resolve this situation. It was the idea of spontaneous symmetry breaking (SSB): the fundamental equation can have a maximum symmetry, but other symmetries can be introduced by the spontaneous breaking of this symmetry.

One of the most important mechanisms of SSB within the framework of Heisenberg's program was proposed at the beginning of the 1960's by Nambu and Jona-Lasinio (Nambu and Jona-Lasinio, 1961a, 1961b). It was taken from the microscopic theory of superconductivity of Bardeen, Cooper and Shriver (known as the BCS mechanism).

Mathematically this was like the appearance of a new symmetry - so-called chiral symmetry, which is spontaneously broken. As a result of the breaking of chiral symmetry, in the model of Nambu and Jona-Lasinio mesons appeared, and fermions acquired significant mass.

Heisenberg's equation (1.2) and the equation of superconductivity (nonrelativistic here):

$$\left[ i \frac{\partial}{\partial t} + \frac{\nabla^2}{2m} - \lambda(\psi^+ \hat{\gamma} \psi) \right] \psi = 0, \quad (8.1.3)$$

have similarities. In Heisenberg's theory, in the case of attraction between primary particles, SSB also occurs as the result of formation of Cooper's pairs of primary particles and their Bose condensation.

The generalization of the SSB model in the case of interaction of scalar and vector EM fields was examined by Higgs. In a static limit, Higgs' model is completely analogous to the theory of Ginsburg-Landau's superconductivity, being its relativistic generalization.

Thus, we come to the conclusion that in order to introduce the required symmetries and particle masses we must take the initial dynamic equations in a mass-free form and use the idea of spontaneous symmetry breakdown (SSB).

Early versions of a unified theory of weak and EM interactions were proposed by Weinberg and Salam. An essential element of this theory was the use of Higgs's model.

### 1.3. The SSB mechanism and mass generation

The possibility of calculation of the particle masses by means of the SSB is the characteristic property of SM. The mathematical description of this procedure is called Higgs's mechanism. This mechanism is repeatedly described in literature. Therefore, we will only consider the conclusions of the theory.

The Higgs field in SM has three important functions:

- 1) it breaks the gauge symmetries and gives masses to intermediate bosons (W and Z);
- 2) it breaks the chiral symmetry and gives masses to fermions;
- 3) it restores the unitarity of the theory.

The last role is very important: if Higgs's boson does not exist, the unitarity of theory in the general case will be broken. In this case it is necessary to exceed the limits of SM. According to present ideas this possibility gives: super-symmetry; the additional measurements of space-time; "great" unification of interactions; new internal particle structure of SM (technicolor, little Higgs, etc); superstring, membranes, and the like. But all these versions lie beyond the limitations of the experimental check.

In the Standard Model theory the Higgs's boson mass is not determined. Some estimations, which is based on experimental data, showed that the mass of Higgs's boson must lie approximately in the interval of 96-251 GeV. The results of the experiments, which were set until now for confirmation of Higgs's mechanism, are negative. With a 95% confidence level (ScienceDaily, 2009) the mass of the Higgs boson (within the framework of SM) must be in the limits:  $m(H) > 114$  GeV from straight searches on LEP II, and  $m(H) < 160$  GeV from the fit of precision measurements on LEP and Tevatron. Also the 1<sup>st</sup> type of two-doublet Higgs model, in which the different bosons of Higgs are required, was not confirmed.

Other results show that the probability of the Higgs boson detection in a remained, comparatively small, region of energies from 114 to 160 GeV is limited. In connection with the difficulties, which will appear if Higgs's bosons is not discovered, an interest arises in other possible variations of the field theory, which can be accessible for experimental check.

Earlier (see chapter 4) we have shown that self-action of fields of a photon leads to occurrence of mass of a particle and transformation of a usual (massless) photon into an intermediate massive photon, which, due to spontaneous breakdown, can generate the massive spinor particles – electron and positron ((see chapter 5). This mechanism solves the problem of particle masses without the Higgs mechanism. Below we will examine the nonlinear theory of electron (positron)

to show that in this case also the particles mass are generated by self-interaction of the particle fields.

## 2.0. Nonlinear electron equation of NTEP and its Lagrangian

“Is the quantum theory linear or is it a nonlinear theory?” - this question, set by W. Heisenberg in 1967 (Heisenberg, 1967), arose in connection with the fact that “practically every problem in theoretical physics is governed by nonlinear mathematical equations, except perhaps quantum theory, and even in quantum theory it is a rather controversial question whether it will finally be a linear or nonlinear theory”. A number of works is devoted to the analysis of this contradiction (Parwani, 2005; Jordan, 2007; etc), but no final solution was found until now.

### 2.1. About specifics of NTEP as a nonlinear theory

NTEP discloses two types of nonlinearity. The first is related to the postulate of NTEP about the rotation transformation of a quantum of an EM wave. It is possible to consider the motion of rotation as a deviation from linearity, i.e. as a kind of nonlinearity. However, in this case, such nonlinear motions are of a specific type: they are created and described by harmonic functions and their superposition. This allows us to describe this type of nonlinearity by linear equations.

Actually, rotation, as a motion along the circle, can be represented by a sum of two linear, mutually perpendicular harmonic oscillations. The sum of a greater number of oscillations leads to curvilinear trajectories with a form known as Lissajous figures. Apparently, all these nonlinearities are conveniently and simply described by complex functions. It is possible to assume that Fourier theory reflects the possibility of a linear description of these nonlinear curves.

Since the Fourier transform is linear, this “rotation” or “harmonic curvilinearity” allows us to consider NTEP as a linear theory, i.e. a theory in which the principle of superposition is strictly fulfilled.

On the other hand, the rotation transformation of EM fields also gives us another type of nonlinearity. Here, we deal not only with rotation motions, but also with the fields which are “attached” to these motions in a strictly defined way. During the formation of EM particles (i.e. as the result of rotation of a quantum of an EM wave) the field configuration changes inside the particle’s volume. In this case the self-interaction of particle fields appears, which is described by the nonlinear terms. Thus, strictly speaking, nonlinear field theory operates inside of a particle, and probably the principle of superposition is not valid in this case.

The simplest way to approach the nonlinear theory is the use of the electromagnetic representation of Dirac’s lepton theory. Further we will derive the general type of the nonlinear equation of electron and construct its Lagrangian.

### 2.2. Self-action and the nonlinear equation of electron

The stability of a semi-photon (i.e. electron) is only possible because of the self-action of the semi-photon fields. This self-action forms the particle itself, and the particle’s internal parameters must ensure this self-action. The basic parameters which determine the behaviour of a particle are the energy and momentum of the particle’s fields. This shows how self-action can be introduced into the equation.

Since Dirac’s equation does not have other parameters, the internal parameters of electron must be connected with the free term:  $\hat{\beta} m_e c^2$ . Linearizing the conservation law of energy-momentum

$\varepsilon^2 - c^2 \vec{p}^2 - m_e^2 c^4 = 0$  according to Dirac’s method, namely  $\varepsilon_{\pm} = \pm \sqrt{c^2 \vec{p}^2 + m_e^2 c^4} = \pm (c \hat{\alpha} \vec{p} + \hat{\beta} m_e c^2)$ , we obtain the linear equivalent of this relationship: the linear expression of the energy-momentum conservation law (in present case for the internal – *in* – field:

$$\hat{\beta} m_e c^2 = -\varepsilon_{in} - c \hat{\alpha} \vec{p}_{in} = -e \varphi_{in} - e \hat{\alpha} \vec{A}_{in}, \quad (\text{A})$$

(note that here  $\varepsilon_{in} = e\varphi_{in}$  and  $p_{in} = ec\vec{A}_{in}$  are not operators, but the energy and momentum of field;  $\varphi_{in}$  and  $\vec{A}_{in}$  are the scalar and vector potentials correspondingly). Substituting (A) into Dirac's equation, we obtain the following equation:

$$\left[ \hat{\alpha}_0 (\hat{\varepsilon} - \varepsilon_{in}) + c \hat{\alpha} \cdot (\hat{p} - \vec{p}_{in}) \right] \psi = 0, \quad (8.2.1)$$

Here, the inner energy  $\varepsilon_{in}$  and momentum  $p_{in}$  can be expressed using the inner energy density  $u$  and the inner momentum density  $\vec{g}$  (or Poynting vector  $\vec{S}$ ) of an EM wave:

$$\varepsilon_{in} = \frac{1}{8\pi} \iiint_{x,y,z} (\vec{E}^2 + \vec{H}^2) dx dy dz = \int_0^\tau u d\tau, \quad (8.2.2)$$

$$\vec{p}_{in} = \iiint_{x,y,z} [\vec{E} \times \vec{H}] dx dy dz = \int_0^\tau \vec{g} d\tau = \frac{1}{c^2} \int_0^\tau \vec{S} d\tau, \quad (8.2.3)$$

assuming that the upper limit of integration for the space is variable ( $0 \leq x, y, z < \infty$ ) or conditionally ( $0 \leq \tau < \infty$ ), where  $d\tau = dx dy dz$ .

Taking into account the EM form of  $\psi$  - function (see chapter 6), we obtain the quantum forms of  $u$  and  $\vec{S}$  as follows:

$$u = \frac{1}{8\pi} (\vec{E}^2 + \vec{H}^2) = \frac{1}{8\pi} \psi^\dagger \hat{\alpha}_0 \psi, \quad (8.2.4)$$

$$\vec{S} = \frac{c}{4\pi} [\vec{E} \times \vec{H}] = c^2 \vec{g} = -\frac{c}{8\pi} \psi^\dagger \hat{\alpha} \psi, \quad (8.2.5)$$

Substituting expressions (8.2.2) and (8.2.3) into the electron equation (8.2.1), and taking into account (8.2.4) and (8.2.5), we will obtain the *nonlinear integro-differential equation in both electromagnetic and quantum forms*.

*We assume that equation (8.2.1) is the basic nonlinear equation of the electron, which describes both the electron's motion and structure.*

Actually, taking into account the relationship (A), the equation (8.2.1) is reduced to the usual Dirac's equation (8.2.1), which describes *motion* of an electron.

For the description of the electron field *structure* apparently it is necessary to solve the nonlinear equation. The difficulty of solving such equations is already noted by Heisenberg (Heisenberg, 1967). The solution is usually anticipated by the analysis of the properties of the equation symmetry and by the possibility of its conversion into the system of linear equations.

In order to study the properties of symmetry, let us find the approximate quantum form of the equation (8.2.1). Then the nonlinear equation of Heisenberg occurs unexpectedly, which properties of symmetry are well studied.

### 2.2.1. The derivation of the Heisenberg nonlinear equation as first approximation

Let us find the approximate quantum form of the equation (8.2.1).

Taking into account that the solution of Dirac's equation for a free electron is the plane wave

$$\psi = \psi_0 \exp[i(\omega t - ky)], \quad (8.2.6)$$

we can approximately write (8.2.2) and (8.2.3) as follows:

$$\varepsilon_p = u \Delta \tau = \frac{\Delta \tau}{8\pi} \psi^\dagger \hat{\alpha}_0 \psi = \frac{\Delta \tau}{8\pi} (\vec{E}^2 + \vec{H}^2), \quad (8.2.7)$$

$$\vec{p}_p = \vec{g} \Delta \tau = -\frac{\Delta \tau}{8\pi c} \psi^\dagger \hat{\alpha} \psi = \frac{\Delta \tau}{4\pi c} [\vec{E} \times \vec{H}], \quad (8.2.8)$$

where  $\Delta\tau$  is the volume that contains the main part of the semi-photon's energy. If we assume that the fields of the particle apply to infinity, then apparently the cutting of integral will lead to the violation of the unitarity of theory. This must be taken into account in the use of this (approximate) equation for the description of particles.

Using (8.2.7) and (8.2.8) we can find the approximate form of the equation (8.2.1) as follows:

$$\frac{\partial \psi}{\partial t} - c \hat{\alpha} \vec{\nabla} \psi + i \frac{\Delta\tau}{8\pi c} (\psi^+ \hat{\alpha}_0 \psi - \hat{\alpha} \psi^+ \hat{\alpha} \psi) \psi = 0, \quad (8.2.9)$$

If instead of using the  $\alpha$ -set of Dirac's matrices we use the  $\gamma$ -set matrices, from the equation (8.2.9) we obtain the equation of Heisenberg in a form, which is known from the theory (Heisenberg, 1966; Paper translation collection, 1959):

$$\gamma_\mu \frac{\partial \psi}{\partial x_\mu} + \frac{1}{2} i \lambda [\gamma_\mu \psi (\bar{\psi} \gamma_\mu \psi) + \gamma_\mu \gamma_5 \psi (\bar{\psi} \gamma_\mu \gamma_5 \psi)] = 0, \quad (8.2.10)$$

where in our case constant  $\lambda$  is  $\lambda = \frac{\Delta\tau}{4\pi c}$ .

The nonlinear equation (8.2.10) was postulated by Heisenberg. Unlike, the equation (8.2.9) was obtained in a logical and correct way, and the constant  $\lambda$  automatically appears in this equation as a self-action constant.

### 2.3. The Lagrangian of the nonlinear electron theory

The linear type Lagrangian is presented in quantum form in Dirac's electron theory as follows (Schiff, 1955):

$$L_D = \psi^+ (\hat{\varepsilon} + c \hat{\alpha} \hat{p} + \hat{\beta} m_e c^2) \psi, \quad (8.2.11)$$

It is not difficult to find its electromagnetic form:

$$L_D = \frac{\partial u}{\partial t} + \text{div } \vec{S} - i \frac{\omega}{8\pi} (\vec{E}^2 - \vec{H}^2), \quad (8.2.12)$$

(Note that in the case of a variation procedure we must distinguish the complex conjugate field vectors  $\vec{E}^*$ ,  $\vec{H}^*$  and  $\vec{E}$ ,  $\vec{H}$ ).

The Lagrangian of nonlinear theory can be obtained from the Lagrangian (8.2.11) using the same method that we used to find the nonlinear equation. Substituting relationship (A) into this equation, we obtain:

$$L_N = \psi^+ (\hat{\varepsilon} - c \hat{\alpha} \cdot \hat{p}) \psi + \psi^+ (\varepsilon_{in} - c \hat{\alpha} \cdot \vec{p}_{in}) \psi, \quad (8.2.13)$$

We will assume that (8.2.13) represents the general form of the Lagrangian of nonlinear electron theory.

### 2.4. The effective Lagrangian of the nonlinear electron theory

In order to understand the connection of this theory with the contemporary results, let us find electromagnetic and quantum approximations of Lagrangian (8.2.13), which corresponds to equation (8.2.9-8.2.10). Using (8.2.7) and (8.2.8), we can represent (8.2.11) in the following quantum form:

$$L_N = i\hbar \left[ \frac{\partial}{\partial t} \left[ \frac{1}{2} (\psi^+ \psi) \right] - c \text{div} (\psi^+ \hat{\alpha} \psi) \right] + \frac{\Delta\tau}{8\pi} \left[ (\psi^+ \psi)^2 - (\psi^+ \hat{\alpha} \psi)^2 \right], \quad (8.2.14)$$

In order to obtain an EM form of (8.2.14), we initially substitute the normalized  $\psi$ -function using the expression  $L'_N = \frac{1}{8\pi mc^2} L_N$ . Then, using (8.2.4) and (8.2.5), we obtain the following electromagnetic approximation:

$$L'_N = i \frac{\hbar}{2m_e} \left( \frac{1}{c^2} \frac{\partial u}{\partial t} + \text{div } \vec{g} \right) + \frac{\Delta \tau}{m_e c^2} (u^2 - c^2 \vec{g}^2), \quad (8.2.15)$$

We can transform here the second term using the following known electrodynamics identity:

$$(8\pi)^2 (U^2 - c^2 \vec{g}^2) = (\vec{E}^2 + \vec{H}^2)^2 - 4(\vec{E} \times \vec{H})^2 = (\vec{E}^2 - \vec{H}^2)^2 + 4(\vec{E} \cdot \vec{H})^2, \quad (8.2.16)$$

Taking into account that  $L_D = 0$ , and using (8.2.12) and (8.2.16), we can represent (8.2.15) in the following form:

$$L'_N = \frac{1}{8\pi} (\vec{E}^2 - \vec{H}^2) + \frac{\Delta \tau}{(8\pi)^2 mc^2} \left[ (\vec{E}^2 - \vec{H}^2)^2 + 4 (\vec{E} \cdot \vec{H})^2 \right], \quad (8.2.17)$$

As we can see, the approximation of the full Lagrangian of the nonlinear equation contains only invariants of Maxwell's theory. It is similar to the known Lagrangian of photon-photon interaction (Akhiezer and Berestetskii, 1965), Born-Infeld Lagrangian ( ) and Gustav Mie Lagrangian ( ) also.

Now, let us analyze the quantum form of the Lagrangian density (8.2.17). The equation (8.2.14) can be written in the form:

$$L_Q = \psi^+ \hat{\alpha}_\mu \partial_\mu \psi + \frac{\Delta \tau}{8\pi} \left[ (\psi^+ \hat{\alpha}_0 \psi)^2 - (\psi^+ \hat{\alpha} \psi)^2 \right], \quad (8.2.18)$$

We can see that in quantum form, the electrodynamics correlation (8.2.16) takes the form of the known Fierz identity (Cheng and Li, 1984; 2000):

$$(\psi^+ \hat{\alpha}_0 \psi)^2 - (\psi^+ \hat{\alpha} \psi)^2 = (\psi^+ \hat{\alpha}_4 \psi)^2 + (\psi^+ \hat{\alpha}_5 \psi)^2, \quad (8.2.19)$$

Using (8.2.19), we obtain from (8.2.18):

$$L_Q = \psi^+ \hat{\alpha}_\mu \partial_\mu \psi + \frac{\Delta \tau}{8\pi} \left[ (\psi^+ \hat{\alpha}_4 \psi)^2 - (\psi^+ \hat{\alpha}_5 \psi)^2 \right], \quad (8.2.20)$$

If instead of using the  $\alpha$ -set of Dirac's matrices we use the  $\gamma$ -set of matrices, *the Lagrangian* (8.2.20) *coincides with the Lagrangian of Nambu – Jona-Lasinio* (Nambu and Jona-Lasinio, 1961; 1961a).

The first presentation of the idea of this Lagrangian was made in (Nambu, 1960a, 1960b); the model system Nambu worked out with Jona-Lasinio (Nambu and Jona-Lasinio, 1961a, 1961b) is a concrete realization of the proposed SSB. It has the form similar to the Bardeen-Cooper-Schrieffer model

$$L = -\bar{\psi} \gamma^\mu \partial_\mu \psi + g \left[ (\bar{\psi} \psi)^2 - (\bar{\psi} \gamma_5 \psi)^2 \right], \quad (8.2.21)$$

which is invariant against the particle number and chiral transformations.

In the current Standard Model of particle physics, the Nambu–Jona-Lasinio (NJL) model may be regarded as an effective theory for the QCD with respect to generation of the so-called constituent masses. One is interested in the low energy degrees of freedom on a scale smaller than some cutoff  $\Lambda \sim 1$  GeV. The short distance dynamics as well as the confinement may be treated as a perturbation. The problem has been extensively studied by many people.

Let us note some special features of the results, obtained in the NTEP in comparison with the results that were obtained in the contemporary theory.

Since the Lagrangian of Nambu – Jona-Lasinio is a Lagrangian of weak interaction of the type (V - A), the nonlinear theory – NTEP - covers not only electromagnetic, but also weak



interactions. As we will show in future, this conclusion conforms to the fact that in the general case the Dirac equation describes massive neutrino with a conserved inner helicity.

The NTEP show that Lagrangian of Nambu – Jona-Lazinio is actually approximate. Therefore its use can cause different violations of the type of violations of unitarity. This is connected to the fact that the probability distribution density must behave under the Lorenz transformation as time component of the four-dimensional vector, whose divergence is equal to zero. But the Lagrangian of Nambu - Jona-Lazinio contains the strengths of electromagnetic field. As is known, from the strengths of electromagnetic field it is not possible to compose the bilinear combination, which forms the four-dimensional vector, whose divergence would be equal to zero.

However, this value can be constructed, relying on the integral values - energy and momentum of full Lagrangian (8.2.13), which compose a completely determined 4-vector. It is understandable that in order to avoid these difficulties there is no need to use some additional models; it is sufficient to use the precise Lagrangian (8.2.13).

As we noted, the Heisenberg equation has a high degree of symmetry because of the absence of mass, but a special mathematical mechanism SSB is required for the primary particles of equation (8.2.10) to become massive.

In our case the nonlinear integro-differential equation (8.2.1) does not contain mass, and “the mechanism”, through which the mass is introduced into the quantum field equations, is the relationship (A):

$$-\varepsilon_{in} - c\hat{\alpha} \vec{p}_{in} = -e\varphi_{in} - e\hat{\alpha} \vec{A}_{in} = \hat{\beta} m_e c^2, \quad (A')$$

This relationship, recorded here in the reverse order, clearly reflects the process of symmetry breaking, since we substitute the term of high degree of symmetry with a term of low degree of symmetry. Moreover, it is possible to show that the relationship (A') reflects the result of the rotation transformation of the internal symmetry of particle, which is mathematically equivalent to the gauge transformation result (see chapter 4). The special feature of this mechanism is that it does not require the introduction of additional particles and at the same time it does not lead to the necessity to exceed the limits of SM.

Heisenberg poses a problem to obtain all the remaining particles in the form of bound states of a different number of primary particles on the basis of some primary spinor particles. If we consider the spinor particles as the primary building elements of matter, then (as we will show further) it is really possible, using spinor equations, to obtain the equations of all other particles.

### 3.0. Lagrangian of self-interaction of Dirac's fermions in NTEP

The Lagrangian of fermions

$$L = \psi^+ \left( \hat{\alpha}_o \hat{\varepsilon} \mp c\hat{\alpha} \cdot \hat{p} \pm \hat{\beta} m c^2 \right) \psi \quad (8.3.1)$$

can be represented as the sum:

$$L = L_0 + L', \quad (8.3.2)$$

where

$$L_0 = \psi^+ \left( \hat{\alpha}_o \hat{\varepsilon} \mp c\hat{\alpha} \cdot \hat{p} \right) \psi, \quad (8.3.3)$$

is the Lagrangian of the mass-free particle, and

$$L' = \psi^+ \left( \pm \hat{\beta} m c^2 \right) \psi, \quad (8.3.4)$$

corresponds to the Lagrangian of self-interaction, which generates the mass.

Let us note that because of the validity of Dirac's equation we have:

$$L = \psi^+ \left( \hat{\alpha}_o \hat{\varepsilon} \mp c\hat{\alpha} \cdot \hat{p} \pm \hat{\beta} m c^2 \right) \psi = 0$$

From this the relationship follows:

$$\psi^+ \left( \hat{\alpha}_o \hat{\varepsilon} \mp c \hat{\alpha} \cdot \hat{p} \right) \psi = \psi^+ \left( \pm \hat{\beta} m c^2 \right) \psi, \quad (8.3.5)$$

which reflects the virial theorem. Let us analyze the physical meaning of the relationship (8.3.5).

Using the Lagrangian (8.3.1), we can obtain the Euler-Lagrange equation:

$$\begin{cases} \text{rot } \vec{E} + \frac{1}{c} \frac{\partial \vec{H}}{\partial t} = \vec{j}_\tau^m, \\ \text{rot } \vec{H} - \frac{1}{c} \frac{\partial \vec{E}}{\partial t} = \vec{j}_\tau^e, \end{cases} \quad (8.3.6)$$

where

$$\vec{j}_\tau^e = i \frac{\omega}{4\pi} \vec{E}, \quad \vec{j}_\tau^m = i \frac{\omega}{4\pi} \vec{H}, \quad (8.3.7)$$

Using the EM form of the wave function, and taking into account equation (8.3.7), we obtain the following expression for the Lagrangian (8.3.4):

$$L' = i \frac{\omega}{8\pi} (\vec{E}^2 - \vec{H}^2) = \frac{1}{2} (\vec{j}_\tau^e \vec{E} - \vec{j}_\tau^m \vec{H}), \quad (8.3.8)$$

Thus, the Lagrangian of electron self-interaction corresponds to the interaction of a fermion's own current with a fermion's own fields.

#### 4.0. On the mass of interacting particles

From the relationship (A') follows, that a particle's mass is equivalent to the energy-momentum of self-interaction of the particle. Basing on this conclusion, it is possible to analyze how the particle's mass changes during its interaction with other particles.

Let us examine Dirac's equation with external ("ex") field:

$$\left[ (\hat{\alpha}_o \hat{\varepsilon} - c \hat{\alpha} \cdot \hat{p}) + (\hat{\alpha}_o \varepsilon_{ex} - c \hat{\alpha} \cdot \vec{p}_{ex}) + \hat{\beta} m c^2 \right] \psi = 0, \quad (8.4.1)$$

The own mass of the electron corresponds to its inner field is:

$$\hat{\beta} m_e c^2 = \hat{\alpha}_o \varepsilon_{in} - c \hat{\alpha} \cdot \vec{p}_{in}. \quad (8.4.2)$$

In this case, we can rewrite (8.4.1) in the following form:

$$\left[ (\hat{\alpha}_o \hat{\varepsilon} - c \hat{\alpha} \cdot \hat{p}) + (\hat{\alpha}_o \varepsilon_{ex} - c \hat{\alpha} \cdot \vec{p}_{ex}) + (\hat{\alpha}_o \varepsilon_{in} - c \hat{\alpha} \cdot \vec{p}_{in}) \right] \psi = 0, \quad (8.4.3)$$

Similarly to (8.4.2), we can also assert that a certain mass  $m_{ad}$  corresponds to the interaction of the external and internal fields:

$$\hat{\alpha}_o \varepsilon_{ex} - c \hat{\alpha} \cdot \vec{p}_{ex} = \hat{\beta} m_{ad} c^2, \quad (8.4.4)$$

Using (8.4.4), we obtain:

$$\left[ (\hat{\alpha}_o \hat{\varepsilon} - c \hat{\alpha} \cdot \hat{p}) + \hat{\beta} (m_e + m_{ad}) c^2 \right] \psi = 0, \quad (8.4.6)$$

or

$$\left( \hat{\alpha}_o \hat{\varepsilon} - c \hat{\alpha} \cdot \hat{p} \right) \psi = -\hat{\beta} (m_e + m_{ad}) c^2 \psi. \quad (8.4.7)$$

It follows from (8.4.6) that the mass  $m_{ad}$  is an addition to the electron's own mass  $m_e$ . Note, the value of  $m_{ad}$  must satisfy the specified resonance conditions relative to  $m_e$ .

It is also possible to represent the right side of equation (8.4.7) through the currents (8.3.15).

Taking into account that  $\omega = \frac{m c^2}{\hbar}$ , we obtain:

$$m c^2 \vec{E} = -i 4\pi \hbar \vec{j}, \quad (8.4.8')$$

or

$$mc^2\psi = -i4\pi\hbar\vec{j}, \quad (8.4.8'')$$

Substituting (8.4.8) into (8.4.7), we find that:

$$\left(\hat{\alpha}_o\hat{\varepsilon} - c\hat{\alpha}\cdot\hat{p}\right)\psi = -i\hat{\beta}4\pi\hbar(j_e + j_{ad}), \quad (8.4.9)$$

By comparing the above formulas we can make the following conclusions. Within the framework of NEPT we have:

1) the external field of Dirac's equation in quantum form can be considered to be an addition to an electron's own mass;

2) the external field of Dirac's equation in electromagnetic form can be considered to be an addition to an electron's own inner current, i.e., as a certain external current;

3) an external field can be considered to be an environment that has some polarization properties, and can be characterized by a variable electrical and magnetic permeability.

4) it follows from the above considerations that the interaction of an elementary particle with other particles can be considered to be an interaction of the elementary particle's charge and current with some electromagnetic medium.

The transition from Dirac's linear equation to the nonlinear equation of a semi-photon is accomplished through simple substitution: replacing the constant mass term by a functional that contains EM fields. These fields depend on three dimensional coordinates and time. This procedure corresponds to the transition from a point (linear) to a volume (nonlinear) representation of the electron theory.

It is interesting that this transition was already described within the framework of the old nonlinear electromagnetic theory. This was done by making it possible to solve certain nonlinear equations in both "point" and "volume" forms.

## 5.0 The interaction Hamiltonian of the electron nonlinear theory in EM form

In frameworks of NTEP the equations of interaction of the electron with other charged particles (or, in other words, the equations of the electron motion in the field of other particle) can be presented in form of the equations of the classical electrodynamics of medium:

$$\frac{1}{c}\frac{\partial \vec{E}}{\partial t} - \text{rot}\vec{H} = -\frac{4\pi}{c}(\vec{j}^e + \vec{j}_{ex}^e), \quad (8.5.1)$$

$$\frac{1}{c}\frac{\partial \vec{H}}{\partial t} + \text{rot}\vec{E} = \frac{4\pi}{c}(\vec{j}^m + \vec{j}_{ex}^m), \quad (8.5.2)$$

where  $\vec{j}^e, \vec{j}^m$  are the electric and magnetic current densities of the particle,  $\vec{j}_{ex}^e, \vec{j}_{ex}^m$  are the external current densities, which caused by the interaction of the given particle with other particles. In case if other particles (including also the virtual particles of the physical vacuum) form a medium, this equations can be presented as the electromagnetic theory of polarized medium (Jackson, 1999).

The Hamiltonian of Dirac's electron theory is following:

$$\hat{H} = c\hat{\alpha}\cdot\hat{p}\psi - \left[\hat{\beta}mc^2 + \left(\hat{\alpha}_o\varepsilon_{ex} - c\hat{\alpha}\cdot\vec{p}_{ex}\right)\right]\psi, \quad (8.5.5)$$

Using (8.5.2) we can obtain the EM representation of (8.5.5), which we will conditionally write in the form:

$$\hat{H} = \pm\text{rot}(\vec{E}, \vec{H}) \mp \frac{4\pi}{c}(\vec{j}^{e,m} + \vec{j}_{ex}^{e,m}), \quad (8.5.6)$$

The expression (8.5.6) show that the connection of Hamiltonian with above currents (8.5.3) and (8.5.4) and correspondingly with the features of external medium  $\varepsilon_{ex}$  and  $\mu_{ex}$  exists.

## Chapter 9. Physical vacuum and its effect on elementary particles and their interactions

### 1.0. The introduction of physical vacuum in physics

A physical vacuum is a key issue of fundamental physics. The existence of vacuum is in many respects responsible for the properties of elementary particles and their interactions in quantum field theory and needed for the description of such phenomena as radiation effects in quantum electrodynamics (the Lamb shift, the anomalous magnetic moments of the electron and muon, etc), colour confinement in quantum chromodynamics, spontaneous symmetry breaking in the physics of electroweak interactions, the massiveness of W- and Z-bozons, etc.

#### 1.1. The second quantization and physical vacuum

The application of quantization principle of discrete particles to the continuous fields is conditionally called second quantization. Because of the second quantization the wave functions of elementary particles become the operators, which are subordinated to the specified quantum conditions - commutation relations. This relates both to the classical wave functions of electromagnetic field and to the wave functions of Dirac's electron and other particles.

The procedure of second quantization confirms the existence of the lowest level of the energy state of particles, in which there are no real particles. This state is called physical vacuum (PV). It is considered that PV consists of the so-called virtual particles. Nevertheless, it turned out that the virtual particles interact with the real particles. Generally this interaction is conditionally called the polarization of vacuum. The experimental data, obtained even for the free particles, cannot be explained without taking into account this interaction.

The method of second quantization of the amplitudes due to its expansion in a Fourier integral (Medvedev and Shirkov, 1987), which was developed by Dirac (Dirac, 1927b) in application to the electromagnetic field and by Jordan (Jordan, 1927) and Jordan and Klein (Jordan and Klein, 1927) in application to the field of electrons developed into a common theory of an arbitrary free quantum field.

According to this approach a quantum (or quantized) field is a sort of synthesis of the concepts of a classical field of the electromagnetic type and of a probability field of quantum mechanics. According to the present understanding, it is the most fundamental and universal form of matter, underlying all specific manifestations of matter.

It should be noted that this hybrid of classical field and field of probability is strange already because of their different dimensionality. The explanation of this strangeness is given by NTEP. In NTEP classical field and field of probability do not come out as the synthesis of different fields, but as equal concepts. As we showed, the field of probability is the successful mathematical interpretation of the normalized nonlinear electromagnetic field. This restores the unity of the picture of physical fields without any stretch.

On the other hand, if we speak about the fundamental field, i.e. physical vacuum, between it and the real field (especially particles) there is no equality. Fundamental field is the basis, on which the elementary particles appear. The opposite assertion is not correct: particles are not the basis of existence of fundamental field. Actually, in 1927 (Medvedev and Shirkov, 1987) Dirac subjected the variables describing a field to second quantization (Dirac, 1927b), but six years later he raised a decisive objection that Heisenberg and Pauli "regard the field itself as a dynamical system amenable to Hamiltonian treatment so that the usual methods of Hamiltonian quantum mechanics may be applied. There are serious objections to these views... We cannot... suppose the field to be a dynamical system on the same footing as the particles . . . The field should appear in the theory as something more elementary and fundamental" (Dirac, 1932).

The influence of physical vacuum on the particles was also predicted for the first time by P. Dirac. In his Solvay report in 1933, Dirac (Dirac, 1934b) stated that external charges should polarize the vacuum in his theory, with the result that the electric charges which are normally observable for the electron, the proton, and other electrified particles are not the charges which are actually carried by these particles and which figure in the fundamental equations; they are instead smaller. A calculation which he carried out on this new physical effect reduced to a logarithmically divergent integral, whose cutoff at momenta of the order of  $100 mc$  (corresponding to the classical radius of an electron; here  $m$  is electron mass and  $c$  is light velocity) yields a "radiation correction" to the charge of an electron, which reduced it by a fraction of about  $1/137$ . Calculations on the "field" self-energy of a photon also led to an infinite result and again violated gauge invariance.

As early as the middle of 1930s, there were suggestions (Weisskopf, 1936; Euler, 1936) that the infinities in higher orders for the observable effects were traces of these fundamental ultraviolet divergences and that they could be eliminated by subtracting from the infinite quantity for a bound electron the corresponding infinite quantity for a free electron (Kramers, 1938; Stueckelberg, 1935, 1938). This was the basic idea of the renormalization method.

## 2.0. The mathematical description of physical vacuum

### 2.1. The introduction of physical vacuum for free fields

In order to fix the state of a particle (Medvedev and Shirkov, 1987), it is necessary in quantum mechanics to specify the values of a complete set of commuting operators. For a free particle, it is convenient to choose the three components of the momentum  $\vec{p}$  (or wave vector  $\vec{k}$ ) and the projection  $s$  of the spin  $l_s$  onto some direction. The state of a single free particle is thus characterized completely by specifying the six numbers  $m, l_s, p_x, p_y, p_z, s$ , (for charged particles, one adds some other quantum numbers, which we denote by the single letter  $t$ ).

A straightforward extension of these arguments to a system of  $n$  particles would result in the use of  $n$  sextets, one for each particle. In 1927 Dirac suggested that the state of an ensemble of  $n$  identical particles be characterized not by the state of each particle but by the number of particles,  $n_{\vec{p},s,t}$  - occupation numbers - in each of the one-particle states (Dirac, 1927b). The "interpretation" of a wave function gives us not simply the expected numbers of particles, but the probability for any given distribution of particles among different states. This probability is actually the square of the modulus of the normalized solution of the wave equation.

#### 2.1.1. The introduction of creation and annihilation operators

In the occupation-number representation, a state  $|n_{\vec{p},s,t}\rangle$ , is written as the result  $|n_{\vec{p},s,t}\rangle = (n_{\vec{p},s,t})^{-1/2} [a^+(\vec{p},s,t)]^{n_{\vec{p},s,t}} |0\rangle$  of an action on a *vacuum state* (i.e., a state in which there are no particles at all) of the *creation operators*  $a^+(\vec{p},s,t)$ . The creation operators  $a^+$  and their Hermitian-conjugate *annihilation operators*  $a^-$ , were introduced by Dirac in the same paper (Dirac, 1927b).

The creation and annihilation operators  $a^\pm$  describe particles with definite momentum and spin values. To take the local properties into account, we need to put the  $a^\pm$  in the coordinate representation. As transformation functions it is convenient to use the classical solutions of the equations of motion of Euler-Lagrange of a suitable free field.

It is possible to show (Landau and Lifshitz, 1975; Levich et al, 1973; Martynenko, 2001) that electromagnetic field can be conditionally represented in the form of the superposition of some harmonic oscillators:

$$\varepsilon = \sum_k \left( \frac{|\dot{\vec{A}}_{\vec{k}}|^2}{8\pi c^2} + \frac{\vec{k}^2 |\vec{A}_{\vec{k}}|^2}{8\pi} \right),$$

where  $\varepsilon$  is the energy and  $\vec{A}$  is the vector potential of EM field. Here the total energy of the EM field can be represented as the sum of energies of harmonic oscillators.

$$\varepsilon = \frac{1}{2m} \sum_k (p_k^2 + m^2 \omega_k^2 q_k^2),$$

In this sense, the first term in (3.5.4) is a kinetic electromagnetic energy, and the second term is a potential energy. Thus, the EM field in space without charges can be considered as the sum of independent harmonic oscillators with all possible values of the wave vector  $\vec{k}$ . Note that the transition from (3.5.4) to (3.5.5) is clearly artificial assumption. In other words, this is not proof; this is only hypothesis.

Let us examine how on this basis are introduced the creation and annihilation (destruction) operators of particles, which lead to the appearance of the concept of physical vacuum.

The one-dimensional harmonic oscillator (Feynman, 1972) has a Hamiltonian of the form

$$\hat{H} = \frac{1}{2m} p^2 + \frac{m\omega^2}{2} x^2, \quad (9.2.1)$$

where  $x$  and  $p$  are the position and momentum operators for the particle and satisfy

$$[x, p] = i\hbar, \quad (9.2.2)$$

Lets find the eigenvalues and eigenstates of  $\hat{H}$ . We define

$$a^- = \frac{1}{\sqrt{2}} \left( \sqrt{\frac{m\omega}{\hbar}} x + i \frac{1}{\sqrt{m\omega\hbar}} p \right), \quad (9.2.3)$$

Because  $x$  and  $p$  are Hermitian it follows that

$$a^+ = \frac{1}{\sqrt{2}} \left( \sqrt{\frac{m\omega}{\hbar}} x - i \frac{1}{\sqrt{m\omega\hbar}} p \right), \quad (9.2.4)$$

### 2.1.2. Properties of creation and annihilation operators

From (9.2.2) we obtain

$$[a^-, a^+] = 1, \quad (9.2.5)$$

where  $a^+$  denotes the Hermitian conjugate of  $a^-$ , and  $[A, B]$  is the commutator  $AB - BA$ .

To find the the eigenvalues and eigenstates of  $\hat{H}$ , the problem is to find the eigenvalues of the Hermitian operator  $a^+, a^-$ , and to relate the eigenvectors. We may then construct the eigenstates of  $a^+, a^-$  as follows. First we find a state  $|0\rangle$  such that

$$a^-|0\rangle = 0, \quad (9.2.6)$$

Then we define  $|1\rangle = a^+|0\rangle$ ;  $|2\rangle = \frac{1}{\sqrt{2}} a^+|1\rangle = \frac{1}{\sqrt{2}} (a^+)^2|0\rangle$ ; ..., and in general

$$|n\rangle = \frac{1}{\sqrt{n!}} (a^+)^n |0\rangle, \quad (9.2.7)$$

(Note that we could have included arbitrary phase factors in the definition of  $|n\rangle$ ; for simplicity we make them unity.) With this definition, the  $|n\rangle$  are orthonormal and satisfy

$$a^+|n\rangle = \sqrt{n+1}|n+1\rangle, \quad a^-|n\rangle = \sqrt{n}|n-1\rangle, \quad a^+, a^-|n\rangle = n|n\rangle, \quad (9.2.8)$$

The operators  $a^-$  and  $a^+$  are called "raising" and "lowering" operators, respectively, because they raise and lower the eigenvalue of  $a^+, a^-$ . In later applications  $a^+, a^-$  will be interpreted as the observable representing the number of particles of a certain kind, in which case  $a^-$  and  $a^+$  are called "creation" and "annihilation" (destruction) operators, or "emission" and "absorption" operators.

Two first equations from (9.2.8) may be alternatively expressed in terms of matrix elements:

$$\langle m|a^+|n\rangle = \sqrt{n+1} \delta_{m,n+1}, \quad \langle m|a^-|n\rangle = \sqrt{n} \delta_{m,n-1}, \quad (9.2.9)$$

Equation (9.2.6) through the last equation from (9.2.8) form the answer to the problem of finding the the eigenvalues and eigenstates of  $\hat{H}$ .

Expressing  $x$  and  $p$  in terms of  $a^-$  and  $a^+$ , we have

$$x = \sqrt{\frac{\hbar}{m\omega}} \frac{a^- + a^+}{\sqrt{2}}, \quad p = \sqrt{m\omega\hbar} \frac{a^- - a^+}{\sqrt{2}}, \quad (9.2.10)$$

We get, for the Hamiltonian,

$$\hat{H} = \frac{\hbar\omega}{2} (a^+a^- + a^-a^+) = \hbar\omega \left( a^+a^- + \frac{1}{2} \right), \quad (9.2.11)$$

Thus, the eigenstates of  $\hat{H}$  are those of  $a^+a^-$ . Now we can apply the results of (9.2.6) – (9.2.8), obtaining the eigenstates  $|0\rangle, |1\rangle, |2\rangle, \dots$  that satisfy

$$\hat{H}|n\rangle = \left( n + \frac{1}{2} \right) \hbar\omega |n\rangle, \quad (9.2.12)$$

The energy levels are thus  $\varepsilon_n = \left( n + \frac{1}{2} \right) \hbar\omega$ . The eigenstates themselves are given by equations (9.2.6) and (9.2.7).

The eigenstates themselves are given by (9.2.6) and (9.2.7). We can easily obtain the wave functions  $\varphi_n(x) = \langle x|n\rangle$  as follows: from (9.2.3) and (9.2.6).

$$a^-|0\rangle = \sqrt{\frac{m\omega}{2\hbar}} \left( x + \frac{i}{m\omega} p \right) |0\rangle = 0, \quad (9.2.13)$$

Applying  $\langle x|$ , and noticing that  $\langle x|p|\varphi\rangle = -i\hbar(d\langle x|\varphi\rangle/dx)$ , we get

$$\sqrt{\frac{m\omega}{2\hbar}} \left( x + \frac{\hbar}{m\omega} \frac{d}{dx} \right) \langle x|0\rangle = 0, \quad (9.2.14)$$

(where  $x$  is now a number, rather than an operator.) Equation (9.2.14) is merely Eq. (9.2.6) *in coordinate representation*, in which it takes the form of a differential equation. Solving it, we get

$\langle x|0\rangle = Ae^{-m\omega x^2/2\hbar}$ , where  $A$  is a constant.

Within the framework of electromagnetic theory the entire procedure of second quantization, described above, appears much more sequentially and can be without change transferred to NTEP. Usually in our days the quantum electrodynamics (QED) and generally the quantum field theory (QFT) is constructed with the aid of the potentials. In this case the procedure of second quantization is based on the following mathematical apparatus.



## 2.2. Second quantization of electromagnetic field

### 2.2.1. Second quantization with use of vector potential

The Lagrangian and Hamiltonian in QFT (Schiff, 1955) is most conveniently expressed in terms of the potentials  $\vec{A}$ ,  $\varphi$  that are partially defined by

$$\vec{E} = -\frac{1}{c} \frac{\partial \vec{A}}{\partial t} - \text{grad} \varphi = -4\pi c \vec{P}, \quad \vec{H} = \text{rot} \vec{A}, \quad (9.2.15)$$

where  $\vec{P} = \frac{1}{4\pi c} \left( \frac{1}{c} \frac{\partial \vec{A}}{\partial t} + \text{grad} \varphi \right)$  is the momentum canonically conjugate to  $\vec{A}$ . As is known,

this does not specify the potentials completely, since gauge transformations of the potentials can still be made without altering the electric and magnetic field strengths computed from (9.2.15). The momentum canonically conjugate to  $\varphi$  vanishes identically, since  $\varphi$  does not appear in the Lagrangian density. The Hamiltonian is then

$$\hat{H} = \int \left[ 2\pi c^2 \vec{P}^2 + \frac{1}{8\pi} (\text{rot} \vec{A})^2 \right] d\tau, \quad (9.2.16)$$

and  $\varphi$  has disappeared. This is in agreement with the usual expression  $\varepsilon = (1/8\pi) \int (\vec{E}^2 + \vec{H}^2) d\tau$  for the total energy in the electromagnetic field.

The commutation relations between the field variables become

$$\begin{aligned} [A_s(\vec{r}, t), A_{s'}(\vec{r}', t)] &= [P_s(\vec{r}, t), P_{s'}(\vec{r}', t)] = 0, \\ [A_s(\vec{r}, t), P_{s'}(\vec{r}', t)] &= i\hbar \delta_{ss'}(\vec{r} - \vec{r}') \end{aligned}, \quad (9.2.17)$$

The equation of motion for a typical component of  $A_s$  and  $P_s$  are

$$i\hbar \dot{A}_s(\vec{r}, t) = [A_s(\vec{r}, t), \hat{H}], \quad (9.2.18)$$

$$i\hbar \dot{P}_s(\vec{r}, t) = [P_s(\vec{r}, t), \hat{H}], \quad (9.2.19)$$

where each of the indices  $s, s'$  can be  $x, y$ , or  $z$ .

Thus if we define (9.2.15), the quantum equations of motion for  $\vec{A}$  and  $\vec{P}$  agree with the three of Maxwell's equations except the equation  $\text{div} \vec{E} = 0$ , which corresponds to  $\text{div} \vec{P} = 0$ . This Maxwell's equations must be imposed as a supplementary condition, as in the classical case. If we set  $\text{div} \vec{P}$  equal to zero at a particular time, it is always zero since its time derivative is zero. Equation (9.2.9) then shows that the time derivative of  $\text{div} \vec{A}$  is always zero, or that  $\text{div} \vec{A}$  is a constant in time. It is convenient to restrict the choice of gauge so that  $\text{div} \vec{A}$  is zero everywhere at a particular time, in which case we see that it is zero at all space-time points. It is apparent, however, that the introduction of the supplementary condition is inconsistent with the commutation relations (9.2.17). For example, the commutator bracket of  $A_s$  and  $\text{div} \vec{P} = 0$  should be zero, since  $\text{div} \vec{P} = 0$  is zero, but is computed from (9.2.17) to be

$$[A_s(\vec{r}, t), \text{div}' \vec{P}(\vec{r}', t)] = i\hbar \frac{\partial}{\partial s'} \delta(\vec{r} - \vec{r}'), \quad (9.2.20)$$

It is not surprising that this inconsistency should arise, since (9.2.17) imply that there are three independent pairs of canonical variables, whereas the restrictions  $\text{div} \vec{P} = 0$  and  $\text{div} \vec{A} = 0$  cause only two of these pairs to be linearly independent. We should therefore modify the commutation relations so that they are consistent with the supplementary condition.

It turns out that the commutator brackets of  $\vec{A}(\vec{r}, t)$  and  $\vec{P}(\vec{r}, t)$  do not vanish when  $\vec{r} - \vec{r}'$  is finite. This would appear at first to contradict the physical principle that there can be no interference between measurements performed at different places and the same time. However,

the vector potential  $\vec{A}$  is not in itself a physical quantity; only the electric and magnetic fields are directly measurable.

As we repeatedly noted, the use of potentials not only is not the unique way of constructing the quantum field theory, but leads to numerous difficulties. The use of field strengths is not only possible and convenient, but makes it possible to avoid these difficulties.

### 2.2.2. Second quantization with use of field strengths

We will now show with the help of (9.2.17) that (Schiff, 1955) the commutation relations of  $\vec{E}$  and  $\vec{H}$  have the required infinitesimal character and are, moreover, consistent with the supplementary condition  $\text{div } \vec{E} = 0$ . It can also be shown that the same results are obtained by starting with the modified canonical commutation relations.

The electric and magnetic fields are defined by the equations

$$\vec{E} = -4\pi c\vec{P}, \quad \vec{H} = \text{rot } \vec{A}, \quad (9.2.10)$$

where the commutation relations for A and P are assumed to have the form (9.2.17). We see at once that

$$[E_s(\vec{r}, t), E_{s'}(\vec{r}', t)] = [H_s(\vec{r}, t), H_{s'}(\vec{r}', t)] = 0, \quad (9.2.21)$$

where each of the indices  $s, s'$  can be  $x, y$  or  $z$ . The commutator bracket for typical parallel components of E and H is:

$$[E_x(\vec{r}, t), H_x(\vec{r}', t')] = 0, \quad (9.2.22)$$

For typical perpendicular components of E and H, we obtain:

$$[E_x(\vec{r}, t), H_y(\vec{r}', t')] = 4\pi c i \hbar \frac{\partial}{\partial z'} \delta(\vec{r} - \vec{r}'), \quad (9.2.22')$$

Other relations similar to (9.2.13) are obtained by cyclic permutation of  $x, y, z$ .

Let us examine how the operators of creation and annihilation of particles are introduced in EM theory and what physical sense do they make there. The Hamiltonian equation of EM theory is:

$$\hat{H} = \frac{1}{8\pi} \int (\vec{E}^2 + \vec{H}^2) d\tau, \quad (9.2.23)$$

As would be expected, the field commutation relations (9.2.21), (9.2.22), and (9.2.22'), together with the Hamiltonian (9.2.23), can be used in place of the canonical formalism originally developed in terms of  $\vec{A}$  and  $\vec{P}$ .

The first two of Maxwell's equations then follow as special cases of the general equation of motion. The equation of motion for any quantum dynamical variable  $F$  is obtained if the Poisson bracket is replaced by the commutator bracket divided by  $i\hbar$ :

$$\dot{F} = \frac{1}{i\hbar} [F, \hat{H}], \quad (9.2.24)$$

where we write  $\hat{H}$  as the volume integral of a Hamiltonian density  $\hat{H}$

$$\hat{H} = \int \hat{H} d\tau, \quad (9.2.25)$$

The commutator bracket can be evaluated with the help of the quantum conditions for the canonical EM field variables (9.2.21)-(9.2.22')

$$\begin{aligned} i\hbar \dot{E}_x &= [E_x, \hat{H}] = \frac{1}{8\pi} \int [E_x, (H_y^2 + H_z^2)] d\tau' = i\hbar (\text{rot } \vec{H})_x \\ i\hbar \dot{H}_x &= [H_x, \hat{H}] = \frac{1}{8\pi} \int [H_x, (E_y^2 + E_z^2)] d\tau' = i\hbar (\text{rot } \vec{E})_x \end{aligned} \quad (9.2.26)$$

The Hamiltonian density  $\hat{H}$  of EM theory

$$\hat{H} = \frac{1}{8\pi} (\vec{E}^2 + \vec{H}^2), \quad (9.2.27)$$

can be expressed also through various forms of the electromagnetic theory, which are used in NTEP. In particular, using the 6-vectors of EM field, it is possible to write down the Hamiltonian density in the following form:

$$\hat{H} = \frac{1}{8\pi} \hat{F}^+ \hat{F} = \frac{1}{8\pi} (\vec{E} - i\vec{H})(\vec{E} + i\vec{H}), \quad (9.2.28)$$

where  $\hat{F}^+ = \vec{E} - i\vec{H}$  is the Hermitian-conjugate 6-vector of EM field. In the case, using a wave function of EM field in the form:

$$\Phi = \begin{pmatrix} E_x \\ E_z \\ iH_x \\ iH_z \end{pmatrix}, \quad \Phi^+ = (E_x \quad E_z \quad -iH_x \quad -iH_z), \quad (2.2.8)$$

it is possible to write down a Hamiltonian density in the following form:

$$\hat{H} = \frac{1}{8\pi} \Phi^+ \Phi, \quad (9.2.29)$$

If we consider the quantization of field, then it is necessary to replace the integral in the equation (9.2.23) by the sum.

In the case of normalization of the wave function by maximum field according to M. Born (or by other equivalent form through the mass of particle or its energy), it is possible to obtain a dimensionless Hamiltonian. In this case the operator of the number of particles is given by

$$\hat{N} = \int \Phi^+ \Phi d\tau = \sum_{\vec{k}} \hat{a}_{\vec{k}}^+ \hat{a}_{\vec{k}}^- = \hat{N}, \quad (9.2.30)$$

The expressions (9.2.23) and (9.2.27), (9.2.28), (9.2.29) relate to the electromagnetic wave, which consists of many photons. This corresponds to the fact that we used commutators (9.2.21) - (9.2.13), which are characteristic for the bosons.

Let us examine how the operators of second quantization act on the state vectors  $\Phi$ . Let us denote  $\Phi_0$  as the state vector of field without the particles, i.e., the vector of vacuum state. From above follows that the state vector  $\Phi_0$  satisfies the condition  $\hat{a}_{\vec{k}}^- \Phi_0 = 0$  for any values of wave vector  $\vec{k}$ .

State vector  $\hat{a}_{\vec{k}}^+ \Phi_0 \equiv \Phi_1$  describes a single-particle state, i.e. the state of field, in which there is one boson in the state  $\vec{k}$ . Let us note the equality  $(\Phi_0)^+ \hat{a}_{\vec{k}}^+ = 0$  and the condition of normalization of the vector of vacuum state  $(\Phi_0)^+ \Phi_0 = 1$ . Multiparticle states can be obtained, if we act on the state vector by the operator of particle production the necessary number of times. For example, state vector  $(\hat{a}_{\vec{k}}^+)^n (\hat{a}_{\vec{k}'}^+)^m \Phi_0$  describes the state of field with  $n$  bosons in the state  $\vec{k}$  and  $m$  bosons in the state  $\vec{k}'$ .

Analysis show (Schiff, 1955) that the energy and momentum of each plane wave are quantized in units of  $\hbar kc$  for the energy and  $\hbar \vec{k}$  for the momentum.

We will therefore require an expression for  $\Phi(\vec{r}, t)$  in the plane wave representation that is specified by the eigenvalues  $n_{\vec{k}}$  of the operators  $\hat{N}$ . A typical wave functional for this representation can be written as  $\Phi(\vec{r}, t) = \Phi(\dots n_{\vec{k}} \dots)$ , which describes a state of the electromagnetic field in which there are  $n_{\vec{k}}$  light quanta with momentum  $\hbar \vec{k}$  and polarization  $\vec{\varepsilon}_{\vec{k}}$  (which are the unit vectors).

Expansions for  $\vec{E}$  and  $\vec{H}$  in terms of the amplitudes  $a_{\vec{k}}$  of plane waves can be found without difficulty:

$$\begin{aligned}\vec{E}(\vec{r}, t) &= \sum_{\vec{k}} i\vec{k} \vec{\varepsilon}_{\vec{k}} \left[ a_{\vec{k}} e^{i(\vec{k}\cdot\vec{r}-\omega t)} - a_{\vec{k}}^* e^{-i(\vec{k}\cdot\vec{r}-\omega t)} \right] \\ \vec{H}(\vec{r}, t) &= \sum_{\vec{k}} i(\vec{k} \times \vec{\varepsilon}_{\vec{k}}) \left[ a_{\vec{k}} e^{i(\vec{k}\cdot\vec{r}-\omega t)} - a_{\vec{k}}^* e^{-i(\vec{k}\cdot\vec{r}-\omega t)} \right],\end{aligned}\quad (9.2.31)$$

We then see from (9.2.28) that the operators  $a_{\vec{k}}$  and  $a_{\vec{k}}^*$  have the properties

$$\begin{aligned}a_{\vec{k}} \psi(\dots n_{\vec{k}} \dots) &= n_{\vec{k}}^{1/2} \psi(\dots n_{\vec{k}} + 1 \dots) \\ a_{\vec{k}}^* \psi(\dots n_{\vec{k}} \dots) &= (n_{\vec{k}} + 1)^{1/2} \psi(\dots n_{\vec{k}} + 1 \dots),\end{aligned}\quad (9.2.32)$$

It follows from the structure of (9.2.31) that  $a_{\vec{k}}$  and  $a_{\vec{k}}^*$  are, annihilation and creation operators  $a_{\vec{k}}^-$  and  $a_{\vec{k}}^+$ , respectively, for a light quantum in the state  $\{\vec{k}, \varepsilon_{\vec{k}}\}$ . Thus the Hamiltonian would give rise to the emission and absorption of light quanta.

### 2.3. Second quantization of the fermion fields

Let us pause briefly at the results of second quantization in the case of the fermions.

In this case the fundamental aspect of the matter remains without change. At the same time the concrete formulas will change.

For the bosons the operators of creation and annihilation satisfy the commutation relations:

$$[\hat{a}_{\vec{k}}^+, \hat{a}_{\vec{k}'}^+] = 0, \quad [\hat{a}_{\vec{k}}^-, \hat{a}_{\vec{k}'}^-] = 0, \quad [\hat{a}_{\vec{k}}^-, \hat{a}_{\vec{k}'}^+] = \delta(\vec{k} - \vec{k}'), \quad (9.2.33)$$

where  $\delta(\vec{k})$  is Dirac's delta function and the brackets, as usual, indicate a commutator, i.e.  $[b, c] = bc - cb$ .

For fermions the operators of creation and annihilation satisfy the commutation relations of another type:

$$\{\hat{a}_{\vec{k}}^+, \hat{a}_{\vec{k}'}^+\} = 0, \quad \{\hat{a}_{\vec{k}}^-, \hat{a}_{\vec{k}'}^-\} = 0, \quad \{\hat{a}_{\vec{k}}^-, \hat{a}_{\vec{k}'}^+\} = \delta(\vec{k} - \vec{k}'), \quad (9.2.34)$$

where the braces indicate an anti-commutator, i.e.  $\{b, c\} = bc + cb$ . Now the wave functions are antisymmetric. In this case the occupation numbers can be only equal to 0 or 1. All the other formulas remain valid. The rules of commutation for  $\hat{\psi}$ -operators now take the form:

$$\hat{\psi}^+(\xi') \hat{\psi}(\xi) + \hat{\psi}(\xi) \hat{\psi}^+(\xi') = \delta(\xi - \xi'), \quad (9.2.35)$$

The antisymmetry and other special features of the quantum description of fermions in comparison with the bosons are connected, as we noted with the fact that bosons are formed by full wave period, and fermions are formed by the half-period of wave.

## 3.0. The consideration of influence of physical vacuum on free electron

### 3.1. The quantum-mechanical description

At present the experiments actually confirmed that there is a special medium - physical vacuum (PV), which influences the characteristics of free particles, and also their interaction with each other.

The initial equations of free particles describe the particles as if they were in empty space, without the influence of PV. Such particles are called "bare" particles, and their characteristics can be named "bare" characteristics. The particles can influence the physical vacuum. In turn this produces a change in the characteristics of free particles, and also a change in their interaction with each other.

In QED the free electron in the empty space is described by Dirac's equation

$$\left[ (\hat{\alpha}_o \hat{\varepsilon} + c \hat{\alpha} \hat{p}) + \hat{\beta} m_e c^2 \right] \psi = 0, \quad (9.3.1)$$

It has only one free parameter: a certain constant  $m$ . It is assumed that this constant is a theoretical mass of electron in an empty space. Therefore this mass is called the mass of “bare” electron. In the calculations as mass the experimental mass of electron is used, i.e. a mass, which corresponds to the electron in PV.

Since in the Dirac equation there is no a size of electron, in QED the electron is considered as point, i.e., one that has zero size. Therefore, the solution for the stationary field of electron here coincides with the formula of Coulomb and has the form  $e/r^2$  for the force, and  $1/r$  for the energy. These formulas with  $r \rightarrow 0$  give the infinite values of force and energy (and, therefore, of mass) of the electron.

The problem of infinities in quantum field theory (Weinberg, 1995) was apparently first noted in the papers of Heisenberg and Pauli (Heisenberg and Pauli, 1929, 1930). Soon after, the presence of infinities was confirmed in calculations of the electromagnetic self-energy of a bound electron by Oppenheimer, and of a free electron by Ivar Waller. They used ordinary second-order perturbation theory, with an intermediate state consisting of an electron and a photon: for instance, the shift of the energy  $\Delta E_n$  of an electron in the  $n^{\text{th}}$  energy level of hydrogen is given by

$$\Delta E_n = \sum_{m,\lambda} \int d^3k \frac{\left| \langle m; \vec{k}, h | H' | \vec{n} \rangle \right|^2}{E_n - E_m - |\vec{k}|c}, \quad (9.3.2)$$

where the sums and integral are over all intermediate electron states  $m$ , photon helicities  $h$ , and photon momenta  $\vec{k}$ , and  $H'$  is the term in the Hamiltonian representing the interaction of radiation and electrons. This calculation gave a self-energy that is formally infinite; further: if this infinity is removed by discarding all intermediate states with photon wave numbers greater than  $1/a$ , then the self-energy behaves like  $1/a^2$  as  $a \rightarrow 0$ . Infinities of this sort are often called ultraviolet divergences, because they arise from intermediate states containing particles of very short wavelength.

These calculations treated the electron according to the rules of the original Dirac theory, without filled negative-electron states. A few years later Weisskopf (Weisskopf, 1939) repeated the calculation of the electron self-mass in the new “hole” Dirac theory, with all negative-energy states full. In this case another term appears in second-order perturbation theory, which in a non-hole-theory language can be described as arising from processes in which the electron in its final state first appears out of the vacuum together with a photon and a positron which then annihilate along with the initial electron.

Initially Weisskopf found a  $1/a^2$  dependence on the photon wave-number cutoff  $1/a$ . The same calculation was being carried out (at the suggestion of Bohr) at that time by Carlson and Furry. After seeing Weisskopfs results, Furry realized that while Weisskopf had included an electrostatic term that he and Carlson had neglected, Weisskopf had made a new mistake in the calculation of the magnetic self-energy. After hearing from Furry and correcting his own error, Weisskopf found that the  $1/a^2$  terms in the total mass shift cancelled! However, despite this cancellation, an infinity remained: with a wave-number cutoff  $1/a$ , the self-mass was found to be:

$$m_{em} = \frac{3\alpha}{2\pi} m \ln \left( \frac{\hbar}{mca} \right), \quad (9.3.3)$$

The weakening of the cut-off dependence, to  $\ln a$  as compared with the classical  $1/a$  or the early quantum  $1/a^2$ , was mildly encouraging at the time and turned out to be of great importance later, in the development of renormalization theory.

An infinity of quite a different kind (Weinberg, 1995) was encountered in 1933, apparently first by Dirac (Dirac, 1933). He considered the effect of an external static nearly uniform charge

density  $\rho_e(x)$  on the vacuum, i.e., on the negative-energy electrons in the filled energy levels of hole theory, The Coulomb interaction between  $\rho_e(x)$  and the charge density of the negative-energy electrons produces a 'vacuum polarization,' with induced charge density

$$\delta\rho_e = A\rho_e + B\left(\frac{\hbar}{mc}\right)^2 \nabla^2 \rho_e + \dots, \quad (9.3.4)$$

The constant  $B$  is finite, and of order  $\alpha$ . On the other hand,  $A$  is logarithmically divergent, of order  $\alpha \ln \alpha$ , where  $1/a$  is the wave-number cutoff.

It is interesting that the results of the calculations of the effects of scattering of photons on the electrons (i.e. interaction of electron and photon) without the consideration of PV (but using the real mass of electron), give the final results of the interaction cross-section, which contain as the coefficient a classical radius of electron  $r_0 = e^2/m_e c^2$  (Thomson cross-section and others) In QED it is usual to assume that this coefficient does not refer to the dimensions of electron. In framework of NTEP the results are other.

### 3.2. The description in framework of NTEP

The equation for "bare" electron is derived here on the basis of the postulate of nonlinearity. According to the derivation logic and in accordance with the analysis of the electron equation solution, the "bare" electron is the ring field, whose radius is equal to the Compton wavelength of free electron  $r_C$ . The electron equation in this case takes the form:

$$\frac{1}{c} \frac{\partial \psi}{\partial t} + \vec{\alpha} \cdot \vec{\nabla} \psi + i \frac{1}{r_C} \psi = 0, \quad (9.3.5)$$

Substituting  $r_C = \hbar/mc$  in (4.5.2), it is not difficult to see that (4.5.2) is Dirac's electron equation

$$\frac{1}{c} \frac{\partial \psi}{\partial t} + \vec{\alpha} \cdot \vec{\nabla} \psi + i \frac{mc}{\hbar} \psi = 0, \quad (9.3.6)$$

which in this record *does not contain* a size of electron. Nevertheless, the Dirac electron equation and the equation of electron in NTEP coincide completely. Obviously, their solutions coincide. But we have different interpretation of these solutions in QED and NTEP. Actually, in the first case the size is infinite, and in the second case it has a finite value. Why this is possible?

As we know, in the case of QED the renormalization procedure is used for obtaining of the final result. In NTEP this result is obtained without the additional procedures by direct solution of problem. The solutions of nonlinear equations in the spherical approximation show that in the nonlinear theory there are two types of solution - point and nonpoint. Moreover, the second type of the solution appears as a result of self-action of the electron fields. This self-action can be described as some "self-polarization" of the electron fields. But this is not a polarization of physical vacuum.

## 4.0. Influence of vacuum polarization on the electron characteristics

### 4.1. Peculiarities of renormalization procedure in quantum field theory

The polarization of the physical vacuum and the renormalization procedure are considered in a number of modern books and papers (Schweber, Bethe, Hoffmann, 1957; Georgi, 1981; etc.). We will consider briefly the results of this theory, as classical picture.

In QED the physical vacuum represents conditionally a number of enclosed in each other specific vacuums, formed by the various sorts of the virtual particles. For the dielectric permeability of such "dielectric" we can *conditionally* write:

$$d_V = d_V(\check{\gamma}, \check{\lambda}, \check{\mu}, \check{\beta}), \quad (9.4.1)$$

where  $\varepsilon_V$  is a full dielectric constant of the physical vacuum as a mixture of the vacuums  $\check{\gamma}, \check{\lambda}, \check{\mu}, \check{\beta}$  of the virtual photons, leptons, mesons and barions accordingly.

The Coulomb potential energy of systems of two charges  $q'$  and  $q''$  in a dielectric is equal to:

$$W(r) = \frac{q' q''}{d_d r}, \quad (9.4.2)$$

where  $d_d$  is a dielectric constant of a medium. In classical physics was accepted, that the vacuum cannot be polarized and consequently  $d_v = d_d = 1$ . In this case we have some theoretical value of the Coulomb potential energy:

$$W(r) = \frac{q_0 q_0}{r}, \quad (9.4.3)$$

The electron characteristics, e.g. a charge  $q_0$ , considered without the influence of polarization, are referred in QED as "bare":  $q_0 \equiv q_{bar}$ .

On the other hand the electric charge, observable in the experiments, is not equal to theoretical value  $q_0$ , but some value  $q_{exp}$ . So in the quantum field theory the Coulomb potential energy of two charges in physical vacuum is equal to

$$W(r) = \frac{q_0 q_0}{d_v r} = \frac{q_{exp} q_{exp}}{r}, \quad (9.4.4)$$

Then

$$q_{exp}' = \frac{q_0'}{\sqrt{d_v}}, \quad q_{exp}'' = \frac{q_0''}{\sqrt{d_v}}, \quad (9.4.5)$$

An electron polarizes the physical vacuum and creates around itself the screening layer from dipoles of the electron-positron pairs. The polarization charge of physical vacuum are referred in QED as polarized or screening:  $q_{pol} \equiv q_{scr}$ .

The theoretical calculation in QED leads to the conclusion that both the "bare" charge and the screening charge are equal to infinity:

$$q_{bare}^{QED} = \infty_1, \quad q_{scr}^{QED} = \infty_2, \quad (9.4.6)$$

The measured charge can be considered as a difference among the "bare" charge and the screening charge:

$$q_{exp} = q_{bare}^{QED} - q_{scr}^{QED} = \infty_1 - \infty_2 = const = q_{exp} \equiv e, \quad (9.4.7)$$

The calculation procedure, which leads to the obtaining of experimental values, is named in the QED the renormalization procedure.

Thus, if it could be possible to measure an electron charge in very small distances from electron, it would be found that in the process of penetration behind the screening layer, this charge increases. The known measured constant is observed on atomic distances about  $10^{-8}$  cm.

What we have now for the electromagnetic (fine structure) constant? Since  $\alpha_{exp} = \frac{e}{\hbar c}$ , we can suppose that  $\alpha_{bar} = \frac{q_{bar}}{\hbar c}$ ,  $\alpha_{scr} = \frac{q_{scr}}{\hbar c}$ , so as in the QED  $\alpha_{bar} = \infty$ ,  $\alpha_{scr} = \infty$  and  $\alpha_{bare} > \alpha_{exp}$ , we have that  $\alpha_{exp} = \alpha_{bare} - \alpha_{scr} = \frac{e}{\hbar c}$  is finite value. The direct consequence is, that the electromagnetic constant is not actually a constant, but it grows with reduction of distance between the interacting particles.

## 4.2. Peculiarities of renormalization procedure in NTEP

The question arises: what is the basis of the subtraction of infinities in the renormalization procedure?

As this is noted above, the screening charge is a function of distance:

$$q_{bare}^{QED} \equiv q_{bar}^{QED}(r) \xrightarrow{r \rightarrow 0} \infty_1 \quad q_{scr}^{QED} \equiv q_{scr}^{QED}(r) \xrightarrow{r \rightarrow 0} \infty_1, \quad (9.4.6')$$

Thus

$$q_{exp} = q_{bar}^{QED}(r) - q_{scr}^{QED}(r) = e, \quad (9.4.6'')$$

In NTEP a “bare” charge has a final size. Obviously, the screening charge also has a final size:

$$q_{bar}^{NTEP} = q_1, \quad q_{scr}^{NTEP} = q_2, \quad (9.4.8)$$

Obviously  $q_{bare} > q_{scr}$  or  $q_1 > q_2$ . Then the experimental charge in NTEP should be defined by their difference:

$$q_{exp}^{NTEP} = q_1 - q_2 = e, \quad (9.4.9)$$

*Thus, NTEP does not need the renormalization procedure, which has place in QED, as transition from infinite value to finite value. In NTEP the renormalization takes only into account the polarization of the physical vacuum, when transition from the “bare” characteristics to the experimental characteristics occurs.*

Hence it follows that renormalization in the QED and generally in the quantum field theory is needed to take into account the sizes of particles and polarization of physical vacuum.

With respect to electromagnetic constant we have following. According to (9.4.5) in general case we have  $e = q_{exp} = \frac{q_{bar}}{\sqrt{d_V}}$  so that

$$q_{bare} = e\sqrt{d_V}, \quad (9.4.10)$$

Then

$$\alpha_{bar} = \frac{q_{bar}^2}{\hbar c} = \frac{e^2}{\hbar c} d_V = \alpha_{exp} d_V, \quad (9.4.11)$$

Using (9.4.11) we receive for the fine structure constant:

$$\alpha_{exp} \equiv \alpha = \frac{\alpha_{bare}}{d_V}, \quad (9.4.12)$$

#### 4.2.2. The size of electron in NTEP taking into account the physical vacuum polarization

According to the representation (9.3.5) of the Dirac electron equation in NTEP, the bare (theoretical) size of electron in NTEP is equal to the Compton wavelength. How will change this size in the physical vacuum?

Taking into account (9.4.10) and (9.4.12), we can obtain:

$$r_0 = \frac{e^2}{mc^2} = \frac{q_{bar}^2}{d_V m_e c^2} \frac{\hbar c}{\hbar c} = \frac{\alpha_{bar}}{d_V} r_C = \alpha_{exp} \cdot r_C \equiv \alpha \cdot r_C, \quad (9.4.13)$$

where  $r_0 = \frac{e^2}{mc^2}$  is the known characteristic of the electron energy distribution: the so-called classical electron radius  $r_0 = \frac{e^2}{mc^2}$ . In other words we obtained the result, known from the quantum mechanics: at large distance from electron the relation occurs:

$$r_0 = \alpha r_C \quad \text{or} \quad \frac{r_0}{r_C} = \alpha \approx \frac{1}{137}, \quad (9.4.14)$$

Taking into account that  $r_C \equiv r_{bar}$  and  $r_0 \equiv r_{exp}$ , we obtain from (9.4.13):



$$r_0 \equiv r_{\text{exp}} = \frac{\alpha_{\text{bar}} r_{\text{bar}}}{d_V}, \quad (9.4.15)$$

The relation (9.4.13-15) can be interpreted in the following way: the classical radius of electron corresponds to the “bare” (theoretical) electron into polarized physical vacuum.

## 5.0. The consideration of the vacuum effects in electromagnetic view

After the appearance of the relativistic Dirac electron equation (Dirac, 1928a, b), calculations were carried out on several effects of electromagnetic interactions of electrons: the scattering of light by light, light by an electron, the annihilation of an electron-positron pair, the scattering of electrons by electrons, etc.

Practical calculations on real effects were carried out primarily by means of the perturbation theory developed by Dirac (Dirac, 1926, 1927b) for time-dependent perturbations. That theory corresponds to the method of the variation of constants in the theory of linear differential equations.

In all these cases, the results found in lowest-order perturbation theory turned out to agree well with experimental data, thereby confirming that this new theory was sound. However, attempts to refine the predictions through calculations of higher-order approximations led to integrals which diverge at large momenta: *ultraviolet divergences*.

Until now we examined the nonlinearities, which correspond to the free equation of Dirac. At the same time (Collection of article transl., 1959) there are nonlinearities, induced or vacuum, obliged to interaction fields with each other, or, clearly speaking, that appear because of the mutual transformation of particles' fields. The simplest examples are the nonlinearities in Maxwell's equations, induced by the mutual transformations of electron-positrons and photons, examined for the first time by Euler and Kockel and by Heisenberg, and also by Weisskopf and by Schwinger. It was shown that it is possible to select nonlinear Lagrangian of electrodynamics as the function of two invariants of EM field in the form of the series:

$$L = \alpha(E^2 - H^2)^2 + \beta(EH)^2 + \gamma(E^2 - H^2)^4 + \dots \quad (9.5.1)$$

so to obtain the scattering of light by light. Later Heisenberg and Schwinger obtained closed expressions for nonlinear Lagrangian of electrodynamics, without the expansion in series, for the case of arbitrarily strong, but slowly changed fields (the details see (Akhiezer and Berestetskii, 1965).

They found the effective Lagrangian to order  $\alpha^3$  induced by static, homogeneous, external fields when no real electron-positron pairs could be produced. In their papers they also pointed out that the theory contained divergent vacuum self energy contributions that had to be subtracted. They also noted that in QED the fourth order contribution to Compton scattering diverged, as did the sixth order contribution to the scattering of light by light.

Below we present briefly the bases and results of the theory of scattering of light by light. They show that the quantum-mechanical tasks can be completely solved within the framework of nonlinear electromagnetic theory. As we noted previously this is possible because these two theories are two equivalent descriptions of reality.

### 5.1. On the scattering of light by light according to the Dirac electron theory in electromagnetic form (according to Heisenberg, Euler and Kockel)

Below (Heisenberg, 1934; Euler and Kockel, 1935; Euler, 1936; Heisenberg and Euler, 1936)  $m$  is mass of electron,  $e$  is charge of electrons,  $c$  is speed of light,  $\hbar = 2\pi\hbar$  is Planck's constant;  $p_1, p_2$  are light quanta before the collision,  $-p_3, -p_4$  are light quanta after the collision,  $(p_1 p_2 | 0 | -p_3 - p_4)$  is matrix element of the operator  $0$ ,  $H^4$  is 4<sup>th</sup> order matrix element of the Dirac theory;  $F_{ik}$  is field-strength of EM field,  $\tau$  is volume of the area.

Halpern (Halpern, 1934) and Debye (in a discussion with W. Heisenber) have pointed out that according to the Dirac theory, there must be scattering of light by light. In this process one must differentiate two cases:

1) **If** the energies  $cp_1$  and  $cp_2$  of the two light quanta and the angle between its momentums  $\vec{p}_1, \vec{p}_2$  are so large that energy and law of momentum permit the production of a real pair  $(p_1 p_2 - (\vec{p}_1 \cdot \vec{p}_2)) > 2(mc)^2$ . Then we will receive the probability of the dispersion of the light quanta by summing up the probabilities of the pair creation. This was accomplished by (Breit and Wheeler, 1934).

2) **Or** if energy and momentum of two light quanta are not sufficient for the production of a real pair:

$$p_1 p_2 - (\vec{p}_1 \cdot \vec{p}_2) < 2(mc)^2, \quad (9.5.2)$$

(i.e. in suitable reference system:  $p_1 < mc$ ,  $p_2 < mc$ ), nevertheless the light quanta  $\vec{p}_1, \vec{p}_2$  can, due to the virtual pair creation, in two other light quanta be converted, and this must a dispersion of light by light give.

The probability of the transition of two light quanta  $\vec{p}_1, \vec{p}_2$  in two different  $-\vec{p}_3, -\vec{p}_4$  is given by the square of the matrix element  $H^4$  of the Dirac theory.

The direct calculation of this matrix  $H^4$  of the Dirac theory would be very difficult. It can be attributed however to the simpler problem of the calculation of two matrix elements by the following general views.

If two light waves disperse themselves one to other, this means a deviation from the superposition principle. The optical superposition principle is expressed by the linearity of the vacuum Maxwell equations. Thus the dispersion of light by light could be described by a nonlinear additive to the Maxwell vacuum equations, if a direct description is possible. This direct description, possibility of which we later proves, is suggested by the following analogy, which exists in the Dirac theory between light quanta and electrons.

Two electrons can produce the light quanta and enter into mutual interaction, which can be expressed in the dispersion of the electrons or in the Coulomb law. Likewise two light quanta can produce a virtual quantity of electron-positron pairs so that between them an interaction develops, which leads to the dispersion of light by light. Also for this interaction of the light quanta with one another one should expect a simple, similar to the Coulomb law, direct expression.

It is the analogue of the Coulomb interaction of electrons:

$$\iint \frac{\rho_1 \cdot \rho_2}{r_{12}} d\tau_1 d\tau_2, \quad (9.5.3)$$

where  $\rho_1, \rho_2$  is charge densities,  $r_{12}$  is a distance between two charges.

The Coulomb interaction in a matter field, which is described by a density operator  $\psi^* \psi$ , is

$$U = \frac{e^2}{2} \iint \frac{\psi^*(\xi) \psi(\xi) \psi^*(\xi') \psi(\xi')}{(\xi - \xi')} d\tau d\tau', \quad (9.5.4)$$

The effective cross-section for the dispersion of an electron with an electron is received from the square of the matrix element (9.5.4) for a transition in the matter field, which means the dispersion of two electrons with each other.

In order to find an interaction of the light quanta, similar to (9.5.4), one must search for a function  $U_1$  of the degrees of freedom of the radiation field, and also for the field strengths  $F_{ik}$ . The matrix element  $F_{ik}$  for a transition in the radiation field, which means the dispersion of two light quanta with each other, is equal to this, which was discussed above. Then matrix element  $H_{in}^4$  of the Dirac theory for this process can be computed. About this interaction  $U_1$  of the light quanta as function of the field strengths we can the following say.

Since it must lead to processes, during which two light quanta disappear and originate two other, the field strengths or their derivatives in the 4<sup>th</sup> power then must contain:

$$U_1 = const \int \left[ FFFF + const' \frac{\partial F}{\partial x} \frac{\partial F}{\partial x} FF + \dots \right] d\tau, \quad (9.5.5)$$

(indices of tensors and vectors are here and in the following omitted).

Since the interaction  $U_1$ , which have dimension of an energy, but (as term of 4<sup>th</sup> order of the Dirac theory) the electron charge in the 4<sup>th</sup> power must contain (and due to the fact that from 4 universal units  $e, m, c, h$  only one dimensionless number, which can form the Sommerfeld fine structure constant  $e^2/\hbar c \sim 1/137$ ), is the constant up to a numeric factor determined:

$$const = \frac{\hbar c}{e^2} \frac{1}{E_0^2}, \text{ so that } E_0 = \frac{e}{(e^2/mc^2)^2} \text{ is the "field strength at the edge of the electron".}$$

For the same reason the terms with the derivatives of the field strengths must contain still another length independent of the electron charge, such as the Compton wave length  $h/mc$  as additional factor.

First of all the fact is surprising that in the vacuum electrodynamics the electron mass is to occur, while is nevertheless presupposed that only light quanta and no electrons are present.

Although the terms, regarded here, have only validity as long as no real pairs are produced, they come off only by the virtual possibility of the pair creation and are disclosed itself in the occurrence of the electron mass. It can expect also (close to the Maxwell energy of the individual light quanta) a mutual interaction energy of the light quanta of the form:

$$U_1 = \frac{\hbar c}{e^2} \frac{1}{E_0^2} \int \left[ FFFF + \left( \frac{\hbar}{mc} \frac{\partial F}{\partial x} \right) \left( \frac{\hbar}{mc} \frac{\partial F}{\partial x} \right) FF + \dots \right] d\tau, \quad (9.5.6)$$

It will be shown later that the matrix element  $H^4$  discussed above, which follows from the Dirac theory, can be also really transformed into the matrix element such as an expression (9.5.6).

Since we want by soft light ( $|\vec{p}| < mc$ ) and also by slowly variable fields ( $\left| \frac{\hbar}{mc} \frac{\partial F}{\partial x} \right| < F$ ) according to (9.5.2) to be limited, we can into (9.5.6) the terms with the derivatives of the field strengths let go away.

We take also now, as a subject to the later proof that the dispersion of soft light by light by an additional energy density in the radiation field of the form

$$u_1 = \frac{\hbar c}{e^2} \frac{1}{E_0^2} FFFF, \quad (9.5.7)$$

can be described as:

$$H^4 = \left( p_1 p_2 \left| \int u_1 d\tau \right| - p_3 - p_4 \right), \quad (9.5.8)$$

For this, by the ordinary perturbation of the Dirac theory, the matrix element of 4<sup>th</sup> order for this process is calculated and designed for light quantum energies  $cp$  (or  $\frac{h\nu}{mc^2}$ )

$$H^4 = \frac{-1}{12\pi^2} \left( \frac{e^2}{\hbar c} \right)^2 \cdot \frac{1}{\hbar c} \cdot \lim_{r \rightarrow 0} \int d\xi \left( A(\xi), \frac{\mathbf{r}}{r} \right)^4, \quad (9.5.9)$$

( $\vec{A}$  is a potential of the radiation field).

The terms of 1<sup>st</sup>, 2<sup>nd</sup> and 3<sup>rd</sup> order disappeared, and the element of 4<sup>th</sup> order by  $\frac{h\nu}{mc^2}$  could be represented formally as a matrix element of a function of the radiation field, so that for the

considered processes, the ordinary Hamiltonian, which contains the energies of light and matter (see (Heisenberg and Pauli, 1930)), can be replaced by the following, which depends only on the radiation field:

$$\int u d\tau = \frac{1}{8\pi} \int (\vec{B}^2 + \vec{D}^2) d\tau - \frac{1}{360\pi^2} \frac{\hbar c}{e^2} \frac{1}{E_0^2} \int \left[ (\vec{B}^2 - \vec{D}^2)^2 + 7(\vec{B} \cdot \vec{D})^2 \right] d\tau, \quad (9.5.10)$$

Here  $\vec{D}$  is the electric displacement,  $\vec{B}$  is the magnetic induction,  $E_0 = \frac{e}{(e^2/mc^2)^2}$  is the value

of "field strength at the edge of the electron" This stands  $\vec{B} = \text{rot}\vec{A}$ ,  $\vec{D}$  is canonically conjugate to  $\vec{A}$ , i.e.:

$$D_i(\xi)A_k(\xi') - A_k(\xi')D_i(\xi) = 2\hbar c i \cdot \delta(\xi - \xi')\delta_{ik}, \quad (9.5.11)$$

or

$$D_i(\xi)B_k(\xi') - B_k(\xi')D_i(\xi) = 2\hbar c i \frac{\partial}{\partial \xi'} \cdot \delta(\xi - \xi'), \quad (9.5.12)$$

(with cyclic  $i, k, l$ )

If one introduce by the usual way the quantities  $\vec{E}$  and  $\vec{H}$  by the equations:

$$\begin{cases} -\frac{1}{c} \dot{\vec{A}} = \vec{E}, \quad \text{i.e.} : \frac{1}{c} \dot{\vec{B}} + \text{rot}\vec{E} = 0 \\ -\frac{1}{c} \dot{\vec{D}} + \text{rot}\vec{H} = 0 \end{cases}, \quad (9.5.13)$$

then follows:

$$\begin{aligned} \frac{1}{4\pi} \vec{E} &= \frac{\partial L}{\partial \vec{D}} = \frac{1}{4\pi} \vec{D} - \frac{1}{360\pi^2} \frac{\hbar c}{e^2} \frac{1}{E_0^2} \int \left[ -4(\vec{B}^2 - \vec{D}^2)\vec{D} + 14(\vec{B} \cdot \vec{D})\vec{B} \right] d\tau \\ \frac{1}{4\pi} \vec{H} &= \frac{\partial L}{\partial \vec{B}} = \frac{1}{4\pi} \vec{B} - \frac{1}{360\pi^2} \frac{\hbar c}{e^2} \frac{1}{E_0^2} \int \left[ -4(\vec{B}^2 - \vec{D}^2)\vec{B} + 14(\vec{B} \cdot \vec{D})\vec{D} \right] d\tau \end{aligned}, \quad (9.5.14)$$

The relationship between the variables  $\vec{B}$  and  $\vec{D}$  on the one hand,  $\vec{E}$  and  $\vec{H}$  on the other hand, in this theory is not linear, because the scattering of light by light means a deviation from the principle of superposition.

The addition to Maxwell's energy in (9.5.10):

$$-\frac{1}{360\pi^2} \frac{\hbar c}{e^2} \frac{1}{E_0^2} \int \left[ (\vec{B}^2 - \vec{D}^2)^2 + 7(\vec{B} \cdot \vec{D})^2 \right] d\tau, \quad (9.5.15)$$

can vividly as the interaction energy of the light-quantum to be interpreted. It is analog to the Coulomb interaction of electrons (9.5.3). The fact that in (9.5.15), unlike (9.5.3) only a simple integral is, means that two photons can interact in the same place only.

The non-linear correction of Maxwell's equations of the vacuum will be essential, when the field strengths are close to "the edge of the electron"; the derived here formulas are valid only as long as they are not became too large ( $|\vec{E}|, |\vec{B}|, |\vec{D}|, |\vec{H}| \ll E_0$ ).

It is interesting, that this additive, which is added to the Maxwell energy, can be compared with the Born (Born and Infeld, 1934) considerations proposed in the classical theory, where first expansion term is:

$$-\frac{(1,2361)^4}{32\pi} \frac{\hbar c}{e^2} \frac{1}{E_0^2} \int \left[ (\vec{B}^2 - \vec{D}^2)^2 + 4(\vec{B} \cdot \vec{D})^2 \right] d\tau, \quad (9.5.16)$$

Apart from the fact that the ratio of the coefficients of the two additional terms by Born is 1: 4, and by us is 1: 7, two expressions differ by a factor:

$$\frac{4}{45\pi \cdot (1,2361)^4} \cdot \frac{\hbar c}{e^2}, \quad (9.5.17)$$

Due to the actual value of the Sommerfeld fine structure constant the numeric value of this factor is  $\sim 1.7$ , and it is remarkable that the quantum-theoretic modification of Maxwell's equations in any case has the magnitude that would be expected from classical notion due to the self energy.

The equations (9.5.10), (9.5.13), (9.5.14), which follows from the Dirac theory, have a place only in case of the condition that the wavelengths of light are large than the Compton wavelength. Otherwise, in contrast to Born's theory, a developing higher terms on the light quantum energy levels will arise, and also other additives to the interaction of the 4<sup>th</sup> order in the derivatives of the field strengths (multiplied with  $\frac{\hbar}{mc}$ ).

The experimental test of the deviations from the Maxwell's theory is difficult because the alleged effects are extremely small. The cross section for scattering of light by light of average wavelength  $\lambda$  is in the Dirac theory by (9.5.10) of the order:  $Q \sim (e^2/mc^2)^4 (\hbar/mc)^4 (1/\lambda^6)$

So, it is about  $10^{-30} cm^2$  for gamma-rays and  $10^{-70} cm^2$  for visible light.

## 6.0. Modern calculation of particle interactions (S-matrix, Feynman diagrams, etc)

### 6.1. Calculations in quantum field theory

The quantum-mechanical calculations in contemporary QFT are produced with the aid of the mathematics, which includes the operators of creation and annihilation of particles, and also with the aid of the apparatus of Feynman's diagrams, connected with them. In the following paragraphs we will consider the representation of calculated apparatus both in QFT and in NTEP.

As it was described above, in the quantum field theory, the functions  $\psi$ ,  $\psi^+$ ,  $A_\mu$  are substituted by the operators  $\hat{\psi}$ ,  $\hat{\psi}^+$ ,  $\hat{A}_\mu$ , which satisfy the same commutation relations (for one and the same moment of time), as for the free fields.

We have for the operator of the energy density of interaction (Hamiltonian):

$$\hat{H}_{\text{int}} = -L_{\text{int}} = -\frac{1}{c} \hat{j}_\mu \hat{A}_\mu = -e(\hat{\psi}^+ \hat{\alpha}_\mu \hat{A}_\mu \hat{\psi}), \quad (9.6.1)$$

where  $\hat{j}_\mu = -ec(\hat{\psi}^+ \hat{\alpha}_\mu \hat{\psi})$  is current density.

Introducing designation  $\hat{A} = \hat{\alpha}_\mu \hat{A}_\mu$ , we rewrite formula (9.6.1) as follows:

$$\hat{H}_{\text{int}} = -e(\hat{\psi}^+ \hat{A} \hat{\psi}), \quad (9.6.2)$$

Solutions of the free-field equations are proportional to the creation and annihilation operators of stationary states of particles. In order to incorporate cases in which certain particles affect the motion of others or convert into others, we need to make the equations of motion nonlinear. In other words, we need to introduce in the Lagrangian terms  $L_{\text{int}}$  of higher powers in addition to the quadratic terms.

From the standpoint of the above theory, such interaction Lagrangians  $L_{\text{int}}$  might be any functions of the fields and their first derivatives, provided only that they satisfy some simple conditions of invariance.

$$i\hbar \frac{\partial \psi(t)}{\partial t} = \hat{H}(t)\psi(t), \quad (9.6.3)$$

On the other hand, one can, as in ordinary quantum mechanics, transform by means of a unitary transformation  $\psi(t) = e^{i\hat{H}t}$  from the Heisenberg representation with constant state amplitudes to the Schrödinger representation, in which the state amplitude evolves in time in accordance with a Schrödinger equation,

$$i\hbar \frac{\partial \psi(t)}{\partial t} = \hat{H}(t)\psi(t), \quad (9.6.3)$$

and the field operators are constant.

In quantum field theory, a third representation proved to be most convenient. This representation is usually called the *interaction representation*  $\Theta(t)$ .

$$i\hbar \frac{\partial \Theta(t)}{\partial t} = \hat{H}(t)\Theta(t), \quad (9.6.4)$$

where

$$\hat{H}(t) = e^{i\hat{H}_0 t} \hat{H} e^{-i\hat{H}_0 t}, \quad (9.6.5)$$

is the Schrödinger Hamiltonian of the interaction representation, which, as can be seen from (9.6.5), depends on time.

The general solution of (9.6.4) can be written in the form  $\Theta(t)S(t, t_0)\Theta(t_0)$ , where the evolution operator  $S(t, t_0)$  satisfies the same equation (9.6.4) in terms of  $t$  and can be written as a chronological exponential function:

$$S(t, t_0) = \hat{T} \left\{ \exp \left( -i \int_{t_0}^t \hat{H}(t') dt' \right) \right\}, \quad (9.6.7)$$

where  $\hat{T}$  is the operator of normal product, who makes it possible to pass in the interaction representation to the products for different time moments.

For a comparison with experiment, the most interesting problem is that of scattering, for which we need an evolution operator over an infinite time interval, which transforms a stationary state  $\Theta_{-\infty}$ , in which the system is before the scattering, at  $t \rightarrow -\infty$ , into a stationary state  $\Theta_{+\infty}$ , which the system reaches after the scattering, at  $t \rightarrow +\infty$ :

$$\Theta_{+\infty} = S \Theta_{-\infty}, \quad (9.6.8)$$

where  $S$  is the scattering matrix (Heisenberg, 1943). Taking the limit  $t \rightarrow +\infty$ ,  $t \rightarrow -\infty$  in (9.6.7), and expressing the Hamiltonian  $\hat{H}(t)$  in terms of a spatial integral of the interaction Lagrangian

$\hat{H}(t) = -\int_t d^3x L_{\text{int}}(x)$ ; where it is to be understood that the interaction Lagrangian is written not

in terms of Heisenberg fields, but in the form of the same function of the fields (15) in the Dirac representation, we find a compact expression for the scattering matrix:

$$S = \hat{T} \left\{ \exp \left( -i \int_{-\infty}^{+\infty} dt \hat{H}(t) \right) \right\} = \hat{T} \left\{ \exp \left( -i \int_{-\infty}^{+\infty} d^3x L_{\text{int}}(x) \right) \right\}, \quad (9.6.9)$$

This expression is explicitly relativistically invariant. The scattering matrix can be used to find probabilities for physical processes without plunging into the details of the time evolution, described by the amplitude  $\Theta(t)$ .

We need to underline, however, that expression (9.6.9), despite its simple form, is not a ready solution for further use; it is only a compact symbolic equation.

For this reason is necessary to resort to the assumption that the interaction is weak and to assume that the interaction Lagrangian  $L_{\text{int}}$  is proportional to a small interaction constant  $g$ . It

then becomes possible to expand the chronological exponential function (9.6.9) in a power series according to perturbation theory:  $S = 1 + \sum_{n \geq 1} g^n S_n$ .

In this case the matrix elements for each order of the perturbation theory are expressed by terms of the matrix elements of chronological products of the corresponding number of interaction Lagrangians:  $\int \langle \Theta^* \hat{T} \{ L(x_1) L(x_2) \dots L(x_n) \} \Theta \rangle dx_1 dx_2 \dots dx_n$ .

Individual terms of  $S$ -matrix are integrals of the mixed products of operators  $\hat{\psi}$ ,  $\hat{\bar{\psi}}$ ,  $\hat{A}$ . Using the second Wick theorem, we can reduce arbitrary products of operators to sums of products of pairs of these operators.

A practical calculation of the matrix elements and integrals over  $x_1, \dots, x_n$  of these elements is carried out by a technique proposed by R. Feynman in 1949. This technique includes the known Feynman diagrams (graphs) and correspondent rules.

Each of normal product it is possible to compare with the Feynman diagram (Akhiezer and Berestetskii, 1965).

Graphs with  $n$  vertexes correspond to the term  $n$  of  $S$ -matrix. Because in the electrodynamics an  $n^{\text{th}}$  term is proportional to the factor  $(e/\hbar c)^n = (1/137)^n$ , the matrix elements, obtained from it, will be also proportional to  $(e/\hbar c)^n$ . The graphs, which depict such processes, are called graphs of  $n$ -order. One and the same graph, which corresponds to a certain normal product of field operators, can describe a number of different processes of scattering. The terms, the Feynman graphs of which are characterized only by the transposition of the indices of vertexes, are called equivalent. The equivalent products describe one and the same totality of processes and they are equal to each other.

To the first term of  $S$ -matrix one graph of Feynman of the first order of the type  $(\hat{\bar{\psi}} \hat{A} \hat{\psi})$  corresponds. To the second term  $S$ -matrix 6 different graphs of Feynman of the second order of the type  $(\hat{\bar{\psi}} \hat{A} \hat{\psi})(\hat{\bar{\psi}} \hat{A} \hat{\psi})(\hat{\bar{\psi}} \hat{A} \hat{\psi})$  correspond. The third term  $S$ -matrix describes all effects of the third order and count 15 graphs, which have a type  $(\hat{\bar{\psi}} \hat{A} \hat{\psi})(\hat{\bar{\psi}} \hat{A} \hat{\psi})(\hat{\bar{\psi}} \hat{A} \hat{\psi})$ . And so forth.

## 6.2. Calculations in framework of NTEP

The Hamiltonian and Lagrangian of the NTEP, as the non-linear theory, must contain all possible invariants of non-linear electromagnetic field theory. Thus we can suppose that a Lagrangian must be some function of the field invariants:

$$L = f_L(I_1, I_2), \quad (9.6.10)$$

where  $I_1 = (\vec{E}^2 - \vec{H}^2)$ ,  $I_2 = (\vec{E} \cdot \vec{H})$ .

Hamiltonian is fully defined through the Lagrangian. Thus, if the function (9.6.10) is known, it is easy, using the formulas (12.1.13), to calculate the Hamiltonian, which will be now the function of the various powers of electromagnetic field vectors:

$$\hat{H} = f_H(\vec{E}, \vec{H}), \quad (9.6.11)$$

Apparently, for each problem the functions  $f_L$  and  $f_H$  will have their special form, which is unknown before the solution of problem. As it is known the approximate form of the function  $f_H$  can be found on the basis of the Schrodinger or Dirac wave equation, using the so-called perturbation method.

We suppose here that an expansion of the function  $f_H$  in Taylor–MacLaurent power series with unknown expansion coefficient exists. Then the problem is to calculate these coefficients.

The solution for each term of expansion is searched separately, starting from first. Usually this is the problem for a free particle, whose solution is already known. Then using the equation with the two first terms, we find the coefficient of the second term. Further using the equation for the

three first terms, we find the coefficient for the third term of expansion, etc. In many cases by this method it is possible to obtain the solution with any desirable accuracy.

In case of function of two variables  $\xi = f(x, y)$  the Taylor – MacLaurent power series nearly to a point  $(x_0, y_0)$  is:

$$f(x, y) = f(x_0, y_0) + \sum_{k=1}^n \frac{1}{k!} \left( (x-x_0) \frac{\partial}{\partial x} + (y-y_0) \frac{\partial}{\partial y} \right)^k f(x_0, y_0) + O(\rho^n), \quad (9.6.12)$$

where  $\rho = \sqrt{(x-x_0)^2 + (y-y_0)^2}$ ,

$$\left( (x-x_0) \frac{\partial}{\partial x} + (y-y_0) \frac{\partial}{\partial y} \right) f(x_0, y_0) \equiv (x-x_0) \frac{\partial f(x_0, y_0)}{\partial x} + (y-y_0) \frac{\partial f(x_0, y_0)}{\partial y}, \quad (9.6.13)$$

$$\begin{aligned} & \left( (x-x_0) \frac{\partial}{\partial x} + (y-y_0) \frac{\partial}{\partial y} \right)^2 f(x_0, y_0) \equiv \\ & \equiv (x-x_0)^2 \frac{\partial^2 f(x_0, y_0)}{\partial x^2} + 2(x-x_0)(y-y_0) \frac{\partial^2 f(x_0, y_0)}{\partial x \partial y} + (y-y_0)^2 \frac{\partial^2 f(x_0, y_0)}{\partial y^2} \end{aligned}, \quad (9.6.14)$$

Etc. (In case when  $x_0 = 0, y_0 = 0$  we obtain the MacLaurent series).

Obviously, for the most types of the functions the expansion contains approximately the same set of the terms, which distinguish only by the constant coefficients, any of which can be equal to zero (as examples, see the expansions of the quantum electrodynamics Lagrangian for particle at the presence of physical vacuum (Akhiezer and Berestetskii., 1965; Schwinger, 1951; Weisskopf, 1936). Generally the expansion will look like:

$$L_M = \frac{1}{8\pi} (\vec{E}^2 - \vec{B}^2) + L', \quad (9.6.15)$$

where

$$\begin{aligned} L' = & \alpha (\vec{E}^2 - \vec{B}^2)^2 + \beta (\vec{E} \cdot \vec{B})^2 + \gamma (\vec{E}^2 - \vec{B}^2) (\vec{E} \cdot \vec{B}) + \\ & + \xi (\vec{E}^2 - \vec{B}^2)^3 + \zeta (\vec{E}^2 - \vec{B}^2) (\vec{E} \cdot \vec{B})^2 + \dots \end{aligned}, \quad (9.6.16)$$

is the part, which is responsible for the non-linear interaction (here  $\alpha, \beta, \gamma, \xi, \zeta, \dots$  are some constants).

The corresponding Hamiltonian will be defined as follows:

$$\hat{H} = \sum_i E_i \frac{\partial L}{\partial E_i} - L = \frac{1}{8\pi} (\vec{E}^2 + \vec{B}^2) + \bar{H}', \quad (9.6.17)$$

where the Hamiltonian part responsible for non-linear interaction is:

$$\begin{aligned} \hat{H}' = & \alpha (\vec{E}^2 - \vec{B}^2) (3\vec{E}^2 - \vec{B}^2) + \beta (\vec{E} \cdot \vec{B})^2 + \\ & \xi (\vec{E}^2 - \vec{B}^2) (5\vec{E}^2 + \vec{B}^2) + \zeta (3\vec{E}^2 - \vec{B}^2) (\vec{E} \cdot \vec{B})^2 + \dots \end{aligned}, \quad (9.6.18)$$

It is not difficult to obtain the quantum representation of Hamiltonian (9.6.18) of non-linear theory. Replacing the electromagnetic wave field vectors by quantum wave function, we will obtain a series of type:

$$\begin{aligned} \hat{H} = & (\psi^+ \hat{\alpha}_0 \psi) + \sum c_{1i} (\psi^+ \hat{\alpha}_i \psi) (\psi^+ \hat{\alpha}_i \psi) + \\ & + \sum c_{2i} (\psi^+ \hat{\alpha}_i \psi) (\psi^+ \hat{\alpha}_j \psi) (\psi^+ \hat{\alpha}_k \psi) + \dots \end{aligned}, \quad (9.6.19)$$

where  $\hat{\alpha}_i, \hat{\alpha}_j, \hat{\alpha}_k$  are Dirac matrixes,  $c_i$  are the coefficients of expansion.



## 7.0. Comparison of representations QED and NTEP

### 7.1. On the physical sense of the terms of Feynman graphs

As it was said above, the terms, Feynman's graphs of which are characterized only by the transposition of the indices of vertexes, are called equivalent. The equivalent products describe one and the same totality of processes and are equal to each other. The question arises: how can explain this equivalence (i.e. the presence of the certain number of terms of identical degree)?

The electromagnetic Hamiltonian of interaction in the quantum form, given above, in the first approximation, contains the sum of terms of the type of the diagrams of the second order of type  $(\hat{\psi}\hat{A}\hat{\psi})(\hat{\psi}\hat{A}\hat{\psi})$ . Continuing expansion and calculating the terms of the expansion of the third order, we will, obviously, obtain the sum of terms of the type of the diagrams of the third order of type  $(\hat{\psi}\hat{A}\hat{\psi})(\hat{\psi}\hat{A}\hat{\psi})(\hat{\psi}\hat{A}\hat{\psi})$ , and so forth. Thus, it is not difficult to see that expression (9.6.18) is the electromagnetic representation of expansion of S-matrix of the quantum field theory. This proves that all special features of the quantum-field calculations of interaction energy of elementary particles can be represented by electrodynamic forms NTEP.

The electromagnetic Hamiltonian of interaction in the quantum form, given above, in the first approximation, contains the sum of terms of the diagrams of the second order of type  $(\hat{\psi}\hat{A}\hat{\psi})(\hat{\psi}\hat{A}\hat{\psi})$ . Continuing expansion and calculating the terms of the expansion of the third order, we will, obviously, obtain the sum of terms of the diagrams of the third order of type  $(\hat{\psi}\hat{A}\hat{\psi})(\hat{\psi}\hat{A}\hat{\psi})(\hat{\psi}\hat{A}\hat{\psi})$ , and so forth. Thus, it is not difficult to see that expression (9.6.18) is the electromagnetic representation of expansion of S-matrix of the quantum field theory. This proves that all special features of the quantum-field calculations of interaction energy of elementary particles can be represented by electrodynamic forms NTEP.

Note that using the analysis, which is outlined above, can explain the electrodynamic sense of the special features of S-matrix theory within the framework of NTEP.

### 7.2. On the physical sense of the terms of the expansion of the Hamiltonian

As we see, the terms of the series of Lagrangian and Hamiltonian expansions contain the limited number of uniform elements, such as  $(\vec{E}^2 + \vec{B}^2)$ ,  $(\vec{E} \cdot \vec{B})^2$ ,  $(\vec{E}^2 - \vec{B}^2)$ , and some other. It is possible to assume that each term of the expansion of the Hamiltonian of nonlinear theory and each element of term of series have a certain constant physical sense.

For example, it is obvious that the first term of the expansion of Hamiltonian  $(\vec{E}^2 + \vec{B}^2)$  (which corresponds to the term of Lagrangian  $(\vec{E}^2 - \vec{B}^2)$ ), is charged with the interaction of the currents of electrons and photons. The second term of expansion of Hamiltonian  $(\vec{E} \cdot \vec{B})^2$  corresponds to the term  $(\vec{E} \cdot \vec{B})$  of Lagrangian, which, according to studies, is charged with the currents of the helicity of electromagnetic field (according to NTEP the currents of helicity there are own currents of neutral elementary particles).

In this case it is not difficult to see the analogy with expansion of fields on the electromagnetic moments, and also with decomposition of a S-matrix on the elements (Akhiezer and Berestetskii, 1965), each of which corresponds to the particularities of interaction of separate particles. But the detailed analysis of the physical sense of the terms of the expansion of Lagrangian and Hamiltonian of nonlinear theory requires a separate study and lies beyond the limits of the purpose of this monograph.

# Chapter 10. The theory of massive neutrino

## 1.0. Introduction. Neutrino of Standard Model theory

Before we expound the nonlinear electromagnetic theory of neutrino, we will briefly look into the present neutrino theory.

The present status of neutrino theory within the framework of Standard Model (SM) is summarized in many publications (Bilenky, Giunti and Kim, 2000; Glashow, 1961; Weinberg, 1967; Salam, 1969; Bilenky, 2004) and others.

### 1.1. Neutrinos' features

The previous experimental results show that the neutrino mass is very small and maybe is equal to zero; only left-handed neutrinos and right-handed antineutrinos exist and three sets of neutrinos have been observed (Danby, G., *et al.*, 1962; Kodama, K. *et al.* (DONUT collaboration) 2001): one that is connected with electrons, one with muons, and one with tau leptons (Perl, M. L. *et al.*, 1975).

Consequently in the Standard Model is postulated that neutrinos are strictly massless:  $m = 0$ ; all neutrinos are left-handed, with helicity -1, and all antineutrinos are right-handed, with helicity +1; here, the lepton family number is strictly preserved.

Within the framework of SM the left-handed helicity of neutrino and right-handed helicity of antineutrino can be explained only on the basis of massless neutrino ( $m_\nu = 0$ ). For the massive particle there is always such Lorentz transformation, that changes the direction of particle momentum on opposite without changing the particle spin direction. In this case in the new frame of reference neutrino must have right-handed helicity and coincide with the antineutrino. This, in turn, would lead to the nonconservation of lepton charge (number). Thus, the mass of neutrino would lead to the disturbance of the conservation law of total lepton charge.

However, the latest experimental evidence indicates that these simple properties need serious corrections (Bilenky, Giunti and Kim, 2000; Bilenky, 2004). In experiments of the SuperKamiokande researchers (Fukuda, Y. *et al.* (Super-Kamiokande Collaboration), 1998) have discovered neutrino oscillations, in which one flavor of neutrino changed into another. This means that neutrinos have non-zero mass.

#### 1.1.1. Helicity and Chirality

In the neutrino theory, the conceptions of helicity and chirality play an important role.

**Helicity** refers to the relationship between the particle's spin and direction of motion. The axis defined by its linear momentum is associated with a particle in motion; the particle helicity is defined by a projection of the particle's spin  $\vec{s}$  into this axis:  $h = \frac{\vec{s}\vec{p}}{|\vec{s}||\vec{p}|}$ , i.e. the helicity is a

component of an angular momentum along the direction of linear momentum.

According to definition, the helicity operator projects two physical states: one with a spin along the direction of motion, and the other with a spin against this direction, regardless whether the particle is massive or not. If the spin is along the direction of motion, then the particle have the right helicity; otherwise, the particle has the left helicity.

In the Standard Model theory, neutrino and antineutrino have opposite helicities. Mathematically, it is possible that this is the *only* difference between neutrinos and antineutrinos, i.e., in this case, the right-handed neutrino is an antineutrino. Particles of this sort are called Majorana particles.

If a neutrino is massless, its helicity is completely defined, and Majorana's neutrino would be a different particle from its antineutrino. However, if neutrinos have mass, and therefore do not travel at the speed of light, it is possible to define the reference frame in which the helicity can change to opposite. This means that there is an effective mixing between neutrino and antineutrino (which violates the lepton's number conservation).

Some object is called **chiral** if it cannot coincide with its image in the mirror, for instance, as our hand does. Like our hands, chiral objects are classified into left-chiral and right-chiral objects. Chirality is introduced into the theory as follows.

In the Standard Model the massless neutrino is described by Dirac's lepton equation without a mass term:

$$\alpha^\mu \partial_\mu \psi = 0, \quad \mu = 1, 2, 3, 4, \quad (10.1.1)$$

which is also satisfied by the function  $\alpha_5 \psi$ :

$$\alpha^\mu \partial_\mu (\alpha_5 \psi) = 0, \quad (10.1.2)$$

where the combination of  $\alpha$  matrices  $\alpha_5 = \alpha_0 \alpha_1 \alpha_2 \alpha_3$  has the properties  $\alpha_5^2 = 1$  with the commutators  $\{\alpha_5, \alpha_\mu\} = 0$ . This allows to define the *chirality operators*, which separate the left-handed and right-handed states:

$$\psi_L = \frac{1}{2}(1 - \alpha_5) \psi \quad \text{and} \quad \psi_R = \frac{1}{2}(1 + \alpha_5) \psi, \quad (10.1.3)$$

where  $\psi_L$  and  $\psi_R$  satisfy to equations  $\alpha_5 \psi_L = -\psi_L$  and  $\alpha_5 \psi_R = \psi_R$ , which indicates that chiral fields are eigenfields of matrix  $\alpha_5$ , regardless of its mass.

We can express any fermion as  $\psi = \psi_L + \psi_R$ , so that a massive particle always has  $L$ -handed, as well as  $R$ -handed components. However, in the massless case,  $\psi$  separates into distinct helicity states: Dirac equation splits into two independent parts reformulated as Weyl equations

$$\frac{\hat{\sigma} \cdot \hat{p}}{|\hat{\sigma}| |\hat{p}|} \left[ \frac{1}{2}(1 \pm \alpha_5) \psi \right] = \pm \frac{1}{2}(1 \pm \alpha_5) \psi, \quad (10.1.4)$$

where  $\frac{\hat{\sigma} \cdot \hat{p}}{|\hat{\sigma}| |\hat{p}|}$  is the helicity operator expressed in terms of Pauli matrices  $\hat{\sigma}$ .

The Weyl fermions (i.e. the massless chiral states  $\frac{1}{2}(1 \pm \alpha_5) \psi$ ) are physical, since they correspond to eigenstates of the helicity operator. Thus, a massless particle, which is in perpetual motion, has unchangeable helicity. The reason is that its momentum cannot be altered, and its spin, of course, remains unchanged.

However, for a massive particle, we can perform the Lorentz transformation along the direction of the particles' momentum with a velocity larger than the particle's velocity, changing the direction of momentum. Since the spin direction remains the same, the helicity of the particle changes.

As experiments show, the helicity of neutrino is a permanent value.

### 1.1.2. Electromagnetic characteristics of neutrino

It is interesting to note that in spite of neutrality, neutrino has electromagnetic properties. Analysis of these properties has implications for the nature of neutrino mass (Ternov, 2000). Electromagnetic properties of the Dirac and Majorano neutrino prove to be substantially different.

Dirac's massive neutrino acquires its magnetic moment by interaction with the vacuum. The magnetic moment of neutrino has the same direction as its spin, while antineutrino's magnetic

moment is directed against the spin. Thus, the particle and the antiparticle differ by direction of their magnetic moments.

The massive Majorano neutrino, which is identical to its antiparticle, cannot have neither magnetic moment nor a dipole electric moment.

The mass and the magnetic moment of the neutrino are nonlinear functions of the field strength and the particle's energy.

During the motion in an external field, the magnetic moment of the Dirac neutrino becomes partly an electric dipole moment  $d_\nu$ ; this is in part a well-known classical effect of Lorentz's transformation producing an inter-conversion of electric and magnetic fields.

Calculations show that an electric moment of a massive Dirac neutrino, which moves in a constant external electromagnetic field, is proportional to the pseudo-scalar  $(\vec{E} \cdot \vec{H})$  that changes sign when time reverses. In other words, the electric moment is induced by an external field if the pseudo-scalar of this field is not zero (i.e.  $(\vec{E} \cdot \vec{H}) \neq 0$ ), and its existence conforms with the T-invariancy of the Standard Model. In this Dirac's model, both the electric dipole and magnetic moments of a neutrino have dynamic nature.

Let us note also that there is one electromagnetic characteristic of the Dirac's neutrino, which appears also for the Majorana neutrino: this is anapole (or toroidal dipole) moment.

We will show below that within the NEPT framework a massive neutrino is fully described by Dirac's lepton equation, and has a preserved inner poloidal helicity (p-helicity) that produces the above-mentioned electromagnetic features.

## 2.0. Hypothesis about neutrino structure in NEPT

In the previous chapters, we showed that the electron is a half of the period of the intermediate *plane-polarized photon*, or the *plane-polarized* (this is how we called it for brevity) semi-photon.

According to contemporary experimental data, a neutrino, similar to an electron, is lepton, and must have a mass. However, in contrast to electron, neutrino must have a zero charge and preserved helicity. Moreover, the neutrino and antineutrino must have mirror asymmetry.

In order to satisfy these requirements, we propose the following hypothesis about the structure of EM neutrino: *neutrino is a semi-photon with a circular polarization*.

On the basis of this hypothesis, we will show below that within the framework of NEPT the massive neutrino is fully described by Dirac's lepton equation, and it has a preserved inner poloidal helicity (p-helicity) which produces the above-mentioned electromagnetic features.

## 3.0. Plane and circularly polarized electromagnetic waves

In general, electromagnetic waves emitted by charged particles are circularly (or elliptically) polarized (Ivanenko and Sokolov, 1949; Grawford, 1970); these electromagnetic waves are also transverse in the sense that associated electric and magnetic field vectors are both perpendicular to the direction of wave propagation.

Circularly polarized waves carry energy  $\varepsilon$  and momentum  $\vec{p}$ , as well as the angular momentum  $\vec{s}$ , which are defined by the energy density  $u$ , momentum density  $\vec{g}$ , and angular momentum flux density, which is defined as follows:

$$\vec{s} = \vec{r} \times \vec{g} = \frac{1}{c^2} r \times \vec{E} \times \vec{H}, \quad (10.3.1)$$

A plane electromagnetic wave can be regarded as a vector combination of two circularly polarized waves rotating in opposite directions. Figure 1 (below) shows the motion of an electric field associated with a circularly polarized wave, with the positive (right) and negative (left) helicity (Fig. 8.1):

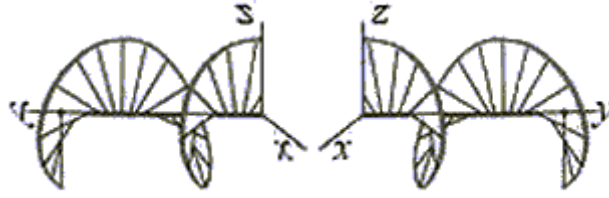

Fig. 8.1.

Positive helicity is a case such that the right screw would move in the direction of wave propagation when rotated with the electric field (in optics, it is called the "left hand" circular polarization). Negative helicity (the right hand polarization in optics) refers to rotation in the opposite direction. The direction of the end of the helix indicates the head of the electric field vector, which is rotating here around  $y$ -axis.

Since it is impossible to transfer the right- (left)-handed helix to the left- (right)-handed helix by any transformation (except the spatial reflection), the *circular polarization of photons is their integral characteristic invariant under all transformations, except for the mirror reflection.*

Since the photons' helicity is related to a field rotation, this sometimes referred to as 'rotation of a photon', and it is included into the photons' rotation characteristic: an angular momentum, or spin, of a photon. In quantum mechanics, the spin of a photon is regarded differently, namely as an internal angular momentum of a particle when its linear momentum is zero. Therefore, in case of a photon whose speed cannot be anything else but the speed of light, it is more correct to talk about the photon helicity rather than about a photon spin (Gottfried and Weisskopf, 1984). In this case, it is possible to define the helicity (Grawford, 1970) by the vector:

$$\vec{h}_{ph} \equiv \vec{s}_{ph} = \pm \frac{\varepsilon_{ph}}{\omega} \vec{p}^0, \quad (10.3.2)$$

where  $\vec{p}^0$  is the unit Pointing vector,  $\varepsilon_{ph}$  and  $\omega$  are photon's energy and circular frequency, correspondingly. Apparently, the angular momentum's value of this vector is equal to  $|\vec{h}_{ph}| = 1\hbar$ .

Below, we will show that in a general case the solution of Dirac's equation in EM form describes the motion of a circularly polarized semi-photon. We will also show that this particle has a mass, a zero charge, and the spin half, similar to neutrino; We will show also that these EM neutrino and antineutrino have opposite internal conserved helicities.

#### 4.0. Quantum form of circularly polarized EM wave quantum equations

Let us consider a plane electromagnetic wave that moves, for instance, along the  $y$ -axis. In general, such a wave has two polarizations and contains the following four field vectors:  $\vec{\Phi}(y) = \{E_x, E_z, H_x, H_z\}$

Similar to the method used in chapter 2, we can obtain two equations in a quantum form from the wave equation as follows:

$$\Phi^+ (\hat{\alpha}_o \hat{\varepsilon} - c \hat{\alpha} \hat{p}) = 0, \quad (10.4.1')$$

$$(\hat{\alpha}_o \hat{\varepsilon} + c \hat{\alpha} \hat{p}) \Phi = 0, \quad (10.4.1'')$$

If we choose the wave function  $\Phi$  as

$$\Phi = \begin{pmatrix} E_x \\ E_z \\ iH_x \\ iH_z \end{pmatrix}, \Phi^+ = (E_x \quad E_z \quad -iH_x \quad -iH_z), \quad (10.4.2)$$

then, substituting (10.4.2) into (10.4.1), we obtain the following Maxwell like equations for the advanced and retarded waves :

$$\left\{ \begin{array}{l} \frac{1}{c} \frac{\partial E_x}{\partial t} - \frac{\partial H_z}{\partial y} = 0 \\ \frac{1}{c} \frac{\partial H_z}{\partial t} - \frac{\partial E_x}{\partial y} = 0 \\ \frac{1}{c} \frac{\partial E_z}{\partial t} + \frac{\partial H_x}{\partial y} = 0 \\ \frac{1}{c} \frac{\partial H_x}{\partial t} + \frac{\partial E_z}{\partial y} = 0 \end{array} \right. , (10.4.3) \quad \left\{ \begin{array}{l} \frac{1}{c} \frac{\partial E_x}{\partial t} + \frac{\partial H_z}{\partial y} = 0 \\ \frac{1}{c} \frac{\partial H_z}{\partial t} + \frac{\partial E_x}{\partial y} = 0 \\ \frac{1}{c} \frac{\partial E_z}{\partial t} - \frac{\partial H_x}{\partial y} = 0 \\ \frac{1}{c} \frac{\partial H_x}{\partial t} - \frac{\partial E_z}{\partial y} = 0 \end{array} \right. , (10.4.4)$$

Let us show that the photons of the right and left systems (10.4.3), (10.4.4) move in opposite directions, and that these waves have different - left and right - circular polarizations.

Equations (10.4.1) have the following harmonic solution (in a trigonometric and exponential forms correspondingly):

$$\Phi_\mu = A_\mu \sin(\omega t - \vec{k}\vec{r} + \delta), \quad (10.4.5)$$

$$\Phi_\mu = A_\mu e^{\frac{i}{\hbar}(\alpha - \vec{p}\vec{r} + \delta)}, \quad (10.4.5')$$

where  $\mu = 1,2,3,4$ ,  $A_j$  are the amplitudes and  $\delta$  is a constant phase.

Substituting  $A_\mu = A_0$ ,  $\delta = 0$ , we obtain the following trigonometric form of solutions of these equations:

$$\left\{ \begin{array}{l} E_x = A_0 \cos(\omega t - ky) \\ H_z = -A_0 \cos(\omega t - ky) \\ E_z = -A_0 \sin(\omega t - ky) \\ H_x = -A_0 \sin(\omega t - ky) \end{array} \right. , (10.4.6) \quad \left\{ \begin{array}{l} E_x = A_0 \cos(\omega t - ky) \\ H_z = A_0 \cos(\omega t - ky) \\ E_z = -A_0 \sin(\omega t - ky) \\ H_x = A_0 \sin(\omega t - ky) \end{array} \right. , (10.4.7)$$

It is easy to show that vectors  $\vec{E}$  and  $\vec{H}$  rotate in  $XOZ$  plane. Substituting  $y = 0$ , we obtain:

$$\vec{E} = E_x \vec{i} + E_z \vec{k} = A_0 (\vec{i} \cos \omega t - \vec{k} \sin \omega t), \quad (10.4.8')$$

$$\vec{H} = H_x \vec{i} + H_z \vec{k} = A_0 (-\vec{i} \sin \omega t - \vec{k} \cos \omega t), \quad (10.4.8'')$$

and

$$\vec{E} = E_x \vec{i} + E_z \vec{k} = A_0 (\vec{i} \cos \omega t - \vec{k} \sin \omega t), \quad (10.4.9')$$

$$\vec{H} = H_x \vec{i} + H_z \vec{k} = A_0 (\vec{i} \sin \omega t + \vec{k} \cos \omega t) \quad (10.4.9'')$$

where  $\vec{i}$ ,  $\vec{k}$  are the unit vectors of  $OX$  and  $OZ$  axes. We could show using the known algebraic analysis (Jackson, 1999) that we have obtained a circular polarized wave. However, we will analyze these relationships from the geometrical point of view.

The Poynting vector defines the direction of the wave motion:

$$\vec{S}_p = \frac{c}{4\pi} \vec{E} \times \vec{H} = -\vec{j} \frac{c}{4\pi} (E_x H_z - E_z H_x), \quad (10.4.10)$$

where  $\vec{j}$  is a unit vector of  $OY$  axis. Transforming the above equation (10.4.10), we have for (10.4.6) and (10.4.7):

$$\vec{S}_p = \frac{c}{4\pi} A_0^2 \vec{j}, \quad (10.4.11)$$

$$\vec{S}_p = -\frac{c}{4\pi} A_0^2 \vec{j}, \quad (10.4.12)$$

respectively. Thus, photons of the right and left systems (10.4.8) and (10.4.9) move in opposite directions.

Fixing the positions of vectors  $\vec{E}, \vec{H}$  in two successive time moments (at the initial moment  $t_0 = 0$ , and after a small time period at  $t_1 = t_0 + \Delta t$ ), we can define the rotation direction. The results are represented in a graphical form in Figures 8.2 and 8.3:

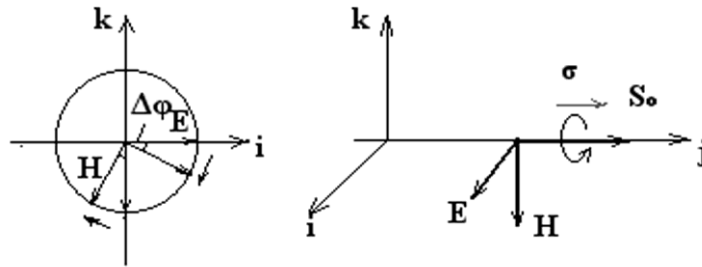

Fig. 8.2.

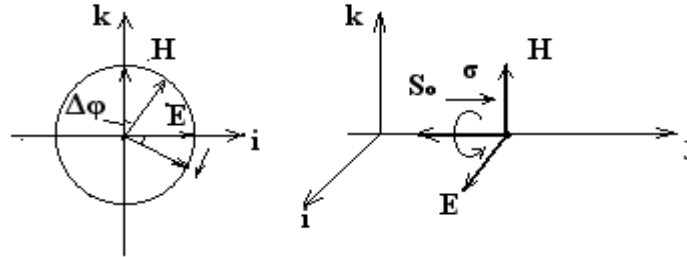

Fig. 8.3.

It is apparent that the equation sets (10.4.3) and (10.4.4) describe the waves with the right and left circular polarizations respectively.

In a case of rotation transformation of a circular-polarized photon, its helicity does not disappear, but it become, inside the torus, the poloidal helicity (or “p-helicity”). At the same time, the motion of photon fields along the ring trajectory forms other characteristics of elementary particle: an angular momentum of the particle, or spin.

Thus, the spin of a massive particle and its poloidal angular momentum (p-helicity) are different characteristics. Since these characteristics are internal characteristics of a “liner” photon (i.e. which obeys the linear equation), *in nonlinear electromagnetic theory, the spin and the poloidal helicity of a particle are independently conserved values.*

## 5.0. An equation of a massive neutrino of NEPT

In the case of electron and positron (massive charged particles with a spin half), their mass and charge appears with the rotation transformation and breaking of the **plane** polarized photon.

Now, our purpose is to show that during the rotation transformation and breaking of the **circularly** polarized photon, a particle with a mass term originates, although it does not have electrical charge.

Consider the mass term appearance in this case.

Let the circularly-polarized wave  $\vec{E}, \vec{H}$ , which has the field vectors  $\{E_x, E_z, H_x, H_z\}$ , be rotated with some radius  $r_k$  in the plane  $(X', O', Y')$  of a fixed co-ordinate system  $(X', Y', Z', O')$ , so that  $E_x, H_x$  are parallel to the plane  $(X', O', Y')$ , and  $E_z, H_z$  are perpendicular to it (see Fig. 8.4)

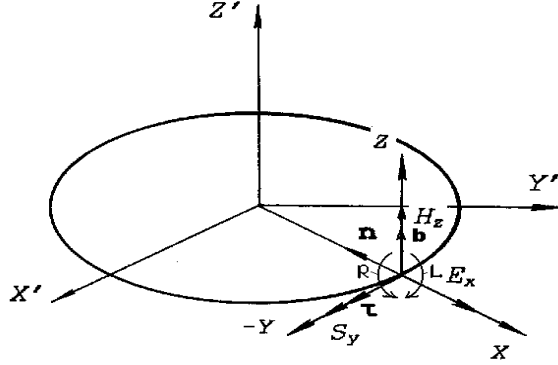

Fig. 8.4.

where the circular arrows shows the right ( $R$ ), and the left ( $L$ ) rotation of photon fields.

Let us replace the unit vectors  $\{\vec{i}_x, \vec{i}_y, \vec{i}_z\}$  of the Cartesian coordinate system of section 3, connected with wave vectors, by the Frenet-Serret trihedron vectors  $\{\vec{n}, \vec{\tau}, \vec{b}\}$  accordingly. Then, we have for electric and magnetic vectors:

$$\vec{E}(y, t) = \vec{n}E_x + \vec{b}E_z = (\vec{n}E_{x0} + \vec{b}E_{z0})e^{i\alpha t}, \quad (10.5.1)$$

$$\vec{H}(y, t) = \vec{n}H_x + \vec{b}H_z = (\vec{n}H_{x0} + \vec{b}H_{z0})e^{i\alpha t}, \quad (10.5.2)$$

Here, as well as in the case of the plane polarized EM wave quantum, the unit vector of the normal  $\vec{n}$  turns around  $O'Z'$  axis, and bivector  $\vec{b}$  remains parallel to it.

Similar to the procedure stated in chapters 2 and 3, it is easy to obtain equations of semi-photons (i.e. the Dirac's equation with a mass term).

Unlike in the case of rotation transformation of plane-polarized photons considered in chapters 2 - 3, here we cannot assert that magnetic current is equal to zero.

Really, in the first case the behavior of magnetic vector was completely different from the behavior of an electric vector: the magnetic vector was parallel to the rotation axis and preserved the constant direction in space, while the electric vector continuously rotated around it changing direction in space. In the given case, the magnetic vector is rotated around the trajectory of motion, and it is transported along the trajectory just as the electric vector. It can be shown that in this case there are both electric and magnetic currents.

Let us consider expressions  $\vec{j}^e = \frac{1}{4\pi} \frac{\partial \vec{E}}{\partial t}$  and  $\vec{j}^m = \frac{1}{4\pi} \frac{\partial \vec{H}}{\partial t}$  in the equations of the initial EM wave quantum (10.4.3-4.4). (Recall that after transformation of EM quantum, the field vectors of initial wave  $\vec{E}, \vec{H}$  are transformed into the field vectors of transformed wave, which we denoted in electromagnetic form as  $\vec{E}, \vec{H}$ , and in the quantum form as  $\psi$ ). Taking into account that  $\frac{\partial \vec{b}}{\partial t} = 0$ , we will obtain using (10.5.1) and (10.5.2) the following:

$$\frac{\partial \vec{E}}{\partial t} = -\frac{\partial E_x}{\partial t} \vec{n} + \frac{\partial E_z}{\partial t} \vec{b} - E_x \frac{\partial \vec{n}}{\partial t}, \quad (10.5.3)$$

$$\frac{\partial \vec{H}}{\partial t} = \frac{\partial H_x}{\partial t} \vec{n} + \frac{\partial H_z}{\partial t} \vec{b} + H_x \frac{\partial \vec{n}}{\partial t}, \quad (10.5.4)$$



where  $\frac{\partial \vec{n}}{\partial t} = -c\kappa\vec{\tau} = -\frac{c}{r_c}\vec{\tau}$ , and  $r_c = \hbar/mc$ . Thus, we have obtained electric and magnetic tangential currents, which specific is that they are *alternating*:

$$\vec{j}_\tau^e = \frac{\omega_p}{4\pi} E_x \cdot \vec{\tau} = \frac{\omega_p}{4\pi} E_{x0} \cdot \vec{\tau} \cdot \cos \omega t, \quad (10.5.5)$$

$$\vec{j}_\tau^m = -\frac{\omega_k}{4\pi} H_x \cdot \vec{\tau} = -\frac{\omega_k}{4\pi} H_{x0} \cdot \vec{\tau} \cdot \cos \omega t, \quad (10.5.6)$$

Now, it is not difficult to see that a quantum form of the equation of circular polarized semi-photons with the opposite helicity are Dirac's equations with mass terms for the particle and antiparticle.

Taking into account the results of the previous section, we obtain the semi-photon equations in a quantum form which are equivalent to Dirac's equations:

$$\frac{\partial \psi}{\partial t} - c\hat{\alpha} \vec{\nabla} \psi - i\hat{\beta} \frac{c}{r_c} \psi = 0, \quad (10.5.7')$$

$$\frac{\partial \psi}{\partial t} + c\hat{\alpha} \vec{\nabla} \psi + i\hat{\beta} \frac{c}{r_c} \psi = 0, \quad (10.5.7'')$$

and electromagnetic form of these equations:

$$\left\{ \begin{array}{l} \frac{1}{c} \frac{\partial E_x}{\partial t} - \frac{\partial H_z}{\partial y} = -ij_x^e \\ \frac{1}{c} \frac{\partial H_z}{\partial t} - \frac{\partial E_x}{\partial y} = 0 \\ \frac{1}{c} \frac{\partial E_z}{\partial t} + \frac{\partial H_x}{\partial y} = 0 \\ \frac{1}{c} \frac{\partial H_x}{\partial t} + \frac{\partial E_z}{\partial y} = ij_x^m \end{array} \right. , (10.5.8') \quad \left\{ \begin{array}{l} \frac{1}{c} \frac{\partial E_x}{\partial t} + \frac{\partial H_z}{\partial y} = -ij_x^e \\ \frac{1}{c} \frac{\partial H_z}{\partial t} + \frac{\partial E_x}{\partial y} = 0 \\ \frac{1}{c} \frac{\partial E_z}{\partial t} - \frac{\partial H_x}{\partial y} = 0 \\ \frac{1}{c} \frac{\partial H_x}{\partial t} - \frac{\partial E_z}{\partial y} = ij_x^m \end{array} \right. , (10.5.8'')$$

which are complex Maxwell equations *with imaginary tangential alternating currents*.

We can schematically represent the fields' motion of particles, described by these equations (Fig. 8.5):

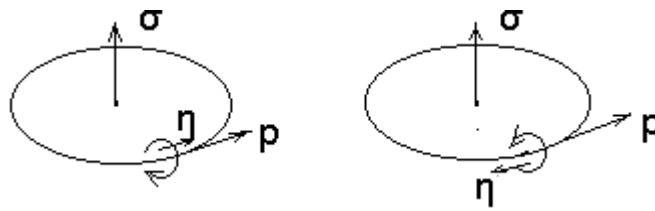

Fig. 8.5.

According to Figures 8.2 and 8.3, the semi-photons in Fig. 8.5 have the opposite  $p$ -helicities. In the first case, the helicity vector and the Poynting vector have the same directions; in the second case, they are opposite. Therefore, in nonlinear theory we can define the *inner helicity* (or  $p$ -helicity) as a projection of the poloidal rotation momentum to a momentum of the ring field motion.

It can be shown (Davydov, 1965) that actually the helicity is described in NEPT by matrix  $\hat{\alpha}_5$ . Multiplying the Dirac equation by  $i\hat{\alpha}_5\hat{\beta}$ , and taking into account that  $i\hat{\alpha}_5\hat{\beta}\vec{\alpha} = \hat{\vec{\sigma}}$ , where

$\hat{\vec{\sigma}} = \begin{pmatrix} \hat{\sigma} & 0 \\ 0 & \hat{\sigma} \end{pmatrix}$  are the spin matrix, and  $\hat{\beta}\hat{\alpha}_5 = -\hat{\alpha}_5\hat{\beta}$ ,  $\hat{\beta}^2 = 1$ , we obtain:

$$\left(i\hat{\beta}\hat{\alpha}_5\hat{\varepsilon} + c\hat{\vec{\sigma}}'\hat{\rho} - imc^2\hat{\alpha}_5\right)\psi = 0, \quad (10.5.9')$$

$$\left(i\hat{\beta}\hat{\alpha}_5\hat{\varepsilon} - c\hat{\vec{\sigma}}'\hat{\rho} + imc^2\hat{\alpha}_5\right)\psi = 0, \quad (10.5.9'')$$

Using this, we can get the following expressions for matrix  $\hat{\alpha}_5$ :

$$\hat{\alpha}_5 = \frac{c\hat{\vec{\sigma}}'\vec{p}}{i(\hat{\beta}\hat{\varepsilon} + mc^2)}, \quad (10.5.10')$$

$$\hat{\alpha}_5 = \frac{-c\hat{\vec{\sigma}}'\vec{p}}{i(\hat{\beta}\hat{\varepsilon} - mc^2)}, \quad (10.5.10'')$$

that relates the  $\hat{\alpha}_5$  matrix to helicity, but not in the case when  $m = 0$ .

According to our theory, the operator  $\hat{\alpha}_5$  describes the poloidal rotation of the fields inside a particle (Fig. 8.5). Recalling that the value  $\psi^+\hat{\alpha}_5\psi$  is a pseudoscalar of EM theory  $\psi^+\hat{\alpha}_5\psi = \vec{E} \cdot \vec{H}$ , we can affirm that, in p-helicity, the NEPT is the Lorentz-invariant value, and actually this is the reason of the parity's non-conservation for massive particles.

## 6.0. Topological particularities of neutrino's particle structure

According to our analysis, the lepton are half-periods of a photon after the rotation transformation. In this case, a neutrino, as a rotated helicoids, represents the Moebius's strip: its field vectors (electric and magnetic) at the end of one coil transform to the state with opposite direction, compared to rotated photon vectors, and the vector comes to the starting position only by two coils (see Fig. 8.6)

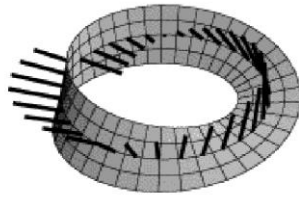

Fig. 8.6.

(See also figure from the MathWorld website: <http://mathworld.wolfram.com/MoebiusStrip.html>, where the animation shows a series of gears arranged along the Möbius strip as the electric and magnetic field vectors' motion).

Theory of neutrino presented above makes it possible to understand the known topological feature of leptons, which are described in detail in chapter 4 (see section 4.0. *Topological particularities of wave function of electron theory*).

Actually, electromagnetic waves of any polarization can be represented as a superposition of circular polarized photons. If one assumes that the basic state of photons in nature is a circular polarized state, then not only neutrino but also all fermions must be considered as the superposition of Moebius's strips.

Moreover, this structure of fermions as Moebius's strip allows to understand the origin of Pauli exclusion principle.

## 7.0. On the charge and mass of neutrino

Let us show now that the electrical charge of a neutrino of NEPT is really equal to zero, while its mass is not equal to zero.

### 7.1. The charge of neutrino

The charge density of a semi-photon particle can be calculated as follows:

$$\rho_p = \frac{j_\tau}{c} = \frac{1}{4\pi} \frac{\omega_p}{c} E = \frac{1}{4\pi} \frac{1}{r_p} E, \quad (10.7.1)$$

Then, the full charge of this object can be defined by integrating

$$q = \int_{\Delta\tau} \rho_p d\tau, \quad (10.7.2)$$

where  $\Delta\tau$  is the approximate volume of particle fields.

Using as the first approximation the ring (torus) model of a particle, and assuming  $\vec{E} = \vec{E}(l)$ , where  $l$  is the length along the circular trajectory, we obtain:

$$q = \frac{\Delta\tau}{4\pi} \frac{\omega_p}{c} E_o \int \cos k_p l dl = 0, \quad (10.7.3)$$

(here,  $E_o$  is the amplitude of the semi-photon wave field,  $dl$  is the element of the ring length,  $k_p = \frac{\omega_p}{c}$  is the wave-vector value).

It is easy to understand these results: for the reason that the ring current is alternating, the full charge is equal to zero.

### 7.2. The mass of neutrino

To calculate the mass we must calculate first the energy density of electromagnetic field:

$$\rho_\varepsilon = \frac{1}{8\pi} (\vec{E}^2 + \vec{H}^2), \quad (10.7.4)$$

Let for simplicity be  $|\vec{E}| = |\vec{H}|$ . Then, (10.7.4) can be written as:

$$\rho_\varepsilon = \frac{1}{4\pi} E^2, \quad (10.7.5)$$

Using (10.7.5) and the well-known relativistic relationship between the mass density and the energy density:

$$\rho_m = \frac{1}{c^2} \rho_\varepsilon, \quad (10.7.6)$$

we obtain:

$$\rho_m = \frac{1}{4\pi c^2} E^2 = \frac{1}{4\pi c^2} E_o^2 \cos^2 k_s l, \quad (10.7.7)$$

Using (10.7.7), we can write the following approximation for the semi-photon mass:

$$m_s = \int \rho_m d\tau = \Delta\tau \frac{E_o^2}{\pi c^2} \int \cos^2 k_s l dl \neq 0, \quad (10.7.8)$$

Obviously, this expression can be never equal to zero in contrast to the charge. It is easy to understand the origin of this difference.

The particle's mass is defined by integral with respect to energy density, which is proportional to the second power of the field strength. In this case, the integral is always differs from zero if the field is not zero.

At the same time, the charge is defined by integral with respect to a current density, which is proportional to the first power of the field strength. Obviously, it is possible that the integrand is not equal to zero, but the integral itself is equal to zero: such result takes place in case when the integrand changes according to a harmonic law, which is our case.

Thus, it is possible that the particle mass is not equal to zero within the framework of NEPT, but the particle charge is equal to zero.

## 8.0. The Pauli exclusion principle

The Pauli exclusion principle can be written in the following form: *the particles of half-integer spin have antisymmetric wavefunctions, and the particles of integer spin have symmetric wavefunctions.*

The answer to the question (Feynman, Leighton, and Sands, 1963), why "particles with half-integer spin are Fermi particles whose amplitudes add with the minus sign", underlies the Pauli exclusion principle, and, therefore, the Fermi statistics.

There is (Gould, 1995; Weisskopf, 1939; Gottfried and Weisskopf, 1984) "a remarkable property of lepton in a three dimensional space: when lepton is rotated 360 degrees (which means that the wave function phase shifts to 360 degrees), it returns to the state that looks the same geometrically, but that is distinct topologically with respect to its surroundings: a twist has been introduced. The second full rotation (a total of 720 degrees) brings the object back to its original state.

In his last lecture, R. Feynman (Feynman, 1987) sketched an elementary argument for the above problem (see Fig 8.7 that was taken from the R. Feynman's paper))

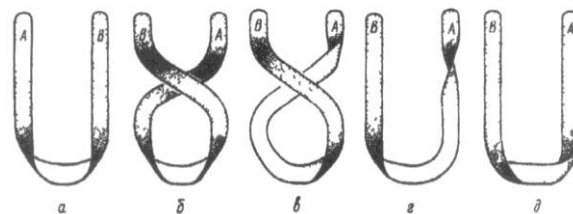

Fig. 8.7.

To see this, first grasp two ends of a belt, one end in each hand; then interchange the position of your hands. This way we have introduced a "twist", which is topologically equivalent to rotating one end of the belt by 360 degrees.

Thus, when fermions are interchanged, one must keep track of this "implied rotation" and the phase shift, change of the sign, and destruction interference to which it gives the rise. For example, if  $\mathbf{A(1)B(2)}$  describes "electron 1 in state  $\mathbf{A}$ , and electron 2 in state  $\mathbf{B}$ ," then the state with the interchanged electrons must be  $-\mathbf{A(2)B(1)}$ , and their superposition is  $\mathbf{A(1)B(2) - A(2)B(1)}$ ".

Since within the framework of NEPT leptons have a topology of the Moebius strip, elementary particles of NEPT must behave as fermions of quantum field theory, and must be subordinated to the exclusion principle of Pauli.

## 9.0. Conclusions. Neutrino of the SM and neutrino of the NEPT

In the Standard Model, neutrinos are strictly massless and described by Weyl equation. However, this hypothesis does not withstand experimental facts.

On the other hand, the NEPT neutrino has a mass, and it is described by Dirac equation. All other features of the SM neutrino and the NEPT neutrino are identical, namely:

1. They are leptons. 2. They do not have any charge. 3. The particles and antiparticles are distinguished only by helicity. 4. They have all the necessary invariant properties according to the theory of weak interaction.

Is there a contradiction between the SM and NEPT approaches to the problem about the mass?

It was shown above that the internal motion of semi-photon fields of neutrino along a circular trajectory is described by the Dirac's lepton equation with a mass equal to zero, i.e. by Weil equation. In other words, within the framework of NEPT, the Weyl equation is an equation of internal motion of neutrino fields as a massless particle (semi-photon fields).

At the same time, a massive neutrino, being considered as a "stopped" after transformation electromagnetic wave, is described by the Dirac's equation with a mass term. Since the neutrino actually has a very small mass, the description of a real neutrino by means of Weyl's equation is completely satisfactory.

# Chapter 11. On the structure and theory of hadrons

## 1.0. Introduction. Short review of QCD

Hadrons are particles made from quarks and gluons, bound together by their strong interactions. Hadrons have no net strong charge (or color charge) but they do have residual strong interactions due to their color-charged substructure. The theory, which describes hadrons, is called quantum chromodynamics (QCD).

### 1.1. QCD as the Yang-Mills theory. Generally information

Quantum chromodynamics (QCD) (The Columbia Encyclopedia, 2008) is quantum field theory that describes the properties of the strong interactions between quarks and between protons and neutrons in the framework of quantum field theory .

Quarks possess a distinctive property called color that governs their binding together to form other elementary particles . Color is of three varieties, analogous to electric charge in charged particles, arbitrarily designated as red, blue, and yellow, and - analogous to positive and negative charges - three anticolor varieties. Just as positively and negatively charged particles form electrically neutral atoms, colored quarks form particles without color.

Quarks interact by emitting and absorbing massless particles called gluons , each of which carries a color-anticolor pair. Eight kinds of gluons are required to transmit the strong force between quarks, e.g., a blue quark might interact with a yellow quark by exchanging a blue-antiyellow gluon.

Quantum chromodynamics is the study of the SU(3) Yang–Mills theory, which is a quantum field theory of a special kind called a non-abelian gauge theory. It is an important part of the Standard Model of particle physics (Okun, 1982; 1988; Pich, 2000; Ryder, 1985).

The dynamics of the quarks and gluons are controlled by the quantum chromodynamics Lagrangians. The full QCD Lagrangian is

$$L_{QCD} = L_q + L_G$$

where  $L_q = \sum_{i,\alpha} \psi^{+}_{i,a} (\alpha_{\mu} \hat{D}_{\mu} + m_i) \psi_{i,a}$  is the Lagrangian of quarks,  $L_G = -\frac{1}{4} G_{\mu\nu}^a G_a^{\nu\mu}$ , ( $a = 1,2,\dots,8$ ) is the Lagrangian of gluons, so that

$$L_{QCD} = \sum_{i,\alpha} \psi^{+}_{i,a} (\alpha_{\mu} \hat{D}_{\mu} + m_i) \psi_{i,a} - \frac{1}{4} G_{\mu\nu}^a G_a^{\nu\mu}$$

where  $\psi_{ia}$  is the quark bispinor, a dynamical function of space-time, in the fundamental representation of the SU(3) gauge group;  $i$  is a particle flavour index,  $a$  is a particle colour index,  $m_i$  is a mass of  $i$ -quark;  $G_{\mu} = G_{\mu}^a \lambda_a / 2$ , ( $a = 1,2,\dots,8$ ) are the vector potentials of eight gluon fields, also a dynamical function of space-time, in the adjoint representation of the SU(3) gauge group;  $\lambda_a$  are eight Gell-Mann matrices.  $D_{\mu} = \partial_{\mu} - igG_{\mu}$  is the covariant derivative in QCD (now this is also a matrix). The  $\alpha_{\mu}$  are Dirac matrices connecting the spinor representation to the vector representation of the Lorentz group. The Gell-Mann matrices provide one such representation for the generators.

The symbol  $G_{\mu\nu}^a$  represents the gauge invariant gluonic field strength tensor, analogous to the electromagnetic field strength tensor,  $F^{\mu\nu}$ , in electrodynamics. It is given by  $G_{\mu\nu}^a = \partial_{\mu} G_{\nu}^a - \partial_{\nu} G_{\mu}^a - ig [G_{\mu} G_{\nu} - G_{\nu} G_{\mu}]$ , where the constant  $g$  is the coupling constants of the theory.

## 1.2. Yang-Mills equation in electromagnetic representation

QCD is nearly identical in mathematical structure to quantum electrodynamics (QED) and to the unified theory of weak and electromagnetic interactions. According with Y. Nambu: “The theory of the Yang-Mills fields is the generalization of the Maxwell theory or non-Abelian gauge fields; its equations are nonlinear; in contrast to this, the equations of Maxwell are linear, in other words, Abelian”.

The simplest generalization (Ryder, 1985) is to SU(2). This group, as well as the more complicated ones which are considered in physics, is non-Abelian, so what we are studying is the subject of non-Abelian gauge fields.

The problem is that we are performing a different 'iso-rotation' at each point in space, which we may express by saying that the 'axes' in isospace are oriented differently at each point.

Let us examine the rotations of a certain field vector  $\vec{F}$  about the 3 axis in the internal symmetry space through an infinitely small angle  $\vec{\varphi}$ . The meaning of this angle is that  $|\vec{\varphi}|$  is the angle of rotation, and  $\vec{\varphi}/|\vec{\varphi}|$  is the axis of rotation. Then transition from the initial position of the vector to the final one will be determined by the transformation:

$$\vec{F} \rightarrow \vec{F}' = \vec{F} - \vec{\varphi} \times \vec{F}, \quad (11.1.1)$$

We have then a gauge transformation of the first kind, and is, of course, effectively three equations.

$$\delta\vec{F} = \vec{F}' - \vec{F} = -\vec{\varphi} \times \vec{F}, \quad (11.1.2)$$

In contrast to electrodynamics the present case is more complicated, however, and this is directly traceable to the fact that in the present case the rotations form the group SO(3) which is non-Abelian. Its non-Abelian nature is responsible for that fact that  $\vec{a} \times \vec{b} = -\vec{b} \times \vec{a}$ : the vector product is not commutative. It will be seen below how this complicates matters. These complications have direct physical consequences.

First note that (11.1.2) is an instruction to perform a rotation in the internal space of  $\vec{F}$  through the same angle  $\vec{\varphi}$  at all points in space-time. We modify this to the more reasonable demand that  $\vec{\varphi}$  depends on  $x^\mu$   $\vec{\varphi} = \vec{\varphi}(x^\mu)$  (i.e. that the same relationships are also valid in the four-dimensional space). In this case  $\partial_\mu \vec{F} \rightarrow \partial_\mu \vec{F}' = \partial_\mu \vec{F} - \partial_\mu \vec{\varphi} \times \vec{F} - \vec{\varphi} \times \partial_\mu \vec{F}$ , or

$$\delta(\partial_\mu \vec{F}) = \partial_\mu \vec{F}' - \partial_\mu \vec{F} = -\partial_\mu \vec{\varphi} \times \vec{F} - \vec{\varphi} \times \partial_\mu \vec{F}, \quad (11.1.3)$$

Expressed in words,  $\partial_\mu \vec{F}$  does not transform covariantly, like  $\vec{F}$  does. We must construct a 'covariant derivative'. This will involve introducing a gauge potential analogous to electromagnetic potential  $A_\mu$ . We then write the covariant derivative of the vector  $\vec{F}$  as

$$D_\mu \vec{F} = \partial_\mu \vec{F} + g \vec{W}_\mu \times \vec{F}, \quad (11.1.4)$$

where  $\vec{W}_\mu$  is the gauge potential analogous to  $A_\mu$ . Note that it is a vector in the internal space, whereas  $A_\mu$  only had one component; g is a coupling constant, analogous to electric charge  $e$ .

Analogous to the case of  $A_\mu$  we can write for  $\vec{W}_\mu$ :  $\vec{W}_\mu \rightarrow \vec{W}_\mu - \vec{\varphi} \times \vec{W}_\mu + \frac{1}{g} \partial_\mu \vec{\varphi}$ , or

$$\delta \vec{W}_\mu = -\vec{\varphi} \times \vec{W}_\mu + \frac{1}{g} \partial_\mu \vec{\varphi}, \quad (11.1.5)$$

Let us call the analogue of the field strength  $F_{\mu\nu} = \partial_\mu A_\nu - \partial_\nu A_\mu$  as  $\vec{W}_{\mu\nu}$ . Unlike  $F_{\mu\nu}$ , which is a scalar under SO(2),  $\vec{W}_{\mu\nu}$  will be a vector under SO(3), and so will transform like  $\vec{F}$  itself:

$\delta(\vec{W}_{\mu\nu}) = -\vec{\varphi} \times \vec{W}_{\mu\nu}$ . So if we define

$$\vec{W}_{\mu\nu} = \partial_\mu \vec{W}_\nu - \partial_\nu \vec{W}_\mu + g \vec{W}_\mu \times \vec{W}_\nu, \quad (11.1.6)$$

The field strength  $\vec{W}_{\mu\nu}$  is a vector; so  $\vec{W}_{\mu\nu} \cdot \vec{W}^{\mu\nu}$  is a scalar and will appear in the Lagrangian

$$L = (D_\mu \vec{F}) \cdot (D^\mu \vec{F}) - m^2 \vec{F} \cdot \vec{F} - \frac{1}{4} \vec{W}_{\mu\nu} \cdot \vec{W}^{\mu\nu}, \quad (11.1.7)$$

The equations of motion are obtained by functional variation of this Lagrangian in the usual way from the Euler-Lagrange equation

$$D^\nu \vec{W}_{\mu\nu} = g(D_\mu \vec{F}) \times \vec{F} \equiv g \vec{J}_\mu, \quad (11.1.8)$$

This equation is analogous to Maxwell's equation for the 4-current, so that  $\vec{W}_{\mu\nu}$  is the 'isospin' gauge field,  $\vec{J}_\mu$  is the source or 'matter' term, and instead of ordinary derivatives there are covariant ones. Whereas Maxwell's equations are linear in  $A_\mu$ , however, this equation is non-linear in  $\vec{W}_\mu$ . In the absence of matter Maxwell's equation indicates that there is no source term for the electromagnetic field; on the contrary, the non-Abelian gauge-field equation indicates that the field  $\vec{W}_{\mu\nu}$  acts as a source for itself.

Not everything is different when we go to the non-Abelian case, however. One thing that is the same is that the 'isospin' field  $\vec{W}_{\mu\nu}$ , **must be massless**, just like the electromagnetic field. The reason is the same: to account for a field with mass  $m$ , an extra term

$$L_m = m^2 \vec{W}_\mu \cdot \vec{W}^\mu, \quad (11.1.9)$$

must be added to the Lagrangian. The equation of motion (11.1.8) is then changed to

$$D^\nu \vec{W}_{\mu\nu} = g \vec{J}_\mu + m^2 \vec{W}_\mu, \quad (11.1.10)$$

The term (11.1.9), however, is clearly not gauge invariant, so, as before, we see that gauge invariance implies zero mass for the gauge field.

The non-Abelian generalisation of equations, which are analogous to the homogeneous Maxwell equations  $\partial_\lambda F_{\mu\nu} + \partial_\mu F_{\nu\lambda} + \partial_\nu F_{\lambda\mu} = 0$ , is

$$D_\lambda \vec{W}_{\mu\nu} + D_\mu \vec{W}_{\nu\lambda} + D_\nu \vec{W}_{\lambda\mu} = 0, \quad (11.1.11)$$

Let us note that the procedure of obtaining Yang- Mills equation, described above, cannot be considered as a sequential derivation of the equation. Firstly, because: 'to account for a field with mass  $m$ , an extra term  $L_m = m^2 \vec{W}_\mu \cdot \vec{W}^\mu$  must be added to the Lagrangian'. With the sequential derivation of the equation this term must be obtained automatically. Secondly, this introduction of mass leads to a significant complication of the theory. In particular, 'the 'isospin' field  $\vec{W}_{\mu\nu}$  **must be massless**, just like the electromagnetic field'.

The reason of this, as we have already noted, is the use of potential instead of the field strength. Further we will ascertain that within the framework of NTEP these difficulties do not appear.

### 1.3. A three Dirac spinor model for description of the proton

Attempts to derive the Yang- Mills equation on the basis of his similarity to Dirac's equation were undertaken. An important feature of this enterprise is the treatment of the structure of composite systems consisting of two or three quarks. The general form of the two-spinor wave function was given many years ago by Goldstein (Goldstein, 1953), and these forms have been widely used for the quark-antiquark mesonic system.

For example, in the paper (Henriques, et al., 1975), authors consider the relativistic spin structure of the three-quark baryonic system. The general form of the three-spinor wave function



was developed as a natural extension of the two-spinor system, but the situation is here considerably complicated by the necessity for maintaining the symmetry properties of the wave function under quark interchange.

A relativistic spin  $\frac{1}{2}$  -particle is described by a four-component Dirac spinor, whether the particle is free or bound. In the single particle case, this spinor is the solution of the Dirac equation with an appropriate potential. When two or more spin  $\frac{1}{2}$ -particles mutually interact to form a composite system, the general wave function has the form of a product of the Dirac spinors for the individual constituents.

Goldstein (Goldstein, 1953) has shown that for the two-fermion case, it is convenient to rewrite this direct product of spinors as an outer product, and expand the resulting  $4 \times 4$  matrix representation in terms of the complete set of 16 Dirac matrices. In this representation, operators acting on the second quark are represented by postmatrix multiplication by the transpose of the operator. The two-fermion wave function is written  $\Psi_{\alpha\beta} = \Psi_{\alpha}\Psi_{\beta}$ , where  $\Psi_{\alpha}$  is the individual quark spinor.

For the three-quark system authors develop a similar generalized matrix representation for the direct product of three spinors.

The idea of the wave function of the hadrons in the form of the product of spinor functions, proposed above, was not very popular. Nevertheless, similarity and relationship of the Yang-Mills equation and the Dirac equation follow from NTEP and, as we will show below, can be assumed as the basis of derivation of Yang- Mills equation.

## **1.4. The difficulties and peculiarities of hadron theory**

### **1.4.1. Asymptotic freedom**

Asymptotic freedom is a feature of QCD. The theory of asymptotic freedom states that the interaction between quarks reduces as the distance between them reduces (and hence energy increases), and tends to zero as the distance between them reduces to zero. Conversely, the interaction between them increases as they are separated by larger distances (and hence lower energies).

If a theory requires the presence of Higgs Boson, asymptotic freedom is destroyed. Hence, the electroweak theory is not asymptotically free (or, the electromagnetic and weak forces are asymptotically not free). Also the strong nuclear force obeys the theory of asymptotic freedom.

Another result, originating from the theory of asymptotic freedom, is the quark confinement hypothesis.

### **1.4.2. Quark confinement**

Recalling the implications of the asymptotic freedom, we ultimately see that the force between the two quarks (due to a "colour charge"), increases at lower energies as they are separated more and more from one another. This leads to the idea that free quarks are never seen in isolation.

Color confinement is the physical principle explaining the non-observation of color charged particles like free quarks. Color confinement often simply called confinement. The reasons for quark confinement are somewhat complicated; no analytic proof exists that QCD should be confining, but intuitively, confinement is due to the force-carrying gluons having color charge.

### **1.4.3. Proton spin crisis**

The proton has a definite, measurable mass, electric charge, and spin, and its lifetime is at least as long as the universe is old. On the other hand, the proton has a complicated internal structure. It is composed of different types of quarks held together by the strong force, which is mediated by gluons.

Because the proton has a well-defined spin of  $\frac{1}{2}$ , the spins of the individual bits and pieces inside it should add up to exactly that value. Each quark has a spin of  $\frac{1}{2}$ , and each gluon a spin of 1. Initially, theorists made the naive assumption that two of a proton's quarks align like tops spinning in opposite directions, so their net spin is zero, while the third quark has an

uncompensated spin of  $\frac{1}{2}$ . This configuration leads to an overall spin of  $\frac{1}{2}$  for the proton, provided that the spins of the gluons somehow cancel out.

The first news that the simple quark spin model was inadequate came from the 1988 experiment of European Muon Collaboration (EMC) at the European Laboratory for Particle Physics (CERN) in Geneva. The finding experimental evidence suggests that very little of the proton's spin comes from the spin of the quarks thought to make up the proton (Science News: 4/8/89, p. 215). This apparent paradox was called the *proton spin crisis*.

One check on the experimental results was to perform a similar experiment using neutrons instead of protons. That experiment was done at the Stanford Linear Accelerator Center (SLAC). The results indicated that a neutron's quarks carry roughly 50 percent of its spin (Science News: 9/18/93, p. 191).

Complicating the picture, the number of quarks within the particle can actually fluctuate rapidly with the continuous creation and annihilation of quark-antiquark pairs. In other words, the three constituent quarks speed about within a foaming sea of virtual particles produced by short-lived quantum fluctuations, during which a gluon can momentarily split itself into a quark-antiquark pair.

Most physicists suspected that much of the proton's spin comes from its gluons. In the paper (Balitsky and Xiangdong, 1997) authors calculate that gluons contribute at least half of the proton spin. However, there is scant experimental evidence concerning the gluon's effect on the proton's spin.

A new experiment in 2002 began at CERN, called COMPASS, which stands for Common Muon and Proton Apparatus for Structure and Spectroscopy. It expect to probe the gluon content of the proton by firing high-energy muons at polarized targets and looking for ejected mesons containing the charm quark. It turned out that the contribution of gluons to the spin of proton is less than the contribution of quarks!

Spin crisis is not overcome until now. The scientists attempted to represent the spin of proton by the sum of contributions from quarks, gluons and their orbital angular momentum. Thus, now the basic task is the measurement of the contribution to the spin of proton from the orbital angular momentum of all its components. A series of experiments on the study of the three-dimensional structure of proton will be carried out for this. The COMPASS-II is planned to begin these experiments in 2014.

When these and several related experiments are completed, physicists would have the data to tell of how the proton's constituents give it its spin.

#### **1.4.4. Hadron mass problem**

The hadrons are made up of two (meson) or three (barion) quarks. The lighter barion are proton and neutron. The proton has a mass in energy units of 938.256 MeV while the neutron is 939.550 MeV. The proton and neutron are made from lights quarks. A proton is made up of two u-quarks and one d-quark while a neutron is made from two d-quarks and one u-quark. The lighter particles of meson called Pions that are made from pairs of u- and d-quarks. Pions have masses of 139.6 MeV for  $\text{Pi}^+$  or  $\text{Pi}^-$  and 134.975 MeV for the  $\text{Pi}^0$  (neutral).

If we could produce free quarks we could simply measure their masses just like we have measured the proton, the electron, the neutron and other particles to very high accuracy. But free quarks have not been found so we must derive their properties by a mix of theory and experiments.

One of the reasons that we can't just use simple algebra to get the quark masses is that the quarks are bound tightly together. That is, the composite particle mass is less than the separate quarks would. If we had a theory that could predict the binding energy of the common particles then we could calculate the quark masses correctly. A possible mechanism that extends the Standard Model and accounts for the origin of the masses of the quarks is called the Higgs Mechanism. But until now it could not be confirmed by experiments.

**1) In the framework of Standard Model** (Wikipedia. Quark's Masses) two terms are used in referring to a quark's mass: *current quark mass* refers to the mass of a quark by itself, while *constituent quark mass* refers to the current quark mass plus the mass of the gluon particle field surrounding the quark. These masses typically have very different values. Most of a hadron's mass comes from the gluons that bind the constituent quarks together, rather than from the quarks themselves. While gluons are inherently massless, they possess energy - more specifically, *quantum chromodynamics binding energy* - and it is this that contributes so greatly to the overall mass of the hadron. For example, a proton has a mass of approximately  $938 \text{ MeV}/c^2$ , of which the rest mass of its three valence quarks only contributes about  $11 \text{ MeV}/c^2$ ; much of the remainder can be attributed to the gluons' binding energy.

The current quark mass is a logical consequence of the mathematical formalism of the QFT, thus it is from a not descriptive origin. The current quark mass is a parameter to compute sufficiently small color charges. The current quark mass is also called the mass of the 'bare' quarks. The mass of the *current quark* is reduced by the term of the *constituent quark covering mass*. Therefore the current quark masses of the light current quarks are much smaller than the constituent quark masses.

At present large efforts are applied in order to calculate the mass of the hadrons on the basis of chiral symmetry breakdown approach. But this approach has the serious limitations

## 2) Chiral symmetry breakdown approach

The QCD Lagrangian (Ioffe, 2006; Manohar and Sachrajda, 2010) has a chiral symmetry in the limit that the quark masses vanish. This symmetry is spontaneously broken by dynamical chiral symmetry breaking, and explicitly broken by the quark masses. The nonperturbative scale of dynamical chiral symmetry breaking,  $\Lambda_\chi$ , is around  $1 \text{ GeV}$ . It is conventional to call quarks heavy if  $m > \Lambda_\chi$ , so that explicit chiral symmetry breaking dominates (c, b, and t quarks are heavy), and light if  $m < \Lambda_\chi$ , so that spontaneous chiral symmetry breaking dominates (u, d and s quarks are light).

The origin of the mass of the matter will be clarified when the mechanism of chiral symmetry breaking in QCD is established.

Two approaches exist, which are close to the approach, which is used in NTEP.

## 3) Approach on the basis of nonlinear Heisenberg theory

Within the framework of the Heisenberg variant of the unified nonlinear spinor theory of elementary particles an attempt is made to calculate the mass of the fundamental fermion (proton) (Naumov, 1965). The guiding principle is here the notion of the existence of a relation between the helicity properties of particles and their masses. In this case it proves necessary to take into account the possibility of degeneracy of the vacuum of the system of interacting fields in certain quantum numbers. A program is outlined for constructing a realistic scheme of elementary particles to include their isotropic and "strange" properties. The possibility of eliminating divergences from the nonlinear theory, while preserving its applicability, by means of a somewhat modified perturbation theory is briefly discussed.

## 4) Approach on the basis of electromagnetic theory and QED

Motivated by the need to understand hadron masses, in the article (Xiangdong and Wei, 1998), the authors return to an old problem - the composition of the electron mass. They showed that in the unrenormalized representation of electron, the vacuum subtraction plays an important role in understanding basic sources of the electron mass.

From the formal side of quantum field theory, one can see a number of similarities between the proton and electron. Both of them are elementary excitations of the field theoretical vacua. In the case of the proton, they are the bare or renormalized quarks and gluons, while in the case of the electron, they are the bare or renormalized electrons and photons. Additionally, both the electron and proton are stable, and have lower energy level in their families.

Hence, it is possible to hope to learn some field theoretical aspects of the proton through studying the simpler electron. In this case the understanding of the internal structure of hadrons, the proton in particular, is perhaps one of the most important problem in theoretical physics.

As authors note, a consistent formulation of the electron mass problem became possible only after Dirac proposed his positron theory – the precursor of QED. According to modern interpretation, the basic building blocks in the theory are the *bare electrons and photons*, which are defined when the electromagnetic interactions were turned off. Clearly then, they are not physically observable particles. The bare electron does have a mass (the bare mass), but question is if it has the electromagnetic origin.

We note that question about electromagnetic mass examined R. Feynman in his lectures (Feynman et al., 1964) in chapter 28. “Electromagnetic mass”, where Feynman concludes : “So we come back again to the original idea of Lorentz - may be all the mass of an electron is purely electromagnetic, maybe the whole 0.511 MeV is due to electro-dynamics. Is it or isn't it? We haven't got a theory, so we cannot say”.

Note that since in the NTEP it is shown that the electron mass is only the electromagnetic mass, the approach of the authors (Xiangdong and Wei, 1998) is completely consistent.

When the electromagnetic interaction is turned on, the QED vacuum becomes nontrivial and the vacuum excitations produce a physical particle whose quantum numbers are the same as those of the bare electron. Pictorially this physical electron contains a bare electron in the QED vacuum plus the vacuum polarizations. Because of the small electromagnetic coupling, the structure of the physical electron can be calculated perturbatively using the bare degrees of freedom. Hence the physical mass of the electron can be “explained” in terms of the bare electron mass plus the contributions from the electromagnetic interactions. In light of the fact that the physical mass is observable while the bare mass is not, such an explanation is not practically interesting and is usually ignored in modern textbooks. However, as we shall advocate in this paper, the explanation may help to understand some interesting aspects of the proton bound state about which we know very little in QCD.

In other papers (Xiangdong, 1994; Xiangdong, 2006)) author shows that an insight on the mass structure of the nucleon can be produced within QCD with the help of the deep-inelastic momentum sum rule and the trace anomaly. The result is a separation of the nucleon mass into the contributions from the quark, antiquark, gluon kinetic and potential energies, the quark masses, the gluon trace anomaly. Numerically, the only large uncertainty is the size of matrix element  $\langle P | m_s \bar{s}s | P \rangle$ , the strange scalar charge of the nucleon. Some implications of this break-up of the masses are obtained. The complete result of the mass decomposition at the scale of  $\mu^2 = 1 \text{ GeV}^2$ , together with the two numerical estimates, is shown Table 1.

Table 1. A decomposition of the nucleon mass into different contributions.

mass type	$H_i$	$M_i$	$m_s \rightarrow 0(\text{MeV})$	$m_s \rightarrow \infty(\text{MeV})$
quark energy	$\bar{\psi}(-i\mathbf{D} \cdot \boldsymbol{\alpha})\psi$	$3(a - b)/4$	270	300
quark mass	$\bar{\psi}m\psi$	$b$	160	110
gluon energy	$\frac{1}{2}(\mathbf{E}^2 + \mathbf{B}^2)$	$3(1 - a)/4$	320	320
trace anomaly	$\frac{9\alpha_s}{16\pi}(\mathbf{E}^2 - \mathbf{B}^2)$	$(1 - b)/4$	190	210
<b>Total</b>			<b>940</b>	<b>940</b>

#### 1.4. 5. Hadron properties of photon and electron

During the recent decades high-energy photon interactions are discussed (Bauer et al., 1978) in terms of the hadronic structure of the photon. Experiments demonstrate and yield information about this hadronic structure.

The concept of the photon originated in the first years of quantum mechanics, and the study of electromagnetic interactions with matter has played a prominent role throughout the history of

quantum theory. At first, the photon was regarded as structureless, and the theory was very successful in predicting various spectral lines and their intensities and in understanding other processes such as the atomic photoeffect.

Pair production occurs because of the basic interactions  $\gamma \leftrightarrow e^- + e^+$  required by relativistic quantum theory. These interactions are between "bare" states described by a "free Hamiltonian". Physical particle states, however, are eigenstates of the complete Hamiltonian. Therefore, a physical particle state contains not only the corresponding bare particle state, but also contributions from all bare states coupled to it by the interaction.

Accordingly, with the above interaction, the physical photon has an electron-positron pair constituent. It is possible to think of pair production as arising through the scattering of this constituent by the Coulomb potential, permitting the pair to actually materialize, provided that the energy available is sufficiently high, i.e.,  $> 2m_e c^2$ . At low energies ( $\ll 2m_e c^2$ ), the virtual  $e^- e^+$  pair does not manifest itself in a very pronounced way, although it does of course play an important role in refined quantum-electrodynamic effects. This illustrates the point that *at different energy scales, different aspects of the underlying dynamics become visible*.

When the first experiments on photoproduction of pions and electron scattering from nucleons were carried out, the photon (real or virtual) was for purposes of hadronic interactions again regarded as structureless. Within the last years, there has been a growing awareness that this is too simple a view, and that in reality the photon has an internal structure which is very similar to that of hadrons. Special attention is paid to diffractive processes such as the photoproduction of *vector mesons* and to photon shadowing effects on nuclei.

The ability of interacting high-energy photons to assume a broad range of masses (Murphy and Yount, 1971) is crucial in understanding the hadronic character of light since it allows interacting photons to take on the masses and attributes of vector mesons. The uncharged members of a certain class of particles called vector mesons have the same quantum numbers as the photon. However, even in their free, real state they are not massless, and they interact strongly with other mesons and with nucleons (i.e., they are hadrons).

In 1 GeV range three vector mesons are presently known: the rho, the omega, and the phi. The charge of the rho can be positive, negative, or zero, while the omega and phi exist only with zero charge. (Photons, being neutral, couple strongly only to neutral vector mesons.)

In this energy range the quark model predicts that the photon should behave as if it were 75% rho, 8% omega, and 17% phi. This really means, of course, that in a large sample of interactions the photon will behave as a rho in 75% of the interactions, as an omega in 8%, and as a phi in 17%.

Mathematically for obtaining this result the standard expansion of unity into the theories of the linear operators is used:

$$1 = \sum |H(x)\rangle\langle H(x)|$$

where  $|H(x)\rangle$  are hadron wave functions, which form a complete basis. In the general case unit is a unit matrix. A unit, (unit matrix) is obtained regarding the complete basis. In order to obtain expansion, it is necessary to act by this unit on the wave function of the photon  $|\Phi(x)\rangle$ :

$$|\Phi(x)\rangle = 1 \cdot |\Phi(x)\rangle = \sum |H(x)\rangle\langle H(x)||\Phi(x)\rangle = \sum c(x, y) |H(x)\rangle$$

and  $c(x, y)$  are assumed as the coefficients of the expansion of photon into hadrons. In this case it is considered that all known vector mesons form a complete basis. In the expansion of photon the ground states play a main role, and the contributions of excited states are small.

The most elegant method for studying the vector-meson composition of the photon is clearly the colliding electron and positron beams in which the production of the vector mesons is well isolated from other, potentially confusing, interactions. The reaction  $e^+ e^- \rightarrow e^+ e^- p \bar{p}$  is studied (The L3 Collaboration, 2003) with the L3 detector at LEP. Electron-positron colliders are a

suitable place for the study of two-photon interactions via the process  $e^+e^- \rightarrow e^+e^-\gamma^*\gamma^* \rightarrow e^+e^-X$ , where  $\gamma^*$  denotes a virtual photon.

The knowledge of the structure of the photon is presented in the paper (Nisius, 2000) with emphasis on measurements of the photon structure obtained from deep inelastic electron-photon scattering at  $ee^+$ -collider.

## 2.0. The hadron theory: target setting

According to the axiomatics, accepted in NTEP, the reason for the generation of massive elementary particles is the rotatory transformation of mass-free electromagnetic wave fields. Moreover, within the framework of NTEP it is shown that all characteristics of particles must appear uniformly from the transformations of electromagnetic wave fields.

In the chapters 4, 5 we have shown that for the generation of leptons the rotatory transformation in the plane is necessary. To this corresponds the group structure of the electro-weak interaction  $SU(2) \times U(1)$ .

Since  $SU(3)$  gauge invariance group describes the rotation in the three-dimensional space, we assume that the fields' rotation in the coordinate representation, according to the postulate of nonlinearity of NTEP, in this case must be achieved in the three-dimensional space

In the framework of the Standard Model theory the quark family is analogue to the lepton family and the Yang-Mills equation is some generalisation of the Dirac electron equation. In Quantum Chromodynamics we have quarks instead of electrons and gluons instead of photons, between which there are the strong interactions instead of electromagnetic interactions. Thus, formally, we can say that hadrons are described by two (meson) or three (barion) Dirac's lepton equations. Thus, we can name the Dirac's lepton equation conditionally as a "one quark" equation. Based on this analogy we suppose that:

1) the electromagnetic representation of the hadrons is similar to the electromagnetic representation of the leptons;

2) the hadron Lagrangian and equation are composed from two or three Lagrangian (or equations) of the lepton types, i.e. by two or three Dirac's equation Lagrangian (or Dirac's equation).

In other words, we suppose that the lepton Lagrangian or equation is conditionally the «one quark» Lagrangian or equation and the Yang-Mills equation "contains" three Dirac electron equation, as some their superposition (what means "it contains", we will refine more lately)

Therefore before passing to the derivation of the equation of hadrons, we will briefly recall the results of the theory of photons and leptons.

Our strategy is to proceed as far as possible in analogy with the case of electromagnetism.

## 3.0. The quantum and electromagnetic forms of the "one quark" equation

### 3.1. Derivation of electromagnetic form of one-quark equation

Within the framework of QED (Akhiezer and Berestetskii, 1969; Gottfried, and Weisskopf, 1984), the Maxwell equations are considered as field equations which describe the quantum mechanical state of photons or a photon system, taking into account the quantization rules for energy and wave vector  $\omega = \varepsilon/\hbar$  and  $k = p/\hbar$ . The wave equations, in which wave functions  $\vec{E}$  and  $\vec{H}$  are vectors of the electromagnetic (EM) field, are the consequence of Maxwell equations:

$$\begin{aligned} \Delta \vec{E} - \frac{1}{c^2} \frac{\partial^2 \vec{E}}{\partial t^2} &= 0 \\ \Delta \vec{H} - \frac{1}{c^2} \frac{\partial^2 \vec{H}}{\partial t^2} &= 0 \end{aligned} \quad , \quad (11.3.1)$$

An plane electromagnetic wave, propagating in any direction (e.g.,  $y$ -direction), can have two line polarizations ( $E_x, H_z$ ) and ( $E_z, H_x$ ) or one circular polarization ( $E_x, E_z, H_x, H_z$ ); thus it contains only four component of field vectors:

$$\vec{\Phi}(y) = \{E_x, E_z, H_x, H_z\}, \quad (11.3.2)$$

and  $E_y = H_y = 0$  for all transformations. In this case the EM wave equations (11.3.1) can be rewrite as following:

$$\left( \frac{\partial^2}{\partial t^2} - c^2 \vec{\nabla}^2 \right) \vec{\Phi}(y) = 0, \quad (11.3.3)$$

where  $\vec{\Phi}(y)$  is any of the above electromagnetic wave field vectors (11.3.2). Taking into account that  $\hat{\varepsilon} = i\hbar(\partial/\partial t)$ ,  $\hat{p} = -i\hbar\vec{\nabla}$  are correspondingly the operators of energy and momentum, and

$$(\hat{\alpha}_0 \hat{\varepsilon})^2 = \hat{\varepsilon}^2, \quad (\hat{\alpha} \hat{p})^2 = \hat{p}^2, \quad (11.3.4)$$

where  $\hat{\alpha}_0$ ;  $\hat{\alpha}$ ;  $\hat{\beta} \equiv \hat{\alpha}_4$  are Dirac's matrices, the equation (11.3.3) can also be represented in a matrix form:

$$\left[ (\hat{\alpha}_0 \hat{\varepsilon})^2 - c^2 (\hat{\alpha} \hat{p})^2 \right] \Phi = 0, \quad (11.3.5)$$

Factoring (11.3.5) and multiplying it on the left by the Hermitian-conjugate function  $\Phi^+$ , we get:

$$\Phi^+ (\hat{\alpha}_0 \hat{\varepsilon} - c \hat{\alpha} \hat{p}) (\hat{\alpha}_0 \hat{\varepsilon} + c \hat{\alpha} \hat{p}) \Phi = 0, \quad (11.3.6)$$

Equation (11.3.6) may be broken down into two Dirac-like equations without mass:

$$\begin{cases} (\hat{\alpha}_0 \hat{\varepsilon} + c \hat{\alpha} \hat{p}) \Phi = 0 \\ \Phi^+ (\hat{\alpha}_0 \hat{\varepsilon} - c \hat{\alpha} \hat{p}) = 0 \end{cases}, \quad (11.3.7)$$

Note that the system of equations (11.3.7) is identical to the equation (11.3.5) and can be represented (Akhiezer and Berestetskii, 1965; Levich, Myamlin and Vdovin, 1973) as a system of quantum equations for a photon in Hamilton's form. At the same time in the electromagnetic interpretation they are the equations of EM waves.

Actually, it is not difficult to show that only in the case when the  $\Phi(y)$ -matrix has the form:

$$\Phi(y) = \begin{pmatrix} \Phi_1 \\ \Phi_2 \\ \Phi_3 \\ \Phi_4 \end{pmatrix} = \begin{pmatrix} E_x \\ E_z \\ iH_x \\ iH_z \end{pmatrix}, \quad \Phi^+(y) = (E_x \quad E_z \quad -iH_x \quad -iH_z), \quad (11.3.8)$$

the equations (11.3.7) are the right Maxwell-like equations of the retarded and advanced electromagnetic waves. Actually, substituting (11.3.8) into (11.3.7), we obtain:

$$\left\{ \begin{array}{l} \frac{1}{c} \frac{\partial E_x}{\partial t} - \frac{\partial H_z}{\partial y} = 0 \\ \frac{1}{c} \frac{\partial H_z}{\partial t} - \frac{\partial E_x}{\partial y} = 0 \\ \frac{1}{c} \frac{\partial E_z}{\partial t} + \frac{\partial H_x}{\partial y} = 0 \\ \frac{1}{c} \frac{\partial H_x}{\partial t} + \frac{\partial E_z}{\partial y} = 0 \end{array} \right. , \quad (11.3.9')$$

$$\left\{ \begin{array}{l} \frac{1}{c} \frac{\partial E_x}{\partial t} + \frac{\partial H_z}{\partial y} = 0 \\ \frac{1}{c} \frac{\partial H_z}{\partial t} + \frac{\partial E_x}{\partial y} = 0 \\ \frac{1}{c} \frac{\partial E_z}{\partial t} - \frac{\partial H_x}{\partial y} = 0 \\ \frac{1}{c} \frac{\partial H_x}{\partial t} - \frac{\partial E_z}{\partial y} = 0 \end{array} \right. , \quad (11.3.9'')$$

For waves of any other direction the same results can be obtained by cyclic transposition of indices, or by a canonical transformation of matrices and wave functions. In the quantum form the wave function (11.3.8), regardless the direction of initial EM wave, does not have coordinate, but numerical indices, for the simple reason that the plane waves of any direction are equal. The same is correct for the equations of the massive particles, obtained further.

### 3.2. The intermediate photon and mass generation theory

In the NTEP, in contrast to SM, only a quantum of electromagnetic wave (photon) does not have mass. The postulate of generation of massive particles is: *the fields of an electromagnetic wave quantum must undergo a rotation transformation and breaking of the initial symmetry to generate the massive particle.*

The rotation transformation can be conditionally written in the following form:

$$\hat{R}\Phi \rightarrow \Phi', \quad (11.3.10)$$

where  $\hat{R}$  is the rotation operator for the transformation of a photon wave fields from linear state to curvilinear state, and  $\Phi'$  is some final wave function:

$$\Phi' = \begin{pmatrix} \Phi'_1 \\ \Phi'_2 \\ \Phi'_3 \\ \Phi'_4 \end{pmatrix} = \begin{pmatrix} E'_x \\ E'_z \\ iH'_x \\ iH'_z \end{pmatrix}, \quad (11.3.11)$$

which appears after the nonlinear transformation (11.3.1); here,  $(E'_x \ E'_z \ -iH'_x \ -iH'_z)$  are electromagnetic field vectors after the rotation transformation, which correspond to the wave functions  $\Phi'$ .

### 3.3. The description of rotation transformation in differential geometry

According to Maxwell (Jackson, 1999), the following term of equations (11.3.7)  $\hat{\alpha}_0 \hat{\epsilon} \Phi = i\hbar \frac{\partial \Phi}{\partial t}$  contains the Maxwell's displacement current

$$j_{dis} = \frac{1}{4\pi} \frac{\partial \vec{E}}{\partial t}, \quad (11.3.12)$$

The electrical field vector  $\vec{E}$ , which moves along the curvilinear trajectory, can be written in the form:

$$\vec{E} = -E \cdot \vec{n}, \quad (11.3.13)$$

where  $E = |\vec{E}|$ , and  $\vec{n}$  is the normal unit-vector of the curve, directed, e.g., to the center of ring.

Then:



$$\frac{\partial \vec{E}}{\partial t} = -\frac{\partial \vec{E}}{\partial t} \vec{n} - E \frac{\partial \vec{n}}{\partial t}, \quad (11.3.14)$$

Here, the first term has the same direction as  $\vec{E}$ . The existence of the second term shows that at the rotation transformation an additional displacement current appears. It is not difficult to show that it has a direction tangential to the curve (e.g., ring):

$$\frac{\partial \vec{n}}{\partial t} = -v_p K \vec{\tau}, \quad (11.3.15)$$

where  $\vec{\tau}$  is the tangential unit-vector,  $v_p \equiv c$  is the electromagnetic wave velocity,  $K = 1/r_p$  is the curvature of the trajectory, and  $r_p$  is the curvature radius. Thus, the displacement current of the plane wave, moving along the ring, can be written in the following form:

$$\vec{j}_{dis} = -\frac{1}{4\pi} \frac{\partial E}{\partial t} \vec{n} + \frac{1}{4\pi} \omega_p E \cdot \vec{\tau}, \quad (11.3.16)$$

where  $\omega_p = \frac{m_p c^2}{\hbar} = \frac{v_p}{r_p} \equiv cK$  is an angular velocity,  $m_p c^2 = \varepsilon_p$  is photon energy, where  $m_p$  is

some mass, corresponding to the energy  $\varepsilon_p$ . Obviously, the terms  $\vec{j}_n = \frac{1}{4\pi} \frac{\partial E}{\partial t} \vec{n}$  and

$\vec{j}_\tau = \frac{\omega_p}{4\pi} E \cdot \vec{\tau}$  are the normal and tangent components of the displacement current of the rotated electromagnetic wave accordingly.

### 3.4. A description of the rotation transformation in Riemann geometry

In order to generalize the Dirac equation in the form of Riemann geometry, we must replace the usual derivative  $\partial_\mu \equiv \partial / \partial x_\mu$  (where  $x_\mu$  are the co-ordinates in the 4-space) with the covariant derivative:

$$D_\mu = \partial_\mu + \Gamma_\mu, \quad (11.3.17)$$

where  $\mu = 0, 1, 2, 3$  are the summing indices, and  $\Gamma_\mu$  is the analogue of Christoffel's symbols in the case of spinor theory, which are called Ricci symbols (or connection coefficients). When a spinor moves along a straight line, all the symbols  $\Gamma_\mu = 0$ , and we have the usual derivative. However, if the spinor moves along the curvilinear trajectory, not all  $\Gamma_\mu$  are equal to zero, and in this case an additional term appears. Typically, the last term is not the derivative, but is equal to a product of the spinor itself with some coefficient  $\Gamma_\mu$ , which is an increment in the spinor. It is easy to see that the tangent current  $j_\tau$  corresponds to the Ricci connection coefficients (symbols)  $\Gamma_\mu$ .

According to the general theory (Sokolov and Ivanenko, 1952), we can obtain as an additional term the following term:

$$\hat{\alpha}_\mu \Gamma_\mu = \hat{\alpha}_0 \varepsilon_p + \hat{\alpha} \vec{p}_p, \quad (11.3.18)$$

where  $\varepsilon_p$  and  $p_p$  are the photon's energy and momentum respectively (not the operators). Taking into account that according to the law of conservation of energy  $\hat{\alpha}_0 \varepsilon_p + \hat{\alpha} \vec{p}_p = \pm \hat{\beta} m_p c^2$ , we can see that the additional term contains mass of the transformed wave as a tangential current. If we represent the energy and momentum of the intrinsic field in

equation (11.3.18), using the 4-potentials  $A_\mu$ , which is the gauge field within the framework of SM, we obtain:

$$\hat{\alpha}_\mu \Gamma_\mu = \hat{\alpha}_0 \varepsilon_p + \hat{\alpha} \vec{p}_p = e \alpha_\mu A^\mu \quad (11.3.19)$$

According to the analysis (Ryder, 1985), the gauge transformation is the rotation transformation of the field in the space of internal symmetry. In general case of a vector  $V^\mu$ , its covariant derivative is

$$D_\nu V^\mu = \partial_\nu V^\mu + \Gamma_{\lambda\nu}^\mu V^\lambda, \quad (11.3.20)$$

The quantities  $\Gamma_{\lambda\nu}^\mu$ , called the Christoffel's symbols or 'connection coefficients', clearly play a role of the vector potentials  $A_\mu^a$ , which often are also called connection coefficients. In quantum field theory in case of a vector parallel transport (Kaempffer, 1965; Ryder, 1985) the equation

$$\frac{D\psi}{dx^\mu} = D_\mu \psi = \left( \partial_\mu - ig M^a A_\mu^a \right) \psi, \quad (11.3.21)$$

defines the covariant derivative of an arbitrary field  $\psi$  transforming under an arbitrary group, whose generators are represented by the matrices  $M^a$  appropriate to the representation of  $\psi$ .

### 3.5. An equation of the massive intermediate photon

As it follows from the previous sections, some additional terms  $K = \hat{\beta} m_p c^2$ , where  $m_p$  is mass of some intermediate photon and  $m_p c^2 = \varepsilon_p$  is intermediate photon own energy, must appear in equation (2.2.6). Thus we have:

$$\left( \hat{\alpha}_0 \hat{\varepsilon} - c \hat{\alpha} \cdot \hat{p} - K \right) \left( \hat{\alpha}_0 \hat{\varepsilon} + c \hat{\alpha} \cdot \hat{p} + K \right) \Phi' = 0, \quad (11.3.22)$$

or

$$\left( \hat{\varepsilon}^2 - c^2 \hat{p}^2 - m_p^2 c^4 \right) \Phi' = 0, \quad (11.3.23)$$

Equation (4.4.2) is similar to the Klein-Gordon equation, which describes the massive **scalar** field. It is not difficult to prove, using an electromagnetic form, that (4.4.2) is an equation of a massive **vector** particle.

### 3.6. The intermediate photon symmetry breaking

Factorizing (4.4.2) and multiplying it on the left side by  $\Phi'^+$ , we obtain:

$$\Phi'^+ \left( \hat{\alpha}_0 \hat{\varepsilon} - c \hat{\alpha} \cdot \hat{p} - \hat{\beta} m_p c^2 \right) \left( \hat{\alpha}_0 \hat{\varepsilon} + c \hat{\alpha} \cdot \hat{p} + \hat{\beta} m_p c^2 \right) \Phi' = 0, \quad (11.3.24)$$

Now, we can separate the intermediate photon equation (11.3.1) into two massive waves, *advanced* and *retarded*, in order to obtain two new equations for the massive particles:

$$\left[ \left( \hat{\alpha}_0 \hat{\varepsilon} + c \hat{\alpha} \cdot \hat{p} \right) + \hat{\beta} m_p c^2 \right] \psi = 0, \quad (11.3.25')$$

$$\psi^+ \left[ \left( \hat{\alpha}_0 \hat{\varepsilon} - c \hat{\alpha} \cdot \hat{p} \right) - \hat{\beta} m_p c^2 \right] = 0, \quad (11.3.25'')$$

where

$$\psi = \begin{pmatrix} \psi_1 \\ \psi_2 \\ \psi_3 \\ \psi_4 \end{pmatrix} = \begin{pmatrix} E_x \\ E_z \\ iH_x \\ iH_z \end{pmatrix}, \quad \psi^+ = (E_x \quad E_z \quad iH_x \quad iH_z), \quad (11.3.26)$$

is some new transformed EM wave function, which appears after the intermediate photon symmetry breaking. In the case of an electron-positron pair production, it must be  $m_p = 2m_e$ . So, we have from (11.3.25):

$$\left[ (\hat{\alpha}_0 \hat{\varepsilon} + c \hat{\alpha} \hat{p}) + 2\hat{\beta} m_e c^2 \right] \psi = 0, \quad (11.3.27')$$

$$\psi^\dagger \left[ (\hat{\alpha}_0 \hat{\varepsilon} - c \hat{\alpha} \hat{p}) - 2\hat{\beta} m_e c^2 \right] = 0, \quad (11.3.27'')$$

Thus during the breaking of the intermediate photon, the non-charged massive particle is divided into two charged massive particle, which we conditionally can name as **semi-photons**. Obviously, the equations, which originate after the breaking-up of the intermediate photon, cannot be free positive and negative particle equations, but they have to be the particle equations with an external field.

Using a linear equation for the description of the law of energy conservation, we can write:

$$\pm \hat{\beta} m_e c^2 = -\varepsilon_{ex} - c \hat{\alpha} \vec{p}_{ex} = -e\varphi_{ex} - e \hat{\alpha} \vec{A}_{ex}, \quad (11.3.28)$$

where “ex” is indices of “external” fields. Substituting (11.3.28) into (11.3.27), we obtain the Dirac equations with an external field, which appears in the theory automatically:

$$\left[ (\hat{\alpha}_0 \hat{\varepsilon} + c \hat{\alpha} \hat{p}) + (\hat{\alpha}_0 \varepsilon_{ex} + c \hat{\alpha} \vec{p}_{ex}) + \hat{\beta} m c^2 \right] \psi = 0, \quad (11.3.29')$$

$$\psi^\dagger \left[ (\hat{\alpha}_0 \hat{\varepsilon} - c \hat{\alpha} \hat{p}) - (\hat{\alpha}_0 \varepsilon_{ex} - c \hat{\alpha} \vec{p}_{ex}) - \hat{\beta} m c^2 \right] = 0, \quad (11.3.29'')$$

Or in short

$$\left[ \hat{\alpha}_0 (\hat{\varepsilon} \mp \varepsilon_{ex}) + c \hat{\alpha} \cdot (\hat{p} \mp \vec{p}_{ex}) + \hat{\beta} m_e c^2 \right] \psi = 0, \quad (11.3.30)$$

On the other hand, the electron's own mass is formed due to the self-action of the fields of electron as an inherent characteristic of the electron:

$$\pm \hat{\beta} m_e c^2 = -\varepsilon_{in} - c \hat{\alpha} \vec{p}_{in} = -e\varphi_{in} - e \hat{\alpha} \vec{A}_{in}, \quad (11.3.31)$$

so that any interaction energy we can be considered as additional mass.

### 3.7. Electromagnetic representation of one-quark and one-antiquark equations

In the case of the linear polarized waves we will obtain from (11.3.3) two pairs of independent *spinor* equations for the electron and the positron, which contain only electric currents. This equations in the electromagnetic form are:

$$\left\{ \begin{array}{l} \frac{1}{c} \frac{\partial E_x}{\partial t} - \frac{\partial H_z}{\partial y} = -i \frac{4\pi}{c} j_x^e \\ \frac{1}{c} \frac{\partial H_z}{\partial t} - \frac{\partial E_x}{\partial y} = 0 \end{array} \right. , \quad (11.3.33') \quad \left\{ \begin{array}{l} \frac{1}{c} \frac{\partial E_x}{\partial t} + \frac{\partial H_z}{\partial y} = -i \frac{4\pi}{c} j_x^e \\ \frac{1}{c} \frac{\partial H_z}{\partial t} + \frac{\partial E_x}{\partial y} = 0 \end{array} \right. , \quad (11.3.33'')$$

$$\left\{ \begin{array}{l} \frac{1}{c} \frac{\partial E_z}{\partial t} + \frac{\partial H_x}{\partial y} = -i \frac{4\pi}{c} j_z^e \\ \frac{1}{c} \frac{\partial H_x}{\partial t} + \frac{\partial E_z}{\partial y} = 0 \end{array} \right. , \quad (11.3.34') \quad \left\{ \begin{array}{l} \frac{1}{c} \frac{\partial E_z}{\partial t} - \frac{\partial H_x}{\partial y} = -i \frac{4\pi}{c} j_z^e \\ \frac{1}{c} \frac{\partial H_x}{\partial t} - \frac{\partial E_z}{\partial y} = 0 \end{array} \right. , \quad (11.3.34'')$$

In the case of the circularly polarized wave we will obtain one bispinor equation for the neutrino and one for the antineutrino, which contain alternating electrical and magnetic currents. These equations in the electromagnetic form are:

$$\left\{ \begin{array}{l} \frac{1}{c} \frac{\partial E_x}{\partial t} - \frac{\partial H_z}{\partial y} = -i \frac{4\pi}{c} j_x^e \\ \frac{1}{c} \frac{\partial H_z}{\partial t} - \frac{\partial E_x}{\partial y} = i \frac{4\pi}{c} j_z^m \\ \frac{1}{c} \frac{\partial E_z}{\partial t} + \frac{\partial H_x}{\partial y} = -i \frac{4\pi}{c} j_z^e \\ \frac{1}{c} \frac{\partial H_x}{\partial t} + \frac{\partial E_z}{\partial y} = i \frac{4\pi}{c} j_x^m \end{array} \right. , \quad (11.3.35') \quad \left\{ \begin{array}{l} \frac{1}{c} \frac{\partial E_x}{\partial t} + \frac{\partial H_z}{\partial y} = -i \frac{4\pi}{c} j_x^e \\ \frac{1}{c} \frac{\partial H_z}{\partial t} + \frac{\partial E_x}{\partial y} = i \frac{4\pi}{c} j_z^m \\ \frac{1}{c} \frac{\partial E_z}{\partial t} - \frac{\partial H_x}{\partial y} = -i \frac{4\pi}{c} j_z^e \\ \frac{1}{c} \frac{\partial H_x}{\partial t} - \frac{\partial E_z}{\partial y} = i \frac{4\pi}{c} j_x^m \end{array} \right. , \quad (11.3.35'')$$

### 3.8. The Dirac and the Yang-Mills equations

As it follows from the Standard Model theory (Pich, 2000; Peak and Varvell ; Okun, 1982), the quark family is analogue to a lepton family, and the Yang-Mills equation is the generalization of the Dirac's electron equation.

In short the Dirac lepton equation for an electron in the external field can be written in the form:

$$\hat{\alpha}_\mu (\hat{p}_\mu + p_\mu^e) \psi + \hat{\beta} m_e c^2 \psi = 0 \quad (11.1.36)$$

where  $\mu = 0, 1, 2, 3$ ,  $\hat{p}_\mu = \{\hat{\varepsilon}, c\hat{p}\}$  is operator of energy and momentum,  $p_\mu^e = \{\varepsilon_{ex}^e, c\vec{p}_{ex}^e\}$  is energy and momentum in the external electromagnetic field, where  $\varepsilon_{ex}^e = e\varphi$ ,  $\vec{p}_{ex}^e = \frac{e}{c} \vec{A}$ .

The Yang-Mills equation for one quark may be written similarly to (11.1.1) as follows (Pich, 2000; Peak and Varvell ; Okun, 1982):

$$\hat{\alpha}_\mu (\hat{p}_\mu + p_\mu^q) \psi_q + \hat{\beta} m_q c^2 \psi_q = 0, \quad (11.1.37)$$

where  $\psi_q$  are the quark wave function,  $p_\mu^q \equiv icg\vec{A}_\mu$  with  $\vec{A}_\mu = \frac{1}{2} \sum_{a=1}^8 A_\mu^a \lambda_a$  is the potential of the gluon field,  $\lambda_a$  are Gell-Mann matrices,  $g$  is a strong charge, and  $m_q$  is a quark mass. Thus, we have quarks instead of lepton, gluons instead of photons, and strong interactions instead of electromagnetic interactions.

### 4.0. The derivation of Yang-Mills equation within the framework of NEPT

Let us assume that hadrons are some superposition of semi-photons and attempt to find the equations which describe this superposition of two or three semi-photons.

From above follows that the appearing of the lepton current, mass and interaction are the result of the same process – the rotation transformation and symmetry breaking of free EM wave quantum. According to postulates of NTEP the similar must occur in the case of hadrons.

But an essential difference there is here. The Dirac equation (11.1.36) is not a free lepton (e.g., electron) equation: the external field terms are used in Dirac's equation for the description of interaction between the electron and other particles. At the same time, the equation (11.1.37) is the equation of one "free" quark within the hadron and the interaction terms in the Yang-Mills equation must describe the internal field of a quark-quark interaction within the same hadron.

The fermions of the Standard Model are classified according to how they interact (or equivalently, by what charges they carry). There are six quarks (up, down, charm, strange, top, bottom), and six leptons (electron, electron neutrino, muon, muon neutrino, tau, tau neutrino). Pairs from each classification are grouped together to form a *generation*, with corresponding particles exhibiting similar physical behavior (see table).

	First generation		Second generation		Third generation	
Quarks	Up	u	Charm	c	Top	t
	Down	d	Strange	s	Bottom	b
Leptons	Electron	e <sup>-</sup>	Muon	μ <sup>-</sup>	Tau	τ <sup>-</sup>
	Electron neutrino	ν <sub>e</sub>	Muon neutrino	ν <sub>μ</sub>	Tau neutrino	ν <sub>τ</sub>

On this base we can suppose that first generation hadrons, which consist of Up- and Down-quarks must be described by electron spinor and neutrino bispinor.

#### 4.1. Quantum form of “three quark” equations without currents – masses – interactions

The system of the wave equations of first order (11.3.7)

$$\begin{cases} (\hat{\alpha}_o \hat{\varepsilon} + c \hat{\alpha} \hat{p}) \Phi = 0 \\ \Phi^+ (\hat{\alpha}_o \hat{\varepsilon} - c \hat{\alpha} \hat{p}) = 0 \end{cases}$$

is like the Dirac equations without mass:

We assume that the hadrons are the three-dimensional superposition of spinor particles (fermions) (in the general case it is possible to assume that in this superposition can participate simultaneously retarded and advanced waves). Thus, the equations, from which it is possible to compose the quark system, e.g., proton, must be of the following type:

$$\begin{cases} (\hat{\alpha}_o \hat{\varepsilon} + c \hat{\alpha} \hat{p}) \Phi_1 = 0 \\ (\hat{\alpha}_o \hat{\varepsilon} + c \hat{\alpha} \hat{p}) \Phi_2 = 0 \\ (\hat{\alpha}_o \hat{\varepsilon} + c \hat{\alpha} \hat{p}) \Phi_3 = 0 \end{cases}, \quad \begin{cases} \Phi_1^+ (\hat{\alpha}_o \hat{\varepsilon} - c \hat{\alpha} \hat{p}) = 0 \\ \Phi_2^+ (\hat{\alpha}_o \hat{\varepsilon} - c \hat{\alpha} \hat{p}) = 0 \\ \Phi_3^+ (\hat{\alpha}_o \hat{\varepsilon} - c \hat{\alpha} \hat{p}) = 0 \end{cases}$$

where  $\Phi_1 = \Phi_1(y)$ ,  $\Phi_2 = \Phi_2(x)$ ,  $\Phi_3 = \Phi_3(z)$ .. After the rotation transformation these functions become the wave functions of the massive particles, which are designated below by italics. In this case according to (Kiryakos, 2010d) in the matrix form these wave functions are expressed as EM of field as follows:

$$\psi(x) = \begin{pmatrix} E_z \\ E_y \\ iH_z \\ iH_y \end{pmatrix}, \quad \psi(y) = \begin{pmatrix} E_x \\ E_z \\ iH_x \\ iH_z \end{pmatrix}, \quad \psi(z) = \begin{pmatrix} E_y \\ E_x \\ iH_y \\ iH_x \end{pmatrix}, \quad \psi^+(x) = (E_z \ E_y \ -iH_z \ -iH_y),$$

$$\psi^+(y) = (E_x \ E_z \ -iH_x \ -iH_z), \quad \psi^+(z) = (E_y \ E_x \ -iH_y \ -iH_x).$$

The Pauli matrices are (Ryder, 1985) generators of a 2D rotation. So, for the “three quark” electromagnetic representation, we must use the generators of a 3D rotation, which are the known photon spin 3x3-matrices  $\hat{S}$  of O(3) group, which are identical with the part of Yang-Mills matrices:

$$\hat{S}_1 = \begin{pmatrix} 0 & 0 & 0 \\ 0 & 0 & -i \\ 0 & i & 0 \end{pmatrix}, \quad \hat{S}_2 = \begin{pmatrix} 0 & 0 & i \\ 0 & 0 & 0 \\ i & 0 & 0 \end{pmatrix}, \quad \hat{S}_3 = \begin{pmatrix} 0 & -i & 0 \\ i & 0 & 0 \\ 0 & 0 & 0 \end{pmatrix}, \quad (11.4.1)$$

We will use as “three quark” equation for the particle and antiparticle without currents – masses – interactions the following form:

$$\left( {}^6\hat{\alpha}_o \hat{\varepsilon} - c {}^6\hat{\alpha} \hat{p} \right) {}^6\Phi = 0, \quad (11.4.2')$$

$${}^6\Phi + \left( {}^6\hat{\alpha}_o \hat{\varepsilon} + c {}^6\hat{\alpha} \hat{p} \right) {}^6\Phi = 0, \quad (11.4.2'')$$

where the left upper index “6” means that these matrices are 6x6-matrices of the following type:

$${}^6\hat{\alpha} = \begin{pmatrix} \hat{0} & \hat{S} \\ \hat{S} & \hat{0} \end{pmatrix}, \quad {}^6\hat{\alpha}_o = \begin{pmatrix} \hat{S}_o & \hat{0} \\ \hat{0} & \hat{S}_o \end{pmatrix}, \quad {}^6\hat{\alpha}_4 \equiv {}^6\hat{\beta} = \begin{pmatrix} \hat{S}_o & \hat{0} \\ \hat{0} & -\hat{S}_o \end{pmatrix}, \quad (11.4.3)$$

where  $\hat{S}_o = \hat{1}$ , and the wave function  ${}^6\Phi = \begin{pmatrix} \vec{E} \\ i\vec{H} \end{pmatrix}$  is a 6x1 matrix.

It is not difficult to test that the above matrices give the right electromagnetic expressions of a bilinear form of the theory:

$$\text{the energy density :} \quad {}^6\Phi + {}^6\hat{\alpha}_o {}^6\Phi = \vec{E}^2 + \vec{H}^2 = 8\pi U,$$

$$\text{the Poynting vector (and momentum density also):} \quad \vec{S}_p = \frac{1}{8\pi} {}^6\Phi + {}^6\hat{\alpha} {}^6\Phi,$$

$$\text{and the 1<sup>st</sup> scalar of the electromagnetic field:} \quad {}^6\Phi + {}^6\hat{\alpha}_4 {}^6\Phi = 2(\vec{E}^2 - \vec{H}^2) = 4\pi F_{\mu\nu} F^{\mu\nu}.$$

## 4.2. EM form of “three quark” equations without the currents-masses-interactions

It follows from the above that the proton and antiproton equations (without the currents-masses-interactions) can be represented by three “one quark” equations (without the currents-masses-interactions) of a type (11.4.2), i.e. by three electron equations, or three pairs, of scalar Maxwell equations (one pair per each co-ordinate). Obviously, there is a possibility of two directions of rotations of each quark (the left and the right quarks). Therefore, the 6+6 scalar equations for the proton description must exist, as well as the 6+6 equations for the antiproton description.

Let us find at first these equations without mass (i.e. without an inner interaction), assuming the mass-interaction terms equal to zero. Using (11.4.3), we obtain from the equations (11.4.2') or (11.4.2'') Maxwell-like equations without current:

$$\frac{1}{c} \frac{\partial}{\partial t} \begin{pmatrix} E_x \\ E_y \\ E_z \\ iH_x \\ iH_y \\ iH_z \end{pmatrix} + \left[ \frac{\partial}{\partial x} \begin{pmatrix} 0 \\ H_z \\ -H_y \\ 0 \\ -iE_z \\ iE_y \end{pmatrix} + \frac{\partial}{\partial y} \begin{pmatrix} -H_z \\ 0 \\ H_x \\ iE_z \\ 0 \\ -iE_x \end{pmatrix} + \frac{\partial}{\partial z} \begin{pmatrix} H_y \\ -H_x \\ 0 \\ -iE_y \\ iE_x \\ 0 \end{pmatrix} \right] = 0, \quad (11.4.4)$$

In the case of superposition of three photons, we obtain from (11.4.4):

$$\left\{ \begin{array}{l} \frac{1}{c} \frac{\partial E_x}{\partial t} - \frac{\partial H_z}{\partial y} = 0, \quad a \\ \frac{1}{c} \frac{\partial H_z}{\partial t} - \frac{\partial E_x}{\partial y} = 0, \quad a' \\ \frac{1}{c} \frac{\partial E_y}{\partial t} - \frac{\partial H_x}{\partial z} = 0, \quad b \\ \frac{1}{c} \frac{\partial H_x}{\partial t} - \frac{\partial E_y}{\partial z} = 0, \quad b' \\ \frac{1}{c} \frac{\partial E_z}{\partial t} - \frac{\partial H_y}{\partial x} = 0, \quad c \\ \frac{1}{c} \frac{\partial H_y}{\partial t} - \frac{\partial E_z}{\partial x} = 0, \quad c' \end{array} \right. \quad (11.4.5')$$

$$\left\{ \begin{array}{l} \frac{1}{c} \frac{\partial E_z}{\partial t} + \frac{\partial H_x}{\partial y} = 0, \quad a \\ \frac{1}{c} \frac{\partial H_x}{\partial t} + \frac{\partial E_z}{\partial y} = 0, \quad a' \\ \frac{1}{c} \frac{\partial E_x}{\partial t} + \frac{\partial H_y}{\partial z} = 0, \quad b \\ \frac{1}{c} \frac{\partial H_y}{\partial t} + \frac{\partial E_x}{\partial z} = 0, \quad b' \\ \frac{1}{c} \frac{\partial E_y}{\partial t} + \frac{\partial H_z}{\partial x} = 0, \quad c \\ \frac{1}{c} \frac{\partial H_z}{\partial t} + \frac{\partial E_y}{\partial x} = 0, \quad c' \end{array} \right. \quad (11.4.5'')$$

As we can see, each pair of equations  $a, b, c$  describes a separate semi-photons. The fields vectors of equations (11.4.5') rotate in the planes  $XOZ, ZOY, YOX$ ; and similarly the fields' vectors of equations (11.4.5'') rotate in the planes  $XOY, YOZ, ZOY$ .

### 4.3. Description of appearance of currents-masses-interactions in the differential geometry

The spinor theory shows that the appearance of the internal interaction terms is bounded by three vectors  $\vec{E}, \vec{H}, \vec{S}_p$ , moving along the curvilinear trajectory. These vectors represent the moving trihedral of Frenet-Serret (Gray, 1997). In a general case, when the electromagnetic wave field vectors of e.g. three-quark particles move along the spatial curvilinear trajectories, not only the additional term defined by the curvature appears, but also the terms that are defined by the torsion of the trajectory.

Actually, in this case we have:

$$\begin{aligned} \frac{\partial \vec{E}}{\partial t} &= -\frac{\partial E}{\partial t} \vec{n} - E \frac{\partial \vec{n}}{\partial t} \\ \frac{\partial \vec{H}}{\partial t} &= \frac{\partial \vec{H}}{\partial t} \vec{b} + H \frac{\partial \vec{b}}{\partial t} \end{aligned} \quad (11.4.6)$$

where  $\vec{b}$  is a binormal vector. According to Frenet-Serret formulas, we have:

$$\begin{aligned} \frac{\partial \vec{n}}{\partial t} &= -\nu_p K \vec{\tau} + \nu_p T \vec{b} \\ \frac{\partial \vec{b}}{\partial t} &= -\nu_p T \vec{n} \end{aligned} \quad (11.4.7)$$

where  $T = \frac{1}{r_T}$  is the torsion of the trajectory, and  $r_T$  is the torsion radius. Thus, the displacement currents can be written in the form:

$$\begin{aligned} \vec{j}_i^e &= -\frac{1}{4\pi} \frac{\partial E_i}{\partial t} \vec{n} + {}^\tau j_i^e \vec{\tau} + {}^b j_i^e \vec{b} \\ \vec{j}_k^m &= \frac{1}{4\pi} \frac{\partial H_k}{\partial t} \vec{b} + {}^n j_k^m \vec{n} \end{aligned} \quad (11.4.8')$$

or

$$\begin{aligned}\vec{j}^e &= -\frac{1}{4\pi} \frac{\partial \vec{E}}{\partial t} \vec{n} + \frac{1}{4\pi} \omega_K \vec{E} \cdot \vec{\tau} - \frac{1}{4\pi} \omega_T \vec{E} \cdot \vec{b} \\ \vec{j}^m &= \frac{1}{4\pi} \frac{\partial \vec{H}}{\partial t} \vec{b} - \frac{1}{4\pi} \omega_T \vec{H} \cdot \vec{n}\end{aligned}, \quad (11.4.8'')$$

where  ${}^\tau j_i^e = \frac{1}{4\pi} \omega_K E_i \cdot \vec{\tau}$  and  ${}^b j_i^e = -\frac{1}{4\pi} \omega_T E_i \cdot \vec{b}$  are electrical currents,  ${}^n j_i^m = \frac{1}{4\pi} \omega_T H_i \cdot \vec{n}$  are magnetic currents,  $i, k = x, y, z$ ;  $\omega_T = \frac{v_p}{r_T} \equiv c\Gamma$  and  $\omega_K = \frac{v_p}{r_K} \equiv cK$  we name as the torsion and curvature angular velocities.

Thus, we can obtain the following electromagnetic representation of Yang-Mills equations with the mass terms:

$$\left\{ \begin{array}{l} \frac{1}{c} \frac{\partial E_x}{\partial t} - \frac{\partial H_z}{\partial y} = {}^\tau j_x^e + {}^b j_x^e, a \\ \frac{1}{c} \frac{\partial H_z}{\partial t} - \frac{\partial E_x}{\partial y} = {}^n j_z^m, a' \\ \frac{1}{c} \frac{\partial E_y}{\partial t} - \frac{\partial H_x}{\partial z} = {}^\tau j_y^e + {}^b j_y^e, b \\ \frac{1}{c} \frac{\partial H_x}{\partial t} - \frac{\partial E_y}{\partial z} = {}^n j_x^m, b' \\ \frac{1}{c} \frac{\partial E_z}{\partial t} - \frac{\partial H_y}{\partial x} = {}^\tau j_z^e + {}^b j_z^e, c \\ \frac{1}{c} \frac{\partial H_y}{\partial t} - \frac{\partial E_z}{\partial x} = {}^n j_y^m, c' \end{array} \right., \quad (11.4.9')$$

$$\left\{ \begin{array}{l} \frac{1}{c} \frac{\partial E_z}{\partial t} + \frac{\partial H_x}{\partial y} = {}^\tau j_z^e + {}^b j_z^e, a \\ \frac{1}{c} \frac{\partial H_x}{\partial t} + \frac{\partial E_z}{\partial y} = {}^n j_x^m, a' \\ \frac{1}{c} \frac{\partial E_x}{\partial t} + \frac{\partial H_y}{\partial z} = {}^\tau j_x^e + {}^b j_x^e, b \\ \frac{1}{c} \frac{\partial H_y}{\partial t} + \frac{\partial E_x}{\partial z} = {}^n j_y^m, b' \\ \frac{1}{c} \frac{\partial E_y}{\partial t} + \frac{\partial H_z}{\partial x} = {}^\tau j_y^e + {}^b j_y^e, c \\ \frac{1}{c} \frac{\partial H_z}{\partial t} + \frac{\partial E_y}{\partial x} = {}^n j_z^m, c' \end{array} \right., \quad (11.4.9'')$$

Thus, within the framework of electromagnetic representation, a proton is topologically the superposition of three rings. Therefore, we can suppose that it has a composition of a trefoil loop:

As we noted during the analysis of electromagnetic representation of electron equation, the charge, mass and interaction between the particles appear simultaneously during the rotation transformation and separation of a photon. In other words, the appearance of currents at rotation transformation of a “linear” photon simultaneously describes the generation of the charge, masses, and interactions of inner electron parts.

Since in this case we have, conditionally speaking, three electromagnetic equations of electron, one should conclude that the EM masses of quarks, their charges, and interactions between them are described by nine currents of equations (11.4.9).

It is possible to assume that three of them, which are tangential electric currents, determine the charges and masses of quarks.

However, at the same time, all currents together (three electrical tangential, three electrical binormal, and three magnetic normal) must determine the interaction between quarks. Moreover, since we have a closed system, it can be assumed that at least one of the currents can be expressed through others. In this case, there are only eight different terms of interaction.

Note also that in case of a 3D-space we cannot mathematically consistently write the Yang-Mills-equation in electromagnetic form using the usual complex form, since the latter includes only the plane geometry. In this case, the algebra of Hamilton's quaternions most likely must be used, which is the expansion of the theory of complex analysis into 3D-space.



#### 4.4. The description of appearance of current-mass-interaction terms within the framework of Rieman's geometry

The appearance of an additional derivative term follows from the general theory of vector motion along curvilinear trajectory. This subject was studied in vector analysis, in the differential geometry, and in the hypercomplex number theory many years ago (Madelung, 1957; Korn and Korn, 1961). The results are well known. Below, we consider some conclusions of these theories.

Any vector  $\vec{F}(\vec{r}, t)$  can have the following forms:

$$\begin{aligned}\vec{F}(\vec{r}, t) &= \vec{F}(x^0, x^1, x^2, x^3) = F^0 \vec{e}_0 + F^1 \vec{e}_1 + F^2 \vec{e}_2 + F^3 \vec{e}_3, \\ &= F_0 \vec{e}^0 + F_1 \vec{e}^1 + F_2 \vec{e}^2 + F_3 \vec{e}^3,\end{aligned}\quad (11.4.10)$$

where  $F^0, F^1, F^2, F^3, F_0, F_1, F_2, F_3$  are the invariant and co-variant vector modulus, and  $\vec{e}^i$  and  $\vec{e}_i$  are the basis unit vectors that in general case change from point to point. When the vector moves along the curvilinear trajectory, the partial derivatives take the form:

$$\frac{\partial \vec{F}}{\partial x^j} = \frac{\partial F^i}{\partial x^j} \vec{e}_i + F^i \frac{\partial \vec{e}_i}{\partial x^j} = \frac{\partial F_i}{\partial x^j} \vec{e}^i + F_i \frac{\partial \vec{e}^i}{\partial x^j}, \quad (11.4.11)$$

where the following notations are used:

$$\frac{\partial \vec{e}_i}{\partial x^j} = \Gamma_{ij}^k \vec{e}_k = -\Gamma_{kj}^i \vec{e}^k, \quad (11.4.12)$$

(here  $i, j, k, = 0, 1, 2, 3$ )

The coefficients  $\Gamma_{ij}^k$  are named Christoffel symbols, or the bound coefficients. Thus, for the  $y$  - direction of an initial photon

$$\begin{cases} \vec{E} = E_3 \vec{e}^3 \\ \vec{H} = H_1 \vec{e}^1 \end{cases}, \quad (11.4.13)$$

we will obtain in the case of its curvilinear motion:

$$\begin{cases} \frac{1}{c} \frac{\partial \vec{E}}{\partial t} = \frac{\partial E_3}{\partial x^0} \vec{e}^3 + E_3 \Gamma_{k0}^3 \vec{e}^k, & \frac{\partial \vec{E}}{\partial y} = \frac{\partial E_3}{\partial x^2} \vec{e}^3 + E_3 \Gamma_{k2}^3 \vec{e}^k \\ \frac{1}{c} \frac{\partial \vec{H}}{\partial t} = \frac{\partial H_1}{\partial x^0} \vec{e}^1 + H_1 \Gamma_{k0}^1 \vec{e}^k, & \frac{\partial \vec{H}}{\partial y} = \frac{\partial H_1}{\partial x^2} \vec{e}^1 + H_1 \Gamma_{k2}^1 \vec{e}^k \end{cases}, \quad (11.4.14)$$

We can obtain the same for the waves of two other directions.

As we can see, the additional terms have appeared, which the initial linear equations did not have. Thus, in a general case, when electromagnetic field vectors of the three-knot particles move along curvilinear trajectories, additional terms of the same type that we obtained in the case of Yang-Mills equation appear.

*Note:* within the framework of NEPT the Christoffel or Ricci symbols are not the abstract mathematical values. On one hand, they are physical values; namely, they are the currents that appeared due to the rotation and torsion of electromagnetic vectors. On the other hand, they have a geometrical sense: they are proportional to trajectory's curvature  $K$ , and to the trajectory's torsion  $T$ .

#### 4.5. The hadrons' equations with own currents-masses-interactions terms

Let us examine the formation of hadrons, e.g., protons, from the point of view of proton-antiproton pair production in two-photon collisions (The L3 Collaboration, 2003)

$$\gamma + \gamma \rightarrow p^+ + p^-, \quad (11.4.15)$$

We should conclude from (11.4.1) that quarks themselves are produced simultaneously by interaction between them. In other words, the total energy of a proton must be equally divided between the quarks and gluons. Recall that we had the same in case of photoproduction of an electron-positron pair with the only difference that in the last case the interaction was external.

As a consequence of this result, we obtained a doubled value of the mass terms. Consequently, instead of (11.4.2), we will have

$$\begin{aligned} & \left[ \left( {}^6\hat{\alpha}_o \hat{\varepsilon} - c {}^6\hat{\alpha} \hat{p} \right) - \left( {}^6\hat{\alpha}_o \varepsilon_l - c {}^6\hat{\alpha} \bar{p}_l \right) - {}^6\hat{\beta} m_l c^2 \right] {}^6\psi = 0 \\ & {}^6\psi^+ \left[ \left( {}^6\hat{\alpha}_o \hat{\varepsilon} + c {}^6\hat{\alpha} \hat{p} \right) + \left( {}^6\hat{\alpha}_o \varepsilon_l + c {}^6\hat{\alpha} \bar{p}_l \right) + {}^6\hat{\beta} m_l c^2 \right] = 0 \end{aligned} \quad (11.4.16)$$

where  $l = 1, 2, \dots, 9$ , enumerate the appropriate quark mass (currents) and gluon energy-momentums. According to (11.4.9) and (11.4.16), we have nine quark currents and nine gluon currents, so that the total energies of quarks and currents must be the same.

As in the case of leptons, the appearance of currents simultaneously describes the appearance of a charge, mass and interaction of hadrons.

## 5.0. Heuristic hadron models

We assume that the hadrons, as superposition of two or three lepton-like particles, are the superposition of two or three loops (rings) of EM waves. For example, the baryon model can have a form of the trefoil knot (Fig. 11.1):

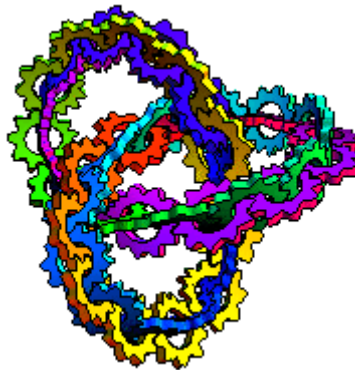

Fig. 11.1.

(This figure is from website MathWorld named ‘Trefoil knot’ <http://mathworld.wolfram.com/TrefoilKnot.html>, where the animation shows a series of gears motion along the Möbius strip’s trefoil knot as the electric and magnetic field vectors motion).

A knot is defined as a closed, non-self-intersecting curve embedded into a 3D-space. Knot theory was given its first impetus when Lord Kelvin proposed a theory that atoms of Democritus are vortex loops (Kelvin, 1867).

It is interesting that the trefoil and its mirror image are not equivalent. In other words, *the trefoil knot is a chiral object*. However, it is invertible.

The equation of one loop (ring) is the Dirac’s equation that has a harmonic solution. Therefore, it can be supposed that EM hadrons represent a 3D superposition of two or three harmonic oscillations. In other words, EM hadrons are similar to space wave packets. According to Schrödinger (Schrödinger, 1926), the wave packets built from the harmonic waves (oscillations) do not have dispersion, i.e. they are stable. Thus, as the first approximation, we can build the hadrons model as a space packet of a 3D superposition of two or three harmonics oscillations, i.e. as the Lissajoues figures.

Here, there are two difficulties: 1) the superpositions of harmonic oscillations are not topological figures as knots, because they are self-intersecting curves (maybe in this case the loops will not intersect because of the repulsion of currents, but this requires proof); 2) hadrons are not the superposition of complete harmonic waves, but half-periods of such waves. The

description of the superposition of half-periods waves is absent in the literature. Therefore, we use the usual harmonic waves.

### 5.1. “Three quarks” (baryon) model

The models were constructed using MathCAD-program. We assume that the three-knot (baryon) model is built from three harmonics oscillation.

The harmonic oscillations are described by functions (for each co-ordinate axis):

$$X_{k,j} := r_1 \cdot \cos(\omega_1 \cdot t_j + \phi_1)$$

$$Y_{k,j} := r_2 \cdot \sin(-\omega_2 \cdot t_j + \phi_2)$$

$$Z_{k,j} := r_3 \cdot \sin(\omega_3 \cdot t_j + \phi_3)$$

If we choose the following oscillation parameters:

$$\omega_1 = 3, \quad \omega_2 = 2, \quad \omega_3 = 3,$$

$$\phi_1 = \phi_2 = \phi_3 = 0,$$

$$r_1 = r_2 = r_3 = 2.$$

with  $t_j := j \cdot 2 \cdot \frac{\pi}{N}$ , where  $N := 200, j := 0..N, k := 0..N$ , then we obtain the following three-loops figure as a superposition of the above harmonic oscillations (Fig. 11.2):

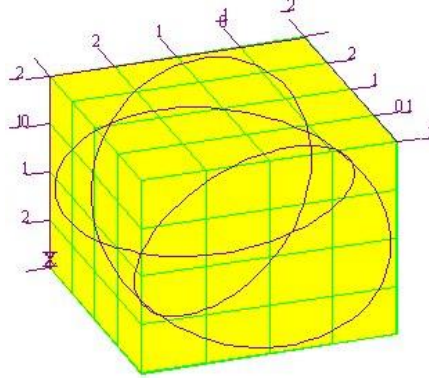

Fig. 11.2.

In order to show the rotation and twisting of a field vector, we change the parameter  $t_j$  to

$t_j := \frac{j}{2.2}$ . Then, we have (Fig. 11.3):

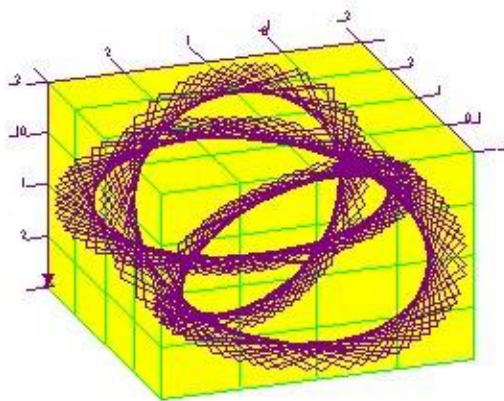

Fig. 11.3.

### 5.2. “Two quarks” model

In order to build the two-loops (meson) model, we choose in the above proton model the following equations  $\omega_1 = 1, \omega_2 = 2, \phi_1 = \phi_2 = \phi_3 = 0, r_1 = r_2 = r_3 = 2$  and

$$X_{k,j} := r_1 \cdot \cos(\omega_1 \cdot t_j + \phi_1)$$

$$Y_{k,j} := r_2 \cdot \sin(-\omega_2 \cdot t_j + \phi_2)$$

$$Z_{k,j} := 0$$

Then, we obtain the Fig. 11.4:

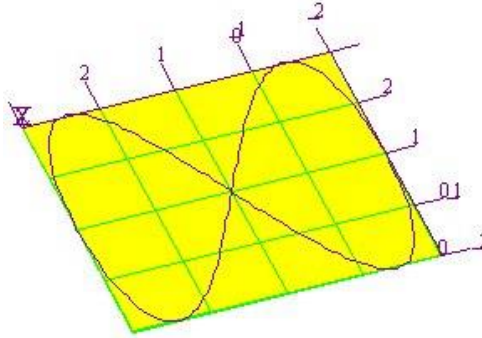

Fig. 11.4.

It is necessary to note that depending on the polarization of the curvilinear photon (plane, circular, elliptic), the meson models can have numerous different features.

We hope that further research will allow us to build more realistic models, which will give us an opportunity to calculate the properties of NEPT particle.

Thus, the models presented above differ a lot from the real NEPT hadrons and cannot be used for a calculation of particle's properties. However, they give several interesting consequences, which don't contradict the QCD results. These models give us an opportunity to compare some characteristics of EM hadrons with the real hadrons. We will discuss below the results of the above theory and models for the purpose of explaining the difficulties of the modern theory of hadrons.

## 6.0. Discussion of results

**1. The fractional charge of quarks:** according to the above results an electric field trajectory of the EM quark wave has not only a curvature, but also a torsion. Hence, the tangential current generated by the transport of the electrical field vector alternates along the space trajectory. Consequently, the electric charge of one knot, as an integral with respect to this current, will be less than the electron charge. However, the total charge from all knots can be equal to electron's charge.

Furthermore, one of the frequencies has a negative sign. This result can be compared to the fact that, in the baryon, two quarks have charges, which have opposite signs relative to the charge of the third quark.

**2. Quarks confinement:** if quarks are two or three connected knots, then they cannot exist in a free state.

**3.** The mass of hadron will be determined by the sum of the masses of quarks themselves and the mass of energy of EM interaction fields in the box, which in this case is the hadron. (see as example the results of (Xiangdong and Wei, 1998; Xiangdong, 1994; Xiangdong, 2006))

**4.** Spin will be determined by the rotary motion of all these masses.

**5. Correlation of masses of quarks:** in the NEPT model, masses are defined by the rotation frequencies of each knot. As we have seen, three-knot (see Fig. 9.1-3) is self-consistent only at a certain ratio of circular frequencies  $\omega_1 : \omega_3 : \omega_2 = 3 : 3 : 2$ . So, for the baryon model, two quark masses must be equal to each other, and not equal to the mass of the third quark. Similar, the two-knot (see Fig. 9.4) have frequencies ratio 2 to 3 and, therefore, the meson model must have two different quarks.

**6. Nonlinearity of the Yang-Mills equation:** obviously, the Yang-Mills equation as the superposition of nonlinear electromagnetic waves is a nonlinear equation.

**7. The confinement of gluons.** According to the NEPT, gluons are virtual photons by which the knots interact between themselves. Then, the radius of an action of these particles is limited by the space of a hadron.

**8. *The colours of quarks:*** it can be assumed that the colours of quarks can be identified with the quark currents since each of the model's knots has three different currents.

**9. *The colours of gluons:*** it can be assumed that colours of gluons can be identified with the currents of each of two half-periods of virtual photons; with this respect, these photons are bent in the inner space of the hadrons, and have currents of a different type.

**10. *The strong interactions:*** It is believed that colour, like an electric charge, gives rise to a quantized field, massless, and with a spin of one, like a photon, that ensures the strong interaction. The proton-neutron force must be in reality a complicated force, a sort of "residual" force between the quarks.

According to Denis Wilkinson (Wilkinson, 1981), the strong interaction can appear analogically to Van der Waals forces between atoms, which are caused by electric charges inside the atoms. Their short range interaction is a special feature of these forces. At a great distance, these forces are considerably weaker than the Coulomb force, but they are considerably stronger than the Coulomb force at short distances. According to D. Willkinson, the strong interaction between protons appears as a "residue" from the strong interaction between the quarks inside of protons. Thus, the electromagnetic forces, which according to NEPT act between the quarks inside the proton, can explain very large forces of interaction between protons.

As we have seen, the NEPT has the possibilities to explain many features of QCD. Of course, further analysis is needed to confirm or reject some of the above assertions.

## Chapter 12. The interaction description

### 1.0. Introduction. The modern state of the interaction description.

In previous articles we have shown, that in the nonlinear electrodynamics, i.e., in theory of elementary particles (NTEP), the equations of free particles are mathematically equivalent to the equations of quantum field theory. The purpose of present part is to show that the mathematical description of interaction in NTEP are also equivalent to that in quantum theory.

#### 1.1. The force and energy forms of the interaction description

It is known that interactions define the most important characteristics of the matter motion. They are included in all equations of motion: equations of Newton, Schrödinger, Dirac, equations of weak and strong interactions, etc.

As it is known, interaction can be expressed as force and as energy. The force form of the description of interaction is integral, and the energy form relatively to the last is differential. These forms are interconnected and can be defined one through another. In classical physics, the force is equal to a gradient of potential energy. Generally this dependence is more complex, but is also defined by the operation of differentiation. This implies the particularity of the connection of these two kinds of interaction description: the full unambiguity of transition from force to energy (and on the contrary) does not exist. For example, it is always possible to add to the energy some function (at least, a constant) so that the force value does not change.

In modern physics the most general forms of the interaction description are introduced by Lagrange and Hamilton approaches (Leech, 1958; Landau and Lifshitz, 1977).

#### 1.2. Lagrangian and Hamiltonian approaches

##### 1.2.1. Mechanical system of a rigid body (particles)

The Lagrangian mechanics works generally in  $n$ -dimensional configuration space, which includes all parameters, defining the state of mechanical system (coordinates of particles, orientation of rigid body, etc). A point  $x_\nu$  in this space draws a curve  $x_\nu(t)$  in evolution ( $\nu = 1, 2, \dots, n$ , where  $n$  is a number of independent variables). For such curves a functional  $S(x(t))$ , called action, is introduced. Only those curves, on which the action reaches an extremum, correspond to real evolution (Hamilton principle).

Usually consideration is connected to functional of the form:

$$S = \int_{t_1}^{t_2} \bar{L} dt, \quad (12.1.1)$$

with Lagrange function  $\bar{L} = \bar{L}(x_\nu, \dot{x}_\nu)$  dependent only on generalized coordinates and velocities  $x_\nu, \dot{x}_\nu$ . For one material point this expression will be written down as follows

$$\bar{L} = \bar{L}(\vec{r}, \dot{\vec{r}}, t) = \bar{L}(\vec{r}, \vec{v}, t), \quad (12.1.2)$$

where  $\vec{r}, \vec{v}, t$  are radius-vector, velocity and time correspondingly.

The condition of extremum for the action

$$\delta S = \delta \left( \int_{t_1}^{t_2} \bar{L} dt \right) = 0, \quad (12.1.3)$$

leads to Euler-Lagrange equations

$$\frac{d}{dt} \frac{\partial \bar{L}}{\partial \dot{x}_i} - \frac{\partial \bar{L}}{\partial x_i} = 0, \quad (12.1.4)$$

This is (normally) a system of second order differential equations, with solutions uniquely defined by initial coordinates and velocities  $x_v(0), \dot{x}_v(0)$ .

In Hamiltonian's mechanics approach the state of the system is described by point  $(x, p)$  in 2n-dimensional phase space, where  $p$  is momenta of particle. The dynamics is defined by a function  $\bar{H}(x, p)$ , called Hamilton function, via equations:

$$\dot{x} = \frac{\partial \bar{H}}{\partial p}, \quad \dot{p} = -\frac{\partial \bar{H}}{\partial x}, \quad (12.1.5)$$

Transition from Lagrange's to Hamilton's function mechanics is performed by *Legendre transformation*. It defines the momenta and Hamilton's function as:

$$p(x, \dot{x}) = \frac{\partial \bar{L}}{\partial \dot{x}}, \quad \bar{H}(x, p) = p\dot{x} - L, \quad (12.1.6)$$

The Hamilton function depends on coordinates and momenta, so one should express the velocities via momenta, inverting the definitions of momenta:  $\dot{x} = \dot{x}(x, p)$ , and substitute the result into Hamilton's function.

### 1.2.2. Continuous systems (fields)

For fields the Lagrange function is defined by density of Lagrange function  $L$  in following way:

$$\bar{L} = \int L d\tau, \quad (12.1.7)$$

where  $d\tau$  is an element of spatial volume. The Lagrange function density or Lagrangian depends generally on field functions and their derivatives, coordinates and time:

$$L = L\left(\psi_\mu, \frac{\partial \psi_\mu}{\partial x_\nu}, x_\nu\right), \quad (12.1.8)$$

where  $\psi_\mu$  are the field functions,  $\mu = 1, 2, \dots, N$  ( $N$  is a number of the functions);  $\nu = 1, 2, \dots, n$  ( $n$  is a number of independent variables). In this case the action will be written down as follows:

$$S = \int_{t_1}^{t_2} L dx^1 dx^2 \dots dx^n, \quad (12.1.9)$$

and Euler-Lagrange equations in case of the continuous system (field) become:

$$\sum_{i=1}^n \frac{\partial}{\partial x^i} \frac{\partial L}{\partial \dot{\psi}_\mu} - \frac{\partial L}{\partial \psi_\mu} = 0, \quad (12.1.10)$$

In the present time the Lagrangians are selected on base of some general requirements of symmetry (invariance).

The approach of Hamilton in case of a continuous system performs by following way. Putting the value  $\bar{H}$  named density of Hamilton function, or Hamiltonian of the system:

$$H = H\left(\psi_\nu, \frac{\partial \psi_\nu}{\partial x_\nu}, \pi_\nu, x_\nu\right), \quad (12.1.11)$$

so that

$$H = \int \bar{H} d\tau, \quad (12.1.12)$$

the Legendre transformation can be now written down as:

$$\pi_\nu = \frac{\partial L}{\partial \dot{\psi}_\nu}, \quad H = \sum_\nu \pi_\nu \dot{\psi}_\nu - L, \quad (12.1.13)$$

where  $\pi_v$  is canonical momentum density. Then the dynamics is defined by Hamiltonian via equations:

$$\dot{x} = \frac{\partial H}{\partial \pi}, \quad \dot{\pi} = -\frac{\partial H}{\partial x}, \quad (12.1.14)$$

Hamilton's function defines the full energy of system. When Hamiltonian is known, it is possible to express through it all other characteristics of system. This approach is most frequently used for the description of elementary particles and fields.

### 1.3. Structure of Lagrangian and Hamiltonians of interaction systems

Numerous testing established that any Lagrangian can be presented in the form:

$$L = L_{free} + L_{int}, \quad (12.1.15)$$

where the first term  $L_{free}$  answers the sum of the Lagrangian of free particles, and the second term  $L_{int}$  answers their interaction by pairs with each other.

Analogously can be recorded the Hamiltonian of the system of the interacting bodies (particles):

$$H = H_{free} + H_{int}, \quad (12.1.16)$$

In the classical mechanics free particles are usually the moving solid bodies (material points). As interactions are here considered in essence only elastic and gravitational interactions (note that the development of the relativistic theory of gravity showed that would be more correctly to examine the gravitational field and gravitational interaction as the independent areas of physics).

In the classical electrodynamics the system contains electromagnetic fields and charged particles. The Lagrangian and Hamiltonian of first and second systems are considered as free, without taking into account their interactions. With respect to their interactions there is a special feature: since in the usual cases the EM fields do not interact with each other, Lagrangian of interaction includes only interaction of EM field with the charge particles.

In the quantum field theory (Kaempffer, of 1965; Ryder, 1985), as in the other cases, the Lagrangian is postulated as sum (12.1.15). But the quantum field theory has the following special feature: here fields and particles are considered equally. Therefore the boundary between Lagrangian of free particles and Lagrangian of interaction become relative. Lagrangian of free particles is written as the sum of the Lagrangian of each free particle, but some of these particles can be considered as the interaction fields.

For example, in QED we have:

$$L_{free} = L_e + L_\gamma, \quad (12.1.17)$$

where  $\bar{L}_e, \bar{L}_\gamma$  are the Lagrangians of free electron and photon respectively. But photon is simultaneously both particle and interaction carrier.

In this case Lagrangian of free electron is selected to give the Dirac electron equation. Lagrangian of interaction is postulated in the form "current-on-current" interaction (or it is derived on the basis of the gauge invariance principle).

In other divisions of Standard Model (SM) the Lagrangian of free particles and their interaction are the generalization of Lagrangian of QED (Ryder, 1985; Frauenfelder and Henley, 1974).

## 1.4. Some significant Lagrangians and Hamiltonians of classical physics

### 1.4.1. Conservative systems of the material bodies

As "conservative" we call here the narrow class of the systems, for which the forces are potential gradients. For such systems of material bodies (particles), it was established that Lagrange's function could be expressed as follows:

$$\bar{L} = \bar{L}(x_v, \dot{x}_v) = T(x_v, \dot{x}_v) - V(x_v), \quad (12.1.18)$$



where  $T(x_\nu, \dot{x}_\nu) = \sum_{\nu=1}^n \frac{m_\nu \bar{v}_\nu^2}{2}$  is total kinetic energy of the system of  $n$  particles;  $V(x_\nu) = V(x_1, x_2, \dots, x_n)$  is potential energy of system. Here the first term answers energy of free particles and corresponds to  $L_{free}$ , and the second term answers interaction energy of particles and corresponds to  $L_{int}$ .

Thus the expression (12.1.18) can be rewritten as:

$$\bar{L} = \bar{L}_{free} + \bar{L}_{int}, \quad (12.1.19)$$

Moreover force is expressed as gradient of potential energy  $\vec{F} = -gradV(\vec{r})$ .

Note also that in relativistic mechanics the correct equations of motion is obtained only when instead of kinetic energy the value is entered:

$$K = m_0 c^2 \left( 1 - \sqrt{1 - \frac{v^2}{c^2}} \right), \quad (12.1.20)$$

which is named the kinetic potential.

From Euler-Lagrange equations we obtain the equations of motion of material point (which are practically the Newton equations of motion):

$$\frac{d}{dt} \frac{\partial T}{\partial \dot{x}_i} = \frac{\partial T}{\partial x_i} - \frac{\partial V}{\partial x_i}, \quad (12.1.21)$$

where  $\frac{d}{dt} \frac{\partial T}{\partial \dot{x}_i} = Q_i$  are inertial forces;  $\frac{\partial T}{\partial x_i} = Q_{c-K}$  are the generalized form of centrifugal and

Coriolis forces;  $\frac{\partial V}{\partial x_i} = Q_v$  are the generalized forces of interaction.

#### 1.4.2. Electrodynamics. Non-conservative forces

In the vacuum Lagrangian of classical electrodynamics (Landau and Lifshitz, 1977; Jackson, 1999) looks like sum (12.1.15). The Lagrangian:

$$L_{free} = -\frac{1}{16\pi} F_{\mu\nu} F^{\mu\nu} = \frac{1}{8\pi} (\vec{E}^2 - \vec{H}^2), \quad (12.1.22)$$

answers free electromagnetic field. The Lagrangian of interaction describes only interaction of EM field and charged particles:

$$L_{int} = j_\mu A^\mu$$

Expression for the Hamiltonian of free EM field has the form:

$$H_{free} = \frac{1}{8\pi} (\vec{E}^2 + \vec{H}^2), \quad (12.1.23)$$

The Hamiltonian of interaction (i.e. the energy density of interaction) is written as:

$$H_{int} = -\frac{1}{2} (\rho\varphi + \vec{j} \cdot \vec{A}), \quad (12.1.24)$$

In nature it is not always possible to assign the forces in the form of gradient of potential. In particular, this does not occur in the electrodynamics. But surprisingly (Leech, 1958) in this case the generalized components of force can be assigned so that it keep the form of Euler-Lagrange equations.

It appears that instead of potential  $V(x_\nu) = V(x_1, x_2, \dots, x_n)$ , which does not depend on time, it is often possible to set the function  $\bar{M} = \bar{M}(x_\nu, \dot{x}_\nu)$  so that the generalized force, instead of  $Q_i = -\frac{\partial V}{\partial x_i}$ , can be written as:

$$Q_i = \frac{d}{dt} \left( \frac{\partial \bar{M}}{\partial \dot{x}_i} \right) - \frac{\partial \bar{M}}{\partial x_i}, \quad (12.1.25)$$

For example in such important case as electrodynamics the Lorentz force can be expressed in the above form if as  $\bar{M}$ -function we will choose the following expression:

$$\bar{M} = e \left( \varphi - \frac{1}{c} \vec{v} \cdot \vec{A} \right), \quad (12.1.26)$$

where  $\varphi$  is a scalar potential, and  $\vec{A}$  is a vector potential of an electromagnetic field. Actually, substituting this expression in (12.1.20), we will obtain:

$$F_i = \left[ \frac{d}{dt} \left( \frac{\partial}{\partial \dot{x}_{ii}} \right) - \frac{\partial}{\partial x_i} \right] \bar{M} = \left[ \frac{d}{dt} \left( \frac{\partial}{\partial \dot{x}_i} \right) - \frac{\partial}{\partial x_i} \right] e \left( \varphi - \frac{1}{c} \vec{v} \cdot \vec{A} \right), \quad (12.1.27)$$

By differentiation of (12.1.27) and taking into account that  $\vec{B} = \vec{\nabla} \times \vec{A}$  and  $\vec{E} = -\vec{\nabla} \varphi - \frac{1}{c} \frac{\partial \vec{A}}{\partial t}$ , it is easy to obtain the usual expression of Lorentz force:

$$\vec{F} = e\vec{E} + \frac{e}{c} \vec{v} \times \vec{B} = e\vec{E} + \frac{1}{c} \vec{j} \times \vec{B}, \quad (12.1.28)$$

Since in this case

$$\bar{L}_{\text{int}} = -\bar{M}(x_\nu, \dot{x}_\nu), \quad (12.1.29)$$

we have that the  $\bar{M}$ -function is the energy of the electromagnetic interaction, corresponding to Lorentz force. In fact, using known relationships of 4-current and 4-potential:

$$I_\nu = e v_\nu = e(ic, \vec{v}), \quad (12.1.30)$$

$$A_\nu = (i\varphi, \vec{A}), \quad (12.1.31)$$

we obtain the known expression of the current-on-current interaction energy:

$$\bar{M} = -I_\nu A_\nu, \quad (12.1.32)$$

Using 4-current density:

$$j_\nu = \rho v_\nu = \rho(ic, \vec{v}), \quad (12.1.33)$$

we can introduce the  $M$ -density:

$$M = -j_\nu A_\nu, \quad (12.1.34)$$

## 1.5. About the interaction description in the quantum field theory

In quantum field theory the general Lagrangian is postulated in form (12.1.15). But there are no enough proved arguments here (Kaempffer, 1965), which allow to deduce theoretically the real interactions.

The rule of replacement in the presence of an electromagnetic field  $p_\mu$  with  $(p_\mu + j_\mu A_\mu)$  is known for a long time. It is successfully applied to the correct description of experimental situations, when the representation of an electromagnetic field through classical potentials is meaningful. The substantiation of this choice can be made, proceeding from the gauge invariance principle. But the gauge invariance is introduced in this case as postulate, which does not explain the matter.

Let us note something that is important in connection with our theory. It is noted (Kaempffer, 1965) that derivative of phase  $\phi(x)$  of  $\psi$ -function can be expressed through the electromagnetic potentials as follows:

$$\frac{\partial \phi}{\partial x_\nu} = -eA_\nu, \quad (12.1.35)$$

This relationship leads to some observable effects, whose sense for the understanding of interaction has been realized from Aharonov and Bohm (Aharonov and Bohm, 1959). In connection with NTEP it is interesting also (Kaempffer, 1965) that it is possible to formulate the QED without the potentials if we recognize that non-locality is inherent to the concept of the phase, which depends on the integration way, as Mandelstam has shown (Mandelstam, 1962). Then it is more reasonable to consider the Bohm-Aharonov experiment as the instruction of essential non-locality of  $\psi$ -function in EM field.

Note that the interaction of the type (10.1.34) is called the vector interaction in quantum field theory. Besides this, there is the axial-vector interaction, which, together with the vector interaction, defines the so-called electro-weak interactions of elementary particles

### 1.5.1. Some features of the description of the interactions in quantum field theory

In the classical field theory coordinate representation of the material particles and their interactions is used. In quantum field theory, in contrast to the classical field theory, there is the possibility of more than one equivalent descriptions of the motion of particles and their interactions. In particular, the use of Laplace or Fourier transformations allows to pass from the coordinate representation to the momentum representation (in other words, we can talk about the transition from coordinate space to momentum space).

Currently, in the QFT the momentum representation is mainly used. As we noted, this creates difficulties in the modern theory (in particular, the renormalization procedure is then needed). In NTEP we use the coordinate representation of the wave functions and energy (potential) interactions (see previous part of the study).

In this section we will make a brief comparison of the interaction description in both views (Lokhtin, 2009; Valecka, 2008)..

The complete theory - quantum field theory - must incorporate both QM and relativity and individual forces are described here by QFT Lagrangians which essentially tell us, which particles interact with which other particles. But in special cases these equations coincide with the classical non-relativistic equations.

For example, the Coulomb force equation is classical (both non-quantum mechanical and nonrelativistic) limit of QM theory. As for gravitation Newton law, that can be derived from general relativity. Strong force is confining, and we can not ever observe individual color charged particles; so we can not really have a macroscopic equation for them. But at the level of quantum hadron dynamics the Yukawa potential, though it is a semi-classical approximation, is good enough for experiment description. Etc.

In the QFT in contrast to classical physics the forces among the elementary particles are considered as the *exchange forces*, i.e., the forces produced by the exchange of force carrier particles: photons, intermediate bosons and gluons.

#### Electromagnetic forces

In coordinate space  $r$ , the interaction energy is:

$$\mathcal{E}_{em}(\vec{r}) = \frac{e_1 e_2}{4\pi r}, \quad (12.1.36)$$

To get the force related to this we would take the derivative in  $r$ :

$$\vec{F} = \text{grad} \varepsilon_{em}(\vec{r}) = \frac{e_1 e_2}{4\pi} \frac{1}{r^2} \frac{\vec{r}}{|\vec{r}|}, \quad (12.1.37)$$

In momentum space  $q$  the energy is written as:

$$\varepsilon_{em}(q) = \int \varepsilon_{em}(r) e^{-i\vec{q}\vec{r}} d^3\vec{r} \sim \frac{\alpha}{q^2}, \quad (12.1.38)$$

$\alpha = 1/137$  is electromagnetic constant.

The exchange of energy (or force action) is realized by the virtual photons' exchange.

### Strong interactions

In coordinate space

$$\varepsilon_{strong}(\vec{r}) = \frac{g_s^2(\vec{r})}{4\pi} \frac{1}{r}, \quad (12.1.39)$$

In the momentum space it is:

$$\varepsilon_{st}(q) = \int \varepsilon_{st}(r) e^{-i\vec{q}\vec{r}} d^3\vec{r} \sim \frac{\alpha_{st}}{q^2}, \quad (12.1.40)$$

$\alpha_{st}$  is strong constant.

The exchange of energy (or force action) is realized by the virtual gluons' exchange.

From the study of the spectrum of quarkonium (bound system of quark and antiquark) and the comparison with positronium one finds as potential for the strong force

$$\varepsilon_{st}(\vec{r}) = -\frac{4\hbar c g_s(\vec{r})}{3} \frac{1}{r} + kr, \quad (12.1.41)$$

where the constant  $k$  determines the field energy per unit length and is called string tension. For short distances  $r \approx 0,4$  fm this resembles the Coulomb law, while for large distances the confinement factor  $kr$  dominates.

### Yukawa potential of nuclear force

The nuclear force is now understood as a residual effect of the more powerful strong force, or strong interaction. This force is mediated by particles called pions:

$$\varepsilon_{nuc}(\vec{r}) = \frac{g_n^2}{4\pi c^2} \frac{1}{r} e^{-M_{\pi} r}, \quad (12.1.42)$$

where  $M_{\pi}$  is roughly the pion mass and  $g_n$  is an effective coupling constant.

### Weak force

In coordinate space

$$\varepsilon_{weak}(\vec{r}) = \frac{g_1 g_2}{4\pi} \frac{1}{r} e^{-M_Z r}, \quad (12.1.43)$$

In momentum space

$$\varepsilon_w(q) = \int \varepsilon_w(r) e^{-i\vec{q}\vec{r}} d^3\vec{r} \sim \frac{\alpha_w}{q^2 + M_Z^2}, \quad (12.1.44)$$

$G_F \sim 1/M_Z^2$  is the Fermi constant of weak interaction.

The exchange of energy (or force action) is realized by the virtual Z bosons' exchange.

### Gravitational Newton force

For completeness we also add to this list the gravitational interaction.

In coordinate space

$$\varepsilon_{gr}(\vec{r}) = G_N \frac{m_1 m_2}{r}, \quad (12.1.45)$$

In momentum space

$$\varepsilon_{gr}(q) = \int \varepsilon_{gr}(r) e^{-i\vec{q}\vec{r}} d^3\vec{r} \sim G_N \frac{m_1 m_2}{q^2}, \quad (12.1.46)$$

The exchange of energy (or force action) is realized by the virtual gravitons' exchange.

$G_N$  is the gravitation constant.

The target of following sections is to show that NTEP allows us to obtain the mathematical description of these interactions.

## 2.0. The derivation of the Lagrangian and the Hamiltonian of 4-vector interactions

### 2.1. The theorem of the Lagrangian and Hamiltonian structure of the vector interaction

As we showed, special feature of NTEP is the unified description of all elementary particles as the nonlinear quantized electromagnetic wave fields. This result gives grounds to assume that the Lagrangian and Hamiltonian of non-linear electromagnetic field must describe all sides of the behavior of particles, including their interaction.

We will prove below the theorem, which confirms this assumption. The proof of theorem is based on the properties of Lagrangian, which follow from the above brief review. A Lagrangian is a very convenient tool for the operating with composite systems: in the case of the joining up of several non-interacting bodies into the system (or even several systems into one), their Lagrange functions are added. With the appearance of interactions between the bodies, the corresponding interaction energy of these particles is added into Lagrange's function. The same can be said of the Hamiltonian.

We will accept as initial the expressions of Lagrangian and Hamiltonian for the free electromagnetic field (particle):

$$L = \frac{1}{8\pi} (\vec{E}^2 - \vec{H}^2), \quad (12.2.1)$$

$$H = \frac{1}{8\pi} (\vec{E}^2 + \vec{H}^2), \quad (12.2.2)$$

Let us show that within the framework of NTEP the Lagrangian (12.2.1) and Hamiltonian (12.2.2) allow to obtain the description not only of free fields, but also interactions.

For this purpose we prove the theorem, called by us the **theorem of the interaction structure**:

*Due to the principle of superposition of fields the Lagrangian (Hamiltonian) of the system of interacting fields is automatically divided into two parts: the part, which corresponds to free fields, and the part, which corresponds to their interaction; in this case :*

*1. The Lagrangian (Hamiltonian) of the system of free particles is defined by the sum of the Lagrangians (Hamiltonians) of the free particles, each of which is determined by the squares of its own fields;*

*2. Lagrangian (Hamiltonian) of interaction of particles is the sum of the Lagrangians (Hamiltonians), each of which describes interaction only of one pair of the particles, does not depend on the presence of other particles and is determined by cross product of their fields.*

Let us first prove the general formula of theorem.

Let the system consists of two parts (particles) 1 and 2, which have both the electric and magnetic fields:  $\vec{E}_1$ ,  $\vec{H}_1$  and  $\vec{E}_2$ ,  $\vec{H}_2$ . According to the superposition principle a total field of system of particles is equal to the sum of the fields, created by each particle separately:  $\vec{E} = \vec{E}_1 + \vec{E}_2$ ,  $\vec{H} = \vec{H}_1 + \vec{H}_2$ .

Thus, for Lagrangian and Hamiltonian of two interacting particles we obtain:

$$L = \frac{1}{8\pi} (\vec{E}^2 - \vec{H}^2) = \frac{1}{8\pi} (\vec{E}_1^2 - \vec{H}_1^2) + \frac{1}{8\pi} (\vec{E}_2^2 - \vec{H}_2^2) + \frac{1}{8\pi} (\vec{E}_1 \vec{E}_2 - \vec{H}_1 \vec{H}_2), \quad (12.2.3)$$

$$H = \frac{1}{8\pi} (\vec{E}^2 + \vec{H}^2) = \frac{1}{8\pi} (\vec{E}_1^2 + \vec{H}_1^2) + \frac{1}{8\pi} (\vec{E}_2^2 + \vec{H}_2^2) + \frac{1}{8\pi} (\vec{E}_1 \vec{E}_2 + \vec{H}_1 \vec{H}_2), \quad (12.2.4)$$

As we see, because of the principle of superposition of fields, Lagrangian (Hamiltonian) of the particles' system is actually divided into two parts, one of which is determined only by own fields of particles, and the second is determined by the fields of the pairs of particles.

It is not difficult to see that the cross terms are determined by the fields, which belong always to two different particles.

Now we need prove that these terms determine the interaction of particles.

## 2.1. The description of interaction of two charge particles

Taking into account the known results (Landau and Lifshitz, 1977; Jackson, 1999; Brillouin, 1970) we will prove first the above theorem for the case of two charged particles.

### 2.1.1. The description of interaction in case of rest particles

Let us consider first a case when only electrostatic fields are present.

Let we have two charges  $q_1$  and  $q_2$ , situated on distance  $r_a$  from each other. The values of field in any point of space P from charges, which distances from P are determined with radius-vectors  $\vec{r}_1$  and  $\vec{r}_2$ , are:

$$\vec{E}_1 = \frac{q_1}{r_1^2} \vec{r}_1^0, \quad \vec{E}_2 = \frac{q_2}{r_2^2} \vec{r}_2^0, \quad (12.2.5)$$

where  $\vec{r}_1^0$  and  $\vec{r}_2^0$  are the unit vectors of corresponding radius-vectors, and  $r_1$  and  $r_2$  are their absolute values. The energy density of an electric field in point P is equal to:

$$\begin{aligned} \frac{1}{8\pi} \vec{E}^2 &= \frac{1}{8\pi} (\vec{E}_1 + \vec{E}_2)^2 = \frac{1}{8\pi} [\vec{E}_1^2 + 2\vec{E}_1 \vec{E}_2 + \vec{E}_2^2] = \\ &= \frac{q_1^2}{8\pi r_1^4} + \frac{q_2^2}{8\pi r_2^4} + 2 \frac{q_1 q_2}{8\pi r_1^2 r_2^2} \cos \theta \end{aligned}, \quad (12.2.6)$$

where  $\theta$  is a angle between vectors  $\vec{r}_1$  and  $\vec{r}_2$ . Thus the Lagrangian of total field can be written down as:

$$L = L_1 + L_2 + L_{12}, \quad (12.2.7)$$

$$\text{where } L_1 = \frac{1}{8\pi} \vec{E}_1^2 = \frac{q_1^2}{8\pi r_1^4}, \quad L_2 = \frac{1}{8\pi} \vec{E}_2^2 = \frac{q_2^2}{8\pi r_2^4}, \quad L_{12} = \frac{1}{4\pi} \vec{E}_1 \cdot \vec{E}_2 = 2 \frac{q_1 q_2}{8\pi r_1^2 r_2^2} \cos \theta.$$

Here the first and second terms obviously represent the Lagrangian of free particles (fields). To find out the meaning of third term, we will calculate the Lagrange function, corresponding to this term, using (12.1.7). Since  $\vec{E}_2 = -\text{grad} \varphi_2 = -\vec{\nabla} \varphi_2$ , where  $\varphi_2 = \frac{q_2}{r_2}$  is static potential for the second charge, we will obtain:

$$L = -\frac{1}{4\pi} \int \vec{\nabla} \varphi_2 \cdot \vec{E}_1 d\tau, \quad (12.2.8)$$

Integrating by parts, we obtain:

$$L = -\frac{1}{4\pi} \int \vec{\nabla} \varphi_2 \cdot \vec{E}_1 d\tau = -\frac{1}{4\pi} \varphi_2 (E_x + E_y + E_z) \Big|_{-\infty}^{\infty} + \frac{1}{4\pi} \int \varphi_2 (\vec{\nabla} \vec{E}) d\tau, \quad (12.2.9)$$

Here the first term is equal to zero, and in the second term, according to Maxwell we have:

$$\vec{\nabla} \vec{E} = 4\pi \rho_e, \quad (12.2.10)$$

where  $\rho_e$  is the density of electric charge  $q_1$ . Then, accepting, that  $r_o \ll r_a$ , we obtain:

$$L_{12} = \rho_e \varphi, \quad (12.2.11)$$

This means that *the Lagrangian, which is adequate to the third term, is Lagrangian of interaction of two charges and has the form of a current - current interaction for the case of a static field.*

### 2.1.2. The description of interaction in case of moving particles

Now we will consider the Lagrangian of two interacting charges, which are in motion. Here together with electric field the magnetic field will also appear. Thus, we should analyze a general view of the Lagrangian in case of any motion of electric charges

First of all, a question arises of whether the electric field varies in case that charges move. This question can be formulated in more general sense: will the Gauss theorem be true in case when the charges move? The experiment answers positively (Purcell, 1975). Hence, the above-stated analysis, concerning static electric field, is true in case of moving charges. Thus, it is enough to analyze further only the term of the general Lagrangian, which contains a magnetic field.

In point P, the magnetic fields from each particle have the form:

$$\vec{H}_1 = \frac{q_1}{r_1^2} [\vec{v} \times \vec{r}_1^0], \vec{H}_2 = \frac{q_2}{r_2^2} [\vec{v} \times \vec{r}_2^0], \quad (12.2.12)$$

where  $\vec{v}$  is the particle velocity. Then the energy density will be

$$\begin{aligned} \frac{1}{8\pi} \vec{H}^2 &= \frac{1}{8\pi} (\vec{H}_1 + \vec{H}_2)^2 = \frac{1}{8\pi} [\vec{H}_1^2 + \vec{H}_2^2 + 2\vec{H}_1 \vec{H}_2] = \\ &= \frac{q_1^2}{8\pi r_1^4} [\vec{v} \times \vec{r}_1^0]^2 + \frac{q_2^2}{8\pi r_2^4} [\vec{v} \times \vec{r}_2^0]^2 + 2 \frac{q_1 q_2}{8\pi r_1^2 r_2^2} [\vec{v} \times \vec{r}_1^0] \cdot [\vec{v} \times \vec{r}_2^0] \end{aligned} \quad (12.2.13)$$

The result (12.2.13) can be rewritten as:

$$L = L_1 + L_2 + L_{12}, \quad (12.2.14)$$

where  $L_1 = \frac{1}{8\pi} \vec{H}_1^2$ ,  $L_2 = \frac{1}{8\pi} \vec{H}_2^2$  are Lagrangian of free particles, and according to our

supposition the term  $L_{12} = \frac{1}{4\pi} \vec{H}_1 \cdot \vec{H}_2$  is the Lagrangian of interaction. This fact follows from direct calculating of the Lagrangian:

$$\bar{L}_{12} = \int L_{12} d\tau, \quad (12.2.15)$$

Since  $\vec{H}_2 = \vec{\nabla} \times \vec{A}_2$ , where  $\vec{A}_2 = \frac{1}{c} \frac{i_2}{r_2} \vec{r}_2^o = \frac{1}{c} \int \frac{\vec{j}_2}{r_2} d\tau_2$  is the vector potential of current of the second charge, we will obtain:

$$L_{12} = \frac{1}{4\pi} \int \vec{\nabla} \times \vec{A}_2 \cdot \vec{H}_1 d\tau, \quad (12.2.16)$$

Integrating by parts in scalar form, we obtain:

$$L_{12} = \frac{1}{4\pi} \sum_{l,n} (\pm) \bar{A}_{2l} \bar{H}_m \Big|_{-\infty}^{+\infty} + \frac{1}{4\pi} \int \bar{A}_2 (\bar{\nabla} \times \bar{H}) d\tau, \quad (12.2.17)$$

where  $l = (x, y, z)$ ,  $m = (x, y, z)$ ,  $l \neq m$  and under the sum the signs are alternated. Here the first term is equal to zero, and in the second term according to Maxwell we have:

$$\bar{\nabla} \times \bar{H} = \frac{4\pi}{c} \bar{j}, \quad (12.2.18)$$

Then we obtain:

$$L_{12} = \frac{1}{c} \bar{j} \cdot \bar{A} = L_{\text{int}}, \quad (12.2.19)$$

This means that the *Lagrangian, relatively to magnetic fields of two moving charges, has the form of current-on-current interaction.*

So, generally we obtain that the interaction Lagrangian of two moving charge particles is defined by the commutator of the electric and magnetic fields of two particles, and can be written down in the form of a current-on-current interaction:

$$L_{\text{int}} = -j_v A_v, \quad (12.2.20)$$

Obviously, in this case the general Hamilton function of interactions will be written down as follows:

$$\bar{H}_{\text{int}} = -\frac{1}{2} \int (\rho\phi + \bar{j} \cdot \bar{A}) d\tau = q\phi - \frac{q}{c} \bar{v} \cdot \bar{A}, \quad (12.2.21)$$

### 2.3. Consequences of the theorem

We have shown that the cross product of fields in Lagrangian (Hamiltonian) corresponds to a current-on-current interaction form. From this the next important consequences follow:

1. *The full energy of two interacting objects is bigger than the sum of energies of free objects, and the energy difference corresponds to the energy of cross product of fields.*

An important question arises: how the interaction energy of two objects is divided between them?

Let's consider one concrete case of electric field. The full of energy density of two interacting particles looks like:

$$u = \frac{1}{8\pi} (\bar{E}_1 + \bar{E}_2)^2 = u_{1o} + u_{\text{int}} + u_{2o}, \quad (12.2.22)$$

where  $u_{1o} = \frac{1}{8\pi} \bar{E}_1^2$  and  $u_{2o} = \frac{1}{8\pi} \bar{E}_2^2$  are the energy densities of first and second particles in a free state respectively, and  $u_{\text{int}} = \frac{1}{8\pi} [\bar{E}_1 \bar{E}_2 + \bar{E}_2 \bar{E}_1]$  is the density of interaction energy of these particles.

2. Since both components  $u_{\text{int1}} = \frac{1}{8\pi} \bar{E}_1 \bar{E}_2$  and  $u_{\text{int2}} = \frac{1}{8\pi} \bar{E}_2 \bar{E}_1$  in the above formula are equal:

$$u_{\text{int1}} = u_{\text{int2}}, \quad (12.2.23)$$

we can accept that *the interaction energy is divided fifty-fifty between two interacting particles.*

Then the full energy density of each interacting particles is equal to  $u_1 = \frac{1}{8\pi} (\bar{E}_1^2 + \bar{E}_1 \bar{E}_2)$  for first particle, and to  $u_2 = \frac{1}{8\pi} (\bar{E}_2^2 + \bar{E}_1 \bar{E}_2)$  for second particle.



Since the energy is defined as  $\varepsilon = \frac{1}{c^2} \int_0^\infty u d\tau$ , the same conclusion refers also to the energies of rest and interacting particles.

3. From above, in conformity with the known expression  $m = \frac{\varepsilon}{c^2}$ , it follows also that *the mass of each interacting particle increases in comparison with the mass of free particle on half value of the term of the field cross product.*

In other words, the mass of interaction of two particles divides fifty-fifty between them so that  $m_{\text{int1}} = m_{\text{int2}}$ , and for the masses of interacting particles we have

$$m_1 = m_{01} + m_{\text{int1}}, \quad m_2 = m_{02} + m_{\text{int2}}, \quad (12.2.24)$$

where  $m_{01}$  and  $m_{02}$  the rest masses of particles without interaction.

### 3.0. Vector electromagnetic interaction as the basis of the interactions in macro-word

#### 3.1. Interaction description of systems of many charge particles

In case when the system consists of a number of charged particles of both (+) and (-) signs and different sizes, we receive the object, possessing various new electromagnetic properties.

As it is known, the system of moving charges possesses in general the electromagnetic moments. In some cases the total charge of such system (which in this case are also named zero moments of a system) can be equal to zero, while other moments are not. This means that these systems are capable to interact due to other moments. The interaction energy of such systems is much lower than the energy of interaction of the charged systems, but is not equal to zero. For example, the atoms, being the neutral objects, nevertheless are capable to interact between themselves by various forces, which frequently are named Van der Waals forces. In QM these forces depend additionally on spin orientation and other quantum parameters.

Since in framework of NTEP the neutral particles are an electromagnetic fields, their interactions must also described by the formula of a current-on-current interaction.

For description of the charge system the potentials are usually used. As it is known, the use of potentials facilitates the mathematical analysis of electrodynamics problems. Since in the NTEP instead of potentials the strengths of electromagnetic field is considered as wave function, we remember that in electrodynamics the interaction can be written through field strengths. In general case (Bredov, Ruma'ntsev et al, 1985) the electromagnetic fields of a moving charge can be described as following:

$$\vec{E}(\vec{r}, t) = \frac{e(1 - \vec{v}^2 / c^2)(\vec{n} - \vec{v} / c)}{R^2(1 - \vec{n} \cdot \vec{v} / c)^3} \Big|_i + \frac{e\vec{n} \times [(\vec{n} - \vec{v} / c) \times \dot{\vec{v}}]}{R^2(1 - \vec{n} \cdot \vec{v} / c)^3} \Big|_i, \quad (12.3.1)$$

$$\vec{H}(\vec{r}, t) = \frac{e(1 - \vec{v}^2 / c^2)(\vec{v} \times \vec{n})}{R^2(1 - \vec{n} \cdot \vec{v} / c)^3} \Big|_i + \frac{e\{c\dot{\vec{n}} + \vec{n} \times [(\vec{v} \times \dot{\vec{v}}) \times \vec{n}]\}}{R^2(1 - \vec{n} \cdot \vec{v} / c)^3} \Big|_i, \quad (12.3.2)$$

Each of these expressions consists of two components. The first components of (12.3.1) and (12.3.2) forms quasi-stationary fields, which change in space as  $R^{-2}$  and does not contain the acceleration of a charge. Hence, the quasi-stationary field remains all time connected with a particle and does not create energy flux on infinity.

The second components describe a wave field of radiation: it is proportional to acceleration  $\dot{v}$  and decreases as  $R^{-1}$ . It is easy to show, that in this case the energy flux decreases as  $R^{-2}$ . Thus on large distances from a particle in expressions (12.3.1)-(12.3.2) only the second terms remains, named wave field. This means that the electromagnetic perturbations can propagate from charge particle to the infinity. Due to these fields, i.e. electromagnetic waves, the particle systems interact with each other on a long distance.

The description of charged particles' system by means of potentials is more often, although it have mathematical advantages only. In general case of arbitrarily moving charges we obtain the so-called Lienar - Wiechert potentials:

$$\vec{A}(\vec{r}, t) = \frac{e\vec{v}}{cR(1 - \vec{n} \cdot \vec{v}/c)} \Big|_{t'}, \quad (12.3.3)$$

$$\varphi(\vec{r}, t) = \frac{e}{cR(1 - \vec{n} \cdot \vec{v}/c)} \Big|_{t'}, \quad (12.3.4)$$

where  $\vec{s}(t')$  are the coordinates of the particle,  $\vec{r}$  are the coordinates of the observation point,  $\vec{v}(t) = \dot{\vec{s}}(t)$  is its velocity,  $e$  is the charge,  $\vec{R}(t') = \vec{r} - \vec{s}(t')$  and  $t'$  is the retarded moment of time, which is defined by the relation:

$$c(t - t') = |\vec{r} - \vec{s}(t')|, \quad (12.3.5)$$

so that difference  $t - t' = |\vec{r} - \vec{s}(t')|/c$  represents the time of distribution of the electromagnetic perturbation from the particle up to an observation point of field.

### 3.2. The case of stationary system of electric charges

In particular, for the scalar potential in large distances from the system of charges, we have the expansion:

$$\varphi(r) = \frac{q}{r} + \frac{\vec{p} \cdot \vec{r}}{r^3} + \frac{Q_{\alpha\beta} x_\alpha x_\beta}{2r^5} + \dots, \quad (12.3.6)$$

where in case of continuous distribution of charges we have:  $q = \int \rho(r') dV'$  is the full charge of the system,  $\vec{p} = \int r' \rho(r') dV'$  is the dipole moment of the system,  $Q_{\alpha\beta} = \int \rho(r') (3x'_\alpha x'_\beta - r'^2 \delta_{\alpha\beta}) dV'$  is the tensor of the quadrupole moment of the system of charges, etc. (in case of a discrete system of point charges we have sums instead of integrals).

If  $q = 0$  then the system is neutral and is described by other electrical moments, which are not zero.

The interactions that occur between the neutral systems of charges play an important role in the existence of real forms of matter: elementary particles, atoms and molecules.

In the case of interactions between two or more molecules are called *intermolecular* interactions (the interactions between the atoms within a molecule are called *intramolecular* interactions). Intermolecular interactions occur between all types of molecules or ions in all states of matter. They have range from the strong, long-distance electrical attractions and repulsions between ions to the relatively weak dispersion forces. The various types of interactions are classified as (in order of decreasing strength of the interactions): ion - ion, ion - dipole, dipole - dipole, ion - induced dipole, dipole - induced dipole, dispersion forces, etc. They can be often explained using a simple classical electrodynamics approach, but for more accuracy a quantum mechanical approach needs.

## 4.0. About the Newton dynamics laws

Let's show that in framework of NTEP the consequences of the above-stated theorem are the equations of classical mechanics (Leech, 1958).

### 4.1. First Newton's law (inertia law)

First Newton's law can be formulated as follows: "An object at rest or moving at constant velocity will continue to do so unless acted upon by an external force". In this form this law can be considered as the consequence of the second Newton's law (although here there are some difficulties, which there is no sense to examine in this case).

Obviously, an inertial motion is accomplished only when there is no energy loss. Motion without energy loss is characteristic of “linear” photon motion. Then, a neutral particle, formed by the rotation of photon fields, must also move without energy loss. It is possible to assume that this motion must be described by the theory, related to the theory of superfluidity. Since nonlinear equations of NTEP reveal relationship with the equations of superconductivity and superfluidity, our assumption has a base.

#### 4.2. The second law of Newton

According to the second Newton’s law we have

$$\frac{d\vec{p}}{dt} = \sum \vec{F}_i, \quad (12.5.1)$$

where  $\vec{p}$  is a linear momentum of the particle motion,  $\vec{F}_i$  are all forces acted on the particle.

For particles in electromagnetic field the equation (12.3.1) follows from relativistic Lagrangian of the charge particle in the electromagnetic fields (see e.g. (Bo Thide, 2002; Jackson, 1999)). If the question is only about the electromagnetic field without particles, in this case “The momentum theorem” exists, which shows the validity of the Newton law concerning the electromagnetic field as a material carrier. It is understood that in framework of NTEP “The momentum theorem” can be easy to prove.

We should also remind that according to Ehrenfest theorem (Schiff, 1955) it is possible from Dirac equation to obtain the Newton equation (12.3.1) (Leech, 1958; Landau and Lifshitz, 1977; Schiff, 1955). Since the Dirac equation coincides precisely with the electron equation of NTEP, it is possible to assert that Ehrenfest theorem proves that the equation of Newton also follows from NTEP.

#### 4.3. Third Newton’s law

Recall Newton's Third Law: “For every action there is an equal and opposite reaction”. Let us show that third Newton’s law follows from the features of electromagnetic theory. Actually, taking into account the expression (12.1.29), we can write:

$$\varepsilon_{int1} = \varepsilon_{int2} = \frac{1}{2} \overline{M}, \quad (12.5.2)$$

On the base (12.1.25) from (12.3.5) it follows that action and counteraction forces are equal and have opposite directions  $\vec{F}_1 = -\vec{F}_2$  in accordance with Newton's Third Law .

## 5.0 Connection of de Broglie’s waves refraction index with Hamiltonian

In frameworks of NTEP the equations of interaction of the electron with other charged particles (or, in other words, the equations of the electron motion in the field of other particle) can be presented in form of the equations of the classical electrodynamics of medium:

$$\frac{1}{c} \frac{\partial \vec{E}}{\partial t} - \text{rot} \vec{H} = -\frac{4\pi}{c} (\vec{j}^e + \vec{j}_{ex}^e), \quad (12.5.1)$$

$$\frac{1}{c} \frac{\partial \vec{H}}{\partial t} + \text{rot} \vec{E} = \frac{4\pi}{c} (\vec{j}^m + \vec{j}_{ex}^m), \quad (12.5.2)$$

where  $\vec{j}^e, \vec{j}^m$  are the electric and magnetic current densities of the particle,  $\vec{j}_{ex}^e, \vec{j}_{ex}^m$  are the external current densities, which caused by the interaction of the given particle with other particles. In case if other particles (including also the virtual particles of the physical vacuum) form a medium, this equations can be presented as the electromagnetic theory of polarized medium (Jackson, 1999; Purcell, 1975; Bo Thide, 2002). In this case the external currents can be represented in the following way:

$$\vec{j}_{ex}^e = i\omega_{ex}^e \vec{E} \quad (12.5.3)$$

$$\vec{j}_{ex}^m = i\omega_{ex}^m \vec{H} \quad (12.5.4)$$

where  $\omega_{ex}^e$  and  $\omega_{ex}^m$  can be conditionally named electroconductivity and magnetoconductivity in the external medium.

The Hamiltonian of Dirac's electron theory is following:

$$\hat{H} = c\hat{\alpha} \cdot \hat{p}\psi - \left[ \hat{\beta} mc^2 + (\hat{\alpha}_0 \varepsilon_{ex} - c\hat{\alpha} \cdot \vec{p}_{ex}) \right] \psi, \quad (12.5.5)$$

Using (12.5.2) we can obtain the NTEP representation of (12.5.5), which we will conditionally write in the form:

$$\hat{H} = \pm rot(\vec{E}, \vec{H}) \mp \frac{4\pi}{c} (\vec{j}^{e,m} + \vec{j}_{ex}^{e,m}), \quad (12.5.5')$$

The expression (12.5.5') show that the connection of Hamiltonian with above currents (12.5.3) and (12.5.4) and correspondingly with the features of external medium  $\varepsilon_{ex}$  and  $\mu_{ex}$  exists.

Due to above result in non-relativistic case the Schroedinger equation with an external field can be written down through a "quantum" refraction index of medium. Conformity between electrodynamics of optical waves and electrodynamics of de Broglie waves is the most evident look for the stationary Schroedinger equation. Actually, the stationary Schroedinger equation:

$$\nabla^2 \psi + \frac{2m}{\hbar^2} (\varepsilon - \varepsilon_{int}) \psi = 0, \quad (12.5.6)$$

(where the energy  $\varepsilon$  are Hamiltonian eigenvalues,  $\varepsilon_{int} = e\varphi(r)$  is an interaction energy) is similar (Ebert, 1957) to the optical wave equation, which determinates the light propagation in the medium, whose refraction index changes in space from point to point:

$$\nabla^2 \psi + \left( \frac{2\pi n}{\lambda_0} \right)^2 \psi = 0, \quad (12.5.7)$$

where  $n = n(r) = \sqrt{\varepsilon_{ex} \mu_{ex}}$  is a refraction index,  $\lambda_0$  is the light wavelength in vacuum; and the optical wavelength  $\lambda = \frac{\lambda_0}{n}$  corresponds to the length of the de Broglie wave

$$\lambda = \frac{h}{p} = \frac{h}{\sqrt{2m(\varepsilon - \varepsilon_{int})}}.$$

Since the elementary particles of NTEP are the nonlinear electromagnetic waves, from the above follows that when particles propagate through the medium, the refraction, diffraction, interference of these waves takes place like as for usual light waves. In this case of particles' interaction the interconversion of particles can be considered as a dispersion of the curvilinear waves. Therefore we can suppose also that the dispersion matrix of the field theory performs here the same role as a dispersion matrix in optics.

To obtain the corresponding relativistic equation is very difficult, since in this case the permittivity and permeability compose a tensor and it is not possible to introduce refractive index as above.

It is more complicated to perform the introduction of the refractive index in the Dirac equation, and in general, probably, impossible (Bredov, Ruma'ntsev et al, 1985). As is known in electromagnetic theory the properties of the medium are characterized by complex magnetic and electrical permeabilities, through which the refractive index can be expressed only in the particular case. In this case the equations (12.5.1) - (12.5.4) will contain in place of the electric and magnetic fields, the induction vectors of electric  $\vec{D} = f_1(\vec{E})$  and magnetic  $\vec{B} = f_2(\vec{H})$  fields.

Thus, the introduction of complex permittivity in the equation of NTEP (or in the corresponding quantum equations) should be associated with the introduction of additional complex functions, reflecting the effect of external or internal fields.

## 6.0. The axial-vector interaction

In classical electrodynamics there is only the vector interaction (a vector in this case means a 4-vector-potential, consisting of a scalar and vector parts). In quantum field theory was observed the existence of some different interactions: the axial-vector or the weak interaction, which plays an important role in the interactions of elementary particles. In quantum field theory, this interaction, as well as a vector is in fact postulated. In the nonlinear theory (Kiryakos. 2010a) an axial-vector interaction occurs on the basis of the initial axioms and does not require any additional assumptions. We briefly recall this conclusion here.

### 6.1. The Lagrangian of the nonlinear lepton equation

The Lagrangian of nonlinear theory (see previous chapters) can be obtained from the Lagrangian of Dirac's linear equation. Using the linear equivalent of the energy-momentum conservation law for the internal (*in*) field of particle:

$$\hat{\beta} m_e c^2 = -\varepsilon_{in} - c\hat{\alpha} \vec{p}_{in} = -e\varphi_{in} - e\hat{\alpha} \vec{A}_{in}, \quad (\text{A})$$

where the inner (self) energy  $\varepsilon_{in}$  and momentum  $p_{in}$  of lepton can be expressed using the inner energy density  $u$  and the inner momentum density  $\vec{g}$  (or Poynting vector  $\vec{S}$ ) of an EM wave:

$$\varepsilon_{in} = \int_0^\tau u d\tau = \frac{1}{8\pi_0} \int_0^\tau (\vec{E}^2 + \vec{H}^2) d\tau, \quad (12.6.1)$$

$$\vec{p}_{in} = \int_0^\tau \vec{g} d\tau = \frac{1}{c^2} \int_0^\tau \vec{S} d\tau = \frac{1}{4\pi_0} \int_0^\tau [\vec{E} \times \vec{H}] d\tau, \quad (12.6.2)$$

Substituting relationship (A) into this equation, we obtain:

$$L_N = \psi^\dagger \left( \hat{\varepsilon} - c\hat{\alpha} \cdot \hat{p} \right) \psi + \psi^\dagger \left( \varepsilon_{in} - c\hat{\alpha} \cdot \vec{p}_{in} \right) \psi, \quad (12.6.3)$$

We will assume that (12.6.3), taking into account (12.6.1) and (12.6.2), represents the general form of the Lagrangian of nonlinear electron theory.

Therefore this Lagrangian, together with the vector interaction must also takes into account the weak interaction. In this sense, this Lagrangian is a Lagrangian of electro-weak theory. The correctness of this assumption proves the effective Lagrangian form, derived from it below.

### 6.2. The effective Lagrangian of the nonlinear lepton equation (the Heisenberg equation)

We can rewrite the equations (12.6.1) and (12.6.2) in the following form:

$$\varepsilon_{in} = \int_0^{\tau_0} u d\tau + \int_{\tau_0}^{\infty} u d\tau, \quad (12.6.4)$$

$$\vec{p}_{in} = \int_0^{\tau_0} \vec{g} d\tau + \int_{\tau_0}^{\infty} \vec{g} d\tau, \quad (12.6.5)$$

where the first terms of equations (12.6.4) and (12.6.5) contain the bulk of own energy and momentum of the particle and the second terms are the residual parts of these quantities. Obviously, these residual pieces give a small contribution to the total value of the energy and momentum.

Taking into account that the solution of Dirac's equation for a free electron is the plane wave

$$\psi = \psi_0 \exp[i(\omega t - ky)], \quad (12.6.6)$$

we can approximately write (12.6.1) and (12.6.2) as follows:

$$\varepsilon_p = \int_0^{\tau_0} u d\tau = u \tau_0 = \frac{\tau_0}{8\pi} \psi^+ \hat{\alpha}_0 \psi, \quad (12.6.7)$$

$$\vec{p}_p = \int_0^{\tau_0} \vec{g} d\tau = \vec{g} \tau_0 = \frac{1}{c^2} \vec{S} \tau_0 = -\frac{\tau_0}{8\pi c} \psi^+ \hat{\alpha} \psi, \quad (12.6.8)$$

where  $\tau_0$  is the volume that contains the main part of the semi-photon's energy.

Using (12.6.7) and (12.6.8), we can represent (12.6.3) in the following quantum form:

$$L_N = i\hbar \left[ \frac{\partial}{\partial t} \left[ \frac{1}{2} (\psi^+ \psi) \right] - c \operatorname{div} (\psi^+ \hat{\alpha} \psi) \right] + \frac{\tau_0}{8\pi} \left[ (\psi^+ \psi)^2 - (\psi^+ \hat{\alpha} \psi)^2 \right], \quad (12.6.9)$$

or in the electromagnetic forme:

$$L_N = i \frac{\hbar}{2m_e} \left( \frac{1}{c^2} \frac{\partial u}{\partial t} + \operatorname{div} \vec{g} \right) + \frac{\tau_0}{m_e c^2} (u^2 - c^2 \vec{g}^2), \quad (12.6.10)$$

We can transform here the second term using the known electrodynamics identity (Lightman Alan R. et al.,1975):

$$(8\pi)^2 (u^2 - c^2 \vec{g}^2) = (\vec{E}^2 + \vec{H}^2)^2 - 4(\vec{E} \times \vec{H})^2 = (\vec{E}^2 - \vec{H}^2)^2 + 4(\vec{E} \cdot \vec{H})^2, \quad (12.6.11)$$

What is the physical meaning of this transformation? In (12.6.11), the expression  $(\vec{E}^2 + \vec{H}^2)^2 - 4(\vec{E} \times \vec{H})^2$  is scalar, i.e., is an EM invariant, but the expressions  $(\vec{E}^2 + \vec{H}^2)^2$  and  $4(\vec{E} \times \vec{H})^2$  are separately not invariants. At the same time the expressions  $(\vec{E}^2 - \vec{H}^2)^2$  and  $(\vec{E} \cdot \vec{H})^2$  are individually the invariants of the EM theory.

Taking into account electromagnetic representation of the wave function we can represent the nonlinear part of (12.6.10) in the following form:

$$L'_N = \frac{\tau_0}{(8\pi)^2 m c^2} \left[ (\vec{E}^2 - \vec{H}^2)^2 + 4(\vec{E} \cdot \vec{H})^2 \right], \quad (12.6.12)$$

As we can see, it contains only the Maxwell theory invariants.

According to the equation (12.6.9) the quantum form of the Lagrangian density (12.6.12) is:

$$L'_N = \frac{\tau_0}{8\pi} \left[ (\psi^+ \hat{\alpha}_0 \psi)^2 - (\psi^+ \hat{\alpha} \psi)^2 \right], \quad (12.6.13)$$

We can see that in quantum form, the electrodynamics correlation (12.6.11) takes the form of the known Fierz identity (Cheng and Li, 1984; 2000):

$$(\psi^+ \hat{\alpha}_0 \psi)^2 - (\psi^+ \hat{\alpha} \psi)^2 = (\psi^+ \hat{\alpha}_4 \psi)^2 + (\psi^+ \hat{\alpha}_5 \psi)^2, \quad (12.6.14)$$

Using (12.6.14), we obtain from (12.6.9):

$$L_Q = \psi^+ \hat{\alpha}_\mu \partial_\mu \psi + \frac{\Delta \tau}{8\pi} \left[ (\psi^+ \hat{\alpha}_4 \psi)^2 - (\psi^+ \hat{\alpha}_5 \psi)^2 \right], \quad (12.6.15)$$

As we see *the Lagrangian* (12.6.15) *coincides with the Lagrangian of Nambu – Jona-Lazinio* (Nambu and Jona-Lazinio, 1961; 1961a). The second term of this Lagrangian describes a vector-axial-vector (VA) interaction.

What is the physical meaning of expression  $(\psi^+ \hat{\alpha}_5 \psi)$ ?

### 6.3. Helicity in fluid mechanics and electrodynamics

The physical meaning of the term  $(\psi^+ \hat{\alpha}_5 \psi)^2 = 4(\vec{E} \cdot \vec{H})^2$  has been studied in both classical and quantum physics. In connection with the geometric (topological) properties, this term is called chirality.

In classical physics, the analysis of the physical meaning of this term is based on the mathematical similarity between electromagnetic vectors with hydrodynamic vectors.

Kelvin's vision (Moffatt, 2008) of the role of knotted or linked vortex tubes in a hypothetical ether was largely qualitative in character. He correctly perceived that knots and linkages would be conserved by virtue of the frozen-in property of vortex lines, but he had no quantitative measure of such knottedness or linkage. The simplest such quantitative measure for any localised vorticity distribution is in fact provided by its helicity, the integrated scalar product of the vorticity field  $\vec{\omega}$  and the velocity  $\vec{v}$  to which it gives rise:  $h = \int \vec{v} \cdot \vec{\omega} d\tau$ .

A similar analysis shown that in the case of free electromagnetic fields, the value  $(\vec{E} \cdot \vec{H})$  corresponds to the above definition (Trueba, Jose L. and Ranada, Antonio F. (2000). In this regard, it is called an electromagnetic helicity.

In quantum physics (Ternov, 2000) the study of electromagnetic properties of massive neutrinos have shown that the electric dipole moment of Dirac neutrinos, as well as the magnetic, has a dynamic nature: it depends by complex nonlinear way on the strength of field and particle energy. In weak electric and magnetic fields  $\vec{E}, \vec{H} \ll \vec{B}_0 \lambda$  is equal to  $d_v = \frac{2}{9} \frac{(\vec{E} \cdot \vec{H})}{\lambda B_0^2}$ .

The results of the analysis of neutrino equation in the NTEP showed that the helicity emerges as one of the distinguishing characteristics of the neutrino (chapter 10).

## 7.0. The general case of the interaction Lagrangian and Hamiltonian of NTEP

The Hamiltonian and Lagrangian of the NTEP as the non-linear theory must contain all possible invariants of non-linear electromagnetic field theory. Thus we can suppose that Lagrangian must be some function of the field invariants:

$$L = f_L(I_1, I_2), \quad (12.7.1)$$

where  $I_1 = (\vec{E}^2 - \vec{H}^2), I_2 = (\vec{E} \cdot \vec{H})$ .

Hamiltonian is fully defined through the Lagrangian. Thus, if the function (12.7.1) is known, using the formulas (12.1.13), it is easy to calculate the Hamiltonian, which will be now the function of the various powers of electromagnetic field vectors:

$$H = f_H(\vec{E}, \vec{H}), \quad (12.7.2)$$

Apparently, for each problem the functions  $f_L$  and  $f_H$  must have its special form, which is unknown before the problem solution. As is known the approximate form of the function  $f_H$  can be found on the basis of Schroedinger's or Dirac's wave equation, using the so-called perturbation method. It is supposed here that there is an expansion of the function  $f_H$  in Taylor–MacLaurent power series with unknown expansion coefficient. Then the problem is reduced to the calculation of these coefficients. The solution is searched for each term of expansion separately, starting from first. Usually this is the problem for a free particle, whose solution is already known. Then using the equation with the two first terms, we find the coefficient of the second term. Further using the equation for the three first terms, we find the coefficient for the third term of expansion, etc. In many cases by this method it is possible to obtain the solution with any desirable accuracy.

In case of function of two variables  $\xi = f(x, y)$  the Taylor – MacLaurent power series nearly to a point  $(x_0, y_0)$  is:

$$f(x, y) = f(x_0, y_0) + \sum_{k=1}^n \frac{1}{k!} \left( (x-x_0) \frac{\partial}{\partial x} + (y-y_0) \frac{\partial}{\partial y} \right)^k f(x_0, y_0) + O(\rho^n), \quad (12.7.3)$$

where  $\rho = \sqrt{(x-x_0)^2 + (y-y_0)^2}$ ,

$$\left( (x-x_0) \frac{\partial}{\partial x} + (y-y_0) \frac{\partial}{\partial y} \right) f(x_0, y_0) \equiv (x-x_0) \frac{\partial f(x_0, y_0)}{\partial x} + (y-y_0) \frac{\partial f(x_0, y_0)}{\partial y}, \quad (12.7.4)$$

$$\begin{aligned} \left( (x-x_0) \frac{\partial}{\partial x} + (y-y_0) \frac{\partial}{\partial y} \right)^2 f(x_0, y_0) &\equiv (x-x_0)^2 \frac{\partial^2 f(x_0, y_0)}{\partial x^2} + \\ &+ 2(x-x_0)(y-y_0) \frac{\partial^2 f(x_0, y_0)}{\partial x \partial y} + (y-y_0)^2 \frac{\partial^2 f(x_0, y_0)}{\partial y^2}, \end{aligned} \quad (12.7.5)$$

Etc. (In case when  $x_0 = 0$ ,  $y_0 = 0$  we obtain the MacLaurent series).

Obviously, for the most types of the functions  $f_L(I_1, I_2)$  the expansion contains approximately the same set of the terms, which distinguish only by the constant coefficients, any of which can be equal to zero (as examples see the expansions of the quantum electrodynamics Lagrangian for particle at the present of physical vacuum (Akhiezer and Berestetskii., 1965; Schwinger, 1951; Weisskopf, 1936). Generally the expansion will look like:

$$L_M = \frac{1}{8\pi} (\vec{E}^2 - \vec{B}^2) + L', \quad (12.7.6)$$

where

$$\begin{aligned} L' = &\alpha (\vec{E}^2 - \vec{B}^2)^2 + \beta (\vec{E} \cdot \vec{B})^2 + \gamma (\vec{E}^2 - \vec{B}^2) (\vec{E} \cdot \vec{B}) + \\ &+ \xi (\vec{E}^2 - \vec{B}^2)^3 + \zeta (\vec{E}^2 - \vec{B}^2) (\vec{E} \cdot \vec{B})^2 + \dots \end{aligned} \quad (12.7.7)$$

is the part, which is responsible for the non-linear interaction (here  $\alpha, \beta, \gamma, \xi, \zeta, \dots$  are constants)

Corresponding Hamiltonian will be defined as follows:

$$H = \sum_i E_i \frac{\partial L}{\partial E_i} - L = \frac{1}{8\pi} (\vec{E}^2 + \vec{B}^2) + \bar{H}', \quad (12.7.8)$$

where the Hamiltonian part responsible for non-linear interaction is:

$$\begin{aligned} \hat{H}' = &\alpha (\vec{E}^2 - \vec{B}^2) (3\vec{E}^2 - \vec{B}^2) + \beta (\vec{E} \cdot \vec{B})^2 + \\ &\xi (\vec{E}^2 - \vec{B}^2) (5\vec{E}^2 + \vec{B}^2) + \zeta (3\vec{E}^2 - \vec{B}^2) (\vec{E} \cdot \vec{B})^2 + \dots \end{aligned} \quad (12.7.9)$$

It is not difficult to obtain the quantum representation of Hamiltonian (12.7.9) of non-linear theory. Replacing the electromagnetic wave field vectors by quantum wave function, we will obtain a series of type:

$$\hat{H} = (\psi^+ \hat{\alpha}_0 \psi) + \sum c_{1i} (\psi^+ \hat{\alpha}_i \psi) (\psi^+ \hat{\alpha}_j \psi) + \sum c_{2i} (\psi^+ \hat{\alpha}_i \psi) (\psi^+ \hat{\alpha}_j \psi) (\psi^+ \hat{\alpha}_k \psi) + \dots, \quad (12.7.10)$$

where  $\hat{\alpha}_i, \hat{\alpha}_j, \hat{\alpha}_k$  are Dirac matrixes,  $c_i$  are the coefficients of expansion.

As we see, the terms of Lagrangian and Hamiltonian series contain the same elements, such as  $(\vec{E}^2 + \vec{B}^2)$ ,  $(\vec{E} \cdot \vec{B})^2$ ,  $(\vec{E}^2 - \vec{B}^2)$  and some others. It is possible to assume that each element of series has some particular physical sense. In this case it is possible to see the analogy with expansion of fields on the electromagnetic moments, and also with decomposition of a S-matrix on the elements (Akhiezer and Berestetskii., 1965), each of which corresponds to the particularities of interaction of separate particles.



# Chapter 13. On elementary particles' spectra

## 1.0. Introduction

We identify the area of interference, the diffraction halo, with the atom; we assert that the atom in reality is merely the diffraction phenomenon of an electron wave captured as it were by the nucleus of the atom. It is no longer a matter of chance that the size of the atom and the wavelength are of the same order of magnitude: it is a matter of course.

**Erwin Schrödinger. The fundamental idea of wave mechanics.**  
*Nobel Lecture, December 12, 1933*

According to modern representations all elementary particles are the bound states of a small set of more light particles. Among all these objects are now recognized as fully stable only electron, neutrino, proton and neutron in a bound state in the stable nuclei. All other particles are the spectra of particles, which decay into one another.

## 1.1. The spectra of the elementary particles

Generally, each elementary particle is defined by a set of various characteristics: mass, spin, electric charge, strong and weak "charges" (i.e. the characteristics, which define intensity of strong and weak interaction), numbers of "affinity" (numbers, due to which one family of particles differs from another: lepton number, baryon number and others), etc.

We say that the particles, which are characterized by identical characteristics, except for any one of them, compose a spectrum regarding this chosen characteristic. For example, if as such characteristic the mass of particles is accepted, we speak about a mass spectrum of elementary particles.

The first (Gottfried and Weisskopf, 1984) were the atomic and molecular photon radiation spectra; the second the nuclear gamma-quantum spectra, at which nature offers us a series of well-defined quantum states. Further were disclosed the lepton and hadron spectra.

The heavy charged leptons (muon and tauon) are heavier (i.e., more massive) replicas of the electron, and each has its own neutrino. Thus the electron is the ground state of a spectrum that we can call the spectrum of charged lepton; and the electron neutrino is the ground state of a spectrum of non-charged leptons – neutrinos. The proton is merely the ground state of a complex spectrum that we called the baryon spectrum. In an analogous manner, the  $\pi$ 's are the lowest-lying members of the meson spectrum.

According to the contemporary theory there are some limiting conditions of the composition of elementary particles, which can be named the conservation laws of this characteristic: e.g. the laws of conservation of energy, momentum, angular momentum, electric charge and charges of other interactions, laws of conservation of numbers of "affinity", etc. Some laws (principles) also exist - the uncertainty principle of Heisenberg, which restrict the transition from one family or spectrum to another.

If to speak, for example, about mass spectra of particles, there are following limitations for shaping of such spectra:

- 1) according to the energy-momentum conservation law the rest free light particles cannot decay to heavier particles, but heavy particles can decay to more light particles;
- 2) nevertheless, according to a uncertainty principle of Heisenberg, heavy particles cannot comprise the light particles as a ready particles (for example, the neutron cannot comprise electron as a free particle).

As is known, the existing theory cannot explain the occurrence of elementary particle characteristics and of their conservation laws: they are entered as consequences of experiments.

The conclusions of the quantum theory are undoubtedly correct and was confirmed by experiments. Thus we should show that they do not contradict to the results of nonlinear theory of elementary particles (NTEP).

Within the framework of NTEP the fundamental particles are the simple harmonic nonlinear waves. The purpose of this chapter is to show that the spectra of elementary particles appear due to the superposition of these nonlinear waves. Most of all we will be interested in mass spectra.

## 2.0. A hypothesis of formation of spectra of elementary particles in NTEP

The electromagnetic nonlinear waves have the same characteristics as elementary particles. The nonlinear harmonic waves have the masses, can have integer or half spin, can be charged or neutral, etc.

The mass of particles within the frameworks of NTEP is the "stopped" energy of the nonlinear standing wave, which are defined by frequency of this wave. Therefore to a heavy particle the nonlinear wave of relatively high frequency must correspond, and to light particle - the nonlinear wave of lower frequency. What another can change the mass of particle?

The nonlinear harmonic waves of NTEP correspond to the simple harmonic waves of classical electrodynamics (briefly CED). What possibility to change the characteristics of EM wave does exist in the classical electrodynamics?

As we know, the most simple possibility consists in the waves' superposition. In this case the harmonic waves of various frequencies can coexist in some composite formations.

Analogically to the results of classical theory of EM waves, whose quantum non-linear generalization our theory is, we assume that in the framework of NTEP:

1) *the cause of formation of spectrum of composite particles is the superposition of simple (harmonic) nonlinear waves;*

2) *the cause of decay of particles is the disintegration of the composite nonlinear waves to the simple waves.*

We will recall the description of the superposition of waves in the classical theory, to attempt to use these ideas in NTEP.

### 2.1. Superposition of «linear» waves

As is known (Crawford, 1970), the composite system of waves can be represented by the superposition of the simpler waves, called "modes" (note that the terms: "simple harmonic oscillation", "harmonics", "normal oscillation", "own oscillation", "normal mode" or simply "mode" are identical; recall also that under "linear" wave we understand the wave, which is the solution of linear wave equation). Let's consider a simple case of such superposition.

In many physical phenomena the system represents a superposition of two harmonic oscillations, having various angular frequencies  $\omega_1$  and  $\omega_2$ . These oscillations can, for example, correspond to two normal modes of the system, having two degrees of freedom. The known example of such system is the molecule of ammonia (Crawford, 1970).

It is possible to illustrate this fact based on example of energy spectrum of electron in hydrogen atom. Really, the electron energy spectrum in electron-proton system is from the general point of view a spectrum of electron masses. Then it is possible to speak about a basic mass (basic energy) of electron in the not excited state and about a lot of masses of electron in the excited states, when electron receives additional portions of energy (mass).

These portions are very small in comparison with the rest electron energy (mass). The increase of electron mass occurs due to absorption of photons, and the reduction of mass takes place due to emission of photons. On the other hand, we cannot tell that the electron contains a photon as a ready particle. In the case of particle composition and decay we cannot say the same about the energy portions. But nevertheless, it does not exclude that these are the same phenomenon.

It is easy to show (Crawford, 1970) that the change of electron energy as a result of its excitation corresponds to a hypothesis about the production of new particles owing to superposition of waves.

Let's consider the stable states of the electron in one-dimensional potential well with infinitely high walls, whose coordinates are  $z = -\frac{L}{2}$  and  $z = +\frac{L}{2}$ . We will assume that the electron state is defined by superposition of the basic state and the first excited state:

$$\psi(z, t) = \psi_1(z, t) + \psi_2(z, t), \quad (13.2.1)$$

where  $\psi_1(z, t) = A_1 e^{-i\omega_1 t} \cos k_1 z$ ,  $k_1 L = \pi$ ,  $\psi_2(z, t) = A_2 e^{-i\omega_2 t} \sin k_2 z$ ,  $k_2 L = 2\pi$ .

The probability of electron state in the position  $z$  in the time moment  $t$  is equal to:

$$\begin{aligned} |\psi(z, t)|^2 &= \left| A_1 e^{-i\omega_1 t} \cos k_1 z + A_2 e^{-i\omega_2 t} \sin k_2 z \right|^2 = A_1^2 \cos^2 k_1 z + \\ &+ A_2^2 \sin^2 k_2 z + 2A_1 A_2 \cos k_1 z \cdot \sin k_2 z \cdot \cos(\omega_2 - \omega_1)t \end{aligned}, \quad (13.2.2)$$

We can see that the expression (13.2.2) has a term, which makes harmonic oscillations with beats frequency between two Bohr frequencies  $\omega_1$  and  $\omega_2$ . The average electron position in space between the wells can be found by means of the expression:

$$\bar{z} = \frac{\int z |\psi|^2 dz}{\int |\psi|^2 dz} = \frac{32L}{9\pi^2} \frac{A_1 A_2}{A_1^2 + A_2^2} \cos(\omega_2 - \omega_1)t, \quad (13.2.3)$$

where the integration is from one wall  $-\frac{L}{2}$  up to the other  $+\frac{L}{2}$ .

Obviously, the frequency of radiation is defined by beats frequency. Actually, electron is charged and, consequently, it will emit out the electromagnetic radiation of the same frequency, with which it oscillates. From the equation (13.2.3) we see that average position of charge oscillates with beats frequency  $\omega_2 - \omega_1$ . Therefore the frequency of radiation is equal to beats frequency between two stationary states:

$$\omega_{rad} = \omega_2 - \omega_1, \quad (13.2.4)$$

In the framework of NTEP, the non-normalized quantum wave function is simply the wave field. As a consequence of this fact, the square of this wave function (i.e. the possibility density in the framework of QED) is the energy density.

As other example of such problem we will consider the calculation of more general case of the interference between waves of various frequencies.

We will assume that we have two EM waves 1 and 2, having electric fields  $\vec{E}_1$  and  $\vec{E}_2$ . The full field in the fixed point P of space will be the superposition of  $\vec{E}_1$  and  $\vec{E}_2$ . Using complex representation of oscillations, we will write the expression for superposition of oscillations:

$$\vec{E}(t) = E_1 e^{-i(\omega_1 t + \phi_1)} + E_2 e^{-i(\omega_2 t + \phi_2)}, \quad (13.2.5)$$

The energy flux is proportional to average value of  $\vec{E}^2(t)$  for period  $T$  of the "fast" oscillations, occurring with average frequency:

$$\begin{aligned} 2 \langle E^2(T) \rangle &= \left| E(t) \right|^2 = \left| E_1 e^{-i(\omega_1 t + \phi_1)} + E_2 e^{-i(\omega_2 t + \phi_2)} \right|^2 = \\ &= E_1^2 + E_2^2 + 2E_1 E_2 \cdot \cos[(\omega_2 - \omega_1)t + (\phi_1 - \phi_2)] \end{aligned}, \quad (13.2.6)$$

As we see, the energy flux varies with relatively slow beats frequency  $\omega_2 - \omega_1$ .

### 3.0. Superposition of the nonlinear electromagnetic waves

We should show at first that the superposition of the nonlinear electromagnetic waves exists, and secondly that due to this superposition it is possible to obtain all those results, which are known from the theory of “linear” electromagnetic waves. In other words, it is necessary to show, that in this case there are actually the series (spectra) of particles, each of which represents complication due to the superposition with other nonlinear waves.

As is known, all the phenomena of superposition of waves and their disintegration are described by Fourier theory. The Fourier theory of analysis-synthesis of functions show that any composite wave field consists from harmonic waves and can be analysed to harmonic waves.

We will show that Fourier theory is true not only in case of “linear” waves, but also in case of the nonlinear waves.

#### 3.1. The real and complex form solutions of the wave equation as reflection of an objective reality

As we showed the wave equation can be described in two forms:

<p>CED form:</p> $\left( \frac{\partial^2}{\partial t^2} - c^2 \vec{\nabla}^2 \right) \vec{\Phi}(y) = 0$ <p>where</p> $\vec{\Phi}(y) = \{E_x, E_z, H_x, H_z\}$	<p>NTEP form:</p> $\left[ (\hat{\alpha}_0 \hat{\varepsilon})^2 - c^2 (\hat{\alpha} \hat{p})^2 \right] \Phi = 0$ <p>where <math>\Phi = \begin{pmatrix} E_x \\ E_z \\ iH_x \\ iH_z \end{pmatrix}</math>, <math>\hat{\varepsilon} = i\hbar \frac{\partial}{\partial t}</math>,</p> $\hat{p} = -i\hbar \vec{\nabla} \text{ and } \hat{\alpha}_0; \hat{\alpha}; \hat{\beta} \equiv \hat{\alpha}_4$ <p>are Dirac's matrices</p>
--	---

and has the solution, which can be written down in the form of real periodic (in particular, trigonometric) functions, as well as in the form of complex (exponential) functions:

<p>CED form:</p> $\vec{\Phi}(\vec{r}, t) = \vec{\Phi}_0 \cos(\omega t - \vec{k} \cdot \vec{r})$ $\vec{\Phi}(\vec{r}, t) = \vec{\Phi}_0 \sin(\omega t - \vec{k} \cdot \vec{r})$	<p>NTEP form:</p> $\Phi = \Phi_0 e^{-i(\omega t \pm ky)}$ <p>or</p> $\begin{cases} \vec{E} = \vec{E}_0 e^{-i(\omega t \pm ky)}, \\ \vec{H} = \vec{H}_0 e^{-i(\omega t \pm ky)}, \end{cases}$
--	--

Nowadays it is considered that the representation of the wave equation solution in complex form is only a formal mathematical method, since the final solutions should be real. It was also marked that the use of complex representation is dictated only by the reasons of convenience: in many cases the mathematical operations with exponential functions are much easier, than with trigonometric.

We have shown, that within the framework of NTEP the exponential solutions have the actual meaning, if we understand them in geometrical sense. For instance, the description of wave motion along the circular trajectory can be represented as the sum of two linear mutual-perpendicular oscillations.

*Thus, it is possible to assume, that the existence of the real and complex descriptions indicates the existence of two types of real objects: the linear and nonlinear waves. In this case the real functions describe “linear” waves, and the complex functions describe the nonlinear waves*

As is known, the Fourier analysis-synthesis theory allows equally to work both with real and complex functions.

From this two extremely important conclusions follows

1) *all tools of the Fourier analysis-synthesis theory in complex representation is the mathematical apparatus of the superposition and decomposition of complex nonlinear waves description (i.e. description of elementary particles).*

2) *the non-linear theory of the nonlinear waves is the theory, in which the principle of superposition takes place as well as in the linear theory.*

For this reason the classical (real) Maxwell-Lorenz theory can be written down in a complex form and it looks in such form simple and consistent. Transition from the nonlinear waves to "linear" (i.e. to one of components of the nonlinear wave) corresponds to transition from complex values to real.

Let us consider now some details of the Fourier analysis-synthesis theory in case of superposition of the nonlinear waves.

#### 4.0. Elementary particles as stable wave packets of nonlinear waves

As is known, in case of superposition of more than two running harmonic waves the wave groups or *wave packets* are formed, which are the limited in space formations, which transfer energy and move with some group speed.

In the quantum mechanics a wave packet is the concept, described a field of matter, i.e. de Broglie particle waves, which is concentrated in the limited area. The probability to find a particle is distinct from zero only in the area, occupied by a wave packet.

This wave field is the result of superposition of the set of de Broglie plane waves, corresponding to the different wavelengths. The composition and decomposition of wave packets is described by Fourier theory.

It is meaningful to apply the concept of a wave packet when the used wave numbers  $\vec{k}$  are grouped near to some  $\vec{k}_0$  with small variation  $\Delta\vec{k}$ ,  $\Delta k \ll k_0$ . In this case the wave field, i.e. wave packet will move during some time as a whole, with a little deformation. The group speed

$k_0 u = \left( \frac{d\omega}{dk} \right)_{k=k_0}$  corresponds to a speed of a particle, described by this wave packet. As is known,

the "smearing" of the wave packet does not take place if it can be decomposed on standing waves, i.e. if in the decomposition series for each vector  $\vec{k}$  the vector  $-\vec{k}$  with the same amplitude exists.

Since the superposition of "linear" waves leads to formation of the "linear" wave packets, it is consistently to conclude that superposition of the nonlinear waves will lead to formation of the nonlinear wave packets, i.e. to the composite elementary particles.

It is characteristic that the representation of wave function by the Fourier sum:

<p>In the real form:</p> $f(t) = \frac{a_0}{2} + \sum_{n=1}^{\infty} (a_n \cos n\omega t + b_n \sin(\omega t)),$ <p>where <math>a_n, b_n</math> are the Fourier coefficients.</p>	<p>In the complex form:</p> $f(t) = \sum_{n=-\infty}^{\infty} c_n e^{-in\omega t}$ <p>where <math>c_n</math> are the Fourier coefficients.</p>
---	--

(i.e. the Fourier series or Fourier integral), contains the negative frequencies, which in the "linear" theory have no place. In the classical optics (Matveev, 1985) it is taken that  $e^{i\omega t}$  describes the complex unit vector, which is started from the origin of coordinates. At

increase of time  $t$  it rotates around this origin in a positive direction (by a rule of the right screw). In the same time the complex unit vector  $e^{-i\omega t}$  rotates in the negative direction.

The above completely corresponds to our hypothesis on the correspondence of Fourier mathematical tools to the requirements of NTEP.

As a simple example of a wave packet formation, we will consider a packet, formed by the rectangular equidistant frequency spectrum of waves of equal amplitudes. The description of superposition of such waves can be made both in real (Crawford, 1970) and in a complex form (Matveev, 1985), which reflects the existence of the “linear” and non-linear world of particles.

We will find the expression for a packet  $\psi(t)$  formed by superposition of  $N$  various harmonic components, which have equal amplitude  $A$ , an identical initial phase, equal to zero, and which frequencies distributed by regular intervals between the lowest frequency  $\omega_1$  and the highest frequency  $\omega_2$ . Generally we have:

<p>in the real form</p> $\psi(t) = A \cos \omega_1 t +$ $+ A \sum_{n=1}^{N-1} \cos(\omega_1 + n\delta\omega) t + A \cos \omega_2 t$	<p>in the complex form</p> $\psi(t) = A \sum_{n=0}^{N-1} e^{i(\omega_1 t + n\delta\omega t)}$
---	---

where  $\delta\omega$  is the difference of frequencies of two next components,  $n = 1, 2, 3, \dots, N-1$  and  $\omega_2 = \omega_1 + N\delta\omega$ .

These formulas represent the composite wave function  $\psi(t)$  in the form of linear superposition of the lot of harmonic components. It appears that this sum can be expressed in the form, which are the generalization of the above case of two oscillations:

$$\psi(t) = A(t) \cos \omega_m t, \quad (13.4.1)$$

where  $A(t) = A \frac{\sin(0,5N\delta\omega \cdot t)}{\sin(0,5\delta\omega \cdot t)}$  is the variable amplitude,  $\omega_m$  is the average frequency of a wave packet. The amplitude  $A(t)$  describes a wave packet envelope. It is possible to show (Crawford, 1970) that for a wave packet the Heisenberg uncertainty principles are true, what proves their origin in wave origin of matter.

Since the nonlinear waves already represent the limited objects, the elementary particles can be combined not from infinite Fourier series of waves, but they can be presented by the sum of the limited number of the nonlinear waves.

Let us show that any nonlinear wave packet can be presented as the sum of wave sub-packets. In this case, obviously, superposition of several big packets can be considered not as superposition of their separate harmonic components, but as superposition of their sub-packets.

Let's consider the splitting of a big packet into two sub-packets. We will present a composite wave  $\psi(t)$  (see above (13.4.1)) in the following form:

$$\begin{aligned} \psi(t) &= A \cos \omega_1 t + A \sum_{n=1}^{N-1} \cos(\omega_1 + n\delta\omega) t + A \cos \omega_2 t = \\ &= (A \cos \omega_1 t + A \sum_{m=1}^{N_1-1} \cos(\omega_1 + m\delta\omega) t + A \cos \omega_2' t) + \\ &+ (A \cos \omega_1' t + A \sum_{l=1}^{N_2-1} \cos(\omega_1' + l\delta\omega) t + A \cos \omega_2 t) \end{aligned} \quad (13.4.2)$$

where  $N = N_1 + N_2$ ,  $\omega_2' = \omega_1 + N_1\delta\omega$ ,  $\omega_1' = \omega_1 + (N_1 + 1)\delta\omega = \omega_2' + \delta\omega$ .

Thus, we can represent the wave packet  $\psi(t)$  as two sub-packets:

$$\psi(t) = \psi_1(t) + \psi_2(t), \quad (13.4.3)$$

where  $\psi_1(t) = A \cos \omega_1 t + A \sum_{m=1}^{N_1-1} \cos(\omega_1 + m\delta\omega)t + A \cos \omega_2 t$  and

$$\psi_2(t) = A \cos \omega_1 t + A \sum_{l=1}^{N_2-1} \cos(\omega_1 + l\delta\omega) t + A \cos \omega_2 t.$$

It is convenient to enter for a normal harmonic the symbol  $\psi(t)$ , for a packet of wave packets - the symbol  ${}^{\Sigma}\psi(t)$ , for a sub-packet the symbol  ${}^{\Sigma}\psi_i(t)$ , where sigma means the sum. Then in the general case any packet can be written down in the form of the sum of sub-packets:

$${}^{\Sigma}\psi(t) = {}^{\Sigma}\psi_1(t) + \dots + {}^{\Sigma}\psi_2(t) = \sum_i {}^{\Sigma}\psi_i(t), \quad (13.4.4)$$

From the above follows that decomposition of packets is not single-valued, since harmonic waves can be grouped in the sub-packets in various ways. It allows to explain the possibility of the disintegration of particle along the different channels.

Using the above representations it is easy to prove also that superposition of sub-packets leads to the same consequences as superposition of separate harmonic waves. In other words, it leads to beats and to change of the energy level, as in the case the particles' interaction.

Besides the nonlinearity in NTEP there is one more serious difference from linear electrodynamics. In NTEP together with the full periodic nonlinear waves (bosons), the half-period nonlinear waves - fermions - exist also. This creates a great number of additional variants of the wave superposition, which are not present in linear electrodynamics. Furthermore, the nonlinearity is the origin of one more characteristic of particles - the currents.

It is clear also that the superposition of the nonlinear waves in comparison with the superposition of "linear" waves has more variants of the spatial arrangement of waves, and, hence, more complex mathematical description. Actually we can see this in the case of description of hadrons.

It is easy to see that the principle of superposition does not provide stability of composite particles. Thus, we should additionally find out the conditions of stability of the nonlinear waves.

## 5.0. Conditions of stability and quantization of elementary particles in NTEP

In framework of NTEP the particles are the spatial formations or spatial packets. As an example of three-dimensional packets we can consider also the superposition of the usual waves of different direction in the space.

As is known (Shpolskii, 1951), at such superposition of harmonic waves can be formed the Lissajous figures of two various types. At the waves with commensurable frequencies (i.e. when frequencies are correlated as the rational fractions) are formed the standing waves and Lissajous figures are stable. At incommensurable frequencies the motion of waves is referred to as quasi-periodic, and Lissajous figures are not stable (i.e. they constantly change their form).

In the physics of waves and oscillations two sorts of the tasks exist, which lead to the formation of the composite waves and oscillations.

An example of first type is oscillation of the body surface or volume (sphere, cylinder, torus, etc.), by which we represent a particle. Here the suitable mechanical example is the oscillation of the drop of liquid in zero gravity. In a nuclear physics the similar model is the drop model of a nucleus.

The same types problems the oscillation of vortex rings in a perfect liquid or gas is that, which studied by Kelvin (we will conditionally name these as "Kelvin's problems"). In case of the oscillations of the linear vortex (Kelvin, 1867) he obtained the exact solution. Here Kelvin has compared the radiation spectra of the atoms (obtained little time before by Bunsen) to possible

spectra of oscillation of vortex (note that in Kelvin's articles the term "atom" is used in sense of "elementary particle").

Comparison of such type of oscillations with observable results is also available in contemporary works, e.g. in (Paper collection, 1975; Kopiev and Chernyshev, 2000) and others. Certain of the Kelvin significant conclusions from the paper "On Vortex Atom" (Kelvin, 1867) we cite below:

*"As the experiments illustrate, the vortex atom has perfectly definite fundamental modes of vibration, depending solely on that motion the existence of which constitutes it. The discovery of these fundamental modes forms an intensely interesting problem of pure mathematics...*

*One very simple result... is the following. Let such a vortex be given with its section differing from exact circular figure by an infinitesimal harmonic deviation of order  $i$ . This form will travel as waves round the axis of the cylinder in the same direction as the vortex rotation, with an angular velocity equal to  $(i-1)/i$  of the angular velocity of this rotation. Hence, as the number of crests in a whole circumference is equal to  $i$ , for an harmonic deviation of order  $i$  there are  $i-1$  periods of vibration in the period of revolution of the vortex. For the case  $i=1$  there is no vibration, and the solution expresses merely an infinitesimally displaced vortex with its circular form unchanged. The case  $i=2$  corresponds to elliptic deformation of the circular section; and for it the period of vibration is, therefore, simply the period of revolution".*

As examples of other type of problems are oscillations of sound and electromagnetic waves into various types of the closed cavities, whose surface is motionless. Such cavities refer to as closed wave-guides or resonators and consequently we will conditionally name this type of problems as "resonator problems". In the classical physics a set of researches is devoted to such type of problems.

The above first and second type of problems leads to the solution in the form of the standing waves. Thus, it is possible to assume that stability of elementary particles is connected with a formation of standing waves.

As we noted, the condition of standing wave formation is the commensurability of wavelength with the size of body, in which the wave propagates. Therefore, the possible solution of these sorts of problems must be defined by the boundary conditions, which specify the value or the normal derivative of the function on a surface.

Below we will show that from the boundary states follow the quantization conditions for elementary particles.

### 5.1. Photon wave equation of classical electrodynamics

From Maxwell-Lorentz equations it is easy to obtain (Matveev, 1989) wave equation for the electric and magnetic field vectors:

$$\left( \frac{\partial^2}{\partial t^2} - c^2 \vec{\nabla}^2 \right) F(\vec{r}, t) = 0, \quad (13.5.1)$$

where  $\vec{F}$  is whichever of the EM wave functions.

The general harmonic solution of this wave equation has the complex

$$F(\vec{r}, t) = F(\vec{r})e^{-i\omega t} = F_0 e^{i(\vec{k}\vec{r} - \omega t)}, \quad (13.5.2')$$

or trigonometric forms

$$F(\vec{r}, t) = F_0 \cos(\vec{k}\vec{r} - \omega t), \quad (13.5.2'')$$

where  $\omega = 2\pi\nu$  is the angular frequency,  $\vec{k} = \frac{2\pi}{\lambda} \frac{\vec{p}}{|\vec{p}|}$  is the wave vector (here  $\nu$  is the linear

frequency,  $k = |\vec{k}|$  called the *wave number*). Using these solutions it is also easy to obtain the dispersion law for EM waves:



$$\frac{\omega^2}{c^2} = k_x^2 + k_y^2 + k_z^2$$

Putting this solution in (13.5.1) we find for  $F(\vec{r})$  the following equation for stationary waves:

$$\left(\vec{\nabla}^2 + k^2\right)F(\vec{r}) = 0, \quad (13.5.3)$$

where  $k = \omega/v = 2\pi/vT = 2\pi/\lambda$ ,  $T$  is the period and  $\lambda$  - wavelength.

The equation (13.5.3) refers to as Helmholtz equation and is universal for the description of space dependence of characteristics of harmonic waves.

Using this equation, Kirchhoff developed the theory of the diffraction and interference of light, which was excellently confirmed by the numerous experiments.

## 5.2. Wave equation solution for resonator

To analyse the electromagnetic wave equation solution for resonator we will take (Wainstein, 1957) an orthogonal box from metal with  $a$ ,  $b$  and  $d$  sites as our model of resonator. We will show that this solution is the standing electromagnetic waves.

According to (13.5.3) the electric field must satisfy the equations  $(\vec{\nabla}^2 + k^2)\vec{E}(\vec{r}) = 0$  and  $\vec{\nabla}\vec{E} = 0$  with the boundary state  $\vec{E}_n = 0$  at the walls of the cavity (because inside the walls the electric energy will be rapidly dissipated because of polarization currents, the electric field intensity drops rapidly to zero into the walls). However, the perpendicular to the walls electric field can exist, which is caused by surface charge. These define the possible solution:

$$\begin{cases} \vec{E}_x = E_{0x}k_x \cos k_x x \sin k_y y \sin k_z z \\ \vec{E}_y = E_{0y}k_y \sin k_x x \cos k_y y \sin k_z z, \\ \vec{E}_z = E_{0z}k_z \sin k_x x \sin k_y y \cos k_z z \end{cases} \quad (13.5.4)$$

For example, taking any  $x$ , for which  $\sin k_x x = 0$ , we will obtain that the second and third terms of system (13.5.4) are identically zero, but the first term certainly isn't.

Also if we will choose  $\vec{k}$  so that  $\vec{k} \cdot \vec{E}_0 = 0$ , from  $div\vec{E} = 0$  using (13.5.4) we find:

$$\vec{\nabla}\vec{E} = (E_{0x}k_x + E_{0y}k_y + E_{0z}k_z) \sin k_x x \cdot \sin k_y y \cdot \sin k_z z = 0.$$

In this case wave equation requires fulfilling of the relationships:  $k_x = m\pi/a$ ,  $k_y = n\pi/b$ ,  $k_z = l\pi/d$ ,  $\omega^2 = c^2(k_x^2 + k_y^2 + k_z^2)$  or  $\omega = c\sqrt{k_x^2 + k_y^2 + k_z^2}$ , where  $(l, m, n)$  are positive integers, e.g. (1, 1, 0) or (3, 2, 4). In other words, each possible standing electromagnetic wave in the box corresponds to a point in the  $(k_x, k_y, k_z)$  space, labelled by three positive integers.

Since the magnetic field satisfies the same equations and the boundary states as the electric field, the solution for magnetic field will look exactly the same as for the electric field (an alternative way is to use the relationship  $\vec{B} = \vec{\nabla} \times \vec{E}/i\omega$ , which can be easily obtained from Maxwell theory).

Thus, the character of the general solution for EM wave in the cavity is the standing electromagnetic wave.

It is easy to see that the above description of a resonance of the "linear" electromagnetic waves, if we make it in the complex form, will correspond to the description of the resonance of the nonlinear waves.

Let us show now that solutions of quantum wave equations for the steady states give identical results.

## 6.0. The quantum wave equations and their solutions for stationary waves

### 6.1. De Broglie waves as nonlinear EM waves

De Broglie has assumed that mater particles together with corpuscular properties have the wave properties and can be described by the same formula of a plane wave as electromagnetic wave:

$$\psi(\vec{r}, t) = \psi(\vec{r})e^{-i\omega t} = \psi_0 e^{i(\vec{k}\vec{r} - \omega t)} = \psi_0 e^{\frac{i}{\hbar}(\vec{p}\vec{r} - \varepsilon t)}$$

He shows that to the energy and momentum of a particle in corpuscular picture the wave frequency and wavelength in a wave picture correspond as follows:

$$\varepsilon = \hbar\omega, \quad \vec{p} = \frac{\hbar}{2\pi\lambda} \frac{\vec{P}}{|\vec{p}|} = \hbar\vec{k}$$

Thus the dispersion law for de Broglie wave it is easy to find from the energy-momentum conservation law for a particle:

$$\frac{\varepsilon^2}{c^2} = m_0^2 c^2 + \vec{p}^2$$

Really, replacing the energy and momentum by the wave characteristics, we will obtain the dispersion correlation for waves of matter:

$$\frac{\omega^2}{c^2} = \frac{m_0 c^2}{\hbar^2} + \vec{k}^2$$

It is easy to see, that within the framework of NTEP this dispersion correlation satisfies the equation of the nonlinear photon.

We will consider now, to what wave equation this dispersion correlation corresponds.

### 6.1. Helmholtz equation for de Broglie waves

The Helmholtz equation (13.5.3) describes the waves of various nature in homogeneous mediums with constant frequency ( $\omega = const$ ) and vacuum. The constancy of wavelength is here not supposed.

Planck's correlation  $\varepsilon = \hbar\omega$  shows that the condition  $\omega = const$  entails the equality  $\varepsilon = const$ . Hence, Helmholtz equation can be applied to de Broglie waves at the description of motion of corpuscles in potential fields when their full energy is constant:

$$\varepsilon = \varepsilon_k + \varepsilon_p = p^2/2m + \varepsilon_p = const, \quad (13.6.1)$$

where  $\varepsilon_k = p^2/2m$  is a kinetic energy,  $\varepsilon_p(\vec{r}) \equiv V(\vec{r})$  is potential energy of a corpuscle in a field. From de Broglie's correlation  $\vec{p} = \hbar\vec{k}$  in view of (13.6.1) the equality follows:

$$k^2 = \frac{2m}{\hbar^2} (\varepsilon - \varepsilon_p), \quad (13.6.2)$$

Substituting the expression (13.6.2) in (13.5.3) we receive the equation:

$$\left( \vec{\nabla}^2 + \frac{2m}{\hbar^2} (\varepsilon - \varepsilon_p) \right) F(\vec{r}) = 0, \quad (13.6.3),$$

named the Schrödinger stationary equation.

From this follows, that the existing calculation methods of the energy, momentum, angular momentum and other characteristics of particles state in the quantum field theory are calculations of resonance states of elementary particles in the various types of resonators (boxes), which in the quantum theory are usually named the potential wells. From the mathematical point of view these problems refer to as eigenvalues problems.

Consider the connection of these problems with NTEP.

## 6.2. Particle in a box

In quantum mechanics, the particle in a box model describes a particle free to move in a small space surrounded by impenetrable barriers. The particle in a box model provides one of the very few problems in quantum mechanics which can be solved analytically, without approximations. We will use this model as an example to illustrate the similarity between our and quantum approaches.

In quantum mechanics, the wavefunction, as electromagnetic field vectors in classical electrodynamics, gives the most fundamental description of the behavior of a wave-particle. The wavefunction  $\psi(\vec{r}, t)$  can be found by solving the Schrödinger equation (11.6.3). Inside the box, no forces act upon the particle, which means that the part of the wavefunction inside the box oscillates through space and time with the same form as a free particle. For a three dimensional box, the solutions are

$$\psi_{n_x, n_y, n_z} = \sqrt{\frac{8}{L_x L_y L_z}} \sin(k_{n_x} x) \cdot \sin(k_{n_y} y) \cdot \sin(k_{n_z} z), \quad (13.6.4)$$

If a particle is trapped in a three-dimensional box, it may freely move in the  $x, y, z$  - directions, between barriers separated by lengths  $L_x, L_y, L_z$  respectively

The energies which correspond with each of the permitted wave numbers may be written as

$$\mathcal{E}_{n_x, n_y, n_z} = \frac{\hbar^2 k_{n_x, n_y, n_z}^2}{2m}, \quad (13.6.5),$$

where the three-dimensional wavevector is given by

$$k_{n_x, n_y, n_z} = k_{n_x} \vec{e}_x + k_{n_y} \vec{e}_y + k_{n_z} \vec{e}_z = \frac{n_x \pi}{L_x} \vec{e}_x + \frac{n_y \pi}{L_y} \vec{e}_y + \frac{n_z \pi}{L_z} \vec{e}_z, \quad (13.6.6),$$

As we can see, the obtained solution coincides with the above solution for electromagnetic waves in the waveguide.

## 7.0. Formation of elementary particles' spectra

The first calculations of quantum systems related to the electron motion in the orbits of the hydrogen atom (Shpolskii, 1951). The formulas of quantization of electron characteristics in the hydrogen atom have been first found empirically (formulas of Balmer, Paschen, etc.). Then, it has been shown that they turn out as consequence of conditions of Bohr quantization.

Wilson and Sommerfeld have made the generalization of Bohr quantization rules independently. They have shown that in case of systems with any number of degree of freedom it is possible to find such generalized coordinates  $q_1, q_2, \dots, q_i$ , in which the motion of system is separated on  $i$  harmonic oscillations; in this case a known rule of oscillator quantization can be applied for any of degrees of freedom.

The representation of any quantum system as the set of oscillators completely corresponds to the representation of the elementary particles in the form of nonlinear electromagnetic waves within the framework of NTEP.

Due to Wilson-Sommerfeld's theorem can receive  $f$  quantum conditions:

$$\oint p_1 dq_1 = \left(n_1 + \frac{1}{2}\right)h, \quad \oint p_2 dq_2 = \left(n_2 + \frac{1}{2}\right)h, \quad \dots, \quad \oint p_i dq_i = \left(n_i + \frac{1}{2}\right)h, \quad (13.7.1)$$

where the integers  $n_1, n_2, \dots, n_i$  refer to as quantum numbers.

As an example of the application of these rules we will present the calculation results of the hydrogen-like atom. Electron position in space at its motion around a nucleus is characterized by

three polar coordinates  $r, \vartheta, \psi$ , which describe the radial, equatorial and azimuthal motions, respectively. Therefore quantum conditions in this case take the form

$$\oint p_r dr = \left(n_r + \frac{1}{2}\right)h, \oint p_\vartheta d\vartheta = \left(n_\vartheta + \frac{1}{2}\right)h, \oint p_\psi d\psi = \left(n_\psi + \frac{1}{2}\right)h, \quad (13.7.2)$$

The generalized momentums  $p_r, p_\vartheta, p_\psi$  are calculated by the following rules: at first it is necessary to write the expression of kinetic energy in polar coordinates  $r, \vartheta, \psi$ :

$$\varepsilon_k = \frac{m}{2}v^2 = \frac{m}{2} \left( \dot{r}^2 + r^2 \dot{\vartheta}^2 + r^2 \sin^2 \vartheta \dot{\psi}^2 \right), \quad (13.7.3)$$

and next to find the derivatives regarding the generalized velocities (which correspond to linear momentums):

$$p_r = \frac{\partial \varepsilon_k}{\partial \dot{r}} = m \dot{r}, \quad p_\vartheta = \frac{\partial \varepsilon_k}{\partial \dot{\vartheta}} = mr^2 \dot{\vartheta}, \quad p_\psi = \frac{\partial \varepsilon_k}{\partial \dot{\psi}} = mr^2 \sin^2 \vartheta \dot{\psi}, \quad (13.7.4)$$

Then, using (13.7.2) it is possible to obtain the formulas of the momentums' quantization, defined by radial, equatorial and azimuthal quantum numbers:  $n_r, n_\vartheta, n_\psi$

As de Broglie showed later, the Bohr and Wilson-Sommerfeld's quantisation rules define the conditions of *integrality* of the electron wavelengths in different closed trajectories.

Obviously within the framework of NTEP these rules determine the resonance conditions of the nonlinear electromagnetic waves, if we take into account a quantization of their energy according to Planck. Since any field can be represented as the oscillators' sum, we can consider this rule as true for any quantum systems.

The results of Wilson and Sommerfeld were obtained later as solutions of the wave equation for standing de Broglie waves, i.e. of the Schroedinger equation for different potential wells. Note, that also the boundary states are expressed here by the same way, as in the classical EM theory:

$$\psi(a) = 0, \quad \psi(b) = 0, \quad \psi(d) = 0, \quad (13.7.5)$$

Thus, we can say that Schrödinger's equation is the equation for calculation of resonance states of nonlinear EM wave in potential wells (resonators) of different type, in which the boundary of wave motion are defined by potential energy of the system.

This problem is identical to the problem of standing EM wave in resonator. The difference consists only in that the *wave vector is not constant here, but by some complex way depends on spatial coordinates; in other words, the dispersion relation is here defined by the potential of system, which varies from a point to point according* (13.6.2). Moreover, the mathematical descriptions would coincide here completely if we imagine that medium in the EM resonator can have dispersion, depending on spatial coordinates under the same law as potential energy in a potential well of quantum-mechanical problem.

## Conclusion. On calculation of the spectra of the elementary particles

Thus we showed that the wave spectra in NTEP appear in the same manner as into CED and QED, but at the same time these spectra are the spectra of elementary particles.

The calculation of own particle spectra in NTEP has important peculiarity in comparison with the calculation of stable states of the particle in the external field, i.e., in field of other particles: *the particle itself acts here as potential well*. In order to calculate the energy-mass spectrum, we must calculate the resonance states of the particle itself as resonator.

Additionally, in this case the initial equation must be a nonlinear equation. But as the studies showed, solution of nonlinear tasks has great mathematical difficulties. In spite of a number of the successes, final solutions are not obtained until now.

Therefore we will attempt firstly to obtain the solution on the basis of the resonance conditions, described above. This way corresponds to calculation of energy levels of hydrogen atom in the early time of development of quantum theory.

## Part 14. On calculation of elementary particles' masses

### 1.0. Introduction.

As we know neither classical nor quantum theory could yet explain the origin of the spectra of elementary particles masses and deduce numerical values for this masses.

The main experimental facts here are: 1) the masses of elementary particles arrange a discrete spectrum of mass values, 2) according to modern ideas, all elementary particles are excited states of a small set of stable particles, which have the lower value in the mass spectrum (electron neutrinos, quarks) .

The main difficulty in the classical electromagnetic (EM) theory, obviously, is that it does not take into account the quantum properties of elementary particles. However, there is an approach that allows us to create here the mass spectra of particles - the existence of resonant modes of EM waves in potential well. The essential difficulty of the quantum theory is that its fundamental particles are considered as pointlike (i.e., they do not have spatial dimensions). This deprives them of the degrees of freedom, needed to create a variety of masses of elementary particles.

In a previous chapters, we have shown that fundamental particles have a size and it does not contradict the quantum field theory. This makes it possible to return to the idea of the existence of the mass spectrum of elementary particles, based on the resonance. As is well known, de Broglie explained in such a way the existence of energy levels of electrons in the atom.

### 1.1. The reasons of quantization of mass-energy

According to Einstein's formula of equivalence of energy and mass  $\varepsilon = mc^2$ , to any stationary level of particle energy the certain rest mass corresponds. Therefore it is possible to assume that the discreteness of the mass spectrum of elementary particles corresponds to the discreteness of energy spectrum of electron in the atom.

The first calculation of energy-mass spectrum of electron in hydrogen atom has been based on the known Bohr atom theory. This approach allows the calculation of energy spectrum of electron, but it does not reveal the reasons of quantization.

The reasons of quantization have been specified by de Broglie. He showed that electron in a stationary state in orbits of hydrogen atom can be considered as standing de Broglie waves under conditions of the wavelength integrality. De Broglie has shown (Broglie, de, 1924; 1925;. Andrade e Silva and Loshak, 1972) that the length of any Bohr orbit  $L$  should contain an integer number of electron wavelengths  $L = n\lambda$  (where  $n = 1, 2, 3, \dots$   $\lambda = h/mv = 2\pi\hbar/p$ ,  $v$  is the particle velocity) (see fig. 15.1):

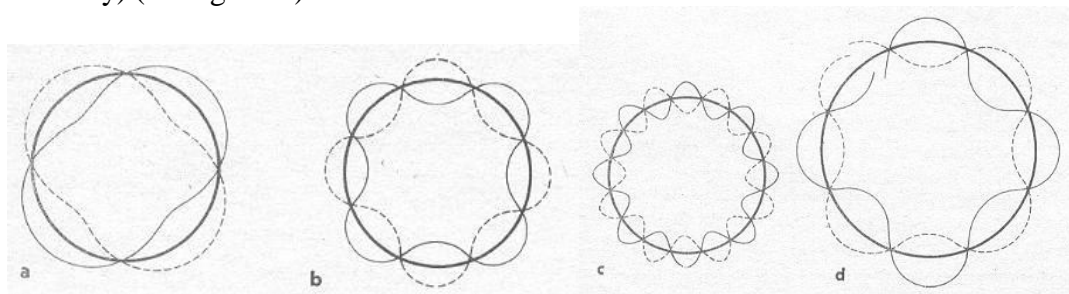

Fig. 15.1

For icons **a**, **b** and **c** of fig.1 this condition is carried out, when  $n = 2, 4, 8$  respectively. In case of **d** this condition is not carried out and electron motion is unstable; this leads to self-destruction of a wave as a result of wave self-interference. Mathematically the integrality condition corresponds to the requirement of unambiguity of wave function.

A similar condition takes place also for elliptic orbits, but this case is more complex, since the length of de Broglie wave in different points of an elliptic orbit varies because the electron speed is not constant. In this case it is necessary to use the general quantization condition:

$$\int \frac{ds}{\lambda} = \int_0^T \frac{m\beta^2 c^2}{h\sqrt{1-\beta^2}} dt = n, \quad (14.1.1)$$

where  $ds$  is the orbit length element,  $T$  is the period of motion,  $dt$  - time element,  $\beta = c/v$ .

From the above follows that the conditions of stationarity correspond to resonance conditions, which are adequate to conditions of integrality of the standing waves.

Such sight at the reason of appearance of quantum levels of electron energy also allows to calculate the lasts in other similar cases. For example, as approximate model of 3-dimensional short-range potential, can be considered the spherical potential well of some radius  $R$  (Naumov, 1984). According to de Broglie for the big circle of sphere of radius  $R$  we will have:

$$2\pi R = n\lambda = n \frac{2\pi\hbar}{p} = n \frac{2\pi\hbar}{\sqrt{2m\varepsilon}}, \quad (14.1.2)$$

From here we obtain for energy levels:  $\varepsilon_n = \frac{\hbar^2 n^2}{2mR^2}$ . The Schrödinger wave equation (i.e., the Helmholtz equation for de Broglie waves) gives in this case the exact result, which differs from the approximate one only by the factor  $\pi^2$ .

It follows that the reason for the quantization of energy-mass of an electron in the atoms are resonant conditions of the motion of de Broglie waves in a closed cavity (potential well). In this case, the sizes of the resonant cavity (potential well) and the medium, which fill the cavity, play a decisive role. Let us recall that according to the nonlinear theory of elementary particles (NTEP), de Broglie waves of massive particles are nonlinear (self-acting) electromagnetic waves.

In other words, the diversity of the quantization of energy takes place due to the difference of the dispersion relations for nonlinear electromagnetic waves in 3-dimensional space. For electromagnetic waves in a homogeneous medium the dispersion relation is independent from position and time; at the same time in field theory problems these relations are determined by the spatial dependence of potential energy, mathematical expressions of which can be quite diverse (conditionally speaking, in this case we have an EM wave in an inhomogeneous medium with the suitable dispersion relations).

Practically all the waves that we have considered have been "one-dimensional" (Crawford, 1968). That is, they have been waves propagating along a straight line, which we usually call the  $y$  axis. Now we must introduce three-dimensional waves.

We can see that there is something more to having extra dimensions than is implied by a mere change of variables. One has qualitatively new features because the extra dimensions give extra degrees of freedom. For example, in three dimensions and in vacuum one can have an electromagnetic wave that is a pure traveling wave in one direction, a pure standing wave in another, and an exponential wave in still another direction! In one dimension it is not possible to have exponential electromagnetic waves in vacuum, because the dispersion relation  $\omega^2 = c^2 k^2$  cannot become  $\omega^2 = -c^2 k^2$  for some frequency ranges. In order to have exponential waves in one dimension, one needs a cutoff frequency, i.e., one needs a dispersion relation like that of the ionosphere,  $\omega^2 = \omega_0^2 + c^2 k^2$ , which can become  $\omega^2 = \omega_0^2 - c^2 k^2$  for sufficiently low frequency.

In three dimensions we will find that  $k$  is the magnitude of a vector, called the propagation vector. Thus the dispersion relation for electromagnetic waves in vacuum becomes  $\omega^2 = c^2 (k_x^2 + k_y^2 + k_z^2)$ . Under certain circumstances one can have one or two of the components  $k_x^2$ , etc., replaced by  $-k_x^2$ , etc., and still have the return force per unit displacement per unit inertia,  $\omega^2$ , be positive, as it must be". As examples, we will be referring to the electromagnetic waves in three-dimensional waveguides and resonators.

We should note one remarkable feature, which has the solution of Schrödinger equation for electron in a potential well of final depth. In this case (Shiff, 1955; Matveev, 1989) there is a *limit*

number of own levels of energy. A similar limitation exists for the masses of some families of particles. For example, the family of leptons has only three generations: electron, muon and tauon and the corresponding neutrinos. If we will consider the electron self field as potential well of final depth, then heavy leptons can be examined as the electron excitations, whose number can be limited.

## 2.0. On present calculations of elementary particle masses

The attempts of calculation of mass-energy spectra on the basis of resonance behavior of particles exist for a long time. We will briefly mention the most consecutive of them. Unfortunately the existing calculations are based on assumptions and guesses, which cannot be proved enough within the framework of the quantum field theory.

### 2.1. Quasi-classical approaches to mass calculation

According to this approaches the basic particle is assimilated to a potential well (or, that is the same, to the resonator). The spectrum of masses of particles arises, when some additional resonance wave-particle (e.g. photon) is placed in this potential well. Characteristics of addition particle change the characteristics (mass, spin, charge, etc) of the basic particle and we can consider the last one as a new particle.

One of the first attempts of quasi-classical calculation (for masses of muon and pion) belongs to Putilov (Putilov, 1964). Note that this calculation does not take into account the experimental facts, which have been found out later (e.g., the existence of a tau-lepton, the law of lepton number conservation, etc.) and it should be considered only as an example of a corresponding computational procedure.

A second, much more detailed calculation (for the big number of particles, known at that time) is stated in paper (Kenny, 1974). Here is already the theoretical substantiation of a method of calculation and are obtained impressing results. But calculation is made by analogy to the theory of Bohr; therefore here was used Coulomb potential well. The obtained numerical values of masses, without serious substantiation, are corresponded with masses of known particles; this conduct to infringement of laws of conservation of quantum numbers, etc.

The calculations, based on idea of composite particles, has near connection to the resonance theory. One of the first possible approaches (Rivero and Gsponer, 2005) to an estimation of masses of elementary particles was based on the known composite model of Nambu-Barut (Nambu, 1952; Barut, 1979). In particular, for leptons Barut has obtained the following formula:

$$m(N) = m_e \left( 1 + \frac{3}{2\alpha} \sum_{n=0}^{n=N} n^4 \right)$$
, which gives satisfactory values for both heavy leptons (here  $m_e$  is the electron mass,  $\alpha$  is electromagnetic constant).

In this approach it is postulated that for calculation of masses of heavy leptons to the rest mass of electron the quantized magnetic energy  $(3/2)\alpha^{-1} \sum_{n=0}^{n=N} n^4$  must be added, where  $n$  is a new quantum number, which for  $n = 1$  gives muon mass and for  $n = 2$  – tauon mass  $m_\tau = 1786,08$  MeV.

A similar expression had been obtained from other reasons. In paper (Rodriguez and Vases, 1998) for muon mass as excited state of electron (which is allocated with properties of a quark)

following formula is obtained:  $m_l = \left( 1 + \frac{q_m^n}{e} \right) m_e$ , where  $q_m^n = \frac{3e}{2\alpha} n$ . E.g., for muon at  $n = 1$  turns

out:  $m_\mu = \left( 1 + \frac{3}{2\alpha} \right) m_e = 206,55 m_e$ . Assuming that tauon is the excited state of muon, authors



obtain also formula:  $m_l = \left(1 + \frac{3}{2\alpha}\right)m_e + \frac{q_m^n}{e}m_e = \left(1 + \frac{3}{2\alpha}\right)m_e + \frac{3}{2\alpha}n$ , which at  $n = 16$  gives for taon mass the value, closed to experimental, namely  $m_\tau = 3494m_e = 1781,9 \text{ MeV}$ .

In (Greulich, 2010) “*the masses of all fundamental elementary particles (those with a lifetime > 10<sup>-24</sup> sec) can be calculated with an inaccuracy of approximation 1% using the equation  $m/m_{\text{electron}} = N/2\alpha$ , where  $\alpha$  is the coupling constant of quantum electrodynamics (also known as fine structure constant) (= 1/137.036), and  $N$  is an integer variable.*

*Thus, the masses of the muon, charged pions, kaons can be expressed as  $m/m_{\text{electron}} = N/2\alpha$ , with  $N = 3$  for the muon,  $N = 4$  for the pion and  $N = 14$  for the kaon with a 1% inaccuracy except for eta and omega mesons (2.22% and 1.6%, respectively), and the  $\mathbf{x}_i$  baryon (1.23%). The masses of other particles may also be expressed in such simple terms. The results are listed in Table 2 (see the paper (Greulich, 2010)). Can this result have been obtained simply by chance?”*

Another approach is based on the quantization rules of Wilson-Sommerfeld. The group of scientists Yu. L. Ratic, F.A. Gareev et al. (Ratis and Garejev, 1992; Garejev, Kazacha, Ratis, 1996; Garejev, Kazacha, Barabanov, 1998; etc) has achieved impressive results, using the quantization condition for asymptotic momenta of decay products of the hadronic resonances.

## 2.2. Quantum approaches to mass calculation

### 2.2.1. Kowalczyński model

A simple theory of the elementary particle mass spectrum is proposed (Kowalczyński, 1988). “*It originates from the Dirac idea of the free electron motion and from the transformed Klein-Gordon equation. The theory is based on an equation that includes the squared mass operator having an infinite sequence of orthogonal eigenfunctions and a discrete spectrum of eigenvalues. A discrete mass formula is derived. It yields values of mass that are in agreement with present-day empiric data for elementary particles...*

*All our considerations concern free particles. One of the known peculiarities of the Dirac electron is that its velocity operator has only two eigenvalues  $\pm c$ . Together with other specific properties of the spinorial wave, this makes a classical description of the Dirac particle extremely difficult. If one insists, however, on giving such a description, then one may imagine a rapidly oscillating particle having, e.g., a periodic spiral-like trajectory determined by a classical motion equation including terms periodic in time. This kind of trajectory could only represent the classical rectilinear free motion as an average. Such a picture, though somewhat vague, is automatically contained in the Dirac equation and, consequently, in the Klein-Gordon equation, which, as yet, is obligatory for every free particle. As a free extension of the Dirac idea, it is therefore tempting to introduce an equation including terms periodic in time and being a modification of the Klein-Gordon equation.*

*The slower-than-light free particle has a straight time-like world line in terms of relativity, and is represented by a plane harmonic de Broglie wave in terms of quantum mechanics. Thus, after applying the appropriate Lorentz transformation, the particle can be described by expressions with only one variable. The particle proper time  $s$  (affine parameter of the world line) is the most natural choice. Then the Klein-Gordon equation reduces to*

$$-\frac{\hbar^2}{c^4} \frac{d^2}{ds^2} \psi(s) = m^2 \psi(s), \quad (14.2.1)$$

*If we observe the particle at rest, then  $s$  is, of course, the laboratory time. Thus, by Equation (2.1), operator  $-\hbar^2 c^{-4} d^2/ds^2$  could be considered as a squared rest mass operator. However, its spectrum of eigenvalues is continuous, while the elementary particle masses form a discrete set of values. Basing upon our previous considerations, we can assume that this operator is only a zero approximation, being too coarse to perceive the frequent oscillations of the particle.*

*Let us consider the equation*

$$\frac{\hbar^2}{c^4} \left[ -\frac{d^2}{ds^2} + \omega \tan(\omega s) \frac{d}{ds} + \frac{\omega^2 a^2}{2(1 - \sin \omega s)} + \frac{\omega^2 b^2}{2(1 + \sin \omega s)} \right] \psi(s) = m^2 \psi(s), \quad (14.2.2)$$

where  $-\infty < s < +\infty$ ,  $a$  and  $b$  are dimensionless real constants, and  $\omega$  is a constant frequency such that  $\omega = 2\pi/T$ .

Thus, on the left-hand side of Equation (14.2.2) we have a new squared mass operator with eigenfunctions  $\psi$  and eigenvalues  $m^2$ . Equation (14.2.2) is a generalization of Equation (14.2.1), since the terms added to the operator  $-\hbar^2 c^{-4} d^2/ds^2$  are periodically singular. Of course, its concrete form is arbitrarily postulated”.

### 2.2.2. Chiatti model (Chiatti, 2009)

“A model is conjectured in article for the calculation of the masses of elementary particles, based on the following assumptions.

The localisation of the particle takes place in a region having minimum space size  $L$ . To bring about this localization, an energy  $\hbar c/L$  is required, by virtue of the uncertainty principle. Dividing this energy by  $c^2$ , the mass  $m_s = \hbar/cL$  is obtained, which shall be called, in this context, the “skeleton” mass of the particle.

The lepton is delocalised over a spatial region whose size is  $L = \hbar/m_s c$ ; however, the radius  $r_0 = e^2/m_s c^2 = \alpha L$

If we only consider electromagnetic interaction, the interaction energy can be estimated as:

$$\varepsilon_{\text{int}} \approx e^2/L = e^2/(\hbar/m_s c) = (e^2/\hbar c) m_s c^2 = \alpha m_s c^2, \quad (14.2.3)$$

with the additional energy  $k\alpha m_s c^2$  (where  $|k| \approx 1$ ), equal to the self-interaction energy of the virtual lepton. This is equivalent to saying that the effective rest mass of the lepton is not  $m_s$ , but  $m_s + k\alpha m_s = m_s(1 + k\alpha)$ .

One can suppose that the self-interaction term that must be added to the skeleton mass to obtain the effective mass is expressed by the integral:

$$m_{\text{self}} = k\alpha m_s = \frac{e}{c^2} \int \bar{\psi} \gamma^\mu \psi d\tau, \quad (14.2.4)$$

where

$$\gamma^\mu \left( \partial_\mu - \frac{ie}{\hbar c} A_\mu \right) \psi = -\frac{m_s c}{\hbar} \psi, \quad (14.2.5)$$

$$\partial^\nu \partial_\nu A_\mu = -4\pi ie \bar{\psi} \gamma_\mu \psi, \quad (14.2.6)$$

In calculating the integrals that express  $m_{\text{self}}$  and  $A_\mu$ , it must be borne in mind that self-interaction is limited (in the particle rest frame of reference) to distances greater than  $r_0$ ; at lower distances, only one lepton copy is present, which certainly cannot interact with itself”.

Below, we will show that all these approaches of calculation of the mass spectra of elementary particles are based on the resonance condition for nonlinear electromagnetic waves in the cavity, which is formed by means a stable particle.

## 3.0. Statement of problems of calculation of masses of particles in framework of NTEP. Elementary particles as resonators

In framework of NTEP we will take following assumptions, which don't contradict the modern theory:

- 1) all particles are divided into two groups: a) absolutely stable particles: photon, electron, neutrino, proton and their antiparticles; and b) metastable particles: all other particles;
- 2) the stable elementary particles are the simplest modes of non-linear waves;
- 3) the stable elementary particle are the box (potential well), which are the resonator for non-linear waves;

4) the metastable elementary particles are the composite non-linear waves, appearing as superposition of an absolutely stable non-linear waves and some additive non-linear waves;

5) the metastability of composite particles is ensured by resonance conditions and known conservation laws.

As a simplest reaction of formation of composite particle it is possible to consider the transition of electron  $e^-$  in hydrogen atom from a low level to higher level of energy:

$$e^-(\varepsilon_n) + N = \gamma + e^-(\varepsilon_b) + N, \quad (14.3.1)$$

where  $\varepsilon_n$  is any level of electron energy,  $\varepsilon_b$  is the base electron energy and  $\varepsilon_n > \varepsilon_b$ ;  $\gamma$  is the photon (gamma-quantum);  $N$  means the field of the nucleus, which in this case works as a resonator. The solution of Schrödinger's equation gives spectra, which the resonator - potential well of proton Coulomb field - allows.

Note that the reaction of electron-positron pair production from a photon can be also described in the same way as (14.3.1):

$$\gamma + N = e^- + e^+ + N, \quad (14.3.2)$$

The record (14.3.1) is possible to be considered as an instruction that the electron in a mass-energy state  $\varepsilon_n$  conditionally "is composed" from the electron in the state  $\varepsilon_b$  and some photon  $\gamma$  inside the potential well (this problem we can conditionally name "direct")

As we noted above, the concrete result of calculation depends on distribution of the potential energy (i.e. on dispersion relationship and characteristics of well). Since we do not have information about the field distribution inside the elementary particles, we can rest only upon some (more or less) believable hypotheses.

In the case of electron as basic particle, it can be assumed that we deal with the toroidal resonator. What we can say about the properties of this resonator, i.e. about the dispersion relationship, which describes space inside this resonator?

If we consider an electron as circular high-frequency current, then its charge due to the skin effect is displaced to the surface; this means that the electric field is absent inside it. If we accept the circular current of electron as constant, then distribution can be other. In the case of such composite particles as mesons and baryons, the distribution can be even more complex.

Another statement of the problem (conditionally, an "inverse" problem) arises in case when we will write down the reaction (14.3.1) in the opposite direction:

$$\gamma + e^-(\varepsilon_b) + N = e^-(\varepsilon_n) + N, \quad (14.3.3)$$

Here initial particles  $\gamma$ -quantum and electron  $e^-(\varepsilon_b)$  can be considered as the reason of generation of a composite particle  $e^-(\varepsilon_n)$ . In this case for calculation of energy-mass of a composite particle it is necessary to know the experimental characteristics of waves (particles), which have formed this level of energy.

For simplicity we will further consider the reactions with the participation of electron (14.3.1) and (14.3.2). In these reactions electron appears simultaneously as particle and the wave. The following paragraphs will be dedicated to the brief analysis of the kinematics and wave properties of electron and other particles.

#### 4.0. Kinematics characteristics of a composite particle

The above-stated reactions in a general view can be presented as follows:

$$X_0 \Leftrightarrow X_1 + X_2, \quad (14.4.1)$$

where through  $X_0$  we designated composite particle; indices 1 and 2 relate to the particles, whose superposition creates composite particle.

The law of conservation of the energy-momentum is valid for each of the particles:

$$\varepsilon_0^2 = c^2 p_0^2 + m_0^2 c^4, \quad (14.4.2)$$

$$\varepsilon_1^2 = c^2 p_1^2 + m_1^2 c^4, \quad (14.4.3)$$

$$\varepsilon_2^2 = c^2 p_2^2 + m_2^2 c^4, \quad (14.4.4)$$

where  $c$  is the speed of light,  $m$  means in this chapter the particle rest mass; the energies and momentums are defined by relativistic expressions:

$$\varepsilon = mc^2 \delta, \quad \vec{p} = m\vec{v}\delta, \quad (14.4.5)$$

where,  $\delta = 1/\sqrt{1-\beta^2}$ ,  $\beta = \vec{v}/c$ ,  $\vec{v}$  is speed of a particle. Besides, in the relativistic mechanics the kinetic energy is entered by the following expression:

$$\varepsilon_k = mc^2(\delta - 1) = mc^2\delta - mc^2, \quad (14.4.6)$$

Since  $v < c$ , the expressions, containing  $\delta$ , can be expanded to Maclaurin series (we take here into account only 4 terms):

$$\delta = 1 + \left\{ \frac{1}{2}\beta^2 + \frac{3}{8}\beta^4 + \frac{5}{16}\beta^6 + \frac{35}{128}\beta^8 + \dots \right\}, \quad (14.4.7)$$

$$\beta\delta = 0 + \beta + 0 + \frac{1}{2}\beta^3 + \dots \quad (14.4.8)$$

Thus we can obtain for energy and momentum the following expressions:

$$\varepsilon = mc^2 + mc^2 \left\{ \frac{1}{2}\beta^2 + \frac{3}{8}\beta^4 + \frac{5}{16}\beta^6 + \frac{35}{128}\beta^8 + \dots \right\}, \quad (14.4.9)$$

$$\begin{aligned} \varepsilon_k &= \varepsilon - mc^2 = mc^2 \left\{ \frac{1}{2}\beta^2 + \frac{3}{8}\beta^4 + \frac{5}{16}\beta^6 + \frac{35}{128}\beta^8 + \dots \right\} = \\ &= \frac{1}{2}mv^2 + \frac{3}{8}m\left(\frac{v^4}{c^2}\right) + \frac{5}{16}m\left(\frac{v^6}{c^4}\right) + \frac{35}{128}m\left(\frac{v^8}{c^6}\right) + \dots \end{aligned} \quad (14.4.10)$$

$$p = m\vec{v} + \frac{1}{2}m\frac{v^3}{c^2} + \dots, \quad (14.4.11)$$

At  $\beta \ll 1$  we obtain from (14.4.9)-(14.4.11) as first approximation the non-relativistic expressions:

$$\varepsilon \approx mc^2 + \frac{1}{2}mv^2; \quad p \approx m\vec{v}; \quad \varepsilon_k \approx \frac{1}{2}mv^2; \quad (14.4.12)$$

In this case according to conservation laws of energy and momentum we have:

$$\varepsilon_0 = \varepsilon_1 + \varepsilon_2, \quad (14.4.13)$$

$$\vec{p}_0 = \vec{p}_1 + \vec{p}_2, \quad (14.4.14)$$

Not narrowing the framework of the problem, we can consider a case, when the particle  $X_0$  is motionless; that means  $\vec{p}_0 = 0$ . Then from (14.4.2) we obtain  $\varepsilon_0 = m_0c^2$ , and from (14.4.13):  $\vec{p}_1 = -\vec{p}_2$ . Entering a designation  $|\vec{p}_1| = |\vec{p}_2| = p_r$ , from (14.4.15) we will obtain the known kinematic expression:

$$m_0c^2 = \sqrt{m_1^2c^4 + c^2p_r^2} + \sqrt{m_2^2c^4 + c^2p_r^2}, \quad (14.4.15)$$

Considering the particles 1 and 2 as composite parts of particle 0, we can, according to N. Bohr, postulate here the quantization of momentum  $p_r$  and compare the solution with experimental data (see below the results of Yu. Ratis, F. Gareev et al.).

## 5.0. The wave characteristics of elementary particles

As it is known de Broglie's waves appearance is clearly relativistic effect, connected with motion of electron relative to other particles.

According to de Broglie the particle-wave with energy  $\varepsilon$  and momentum  $p$  has the following frequency and wavelength (taking into account (14.4.9)-(14.4.11)):

$$\nu = \frac{\varepsilon}{h} = \frac{mc^2}{h} + \frac{\varepsilon_k}{h} = \nu_0 + \nu(\nu), \quad (14.5.1)$$

$$\lambda = \frac{h}{p} = h / \left( m\nu + \frac{1}{2} m \frac{\nu^3}{c^2} + \dots \right), \quad (14.5.2)$$

where  $\nu_0 = mc^2/h$  and  $\nu(\nu) = \frac{1}{h} \left\{ \frac{1}{2} m\nu^2 + \frac{3}{8} m \left( \frac{\nu^4}{c^2} \right) + \frac{5}{16} m \left( \frac{\nu^6}{c^4} \right) + \frac{35}{128} m \left( \frac{\nu^8}{c^6} \right) + \dots \right\}$ .

In the non-relativistic case  $\nu \ll c$  we will obtain:

$$\nu = \frac{\varepsilon}{h} \approx \frac{mc^2}{h} + \frac{1}{2} m\nu^2 / h, \quad (14.5.3)$$

$$\lambda = \frac{h}{p} \approx \frac{h}{m\nu}, \quad (14.5.4)$$

Let's analyse these expressions.

**Firstly** we can note the interesting special feature of a de Broglie wave: in the general case it seemingly consists of the infinite sum of waves, whose frequencies are added arithmetically.

This series has always a certain "basic" wave with maximum frequency of very high value  $\nu_0$ , which does not depend on particle motion.

The series remainder, which corresponds to expansion  $\nu(\nu)$ , contains the terms, whose frequencies depend on the speed of particle motion. The values of the frequencies of these waves are considerably less than the frequency of "basic" wave, so it seems these waves modulate the "basic" wave.

**Secondly**, the frequency  $\nu_0$  of the "basic" wave of particle is connected with the particle in rest and is determined by its self-energy (rest mass).

According to de Broglie's hypothesis (Broglie, 1923, 1924, 1925), to this frequency corresponds certain internal particle motion. From the other side, this "basic" frequency determines the Compton wavelength of "bare" rest particle; in accordance with our theory, it means that this frequency determines electromagnetic radius of particle. Actually in NTEP a radius of "bare" electron is equal:

$$r_e = \frac{\hbar}{m_e c} \equiv \tilde{\lambda}_e = \frac{c}{\nu_0}, \quad (14.5.5)$$

where  $\tilde{\lambda}_e$  is a Compton (bar) wavelength of electron.

Thus, hypothetical motion of rest particle is the rotation of the non-linear EM wave.

Usually in the expansion of frequency is considered only one wave, which has frequency and wavelength, which correspond to non-relativistic formulas (14.5.3)-(14.5.4). Specifically, these characteristics served for the experimental testing of hypothesis de Broglie about the particle as about the wave. In reality as it follows from formulas (14.5.1)-(14.5.2) besides this wave there is an infinite number of waves of smaller energy and longer wavelength.

What role these waves play in nature separately, we do not know, but they could be manifested with the high energy, if other more probable effects did not screen them. Thus, into some natural phenomena they could apparently play essential role.

**Thirdly:** De Broglie's wavelength of particle with zero speed is equal to infinity. For the classical oscillator such speed corresponds to the zero frequency. In contrast to this fact in this case de Broglie's wave has very high frequency  $\nu_0$  (about  $10^{15}$  Hz).

It is easy to see that in the case of hydrogen atom the formation of the new levels of electron occurs not because electron itself, as resonator, absorbs a photon. The size of electron corresponds to the wavelengths of the photons, whose energies are considerably more than the energies of the electron between the levels of atom. The wavelengths of the photons, whose energies correspond to electron transitions in hydrogen atom, are considerably less. But as we know, these lengths are commensurate with the de Broglie wavelengths of the electron in hydrogen atom.

It is easy to see that in the case of hydrogen atom the formation of the new levels of electron occurs not because electron itself as resonator absorbs photon. Actually, according to NTEP the size of electron corresponds to the wavelength of the photon, whose energy is considerably bigger than the energies of the electron transition between the levels of atom. But as we know, the lasts are commensurate with the De Broglie wavelengths for the electron motion in hydrogen atom.

Thus, in the atom an electron itself does not carry out role of resonator, but resonator is formed by potential well of nuclear field.

It is possible to say that in this case the nature devised some "crafty" mechanism. The rest electron has high constant internal frequency. But the frequencies of attendant additional waves of electron in motion change from zero to infinity in dependence on the speed. Thus in dependence on the electron speed the wavelengths of these additional waves can be commensurate not only with the lengths of electron orbits in atoms, but also with the size of the slot of diffraction grating (which value is macroscopic).

Let us attempt to show now that the mass spectrum of elementary particles can be explained analogously with the mass spectrum of electron in hydrogen atom, taking into account the fact that in this case particle itself serves as resonator for the additional particles.

## 6.0. To the calculation of mass spectra of elementary particles

### 6.1. A direct problem

We will consider here a particle  $X_0$  (see (14.4.1)) as the given resonator, and particles  $X_1$ ,  $X_2$  as the unknown waves, which satisfy to resonance conditions of this resonator.

The examples of the simple reactions (Review of Particle Properties, 1994) are:

- 1) reaction of electron-positron pair production  $\gamma + N = e^- + e^+ + N$ ;
- 2) muon decay  $\mu^\pm = e^\pm + \nu + \bar{\nu}$  (99%),  $\mu^\pm = e^\pm + \nu + \bar{\nu} + \gamma$  (1%) (14.3.6 %) and taon decay  $\tau^\pm = \mu^\pm + \nu_\tau + \bar{\nu}_\mu$  (17.37 %),  $\tau^\pm = \mu^\pm + \nu_\tau + \bar{\nu}_\mu + \gamma$ . Here:  $m_\mu = 105.6 MeV$ ,  $m_\tau = 1777 MeV$ ,  $m_e = 0.51 MeV$ ,  $m_{\nu_e} < 3 eV$ ,  $m_{\nu_\mu} < 0.19 MeV$ ,  $m_\nu \approx 1 eV$

We can consider these reactions as superposition of the non-linear photons and semi-photons. For instance, muon or taon are possibly to represent as superposition of the electronic linear polarized half-wave and two neutrino as circularly polarized half-waves with the opposite direction of rotation. (Here in Putilov's approach we will consider neutrino and antineutrino as one photon). Similarly it can be considered other reactions without the infringement of corresponding conservation laws, for example, the pions decay:  $\pi^\pm = \mu^\pm + \nu_\mu$  (99.98%),  $\pi^0 = 2\gamma$  (98.79%),  $\pi^0 = e^+ + e^- + \gamma$  (14.1.19 %) ( $m_{\pi^0} = 134.97 MeV$ ,  $m_{\pi^\pm} = 139.57 MeV$ ).

Let us calculate accordingly this method the mass of heavy leptons as the excited states of free electron. The free Dirac electron equation

$$\left( \hat{\alpha}_0 \hat{\varepsilon} + c \hat{\alpha} \hat{p} + \hat{\beta} m c^2 \right) \psi = 0, \quad (14.6.1)$$

is satisfied by any mass, not only the electron mass. Therefore, the Dirac electron equation with an external field

$$\left[ \hat{\alpha}_0 (\hat{\varepsilon} - \varepsilon_{ph}) + c \hat{\alpha} (\hat{\vec{p}} - \vec{p}_{ph}) + \hat{\beta} mc^2 \right] \psi = 0, \quad (14.6.2)$$

after grouping the mass-energy part in brackets, we can rewrite as following:

$$\left\{ (\hat{\alpha}_0 \hat{\varepsilon} + c \hat{\alpha} \hat{\vec{p}}) - \left[ (\hat{\alpha}_0 \varepsilon_{ph} + c \hat{\alpha} \vec{p}_{ph}) + \hat{\beta} mc^2 \right] \right\} \psi = 0, \quad (14.6.3)$$

Here the expression in the brackets corresponds to the excited electron energy-masses:

$$M(n) = \left[ (\hat{\alpha}_0 \varepsilon_{ph} + c \hat{\alpha} \vec{p}_{ph}) - \hat{\beta} mc^2 \right] = \hat{\beta} (m_e + m_{ad}) c^2, \quad (14.6.4)$$

where  $m_{ad} = m_{ad}(n)$  is some additional masses, which are in the general case the discrete number of values depending on  $n = 1, 2, 3, \dots$ . In other words we have here the transition of electron from the energy level of free electron  $m_e c^2$  to the level of excited electron  $(m_e + m_{ad}) \cdot c^2$ .

As we noted in the introduction, a resonance cavity can support standing waves in three different directions, and, in addition, these waves can be of different types, independent from each other. This means that the number of additional masses may be at least equal to three different values, but in general is far more:

$$M(n) = \beta (m_e + \sum_{i=1}^3 (m_{ad})_i) c^2, \quad (14.6.4')$$

Substituting (14.6.4) in (14.6.2) and taking into account  $\hat{\varepsilon} = i\hbar \partial / \partial t$ ,  $\hat{\vec{p}} = -i\hbar \vec{\nabla}$ , we will obtain:

$$\left[ \left( \hat{\alpha}_0 \frac{\partial}{\partial t} - c \hat{\alpha} \vec{\nabla} \right) + i \hat{\beta} c \frac{(m_e + \sum_{i=1}^3 (m_{ad})_i) c}{\hbar} \right] \psi = 0, \quad (14.6.5)$$

### 6.1.1. The examples of approximate calculation of particle masses

Since we do not know the exact size and shape of particles of the lower level of mass, such as the electron, we can not construct a rigorous theory for calculating the mass spectrum of more massive particles. Therefore, we restrict ourselves to calculations using a spherical approximation of the electron.

In order to consider the resonance conditions we will try now to transform a mass term of Dirac's equation so that it included the wavelengths of particles.

It is possible to present the mass term in (14.6.5) (without coefficient  $i\hat{\beta} c$ ) as follows:

$$\frac{(m_e + m_{ad})c}{\hbar} = \frac{m_e c}{\hbar} + \frac{m_{ad} c}{\hbar} = \frac{1}{\tilde{\lambda}_e} + \frac{1}{\tilde{\lambda}_{ad}}, \quad (14.6.6)$$

where  $\tilde{\lambda}_e$ ,  $\tilde{\lambda}_{ad}$  are the Compton waves' lengths (bar) of the electron and of the additional mass, respectively (by definition  $\tilde{\lambda}_C = \hbar/mc = \lambda_C/2\pi mc$ ). Since the basic wave and additional waves should be commensurable, so the basic wave contains an integer number of the additional waves. Thus they should satisfy the following condition of wave quantization:

$$\lambda_{ad} = \kappa \frac{\lambda_e}{n} \text{ or } \tilde{\lambda}_{ad} = \kappa \frac{\tilde{\lambda}_e}{n}, \quad (14.6.7)$$

where  $\kappa$  is the number, describing a resonance condition at different motion of waves (longitudinal, cross-sectional resonance, etc.);  $n = 1, 2, 3, \dots$  is an integer (quantum number).

In case of propagation of a wave along the circle (as in the above problem (14.1.2)) we have  $\kappa = 2\pi$ . In case of wave propagation along radius of the sphere:  $\kappa = 4$ ; along the ring tube radius  $\kappa = 2$ , etc.

Thus, for mass term in Dirac equation (i.e. for mass of a composite elementary particle) we obtain:

$$\frac{c}{\hbar} m_{ep} = \frac{(m_e + m_{ad})c}{\hbar} = \frac{1}{\tilde{\lambda}_e} + \frac{1}{\tilde{\lambda}_{ad}} = \frac{1}{\tilde{\lambda}_e} \left( 1 + \frac{\tilde{\lambda}_e}{\tilde{\lambda}_{ad}} \right), \quad (14.6.8)$$

Since the value  $\alpha = e^2/\hbar c = r_0/\tilde{\lambda}_e \approx 1/137$  represents an electromagnetic constant, we have  $\tilde{\lambda}_e = r_0/\alpha$  (where  $r_0 = e^2/m_e c^2$  is the classical electron radius). Then from (14.6.8) we will obtain:

$$\frac{c}{\hbar} m_{ep} = \frac{1}{\tilde{\lambda}_e} \left( 1 + \frac{\tilde{\lambda}_e}{\tilde{\lambda}_{ad}} \right) = \frac{\alpha}{r_0} \left( 1 + \frac{r_0}{\alpha \tilde{\lambda}_{ad}} \right), \quad (14.6.9)$$

As we have shown, the “bare” size of electron corresponds to Compton wave length, which at polarization in physical vacuum decreases in  $1/\alpha \approx 137$  times. Thus, taking into account the polarization of vacuum, instead of (14.6.7), we should write down:

$$\lambda_{ad} = \kappa \frac{r_0}{n} \text{ или or } \tilde{\lambda}_{ad} = \kappa \frac{r_0}{2\pi n}, \quad (14.6.10)$$

From here  $\frac{r_0}{\tilde{\lambda}_{ad}} = \frac{2\pi}{\kappa} n$ , which by substitution in the formula (14.6.9), gives the final formula for mass of a composite particle, which are close to above results of A.O. Barut, K.A Putilov., W.A Rodrigues.- J. Vaz:

$$m_{ep} = \left( 1 + \frac{2\pi}{\kappa \alpha} n \right) m_e \approx \left( 1 + \frac{2\pi}{\kappa} 137 \cdot n \right) m_e, \quad (14.6.11)$$

- 1) for  $n=0$  we obtain a trivial case of electron mass:  $m_1 = m_e$  ;
- 2) for  $\kappa = 4$ ,  $n = 1$  we obtain  $m_2 = 110.2 \text{ MeV}$  (that corresponds to  $m_\mu = 105.6 \text{ MeV}$ ) ;
- 3) for  $\kappa = 4$ ,  $n = 16$  we obtain  $m_3 = 1755 \text{ MeV}$  (that corresponds to  $m_\tau = 1777 \text{ MeV}$ ) ;
- 4) for  $\kappa = \pi$ ,  $n = 1$  we obtain  $m_4 = 140.25 \text{ MeV}$  (that corresponds to  $m_{\pi^\pm} = 139.57 \text{ MeV}$ ).

Despite the satisfactory coincidences we must not exclude that they are accidental. Nevertheless, these results confirm that the resonance theory of mass spectra has the good reasons.

It is also confirmed with calculations of particle masses according to the inverse problem.

## 6.2. Inverse problem.

We will consider here a particle  $X_0$  of the reaction (14.4.1) as the unknown resonator, and particles  $X_1$ ,  $X_2$  as the initial waves, which create this resonator.

In each resonator there are at least three sizes  $L_j$  ( $j=1,2,3$ ), which define lengths of resonance waves. Thus we can write down at least three resonance conditions:

$$L_j / \lambda_i = \kappa n_{ij}, \quad (14.6.12),$$

where  $i$  is number of a particle, participating in synthesis (in our example  $i = 1, 2$ ),  $n_{ij} = 1, 2, 3, \dots$  is an integer,  $\kappa_j$  is the dimensionless coefficient, defining resonance conditions. Since according to De Broglie  $\lambda_i = h/p_i$ , the formula (14.6.12) can be rewritten in the form:

$$p_{ij} \cdot L_j = \kappa_j h n_{ij}, \quad (14.6.13)$$

From here at  $n_{ij} = 1$  we obtain the condition for lowest states of a particle  $X_0$ :

$$p_{ij0} = \kappa_j \cdot h / L_j = \text{const}, \quad (14.6.14)$$



Then for any other "excited" state of a particle  $X_0$  we have:

$$p_{ij} = \kappa_j \frac{h}{L_j} n_{ij} = p_{ij0} \cdot n_{ij}, \quad (14.6.15)$$

In case of two fussion particles ( $i = 2$ ) we have for lowest momentums and quantum numbers the values, which depend only on the index  $j$ ; namely:  $p_{1j} = p_{2j} = p_{j0}$  and  $n_j$ . Thus, we can calculate the masses for different  $j$ .

In works of group of Ratis, Yu.L., Garejev, F.A. et al. (Ratis and Garejev, 1992;; Garejev, Kazacha et al, 1998;; etc.) values  $p_{j0}$  for the big group of hadron resonances were selected, which give encouraging confirmations to our approach.

In case if number of particles  $X_i$  is more than 2 (i.e.  $i > 2$ ) for the calculation of spectra it is necessary to have additional correlations between  $p_{ij}$  with different  $i$ . Probably, the correlations, obtained in section 4, can be useful in this case.

# Chapter 15. The non-linear theory as string theory of Compton wavelength scale

## 1.0. Introduction. String theory review

Using the some of the many sources of modern string theory (in particular (Schwarz, 1987; Peat, 1988; Greene, 1999; etc) we briefly review the basics of string theory.

String theory is a model of fundamental physics whose building blocks are one-dimensional extended objects called strings, rather than the zero-dimensional point particles that form the basis for the Standard Model of particle physics.

### 1.1. Basic idea

The basic idea behind all string theories is that the constituents of reality are strings of extremely small size (possibly of the order of the Planck length, about  $10^{-35}$  m) which vibrate at specific resonant frequencies. Thus, any particle should be thought of as a tiny vibrating object, rather than as a point. This object can vibrate in different modes (just as a guitar string can produce different notes), with every mode appearing as a different particle (electron, photon, etc.). Strings can split and combine, which would appear as particles emitting and absorbing other particles, presumably giving rise to the known interactions between particles.

String theory as a whole has not yet made falsifiable predictions that would allow it to be experimentally tested, though various planned observations and experiments, particularly, on the LHC, could confirm some essential aspects of the theory, such as supersymmetry and extra dimensions. In addition, the full theory is not yet understood. For example, the theory does not yet have a satisfactory definition outside of perturbation theory; the quantum mechanics of branes (higher dimensional objects than strings) is not understood; the behaviour of string theory in cosmological settings (time-dependent backgrounds) is still being worked out; finally, the principle by which string theory selects its vacuum state is a hotly contested topic (see string theory landscape).

### 1.2. Basic properties

String theory is formulated in terms of an action principle, either the Nambu-Goto action or the Polyakov action, which describes how strings move through space and time. Like springs with no external force applied, the strings tend to shrink, thus minimizing their potential energy, but conservation of energy prevents them from disappearing, and instead they oscillate. By applying the ideas of quantum mechanics to strings it is possible to deduce the different vibrational modes of strings, and that each vibrational state appears to be a different particle. The mass of each particle, and the fashion with which it can interact, are determined by the way the string vibrates - the string can vibrate in many different modes, just like a guitar string can produce different notes. The different modes, each corresponding to a different kind of particle, make up the "spectrum" of the theory.

Strings can split and combine, which would appear as particles emitting and absorbing other particles, presumably giving rise to the known interactions between particles.

String theory includes both *open* strings, which have two distinct endpoints, and *closed* strings, where the endpoints are joined to make a complete loop (Fig. 16.1).

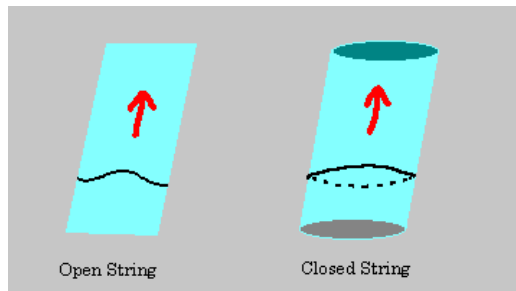

Fig. 16.1

The two types of string behave in slightly different ways, yielding two different spectra. For example, in most string theories, one of the closed string modes is the graviton, and one of the open string modes is the photon. Because the two ends of an open string can always meet and connect, forming a closed string, there are no string theories without closed strings.

The earliest string model - the bosonic string, which incorporated only bosons, describes - in low enough energies - a quantum gravity theory, which also includes (if open strings are incorporated as well) gauge fields such as the photon (or, more generally, any Yang-Mills theory). However, this model has problems. Most importantly, the theory has a fundamental instability, believed to result in the decay (at least partially) of space-time itself. Additionally, as the name implies, the spectrum of particles contains only bosons, particles which, like the photon, obey particular rules of behavior. Roughly speaking, bosons are the constituents of radiation, but not of matter, which is made of fermions.

Investigating how a string theory may include fermions in its spectrum led to the invention of supersymmetry, a mathematical relation between bosons and fermions. String theories which include fermionic vibrations are now known as superstring theories.

In some string theories (namely, closed strings and string in some version of the bosonic string), strings can split and reconnect in an opposite orientation (as in a Möbius strip or a Klein bottle).

### 1.3. String Tension

While understanding the details of string and superstring theories requires considerable mathematical sophistication, some qualitative properties of quantum strings can be understood in a fairly intuitive fashion. For example, quantum strings have tension, much like regular strings made of twine; this tension is considered a fundamental parameter of the theory. The tension of a quantum string is closely related to its size. Consider a closed loop of string, left to move through space without external forces. Its tension will tend to contract it into a smaller and smaller loop. Classical intuition suggests that it might shrink to a single point, but this would violate Heisenberg's uncertainty principle. The characteristic size of the string loop will be a balance between the tension force, acting to make it small, and the uncertainty effect, which keeps it "stretched". Consequently, the minimum size of a string is related to the string tension.

The tension of ordinary strings - like guitar strings - is determined by plucking them. If we could pluck a superstring, we could determine the tension in the string. This intrinsic "stiffness" of strings has several significant consequences.

First, it is the huge tension of a string that causes its contraction to an infinitesimal size - the Planck length of  $10^{-33}$  cm.

Second, the high tension results in the typical energy of a string being extremely high.

Strings' minimum energies are actually whole-number multiples of the Planck energy, which, translated into mass, yields the Planck mass (ten billion billion times that of a proton; roughly 1/100 of 1/000 of a gram; about the mass of a grain of sand).

Of course, the Planck mass is enormous by elementary-particle standards. How can strings, with average energies corresponding to the Planck mass, create the observed elementary particles with much smaller masses and lower energies?

## 1.4. String theory and quantum theory

A quantum mechanical theory of closed strings incorporates a lot of massless particle like excitations. And again, there is one among them that is very special, and familiar. It is a massless spin 2 particle. Remember, that we didn't order this. But we get it anyway, and miraculously, it is exactly what we need to formulate the relativistic theory of gravitation. We struck lucky again. It is the crucial second characteristic of string theory.

By merely studying the theory of open and closed strings, or string theory, in its quantum mechanical formulation, we got everything we needed to formulate a unified theory that incorporates the Standard Model and relativistic theory of gravitation. That doesn't mean we already have the unified theory, but it says we're on the right track.

In string theory all the known fundamental particles - including the messenger particles - have properties resulting from types of vibrational patterns. This fact is one of the most attractive and unifying aspects of string theory - it postulates that all particles are made of the same "fabric," as opposed to the particle physics view that each elementary particle is in effect "cut from a different fabric" (Greene, 1999).

## 2.0. Mathematical basis of the string theory

The theory of strings is represented as the generalization of the theory of elementary particles. As is known, elementary particles are simultaneously waves, and all equations of the quantum field theory (i.e. of Standard Model and also of NTEP) are wave equations. This cannot be abolished by any new theory, since SM is very well checked experimentally.

This fact alone indicates that the theory of strings, if it attempts to describe elementary particles, must be reduced to the wave equations, or, in other words, it must have Lagrangian and action function, which correspond to wave equations.

In the simplest case the equation of motion of real wave field  $\psi$  will be written as:

$$\frac{1}{c^2} \frac{\partial^2 \psi}{\partial t^2} + \Delta \psi = 0, \quad (15.2.1)$$

The function of action, which corresponds to it, is:

$$S = -\frac{1}{2} c^2 \int dt \int_V \partial_\nu \psi \partial^\nu \psi dx, \quad (15.2.2)$$

and the Lorentz-invariant Lagrangian is

$$\bar{L} = -\frac{1}{2} c^2 \sum_\nu \frac{\partial \psi}{\partial x_\nu} \frac{\partial \psi}{\partial x_\nu} \equiv \frac{1}{2} c^2 \partial_\nu \psi \partial^\nu \psi, \quad (15.2.3)$$

But that is for a nonrelativistic string, one with a wave velocity much smaller than the speed of light. How do we write the equation for a relativistic string?

In the nonrelativistic string, there was a clear difference between the space coordinate along the string, and the time coordinate. But in a relativistic string theory, we wind up having to consider the world sheet of the string as a two-dimensional spacetime of its own, where the division between space and time depends upon the observer.

The classical equation can be written here as

$$\frac{1}{c^2} \frac{\partial^2 X^\mu(\sigma, \tau)}{\partial \tau^2} - \frac{\partial^2 X^\mu(\sigma, \tau)}{\partial \sigma^2} = 0, \quad (15.2.4)$$

where  $\sigma$  and  $\tau$  are coordinates on the string world sheet representing space and time along the string, and the parameter  $c^2$  is the ratio of the string tension to the string mass per unit length.

These equations of motion can be derived from Euler-Lagrange equations from an action based on the string world sheet

$$S = -T \int d\sigma \int d\tau \sqrt{-h} h^{ab} \partial_a X^\mu \partial_b X^\nu, \quad (15.2.5)$$

where  $T_{string} = \frac{1}{2\pi a'}$  is string tension; the spacetime coordinates  $X^\mu$  of the string in this picture are also fields  $X^\mu$  in a two-dimension field theory defined on the surface that a string sweeps out as it travels in space. The partial derivatives are with respect to the coordinates  $\sigma$  and  $\tau$  on the world sheet and  $h^{ab}$  is the two-dimensional metric defined on the string world sheet.

The general solution to the relativistic string equations of motion looks very similar to the classical nonrelativistic case above. The transverse space coordinates can be expanded in normal harmonic modes. This string solution is unlike a guitar string in that it isn't tied down at either end and so travels freely through spacetime as it oscillates. The string (15.2.4) is an open string, with ends that are floppy.

Relativistic Lagrangian of the motion of point particle is used as initial Lagrangian of the theory of strings. On the basis of the last the action, function of the Nambu-Goto of non-pointlike particle is introduced into the theory:

$$S(x) = -\frac{1}{2} \int d\sigma \int d\tau \sqrt{\dot{X}^2 \cdot X'^2 - (\dot{X} \cdot X')^2}, \quad (15.2.6)$$

The Nambu-Goto action square root can be recorded in the linear form (this makes possible more simply to pass to quantum representation). The equivalent action of Polyakov, introduced on this basis, is the initial Lagrangian of the string theory:

$$S(X, \gamma) = -T \int d\sigma \int d\tau \sqrt{-\gamma} \gamma^{ab} \partial_a X^\mu \partial_b X^\nu \eta_{\mu\nu}, \quad (15.2.7)$$

For a closed string, the boundary conditions are periodic, and the resulting oscillating solution looks like two open string oscillations moving in the opposite direction around the string. These two types of closed string modes are called right-movers and left-movers, and this difference will be important later in the supersymmetric heterotic string theory.

This is classical string. When we add quantum mechanics by making the string momentum and position obey quantum commutation relations, the oscillator mode amplitudes have the known commutation relations.

The quantized string oscillator modes wind up giving representations of the Poincaré group, through which quantum states of mass and spin are classified in a relativistic quantum field theory.

So this is where the elementary particle arise in string theory. Particles in a string theory are like the harmonic notes played on a string with a fixed tension  $T$ . The parameter  $a'$  is called the string parameter and the square root of this number represents the approximate distance scale at which string effects should become observable.

By looking at the quantum mechanics of the relativistic string normal modes, one can deduce that the quantum modes of the string look just like the particles we see in spacetime, with mass.

Remember that boundary conditions are important for string behavior. Strings can be open, with ends that travel at the speed of light, or closed, with their ends joined in a ring.

One of the particle states of a closed string has zero mass and two units of spin, the same mass and spin as a graviton, the particle that is supposed to be the carrier of the gravitational force.

### 3.0. The NTEP as theory of strings

Let's compare the NTEP with modern theory of strings, as it is described by one of the founders of this theory (Schwarz, 1987):

*"Strings can have two various topology, which refer as opened and closed. The open strings are pieces of lines with free ends, while the closed strings represent loops with topology of a circle and have no free ends..."*

*... Various quantum-mechanical excitation (normal modes) of string for each solution of the given theory of strings are interpreted as a spectrum of elementary particles. The excitations can include the rotary and oscillatory degrees of freedom of a string and also the excitations of*

*various "internal" degrees of freedom, which it possesses. The internal degrees of freedom are caused by symmetry of the Lie groups, supersymmetry, etc.*

*The theory of strings gives the uniform approach to the rich world of the elementary particles, considered as a various modes of excitations of a unique fundamental string".*

Let us note the essential features of the string theory (and its modern variant - the superstring theory) compared with NTEP.

First of all we pay attention to the fact that the string have the Planck scale lengths (about  $10^{-35}$  m), which do not has place in the real world.

Note also that here the formalism of multi-dimensional Riemann space is used and therefore the theory of strings contains very complex mathematical apparatus. To explain what has here the real sense and what is mathematical fiction is very complicated.

Further: in the theory of strings the meaning of strings itself are mysterious. They are some energy formations, which can be named "energetic line", which do not attached to any concrete physical objects. But in nature there is no energy without matter. In the quantum theory of elementary particles, the objects, which carry an energy, are de Broglie's waves, described by  $\psi$  - function.

Difficulties of initial string theory have led to the need to incorporate in the theory of the so-called supersymmetric particles, which have never been observed in experiments. That is why the modern string theory is called superstring theory. In NTEP there is no need for such a complication of the theory.

Thus, applying the theory of strings to the description of elementary particles, we, first of all, must connect the strings with the known theoretical objects. Let us look how this it is possible to make sequentially, not disrupting principles both the one and the other theory.

Obviously, in order to switch over to real elementary particles within the framework of NTEP (where the particles are not pointlike) we must examine the functions  $X^\mu$  as the wave functions (then at least an energy of strings finds the carrier, and also the vibrations of the strings, which generate different string modifications, become understandable). As it is not difficult to see, in this case the above action is similar to the action of the wave equation.

As we see, there is the big number of contact points between two theories. It is possible to assume that NTEP is the theory of strings, which describes the elementary particles of real (not of Planck) scale. Below we will try to substantiate this claim, without detailed mathematical proofs, since they are fully described in previous chapters .

In the NTEP it is shown that at twirling of these strings within the strong electromagnetic field the closed strings, corresponding to the massive non-linear waves – solitons, are formed. It is also shown here that above twirling is similar to the transformations of the gauge type. The peculiar solitons, which are the constituents of this theory, are identical with the objects of Standard Model theory. In particular they have masses, can be only in two states – bosonic and fermionic, can have positive and negative charges, etc.

It is shown that the equations of this theory fully coincide with quantum field theory equations. The theory initiates the question, whether between the modern string theory and NTEP some connection exists?

A solitary stable wave is defined here as a spatially confined, non-dispersive and non-singular solution of a non-linear wave theory. For any non-linear wave theory the solitons are the same fundamental solutions, as the usual waves are the fundamental solutions of the linear equations. As it is known the newer fundamental non-Abelian gauge theories are non-linear and have the soliton solutions. In the framework of the quantum field theory it is not difficult to find the relations between solitons and elementary particles that go very deep and are entirely unexpected from a classical viewpoint.

According to modern theory the observed substance of the Universe consists of photons, leptons and quarks, among them besides electromagnetic interactions, act also strong and weak interactions. All these interactions are described by the unified theory – the Standard Model theory, which deeply generalizes Maxwell's theory. Instead of the vectors of the usual electrical

and magnetic fields  $\vec{E}, \vec{H}$ , several similar vector fields  $\vec{E}_i$  and  $\vec{H}_i$  act in it, waves of which by their nature are strongly non-linear. First C.N. Yang and R. Mills made such generalization of Maxwell's theory in 1954 (so-called Yang-Mills theories). Let us emphasize that the nonlinearity is so deeply placed in the nature of Yang-Mills fields as well as in the nature of the solitary waves. This nonlinearity unavoidably leads to the fact (Ryder, 1985) that the solitons must play the significant role in the structure of the Universe.

### 3.1. Bosonic open string in the NTEP

Let us show that in the nonlinear theory the quanta of electromagnetic waves can be represented as massless boson strings of Compton wavelength scale.

In accordance with the Planck- Einstein theory each photon has zero mass, energy  $\varepsilon$ , momentum  $\vec{p}$ , frequency  $\omega$  and wavelength  $\lambda$ , whose values are mutually unambiguously connected among themselves:  $\varepsilon = \hbar\omega$ ,  $\vec{p} = \hbar\vec{k}$ ,  $\varepsilon = cp$ , ( $\vec{k} = \vec{k}^0/\lambda$  is wave vector,  $\tilde{\lambda} = \lambda/2\pi$  is reduced wavelength).

As it is known, in framework of QED (Akhiezer and Berestetskii, 1965) for construction of the theory of the photons and their interaction with other particles the Maxwell equations along with the relationship  $\varepsilon = \hbar\omega$  are sufficient. To obtain the photon wave function the second order wave equations for EM field vectors  $\vec{E}$  and  $\vec{H}$  are used.

Factorizing the wave equation to the equations for retarded and advanced waves, we receive two equations of first degree regarding to some function  $f_k$ , which correspond to a wave vector  $k$  and is some generalization of the EM field vectors. The equation for this function is equivalent to the Maxwell-Lorentz equations. The function  $f_k$  is interpreted as local wave function of a photon in the momentum representation, which doesn't give possibility of the space description of photon interactions.

The attempt to enter the photon function in the coordinate representation has strike on an insuperable difficulty. According to analysis of Landau, L.D. and Peierls, R. (Landau and Peierls, 1930) and later of Cook, R.J. (Cook, 1982a,b) and Inagaki, T. (Inagaki, 1994) the photon wave function is nonlocal object. The result means that the localization of a photon in a area smaller of the photon wavelength is impossible.

Note that since the photon characteristics are mutually unambiguously connected among themselves, we can insist that photon has only one own independent characteristic (e.g., the wavelength). Then, keeping in mind the wavelength of photon, it is possible to say that photon is conditionally one-dimensional formation.

The one-dimensional object, which, on the one hand, obeys the wave equation, and on the other hand is not localized, in physics is referred to as a *string* (not forgetting of course that this supposition can have no relationship to the real structure of a photon) (see Fig. 16.2).

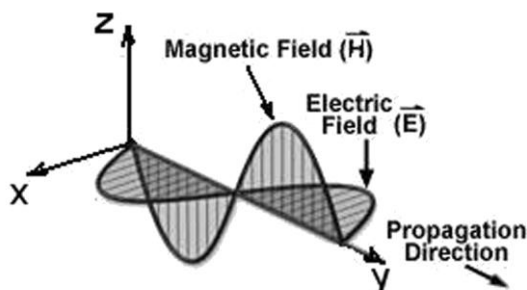

Fig. 16.2

These allows us to *introduce that the fundamental particle of an EM field - photon - is the open relativistic EM string with one wavelength size, which corresponds to the Compton electron wavelength scale.*

The main proof of validity of this assertion is the opportunity to construct on its basis the theory, which mathematically coincides completely with the results of quantum field theory (QFT).

Since a photon is a boson, we can expect that the photon string theory will be cognate to the initial modern string theory, in which the boson strings are the source material, from which by twirling, the close strings, i.e. the elementary particles, are formed. Obviously, in the case of the photon string the introduction of such postulate is not needed. Actually, the bending of a trajectory of an EM wave in the strong EM field follows already from the Maxwell-Lorentz theory.

### 3.2. Production of the closed strings of electron and positron

Thus, we can suppose that *under certain external conditions the EM-string can start to move along the closed nonlinear trajectory, forming the closed strings (or in other words, solitons), which can be considered as EM elementary particles.*

It is obvious, that due to the quantum nature of a photon string the formed closed strings should possess, at least, a rest mass and the angular momentum (spin). Moreover, the detail analysis (see previous chapters) shows that such EM elementary particles can have electric charge, helicity and all other characteristics and parameters of real elementary particles.

Then we can consider the reaction of electron-positron pair production from EM-string as production of two closed string (see Fig.16.3)

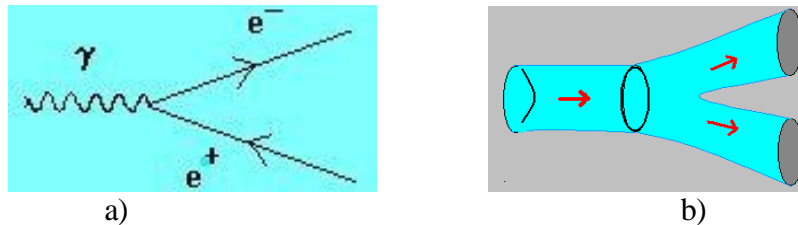

Fig. 16.3 Electron-positron pair production:  
a) in QFT as Feynman diagram; b) in string theory

In the NTEP this process is illustrated by Fig. 16.4:

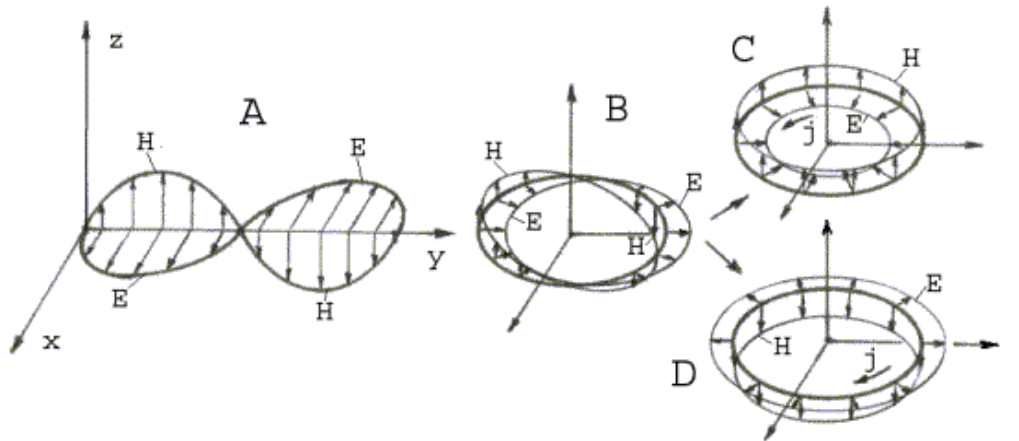

Fig. 16.4

Thus, conditionally speaking, from one vector particle (i.e., open string) we receive two antisymmetrical semi-vector particles, (two spinors), which according to Fig. 16.4 and solution of Dirac electron equation are close strings.

### 3.3. The neutrino closed string

In the previous chapters it is also shown that at plane twirling and division of the **circularly polarized** initial photon are produced the neutral massive leptons – the same type as neutrino and antineutrino, which are also described by Dirac equations. Figure 16.5 shows the distribution of the electric field connected with the circularly polarized wave of the positive (right) and negative (left) helicity:



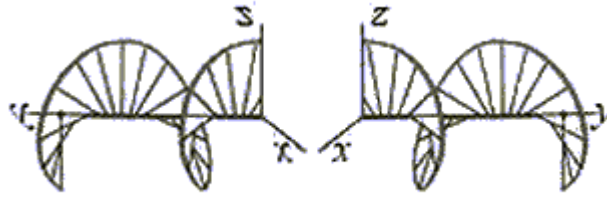

Fig. 16.5

The twirled half-periods of such photons give the EM particles with inner helicity (Fig. 16.6)

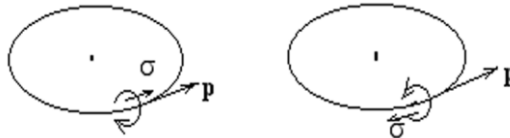

Fig.16.6)

In this case neutrino as twirled helicoids represents Moebius's strip: its field vector at end of one coil has the opposite direction in relation to the initial vector, and only at two coils, comes back to the starting position (Fig. 16.7). This property of the EM-lepton vector corresponds to the same property of wave function of Dirac lepton theory.

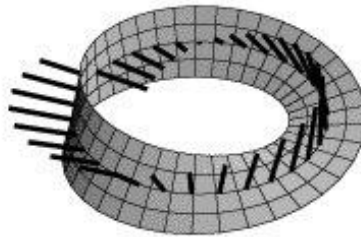

Fig.16.7

### 3.4. The hadrons' strings

Further in this research it is described the occurrence of spatial particles, as the superposition of the twirled semi-vector particles (spinors). The equations of such particles' superpositions coincide with Young-Mills equations for hadrons (mesons and baryons). In this case the spatial superposition of two twirled semi-photons generates the mesons, and spatial superposition of three twirled semi-vectors leads to occurrence of baryons, e.g. proton (Fig.16.8):

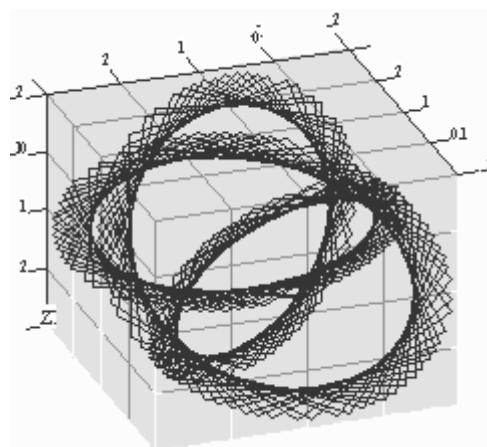

Fig.16.8

## 4.0. The vibrational modes of strings as the mass spectra of elementary particles

To the question of origin of the mass spectra of elementary particles, we have devoted the chapters 13 and 14 . We have shown that the appearance of mass spectra requires that the particles had a size. In this case, as we have shown, the particles can serve as a potential well for the resonance absorption of an additional portion of electromagnetic energy in the form of the corresponding de Broglie wave. Both the bases of the mass spectrum appearance are adequate to the hypothesis about the origin of the mass spectra of elementary particles in string theory. A major difference lies only in the fact that the energy (mass) of excitations in this case have energies which correspond to the scale of the Compton wavelength of an electron and not of the length scale of Planck.

### Why is not modern string theory confirmed?

It was assumed that the experimental discovery of supersymmetric particles on the Large Hadron Collider (LHC) will be a substantial confirmation of the theory of superstrings.

The recent observations and experiments on the LHC do not confirm some essential aspects of the string theory. The last LHC results cast doubt on supersymmetry theory. Data was presented at the Lepton-Photon science meeting “Lepton Photon 2011” in Mumbai. (ANI) 22–27 August 2011 (<http://www.tifr.res.in/~lp11/>, <http://truthdive.com/2011/08/28/LHC-results-cast-doubt-on-supersymmetry-theory.html>):

Results from the Large Hadron Collider (LHC) have disappointed theorists on the lookout for Higgs boson and has them rethinking that the basic idea of supersymmetry might be wrong. The theory of supersymmetry in its simplest form is that as well as the subatomic particles we know about, there are “super-particles” that are similar, but have slightly different characteristics. The theory, which was developed 20 years ago, can help to explain why there is more material in the Universe than we can detect – so-called “dark matter”.

Researchers failed to find evidence of so-called “supersymmetric” particles, which many physicists had hoped would plug holes in the current theory. According to Professor Jordan Nash of Imperial College London, who is working on one of the LHC’s experiments, researchers could have seen some evidence of supersymmetry by now. “The fact that we haven’t seen any evidence of it tells us that either our understanding of it is incomplete, or it’s a little different to what we thought – or maybe it doesn’t exist at all,” he said.

According to Dr. Tara Shears of Liverpool University, a spokesman for the LHCb experiment: “It does rather put supersymmetry on the spot”.

Dr Joseph Lykken of Fermilab, who is among the conference organisers, says that he and others working in the field are “disappointed” by the results – or rather, the lack of them: “The worry is that the basic idea of supersymmetry might be wrong. There’s a certain amount of worry that’s creeping into our discussions... It’s a beautiful idea. It explains dark matter, it explains the Higgs boson, it explains some aspects of cosmology; but that doesn’t mean it’s right... It could be that this whole framework has some fundamental flaws and we have to start over again and figure out a new direction”.

As we know, any theory can be written down and formulated by means of many different methods. For example, in the classical mechanics it is equally possible to use the approach of Newton, Lagrange, Jacobi, Hamilton, etc. In quantum mechanics the matrix mechanics of Heisenberg, wave mechanics of Schrödinger, integrals along the paths of Feynman, etc are used for the description of elementary particle motion.

The equations of electrodynamics can also be written down in the forms of eight scalar equations, four vector equations, two tensor equations, quaternion and octanion equations and others. But all these approaches (as Feynman remarked in his lectures “Electrodynamics”, volume 28 (Feynman, Leighton and Sands, 1964)) give the same results: in order to calculate something

in the electrodynamics, it is necessary to turn to eight scalar equations. In other words, all methods of description, enumerated above, are almost useless.

Furthermore: it is possible to write them down in 11 different orthogonal systems, and also in the space of many dimensions, including a Riemannian space of an infinite number of measurements.

Thus, many things in abstract theories have only mathematical sense. From the above analysis it is possible to conclude that the modern theory of strings is one of the methods of super-abstract mathematical description of modern elementary particle theory. Maybe, namely this description of elementary particle is the only destination of the string theory. And the rest of its content is only a useless formal abstract construction.

# Chapter 16. On photon and electron structure

## 1.0. Introduction. The point and non-point particles

This work investigates the structure of elementary particles and first of all photon and electron, for which is collected the largest amount of experimental data and is created the most developed theory - quantum electrodynamics (QED).

As it was shown in previous chapters, the fundamental equations of elementary particles in quantum field theory (QFT) and the equations of nonlinear theory of elementary particles (NTEP) by the linear representation are identical. However, the structure of elementary particles, described by them, is very different.

Fundamental particles are regarded as point in QFT and emerging with this infinities are eliminated by renormalization procedure. Particles in NTEP are not point and have an internal structure. As a consequence, infinities does not arise here.

Therefore, the first target of this article is to show that the renormalization procedure is a procedure, which latently takes into account the size and the structure of particles and also the polarization of physical vacuum.

In other words, we want to show that the following correspondence exists:  
(Solution of the QFT equation for a point particle + renormalization procedure) = Solution of the NTEP equation for non-point particle.

It is easy to understand that this fact is equivalent to the assertion that a point particle is an artificial concept and that its successful use in the quantum theory became possible after the invention of the renormalization procedure.

Therefore in the next section we want to show that there is no evidence of point particles' existence and that this interpretation is the accidental consequence of the historical development of quantum theory based on the new methodology of physics.

The third purpose of this chapter is an attempt to clarify the structure of non-point particles and its parameters.

Sections 2, 3 and 4 deals with the photon and electron in framework of classical electrodynamics. Sections 5, 6 and 7 give the conception of photon and electron in quantum mechanics and quantum field theory, respectively. Sections 8 and 9 describe these particles in NTEP, and Section 10 gives an indication of possible models of particles, which do not contradict their mathematical description.

Let note that most publications, mentioned in this article, can be found in the Internet by free access. This allows us to be brief, referring the reader for details to these publications.

## 2.0. Photon and electron in classical electrodynamics

### 2.1. The development of representations of a photon in classical electrodynamics

The study of photon (as a quantum of electromagnetic wave) and electron (as a charged particle that transfers electrical current) began in the framework of classical electrodynamics (H. Lorentz, J.J. Thomson and others) and continued till the 1926-30 up to the early development of quantum field theory.

Classical physics was based on an axiomatic foundation (on the "Greek theory," as it was called by Feynman (Feynman, 1985). The point-like objects, which contradict logic and experiment, can not exist here. Indeed, a point particle is a particle of zero size, i.e., it is "nothing". A charged point particle has an infinite amount of energy which violates the law of energy conservation. And nothing can be told about the point particle structure.

The wave equation for electromagnetic (EM) field vector was considered as an equation describing a photon, taking into account the quantization of wave energy according to Planck . In

Maxwell's equations and in EM wave equation the size of the photon is absent. Experiments also did not allow to measure this parameter.

Therefore, despite the lack of experimental data, researches of the structure of the non-point particles - photon and electron - appeared on the basis of classical electrodynamics, taking into account the quantization rule of Planck.

### 2.1. 1. Photon of J.J. Thomson

The greatest success in description of a structure of photon was achieved by J.J. Thomson ((Thomson, 1924) (see also (Thomson, 1925, 1930, 1933, 1936)). He started from the field nature of the photon, which follows from the Faraday-Maxwell's electromagnetic field theory. Let us note the main results of his theory of photon, translating the terms used by Thomson in modern language.

Thompson suggested that there are two kinds of photons: the longitudinal photons corresponding to a stationary electromagnetic field and transverse photons corresponding to electromagnetic waves.

#### Longitudinal photons

The Thomson's longitudinal photons are attached to the charges and move together with them. In terms of force they represent force lines of electromagnetic field. They have energy, mass and are capable to exert a force act on each other. Their aggregate is a static field of an electron. The real behavior of longitudinal photons is simulated by field lines.

According to Thomson the longitudinal photons are vortex lines of electromagnetic ether of a certain length. Longitudinal photons are connected with the charge at one end while the other end is free in space when other charged particles are absent. These longitudinal photons appear the same time with a charged particle and their ends move with the speed of light. But they do not exist and move independently in space.

Thus the longitudinal photons can reach the area of longitudinal photons of other charge and interact with them. This interaction is described by Coulomb's law for stationary charges and is complemented by the law of Biot-Savart-Laplace for moving charges. In other words the longitudinal photons provide the interaction for the charged particles which move uniformly with a velocity less than the speed of light.

All this coincides with the results of both classical and modern quantum theory almost literally (for details, (Dirac, 1978; Stewart, 2008, etc.) . The 4-potential  $A_\mu = \{\varphi, \vec{A}\} \equiv \{A_0, \vec{A}\}$  contains the 3-vector potential  $\vec{A}$  and scalar potential  $A_0$ . The 3-vector potential  $\vec{A}$  (Review of the Universe, 2003) can always be decomposed into a transverse component and a longitudinal component (parallel to the direction of motion) such that the transversality condition  $\vec{\nabla} \cdot \vec{A}_\perp = 0$  (which dictates that the transverse components are perpendicular to the direction of motion) and the irrotational condition of the longitudinal component  $\vec{\nabla} \times \vec{A}_\parallel = 0$  are satisfied the equation  $\vec{A} = \vec{A}_\perp + \vec{A}_\parallel$ .

It can be shown that  $\vec{A}_\parallel$  and  $A_0$  together give rise to the instantaneous static Coulomb interactions between charged particles with the total Hamiltonian in the form (the Hamiltonian H is related to the Lagrangian L by the formula  $\tilde{H} = p\dot{q} - L$  :

$$\tilde{H}_{em} + \tilde{H}_{int} = \frac{1}{2} \int \left( |\vec{\nabla} \times \vec{A}_\perp|^2 + \left| \frac{1}{c} \frac{\partial \vec{A}_\perp}{\partial t} \right|^2 \right) d^3x - \int \vec{j} \cdot \vec{A}_\perp d^3x + \frac{1}{2} \int d^3x \int d^3x' \frac{\rho(x,t)\rho(x',t)}{4\pi|x-x'|}, \quad (16.2.1)$$

where  $\vec{A}_\parallel$  and  $A_0$  have been completely eliminated in favor of the instantaneous Coulomb interaction in the last term. It is instantaneous in the sense that its value at t is determined by the charge distribution at the same instant of time. This formalism was derived by E. Fermi in 1930. Since the separation into different terms is not relativistically covariant, nor is the

transversality condition itself, the whole formalism appears noncovariant; each time we perform a Lorentz transformation, we must simultaneously make a gauge transformation to obtain a new set of  $\bar{A}$  and  $A_0$ . It had been shown that it is possible to develop manifestly covariant calculational techniques starting with this Hamiltonian. It is also possible to construct a formalism, which preserves relativistic covariance at every stage.

Note that the long range instantaneous Coulomb interaction does not imply a force travelling faster than the speed of light. Although the interaction is instantaneous, it can be considered as the interaction between two overlapping Coulomb tails (clouds of virtual photons) of the two charged particles, so there is no need for the interaction to travel from one point to another in zero time.

### Transverse photons

The J.J. Thomson's theory of emission and absorption of transverse photon is the most remarkable (Thomson, 1924). According to Thomson, the transverse photons arise from longitudinal photons during the accelerated motion of charges (in particular, when the oscillation of charges or rotation of the electron around the atom nucleus takes place). According to Thomson, the closing of the longitudinal photon into a ring takes place owing to the accelerated oscillatory motion of the electron (Fig. 14.1). In this case the field itself (the vortex filament of Thomson) is moving along a circle. But the field ring as a whole is moving perpendicularly to the direction of the motion. According to Thomson, the reverse process of transformation of transverse photons in longitudinal photons also takes place ((Fig. 14.2).

To describe this process let's use the words of J.J. Thomson himself:

*"We may picture the energy as getting free in the following way: during the approach of E to P the tube EP may first be thrown into a loop as in fig. 2; the two sides of the loop near E' approach each other as in fig. 3; the closed part of the loop gets detached (fig. 4) and goes off as a closed ring, which rapidly becomes circular and travels with the velocity of light in a direction at right angles to its plane, like a circular vortex ring. The energy in the ring, which is that due to the fall from E to E', remains constant as long as the ring is unbroken. The emission of this ring is taken to represent the emission of radiation, and the energy of the light is concentrated in this ring."*

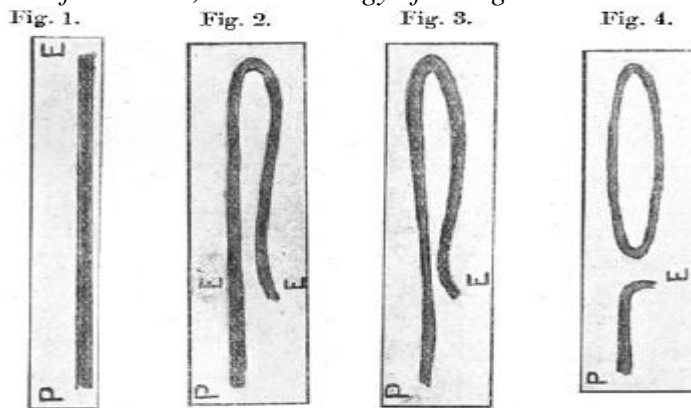

Fig. 14.1

*For this ring to give up its energy a process the reverse of that which led to its formation has to be gone through. When the ring comes near a tube of force joining an electron to a positive charge, the stages indicated in the figs. 5, 6, 7, and 8 are gone through. When in the reverse process the ring breaks and its tube of force gets attached to the electron in the stage represented in fig. 7, the energy in the circuit between P and E introduced by the ring is available for pulling the electron further away from P. If this energy is large enough to detach the electron from P, a free electron is produced and the ring disappears."*

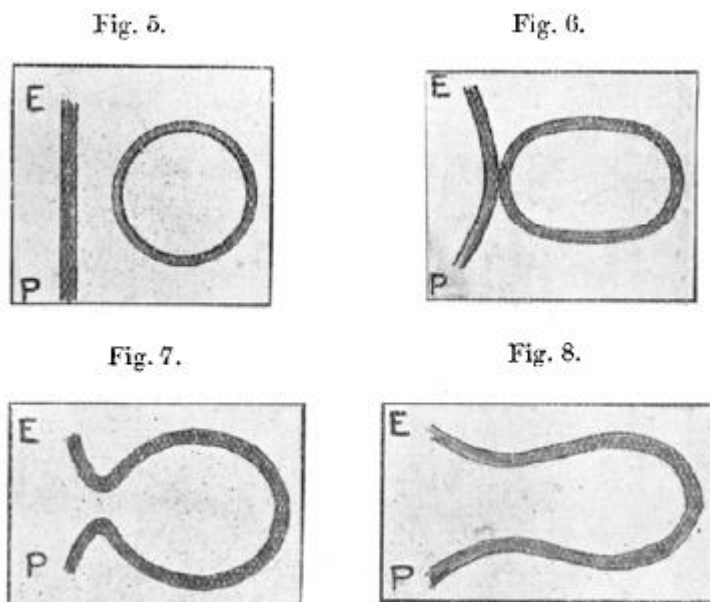

Fig. 14.2

Thomson does not adduce calculations which prove the stability of such formation. But he underlines that the condition of proportionality should be fulfilled: the photon wave length must be packed on a ring circumference an integer number of times. Thomson had shown that if the wave length is equal to the length of a ring circumference, a transverse photon has the EM energy according to Planck relation.

**“Energy of a Ring.**

If  $E$  is the electric polarization in the ring, the energy  $\varepsilon$  is given by the equation

$$\varepsilon = 2\pi E^2 \cdot (\text{volume of ring}) = 2\pi E^2 \cdot S \cdot 2\pi \cdot r^2$$

where  $S$  is the cross-section of the ring and  $2\pi r$  its circumference. As the tube of force came from an electron  $ES = pe$ , where  $e$  is the charge on an electron and  $p$  a number not greater than unity;  $p$  would be equal to unity if all the lines of force from the electron were done up into one bundle; it will have a smaller value if there are more bundles than one. Substituting this value for  $f$  and writing  $S = \pi b^2$ , where  $b$  is the radius of the cross-section of the ring, we find

$$\varepsilon = 8\pi^2 p^2 e^2 \frac{r^2}{b^2} \frac{1}{2\pi r}, \quad (16.2.2)$$

Thus, if the rings are geometrically similar, their energy will be inversely proportional to their linear dimensions...

**Planck's Law.**

There ought on this law to be a very simple relation between the energy of the ring and the frequency of the light of which it is the unit. If  $E$  is the energy and  $\nu$  the frequency,  $\varepsilon = h\nu$ , where  $h$  is Planck's constant  $6,55 \times 10^{-28}$ .

Thus the frequency of the light is directly, and the wavelength inversely, proportional to the energy. This kind of relation might be expected on the view we are discussing, for we have seen that the energy of the ring is equal to (16.2.2).

If the rings are geometrically similar,  $r/b$  will be the same for all rings. The frequency of the waves is the same as that of the ring; in geometrically similar rings we should expect the wave-length of the vibration to be proportional to the linear dimension. Hence from (1) we should expect the energy to be inversely proportional to the wave-length; this is Planck's law. To estimate whether the value of the constant would be anything like Planck's value: let us suppose that the time of vibration of the ring is the time taken by light to travel round the circumference of the core; then  $\nu = c/2\pi r$ , where  $c$  is the velocity of light. Hence from (16.2.2)

$$\varepsilon = 8\pi^2 p^3 e^2 \frac{r^2}{b^2 c} \cdot \nu \cong \frac{p^2 r^2}{b} h \cdot \nu, \quad (16.2.3)$$

So that  $pr/b = \pi$ , the numerical value of the constant connecting  $\varepsilon$  and  $\nu$  would agree well with Planck's value".

Such a photon has also a spin equal to Planck's constant. In other words the transverse photon of Thomson has the characteristics of a photon of QED: it has an integer spin and helicity equal to 1. The totality of these transverse photons represent transverse electromagnetic waves.

## 2.2. The development of electron picture in classical electrodynamics

Lorenz used the Coulomb law to describe the static electron in a spherical approximation. He calculated the radius of sphere which encloses the energy of electron field. This radius is determined by the value  $r_0 = \frac{e^2}{mc^2} = 2,81794 \cdot 10^{-13}$  cm up to the numerical factor of order 1, which was called later a "classical electron radius" (CER).

In quantum era it was assured that CER has no relation to the size of electron though in some problems of classic electrodynamics an electron behaves as a particle with radius  $r_0$ . For example, the total cross-section of EM waves ( $h\nu \ll m_e c^2$ ,  $\nu$ - frequency) by a single electron approximates a circle with radius  $r_0$  (see Thompson scattering of light). As it became clear later, the same quantity appears in all sections of interaction between a photon and an electron. These cross-sections are calculated on the basis of quantum field theory.

After the discovery of the electron magnetic properties, the toroidal (ring) model of electron appeared. It was investigated very deeply by known scientists in early 19th century (see, e.g., (Allen, 1918, 1920, 1921; Compton, 1919a,b, 1921a,b) and others).

The success of these calculations can be indeed by the list of 13 items (Allen, 1918), where one of the creators of this model Dr. H. S. Allen discusses the arguments in favour of an electron in the form of a current circuit capable of producing magnetic effects..

At an early stage these researches did not use the achievement of the quantum theory. Therefore, they had become the subject of a sharp criticism. For this reason a number of scientists which tried to develop and agree about a toroidal model with a quantum theory had decreased dramatically.

## 3.0. The field structure of matter

### 3.1. The physical meaning of elementary particle

From the standpoint of classical electrodynamics (H. Lorentz, J.J. Tomson, etc.) an electron is an electromagnetic field. At the beginning of the quantum era the representation of elementary particles as a field became generally accepted. This was noted by A. Einstein (Einstein and Infeld, 1938). *"We cannot build physics on the basis of the matter-concept alone. But the division into matter and field is, after the recognition of the equivalence of mass and energy, something artificial and not clearly defined. Gould we not reject the concept of matter and build a pure field physics? What impresses our senses as matter is really a great concentration of energy into a comparatively small space. We could regard matter as the regions in space where the field is extremely strong. In this way a new philosophical background could be created. Its final aim would be the explanation of all events in nature by structure laws valid always and everywhere. A thrown stone is, from this point of view, a changing field, where the states of greatest field intensity travel through space with the velocity of the stone. There would be no place, in our new physics, for both field and matter, field being the only reality. This new view is suggested by the great achievements of field physics, by our success in expressing the laws of electricity, magnetism, gravitation in the form of structure laws, and finally by the equivalence of mass and energy. Our ultimate problem would be to modify our field laws in such a way that they would not break down for regions in which the energy is enormously concentrated...."*



*A new concept appears in physics, the- most important invention since Newton's time: the field. It needed great scientific imagination to realize that it is not the charges nor the particles but the field in the space between the charges and the particles which is essential for the description of physical phenomena. The field concept proves most successful and leads to the formulation of Maxwell's equations describing the structure of the electromagnetic field and governing the electric as well as the optical phenomena. The theory of relativity arises from the field problems."*

Moreover, in accordance with A. Einstein (Einstein, 1920) in his speech "Aether and the theory of relativity" pronounced on May 5, 1920 at the Leyden university, emphasized that «According to our present conceptions the elementary particles of matter are also, in their essence, nothing else than condensations of the electromagnetic field...»

These conceptions do not contradict with quantum field theory. However, now the term 'field' means all known fields. It is clear, from this point of view that any material particle is a field clot.

In the case of an uncharged particle the energy distribution is abruptly ended at a ball surface which is his boundary. This boundary can be easily fixed by eye or with the help of some tool. The distance between the extreme points on the surface of the object can be called the size of the object. Depending on the shape of the object the number of sizes can vary from infinity (some complex surface) to one, in case of a ball whose size is determined by its radius.

A continuous distribution of charged particle field in space does not allow to fix identically the boundary of a particle (e.g., of electron).

Strictly speaking, the boundary surface of solid objects (e.g., ball) also does not coincide with a mathematical surface. Indeed, the electrons of surface of the atoms and the molecules fluctuate continuously around some average surface. If the object is charged, its field extends continuously from the surface of the object to infinity. The charged sphere (ball) has a jump of electric field on the surface which corresponds to an uncharged ball. In this case, we can take the surface corresponding to the field jump, as a boundary which defines the size of the object.

Thus, in any case we mean as a body size some conditional distance between the utmost points of body surface which we agreed to consider as a boundary.

Therefore, if we agree that some surface, containing the energy of the electron, is regarded as the boundary surface, it is logical to assume that the electron also has a size. The size of the electron was calculated in classical physics exactly in this way, as it will be shown below.

#### **4.0. Distribution of electron field and its characteristics**

The electron in the classical, quantum or nonlinear theories is an electromagnetic (EM) field body. The spatial distribution of electromagnetic field of an electron can be represented conditionally as follows (Fig. 14.3):



Fig. 14.3

This figure shows clearly that the electron has no size as a usual macroscopic body. But obviously, it has the characteristics of the field distribution and energy in space.

Therefore, by the term "the structure of electron" we must understand the structure its EM field. The description of electron field distribution and its characteristics will be the purpose of the present paragraph. In the article we use the CGS system.

#### 4.1. General characteristics of electron field distribution

As is known, for a charged body of any shape there is some radius  $R$ , measured from its center of mass, beginning from which, the electric field of this body is defined by law, close to the Coulomb law.

We do not know the exact distribution of the EM field of electron at a distance less than  $R$ . But, based on the energy conservation law, we can be sure that nowhere is the electron field an infinite value, since otherwise the total energy of the electron should be infinite.

For definiteness, we will use a cylindrical system of coordinates  $(r, z, \varphi)$ . We will place the center of mass (or, equivalently, of the field energy) into the origin of the coordinates. Let us denote the current radius of the field distribution as  $r$ .

#### 4.2. Spherical electron

Let us divide the charge volume conditionally by means of a spherical surface with a radius  $R$  into two parts. 1)  $r \leq R$ , when the field obeys to some real (and, in general, unknown to us), distribution law, and 2)  $r > R$ , when the field approximately obeys to the Coulomb law.

We will calculate the energy of the field inside this sphere and outside of it in some hypothetical cases of spherical charge distribution.

##### 4.2.1 The uniform distribution of charge on the surface of a sphere

We consider a simple model of an standing electron, in which all of its charge  $e$  is uniformly distributed on the surface of a sphere of radius  $R_s$ , which we may take to be zero for the special case of a point charge.

In this case, the electric field is  $E_{out} = \frac{q}{r^2}$  at  $r > R_s$ , and  $E_{in} = 0$  if  $r \leq R_s$  (Fig. 14.4):

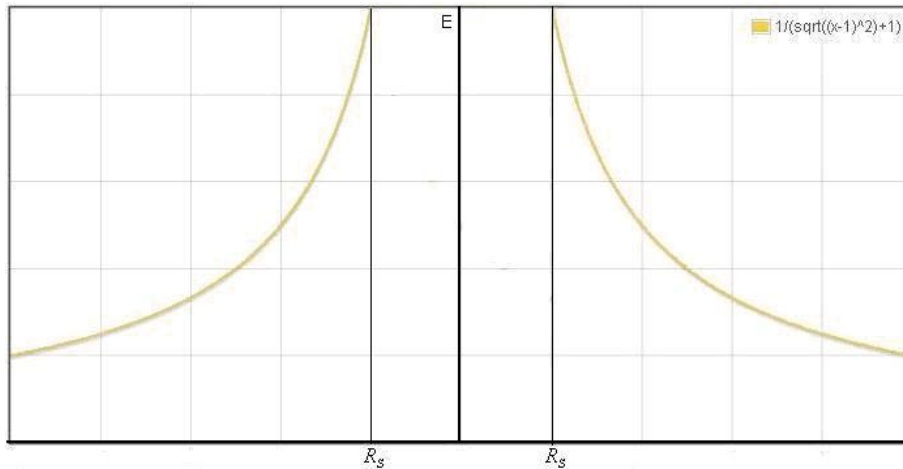

Fig. 14.4. (this figure was made with the help of online math tools <http://www.numberempire.com/>)

Now let us calculate the energy in the electromagnetic field. If the electron is standing still, there is no magnetic field, and the energy per unit volume is proportional to the square of the electric field. The energy density is:

$$u = \frac{1}{8\pi} E^2 = \frac{1}{8\pi} \frac{e^2}{r^4}$$

To get the total energy, we must integrate this density over all space. Using the volume element  $4\pi r^2 dr$ , we obtain

$$\varepsilon_{el} = 4\pi \int_{R_s}^{\infty} u r^2 dr$$

The lower limit is  $R_s$ , and the upper limit is  $\infty$ , so this is readily integrated.

$$\varepsilon_s = \frac{1}{8\pi} \int_{R_s}^{\infty} E^2 d\tau = \frac{e^2}{2} \int_{R_s}^{\infty} \frac{dr}{r^2} = \frac{1}{2} \frac{e^2}{R_s}.$$

Equating this energy to the total mechanical energy of the electron, we get:  $\frac{1}{2} \frac{e^2}{R_s} = m_e c^2$ .

From here the characteristic radius of the ball, which simulates the electron, is:

$$R_s = 0.5(e^2/m_e c^2) = 0.5 \cdot r_0,$$

where  $r_0 = \frac{e^2}{m_e c^2} = 2,81794 \cdot 10^{-13}$  cm is conventionally named “classical electron radius”.

Next, we will restrict ourselves to figures and physical quantities only.

#### 4.2.2. A sphere which is uniformly charged by volume

The full field distribution is given by Fig. 14.5:

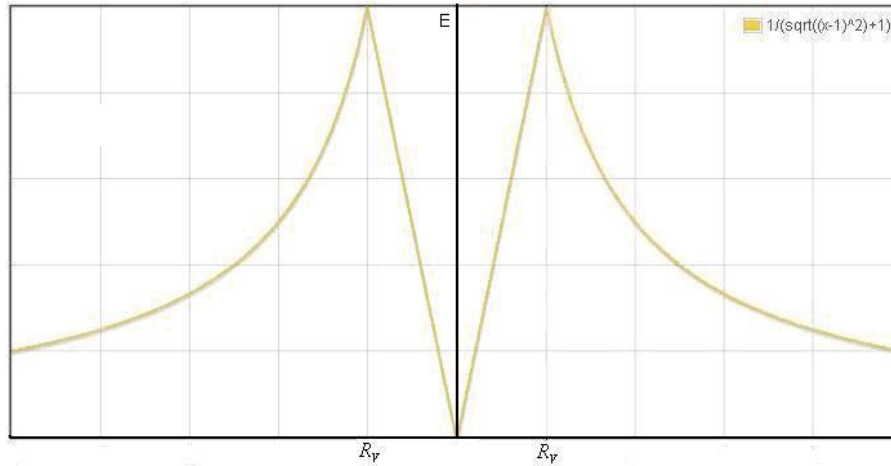

Fig. 14.5 (this figure was made with the help of online math tools <http://www.numberempire.com/>)

Field distribution:  $E_{in} = \frac{e}{R_v^3} r$  at  $r \leq R_v$ ;  $E_{out} = \frac{e}{r^2}$  at  $r > R_v$ .

The energy:  $\varepsilon_{out} = \frac{1}{2} \frac{e^2}{R_v}$ ,  $\varepsilon_{in} = \frac{3}{5} \frac{e^2}{R_v}$ .

The total electron energy is:  $\frac{1}{2} \frac{e^2}{R_v} + \frac{3}{5} \frac{e^2}{R_v} = m_e c^2$ .

Then, the characteristic radius is:  $R_v = 1,1(e^2/m_e c^2) = 1,1 \cdot r_0$ .

#### 4.2.3. Nonlinear electron: Born-Infeld spherical approximation

According to nonlinear theory NTEP a complete description of the field distribution should be based on the solution of nonlinear equations of the electron. We have shown that as a first approximation we can use a solution of the nonlinear theory for spherical electron (Born and

Infeld, 1934). We have here the field distribution:  $\vec{E}_{BI} = \frac{e\vec{r}}{r\sqrt{r^4 + r_{BI}^4}}$ , where  $r_{BI}$  is constant (Fig.

14.6)

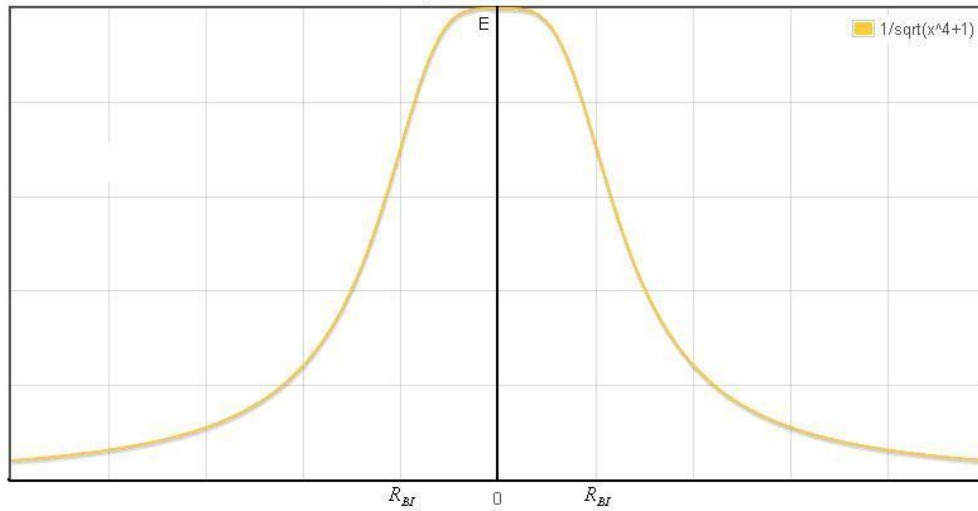

Fig. 14.6 (this figure was made with the help of online math tools <http://www.numberempire.com/>)

The maximal field of electron is in the center of electron at  $r=0$ :  
 $E_{BIm} = \frac{e}{r_{BI}^2} = 9,18 \cdot 10^{15} \text{ CGS} = 2,75 \cdot 10^{20} \frac{\text{V}}{\text{m}}$ , and at the same time  $r_{BI} = \sqrt{\frac{e}{E_0}} = 2.28 \cdot 10^{-13} \text{ cm}$   
 (which is approximately equal to classical electron radius  $r_0$ ).

According to (Born and Infeld, 1934) the charge of non-linear electron can be considered as distributed in a sphere of radius  $r_{BI}$ , since, because of the condition  $r \gg r_0$ , the density will quickly go to zero. Therefore, the size  $r_{BI}$  can be considered as an effective radius of an electron. (see also (Ivanenko and Sokolov, 1949; Kyriakow, 2009).

Thus, we can consider that the characteristic radius is:  $R_{BI} \cong r_{BI} = 1.23 \cdot r_0$ ,

The energy:  $\varepsilon_{out} = \frac{1}{2} \frac{e^2}{R_{BI}} \cong 0.406 m_e c^2$ ,  $\varepsilon_{in} \cong 0.594 m_e c^2$ .

The question arises: why energy radius is attached to a constant CER? It is easy to understand that CER appears owing to two physical results. The first result consists of the fact that the electric field of a charged sphere at distance  $r > R$  is distributed according to Coulomb's law  $e/r^2$ , and the energy field in conformity with this is under the law  $e/r^2$ . The second fact is that the total energy of any particle is equal to  $mc^2$ . It follows that the volume of radius  $R$  always contains a part of the particle energy, is equal to  $k \cdot mc^2 = \frac{e^2}{R}$ , where  $0 < k \leq 1$ ; whence

$$R = \frac{1}{k} \frac{e^2}{m_e c^2} = \frac{1}{k} r_0.$$

The result of the above analysis is: the classical electron radius (CER) is not the size of electron, but is the characteristic of the energy distribution of electron field. Thus, the CER is not the classical parameter; it is the parameter of electron in any theory. Therefore the classical electron radius is involved in quantum theory, e.g., in non-relativistic Thomson scattering and the relativistic Klein-Nishina formula, etc. Also, the classical electron radius is roughly the length scale at which renormalization becomes important in quantum electrodynamics.

#### 4.2.4. The distribution of the electron field by V. Weisskopf

In the paper of V. Weisskopf (Weisskopf, 1939) “*the charge distribution, the electromagnetic field and the self-energy of an electron are investigated.*”

The quantum theory of the electron has put the problem of the self-energy in a critical state. There are three reasons for this:

(a) Quantum kinematics shows that the radius of the electron must be assumed to be zero. It is easily proved that the product of the charge densities at two different points,  $\rho(r - \xi/2) \times \rho(r + \xi/2)$ , is a delta-function  $e^2 \delta(\xi)$ . In other words: if one electron alone is present, the probability of finding a charge density simultaneously at two different points is zero for every finite distance between the points. Thus the energy of the electrostatic field is infinite as  $W_{st} = \lim_{(a \rightarrow 0)} e^2/a$

(b) The quantum theory of the relativistic electron attributes a magnetic moment to the electron, so that an electron at rest is surrounded by a magnetic field. The energy”.

In other words, as a source of electron field V. Weisskopf considered the Dirac delta function or unit impulse function: a generalized function depending on a real parameter such that it is zero for all values of the parameter except when the parameter is zero, and its integral over the parameter from  $-\infty$  to  $\infty$  is equal to one. Formally the Dirac delta function can be defined as a point distribution of the electron field .

“The presence of an electron in the vacuum causes a considerable change in the distribution of the vacuum electrons because of a peculiar effect of the Pauli exclusion principle. According to this principle it is impossible to find two or more electrons in a single cell of a volume  $h^3$  in the phase space. If two electrons of equal spin are brought together to a small distance  $d$ , their momentum difference must be at least  $h/d$ . This effect is similar to a repulsive force which causes two particles with equal spin not to be found closer together than approximately one de Broglie wave-length.

As a consequence of this he found “at the position of the electron a "hole" in the distribution of the vacuum electrons which completely compensates its charge. But we also find around the electron a cloud of higher charge density coming from the displaced electrons, which must be found one wave-length from the original electron. The total effect is a broadening of the charge of the electron over a region of the order  $h/mc$  as it is indicated schematically in Fig. 1. The product  $\rho(r - \xi/2) \times \rho(r + \xi/2)$  is no longer zero for a finite distance  $\xi$ , and is given by the function”.

Thus, “as a result of Dirac's positron theory, the charge and the magnetic dipole of the electron are extended over a finite region; the reasons that the self-energy is only logarithmically infinite in positron theory are given. Some evidence is given that the "critical length" of positron theory is as small as  $h/(mc) \exp(-hc/e^2)$ ”.

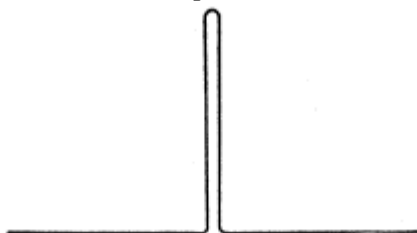

14.7la. Schematic charge distribution of the electron.

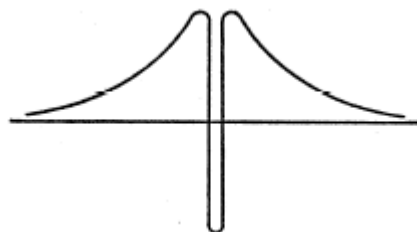

Fig. 14.7b. Schematic charge distribution of the vacuum electrons in the neighborhood of an electron.

The fact that the electron has an intrinsic angular momentum and magnetic moment conflicts with its point description in quantum theory. But for historical reasons it is assumed that in frames of the linear quantum theory the electron is a point (see the following sections).

## 5.0. Ideological and methodological foundations of quantum mechanics

### 5.1. The change of paradigm

It is believed that in physics at the passage from the 19<sup>th</sup> to the 20<sup>th</sup> century there was a crisis and a "revolution". In his book "Valeur de la science" (Poincaré, 1905), i.e., "Value of Science" (Poincaré, 1958), the famous French mathematic and physicist Henri Poincaré says that there are "symptoms of a serious crisis" in physics, and he devotes a special chapter to this crisis (Chap. VIII). But Poincaré does not develop these deductions consistently.

It is dealt in detail by the French philosopher Abel Rey, in book (Rey, 1907): "*The collapse of traditional mechanism, or, more precisely, the criticism to which it was subjected, led to the proposition that science itself had also collapsed. From the impossibility of adhering purely and simply to traditional mechanism it was inferred that science was impossible*". And the author asks: "*Is the present crisis in physics a temporary and external incident in the evolution of science, or is science itself making an abrupt right-about-face and definitely abandoning the path it has hitherto pursued?*"

This collapse and the subsequent revolution in physics, which the philosopher Thomas Kuhn (Kuhn, 1962) has called the scientific paradigm change, has led to a new methodology of physics. (Karl Popper calls such theories "instrumentalistic" and Richard Feynman - "Babylon theories" (see (Feynman, 1985). The classical axiomatic approach was rejected and replaced by the positivistic methodology of the theory construction.

About this in more detail discussed the famous philosopher Karl Popper (Popper, 1982) (see "Preface 1982. On a realistic and commonsense interpretation of quantum theory").

*"Today, physics is in a crisis. In my view, the crisis is, essentially, due to two things:*

*a) the intrusion of subjectivism into physics; and*

*(b) the victory of the idea that quantum theory has reached complete and final truth.*

*Subjectivism in physics can be traced to several great mistakes. One is the positivism or idealism of Mach. It spread to the British Isles... through Russell, and to Germany through the young Einstein (1905). This view was rejected by Einstein in his forties (1926), and it was deeply regretted by the mature Einstein (1950)*".

In this approach, there is no prohibition on the use of any hypotheses, providing that this hypothesis allowed (by any method, including, the trial and error method) the calculation procedure which gives verifiable by experiment results.

Therefore today (Anthony, 1985) "*quantum mechanics is not a dynamical theory; it is silent on the nature of the particles that make up the Universe and the forces that act between them. Rather it is a set of rates that may be applied to a dynamical theory to calculate what is likely to happen in a given situation. The physicist, having first decided on a possible theory, then applies the quantum mechanical rules to see what the theory predicts*".

And Richard Feynman has written: "*I think I can safely say that no-one understands quantum mechanics... Do not keep asking yourself, if you can possibly avoid it, ...*"

### 5.2. Ideological bans

In quantum theory, from its beginning appeared a ban on the visualization and modeling of objects in the microcosm. This approach was justified firstly by that we can not principally visualize or simulate them. Secondly, according to positivism it was taken that the use of images and models is just unnecessary and not profitable.

As the study of this question shows, the proofs of the validity of these prohibitions do not exist. One of the founders of quantum mechanics, Niels Bohr justified the ban on the visibility of the micro-world as follows (Collection of translations, 1962), p. 249: "*After a short period of*

*ideological disorder and disagreements, caused by a short-term restriction of "visualization", the **consensus** about replacement of concrete images with abstract mathematical symbols, for example  $\psi$ , has been reached. In particular, the concrete image of rotation in three-dimensional space has been replaced by mathematical characteristics of representation of rotation group".*

As quoted in "The philosophy of Niels Bohr" by Aage Petersen, in the Bulletin of the Atomic Scientists Vol. 19, No. 7 (September 1963): "There is no quantum world. There is only an abstract physical description. It is wrong to think that the task of physics is to find out how nature is. Physics concerns what we can say about nature..."

"We regard quantum mechanics as a complete theory for which the fundamental physical and mathematical hypotheses are no longer susceptible of modification".

It is clear that there is no proof, but only a **consensus**. Probably therefore Gell-Mann once wrote: 'Bohr brainwashed a whole generation of physicists into 'believing' the Copenhagen interpretation of quantum mechanics'.

## 6.0. Photon and electron in quantum mechanics

### 6.1. Photon in QM

Quantum mechanics (QM) was an initial period of development of quantum theory. In the QM under the 'photon' was understood a portion or quantum of electromagnetic fields.

The name 'photon' was coined in 1926 by the physical chemist Gilbert N. Lewis (nominated for the **Nobel Prize** in chemistry over 30 times), who published a speculative theory "The conservation of photons" (Lewis, 1926), in which photons were "**uncreatable and indestructible**"

He postulated for the photon the following properties (in short-cut version):

"(1) In any isolated system the total number of photons is constant.

(2) All radiant energy is carried by photons...

(3) All photons are intrinsically identical...

(4) The energy of an isolated photon, ... gives the frequency of photons which is ... strictly monochromatic; although two photons coming even from similar atoms would never have precisely the same frequency.

(5) All photons are alike in one property which has the dimensions of action or of angular momentum, and is invariant to a relativity transformation".

Lewis' theory was never accepted, as it was contradicted by many experiments, where photon by interaction with other particles can disappear, arise or transform in other particles. But if we assume that all elementary particles are some modifications of the photon, then photons can be actually considered as "uncreatable and indestructible".

### 6.2. Electron in QM

In the initial period of the quantum theory development, the understanding of the electron was based on the methodology of QM and on the electron theories of Heisenberg, Schrödinger and Dirac (Schiff, 1949).

#### 6.2.1. The "proofs" of the electron pointness in quantum mechanics

In the QM the following assumptions are considered as proofs in favor of the electron pointness

##### 1) The meaning of the wave function (Feynman, 1964a)

"When Schrödinger first discovered his equation he discovered the conservation law  $\frac{\partial P}{\partial t} = -\vec{\nabla} \cdot \vec{j}$  as a consequence of his equation. But he imagined incorrectly that  $P$  was the electric charge density of the electron and that  $\mathbf{J}$  was the electric current density

It was at this point that Born made an essential contribution to our ideas regarding quantum mechanics. It was Born who correctly (as far as we know) interpreted the  $\psi$  of the Schrödinger

*equation in terms of a probability amplitude—that very difficult idea that the square of the amplitude is not the charge density but is only the probability per unit volume of finding an electron there, and that when you do find the electron some place the entire charge is there.*

*The wave function  $\psi(r)$  for an electron in an atom does not, then, describe a smeared-out electron with a smooth charge density. The electron is either here, or there, or somewhere else, but wherever it is, it is a **point charge**”.*

## 2) The electron description forms

The forms of the description of the electron, created in 1926-1929 supported these ideas. In none of the representations of quantum theory (Heisenberg matrix mechanics, Schrödinger wave mechanics, Dirac's electron theory, Dirac's transformation theory, based on extending classical Hamiltonian formalism to the quantum level, Feynman path integral approach and other) have the elementary particles size.

It is one of the most important feature of Dirac's relativistic wave equation (Bloch, 1953) that it implies a spin  $\sigma = 1/2$  of the electron as well as a corresponding magnetic moment  $\mu_e = -g_e \sigma \mu_0$ , where  $\mu_0 = eh/4\pi m_e c$  is the Bohr magneton and  $g_e = 2$  is the “g-factor”.

But, the attributes of point particles are only their mass and charge respectively; not an angular momentum or magnetic moment. The first advantage of non-point electron is the existence of a spin (own angular momentum) and an electron magnetic dipole moment, which are indeed present. Therefore N. Bohr and W. Pauli postulated that spin and magnetic moment of a point-like particle are some “intrinsic” quantum, not classical, characteristics.

From this follows that in order to describe the electron spin and magnetic moment the existence of the size of the electron is not require, in contrast to the classical description.

## 3) The Heisenberg uncertainty principle

In quantum mechanics the **Heisenberg uncertainty principle** states a fundamental limit on the accuracy with which certain pairs of physical properties of a particle, such as position and momentum, cannot be **simultaneously** known. In other words, the more precisely one property is measured, the less precisely the other can be controlled, determined, or known.

This limit was interpreted as a ban on the measurement characteristics of the particles belonging to these groups, including a ban on the existence of the particle size. Some difficulty was caused by the electron spin and magnetic moment.

*“From atomic spectra it was clear (Zorn, 2010) that bound electrons have magnetic moment associated with their spin angular momentum. In the early days, however, there was some suggestion that free electrons might behave differently. In 1926 Bohr argued, on the basis of the uncertainty principle, that a Stern-Gerlach experiment could not usefully discriminate between electron spin states, and some had interpreted his argument to mean that the spin of the free electron was unobservable”.*

In this respect, Pauli's Nobel Lecture (Pauli, 1946; Giulini, 2008) contains the following instructive passage:

*“Although at first I strongly doubted the correctness of this idea (Uhlenbeck and Goudsmit's idea of electron spin) because of its classical-mechanical character, I was finally converted to it by Thomas' calculations on the magnitude of doublet splitting. On the other hand, my earlier doubts as well as the cautious expression «classically non-describable two-valuedness» experienced a certain verification during later developments, since Bohr was able to show on the basis of wave mechanics that the electron spin cannot be measured by classically describable experiments (as, for instance, deflection of molecular beams in external electromagnetic fields) and must therefore be considered as an essentially quantum-mechanical property of the electron.”*

But, actually the Bohr's arguments do not banned the measuring of the angular and magnetic moment (Akhiezer and Recalo, 1979, Pp. 58): *“Bohr has shown that both of these capabilities (measurement of the spin and magnetic moment of a free electron) are practically not feasible, if*



*we take into account the Heisenberg uncertainty principle... This statement is included in textbooks and, one might say, has become a kind of religious persuasion (Crane, 1968). However, the anomalous magnetic moment of the electron has been measured."*

*The knowing simple proof by Niels Bohr (Crane, 2000), quoted in the textbooks, that the magnetic moment of the free electron is not observable. Reason is the uncertainty principle. Bohr's calculation showed that if the same kind of experiment were done with electrons the separation would be fuzzy, unmeasurable.*

*Bohr gave his proof in a lecture; it was not published. (A little later it was quoted by Wolfgang Pauli, in the Handbuch der Physik) We will never know whether Bohr meant his proof to be general: that the magnetic moment of the free electron would be unmeasurable in any experiment. But it very soon got taken to be that. Unfortunately, writers of books took it to be general. One example will suffice. It's from N.F. Mott and H.S.W. Massey's well-known (almost a bible in those times) "Theory of Atomic Collisions", 1<sup>st</sup> edition 1933, 2<sup>nd</sup> edition 1941. After giving the proof they say: "From these arguments we much conclude that it is meaningless to assign to the free electron a magnetic moment".*

It turned out that it is possible to measure the parameters of the particles, without violating the Heisenberg uncertainty relation. And let us note that the precision of this measurement was the basis of other "religious beliefs" - the pointness of elementary particles, which we discussed above.

Does the uncertainty principle contradict the Crain's experiment? Of course, not. Crane writes: *"we have proposed an experiment to measure the precession of a free electron, for which it was not required to know **simultaneously** both the position and momentum of a particle with an accuracy that violate the limits imposed by the relation uncertainty."*

Of course, the non simultaneous measurement of canonical parameters of elementary particles, does not contradict the uncertainty principle (see also (Kim and Shih 1999)).

### **6.2.2. Infinities in the theory of the point electron**

The pointlike electron would have a diverging electromagnetic field. In accordance with QED, deviations from the Coulomb law are predicted already on the Compton distances from the center of electron,  $10^{-11}$  cm.

The difficulties, associated with infinities of point electron, were overcome later in quantum field theory by using the renormalization procedure.

## **7.0. Photon and electron in quantum field theory**

For the majority of young theoretical physicists the assumption about the non-point nature of electron is a quite unacceptable idea, which seems to contradict the theoretical representations of the quantum theory. Moreover, it seems that it contradicts the experimental data. Because of the importance of this question we will analyze this question in detail.

At the same time the majority of physicists-theorists of the senior generation, not only of classical epoch, but also the founders of the quantum field theory, as Dirac, Tomonaga, Feynmann, etc., considered that the representation of elementary particles as points is a conception, which appeared because of the limitation of our knowledge. Tomonaga's article (Tomonaga, 1949) "The cut-off theory and the sizes of elementary particles" introduces us briefly to this topic:

*"Already in the old electron theory (of Lorentz) the assumption of the final sizes of the electron has eliminated the divergences. Is it possible to use similar reasons in the modern theory of elementary particles? The matter is that the sizes of elementary particles do not exist in this theory... If somehow it was possible to include in the theory the final size of electron ... such theory would be very attractive, since it would apparently correspond to the reality... However, it is exclusively difficult to introduce the electron final sizes within the framework of modern theory. It is known, that the finiteness of the sizes of elementary particles is closely connected with the formulation of the theory in the form of the theory of quantum fields. And while we will not deny*

*this formulation, we will not manage to include in the theory the representation about the sizes of elementary particles."*

### 7.1. The "proofs" of the photon pointness in quantum field theory

In the initial period of time, the vectors of electromagnetic fields were used to describe the photon. This made it possible to speak about the coordinate representation of the photon wave function (Akhiezer and Berestetskii 1965; Levich, 1969; Goldstein, 1971). In the QED was shown (Landau and Peierls, 1930) that a photon in the coordinate representation is nonlocal and has a size, characterized by its wavelength. But the structure of the photon was not considered.

*"When (Feynman, Leighton and Sands, 1964) we go from classical to quantum mechanics, the force concept gradually fades away, while the concepts of energy and momentum become of paramount importance. It is just because momentum and energy play a central role in quantum mechanics that  $\vec{A}$  and  $\varphi$  provide the most direct way of introducing electromagnetic effects unto quantum descriptions"*.

Due to this fact, in description of the photon wave function was introduced the use of  $\vec{A}$  and  $\varphi$  (see, for example, (Berestetskii, Lifshitz and Pitaevskii, 1982)).

In this representation of the wave function, about particle size, nothing can be said. Therefore, by tacit agreement, physicists assume began to that a photon is also point particle. Since in the QED the particle size does not affect the calculation results, the question of particle structure is considered to be meaningless.

### 7.2. The "proofs" of the electron pointness.

#### 1) The theoretical argument of electron pointness, connected to SRT

The theoretical argument of pointness of electron is ostensibly connected to relativistic theory. What is this argument? We will take its description from the known textbook (Landau and Lifshits, 1962), section 15: "*Elementary particles in the theory of relativity*".

*"...it is easy to see that the theory of relativity makes the existence of rigid bodies impossible in general... From (above said) we can draw certain conclusions concerning the treatment of "elementary" particles, i.e. particles whose state we assume to be described completely by giving its three coordinates and the three components of its velocity as a whole. It is obvious that if an elementary particle had finite dimensions, i.e. if it were extended in space, it could not be deformable, since the concept of deformability is related to the possibility of independent motion of individual parts of the body. But, as we have seen, the theory of relativity shows that it is impossible for absolutely rigid bodies to exist.*

*Thus we come to the conclusion that in classical (non-quantum) relativistic mechanics, we cannot ascribe finite dimensions to particles which we regard as elementary. In other words, within the framework of classical theory elementary particles must be treated as points.*

*... Quantum mechanics makes a fundamental change in this situation, but here again relativity theory makes it extremely difficult to introduce anything other than point interactions".*

Let's analyze the above "proof" of particle pointness. Undoubtedly, the assertion that "*the theory of relativity makes the existence of rigid bodies impossible in general*" is correct. But what relation do the elementary particles have to an absolutely rigid body? Why should elementary particles be absolutely rigid bodies (concept, which in classical mechanics is some conditional abstraction)?

As it is not difficult to see this assertion follows from the introduction (i.e. postulate) of the concept of elementariness: Landau names elementary such "*particles whose state we assume to be described completely by giving its three coordinates and the three components of its velocity as a whole*". Further, using this definition, authors prove that such a particle should be an absolutely rigid body (more correct - a "rigid" point); and since this definition really contradicts to the relativistic theory, the author finds that the elementary particle has no sizes.

Thus, authors first postulate some concept of elementarity, **identical to absolute rigidity**, and then prove that such elementarity demands the pointness of elementary particle. But it is clear that

the assertion: "*the mechanical state of particle is completely described by three coordinates and three components of velocity*," is the postulate of the pointness of particles.

Apparently, it is more simple to postulate immediately that the elementary particle is point instead of connecting this question with the authority of Special Theory of Relativity (SRT).

About this "proof" of the pointness of elementary particles the known physicists – academician A.I. Akhieser and Dr. M.P. Rekaló (Akhieser and Rekaló, 1979) write: "*Here it is necessary to note that not long ago it was considered that the elementary particle cannot have sizes and should necessarily be point. Such sight has been connected by the conception that a not-point particle was considered as a rigid not deformable ball. For example, in known textbook of Landau and Lifshits ... it is written... (see the above citation)... **But actually the existence of the sizes of a particle is not equivalent to their non-deformability***".

Thus, SRT is not connected with the pointness of elementary particles and does not demand that the particle was point.

## 2) The renormalization procedure as argument of particle pointness

The question of whether the electron has a substructure must be decided by experiment. All experiments to date agree with the Standard Model and particularly with QED, where the electron is structureless and point-like. The two major approaches are high-energy electron-positron scattering and high-precision atomic tests of quantum electrodynamics, both of which agree that the electron is point-like.

What do physicists mean, when they say that from experiments follows that the electron is pointness? The brief answer to this question is (Naumov, 1984):

*"When we say that the electron is point, it mean in fact that quantum electrodynamics is true on very small distances. Experimentally it is checked up to a distance  $2 \cdot 10^{-20}$  m. In such situation it is natural to consider an electron completely as an elementary particle, which does not consist from other subparticles"*.

It is understandable that in this case we must change the concepts. "Electron is point" and "QED is true on any distance" are absolutely inadequate statements. Nothing forbids of the existence of non-point electron theory, which is true on any distance.

In fact, as we know the calculations according to QED are true only because we use the renormalization procedure, i.e., an artificial replacement of infinite sizes by finite. Since the theory does not contain the electron size, the experiment says nothing about the size of the electron. The experiments only verify that the given mathematical procedure is true.

Note also that founders and developers of QED (Dirac, Feynman, etc.) considered the approach, based on renormalization procedure, compelled and temporary. Thus, the refusal from these representations should not be unexpected for modern theorists.

### 7.3. Physical meaning of the renormalization procedure

To get acquainted with the appearance of infinity in the theory of the electron, (Feynman, Leighton and Sands, 1964) "*we compute the energy of a charged particle. Suppose we take a simple model of an electron in which all of its charge  $q$  is uniformly distributed on the surface of a sphere of radius  $a$ , which we may take to be zero for the special case of a point charge.*

Now let's calculate the energy in the electromagnetic field  $\epsilon_{el} = \frac{1}{2} \frac{e^2}{a}$

*It is all fine until we set  $a$  equal to zero for a point charge – there's the great difficulty. Because the energy of the field varies inversely as the fourth power of distance from the center, its volume integral is infinite. There is an infinite amount of energy in the field surrounding a point charge.*

*But the difficulties do not disappear in quantum electrodynamics. The quantum effects do make some changes – the formula for the mass is modified, and Planck's constant appears – but the answer still comes out infinite unless you cut off an integration somehow – just as we had to stop the classical integrals at  $r = a$ . And the answers depend on how you stop the integrals. We word*

*that the quantized theory of Maxwell's electrodynamics gives an infinite mass for a point electron".*

Correctly is in QED to talk about the probabilities of measuring a particular value. Here (Anthony, 1985) *"a method does exist for dealing with infinite probabilities under some circumstances. Provided that there are only a finite number of infinities, it is possible to make the theory internally consistent, and to extract sensible predictions which are sometimes in spectacular agreement with experiment. The dubious procedure that removes infinities skulks under the name of "renormalisation", its justification lying in expediency rather than in any underlying physical reasons"*.

*"If (Feynman, 1964) electrons were ideal, and, then  $m^*$  would simply be the mass of an electron (which we can determine by observation), and  $e^*$  would simply be its "charge" (the amplitude for the electron to couple with a photon). It can also be determined by experiment. But no such ideal electrons exist...The experimentally measured mass,  $m$ , and the experimentally measured charge,  $e$ , of the electron are different from the numbers we use in our calculations,  $m^*$  and  $e^*$ ...*

*In 1949 Hans Bethe and Victor Weisskopf noticed something: if two people who stopped at different distances to determine  $m^*$  and  $e^*$  from the same  $m$  and  $e$  then calculated the answer to some other problem— each using the appropriate but different values for  $m^*$  and  $e^*$ — when all the arrows from all the terms were included, their answers to this other problem came out nearly the same! In fact, the closer to zero distance that the calculations for  $m^*$  and  $e^*$  were stopped, the better the final answers for the other problem would agree! Schwinger, Tomonaga, and I independently invented ways to make definite calculations to confirm that it is true...*

*The shell game that we play to find  $m^*$  and  $e^*$  is technically called "renormalization". But no matter how clever the word, it is what I would call a dippy process! Having to resort to such hocus-pocus has prevented us from proving that the theory of quantum electrodynamics is mathematically self-consistent. It's surprising that the theory still hasn't been proved self-consistent one way or the other by now; I suspect that renormalization is not mathematically legitimate. What is certain is that we do not have a good mathematical way to describe the theory of quantum electrodynamics: such a bunch of words to describe the connection between  $m^*$  and  $e^*$  and  $m$  and  $e$  is not good mathematics"*.

In other words, the fact that the artificial replacement of the infinite values by finite values to obtain the final mass and charge, verifies already that electron has a finite size.

Since the experiments verify perfectly the calculations, made with the help of renormalization, within the framework of QED the electron size does not influence the calculation results. But this calculations do not prove in any way the absence of the electron size: we have simply did a *"hocus-pocus"* (as Feynmann said) to receive the correct result.

This situation is identical to the one, which exists in the classical mechanics for the calculation of the motion of planets, which are obviously not point objects. With sufficient accuracy all movements of planets are described by the theory, in which all masses of the planets and Sun are concentrated in points - in the center of mass of spheres. The Newton gravitation law does not include the size of planets. But in this case we don't agree that planets are point objects. To make more precise calculations of planet motion we must take into account the real distributions of mass and real forms and sizes of bodies, and the theory becomes more complex.

Thus, we should show that the occurrence of the electron size in the NTEP does not contradict to the modern theory and experiment

## **8.0. Photon and electron in NTEP**

### **8.1. Photon in NTEP**

(This section presents the short result of photon and electron theories of the NTEP)

We will consider the general case of a circularly polarized electromagnetic (EM) wave that is moving, for instance, along the  $y$ -axis. This wave is the superposition of two plane-polarized waves with mutually perpendicular vectors of the EM fields:  $\vec{E}_x, \vec{H}_z$  and  $\vec{E}_z, \vec{H}_x$ .

The EM wave equation has the following known form (Jackson, 1999):

$$\left( \frac{\partial^2}{\partial t^2} - c^2 \vec{\nabla}^2 \right) \vec{\Phi}(y) = 0, \quad (16.8.1)$$

where  $\vec{\Phi}(y)$  is any of the above electromagnetic wave field vectors. In other words, this equation represents four equations: one for each vector of the electromagnetic field.

We can also write this equation in the following operator form:

$$\left[ (\hat{\alpha}_0 \hat{\varepsilon})^2 - c^2 (\hat{\alpha} \hat{p})^2 \right] \Phi = 0, \quad (16.8.2)$$

where  $\hat{\varepsilon} = i\hbar \frac{\partial}{\partial t}$ ,  $\hat{p} = -i\hbar \vec{\nabla}$  are correspondingly the operators of energy and momentum;  $\Phi$  is a matrix which consists of the four components  $\vec{\Phi}(y)$

$$\Phi = \begin{pmatrix} E_x \\ E_z \\ iH_x \\ iH_z \end{pmatrix}, \quad \Phi^+ = (E_x \quad E_z \quad -iH_x \quad -iH_z), \quad (16.8.3)$$

$\hat{\alpha}_0$ ;  $\hat{\alpha}$ ;  $\hat{\beta} \equiv \hat{\alpha}_4$  are Dirac's matrices. Recall that in case of a photon  $\omega = \varepsilon/\hbar$  and  $k = p/\hbar$ .

Factoring (16.8.2) and multiplying it on the left by the Hermitian-conjugate function  $\Phi^+$ , we get:

$$\Phi^+ (\hat{\alpha}_0 \hat{\varepsilon} - c \hat{\alpha} \hat{p}) (\hat{\alpha}_0 \hat{\varepsilon} + c \hat{\alpha} \hat{p}) \Phi = 0, \quad (16.8.4)$$

Equation (16.8.4) may be broken down into two Dirac-like equations without mass:

$$\begin{cases} \Phi^+ (\hat{\alpha}_0 \hat{\varepsilon} - c \hat{\alpha} \hat{p}) = 0 \\ (\hat{\alpha}_0 \hat{\varepsilon} + c \hat{\alpha} \hat{p}) \Phi = 0 \end{cases}, \quad (16.8.5)$$

In EM form the equations (16.8.5) are the right Maxwell-like equations of the retarded and advanced electromagnetic waves.

The solution of equation (16.8.2) can be written in a complex form as follows:

$$\Phi = \Phi_o e^{-i(\omega t - ky)} + \Phi_o^+ e^{i(\omega t - ky)}, \quad (16.8.6)$$

## 8.2. Electron in NTEP

Starting from above considerations, we will use the following basic postulates of nonlinear theory: *Under specified conditions a photon fields can undergo the rotation transformation (or generally, curvilinear transformation), which generate new elementary particles.*

In this case the matrix function  $\psi$  is the vectors of the electromagnetic field (16.8.3), moving in a circular path. If we will choose  $F \equiv \psi = (E_x \quad iH_z)$ , we have:

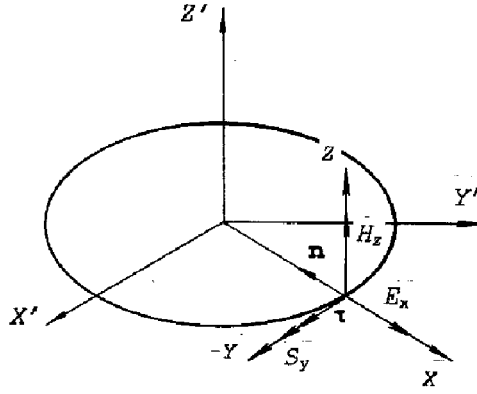

Fig. 14.8

The electrical field vector  $\vec{E}$ , which moves along the curvilinear trajectory, can be written in the form:  $\vec{E} = -E \cdot \vec{n}$ . Thus, the displacement current of the Maxwell equation can be written as:  $\vec{j}_{dis} = -\frac{1}{4\pi} \frac{\partial E}{\partial t} \vec{n} + \frac{c}{4\pi r_C} \cdot \vec{\tau}$ , where  $\vec{\tau}$  is the tangential unit-vector,  $c$  is the

electromagnetic wave velocity,  $K = \frac{1}{r_C}$  is the curvature of the trajectory and  $r_C = \frac{\hbar}{mc^2}$  is the curvature radius. Here, along with  $\frac{\partial E}{\partial t}$ , a tangential current (source of the electron field)

$$\vec{j}_\tau = \frac{c}{4\pi r_C} \cdot \vec{\tau} = \frac{1}{4\pi} \omega_e E \equiv \frac{1}{4\pi} \frac{m_e c^2}{\hbar} E$$

appears, which is equivalent to free term of Dirac's equation ( $\hbar$  is Planck constant). In other words, the Dirac equation in the EM form includes the EM parameters of the electron and the electron can be regarded as the ring current.

### 8.3. A ring electron of Dirac's theory in NTEP

It is not difficult to show that the ring representation of electron does not contradict to the solution of Dirac's electron equation.

#### 8.3.1. The geometric interpretation of the Dirac electron equation solution

In the nonlinear theory we have shown that the Dirac electron equation

$$\left[ (\hat{\alpha}_o \hat{\varepsilon} + c \hat{\alpha} \hat{p}) + \hat{\beta} m_e c^2 \right] \psi = 0, \text{ where } \psi = \begin{pmatrix} \psi_1 \\ \psi_2 \\ \psi_3 \\ \psi_4 \end{pmatrix} = \begin{pmatrix} E_x \\ E_z \\ iH_x \\ iH_z \end{pmatrix}, \psi^+ = (E_x \quad E_z \quad iH_x \quad iH_z),$$

are the complex Maxwell's equations

$$\begin{cases} \frac{1}{c} \frac{\partial E_x}{\partial t} - \frac{\partial H_z}{\partial y} = -i \frac{4\pi}{c} j_x^e \\ \frac{1}{c} \frac{\partial H_z}{\partial t} - \frac{\partial E_x}{\partial y} = 0 \end{cases} \text{ or } \begin{cases} \frac{1}{c} \frac{\partial E_z}{\partial t} + \frac{\partial H_x}{\partial y} = -i \frac{4\pi}{c} j_z^e \\ \frac{1}{c} \frac{\partial H_x}{\partial t} + \frac{\partial E_z}{\partial y} = 0 \end{cases}$$

(выбор компонент определяется выбором начальных условий), где  $j_\tau$  есть плотность тока электрона:

(the choice of field components is determined by the choice of initial conditions), where  $j_\tau$  is the current density of the electron:

$$j_\tau = \frac{1}{4\pi} \omega_e E \equiv \frac{1}{4\pi} \frac{m_e c^2}{\hbar} E, \quad (16.8.7)$$

Since  $\vec{j} = \rho \vec{v}$ , where  $\rho$  is charge density, and in our case  $v = c$  is light velocity, we have:

$$\rho = j/c = \frac{1}{4\pi} \frac{m_p c}{\hbar} E \equiv \frac{1}{4\pi} \frac{m_p c}{\hbar} \psi, \quad (16.8.8)$$

It is known (Schiff, 1955) that the solution of the Dirac free electron's equation (6.2.2) has a form of a plane wave:

$$\psi = B \exp\left(-\frac{i}{\hbar}(\varepsilon t - \vec{p}\vec{r})\right), \quad (16.8.9)$$

where  $B$  is the amplitude (constant).

It is easy to show that in electromagnetic form, the solution of Dirac's equation is a standing wave. Actually, whenever the wave rotates along a circle, we have  $\vec{p} \perp \vec{r}$  and, therefore,  $\vec{p} \cdot \vec{r} = 0$ . Then, instead of (16.8.9), we obtain the standing wave:

$$\psi \equiv E = E_0 \exp\left(-\frac{i}{\hbar} \varepsilon t\right) = E_0 \exp(-i\omega t) = E_0 \exp(-i\varphi), \quad (16.8.10)$$

Thus we have

$$j = \frac{1}{4\pi} \omega_p E = \frac{1}{4\pi} \omega_p E_0 \exp(-i\omega t), \quad (16.8.11)$$

and

$$\rho = \frac{1}{4\pi c} \omega_p E = \frac{1}{4\pi c} \omega_p E_0 \exp(-i\omega t), \quad (16.8.12)$$

According to Euler's formula  $e^{i\varphi} = \cos \varphi + i \sin \varphi$ , where  $\varphi = \omega t$ , the solution of Dirac's equation (16.8.11) describes a circle with radius  $r_c = \frac{\hbar}{m_e c}$ . Thus, we can write the Dirac equation in the form

$$\frac{1}{c} \frac{\partial \psi}{\partial t} + \vec{\alpha} \cdot \vec{\nabla} \psi + i \frac{1}{r_c} \psi = 0, \quad (16.8.13)$$

## 9.0. Harmonization of point and non-point concepts of elementary particle in the NTEP

We have discussed above the various "proofs" of the concept of point-like elementary particles that exist in quantum mechanics (QM) and quantum field theory (QFT). Next, we will show that in framework of the NTEP the same substantiation can be interpreted as evidence of non-point particles. Thus, we will show that in terms of obtaining mathematical results both concepts are equivalent. But the advantage of non-pointness of particles, except its logic, lies in the fact that it allows to answer the many questions that the QM and QFT can not answer.

### 9.1. On the size of electron and "hidden parameters"

Within the framework of NTEP an electron is the electromagnetic field of special configuration, concentrated in a small volume with the characteristic dimension of one Compton wavelength.

Does not the presence of electron size in NTEP contradict its absence in Dirac's theory? Obviously, it does not contradict, since both equations (16.8.13)

$$\frac{1}{c} \frac{\partial \psi}{\partial t} + \vec{\alpha} \cdot \vec{\nabla} \psi + i \frac{1}{r_c} \psi = 0, \quad (16.9.1)$$

and

$$\frac{1}{c} \frac{\partial \psi}{\partial t} + \vec{\alpha} \cdot \vec{\nabla} \psi + i \frac{m_e c}{\hbar} \psi = 0, \quad (16.9.2)$$

are the same Dirac's electron equations ( $r_c$  is the Compton wave length of electron).

But another difficulty appears. Then the question arises, how the same equation can simultaneously contain and not contain size?

Here we approach the very interesting result of NTEP, which solves numerous disputes, which have for a long time. Are there in quantum mechanics "hidden parameters"? Is it possible to introduce them, without destroying quantum mechanics? Etc.

It occurs here that partially von Neumann was right, proving that it is not possible to introduce the hidden parameters into existing QM. But in the same time de Broglie, Bohm and others were also right, showing that von Neumann's proof is limited by the existing QM interpretation.

*The results of NTEP show that nothing more could be introduced into the existing equations because everything that it is necessary in this equation already exists.*

Specifically, in Dirac's electron equation there is already a size of electron, but it is "hidden" because of the form, in which we present and interpret this equation..

However the size of electron, equal to the Compton wavelength, exists neither in the quantum nor in the classical theory results. What is the matter here? In classical electrodynamics electron has the size of a classical radius of electron  $r_0 = e^2/mc^2$ . This value appears also in all first terms of the cross-sections of electron interactions in QED, calculated according to the perturbation theory.

We do not take into account all here. Accordingly with QED the electron mass and charge in equation (16.9.1-14.9.2) is "bare". This indicates that here is not examined the polarization of the physical vacuum and not considered the screening of electron in the physical vacuum. During this polarization both the charge and the size of the electron must decrease to the values, which characterize the real electron. How is it possible to estimate these real values?

The Dirac sea of virtual particles, present in the vacuum, is polarized by the intense electric field of electron in the proximity of the charge. The result is a change of all electron parameters (Fig. 14.9).

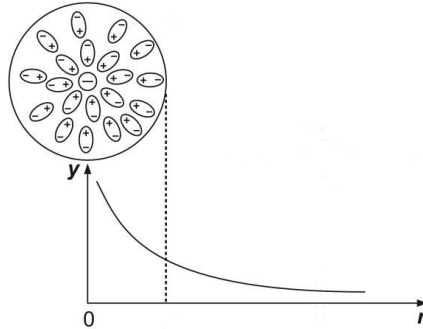

Fig. 14.9

As is known, (Georgi, 1982) due to the screening in the physical vacuum electron charge must be reduced in the same ratio as fine structure constant.

Radius  $r_c$  is  $\sim 137$  times larger than the classical electron radius  $r_0$ . When the polarization is taken into account, we obtain the classical electron radius:  $r_0 = \alpha r_c = \frac{e^2}{m_e c^2}$ , where

$\alpha = \frac{e^2}{\hbar c} \approx \frac{1}{137}$  is the electromagnetic constant (or the fine structure constant).

This fact explains also, why there is such relationship as  $r_0/r_c = \alpha \approx 1/137$ : we can suppose that during polarization of physical vacuum the mass, charge and size of the electron decrease



approximately in 137 times. Then it is understandable that in the cross-sections of interactions the classical radius occurs namely because it characterizes the real size of electron.

Of course, such representation does not disrupt the results of QED. Until we do not know that Dirac's equation contains an electron radius, the last one is actually "hidden" parameter. But, from the other side, this value is "hidden" because the canonized the form of equation and its presence in no way contradicts the quantum mechanics.

In this connection one additional question can arise: is it possible to exclude the renormalization from NTEP?

It should be noted that in the quantum field theory there are two forms of renormalization.

One renormalization procedure is necessary, when we consider the polarization of vacuum and pass from "bare" charges to the real. This renormalization is physical and necessary in any theory.

The other renormalization procedure is connected with the elimination of infinities, which appear as a result of the point-like representation of particles. This "mathematical" renormalization can be eliminated in NTEP.

Let us note that already in the nonlinear classical electromagnetic field theory the possibility of describing of the same particle as point and nonpoint exists and is known for a long time.

Next, we explain the other "proofs" of electron pointness in the quantum theory in terms of NTEP.

## 9. 2. The uncertainty principle of Heisenberg

### 9. 2. 1. Physical sense of quantization

As we know, quantization is the fact, by which quantum physics differs from classical. At the basis of quantization lies the idea that some physical quantities, as, e.g., energy and momentum, can take only determined values.

For example, the energy of the electromagnetic radiation, which has angular frequency  $\omega$ , can only take the values  $\varepsilon_{ph} = N\hbar\omega$ , where  $\hbar$  is the Planck constant, and  $N$  is the integer. In this case  $\hbar\omega$  has the sense of energy of one quantum of radiation (photon), and  $N$  is the number of quanta (photons). Since  $\varepsilon_{ph} = pc$ , the photon momentum  $p_{ph} = h/\lambda = \hbar/\lambda$

*Thus, quantization is the recognition of the experimental fact of some limitation: in nature there are objects, whose characteristics have completely determined values, which cannot change arbitrarily.*

### 9. 2. 2. Wave packets and non-linear EM waves

The wave packet (WP) is the wave field, which occupies at each moment of time a limited part of space. A WP can be of any nature (sonic, electromagnetic, etc). A WP in a certain region of space can be expanded on the sum of the simple harmonic waves, whose frequencies (or wave numbers) lie within certain limits.

At early stages of development of quantum mechanics the representation of particles as wave packets was widely used due to the following basic fact: in quantum mechanics to each particle corresponds a de Broglie's wave. Therefore the attempt arises to simulate the particles as de Broglie wave packets.

Thus many features of quantum mechanics have found an almost classical representation. However serious deficiencies in these wave packets were revealed: 1) according to contemporary theory each particle wave occupies all space; 2) the wave packet dispersion excludes the possibility of simulation of elementary particles as wave packets.

Within the framework of NTEP, between the non-linear waves and wave packets exists a close affinity: non-linear wave is the sum of harmonic monochromatic standing waves, limited in the space. As particle, the non-linear wave has the group velocity, and as a wave it has phase velocity, like the de Broglie wave. Moreover, the principal disadvantage of usual wave packet - their dispersion - is absent at the non-linear waves (solitons) due to its harmonicity, monochromaticity and space limitedness.

In connection with the idea of the elementary particles as special wave packets, the NTEP makes it possible to explain the existence of one special property of quantum mechanics: the *uncertainty principle*.

### 9. 2. 3. Interpretation of the uncertainty relation of Heisenberg in NTEP

In quantum mechanics **the uncertainty principle** is a fundamental relationship, which establishes the limit of accuracy of the simultaneous measurement of the so-called canonical physical variables.

At first it is necessary to point out that this principle is not just only quantum. As is known from the Rayleigh's epoch (Shpolski, 1951), the uncertainty relations appear into the theory of any waves. If discrete traveling waves (HyperPhysics, 2000) are combined, they can create a wave packet which is localized as single object (fig. 14.10)

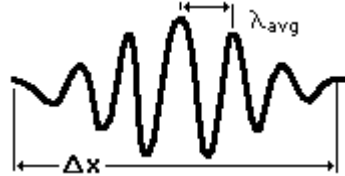

Fig. 14.10

Adding several waves of different wavelength together will produce an interference pattern which begins to localize the wave. But that process spreads the wave number  $k$  values and makes it more uncertain. This is an inherent and inescapable increase in the uncertainty  $\Delta k$  when  $\Delta x$  is decreased so that  $\Delta k \cdot \Delta x \approx 2\pi$

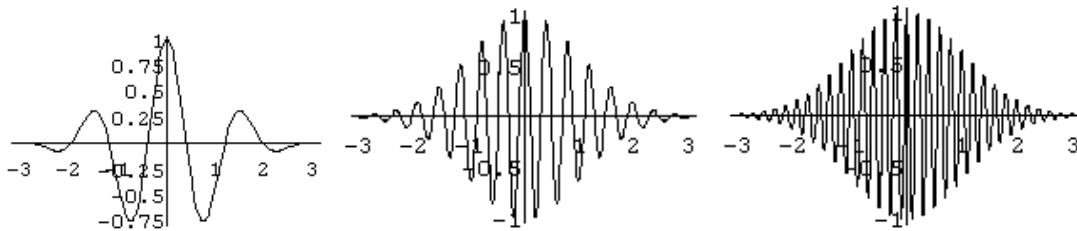

Fig. 14.11

Its interpretation is almost trivial: for the formation of the wave packet of length  $\Delta x$  the interval of the continuous spectrum  $\Delta k$  cannot be less than some certain value, namely:  $\Delta x \cdot \Delta k_x \geq 2\pi$ ,  $\Delta y \cdot \Delta k_y \geq 2\pi$ ,  $\Delta z \cdot \Delta k_z \geq 2\pi$ . Correspondingly, inequality can be also obtained with respect to the time-duration of the packet  $\Delta t$  and its spectral interval  $\Delta \nu$ :  $\Delta \nu \cdot \Delta t \geq 2\pi$  (fig. 14.11).

This property of classical waves is mirrored in the quantum mechanical uncertainty principle. In the case of de Broglie's waves we have for a photon  $\varepsilon = h\nu$  and  $\hbar\vec{k} = \vec{p}$ . Multiplying both parts of classical relations to Planck's constant  $\hbar$ , we obtain  $\Delta\varepsilon \cdot \Delta t \geq \hbar$  and  $\Delta x \cdot \Delta p_x \geq \hbar$  and so forth.

The basic uncertainty relationships of quantum theory have the form of inequalities:  $\Delta\varepsilon \cdot \Delta t \geq \hbar$  and  $\Delta x \cdot \Delta p \geq \hbar$ , where  $\Delta\varepsilon, \Delta t, \Delta x, \Delta p$  are the uncertainties of simultaneous measurement of particle energy, life time, coordinate and momentum, correspondingly. From this it follows, e.g., that the product of the uncertainties of coordinate and momentum cannot be less than  $\hbar$ .

In the framework of Copenhagen interpretation this relationship is interpreted as a limitation: an increase of the accuracy of the measurement of the energy (coordinate) gives necessarily the loss of the accuracy of the determination of the life time (momentum) of particle. Thus, the maximum accuracy of the simultaneous determination of energy (coordinate) and life time (momentum) is determined by the relationships:  $\Delta\varepsilon \cdot \Delta t \approx \hbar$  and  $\Delta x \cdot \Delta p \approx \hbar$ .

What interpretation of uncertainty relation do we have in the framework of NTEP? Let us show that this interpretation is different, but does not contradict mathematically the Copenhagen interpretation of quantum theory.

Since in quantum theory it is accepted that the fundamental particles are point, the position of such particle is determined as  $(x, y, z)$ . However, the uncertainty principle indicates that there are uncertainties of simultaneous measurement of coordinate and momentum.

In the NTEP a particle has a certain size. Therefore the position of a particle in space becomes indeterminate: coordinates of its position are determined to the particle size. This relationship needs to be treated as the *uncertainty of coordinates of the particle position within the volume of space, which a particle occupies*. In other words, the uncertainty principle in this case is tightly connected with the presence of the particles size.

Actually, in our theory the electron size is determined by the wavelength of the initial photon  $\lambda_{ph}$ :  $r_e = \lambda_{ph}/2\pi = 1/k_{ph}$ . On the other hand we have the relationship of Planck for the photon energy  $\varepsilon_{ph} = h\nu_{ph} = \hbar\omega_{ph}$  and also its connection with its momentum  $\varepsilon_{ph} = p_{ph}c$ .

According to the energy-momentum conservation law, after the photon rotation and division into electron and positron, for a fixed electron we will have:  $\varepsilon_e = \frac{1}{2} p_{ph} \cdot c = p_e \cdot c$ . Since the

frequency is connected with the wavelength as  $\nu_{ph} = \frac{c}{\lambda_{ph}}$ , the Planck relationship for the **non-relativistic** electron can be rewritten as:  $r_e \cdot p_e = \hbar$ .

Thus, we obtain the relationship  $r_e = \frac{\hbar}{p_e}$  which describes the maximum accuracy of the measurement of the position of the electron in space depending on its momentum.

With respect to the energy and time it is also not difficult to obtain the appropriate uncertainty principle. Combining relationships  $r_e = \lambda_{ph}/2\pi = 1/k$ ,  $\varepsilon_e = \frac{1}{2} p_{ph} \cdot c = p_e \cdot c$  and  $r_e \cdot p_e = \hbar$  we obtain the condition:  $\varepsilon_e \cdot t_e = \hbar$ , where  $t_e$  is a period of rotation of the electromagnetic wave of electron on the ring.

It is easy to see that the uncertainty relations in terms of range equalities are the relations of quantization of energy and momentum. This means that the restriction imposed by the uncertainty relation takes place due to the limitations inherent in the objects of the microworld: the parameters of these objects are not arbitrary, but are coupled by some constant: the Planck constant.

In the case of the point description of particles the traditional Copenhagen interpretation of the Heisenberg uncertainty principle is also completely legitimate and reflects the fact that a point particle is located at any point of space in frames of the volume, which a nonpoint particle has.

In this case the calculation of the probability that the particle has the position, which is determined by the integral of the square of the wave function in infinite space, will result only in the volume of real particles, because outside of this volume, the integral is everywhere equal to zero.

### 9.3. Physical meaning of wave function

In quantum field theory, the wave function actually has no physical meaning (especially if it is represented in momentum space). Therefore here it can not be related to inherent characteristics of the electron. This fact confirms indirectly the pointness of the electron, the own characteristics of which are somehow "hidden" parameters, about which nothing can be said. Nevertheless, here, for calculation of the inherent characteristics of the electron, postulated expressions are used.

In NTECH a wave function is considered in the coordinate space and has a field sense. Therefore the wave function is closely linked here with the proper characteristics of the electron. In this case, of course, the final formula in the CFT and NTECH must match. We will show this

### 9. 3. 1. The bond of normalized and unnormalized electron wave functions

In framework of the NTEP the physical meaning of a wave function is that it represents the intensity of the nonlinear electromagnetic field. The difference between a normalized function and an unnormalized lies only in a constant dimensional factor.

The normalization factor is the energy of a particle. As the normalization factor we can use the mass of particles according to Einstein's formula  $\varepsilon = mc^2$ .

We will use the indices 'nor' and 'non' as normalized and non-normalized wave functions, respectively. Taking into account that the value  $\psi_{non}^+ \psi_{non} = \vec{E}^2 + \vec{H}^2 = 8\pi u$ , where  $u$  is the energy density of the electron, we can write:

$$\psi_{nor}(\vec{r}, t) = \frac{\psi_{non}(\vec{r}, t)}{\sqrt{8\pi\varepsilon}} = \frac{\psi_{non}(\vec{r}, t)}{\sqrt{8\pi mc^2}}, \quad (16.9.3)$$

The probability of finding an electron at a given point of space-time will be expressed as follows:

$$P(\vec{r}, t) = \psi_{nor}^+ \psi_{nor} = \frac{\psi_{non}^+ \psi_{non}}{8\pi\varepsilon} = \frac{\psi_{non}^+ \psi_{non}}{8\pi mc^2}, \quad (16.9.4)$$

In fact, the normalization expresses the conservation of the particle self-energy or mass. Actually, the integral

$$\int_0^\infty \psi_{non}^+ \psi_{non} d\tau = 8\pi\varepsilon, \quad (16.9.5)$$

is the expression of energy conservation law. Then we have the normalization requirement

$$\int_0^\infty \psi_{nor}^+ \psi_{nor} d\tau = 1, \quad (16.9.5')$$

Thus, the absence of physical meaning of the wave function in quantum theory based on the fact that in the quantum theory the self-energy of an elementary particle is taken as a dimensionless unit. Clearly, this imposes no requirement that the particle is actually point.

### 9. 3.2. Own energy, mass and charge of electron

A more difficult task is to prove the other postulates of quantum mechanics (Schiff, 1949, sec.10) “*the expectation value of an operator is to be calculated by inserting the operator between  $\psi^+(r)$  and  $\psi(r)$ , so that it operates just on the latter, and integrating over  $\vec{r}$* ”.

Designating any operator as  $\hat{O}_i$  (e.g., for energy  $\hat{O}_\varepsilon = \hat{\varepsilon} = i\hbar \frac{\partial}{\partial t}$ , momentum  $\hat{O}_p = \hat{p} = -i\hbar \vec{\nabla}$ , radius-vector  $\hat{O}_r = \vec{r}$ , mass  $\hat{O}_m = m$ , charge  $\hat{O}_q = q$ , current  $\hat{O}_j = \vec{j}$ , etc.), it is easy to show that the above postulate is indeed satisfied, when the following condition is satisfied: we have to postulate that for a given particle (e.g., electron) in the steady-state *the eigenvalues of energy, mass, momentum, charge, current, spin and all the other inherent characteristics are conserved*.

In the framework of NTEP, already at this stage of its development, it can be theoretically shown that some of these quantities are physical constants. In the future, we hope that the same evidence could be presented for all other inherent particle parameters. But in this case it is sufficient to use the experimental data. According to the latest all particles have the above conserved characteristics, which determined them.

Therefore, we must calculate the expression:

$$\int_0^\infty \psi_{non}^+ \hat{O}_i \psi_{non} d\tau, \quad (16.9.6)$$

where  $\hat{O}_i = Const \equiv C_i$ .

For the operators, which represent the physical constants, the integration will give:

$$\int_0^{\infty} \psi_{non}^+ \hat{O}_i \psi_{non} d\tau = C_i \int_0^{\infty} \psi_{non}^+ \psi_{non} d\tau = C_i \cdot 8\pi\varepsilon, \quad (16.9.7)$$

For differential operators (of energy, momentum, angular momentum, etc.), we obtain in (16.9.6) for the  $\hat{O}_\varepsilon \psi$ , the corresponding physical constant, multiplied by the wave function:

$$\hat{O}_\varepsilon \psi = \hat{\varepsilon} \psi = i\hbar \frac{\partial}{\partial t} \psi = \varepsilon \psi, \quad \hat{O}_p \psi = \hat{p} \psi = -i\hbar \vec{\nabla} \psi = p \psi, \text{ etc, where } \varepsilon, p \text{ etc. are constants.}$$

As a result of integration of (16.9.7) we get  $C_i \cdot \varepsilon$ . The normalization demands to divide (16.9.7) on its own energy, which gives the corresponding constant  $C_i$  of energy, momentum, mass, charge, etc.

### 9. 3.3. The distribution of the electron energy (mass) and charge

The NTEP allows to obtain interesting results on the distribution of electron energy and charge.

In particular, NTEP allows to understand why we can describe a particle as point  $(x, y, z)$ .

In NTEP the energy, mass and charge of particles are distributed in space. According to the definition of density we can write the following expressions for the energy, mass and charge densities:

$$\rho_\varepsilon(\vec{r}) = d\varepsilon/d\tau, \quad \rho_m(\vec{r}) = dm/d\tau, \quad \rho_e(\vec{r}) = de/d\tau, \quad (16.9.8)$$

where  $\varepsilon = \varepsilon(\vec{r})$ ,  $m = m(\vec{r})$  and  $e = e(\vec{r})$  are energy, mass and charge, correspondingly.

Moreover, since  $\varepsilon = mc^2$ , we can write  $\rho_\varepsilon(\vec{r}) = c^2 \rho_m(\vec{r})$ .

On the other hand, the density of the electron energy is determined by the unnormalized wave function:

$$\rho_\varepsilon(\vec{r}) = \frac{1}{8\pi} \psi_{non}^+ \psi_{non} = \frac{1}{8\pi} (\vec{E}^2 + \vec{H}^2), \quad (16.9.9)$$

where (recall)  $\psi_{non}$  is a unnormalized wave function

In quantum theory, the charge density is introduced by means of expressions

$$\rho_e(\vec{r}) = e \psi_{nor}^+ \psi_{nor}, \quad (16.9.10)$$

where  $\psi_{nor}$  is a normalized wave function.

Turning to the unnormalized function we obtain according to (16.9.3):

$$\rho_e(\vec{r}) = e \psi_{nor}^+ \psi_{nor} = e \frac{\psi_{non}^+ \psi_{non}}{8\pi\varepsilon} = e \frac{\psi_{non}^+ \psi_{non}}{8\pi mc^2} = \frac{e}{\varepsilon} \rho_\varepsilon(\vec{r}), \quad (16.9.11)$$

from where :

$$\frac{e}{\varepsilon} = \frac{\rho_e}{\rho_\varepsilon} \quad \text{or} \quad \frac{e}{m} = \frac{\rho_e}{\rho_m}, \quad (16.9.12)$$

Since both  $\frac{e}{\varepsilon}$  and  $\frac{e}{m}$  are constant, the relationships  $\frac{\rho_e}{\rho_\varepsilon}$  and  $\frac{\rho_e}{\rho_m}$  are also constants. From here follows that

$$\rho_e = \zeta_\varepsilon \rho_\varepsilon \quad \text{and} \quad \rho_e = \zeta_m \rho_m, \quad (16.9.13)$$

where  $\zeta_\varepsilon$  and  $\zeta_m$  are some constants. This means that the spatial distribution of energy, mass and charge of an electron coincide.

From above follows, firstly, that the normalization of the electron mass and charge are connected one-to-one (in other words, if the normalization of the charge is possible, the normalization of the mass is possible, and vice versa).

Secondly (what is more important), these relations show that the motion of any point of the electron determines the motion of an electron as a whole. This means that in order to describe the motion of an electron, we can choose any point  $(x, y, z)$  of its field. And the size of the electron must be taken into account additionally (e.g., if we want to investigate the collision of planets in the solar system, then, obviously, we would have to take their sizes into account in a similar way).

## 10.0. Heuristic model of the photon and electron

Here we will try to give a geometric interpretation of mathematical results of the description of the photon and electron of QED in framework of NTEP.

### 10.1. Photon production field diagram

We can illustrate the mathematical results of photon production process by electron-positron annihilation by following figure (Fig. 14.12)

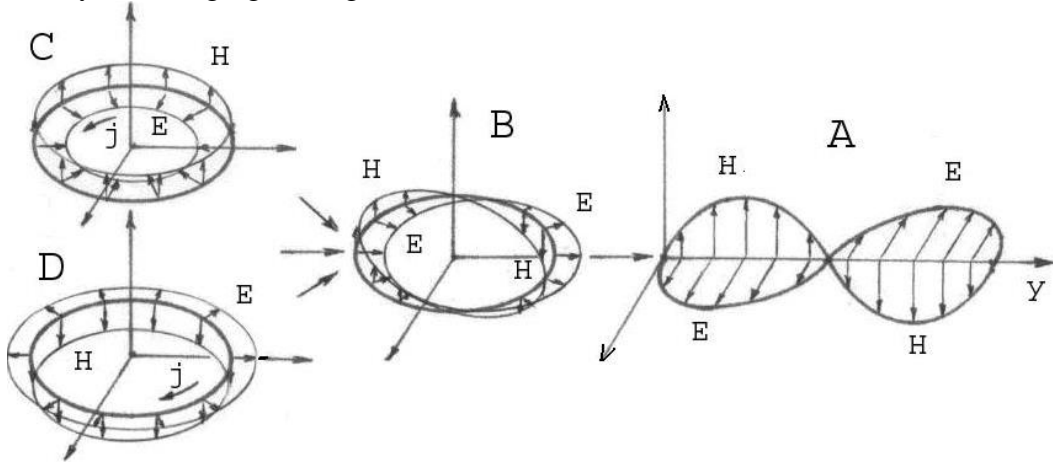

Fig. 14.12.

Here A is “linear” photon (i.e., which obeys the linear wave equation); B is “nonlinear” intermediate photon (i.e., which obeys the nonlinear wave equation); D and C are electron and positron, which obey the Dirac equation.

As we have shown, in the case of formation of electron-positron pairs from photon, the kinetic energy of the massless photon is converted into the internal (potential) energy of the electromagnetic field of an electron and a positron, i.e., in their mass:

$$\hat{\alpha}_0 \varepsilon_{ph} + \hat{\alpha} \vec{p}_{ph} = e \alpha_\mu A^\mu = \hat{\beta} m_{ph} c^2 \quad (16.10.1)$$

where  $A_\mu$  is 4-potentials.

In the case of annihilation of electron-positron (Fig. 14.10), the reverse transformation takes place: internal (potential) energy of the electron and positron is transformed completely into kinetic energy of the photon:

$$\hat{\beta} m_{ph} c^2 = \hat{\alpha}_0 \varepsilon_{ph} + \hat{\alpha} \vec{p}_{ph} = e \alpha_\mu A^\mu, \quad (16.10.2)$$

Therefore, the photon has no rest mass.

#### 10.1.1. Photon model

The solution of the photon wave equation is the sum of two exponential solutions

$$\Phi = \Phi_o e^{-i(\omega t - ky)} + \Phi_o^+ e^{i(\omega t - ky)}, \quad (16.10.3)$$

The geometric representation of the exponent is a circle. Thus, we can assume that a photon consists of two toroids, which travel at the speed of light.

Here two suggestions can be made: 1) two toroids fuse into one torus, 2) the photon represents two separate rings, as shown in Fig. 14.13

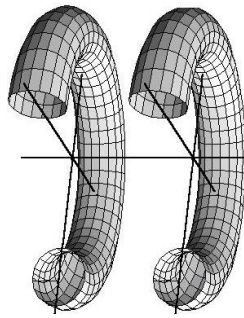

Fig. 14.13

To be neutral, the photon must represent a combination of lepton and antilepton. This model corresponds to the theory of de Broglie's fusion (Broglie, 1943; Dvoeglazov, 1999). Using the characteristics of such a photon is easy to show that the charge of a photon is zero.

## 10.2. A ring electron model

### 10.2.1. Field diagram of electron-positron photoproduction

Let's try now to illustrate the mathematical results of electron-positron pair production process. The field diagram of electron-positron photoproduction in the framework of NTEP is (Fig. 14.14)

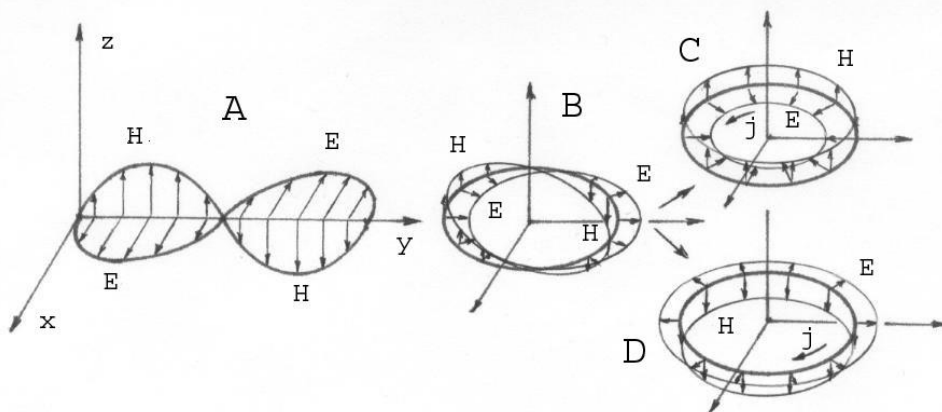

Fig. 14.14

### 10.2.2. The shape of the ring electron field

The solution of the Dirac equation

$$\psi = B \exp\left(-\frac{i}{\hbar}(\varepsilon t - \vec{p}\vec{r})\right), \quad (16. 10.7)$$

can be considered from a geometrical point of view as a single ring (Fig.14.15)

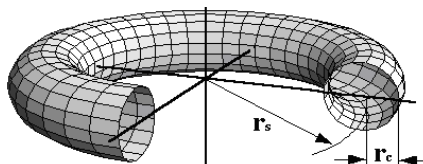

Fig. 14.15

the radius of which is equal to the Compton electron wavelength. We have no data on other characteristics of the ring. At present we can express only some hypothesis about this.

For example it is obvious that the shape of the electron field depends on the distance at which we consider it. Within a sphere of radius  $R$  (as we defined it above), the form of electron can be

either spherical or toroidal. Outside the sphere of radius  $R$  the electron form is approximately spheroidal. However, we can assume that the electron field can deform itself so that at a distance less than  $R$  it would be close to spherical, for example, as shown in Fig. 14.16.

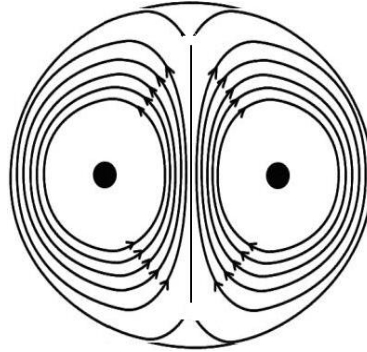

Fig. 14.16

Experiments to determine the shape of the particles have only just begun, and we do not have many results here.

The latest study, published in *Nature* (Hudson, J. J. et al., 2011), looked for the effect of asymmetry on the spins of electrons exposed to strong electric and magnetic fields — but found nothing. Indeed, the researchers say that any deviations from perfect roundness within electrons must measure less than a  $10^{-28}$  of a centimetre across. This result indicates that the electron is spherical.

Unfortunately, from this article it is not clear at what distance from the center of the electron this sphericity takes place.

Note that photon and electron fields and charges can be calculated as ring currents or ring charge by means of classical electrodynamics (Selvaggi, Sheppard and Chari, 2007; and others).

### 10.3. The electron model parameters

The toroidal model not only explains the fact that the electron has an angular momentum, magnetic moment and other characteristics; but it also shows that such electron must have a charge, which is a universal constant.

#### 10.3.1. Charge and mass of electron model

Suppose that in the general case the torus tube radius (Fig. 14.15) is equal to  $r_c = \zeta r_s$ , where  $\zeta \leq 1$ . The charge density of the electron is:  $\rho_e = \frac{j_\tau}{c} = \frac{1}{4\pi} \frac{\omega_e}{c} E_0$ , where  $E_0$  is the wave function amplitude. The full charge can be find by integrating along all the torus volume  $\Delta\tau_i$ :  $q_e = \int_{\Delta\tau_i} \rho_e d\tau$ . Taking  $\vec{E} = \vec{E}(l)$ , where  $l$  is the length of the ring way, we obtain the electron charge:

$$q_e = \frac{1}{\pi} \frac{\omega_s}{c} E_o S_s 2 \int_0^{\frac{\lambda_s}{4}} \cos k_s l dl = \frac{1}{\pi} E_o S_c, \quad (16. 10.8)$$

where  $S_c = \pi r_c^2$  is cross-section of tube. Thus:

$$q_e = E_o r_c^2 = \zeta^2 E_o r_s^2, \quad (16. 10.9)$$

To calculate the mass we must calculate first the energy density of the electromagnetic field:

$$\rho_\varepsilon = \frac{1}{8\pi} (\vec{E}^2 + \vec{H}^2), \quad (16. 10.10)$$



In linear approximation we have  $|\vec{E}| = |\vec{H}|$  in Gauss's system. Then (16. 10.10) can be written:

$$\rho_\varepsilon = \frac{1}{4\pi} E^2, \quad (16. 10.11)$$

Using (16. 10.11) and a well-known relativistic relationship between a mass and energy densities:

$$\rho_m = \frac{1}{c^2} \rho_\varepsilon, \quad (16. 10.12)$$

we obtain:

$$\rho_m = \frac{1}{4\pi c^2} E^2 = \frac{1}{4\pi c^2} E_o \cos^2 k_s l, \quad (16. 10.13)$$

Using (16. 10.13), we can write for the electron mass:

$$m_e = \int \int_{s, l} \rho_m ds dl = \frac{S_c E_o^2}{\pi c^2} \int_0^{\lambda_s} \cos^2 k_s l kl, \quad (16. 10.14)$$

From (16. 10.14) we obtain:

$$m_e = \frac{E_o S_c}{4\omega_e c} = \frac{\pi \zeta^2 E_o^2 r_s^2}{4\omega_e c}, \quad (16. 10.15)$$

### 10.3.2. The proof of the universality of the electron charge

The following note of Feynman is remarkable (Feynman, 1985): “*There is a most profound and beautiful question associated with the observed coupling constant,  $e$  — the amplitude for a real electron to emit or absorb a real photon. It is a simple number that has been experimentally determined to be close to -0.08542456. It has been a mystery ever since it was discovered more than fifty years ago*”.

Let us show that the presence of the structure and size of the electron, set in NTEP, allows us to prove the universality of the electron charge.

Using Eqs. (16.10.9) and (16.10.15) we can write:

$$m_e = \frac{\pi q_e^2}{4\zeta^2 \omega_e c r_s^2}, \quad (16. 10.16)$$

or, taking in account that  $\omega_e \cdot r_s = c$  we obtain:

$$r_s = \frac{\pi q_e^2}{2\zeta^2 2m_e c^2}, \quad (16. 10.17)$$

Putting here the values  $\omega_e$  and  $r_s$ , we will obtain the value:

$$\alpha_e = \frac{q_e^2}{\hbar c} = \frac{2}{\pi} \zeta^2, \quad (16. 10.18)$$

Our heuristic model can not allows accurately calculate this quantity. But it is clear that it corresponds to the electromagnetic constant  $\alpha = \frac{e^2}{\hbar c} \cong \frac{1}{137} \approx 0,007$ . However, the formula (16. 10.18) shows that *in the nonlinear theory the electric charge is defined only by the universe constants; that means that there are no free charges less than this one.*

At the same time, *our theory doesn't limit the mass value of electron; this fact is also according to the experimental data.*

## Chapter 17. The mass origin theory

### 1.0. Introduction. "The garbage of the past often becomes the treasure of the present (and vice versa)".

*"We have no better way of describing elementary particles than quantum field theory. A quantum field in general is an assembly of an infinite number of interacting harmonic oscillators. Excitations of such oscillators are associated with particles..."*

*All this has the flavour of the XIX century, when people tried to construct mechanical models for all phenomena. I see nothing wrong with it because any nontrivial idea is in a certain sense correct. The garbage of the past often becomes the treasure of the present (and vice versa). For this reason we shall boldly investigate all possible analogies together with our main problem..."*

*Elementary particles existing in nature resemble very much excitations of some complicated medium (aether). We do not know the detailed structure of the aether but we have learned a lot about effective Lagrangians for its low energy excitations."*

A.M. Polyakov. Gauge Fields and Strings. Harwood Academic Publishers, 1987.

Three theories of the origin of the masses of elementary particles were developed until present time.

The first was created at the end of 19<sup>th</sup> century within the framework of classical (i.e. pre-quantum) physics, and it is called electron theory. There it was assumed that the mass of the electron and other electrified bodies has electromagnetic origin.

Another theory arose at the end of 20<sup>th</sup> century within the framework of the Standard Model theory and it is called the theory of the spontaneous breaking of gauge symmetry or briefly Higgs's mechanism.

Both these theories have general initial basis: it is considered that the mass occurs due to interaction of a material particle with a certain nonmaterial medium (or more precisely, with the medium, in which there are no material particles). In the electron theory this medium is called electromagnetic aether. In the Standard Model this medium is one of the forms of the so-called physical vacuum, namely Higgs's vacuum, which possesses the property of being spontaneously converted to the state, in which mass-free particles become massive.

As it will be evident from the following chapters, third theory of the mass origin, proposed within the framework of the present nonlinear theory of elementary particles (NTEP), has close connections both with the first and with the second theory. Therefore the analysis of the existing theories of the generation of masses is useful not only by itself, but also for further development of this issue within the framework of nonlinear theory.

Before passing to the examination of abovementioned theories, it is necessary to note two serious factors. The first of them consists in the fact that the language of science, as generally the language of people, changes continuously. Therefore many old concepts have a different name today, and we think that they have no connection with the previous ones. With the sequential analysis it is revealed that the majority of contemporary concepts originate from previous concepts and are only their redesignation.

The second factor is even more important. For specific reasons the development of the classical theory of mass stopped at the beginning of the 20<sup>th</sup> century. During the following period, since 1926 (by this year last works on this area are dated) until our times within the framework of a new quantum approach in this region, an enormous volume of additional information is accumulated.

It is sufficient say that up to the 20<sup>th</sup> century the electron was the only known elementary particle. The mathematical circumscription of classical electron from a contemporary point of view is extremely simplified. Before 1926 the electron equations of Schroedinger and Dirac and all consequences of the quantum theory of electron were unknown. Classical electron does not have a connection with the quantum theory: it does not have a momentum (spin) and a magnetic moment, it cannot be stable, and so forth. It was already at that time understandable that the classical theory is clearly incomplete. Nevertheless, within its framework a number of very meaningful results was obtained, which became the basis of contemporary physics.

For the comparison of each ideas in the question of the mass origin, we will use brief quotations from books and articles of the well-known scholars, accompanied by small commentaries. For additional information on the questions examined, the reader can become familiar with books and publications, indicated in the bibliography of this article.

## 2.0. The electron theory

Electron theory (The Great Soviet Encyclopedia, 1970-1979) in the broad sense is the generalization of Maxwell's theory, called Maxwell-Lorentz electrodynamics. In vacuum its equations coincide with the Maxwell equations.

*“Maxwell-Lorentz equations are the fundamental equations of classical electrodynamics describing the microscopic electromagnetic fields generated by individual charged particles. The Maxwell-Lorentz equations were obtained as a result of a generalization of the macroscopic Maxwell equations. According to the electron theory, Maxwell-Lorentz equations accurately describe the fields at any point in medium and space (including interatomic and intraatomic fields and even the fields within an electron) at any point in time. In Lorentz’ theory all charges are divided into free charges and bound charges (which are part of electrically neutral atoms and molecules).*

*Lorentz’ electron theory has made it possible to clarify the physical meaning of the fundamental constants that enter into the Maxwell equations and that characterize the electrical and magnetic properties of matter. Certain important electrical and optical phenomena, such as the normal Zeeman effect, the dispersion of light, and the properties of metals and dielectrics, were predicted or explained on the basis of this theory.”*

The “electron theory” in the narrow sense is the first theory of field and elementary particles, in which as the object of investigation was the first elementary particle - electron. Since the electron is an electrically charged particle, as the field theory, in which it was examined, became the electromagnetic theory of Maxwell (expanded by Lorentz this theory is known as Maxwell-Lorentz theory).

Many books published until 1926 (some of them were republished later) are devoted to the electron theory (Lorentz, 1953; Becker, 1982; Richardson, 1916; and so forth). In the newest literature to this theme special attention is given to “Classical electrodynamics” of J.D. Jackson, (Jackson, 1999) and to the lecture about electrodynamics of (Feynman et al, 1964 ). Therefore we omit all details and suggest that the reader to revert to the corresponding reference.

Electron theory was designed in the sufficiently final form in the works of Lorentz, but in its development participated many great physicists. The following were the basic hypotheses of this theory:

1) there is an electromagnetic medium, called electromagnetic (EM) aether, in which there are no material bodies. In the contemporary theory of elementary particles a similar medium is called “the field in the lowest energy state” or “physical vacuum”. For EM aether Maxwell-Lorentz equations without the sources or the equation of electromagnetic waves are valid.

2) Electron is not a particle of EM aether, but it is a certain modification (concentration, clot or, according to A. Einstein, condensation) of the electromagnetic field of aether. Electron consists of the electrical (in the later versions of the beginning of 20<sup>th</sup> century, electromagnetic) field, concentrated in some volume of space. It is a continuous field distribution and therefore it does not have specific boundaries in a mechanical sense, but the field distribution of electron is

characterized by specific sizes. Nothing was known about the structure of electron or the method of the appearance of electron. Therefore an evenly charged (over the surface or by volume) ball was initially accepted as the model of electron.

3) all neutral bodies (atoms) consist of positive and negative charges, similar to electron, whose charges are compensated;

4) all interactions in nature, which connect atoms and molecules between themselves, are electromagnetic (i.e. in other words, they are described by Lorentz's force).

In the 19<sup>th</sup> century there was no experimental proof of these hypotheses, but the calculations, made on the basis of electron theory, in essence, were confirmed by experiments. The experimental and theoretical results, obtained in the past century, showed the validity of these hypotheses; today we can assert with good reason that they are accurate. Let us enumerate some of these results.

The equation of photon - the quantum of electromagnetic wave – is, taking into account the quantization of its energy, the Maxwell equation (see Akhiezer and Berestetskii, 1965, Levich et al, 1973)

The equation of Dirac's electron, which with huge accuracy describes the characteristics of electron, proved to be the nonlinear electromagnetic equation, whose all characteristics have electromagnetic origin. The same goes for all leptons, since in the bispinor form the Dirac equation describes also other leptons .

It is proven that all remaining elementary particles - hadrons - and their interactions have electromagnetic origin. The contemporary theory of hadrons is based on Yang- Mills equations, which, as it is repeatedly noted, are the nonlinear generalizations of Maxwell's equations (Nambu, 1962): *“The generalization of the Maxwell theory is the theory of the Yang-Mills fields or non-Abelian gauge fields. Its equations are nonlinear. In contrast to this, the equations of Maxwell are linear, in other words, Abelian”*.

It is also proven that all fundamental particles (leptons and quarks) are structureless particles. Since the description of such particles does not contain their geometric dimension, such particles are also called point particles.

By theoretical calculations and by experiments it is also confirmed that interactions of atoms and molecules are electromagnetic (Gottfried and Weisskopf, 1984; see **“6. The electromagnetic nature of atomic phenomena:**

*The most important consequence of the application of quantum mechanics to atomic systems is the recognition that all properties of atoms, molecules, and their aggregates, can be understood by assuming that an atom is a system consisting of a nucleus...with a charge  $Ze$ , and of  $Z$  electrons, each of charge  $-e$ , with interaction between these constituents being solely due to the electromagnetic fields produced by the charges... This dynamical problem is simple in principle; ... It is not simple in practice...Nevertheless, we are certain that all the interatomic and intermolecular forces... are manifestations of the electromagnetic interactions between the constituents, among which the electrostatic attraction or repulsion (Coulomb force) plays the dominant role. Since almost all natural phenomena... are due to interactions between atoms, we conclude that these phenomena are all consequences of the electromagnetic interaction between nuclei and electrons, and of quantum mechanics”*.

The results of electron theory, taking into consideration scant experimental data, which physics had at the end of the 19<sup>th</sup> century, were very important. It was discovered, that the energy field distribution of electron is characterized by a certain size, which was conditionally called classical radius of electron.

Electron motion as electrical body, was completely described by the electromagnetic theory. It was shown that without the action of forces the electron moves by the inertia, since all forces in it are balanced. In the case of accelerated motion the self-forces, which hamper the motion, appear.

According to electrodynamics the accelerated electron must emit electromagnetic waves. assuming that a pair of opposite charges - electron and atomic nucleus - can be examined as dipole with the harmonically oscillated charges, Lorentz constructed the dipole theory of electron

emission of the atom. His theory of the emission of EM waves from hydrogen atoms coincides precisely with the quantum theory of the emission of photons by hydrogen atoms, developed considerably later. On this base were explained many effects of emission of light by atoms (Zeeman effect and others).

But Lorentz made even more important discoveries, investigating electron motion relatively to EM aether. These discoveries were made on the border of two branches of physics: electrodynamics and mechanics, i.e., on the border, that divides electrified bodies and neutral bodies.

Electron, like neutral atoms, has also the mechanical characteristics: mass, energy, momentum and the like. Therefore the most important question of electron theory was the question about the description of these characteristics from the point of view of the theory of electromagnetic field. Therefore enormous efforts were applied by scientists in order to show that all these mechanical characteristics can be explained by electromagnetic theory. In other words it was necessary to express all these characteristics through the characteristics of electromagnetic field.

Remarkable successes were here achieved. The nonquantized nature of theory was their only great drawback. About the significance of electron theory testifies the fact that the majority of its results were used for the development of the quantum theory of elementary particles.

Some of the first, were results obtained by J.J. Thomson (Thomson, 1881). These results were confirmed and developed by other scientists (Lorentz, Heaviside, Hasenoehrl], Larmor, Abraham, Poincare and other). As an introduction we give quotations from the later popular article of J.J. Thomson "**The origin of the mass of the charge corpuscle**" (Thomson, 1907):

*"The origin of the mass of the corpuscle is very interesting; for it has been shown that this mass arises entirely from the charge of electricity on the corpuscle. We can see how this comes about in the following way. If we take an uncharged body of mass  $m$  at rest and set it moving with the velocity  $v$ , the work we shall have to do on the body is equal to the kinetic energy it has acquired, i.e., to  $mv^2/2$ . If, however, the body is charged with electricity we will have to do more work to set it moving with the same velocity, for a moving charged body produces magnetic force, it is surrounded by a magnetic field*

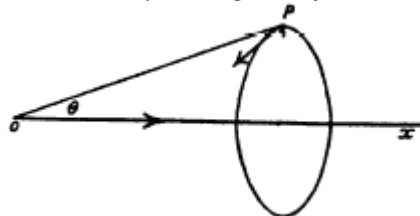

Fig. 3.1.

*and this field contains energy; thus when we set the body in motion we have to supply the energy for this magnetic as well as for the kinetic energy of the body. If the charged body is moving along the line OX, the magnetic force at a point P is at right angles to the plane POX; thus the lines of magnetic forces are circles having OX for their axis. The magnitude of the force at P is equal to  $\frac{e v \sin \theta}{OP}$  where  $\theta$  denotes the angle POX. Now in a magnetic field the*

*energy per unit volume at any place, where the magnetic force is equal to  $H$ , is  $H^2/8\pi$ . Thus the energy per unit volume at P arising from the magnetic force produced by the moving*

*charge is  $\frac{1}{8\pi} \frac{e^2 v^2 \sin^2 \theta}{(OP)^4}$ , and by taking the sum of the energy throughout the volume*

*surrounding the charge, we find the amount of energy in the magnetic field. If the moving body is a conducting sphere of radius  $a$ , a simple calculation shows that the energy in the*

magnetic field is equal to  $\frac{1}{3} \frac{e^2 v^2}{a}$ . The energy which has to be supplied to set the sphere in

motion is this energy plus the kinetic energy of the sphere, i.e., it is equal to  $\frac{1}{2} \left( m + \frac{1}{3} \frac{e^2}{a} \right) v^2$

Thus the energy is the same as if it were the kinetic energy of a sphere with a mass  $\frac{2}{3} \frac{e^2}{a}$

instead of  $m$ . Thus the apparent mass of the electrified body is not  $m$  but  $m + \frac{2}{3} \frac{e^2}{a}$ . The seat of this increase in mass is not in the electrified body itself but in the space around it, just as if the aether in that space were set in motion by the passage through it of the lines of force proceeding from the charged body, and that the increase in the mass of the charged body arose from the mass of the aether set in motion by the lines of electric force. It may make the consideration of this increase in mass clearer if we take a case which is not electrical but in which an increase in the apparent mass occurs from causes which are easily understood. Suppose that we start a sphere of mass  $m$  with a velocity  $v$  in a vacuum, the work which has to be done on the sphere is  $mv^2/2$ ...

But since this addition to the mass increases rapidly as the body gets smaller, the question arises, whether in the case of these charged and exceedingly small corpuscles the electrical mass, as we may call it, may not be quite appreciable in comparison with the other (mechanical) mass. We shall now show that this is the case; indeed for corpuscles there is no other mass: all the mass is electrical.

The method by which this result has been arrived at is as follows: The distribution of magnetic force near a moving electrified particle depends upon the velocity of the particle, and when the velocity approaches that of light, is of quite a different character from that near a slowly moving particle. Perhaps the clearest way of seeing this is to follow the changes which occur in the distribution of the electric force round a charged body as its velocity is gradually increased."

Foreseeing some questions let us note that all these results were obtained within the framework of electromagnetic theory, which remains the same from the times of J.J. Thomson and H. A. Lorentz till the present time. Moreover, the obtained mathematical "electromagnetic" expressions are the same "relativistic" expressions, which are used today, because the classical electrodynamics is invariant with respect to the Lorentz transformations.

In order to be convinced of this, it is sufficient to compare the content of the articles and books of J.J. Thomson, Lorentz and other authors of that time with the contemporary textbooks on the electrodynamics; see, for example, (Jackson, 1999; Purcell, 1984; and others). In many of these books are presented the results, obtained in the 19<sup>th</sup> century. Especially recommended is the textbook (Jackson, 1999), and also R. Feynman lectures. In particular, questions about electromagnetic mass briefly, but very deeply examined in the chapter 28 of volume 6, called "Electromagnetic mass" (Feynman et al., 1964).

It does not make any sense to present in detail all these results, since, because of the Internet, the reader can be introduced to them by the ultimate sources. We will here only illustrate the basic achievements of these scientists, among whom Lorentz was rightfully the most important one.

In 19<sup>th</sup> Century it was shown:

**1) The part of energy and momentum of an electron as a "clot" of electromagnetic field is determined by energy and momentum of its electromagnetic field. In this case the mass is determined through the energy of the field of electron.**

(Feynman et al., 1964; see sections 28-1 *The field energy of rest charge* and 28-2 *The field momentum of a moving charge*)

Suppose we take a simple model of an electron in which all of its charge  $e$  is uniformly distributed on the surface of a sphere of radius  $a$ . Now let's calculate the energy in the electromagnetic field. The magnitude of the electric field is  $E = e/r^2$ , and the energy density is

$$u = \frac{1}{8\pi} \vec{E}^2 = \frac{e^2}{64\pi^2 r^4}, \quad (17.2.1)$$

This is readily integrated. The lower limit is  $a$ , and the upper limit is  $\infty$ , so

$$\varepsilon = \frac{1}{2} \frac{e^2}{a}, \quad (17.2.2)$$

The momentum density is

$$\vec{g} = \frac{1}{4\pi c} [\vec{E} \times \vec{H}], \quad (17.2.3)$$

The component of  $\vec{g}$  in direction of motion we must integrate over all space

$$\vec{p} = \frac{2}{3} \frac{e^2}{ac^2} \vec{v}, \quad (17.2.4)$$

(or taking into account that  $\varepsilon = \frac{1}{2} \frac{e^2}{a}$ , we obtain  $\vec{p} = \frac{4}{3} \frac{\varepsilon}{c^2} \vec{v}$ ).

Our calculation was for  $v \ll c$ ; what happens if we go to high velocities? .. Lorentz realized that the charged sphere would contract into a ellipsoid at high velocities, and that the fields would change in accordance with formulas, we derived for the relativistic case. If you carry through the integrals for  $\vec{p}$  in that case, you find

$$\vec{p} = \frac{2}{3} \frac{e^2}{ac^2} \frac{\vec{v}}{\sqrt{1-v^2/c^2}}, \quad (17.2.5)$$

Inaccuracies in the calculations arose because of the imperfection of the electron model as a statically charged ball. Such an electron cannot be stable. Upon consideration of any forces, which restore stability, the calculations lead to results, which are correct from a contemporary point of view (Fermi, 1922; Wilson, 1936; Kwal, 1949; Rohrlich, 1960).

(Feynman et al., 1964): "In deriving our equations for energy and momentum, we assumed the conservation laws. We assumed that all forces were taken into account and that any work done and any momentum carried by other "nonelectrical" machinery was included. Now if we have a sphere of charge, the electrical forces are all repulsive and an electron would tend to fly apart. Because the system has unbalanced forces, we can get all kinds of errors in the laws relating energy and momentum. To get a consistent picture, we must imagine that something holds the electron together. The charges must be held to the sphere by some kind of rubber bands—something that keeps the charges from flying off. It was first pointed out by Poincare that the rubber bands—or whatever it is that holds the electron together—must be included in the energy and momentum calculations. For this reason the extra nonelectrical forces are also known by the more elegant name "the Poincare stresses." If the extra forces are included in the calculations, the masses obtained in two ways are changed (in a way that depends on the detailed assumptions). And the results are consistent with relativity; i.e., the mass that comes out from the momentum calculation is the same as the one that comes from the energy calculation. However, both of them contain two contributions: an electromagnetic mass and contribution from the Poincare stresses. Only when the two are added together do we get a consistent theory."

Thus, the problem is how to create the model of electron, in which stresses of Poincare will appear due to the electromagnetic forces of electron itself.

In EM theory for the solution of this problem we have only Lorentz's force, which consists of the electrical part  $\rho\vec{E}$  and the magnetic part  $\frac{1}{c}\vec{j}\times\vec{H}_s$ . In the electron theory only the electrical part is examined. Thus, the sequential model of electron must contain a magnetic field that ensures the appearance of magnetic force, which balances the electrical part of Lorentz's force.

## 2) The self-forces of electron is the reason for the appearance of mass as measures of the inertia of a body

(Jackson, 1999; Jimenez and Campos, 1999): *“The structure and dynamics of the electron derive from the interaction of a charged body with its self-field, and take specific aspects according to the postulated model, either a finite point charge or an extended charged body in interaction with itself.*

*This self-interaction gives rise to the radiation reaction problem, that for the point charge appears as self-acceleration or preacceleration, and to an extra inertia, the electromagnetic mass, whose behaviour has been thought to be in conflict with relativity theory ...*

### 2. The extended charge radiation reaction

*Historically the first model of the electron to be explored was the extended electron. Lorentz and others conceived the electron as a small spherical charge and the self-force, or radiation reaction, as arising from the retarded interaction of one infinitesimal part of the electron on another. The final result of this approach in the non relativistic limit, for a charge distribution with spherical symmetry, without rotation, and neglecting nonlinear terms, is the series that represents the radiation reaction force  $\vec{f}$  as*

$$\vec{f} = -\frac{2e^2}{3c^2} \sum_{n=0}^{\infty} \frac{(-1)^n}{c^n n!} G_n \frac{d^n \vec{a}(t)}{dt^n}, \quad (17.2.6)$$

where

$$G_n = \int d^3x d^3x' \rho(x,t) \rho(x',t) |x-x'|^{n-1}, \quad (17.2.7)$$

The first two terms are

$$\vec{f}_0 = -\frac{4}{3} \frac{\varepsilon}{c^2} \vec{a}, \quad (17.2.8)$$

where  $\varepsilon$  is the electrostatic energy of the charge distribution, and

$$\vec{f}_1 = -\frac{2e^2}{3c^3} \dot{\vec{a}}, \quad (17.2.9)$$

*Here  $\vec{a}$  is the acceleration and  $\dot{\vec{a}}$  is the time derivative of acceleration. The other terms are proportional to the size of the charge and therefore go to zero for the point charge. The term proportional to the acceleration may be written as*

$$\vec{f}_0 = -\frac{4}{3} m \vec{a}, \quad (17.2.10)$$

*defining  $m = \varepsilon/c^2$ . Here appears the factor 4/3, that supposedly is in conflict with relativity theory. We will argue that the conflict is rather between two different conceptions of a purely electromagnetic electron. The other term, proportional to  $\dot{\vec{a}}$  and independent of the size of the electron, is usually but not correctly interpreted as a radiation reaction force for a point charge.”*

(Feynman et al., 1964; 28-4 *The force of an electron on itself*):

*We can think of the electron as a charged sphere. When it is at rest, each piece of charge repels electrically each other piece, but the forces all balance in pairs, so that there is no net*



force. [See Fig. 28-3(a).] However, when the electron is being accelerated, the forces will no longer be in balance because of the fact that the electromagnetic influences take time to go from one piece to another. For instance, the force on the one piece in Fig. 28-3(b) from this piece on the opposite side depends on the position of at an earlier time, as shown. Both the magnitude and direction of the force depend on the motion of the charge. If the charge is accelerating, the forces on various parts of the electron might be as shown in Fig. 28-3(c). When all these forces are added up, they don't cancel out. They would cancel for a uniform velocity, even though it looks at first glance as though the retardation would give an unbalanced force even for a uniform velocity. But it turns out that there is no net force unless the electron is being accelerated. With acceleration, if we look at the forces between the various parts of the electron, action and reaction are not exactly equal, and the electron exerts a force on itself that tries to hold back the acceleration. It holds itself back by its own bootstraps”.

### 3) The mass of electron depends on the speed of the motion of electron. A change in the momentum of an electron is also connected with this.

“In the theory of electron (Bulgakov, 1911) it is necessary to deny the simple view of the mass as constant, which does not depend on speed, and it is necessary to consider that  $m$  there is a function of  $v$  and, furthermore, value  $m$  depends on the direction of the acting force.

Let us assume that the force has the same direction as the momentum (therefore, as speed). Then it is expressed by time derivative  $dp/dt$ . The projection of acceleration in the direction of speed is equal to  $dv/dt$ ; at the same time  $dp/dt = \frac{dp}{dv} \frac{dv}{dt}$ . Value  $m_s = dp/dv$  has the name of longitudinal mass.

If the value of momentum does not change, and the only thing that changes is the direction, then it is necessary to examine the geometric increase in the momentum  $\Delta p = \alpha p$ , where  $\alpha$  is the angle, to which the direction  $p$  was turned. On the other hand, we know that acceleration, perpendicular to the speed, is equal to  $v^2/\rho$ , where  $\rho$  is radius of curvature. The angle  $\alpha$ , to which the direction of tangent in the time interval  $\Delta t$  is turned, is determined by equality  $\alpha = \frac{v}{\rho} \Delta t$  (since  $\rho = \lim \frac{\Delta s}{\alpha}$ , where  $\Delta s = v\Delta t$  is the arc length).

The value of force in this case is equal to  $\Delta p/\Delta t$ . But  $\Delta p = p \frac{v}{\rho} \Delta t$ . Consequently, the amount

of force is equal to  $p \frac{v}{\rho}$ ; this value is possible to be presented in the form of product  $\frac{p}{v} \cdot \frac{v^2}{\rho}$ .

Coefficient  $p/v$  in the acceleration  $v^2/\rho$  has the name of transverse mass  $m_r = p/v$ .

In the simplest case of material point, examined in mechanics, the momentum  $p$  is expressed by the product  $m v$ , where  $m$  is a constant value. Then  $p/v$  is equal to  $p/v$  and therefore  $m_s = m_r = m$ .

This does not take place for the electron: in this case the momentum  $p$  is expressed by a more complicated function of  $v$  and longitudinal mass  $m_s$  is not equal to transverse  $m_r$ .

Let us derive the expression of the mass of electron, relying on the law of relativity; taking into account that with  $v = 0$   $m_s = m_r = m_0$  we will obtain for the longitudinal and transverse masses

$m_s = \frac{dp}{dv} = \frac{m_0}{(1-v^2/c^2)^{3/2}}$  and  $m_r = \frac{p}{v} = \frac{m_0}{\sqrt{1-v^2/c^2}}$ , respectively. This form have expressions

of mass, which are derived from the law of relativity and are in accordance with Lorentz's theory...”.

**4) Electron as “clot” of field is more deformed, the higher the speed of electron motion is, moreover in this case in longitudinal direction body size is contracted and in the transversal direction it is enlarged.**

Let us consider the connection of the shape of the electromagnetic field of electron with the motion of the charged particle (Pamyatnykh, 2001):

“Let us examine the motion of charge (in particular, classical electron), in a certain fixed coordinate system. What does occur in this case regarding the field of electron?”

“Let us introduce the vector  $\mathbf{R} = (x - \mathbf{V} \cdot t, y, z)$  (Fig. 1),

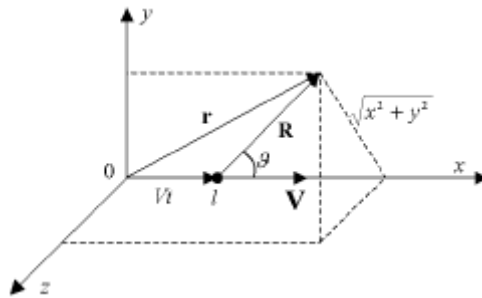

Fig. 3.2

which is directed from the charge to the observation point. Using Lorentz transformation for EM field it is not difficult to show that the strengths of the field of the moving charge (electron) will take the form:

$$\mathbf{E} = \frac{e\mathbf{R}}{R^3} \frac{1 - V^2/c^2}{(1 - (V^2/c^2)\sin^2\theta)^{3/2}} \quad \mathbf{H} = \frac{1}{c}[\mathbf{V} \times \mathbf{E}]$$

From here it follows that with low speeds ( $|\mathbf{V}| \ll c$ ) the strength of electric field is approximately identical to all directions and is equal to the strength of the field of the rest charge:

$$\mathbf{E} = \frac{e\mathbf{R}}{R^3}$$

Furthermore, a magnetic field  $\mathbf{H} = (1/c)[\mathbf{V} \times \mathbf{E}]$  also appears.

With the high speed motion the value of the field strength depends on direction. In particular, along and against the direction of motion the field is decreased in comparison with the value for the rest charge:

$$E_{\parallel} = \frac{e}{R^2} \left(1 - \frac{V^2}{c^2}\right) < \frac{e}{R^2}$$

On the contrary, in the transversal direction it grows:

$$E_{\perp} = \frac{e}{R^2} \frac{1}{\sqrt{1 - (V^2/c^2)}} > \frac{e}{R^2}$$

Thus, the field seems to be “flattened” in the direction of motion (Fig. 2)

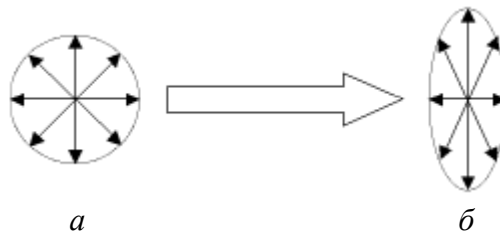

Fig. 3.3. The “flattening” of the field of the moving charge. The length of arrows depicts in arbitrary units the value of electric field strength in a given direction.”

**5) Velocity mass dependence can be connected with the deformation of electron, if we interpret mass as the resistance to motion of electron in EM aether.**

We will use quotation from the same popular article of Thomson (Thomson, 1907):

“When the body is at rest the electric force is uniformly distributed round the body, i.e., as long as we keep at the same distance from the charged body the electric force remains the same whether we are to the east, west, north or south of the particle; the lines of force which come from the body spread out uniformly in all directions. When the body is moving this is no longer the case, for if the body is moving along the horizontal line (Fig. 3.3), the lines of electric force tend to leave the regions, which we shall call the polar regions, and crowd towards a plane drawn at right angles to the horizontal line; the regions in the neighborhood of this plane we shall call the equatorial regions. This crowding of the lines of force is exceedingly slight when the velocity of the body is only a small fraction of that of light, but it becomes very marked when the velocity of the body is nearly equal to that velocity...

The effect of this crowding of the lines of force towards the equatorial plane is to weaken the magnetic force in the polar and increase it in the equatorial regions. The polar regions are those where the magnetic force was originally weak, the equatorial regions those where it was strong. Thus the effect of the crowding is to increase relatively the strength of the field in the strong parts of the field and to weaken it in the weak parts. This makes the energy in the field greater than if there were no crowding, in which case the energy is  $\frac{1}{3} \frac{e^2 v^2}{a}$  where  $e$  is the charge,  $v$  the velocity and  $a$  the radius of the sphere. When we allow for the crowding, the energy will be  $\frac{1}{3} \beta' \frac{e^2 v^2}{a}$ , where  $\beta'$  is a quantity which will be equal to unity when  $v$  is small compared with  $c$  the velocity of light, but becomes very large when  $v$  approaches  $c$ . The part of the mass arising from the charge is  $\frac{1}{3} \beta' \frac{e^2 v^2}{a}$ , thus since  $\beta'$  depends upon  $v$  - the velocity of the particle - the electrical mass will depend upon  $v$ , and thus this part of the mass has the peculiarity that it is not constant but depends upon the velocity of the particle. Thus if an appreciable part of the mass of the corpuscle is electrical in origin, the mass of rapidly moving corpuscles will be greater than that of slow ones, while if the mass were in the main mechanical, it would be independent of the velocity”.

**6) Lorentz also revealed that the electron has its own “local” time, which depends on the speed of the motion of body relatively to EM aether.**

In the electron theory this effect can be interpreted dynamically, as a change in the frequency of wave, which represents the given particle during its motion through EM aether. In framework of STR this effect is interpreted not as local time, but as the kinematics effect of time dilation due to relative motion of bodies.

7) On the basis of Maxwell's equations Lorentz and Larmor derived the Lorentz transformations.

(Feynman et al., 1964; see 21-6 *The potentials for a charge moving with constant velocity; the Lorentz formula*):

We want next to use the Lienard-Wiechert potentials for a special case — to find the fields of a charge moving with uniform velocity in a straight line. We (can) do it, using the principle of relativity. We already know what the potentials are when we are standing in the rest frame of a charge. When the charge is moving, we can figure everything out by a relativistic transformation from one system to the other. But relativity had its origin in the theory of electricity and magnetism. The formulas of the Lorentz transformation... were discoveries made by Lorentz when he was studying the equations of electricity and magnetism. So that you can appreciate where things have come from, we would like to show that the Maxwell equations do lead to the Lorentz transformation. We begin by calculating the potentials of a charge moving with uniform velocity, directly from the electrodynamics of Maxwell's equations. We have shown that Maxwell's

equations lead to the potentials for a moving charge that we got in the last section. So when we use these potentials, we are using Maxwell's theory...

...We get for (scalar potential)  $\phi$

$$\phi(x, y, z, t) = \frac{q}{\sqrt{(x - vt)^2 + (1 - v^2/c^2)(y^2 + z^2)}}, \quad (17.2.11)$$

This equation is more understandable if we rewrite it as

$$\phi(x, y, z, t) = \frac{q}{\sqrt{(x - vt)^2} \left[ \left( \frac{(x - vt)}{\sqrt{1 - v^2/c^2}} \right)^2 + y^2 + z^2 \right]}, \quad (17.2.12)$$

The vector potential  $\vec{A}$  is the same expression with an additional factor of  $v/c^2$

$$\vec{A} = \frac{\vec{v}}{c^2} \phi, \quad (17.2.13)$$

In Eq. (17.2.12) you can clearly see the beginning of the Lorentz transformation. If the charge were at the origin in its own rest frame, its potential would be

$$\phi(x, y, z) = \frac{q}{[x^2 + y^2 + z^2]^{1/2}}, \quad (17.2.14)$$

We are seeing it in a moving coordinate system, and it appears that the coordinates should be transformed by

$$\begin{aligned} x &\rightarrow \frac{(x - vt)}{\sqrt{1 - v^2/c^2}} \\ y &\rightarrow y \\ z &\rightarrow z \end{aligned}, \quad (17.2.15)$$

That is just the Lorentz transformation, and what we have done is essentially the way Lorentz discovered it.

**8) The theoretical results of electron theory coincided with the results of the experiments, set for the purpose of their checking (experiment of Michaelson- Morley and, etc).**

To explain the negative result of the Michelson–Morley experiment the contraction hypothesis was proposed by George Francis FitzGerald and independently proposed and extended by Hendrik Lorentz. (Lorentz, 1916):

“§168. In order to explain this absence of any effect of the earth's translation, I have ventured the hypothesis, which has also been proposed by FitzGerald, that the dimensions of a solid body undergo slight changes, of the order  $\frac{v^2}{c^2}$ , when it moves through the aether. If we assume that the lengths of two lines  $L_1$  and  $L_2$  in a ponderable body, the one parallel and the other perpendicular to the translation, which would be equal to each other if the body were at rest, are to each other in the ratio during the motion,

$$\frac{L_2}{L_1} = 1 + \frac{v^2}{2c^2}, \quad (17.2.16)$$

the negative result of the experiments is easily accounted for...

The hypothesis certainly looks rather startling at first sight, but we can scarcely escape from it, so long as we persist in regarding the aether as immovable. We may, I think, even go so far as to

say that, on this assumption, Michelson's experiment proves the changes of dimensions in question...

§172. We can understand the possibility of the assumed change of dimensions, if we keep in mind that the form of a solid body depends on the forces between its molecules, and that, in all probability, these forces are propagated by the intervening aether in a way more or less resembling that in which electromagnetic actions are transmitted through this medium. From this point of view it is natural to suppose that, just like the electromagnetic forces, the molecular attractions and repulsions are somewhat modified by a translation imparted to the body, and this may very well result in a change of its dimensions."

**9) Since, according to Lorentz's hypothesis, all material bodies in the Universe consist of the electromagnetic field, they undergo all effects, which are enumerated above for the electron.**

Let us note also that the difficulties of electron theory and inaccuracy in the expressions, obtained in the 19<sup>th</sup> century, proved to be essentially connected with the imperfection (simplicity) of "ball" model of electron as elementary particle. Unfortunately, there were no attempts to improve theory, taking into account all this knowledge, which was obtained from the end of the 19<sup>th</sup> century up to now.

Results enumerated above were rediscovered and refined by A. Einstein within the framework the special theory of relativity (STR). (see sources: **Relativity and Electrodynamics of Moving Bodies**. <http://en.wikisource.org/wiki/Wikisource:Relativity> )

### **3.0. Kinematics non-electromagnetic theory of matter – specially theory of relativity of Einstein**

The special theory of relativity (STR), which appeared in the beginning of the 20<sup>th</sup> century, is not itself a theory of matter. It is a theory of invariance of the laws of physics relative to the specific transformations. However, the requirement of invariance, which STR imposes on the laws of physics, leads to the reformation of all laws of nature. In this sense STR generates the new theory of matter, results of which are equivalent to the electromagnetic theory of matter.

STR is very simple: it contains two postulates: principle of relativity and postulate of constancy of light speed. The content of postulates of STR is in no way connected with presence or absence of aether or electromagnetic field. These postulates lead directly to the Lorentz transformations. This is sufficient to predict all effects, discovered within the framework of electron theory.

Some scientists and the majority of popularizers asserted on this base that the electron theory of Lorentz was false, since it relies on aether and on the special assumptions.

After being introduced to the work of Einstein, it is possible to ascertain easily that Einstein himself never allowed similar assertions. In his articles there are assertions that within the framework of STR aether is not necessary. There is also an assertion that in nature it is not possible to assign absolute frame of reference. Both assertions are completely correct, but they (for different reasons) do not refute the Lorentz - Larmor theory.

In the theory of Lorentz - Larmor the derivation of the Lorentz transformations is more complex, since the theory uses a more complex system of postulates, and the explanation of effects is here connected with the structure of material bodies and with their interaction with EM aether. During the creation of this theory this was its weak place, since there were no sufficient experimental results, which confirm the theory.

So, in the 19<sup>th</sup> century there were no proofs of the basic assumption (hypothesis), which lies in the basis of electron theory, that the entire matter in nature "consists" of electromagnetic field, and about the fact that "molecular forces are reduced to electrical". The substantiation of these hypotheses required much time and only now we can assert with good reason that they are correct.

The question arises: what connection does exist between STR and electron theory? This connection is revealed, when we attempt to base Einstein's postulates.

Historically Einstein came to the law of relativity on the basis of criticism of the absoluteness of space and time, which was developed by Ernst Mach, and also on the basis of the work of Poincaré, who was the first who formulated the relativity principle ([http://en.wikipedia.org/wiki/Principle\\_of\\_relativity](http://en.wikipedia.org/wiki/Principle_of_relativity)):

*“Joseph Larmor and Hendrik Lorentz discovered that Maxwell's equations, the cornerstone of electromagnetism, were invariant only by a certain change of time and length units...*

*In their 1905 papers on electrodynamics, Henri Poincaré and Albert Einstein explained that with the Lorentz transformations the relativity principle holds perfectly. Einstein elevated the (special) principle of relativity to a postulate of the theory and derived the Lorentz transformations from this principle combined with the principle of the independence of the speed of light (in vacuum) from the motion of the source. These two principles were reconciled with each other (in Einstein's treatment, though not in Poincaré's) by a re-examination of the fundamental meanings of space and time intervals”.*

It is not difficult to see that the law of relativity occurs due to the fulfillment of the effects of a change in the sizes and own time of bodies, which move relatively to ether. In other words, the substantiation of STR principles lies in the electronic theory of Lorentz and others.

Another question concerns the need for principles of STR in nature. It is possible to see that in the case of the nonfulfillment of these principles (or else: if the effects of a change in the sizes and time are absent), then in each inertially moving system the laws of nature must differ.

As we noted in previous chapter, the selection of the system of postulates of any theory is ambiguous, but this does not witness the inaccuracy of one or the other theory, if they lead to the same results (Lorentz, 1916):

*“§194. I cannot speak here of the many highly interesting applications which Einstein has made of this principle. His results concerning electromagnetic and optical phenomena... agree in the main with those which we have obtained in the preceding pages; the chief difference being that Einstein simply postulates what we have deduced, with some difficulty and not altogether satisfactorily, from the fundamental equations of the electromagnetic field. By doing so, he may certainly take credit for making us see in the negative result of experiments like those of Michelson, Rayleigh and Brace, not a fortuitous compensation of opposing effects, but the manifestation of a general and fundamental principle.”*

Thus the contradictions between the electromagnetic theory of matter of Lorentz and STR of Einstein do not exist. In STR the EM aether is seemingly one of the inertial reference systems, which cannot be chosen with experiments, i.e., it can be considered as an absolute frame of reference.

A. Einstein (Einstein, 1920) in his speech “Aether and the theory of relativity” pronounced on May 5, 1920 at the Leyden university, emphasized that **at this prerequisite** the existence of electromagnetic aether does not contradict the special theory of relativity .

*“The next position which it was possible to take up in face of this state of things appeared to be the following. The aether does not exist at all....*

***More careful reflection teaches us, however, that the special theory of relativity does not compel us to deny aether.** We may assume the existence of an aether; only we must give up ascribing a definite state of motion to it...*

*The special theory of relativity forbids us to assume the aether to consist of particles observable through time, but the hypothesis of aether in itself is not in conflict with the special theory of relativity. Only we must be on our guard against ascribing a state of motion to the aether.*

*The electromagnetic fields appear as ultimate, irreducible realities, and at first it seems superfluous to postulate a homogeneous, isotropic aether-medium, and to envisage electromagnetic fields as states of this medium.*



*But on the other hand there is a weighty argument to be adduced in favour of the aether hypothesis. To deny the aether is ultimately to assume that empty space has no physical qualities whatever. The fundamental facts of mechanics do not harmonize with this view...*

*According to our present conceptions the elementary particles of matter are also, in their essence, nothing else than condensations of the electromagnetic field...»*

The absence of contradictions between these two theories (the Lorentz electron theory and STR of Einstein) was already understood by the contemporaries of Einstein. This is quote from article of Ehrenfest - friend of Einstein (Ehrenfest, 1913):

*“Einstein's theory, denying aether, requires the same as the aether theory of Lorentz. On this base the observer must, according to Einstein's theory, observe on the moving measuring bar, clock et cetera, the same reductions, time difference et cetera, as according to Lorentz's theory. Let us note in this case that such experimentum crucis, which would solve the dispute in favor of one or the other theory, is principally impossible.”*

Therefore for obtaining the mathematical results we can use both the approaches of Lorentz and of Einstein.

#### 4.0. Electromagnetic wave theory of mass

In the history of physics a theory under this name is absent. But a number of meaningful results, obtained even in the 19<sup>th</sup> century, makes it possible to choose this approach as electromagnetic wave theory of matter.

Wave approach to the organization of matter is much closer to the contemporary field and elementary particles theory, than approaches of electron theory of Lorentz and STR of Einstein, mentioned above. As is known, the contemporary theory of elementary particles (Standard Model) is a wave theory. This means that all elementary particles are wave fields and are described mathematically by different wave equations.

In the Maxwell-Lorentz electromagnetic theory the only existing waves are the electromagnetic waves. At the beginning of the 20<sup>th</sup> century it was revealed that these waves are quantized and consist of particles - the quanta of EM field, i.e. photons; moreover, photons are mass-free particles. Thus, on the basis of the contemporary ideas, the only possibility of the generation of massive particles in the electromagnetic theory is some transformation of photons, as a result of which special massive electromagnetic waves-particles must appear (this approach is close to Higgs's mechanism, see below).

Here we will recall some results of the 19<sup>th</sup> century and estimate them from the results of contemporary theory point of view of the. Because of the dualism wave-particle, we will further examine photon as electromagnetic wave and particle simultaneously.

##### 4.1. Energy and momentum of electromagnetic wave (photon)

The fact that EM wave has an energy and a momentum, it was discovered already into the 19<sup>th</sup> century. The EM wave presses the metallic wall, and also it can revolve a light rotator. By this we can assume that EM wave (photon) has a mass.

For the time average of the pressure of the train of EM waves with area  $s$  and length  $l$ , the following expression (Becker, 1982) is obtained:  $P = \frac{1}{8\pi} (\bar{\mathbf{E}}^2 + \bar{\mathbf{H}}^2) = u$ , where  $u$  is the energy density of EM wave. The important dependence between energy and momentum of wave is already included in this equation. The total momentum, transmitted from EM train to wall will be equal to:  $p = u \cdot s \cdot t$ , where  $t = l/c$  is the time of action of train. Thus, the transmitted momentum is equal to:  $p = u \cdot s \cdot l/c$ . Since the numerator  $u \cdot s \cdot l = \varepsilon$  is the energy of train, we obtain  $p = \varepsilon/c$ . If we assign to EM wave a mass  $m'$ , then it is possible to consider that  $p = m'c$ . In that case we obtain  $m' = \varepsilon/c^2$  - the known relationship of Einstein.

Nevertheless, later it was proven that photon is a mass-free particle in the sense that its rest mass is equal to zero. But if we interpret the collision of EM wave with the wall as the stoppage of EM wave, then it is possible to say that the “stopped” photon acquires mass  $m'$ .

This result led, evidently, to a study of other methods of the “stoppage” of EM waves for the purpose of understanding the origin of mechanical mass of the material bodies (The authors, 2005; see “15. The Mass of a Box Full of Light):

*The experimental confirmation of the pressure of light in 1901 led to new theoretical work. In 1904, Max Abraham computed the pressure produced by radiation upon a moving surface, when the beam of light reaches the surface in a mirror in any angle. Starting from Abraham's results, Friedrich Hasenoehrl (1874-1916) studied the dynamics of a box full of radiation.*

*Imagine a cubic box with perfectly reflecting internal surfaces, full of light. When the box is at rest, the radiation produces equal forces upon all those surfaces. Now, suppose that the box is accelerated, in such a way that one of its surfaces moves in the  $x$  direction. It is possible to prove that, when the radiation inside the box strikes this surface, the pressure will be smaller, and when it strikes the opposite surface, the pressure will be greater, than in the case when the box is at rest (or in uniform motion). Therefore, the radiation inside the box will produce a resultant force against the motion of the box. So, to accelerate a box full of light requires a greater force than to accelerate the same box without light. In other words, the radiation increases the inertia of the box. In the case when the radiation inside the box is isotropic, there is a very simple relation between its total energy  $E$  and its contribution  $m$  to the inertia of the box (Hasenoehrl, 1904; 1905):*

$$m = \frac{4\varepsilon}{3c^2}, \quad (17.4.1)$$

*Note that here, as in the theory of the electron, there appears a numerical factor 4/3. This is not a mistake. The relation between those equations and the famous  $\varepsilon = mc^2$  will be made clear later (Fadner, 1988).*

*Hasenoehrl also computed the change of the radiation energy as the box was accelerated. He proved that the total radiation energy would be a function of the speed of the box. Therefore, when the box is accelerated, part of the work done by the external forces is transformed into the extra radiation energy. Since the inertia of the radiation is proportional to its energy, and since this energy increases with the speed of the box, the inertia of the box will increase with its speed. Of course, if the internal temperature of the box were increased, the radiation energy would augment, and the inertia of the box would also increase. Therefore, Hasenoehrl stated that the mass of a body depends on its kinetic energy and temperature”.*

Some additions can be found in the V. Pauli book (Pauli, 1958):

**“Black-body radiation in a moving cavity.** *This case is of historical interest, since it can be treated entirely on the basis of electrodynamics, without relativity. When this is done, one comes to the inevitable conclusion that a momentum, and thus also' an inertial mass, must be ascribed to the moving radiation energy. It is of interest that this result should have been found by Hasenoehrl [259] already before the theory of relativity had been formulated. Admittedly, his deductions were open to correction on some points. A complete- solution of 'the problem was first given by Mosengeil. [260] Planck [261] derived many of his formulae for the dynamics of moving systems by generalizing Mosengeil's results”.*

Let us conditionally name the totality of EM waves in a box as ‘EM-particle’. From the foresaid above it is obvious that the mass of ‘EM-particle’, calculated according to Lorentz's theory, will also have a coefficient of 4/3 like the mass of classical electron. Obviously, upon consideration of the stresses of Poincare we will obtain the coefficient one. The stresses of Poincare were introduced for the stabilization of the electrostatic field of classical electron. In the case in question the stability exists due to interaction of EM wave with the walls of the box. These



interactions play in this case the role of the stresses of Poincare, which ensure the stability of ‘EM particle’. Naturally, if we take into account the presence of these stresses, we will also obtain the coefficient one (of course this result will also appear, if we use Einstein's approach).

With the perpendicular fall of EM waves on the walls of the box the stress is pressure. With inclined fall the components of stress will formally consist both of pressures and tangent stresses (as a result of the resolution of momentum on perpendicular and tangential components). The stress tensor of Maxwell (and generally, continuous medium tensor) consists precisely of such components. In this example the stresses are not mechanical: EM waves interact with the electrons of the wall atoms by means of EM Lorentz's forces. Nevertheless, these stresses are external with respect to EM waves in the box, i.e., they are not organized by the EM waves themselves.

The question arises: are such conditions possible, when EM wave can ensure themselves the stability of ‘EM-particle’ without the presence of external actions? In this case we will actually have a massive “particle”, generated by EM waves. Obviously, this case can be realized only as a result of the self-interaction of parts of EM waves. This means that the equation of EM wave-particle must be nonlinear.

We can improve our model for the purpose to do approach the quantum field theory. Let us select a box with mirror walls of the size of the order of a wavelength  $\lambda$ . If we consider resonance conditions, the box itself will select the appropriate wavelength. This corresponds to the case when we placed into this box one photon. In the case of quantum theory we can speak about the photon in a cell of phase size. If we ignore the presence of walls, it is possible to consider photon in the box as particle. This particle possesses spin one and mass, determined by its energy  $m' = \varepsilon/c^2 = \hbar/\lambda c$ . In other words, we have a model of the neutral massive boson, similar to intermediate boson.

The mathematical description of this model in the classical case can be given on the basis of the theory of waveguides and resonators (Crawford Jr., 1968; Broglie, 1941). As is known, the motion of waves is determined by the dispersion equation (or by another dispersion relationship).

Dispersion equation is the relationship, which connects angular frequencies  $\omega$  and wave vectors  $k$  of natural harmonic waves (normal waves) in linear uniform systems: continuous media, waveguides, transmission lines and others. Dispersion equation is written in the form  $\omega = \omega(k)$ .

Dispersion equations are the consequence of the dynamic (in the general case integrodifferential) equations of motion and of boundary conditions. And also, vice versa, on the base of the form of dispersion equation the dynamic equations of processes can be restored with the replacement:

$$i\omega \rightarrow \frac{\partial}{\partial t}, \quad ik_x \rightarrow -\frac{\partial}{\partial x}, \quad \frac{1}{i\omega} \rightarrow \int (\dots) dt, \quad \frac{1}{ik_x} \rightarrow \int (\dots) dx, \quad (17.4.2)$$

It is easy to obtain the dispersion equation for the infinite wave without any limiting conditions,  $\vec{\Phi} = \vec{\Phi}_0 e^{-i(\omega t - ky)}$ , using the homogeneous wave equation:

$$\left( \frac{\partial^2}{\partial t^2} - c^2 \vec{\nabla}^2 \right) \vec{\Phi} = 0, \quad (17.4.3)$$

where  $\vec{\Phi}$  are in our case any vector components of electrical and magnetic field. Putting this solution, we obtain  $\omega^2 - \nu^2 k^2 = 0$  or  $\omega = \nu \cdot k$ .

In the case of the presence of limitations, superimposed on the wave by medium or by it self, the equation becomes heterogeneous:

$$\left( \frac{\partial^2}{\partial t^2} - c^2 \vec{\nabla}^2 \right) \vec{\Phi} = \vec{\Phi}_0, \quad (17.4.4)$$

where  $\vec{\Phi}_0$  is certain function of the electromagnetic fields. In this case dispersion relationship becomes more complex: new terms are introduced and its linearity is disrupted.

The same relationship dispersion equation:

$$\omega^2 = \omega_0^2 + \nu^2 k^2, \quad (17.4.5)$$

can correspond to: 1) EM waves in the isotropic plasma; 2) plasma waves; 3) waves in the waveguides; 4) waves in the acoustic waveguides; 5) elementary particle in relativistic wave mechanics ( $\nu = c$ ,  $\omega_0 = m_0 c^2 / \hbar$ ,  $m_0$  is rest mass).

In the latter case the discussion deals with de Broglie wave dispersion relation. Energy, momentum, and mass of particles are connected through the relativistic relation

$$\varepsilon^2 = (m_0 c^2)^2 + (pc)^2, \quad (17.4.6)$$

Elementary particles, atomic nuclei, atoms, and even molecules behave in some context as matter waves. According to the de Broglie relations, their kinetic energy  $\varepsilon$  can be expressed as a frequency  $\omega$ :  $\varepsilon = \hbar \omega$ , and their momentum  $p$  as a wave number  $k$ :  $p = \hbar k$ .

(Broglie, 1941): “The relationships, obtained for EM wave in a waveguides or in a box, are completely analogous to those, which exist in wave mechanics, in which the rectilinear and uniform particle motion with the rest mass  $m_0$  depicts in the form of propagation of plane simple harmonic wave  $\psi = \psi_0 e^{i(\omega t - kr)}$ .”

As we noted,  $\omega = ck$  corresponds to the propagation of EM wave in the vacuum. But if EM wave is in the waveguide, then between  $\omega$  and  $k$  we have the relationship (17.4.6), where  $\omega_0$  is different from zero and it is equal to one of its eigenvalues, which correspond to the form of the waveguide in question. From the point of view of wave mechanics everything happens as if the photon had its own mass, determined by the form of waveguide and by the eigenvalue  $\omega_{0i} = m_{0i} / \hbar$ . Thus, it is possible to say that in this waveguide the photon can possess a series of possible own masses”.

From a contemporary point of view we can interpret the appearance of photon mass as follows. A photon, until its entry into a waveguide or resonator, obeys to the linear equation

$$\left( \Delta - \frac{1}{c^2} \frac{\partial^2}{\partial t^2} \right) \vec{\Phi} \equiv \sum_{\nu} \frac{\partial^2}{\partial x_{\nu}^2} \vec{\Phi} \equiv \partial_{\nu} \partial^{\nu} \vec{\Phi} = 0, \quad (17.4.7)$$

Lagrangian of which

$$L = \frac{1}{2} \left\{ \left( \frac{\partial \vec{\Phi}}{\partial t} \right)^2 - c^2 (\vec{\nabla} \vec{\Phi})^2 \right\} \equiv \frac{1}{2} c^2 \sum_{\nu} \left( \frac{\partial \vec{\Phi}}{\partial x_{\nu}} \right)^2 \equiv \partial_{\nu} \vec{\Phi} \partial^{\nu} \vec{\Phi}, \quad (17.4.8)$$

describes the mass-free field. After entry to a box the photon experiences a certain spontaneous transformation and becomes massive particle. Each component of the field of this massive particle obeys to Klein-Gordon wave equation (Wentzel, 2003):

$$\left( \Delta - \frac{1}{c^2} \frac{\partial^2}{\partial t^2} - m^2 \right) \vec{\Phi} \equiv \left( \sum_{\nu} \frac{\partial^2}{\partial x_{\nu}^2} - m^2 \right) \vec{\Phi} \equiv (\partial_{\nu} \partial^{\nu} - m^2) \vec{\Phi} = 0, \quad (17.4.9)$$

This is achieved by choosing the following, evidently Lorentz-invariant Lagrangian:

$$L = \frac{1}{2} \left\{ \left( \frac{\partial \vec{\Phi}}{\partial t} \right)^2 - c^2 (\vec{\nabla} \vec{\Phi})^2 - c^2 m^2 \vec{\Phi}^2 \right\} \equiv -\frac{1}{2} c^2 \left\{ \sum_{\nu} \left( \frac{\partial \vec{\Phi}}{\partial x_{\nu}} \right)^2 + m^2 \vec{\Phi} \vec{\Phi}^+ \right\} \equiv \partial_{\nu} \vec{\Phi} \partial^{\nu} \vec{\Phi} - c^2 m^2 \vec{\Phi}^2 \quad (17.4.10)$$

This transformation has some common features with Higgs's mechanism, to the examination of which we will pass.

## 5.0. From electromagnetic aether to the physical vacuum and from the latter to Higgs's vacuum

### 5.1. Idea of electromagnetic aether

From the times of Faraday and Maxwell the existence of the equations, which describe the electromagnetic field, is the consequence of the existence of a certain medium - electromagnetic aether (EME), motions of which are described by Maxwell's equations without charges and currents (Lorentz, 1933; Bateman, 1915; Richardson, 1916; etc).

(Bateman, 1915; see “Ch. I. 1. The fundamental equations for free aether).

*In Maxwell's electromagnetic theory the state of the aether in the vicinity of a point  $(x, y, z)$  at time  $t$  is specified by means of two vectors  $E$  and  $H$  which satisfy the circuital relations*

$$\text{rot}\vec{H} = \frac{1}{c} \frac{\partial \vec{E}}{\partial t}, \quad \text{rot}\vec{E} = -\frac{1}{c} \frac{\partial \vec{H}}{\partial t}, \quad (17.5.1)$$

*and the solenoidal or sourceless conditions*

$$\text{div}\vec{E} = 0, \quad \text{div}\vec{H} = 0, \quad (17.5.1)$$

As we know, for such – electromagnetic - aether the Lorentz transformations are valid. The question about the mathematical description of aether as a certain continuous medium, came up from the early times. But it is obvious that the use of Maxwell's electrodynamics for the derivation of equations of EMA is illogical. This would indicate the change of places of cause and effect. In the sequential theory we must first describe the medium – i.e., EME, and on this base derive Maxwell's equations as the equations of its motion. Physicists of classical epoch attempted to do specifically this during the 19<sup>th</sup> century.

But according to Maxwell's equations the structure of EM field is very complex: here exist field rotations, the mutual perpendicularity of the vectors of field, different polarization and many others. The medium, which must generate these effects, does not exist among known classical continuous media (gas, liquid, plasma, electrolyte, crystal and the like). Therefore the invention of such medium, in which Maxwell's equations can “exist”, was not successful.

Most suitable proved to be the hypothetical medium with rotatory elasticity, proposed by McCullagh and then modeled by William Thomson (Lord Kelvin). The equations of motion of this medium were identical to Maxwell's equations. But investigations in this direction were stopped after the appearance of QM. Only in the middle of 20<sup>th</sup> century the theory of a medium arose, which replaced aether, as the basis of existence of elementary particles; this was the theory of physical vacuum.

The history of the development of ideas in this area is presented in many courses of the physics history (Whittaker, 1910; Kudryavtsev, 1971; Spasskiy, 1977), and we will not stop on this question. Let us give only several quotations of the last survey work in this area of Oliver Lodge (Lodge, 1909), which sum up the results of the electromagnetic theory of matter:

*“The problem of the constitution of the Aether, and of the way in which portions of it are modified to form the atoms or other constituent units of ordinary matter, has not yet been solved...*

*Meanwhile there are few physicists who will dissent from Clerk-Maxwell's penultimate sentence in the article "Aether," of which the beginning has already been quoted: “Whatever difficulties we may have in forming a consistent idea of the constitution of the aether, there can be no doubt that the interplanetary and interstellar spaces are not empty, but are occupied by a material substance or body, which is certainly the largest, and probably the most uniform body of which we have any knowledge.”...*

*But now comes the question, how is it possible for matter to be composed of aether? How is it possible for a solid to be made out of fluid? A solid possesses the properties of rigidity, impenetrability, elasticity, and such like; how can these be imitated by a perfect fluid such as the aether must be?*

*The answer is: they can be imitated by a fluid in motion; a statement which we make with confidence as the result of a great part of Lord Kelvin's work...*

*A vortex-ring, ejected from an elliptical orifice, oscillates about the stable circular form, as an india-rubber ring would do; thus furnishing a beautiful example of kinetic elasticity, and showing us clearly a fluid displaying some of the properties of a solid...*

*A still further example is Lord Kelvin's model of a spring balance, made of nothing but rigid bodies in spinning motion. This arrangement utilises the processional movement of balanced gyrostats — concealed in a case and supporting a book — to imitate the behaviour of a spiral spring, if it were used to support the same book...*

*If the aether can be set spinning, therefore, we may have some hope of making it imitate the properties of matter, or even of constructing matter by its aid.*

*The estimates of this book, and of Modern Views of Electricity, are that the aether of space is a continuous, incompressible, stationary fundamental substance...*

*The aether inside matter is just as dense as the aether outside, and no denser. A material unit — say, an electron — is only a peculiarity or singularity of some kind in the aether itself, which is of perfectly uniform density everywhere. What we "sense" as matter is an aggregate or grouping of an enormous number of such units.*

*The elasticity of the aether, ... if this is due to intrinsic turbulence, the speed of the whirling or rotational elasticity must be of the same order as the velocity of light...*

*The three vectors at right angles to each other, which may be labeled Current, Magnetism and Motion respectively or more generally  $\vec{E}$ ,  $\vec{H}$  and  $\vec{v}$ , represent the quite fundamental relation between aether and matter, and constitute the link between Electricity, Magnetism and Mechanics. Where any two of these are present, the third is necessary consequence".*

## **5.2. Representation of classical EM field in the form of oscillators (canonical representation of classical EM field according to Hamilton)**

Maybe it is strange, but the push to mathematical analysis of the structure of electromagnetic aether (EMA) was given by the investigation of the structure of "quantum aether" - electromagnetic physical vacuum (Dirac, 1927; Fermi, 1932; and others). As one would expect, these representations are not based on a strict axiomatics, but they contain a number of hypotheses. It is possible to say that these researches are not the construction of the theory of aether, but the "reconstruction" of its model on the basis of the equations of EM waves, which are propagated in it.

(Feynman, 1948): *In classical electrodynamics the fields describing, for instance, the interaction of two particles can be represented as a set of oscillators. The equations of motion of these oscillators may be solved and the oscillators essentially eliminated (Lienard and Wiechert potentials).*

(Thus, the discrete continuum of particles-oscillators is changed here by the continuum of field, expressed through the potentials; but obviously, it is possible to express it also through the field strengths).

*The interactions which result involve relationships of the motion of one particle at one time, and of the other particle at another time. In quantum electrodynamics the field is again represented as a set of oscillators. But the motion of the oscillators cannot be worked out and the oscillators eliminated.*

Let us present without details the principles of the theory of physical vacuum in the quantum field theory (Landau and Lifshitz, 1975; Levich et al., 1973; Martynenko, 2001). The theory consists of two parts: 1) the theory of electromagnetic aether, and 2) the theory of the quantization of EM aether, which leads to the physical vacuum. Let us examine them in this sequence.

*"Let us examine electromagnetic (EM) field in space  $\tau$  without charges. The energy of EM field in this space is:*

$$\varepsilon = \frac{1}{8\pi} \int_{\tau} (\vec{E}^2 + \vec{H}^2) d\tau, \quad (17.5.1)$$

*where the strengths of EM field  $\vec{E}, \vec{H}$  can be expressed through the vector potential:*

$$\vec{E} = -\frac{1}{c} \frac{\partial \vec{A}}{\partial t} = -\frac{1}{c} \dot{\vec{A}}_{\vec{k}}, \quad \vec{H} = \text{rot } \vec{A}, \quad (17.5.2)$$

Expanding the vector potential on the plane waves

$$\vec{A} = \sum_k \left( \vec{A}_{\vec{k}} e^{i\vec{k}\vec{r}} + \vec{A}_{\vec{k}}^* e^{-i\vec{k}\vec{r}} \right), \quad (17.5.3)$$

we obtain for the energy of EM field the following expression:

$$\varepsilon = \sum_k \left( \frac{|\dot{\vec{A}}_{\vec{k}}|^2}{8\pi c^2} + \frac{\vec{k}^2 |\vec{A}_{\vec{k}}|^2}{8\pi} \right), \quad (17.5.4)$$

Thus, the total energy of the EM field can be represented as the sum of energies of harmonic oscillators. Value  $\vec{A}_{\vec{k}}$  plays here the role of coordinate  $q_{\vec{k}}$ ;  $\dot{\vec{A}}_{\vec{k}}$  - the role of speed  $v_{\vec{k}}$ ;  $1/4\pi c^2$  - of mass of harmonic oscillator;  $\omega_{\vec{k}} = \sqrt{\beta/m} = ck$  are the frequencies of oscillators (here  $\beta = k^2/4\pi$ ). In this case the product of “mass” to “speed” corresponds to the momentum of oscillator  $p_{\vec{k}}$ . In this sense, the first term in (17.5.4) is kinetic electromagnetic energy, and the second – potential energy.

Thus, the EM field in space without charges can be considered as the sum of independent harmonic oscillators with all possible values of wave vector  $\vec{k}$ .

In these designations (Levich et al., 1973) the energy of field can be written down in the form

$$\varepsilon = \frac{1}{2} \sum_k (p_k^2 + \omega_k^2 q_k^2), \quad (17.5.5)$$

It is interesting to note that the medium, proposed by lord Kelvin and others as EMA (see above the quote from book of Lodge (Lodge, 1909)), also consists of free oscillators: the rotating elements of this medium, which can be considered as mechanical, can be described by harmonics  $e^{i\vec{k}\vec{r}}$ .

Let us note, that everything that we presented above is the classical theory of electromagnetic field.

Thus (Levich et al., 1973), the electromagnetic field in its final volume is formally equivalent to mechanical system with an infinitely large, but enumerable number of degrees of freedom, i.e., the collection of the field oscillators. In this case the equations of field are equivalent to Hamiltonian equations of motion of the field oscillators. Frequently the Hamilton function of the equivalent system of oscillators is simply named as Hamiltonian function of field, and the expansion of vector (17.3) – as field expansion to the oscillators.

Let us focus on the fact that at present the passage to the canonical form is most frequently accomplished with the use of potentials. Because of the important role of gauge transformations in contemporary physics, the form of the wave function in the form of potential was affirmed in the field theory as preferred. In reality the same transformations can be produced, using the field strengths (for example, see (Goldstein and Zernov, 1971))

How should the possibility of the representation of the EM field be interpreted in the form of oscillators? Obviously, it is possible to consider that the field expansion to the oscillators has a nature of computational method, since within the framework of classical electrodynamics the oscillators of field cannot be connected with any particles, because do not take into account the quantization of field. The importance of this decomposition was revealed in the quantum theory of electromagnetic field. This makes it possible to assert that quantized aether of classical electrodynamics is the physical vacuum of the quantum field theory.

### 5.3. Quantization of the electromagnetic field. Quantum field theory

At the basis of the quantum theory of EM field lies (Levich et al., 1973) “*the assumption that this analogy is possible to be given the direct physical content*”. Specifically, it is assumed that the real EM field presents the quantum system, which is obeyed to the usual laws of quantum mechanics.

EM aether is electromagnetic field in the lower energy level. Therefore it can be quantized just as the electromagnetic field.

For the passage from the classical description to the quantum it is necessary to replace classical characteristics with quantum operators.

The quantum operator Hamilton is obtained from (17.5.5) by the usual replacement of the mechanical values of generalized coordinates and momentums by the corresponding quantum operators  $\hat{p}_\lambda$  and  $\hat{q}_\lambda$ , which must obey to the known commutation relationships:

$$\begin{aligned} \hat{q}_\mu \hat{p}_\lambda - \hat{p}_\lambda \hat{q}_\mu &= i\hbar \delta_{\lambda\mu} \\ \hat{q}_\mu \hat{q}_\lambda - \hat{q}_\lambda \hat{q}_\mu &= 0, \hat{p}_\mu \hat{p}_\lambda - \hat{p}_\lambda \hat{p}_\mu = 0 \end{aligned} \quad (17.5.6)$$

This representation is possible according to the fact (Gottfried and Weisskopf, 1984), that the electrical  $\vec{E}$  and magnetic  $\vec{H}$  fields obey to commutation relationships of the same type as operators  $\hat{q}$  and  $\hat{p}$ . Actually (Shirkov and Belokurov, 1991), “*An important role in understanding of the physical sense of the quantized field of emission played the work of N. Bohr and L. Rosenfeld (Bohr and Rosenfeld, 1933; Engl. trans.: 1979), which showed that between the strengths of electrical and magnetic field exist the uncertainty principles, similar to the Heisenberg relationships between the coordinate and the momentum. Therefore, for example, it is not possible simultaneously to measure accurately the x component of the strength of electric field and y - and z -components of the strength of magnetic field*”.

Let us (Levich et al., 1973) apply now the laws of quantum mechanics to the system in question. In quantum mechanics the oscillator can be found only in the states with discrete values of the energy:

$$\varepsilon = \sum_k \left( n_{\vec{k}} + \frac{1}{2} \right) \hbar \omega_{\vec{k}}, \quad (17.5.7)$$

where  $n_{\vec{k}}$  is the number of quanta of EM field (i.e., of photons) with the wave vector  $\vec{k}$ . The basic (vacuum) state of EM field is characterized by the absence of real photons at  $n_{\vec{k}} = 0$ . In this case the energy of EM field occurs to be an infinite value:

$$\varepsilon_0 = \frac{\hbar}{2} \sum_k \omega_{\vec{k}}, \quad (17.5.8)$$

In the quantum field theory all observed energies are counted from the energy of vacuum  $\varepsilon_0$ . In practice this is reduced to the subtraction  $\varepsilon_0$  from all values in question. In particular, for the vacuum of EM field the observed energy is equal to 0. Average values of electrical and magnetic field in the vacuum state are equal to 0, but average values from the squares of these values are different from zero, which leads to the consequences observed during the experiment (see below). This means that EM fields in the vacuum are oscillated. These fluctuations are called the zero point oscillations of EM field.

The said testifies that vacuum should be understood as the field in one of its states, i.e., as a certain matter system. On this base (Wilczek, 1999) “*Following Einstein, Paul Dirac (1902-1984) then showed that photons emerged as a logical consequence of applying the rules of quantum mechanics to Maxwell's electromagnetic aether. This connection was soon generalized so that particles of any sort could be represented as the small-amplitude excitations of quantum fields. Electrons, for example, can be regarded as excitations of an electron field, an aether that pervades all space and time uniformly. Our current and extremely successful theories of the*

*strong, electromagnetic, and weak forces are formulated as relativistic quantum field theories with local interactions.*"

Thus (Levich et al., 1973), from the point of view of contemporary electrodynamics "emptiness", i.e., the absence of elementary particles and photons, is not "nothing", but is a specific state of field, named physical vacuum.

#### **5.4. Experimental proofs of existence of quantized electromagnetic aether**

The indicated representation of the field in the form of oscillators gives the theoretical predictions, which describe well some thin effects of interaction of electron with EM aether both in classical and quantum physics.

Unfortunately, as Feynman noted, "*In quantum electrodynamics the field is again represented as a set of oscillators. But the motion of the oscillators cannot be worked out and the oscillators eliminated*", which leads to the known infinities. Bethe (Bethe, 1947) managed to overcome these, proposing the procedure of renormalization with the necessity of subtracting two infinite terms.

Although the operation of renormalization leads to very accurate calculated results, as it was noted by many scientists (for example, by Feynman), the operation of renormalization is not correct.

If we use an idea of the particles as of the oscillators of EM field with limited sizes, in many incidents it is possible to calculate the same values without the renormalization. Let us give briefly some examples.

We will use the book: (Levich et al., 1973), and also the article by Th. Welton (Welton, 1948).

In particularity, the phenomenon of Lamb displacement gives an illustrative example of the correctness of those ideas, which were assumed as the basis of the quantum theory of emission and positron theory (Welton, 1948):

*"An intuitive explanation is given for the electromagnetic shift of energy levels by calculating the mean square amplitude of oscillation of an electron coupled to the zero-point fluctuations of the electromagnetic field.*

##### **II. The mean square fluctuation in position of a free electron**

*Our starting point is the observation that the quantum-mechanical zero-point variation of the radiation field in empty space gives rise to fluctuating electric and magnetic fields whose mean square values at a point in space are given by the well-known relation*

$$\langle E_{0\omega}^2 \rangle = \langle H_{0\omega}^2 \rangle = \frac{2\hbar c}{\pi} \int_0^\infty k^3 dk, \quad (17.5.9)$$

*In this equation the variable  $k$  refers to the wave number of a quantum, and the contribution to the mean square fluctuation arising from frequencies in the range  $cdk$  is therefore explicitly displayed.*

*Equation (17.5.9) can be simply derived by ascribing to every normal mode of the radiation field an energy which is just the zero-point energy for an oscillator with the frequency of the normal mode. The total energy can be written either as the volume integral of the ordinary electromagnetic energy density or as a sum over normal modes, and Eq. (17.5.9) merely states the equality of these two forms.*

*It will now be assumed that an otherwise free electron is acted on by these fluctuating fields. The electron will be assumed to move with non-relativistic velocities so that if  $\vec{r}$  is its position vector, the equation of motion is*

$$m \frac{d^2 \vec{r}}{dt^2} = e \vec{E}, \quad (17.5.10)$$

*The vector  $\vec{E}$  is the fluctuating field specified by (17.5.9), Since Eq. (17.5.10) is linear, we can regard it as a classical equation for the quantum-mechanical expectation value of  $\vec{r}$ . For a given harmonic component of  $\vec{E}$  the solution of (17.5.10) is obvious. We perform this integration, find*



the resulting value of  $\langle (\Delta r^2) \rangle$  and sum over frequencies using (1). We then obtain a quantity  $\langle (\Delta r^2) \rangle$ , defined as the mean square fluctuation in position of a free electron

$$\langle (\Delta r^2) \rangle = \frac{2}{\pi} \frac{e^2}{\hbar c} \left( \frac{\hbar}{mc} \right)^2 \int_{k_0}^{\infty} \frac{dk}{k}, \quad (17.5.11)$$

Consider the motion of an electron in a static field of force specified by a potential energy  $V(\vec{r})$ . The coordinates of the electron consist of two parts: the smooth part  $\vec{r}$  and the random part  $\Delta \vec{r}$ . The instantaneous potential energy is then given by

$$V(r + \Delta r) = \left[ 1 + \Delta r \cdot \vec{\nabla} + \frac{1}{2} (\Delta r \cdot \vec{\nabla})^2 + \dots \right] V(r), \quad (17.5.12)$$

The effective potential energy in which the particle moves will just be the average of (5) over all values of  $\Delta r$ . Remembering that  $\Delta r$  has an isotropic spatial distribution, we obtain

$$\langle V(r + \Delta r) \rangle = \left[ 1 + \frac{1}{6} \langle (\Delta r)^2 \rangle \vec{\nabla}^2 + \dots \right] V(r), \quad (17.5.13)$$

(With the correct selection of the upper and lower limits of integration in (17.5.11) ) we thus see that the existence of the position fluctuation of the electron will effectively modify the potential in which it moves by the addition of a term proportional to the Laplacian of the potential energy...

The magnitude of this mean square fluctuation in position will be very small for any reasonable  $kt$ , but an observable effect will arise when the electron moves in a potential with a large curvature."

Also Welton examined with success the several simple processes involving the interaction of electrons with other particles and electron radiation (Lamb shift, low energy Compton scattering, the interaction between a spin and a magnetic field):

"For example, in the case of the **Lamb shift** the correction to the energy of a stationary state of the atom with wave function  $\psi(\vec{r})$  will be

$$\Delta \varepsilon = \frac{4e}{3} \frac{e^2}{\hbar c} \left( \frac{\hbar}{mc} \right)^2 \ln \frac{mc^2}{\hbar c k_0} |\psi(0)|^2, \quad (17.5.13)$$

This expression will be recognized as identical with the expression derived by Bethe for the level shift. The quantity  $\hbar c k_0$  should clearly be taken equal to the average excitation energy (17.8Ry) (Ry - Rydbergs) introduced by Bethe, (Bethe, 1947) ] in order to obtain approximate agreement with the experimental result of Lamb....

The derivation just given has some attractive features. It gives a convergent result for the physically meaningful part of the reaction of the field on the electron, without the necessity of subtracting two infinite terms."

## 6.0. Higgs's mechanism of mass generation

### 6.1. Basic principles

"Einstein first purified, and then enthroned, the aether concept. As the 20th century has progressed, its role in fundamental physics has only expanded. At present, renamed and thinly disguised, it dominates the accepted laws of physics." Frank Wilczek. The Persistence of Ether. (Physics Today, 52, 11-13, January 1999) [http://xserver2.lns.mit.edu/~csuggs/physics\\_today/wilczekpubs.html](http://xserver2.lns.mit.edu/~csuggs/physics_today/wilczekpubs.html)

The concept that what we ordinarily perceive as empty space is in fact a complicated medium is a profound and pervasive theme in modern physics. This invisible inescapable medium alters the behavior of the matter that we do see. Just as Earth's gravitational field allows us to select a unique direction as up, and thereby locally reduces the symmetry of the



*underlying equations of physics, so cosmic fields in "empty" space lower the symmetry of these fundamental equations everywhere. For although this concept of a symmetry-breaking aether has been extremely fruitful (and has been demonstrated indirectly in many ways), the ultimate demonstration of its validity --cleaning out the medium and restoring the pristine symmetry of the equations -- has never been achieved: that is, perhaps, until now.*

Frank Wilczek. High-energy physics: An emptier emptiness? *Nature*, **435**, 152-153 (12 May 2005) <http://scienceweek.com/2005/sw050708-6.htm>

In the classical field theory the appearance of mass is not directly connected with the interaction of elementary particles with the physical vacuum. The generation of mass occurs here as a result of interaction of the particle field with itself. If we speak about the influence of physical vacuum on the energy states of the connected particles (for example, electron with proton in the hydrogen atom), then the discussion here only deals with the correction of the energy of electron. A similar influence on free particles is not noted.

In a different way a mass is introduced in the Standard Model. In the SM the physical vacuum is used for the particles mass generation description, which the Nobel laureate Frank Wilczek also calls aether, and which consists of the oscillators of scalar massive boson field - Higgs's field.

In order to explain, which is the reason why this way of introduction of mass was selected and how this is realized, let us briefly examine, what is interaction of particle with vacuum and how the mechanism of the generation of mass in SM works.

*"It is assumed (Practicum, 2004) in Standard Model that besides fields of particles, an additional field exists, which is practically separated from the empty space. It is conventionally named as Higgs's field. It is considered that entire space is filled with this field and that particles acquire mass by interaction with it. Those of them, which strongly interact with Higgs's field, are heavy particles, and weakly interacting particles are light. This effect is analogous to the effect of the motion of a body in a viscous fluid, when due to interaction with the liquid, it acquires additional effective mass. One additional example is electron in a crystal. Because of electromagnetic interaction with the atoms of crystal lattice the electron acquires an effective mass, different from the mass of free electron."*

*"The theory (Ivanov, 2007, 2007a) is based on the specific symmetry between the electromagnetic and weak interactions - electro-weak symmetry. It is considered that this symmetry was in the early universe and because of it the particles were mass-free. But symmetry was spontaneously destroyed in some stage of evolutions, and particles acquired mass, since we know from the experience that in our world these particles are massive. Higgs mechanism is exactly that driving force, which disrupts this symmetry.*

*This happens in the following way. In the quantum theory all particles are the quanta, which are oscillated "pieces" of field. For example, electrons are the oscillations of electron field, photons are oscillations of electromagnetic field, and so forth. Each field has a state with lowest energy, called "vacuum" of this field. For the usual particles the vacuum exists when particles are absent, i.e., when their field is everywhere equal to zero. If particles are present (i.e., field is not everywhere equal to zero), then this state of field possesses more energy, than vacuum.*

*But Higgs field is special: it has the non-zero vacuum. In other words, the state with the lowest energy of Higgs field is when the entire space is filled by the Higgs field of some energy or (which is the same thing) mass. Other particles also move in this background. The oscillations of Higgs field relative to "vacuum average" are the quanta of Higgs field, i.e., Higgs bosons.*

*The presence of background Higgs field affects the particle motion by a strictly defined means: it hampers particle acceleration, but it does not prevent their uniform motion. Particles become more inert, in other words, mass appears in them. However, some particles, for example photons, do not interact directly with the Higgs field and remain mass-free... "*

The mathematical procedure of the mass generation according to Higgs's mechanism is presented in many books and papers (see for example, (Dawson, 1999)). We will use recent survey that contains briefly all elements of this theory (Quigg, 2007).

## 6.2. Origin of mass in Standard Model

Mass remained an essence—part of the nature of things—for more than two centuries, until Abraham (1903) and Lorentz (1904) sought to interpret the electron mass as electromagnetic self-energy... Our modern conception of mass has its roots in Einstein's pregnant question: 'Does the inertia of a body depend upon its energy content?' and his powerful conclusion, "The mass of a body is a measure of its energy content; if the energy changes by  $L$ , the mass changes in the same sense by  $[L/c^2]$ , where  $c$  is the speed of light". Mass is rest energy... Among the virtues of identifying mass as  $m = \varepsilon_0/c^2$ , where  $\varepsilon_0$  designates the body's rest energy, is that mass, so understood, is a Lorentz-invariant quantity, given in any frame as

$$m = (1/c^2) \sqrt{\varepsilon^2 - p^2 c^2}, \quad (17.6.1).$$

But not only is Einstein's a precise definition of mass, it invites us to consider the origins of mass by coming to terms with a body's rest energy.

## 6.3. Sources of mass in the electroweak theory

We build the standard model of particle physics on a set of constituents that we regard provisionally as elementary: the quarks and leptons, fundamental forces derived from gauge symmetries. The quarks are influenced by the strong interaction, and so carry colour, the strong-interaction charge, whereas the leptons do not feel the strong interaction and are colourless. We idealize the quarks and leptons as pointlike, because they show no evidence of internal structure at the current limit of our resolution ( $r \leq 10^{-18}$  m). The charged-current weak interaction responsible for radioactive beta decay and other processes acts only on the left-handed fermions. Whether the observed parity violation reflects a fundamental asymmetry in the laws of Nature, or a left-right symmetry that is hidden by circumstance and might be restored at higher energies, we do not know.

The electroweak theory<sup>4</sup> (like QCD) is a gauge theory, in which interactions follow from symmetries. Already in the 1930s, Fermi and Klein proposed descriptions of the weak interaction in analogy to the emerging theory of quantum electrodynamics (QED). The correct electroweak gauge symmetry, which melds the  $SU(2)_L$  family (weak-isospin) symmetry suggested by the left-handed doublets of figure 1 with a  $U(1)_Y$  weak-hypercharge phase symmetry, emerged through trial and error, guided by experiment. We characterize the  $SU(2)_L \otimes U(1)_Y$  theory by the left-handed quarks

$$\mathbf{L}_q^{(2)} = \begin{pmatrix} c \\ s \end{pmatrix}_L, \quad \mathbf{L}_q^{(3)} = \begin{pmatrix} t \\ b \end{pmatrix}_L, \quad (17.6.2)$$

with weak isospin  $I = 1/2$  and weak hypercharge  $Y(\mathbf{L}_q) = 1/3$ ; their right-handed weak-isoscalar counterparts

$$\mathbf{R}_u^{(1,2,3)} = u_R, c_R, t_R \quad \text{and} \quad \mathbf{R}_d^{(1,2,3)} = d_R, s_R, b_R, \quad (17.6.3)$$

with weak hypercharges  $Y(\mathbf{R}_u) = 4/3$  and  $Y(\mathbf{R}_d) = -2/3$ ; the left-handed leptons

$$\mathbf{L}_e = \begin{pmatrix} \nu_e \\ e^- \end{pmatrix}_L, \quad \mathbf{L}_\mu = \begin{pmatrix} \nu_\mu \\ \mu^- \end{pmatrix}_L, \quad \mathbf{L}_\tau = \begin{pmatrix} \nu_\tau \\ \tau^- \end{pmatrix}_L, \quad (17.6.4)$$

with weak isospin  $I = 1/2$  and weak hypercharge  $Y(\mathbf{L}_l) = -1$ ; and the right-handed weak-isoscalar charged leptons

$$\mathbf{R}_{e,\mu,\tau} = e_R, \mu_R, \tau_R, \quad (17.6.5)$$

with weak hypercharge  $Y(\mathbf{R}_l) = -2$ . (Weak isospin and weak hypercharge are related to electric charge through  $Q = I_3 + (1/2)Y$ . Here we have idealized the neutrinos as massless.

The  $SU(2)_L \otimes U(1)_Y$  electroweak gauge group implies two sets of gauge fields: a weak isovector  $\vec{b}_\mu$ , with coupling constant  $g$ , and a weak isoscalar  $A_\mu$ , with independent coupling constant  $g'$ . The gauge fields compensate for the variations induced by gauge transformations, provided that they obey the transformation laws  $\vec{b}_\mu \rightarrow \vec{b}_\mu - \vec{\alpha} \times \vec{b}_\mu - (1/g)\partial_\mu \vec{\alpha}$  under an infinitesimal weak-isospin rotation generated by  $G = 1 + (i/\vec{\alpha} \cdot \vec{\tau})$  (where  $\vec{\tau}$  are the Pauli isospin matrices) and  $A_\mu \rightarrow A_\mu - (1/g)\partial_\mu \vec{\alpha}$  under an infinitesimal hypercharge phase rotation. Corresponding to these gauge fields are the field-strength tensors

$$F_{\mu\nu}^l = \partial_\nu b_\mu^l - \partial_\mu b_\nu^l + g \varepsilon_{jkl} b_\mu^j b_\nu^k, \quad (17.6.6)$$

for the weak-isospin symmetry, and

$$f_{\mu\nu} = \partial_\nu A_\mu - \partial_\mu A_\nu, \quad (17.6.7)$$

for the weak-hypercharge symmetry.

We may summarize the interactions by the Lagrangian

$$L = L_{\text{gauge}} + L_{\text{leptons}} + L_{\text{quarks}}, \quad (17.6.8)$$

with

$$L_{\text{gauge}} = -\frac{1}{4} \vec{F}_{\mu\nu} \vec{F}^{\mu\nu} - \frac{1}{4} f_{\mu\nu} f^{\mu\nu}, \quad (17.6.9)$$

$$L_{\text{leptons}} = \bar{\mathbf{R}}_l i\gamma^\mu \left( \partial_\mu + i \frac{g'}{2} A_\mu Y \right) \mathbf{R}_l + \bar{\mathbf{L}}_l i\gamma^\mu \left( \partial_\mu + i \frac{g'}{2} A_\mu Y + i \frac{g}{2} \vec{\tau} \cdot \vec{b}_\mu \right) \mathbf{L}_l, \quad (17.6.10)$$

where  $l$  runs over  $e, \mu, \tau$ , and

$$L_{\text{quarks}} = \bar{\mathbf{R}}_u^{(n)} i\gamma^\mu \left( \partial_\mu + i \frac{g'}{2} A_\mu Y \right) \mathbf{R}_u^{(n)} + \bar{\mathbf{R}}_d^{(n)} i\gamma^\mu \left( \partial_\mu + i \frac{g'}{2} A_\mu Y \right) \mathbf{R}_d^{(n)} + \bar{\mathbf{L}}_q^{(n)} i\gamma^\mu \left( \partial_\mu + i \frac{g'}{2} A_\mu Y + i \frac{g}{2} \vec{\tau} \cdot \vec{b}_\mu \right) \mathbf{L}_q^{(n)}, \quad (17.6.11)$$

where  $n$  runs over 1, 2, 3.

Although the weak and electromagnetic interactions share a common origin in the  $SU(2)_L \otimes U(1)_Y$  gauge symmetry, their manifestations are very different. Electromagnetism is a force of infinite range, while the influence of the charged-current weak interaction responsible for radioactive beta decay only spans distances shorter than about  $10^{-15}$  cm. The phenomenology is thus at odds with the theory we have developed to this point. The gauge Lagrangian (17.6.9) contains four massless electroweak gauge bosons, namely  $A_\mu, b_\mu^1, b_\mu^2, b_\mu^3$ , because a mass term such as  $\frac{1}{2} m^2 A_\mu A_\mu$  is not invariant under a gauge transformation. Nature has but one: the photon. Moreover, the  $SU(2)_L \otimes U(1)_Y$  gauge symmetry forbids fermion mass terms  $m\bar{f}f = m(\bar{f}_R \bar{f}_L + \bar{f}_L \bar{f}_R)$  in (17.6.10) and (17.6.11), because the left-handed and right-handed fields transform differently.

To give masses to the gauge bosons and constituent fermions, we must hide the electroweak symmetry, recognizing that a symmetry of the laws of Nature does not imply that the same symmetry will be manifest in the outcomes of those laws. How the electroweak gauge symmetry is spontaneously broken—hidden—to the  $U(1)_{\text{em}}$  phase symmetry of electromagnetism is one of the most urgent and challenging questions before particle physics.

The superconducting phase transition offers an instructive model for hiding the electroweak gauge symmetry. To give masses to the intermediate bosons of the weak interaction, we appeal to the Meissner effect—the exclusion of magnetic fields from a superconductor, which corresponds to the photon developing a nonzero mass within the superconducting medium. What has come to

be called the Higgs mechanism is a relativistic generalization of the Ginzburg-Landau phenomenology of superconductivity<sup>6</sup>. The essential insight is that the Goldstone theorem does not operate when a local gauge symmetry, as opposed to a continuous global symmetry, is broken. Instead, a miraculous interplay between the would-be Goldstone bosons and the normally massless gauge bosons endows gauge bosons with mass and removes the massless scalars from the spectrum.

Let us see how spontaneous symmetry breaking operates in the electroweak theory. We introduce a complex doublet of scalar fields

$$\phi \equiv \begin{pmatrix} \phi^+ \\ \phi^0 \end{pmatrix}, \quad (17.6.12)$$

with weak hypercharge  $Y_\phi = +1$ . Next, we add to the Lagrangian new (gauge-invariant) terms for the interaction and propagation of the scalars,

$$L_{\text{scalar}} = (D^\mu \phi)^\dagger (D_\mu \phi) - V(\phi^\dagger \phi), \quad (17.6.13)$$

where the gauge-covariant derivative is

$$D_\mu = \partial_\mu + i \frac{g'}{2} A_\mu Y + i \frac{g}{2} \vec{\tau} \cdot \vec{b}_\mu, \quad (17.6.14)$$

and (inspired by Ginzburg and Landau) the potential interaction has the form

$$V(\phi^\dagger \phi) = \mu^2 (\phi^\dagger \phi) + \lambda (\phi^\dagger \phi)^2, \quad (17.6.15)$$

We are also free to add gauge-invariant Yukawa interactions between the scalar fields and the leptons ( $l$  runs over  $e, \mu, \tau$  as before),

$$L_{\text{Yukawa-}l} = -\zeta_l \left[ (\bar{L}_l \phi) \mathbf{R}_l + \bar{\mathbf{R}}_l (\phi^\dagger L_l) \right], \quad (17.6.16)$$

and similar interactions with the quarks.

We then arrange their self-interactions so that the vacuum state corresponds to a broken-symmetry solution. The electroweak symmetry is spontaneously broken if the parameter  $\mu^2$  is taken to be negative. In that event, gauge invariance gives us the freedom to choose the state of minimum energy—the vacuum state—to correspond to the vacuum expectation value

$$\langle \phi \rangle = \begin{pmatrix} 0 \\ v/\sqrt{2} \end{pmatrix}, \quad (17.6.17)$$

where  $v = \sqrt{-\mu^2/|\lambda|}$ .

Let us verify that the vacuum of (17.6.17) does break the gauge symmetry  $SU(2)_L \otimes U(1)_Y \rightarrow U(1)_{\text{em}}$ . The vacuum state  $\langle \phi \rangle$  is invariant under a symmetry operation corresponding to the generator  $G$  provided that  $e^{i\alpha G} \langle \phi \rangle = \langle \phi \rangle$ , i.e. if  $G \langle \phi \rangle = 0$ . Direct calculation reveals that the original four generators are all broken, but electric charge is not. The photon remains massless, but the other three gauge bosons acquire masses, as auxiliary scalars assume the role of the third (longitudinal) degrees of freedom.

Introducing the weak mixing angle  $\theta_W$  and defining  $g' = g \tan \theta_W$ , we can express the photon as the linear combination  $A = A \cos \theta_W + b_3 \sin \theta_W$ . We identify the strength of its (pure vector) coupling to charged particles,  $gg'/\sqrt{g^2 + g'^2}$  with the electric charge  $e$ . The mediator of the charged-current weak interaction,  $W^\pm = (b_1 \mp ib_2)/\sqrt{2}$  acquires a mass  $M_W = gv/2 = ev/2 \sin \theta_W$ .

The electroweak gauge theory reproduces the low-energy phenomenology of the V-A theory of weak interactions, provided we set  $v = (G_F \sqrt{2})^{-1/2} 246 \text{ GeV}$ , where  $G_F = 1.16637(1) \times 10^{-5} \text{ GeV}^{-2}$  is Fermi's weak-interaction coupling constant. It follows at once that  $M_W \approx 37.3 \text{ GeV} / \sin \theta_W$ . The combination of the  $I_3$  and  $Y$  gauge bosons orthogonal to the photon is the mediator of the neutral-current weak interaction,  $Z = b_3 \cos \theta_W - A \sin \theta_W$ , which acquires a mass  $M_Z = M_W / \cos \theta_W$ . The weak neutral-current interaction was not known before the electroweak theory. Its discovery in 1973 marked an important milestone, as did the observation a decade later of the  $W^\pm$  and  $Z^0$  bosons.

Three decades of extensive studies of the weak neutral current culminated in experiments at the  $e^+e^- \rightarrow Z$  factories. The ALEPH, DELPHI, L3, and OPAL detectors accumulated 17 million  $Z$  decays at LEP, and the SLD detector recorded 600 thousand  $Z$  decays using polarized beams at the Stanford Linear Collider. A broad collection of experimental measurements and the supporting theoretical calculations have elevated the electroweak theory to a law of Nature, tested as a quantum field theory at the level of one part in a thousand. The mass of the neutral weak boson is known to impressive precision,  $M_Z = 91.1876 \pm 0.0021 \text{ GeV}$ , while the world average  $W$ -boson mass is  $M_W = 80.398 \pm 0.025 \text{ GeV}$ . One noteworthy achievement is a clear test of the electroweak gauge symmetry in the reaction  $e^+e^- \rightarrow W^+W^-$ . "in fine agreement with theory."

It is not difficult to see that the Lagrangian of the EM wave theory of matter (17.4.10)

$$L = \frac{1}{2} \left\{ \left( \frac{\partial \bar{\Phi}}{\partial t} \right)^2 - c^2 (\bar{\nabla} \bar{\Phi})^2 - c^2 m^2 \bar{\Phi}^2 \right\} \equiv -\frac{1}{2} c^2 \left\{ \sum_{\nu} \left( \frac{\partial \bar{\Phi}}{\partial x_{\nu}} \right)^2 + m^2 \bar{\Phi} \bar{\Phi}^+ \right\} \equiv \partial_{\nu} \bar{\Phi} \partial^{\nu} \bar{\Phi} - c^2 m^2 \bar{\Phi}^2$$

is similar to Lagrangian of the Higgs field (17.6.13)

$$L_{\text{scalar}} = (D^{\mu} \phi)^+ (D_{\mu} \phi) - V(\phi^+ \phi),$$

if the usual derivative  $\partial_{\nu}$  of Lagrangian (17.4.10) was replaced by the gauge-covariant derivative  $D_{\nu}$  in accordance with (17.6.14). In contrast with the spontaneous transformation of mass-free field into massive, which is described by Higgs's mechanism, in the wave EM theory of matter, only the wave field itself participates in the transformation, but not its vacuum. We will examine more consecutively how this occurs in the following chapters of nonlinear theory.

## The conclusion.

The above nonlinear theory of elementary particles (NTEP) is a nonlinear theory of the electromagnetic field. In this quality, it with full reason proves that all matter of the Universe has an electromagnetic origin. Moreover, it follows that gravity also has an electromagnetic origin. The use of this thesis makes it possible to obtain all solutions of general relativity in the framework of the electromagnetic approach (see "Lorentz invariant gravitation theory", (Summary): <http://vixra.org/abs/1611.0058> ; (Short book): <http://vixra.org/abs/1611.0032> ; (Full book): <http://vixra.org/abs/1611.0015> ).



## Bibliography

- Aharonov, Y. and Bohm, D. (1959). Significance of Electromagnetic Potentials in the Quantum Theory. *Phys. Rev. (Ser. 2)* **115**, 485-491.
- Aitchison, I. J. R. (2007). *An Informal Introduction to Gauge Field Theories*. Published by Cambridge University Press, 2007, 174 pages
- Akhiezer, A.I. (1937). *Sov. Phys.* 11, 263 (1937)
- Akhiezer, A.I. and Berestetskii, W.B. (1965). *Quantum electrodynamics*. Moscow, Interscience publ., New York.
- Akhiezer, A.I. and Rekalov, M.P. (1986). Elementary particles (in Russian). Moscow, Edition house "Science".
- Allen, H. S. (1918). Discussion on "The case for a ring electron." *Proc. Phys. Soc. London* 31 49
- Allen, H. Stanley. (1920). "Optical Rotation, Optical Isomerism, and the Ring Electron", *Philosophical Magazine*, S6, V40, N6, p. 426 (1920).
- Allen, H. Stanley. (1921). "The Angular Momentum and Some Related Properties of the Ring Electron", *Philosophical Magazine*, S6, V41, N6, p. 113 (1921).
- Andrade E Silva J.L., Loshak J., (1972). Fields, particles, quanta. Moscow (translation from French to Russian), p. 56.
- Anthony, S. (1985). Superstrings: a Theory of Everything?// *New Scientist*. 29 August 1986. P. 34–37.
- Archibald, W.J. (1955). *Canadian Journal of Physics*, **33**, 565.
- Areft H. and Kambe T.. (1988) Report on the IUTAM symposium: fundamental aspects of vortex motion. *J Fluid Mech.* vol 190, pp. 571-595
- Arrayas M. and Trueba J. L. (2010). Motion of charge particles in an electromagnetic knot. *J. Phys. A: Math. Theor.*, **43**, 235401
- Bagge, E. (1988). Das Kugelschalenmodell des Elektron als Alternative zur Punktladung, *Fusion* **9**, 39(1988)
- Bagge, E. (1990). *Welt und Antiwelt als physikalische Realitaet*, Baerbel Mende Verlag, Kiel (1990)
- Bagge, E.R. (1993). Electron, proton, neutron as spheroidal particles. *Fortschr. Phys.* 41 (1993) 6, 497-515
- Bagge, Erich. (1951) Die Polarisation des Vakuums als Ursache einer Feldbegrenzung beim Electron. *Zeits. F. Physik*, Bd. 130, S. 650-655 (1951)
- Balitsky, Ian and Xiangdong, Ji. (1997). How Much of the Nucleon Spin is Carried by Glue? (1997) [http://arxiv.org/PS\\_cache/hep-ph/pdf/9702/9702277v2.pdf](http://arxiv.org/PS_cache/hep-ph/pdf/9702/9702277v2.pdf)
- Barut, A. O. (1979). Lepton Mass Formula. *Phys. Rev. Lett.* 42, 1251.
- Bateman, H. (1915). *The mathematical analysis of electrical and optical wave-motion on the basis of maxwell's equations*. Cambridge, Printed by John Clay, M.A. at the university press 1915
- Bauer, T. H. Spital, R. D. and Yennie, D. R. Pipkin, F. M. (1978). The hadronic properties of the photon in high-energy interactions. *Rev. Mod. Phys.* 50, 261–436 (1978)
- Becker, R. (1933) *Theorie der Elektrizitaet*. Band II Elektronentheorie. Teubner Verlag, Leipzig-Berlin.
- Becker, Richard. (1982). *Electromagnetic fields and interactions*, Vol. 1-2. Editor Fritz Sauter. Dover edition, 1982.
- Berestetskii V. B. , Lifshitz E. M. and Pitaevskii, L. P.. (1982). *Quantum electrodynamics*. Volume 4 of *Course of Theoretical Physics* Second edition. Translated from the Russian by J. B. Sykes and J. S. Bell. 1982 Pergamon Press Ltd.
- Bethe, H. A. (1964) *Intermediate Quantum Mechanics*. W. A. Benjamin, Inc., New York - Amsterdam.
- Bethe, H.A. (1947) *Phys. Rev.* 72, 339 (1947)
- Bialynicki-Birula, I. (1983). Nonlinear Electrodynamics: Variations on a theme by
- Bialynicki-Birula, Iwo (1994). On the wave function of the photon. *Acta Physica Polonica*, **86**, 97-116),
- Bilenky, S. M. (2004) Review Paper. Neutrino masses, mixing and oscillations. *Proc. R. Soc. Lond. A* (2004) 460, 403–443
- Bilenky, S.M. Giunti, C. and Kim, C.W. (2000). *Finally neutrino has mass*. *Journal: Int. J. Mod. Phys. A* **15**, 625 (2000). Preprint: KIAS-P99011, DFTT 08/99, hep-ph/9902462.
- Bloch, F. (1953). Experiments on the g-factor of the electron. *Physica*, 19,(1953), 821-851
- Blokhintsev D. I. (1982). Space and time in the microcosm. (in Russian) *Science*, Moscow.
- Bo Thide, (2002). *Electromagnetic field theory*, Upsilon Books, Upsala, (<http://www.plasma.uu.se/CED/Book>)
- Bohr, N. and Rosenfeld, L. (1933). Zur Frage der Mesbarkeit der electromagnetische Feldgroessen. *Mat.-fys. Medd. Dan. Vid. Selsk.*, 12, № 8; (Trans. into English, 1979)
- Born and Infeld etc., World Scientific, Singapore.
- Born, M. (1934a). On the quantum theory of the electromagnetic field. *Proceedings of the Royal Society of London A*, 143: 410–437
- Born, M. (1953). The Conceptual Situation in Physics and the Prospects of its Future Development. *Proc. Phys. Soc.*, 66, № 402A, 501 (1953)



- Born, M. and Infeld, L. (1934). Foundations of the new Field Theory, Proc. Roy. Soc. **A144**, 425 (1934).
- Born, M. and Infeld, L. (1934a). Proc. Roy. Soc. **A 144**, 425 (1934)
- Born, M. and Infeld, L. (1934b). Proc. Roy. Soc. **A 147**, 522 (1934)
- Bredov, M.M., Ruma`ntsev V.V. et.al. (1985) Classical electrodynamics. Publ. house "Science" (in Russian).
- Breit, G. and Wheeler, John A.. (1934) Collision of Two Light Quanta. Phys. Rev. **46**, 12 1087–1091 (1934)
- Brillouin, L. (1970). Relativity reexamined, Academic Press, New York and London.
- Brogliè, de L. *C. R. Acad. Sci. (Paris)* **195** (1932) 536, 577, 862 ; *ibid.* **1973**(1932) 1337; *ibid.* **198** (1934) 135; etc.
- Brogliè, de, L. (1925). Recherches sur la theorie des quanta. Ann. d. Phys., v. III, dixieme serie, pp. 22-128.
- Brogliè, de, L. (1941). Problems de Propagations Guidees des Ondes. Electromagnetiques. Paris, 1941.
- Brogliè, L de. (1924). Tentative theory of light quanta. Phil. Mag. and Journ. of Science, v. XLVII, No. CCLXXVIII, 446.
- Brogliè, L de. (1943). Theorie generale des particules a spin (methode de fusion). Gautier Villars, Paris, 1943, p. 197.
- Bulgakov, N. (1911). On nature of electron. (in Russian). Zh. R.F. - X. O. Fizich. Otd. Tom XLIII, iss. 8, 1911.
- Campolattoro, A.A. (1980). *International Journal of Theoretical Physics*, **19**, No 2, p.99-126.
- Cheng T.-P. and Li, L.-F. (1984). *Gauge Theory of Elementary Particle Physics* Clarendon Press, Oxford.
- Cheng, T.-P. and Li, L.-F. (2000) *Problems and Solution*, Clarendon Press, Oxford.
- Chiatti, Leonardo. (2009). A possible model for the mass spectrum of elementary particles.  
<http://arxiv.org/ftp/arxiv/papers/0905/0905.3794.pdf>
- Collec. of the articles (1959). Nonlinear quantum field theory. Moscow, Foreign Literature Publishing House.
- Collec. of the articles (1959). *Nonlinear quantum field theory*.(Russian) Moscow, Foreign Literature Publishing House.
- Collection of article transl. (1959). Nonlinear quantum field theory. (Paper translation in Russian). Moscow, Foreign Literature Publishing House.
- Collection of article translations from English to Russian, (1962). The theoretical physics of XX century. Moscow.
- Compton, Arthur H. (1919a). "The Size and Shape of the Electron: I. The Scattering of High Frequency Radiation", *Physical Review*, S2, V14, N1, pp. 20-43 (Jul 1919).
- Compton, Arthur H. (1919b). "The Size and Shape of the Electron: II. The Absorption of High Frequency Radiation", *Physical Review*, S2, V14, N3, pp. 247-259 (Sep 1919).
- Compton, Arthur H. (1921a). "Possible Magnetic Polarity of Free Electrons", *Philosophical Magazine*, S6, V41 (Feb 1921).
- Compton, Arthur H. (1921b). "The Magnetic Electron", *Journal of the Franklin Institute*, V192, N2, pp. 145-155 (Aug 1921)
- Cook, R.J. (1982a). Photon dynamics. Phys. Rev. **A25**, 2164
- Cook, R.J. (1982b). Lorentz covariance of photon dynamics. **A26**, 2754
- Crane, H. Richard. (2000). How We Happened to Measure  $g-2$ : A Tale of Serendipity Phys. perspect., 2 (2000) 135-140
- Crawford Jr., F.S. (1968) Waves: Berkeley Physics Course, Vol. 3 . McGraw-Hill Book Co., 1968
- Crawford, F.S. (1970). *Waves*. Berkeley physics course.
- Cronin, J.A., Greenberg, D.F., Telegdi, V.L, (1967). University of Chicago graduate problems in physics.
- Danby, G. *et al.*, (1962). "Observation of high-energy neutrino interactions and the existence of two kinds of neutrinos". *Physical Review Letters* **9**: 36–44..
- Davis, P. J. and Hersh, R. (1982) *The mathematical experience*. Houghton Mifflin Company
- Davydov, A.S. *Quantum Mechanics* (in Russian). Moscow, 1963.
- Dawson, S. (1999). Introduction to Electroweak Symmetry Breaking. <http://arxiv.org/abs/hep-ph/9901280>
- Debye, Peter. (1934). Published in P. Durr, Quantum und Felder, Vieweg, Braunschweig (1971), page 344.
- Dirac, P. A. M. (1926) On the theory of quantum mechanics, Proc. R. Soc. London, Ser. A 112, 661-677.
- Dirac, P. A. M. (1927a) The physical interpretation of the quantum dynamics, Proc. R. Soc. London 113, 621-641.
- Dirac, P. A. M. (1927b) The quantum theory of the emission and absorption of radiation, Proc. R. Soc. London 114, 243-265.
- Dirac, P. A. M. (1928a) The quantum theory of the electron, Proc. R. Soc. London, Ser. A 117, 610-624.
- Dirac, P. A. M. (1928b) The quantum theory of the electron II, Proc. R. Soc. London Ser. A 118, 351-361
- Dirac, P. A. M. (1932) Dirac, P. A. M., Relativistic quantum mechanics, Proc. R. Soc. London 136, 453-64.
- Dirac, P. A. M. (1933a) The Lagrangian in quantum mechanics, Phys. Z. Sowjetunion 3, 64-72.



- Dirac, P. A. M. (1934) Discussion of the infinite distribution of electrons in the theory of the positron, Proc. Cambridge Philos. Soc. 30, pp. 150-163.
- Dirac, P. A. M. (1936) Relativistic wave equations, Proc. R. Soc. London Ser. A 155, 447-459.
- Dirac, P. A. M., (1931). "Quantised singularities in the electromagnetic field". Proc. Roy. Soc., A33, 60
- Dirac, P.A. M. (1938). Proc. Royal Soc. London A167, 148
- Dirac, P.A.M. (1927). The Quantum Theory of the Emission and Adsorbtion of radiation. Proc. Roy. Soc., A114, 243.
- Dirac, P.A.M. (1933). XVII Conseil Solvay de Physique, p. 203 (1933)
- Dirac, P.A.M. (1978). Directions in physics. J. Wiley and Sons, New York.
- Dvoeglazov, Valeri V. (1999). Speculations on the Neutrino Theory of Light. Annales de la Fondation Louis de Broglie, Volume 24,
- Ebert, H. (1957). Physikalisches Taschenbuch, F. Vieweg und Sohn, Braunschweig
- Ehrenfest, Paul. (1913). Zur Krise der Lichtäther-Hypothes. Berlin, 1913
- Einstein, A. (1920) "Aether and the theory of relativity". Speech pronounced on May 5, 1920 at the Leyden university,
- Einstein, A. and Infeld, L.(1938). Evolution of physics. Cambridge University Press, Cambridge
- Eisenhart, L. P. (1960). *A Treatise on the Differential Geometry of Curves and Surfaces*. New York: Dover. engineers.
- Euler, H. (1936) Über die Streuung von Licht an Licht nach der Diracschen Theorie. Ann. d. Phys. **26** (1936), 398
- Euler, H. and Kockel, B.. (1935). Über die Streuung von Licht an Licht nach der Diracschen Theorie. *Naturwissenschaften* 15 (1935), p. 246
- Fadner, W.L. (1988). American Journal of Physics, **56**, pp. 114-122.
- Fermi, E. (1922). Physik. Z., 23, 340 (1922), or Atti accad. nazl. Lincei Rend., 31, 184, 306 (1922).
- Fermi, E. (1932) Quantum theory of radiation. Reviews of modern physics, vol. 4, January, 1932.
- Fermi, E. (1960). Notes on quantum mechanics. The University of Chikago Press
- Fermi, E. (1960). Notes on quantum mechanics. The University of Chikago Press
- Feynman, R. (1948). Space-time approach to non-relativistic quantum mechanics. Rev. Mod. Phys., 20, № 2, 367.
- Feynman, R. (1964) The Character of Physical Law. Messenger Lectures, 1964.
- Feynman, R. (1972). Statistical Mechanics: A Set of Lectures. Benjamin Publishing Company, 1972-1982
- Feynman, R. (1985). QED – the strange theory of light and matter. Princeton, new Jersey, 1986. Lecture 4. Loose Ends
- Feynman, R.P. (1987). The reason for Antiparticles//Elementary particles and the laws of physics: the 1986 Dirac Memorial Lectures/. Cambtidge University Press, 1988. – Pp. 1-510.
- Feynman, R.P., Leighton, R.B., Sands, M., (1964). The Feynman Lectures on Physics.. V. 6. Ch. 28
- Feynman, R.P., Leighton, R.B., Sands, M., (1964). The Feynman Lectures on Physics Vol. 2 (Addison-Wesly, Palo Alto).
- Feynman, R.P., Leighton, R.B., Sands, M., (1964). The Feynman Lectures on Physics Vol. 2, Chap. 28 (Addison-Wesly, Palo Alto).
- Feynman, R.P., Leighton, R.B., Sands, M., (1964a). The Feynman Lectures on Physics Vol. 3, Chap. 21 (Addison-Wesly, Palo Alto).
- Fock, V. (1929a). "Geometrisierung der Diracschen Theorie des Electrons", *Z. Phys.* 57 (1929) 261-277;
- Fock, V. (1929b) "L'Equation d'Onde de Dirac et la Geometrie de Riemann", *J.Phys. Rad.* 10 392-405;
- Fock, V. (1932). *The principles of the quantum mechanics*. Leningrad, (Part III, Chapt. I, § 5) (in Russian)
- Fock, V. and Ivanenko, D. (1929). C.R., *Phys. Zs.* 30, 648
- Frauenfelder, H. and Henley, E.M. (1974). Subatomic physics, Prentice-Hall, Inc., New Jersey,.
- Fukuda, Y. *et al.* (Super-Kamiokande Collaboration) (1998). "Evidence for oscillation of atmospheric neutrinos". *Physical Review Letters* **81** (8): 1562–1567.
- Garejev, F.A., Barabanov, M.Yu., Kazacha, G.S. (1997). JINR Commucations P2-97-292, Dubna.
- Garejev, F.A., Barabanov, M.Yu., Kazacha, G.S. (1998). The Balmer-like formula for mass distribution of elementary particle resonance. [Arxiv: hep-ph/9803352 v2](https://arxiv.org/abs/hep-ph/9803352).
- Gell-Mann, M. (1981). Questions for the future. Series Wolfson College lectures; 1980. Oxford University Press, 1981.
- Gell-Mann, M. (1983). From renormalizability to calculability? In: *Proc. Shelter Island Meeting IICaltech preprint CALT-68-1153* (1983). [UFN, 1987, v. 151, n. 4, p. 683. In Russian]
- Gell-Mann, Marry (1980). Questions on the future. (In Collection The nature of matter". Wolfson College Lectures 1980. Edited by J.H.Mulvey.) Clarendon Press Oxford, 1981.

- Georgi, H. (1981). A unified theory of elementary particles and forces. - Sci. Am., 244, No.4, P.40 (1981); UFN, т.136, vol.2, 1982.
- Gersten, A. (2001) Maxwell of equation - the of one-photon of quantum of equation. Found. of Phys., Vol.31, No. 8, August).
- Giulini, Domenico. (2008). Electron spin or “classically non-describable two-valuedness”. Studies in History and Philosophy of Modern Physics 39 (2008) 557– 578
- Glashow, S.L. Nucl. Phys. **22**, 597 (1961); Weinberg, S. Phys. Rev. Lett. **19**, 1264 (1967); Salam, A. Proc. of the 8<sup>th</sup> Nobel Symposium on *Elementary particle theory, relativistic groups and analyticity*, edited by N. Svartholm, 1969.
- Goenner, H. F. M. (2004). Living Reviews Relativity, 7, Online Article: <http://www.livingreviews.org/lrr-2004-2> )
- Goldstein, A.D. and Grain, N.V. (1971). Electromagnetic fields and waves. (in Russian). Publishing House "Soviet Radio".
- Goldstein, J.S. *Phys. Rev.* **91** (1953), p. 1516.
- Goldstein, L.D. and Zernov, N.V. (1971). Electromagnetic fields and wave. (in Russian). Moscow, Publication “Soviet radio”. 1971.
- Gottfried, K. and Weisskopf, V.F. (1984). *Concepts of Particle Physics*. Oxford.
- Gould, Roy R. (1995). Spin and Statistics. Am. J. Phys., Vol 63, No. 2, February
- Gray, A. (1997). *Modern Differential Geometry of Curves and Surfaces with Mathematica*, 2nd ed. Boca Raton, FL: CRC Press, p. 186.
- Greene, Brian. (1999) *The Elegant Universe*. W.W. Norton and Company, New-York-London
- Greulich, Karl Otto. (2010). Calculation of the Masses of All Fundamental Elementary Particles with an Accuracy of Approx. 1%. Journal of Modern Physics, 2010, 1, 300-302. (<http://www.SciRP.org/journal/jmp> )
- Gsponer, A. (2002) On the “equivalence” of the Maxwell and Dirac equations. Int. J. Theor. Phys. **41**, 689, 694.
- Guinti, C. and Studenikin, A.(2008). Neutrino electromagnetic properties. arXiv:0812.3646v1 [hep-ph]
- Halpern, O. (1934) *Phys. Rev.* 44, p. 855 (1934).
- Hasenoehrl, F. (1904). Zur Theorie der Strahlung in bewegten Koerpern. Ann. der Phys. (ser 4), **15**, 344-370, (1904)
- Hasenoehrl, F. (1905). Zur Theorie der Strahlung in bewegten Koerpern. Ann. der Phys. (ser 4), **16**, 589-592, (1905)
- Heisenberg W. and Euler H. (1936). Folgerungen aus der Diracschen Theorie des Positrons, "Z. Phys.", Bd. 98, S. 714 (1936).
- Heisenberg, W. (1934). Bemerkungen zur Diracschen Theorie des Positron. Z.f. Phys. **90**, 209 (1934)
- Heisenberg, W. (1966). *Introduction to the unified field theory of elementary particles*. London.
- Heisenberg, W. and Pauli, W. (1929) Zur Quantendynamik der Wellenfelder, I. Z. Phys. 56, 1.
- Heisenberg, W. and Pauli, W. (1930) Zur Quantentheorie der Wellenfelder. II. **Z. Phys.** **59**, 168
- Heisenberg, W., (1943) Die "beobachtbaren Grossen" in der Theorie der Elementarteilchen. Z. Phys. 120, 513, 673.
- Henriques, A. B., Kellett, B. H. and Moorhouse, R. G. (1975) General three-spinor wave functions and the relativistic quark model. Annals of Physics, Volume 93, Issues 1-2, 5 September 1975, Pages 125-151
- Hudson, J. J. et al. (2011). Improved measurement of the shape of the electron. Nature 473, 493-497. <http://www.nature.com/nature/journal/v473/n7348/full/nature10104.html> )
- Inagaki, T. (1994). Quantum-mechanical approach to a free photon. Phys.Rev. **A49**, 2839.
- Inagaki, T. (1994). Quantum-mechanical approach to a free photon. Phys.Rev. **A49**, 28310.
- Infeld L. und van der Waerden B. L., (1933). Berliner Berich., S. 380.  
Interscience publ., New York.
- Ioffe, B.L. (2006). Prog. Part. Nucl. Phys. **56**, 232 (2006).
- Ivanenko, D. (1938). Phys. Zs. Sowjetunion, 13, 141 (1938)
- Ivanenko, D. and Sokolov, A. (1949). *The classical field theory* (in Russian). Moscow-Leningrad
- Ivanenko, D. D. (1958). Planck celebrations in Berlin and Leipzig (Meetings and Conferences). Usp. Fiz. Nauk **66**, 523-542 (November, 1958)
- Ivanenko, D. D. (1958). Planck celebrations in Berlin and Leipzig (Meetings and Conferences). Usp. Fiz. Nauk 66, 523-542 (November, 1958)
- Ivanov, I.P. (2007). Higgs mechanism of the breakdown of electro-weak symmetry (in Russian) )
- Ivanov, I.P. (2007a). Higgs mechanism in the analogies (in Russian) )
- Jackson, J. D. *Classical Electrodynamics*, 3<sup>rd</sup> ed., 808 pp. Wiley, New York, 1999.
- Jackson, J.D. (1999). *Classical Electrodynamics*, 3rd ed., 808 pp. Wiley, New York.
- Jimenez, J. L. and Campos, I. (1999). Models of the classical electron after a century. Foundations of Physics Letters, Vol. 12, No. 2, 1999
- Jordan, P., (1927) Zur Quantenmechanik der Gasentartung, Z. Phys. 44, 473.

- Jordan, P., and Klein, O., (1927) Quantization of an electron field; inclusion of the Coulomb interaction. *Z. Phys.* **45**, 751.
- Jordan, T. F. (2007). Why quantum dynamics is linear? <http://arxiv.org/abs/quant-ph/0702171>
- Kaempfer, F. A. (1965). *Concepts in quantum mechanics*, Academic Press, New York and London
- Kelvin, (Lord Kelvin). (1867). On Vortex Atoms. *Proc. Of the Royal Soc. Of Edinburgh*, Vol. VI, 1867, pp. 94-105; reprinted in *Phil. Mag. Vol.XXXIV*, 1867, pp. 15-24.
- Kenny, J. (1974). An electromagnetic inertial mass theory applied to elementary particles. *Intern. Jour. of Theor. Phys.*, vol. 13, No. 5, pp. 341-361].
- Kirzhnits, D. A. (1978) Superconductivity and elementary particles. *UFN*, Tom 125, iss. 1, May.
- Kodama, K.*et al.* (DONUT collaboration) (2001). "Observation of tau neutrino interactions". *Physics Letters B* **504** (3): 218–224..
- Koga, T. (1975). *International Journal of Theoretical Physics*, **13**, No 6, p.377-385.
- Konopinski, E.J. (1980). *Electromagnetic Fields and Relativistic Particles*, Chapter XIV, (McGraw-Hill, New York.,
- Kopiev V. F., Chernyshev S.A. (2000). Oscillation of vortical ring etc., (In Russian). *UFN*, V. 170, No. 7.
- Korn, G.A. and Korn, Th. M., (1961). *Mathematical handbook for scientists and*
- Kowalczyński, J. K. (1988). On the Mass Spectrum of Elementary Particles. *Letters in Mathematical Physics*, **15**, 165-170.
- Kramers, H. A., (1938) Subtraction of infinities. *Nuovo Cimento* **15**, 108.
- Kudryavtsev, P. S. (1971). History of physics. (in Russian) (Part III. Chapter 1. Electrodynamics of the moving media and electronic theory). Moscow: Publication "Education", 1971.
- Kwal, B. (1949). *J. phys. radium*, **10**, 103 (1949).
- Lamb. H. (1931). *Lehrbuch der Hydrodynamik*, 2 Aufl. Leipzig, B.G.Treubner
- Landau, L. D. and Lifshitz, E. M. (1977). *The Classical Theory of Fields (Course of Theoretical Physics, V. 2)*
- Landau, L. D. and Lifshitz, E.M. (1975). *The Classical Theory of Fields, Fourth Edition: Volume 2 (Course of Theoretical Physics Series)*. Reed Educational and Professional Publishing.
- Landau, L.D. and Peierls, R. (1930). Quantenelektrodynamik in Konfigurationsraum. *Zs. f. Phys.*, **62**, 188.
- Larmor, J.J. (1900). *Aether and Matter*. Cambridge. Ch. 6.
- Leech, J. W. (1958). *Classical mechanics*, London: Methuen and Co. Ltd.
- Levich, V. G., Myamlin, V A., Vdovin, Yu.A., (1973). *Theoretical physics. Vol. 2*. North-Holland Publishing Co, (Amsterdam, London).
- Levich, V.G. (1969). *The course of theoretical physics, T. 1*. Publ. House "Science", Moscow.
- Lewis, G.N. (1926). "The conservation of photons". *Nature* **118**: 874–876.
- Lightman Alan R., Press W.H. et al. (1975). *Problem book in relativity and gravitation*. Princeton, New Jersey. Princeton University Press.
- Lightman, A.P., et al. (1975). *Problem book in relativity and gravitation*. Princeton University Press, Princeton, 1975.
- Lodge, Oliver. (1909) *The ether of space*. New York and London, Harper brothers, 1909
- Lokhtin, Igor. (2009). The problems of modern physics of elementary particles at high energies and researches at the Large Hadron Collider (Conference "Young Scientists of Russia", Moscow, April 10, 2009), Moscow State University. [http://lav01.sinp.msu.ru/~igor/Lecture\\_DynastyConf\\_Lokhtin.ppt](http://lav01.sinp.msu.ru/~igor/Lecture_DynastyConf_Lokhtin.ppt)
- Longmire, C.L. (1963) *Elementary plasma physics*. Interscience Publishers, New York - London
- Lorentz, H.A. (1916). *The theory of electrons*. Leipzig. B.G. Teubner.
- Lorentz, H.A. (1952). *Theory of electron*. Dover Publications, Inc., New York.
- Madelung, E. (1943). *Mathematical Tools for the Physicist*. New York: Dover (1943).
- Madelung, E. (1957). *Die mathematischen hilfsmittel des physikers*. Springer verlag, Berlin.
- Mandelstam, S., (1962). *Ann. Phys. New York*, **19**, 1
- Manohar, A.V. and Sachrajda, C.T. (2010). Quark masses. *The Review of Particle Physics*. 2010. <http://pdg.lbl.gov/2010/reviews/rpp2010-rev-quark-masses.pdf>
- Martynenko, A. P. (2001). Vacuum in the contemporary quantum theory. (in Russian) *SOJ*, Vol. 7, №5, 2001.
- MathWorld, Möbius strip: <http://mathworld.wolfram.com/MoebiusStrip.html>
- Matveev, A.N. (1985). *Optics*. (In Russian). Moscow.
- Matveev, A.N. (1989). *Physics of Atom*. (In Russian). Moscow.
- Medvedev, B.V. and Shirkov, D. V. (1987). P. A. M. Dirac and the formation of the basic ideas of quantum field theory. *Usp. Fiz. Nauk* **153**, 59-104 (September 1987)
- Messiah, A. *Quantum Mechanics*. Vol. 2. North-Holland, 1962, page. 947
- Mie, G. (1912a). Grundlagen einer Theorie der Materie. – *Ann. der Physik*, **37**, 511.
- Mie, G. (1912b). Grundlagen einer Theorie der Materie. – *Ann. der Physik*, **39**, 1.

- Mie, G. (1913). Grundlagen einer Theorie der Materie. – Ann. der Physik, **40**, 1.
- Mie, G. (2007). Foundations of a theory of matter (excepts). Springer.
- Mlodinow, L. (2003). Feynman's Rainbow: a Search for Beauty in Physics and in Life. Warner Books.
- Moffatt, Keith. (2008). Vortex dynamics: the legacy of Helmholtz and Kelvin. *A.V. Borisov et al. (eds.), IUTAM Symposium on Hamiltonian Dynamics, Vortex Structures, Turbulence*, 1–10. 2008 Springer.
- Murphy, F.V. and Yount, D.E. (1971). Photons as hadrons. Scientific American, 225, 94 (1971)
- Nambu Y. and Jona-Lasinio G., (1961a) *Phys. Rev.*, **122**, No.1, 345-358.
- Nambu Y. and Jona-Lasinio G., (1961b) *Phys. Rev.*, **124**, 246.
- Nambu, Y. (1949). Prospects of elementary particle physics. The collection of translation from Japan to Russian. Edited by A.S. Davydov. – Kiev, Publication: Naukova Dumka, 1982.
- Nambu, Y. (1952). An empirical mass spectrum of elementary particles. Prog. Theor. Phys. 7 (1952) 595-596
- Nambu, Y. (1960a). Phys. Rev. Lett. **4**, 380.
- Nambu, Y. (1960b). Proceedings of the Midwest Conference on Theoretical Physics (Purdue University, Lafayette, IN), p.1
- Nambu, Y. (1982). Prospects of elementary particle physics. The collection of translation from Japan to Russian. Edited by A.S. Davydov. – Kiev, Publication: Naukova Dumka, 1982.
- Naumov, A.I. (1965). Mass of the fundamental fermion and degeneracy of the vacuum. Izvestiya VUZ. Fizika, No. 5, pp. 137-144, 1965).
- Naumov, A.I. (1984). Physics of atomic nucleus and elementary particles. (in Russian). Moscow.
- Nisius, R. (2000). The photon structure from deep inelastic electron - photon scattering. Physics Reports 332 (2000) 165, 317
- Okun L. B., (1982). Leptons and Quarks, North Holland.
- Pamyatnykh, E.A. (2001). Electrodynamics: Special theory of relativity. Theory of electromagnetic field. (in Russian) Publishing house of Ural University, 2001.
- Paper collection (1975) Mechanics of vortical motion. News in the abroad physics, (in Russian), Moscow.
- Parwani, R.R. (2005). Why is Schrödinger's equation linear? *Braz. J. Phys.* vol.35 no.2b São Paulo June 2005.
- Pauli, W. (1958). Theory of relativity. Pergamon Press, London, New York, Paris
- Pauli, Wolfgang. (1946). Exclusion principle and quantum mechanics. Nobel Lecture, December 13, 1946)
- Peak, L. and Varvell, K., The physics of the standard model. Part 4, Lectures 4-15. <http://www.dleex.com/read/?6888>
- Peat, F.D., (1988) *Superstrings and the Search for The Theory of Everything*, Contemporary Books, New York.
- Perl, M. L. *et al.* (1975). "Evidence for anomalous lepton production in  $e^+ - e^-$  annihilation". *Physical Review Letters* **35** (22): 1489–1492.
- Peskin, M.E. and Schroeder, D.V (1995). *An Introduction to Quantum Field Theory*, Addison-Wesley, 1995;
- Philipov, A.T. (1990). Multifaceted soliton (in Russian). Moscow, Edition house "Science".
- Physical encyclopedia 1962. V. 2, p.129. Radiation theory. (in Russian)
- Pich, A. (2000) Aspects of quantum chromodynamics. (arXiv: [hep-ph/0001118](http://arxiv.org/abs/hep-ph/0001118) v.1. )
- Poincaré, Henri (1905). *La valeur de la science*. Paris: Flammarion.
- Poincaré, Henri (1958). *The Value of Science*. Dover Publications.
- Polyakov, A.M. (1987). Gauge Fields and Strings. Harwood Academic Publishers, 1987.
- Popper K.R. (1982). Quantum theory and the schism in physics. London; New York.
- Practicum, (2004). Practice. Particles and atomic nuclei. (in Russian). , Moscow, Moscow State University, 2004. [http://nuclphys.sinp.msu.ru/p/zad\\_09.pdf](http://nuclphys.sinp.msu.ru/p/zad_09.pdf)
- Practicum, (2004). Practice. Particles and atomic nuclei. (in Russian). , Moscow, Moscow State University, 2004. [http://nuclphys.sinp.msu.ru/p/zad\\_09.pdf](http://nuclphys.sinp.msu.ru/p/zad_09.pdf)
- Purcell, E. M. (1975). Electricity and magnetism, Berkeley physics course, v.2, Mcgraw-hill book Co.
- Pursell, E.M. (1984) Electricity and Magnetism (Berkeley Physics Course, Vol. 2), 1984.
- Putilov, K.A. (1964) Is the model representation of the mesons possible? (In collection: "Field and matter". Editor in Chief Ia.P. Terletski. Moscow University edition, 1971) (in Russian).
- Quigg, Chris. (2007) Spontaneous symmetry breaking as a basis of particle mass. Rep. Prog. Phys. 70 (2007) 1019-1053. (<http://iopscience.iop.org/0034-4885/70/7/R01> )
- Quigg, Chris. (2007) Spontaneous symmetry breaking as a basis of particle mass. Rep. Prog. Phys. 70 (2007) 1019-1053. (<http://iopscience.iop.org/0034-4885/70/7/R01> )
- Ratis, Yu.L. and Gareev, F.A. (1992). Preprint JINR E2-92-3, Dubna; Preprint JINR E2-92-158, Dubna
- Richardson, O.W. (1916). The electron theory of matter/ Cambridge University Press, 1916.
- Rivero, A., and Gsponer, A. (2005). The strange formula of Dr. Koide. E-print [arXiv:hep-ph/0505220](http://arxiv.org/abs/hep-ph/0505220) v1
- Rodrigues, W.A., Jr. (2002). E-print arXiv: math-ph/0212034 v1.

- Rodrigues, W.A. and Vaz, J. (1998). From electromagnetism to relativistic quantum mechanics. *Found. Phys.* 28, 5, (1998).
- Rohrlich, F. (1960). *Am. J. Phys.*, 28, 639 (1960).
- Ryder, L.H. (1985). *Quantum field theory*. Cambridge University Press.
- Schiff, L.T., (1955). *Quantum Mechanics*, 2nd edition, McGraw-Hill Book, Vol.11, Chap. 28 (Addison-Wesley, Palo Alto) p. 28.
- Schrodinger, E. (1926). *Naturwissenschaften*, Bd.14, S.664-666
- Schrödinger E. (1932). *Berliner Berich.*, S.105.
- Schrödinger, E. (1927). *Ann. Phys.*, 1927, **82**, 178.
- Schrödinger, E. (1929); (1930); (1931a); (1931b); *Sitzungber. Preuss. Akad. Wiss., (Berl.Ber.) (Phys.-math. kl.)*, S. 668-682 (1929); S. 418-428 (1930); S. 63-72 (1931); S. 238-347 (1931).
- Schrödinger, E. (1935) Contributions to Born's new theory of the electromagnetic field. *Proceedings of the Royal Society of London. Series A, Mathematical and Physical Sciences*, Volume 150, Issue 870, pp. 465-477, **1935**
- Schrödinger, E. (1952). Are There Quantum Jumps? *The British Journal for the Philosophy of Science*, Part I. Vol. 3, No. 10 (Aug., 1952), pp. 109-123 ); Part II. Vol. 3, No. 11 (Nov., 1952), pp. 233-242).
- Schrodinger, E. (1926). *Ann. Physik*, 1926, **79**, 361.
- Schwarz J. H. (1987) Superstrings. *Physics Today*. November 1987, p. 33-40
- Schwarzschild, R. (1903). *Goet. Nachr.math.-naturw. Kl.*, S.125.
- Schweber, S., Bethe, G., Hoffmann, F. (1955). *Mesons and fields*, vol. 1 and 2, (Row, Peterson and Company, Evanston).
- Schwinger, J. (1951). On gauge invariance and vacuum polarization, "*Phys. Rev.*", 1951, v. 82, p. 664
- Schwinger, J., (1948). On Quantum-Electrodynamics and the Magnetic Moment of the Electron. *Phys. Rev.* 73, 416-417 (1948)
- ScienceDaily (Mar. 22, 2009). New Experiments Constrain Higgs Mass section 7.5
- Selvaggi, Jerry, Sheppard, Salon and Chari, M. V. K. (2007). An application of toroidal functions in electrostatics. *Am. J. Phys.* 75 (8), 2007 [http://ajp.aapt.org/resource/1/ajpias/v75/i8/p724\\_s1](http://ajp.aapt.org/resource/1/ajpias/v75/i8/p724_s1)
- Shirkov, D.V. and Belokurov, V.V. (1991). *The Theory of Particle Interactions (Translation Series)* Springer Verlag, 1991
- Shpolskii, E.W. (1951). *Physics of atom. (In Russian)*. V.1, Moscow-Leningrad.
- Smilga, A.V. (2001). *Lectures on quantum chromodynamics*. World Scientific Publishing Company.
- Smolin, L. (2006). *The trouble with physics: the rise of string theory, the fall of a science, and what comes next*. Houghton Mifflin, Boston, 2006.
- Sokolov, A. and Ivanenko, D. (1952) *The quantum field theory (in Russian)*, Moscow-Leningrad.
- Sommerfeld, A. (1952). *Electrodynamics. Lectures of theoretical physics*, Vol. III, Academic Press Inc., New York, 1952.
- Sommerfeld, A. (1964). *A. Electrodynamics: Lectures on Theoretical Physics*. New York: Academic Press, 1964. .
- Spasskiy, B.I. (1977). *History of physics. (in Russian)*. Vol. 2., Moscow, Publication "High Education Scoole", 1977 .
- Stewart, A.M. (2008). Decomposition of a vector field. Longitudinal and transverse components of a vector field. <http://arxiv.org/ftp/arxiv/papers/0801/0801.0336.pdf> )
- Stückelberg, E. C. G., (1935) First ideas regarding renormalizations. *Ann. Phys. (Leipzig)* 21, 367.
- Stückelberg, E. C. G., (1938) Renormalization ideas. *Helv. Phys. Acta.* 9, 225.
- Temov, A. I. (2000). *Electromagnetic features of massive neutrino*. SOJ, No. 10, (in Russian).
- The authors. (2005) Edited by Marco Mamone Capria. *Physics before and after Einstein*. IOS press, 2005
- The Great Soviet Encyclopedia, 3rd Edition (1970-1979). Maxwell-Lorentz equations © 2010 The Gale Group, Inc.
- The L3 Collaboration. (2003) CERN-EP/2003-014 Proton-Antiproton Pair Production in Two-Photon Collisions at LEP. European organization for nuclear research.. March 26, 2003 (Submitted to *Phys. Lett. B*)
- Thomas, L.H. (1926). *Nature*, **117**, p. 514 (1926)
- Thomson, J.J (1924). A suggestion as to the structure of light', *Philosophical Magazine*, Series 6, Vol. 49. No. 28G. Oct. 1924. 3-D , 737 - 746
- Thomson, J.J. (1881) On the Electric and Magnetic Effects produced by the Motion of Electrified Bodies. *Phil. Mag.* 1981 , v.11, pp. 229-249.
- Thomson, J.J. (1907). *The corpuscular theory of matter*. New York, Charles Scribner's sons, 1907
- Thomson, J.J. (1925) The structure of light. *Phil. Mag.*, ser. 6, I (1925) 1181-1197.



- Thomson, J.J. (1930). On the relation of electronic waves to light quanta and to Planck's law. . *Phil. Mag.*, ser. 7, IX (1930) 1185-1194.
- Thomson, J.J. (1933). On models of electric field and of the photon. . *Phil. Mag.*, ser. 7, XVI (1933) 805-846.
- Thomson, J.J. (1936). The nature of light. *Nature*, 137 (CXXXVII) (1936) 232-233
- Tomonaga, S. (1949). On the divergences in the theory of elementary particles. (Collection of articles translated from Japanese to Russian., "Prospects of quantum physics", Kiev, "Naukova Dumka", 1982. -552 pp.
- Tonnellat M.-A., (1959). *Les Principes de la Theorie Electromagnetique et de la Relativite*. Masson et C., Paris.
- Trueba, Jose L. and Ranada, Antonio F. (1996). The electromagnetic helicity. *Eur. J. Phys.* **17** 141  
(<http://iopscience.iop.org/0143-0807/17/3/008> )
- Twentieth Century Physics. (1995). By L Brown, B Pippard, A Pais Publisher: Ta..yl..or & Fr.anc..is; 2 edition 1995, 2050 Pages |
- Valecka John D. (2008). *Introduction To Modern Physics: Theoretical Foundations*. World Scientific Publishing Co. Pte. Ltd.
- Van der Waerden, B. L. (1929) „Spinoranalyse“, *Gott. Nachr.* 100-109.
- Volkov, M. K. and Radzhabov, A.E. (2006). Model Nambu - Jona-Lazinio and its development. *UFN*, volume 176, iss. 6, June 2006)
- W. Heisenberg. (1967) Nonlinear Problems in Physics, *Physics Today* 20, 27 (1967)
- Wainstein, L.W. (1957). *Electromagnetic waves*. (In Russian). Moscow.
- Weinberg, S. (1967). *Phys. Rev. Lett.* 19, 1264 (1967)
- Weinberg, S. (1992). *Dreams of a Final Teory*, New York: Pantheon Books,
- Weinberg, Steven. (1995). *The Quantum Theory of Fields, Vol. 2*. Cambridge University Press, 1995. 635 pages.
- Weisskopf, V. (1936). *Kgl. Danske Vidensk. Selskab., Mat.-fys. Medd.*, **14**, 6, 1.
- Weisskopf, V. F. (1939). On the Self-Energy and the Electromagnetic Field of the Electron. *Phys. Rev.*, V. 56
- Weisskopf, V., (1939) Explanation of the details of the mechanism for the decrease in the divergence of the self-mass of an electron to logarithmic. *Phys. Rev.* 56, 72.
- Welton, Th. (1948). Some observable effects of the quantum-mechanical fluctuations of the electromagnetic field. *Phys. Rev.*, 74, 1157 (1948)
- Wentzel, Gregor (2003). *Quantum Theory of Fields*. Dover edition, 2003.
- Wheeler, J.A. (1957). *Reviews of Modern Physics* **29**, 463.
- Wheeler, J.A., and Feynman, R.P. (1945). *Reviews of Modern Physics*, **17**, 157.
- Whittaker, E. T. (1910). A history of the theories of aether and electricity : from the age of Descartes to the close of the nineteenth century (1910) <http://www.archive.org/details/historyoftheorie00whitrich>
- Wilczek, Frank. (1999). The Persistence of Ether. (*Physics Today*, 52, 11-13, January 1999)  
[http://xserver2.lns.mit.edu/~csuggs/physics\\_today/wilczekpubs.html](http://xserver2.lns.mit.edu/~csuggs/physics_today/wilczekpubs.html)
- Wilczek, Frank. (2005) High-energy physics: An emptier emptiness? *Nature*, 435, 152-153 (12 May 2005)  
<http://scienceweek.com/2005/sw050708-6.htm>
- Wilkinson, D. (1981) *Wofson College Lectures 1980. The nature of matter*. Edited by J.H. Mulvey. Clarendon Press, Oxford.
- Wilson, W. (1936). *Proc. Phys. Soc. (London)*, A48, 376 (1936).
- Xiangdong Ji and Wei Lu. (1998). A Modern Anatomy of Electron Mass. [http://arxiv.org/PS\\_cache/hep-ph/pdf/9802/9802437v2.pdf](http://arxiv.org/PS_cache/hep-ph/pdf/9802/9802437v2.pdf)
- Xiangdong Ji. (1994) A QCD Analysis of the Mass Structure of the Nucleon. <http://arxiv.org/abs/hep-ph/9410274>
- Xiangdong Ji. (2006) Gluons in a proton. BNL Nuclear Physics Seminar, Dec. 19, 2006 )
- Yang, C. N. and Mills, R. (1954). Conservation of Isotopic Spin and Isotopic Gauge Invariance, *Phys. Rev.* **96**, 191  
York - Amsterdam, Part II, Chapt. 17.
- Zorn, Jens C..(2010). *H. Richard Crane, 1907–2008. Biographical Memoir* . National academy of sciences. 2011.  
National Academy of Sciences, Washington, D.C
- Crane, H. R. (1968). The g- Factor of the Electron. *Scientific American* **218** (1), 72 (1968).