

Explaining duality, the “only mystery” of quantum mechanics, without complementarity or “which way” (welcher-weg)

Dr. Sarma N. Gullapalli, PhD

Email: sngullapalli@hotmail.com; Phone: +1-703-862-2961

Abstract

Early on, Albert Einstein and Niels Bohr heatedly debated wave-particle duality. To explain duality Bohr postulated his principle of complementarity, which is now widely accepted, but has mystifying metaphysical implications. Albert Einstein disagreed. Richard Feynman called it the “only mystery” in quantum mechanics. Ingenious experiments including those using entanglement have confirmed Bohr’s complementarity. In this paper a new Duality Theorem is presented with proof which explains duality with particle always remaining particle and wave always remaining wave throughout, without using wave-particle complementarity or “which way” (welcher-weg) observation. We explain results of reported experiments by showing the equivalence: Coherence and alignment \equiv Interference \equiv No “which way” observation; No coherence or alignment \equiv No interference \equiv “which way” observation. That is, complementarity is redundant; conventional criteria of alignment and coherence alone suffice for interference. Our explanation does not require that photon somehow “know” about the test setup or “which way” observation and change its behavior from particle to wave and vice versa. No new assumptions are made, only new reasoning. In the context of entanglement we also help explain non-local action at a distance, and rephrase Albert Einstein’s unanswered question “Is quantum mechanics complete?” at a more fundamental level.

Key words: Quantum Mechanics; Wave-particle duality; Duality Theorem; Interference; Complementarity; Entanglement; Locality; Causality; Retro-Causality; Quantum Erasure.

ACKNOWLEDGEMENTS

The ideas reported in this paper are entirely due to the author, using his own time and effort in retirement. No funding was received for this work from any individual or organization either before or after retirement. All references to material in books and papers are duly cited in the references section. We acknowledge with thanks permission to reuse, from PNAS for Figure 2A in [6], from APS for Figure 2 in [5] and from OSA for Figure 2 in [4].

I. INTRODUCTION

Proposed by Niels Bohr [1], the widely accepted complementarity principle explanation of wave-particle duality is as follows: (a) if the experimental setup is for detecting the particle, then interference (its wave nature) is destroyed and the particle travels through the particular sensed path (“which way” observation), and (b) if the setup is for detecting interference (wave nature) with no “which way” observation, then particle nature does not hold, and the particle travels as a wave through both (multiple) paths for interference. Richard Feynman, an authority on quantum mechanics, called this “the only mystery” in quantum mechanics [2]. This mystery has also given rise to metaphysical conjectures that somehow the very intent of the experimenter (his or her consciousness) influences the particle’s behavior, some even postulating supernatural influence from outside space-time itself [7]. More generally, early on, Erwin Schrodinger had considered interpreting the probabilistic nature of quantum mechanics to imply that the many trials underlying probability actually occur simultaneously in multiple universes, giving rise to the metaphysical concept of multi-verse which has been seriously considered by eminent scientists including Stephen Hawking, and discussed by philosophers. But, to this day, multi-verse remains merely a speculation by scientists.

Albert Einstein felt that the experimental setup to measure a quantity can in principle be independent of the measured quantity and so cannot determine something as fundamental as the wave or particle nature of the measured quantity. Note that here we are talking about not merely the inclusion of states of measuring instrument in the states of overall quantum system comprising the measured quantity plus the measuring instrument (analogous to the loading or termination effect of measuring instrument in classical networks and systems) which is of course required, but also the more fundamental wave versus particle behavior of measured object being determined by the measurement system.

Recent single photon interference experiments [4], [5], [6] have implemented John Wheeler’s ingenious thought experiment [3] to test Bohr’s complementarity principle. While confirming complementarity, some of these experiments have revealed the weirder phenomenon of retro-causality and quantum erasure which stretches the understanding of duality, complicated further when entangled photon pairs are involved.

All experiments to date confirm Bohr's complementarity. In a multi-path interferometer, the act of observing which path the particle took (which way) is thus believed today to cause the disappearance of the interference pattern, and so "which way" ("welcher-weg" in German) determination has become an accepted analysis and design consideration in multi-path quantum systems. The critical question of whether or not there exists a "which way" measurement implied in a given multipath interferometer system becomes difficult if not impossible as the complexity of the system increases such as in quantum communication systems and quantum computers. Thus it is of great value if the "which-way" determination – which potentially can include consciousness - can be avoided altogether.

The Theorem proposed and proved in this paper does not use any metaphysical "multiverse" or "consciousness" of the observer, and explains duality without complementarity or "which way" consideration or any "knowledge" on the part of the inanimate photon (particle) about experimental setup, and incidentally redeems Albert Einstein's view that measurement purpose may not necessarily influence wave-particle behavior.

Some of the more remarkable experiments reported use entanglement as a carrier of "which way" information, and so our discussions involve entanglement also, which must be understood. Albert Einstein, troubled by the statistical nature of quantum mechanics, suggested a thought experiment in the famous E.P.R. paper [8] (1935) which he co-authored, which predicted action at a distance violating the locality constraint imposed by the relativistic speed limit of velocity of light, and therefore expressed the doubt: "Is quantum mechanics complete?" Erwin Schrodinger immediately responded [9] affirming that the phenomenon described necessarily follows from the wave function concept, and coined for it the term "entanglement". A hypothesis of non-verifiable hidden random variables (as the name implies) to explain entanglement was rendered verifiable by experiment by the landmark inequality test developed by J.S. Bell [10] (1964), improved upon by many others for example [11], and studied by experimenters gradually eliminating loop holes, to finally confirm recently [12] (2015) that there are no hidden variables, thus confirming action at a distance.

As a quick review of the evolution of wave function $\psi(\mathbf{r}, t)$ in space \mathbf{r} and time t , which is central to the relationship (duality) between the particle and its wave function, for example for electron with mass m in potential field $V(\mathbf{r})$ the Schrodinger wave equation is

$$i\hbar \frac{\partial}{\partial t} \psi(\mathbf{r}, t) = H \cdot \psi(\mathbf{r}, t) \quad (1a)$$

where $H = (\mathbf{p} \cdot \mathbf{p} / (2 \cdot m) + V)$ is the Hamiltonian = total energy E , \mathbf{p} is momentum, $i = \sqrt{-1}$ and $\hbar (= \frac{h}{2\pi})$ is the reduced Planck's constant. With operator interpretation of \mathbf{p} as $\mathbf{p} = -i\hbar \cdot \nabla_r$ where $\nabla_r = (\frac{\partial}{\partial x} \cdot \mathbf{u}_x + \frac{\partial}{\partial y} \cdot \mathbf{u}_y + \frac{\partial}{\partial z} \cdot \mathbf{u}_z)$, $\mathbf{u}_x, \mathbf{u}_y, \mathbf{u}_z$ spatial unit vectors, and with operator interpretation of energy E as $i\hbar \cdot \frac{\partial}{\partial t}$ in $E = (\mathbf{p} \cdot \mathbf{p} / (2 \cdot m) + V)$, we get

$$i\hbar \cdot \frac{\partial}{\partial t} \psi = -(\hbar^2 / 2m) \cdot \nabla_r^2 \psi + V \psi \quad (1b)$$

Note: Operator interpretation is implied in "derivation" of Schrodinger's equation starting with $\psi = e^{-i(Et + \mathbf{r} \cdot \mathbf{p})}$ as can be readily seen from partial derivative of ψ with respect to time and space variables.

For photon $m = 0$ and so (1b) is not applicable. Using relativistic relationship $E^2 = m(0)^2 \cdot c^4 + \mathbf{p} \cdot \mathbf{p} \cdot c^2$ where rest mass $m(0)$ does not appear in the denominator, with $m(0) = 0$, the operator interpretation results in

$$\delta^2 \psi / \delta t^2 = c^2 \cdot \nabla_r^2 \psi \quad (2)$$

which is the quantum mechanical wave equation for photon, whose mathematical form is same as that of electromagnetic wave equation of classical electrodynamics, and so has similar solutions that propagate in space. The important difference being that spatial integral of $|\psi|^2$ is constrained to be 1 for quantum mechanical wave function, whereas there is no such constraint for the amplitude of classical electromagnetic wave.

We note that in general

- (a) The operator interpretation of physical quantities links non-physical wave function to physical quantities.
- (b) Either (1) or (2) results in causal evolution of ψ in space-time, from initial conditions of forward motion which result in ψ evolving only forward in time from the initial time of creation (components of backward propagation cancel out due to initial condition of forward motion, as in any wave motion) until annihilation.

As discussed in the next section, complex wave function ψ represents a probability amplitude, with $|\psi|^2$ a probability density function, and so it is a non-physical purely mathematical entity. H or E and \mathbf{p} in (1) or parameter c in (2) contain the physical parameters of the system, and therefore, non-physical wave function ψ propagates in space and time as per physical parameters, obeying locality constraint of speed limit of velocity of light in free space.

The fact that Schrodinger's wave equation works has been confirmed by all experiments and quantum systems. But "Why (not how) does Schrodinger's wave equation work?" remains the unanswered question of quantum mechanics, suggesting rephrasing accordingly Albert Einstein's question "Is quantum mechanics complete?"

II OUR APPROACH

Any approach to explain duality requires the understanding of the relationship between the particle and its wave function. Louis De Broglie and Erwin Schrodinger initially thought that the wave function was actually a physical wave associated with the particle, which led to problems because wave function is inherently complex and not real. This difficulty was removed by Max Born in 1926 by interpreting the physical wave as complex probability amplitude ψ , the wave function. Born states in his Nobel Prize acceptance speech [13] "... an idea of Einstein's gave me the lead. He had tried to make the duality of particles - light quanta or photons - and waves comprehensible by interpreting the square of the optical wave amplitudes as probability density for the occurrence of photons. This concept could at once be carried over to the ψ -function: $|\psi|^2$ ought to represent the probability density for electrons (or other particles)". Note that though the wave function is thus recognized as non-physical complex probability amplitude, it is viewed as an interpretation of a physical wave, especially for photon whose wave nature is more evident as physical electromagnetic wave, while for electron, particle nature is more evident as non-zero physical rest mass. This view of non-physical wave function as somehow connected to some physical wave entity has persisted to this day, requiring co-location (coincidence) of particle and its wave function, changing from particle to wave and vice-versa depending on measurement, and this is at the heart of the duality mystery. The Duality Theorem stated and proved below removes this co-location (coincidence) and thereby explains, as shown in this paper, duality without complementarity or "which way", wave always remaining wave and particle always remaining particle.

II WAVE-PARTICLE DUALITY THEOREM

Given that (1) Wave function $\psi(\mathbf{r}, t)$ of a particle is a non-physical purely mathematical complex probability amplitude, $|\psi(\mathbf{r}, t)|^2$ being the probability density function, that is, $|\psi(\mathbf{r}, t)|^2 \cdot \delta v$ is the probability that the particle is in an infinitesimal volume δv at space-time point (\mathbf{r}, t) (2) Physical particle is indivisible, and (3) In the case of an extended (non-point) physical particle, by "position" of the particle we mean the position of some cardinal point of the particle such as its centroid, it follows that:

At any given time t , wave function ψ can be co-located (coincident) with its particle only at space-time point (\mathbf{r}_0, t) where $|\psi(\mathbf{r}_0, t)|^2 = \delta(\mathbf{r} - \mathbf{r}_0, t)$, the unit Dirac delta function. At any space-time point (\mathbf{r}, t) where $0 < |\psi(\mathbf{r}, t)|^2 < 1$, wave function cannot be co-located (coincident) with its particle.

Proof:

Because spatial integral of probability density function must be equal to 1 at any given time t (particle exists somewhere in space), if there is a space-time point (\mathbf{r}_1, t) where $0 < |\psi(\mathbf{r}_1, t)|^2 < 1$, it means that there are one or more different space-time points $(\mathbf{r}_2, t), (\mathbf{r}_3, t) \dots$ where $|\psi(\mathbf{r}_2, t)|^2 > 0, |\psi(\mathbf{r}_3, t)|^2 > 0, \dots$. That is, there is non-zero probability that the particle may be at $(\mathbf{r}_2, t), (\mathbf{r}_3, t)$, etc. But because the particle is indivisible, it (its cardinal point) cannot be at (more than one) different space points at the same time, that is, the particle cannot be coincident with the wave function; wave-particle coincidence is possible if only if the wave function itself exists at only one point and is zero everywhere else. But the spatial integral of $|\psi(\mathbf{r}, t)|^2$ must equal 1, which is possible only if probability density is Dirac delta function, that is, $|\psi(\mathbf{r}_0, t)|^2 = \delta(\mathbf{r} - \mathbf{r}_0, t)$.

The above logical reasoning is also illustrated in Figure 1.

Figure 1(a) Case of the wave function and particle with non-point spatial spread having the same profile (case of spatial point is covered in 1(d)), representing the conventional view that the wave function is the probability amplitude interpretation of something physical associated with the particle, thereby requiring co-location of identical profiles of both wave and particle. The position of particle is represented by position of some cardinal point such as centroid.

Because of the spread of wave function, there are other points where the physical centroid can be at the same time, not possible for indivisible physical particle.

Figure 1(b) Case of the wave function and particle having different non-point spatial spreads. There are several points where the probability is not zero, and so spatial collocation of wave function and cardinal point of indivisible particle is not possible.

Figure 1(c) Case of multiple paths of wave function, each with non-zero probability. At a given time, cardinal point of indivisible physical particle can be at only one location. Co-location of wave function and particle is not possible. Wave function defines probabilities of multiple probable paths. Physical particle follows only one probable path.

Figure 1(d) Case of the wave function being a Dirac delta function. Only in this case wave function and cardinal point of indivisible particle can coincide, co-location is possible.

Figure 1(e) Example of emission of a single physical particle detected by only one detector, while spherical wave function defines non-zero probabilities for detectors at other locations on the wave front.

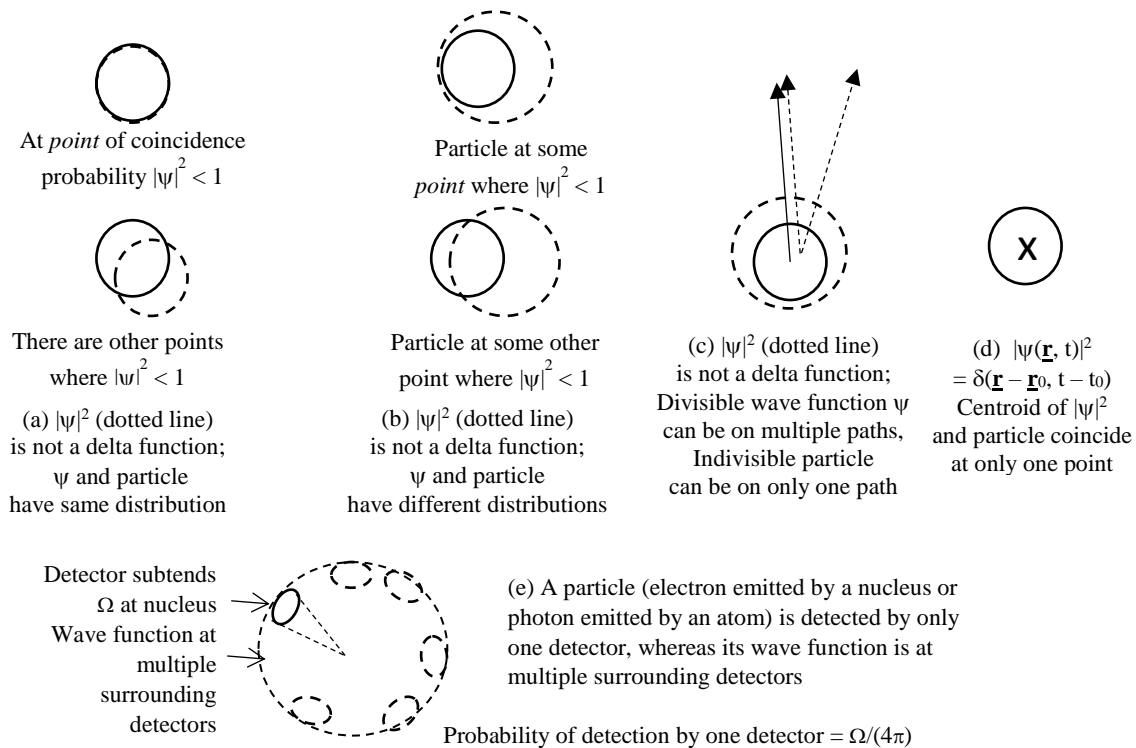

Figure 1. Coincidence / Colocation is possible at (\mathbf{r}_0, t) if only if $|\psi|^2 = \delta(\mathbf{r} - \mathbf{r}_0, t)$

Comments:

1. A photon is indivisible except when it passes through devices such as parametric down converters in which it splits into two photons of less energy. Single photons in all interference experiments such as Young's double slit experiment (which was the subject of heated debates between Albert Einstein and Niels Bohr), and in all experiments that have been conducted to test Bohr's complementarity (some of which are discussed in this paper), and the signal photons in most quantum communication systems and quantum computers, are all indivisible between the time they are created (such as at the output of a parametric down converter source of entangled pair) till the time they are detected by absorption (annihilation) in a detector. Between the time of creation and the time of annihilation the photon may interact with optical media and optical components such as beam splitters which may change its state such as polarization, but it remains physically indivisible. An electron is similarly indivisible unless it is of high energy and may disintegrate into multiple particles, which is not the case in most quantum systems of interest for quantum

computers and quantum communications. Such indivisibility of photon and electron in conditions described, in the interference systems of interest such as Young's double slit experiment and in most quantum communications and quantum computer systems, is an experimentally established fact.

2. At the space-time point of creation $|\psi(\mathbf{r}, t)|^2$ is a Dirac delta function, from which point the wave function evolves per Schrodinger's wave equation.

3. At the space-time point of annihilation (absorption) the "collapse" of the wave function can be viewed as $|\psi(\mathbf{r}, t)|^2$ collapsing into a Dirac delta function.

4. The novelty of Duality Theorem lies in that, as we shall show with examples, it completely does away with complementarity and "which way" (welcher-weg) criterion, and also does not require any "observer" in a measurement process or any "intelligence" on the part of the particle. This has not been done before.

NOTE: The widely accepted definition of probability is the Von Mises definition as the $\text{Lim}_{N \rightarrow \infty} (n/N)$ where n is the number of times the outcome occurs in N hypothetical trials, see [14] p 8-9. Thus the propagation of wave function along all possible paths is hypothetical, corresponding to various hypothetical trials.

An important consequence of the Duality Theorem, which removes the conventional co-location of wave function and particle, is that the wave function hypothetically explores all possible paths defining probabilities for each probable path, that is, the wave function is divisible, whereas the indivisible physical particle follows only one probable path, illustrated in Figure 2 for two important cases: (a) reflection and refraction and (b) Single photon Young's double slit experiment. Note that the configuration may be changed dynamically at any instant of time, and wave function propagates according to new configuration from that instant of time onwards. We shall have occasion to discuss examples of dynamic changes later.

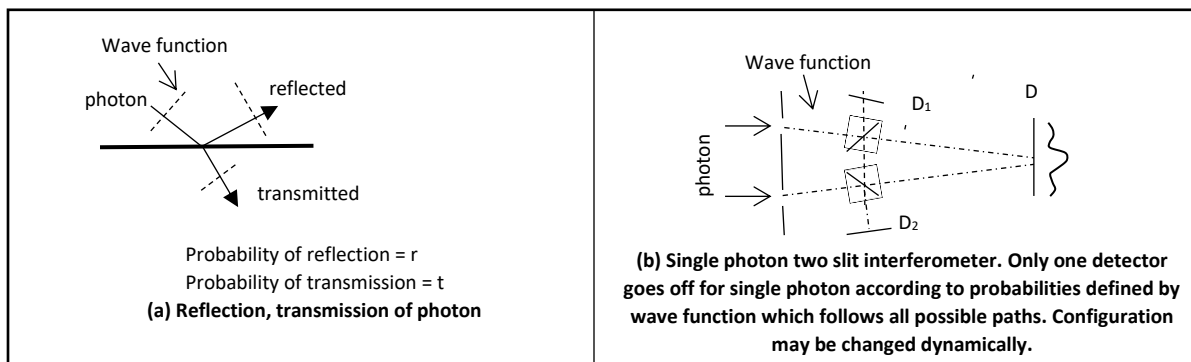

Figure 2. Divisible wave function explores all possible paths defining probabilities, Indivisible physical particle follows only one probable path.

Because propagation of wave function is determined by physical parameters as pointed out earlier, the phenomenon of reflection or refraction of wave function at physical surfaces is governed by interactions with atoms defining the surface and the media. See for example [15] R.P. Feynman "QED the strange theory of light and matter" for the geometrical construction of resultant wave function amplitude as due to wavelets from each point (atom) of the surface (medium). As long as the amplitudes of wave function components in such reflections and refractions (or in general in any medium of propagation or scattering phenomena) remain non-zero, the wave function continues to propagate in such systems.

The state of the wave function, such as the state of polarization of photon, or spin of electron, may be altered due to interactions with the medium. Thus the wave function, which is non-physical probability amplitude, carries with it the probability of the state of the particle due to probable interactions of the physical particle with the physical medium.

ENTANGLEMENT

Because probability is defined axiomatically as a frequency measure based on hypothetical trials (see for example Papoulis [14] page 7), for any given configuration which may vary with time, the wave function ψ can be propagated hypothetically along all possible paths to determine various probabilities, without actual propagations. Which probable path / outcome actually occurs is found by the measurement. In the classical picture the selection of outcome is usually associated with some random variable prior to measurement. However, in the quantum picture, in the context of entanglement it has been demonstrated that there is no random variable selection prior to measurement (no hidden variable), and it is only the measurement that finds the outcome. A pair of particles are entangled if their joint probability density is not factorable as product of individual probability densities, and there is thus a constraint of conditional probability, such as a constraint of polarization between two polarization-entangled photons. In such cases, the outcome found by measurement which must satisfy the entanglement constraint between the two, must necessarily involve measurement of both particles, which may occur at different space-time points, regardless of temporal sequence of the two measurements. For clarity, let us call the measurement of the two entangled particles as one joint measurement, completed only when the last one is measured (to satisfy entanglement constraint). Note that for an entangled pair, one joint measurement finds an outcome for both in the pair out of many probable pair-outcomes. There are no two separate pair-measurements, and so there is really no “erasure” of a prior measurement.

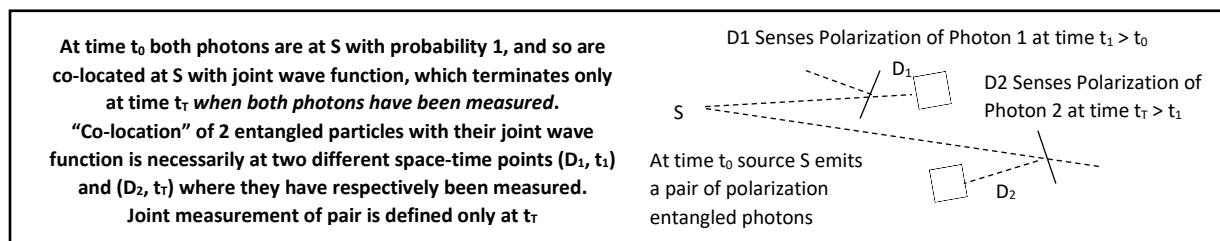

Figure 3. Joint measurement of entangled pair is defined only when both particles have been measured. Co-location (coincidence) with joint wave function only at source S and detectors D_1 and D_2 , not elsewhere.

Joint measurement and the co-location (coincidence) of entangled particle pair with joint wave function is illustrated in Figure 3. Joint wave function magnitude squared is a unit Dirac delta function at Source S at creation time t_0 , and partial Dirac delta function at detector D_1 at time t_1 because of partial collapse and at detector D_2 at time t_r , overall integral of both being 1.

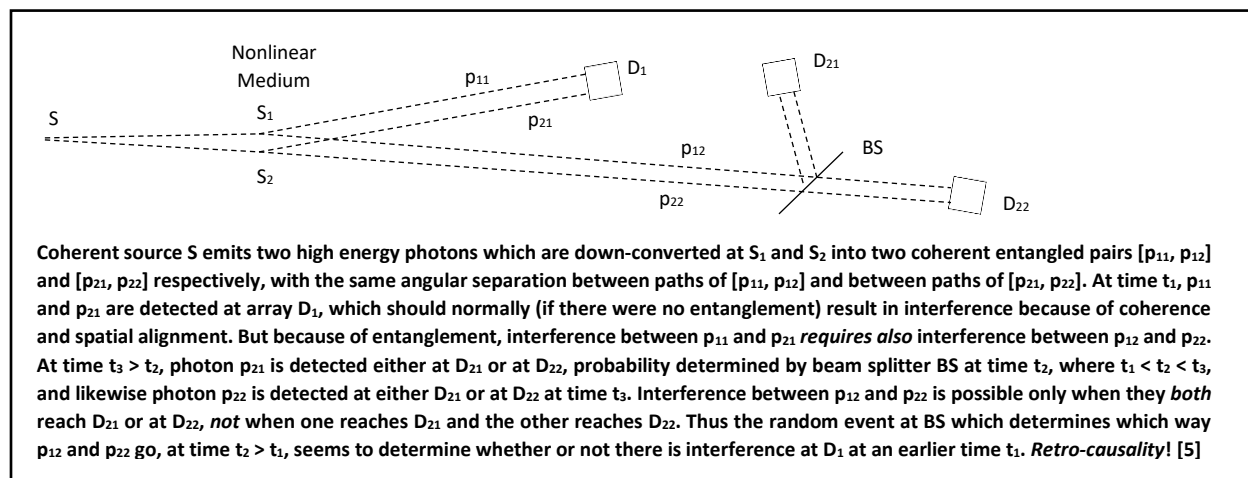

Figure 4 Interference between two pairs of entangled photons – apparent retro-causality.

There is another interesting consequence of entanglement: Because of conditional probability of the entangled pair, interference between two pairs of entangled photons (particles in general), must necessarily involve both pairs fully, not just one particle from each pair. This gives rise to the phenomenon of so-called retro-causality as illustrated in Figure 4. See [5] for details of an experiment. Referring to Figure 4, two high energy photons from a

coherent source S are converted by adjacent atomic systems S_1 and S_2 in a nonlinear medium into two pairs of entangled low energy photons $[p_{11}, p_{12}]$ and $[p_{21}, p_{22}]$, the nature of conversion being such that there is angular separation between paths of p_{11} and p_{12} , and same angular separation between paths of p_{21} and p_{22} . Photons p_{11} and p_{21} are thus spatially aligned so that they have temporal and spatial coherence needed for interference when they are detected at detector array D_1 at time t_1 . At time $t_2 > t_1$, beam splitter BS sends photons p_{12} and p_{22} randomly and separately to either array D_{21} or array D_{22} . At time $t_3 > t_2$, photons p_{12} and p_{22} are accordingly detected at either array D_{21} or D_{22} . If both p_{12} and p_{22} arrive at D_{21} or at D_{22} there is interference between them because of temporal coherence and spatial alignment. But if one arrives at D_{21} and the other at D_{22} , then, due to lack of spatial alignment there can be no interference. Because of joint probability due to entanglement, interference at D_1 at time t_1 is possible only when there is also interference between the counterparts at D_{21} or at D_{22} , and is not possible when there is no interference at D_{21} or at D_{22} . That is, an event at $t_2 > t_1$ seems to influence the event at t_1 . Retro-causality! We shall discuss this further later in the context of the experiment.

Because wave function is non-physical, its state can potentially change instantaneously without being constrained by laws of physics such as the speed limit (speed of light) imposed by theory of relativity. This results in action at a distance to be discussed later. However, the physical process that alters the state due to some interaction takes non-zero time. It appears that the duration of physical interaction of a photon with an electron can be as short as 100 atto-seconds (10^{-16} second) [18]. Thus physical change from one polarization state of photon to another due to electron interaction is not exactly instantaneous, but merely delineates stages in the evolution of wave functions ψ according to (1) or (2). But its propagation determined by Schrodinger's wave equation (which contains physical parameters as discussed earlier) is at speed less than or equal to speed of light. Thus we need to distinguish between propagation of wave function (according to (1) or (2) for example) which satisfies locality constraint, and its state changing almost instantly everywhere (including "collapsing" at detection) without locality constraint.

III. APPLICATIONS OF THE DUALITY THEOREM

The Duality Theorem suggests the following steps to simplify the explanation and accommodation of wave-particle duality in quantum systems, without using complementarity or "which way" observation criteria:

Step1: By inspection, locate space-time points (usually source at instant of creation and detectors at instant of termination) where $|\psi|^2$ is unity, Dirac delta function. For entangled system, termination is when all entangled particles are detected fully. At all other space-time points, co-location of wave function ψ and its particle is not possible, and so wave function ψ can be propagated hypothetically along multiple paths independent of particular path of particle.

Step2: Propagate ψ along all possible paths, without "which way" observation or complementarity considerations, taking into account any entanglement constraints, and determine probabilities for various possible measurement outcomes for the particle. For each outcome, the particle follows that particular path, with that particular probability. Because wave function is propagated along all possible paths including any dynamical changes, there always exists a particular path for the particle from the source all the way to the particular detector for the particular measurement outcome. For entangled system, measurement must be consistent with entanglement constraint regardless of time sequence of the measurements of individual particles. That is, the outcome defined by measurement is one particular entangled set (pair) out of many probable sets (pairs) satisfying the entanglement constraint.

For applications of the Theorem we begin with Young's double slit experiment with single photons, because it has been the center of discussion for duality, and to review the well-established requirement of temporal coherence and spatial alignment for interference. We shall show the following equivalence in all experiments discussed below:

Coherence and spatial alignment \equiv Interference \equiv indistinguishable paths, no "which way"
 No coherence or spatial alignment \equiv No interference \equiv distinguishable paths, "which way"

Here "spatial alignment" means not only alignment of paths, but also alignment of polarizations. That is, traditional coherence and alignment suffice, "which way" criterion is not necessary, better avoided as it opens the door to unwarranted metaphysical conjectures, considerable confusion and mystery.

In each example, we shall first discuss duality, which is the main topic of this paper, rendered simple and straight forward by our Theorem, followed by causality (such as retro-causality) when relevant. Though causality is secondary to the main topic of this paper, nevertheless it arises in the configurations, and so must be discussed.

IV YOUNG'S DOUBLE SLIT EXPERIMENT

Already introduced earlier, we shall discuss this important experiment in some more detail regarding coherence, alignment and the “which way” question. Referring to Figure 5 which shows a functional set up for purpose of discussion (can be implemented in many ways to sense the path) fringes are observed only when the coherence length ($= c \cdot T_c$ where T_c is coherence time of the source and c is velocity of light for the medium of the paths) is longer than the optical path difference between the two paths, and the angle between the two paths at detector array is sufficiently small, to ensure well aligned superposition. When there is polarization, alignment must include also the alignment of polarizations. In the quantum mechanical picture coherence and spatial alignment is that of the wave function associated with the photon (particle), with probability of outcome for that probable path.

A single photon generates just one data point on the interference pattern. Successive single photons overlay successive points on successive interference patterns. For this overlay not to be smeared, the wave functions of successive single photons must have mutual coherence (with time delay adjusted), for which the coherence time of the source must be longer than the frame time over which interference is recorded. This condition is usually readily met with laser sources and mechanically stable configurations. Using functionally similar set ups it has been experimentally confirmed (using polarizers to identify paths instead of beam splitter / detector) that either D_A or D_B or one of EMCCD detectors goes off per pulse (single photon per pulse reaching detector). EMCCD data collected over a number of pulses (for those pulses when neither D_A nor D_B goes off) shows interference pattern.

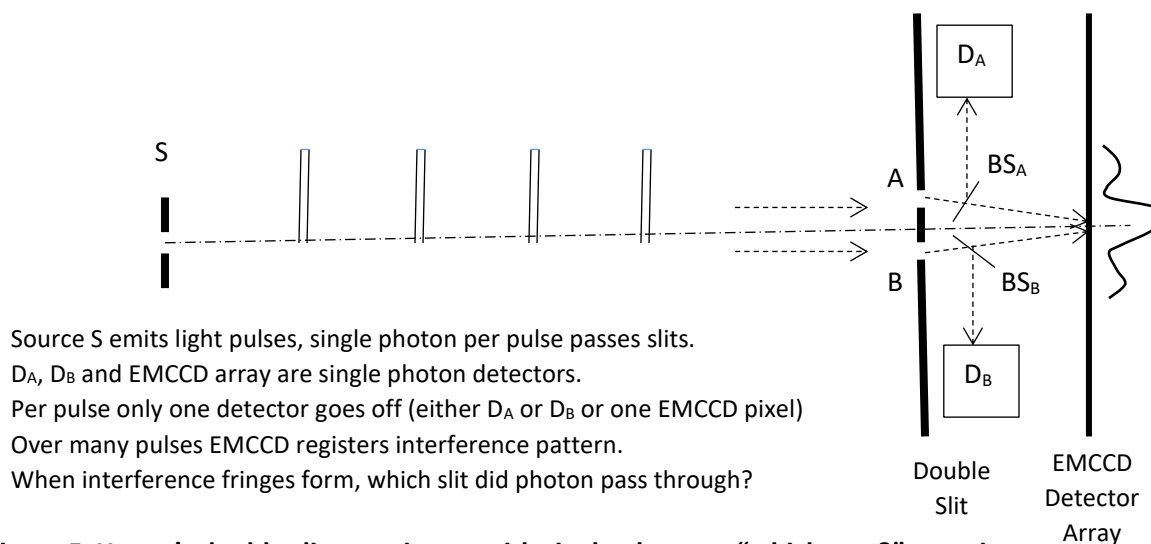

Figure 5. Young's double slit experiment with single photons; “which way?” question

The “which way” question is: When interference fringes form (by superposition of both paths) which path did the single photon take? This question consumed Bohr and Einstein [1], who considered various ways to sense “which way” without affecting the interference pattern, such as using mechanical recoil of hypothetical free-moving slits placed before the physical slits (instead of detectors D_A and D_B), but failed due to the uncertainty principle that precludes sufficiently accurate sensing of both energy (frequency, wavelength) and momentum (direction) of photon. The end result was Bohr's complementarity principle that both interference and “which way” cannot be measured at the same time. Many experiments and implementations of Wheeler's thought experiment (discussed later) used polarization to sense the path to avoid the problem of uncertainty principle. Note that when a polarizer is used to mark the path, say horizontal for path A and vertical for path B, the orthogonality (lack of alignment) destroys interference.

This “which way” question does not arise if we accept our axiom which breaks the co-location (coincidence) of wave and particle at points where probability < 1 , which is true for either path, and so wave function and particle cannot be co-located on either path. The divisible wave function goes through both slits defining various probabilities, the physical photon goes through only one slit, its path always leading to the detector that goes off.

Note that: “which way” \equiv no alignment of the paths (D_A and EMCCD) or (D_B and EMCCD) \equiv No interference
 No “which way” \equiv no D_A or D_B , and alignment of the two paths at EMCCD \equiv Interference.

V. J.A. WHEELER’S THOUGHT EXPERIMENT

In 1982, J.A. Wheeler proposed an ingenious delayed choice thought experiment [3] to test Bohr’s explanation of duality, by dynamically changing the setup after the photon committed to a path. Referring to Figure 6, when BS_2 is in place there is interference, D_1 (constructive interference) registers counts and D_2 (destructive interference) does not. When BS_2 is removed, there is no interference, both D_1 and D_2 register counts (each 50% probability for single photon). That is, according to complementarity / “which way” observation, BS_2 in place \equiv interference, photon travels as a wave through both paths. BS_2 removed \equiv particle, photon travels either through path1 or path2. What happens in the case of delayed choice, by which BS_2 is present (absent) when photon passes BS_1 so that photon is committed to both paths as wave (one path as particle), but is then removed (inserted) before it reaches the detectors?

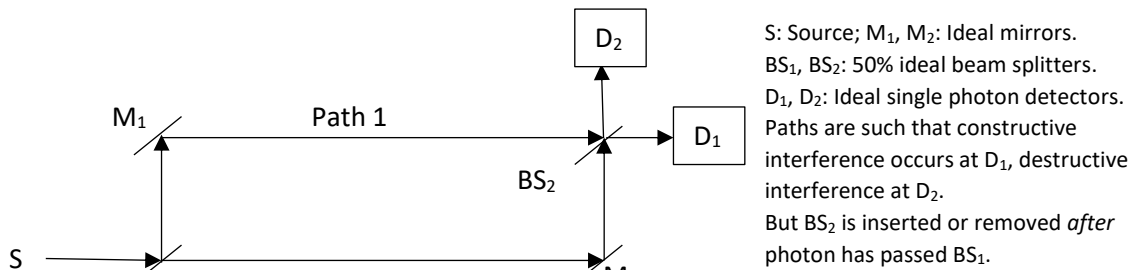

Figure 6 Wheeler’s delayed choice thought experiment

By our Theorem, co-location (coincidence) of wave function and particle is not possible in either path 1 or path 2 because probability at output of BS_1 is not 1 for either path, and so divisible wave function goes through both paths, defining various probabilities of outcomes, while indivisible particle photon goes through only one path, a particular outcome selected by measurement out of many probable outcomes. Probabilities defined by wave function indicate that there is interference when BS_2 is in place and no interference when BS_2 is not in place at the instant of measurement, regardless of which path the photon took and when, agreeing with experimental results discussed below.

Note: BS_2 in place \equiv alignment of both paths at D_1 and D_2 \equiv constructive / destructive interference \equiv no “which way”;
 BS_2 removed \equiv no alignment of paths \equiv no interference \equiv “which way”.

Using orthogonal polarizations as path identifiers for the two paths, and with the availability of extremely fast electro-optic modulator (EOM) devices, it became possible to electro-optically implement the role of insertion or removal of beam splitter BS_2 or its equivalent in Wheeler’s delayed choice thought experiment. Among several remarkably ingenious experimental realizations of Wheeler’s thought experiment, we shall discuss Roch et al [4] (without entanglement) and Yoon-Ho Kim et al [5] and Ma et al [6] (with entanglement) which as reported confirm current explanation (complementarity, that “which way” observation destroys interference) and we shall explain the same results by our Theorem, totally without using complementarity principle or “which way” observation criterion.

VI. EXPERIMENTAL IMPLEMENTATION BY ROCH

Referring to the simplified schematic in Figure 7 (see [4] for details) source S is a single N-V (Nitrogen-Vacancy) color center in a diamond nanocrystal, which when excited by a laser pulse emits a single linearly polarized photon within 45 ns of the narrow 800 ps excitation pulse, enabling precision timing of the photon emission. The photon goes through a polarizing beam splitter PBS in BS_1 , whose H and V orthogonal polarization outputs (single indivisible photon goes to either H or V channel) are separated into two 48 meter long paths, path1 for H and path2

for V. After 48 meters these two paths enter BS₂ consisting of a half wave plate followed by a polarization beam splitter PBS which combines the two (V and H) paths, followed by an electro-optic-modulator (EOM) which when turned on rotates plane of polarization by $\pi/4$, followed by a Wollaston Prism (WP) which separates its H and V polarizations which then terminate in single photon counting detectors D₁ (count N₁) and D₂ (count N₂) respectively. N_c is coincidence count. Phase difference ϕ is introduced between the paths to D₁ and D₂ by tilting PBS in BS₂, by varying which interference pattern can be scanned. The transit time of 160 ns to traverse 48m allows practical implementation of dynamic change at EOM while photon is in midflight (in path1 or path2), ensured by the timing and 48m separation. EOM is turned on or off by Quantum Random Number Generator (QRNG) close to BS₂, so that there is no chance of its random output being “known” to the photon when it passes through BS₁ where path1 or path2 is selected (randomly according to reflection / transmission probabilities in PBS in BS₁).

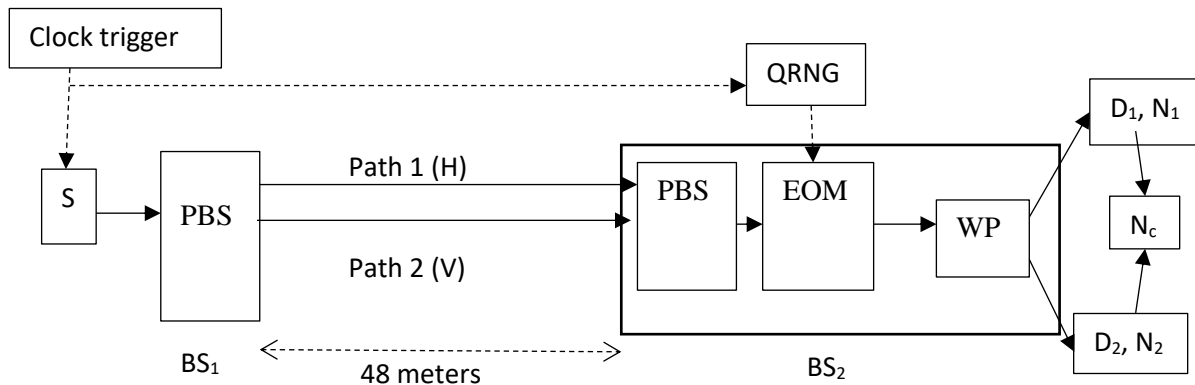

Figure 7. Simplified schematic of Implementation of Wheeler’s delayed choice thought experiment by Roch et al [4]
(with permission from OSA)

EOM off: H and V go to D₁ and D₂ respectively (verified by blocking one channel in the 48m path), “which way” is known, D₁ and D₂ counts are same, do not vary with ϕ , no interference.

EOM on: No “which way”, rotated H and V are mixed by WP, with $\phi = 0$ polarization planes aligned in D₂ (counts) and counter-aligned in D₁ (no counts), that is, interference. Counts vary sinusoidally with ϕ , D₂ out of phase with D₁.

When EOM is turned on or off when photon is in midflight, according to complementarity principle it must change from particle to wave or from wave to particle retrospectively, that is, there is retro-causality.

We can readily explain these results using our theorem, without complementarity or “which way” observation. By inspection we see that until detection $|\psi| < 1$ for either path, and so wave function and particle cannot be co-located. The divisible wave function travels along both H and V channels till it terminates upon detection either by D₁ or D₂, while the indivisible photon is on one of the two channels. Let the photon be on say H channel, inside the interferometer (about 12 to 25m from BS₁) when EOM is switched, say from off to on. When the wave function (and photon) reach EOM, say with $\phi = 0$, the probability amplitude is accordingly 1 for D₂ and 0 for D₁, and so the photon goes to D₂. Note that there is path for the single photon to go from the H channel to D₂ because of the projection in PBS in BS₂ when EOM is on (equivalent to inserting BS₂ in Wheeler experiment in Figure 2). If, on the other hand EOM were switched from on to off, when the wave function (and photon) reach EOM, the wave function accordingly sets probability of 0.5 for D₁ and 0.5 for D₂, and the photon goes to D₁ (if it were on V channel it would go to D₂). Thus the physical photon does not change its behavior particle to wave or vice versa in midflight, it simply follows the probability density determined by the non-physical divisible wave function which travels on both paths at all times. Photon follows only one path. Note that because (due to removal of assumption of co-location of wave function and particle at all times) photon remains particle all along. Also, by this Theorem there is no retro-causality.

Note that: EOM on \equiv alignment of both planes of polarizations \equiv interference \equiv no “which way”;

EOM off \equiv no alignment of the two planes of polarizations \equiv no interference \equiv “which way”.

VII. ENTANGLED IMPLEMENTATION BY KIM

This ingenious experiment by Yoon-Ho Kim et al (see [5] for details) dramatically demonstrates “quantum erasure” using two entangled photon pairs, each pair denoted by “signal” photon and its entangled companion “idler” photon, with idler photons used to “erase” the “memory” of signal photons regardless of the time sequence. Figure 8 shows (simplified) this implementation of Wheeler’s delayed choice thought experiment using entangled photon pairs.

Each pump laser pulse excites close-by atoms say A and B in BBO crystal, each of which emits by cascade decay a pair of entangled photons 1 and 2 in two different specific directions, that is, entangled pair 1_A and 2_A from atom A, and entangled pair 1_B and 2_B from atom B. Excitation is such that 1_A and 1_B are mutually coherent, and by entanglement so are 2_A and 2_B . Photons 1_A and 1_B are focused by lens on single photon counting detector D_0 , which is on a stage that can be moved laterally, introducing path difference between 1_A and 1_B at the detector. Because of coherence and alignment, interference pattern is observed as the stage is moved, conditional on what happens to their entangled partners 2_A and 2_B , because as explained earlier an entangled pair of particles share the same non-factorable joint wave function, and because interference here is between the two joint wave functions of A and B pairs, the interference of entangled pairs A and B requires interference of 1_A and 1_B as well as interference of 2_A and 2_B .

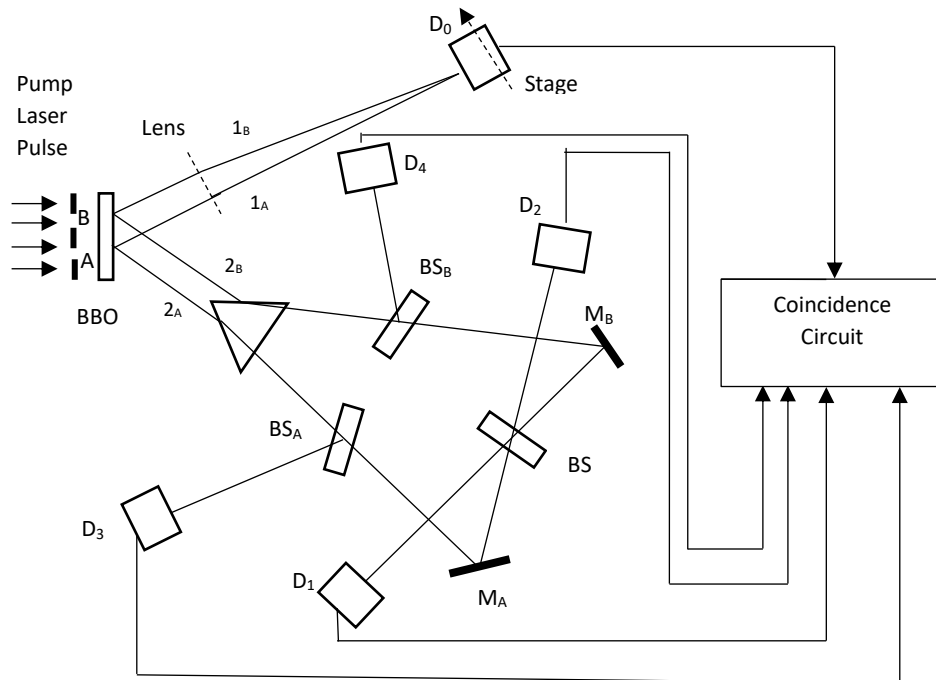

Figure 8. Schematic of Wheeler’s Delayed Choice Thought Experiment Implemented using entangled photon pairs by Yoon-Ho Kim et al [5]
(with permission from APS)

Beam splitter (50%) BS_A sends 2_A either to detector D_3 or towards mirror M_A each with 50% probability. Likewise, 2_B is sent by BS_B either to detector D_4 or to mirror M_B each with 50% probability. After reflection from M_A and M_B , photons 2_A and 2_B are combined in beam splitter BS and sent to detectors D_1 and D_2 , where they can interfere.

D_3 and D_4 unambiguously provide the “which way” information (path A or path B) whereas detections at D_0 , D_1 and D_2 do not provide “which way” information. When 2_A goes to D_3 or when 2_B goes to D_4 , clearly there is no spatial alignment between 2_A and 2_B and so there can be no interference, whereas at D_1 and D_2 there is spatial alignment between 2_A and 2_B and so there can be interference. The path length to D_0 is much shorter than path lengths to D_1 , D_2 , D_3 and D_4 , so that detection at D_0 occurs much earlier than at D_1 , D_2 , D_3 and D_4 . With time stamps adjusted for this difference, the coincidence circuit measures coincidences between (D_0, D_1) , (D_0, D_2) , (D_0, D_3) and (D_0, D_4) for each position of the stage on which D_0 is mounted. Plotted versus stage position, coincidences (D_0, D_1) and (D_0, D_2) show interference, while coincidences (D_0, D_3) and (D_0, D_4) do not show interference. Thus when “which way” is sensed by D_3 or D_4 there is no interference, and when “which way” is not sensed (by D_0 , D_1 and D_2) there is interference, confirming Bohr’s complementarity view of duality and “which way” observation. Moreover, because detection at D_0 occurs much earlier than at D_1 , D_2 , D_3 or D_4 , interference (or not) is determined retrospectively. This experiment thus dramatically demonstrates what appears to be retro-causality. It is as if past “memory” of 1_A and 1_B is erased, and so this is called a “quantum eraser” experiment. We shall discuss this causality question further later on.

Our Theorem explains results without complementarity or “which way” observation: Because $|\psi| < 1$ for the paths, wave function and particle cannot be co-located (coincident) on the paths; divisible wave functions travel all possible paths defining various probabilities for detections at D_0 , D_1 , D_2 , D_3 and D_4 , with interference of the two joint wave functions for (D_0, D_1) and (D_0, D_2) combinations due to path alignments at D_0 , D_1 and D_2 , and no interference of the two joint wave functions for (D_0, D_3) and (D_0, D_4) combinations due to lack of path alignment at D_3 and D_4 . Indivisible photons remain particles throughout and divisible wave functions travel all possible paths, there is no wave-particle dynamic change.

Note that: Alignment at (D_0, D_1) and $(D_0, D_2) \equiv$ interference \equiv no “which way”
 No alignment (at D_3 and D_4) \equiv no interference \equiv “which way”

Note that for a given entangled pair, measurements of the two particles, say of 1_A at D_0 at time t_1 and of 2_A at D_1 , D_2 or D_3 at time t_2 , with $t_2 > t_1$, are done only once, that is, measurement at time t_1 at D_0 for this sample is not repeated again such as at time t_2 . Therefore there is really no erasure of the value measured at time t_1 at D_0 . However, there is retro-causality if we take the measurement at time t_2 as the defining measurement, but which itself is questionable. We shall discuss this causality issue further later on.

VIII. ENTANGLED IMPLEMENTATION BY MA

In recent years, experimenters have conducted and reported many increasingly complex ingenious experiments, sparing no efforts to explore “which way” complementarity and “retro-causality” or “erasure” in single photon interference phenomena. Xiang Song Ma et al (see [6] for details) used a space link to dramatically increase the time difference between the two measurements of an entangled pair of photons to “causally disconnect” the two measurements. As explained in Figure 9 with a simplified schematic, this impressive experiment (repeated successfully with separation of Labs 1 and 2 increased to 144 km using free space link) clearly demonstrated that (a) “which way” knowledge does influence the particle vs wave duality behavior confirming Bohr’s complementarity explanation (b) the effect is retrospective as time t_1 when interference is measured is much earlier than time t_P of polarization projection of environment photon whose state carries the “which way” information (linear polarization = “which way” versus circular polarization = no “which way”), and also the so-called “quantum erasure” is shown. We shall now explain the same experimental results without using “which way” or complementarity considerations.

By inspection we see that wave function amplitude (probability) is less than 1 for either path (path a or path b), and so physical signal photon (particle) cannot be co-located (coincident) with its probabilistic non-physical wave function at any point in either path. Indivisible physical particle (single photon) travels only one path for any given measurement sample, while probabilistic divisible wave function travels both paths a and b to cover all probabilities, demonstrating interference if there is coherent superposition with alignment of polarization when combined at beam splitter BS. When environment photon is linearly polarized, due to spatial orthogonality of $|H\rangle_e$ and $|V\rangle_e$ there is no interference when wave function components via paths a and b are superposed at D_1 or D_2 . However, when

environment photon is circularly polarized, there is alignment of polarization in the superposition at D_1 or D_2 , and so there is interference, whose pattern is observed by varying the optical path difference between paths a and b by tilting polarizing beam splitter PBS_1 .

For elliptical polarization there is partial interference, ranging from theoretical zero for plane polarization to theoretical 100% for circular polarization, varied by varying EOM voltage (see Figure 4 in [6]), which is interpreted in [6] as a complementarity inequality,

$$I^2 + V^2 \leq 1 \quad (3)$$

where I (range 0 to 1) is a measure of particle nature and V (range 0 to 1) is a measure of fringe visibility, wave nature. Our approach explains (3) entirely on the basis of alignment of polarization of the wave function components at D_1 or D_2 , without resorting to complementarity principle or “which way” considerations. Also, we note that (3) is a consequence of orthogonality of polarizations.

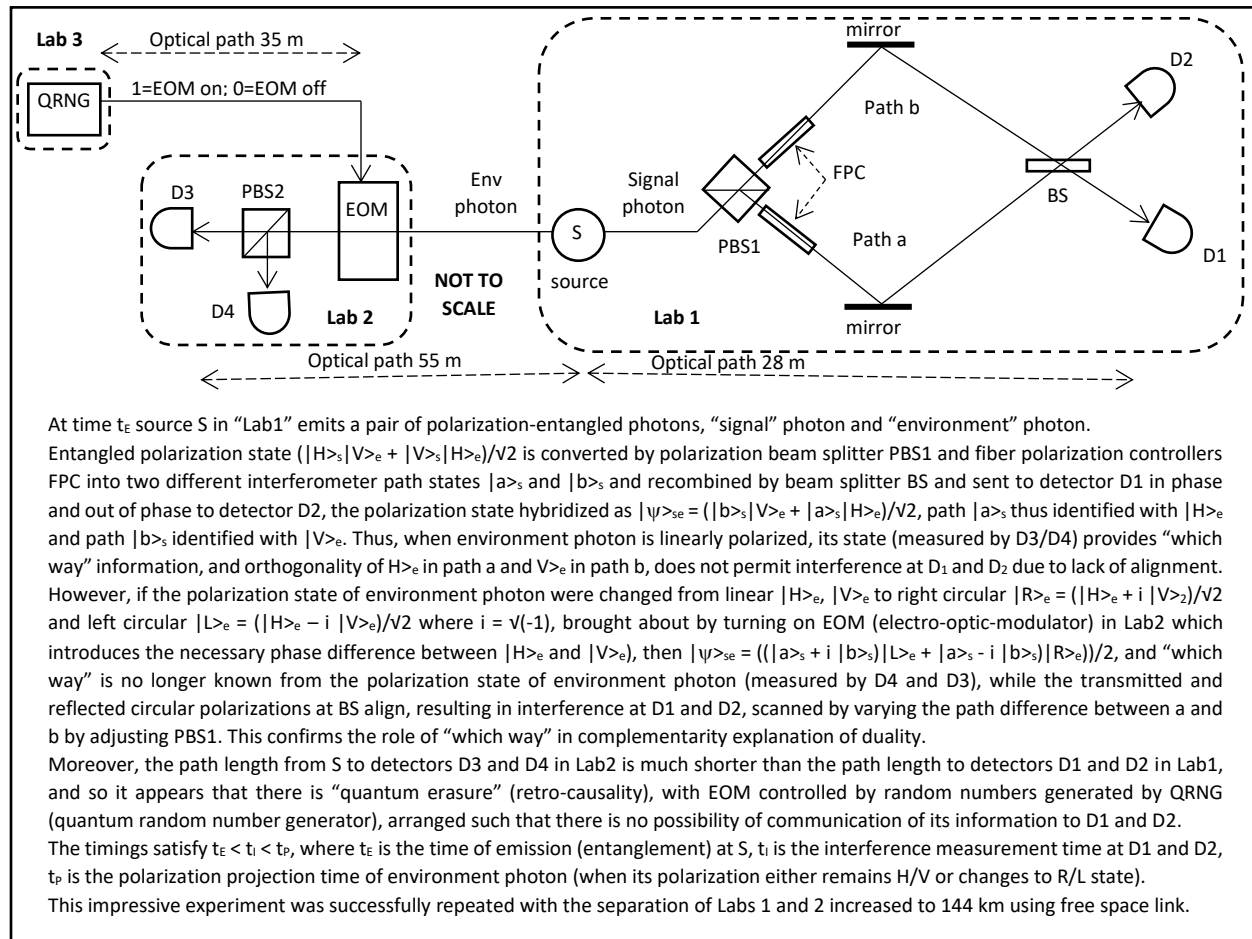

Figure 9. Simplified schematic of “Quantum erasure with causally disconnected choice” by Xiao-Song Ma [6]
(with permission from PNAS)

Note that there is only one measurement at D_1 / D_2 at time t_i corresponding to the one measurement at D_3 / D_4 at time t_p , and together they constitute only one measurement of the entangled pair; it is not as if measurement at D_1 / D_2 changes from its measured value at time t_i to some other value at time $t_p > t_i$. Therefore, there is really no

“erasure”. One may regard the measurement at t_P to be the defining one and so propose retro-causality at t_i , but there is no justification to take one or the other as the defining measurement; both together constitute one measurement of the entangled pair which satisfies the entanglement constraint. The state of quantum system remains undefined until measurement, in this case the one measurement of the entangled pair completed only at time t_P .

Note also that: Alignment of polarization (at D_1 or D_2) \equiv interference \equiv no “which way”
 No alignment of polarization (at D_1 or D_2) \equiv no interference \equiv “which way”

Thus, “which way” is not necessary to determine whether or not there is interference, it suffices to analyze the propagation of wave function along all possible paths for all possible (random) parameters of the system, very similar to classical analysis using coherence and alignment requirements for interference.

IX. E.P.R. THOUGHT EXPERIMENT

The experiments discussed raised very interesting causality questions of “retro-causality” and “quantum erasure”. To shed some light on this, we shall discuss causality in entanglement in a basic well known configuration.

As shown in Figure 10, a pair of polarization-entangled photons a and b generated by source S at time t_0 travel in two different spatial directions, and the state of polarization \underline{a} of a and \underline{b} of b are measured by respective instruments, at A at time $t_A > t_0$ corresponding to distance $L_{SA} = c_A \cdot t_A$ where c_A is velocity of light in channel SA and at B at time $t_B > t_A$ corresponding to distance $L_{SB} = c_B \cdot t_B$. Because there are no hidden variables [10, 11 and 12], we know that polarizations of a and b remain undefined until measurement. The question now is: what constitutes measurement of an entangled pair?

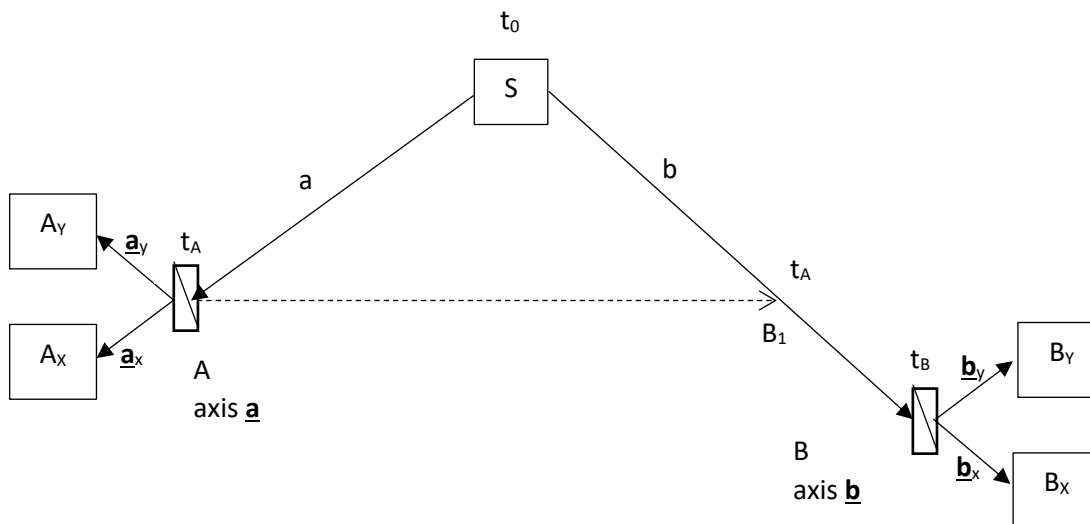

Figure 10: E.P.R. thought experiment using polarization-entangled photons

Early on, it was assumed that the first measurement at time t_A defined the whole measurement, at which time b was thought to become instantly polarized consistent with \underline{a} , at point B_1 at distance L_{SB_1} from S , $L_{SB_1} = c_B \cdot t_A < L_{SB}$. Treating the measurement \underline{a} at A as the cause and \underline{b} as its instantaneous effect at B_1 and noting that distance from A to B_1 is greater than zero and no information was passed via S (no hidden variables) and moreover experimenters had made sure that distances AB and AB_1 are so large as to put B_1 and B outside the light cone of A (light cone defines points reachable at speed of light), it was seen that the effect is non-local with respect to A , faster than speed of light (hence the EPR paradox). However, there is no justification for assuming that polarization \underline{b} is defined at time t_A , because \underline{b} is measured only at time t_B , and so there may be a possibility that its measurement is incomplete at time t_A .

The only correct (experimentally verified) statement we can make is that the measured pair of polarizations **a** and **b** satisfy the entanglement constraint. Thus we may need to regard the pair of entanglement-consistent measurements at times t_A and t_B as one measurement. It is not as if measurement at time t_A is the cause (its effect on b non-local), nor as if measurement at time t_B is the cause (its effect on a non-local and retro-causal with erasure of its value at time t_A). Because **a** is measured only once (at time t_A), there is really no “erasure” of prior measured value.

Neither measurement (at t_A or t_B) is the cause of the other; both are part of the same measurement pair, their constraint caused by entanglement at time t_0 . In this view the real cause of all observed data is the entanglement at time t_0 . In this larger picture which is substantiated by results of all reported experiments, locality and causality are satisfied because from the source S which causes entanglement at time t_0 the joint wave function travels at speed of light to A reaching at time t_A and also at speed of light to B reaching it at time t_B .

On the other hand, if one (conventionally) chooses measurement **a** at time t_A to be the cause and **b** as its instantaneous effect, then locality is clearly violated, or if one (unconventionally) chooses measurement **b** at time t_B as the cause, then there is retro-causality, and also non-locality. We may call these scenarios of causality as partial causality because entanglement at t_0 is totally ignored as an additional, indeed original, cause. If however entanglement at t_0 is also recognized as a cause, then we have a two-input (entanglement at t_0 AND measurement **a** or **b**) single output (**b** or **a**) causality, which we may call total causality. A better total causality picture may be to consider entanglement at time t_0 as the cause and measurement of the entangled pair (**a** at time t_A and **b** at time t_B) as its effect.

It is clear that entanglement certainly changes the classical view of causality as events arranged along a time axis with cause always preceding its effect, and replaces it with the quantum mechanical view of causality with the effect of entanglement at time t_0 felt at two different future time points t_A and t_B which need to be regarded as a single effect, the underlying mechanism being conditional joint probability density created at the time of entanglement. Entanglement thus changes the causal order (effect at two future instants of time instead of one), but does not totally eliminate causal order. There are other interesting discussions of quantum causality (see for example [18], [19]).

ENTANGLEMENT SWAPPING

It has been demonstrated (see for example [20]) that: Given a pair of particles (A_1, A_2) entangled at time t_0 , then at time $t_1 > t_0$ if one of them (say A_1) and a third particle B are brought together to the same space-time point with full coherence and alignment, then there exists a non-zero probability that the pair (A_1, B) gets entangled, in which case A_2 gets un-entangled. This phenomenon is called entanglement swapping. In such cases also our method (Theorem) can be applied, taking into account the change in the entanglement constraint at time t_1 .

X UNANSWERED FUNDAMENTAL QUESTION

The fundamental assumption of quantum mechanics, that physical reality is explained in terms of complex mathematical probability amplitudes which are recognized by all to be non-physical, which the proposed Theorem interprets in a more complete way, leaves the following single fundamental question unanswered:

Why is physical reality explainable in terms of non-physical purely mathematical probability amplitudes?

That it explains reality is not sufficient, the question is “why?” This question, which existed from the earliest days of quantum mechanics, rephrases at a more general fundamental level (not just action at a distance or duality discussions with Bohr) Albert Einstein’s question in the EPR paper: Can quantum mechanical description of physical reality be considered complete? Until this fundamental question (assumption) of quantum mechanics is satisfactorily explained, we have to agree with Albert Einstein and regard quantum mechanics as incomplete. Even if we agree that the universe is fundamentally probabilistic and not deterministic, the question remains as to why this probability comes about from complex probability amplitudes in Schrodinger’s wave equation that relates non-physical mathematical probability amplitudes to real physical quantities – an inexplicable combination of non-physical with physical.

XI CONCLUSIONS, DISCUSSION

1. We have demonstrated, to the best of our knowledge for the first time, that duality can be explained without invoking complementarity or the effect of observation (“which way”).
2. We have achieved this remarkable result by proposing and justifying a more complete statement of the probability that is fundamental to quantum mechanics, making no new assumptions, in the form of a new Theorem with proof: Particle and its wave function $\psi(\mathbf{r}, t)$ cannot be co-located at space-time points (\mathbf{r}_k, t) where $|\psi(\mathbf{r}_k, t)| < 1$, and can be co-located only at space-time points where $|\psi(\mathbf{r}_k, t)| = \delta(\mathbf{r} - \mathbf{r}_k, t)$, the Dirac delta function. This decouples the particle from its wave function propagating on multiple paths, as it must, to define all possible probabilistic outcomes, while particle always travels along only one path, one of the many probable measurement outcomes in a given configuration which may change dynamically.
3. We have shown that in interference experiments reported to demonstrate the effect of “which way” observation,
 - Coherence and alignment (including alignment of polarization) \equiv interference \equiv no “which way”
 - No coherence or alignment (including alignment of polarization) \equiv no interference \equiv “which way”
 Thus, “which way” observation is redundant and unnecessary. Traditional analysis of coherence and alignment applied to wave function suffices. This greatly simplifies analysis and design of multi-path quantum systems and also avoids unnecessary confusion involving “consciousness” of observer and other mystical metaphysical conjectures.
4. We have noted that the inequality $U^2 + V^2 \leq 1$ where V is a measure of “wave nature” and U is a measure of “particle nature” is explainable as due to orthogonality of alignment (interference) and no alignment (no interference).
5. We have suggested a clearer understanding of causality in entanglement by (a) correctly including the act of entanglement itself as a cause (not to be confused with hidden variable because the variable is still undefined until measurement) which always precedes its effect on the pair of measurements which together must always be regarded as a single measurement in spite of space-time separation, because entanglement constraint links them together, and we distinguish this as “total causality” that obeys conventional causality and (b) regard currently viewed retro-causality as “partial causality” (because it excludes the act of entanglement) that may not obey conventional causality.
6. By doing away with complementarity and “which way” observation to explain duality, this paper redeems the view of Albert Einstein that measuring instruments cannot influence the fundamental wave – particle behavior (not to be confused with the requirement that the states of measuring system must be included in the states of the overall quantum system, analogous to the loading effect of measuring instruments in classical analyses): Wave always remains wave, and particle always remains particle.
7. All issues are reduced to a single unanswered question that already existed from the beginnings of quantum mechanics: “Why (not how) physical reality is correctly described by non-physical purely mathematical probability amplitudes?” which, until answered, justifies Albert Einstein’s question: “Is quantum mechanics complete?”

This unanswered question is inherent in the interpretation of physical quantities as “operators” in Schrodinger’s wave equation (and equivalently in Heisenberg’s algebraic formalism), operating on the non-physical purely mathematical wave function, the complex probability amplitude. That the universe is fundamentally probabilistic and not deterministic is not the issue, because there is no justification for it to be deterministic, and in fact it makes better sense that it is probabilistic, because allowing many probable outcomes is more general than insisting on only one outcome. Also, when a measurement is made, it is not as if the measurement has caused the outcome, it is simply (and correctly) that the measurement has measured the outcome as the name itself implies. A single single-photon measurement does not shed much light, as multiple single-photon measurements are needed to establish the correlations that define the relationships; multiple single-photon measurements yield the same result only when there is no other probable outcome possible.

As explained in this paper, the conventional view of causality, that the cause always precedes its effect on the axis of time, remains valid in the quantum picture if we (correctly) regard entanglement as the cause and the subsequent pair of measurements (linked together by entanglement constraint but separated in space-time) as its single effect, as both measurements always have to be considered together, and as there is no repeat of either measurement.

This remains true even when entanglement is swapped at some point in time, after which the entanglement constraint simply changes as between the new pair of particles.

NOTE

An earlier less developed version of this paper is archived at viXra 1712.0558v3: Sarma N. Gullapalli “Explaining Duality without Complementarity or “which way” (welcher-weg) and also Retro-Causality and Non-Locality”

An original version of this paper, before changes for journal publication requirements, is archived at viXra 1807.0106 Archiving does not constitute publication, it is not a journal, it is only to set date of original discovery.

A power point version of an earlier version of this paper was presented at the International Conference on Quantum Mechanics and Applications, July 20-21, Atlanta GA, USA.

XIII REFERENCES

1. Niels Bohr, Discussion with Einstein on epistemological problems in Atomic Physics, in [3] pages 9-31
2. R.P. Feynman, The Feynman Lectures on Physics vol 3, page 1-1
3. J.A. Wheeler and W.H. Zurek, Quantum Theory and Measurement, Princeton University Press 1984 (Figure 4, p 183)
4. Roch, A et al, Experimental realization of Wheeler’s delayed-choice Gedanken Experiment, arXiv:quant-ph/0610241v1 28 October 2006, OSA Conference on Coherence and Quantum Optics 2007, Session XII CQ09, Rochester NY USA.
5. Yoon-Ho Kim, R. Yu, S.P. Kulik, Y.H. Shih, A Delayed Choice Quantum Eraser, Physical Review Letters, 2000, arXiv: quant-ph/9903047v1 13 Mar 1999
6. Xiang Song Ma et al, Quantum erasure with causally disconnected choice, PNAS January 22, 2013, Vol 110 No. 4 p 1221-1226
7. A. Narasimhan, M.C. Kafatos et al, Wave Particle Duality, The Observer and Retrocausality, A.P.I. Conference Proceedings vol.1841, San Diego 15-16 June 2016
8. A. Einstein, B. Podolsky, N. Rosen, Can Quantum-Mechanical Description of Physical Reality Be Considered Complete?, Physics Review 47, 1935
9. E. Schrodinger, Discussion of Probability Relations between Separated Systems, Mathematical Proceedings of Cambridge Philosophical Society, Volume 31, Issue 4, 1935
10. J.S. Bell, On the Einstein Podolsky Rosen Paradox, Physics Vol 1, No. 3, 1964
11. J.F. Clauser, M.A. Horne, A. Shimony and R.A. Holt, Proposed experiment to test local hidden-variable theories, Physics Review Letters, 1969
12. Lynden K. Shalm et al, A strong loophole-free test of local realism, Physics Review Letters, December 2015
13. Max Born, The statistical interpretation of quantum Mechanics, Nobel Lecture, 1954
14. A. Papoulis, Probability, Random Variables and Stochastic Processes, McGraw Hill, 1965
15. R.P. Feynman, QED the strange theory of light and matter, Princeton University Press 1988
16. M.T. Hassan et al, Optical attosecond pulses and tracking the nonlinear response of bound electrons, Nature, February 4, 2016
17. Patrick J. Coles et al, Equivalence of wave-particle duality to entropic uncertainty, arXiv: 1403.4687v2[quant-ph] Sept 2014; Nature Communications 5, 5814, 2014
18. Ognian Oreshkov, Fabio Costa & Caslav Brukner, Quantum correlations with no causal order, Nature Communications 2 October 2012 DOI: 10.1038/ncomms2076
19. Caslav Brukner, Quantum causality, Nature Physics, 1 April 2014 DOI: 10.1038/NPHYS2930
20. Xiao-song Ma et al, Experimental delayed-choice entanglement swapping, Nature Physics 8, March 2012