

# A covariant formulation of the Ashtekar-Kodama quantum gravity and its solutions

Jan Helm

Institute of Physics, London

Email: janhelm@snafu.de

## Abstract

This article consists of two parts.

In the first part A we present in a concise form the present approaches to the quantum gravity, with the ADM formulation of GR, the Ashtekar and the Kodama ansatz at the center, and we also derive the 3-dimensional Ashtekar-Kodama constraints.

In the second part B, we introduce a 4-dimensional covariant version of the 3-dimensional (spatial) Hamiltonian, Gaussian and diffeomorphism constraints of the Kodama state with positive cosmological constant  $\Lambda$  in the Ashtekar formulation of quantum gravity.

We get 32 partial differential equations for the 16 variables  $E^{\mu\nu}$  (E-tensor, inverse densitized tetrad of the metric  $g_{\mu\nu}$ ) and 16 variables  $A_\mu{}^\nu$  (A-tensor, gravitational wave tensor). We impose the boundary condition: for  $r \rightarrow \infty$   $g(E^{\mu\nu}) \rightarrow g_{\mu\nu}$  i.e. in the classical limit of large  $r$  the Kodama state generates the given asymptotic spacetime (normally Schwarzschild-spacetime).

For  $\Lambda > 0$  in the static (time independent) the tetrad decouples from the wave tensor and the 24 Hamiltonian equations yield for  $A_\mu{}^\nu$  the *constant background* solution. The diffeomorphism becomes identically zero, and the tetrad can satisfy the Schwarzschild spacetime and the Gaussian equations for all  $\{r, \theta\}$ , i.e. the Einstein equations *are valid everywhere* outside the horizon.

At the horizon, the E-tensor couples to the A-tensor in the 24 Hamiltonian equations and *the singularity is removed*, there is instead a peak in the metric.

In the time-dependent case with a  $\Lambda$ -scaled wave ansatz for the A-tensor and the E-tensor we get a gravitational wave equation, which yields appropriate *solutions only for quadrupole waves*: as required by GR, the tetrad is *exponentially damped*, only the A-tensor carries the energy.

We examine spherical and planar gravitational waves, derive their *wave component relations*, and calculate the reflection and absorption ratios.

The validity of the *Einstein power formula for gravitational waves* is shown for a binary black hole (binary gravitational rotator).

From the horizon condition we derive the *limit scale* (Schwarzschild radius) of the *gravitational quantum region*:  $r_{\text{gr}} = 30 \mu\text{m}$ , which emerges as the limit scale in the objective wave collapse theory of Gherardi-Rimini-Weber.

We present the *energy-momentum tensor*, which is in agreement with the corresponding GR-expression for small wave amplitudes and is consistent with the Einstein power formula.

In the quantum region  $r \leq r_{\text{gr}}$ , the Ashtekar-Kodama gravitation theory becomes *a gauge theory with the extended SU(2)* (four generators) as gauge group and a corresponding covariant derivative.

In the quantum region we derive the *lagrangian*, which is *dimensionally renormalizable*, the normalized one-graviton wave function, the graviton propagator, and demonstrate the calculation of cross-section from Feynman diagrams at the example of the graviton-electron scattering.

## Introduction

In our opinion, there are six requirements, which a successful quantum gravity has to fulfill :

- it must have a dimensionally renormalizable lagrangian, i.e. the lagrangian must have the correct dimension without dimensional constants, and a covariant derivative with a gauge-group
  - the static version of the theory must deliver the exact GR, except at singularities
  - the static theory should remove the singularities of GR
  - the time-dependent version of the theory must give a mathematically consistent classical description of gravitational waves (i.e. a graviton wave-tensor) with basic quadrupole symmetry (as required by GR)
  - the corresponding energy-momentum tensor must give the Einstein power formula for the gravitational waves and agree with the GR version for small amplitudes
  - the quantum version of the theory must deliver a renormalizable lagrangian, and a quantum gauge theory , which, within Feynman diagrams yields finite cross-sections in analogy to quantum electrodynamics
- The Ashtekar-Kodama (AK-) gravity, which we present in Part B, satisfies all six requirements, therefore it is a good candidate for the correct quantum gravity theory.

The starting point of the AK gravity are the 3-dimensional AK constraints. They can be derived from the Ashtekar version of the ADM-theory plus Kodama ansatz (chapter A7) or from the Plebanski action of the BF-theory , which is a generalized form of GR (chapter A9). Essential for the solvability and non-degeneracy of the AK-constraints is the existence of the positive cosmological constant  $\Lambda$  . It guarantees that the operator of the hamiltonian constraint (also known as the Wheeler-DeWitt -equation) is non-singular and invertible. The 3-dimensional AK constraints can be generalized to 4 dimensions including time in a mathematically consistent and unique way, simply by generalization of the 3-dimensional antisymmetric tensor  $\varepsilon_{ijk}$  in the spatial indices (1,2,3) to the 4-dimensional tensor  $\varepsilon_{\mu\nu\kappa}$  in the temporal-spatial-indices (0,1,2,3), i.e. in the coordinates  $(t,r,\theta,\varphi)$  , using spherical spatial coordinates.

The 4-dimensional AK equations are 32 partial differential equations for the 16 variables  $E^{\mu\nu}$  ( E-tensor, inverse densitized tetrad of the metric  $g_{\mu\nu}$ ) and 16 variables  $A_\mu{}^\nu$  (A-tensor, gravitational wave tensor). We impose the boundary condition:  $E^{\mu\kappa} E^\nu{}_\kappa = g^{\mu\nu} / (-\det(g))^{3/4}$  for  $r \rightarrow \infty$   $g(E^{\mu\nu}) \rightarrow g_{\mu\nu}$  i.e. in the classical limit of large  $r$  the Kodama state generates the given asymptotic spacetime (normally Schwarzschild-spacetime) .

The static equations (time-independent, i.e. without gravitational waves) in the limit  $\Lambda \rightarrow 0$  degenerate in the 24 hamiltonian equations: for the A-tensor we get the trivial solution  $A_\mu{}^\nu = \text{constant half-antisymmetric}$  , the E-tensor solutions of the remaining 4 gaussian equations (the last 4 vanish identically) is the *Gauss-Schwarzschild tetrad* (or the *Kerr-Schwarzschild tetrad*), which satisfies the Einstein equations *everywhere in  $r$* , so GR is valid .

If we set the constant A-tensor  $A_\mu{}^\nu = \frac{1}{l_p}$  , the *modified Einstein-Hilbert action*  $S = \frac{\hbar c}{\pi} \int (A_\mu{}^\nu A_\nu{}^\mu) R \sqrt{-g} d^4x$

becomes *dimensionally renormalizable* (chapter 4.1) .

At the horizon in the limit  $r \rightarrow l$  the E-tensor becomes very large and the term  $\Lambda E^{\mu\nu}$  not negligible any more, the singularity is removed and becomes a peak  $g_{1,1} = \frac{1}{\sqrt{\Lambda}}$  . From this condition results a limit for the *quantum*

*gravitational scale*  $r_{gr} = \sqrt{l_p \sqrt{\frac{1}{\Lambda}}} = 3.1 * 10^{-5} m = 31 \mu m$  (chapter B3.3).

This quantum gravitational scale emerges in the objective wave collapse theory of Ghirardi-Rimini-Weber as the critical wave function width  $r_c$  (chapter B8.7) , and the second critical parameter is the critical decay rate

$\lambda(r_c) = \frac{G m_e^2}{\hbar r_c} = 0.19 * 10^{-11} s^{-1}$  , where  $m_e$  is the electron mass and  $r_e = 2.8 * 10^{-15} m$  is the classical electron

radius. This means that the quantum gravitational scale marks the limit of the quantum coherence length, in other words, *it is the border between quantum and classical regime*.

Numerical calculation for strong coupling  $\Lambda = l$  (chapter B5) shows that in free fall from the distance  $r_0 = 10 r_s$  from the horizon the maximum velocity is  $v_{max} = 0.6c$  , and then there is a rebound.

For the time-dependent Ak equations we make the *A-scaled wave ansatz*

$$A_{\mu}^{\nu} = Ab_{\mu}^{\nu} + \Lambda \frac{As_{\mu}^{\nu}}{r} \exp(-ik(r-t))$$

$$E^{\mu\nu} = Eb^{\mu\nu} + \frac{Es^{\mu\nu}}{r} \exp(-ik(r-t))$$

and solve the static part *eqtoievnu3b* for  $Ab, Eb$  and the time-dependent part *eqtoievnu3w* with the factor  $\exp(-ik(r-t))$  for  $As, Es$ .

With the multipole ansatz  $Es(r, \theta) = Es(r) \exp(i * lx * \theta)$ ,  $As(r, \theta) = As(r) \exp(i * lx * \theta)$ ,

*eqtoievnu3w* boils down after variable eliminations to the gravitational wave equation for the variable  $Es_{l0}$  (and identical for variables  $Es_{l1}, Es_{l2}, Es_{l3}$ )

*eqgravlxEn* =

$$\begin{aligned} & (k r_1 (-2 - i k r_1) + l x^3 (1 + i k r_1) + l x^2 (-2 i + 4 k r_1 + 3 i k^2 r_1^2) + l x (-1 - 5 i k r_1 + 4 k^2 r_1^2 + 2 i k^3 r_1^3)) Es_{l0}(r_1) + \\ & r_1 ((-l x^3 + l x^2 (2 i - 5 k r_1) + l x (1 + 3 i k r_1 - 6 k^2 r_1^2) + k r_1 (2 + i k r_1 - 2 k^2 r_1^2)) Es_{l0}'(r_1) + \\ & r_1 (-i (2 l x^2 + 5 k l x r_1 + k r_1 (-i + 3 k r_1)) Es_{l0}''(r_1) + r_1 (l x + k r_1) Es_{l0}^{(3)}(r_1)) \end{aligned}$$

which is a differential equation of degree 3 in  $r_1$  with the parameters  $k$  (wave number) and  $lx$  (angular momentum).

This equation has feasible solutions only for  $lx \geq 2$  (at least quadrupole wave), as required in GR.

The overall solution is (chapter B4.3.1):

-the *E-tensor* is exponentially damped with  $\exp(-\frac{4\sqrt{r}}{\sqrt{3}})$

-the *A-tensor* components  $As_0$  and  $As_1$  are *pure quadrupole waves*,  $As_2$  is a linearly damped quadrupole wave,

$As_3$  is exponentially damped with  $\exp(-\frac{4\sqrt{r}}{\sqrt{3}})$

This means that a classical wave source generates gravitational waves  $As$  via the metric, the *energy is carried away by the  $As$ -tensor* and, when the wave is absorbed, it dissipates energy and generates again a (locally damped) metric oscillation  $Es$ .

We examine spherical and planar gravitational waves, derive their *wave component relations*

$$Es_1 = 0 = Es_0, Es_2 = 3ik(As_0 - As_1 + As_2), Es_3 = -3ik As_2$$

$$As_3 = (As_0 - As_1 + As_2),$$

and calculate the reflection and absorption ratios

$$\frac{\delta A_r}{A} = \frac{\delta A_a}{A} = \frac{\delta k}{k} = \frac{r_s(M)}{2r_s}, \text{ where } r_s(M) = \text{Schwarzschild radius of the interacting matter } M$$

We demonstrate this solution procedure at the example of the binary gravitational rotator (bgr= binary black hole). The metric of bgr is a Kerr-metric with Kerr-parameter  $\alpha$ , the corresponding ( $Eb, Ab$ )-solution is

$Eb$ -tensor= the Gauss-Kerr tetrad  $E_{GK}$ :

$$E_{GK} = E_{GS} \text{ except } (E_{GK})_{03} = \frac{\alpha}{r^{9/2} \sin^{3/4} \theta}, Ab\text{-tensor } Ab = A_{hab} + dAb \text{ perturbed half-antisymmetric background}$$

We develop in a series in  $r$  and  $r_0$  and get in lowest order  $As_{00}(r, \theta, r_0) = \frac{As_{00n01}(\theta)}{r_0}$ , the  $\theta$ -functions are

calculated numerically.

We derive the energy-momentum density tensor of the AK gravity in the form

$$t_{\mu\nu} = D_{\kappa} A_{\mu}^{\kappa} D_{\lambda} A_{\nu}^{\lambda} \hbar c \left( \frac{1}{l_p^2 \Lambda^2 r_s^2} \right), \text{ which is identical to the corresponding expression in GR (chapter B7) and is}$$

consistent (has the correct  $r_0$ -dependence) with the Einstein power formula for the gravitational waves of the

$$\text{binary gravitational rotator } P_{GR} = \frac{\hbar c^2}{2l_p^2} \frac{r_s^5}{r_0^5} \left( \frac{m_1 m_2}{m^2} \right)^2.$$

The lagrangian of the AK gravity is (chapter B8.2)

$$L_{gr} = L_H + L_I = \hbar c \left( -\frac{1}{4} F_{\mu\nu}{}^\kappa F^{\mu\nu}{}_\kappa - \frac{\bar{\varphi}_\Lambda \varphi_\Lambda}{3} (\varepsilon^\kappa{}_{\mu\lambda} E^{\lambda\nu} \partial_\kappa A_{\mu\nu} + \varepsilon_{\mu_2\lambda_2\kappa_2} \varepsilon^{\mu_1\lambda_1\kappa_1} E^{\kappa_1\kappa_2} A_{\lambda_1}{}^{\lambda_2} A_{\mu_1}{}^{\mu_2}) \right. \\ \left. + E^{\kappa_1\nu_1} F_{\mu\kappa_1}{}^{\nu_1} E^{\kappa_2\nu_2} F^{\mu}{}_{\kappa_2}{}^{\nu_2} \right), \text{ with the spacetime}$$

curvature (field tensor)  $F_{\mu\nu}{}^\kappa = \partial_\mu A_\nu{}^\kappa - \partial_\nu A_\mu{}^\kappa + \varepsilon^\kappa{}_{\kappa_1\kappa_2} A_\mu{}^{\kappa_1} A_\nu{}^{\kappa_2}$  and  $\Lambda$  is generated by a scalar field  $\varphi_\Lambda$  with the constraint  $\bar{\varphi}_\Lambda \varphi_\Lambda = \Lambda$ . This lagrangian is dimensionally renormalizable.

As  $\Lambda$  is generated by a scalar field, it is expected to be different in the quantum regime. We expect the quotient

$\frac{\alpha_{gr}}{\alpha_{em}} \approx 10^{-40}$  as results from the classical assessment of the ratio of the electrostatic and gravitational potential

for the electron and get for “quantum- $\Lambda$ ”:  $\Lambda_q = \frac{\sqrt{2}}{\tilde{\lambda}_e r_{gr}} = 1.2 * 10^{17} m^{-2}$ , so dimensionless

$\Lambda_{dl} = \Lambda_q r_{gr}^2 = 1.15 * 10^8 \gg 1$  and we have a *very strong coupling* in the quantum AK-equations.

In the quantum region of AK gravity  $r \leq r_{gr} = \sqrt{l_p} \sqrt{\frac{1}{\Lambda}} = 31 \mu m$  we get for the *energy normalized graviton wave*

*function*  $A_{gn}$  (we demand that  $E(A_{gn}) = \hbar c k$ ):

$$(A_{gn})_\mu{}^\nu = \Omega_\mu{}^\nu \sqrt{\alpha_{gr}} \frac{1}{\sqrt{kr_{gr}}} \frac{r_{gr}^{1/2}}{\sqrt{2V}} (\exp(-ik \cdot x) + \exp(ik \cdot x)), \text{ where } \sqrt{\alpha_{gr}} = \frac{r_{gr} \Lambda_p}{\sqrt{2}}$$

the *gravitational fine structure constant* and the photon-like wave function can be written

$$(A_{gn})_\mu{}^\nu = \sqrt{\alpha_{gr}} (A_p)_\mu{}^\nu \text{ (chapter B8.4).}$$

The covariant derivative of the AK gravity is then

$$(D_\mu)^\lambda{}_\kappa = \partial_\mu + (\varepsilon_a)^\lambda{}_\kappa \sqrt{\alpha_{gr}} (A_p)_\mu{}^a$$

where  $A_p$  is completely analogous to the photon wave function  $A_e$ , and matrices  $(\varepsilon_a)^\lambda{}_\kappa = \varepsilon^\lambda{}_{a\kappa}$   $a=0,1,2,3$  and where the generators  $\tilde{\tau}^a = i\varepsilon^a$  satisfy the *extended SU(2) Lie-algebra*  $[\tilde{\tau}^a, \tilde{\tau}^b] = i\varepsilon^{abc} \tilde{\tau}^c$ . So the quantum AK gravity is a *full-fledged quantum gauge theory with the extended SU(2) as the corresponding Lie-algebra* (chapter B1.1, B8.4).

The propagator of the AK-gravity is the momentum-transform of the gravitational wave equation in analogy to the electromagnetic wave equation:

$$D_F(As, q^2) = \frac{(i - lx)}{12lx^2(q^4 + i\varepsilon)}$$

Based on these results, we can use for AK quantum gravity the full formalism of Feynman-diagrams of quantum field theory.

We demonstrate this for the graviton-electron scattering cross-section in analogy to the Compton scattering (photon-electron scattering). We get the result (chapter B8.6)

$$\bar{\sigma} = \frac{\alpha_{gr}^2}{2\pi} \tilde{\lambda}_e^2 \left( 1.170 + \frac{k_0}{m} 0.400 + \dots \right) \approx 1.170 \frac{\alpha_{gr}^2}{2\pi} \tilde{\lambda}_e^2, \text{ as compared to the photon-electron Thompson cross-}$$

$$\text{section } \sigma_{th} = \alpha^2 \tilde{\lambda}_e^2 \frac{8\pi}{3}$$

with the *reduced de-Broglie wavelength* of the electron  $\tilde{\lambda}_e = \frac{\hbar c}{m_e c^2} = 0.38 * 10^{-12} m$ .

The overview of the chapters in part B and their contents is given below.

Chapter B2 describes the 4-dimensional AK equations and their properties.

Chapter B3 deals with the static solutions of the AK-equations, which yield the Schwarzschild, respectively the Kerr metric solving the Einstein equations. At the horizon  $r=l$  the metric has a peak, not a singularity, as in GR.

In chapter B4 the resulting gravitational wave equation and its solution are described, and in subchapter B4.7 is presented the complete half-analytic solution for the binary black hole.

In B4.5 and B4.6 we present the spherical and planar gravitational waves.

In chapter B5 and 6 numerical solutions for special cases of the time-independent and of time-dependent equations are discussed.

In chapter B7 the energy tensor of the Ashtekar-Kodama gravity is introduced.

In chapter B8 we present the quantum field version of the Ashtekar-Kodama gravity and demonstrate the calculation of cross-sections.

All derivations and calculations were carried out in Mathematica-programs, so the results can be considered with high probability as error-free, the programs are cited in the literature index.

In the chapters B1-4, which deal with the solutions, every subchapter consists of a flow-diagram, which gives the overview and a text part, which describes the corresponding program in detail and can be skipped at first reading.

**Part A Quantum gravity**

1. Motivation and problems
2. Classical mechanics and GR fundamentals
  - 2.1. Lagrangian mechanics
  - 2.2. Hamiltonian mechanics
  - 2.3. General relativity
  - 2.4. The concept of a graviton in GR and weak gravitational waves
3. Quantum field theory fundamentals
  - 3.1. GR-Dirac formalism
  - 3.2. The gauge group in QFT
  - 3.3. Gravitational scale
4. Semiclassical quantum gravity
5. Supersymmetry: quantum supergravity
6. The ADM-formulation (3+1 decomposition)
  - 6.1. Hamiltonian form of the Einstein–Hilbert action
7. Canonical gravity with connections and loops (LQG)
  - 7.1. Ashtekar variables
  - 7.2. Discussion of the constraints
  - 7.3. 3-dimensional Ashtekar-Kodama constraints
8. 4-dimensional Ashtekar-Kodama constraints
9. BF-theory
  - 9.1. Palatini action as BF-theory
  - 9.2. Plebanski action as BF-theory
  - 9.3. From the Plebanski action to the Einstein-Hilbert action

## Part B Ashtekar-Kodama gravity

1. 4-dimensional Ashtekar-Kodama equations and their properties
  - 1.1. AK covariant derivative and its gauge group
  - 1.2. Renormalizable Einstein-Hilbert action with the Ashtekar momentum  $A_{\mu}^{\nu}$
2. The basic equations
  - 2.1 The integrability condition
  - 2.2. Solvability of static and time-dependent equations eqtoiv, eqtoiev
3. Solutions of static equations
  - 3.1. Solution limit  $\Lambda \rightarrow 0$ 
    - 3.1.1. The Gauss-Schwarzschild tetrad
  - 3.2. Solution  $\Lambda \neq 0$  with the half-logarithmic ansatz
    - 3.2.2. Solvability of the metric condition for the half-logarithmic solution
  - 3.3. Behavior at Schwarzschild horizon
4. Solutions of time-dependent equations
  - 4.1. The  $\Lambda$ -scaled wave ansatz for the A-tensor
  - 4.2. Special wave solution  $\Lambda \neq 0$
  - 4.3. Wave equation in Schwarzschild spacetime
    - 4.3.1. Solutions of the gravitational wave equation
  - 4.4. Gravitational waves in General Relativity
  - 4.5. Spherical gravitational waves in AK-gravity
  - 4.6. Planar gravitational waves in AK-gravity
  - 4.7. Wave equation in binary rotator spacetime
    - 4.7.1. Wave equations for the binary gravitational rotator
    - 4.7.2. Solution as a series in  $r$ -powers by comparison of coefficients
    - 4.7.3. Solution of  $\text{coef}(1/r^4)$  as a series in  $r_0$
    - 4.7.4. Complete solution of the  $r$ -powers-series ansatz for  $r_0=1$
5. Numeric solutions of time-independent equations with coupling  $\Lambda=1$ 
  - 5.1. The metric in AK-gravity with coupling: no horizon and no singularity
6. Numeric solutions of time-independent equations with weak coupling and binary gravitational rotator
7. Energy tensor of the gravitational wave
8. Quantum AK-gravitation
  - 8.1. Lagrangian of Hamiltonian equations
  - 8.2. Lagrangian of remaining equations
  - 8.3. Dirac lagrangian for the graviton
  - 8.4. The graviton wave function and cross-sections
  - 8.5. The graviton propagator
  - 8.6. The gravitational Compton cross section
  - 8.7. The role of gravity in the objective collapse theory

## Part A Quantum gravity

Quantum field theory

$$D_\mu \equiv \partial_\mu - ig A_\mu \dots A_\mu(x) \equiv A_\mu^a(x) \tau^a,$$

$$[\tau^a, \tau^b] = if^{abc} \tau^c$$

$$L = -\frac{1}{4} F_{\mu\nu}^a F^{a\mu\nu} + \sum_k (\bar{\psi}_k (i\gamma^\mu D_\mu - m_k) \psi_k)$$

B-F-theory

$$I^{Pleb} = \int \varepsilon^{abcd} \left( B_{ab}^i F_{cdi} - \frac{1}{2} \varphi_{ij} B_{ab}^i B_{cd}^j \right)$$

$$I^{Palatini} = \int \varepsilon_{abcd} \left( e^a \wedge e^b \wedge F^{cd} + \frac{\Lambda}{2} e^a \wedge e^b \wedge e^c \wedge e^d \right)$$

4-dim Ashtekar-Kodama

$$F_{\mu\nu}^\kappa = \partial_\mu A_\nu^\kappa - \partial_\nu A_\mu^\kappa + \varepsilon^\kappa_{\kappa_1 \kappa_2} A_\mu^{\kappa_1} A_\nu^{\kappa_2}$$

$$G^\mu = \partial_\nu E^{\nu\mu} + \varepsilon^\mu_{\kappa\lambda} A_\nu^\kappa E^{\nu\lambda} \quad 4 \text{ Gauss}$$

$$D_\mu = E^\kappa_\nu F_{\mu\kappa}^\nu \quad 4 \text{ diffeo}$$

$$H_{(\mu,\nu)}^\kappa = F_{\mu\nu}^\kappa + \frac{\Lambda}{3} \varepsilon_{\mu\nu\rho} E^{\rho\kappa} \quad 24 \text{ Hamiltonian}$$

Ashtekar-Kodama gravity

graviton tensor  $A_\mu^\nu$   
gen. coordinates  $E^{\mu\nu}$

$A \rightarrow 0$   $A_\mu^\nu = \text{const}$ , GR valid except horizon

grwave: grwave-eq  $\text{weq}_v(E^{1\nu}, \partial_r^3 E^{1\nu})$

$$A_\mu^\nu = \text{quadrupole } l \geq 2, E^{\mu\nu} \text{ damped } \exp(-4\sqrt{\frac{r}{3}})$$

$$r \leq r_{gr} = 31 \mu\text{m} \quad \Lambda \neq 0 \text{ QFT}, D_\mu = \partial_\mu - iA_\mu^a \tau^a$$

$$\tau^a = \varepsilon_\nu^a{}_\lambda \quad [\tau^a, \tau^b] = i\varepsilon_c^{ab} \tau^c \text{ ext.SU(2) Lie-algebra}$$

renormalizable lagrangian

$$L_{gr} = L_H + L_I = \hbar c \left( -\frac{1}{4} F_{\mu\nu}^\kappa F^{\mu\nu\kappa} - \frac{\bar{\varphi}_\Lambda \varphi_\Lambda}{3} (\varepsilon^{\kappa\mu\lambda} E^{\lambda\nu} \partial_\nu A_{\mu\nu} + \varepsilon_{\mu\lambda\kappa_2} \varepsilon^{\mu\lambda_1 \kappa_1} E^{\kappa_1 \kappa_2} A_{\lambda_1}^{\lambda_2} A_{\mu_1}^{\mu_2}) \right. \\ \left. + E^{\kappa_1 \nu_1} F_{\mu\kappa_1}^{\nu_1} E^{\kappa_2 \nu_2} F^{\mu \nu_2} \right)$$

General Relativity

$$R_{\mu\nu} - \frac{1}{2} g_{\mu\nu} R_0 + \Lambda g_{\mu\nu} = \kappa T_{\mu\nu}$$

$$S = \frac{\hbar c}{16\pi l_p^2} \int (R - 2\Lambda) \sqrt{-g} d^4x$$

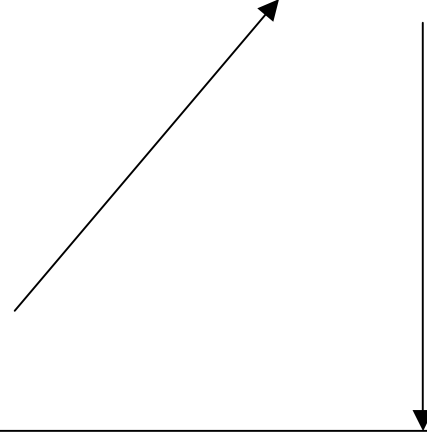

ADM 3+1 decomposition

$$g_{\mu\nu} = \begin{pmatrix} N_a N^a - N^2 & N_b \\ N_c & h_{ab} \end{pmatrix}.$$

$$16\pi G S_{EH} = \int_{\mathcal{M}} dt d^3x N \sqrt{h} (K_{ab} K^{ab} - K^2 + {}^{(3)}R - 2\Lambda)$$

$$\mathcal{H}_\perp^g = 16\pi G G_{abcd} p^{ab} p^{cd} - \frac{\sqrt{h}}{16\pi G} ({}^{(3)}R - 2\Lambda) \quad \text{Hamiltonian}$$

$$\mathcal{H}_a^g = -2D_b p_a^b \quad \text{diffeomorph}$$

Ashtekar

$$A_a^i(x) = \Gamma_a^i(x) + \beta K_a^i(x),$$

$$\{A_a^i(x), E^b_j(y)\} = 8\pi\beta l_p^2 \delta_a^b \delta_j^i \delta(x, y)$$

$$E_a^i \Rightarrow \frac{\beta}{l_p} \frac{\delta}{\delta A^a_i}$$

$$D_a E_i^a \approx 0 \quad 3 \text{ Gauss} \quad \tilde{\mathcal{H}}_a = F_{ab} E_i^b \approx 0, \quad 3 \text{ diffeo}$$

$$\tilde{\mathcal{H}}_\perp = \varepsilon^{ijk} F_{abk} E_i^a E_j^b \approx 0, \quad 9 \text{ Hamiltonian}$$

3-dim Ashtekar-Kodama

$$\Psi[A] = N \exp \left( \frac{3}{\lambda} \int_\Sigma d^3x \varepsilon^{abc} \text{tr} \left( A_a \partial_a A_c + \frac{1}{3} A_a A_b A_c \right) \right)$$

$$\varepsilon^{ijk} \frac{\delta}{\delta A^i_a} \frac{\delta}{\delta A^j_b} \left( F_{abk} - \frac{\Lambda}{3l_p} \varepsilon_{abc} \frac{\delta}{\delta A^k_c} \right) \Psi[A] = 0$$

$$G_i = \partial_a E^a_i + \varepsilon_{ij}^k A_a^j E^a_k \quad \text{Gauss}$$

$$D_a = E^b_i F_{ab}^i \quad \text{diffeo}$$

$$H_{(a,b)}^k = F_{ab}^k + \frac{\Lambda}{3} \varepsilon_{ab}^c E_c^k \quad \text{Hamiltonian}$$



**A1. Motivation and problems**

## 1. unification (successful StdModel)

-classical and quantum concepts (phase space versus Hilbert space, etc.) are most likely incompatible.

-semiclassical theory, where gravity stays classical but all other fields are quantum, has failed up to now

## 2. cosmology and black-holes

-initial big-bang state is a quantum state

- Hawking-Penrose black-holes are quantum objects

## 3. problem of time

-in quantum theory, time is an external (absolute) element, not described by an operator (in special relativistic quantum field theory, the role of time is played by the external Minkowski space-time).

-in GR, space-time is a dynamical (non-absolute) object

## 4. superposition principle

- in QM the fundamental equations are linear in the wave function and the operators, the solutions can be combined additively (superposition principle)

- in GR the Einstein equations the Ricci-tensor is explicitly of order 2 in the metric  $g_{\mu\nu}$  and of additional order 2 in its inverse  $g^{\mu\nu}$ , the solutions cannot be combined linearly.

## 5. action and renormalization

The Einstein-Hilbert action has a dimensional interaction constant  $\frac{1}{2\kappa}$ , and therefore the action is

fundamentally non-renormalizable

6. In GR, there is no adequate description of gravitational waves: a spherical gravitational wave is a metric oscillation, and satisfies the Einstein equation only for small amplitudes

## A2. Classical mechanics and GR fundamentals

### 2.1. Lagrangian mechanics

The *non-relativistic* Lagrangian for a system of particles can be defined by

$$L = T - V \quad T = \frac{1}{2} \sum_{k=1}^N m_k v_k^2$$

Euler-Lagrange equations

$$\delta L = \sum_{j=1}^n \left( \frac{\partial L}{\partial q_j} \delta q_j + \frac{\partial L}{\partial \dot{q}_j} \delta \dot{q}_j \right), \text{ variational principle } \delta L = 0$$

general formulation with parameters  $\lambda_1, \dots, \lambda_p$  instead of time  $t$

$$\delta L = \sum_{j=1}^n \left( \frac{\partial L}{\partial q_j} \delta q_j + \sum_{k=1}^p \frac{\partial L}{\partial \frac{\partial q_j}{\partial \lambda_k}} \delta \frac{\partial q_j}{\partial \lambda_k} \right)$$

by partial integration and total differentiation for time:

$$\int_{t_1}^{t_2} \delta L dt = \sum_{j=1}^n \left[ \frac{\partial L}{\partial \dot{q}_j} \delta q_j \right]_{t_1}^{t_2} + \int_{t_1}^{t_2} \sum_{j=1}^n \left( \frac{\partial L}{\partial q_j} - \frac{d}{dt} \frac{\partial L}{\partial \dot{q}_j} \right) \delta q_j dt.$$

Lagrangian with constraints

$$L' = L(\mathbf{r}_1, \mathbf{r}_2, \dots, \dot{\mathbf{r}}_1, \dot{\mathbf{r}}_2, \dots, t) + \sum_{i=1}^C \lambda_i(t) f_i(\mathbf{r}_k, t)$$

$$\int_{t_1}^{t_2} \delta L dt = 0$$

Hamilton principle

$$\int_{t_1}^{t_2} \delta L' dt = \int_{t_1}^{t_2} \sum_{k=1}^N \left( \frac{\partial L}{\partial \mathbf{r}_k} - \frac{d}{dt} \frac{\partial L}{\partial \dot{\mathbf{r}}_k} + \sum_{i=1}^C \lambda_i \frac{\partial f_i}{\partial \mathbf{r}_k} \right) \cdot \delta \mathbf{r}_k dt = 0$$

Euler-Lagrange equations

$$\frac{\partial L}{\partial \mathbf{r}_k} - \frac{d}{dt} \frac{\partial L}{\partial \dot{\mathbf{r}}_k} + \sum_{i=1}^C \lambda_i \frac{\partial f_i}{\partial \mathbf{r}_k} = 0,$$

### 2.2. Hamiltonian mechanics

Hamiltonian

$$\mathcal{H} = T + V, \quad T = \frac{p^2}{2m}, \quad V = V(q)$$

Hamiltonian from Lagrangian

$$\mathcal{H} = \sum_i \dot{q}^i \frac{\partial \mathcal{L}}{\partial \dot{q}^i} - \mathcal{L} = \sum_i \dot{q}^i p_i - \mathcal{L}$$

Hamiltonian equations

$$\frac{\partial \mathcal{H}}{\partial q^j} = -\dot{p}_j, \quad \frac{\partial \mathcal{H}}{\partial p_j} = \dot{q}^j, \quad \frac{\partial \mathcal{H}}{\partial t} = -\frac{\partial \mathcal{L}}{\partial t}$$

### 2.3. General relativity

#### Equations

The Einstein field equations are Minkowski metric  $\eta = \text{diag}(-1, 1, 1, 1)$  predominantly used in GR

$$R_{\mu\nu} - \frac{1}{2} g_{\mu\nu} R + \Lambda g_{\mu\nu} = \kappa T_{\mu\nu}$$

where  $R_{\mu\nu}$  is the Ricci tensor,  $R$  the Ricci curvature,  $\kappa = \frac{8\pi G}{c^4}$ ,  $T_{\mu\nu}$  is the energy-momentum tensor,  $\Lambda$  is the cosmological constant

with the Christoffel symbols (second kind)

$$\Gamma^{\lambda}_{\mu\nu} = \frac{1}{2} g^{\lambda\kappa} \left( \frac{\partial g_{\kappa\mu}}{\partial x^\nu} + \frac{\partial g_{\kappa\nu}}{\partial x^\mu} - \frac{\partial g_{\mu\nu}}{\partial x^\kappa} \right)$$

and the Ricci tensor

$$R_{\mu\nu} = \frac{\partial \Gamma^{\rho}_{\mu\nu}}{\partial x^\rho} - \frac{\partial \Gamma^{\rho}_{\mu\rho}}{\partial x^\nu} + \Gamma^{\sigma}_{\mu\rho} \Gamma^{\rho}_{\sigma\nu} - \Gamma^{\sigma}_{\mu\nu} \Gamma^{\rho}_{\sigma\rho}$$

The orbit equations in vacuum ( $T_{\mu\nu} = 0$ ) are:

$$\frac{d^2 x^\kappa}{d\lambda^2} + \Gamma^{\kappa}_{\mu\nu} \frac{dx^\mu}{d\lambda} \frac{dx^\nu}{d\lambda} = 0$$

$\kappa=0\dots 3$

with the usual setting  $\lambda = \tau = \text{proper time}$

For  $\lambda = \tau$  we get for the line-element  $ds = c d\lambda = d\lambda$  and therefore trivially:

$$g_{\mu\nu} \frac{dx^\mu}{d\lambda} \frac{dx^\nu}{d\lambda} - 1 = 0$$

The Kerr line element reads

$$\begin{aligned} -ds^2 = & \left( 1 - \frac{rr_s}{r^2 + \alpha^2 \cos^2 \theta} \right) (dt)^2 + \left( \frac{2rr_s \alpha \sin^2 \theta}{r^2 + \alpha^2 \cos^2 \theta} \right) dt d\varphi \\ & - \left( \frac{r^2 + \alpha^2 \cos^2 \theta}{r^2 - rr_s + \alpha^2} \right) dr^2 - \\ & \left( r^2 + \alpha^2 + \frac{rr_s \alpha^2 \sin^2 \theta}{r^2 + \alpha^2 \cos^2 \theta} \right) \sin^2 \theta d\varphi^2 - (r^2 + \alpha^2 \cos^2 \theta) (d\theta)^2 \end{aligned}$$

where  $r_s = \frac{2GM}{c^2}$  is the Schwarzschild radius, and  $\alpha = \frac{J}{Mc}$  is the angular momentum radius (amr),  $\alpha$  has

the dimension of a distance:  $[\alpha] = [r]$ , and  $J$  is the angular momentum.

In the limit  $\alpha \rightarrow 0$  the Kerr line element becomes the standard Schwarzschild line element

$$-ds^2 = \left( 1 - \frac{r_s}{r} \right) c^2 dt^2 - \frac{dr^2}{\left( 1 - \frac{r_s}{r} \right)} - r^2 (d\theta^2 + \sin^2 \theta d\varphi^2)$$

#### Einstein-Hilbert action

Einstein-Hilbert action with boundary term and external curvature  $K$

$$S_{\text{EH}} = \frac{c^4}{16\pi G} \int_{\mathcal{M}} d^4x \sqrt{-g} (R - 2\Lambda) - \frac{c^4}{8\pi G} \int_{\partial\mathcal{M}} d^3x \sqrt{h} K.$$

the Einstein field equations are obtained,

$$G_{\mu\nu} := R_{\mu\nu} - \frac{1}{2} g_{\mu\nu} R = \frac{8\pi G}{c^4} T_{\mu\nu} - \Lambda g_{\mu\nu}.$$

## 2.4. The concept of a graviton in GR and weak gravitational waves

$$\eta_{\mu\nu} = \text{diag}(-1, 1, 1, 1) \quad [13]$$

the Einstein equations in linear approximation yield the gravitational wave equation for  $f_{\mu\nu}$

$$\square f_{\mu\nu} = -16\pi G \left( T_{\mu\nu} - \frac{1}{2} \eta_{\mu\nu} T \right), \quad T := \eta^{\mu\nu} T_{\mu\nu} \quad \text{using the gauge condition} \quad f_{\mu\nu, \nu} = \frac{1}{2} f^{\nu}_{\nu, \mu}$$

analogous to the electrodynamics wave equation

$$\square A^\mu = -4\pi j^\mu \quad \text{with the Lorentz gauge} \quad \partial_\nu A^\nu = 0$$

let us consider a plane wave, purely spatial and transverse (TT-gauge  $(e_{\mu\nu} k^\nu = 0), e^\nu_\nu = 0$ ) moving in the  $x^1 \equiv x$  direction

$$x^0 \equiv t, \quad k^0 = k^1 \equiv \omega > 0, \quad k^2 = k^3 = 0.$$

$$f_{\mu\nu} = 2 \text{Re} \left( e_{\mu\nu} e^{-i\omega(t-x)} \right).$$

there are 2 basic polarizations (not one, as for a spin=1 wave)

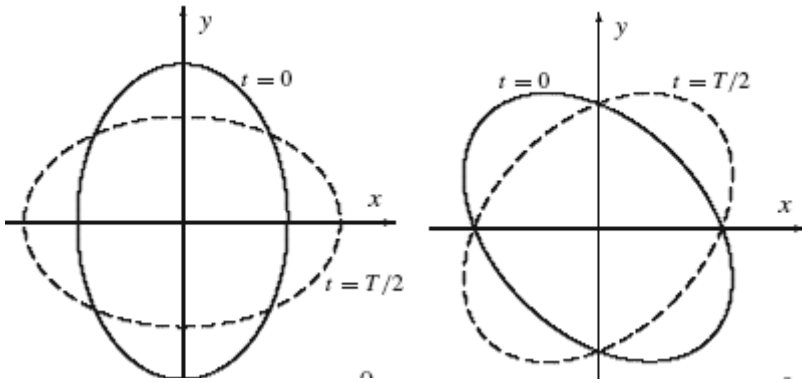

$$e_{22} \mathbf{e}_+ = e_{22} (\mathbf{e}_y \otimes \mathbf{e}_y - \mathbf{e}_z \otimes \mathbf{e}_z) \quad e_{23} \mathbf{e}_\times = e_{23} (\mathbf{e}_y \otimes \mathbf{e}_z + \mathbf{e}_z \otimes \mathbf{e}_y)$$

with circular right and left polarized states

$$\mathbf{e}_R = \frac{1}{\sqrt{2}} (\mathbf{e}_+ + i\mathbf{e}_\times), \quad \mathbf{e}_L = \frac{1}{\sqrt{2}} (\mathbf{e}_+ - i\mathbf{e}_\times)$$

Under counterclockwise rotation by an angle  $\theta$ , the circular polarization states transform according to

$$\mathbf{e}'_R = e^{-2i\theta} \mathbf{e}_R, \quad \mathbf{e}'_L = e^{2i\theta} \mathbf{e}_L.$$

, that is a rotation by  $2\theta$  with helicity  $-2$  and  $+2$

The corresponding left and right circularly polarized electromagnetic waves have helicity 1 and  $-1$ , respectively.

The linearized gravity lagrangian for the above gravitational wave equation is

$$\mathcal{L} = \frac{1}{64\pi G} \left( f^{\mu\nu, \sigma} f_{\mu\nu, \sigma} - f^{\mu\nu, \sigma} f_{\sigma\nu, \mu} - f^{\nu\mu, \sigma} f_{\sigma\mu, \nu} - f^\mu_{\mu, \nu} f^\rho_{\rho, \nu} + 2f^{\rho\nu}_{, \nu} f^\sigma_{\sigma, \rho} \right) - \frac{1}{2} T_{\mu\nu} f^{\mu\nu}.$$

the energy-momentum-tensor is

$$t_{\mu\nu} := \frac{\partial \mathcal{L}}{\partial f^{\alpha\beta}_{, \nu}} f_{\alpha\beta, \mu} - \eta_{\mu\nu} \mathcal{L}.$$

$$\text{in TT-gauge } t_{\mu\nu} = \frac{1}{32\pi G} f_{\alpha\beta, \mu} f^{\alpha\beta}_{, \nu} \quad \text{with the mean value} \quad \bar{t}_{\mu\nu} = \frac{k_\mu k_\nu}{16\pi G} e^{\alpha\beta*} e_{\alpha\beta}.$$

### A3. Quantum field theory fundamentals

#### 3.1. GR-Dirac formalism

GR-Dirac formalism ( $\hbar = c = 1$ ) [22]

$$\nabla_{\mu} A_{\nu} \equiv \partial_{\mu} A_{\nu} + \Gamma_{\mu\nu}^{\lambda} A_{\lambda}$$

$$\nabla_{\mu} A^{\nu} = \partial_{\mu} A^{\nu} - \Gamma_{\mu\lambda}^{\nu} A^{\lambda}$$

GR covariant derivative

its commutator is the Riemann tensor

$$[\nabla_{\mu}, \nabla_{\nu}] A_{\lambda} = R_{\mu\nu\lambda}^{\rho} A_{\rho}$$

$$R_{\mu\nu\lambda}^{\rho} = \partial_{\mu} \Gamma_{\nu\lambda}^{\rho} - \partial_{\nu} \Gamma_{\mu\lambda}^{\rho} - \Gamma_{\mu\sigma}^{\rho} \Gamma_{\nu\lambda}^{\sigma} + \Gamma_{\nu\sigma}^{\rho} \Gamma_{\mu\lambda}^{\sigma}$$

the tetrad  $e_{\mu}^{\alpha} e_{\nu}^{\alpha} = g_{\mu\nu}$

the tetrad-Dirac matrices  $\gamma^{\alpha} e^{\alpha\mu} = \gamma^{\mu}(x)$  with the anti-commutator  $\{\gamma^{\mu}, \gamma^{\nu}\} = 2g^{\mu\nu}(x)$

the tetrad covariant derivative becomes

$$\nabla_{\mu} \psi = \left( \partial_{\mu} - \frac{i}{4} \omega_{\mu}^{ab} \sigma_{ab} \right) \psi \quad \text{where } \sigma_{\mu\nu} = \frac{i}{2} [\gamma_{\mu}, \gamma_{\nu}] \text{ are the Dirac } \sigma\text{-matrices}$$

and  $\omega$  the GR connection field in tetrad-expression

$$\omega_{\mu}^{ab} = \frac{1}{2} e^{a\nu} (\partial_{\mu} e_{\nu}^b - \partial_{\nu} e_{\mu}^b) + \frac{1}{4} e^{a\rho} e^{b\sigma} (\partial_{\sigma} e_{\rho}^c - \partial_{\rho} e_{\sigma}^c) e_{\mu}^c - (a \leftrightarrow b)$$

with these denominations the GR-Dirac equation becomes

$(i\hbar \gamma^{\mu}(x) \nabla_{\mu} - mc) \psi(x) = 0$  and the GR-Dirac Lagrangian

$$L_{GRD} = -\frac{\sqrt{-g}}{2\kappa} (R - 2\Lambda) + \sqrt{-g} \bar{\psi} (i\hbar c \gamma^{\mu}(x) \nabla_{\mu} - mc^2) \psi$$

### 3.2. The gauge group inQFT

structure constants and the generator algebra of the gauge Lie group [22] with  $\eta = \text{diag}(1, -1, -1, -1)$

$$[\tau^a, \tau^b] = if^{abc} \tau^c$$

we introduce the covariant derivative with the connection  $A_\mu$  :

$$D_\mu \equiv \partial_\mu - ig A_\mu \quad A_\mu(x) \equiv A_\mu^a(x) \tau^a$$

The fermion field  $\psi_i$  transforms under the Lie algebra

$$\psi_i(x) \rightarrow \Omega_{ij}(x) \psi_j(x) \quad \Omega_{ij}(x) = \left( e^{-i\theta^a(x) \tau^a} \right)_{ij}$$

then the covariant derivative transforms like  $\psi_i$  under  $\Omega$  (is gauge-covariant):

$$\begin{aligned} (D_\mu \psi)' &= \partial_\mu \psi' - ig A'_\mu \psi' \\ &= \Omega \partial_\mu \psi + (\partial_\mu \Omega) \psi - ig A'_\mu \Omega \psi \\ &= \Omega D_\mu \psi \end{aligned}$$

$$(D_\mu \psi)' = \Omega D_\mu \psi$$

in order to achieve this,  $\psi_i$  and  $A_\mu$  infinitesimally transform like

$$\delta A_\mu^a = -\frac{1}{g} \partial_\mu \theta^a + f^{abc} \theta^b A_\mu^c$$

$$\delta \psi = -ig \theta^a \tau^a \psi$$

, which results from the ansatz above for the covariant derivative

We define the field tensor  $F_{\mu\nu}^a$  from the commutator

$$\begin{aligned} F_{\mu\nu} &= \frac{i}{g} [D_\mu, D_\nu] \\ &= \partial_\mu A_\nu - \partial_\nu A_\mu - ig [A_\mu, A_\nu] \\ &= (\partial_\mu A_\nu^a - \partial_\nu A_\mu^a + g f^{abc} A_\mu^b A_\nu^c) \tau^a \end{aligned}$$

$$F_{\mu\nu}^a = \partial_\mu A_\nu^a - \partial_\nu A_\mu^a + g f^{abc} A_\mu^b A_\nu^c$$

The gauge field action becomes

$$S = \int d^4x \left( -\frac{1}{2} \text{Tr} F_{\mu\nu} F^{\mu\nu} \right) = \int d^4x \left( -\frac{1}{4} F_{\mu\nu}^a F^{a\mu\nu} \right)$$

and the fermion action coupled to the field is

$$S = \int d^4x \bar{\psi} (i \not{D} - m) \psi, \quad \text{where } \not{D} = \gamma^\mu D_\mu \text{ is the covariant "Dirac dagger"}$$

the lagrangian

$$L = -\frac{1}{4} F_{\mu\nu}^a F^{a\mu\nu} + \sum_k (\bar{\psi}_k (i \gamma^\mu D_\mu - m_k) \psi_k)$$

### 3.3. Gravitational scale

universal scale: Planck-scale

$$l_P = \sqrt{\frac{\hbar G}{c^3}} \approx 1.62 \times 10^{-33} \text{ cm},$$

$$t_P = \frac{l_P}{c} = \sqrt{\frac{\hbar G}{c^5}} \approx 5.39 \times 10^{-44} \text{ s},$$

$$m_P = \frac{\hbar}{l_P c} = \sqrt{\frac{\hbar c}{G}} \approx 2.18 \times 10^{-5} \text{ g} \approx 1.22 \times 10^{19} \text{ GeV}/c^2.$$

$$T_P = \frac{m_P c^2}{k_B} \approx 1.41 \times 10^{32} \text{ K},$$

$$\rho_P = \frac{m_P}{l_P^3} \approx 5 \times 10^{93} \frac{\text{g}}{\text{cm}^3}.$$

$$Q_P = \sqrt{m_P l_P} \frac{l_P}{t_P} = \sqrt{G} m_P = \sqrt{\hbar c}, \quad e = \sqrt{\alpha} Q_P = 0.085 Q_P$$

$$\alpha_g = \frac{G m_{\text{pr}}^2}{\hbar c} = \left( \frac{m_{\text{pr}}}{m_P} \right)^2 \approx 5.91 \times 10^{-39},$$

fine structure constant of gravity

$$\text{mean gravity scale } r_{gr} = \sqrt{l_P \sqrt{\frac{1}{\Lambda}}} = 3.1 * 10^{-5} \text{ m} = 31 \mu\text{m}$$

$$\text{mean gravity scale } r_{gr} = \sqrt{l_P \sqrt{\frac{1}{\Lambda}}} = 3.1 * 10^{-5} \text{ m} = 31 \mu\text{m} \text{ with the corresponding energy scale}$$

$$E_{gr} = c^2 M_{gr} = \frac{\hbar c}{r_{gr}} = \frac{1.05 * 10^{-34} \text{ Js} * 3 * 10^8 \text{ m/s}}{3.1 * 10^{-5} \text{ m}} = 1.016 * 10^{-21} \text{ J} = 6.34 * 10^{-3} \text{ eV}$$

$\Lambda$ - energy scale

$$E_\Lambda = \left( \frac{\hbar^2 \Lambda^{1/2} c^6}{G} \right)^{1/3} = \left( \frac{\hbar^3 \Lambda^{1/2} c^3}{l_P^2} \right)^{1/3} \approx 15 \text{ MeV}$$

with the corresponding length scale

$$l_\Lambda = \frac{\hbar c}{E_\Lambda} = \frac{1.05 * 10^{-34} * 6.24 * 10^{18} \text{ eV} * 3 * 10^8 \text{ m}}{15 * 10^6 \text{ eV}} = 1.31 * 10^{-14} \text{ m}$$

#### A4. Semiclassical quantum gravity

Dirac equation  $(i\gamma^\mu \partial_\mu + \frac{mc}{\hbar})\psi(x) = 0$ , with Minkowski metric  $\eta = \text{diag}(-1, 1, 1, 1)$  used in quantum gravity  
 $(i\hbar\gamma^\mu \partial_\mu - mc)\psi(x) = 0$  with  $\hbar = 1, c = 1$ :  $(i\gamma^\mu \partial_\mu - m)\psi(x) = 0$  with  $\eta = \text{diag}(1, -1, -1, -1)$  used in QFT

with commutation relations for  $\gamma^\mu$   $[\gamma^\mu, \gamma^\nu]_+ := \gamma^\mu \gamma^\nu + \gamma^\nu \gamma^\mu = 2\eta^{\mu\nu}$

$$\begin{aligned} e_\mu^a e_\nu^a &= g_{\mu\nu} \\ e^{\alpha\mu} &= g^{\mu\nu} e_\nu^\alpha \\ e_\mu^a e^{b\mu} &= \delta^{ab} \end{aligned}$$

now we introduce the tetrad (vierbein)

and local (x-dependent)  $\gamma^\mu(x)$  with commutation relations  $\{\gamma^\mu, \gamma^\nu\} = 2g^{\mu\nu}(x)$  from original Dirac-matrices  $\gamma^a$

with this local  $\gamma^\mu$  we formulate the covariant derivative

$$\nabla_\mu \psi = (\partial_\mu - \frac{i}{4} \omega_\mu^{ab} \sigma_{ab}) \psi \quad \text{where } \sigma_{ab} = \frac{i}{2} [\gamma_a, \gamma_b]$$

and the connection

$$\omega_\mu^{ab} = \frac{1}{2} e^{a\nu} (\partial_\mu e_\nu^b - \partial_\nu e_\mu^b) + \frac{1}{4} e^{a\rho} e^{b\sigma} (\partial_\sigma e_\rho^c - \partial_\rho e_\sigma^c) e_\mu^c - (a \leftrightarrow b)$$

$$(i\gamma^\mu \nabla_\mu - m)\psi = 0$$

the GR-Dirac equation is now  
and the lagrangian

$$\mathcal{L} = -\frac{1}{2\kappa^2} \sqrt{-g} R + e \bar{\psi} (i\gamma^\mu \nabla_\mu - m) \psi \quad \text{with } e \equiv \det e_\mu^a = \sqrt{-g}.$$

$$L_{grD} = \frac{1}{2\kappa} \sqrt{-g} (R - 2\Lambda) + e \bar{\psi} (i\hbar c \gamma^\mu \nabla_\mu - mc^2) \psi$$

For an observer, with linear acceleration  $\mathbf{a}$  and angular velocity  $\boldsymbol{\omega}$ :

a non-relativistic approximation with relativistic corrections is then obtained by the standard Foldy–Wouthuysen transformation, decoupling the positive- and negative energy states. This leads to (writing  $\beta \equiv \gamma^0$ ) the Schrödinger equation

$$i\hbar \frac{\partial \psi}{\partial t} = H_{FW} \psi$$

$$H_{FW} = - \left( \beta m c^2 + \frac{\beta}{2m} \mathbf{p}^2 - \frac{\beta}{8m^3 c^2} \mathbf{p}^4 + \beta m (\mathbf{a} \cdot \mathbf{x}) \right) - \boldsymbol{\omega} \cdot (\mathbf{L} + \mathbf{S}) - \left( \frac{\beta}{2m} \mathbf{p} \frac{\mathbf{a} \cdot \mathbf{x}}{c^2} \mathbf{p} + \frac{\beta \hbar}{4m c^2} \vec{\Sigma} \cdot (\mathbf{a} \times \mathbf{p}) \right) + \mathcal{O}\left(\frac{1}{c^3}\right)$$

#### Semiclassical Einstein equations

$$R_{\mu\nu} - \frac{1}{2} g_{\mu\nu} R + \Lambda g_{\mu\nu} = \frac{8\pi G}{c^4} \langle \Psi | \hat{T}_{\mu\nu} | \Psi \rangle.$$

‘Schrödinger–Newton equation’  $i\hbar \frac{\partial \psi}{\partial t} = -\frac{\hbar^2}{2m} \nabla^2 \psi - m\Phi \psi$ ,  $\nabla^2 \Phi = 4\pi G m |\psi|^2$ ,

$$i\hbar \frac{\partial \psi(\mathbf{x}, t)}{\partial t} = -\frac{\hbar^2}{2m} \nabla^2 \psi(\mathbf{x}, t) - Gm^2 \int d^3y \frac{|\psi(\mathbf{y}, t)|^2}{|\mathbf{x} - \mathbf{y}|} \psi(\mathbf{x}, t)$$



### A5. Supersymmetry: quantum supergravity

Supergravity (SUGRA) is a supersymmetric theory of gravity encompassing GR. [13]

Supersymmetry (SUSY) is a symmetry which mediates between bosons and fermions via  $N$  generators.

the ( $N=1$ ) simple SUGRA action is the sum of the Einstein–Hilbert action and the Rarita–Schwinger action for the gravitino (spin  $3/2$ ),

$$S = \frac{1}{16\pi G} \int d^4x (\det e_\mu^n) R + \frac{1}{2} \int d^4x \epsilon^{\mu\nu\rho\sigma} \bar{\psi}_\mu \gamma_5 \gamma_\nu D_\rho \psi_\sigma$$

with the tetrad  $e^n{}_\mu$ ,  $\det e_\mu^n = \sqrt{-g}$ ,  $\gamma_5 = i\gamma^0\gamma^1\gamma^2\gamma^3$

$$D_\mu = \partial_\mu - \frac{1}{2} \omega_\mu^{nm} \sigma_{nm} \quad \text{and } \Lambda=0$$

GR covariant derivative

extended action

$$S^{sugra} = \frac{c^4}{64\pi G} \int \epsilon^{\mu\nu\rho\sigma} \epsilon_{abcd} \left( R_{\mu\nu}{}^{ab} e_\rho{}^c e_\sigma{}^d - \frac{\Lambda}{3} e_\mu{}^a e_\nu{}^b e_\rho{}^c e_\sigma{}^d \right) d^4x$$

$$- \frac{c^4}{64\pi G} \int \epsilon^{\mu\nu\rho\sigma} \left( \frac{1}{2} \bar{\psi}_\mu \gamma_5 \gamma_a e_\nu{}^a D_\rho \psi_\sigma - \frac{i}{4l_p} \bar{\psi}_\mu \gamma_5 \gamma_a \gamma_b e_\nu{}^a e_\rho{}^b \psi_\sigma \right) d^4x$$

action  $S$  is general-covariant, Poincare-invariant and also SUSY-invariant under SUSY-transformations

$$\delta e_\mu^m = \frac{1}{2} \sqrt{8\pi G} \bar{\epsilon}^\alpha \gamma_{\alpha\beta}^m \psi_\mu^\beta,$$

$$\delta \psi_\mu^\alpha = \frac{1}{\sqrt{8\pi G}} D_\mu \epsilon^\alpha,$$

which transform fermions into bosons and vice-versa

A special role is played by  $N = 8$  SUGRA. As mentioned above,  $N = 8$  is the maximal number of SUSY generators.

The theory contains an irreducible multiplet that consists of massless states including the spin-2 graviton, eight spin-3/2 gravitinos, 28 spin-1 states, 56 spin-1/2 states, and 70 spin-0 states.

The complete four-loop four-particle amplitude of  $N = 8$  SUGRA. is ultraviolet finite.

This allows the speculation that the theory is finite at all orders. If this were true,  $N = 8$  SUGRA would be a perturbatively consistent theory of quantum gravity.

## A6. The ADM-formulation (3+1 decomposition)

Arnowitt, Deser, Misner 1962

Foliation  $M = R(t) \times \Sigma(x_3)$

space-time metric  $g_{\mu\nu}$  induces a three-dimensional metric on each  $\Sigma_t$  according to

$$h_{\mu\nu} = g_{\mu\nu} + n_\mu n_\nu, \quad (4.39)$$

where  $n_\mu$  denotes again the unit normal to  $\Sigma_t$ , with  $n^\mu n_\mu = -1$ .

one can decompose  $t^\mu$  into its components normal and tangential to  $\Sigma_t$

$$t^\mu = N n^\mu + N^\mu, \quad N \text{ is the lapse and } N^\mu \text{ the shift vector}$$

we can write  $N = -t^\mu n_\mu$ , so  $N = \frac{1}{n^\mu \nabla_\mu t}$

the four-metric can be decomposed into spatial and temporal components,

$$g_{\mu\nu} = \begin{pmatrix} N_a N^a - N^2 & N_b \\ N_c & h_{ab} \end{pmatrix}.$$

$$g^{\mu\nu} = \begin{pmatrix} -\frac{1}{N^2} & \frac{N^b}{N^2} \\ \frac{N^c}{N^2} & h^{ab} - \frac{N^a N^b}{N^2} \end{pmatrix}$$

the inverse is

$h^{ab}$  is the inverse of the three-metric  $h^{ab} h_{bc} = \delta_c^a$  and  $n^\mu = g^{\mu\nu} n_\nu = \left( \frac{1}{N}, -\frac{N}{N} \right)$ , where  $N = \sqrt{N_a N^a}$

$K_{\mu\nu} = h_\mu^\rho \nabla_\rho n_\nu$  is the embedding (external) curvature of  $\Sigma(x_3)$   
its spatial version  $K_{ab}$  can be interpreted as the 'velocity' associated with  $h_{ab}$ .

$$K := K_a^a = h^{ab} K_{ab} =: \theta.$$

its trace

$K_{ab}$  can be written as  $K_{ab} = \frac{1}{2N} \left( \dot{h}_{ab} - D_a N_b - D_b N_a \right)$

### 6.1. Hamiltonian form of the Einstein–Hilbert action

The 'space-time component'  $G_{i0}$  of the Einstein equations reads expressed in embedding curvature

$$K^2 - K_{ab} K^{ab} + {}^{(3)}R = 0.$$

$$D_b K_a^b - D_a K = 0.$$

with the covariant derivative  $D_\mu = \partial_\mu - \frac{1}{2} \omega_\mu^{nm} \sigma_{nm}$   $\omega_a^i{}_j = \Gamma_{kj}^i e_a^k$ , connection

these constraints for  $(h_{ab}, K_{cd})$  on a boundary  $\Sigma$  determine uniquely the solutions of the Einstein equations

interconnection theorems (Kuchař 1981):

1. If the constraints are valid on an initial hypersurface and if the dynamical evolution equations  $G_{ab} = 0$  (pure spatial components of the vacuum Einstein equations) on space-time hold, the constraints hold on every hypersurface. Together, one then has all ten Einstein equations.
2. If the constraints hold on every hypersurface, the equations  $G_{ab} = 0$  hold on space-time.

In electrodynamics, for comparison, one has to specify  $\mathbf{A}$  and  $\mathbf{E}$  on  $\Sigma$  satisfying the constraint Gauss's law

$$\nabla \mathbf{E} = 0.$$

One then gets in space–time a solution of Maxwell’s equations that is unique up to gauge transformation.

$$\sqrt{-g} = N\sqrt{h}.$$

For the volume element we get

The reformulated Einstein-Hilbert action becomes the ADM action after Arnowitt, Deser, Misner 1962:

$$\begin{aligned} 16\pi G S_{\text{EH}} &= \int_{\mathcal{M}} dt d^3x N\sqrt{h}(K_{ab}K^{ab} - K^2 + {}^{(3)}R - 2\Lambda) \\ &\equiv \int_{\mathcal{M}} dt d^3x N \left( G^{abcd} K_{ab}K_{cd} + \sqrt{h}[{}^{(3)}R - 2\Lambda] \right), \end{aligned}$$

here  $\kappa = \frac{8\pi l_p^2}{\hbar c} = \frac{8\pi G}{c^4}$ ,  $16\pi G = 2\kappa c^4$ , where  $G^{abcd} K_{ab}K_{cd} = K_{ab}K^{ab} - K^2$

$$G^{abcd} = \frac{\sqrt{h}}{2}(h^{ac}h^{bd} + h^{ad}h^{bc} - 2h^{ab}h^{cd}) \quad (\text{DeWitt-metric})$$

We get for the spatial metric  $h_{ab}$  and the canonical spatial momenta  $p^{ab}$

$$p^{ab} := \frac{\partial \mathcal{L}^g}{\partial \dot{h}_{ab}} = \frac{1}{16\pi G} G^{abcd} K_{cd} = \frac{\sqrt{h}}{16\pi G} (K^{ab} - Kh^{ab})$$

and for the action

$$\mathcal{H}^g = 16\pi G N G_{abcd} p^{ab} p^{cd} - N \frac{\sqrt{h}({}^{(3)}R - 2\Lambda)}{16\pi G} - 2N_b(D_a p^{ab})$$

$$16\pi G S_{\text{EH}} = \int dt d^3x \left( p^{ab} \dot{h}_{ab} - N \mathcal{H}_{\perp}^g - N^a \mathcal{H}_a^g \right) \quad \text{where}$$

$$\mathcal{H}_{\perp}^g = 16\pi G G_{abcd} p^{ab} p^{cd} - \frac{\sqrt{h}}{16\pi G} ({}^{(3)}R - 2\Lambda) \quad \text{Hamiltonian constraint}$$

$$\mathcal{H}_a^g = -2D_b p_a^b \quad \text{diffeomorphism constraint}$$

Variation with respect to the Lagrange multipliers  $N$  and  $N^a$  yields the constraints

$$\mathcal{H}_{\perp}^g = 16\pi G G_{abcd} p^{ab} p^{cd} - \frac{\sqrt{h}}{16\pi G} ({}^{(3)}R - 2\Lambda) \approx 0,$$

$$\mathcal{H}_a^g = -2D_b p_a^b \approx 0.$$

4 pdeqs 2. order in  $r, \theta$  for 6 symmetric  $h_a^b$  and 6 symmetric  $p_a^b$

If non-gravitational fields are coupled, the constraints acquire extra terms.

$$2G_{\mu\nu} n^{\mu} n^{\nu} = 16\pi G T_{\mu\nu} n^{\mu} n^{\nu} =: 16\pi G \rho, \quad \text{with the energy density } \rho = T_{\mu\nu} n^{\mu} n^{\nu}$$

$$\mathcal{H}_{\perp} = 16\pi G G_{abcd} p^{ab} p^{cd} - \frac{\sqrt{h}}{16\pi G} ({}^{(3)}R - 2\Lambda) + \sqrt{h} \rho \approx 0.$$

Hamiltonian constraint

$$\mathcal{H}_a = -2D_b p_a^b + \sqrt{h} J_a \approx 0, \quad \text{diffeomorphism constraint with external current}$$

where  $J_a := h_a^{\mu} T_{\mu\nu} n^{\nu}$  is the gravitational Poynting vector

## A7. Canonical gravity with connections and loops (LQG)

### 7.1. Ashtekar variables

definition of the (inverse) triad  $e_i^a$

$$h_{ab}e_i^a e_j^b = \delta_{ij},$$

$$h^{ab} = \delta^{ij}e_i^a e_j^b \equiv e_i^a e_i^b. \quad e_a^0 = -n_a = Nt_{,a}$$

$E_i^a$  is the inverse densitized triad  $E_i^a(x) := \sqrt{h}(x)e_i^a(x)$ ,  $\sqrt{h} = |\det(e_i^a)|$ .

the extrinsic curvature  $K_a^i(x) := K_{ab}(x)e^{bi}(x)$ , is the canonical conjugate to  $E_i^a$

$$\begin{aligned} K_a^i \delta E^{ia} &= \frac{K_{ab}}{2\sqrt{h}} \delta (E^{ia} E^{ib}) = \frac{K_{ab}}{2\sqrt{h}} (h\delta h^{ab} + h^{ab}\delta h) \\ &= -\frac{\sqrt{h}}{2} (K^{ab} - K h^{ab}) \delta h_{ab} = -8\pi G p^{ab} \delta h_{ab}. \end{aligned}$$

with  $8\pi G = \kappa c^4$

resulting Gauss constraint  $\mathcal{G}_i(x) := \epsilon_{ijk} K_a^j(x) E^{ka}(x) \approx 0$ ,

the covariant derivative for a vector field  $v^a = v^i e_i^a$ . is  $D_a v^i = \partial_a v^i + \omega_a^i{}_j v^j$ ,

with the GR connection  $\omega_a^i{}_j = \Gamma_{kj}^i e_a^k$ , where  $\Gamma_{kj}^i = e_k^d e_j^f e_c^i \Gamma_{df}^c - e_k^d e_j^f \partial_d e_f^i$  are the Christoffel symbols (Levi-Civita connection)

the triad is covariant consistent :  $D_a e_b^i = 0$ , in analogy to  $D_a h_{bc} = 0$   
Parallel transport is defined by

$$dv^i = -\omega_a^i{}_j v^j dx^a. \quad \Gamma_a^i = -\frac{1}{2} \omega_{ajk} \epsilon^{ijk}, \quad \delta\omega^i = \Gamma_a^i dx^a, \quad dv^i = \epsilon_{jk}^i v^j \delta\omega^k.$$

the Riemann curvature components are

$$R_{ab}^i = 2\partial_{[a} \Gamma_{b]}^i + \epsilon_{jk}^i \Gamma_a^j \Gamma_b^k$$

$$R_{ab}^i e_i^b = 0.$$

with the Riemann scalar

$$R[e] = -R_{ab}^i \epsilon_i^{jk} e_j^a e_k^b = -R_{kab}^j e_j^a e^a{}^b{}^k.$$

the generalized impulse was introduced by Ashtekar 1986:

Ashtekar variables  $A_a^i(x) = \Gamma_a^i(x) + \beta K_a^i(x)$ , with dimension  $[A_a^i] = 1/\text{cm}$ ,  $\beta$  Barbero-Immirzi parameter

$A_a^i$  and  $E_b^j$  are canonically conjugate

$$\{A_a^i(x), E_b^j(y)\} = 8\pi\beta l_p^2 \delta_a^b \delta_j^i \delta(x, y)$$

$$\{A_a^i(x), A_b^j(y)\} = 0$$

i.e. we can replace  $E_a^i$  by the operator  $E_a^i \Rightarrow \frac{\beta}{1l_p} \frac{\delta}{\delta A_a^i}$

### 7.2. Discussion of the constraints

Gauss constraints  $G_i = \partial_a E_i^a + \epsilon_{ijk} A_a^j E^{ka} \equiv D_a E_i^a \approx 0$

field strength tensor  $F_{ab}^i = \partial_a A_b^i - \partial_b A_a^i + \varepsilon_{ijk} A_a^j A_b^k$

$$\tilde{\mathcal{H}}_{\perp} = -\frac{\sigma}{2} \frac{\varepsilon^{ijk} F_{abk}}{\sqrt{|\det E_i^a|}} E_i^a E_j^b + \frac{\beta^2 \sigma - 1}{\beta^2 \sqrt{|\det E_i^a|}} E_{[i}^a E_{j]}^b (A_a^i - \Gamma_a^i) (A_b^j - \Gamma_b^j) \approx 0$$

Hamiltonian constraint

$\sigma = -1$  Lorentzian,  $\sigma = 1$  Euclidean

diffeomorphism  $\tilde{\mathcal{H}}_a = F_{ab}^i E_i^b \approx 0$ .

for  $\beta = l = \sqrt{-1}$

in the Lorentzian case

the Hamiltonian constraint simplifies  $\tilde{\mathcal{H}}_{\perp} = \varepsilon^{ijk} F_{abk} E_i^a E_j^b \approx 0$ .

5 pdeqs order 1 in  $r, \theta$  non-linear (quadratic) for 6 symmetric  $E_i^a$  and 6 symmetric  $A_i^a$

### 7.3. 3-dimensional Ashtekar-Kodama constraints

We construct a theory based on the densitized inverse tetrad  $E_j^b(\mathbf{y})$  and the connection  $A_a^i(\mathbf{x})$  with the commutator

$$[A_a^i(x), E_j^b(y)] = -8\pi l_p^2 \delta_j^i \delta_a^b \delta(x, y) \beta i \text{ where } \kappa = \frac{8\pi l_p^2}{\hbar c} = \frac{8\pi G}{c^4}, \quad 8\pi \hbar G = 8\pi l_p^2 c^3$$

the operators act on the wave functional  $\Psi[A]$

$$\hat{A}_a^i(\mathbf{x}) \Psi[A] = A_a^i(\mathbf{x}) \Psi[A],$$

$$\hat{E}_j^b(y) \Psi[A] = -8\pi l_p^2 \frac{\beta}{i} \frac{\delta \Psi[A]}{\delta A_j^b(y)}, \quad \hat{E}_j^b(y) \Psi[A] = -8\pi l_p^2 \frac{3}{\lambda} \frac{\beta}{i} \varepsilon^{bcd} F_{cdj}$$

where  $\lambda = 8\pi l_p^2 \Lambda$

$$\mathcal{D}_a \frac{\delta \Psi}{\delta A_a^i} = 0.$$

the Gauss constraint becomes

$$F_{ab}^i \frac{\delta \Psi}{\delta A_b^i} = 0.$$

the diffeomorphism constraint becomes

and the Hamiltonian constraint with  $\Lambda=0$  and  $\beta=l=\sqrt{-1}$

$$\varepsilon^{ijk} F_{kab} \frac{\delta^2 \Psi}{\delta A_a^i \delta A_b^j} = 0$$

In the case of vacuum gravity with  $\Lambda \neq 0$ , an exact formal solution in the connection representation was found by Kodama 1990.

The Hamiltonian constraint becomes for  $\beta=l=\sqrt{-1}$

$$\varepsilon^{ijk} \frac{\delta}{\delta A_a^i} \frac{\delta}{\delta A_b^j} \left( F_{abk} - \frac{\Lambda}{3l_p} \varepsilon_{abc} \frac{\delta}{\delta A_c^k} \right) \Psi[A] = 0$$

with the global wave function

$$\Psi[A] = N \exp \left( \frac{3}{\lambda} \int_{\Sigma} d^3 x \varepsilon^{abc} \text{tr} \left( A_a \partial_a A_c + \frac{1}{3} A_a A_b A_c \right) \right)$$

$$\frac{c^3}{G\hbar\Lambda} = \frac{1}{8\pi l_p^2 \Lambda} = \frac{1}{\lambda}$$

derived from the Chern-Simons action

$$S_{CS}[A] = \int_{\Sigma} d^3x \varepsilon^{abc} \text{tr} \left( A_a \partial_b A_c + \frac{1}{3} A_a A_b A_c \right)$$

$$\varepsilon_{abc} \frac{\delta \Psi}{\delta A_c^k} = \frac{3}{\Lambda} F_{kab}$$

results from the variation of the Chern-Simons covariant Lagrangian

$$L_{CS} = \varepsilon^{\mu\nu\lambda} \left( A_{\mu}^{\kappa} \partial_{\nu} A_{\lambda\kappa} + \frac{1}{3} \varepsilon_{\kappa_1\kappa_2\kappa_3} A_{\mu}^{\kappa_1} A_{\mu}^{\kappa_2} A_{\mu}^{\kappa_3} \right)$$

$$\frac{\delta L_{CS}}{\delta A_{\rho}^{\sigma}} = \varepsilon^{\rho\nu\lambda} F_{\nu\lambda\sigma}$$

The resulting constraints are [4] [5]

$$3 \text{ Gauss constraints } G_i = \partial_a E^a_i + \varepsilon_{ij}^k A_a^j E^a_k$$

$$3 \text{ diffeomorphism constraints } D_a = E^b_i F_{ab}^i$$

$$3*3=9 \text{ Hamiltonian constraint } H_{(a,b)}^k = F_{ab}^k + \frac{\Lambda}{3} \varepsilon_{ab}^c E_c^k$$

altogether 15 pdeqs order 1 in  $r, \theta$  nonlinear (quadratic in  $E_i^a$  and  $A_i^a$ , cubic in both), for 9  $E_i^a$  and 9  $A_i^a$

### A8. 4-dimensional Ashtekar-Kodama constraints

We can transform the 3-dimensional Ashtekar-Kodama equations uniquely into the 4-dimensional relativistic form by generalizing the  $\varepsilon$ -tensor from 3 spatial indices (1,2,3) to 4 spacetime indices (0,1,2,3), which is mathematically uniquely and well-defined.

with 16 variables  $E^{\mu\nu}$ : inverse densitized triad of the metric  $g_{\mu\nu}$

with 16 variables  $A_\mu{}^\nu$  connection tensor

spatial spacetime curvature (field tensor)  $F_{\mu\nu}{}^\kappa = \partial_\mu A_\nu{}^\kappa - \partial_\nu A_\mu{}^\kappa + \varepsilon^\kappa{}_{\kappa_1\kappa_2} A_\mu{}^{\kappa_1} A_\nu{}^{\kappa_2}$

4 Gauss constraints  $G^\mu = \partial_\nu E^{\nu\mu} + \varepsilon^\mu{}_{\kappa\lambda} A_\nu{}^\kappa E^{\nu\lambda}$  (covariant derivative of  $E^{\mu\nu}$  vanishes)

4 diffeomorphism constraints  $I_\mu = E^\kappa{}_\nu F_{\mu\kappa}{}^\nu$

24 Hamiltonian constraints  $H_{(\mu,\nu)}{}^\kappa = F_{\mu\nu}{}^\kappa + \frac{\Lambda}{3} \varepsilon_{\mu\nu\rho} E^{\rho\kappa}$

The expression  $(\mu, \nu)$  in the index of H means that only *pairs*  $(\mu, \nu)$  where  $\mu \neq \nu$  in the first index yield different constraints, as the right side is antisymmetric in  $(\mu, \nu)$ , that results in  $6*4=24$  Hamiltonian constraints.

So we have 32 partial differential equations of degree 1, nonlinear (quadratic in  $E^{\mu\nu}$  and  $A^{\mu\nu}$ , cubic in both) in  $\{t, r, \theta\}$  for 32 variables, with the  $E_g{}^{\mu\nu} = \text{tetrad}(g_{\mu\nu})$  boundary condition ( $r \rightarrow \infty$ ) for  $E^{\mu\nu}$ .

## A9. BF-theory

### 9.1. Palatini action as BF-theory

Palatini action (Durka) (in the following the constant factor in the action  $\frac{1}{2\kappa} = \frac{c^4}{16\pi G}$  is skipped)

$$S = \frac{1}{64\pi G} \int d^4x \epsilon^{abcd} (R_{\mu\nu}{}^{ab} e_{\rho k} e_{\sigma d} - \frac{\Lambda}{3} e_{\mu a} e_{\nu b} e_{\rho c} e_{\sigma d}) \epsilon^{\mu\nu\rho\sigma}$$

Riemann tensor expressed by the GR connection  $\omega_{\mu}{}^{ab}$

$$R_{\mu\nu}{}^{ab} = \partial_{\mu}\omega_{\nu}{}^{ab} - \partial_{\nu}\omega_{\mu}{}^{ab} + \omega_{\mu}{}^a{}_c \omega_{\nu}{}^{cb} - \omega_{\nu}{}^a{}_c \omega_{\mu}{}^{cb}, \quad R^a{}_b = d\omega^a{}_b + \omega^a{}_c \wedge \omega^c{}_b$$

and tetrad derivatives

$$T_{\mu\nu}{}^a = \mathcal{D}_{\mu}^{\omega} e_{\nu}{}^a - \mathcal{D}_{\nu}^{\omega} e_{\mu}{}^a, \quad T^a = D^{\omega} e^a = de^a + \omega^a{}_b \wedge e^b$$

$$T_{\mu\nu}{}^a = D_{\mu} e_{\nu}{}^a - D_{\nu} e_{\mu}{}^a \quad D_{\mu} e_{\nu}{}^a = \partial_{\mu} e_{\nu}{}^a + \epsilon^a{}_{bcd} \omega_{\mu}{}^{bc} e_{\nu}{}^d$$

with the covariant derivative

$$\mathcal{L}_{\text{Palatini}}[e, \omega] = \int_{\mathcal{X}} \mathbf{u}_{\alpha\beta} \wedge \mathbf{R}^{\alpha\beta} \quad \text{Vey 1.88}$$

$$[\mathbf{u}]_{\mu\nu}{}^{IJ} = \frac{1}{2} \epsilon^{IJ}{}_{KL} e_{\mu}{}^K e_{\nu}{}^L, \quad (\mathbf{u}_{\Lambda})_{\mu\nu}{}^{IJ} = e_{\mu}{}^I e_{\nu}{}^J \quad 1.78$$

\*u Hodge- transformed

$$I^{\text{Palatini}} = \int \epsilon_{abcd} \left( e^a \wedge e^b \wedge F^{cd} + \frac{\Lambda}{2} e^a \wedge e^b \wedge e^c \wedge e^d \right) \quad [5 (35)] \text{ Lorentzian case}$$

$$F_{\mu\nu}(\omega) = d\omega + \omega \wedge \omega \quad [14],$$

where  $\omega = (\omega_{\nu})^{ab}$  is a *matrix-vector* and  $F_{\mu\nu} = (F_{\mu\nu})^{ab}$  is a *matrix-matrix* or *4-degree-tensor* explicitly:

$$F_{\mu\nu}{}^{ab}(\omega_{\nu}{}^{ab}) = d\omega^{ab} + \omega^{ab} \wedge \omega^{ab} = \partial_{\mu}\omega_{\nu}{}^{ab} - \partial_{\nu}\omega_{\mu}{}^{ab} + \omega_{\mu}{}^a{}_c \omega_{\nu}{}^{cb} - \omega_{\nu}{}^a{}_c \omega_{\mu}{}^{cb}$$

$$F^{ab}(\omega^{ab}) = R_{\mu\nu}{}^{ab}$$

eom's of Palatini action:

$$\frac{\delta I^{\text{Pal}}}{\delta A^{ab}} = \nabla e^a \wedge e^b \quad \nabla e^a \wedge e^b = 0, \quad \text{solution } A^{ab} = \omega^{ab}$$

where  $\omega$  is the SO(4) spin connection

$$\frac{\delta I^{\text{Pal}}}{\delta e_{\mu}{}^a} \text{ corresponding derived Einstein equations}$$

$$\epsilon_{abcd} (e^b \wedge F^{cd} + \Lambda e^a \wedge e^b \wedge e^c \wedge e^d) = 0.$$

### 9.2. Plebanski action as BF-theory

original Lorentzian Plebanski action Smolin [5] (26)

$$I^{\text{Plebanski}} = \int B^i \wedge F_i - \frac{1}{2} \phi_{ij} B^i \wedge B^j, \quad \text{where } \iota = \sqrt{-1} \text{ and } \phi_{ij} \text{ generates the cosmological constant}$$

we add a Chern-Simons boundary term to the action  $S_{CS}[A] = \frac{3\iota}{\lambda} \int_{\Sigma} d^3x \epsilon^{abc} \text{tr} \left( A_a \partial_b A_c + \frac{1}{3} A_a A_b A_c \right)$

to enforce on the boundary  $F^i = -\frac{\Lambda}{3} B^i$

explicitly:

$$I^{\text{Pleb}} = \iota \int d^4x \epsilon^{abcd} \left( B_{ab}{}^i F_{cdi} - \frac{1}{2} \phi_{ij} B_{ab}{}^i B_{cd}{}^j \right) + \frac{3\iota}{\lambda} \int_{\Sigma} d^3x \epsilon^{abc} \text{tr} \left( A_a \partial_b A_c + \frac{1}{3} A_a A_b A_c \right)$$

$$\phi_i{}^i = -\Lambda; \quad \phi_{[ij]} = 0$$

the eom's are



$$\frac{\delta I^{Pleb}}{\delta A} = 2D \wedge B, \quad \frac{\delta I^{Pleb}}{\delta A_\rho^\sigma} = 2\varepsilon^{ab\rho\sigma} \left( \partial_\rho B_{ab}^\sigma + \varepsilon_{i\rho\kappa} A_\rho^\kappa B_{ab}^i \right)$$

$$\frac{\delta I^{Pleb}}{\delta B^i} = F^i - \phi^i_j B^j$$

we get a solution  $\Phi_j^i = -\frac{\Lambda}{3}\delta_j^i$  and  $F^i = -\frac{\Lambda}{3}B^i$

if we set B equal to the self-dual tetrad field, we get  $B_{ab}^i = \varepsilon_{abc} E^{ci}$

and finally  $F_{ab}^i = -\frac{\Lambda}{3}\varepsilon_{abc} E^{ci}$ , which gives the Hamiltonian Ashtekar-Kodama constraint

$$0 = D \wedge B = D_a E^{ai}$$

the first eom becomes for spatial indices and by generalization for covariant 4 indices, which gives the Gaussian constraint.

The Palatini action can be derived from the more general Plebanski action, setting

$$\phi_{ij} = -\Lambda \quad B_{ab}^i = \varepsilon^i_{jk} e_a^j e_b^k$$

and

### 9.3. From the Plebanski action to the Einstein-Hilbert action

the general ansatz for the Plebanski action is

$$S(B, \omega, \phi) = \int B^{IJ} \wedge F_{IJ}(\omega) - \frac{1}{2} \phi_{IJKL} B^{IJ} \wedge B^{KL} - \frac{1}{6} \left( \frac{\lambda}{2} \varepsilon_{IJKL} + \mu \delta_{IJKL} \right) B^{IJ} \wedge B^{KL}.$$

From the resulting eom's one get the new action with a parameter  $\gamma=1/\beta$ , where  $\beta$  is the Immirzi parameter.

$$S(e, \omega) = \int (\star + \gamma) e^I \wedge e^J \wedge F_{IJ} - 2e (\lambda(1 + \gamma^2) + 2\mu\gamma).$$

and  $\star$  is the Hodge-operator  $\star e_a^J = \varepsilon^{Ia}{}_J e_a^I$

is the “anisymmetrized tetrad” and

$$e = \frac{1}{24} \varepsilon_{abcd} \varepsilon_{\mu\nu\kappa\lambda} e_\mu^a e_\nu^b e_\kappa^c e_\lambda^d$$

with the cosmological constant  $\Lambda = \lambda(1 + \gamma^2) + 2\mu\gamma$ .

we get the action  $S(e) = \int e(R - 2\Lambda) + \gamma \epsilon \cdot R$ , and  $\epsilon \cdot R \equiv \varepsilon^{\mu\nu\rho\sigma} R_{\mu\nu\rho\sigma} = 0$  due to the Bianchi identity

$R_{[\mu\nu\rho]\sigma} = 0$ , so we get the Einstein-Hilbert action with a cosmological constant

## Part B Ashtekar-Kodama gravity

### 4-dimensional Kodama-Ashtekar equations

16 variables  $E^{\mu\nu}$ : inverse densitized triad of the metric  $g_{\mu\nu}$

16 variables  $A_\mu^\nu$  connection tensor

spatial spacetime curvature  $F_{\mu\nu}^\kappa = \partial_\mu A_\nu^\kappa - \partial_\nu A_\mu^\kappa + \varepsilon^{\kappa\kappa_1\kappa_2} A_\mu^{\kappa_1} A_\nu^{\kappa_2}$

4 Gauss constraints  $G^\mu = \partial_\nu E^{\nu\mu} + \varepsilon^\mu{}_{\kappa\lambda} A_\nu^\kappa E^{\nu\lambda}$

4 diffeomorphism constraints  $I_\mu = E^\kappa{}_\nu F_{\mu\kappa}{}^\nu$

24 Hamiltonian constraints  $H_{(\mu,\nu)}^\kappa = F_{\mu\nu}^\kappa + \frac{\Lambda}{3} \varepsilon_{\mu\nu\rho} E^{\rho\kappa}$

### AK covariant derivative and its gauge group

$$D_\mu t_\nu^\lambda = \partial_\mu t_\nu^\lambda + \varepsilon^\lambda{}_{\kappa_1\kappa_2} A_\mu^{\kappa_1} t^{\nu\kappa_2}$$

left spin-1/2 representation of the Lorentz-algebra with 4 generators

$$\tau_i = T_+^i; i = 1, 2, 3$$

$$\tau_0 = (T_+^1 + T_-^1) - (T_+^2 + T_-^2) + (T_+^3 + T_-^3)$$

4 extended generators  $\tau_i$  satisfy the extended SU(2) commutator algebra with spacetime indices {0,1,2,3}

$$[\tau_\kappa, \tau_\lambda] = i \varepsilon_{\kappa\lambda\mu} \tau_\mu$$

### Renormalizable Einstein-Hilbert action with the Ashtekar momentum $A_\mu^\nu$

Einstein-Hilbert action

$$S = \frac{\hbar c}{16\pi l_p^2} \int (R - 2\Lambda) \sqrt{-g} d^4x, \quad \kappa = \frac{8\pi l_p^2}{\hbar c}$$

half-symmetric background  $A_\mu^\nu = \frac{1}{l_p} \begin{pmatrix} 1,1,-1,1 \\ 1,1,-1,1 \\ 1,1,-1,1 \\ 1,1,-1,1 \end{pmatrix} = \frac{1}{l_p} \Omega_\mu^\nu$

reformulated Einstein-Hilbert action with  $\Lambda \approx 0$

$$S = \frac{\hbar c}{\pi} \int (A_\mu^\nu A_\nu^\mu) R \sqrt{-g} d^4x \text{ is dimensionally renormalizable}$$

variation with respect to  $g_{\mu\nu}$  yields the Einstein equation as before

$$\text{variation with respect to } A_\mu^\nu \text{ gives } \frac{\partial}{\partial A_\mu^\nu} \frac{\hbar c}{\pi} (A_\mu^\nu A_\nu^\mu) R \sqrt{-g} = -16 \frac{l_p}{r_s} \Omega_\mu^\nu T \sqrt{-g}$$

This is  $\approx 0$  in the classical region, so the eom is satisfied.

## Solutions of static equations

### Solution limit $\Lambda \rightarrow 0$ :

A-tensor becomes a *constant half-antisymmetric background*  $A_{hab}$  in the form

$$A0_i = A00c \{1,1,-1,1\}, A1_i = A10c \{1,1,-1,1\}, A2_i = A20c \{1,1,-1,1\}, A3_i = A30c \{1,1,-1,1\}$$

E-tensor is the Gauss-Schwarzschild tetrad  $E_{GS}$ , satisfying gaussian equations

$$\frac{\partial_\theta E^{2\nu}}{r} + \partial_r E^{1\nu} = 0, \text{ and the metric condition for all } r > 1 \quad E \eta E^t = g^{-1} / (-\det(g))^{3/4}$$

the metric generated by  $E_{GS}$  is the Schwarzschild metric and the Einstein equations are satisfied

### Solution $\Lambda \neq 0$ with the half-logarithmic ansatz

solution  $E$  in  $(r_{th}, \theta)$ ,  $r_{th} = \theta + \log(r)$

$$Eb_{ij}(r, \theta) = \pm Eb_{ij}(r_{th}) + \sum \frac{c_{1kl}}{L} Ab_{0k}(r_{th}) Ab_{3l}(r_{th}) + \sum \frac{c_{4kl}}{L} \frac{Ab_{0k}'(r_{th})}{\exp(r_{th} - \theta)} + \sum \frac{c_{5kl}}{L} \frac{Ab_{3k}'(r_{th})}{\exp(r_{th} - \theta)}$$

$$+ \sum \frac{c_{2kl}}{L} Ab_{0k}(r_{th}) Ab_{3l}'(r_{th})(r_{th} - \theta) + \sum \frac{c_{3kl}}{L} Ab_{0k}'(r_{th}) Ab_{3l}(r_{th})(r_{th} - \theta)$$

metric condition: half-logarithmic Schwarzschild metric

### Behavior at Schwarzschild horizon

Schwarzschild tetrad diverges

$$E_{ds}^{0,0} = \frac{1}{r\sqrt{r-1} \sin^{3/4}(\theta)} \rightarrow \infty, \text{ so the term } \frac{\Lambda}{3} E^{\mu\nu} \text{ becomes significant}$$

$$\text{at } r = 1 + dr, \quad dr = \sqrt{\Lambda}, \text{ i.e. } E_{00}(\theta) = \frac{1}{\Lambda^{1/4} \sin^{3/4}(\theta)}, \text{ the peak in the metric is } g_{1,1} = \frac{1}{\sqrt{\Lambda}}$$

$$\text{gravitational limit for the quantum realm becomes } r_{gr} = \sqrt{l_p \sqrt{\frac{1}{\Lambda}}} = 3.1 * 10^{-5} m = 31 \mu m$$

*objective collapse theory* links the spontaneous collapse of the wave function to quantum gravitation, this puts the limit for quantum behavior at  $r \leq r_{gr}$

## Solutions of time-dependent equations

$\Lambda$ -scaled wave ansatz

$$A_{\mu}^{\nu} = Ab_{\mu}^{\nu} + \Lambda \frac{As_{\mu}^{\nu}}{r} \exp(-ik(r-t))$$

$$E^{\mu\nu} = Eb^{\mu\nu} + \frac{Es^{\mu\nu}}{r} \exp(-ik(r-t))$$

## Wave equation in Schwarzschild spacetime: solutions

solution  $l_x=0$  spherical wave: incoming wave, only zero solution

solution  $l_x=1$  dipole wave: divergent, only zero solution

solution  $l_x=2$  quadrupole wave:

-the E-tensor is exponentially damped with  $\exp(-\frac{4\sqrt{r}}{\sqrt{3}})$

-the A-tensor components  $As_0$  and  $As_1$  are pure quadrupole waves,  $As_2$  is a linearly damped quadrupole wave,

$As_3$  is exponentially damped with  $\exp(-\frac{4\sqrt{r}}{\sqrt{3}})$

## Spherical waves

$\Lambda$ -scaled wave ansatz

$$A_{\mu}^{\nu} = \frac{dAb_{\mu}^{\nu}}{r} + \Lambda \frac{As_{\mu}^{\nu}}{r} \exp(-ik(r-t))$$

$$E^{\mu\nu} = Eb_{GM}^{\mu\nu}(r, \theta) + \frac{dEb^{\mu\nu}(\theta)}{r^{3/2}} + \left( \frac{Es^{\mu\nu}}{r} + \frac{Er^{\mu\nu}}{r^2} \right) \exp(-ik(r-t))$$

*eqtoiev* → static & wave-equations

*eqtoievnu3b*( $dAb, dEb$ )

*eqtoievnu3w*( $As, Es, Er, dAb$ )

wave component relations

$$Es_1 = 0 = Es_0, Es_2 = 3ik(As_0 - As_1 + As_2), Es_3 = -3ik As_2$$

$$As_3 = (As_0 - As_1 + As_2), \text{ free param. } As_f = \{As_0, As_1, As_2\}$$

solution at infinity

$$dAb_{sol} \equiv \{dAb_{21}, dAb_{21}, dAb_{22}, dAb_{32}, dAb_{33}\}$$

$$dAb_{sol} = dAb_{sol}(As_0)$$

$$dEb_{sol}(\theta) \equiv \{dEb_{00}, dEb_{11}, dEb_{12}, dEb_{13}, dEb_{31}, dEb_{32}, dEb_{33}\}$$

$$dEb_{sol} = dEb_{sol}(As_0, \sin(\theta))$$

**Planar waves:**

$\Lambda$ -scaled wave ansatz

$$A_\mu^\nu = dAb_\mu^\nu + \Lambda As_\mu^\nu \exp(-ik(x-t))$$

$$E^{\mu\nu} = Eb_{GM}^{\mu\nu}(x, \theta) + \frac{dEb^{\mu\nu}}{x^{3/2}} + Es^{\mu\nu} \exp(-ik(x-t))$$

*eqtoiev* → static & wave-equations

*eqtoievnu3b(dAb,dEb)*

*eqtoievnu3w(As,Es, dAb)*

wave component relations

$$Es_1 = 0 = Es_0, Es_2 = 3ik(As_0 - As_1 + As_2), Es_3 = -3ik As_2$$

$$As_3 = (As_0 - As_1 + As_2), \text{ free param. } As_f = \{As_0, As_1, As_2\}$$

solution at infinity

$$dAb_i = dAb_i(As_f)$$

$$dEb_{sol} = \{dEb_{00}, dEb_{11}, dEb_{12}, dEb_{13}\}$$

$$dEb_{sol} = dEb_{sol}(As_0)$$

**Wave forms**

wave form planar wave in x-direction

$$As = \begin{pmatrix} As_0 \\ As_1 \\ 0 \\ 0 \end{pmatrix} \quad Es = \begin{pmatrix} 0 \\ 0 \\ Es_2 = 3ik(As_0 - As_1 + As_2) \\ Es_3 = -3ik As_2 \end{pmatrix}$$

tetrad  $Es$  has only transversal components  $(2,3) = (\theta, \varphi) \equiv (z, y)$

metric wave has also only transversal components

$$Es \bullet \eta \bullet Es^t = g^s$$

$$g^s = \begin{pmatrix} 0 & 0 \\ 0 & g^{s_{22}} \end{pmatrix}$$

$$g^{s_{22}} = \begin{pmatrix} Es_2^2 & Es_2 \bullet Es_3 \\ Es_2 \bullet Es_3 & Es_3^2 \end{pmatrix} = \begin{pmatrix} As_2^2 & -(As_0 - As_1)^2 / 2 \\ -(As_0 - As_1)^2 / 2 & -As_2^2 \end{pmatrix}$$

$$\text{gauge cond. } 2As_2 \bullet (As_2 + As_0 - As_1) + (As_0 - As_1)^2 = 0$$

i.e.  $g^s$  has the normal form of a GR metric wave

$g^s$  satisfies the linearized Einstein equations

## Reflection and absorption of gravitational waves

at matter boundary the relative potential changes  $\Phi \approx -\frac{r_s}{2r} \rightarrow \tilde{\Phi} = \Phi + \delta\Phi$   $\delta\Phi = -\frac{r_s(M)}{2r}$

$r_s(M)$  =Schwarzschild radius of the interacting matter  $M$

$k$  has a jump  $\delta k$ : with  $k = \frac{\sqrt{r_s}}{\sqrt{2r_0^3}}$ ,  $\frac{\delta k}{k} = \frac{r_s(M)}{2r_s}$

so the reflected and absorbed amplitude ratio is approximately

$$\frac{\delta A_r}{A} = \frac{\delta k}{k} = \frac{r_s(M)}{2r_s}, \quad \frac{\delta A_a}{A} = \sqrt{\frac{r_s(M)}{r_s}}$$

## Wave equation in binary rotator spacetime

bgr described by Kerr spacetime with  $\alpha = \frac{c_0}{r_0}$

*eqtoiev*  $\Lambda$ -scaled wave ansatz,

background equation *eqtoievnu3b=eqtoiv*

standard solution:

*Eb*-tensor= the Kerr-Schwarzschild-tetrad  $E_{KS}$ :

*Ab*-tensor  $Ab = A_{hab} + dAb$  perturbed *half-antisymmetric background*

wave equation *eqtoievnu3wdA = eqtoievnu3wdA(As, Es,  $\alpha$ , k)*

solution of wave equation of bgr as a series in  $r$ -powers by comparison of coefficients

result: free parameter  $As00(r, \theta, r_0) = \frac{As00n01}{r_0} + \dots$

$As1 \approx As0$ ,  $\{As2, As3\} = O(1/r^2)$ ,  $Es2 = O(1/r^2)$ ,  $\{Es0, Es1, Es3\} = O(1/r)$  function( $As00n01$ )

## Numerical solutions

static *eqtoiv* with full coupling ( $\Lambda=1$ ):

Ritz-Galerkin method with trigonometric polynomials in  $\theta$

metric in AK-gravity with coupling: no horizon and no singularity

time-dependent *eqtoiev* with weak coupling ( $\Lambda=0.001$ ) and binary gravitational rotator (bgr) with  $r_0=1$

Ritz-Galerkin method with trigonometric polynomials in  $\theta$

**gravitational Ashtekar-Kodama energy**

$$\text{AK grav. wave energy density } t_{\mu\nu} = D_\kappa A_\mu^\kappa D_\lambda A_\nu^\lambda \hbar c \left( \frac{1}{l_p^2 \Lambda^2 r_s^2} \right)$$

$$\text{GR } t_{\mu\nu} = \frac{\hbar c}{16\pi l_p^2} k_\mu k_\nu \left( e^{\lambda\kappa} e_{\lambda\kappa} - \frac{1}{2} |e^\lambda{}_\lambda|^2 \right)$$

$$\text{Einstein power formula for bgr } P_{GR} = \frac{\hbar c^2}{2l_p^2} \frac{r_s^5}{r_0^5} \left( \frac{m_1 m_2}{m^2} \right)^2$$

$$\text{power AK-gravity for bgr } P_{KA} = k_0^2 A_{S_{00}}^2 4\pi \hbar c^2 \left( \frac{1}{l_p r_s} \right)^2$$

$$\text{result: } A_{S_{00}} = \frac{f_m}{4\sqrt{2\pi}} \frac{r_s^3}{r_0} \quad \text{with } f_m = \frac{m_1 m_2 \dots m_n}{m^n} = \frac{m_r}{m}$$

**Lagrangian of AK-gravitation**

$$\text{electrodynamics: Maxwell lagrangian } L_{em} = -\frac{1}{4} F_{\mu\nu} F^{\mu\nu}$$

$$\text{diffeomorph lagrangian } L_I = \hbar c C_\mu C^\mu = \hbar c E^{\kappa_1 \nu_1} F_{\mu\kappa_1}{}^{\nu_1} E^{\kappa_2 \nu_2} F^\mu{}_{\kappa_2}{}^{\nu_2}$$

$$\text{hamiltonian lagrangian } L_H = -\hbar c \left( \frac{1}{4} F_{\mu\nu}{}^\kappa F^{\mu\nu}{}_\kappa + \frac{\bar{\varphi}_\Lambda \varphi_\Lambda}{3} (\varepsilon^{\kappa\mu\lambda} E^{\lambda\nu} \partial_\kappa A_{\mu\nu} + \varepsilon_{\mu_2\lambda_2\kappa_2} \varepsilon^{\mu_1\lambda_1\kappa_1} E^{\kappa_1\kappa_2} A_{\lambda_1}{}^{\lambda_2} A_{\mu_1}{}^{\mu_2}) \right)$$

the complete AK lagrangian is then

$$L_{gr} = L_H + L_I = \hbar c \left( \begin{array}{l} -\frac{1}{4} F_{\mu\nu}{}^\kappa F^{\mu\nu}{}_\kappa - \frac{\bar{\varphi}_\Lambda \varphi_\Lambda}{3} (\varepsilon^{\kappa\mu\lambda} E^{\lambda\nu} \partial_\kappa A_{\mu\nu} + \varepsilon_{\mu_2\lambda_2\kappa_2} \varepsilon^{\mu_1\lambda_1\kappa_1} E^{\kappa_1\kappa_2} A_{\lambda_1}{}^{\lambda_2} A_{\mu_1}{}^{\mu_2}) \\ + E^{\kappa_1 \nu_1} F_{\mu\kappa_1}{}^{\nu_1} E^{\kappa_2 \nu_2} F^\mu{}_{\kappa_2}{}^{\nu_2} \end{array} \right)$$

where  $\Lambda$  is generated by a scalar field  $\varphi_\Lambda$

### B1. 4-dimensional Ashtekar-Kodama equations and their properties

We can transform the 3-dimensional Ashtekar-Kodama equations *uniquely* into the 4-dimensional relativistic form by generalizing the  $\varepsilon$ -tensor from 3 spatial indices (1,2,3) to 4 spacetime indices (0,1,2,3), which is mathematically uniquely and well-defined.

with 16 variables  $E^{\mu\nu}$ : inverse densitized triad of the metric  $g_{\mu\nu}$

with 16 variables  $A_\mu{}^\nu$  connection tensor

spacetime curvature tensor (field tensor)  $F_{\mu\nu}{}^\kappa = \partial_\mu A_\nu{}^\kappa - \partial_\nu A_\mu{}^\kappa + \varepsilon^\kappa{}_{\kappa_1\kappa_2} A_\mu{}^{\kappa_1} A_\nu{}^{\kappa_2}$

4 Gauss constraints  $G^\mu = \partial_\nu E^{\nu\mu} + \varepsilon^\mu{}_{\kappa\lambda} A_\nu{}^\kappa E^{\nu\lambda}$  (covariant derivative of  $E^{\mu\nu}$  vanishes)

4 diffeomorphism constraints  $I_\mu = E^\kappa{}_\nu F_{\mu\kappa}{}^\nu$

24 Hamiltonian constraints  $H_{(\mu,\nu)}{}^\kappa = F_{\mu\nu}{}^\kappa + \frac{\Lambda}{3} \varepsilon_{\mu\nu\rho} E^{\rho\kappa}$

The expression  $(\mu, \nu)$  in the index of H means that only *pairs*  $(\mu, \nu)$  where  $\mu \neq \nu$  in the first index yield different constraints, as the right side is antisymmetric in  $(\mu, \nu)$ , that results in  $6 \cdot 4 = 24$  Hamiltonian constraints.

So we have 32 partial differential equations of degree 1, nonlinear (quadratic in  $E^{\mu\nu}$  and  $A^{\mu\nu}$ , cubic in both) in  $\{t, r, \theta\}$  for 32 variables, with the  $E_g^{\mu\nu} = \text{tetrad}(g_{\mu\nu})$  boundary condition ( $r \rightarrow \infty$ ) for  $E^{\mu\nu}$ .

$E_g^{\mu\nu}$  is the solution of the original defining *densitized tetrad* equation  $E^{\mu\kappa} E^\nu{}_\kappa = g^{\mu\nu} / (-\det(g))^{3/4}$  or in matrix-notation for d=4:  $E \eta E^t = g^{-1} / (-\det(g))^{3/4}$  with the Lorentz signature  $\eta = -\text{diag}(1, -1, -1, -1)$ , which is generalized from the densitized triad equation for d=3:  $E \eta E^t = g^{-1} / (-\det(g))$  with the *scaling behavior*

$\det(E) = \frac{1}{\det(g)^2}$ . As is easily shown, the densitized tetrad has the same scaling behavior  $\det(E) = \frac{1}{\det(g)^2}$  and

for the scaling transformation with a scalar  $\alpha$   $g \rightarrow \alpha g$  follows  $E \rightarrow \frac{E}{\alpha^2}$  for both d=3 and d=4.

For the (normalized with  $r_s = 1$ ) Schwarzschild metric in spherical coordinates

$$g_{\mu\nu} = -\text{diag} \left( \left(1 - \frac{1}{r}\right), -\frac{1}{\left(1 - \frac{1}{r}\right)}, -r^2, -r^2 \sin^2 \theta \right)$$

the *diagonal* tetrad solution is

$$(E_{ds})^{\mu\nu} = \text{diag} \left( \frac{1}{\sqrt{r-1} r \sin(\theta)^{3/4}}, \frac{\sqrt{r-1}}{r^2 \sin(\theta)^{3/4}}, \frac{1}{r^{5/2} \sin(\theta)^{3/4}}, \frac{1}{r^{7/2} \sin(\theta)^{3/4}} \right)$$

but, as the tetrad equation has 10 equations for 16 variables, there are 6 degrees of freedom (dof) left.

So we can enforce in addition the validity of the Gauss constraint: this can be achieved, and the solution  $(E_{GS})^{\mu\nu}$  can be calculated in a half-analytical form.



## 1.1. AK covariant derivative and its gauge group

Here the covariant derivative (of the SO(3) group as gauge group) acting on a tensor  $t^{\nu\lambda}$  is

$$D_\mu t_\nu^\lambda = \partial_\mu t_\nu^\lambda + \varepsilon^{\lambda\kappa_1\kappa_2} A_\mu^{\kappa_1} t^{\nu\kappa_2} \quad (D_\mu)^\lambda{}_\kappa = \partial_\mu + \varepsilon^{\lambda\kappa_1\kappa} A_\mu^{\kappa_1}$$

where  $F_{\mu\nu}{}^\kappa = [D_\mu^\lambda, D_\nu^\lambda]$

$D_\mu = \partial_\mu - iA_\mu^a \tilde{\tau}^a$ , where  $\tilde{\tau}^a = i\varepsilon_{\nu\lambda}^a$  satisfy the *extended SU(2) Lie-algebra*

$$[\tilde{\tau}^a, \tilde{\tau}^b] = i\varepsilon^{abc} \tilde{\tau}^c$$

$\varepsilon^{\lambda\kappa_1\kappa_2}$  are the structure constants of the *extended SU(2) Lie-algebra*

A well-known representation of this *extended SU(2) Lie-algebra* are the following 4x4 matrices

$$\tau_i = T_+^i; i=1,2,3$$

$$\tau_0 = (T_+^1 + T_-^1) - (T_+^2 + T_-^2) + (T_+^3 + T_-^3)$$

The  $T_+, T_-$  are combinations of the 6 generators of the Lorentz group:

$$T_\pm^k = \frac{1}{2}(J^k \pm K^k)$$

of the 3 spatial rotators  $J^k$  and the 3 boosts  $K^k$ , which are 4x4 matrices derived from the 4-tensor generator

$$(M^{\mu\nu})^\rho{}_\sigma = -i(\eta^{\mu\nu}\delta_\sigma^\nu - \eta^{\nu\rho}\delta_\sigma^\mu), \quad J^k = \frac{1}{2}\varepsilon^{ijk}M^{ij}, \quad K^k = M^{0k} \quad \text{where } \eta \text{ is the Minkowski metric, e.g.}$$

$$J^1 = M^{23} = i \begin{pmatrix} 0 & 0 & 0 & 0 \\ 0 & 0 & 0 & 0 \\ 0 & 0 & 0 & -1 \\ 0 & 0 & 1 & 0 \end{pmatrix}, \quad K^1 = M^{01} = i \begin{pmatrix} 0 & 1 & 0 & 0 \\ 1 & 0 & 0 & 0 \\ 0 & 0 & 0 & 0 \\ 0 & 0 & 0 & 0 \end{pmatrix}$$

The  $T_+^i$  are the generators of the left spin-1/2 representation of the Lorentz-algebra SO(1,3) and  $T_-^i$  are the generators of the right spin-1/2 representation of the Lorentz-algebra SO(1,3),

the 3 generators  $\tau^i$  satisfy with spatial indices  $i=1,2,3$ : the ordinary *SU(2) algebra*

$$[T_+^i, T_+^j] = i\varepsilon_{ijk}T_+^k, \quad [T_-^i, T_-^j] = i\varepsilon_{ijk}T_-^k, \quad [T_+^i, T_-^j] = 0$$

and the 4 extended generators  $\tau^\mu$  satisfy the *extended SU(2) algebra* with spacetime indices  $\mu=\{0,1,2,3\}$

$$[\tau_\kappa, \tau_\lambda] = i\varepsilon_{\kappa\lambda\mu}\tau_\mu$$

## 1.2. Renormalizable Einstein-Hilbert action with the Ashtekar momentum $A_\mu^\nu$

semiclassical Einstein equations

$$R_{\mu\nu} - \frac{1}{2}g_{\mu\nu}R + \Lambda g_{\mu\nu} = \frac{8\pi G}{c^4} \langle \Psi | \hat{T}_{\mu\nu} | \Psi \rangle. \quad (\text{Kiefer 1.37})$$

Einstein-Hilbert action

$$S = \frac{1}{2\kappa} \int R \sqrt{-g} d^4x \quad \kappa = 8\pi G c^{-4} \quad \kappa = \frac{8\pi l_p^2}{\hbar c} \quad S = \frac{\hbar c}{16\pi l_p^2} \int R \sqrt{-g} d^4x, \text{ with } \Lambda = 0:$$

$$S = \frac{\hbar c}{16\pi l_p^2} \int (R - 2\Lambda) \sqrt{-g} d^4x$$

$$\text{setting } A_\mu^\nu = \frac{1}{l_p} \begin{pmatrix} 1,1,-1,1 \\ 1,1,-1,1 \\ 1,1,-1,1 \\ 1,1,-1,1 \end{pmatrix} = \frac{1}{l_p} \Omega_\mu^\nu$$

(constant background in the Ashtekar-Kodama equations), one can reformulate the Einstein-Hilbert action with  $\Lambda \approx 0$

$$S = \frac{\hbar c}{\pi} \int (A_\mu^\nu A_\nu^\mu) R \sqrt{-g} d^4x, \text{ which makes it dimensionally renormalizable, with the dimensionless}$$

interaction constant  $g_{gr} = \frac{1}{\pi}$ . Variation with respect to  $g_{\mu\nu}$  yields then, as before, the Einstein equations:

$$R_{\mu\nu} - \frac{1}{2}g_{\mu\nu}R = \kappa T_{\mu\nu} \quad \text{or equivalent} \quad R_{\mu\nu} = \kappa \left( T_{\mu\nu} - \frac{T}{2} g_{\mu\nu} \right)$$

From this we derive with  $\Lambda \approx 0$ :

$$R = g^{\nu\mu} R_{\mu\nu} = \kappa \left( T - \frac{T}{2} g^{\nu\mu} g_{\mu\nu} \right) = -\kappa T$$

Now, variation with respect to  $A_\mu^\nu$  gives the left side of the equation-of-motion (eom)

$$\frac{\partial}{\partial A_\mu^\nu} \frac{\hbar c}{\pi} (A_\mu^\nu A_\nu^\mu) R \sqrt{-g} = -\frac{\hbar c}{\pi} 2A_\mu^\nu \kappa T \sqrt{-g} = -16 l_p \Omega_\mu^\nu T \sqrt{-g}$$

The above expression is calculated, as usually, dimensionless, with correct dimension we have

$$\frac{\partial}{\partial A_\mu^\nu} \frac{\hbar c}{\pi} (A_\mu^\nu A_\nu^\mu) R \sqrt{-g} = -16 \frac{l_p}{r_s} \Omega_\mu^\nu T \sqrt{-g}$$

This is  $\approx 0$  in the classical region, so the eom is satisfied.

It is interesting to assess the dimensionless factor  $f_{gr} = \frac{l_p}{r_s} : f_{gr} = 5.3 * 10^{-39}$  for  $r_s = 3km$  (Schwarzschild of sun),

which is about the ratio  $f_{grem} = \frac{E_{gr}}{E_{em}} \approx 10^{-40}$  of the gravitational and electrodynamic interaction strength

**B2. The basic equations**

AK equations  
 24 hamiltonian scheme  $A \bullet A + \partial A + (\Lambda/3)E$   
 4 gaussian scheme  $A \bullet E + \partial E$   
 4 diffeomorphism scheme  $E \bullet A \bullet A + E \bullet \partial A$   
 coordinates  $\{t, r, \theta\}$   
 derivatives order 1:  $\partial_t, \partial_r, \partial_\theta$

*eqto cv* static  
 derivatives order 1:  $\partial_r, \partial_\theta$   
 rvars= A2i,E1i;  
 thvars=A1i,E2i;  
 rthvars=A0i,A3i;  
 avars=E0i,E3i;

integrability cond.

*eqtoiv* static  
 derivatives order 1:  $\partial_r, \partial_\theta$   
 rvars= A2i,E1i;  
 thvars=A1i,E2i;  
 rthvars=A0i,A3i,E3i,E0i;  
 avars=();  
 24 hamiltonian  $A \bullet A + A \bullet \partial A + (\Lambda/3)(\partial E + E)$  or  $A \bullet A + \partial A + (\Lambda/3)E$   
 4 gaussian  $A \bullet E + \partial E$   
 4 diffeomorphism  $A \bullet A \bullet E + E \bullet \partial A$

*eqtocev* time-dependent  
 derivatives order 1:  $\partial_t, \partial_r, \partial_\theta$   
 tvars= A1i,A2i,A3i,E0i;  
 rvars= A2i,E1i;  
 thvars=A1i,E2i;  
 rthvars=A0i,A3i;  
 avars=E3i; \*)

integrability cond.

*eqtoiev* time-dependent  
 derivatives order 1:  $\partial_t, \partial_r, \partial_\theta$   
 tvars= A1,A2,A3,E0,E2;  
 rvars= A2, E1;  
 thvars=A1;  
 rthvars=A0,A3,E0,E2;  
 avars=E3;  
 24 hamiltonian  $A \bullet A + A \bullet \partial A + (\Lambda/3)(\partial E + E)$  or  $A \bullet A + A \bullet \partial A + (\Lambda/3)\partial E$   
 or  $A \bullet A + \partial A + (\Lambda/3)E$   
 4 gaussian  $A \bullet E + \partial E$   
 4 diffeomorphism  $A \bullet A \bullet E + E \bullet \partial A$

The Ashtekar-Kodama equations (AKe) consist of

24 hamiltonian equations with the expression scheme  $A \bullet A + \partial A + (\Lambda/3)E$

4 gaussian equations with the expression scheme  $A \bullet E + \partial E$

4 diffeomorphism equations with the expression scheme  $E \bullet A \bullet A + E \bullet \partial A$

where  $\bullet$  represents multiplicative terms and  $\partial$  means derivatives for covariant coordinates, here the spherical coordinates spacetime  $\{t, r, \theta, \varphi\}$

$$\partial^\mu = (\partial_t, \partial_r, \frac{1}{r} \partial_\theta, \frac{1}{r \sin \theta} \partial_\varphi)$$

We consider here only spacetimes with axial symmetry, i.e.  $\partial_\varphi = 0$  and the variables  $E^{\mu\nu}$  and  $A_\mu^\nu$  are functions of  $\{t, r, \theta\}$

### 2.1. The integrability conditions

In the static (time-independent) AKe equations eq1..4 and eq13..16 contain resp.  $\partial_r A_{0i}$  and  $\partial_\theta A_{0i}$  as the only derivative, also eq9..12 and eq17..20 contain resp.  $\partial_\theta A_{3i}$  and  $\partial_r A_{3i}$  as the only derivative.

Therefore we have to impose integrability conditions  $\partial_\theta \partial_r A_{0i} = \partial_r \partial_\theta A_{0i}$  and  $\partial_\theta \partial_r A_{3i} = \partial_r \partial_\theta A_{3i}$ .

This changes the expression scheme for in eq9..12, eq13..16 :  $A \bullet A + A \bullet \partial A + (\Lambda/3)(\partial E + E)$

Accordingly in the time-dependent AKe equations eq9..12 and eq21..24 are transformed.

Equations with integrability condition static ( $\partial_t = 0$ ): *eqtoiv*

Equations with integrability condition time-dependent: *eqtoiev*

```
(* eqtocv;
  rvars= A2i,E1i;
  thvars=A1i,E2i;
  rthvars=A0i,A3i;
  avars=E0i,E3i; *)

(* eqtoiv;
  rvars= A2i,E1i;
  thvars=A1i,E2i;
  rthvars=A0i,A3i,E3i,E0i;
  avars={};
  *)
  changed eq9...12: no single DthA3, instead Dr, Dth all;
  changed eq13...16: no single DthA0, instead Dr, Dth all

(* eqtocev;
  tvars= A1i,A2i,A3i,E0i;
  rvars= A2i,E1i;
  thvars=A1i,E2i;
  rthvars=A0i,A3i;
  avars=E3i; *)

: (* eqtoiev;
  tvars= A1,A2,A3,E0,E2;
  rvars= A2, E1;
  thvars=A1;
  rthvars=A0,A3,E0,E2;
  avars=E3;
  *)
```

The static equations *eqtoiv* are 32 pdeq's of first order in  $r, \theta$ , quadratic in the variables  $E^{\mu\nu}$  and  $A_\mu^\nu$  in the 24 hamiltonian equations and 4 gaussian equations and cubic in the variables  $E^{\mu\nu}$  and  $A_\mu^\nu$  in the last 4 diffeomorphism equations.

The row-variables in the A- tensor and the E-tensor have different derivative behavior:

$A_{2i}$  and  $E_{1i}$  are pure  $r$ -variables (only  $\partial_r$  derivative present),  $A_{1i}$  and  $E_{2i}$  are pure  $\theta$ -variables (only  $\partial_\theta$  derivative present),  $(A_{0i}, E_{0i}, A_{3i}, E_{3i})$  are  $r$ - $\theta$ -variables (both  $\partial_r$  derivative and  $\partial_\theta$  derivative present).

The time-dependent equations *eqtoiev* are 32 pdeq's of first order in  $t, r, \theta$ , quadratic in the variables  $E^{\mu\nu}$  and  $A_\mu^\nu$  in the 24 hamiltonian equations and 4 Gaussian equations and cubic in the variables  $E^{\mu\nu}$  and  $A_\mu^\nu$  in the last 4 diffeomorphism equations.

Here  $A_{2i}$  and  $E_{1i}$  are  $r$ -variables,  $A_{1i}$  are  $\theta$ -variables,  $(A_{0i}, E_{0i}, A_{3i}, E_{2i})$  are  $r$ - $\theta$ -variables,  $(A_{1i}, A_{2i}, A_{3i}, E_{0i}, E_{2i})$  are  $t$ -variables ( $\partial_t$  derivative present) and  $E_{3i}$  are algebraic variables (no derivative present).

The overall scheme of the static equations *eqtoiv* becomes

24 hamiltonian  $A \bullet A + A \bullet \partial A + (\Lambda/3)(\partial E + E)$  or  $A \bullet A + \partial A + (\Lambda/3) E$

4 gaussian  $A \bullet E + \partial E$

4 diffeomorphism  $A \bullet A \bullet E + E \bullet \partial A$

The overall scheme of the static equations *eqtoiev* becomes

24 hamiltonian  $A \bullet A + A \bullet \partial A + (\Lambda/3)(\partial E + E)$  or  $A \bullet A + A \bullet \partial A + (\Lambda/3)\partial E$  or  $A \bullet A + \partial A + (\Lambda/3) E$

4 gaussian  $A \bullet E + \partial E$

4 diffeomorphism  $A \bullet A \bullet E + E \bullet \partial A$

## 2.2. Solvability of static and time-dependent equations *eqtoiv*, *eqtoiev*

By setting the A-variables and E-variables with derivatives and the coordinates  $r, \theta$  to random values one can

determine the rank of the Jacobi derivative-equation matrix  $\frac{\partial eq_i}{\partial (\partial_\kappa A_\mu^{\nu}, \partial_\kappa E^{\mu\nu})}$ , i.e. the solvability of the

equations for the highest derivatives. This ensures, given appropriate boundary conditions, the solvability of the partial differential equations system (*pdeq*) in a vicinity of the boundary, according to the famous theorem by Kovalevskaya.

The result for *eqtoiv* is : the rank of Jacobi matrix is 24, there are 8 free parameters ( $A2_i, E1_i$ )

The Jacobi matrix of *eqtoiev* has full rank: the equations are solvable for the 32 derivatives

$\partial_\theta (A1_i, E0_i, A02, A03), \partial_r (A3_i, E0_i, A23), \partial_t (A1_i, A2_i, E0_i, E2_i, A33)$

### B3. Solutions of static equations

#### 3.1. Solution limit $\Lambda \rightarrow 0$

Solution *eqtoiv*  $\Lambda \rightarrow 0$  : Einstein equations valid, Schwarzschild & Kerr-spacetime

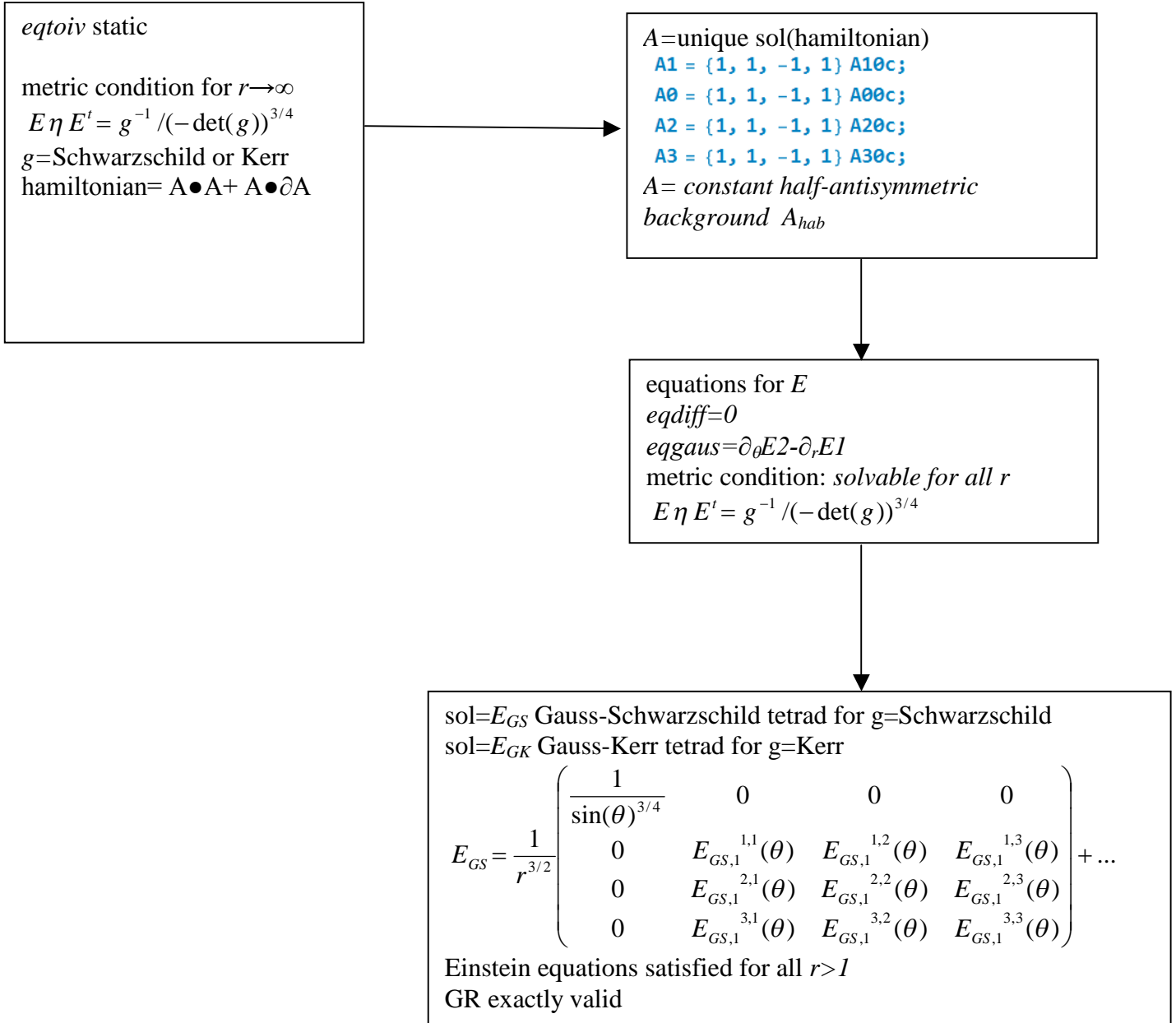

When  $\Lambda=0$ , the tetrad  $E^{\mu\nu}$  decouples in the hamiltonian equations from the graviton tensor  $A_{\mu}^{\nu}$ , the 24 hamiltonian equations are in general overdetermined with 16 variables of the A-tensor. By stepwise elimination we get the following solution:

$$A_1 = \{1, 1, -1, 1\} A_{10c};$$

$$A_0 = \{1, 1, -1, 1\} A_{00c};$$

$$A_2 = \{1, 1, -1, 1\} A_{20c};$$

$$A_3 = \{1, 1, -1, 1\} A_{30c};$$

$$\text{eqdiff} = 0, \text{eqgauss} = D_{th} E_2 / r_1 + D_{r1} E_1 = 0$$

The A-tensor becomes a *constant half-antisymmetric background*  $A_{hab}$  in the form

$$A_{0i} = A_{00c} \{1, 1, -1, 1\}, A_{1i} = A_{10c} \{1, 1, -1, 1\}, A_{2i} = A_{20c} \{1, 1, -1, 1\}, A_{3i} = A_{30c} \{1, 1, -1, 1\}$$

The diffeomorphism equations vanish identically, we are left with the 4 gaussian equations for the E-tensor

$$\frac{\partial_{\theta} E^{2\nu}}{r} + \partial_r E^{1\nu} = 0, \text{ and the E-tensor has to satisfy the 10 equations metric condition at } r \rightarrow \text{infinity}$$

$$E_{\eta} E^{\eta} = g^{-1} / (-\det(g))^{3/4}$$

Now with 16 variables both the Gaussian equations and the metric condition *can be satisfied for all*  $r > 1$ , so the Einstein equations are satisfied, and *GR is valid* not only in the limit  $r \rightarrow \text{infinity}$ , but *everywhere for*  $r > 1$ . The only exception arises at the horizon (Schwarzschild or Kerr), where the E-tensor diverges, and the coupling reappears in the hamiltonian equations. In this case there is *no singularity*, but only a *peak for*  $r \rightarrow 1$ .

### 3.1.1. The Gauss-Schwarzschild tetrad

The metric condition for Schwarzschild spacetime has a diagonal solution, *diagonal Schwarzschild tetrad*

$E_{ds} =$

$$\left\{ \left( \frac{1}{\sqrt{-1+r_1} r_1 \sin[\text{th}]^{3/4}}, 0, 0, 0 \right), \left( 0, \frac{\sqrt{-1+r_1}}{r_1^2 \sin[\text{th}]^{3/4}}, 0, 0 \right), \left( 0, 0, \frac{1}{r_1^{5/2} \sin[\text{th}]^{3/4}}, 0 \right), \left( 0, 0, 0, \frac{1}{r_1^{5/2} \sin[\text{th}]^{7/4}} \right) \right\}$$

For the Kerr metric, there is a *semi-diagonal Kerr tetrad* solution  $E_{dK}$  with a non-zero (0,3)-element.

The solution of the gaussian and Schwarzschild metric equations, the *Gauss-Schwarzschild tetrad*  $E_{GS}$ , can be calculated from the series in  $1/r^{3/2}$  for  $r \rightarrow \text{inf}$

$$E_{GS} = \frac{E_{GS,1}(\theta)}{r^{3/2}} + \frac{E_{GS,2}(\theta)}{r^{5/2}} + \frac{E_{GS,3}(\theta)}{r^{7/2}} + \dots, \text{ the coefficients } E_{GS,i}(\theta) \text{ are calculated from the corresponding}$$

deq in  $\theta$ .

It has the semi-diagonal block-matrix form

$$E_{GS} = \frac{1}{r^{3/2}} \begin{pmatrix} \frac{1}{\sin(\theta)^{3/4}} & 0 & 0 & 0 \\ 0 & E_{GS,1}^{1,1}(\theta) & E_{GS,1}^{1,2}(\theta) & E_{GS,1}^{1,3}(\theta) \\ 0 & E_{GS,1}^{2,1}(\theta) & E_{GS,1}^{2,2}(\theta) & E_{GS,1}^{2,3}(\theta) \\ 0 & E_{GS,1}^{3,1}(\theta) & E_{GS,1}^{3,2}(\theta) & E_{GS,1}^{3,3}(\theta) \end{pmatrix} + \dots$$

The first coefficient function of the Gauss-Schwarzschild tetrad can be given in closed form

$$E_{GS,1}(\theta) =$$

$$\left( \frac{1}{r^{3/2} \sin[\text{th}]^{3/4}}, 0, 0, 0 \right),$$

$$\left( 0, \frac{3 i \cos[\text{th}] \text{Hypergeometric2F1}\left[\frac{3}{2}, \frac{7}{8}, \frac{3}{2}, \cos[\text{th}]^2\right] \left(\sin[\text{th}]^2\right)^{7/8}}{i e^{-\frac{3 i \cos[\text{th}] \text{Hypergeometric2F1}\left[\frac{3}{2}, \frac{7}{8}, \frac{3}{2}, \cos[\text{th}]^2\right] \left(\sin[\text{th}]^2\right)^{7/8}}}} \left( -1 + e^{-\frac{3 i \cos[\text{th}] \text{Hypergeometric2F1}\left[\frac{3}{2}, \frac{7}{8}, \frac{3}{2}, \cos[\text{th}]^2\right] \left(\sin[\text{th}]^2\right)^{7/8}}}} \right), \frac{3 i \cos[\text{th}] \text{Hypergeometric2F1}\left[\frac{3}{2}, \frac{7}{8}, \frac{3}{2}, \cos[\text{th}]^2\right] \left(\sin[\text{th}]^2\right)^{7/8}}{i e^{-\frac{3 i \cos[\text{th}] \text{Hypergeometric2F1}\left[\frac{3}{2}, \frac{7}{8}, \frac{3}{2}, \cos[\text{th}]^2\right] \left(\sin[\text{th}]^2\right)^{7/8}}}} \left( -1 + e^{-\frac{3 i \cos[\text{th}] \text{Hypergeometric2F1}\left[\frac{3}{2}, \frac{7}{8}, \frac{3}{2}, \cos[\text{th}]^2\right] \left(\sin[\text{th}]^2\right)^{7/8}}}} \right), 0 \right),$$

$$\left( 0, \frac{3 i \cos[\text{th}] \text{Hypergeometric2F1}\left[\frac{3}{2}, \frac{7}{8}, \frac{3}{2}, \cos[\text{th}]^2\right] \left(\sin[\text{th}]^2\right)^{7/8}}{2 \sqrt{-e^{-\frac{3 i \cos[\text{th}] \text{Hypergeometric2F1}\left[\frac{3}{2}, \frac{7}{8}, \frac{3}{2}, \cos[\text{th}]^2\right] \left(\sin[\text{th}]^2\right)^{7/8}}}}} \left( -1 + e^{-\frac{3 i \cos[\text{th}] \text{Hypergeometric2F1}\left[\frac{3}{2}, \frac{7}{8}, \frac{3}{2}, \cos[\text{th}]^2\right] \left(\sin[\text{th}]^2\right)^{7/8}}}} \right)^2, \frac{3 i \cos[\text{th}] \text{Hypergeometric2F1}\left[\frac{3}{2}, \frac{7}{8}, \frac{3}{2}, \cos[\text{th}]^2\right] \left(\sin[\text{th}]^2\right)^{7/8}}{2 \sqrt{-e^{-\frac{3 i \cos[\text{th}] \text{Hypergeometric2F1}\left[\frac{3}{2}, \frac{7}{8}, \frac{3}{2}, \cos[\text{th}]^2\right] \left(\sin[\text{th}]^2\right)^{7/8}}}}} \left( -1 + e^{-\frac{3 i \cos[\text{th}] \text{Hypergeometric2F1}\left[\frac{3}{2}, \frac{7}{8}, \frac{3}{2}, \cos[\text{th}]^2\right] \left(\sin[\text{th}]^2\right)^{7/8}}}} \right), \frac{3 i \cos[\text{th}] \text{Hypergeometric2F1}\left[\frac{3}{2}, \frac{7}{8}, \frac{3}{2}, \cos[\text{th}]^2\right] \left(\sin[\text{th}]^2\right)^{7/8}}{2 \sqrt{-e^{-\frac{3 i \cos[\text{th}] \text{Hypergeometric2F1}\left[\frac{3}{2}, \frac{7}{8}, \frac{3}{2}, \cos[\text{th}]^2\right] \left(\sin[\text{th}]^2\right)^{7/8}}}}} \left( -1 + e^{-\frac{3 i \cos[\text{th}] \text{Hypergeometric2F1}\left[\frac{3}{2}, \frac{7}{8}, \frac{3}{2}, \cos[\text{th}]^2\right] \left(\sin[\text{th}]^2\right)^{7/8}}}} \right), \frac{3 i \cos[\text{th}] \text{Hypergeometric2F1}\left[\frac{3}{2}, \frac{7}{8}, \frac{3}{2}, \cos[\text{th}]^2\right] \left(\sin[\text{th}]^2\right)^{7/8}}{2 \sqrt{-e^{-\frac{3 i \cos[\text{th}] \text{Hypergeometric2F1}\left[\frac{3}{2}, \frac{7}{8}, \frac{3}{2}, \cos[\text{th}]^2\right] \left(\sin[\text{th}]^2\right)^{7/8}}}}} \left( -1 + e^{-\frac{3 i \cos[\text{th}] \text{Hypergeometric2F1}\left[\frac{3}{2}, \frac{7}{8}, \frac{3}{2}, \cos[\text{th}]^2\right] \left(\sin[\text{th}]^2\right)^{7/8}}}} \right), \frac{1}{r^{3/2} \sin[\text{th}]^{3/4}} \right),$$

$$\left( 0, \frac{3 i \cos[\text{th}] \text{Hypergeometric2F1}\left[\frac{3}{2}, \frac{7}{8}, \frac{3}{2}, \cos[\text{th}]^2\right] \left(\sin[\text{th}]^2\right)^{7/8}}{2 r^{3/2}} \left( -1 + e^{-\frac{3 i \cos[\text{th}] \text{Hypergeometric2F1}\left[\frac{3}{2}, \frac{7}{8}, \frac{3}{2}, \cos[\text{th}]^2\right] \left(\sin[\text{th}]^2\right)^{7/8}}}} \right), \frac{3 i \cos[\text{th}] \text{Hypergeometric2F1}\left[\frac{3}{2}, \frac{7}{8}, \frac{3}{2}, \cos[\text{th}]^2\right] \left(\sin[\text{th}]^2\right)^{7/8}}{2 r^{3/2}} \left( -1 + e^{-\frac{3 i \cos[\text{th}] \text{Hypergeometric2F1}\left[\frac{3}{2}, \frac{7}{8}, \frac{3}{2}, \cos[\text{th}]^2\right] \left(\sin[\text{th}]^2\right)^{7/8}}}} \right), \frac{3 i \cos[\text{th}] \text{Hypergeometric2F1}\left[\frac{3}{2}, \frac{7}{8}, \frac{3}{2}, \cos[\text{th}]^2\right] \left(\sin[\text{th}]^2\right)^{7/8}}{2 r^{3/2}} \left( -1 + e^{-\frac{3 i \cos[\text{th}] \text{Hypergeometric2F1}\left[\frac{3}{2}, \frac{7}{8}, \frac{3}{2}, \cos[\text{th}]^2\right] \left(\sin[\text{th}]^2\right)^{7/8}}}} \right), \frac{3 i \cos[\text{th}] \text{Hypergeometric2F1}\left[\frac{3}{2}, \frac{7}{8}, \frac{3}{2}, \cos[\text{th}]^2\right] \left(\sin[\text{th}]^2\right)^{7/8}}{2 r^{3/2}} \left( -1 + e^{-\frac{3 i \cos[\text{th}] \text{Hypergeometric2F1}\left[\frac{3}{2}, \frac{7}{8}, \frac{3}{2}, \cos[\text{th}]^2\right] \left(\sin[\text{th}]^2\right)^{7/8}}}} \right), \frac{1}{r^{3/2}} \right),$$

$$\left( 0, \frac{3 i \cos[\text{th}] \text{Hypergeometric2F1}\left[\frac{3}{2}, \frac{7}{8}, \frac{3}{2}, \cos[\text{th}]^2\right] \left(\sin[\text{th}]^2\right)^{7/8}}{2 r^{3/2}} \left( -1 + e^{-\frac{3 i \cos[\text{th}] \text{Hypergeometric2F1}\left[\frac{3}{2}, \frac{7}{8}, \frac{3}{2}, \cos[\text{th}]^2\right] \left(\sin[\text{th}]^2\right)^{7/8}}}} \right), \frac{3 i \cos[\text{th}] \text{Hypergeometric2F1}\left[\frac{3}{2}, \frac{7}{8}, \frac{3}{2}, \cos[\text{th}]^2\right] \left(\sin[\text{th}]^2\right)^{7/8}}{2 r^{3/2}} \left( -1 + e^{-\frac{3 i \cos[\text{th}] \text{Hypergeometric2F1}\left[\frac{3}{2}, \frac{7}{8}, \frac{3}{2}, \cos[\text{th}]^2\right] \left(\sin[\text{th}]^2\right)^{7/8}}}} \right), \frac{3 i \cos[\text{th}] \text{Hypergeometric2F1}\left[\frac{3}{2}, \frac{7}{8}, \frac{3}{2}, \cos[\text{th}]^2\right] \left(\sin[\text{th}]^2\right)^{7/8}}{2 r^{3/2}} \left( -1 + e^{-\frac{3 i \cos[\text{th}] \text{Hypergeometric2F1}\left[\frac{3}{2}, \frac{7}{8}, \frac{3}{2}, \cos[\text{th}]^2\right] \left(\sin[\text{th}]^2\right)^{7/8}}}} \right), \frac{3 i \cos[\text{th}] \text{Hypergeometric2F1}\left[\frac{3}{2}, \frac{7}{8}, \frac{3}{2}, \cos[\text{th}]^2\right] \left(\sin[\text{th}]^2\right)^{7/8}}{2 r^{3/2}} \left( -1 + e^{-\frac{3 i \cos[\text{th}] \text{Hypergeometric2F1}\left[\frac{3}{2}, \frac{7}{8}, \frac{3}{2}, \cos[\text{th}]^2\right] \left(\sin[\text{th}]^2\right)^{7/8}}}} \right), \frac{\text{Csc}[\text{th}]}{r^{3/2}} \left( -1 + e^{-\frac{3 i \cos[\text{th}] \text{Hypergeometric2F1}\left[\frac{3}{2}, \frac{7}{8}, \frac{3}{2}, \cos[\text{th}]^2\right] \left(\sin[\text{th}]^2\right)^{7/8}}}} \right), \frac{\text{Csc}[\text{th}]}{r^{3/2}} \left( -1 + e^{-\frac{3 i \cos[\text{th}] \text{Hypergeometric2F1}\left[\frac{3}{2}, \frac{7}{8}, \frac{3}{2}, \cos[\text{th}]^2\right] \left(\sin[\text{th}]^2\right)^{7/8}}}} \right), \frac{\text{Csc}[\text{th}]}{r^{3/2}} \left( -1 + e^{-\frac{3 i \cos[\text{th}] \text{Hypergeometric2F1}\left[\frac{3}{2}, \frac{7}{8}, \frac{3}{2}, \cos[\text{th}]^2\right] \left(\sin[\text{th}]^2\right)^{7/8}}}} \right), \frac{\text{Csc}[\text{th}]}{r^{3/2}} \left( -1 + e^{-\frac{3 i \cos[\text{th}] \text{Hypergeometric2F1}\left[\frac{3}{2}, \frac{7}{8}, \frac{3}{2}, \cos[\text{th}]^2\right] \left(\sin[\text{th}]^2\right)^{7/8}}}} \right) \right)$$

$$\frac{3 i \cos[\text{th}] \text{Hypergeometric2F1}\left[\frac{3}{2}, \frac{7}{8}, \frac{3}{2}, \cos[\text{th}]^2\right]}{2 r^{3/2}}$$

It contains the hypergeometric function

The coefficients  $E_{GS,2}(\theta)$  and  $E_{GS3}(\theta)$  have been calculated numerically with Ritz-Galerkin method as an power series in  $(\sin(\theta))^{1/4}$ ,  $\cos(\theta)$  of order 8. The resulting order  $1/r^{7/2}$  for  $E_{GS}$  is sufficient to ensure the metric condition exactly at infinity.



### 3.2. Solution $\Lambda \neq 0$ with the half-logarithmic ansatz

eliminated ( $E1_i, E2_i, E3_i$ )

all variables *half-logarithmic ansatz*  $f(\theta + \log(r))$

new coordinate  $r_{th} = \theta + \log(r)$

satisfies automatically gaussian equs

solution  $E$  in  $(r_{th}, \theta)$

$$Eb_{ij}(r, \theta) = \pm Eb_{ij}(r_{th}) + \sum \frac{c_{1kl}}{L} Ab_{0k}(r_{th}) Ab_{3l}(r_{th}) + \sum \frac{c_{4kl}}{L} \frac{Ab_{0k}'(r_{th})}{\exp(r_{th} - \theta)} + \sum \frac{c_{5kl}}{L} \frac{Ab_{3k}'(r_{th})}{\exp(r_{th} - \theta)}$$

$$+ \sum \frac{c_{2kl}}{L} Ab_{0k}(r_{th}) Ab_{3l}'(r_{th})(r_{th} - \theta) + \sum \frac{c_{3kl}}{L} Ab_{0k}'(r_{th}) Ab_{3l}(r_{th})(r_{th} - \theta)$$

metric condition:

half-logarithmic Schwarzschild metric

$$g_{\mu\nu} = \begin{pmatrix} -\left(1 - \frac{1}{\varepsilon}\right) & 0 & 0 & 0 \\ 0 & \frac{\varepsilon^3}{\varepsilon - 1} & -\frac{\varepsilon^3}{\varepsilon - 1} & 0 \\ 0 & -\frac{\varepsilon^3}{\varepsilon - 1} & \varepsilon^2 \left(1 + \frac{\varepsilon}{\varepsilon - 1}\right) & 0 \\ 0 & 0 & 0 & \varepsilon^2 \sin^2(\theta) \end{pmatrix}, \quad \varepsilon = \frac{\exp(r_{th})}{\exp(\theta)}$$

$$I(g_{\mu\nu}) = \frac{(g_{\mu\nu})^{-1}}{(-\det(g_{\mu\nu}))^{3/4}}$$

$$E \bullet \eta \bullet E^t = I(g_{\mu\nu}) = g^{-1} / (-\det(g))^{3/4}$$

solvable for  $r_{th} \rightarrow \infty$

$$I(g_{\mu\nu}) \rightarrow \frac{1}{\varepsilon^{9/2} \sin^{3/2}(\theta)} \begin{pmatrix} -1 & 0 & 0 & 0 \\ 0 & 0 & 0 & 0 \\ 0 & 0 & 0 & 0 \\ 0 & 0 & 0 & 0 \end{pmatrix}$$

$$Eb_{00}(r_{th}) \rightarrow \frac{1}{\exp\left(\frac{9}{4}(r_{th} - \theta)\right) \sin^{3/4}(\theta)}$$

if we demand

We eliminate  $(E1_i, E2_i, E3_i)$  and make for the remaining variables the *half-logarithmic ansatz*  $f(\theta+\log(r))$ , which satisfies the gaussian equations automatically. The results are:

$$\mathbf{Ab1} == \mathbf{Ab0}[\mathbf{th} + \mathbf{Log}[\mathbf{r1}]], \mathbf{Ab2} == \mathbf{Ab3}[\mathbf{th} + \mathbf{Log}[\mathbf{r1}]]$$

$$\mathbf{Ebi} = \mathbf{Ebi}[\mathbf{th} + \mathbf{Log}[\mathbf{r1}]] \text{ with free par. } \mathbf{Ab0i}[\mathbf{th} + \mathbf{Log}[\mathbf{r1}]], \mathbf{Ab3i}[\mathbf{th} + \mathbf{Log}[\mathbf{r1}]], \mathbf{Eb0i}[\mathbf{th} + \mathbf{Log}[\mathbf{r1}]]$$

$$Eb_{ij}(r, \theta) = \pm Eb_{ij}(r_{th}) + \sum \frac{c_{1kl}}{L} Ab_{0k}(r_{th}) Ab_{3l}(r_{th}) + \sum \frac{c_{4kl}}{L} \frac{Ab_{0k}'(r_{th})}{\exp(r_{th} - \theta)} + \sum \frac{c_{5kl}}{L} \frac{Ab_{3k}'(r_{th})}{\exp(r_{th} - \theta)} \\ + \sum \frac{c_{2kl}}{L} Ab_{0k}(r_{th}) Ab_{3l}'(r_{th})(r_{th} - \theta) + \sum \frac{c_{3kl}}{L} Ab_{0k}'(r_{th}) Ab_{3l}(r_{th})(r_{th} - \theta)$$

e.g.

$$Eb00(r, \theta) = \frac{Eb00[r_{th}] - \frac{3 e^{-r_{th} + \theta} Ab30'[r_{th}]}{L}}$$

$$Eb01(r, \theta) = \frac{Eb01[r_{th}] - \frac{6 r_{th} Ab32[r_{th}] Ab00'[r_{th}]}{L} + \frac{6 \theta Ab32[r_{th}] Ab00'[r_{th}]}{L} - \frac{6 r_{th} Ab33[r_{th}] Ab00'[r_{th}]}{L}}$$

$$+ \frac{6 \theta Ab33[r_{th}] Ab00'[r_{th}]}{L} + \frac{6 r_{th} Ab02[r_{th}] Ab30'[r_{th}]}{L} - \frac{6 \theta Ab02[r_{th}] Ab30'[r_{th}]}{L}$$

$$+ \frac{6 r_{th} Ab03[r_{th}] Ab30'[r_{th}]}{L} - \frac{6 \theta Ab03[r_{th}] Ab30'[r_{th}]}{L} + \frac{3 e^{-r_{th} + \theta} Ab31'[r_{th}]}{L}$$

This is a special, not the general solution: the AK-equations are non-linear, so the general solution cannot be built from basic solutions by linear combination. Here, all variables are functions of the coordinate  $r_{th} = \theta + \log(r)$ .

The solution has to satisfy the metric boundary condition for the Minkowski spacetime, so it is desirable to bring the metric into a similar form: a function of the coordinate  $r_{th}$ .

If we use functions of the form  $\exp((-a+b i)(\theta+\log(r))) = \exp(-a \theta) (1/r^a) \exp(i b \log(r)) \exp(i b \theta)$ , we can see that these are *polynomials in 1/r with exponential angle-damping* combined with *almost-periodic* functions. There is no singularity in  $r$ , except at  $r=0$ , and no Schwarzschild-type singularity at  $r=l$ .

### 3.2.1. The half-logarithmic Schwarzschild metric and tetrad

The special solution above has the form  $f(r_{th})$  with the new coordinate  $r_{th} = \theta + \log(r)$

Under the coordinate transformation  $(r \rightarrow r_{th}, \theta \rightarrow \theta)$  the Schwarzschild metric transforms

$$ds^2 = -\left(1 - \frac{1}{r}\right) dt^2 + \frac{1}{1 - \frac{1}{r}} dr^2 + r^2 (d\theta^2 + \sin^2(\theta) d\varphi^2) \quad \text{into}$$

$$ds^2 = -\left(1 - \frac{1}{\exp(r_{th} - \theta)}\right) dt^2 + \frac{\exp(3(r_{th} - \theta))}{\exp(r_{th} - \theta) - 1} (dr_{th}^2 - 2dr_{th}d\theta + d\theta^2) + \exp(2(r_{th} - \theta)) (d\theta^2 + \sin^2(\theta) d\varphi^2)$$

$$ds^2 = -\left(1 - \frac{1}{\exp(r_{th} - \theta)}\right) dt^2 + \frac{\exp(3(r_{th} - \theta))}{\exp(r_{th} - \theta) - 1} (dr_{th}^2 - 2dr_{th}d\theta) + \exp(2(r_{th} - \theta)) \sin^2(\theta) d\varphi^2 + \exp(2(r_{th} - \theta)) \left( \frac{\exp(r_{th} - \theta)}{\exp(r_{th} - \theta) - 1} + 1 \right) d\theta^2$$

$$g_{\mu\nu} = \begin{pmatrix} -\left(1 - \frac{1}{\varepsilon}\right) & 0 & 0 & 0 \\ 0 & \frac{\varepsilon^3}{\varepsilon - 1} & -\frac{\varepsilon^3}{\varepsilon - 1} & 0 \\ 0 & -\frac{\varepsilon^3}{\varepsilon - 1} & \varepsilon^2 \left(1 + \frac{\varepsilon}{\varepsilon - 1}\right) & 0 \\ 0 & 0 & 0 & \varepsilon^2 \sin^2(\theta) \end{pmatrix}, \text{ where}$$

$$\varepsilon = \frac{\exp(r_{th})}{\exp(\theta)},$$

And the densitized inverse metric

$$I(g_{\mu\nu}) = \frac{(g_{\mu\nu})^{-1}}{(-\det(g_{\mu\nu}))^{3/4}} =$$

$$\left( \frac{1}{(\text{Sin}[\theta]^{3/2} \epsilon^{9/2})} \right) \left\{ \left\{ \frac{\epsilon}{(1-\epsilon)}, \theta, \theta, \theta \right\}, \left\{ \theta, \frac{-1+2\epsilon}{\epsilon^3}, \frac{1}{\epsilon^2}, \theta \right\}, \left\{ \theta, \frac{1}{\epsilon^2}, \frac{1}{\epsilon^2}, \theta \right\}, \left\{ \theta, \theta, \theta, \frac{1}{\epsilon^2 \text{Sin}[\theta]^2} \right\} \right\}$$

$$I(g_{\mu\nu}) = \frac{(g_{\mu\nu})^{-1}}{(-\det(g_{\mu\nu}))^{3/4}} = \frac{1}{\epsilon^{9/2} \text{Sin}^{3/2}(\theta)} \begin{pmatrix} -\frac{1}{\left(1-\frac{1}{\epsilon}\right)} & 0 & 0 & 0 \\ 0 & \frac{2\epsilon-1}{\epsilon^3} \left(1+\frac{1}{\epsilon}\right) & \frac{1}{\epsilon^2} & 0 \\ 0 & \frac{1}{\epsilon^2} & \frac{1}{\epsilon^2} & 0 \\ 0 & 0 & 0 & \frac{1}{\epsilon^2 \text{Sin}^2(\theta)} \end{pmatrix}$$

$$E_{\text{hls}} = \left\{ \left\{ \frac{\frac{\text{rth} - 9(\text{rth}-\text{th})}{\epsilon^2}}{\sqrt{e^{\text{rth}} - e^{\text{th}} \text{Sin}[\text{th}]^{3/4}}}, \theta, \theta, \theta \right\}, \left\{ \theta, \frac{e^{-\frac{9}{4}(\text{rth}-\text{th})} \sqrt{-\epsilon^2(\text{rth}-\text{th}) + e^{-3\text{rth}+2\text{th}} (2e^{\text{rth}} - e^{\text{th}})}}{\text{Sin}[\text{th}]^{3/4}}, \theta, \theta, \theta, \frac{e^{\frac{13}{2}(-\text{rth}+\text{th})}}{\text{Sin}[\text{th}]^{7/4}} \right\} \right\}$$

$$E_{\text{hls}} = \frac{1}{\text{Sin}^{3/4}(\theta)} \begin{pmatrix} \frac{1}{\epsilon^{7/4} \sqrt{\epsilon-1}} & 0 & 0 & 0 \\ 0 & \frac{1}{\epsilon^{9/4}} \sqrt{-\epsilon^2 + \frac{2}{\epsilon^2} - \frac{1}{\epsilon^3}} & \frac{1}{\epsilon^{5/4}} & 0 \\ 0 & 0 & \frac{1}{\epsilon^{5/4}} & 0 \\ 0 & 0 & 0 & \frac{1}{\epsilon^{13/2} \text{Sin}(\theta)} \end{pmatrix}$$

The limit of  $g_{\mu\nu}$  for  $\epsilon \rightarrow \infty$  is in  $O(1/\epsilon)$

$$g_{\mu\nu} = \begin{pmatrix} -\left(1-\frac{1}{\epsilon}\right) & 0 & 0 & 0 \\ 0 & \epsilon^2 \left(1+\frac{1}{\epsilon}\right) & -\epsilon^2 \left(1+\frac{1}{\epsilon}\right) & 0 \\ 0 & -\epsilon^2 \left(1+\frac{1}{\epsilon}\right) & \epsilon^2 \left(2+\frac{1}{\epsilon}\right) & 0 \\ 0 & 0 & 0 & \epsilon^2 \text{Sin}^2(\theta) \end{pmatrix}$$

and the limit of  $I(g_{\mu\nu})$  for  $\epsilon \rightarrow \infty$  is in  $O(1/\epsilon^2)$

$$I(g_{\mu\nu}) = \frac{1}{\epsilon^{9/2} \text{Sin}^{3/2}(\theta)} \begin{pmatrix} -\left(1+\frac{1}{\epsilon}\right) & 0 & 0 & 0 \\ 0 & \frac{2-\frac{1}{\epsilon}}{\epsilon^2} \left(1+\frac{1}{\epsilon}\right) & \frac{1}{\epsilon^2} & 0 \\ 0 & \frac{1}{\epsilon^2} & \frac{1}{\epsilon^2} & 0 \\ 0 & 0 & 0 & \frac{1}{\epsilon^2 \text{Sin}^2(\theta)} \end{pmatrix}$$

and the limit of  $I(g_{\mu\nu})$  for  $\varepsilon \rightarrow \infty$  in  $O(1/\varepsilon)$  (Minkowski spacetime)

$$I(g_{\mu\nu}) = \frac{1}{\varepsilon^{9/2} \sin^{3/2}(\theta)} \begin{pmatrix} -1 & 0 & 0 & 0 \\ 0 & \frac{2}{\varepsilon^2} & \frac{1}{\varepsilon^2} & 0 \\ 0 & \frac{1}{\varepsilon^2} & \frac{1}{\varepsilon^2} & 0 \\ 0 & 0 & 0 & \frac{1}{\varepsilon^2 \sin^2(\theta)} \end{pmatrix}$$

### 3.2.2. Solvability of the metric condition for the half-logarithmic solution

In the limit  $r_{th} \rightarrow \infty$  we have  $I(g_{\mu\nu}) \rightarrow \frac{1}{\varepsilon^{9/2} \sin^{3/2}(\theta)} \begin{pmatrix} -1 & 0 & 0 & 0 \\ 0 & 0 & 0 & 0 \\ 0 & 0 & 0 & 0 \\ 0 & 0 & 0 & 0 \end{pmatrix}$ ,

So the Minkowski metric condition  $E \bullet \eta \bullet E^t = I(g_{\mu\nu}) = g^{-1} / (-\det(g))^{3/4}$

can be satisfied, if we demand  $Eb_{00}(r_{th}) \rightarrow \frac{1}{\exp(\frac{9}{4}(r_{th} - \theta)) \sin^{3/4}(\theta)}$  and all others the 0-limit

$$\{Eb_{0i}(r_{th}), Ab_{0i}(r_{th}), Ab_{3i}(r_{th})\} \rightarrow \frac{1}{\exp(\frac{9}{4}(r_{th} - \theta)) \sin^{3/4}(\theta) r_{th}}$$

### 3.3. Behavior at Schwarzschild horizon

At the horizon, the Schwarzschild tetrad diverges

$$E_{ds}^{0,0} = \frac{1}{r\sqrt{r-1}\sin^{3/4}(\theta)} \rightarrow \infty, \text{ so the term } \frac{\Lambda}{3} E^{\mu\nu} \text{ becomes significant}$$

$$\text{at } r = 1 + \sqrt{\Lambda}, \quad dr = \sqrt{\Lambda}, \text{ i.e. } E_{00}(\theta) = \frac{1}{\Lambda^{1/4}\sin^{3/4}(\theta)}, \text{ the peak in the metric is } g_{1,1} = \frac{1}{\sqrt{\Lambda}}$$

we set the gravitational scale for the quantum realm to be  $r_{gr}$  and  $dr = \frac{l_P}{r_{gr}} = \sqrt{\Lambda} r_{gr}$

$$\text{so } r_{gr} = \sqrt{l_P \sqrt{\frac{1}{\Lambda}}} = 3.1 * 10^{-5} m = 31 \mu m$$

gravitation has two scales:

$$\text{in the classical region the } \Lambda\text{-scale } (\Lambda = 2.7 * 10^{-52} m^{-2}): R_\Lambda = \frac{1}{\sqrt{\Lambda}} = 6.09 * 10^{25} m$$

$$\text{in the quantum region } r_{gr} = 3.1 * 10^{-5} m$$

electrodynamics has one scale, the classical electron radius  $r_e = 2.8 * 10^{-15} m$ .

huge  $\Lambda$ -scale in gravitation  $R_\Lambda$  has consequences:

-decoupling of the A-tensor and the E-tensor, Einstein equations and the general covariance are classically valid

-this 'smears out' local structure in the classical region, allowing for invariance against arbitrary coordinate transformations, i.e. the local symmetry becomes insignificant, the symmetry is the unbroken symmetry of the metric, which is invariant under arbitrary coordinate transformations.

*objective collapse theory* links the spontaneous collapse of the wave function to quantum gravitation, this puts the limit for quantum behavior at  $r \leq r_{gr}$

As a consequence of the gravitational quantum scale  $r_{gr}$ , we can characterize two regions of gravity:  
 -classical region  $\Lambda \approx 0$   $r \gg r_{gr}$

background equations  $eqtoeivnu3b$ , where the hamiltonian equations  $eqham(Ab, \partial Ab)$  depend only on  $Ab$   
 $eqtoeivnu3b = \{eqham(Ab, \partial Ab), eqgaus(Ab, Eb, \partial Eb), eqdiff(Ab, \partial Ab, Eb)\}$   
 wave equations  $eqtoeivnu3w$ , where in the hamiltonian equations  $\Lambda eqham(As, \partial As, Es, Ab)$   $\Lambda$  factors out,  
 $eqtoeivnu3w = \{ \Lambda eqham(As, \partial As, Es, Ab), eqgaus(Es, \partial Es, Ab), eqdiff(Es, Ab, \partial Ab)\}$

$Ab \cong \frac{1}{l_p}$  makes EH-action  $S = \frac{\hbar c}{\pi} \int (A_\mu^\nu A_\nu^\mu) R \sqrt{-g} d^4x$  dimensionally renormalizable

metric condition for  $Eb$  is satisfied for all  $r$

$Eb \bullet \eta \bullet Eb^t = I(g_{\mu\nu}) = g^{-1} / (-\det(g))^{3/4}$ , and  $Eb = E_{GS}$  resp.  $= E_{GK}$  for  $g =$  Schwarzschild resp. Kerr

-quantum region  $r \ll r_{gr}$

background equations  $eqtoeivnu3b$ , where the hamiltonian equations  $eqham(Ab, \partial Ab, Eb)$  couple weakly to  $Eb$   
 $eqtoeivnu3b = \{eqham(Ab, \partial Ab, Eb), eqgaus(Ab, Eb, \partial Eb), eqdiff(Ab, \partial Ab, Eb)\}$   
 wave equations  $eqtoeivnu3w$ , where in the hamiltonian equations  $\Lambda eqham(As, \partial As, Es, Ab)$   $\Lambda$  factors out,  
 and  $Ab$  is negligible,  $Ab \ll As$   
 $eqtoeivnu3w = \{ \Lambda eqham(As, \partial As, Es, Ab), eqgaus(Es, \partial Es, Ab), eqdiff(Es, Ab, \partial Ab)\}$

$\Lambda$  not zero,  $\Lambda \gg 1$   $Ab \ll As$ ,  $A \approx As =$  (almost) pure wave graviton

interaction via  $D_\mu^\lambda = \partial_\mu + \varepsilon^\lambda_{\kappa_1} \cdot A_\mu^{\kappa_1}$  covariant derivative, as in quantum electrodynamics

metric = Schwarzschild metric with fixed scale  $r_s = r_{gr}$

metric condition for  $Eb$  for  $r \rightarrow \infty$  Schwarzschild  $g = g_S$ :  $Eb = E_{GS,1}$  Gauss-Schwarzschild tetrad

At the horizon, the Schwarzschild tetrad diverges

$$E_{ds}^{0,0} = \frac{1}{r\sqrt{r-1} \sin^{3/4}(\theta)} \rightarrow \infty, \text{ so the term } \frac{\Lambda}{3} E^{\mu\nu} \text{ becomes significant, the coupling reappears.}$$

When the parameter  $dr=r-1$  becomes  $dr = \sqrt{\Lambda}$ , we get in the limit  $r \rightarrow \infty$  for the E-tensor and the A-tensor a r-independent finite solution in the vicinity of  $r=1$ :

$$A0_i = A00(\theta) \{1,1,-1,1\}, A1_i = A10c \{1,1,-1,1\}, A2_i = A20c \{1,1,-1,1\}, A3_i = A30c \{1,1,-1,1\}$$

$$E0_i = E00(\theta) \{1,1,-1,1\}$$

The parameters of the solution are determined by the continuity condition at  $r = 1 + \sqrt{\Lambda}$ , i.e.

$$E00(\theta) = \frac{1}{\Lambda^{1/4} \sin^{3/4}(\theta)}, \text{ the peak in the metric is } g_{1,1} = \frac{1}{\sqrt{\Lambda}}$$

This reappearance of coupling for  $dr = \sqrt{\Lambda}$  (dimensionless) results in a new scale, at which the classical character of gravity disappears and the quantum realm begins:

$$\text{we set the gravitational scale for the quantum realm to be } r_{gr} \text{ and } dr = \frac{l_p}{r_{gr}} = \sqrt{\Lambda} r_{gr}$$

$$\text{so } r_{gr} = \sqrt{l_p \sqrt{\frac{1}{\Lambda}}} = 3.1 * 10^{-5} m = 31 \mu m$$

So we can say that gravitation has two scales: in the classical region the  $\Lambda$ -scale ( $\Lambda = 2.7 * 10^{-52} m^{-2}$ ):

$$R_\Lambda = \frac{1}{\sqrt{\Lambda}} = 6.09 * 10^{25} m \text{ and in the quantum region } r_{gr} = 3.1 * 10^{-5} m. \text{ The electrodynamics has, in contrast,}$$

only one scale, the classical electron radius  $r_e = 2.8 * 10^{-15} m$ . The huge  $\Lambda$ -scale in gravitation is responsible for the decoupling of the A-tensor and the E-tensor in the classical region with the consequence that the Einstein equations and the general covariance are classically valid, again in contrast to the electrodynamics, which is only gauge-invariant, not general-covariant.

Therefore, one is tempted to explain the validity of the general covariance in GR as the consequence of the huge  $\Lambda$ -scale, which 'smears out' local structure in the classical region, allowing for invariance against arbitrary coordinate transformations.

The situation is similar to the symmetry of a n-polyhedron approximating a sphere: in the limit  $n \rightarrow \infty$  the symmetry becomes the spherical symmetry (the symmetry of the metric) and the local symmetry of edges and vertices becomes insignificant. But this is of course at best a heuristic explanation.

The *objective collapse theory* put forward by Penrose [19], links the spontaneous collapse of the wave function to quantum gravitation, the limit being one graviton. If true, this would put the limit for quantum coherence at  $r \leq r_{gr}$ .

As a consequence of the gravitational quantum scale  $r_{gr}$ , we can characterize two regions of gravity:

-classical region  $\Lambda \approx 0$   $r \gg r_{gr}$

background equations  $eqtoeivnu3b$ , where the hamiltonian equations  $eqham(Ab, \partial Ab)$  depend only on  $Ab$   
 $eqtoeivnu3b = \{eqham(Ab, \partial Ab), eqgaus(Ab, Eb, \partial Eb), eqdiff(Ab, \partial Ab, Eb)\}$

wave equations  $eqtoeivnu3w$ , where in the hamiltonian equations  $\Lambda eqham(As, \partial As, Es, Ab)$   $\Lambda$  factors out,  
 $eqtoeivnu3w = \{ \Lambda eqham(As, \partial As, Es, Ab), eqgaus(Es, \partial Es, Ab), eqdiff(Es, Ab, \partial Ab)\}$

$$Ab \cong \frac{1}{l_p} \text{ makes EH-action } S = \frac{\hbar c}{\pi} \int (A_\mu^\nu A_\nu^\mu) R \sqrt{-g} d^4 x \text{ dimensionally renormalizable}$$

the scale is  $r_s = \frac{2Gm}{c^2}$  and the Schwarzschild radius depends on the mass  $m$  of the gravitating object

metric condition for  $Eb$  is satisfied for all  $r$

$$Eb \bullet \eta \bullet Eb^t = I(g_{\mu\nu}) = g^{-1} / (-\det(g))^{3/4}, \text{ and } Eb = E_{GS} \text{ resp. } = E_{GK} \text{ for } g = \text{Schwarzschild resp. Kerr}$$

-quantum region  $r \ll r_{gr}$

background equations  $eqtoeivnu3b$ , where the hamiltonian equations  $eqham(Ab, \partial Ab, Eb)$  couple weakly to  $Eb$

$eqtoeivnu3b = \{eqham(Ab, \partial Ab, Eb), eqgaus(Ab, Eb, \partial Eb), eqdiff(Ab, \partial Ab, Eb)\}$

wave equations  $eqtoeivnu3w$ , where in the hamiltonian equations  $\Lambda eqham(As, \partial As, Es, Ab)$   $\Lambda$  factors out, and  $Ab$  is negligible,  $Ab \ll As$

$eqtoeivnu3w = \{ \Lambda eqham(As, \partial As, Es, Ab), eqgaus(Es, \partial Es, Ab), eqdiff(Es, Ab, \partial Ab) \}$

$\Lambda$  is much larger than in the classical region  $\Lambda \gg 1$  (see B8.4),  $Ab \ll As$ ,  $A \approx As =$  (almost) pure wave graviton

the scale is constant  $= r_{gr}$

interaction via  $D_\mu^\lambda = \partial_\mu + \varepsilon^\lambda_{\kappa_1} A_\mu^{\kappa_1}$  covariant derivative, as in quantum electrodynamics

metric = Schwarzschild metric with fixed scale  $r_s = r_{gr}$

metric condition for  $Eb$  for  $r \rightarrow \infty$  Schwarzschild  $g = g_S$ :  $Eb = E_{GS,1}$  Gauss-Schwarzschild tetrad



## B4. Solutions of time-dependent equations

### 4.1. The $\Lambda$ -scaled wave ansatz for the A-tensor

$\Lambda$ -scaled wave ansatz

$$A_{\mu}^{\nu} = Ab_{\mu}^{\nu} + \Lambda \frac{As_{\mu}^{\nu}}{r} \exp(-ik(r-t))$$

$$E^{\mu\nu} = Eb^{\mu\nu} + \frac{Es^{\mu\nu}}{r} \exp(-ik(r-t))$$

dimensions:  $[A]=1/cm$   $[E]=1$   $[As]=cm^2$

$eqtoiev \rightarrow$  static & wave-equations

$eqtoeivnu3b = \{eqham(Ab, \partial Ab, Eb), eqgaus(Ab, Eb, \partial Eb), eqdiff(Ab, \partial Ab, Eb)\}$

$eqtoeivnu3w = \{ \Lambda eqham(As, \partial As, Es, Ab), eqgaus(As, Es, \partial Es, Ab), eqdiff(As, \partial As, Es, Ab, \partial Ab) \}$

classical case  $\Lambda \approx 0$   $r \gg r_{gr}$

$eqtoeivnu3b = \{eqham(Ab, \partial Ab), eqgaus(Ab, Eb, \partial Eb), eqdiff(Ab, \partial Ab, Eb)\}$

$eqtoeivnu3w = \{ \Lambda eqham(As, \partial As, Es, Ab), eqgaus(Es, \partial Es, Ab), eqdiff(Es, Ab, \partial Ab) \}$

$Ab \cong \frac{1}{l_p}$  makes EH-action  $S = \frac{\hbar c}{\pi} \int (A_{\mu}^{\nu} A_{\nu}^{\mu}) R \sqrt{-g} d^4x$  dimensionally renormalizable

metric condition for  $Eb$  for all  $r$

$$Eb \bullet \eta \bullet Eb^t = I(g_{\mu\nu}) = g^{-1} / (-\det(g))^{3/4},$$

quantum case  $r \ll r_{gr}$

$\Lambda$  not zero  $\Lambda \ll 1$ ,  $Ab \ll 1$   $A \approx As =$  pure wave graviton

interaction via  $D_{\mu}^{\lambda} = \partial_{\mu} + \varepsilon^{\lambda}_{\kappa_1} \cdot A_{\mu}^{\kappa_1}$

metric = Schwarzschild metric with fixed scale  $r_s = r_{gr}$

metric condition for  $Eb$  for  $r \rightarrow \infty$  Schwarzschild  $g = g_S$ :  $Eb = E_{GS,1}$  Gauss-Schwarzschild tetrad

$eqtoeivnu3b = \{eqham(Ab, \partial Ab, Eb), eqgaus(Ab, Eb, \partial Eb), eqdiff(Ab, \partial Ab, Eb)\}$

$eqtoeivnu3w = \{ \Lambda eqham(As, \partial As, Es, Ab), eqgaus(Es, \partial Es, Ab), eqdiff(Es, Ab, \partial Ab) \}$

The covariant derivative of the AK-gravitation is

$$D_{\mu} t_{\nu}^{\lambda} = \partial_{\mu} t_{\nu}^{\lambda} + \varepsilon^{\lambda}_{\kappa_1 \kappa_2} A_{\mu}^{\kappa_1} t^{\nu \kappa_2} \quad D_{\mu}^{\lambda} = \partial_{\mu} + \varepsilon^{\lambda}_{\kappa_1} \cdot A_{\mu}^{\kappa_1}$$

The gaussian equations have the form of the covariant derivative acting on the E-tensor

$$G^{\mu} = D_{\nu} E^{\nu \mu} = \partial_{\nu} E^{\nu \mu} + \varepsilon^{\mu}_{\kappa \lambda} A_{\nu}^{\kappa} E^{\nu \lambda}$$

One can show, that the second term in the covariant derivative cancels out only if the A-tensor vanishes, i.e. the covariant derivative is not background-independent.

Now, if we separate the static background and the wave component in the A-tensor:

$$A = A_{bg} + A_{wave}, \quad E = E_{bg} + E_{wave}$$

we have to take account of the fact that in GR the gravitational wave interacts weakly with the metric, because it interacts through the energy tensor, which appears on the right side of the Einstein equations with the small factor  $\kappa$ :

$$R_{\mu\nu} - \frac{1}{2} g_{\mu\nu} R_0 - \Lambda g_{\mu\nu} = \kappa T_{\mu\nu}$$

Therefore, classically, we have to use some power of  $\Lambda$  as the factor in the ansatz above (setting  $c=1$ )

$$A_{\mu}^{\nu} = Ab_{\mu}^{\nu} + \Lambda^p \frac{As_{\mu}^{\nu}}{r} \exp(-ik(r-t)) \quad , \text{ where } Ab \text{ is the (static) background, } As \text{ is the wave amplitude}$$

In order to make  $As$  interact with E-tensor in the hamiltonian equations, we have to set  $p=1$ , the ansatz becomes ( $\Lambda$ -scaled ansatz for the A-tensor)

$$A_{\mu}^{\nu} = Ab_{\mu}^{\nu} + \Lambda \frac{As_{\mu}^{\nu}}{r} \exp(-ik(r-t)) \quad \text{and correspondingly for the E-tensor}$$

$$E^{\mu\nu} = Eb^{\mu\nu} + \frac{Es^{\mu\nu}}{r} \exp(-ik(r-t))$$

This has some remarkable consequences: in the Hamiltonian equations we now have the background part of order 1 for  $Ab$  and  $Eb$  and the wave part of order  $\Lambda$  for  $As$ , and  $Es$ .

In the A-tensor and the E-tensor we now have the background part  $Ab$  and  $Eb$  and the wave part  $As$ , and  $Es$ .

We insert this into the AK-equations, and separate the static part  $eqtoeivnu3b$  in the schematic form  $eqtoeivnu3b = \{eqham(Ab, \partial Ab, Eb), eqgaus(Ab, Eb, \partial Eb), eqdiff(Ab, \partial Ab, Eb)\}$

and the wave part  $eqtoeivnu3w$  after stripping the wave factor  $\exp(-ik(r-t))$  in the schematic form

$$eqtoeivnu3w = \{ \Lambda eqham(As, \partial As, Es, Ab), eqgaus(Es, \partial Es, Ab), eqdiff(Es, Ab, \partial Ab) \}$$

where  $\partial = \{ \partial_r, \partial_{\theta} \}$  ist the differential operator for  $r$  and  $\theta$ .

As the dimensions are  $[A] = [1/r] = 1/cm$  and  $[E] = 1$ , we get for the A-amplitude the dimension  $[As] = [r^2] = cm^2$  i.e.  $As$  becomes a cross-section, which is a sensible interpretation in the quantum limit.

In the quantum limit  $r < r_{gr}$ , the graviton interacts via the covariant derivative, like the photon, and the metric condition for  $Eb$  is for the flat Minkowski metric ( $r_s = l_P$ ),  $\Lambda \neq 0$ , the Einstein equation and the general covariance are not valid anymore.

In the classical case  $\Lambda \approx 0$ , the AK-equations separate into the background part for  $Ab$ ,  $Eb$  and the wave-part with the wave factor  $\exp(-ik(r-t))$  for  $Es$ ,  $As$ ,  $Ab$ .

$$eqtoeivnu3b = \{ eqham(Ab, \partial Ab), eqgaus(Ab, Eb, \partial Eb), eqdiff(Ab, \partial Ab, Eb) \}$$

$$eqtoeivnu3w = \{ \Lambda eqham(As, \partial As, Es, Ab), eqgaus(Es, \partial Es, Ab), eqdiff(Es, Ab, \partial Ab) \}$$

The background part  $eqtoeivnu3b$  has the *metric condition at infinity*, not everywhere, as in the static case. Then other solutions  $\{Ab, Eb\}$ , other the trivial constant half-antisymmetric background  $A_{hab}$  are possible and these influence via  $Eb$  the wave part equation  $eqtoeivnu3w$ : this describes the *interaction of the wave with matter*.

The general solution of  $eqtoeivnu3b$  in closed form is not available, but we can get an approximate solution with the ansatz

$$Ab = MAc + dMAbg$$

where the constant half-asymmetric background  $MAc =$

$$\{ A00c \{1, 1, -1, 1\}, A10c \{1, 1, -1, 1\}, A20c \{1, 1, -1, 1\}, A30c \{1, 1, -1, 1\} \}.$$

and the r-dependent correction  $dMAbg =$

$$dMAbg = \{ \{ dAb00[r1, th] / r1, dAb01[r1, th] / r1, dAb02[r1, th] / r1, dAb03[r1, th] / r1 \}, \{ dAb10[r1, th] / r1, dAb11[r1, th] / r1, dAb12[r1, th] / r1, dAb13[r1, th] / r1 \}, \{ dAb20[r1, th] / r1 \{1, 1, -1, 1\}, dAb30[r1, th] / r1 \{1, 1, -1, 1\} \} \}$$

$$Eb = M_{GS,0} + dEb(r, \theta)$$

with a general 4x4 correction matrix  $dEb(r, \theta)$

with a simplified Gaus-Schwarzschild tetrad  $M_{GS,0} =$

$$\left( \left( \frac{1}{r^{3/2} \sin|\theta|^{3/4}}, 0, 0, 0 \right), \left( 0, \frac{2 E_{21n3} |\theta|}{3 r^{3/2}}, -\frac{2 E_{21n3} |\theta| E_{21n3} |\theta|}{3 r^{3/2} \sqrt{1 - E_{21n3} |\theta|^2}}, 0 \right), \left( 0, \frac{E_{21n3} |\theta|}{r^{3/2}}, \frac{\sqrt{1 - E_{21n3} |\theta|^2}}{r^{3/2}}, \frac{i}{r^{3/2}} \right), \left( 0, -\frac{i \operatorname{Csc}|\theta| E_{21n3} |\theta|}{r^{3/2}}, -\frac{i \operatorname{Csc}|\theta| \sqrt{1 - E_{21n3} |\theta|^2}}{r^{3/2}}, \frac{\operatorname{Csc}|\theta|}{r^{3/2}} \right) \right)$$

As we shall see below, the wave  $A_s$  carries the wave energy, and induces locally a tetrad (metric) wave, which is damped exponentially. The gravitational wave energy tensor depends on the wave amplitude  $A_s$  in a similar way as the electromagnetic wave energy depends on the photon vector  $A_\mu$ . Also, it satisfies the Einstein power formula for the gravitational wave.

## 4.2. Special wave solution $\Lambda \neq 0$

equation  $\Lambda$ -scaled wave ansatz

$A_{1i} = A_{0i}$   $A_{2i} = A_{3i}$ ,  
eliminate  $(E_{1i}, E_{2i}, E_{3i})$

remaining variables  $Ab_{0i}, Ab_{3i}, Eb_{0i}, Es_{0i}$   
*half-logarithmic ansatz*,  $f(r_{th})$ ,  $r_{th} = \theta + \log(r)$

solution

$Es_{0i}(r, \theta) = f(As_{0i}(\theta + \log(r)), Ab_{0i}(\theta + \log(r)), \exp(2ikr), \text{ExpIntegralEi}(-2ikr))$

free parameters  $As_{0i}(r_{th})$ ,  $Ab_{0i}(r_{th})$ ,  $Ab_{3i}(r_{th})$ ,  
 $Eb_{0i}(r_{th})$

The 12 free parameters  $\{Ab_{0i}, Ab_{3i}, Eb_{0i}\}$  have to satisfy the 10 equations of the *half-logarithmic Minkowski metric* condition for  $r_{th} \rightarrow \infty$

We make the general ansatz  $A_\mu^v = Ab_\mu^v(r, \theta) + \Lambda As_\mu^v(r, \theta) \exp(-ik(r-t))$ ,

$E_\mu^v = Eb_\mu^v(r, \theta) + \Lambda Es_\mu^v(r, \theta) \exp(-ik(r-t))$ , where  $Ab$  and  $As$  are the time-independent and the wave-component of  $A_\mu^v$ , and correspondingly for  $E_\mu^v$ .

The solution is a function of  $r$  and  $\theta + \log r$  only, and has the form

$$A_1 = A_0 \quad A_2 = A_3$$

$$Ab = \{Ab_0(\theta + \log r), Ab_0'(\theta + \log r), Ab_3(\theta + \log r), Ab_3'(\theta + \log r)\}$$

$$Eb = f(Eb_0(\theta + \log r), Ab_0(\theta + \log r), Ab_3(\theta + \log r), Ab_0'(\theta + \log r), Ab_3'(\theta + \log r))$$

$$As_3 = As_2 = 0, \quad As_1 = As_0, \quad As_0 = r Asc_0(\theta + \log r)$$

$$Es_0 = f(As_0(\theta + \log r), Ab_3(\theta + \log r), As_0'(\theta + \log r), Ab_3'(\theta + \log r))$$

e.g.

$$\{Es_{01}(r_1, \theta) \rightarrow 6 e^{2ikr_1} r_1 As_{02c1}(\theta + \log[r_1]) \text{ExpIntegralEi}[-2ikr_1] Ab_{30}'(\theta + \log[r_1]) + 6 e^{2ikr_1} r_1 As_{03c1}(\theta + \log[r_1]) \text{ExpIntegralEi}[-2ikr_1] Ab_{30}'(\theta + \log[r_1]) - 6 e^{2ikr_1} r_1 Ab_{32}(\theta + \log[r_1]) \text{ExpIntegralEi}[-2ikr_1] As_{00c1}'(\theta + \log[r_1]) - 6 e^{2ikr_1} r_1 Ab_{33}(\theta + \log[r_1]) \text{ExpIntegralEi}[-2ikr_1] As_{00c1}'(\theta + \log[r_1])\}$$

We set  $A1i=A0i$   $A2i=A3i$ , eliminate  $(E1_i, E2_i, E3_i)$  and make for the remaining variables the *half-logarithmic ansatz*  $f(r_{th})$  with  $r_{th} = \theta + \log(r)$ , which satisfies the gaussian equations automatically. The results are:

$$Es_{0i}(r, \theta) = f(As_{0i}(\theta + \log(r)), Ab_{0i}(\theta + \log(r)), \exp(2ikr), \text{ExpIntegralEi}(-2ikr))$$

with free parameters  $As_{0i}(r_{th})$ ,  $Ab_{0i}(r_{th})$ ,  $Ab_{3i}(r_{th})$ ,  $Eb_{0i}(r_{th})$ .

The functions  $f(\theta + \log(r))$  are *exponentially damped* or *almost-periodic* for  $r \rightarrow \infty$ .

The 12 free parameters  $\{Ab_{0i}, Ab_{3i}, Eb_{0i}\}$  have to satisfy the 10 equation of the *half-logarithmic Minkowski metric* condition for  $r_{th} \rightarrow \infty$  (the metric condition is required only for the static part of the solution, not for the wave part).

As in 3.2., one shows that the condition can be satisfied.

### 4.3. Wave equation in Schwarzschild spacetime

eqtoiev  $\Lambda$ -scaled wave ansatz  
 background equation eqtoievnu3b=eqtoiv  
 standard solution:

A-tensor = constant background in the half-antisymmetric form  
 $A_{0i} = A_{00c} \{1,1,-1,1\}$ ,  $A_{1i} = A_{10c} \{1,1,-1,1\}$ ,  $A_{2i} = A_{20c} \{1,1,-1,1\}$ ,  $A_{3i} = A_{30c} \{1,1,-1,1\}$   
 E-tensor= the Gauss-Schwarzschild-tetrad  $E_{GS}$ .

resulting wave equation

eqtoievnu4w={ eqham( $A_s, \partial A_s, E_s, \partial E_s$ ),  
 eqgaus ( $E_{s0i}, E_{s1i}, \partial E_{s1i}, \partial E_{s2i}$ ), eqdiff=0}  
 eliminate ( $E_{s0}, E_{s3}, A_{s1}$ )  
 multipole ansatz  $E_s(r, \theta) = E_s(r) \exp(i * l x * \theta)$ ,  $A_s(r, \theta) = A_s(r) \exp(i * l x * \theta)$   
 eliminate  $E_{s2}$  and get the gravitational wave equation for  $E_{s1}$

#### gravitational wave equation for E-tensor

eqgravlxEn =

$$r (f_s'(r) (lx (-6 k^2 r^2 + 3 i k r + 1) + k r (-2 k^2 r^2 + i k r + 2) + lx^2 (-5 k r + 2 i) - lx^3) + \\ r (r f_s^{(3)}(r) (k r + lx) - i f_s''(r) (5 k lx r + k r (3 k r - i) + 2 lx^2))) + \\ f_s(r) (lx^2 (3 i k^2 r^2 + 4 k r - 2 i) + lx (2 i k^3 r^3 + 4 k^2 r^2 - 5 i k r - 1) + \\ lx^3 (1 + i k r) + k r (-2 - i k r))$$

at infinity eqgravlxEninf=

$$2 i k^2 l x f_s(r) - 2 k^2 r f_s'(r) - 3 i k r f_s''(r) + r f_s'''(r)$$

solution at infinity:  $f_s(r) = c_0 + c_1 \exp(i k r) + c_2 \exp(2 i k r)$ , where the only feasible solution is  $f_s(r) = c_0$ , i.e. the total solution at infinity is the spherical wave.

For comparison, the **radial (electromagnetic) wave equation** for the wave factor  $f_s(r)$  from the ansatz

$$f_s(t, r, \theta) = \frac{f_s(r)}{r} Y_{lx,m}(\theta, \varphi) \exp(-i k (r - t))$$

Helmholtzwr=

$$- l x (1 + l x) f_s(r) - 2 i k r^2 f_s'(r) + r^2 f_s''(r)$$

solution at infinity:  $f_s(r) = c_0 + c_2 \exp(2 i k r)$ , where the only feasible solution is

$f_s(r) = c_0$ , i.e. the total solution at infinity is the spherical wave.

The gravitational and the electromagnetic wave equation are **equivalent at infinity**.

In addition, we get the **gravitational wave equations for the A-tensor** variables  $A_{s00}$ ,  $A_{s30}$  depending on  $E_{s10}$

eqgravlxA0

$$3 (1 + i l x) (l x + k r)^2 A_{s00}[r] - r l \left( (-1 + l x^2 + 2 l x (-i + k r)) E_{s10}[r] + \right. \\ \left. 3 (l x + k r)^2 A_{s00}'[r] + r l ((1 + 2 i l x + 2 i k r) E_{s10}'[r] - r l E_{s10}''[r]) \right)$$

eqgravlxA3

$$6 k l x (1 + i k r) A_{s30}[r] + (1 + i k r - 2 k^2 r^2 + l x (i - k r)) E_{s10}[r] + \\ r l (-6 k l x A_{s30}'[r] - i (-i + l x + 3 k r) E_{s10}'[r] + r l E_{s10}''[r])$$

$A_i = \text{const} + L * \text{sphwave} * A_{si} + A_{bi}$  ,  $E_i = E_{bi} + \text{sphwave} * E_{si}$

As described in 4.1. , we introduce the  $L$ -scaled ansatz for the A-tensor

$$A_{\mu}^{\nu}(t, r, \theta) = Ab_{\mu}^{\nu}(r, \theta) + \Lambda \frac{As_{\mu}^{\nu}(r, \theta)}{r} \exp(-ik(r-t)) \quad \text{and correspondingly for the E-tensor}$$

$$E^{\mu\nu}(t, r, \theta) = Eb^{\mu\nu}(r, \theta) + \frac{Es^{\mu\nu}(r, \theta)}{r} \exp(-ik(r-t))$$

In the A-tensor and the E-tensor we now have the background part  $Ab$  and  $Eb$  and the wave part  $As$  , and  $Es$  . We insert this into the AK-equations, let  $L \rightarrow 0$  , and separate the static part  $eqtoeivnu3b$  in the schematic form  $eqtoeivnu3b = \{eqham(Ab), eqgaus(Ab, Eb), eqdiff(Ab, Eb)\}$

and the wave part  $eqtoeivnu3w$  after stripping the wave factor  $\exp(-ik(r-t))$  in the schematic form  $eqtoeivnu3w = \{L eqham(As, \partial As, Es, \partial Es, Ab), eqgaus(Ab, Es, \partial Es), eqdiff(Es, \partial Es, Ab)\}$

where  $\partial = \{\partial_r, \partial_{\theta}\}$  ist the differential operator for  $r$  and  $\theta$  .

$eqtoeivnu3b$  is identical with  $eqtoiv$  the static AK-equations , and the solution is as in 3.1.

for the A-tensor the *constant background* in the *half-antisymmetric form*

$$A0_i = A00c \{1, 1, -1, 1\} , A1_i = A10c \{1, 1, -1, 1\} , A2_i = A20c \{1, 1, -1, 1\} , A3_i = A30c \{1, 1, -1, 1\}$$

and for the E-tensor the Gauss-Schwarzschild-tetrad  $E_{GS}$  . After inserting this into  $eqtoeivnu3w$  we get a new version of the wave part equations  $eqtoeivnu4w$  in the form

$$eqtoeivnu4w = \{ eqham(As, \partial As, Es, \partial Es), eqgaus(Es0i, Es1i, \partial Es1i, \partial Es2i), eqdiff=0 \}$$

$$eq1 = \frac{1}{3} \left( (-3 - 3ikr1) As00[r1, th] + r1 (3ikAs10[r1, th] + Es20[r1, th] + Es30[r1, th] + 3As00^{(1,0)}[r1, th]) \right)$$

$$eq2 = \frac{1}{3} \left( (3 + 3ikr1) As01[r1, th] + r1 (-3ikAs11[r1, th] + Es21[r1, th] + Es31[r1, th] - 3As01^{(1,0)}[r1, th]) \right)$$

$$eq5 = (1 + ikr1) As20[r1, th] - \frac{1}{3} r1 Es00[r1, th] + \frac{1}{3} r1 Es30[r1, th] + As10^{(0,1)}[r1, th] - r1 As20^{(1,0)}[r1, th]$$

$$eq9 = \frac{1}{3} r1 (-ikr1 Es00[r1, th] + ikr1 Es10[r1, th] - Es00^{(0,1)}[r1, th] - Es20^{(0,1)}[r1, th] + r1 Es00^{(1,0)}[r1, th] - r1 Es10^{(1,0)}[r1, th])$$

$$eq13 = ikr1 As20[r1, th] - \frac{1}{3} r1 Es10[r1, th] + \frac{1}{3} r1 Es30[r1, th] + As00^{(0,1)}[r1, th]$$

$$eq17 = \frac{1}{3} \left( (3 + 3ikr1) As30[r1, th] - r1 (Es00[r1, th] + Es20[r1, th] + 3As30^{(1,0)}[r1, th]) \right)$$

$$eq21 = \frac{1}{3} \left( -ikr1 Es00[r1, th] + (1 + ikr1) Es10[r1, th] + Es20[r1, th] - r1 Es10^{(1,0)}[r1, th] - r1 Es20^{(1,0)}[r1, th] \right)$$

$$eq25 = -ikr1 Es00[r1, th] + (-1 - ikr1) Es10[r1, th] + Es20^{(0,1)}[r1, th] + r1 Es10^{(1,0)}[r1, th]$$

$$eq29 = 0$$

Four consecutive equations contain consecutive variables of a row of the tensor  $As$  and  $Es$  , as shown in  $eq1$  and  $eq2$  in the schematic form

$$eq1 = eq1(As00, As10, Es20, Es30, \partial_r As00)$$

$$eq2 = eq2(As01, As11, Es21, Es31, \partial_r As01)$$

Now we eliminate variables algebraically

$Es0i$  from eq25..28

$$\left\{ \begin{array}{l} Es00[r1, th] \rightarrow \frac{-kr1 Es10[r1, th] - i(Es10[r1, th] - Es20^{(0,1)}[r1, th] - r1 Es10^{(1,0)}[r1, th])}{kr1}, Es01[r1, th] \rightarrow \frac{-kr1 Es11[r1, th] - i(Es11[r1, th] - Es21^{(0,1)}[r1, th] - r1 Es11^{(1,0)}[r1, th])}{kr1}, \\ Es02[r1, th] \rightarrow \frac{-kr1 Es12[r1, th] + i(Es12[r1, th] - Es22^{(0,1)}[r1, th] - r1 Es12^{(1,0)}[r1, th])}{kr1}, Es03[r1, th] \rightarrow \frac{-kr1 Es13[r1, th] - i(Es13[r1, th] - Es23^{(0,1)}[r1, th] - r1 Es13^{(1,0)}[r1, th])}{kr1} \end{array} \right\}$$

$Es3i$  from eq1..4

$$\left\{ \begin{array}{l} Es30[r1, th] \rightarrow \frac{3As00[r1, th] + 3i(kr1 As00[r1, th] - kr1 As10[r1, th]) - r1 Es20[r1, th] - 3r1 As00^{(1,0)}[r1, th]}{r1}, \\ Es31[r1, th] \rightarrow \frac{-3As01[r1, th] - 3i(kr1 As01[r1, th] - kr1 As11[r1, th]) - r1 Es21[r1, th] + 3r1 As01^{(1,0)}[r1, th]}{r1}, \\ Es32[r1, th] \rightarrow \frac{-3As02[r1, th] - 3i(kr1 As02[r1, th] - kr1 As12[r1, th]) - r1 Es22[r1, th] + 3r1 As02^{(1,0)}[r1, th]}{r1}, \\ Es33[r1, th] \rightarrow \frac{-3As03[r1, th] - 3i(kr1 As03[r1, th] - kr1 As13[r1, th]) - r1 Es23[r1, th] + 3r1 As03^{(1,0)}[r1, th]}{r1} \end{array} \right\}$$

$As1i$  from eq13..16

$$\left\{ \begin{array}{l} As10[r1, th] \rightarrow \frac{3(kr1 As00[r1, th] + kr1 As20[r1, th]) + i(-3As00[r1, th] + r1 Es10[r1, th] + r1 Es20[r1, th] - 3As00^{(0,1)}[r1, th] + 3r1 As00^{(1,0)}[r1, th])}{3kr1}, \\ As11[r1, th] \rightarrow \frac{3(kr1 As01[r1, th] + kr1 As21[r1, th]) + i(-3As01[r1, th] - r1 Es11[r1, th] - r1 Es21[r1, th] - 3As01^{(0,1)}[r1, th] + 3r1 As01^{(1,0)}[r1, th])}{3kr1}, \\ As12[r1, th] \rightarrow \frac{3(kr1 As02[r1, th] + kr1 As22[r1, th]) + i(-3As02[r1, th] - r1 Es12[r1, th] - r1 Es22[r1, th] - 3As02^{(0,1)}[r1, th] + 3r1 As02^{(1,0)}[r1, th])}{3kr1}, \\ As13[r1, th] \rightarrow \frac{3(kr1 As03[r1, th] + kr1 As23[r1, th]) + i(-3As03[r1, th] - r1 Es13[r1, th] - r1 Es23[r1, th] - 3As03^{(0,1)}[r1, th] + 3r1 As03^{(1,0)}[r1, th])}{3kr1} \end{array} \right\}$$

We get eqtoievnu5w : 4x4 equations for 4x5 variables  $\{Es1i, Es2i, As2i, As3i, As0i\}$

Now we fix the angular momentum of the wave by setting

$Es1i(r, \theta) = Es1i(r) \exp(i * lx * \theta)$  and correspondingly for  $\{Es2i, As2i, As3i, As0i\}$ ,

where  $lx=0,1,2,\dots$  is the angular momentum of the wave:  $lx=0$  for a spherical wave,  $lx=1$  for a dipole wave,  $lx=2$  for a quadrupole wave.

In GR one can show that the gravitational wave must be at least quadrupole waves, there are no spherical and dipole waves.

In the following, we consider the equations  $eqgravlx=\{eq5,eq9,eq17,eq21\}$ , i.e. the four first equations from the four equation groups, for the five first column variables  $\{Es10i, Es20i, As20i, As30i, As00i\}$

$eqtoievnu5ws0[5]=$

$$As20[r1, th] - \frac{i Es10[r1, th]}{3k} - \frac{2}{3} r1 Es10[r1, th] - \frac{i As00^{(0,1)}[r1, th]}{k r1} - As20^{(0,1)}[r1, th] +$$

$$\frac{i Es10^{(0,1)}[r1, th]}{3k} - \frac{2 i Es20^{(0,1)}[r1, th]}{3k} - \frac{i As00^{(0,2)}[r1, th]}{k r1} - r1 As20^{(1,0)}[r1, th] + \frac{i r1 Es10^{(1,0)}[r1, th]}{3k} + \frac{i As00^{(1,1)}[r1, th]}{k}$$

$eqtoievnu5ws0[9]=$

$$- \frac{i Es10[r1, th]}{3k} + \frac{1}{3} r1 Es10[r1, th] + \frac{2}{3} i k r1^2 Es10[r1, th] - \frac{i Es10^{(0,1)}[r1, th]}{3k} + \frac{1}{3} r1 Es10^{(0,1)}[r1, th] + \frac{i Es20^{(0,1)}[r1, th]}{3k} -$$

$$\frac{2}{3} r1 Es20^{(0,1)}[r1, th] + \frac{i Es20^{(0,2)}[r1, th]}{3k} + \frac{i r1 Es10^{(1,0)}[r1, th]}{3k} - r1^2 Es10^{(1,0)}[r1, th] + \frac{i r1 Es10^{(1,1)}[r1, th]}{3k} - \frac{i r1 Es20^{(1,1)}[r1, th]}{3k} - \frac{i r1^2 Es10^{(2,0)}[r1, th]}{3k}$$

$eqtoievnu5ws0[17]=$

$$As30[r1, th] + i k r1 As30[r1, th] - \frac{i Es10[r1, th]}{3k} - \frac{1}{3} r1 Es10[r1, th] - \frac{1}{3} r1 Es20[r1, th] + \frac{i Es20^{(0,1)}[r1, th]}{3k} - r1 As30^{(1,0)}[r1, th] + \frac{i r1 Es10^{(1,0)}[r1, th]}{3k}$$

$eqtoievnu5ws0[21]=$

$$\frac{2}{3} Es10[r1, th] + \frac{2}{3} i k r1 Es10[r1, th] + \frac{1}{3} Es20[r1, th] - \frac{1}{3} Es20^{(0,1)}[r1, th] - \frac{2}{3} r1 Es10^{(1,0)}[r1, th] - \frac{1}{3} r1 Es20^{(1,0)}[r1, th]$$

The four second equations are identical to these in the four second column variables

$\{Es1li, Es2li, As2li, As3li, As0li\}$  etc.

Now we combine  $eqgravlx[2]$  and  $eqgravlx[4]$  to eliminate  $Es20$  and get from  $eqgravlx[4]$  the gravitational wave equation for the variable  $Es10=fs$ ,

$eqgravlxEn =$

$$r (fs'(r) (lx (-6 k^2 r^2 + 3 i k r + 1) + k r (-2 k^2 r^2 + i k r + 2) + lx^2 (-5 k r + 2 i) - lx^3) +$$

$$r (r fs^{(3)}(r) (k r + lx) - i fs''(r) (5 k lx r + k r (3 k r - i) + 2 lx^2))) +$$

$$fs(r) (lx^2 (3 i k^2 r^2 + 4 k r - 2 i) + lx (2 i k^3 r^3 + 4 k^2 r^2 - 5 i k r - 1) +$$

$$lx^3 (1 + i k r) + k r (-2 - i k r))$$

At infinity

$eqgravlxEninf =$

$$2ik^2 lx fs(r) - 2k^2 r fs'(r) - 3ikr fs''(r) + r fs'''(r)$$

For bounded  $fs(r)$  we can neglect the first term and we obtain the equation

$-2k^2 r fs'(r) - 3ikr fs''(r) + r fs'''(r) = 0$ , which has the solution  $fs(r) = c_0 + c_1 \exp(ikr) + c_2 \exp(2ikr)$ , and  $c_2$  must be zero, because otherwise we would get an incoming wave, and  $c_1$  must also be zero, because otherwise we would get a simple oscillation, so the wave factor  $fs(r) = c_0$  and we have a spherical wave as the only solution at infinity.

For comparison, the radial (electromagnetic) wave equation for the wave factor  $fs(r)$  from the ansatz

$$fs(t, r, \theta) = \frac{fs(r)}{r} Y_{lx,m}(\theta, \varphi) \exp(-ik(r-t))$$

$Helmholtzwr =$

$$-lx(1+lx)fs(r) - 2ikr^2 fs'(r) + r^2 fs''(r)$$

with the solution  $c_1 \sqrt{r} \exp(ikr) J_{lx+1/2}(kr) + c_2 \sqrt{r} \exp(ikr) Y_{lx+1/2}(kr)$ , where  $J_l$  and  $Y_l$  are Bessel functions of the first and the second kind.

At infinity: for bounded  $fs(r)$  we can neglect the first term and we obtain the equation



$-2ikr^2 fs'(r) + r^2 fs''(r) = 0$  , which has the solution  $fs(r) = c_0 + c_1 \exp(2ikr)$  , and  $c_1$  must be zero, because otherwise we would get an incoming wave, so the wave factor  $fs(r) = c_0$  and we have, as expected, a spherical wave as the only solution at infinity.

This means that the *gravitational and the electromagnetic wave equation are equivalent at infinity.*

In addition, we get wave equations for the A-tensor variables  $As_{00}$  ,  $As_{20}$  ,  $As_{30}$

**eqgravlxA02**

$$3(1 + i l x) l x (l x + k r 1) A s_{00}[r 1] + r 1 (3 k (1 + i l x) (l x + k r 1) A s_{20}[r 1] - (-1 - 2 i l x + l x^2 + 2 k l x r 1) E s_{10}[r 1] - 3 l x^2 A s_{00}'[r 1] - 3 k l x r 1 A s_{00}''[r 1] - 3 k l x r 1 A s_{20}'[r 1] - 3 k^2 r 1^2 A s_{20}''[r 1] - r 1 E s_{10}'[r 1] - 2 i l x r 1 E s_{10}''[r 1] - 2 i k r 1^2 E s_{10}'''[r 1] + r 1^2 E s_{10}''''[r 1])$$

**eqgravlxA3**

$$6 k l x (1 + i k r 1) A s_{30}[r 1] + (1 + i k r 1 - 2 k^2 r 1^2 + l x (i - k r 1)) E s_{10}[r 1] + r 1 (-6 k l x A s_{30}'[r 1] - i (-i + l x + 3 k r 1) E s_{10}''[r 1] + r 1 E s_{10}'''[r 1])$$

and setting  $As_{20}=As_{00}$

**eqgravlxA0**

$$3(1 + i l x) (l x + k r 1)^2 A s_{00}[r 1] - r 1 ((-1 + l x^2 + 2 l x (-i + k r 1)) E s_{10}[r 1] + 3 (l x + k r 1)^2 A s_{00}'[r 1] + r 1 ((1 + 2 i l x + 2 i k r 1) E s_{10}''[r 1] - r 1 E s_{10}'''[r 1]))$$

Equations  $eqgravlxA0$  ,  $eqgravlxA3$  and  $eqgravlxEn$  are homogeneous deq's for the A-tensor variables  $As_{0i}$  ,  $As_{3i}$  ,  $Es_{li}$  . Now, if there is a source , which generates an oscillation  $\delta Es$  of the metric (e.g. a binary geavitational rotator), i.e. of the tetrad  $Es$

$eqgravlxEn(Es1) = \delta Es$  , we can calculate  $Es1 = Es1(\delta Es)$  , and from  $(eqgravlxA0(Es1)$  ,  $eqgravlxA0(Es1))$  we calculate  $As0 = As0(Es1(\delta Es))$  and  $As3 = As3(Es1(\delta Es))$  .

### 4.3.1. Solutions of the gravitational wave equation

solution  $l_x=0$  spherical wave:

$$\{Es_{10}[r_1] \rightarrow e^{2i r_1} r_1 C[1] + e^{2i r_1} r_1 C[2] \text{ExpIntegralEi}[-i r_1]\}$$

generates an incoming wave, which is not feasible, therefore  $CI=0$  and  $Es_{10}=0$ ,

solution  $l_x=1$  dipole wave:

$$\{Es_{10}[r_1] \rightarrow \frac{2}{3} i r_1 C[1] \text{Hypergeometric1F1}\left[1-i, 2, \frac{2i r_1}{3}\right] + C[2] \text{MeijerG}\left[\{\{\}, \{1+i\}\}, \{\{\emptyset, 1\}, \{\}, -\frac{2i r_1}{3}\}\right]\}$$

diverges, therefore  $Es_{10}=0$

solution  $l_x=2$  quadrupole wave:

$Re(Es_{10}) =$

$$\{Es_{10}[r_1] \rightarrow C[3] - \frac{i r_1^3 C[1] \text{HypergeometricPFQ}\left[\left\{\frac{3}{2}\right\}, \left\{2, \frac{5}{2}\right\}, \frac{r_1^2}{2}\right] + \frac{1}{2} r_1^2 C[2] \text{MeijerG}\left[\{\{\emptyset\}, \{-1\}\}, \left\{\left\{-\frac{1}{2}, \frac{1}{2}\right\}, \{-1, -1\}\right\}, -\frac{i r_1}{\sqrt{2}}, \frac{1}{2}\right]\right\}$$

$Im(Es_{10}) =$

$$\{Es_{10}[r_1] \rightarrow -2 \times 6^{1/3} r_1^{2/3} \text{BesselI}\left[-\frac{4}{3}, \frac{4\sqrt{r_1}}{\sqrt{3}}\right] C[1] \text{Gamma}\left[\frac{2}{3}\right] - \frac{8(-2)^{1/3} r_1^{2/3} \text{BesselI}\left[\frac{4}{3}, \frac{4\sqrt{r_1}}{\sqrt{3}}\right] C[2] \text{Gamma}\left[\frac{4}{3}\right]}{3 \times 3^{2/3}}\}$$

$$\{Es_{10}[r_1] \rightarrow \mathbf{I} C1 \left( e^{-\frac{4\sqrt{r_1}}{\sqrt{3}}} r_1^{5/12} \right)\}$$

at infinity; exponentially damped

$$\{As_{20}[r_1, th] \rightarrow \frac{As_{20c} e^{2i th}}{r_1}\} \quad \text{linearly damped}$$

$$\{As_{00}[r_1, th] \rightarrow e^{2i th} \left( -\frac{As_{20c}}{2+r_1} - \frac{As_{20c} r_1}{2(2+r_1)} \right)\} \quad \text{quadrupole wave amplitude } \frac{As_{20c}}{2}$$

$$As_{10}[r_1, th] \rightarrow \frac{As_{20c} e^{2i th} (-i + r_1)}{2 r_1}, \quad \text{again a quadrupole wave}$$

$$\{As_{30}[r_1] \rightarrow \frac{i C1 e^{-\frac{4\sqrt{r_1}}{\sqrt{3}}} (-49 - 64\sqrt{3}\sqrt{r_1} + 96r_1 + 288r_1^2)}{1728 r_1^{7/12}}\} \quad \text{exponentially damped wave}$$

The overall result is:

-the E-tensor is exponentially damped with  $\exp\left(-\frac{4\sqrt{r}}{\sqrt{3}}\right)$

-the A-tensor components  $As_0$  and  $As_1$  are pure quadrupole waves,  $As_2$  is a linearly damped quadrupole wave,

$As_3$  is exponentially damped with  $\exp\left(-\frac{4\sqrt{r}}{\sqrt{3}}\right)$

This means that a classical wave source generates gravitational waves  $As$  via the metric, the energy is carried away by the  $As$ -tensor and, when the wave is absorbed, it dissipates energy and generates again a (locally damped) metric oscillation  $Es$ .

For  $lx=0$  (spherical wave) we get the solution for  $Es10$  :

$$\{Es10[r1] \rightarrow e^{2i r1} r1 C[1] + e^{2i r1} r1 C[2] \text{ExpIntegralEi}[-i r1]\}$$

which has the limit at infinity:

$$\{Es10[r1] \rightarrow \frac{C1 e^{2i r1} (-2 + i r1 + r1^2)}{\pi r1^2}\}$$

The factor  $e^{2ir}$  generates an incoming wave, which is not feasible, therefore  $C1=0$  and  $Es10=0$ , and consequently  $As20=As30=Es20=0$ , there is only the zero solution: there are no spherical gravitational waves.

For  $lx=1$  (dipole wave) we get the solution for  $Es10$  :

$$\{Es10[r1] \rightarrow \frac{2}{3} i r1 C[1] \text{Hypergeometric1F1}[1-i, 2, \frac{2i r1}{3}] + C[2] \text{MeijerG}[\{\{\}, \{1+i\}\}, \{\{0, 1\}, \{\}\}, -\frac{2i r1}{3}]\}$$

with hypergeometric and Meijer functions, the limit at infinity is

$$\begin{aligned} & \text{Series}\left[r1 \text{Hypergeometric1F1}\left[1-i, 2, \frac{2i r1}{3}\right], \{r1, \text{Infinity}, 3\}\right] = \\ & r1^{-i} \left( e^{\frac{2i r1}{3}} O\left[\frac{1}{r1}\right]^5 \left( \frac{\left(\frac{2i}{3}\right)^{-1-i}}{\Gamma[1-i]} + \frac{(1+i) i^{-1-i} 2^{-2-i} \times 3^{2+i}}{\Gamma[1-i] r1} + \frac{(2+i) i^{-1-i} 2^{-3-i} \times 3^{3+i}}{\Gamma[1-i] r1^2} + \frac{(15-5i) i^{-1-i} 2^{-4-i} \times 3^{3+i}}{\Gamma[1-i] r1^3} + O\left[\frac{1}{r1}\right]^4 \right) \right. \\ & \left. + r1^{2i} \left( \frac{\left(-\frac{2i}{3}\right)^{-1+i}}{\Gamma[1+i]} + \frac{(1-i) (-i)^{-1+i} 2^{-2+i} \times 3^{2+i}}{\Gamma[1+i] r1} + \frac{(2-i) (-i)^{-1+i} 2^{-3+i} \times 3^{3+i}}{\Gamma[1+i] r1^2} + \frac{(15+5i) (-i)^{-1+i} 2^{-4+i} \times 3^{3+i}}{\Gamma[1+i] r1^3} + O\left[\frac{1}{r1}\right]^4 \right) \right) \\ & \text{Series}\left[\text{MeijerG}[\{\{\}, \{1+i\}\}, \{\{0, 1\}, \{\}\}, -\frac{2i r1}{3}], \{r1, \text{Infinity}, 3\}\right] = \\ & e^{\frac{2i r1}{3}} \frac{\pi}{2} O\left[\frac{1}{r1}\right]^4 r1^{-i} \left( \left(\frac{2}{3}\right)^{-i} + \frac{(1+i) \left(\frac{2}{3}\right)^{-1-i}}{r1} + \frac{(2+i) \left(\frac{2}{3}\right)^{-2-i}}{r1^2} + \frac{(15-5i) 2^{-3-i} \times 3^{2+i}}{r1^3} + O\left[\frac{1}{r1}\right]^4 \right) \end{aligned}$$

which diverges, therefore  $Es10=0$ , and, as before, there is only the zero solution: there are no dipole gravitational waves.

For  $lx=2$  (quadrupole wave) we get the solution for the real part  $Re(Es10)$  :

$$\{Es10[r1] \rightarrow C[3] - \frac{i r1^3 C[1] \text{HypergeometricPFQ}\left[\left\{\frac{3}{2}\right\}, \left\{2, \frac{5}{2}\right\}, \frac{r1^2}{2}\right] + \frac{1}{2} r1^2 C[2] \text{MeijerG}[\{\{0\}, \{-1\}\}, \{\{-\frac{1}{2}, \frac{1}{2}\}, \{-1, -1\}\}, -\frac{i r1}{\sqrt{2}}, \frac{1}{2}]\}}{3\sqrt{2}}\}$$

and for the imaginary part  $Im(Es10)$  :

$$\{Es10[r1] \rightarrow -2 \times 6^{1/3} r1^{2/3} \text{BesselI}\left[-\frac{4}{3}, \frac{4\sqrt{r1}}{\sqrt{3}}\right] C[1] \Gamma\left[\frac{2}{3}\right] - \frac{8 (-2)^{1/3} r1^{2/3} \text{BesselI}\left[\frac{4}{3}, \frac{4\sqrt{r1}}{\sqrt{3}}\right] C[2] \Gamma\left[\frac{4}{3}\right]}{3 \times 3^{2/3}}\}$$

calculation of the limit at infinity yields

$$\{Es10[r1] \rightarrow i C1 \left( e^{-\frac{4\sqrt{r1}}{\sqrt{3}}} r1^{5/12} \right)\}, \text{ i.e. } Es10 \text{ is purely imaginary and exponentially damped with } \exp\left(-\frac{4\sqrt{r}}{\sqrt{3}}\right),$$

the same is valid for  $Es20$ , for  $As20$  we get

$$\{As20[r1, th] \rightarrow \frac{As20c e^{2i th}}{r1}\}, \text{ i.e. a linearly damped quadrupole wave,}$$

for  $As00$  we get

$$\{As00[r1, th] \rightarrow e^{2i th} \left( -\frac{As20c}{2+r1} - \frac{As20c r1}{2(2+r1)} \right)\}$$

i.e.  $As00$  is a quadrupole wave with the amplitude  $\frac{As20c}{2}$ ,

for  $As10$  we get

$$-\frac{As20c e^{2i th} (-i + r1)}{2 r1}$$

$As10[r1, th] \rightarrow$ , again a quadrupole wave,

for  $As30$  we get an exponentially damped wave again:

$$\{As30[r1] \rightarrow \frac{i C1 e^{-\frac{4\sqrt{r1}}{\sqrt{3}}} (-49 - 64\sqrt{3}\sqrt{r1} + 96 r1 + 288 r1^2)}{1728 r1^{7/12}}\}$$

The overall result is:

-the E-tensor is exponentially damped with  $\exp(-\frac{4\sqrt{r}}{\sqrt{3}})$

-the A-tensor components  $As_0$  and  $As_1$  are pure quadrupole waves,  $As_2$  is a linearly damped quadrupole wave,  $As_3$  is exponentially damped with  $\exp(-\frac{4\sqrt{r}}{\sqrt{3}})$

This means that a classical wave source generates gravitational waves  $As$  via the metric, the energy is carried away by the As-tensor and, when the wave is absorbed, it dissipates energy and generates again a (locally damped) metric oscillation  $Es$ .

#### 4.4. Gravitational waves in General Relativity

The gravitational waves in GR are metric waves, i.e. a disturbance of the metric tensor  $g_{\mu\nu}$ , for a plane wave [2]:

$$h_{\mu\nu} = e_{\mu\nu} \exp(-ik_\lambda x^\lambda).$$

They satisfy the wave equation and, with the additional gauge condition

$$2h^\mu{}_{\nu|\mu} = h^\mu{}_{\mu|\nu}$$

they satisfy the *linearized Einstein equations* for small amplitudes (but not the full Einstein equations)

$$\square h_{\mu\nu} = -\frac{16\pi G}{c^4} \left( T_{\mu\nu} - \frac{T}{2} \eta_{\mu\nu} \right)$$

They can be transformed by coordinate transformations

$$x^\mu \rightarrow x'^\mu = x^\mu + \epsilon^\mu(x)$$

into the standard form for a plane wave in x-direction

$$(h_{\mu\nu}) = \begin{pmatrix} 0 & 0 & 0 & 0 \\ 0 & 0 & 0 & 0 \\ 0 & 0 & e_{11} & e_{12} \\ 0 & 0 & e_{12} & -e_{11} \end{pmatrix} \exp(ik(x^1 - ct))$$

where  $e_{12} = 0$  and  $e_{11} = 0$  determine the two polarizations of a

tensor (spin=2) wave

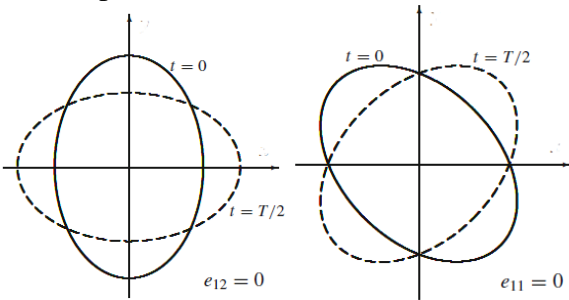

The Newtonian gravitation emerges from GR using the ansatz for the relative Newton potential energy of mass  $m$  in the field of a large mass  $M$

$$\Phi_N = \frac{E_{pot}}{mc^2} = -\frac{MG_N}{r} = -\frac{r_s}{2r}, \text{ where } r_s \text{ is the Schwarzschild radius of } M \text{ and}$$

$$\Phi = \sqrt{g_{00}} - 1 = \sqrt{1 - \frac{r_s}{r}} - 1 \approx -\frac{r_s}{2r} = \Phi_N$$

So a Newtonian wave caused by an oscillation of  $\Phi_N$  is approximately the component  $h_{00}$  of a GR metric wave. Correspondingly, a small static distortion of the metric component  $g_{00}$  caused by a wave causes a *radial* force.

#### 4.5. Spherical gravitational waves in AK-gravity

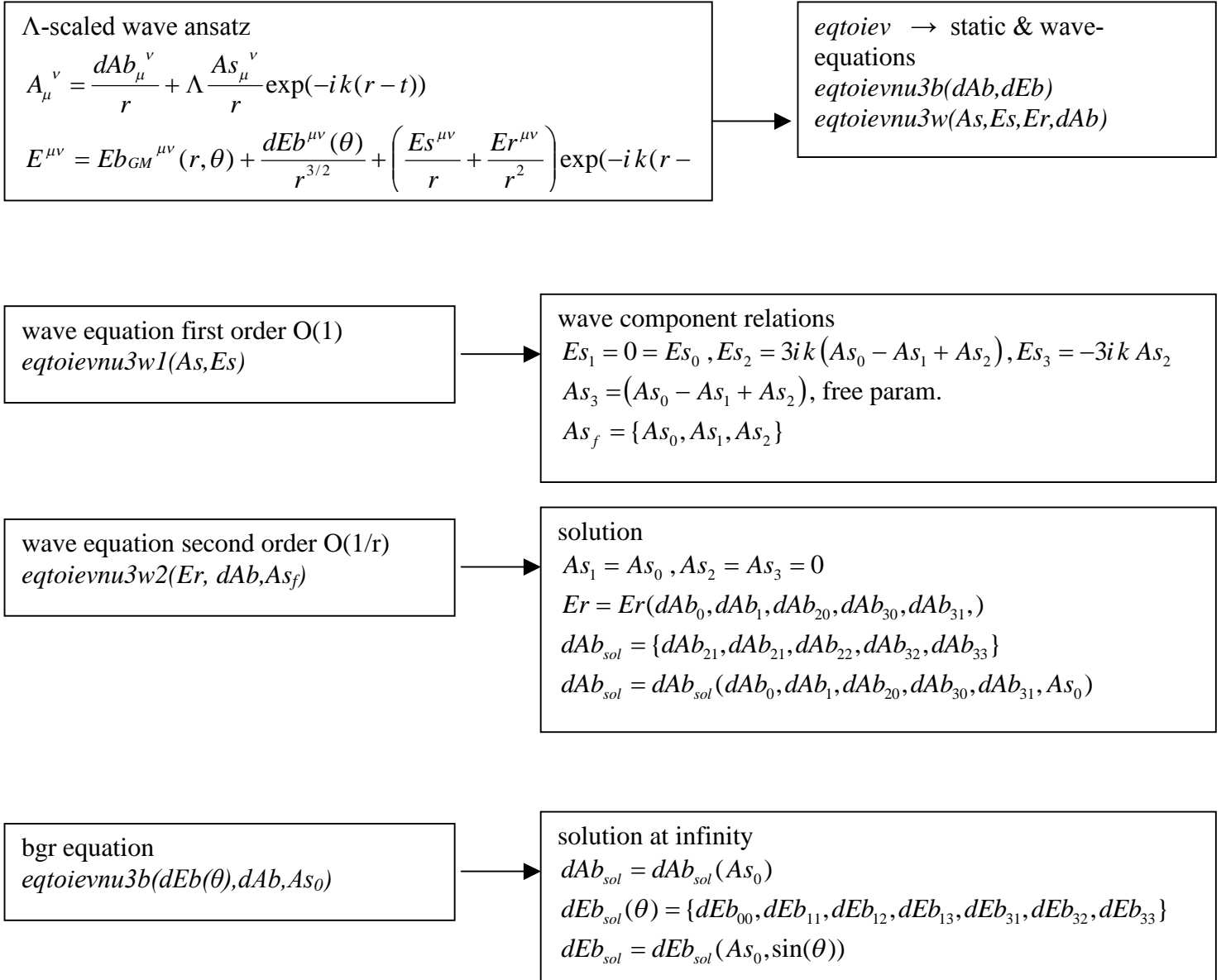

Gravitational waves are quadrupolar (or of higher multipolarity), as was shown in 4.3., and so are the resulting metric waves, in agreement with GR. Spherical gravitational waves are a valid approximation for small intervals of the polar angle  $\theta$ , and planar waves an approximation for large radii  $r$  and small  $\theta$ .

We start, as usual, with the  $\Lambda$ -scaled wave ansatz:

$$A_{\mu}^{\nu} = \frac{dAb_{\mu}^{\nu}}{r} + \Lambda \frac{As_{\mu}^{\nu}}{r} \exp(-ik(r-t))$$

$$E^{\mu\nu} = Eb_{GS}^{\mu\nu}(r, \theta) + \frac{dEb^{\mu\nu}(\theta)}{r^{3/2}} + \left( \frac{Es^{\mu\nu}}{r} + \frac{Er^{\mu\nu}}{r^2} \right) \exp(-ik(r-t))$$

$Eb_{GS}^{\mu\nu}(r, \theta)$  is the Gauss-Minkowski tetrad, which represents the background metric of the (empty)

Minkowski spacetime,  $\frac{dEb^{\mu\nu}(\theta)}{r^{3/2}}$  is the change in the tetrad induced by the wave, i.e. the *interaction of the wave with matter*.

$As_{\mu}^{\nu}$  and  $Es^{\mu\nu}$  are the (constant) wave factors of first order, and  $Er^{\mu\nu}$  is the wave factor of the tetrad of second order.

The AK-equations separate into the background and the wave part

*eqtoievnu3b(dAb,dEb)*

*eqtoievnu3w(As,Es,Er,dAb)*

The wave equation first order  $O(1)$ , i.e. at infinity, is

*eqtoievnu3w1(As,Es)* and the solution are the *wave component relations*

$$Es_1 = 0 = Es_0, Es_2 = 3ik(As_0 - As_1 + As_2), Es_3 = -3ik As_2$$

$$As_3 = (As_0 - As_1 + As_2), \text{ with the 12 free parameters}$$

$$As_f = \{As_0, As_1, As_2\}$$

We insert the solution into the wave equation of second order  $O(1/r)$  and get

*eqtoievnu3w2(Er, dAb, As\_f)*

We know from the gravitational wave equation in 4.3 that all  $Es$  are exponentially damped, so we get from the wave component relations the *vanishing tetrad condition*

$$As_1 = As_0, As_2 = As_3 = 0, \text{ which reduces the number of parameters } As \text{ to 4.}$$

With this condition, *eqtoievnu3w2* has 28 equations for 16  $Er$  and 16  $dAb$  with the parameters  $As_f$ , we eliminate 5  $dAb$  and all  $Er$ :

$$Er = Er(dAb_0, dAb_1, dAb_{20}, dAb_{30}, dAb_{31},)$$

$$dAb_{sol} = \{dAb_{21}, dAb_{21}, dAb_{22}, dAb_{32}, dAb_{33}\}$$

$$dAb_{sol} = dAb_{sol}(dAb_0, dAb_1, dAb_{20}, dAb_{30}, dAb_{31}, As_f)$$

The result is inserted into the background equation giving

*eqtoievnu3b(dEb(\theta), dAb, As\_f)*

It has 19 independent equations of order 4 in  $dAb * As_f$  with the variables:

$$7 dEb_{sol}(\theta) = \{dEb_{00}, dEb_{11}, dEb_{12}, dEb_{13}, dEb_{31}, dEb_{32}, dEb_{33}\},$$

11  $dAb$ , and the parameters  $As_f$  and  $\{E21c, E21cs\}$  from  $Eb_{GM}^{\mu\nu}(r, \theta)$ .

In principle, it is possible to solve the equations algebraically, but it is hopelessly complicated.

So we make a Ritz-Galerkin linear ansatz in  $As_{0i}$  and  $\{1/\sin(\theta), 1/\sin^{3/4}(\theta)\}$ , and minimize the equations.

We get a half-analytic solution linear in  $As_{0i}$

$$dAb_{sol} = dAb_{sol}(As_0)$$

$$dEb_{sol} = dEb_{sol}(As_0, \sin(\theta))$$

$dEb_{sol}$  represents the *interaction of the wave with matter*:

$dEb_{00}$  and  $dEb_{11}$  generate a potential of a radial force, i.e. the wave *exerts a pressure* in direction of movement, the remaining components represent a shear-stress tensor components in  $xy(=13)$ ,  $xz(=12)$  and  $yz(=32)$  directions. As those forces are linearly dependent on the wave components  $As_{0i}$ , they are normally unmeasurably small, but they should exist.

#### 4.6. Planar gravitational waves in AK-gravity

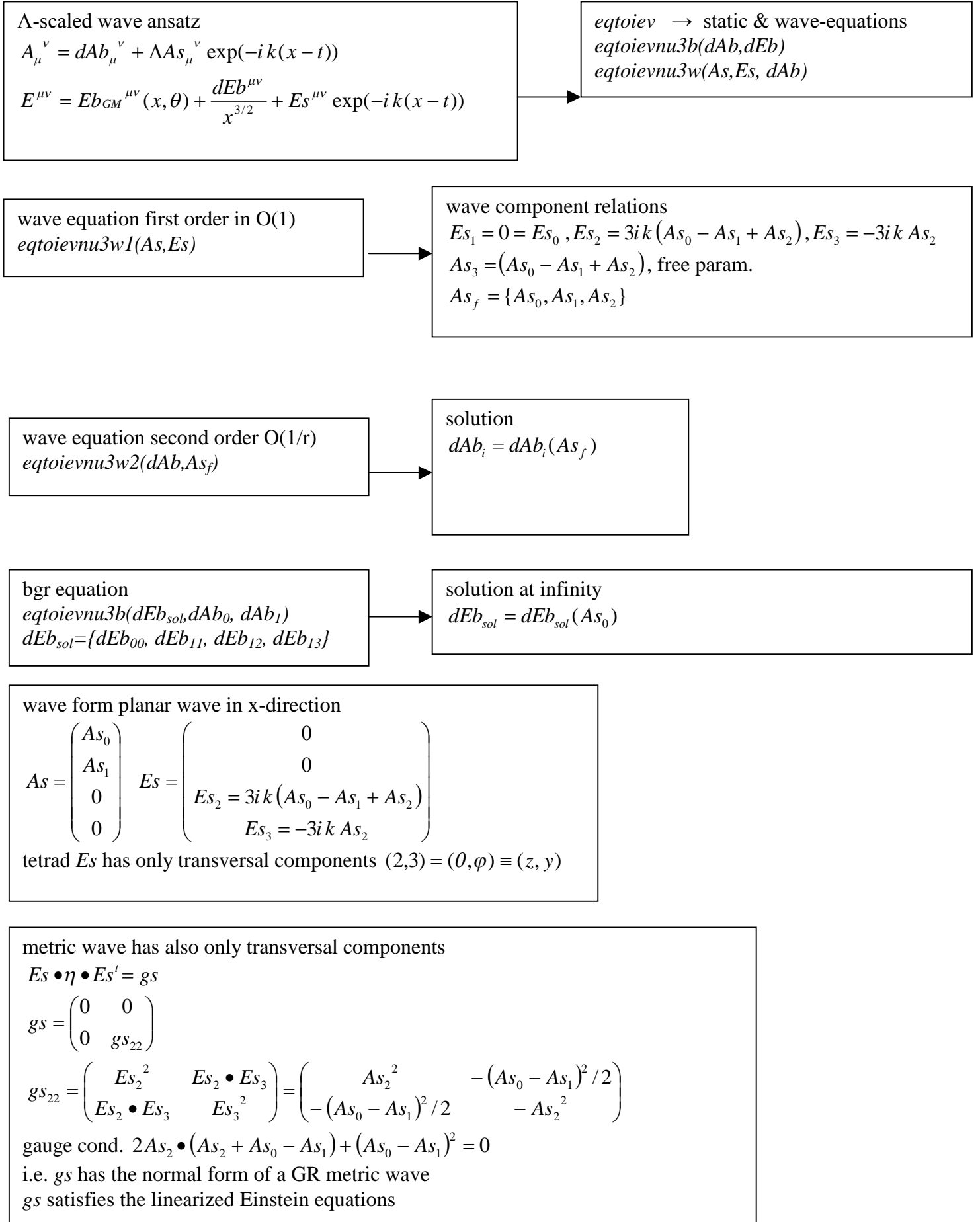



reflection and absorption of gravitational waves:

at matter boundary the relative potential changes  $\Phi \approx -\frac{r_s}{2r} \rightarrow \tilde{\Phi} = \Phi + \delta\Phi$   $\delta\Phi = -\frac{r_s(M)}{2r}$

$r_s(M)$  =Schwarzschild radius of the interacting matter  $M$

$k$  has a jump  $\delta k$  : with  $k = \frac{\sqrt{r_s}}{\sqrt{2r_0^3}}$  ,  $\frac{\delta k}{k} = \frac{r_s(M)}{2r_s}$

so the reflected and absorbed amplitude ratio is approximately

$$\frac{\delta A_r}{A} = \frac{\delta k}{k} = \frac{r_s(M)}{2r_s} , \quad \frac{\delta A_a}{A} = \sqrt{\frac{r_s(M)}{r_s}}$$

Planar gravitational waves are on Earth of course the only realistic form to be measured. As the LIGO observation show, their scale is around  $r_s \propto 100km$  and the induced relative metric strain  $\varepsilon \propto 10^{-21}$ , so for the

$$\text{tetrad } \frac{\delta E}{E} \approx \sqrt{\varepsilon} \propto 10^{-10}.$$

We begin, as before, with the  $\Lambda$ -scaled wave ansatz

$$A_\mu{}^\nu = dAb_\mu{}^\nu + \Lambda As_\mu{}^\nu \exp(-ik(x-t))$$

$E^{\mu\nu} = Eb_{GM}{}^{\mu\nu}(x, \theta) + \frac{dEb^{\mu\nu}}{x^{3/2}} + Es^{\mu\nu} \exp(-ik(x-t))$ , where we use the same variables as before, except the second-order wave factor  $Er$ .

Again, the AK-equations separate into the background and the wave part

$$eqtoievnu3b(dAb, dEb)$$

$$eqtoievnu3w(As, Es, Er, dAb)$$

and the wave equation first order  $O(1)$ , i.e. at infinity, is

$$eqtoievnu3w1(As, Es) \text{ and the solution are the same wave component relations, as for the spherical case:}$$

$$Es_1 = 0 = Es_0, Es_2 = 3ik(As_0 - As_1 + As_2), Es_3 = -3ik As_2$$

$$As_3 = (As_0 - As_1 + As_2), \text{ with the 12 free parameters}$$

$$As_f = \{As_0, As_1, As_2\}$$

The solution is inserted into the wave equation of second order  $O(1/r)$  giving

$$eqtoievnu3w2(dAb, As_f). \text{ Now we get a (trivial) solution if we set } dAb \text{ to a half-antisymmetric background:}$$

$$dAb_{hab} = \{dAb_0(1,1,-1,1), dAb_1(1,1,-1,1), dAb_2(1,1,-1,1), dAb_3(1,1,-1,1)\}, \text{ which furthermore enforces the}$$

vanishing tetrad condition  $As_1 = As_0, As_2 = As_3 = 0$ . This is undesirable, since then the background equations are identically zero.

So we demand that the solution deviates from  $dAb_{hab}$  and introduce the *penalty-factor*  $\frac{1}{\|dAb - dAb_{hab}\|}$  in the

equations. Now again make a linear Ritz-Galerkin ansatz  $dAb_{ij} = \sum_k \alpha_{ijk} As_{f,k}$ , minimize and get the solution

$$dAb_i = dAb_i(As_f)$$

Finally after insertion, we get the bgr equation in  $O(1)$  (at infinity)

$$eqtoievnu3b(dEb_{sol}, d2Ab_0, d2Ab_1) \text{ where}$$

$$d2Ab_0 = \{dAb_{00} - dAb_{01}, dAb_{01} + dAb_{02}, dAb_{02} + dAb_{03}, dAb_{03} - dAb_{01}\} \text{ are the half-antisymmetric background differences and}$$

$$dEb_{sol} = \{dEb_{00}, dEb_{11}, dEb_{12}, dEb_{13}\}, \text{ which depends on } dAb_0, dAb_1 \text{ only.}$$

We minimize again with Ritz-Galerkin and get the solution

$$dEb_{sol,ij} = \sum_k \alpha_{ijk} As_{0k}$$

With planar waves, there is again the radial pressure  $dEb_{00}, dEb_{11}$ , and the shear-stress in  $xy(=13)$  and  $xz(=12)$ , but no other directions, as is to be expected.

We calculate now the form of planar waves. Originally, we have  $3*4$  free parameters  $As_f$ , so we get for a planar wave in x-direction

$$As = \begin{pmatrix} As_0 \\ As_1 \\ 0 \\ 0 \end{pmatrix} \quad Es = \begin{pmatrix} 0 \\ 0 \\ Es_2 = 3ik(As_0 - As_1 + As_2) \\ Es_3 = -3ik As_2 \end{pmatrix}$$

the tetrad  $Es$  has only transversal components  $(2,3) = (\theta, \varphi) \equiv (z, y)$ , as expected.

The form of the metric wave follows from the defining equation of the (inversed densitized) tetrad  $E$

$$Es \bullet \eta \bullet Es^t = gs$$

$g^s = \begin{pmatrix} 0 & 0 \\ 0 & g^{s_{22}} \end{pmatrix}$  and the wave exponential is  $\exp(2ik(x^1 - ct))$ , i.e. the metric frequency is the double of the source frequency  $\omega_g = 2\omega_E$ , as is well known.

$$g^{s_{22}} = \begin{pmatrix} Es_2^2 & Es_2 \bullet Es_3 \\ Es_2 \bullet Es_3 & Es_3^2 \end{pmatrix} = \begin{pmatrix} As_2^2 & -(As_0 - As_1)^2 / 2 \\ -(As_0 - As_1)^2 / 2 & -As_2^2 \end{pmatrix}$$

Now if we impose the gauge condition  $2As_2 \bullet (As_2 + As_0 - As_1) + (As_0 - As_1)^2 = 0$ , then  $g^s$  has the normal form of a GR metric wave

$$(h_{\mu\nu}) = \begin{pmatrix} 0 & 0 & 0 & 0 \\ 0 & 0 & 0 & 0 \\ 0 & 0 & e_{11} & e_{12} \\ 0 & 0 & e_{12} & -e_{11} \end{pmatrix} \exp(2ik(x^1 - ct))$$

and therefore  $g^s$  satisfies the linearized Einstein equations, see 4.4 above.

Finally, let us examine the reflection and absorption of gravitational waves. Let us assume, as a simplification, that there is a sharp edge of the interacting matter, and at this boundary there is a jump of the potential. This is not true, of course, and in fact we have to calculate the background tetrad from the real background metric.

But under this assumption, at the boundary the relative potential changes:  $\Phi \approx -\frac{r_s}{2r} \rightarrow \tilde{\Phi} = \Phi + \delta\Phi$

$\delta\Phi = -\frac{r_s(M)}{2r}$ , where  $r_s(M)$  =Schwarzschild radius of the interacting matter  $M$

Then  $k$  has a jump  $\delta k$ : with  $k = \frac{\sqrt{r_s}}{\sqrt{2r_0^3}}$  (see B4.7),  $\frac{\delta k}{k} = \frac{r_s(M)}{2r_s}$

If we consider the wave component relations, and require that the tetrad and the metric be continuous, the A-tensor will have a jump so the reflected amplitude ratio is approximately

$$\frac{\delta A_r}{A} = \frac{\delta k}{k} = \frac{r_s(M)}{2r_s}$$

The absorption ratio results from the energy balance ( $T$ =energy,  $A_0$ =amplitude):

$$T_{in} = A_0^2 + (\Delta A_0)^2 = T_{out} = (A_0 + \Delta A_0)^2,$$

so the absorbed energy is  $2A_0\Delta A_0$  and  $\frac{\delta A_a}{A} = \sqrt{\frac{2A_0\Delta A_0}{A_0^2}} = \sqrt{\frac{r_s(M)}{r_s}}$

The approximation is only valid if  $r_s(M) \ll r_s$ . If we apply it to the Earth with  $r_s(M) = 9mm$  and the first LIGO black hole merger event GW140915 with  $r_s = r_s(60M_{sun}) = 180km$ , we see that the effect is currently unmeasurable. But recently, echoes of reflection from the originating black hole in GW140915 have been discussed [27] with an assessed amplitude ratio of  $\alpha_r \approx 0.05$ , which is consistent with a reflection from a debris-sphere with a mass of  $M \approx 3M_{sun}$ .

#### 4.7. Wave equation in binary rotator spacetime

binary gravitational rotator: masses  $m_1, m_2$ , distance  $r_0$ , mass ratio  $\mu = m_2/m_1 \leq 1$ , total mass  $m = m_1 + m_2$ ,

Schwarzschild radius  $r_s = \frac{2Gm}{c^2}$ , gravitational wave number  $k = \frac{\sqrt{r_s}}{\sqrt{2r_0^3}}$

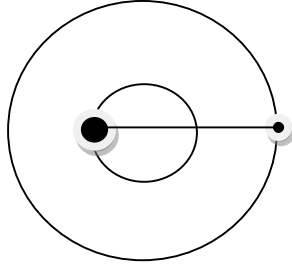

described by Kerr spacetime in first order approximation for  $\alpha \ll 1$

$$g_{\mu\nu} = \begin{pmatrix} -\left(1 - \frac{1}{r}\right) & 0 & 0 & -\frac{\alpha \sin^2 \theta}{r} \\ 0 & \frac{1}{\left(1 - \frac{1}{r}\right)} & 0 & 0 \\ 0 & 0 & r^2 & 0 \\ 0 & 0 & 0 & r^2 \sin^2 \theta \end{pmatrix}$$

$$\alpha = \frac{c_0}{r_0}, \text{ exactly: } \alpha = \frac{8\pi}{5 r_0 F} \frac{\mu}{(1 + \mu)^7 (3 + 8i\mu - 4\mu^2)}$$

The celebrated Einstein's power formula for gravitational waves of the bgr :

$$P_{gr} = \frac{32}{5} m_1^2 m_2^2 m \frac{G^4}{r_0^5 c^5}$$

The binary gravitational rotator, abbreviated bgr, (two masses rotating around their center-of-mass in their own gravitational field) is the simplest source of gravitational waves, a single rotating mass (i.e. with axial symmetry) does not emit gravitational waves.

Bgr has an axial symmetry and can be described by a Kerr-spacetime with an appropriate Kerr-parameter  $\alpha$ , which determines the power of the generated gravitational wave as shown in [11].

The exact formula derived there is

$$\alpha = \frac{8\pi}{5 r_0 F} \frac{\mu}{(1 + \mu)^7 (3 + 8i\mu - 4\mu^2)}, \text{ where } F \approx 1 \text{ is the relativistic velocity factor, } \mu = \frac{m_2}{m_1} \leq 1 \text{ is the mass ratio}$$

and  $r_0$  is the mean distance of the masses., masses  $m_1 m_2$ , total mass  $m = m_1 + m_2$ , Schwarzschild radius

$$r_s = \frac{2Gm}{c^2}$$

The celebrated Einstein's power formula for gravitational waves of the bgr is [2]:

$$P_{gr} = \frac{32}{5} m_1^2 m_2^2 m \frac{G^4}{r_0^5 c^5} \text{ or formulated with } \alpha$$

$$P_{\alpha} = \frac{\Delta E_{\alpha}}{T} = \frac{(1 + i\mu)\alpha}{r_0^5} \frac{F}{4\pi} (3 + 8i\mu - 4\mu^2)$$

The gravitational waves of the bgr have the (dimensionless) wave number  $k = \frac{1}{\sqrt{2r_0^3}}$ , with dimension

$$k = \frac{\sqrt{r_s}}{\sqrt{2r_0^3}}$$

In the following, we need only  $\alpha = \frac{c_0}{r_0}$  with a constant  $c_0$  and the bgr to be described by a Kerr-spacetime to be

exact of order  $O\left(\frac{\alpha^2}{r^2}\right)$ .

### 4.7.1. Wave equations for the binary gravitational rotator

*eqtoiev*  $\Lambda$ -scaled wave ansatz

background equation *eqtoievnu3b*=*eqtoiv*

standard solution:

*Eb*-tensor= the Gauss-Kerr tetrad  $E_{GK}$  :

$$E_{GK} = E_{GS} \text{ except } (E_{GK})_{03} = \frac{\alpha}{r^{9/2} \sin^{3/4} \theta}$$

*Ab*-tensor  $Ab = A_{hab} + dAb$  perturbed *half-antisymmetric background*



*eqtoievnu3wdA* = *eqtoievnu3wdA*( $As, Es, \alpha, k$ )

eliminate  $Es_3, Es_0, Es_1$  , left 18 eqs *eqtoievnu3wdAs2s3* for 20 variables  $Es_2, As$

solution at infinity  $\{Esi2i, Asi0i, Asli, Asi2i, Asi3i\}$  , i.e. order  $O(1)$  in  $r$ -powers is

$$\begin{aligned} & [Es20[r1, th] \rightarrow 0, Es21[r1, th] \rightarrow 0, Es22[r1, th] \rightarrow 0, Es23[r1, th] \rightarrow 0, As00[r1, th] \rightarrow As00[th], As01[r1, th] \rightarrow As00[th], As02[r1, th] \rightarrow -As00[th], As03[r1, th] \rightarrow As00[th], \\ & As10[r1, th] \rightarrow As00[th], As11[r1, th] \rightarrow As00[th], As12[r1, th] \rightarrow -As00[th], As13[r1, th] \rightarrow As00[th], As20[r1, th] \rightarrow 0, As21[r1, th] \rightarrow 0, As22[r1, th] \rightarrow 0, As23[r1, th] \rightarrow 0, \\ & As31[r1, th] \rightarrow 0, As32[r1, th] \rightarrow 0, As33[r1, th] \rightarrow 0, Es00[r1, th] \rightarrow \frac{3(As00[th] + As00'[th])}{r1}, Es01[r1, th] \rightarrow -\frac{3(As00[th] + As00'[th])}{r1}, Es02[r1, th] \rightarrow \frac{3(As00[th] + As00'[th])}{r1}, \\ & Es03[r1, th] \rightarrow -\frac{3(As00[th] + As00'[th])}{r1}, Es10[r1, th] \rightarrow \frac{3(As00[th] + As00'[th])}{r1}, Es11[r1, th] \rightarrow -\frac{3(As00[th] + As00'[th])}{r1}, Es12[r1, th] \rightarrow \frac{3(As00[th] + As00'[th])}{r1}, \\ & Es13[r1, th] \rightarrow -\frac{3(As00[th] + As00'[th])}{r1}, Es30[r1, th] \rightarrow \frac{3As00[th]}{r1}, Es31[r1, th] \rightarrow -\frac{3As00[th]}{r1}, Es32[r1, th] \rightarrow \frac{3As00[th]}{r1}, Es33[r1, th] \rightarrow -\frac{3As00[th]}{r1} ] \end{aligned}$$

free parameter variable  $As00(\theta)$  , for the wave  $As_{00}(r, \theta) = \frac{As_{00}(\theta)}{r} \exp(-ik(r-t))$

with parameters  $k = \frac{1}{\sqrt{2}r_0^3}$  and  $\alpha = \frac{c_0}{r_0}$  ,

*eqtoievnu3wdAs*= *eqtoievnu3wdAs*( $r_0, Es_2, As_0, As_1, As_2, As_3$ )

series in  $r_0$  :

*eqtoievnu3wdAs*= *eqtoievnu3wdAs0*+ *eqtoievnu3wdAs1*/ $r_0$ + *eqtoievnu3wdAs1*/ $r_0^{3/2}$ +...

goal: calculate  $As00(r, \theta, r_0)$  analytically in  $\{\theta, r_0\}$  as a series in  $r$  , then all others

$$As00(r, \theta, r_0) = (As00n00(\theta) + \frac{As00n01(\theta)}{r_0} + \frac{As00n02(\theta)}{r_0^{3/2}} + \dots) + \frac{(As00n10(\theta) + \frac{As00n11(\theta)}{r_0} + \frac{As00n12(\theta)}{r_0^{3/2}} + \dots)}{r} + \dots$$

result:  $As00n00(\theta) = 0$  , i.e. for  $r_0 \rightarrow \infty$   $As00(r, \theta, r_0) = \frac{As00n01(\theta)}{r_0}$

First, we make a  $\Lambda$ -scaled ansatz for the A-tensor

$$A_{\mu}^{\nu} = Ab_{\mu}^{\nu} + \Lambda \frac{As_{\mu}^{\nu}}{r} \exp(-ik(r-t)) \quad \text{and correspondingly for the E-tensor}$$

$$E^{\mu\nu} = Eb^{\mu\nu} + \frac{Es^{\mu\nu}}{r} \exp(-ik(r-t))$$

Then, calculate the tetrad of the Kerr spacetime, which satisfies the gaussian equation (Gauss-Kerr-tetrad)  $E_{GK}$ .

We start with the (dimensionless) Kerr spacetime with  $\frac{\alpha}{r_s} \ll 1$ , i.e. dimensionless (setting  $r_s=1$ )  $\alpha \ll 1$ :

original line element with  $r_s$ :

$$\begin{aligned} -ds^2 = & \left(1 - \frac{rr_s}{r^2 + \alpha^2 \cos^2 \theta}\right) (dt)^2 + \left(\frac{2rr_s \alpha \sin^2 \theta}{r^2 + \alpha^2 \cos^2 \theta}\right) dt d\varphi \\ & - \left(\frac{r^2 + \alpha^2 \cos^2 \theta}{r^2 - rr_s + \alpha^2}\right) dr^2 - \\ & \left(r^2 + \alpha^2 + \frac{rr_s \alpha^2 \sin^2 \theta}{r^2 + \alpha^2 \cos^2 \theta}\right) \sin^2 \theta d\varphi^2 - (r^2 + \alpha^2 \cos^2 \theta) (d\theta^2) \end{aligned}$$

In matrix form dimensionless:

$$g_{\mu\nu} = \begin{pmatrix} \left(1 - \frac{r}{r^2 + \alpha^2 \cos^2 \theta}\right) & 0 & 0 & \frac{r\alpha \sin^2 \theta}{r^2 + \alpha^2 \cos^2 \theta} \\ & -\frac{r^2 + \alpha^2 \cos^2 \theta}{r^2 - r + \alpha^2} & 0 & 0 \\ & & -(r^2 + \alpha^2 \cos^2 \theta) & 0 \\ & & & -\sin^2 \theta \left(r^2 + \alpha^2 + \frac{r\alpha^2 \sin^2 \theta}{r^2 + \alpha^2 \cos^2 \theta}\right) \end{pmatrix}$$

and in first order approximation for  $\alpha \ll 1$

$$g_{\mu\nu} = \begin{pmatrix} -\left(1 - \frac{1}{r}\right) & 0 & 0 & -\frac{\alpha \sin^2 \theta}{r} \\ & \frac{1}{\left(1 - \frac{1}{r}\right)} & 0 & 0 \\ & & r^2 & 0 \\ & & & r^2 \sin^2 \theta \end{pmatrix}$$

Calculation of the Gauss-Kerr-tetrad with the metric condition

$$E \eta E^t = g^{-1} / (-\det(g))^{3/4} \quad \text{and satisfying the gaussian equations}$$

$$\frac{\partial_{\theta} E^{2\nu}}{r} + \partial_r E^{1\nu} = 0,$$

$$\text{yields } E_{GK} = E_{GS} \quad \text{except } (E_{GK})_{03} = \frac{\alpha}{r^{9/2} \sin^{3/4} \theta}$$

This non-diagonal element  $(E_{GK})_{03}$  causes (in first approximation order) a perturbation  $dAb_{\mu\nu}$  of the *constant half-antisymmetric background* solution  $A_{hab}$  for the A-tensor. This perturbation is calculated from the static part of the AK-equations *eqtoievnu3b* (see 4.3.), inserting  $Eb = E_{GK}$  and  $Ab = A_{hab} + dAb$ .

The result for the perturbed solution  $Ab$  is

$$\begin{aligned} & \left[ Ab_{00}[r, \theta] \rightarrow A_{00c} + \frac{\text{alphax}}{r^{13}}, Ab_{01}[r, \theta] \rightarrow A_{00c} + \frac{\text{alphax}}{r^{13}}, Ab_{02}[r, \theta] \rightarrow -A_{00c} + \frac{\text{alphax}}{r^{13}}, Ab_{03}[r, \theta] \rightarrow A_{00c} - \frac{\text{alphax}}{r^{13}}, \right. \\ & Ab_{10}[r, \theta] \rightarrow A_{10c}, Ab_{11}[r, \theta] \rightarrow A_{10c}, Ab_{12}[r, \theta] \rightarrow -A_{10c}, Ab_{13}[r, \theta] \rightarrow A_{10c}, Ab_{20}[r, \theta] \rightarrow A_{20c} + i \text{Csc}[\theta], Ab_{21}[r, \theta] \rightarrow A_{20c} + i \text{Csc}[\theta], \\ & \left. Ab_{22}[r, \theta] \rightarrow -A_{20c} + i \text{Csc}[\theta], Ab_{23}[r, \theta] \rightarrow A_{20c} + i \text{Csc}[\theta], Ab_{30}[r, \theta] \rightarrow 1 - A_{30c}, Ab_{31}[r, \theta] \rightarrow 1 + A_{30c}, Ab_{32}[r, \theta] \rightarrow 1 - A_{30c}, Ab_{33}[r, \theta] \rightarrow 1 + A_{30c} \right] \end{aligned}$$

with constant parameters  $A_{ijc} = \{A_{00c}, A_{10c}, A_{20c}, A_{30c}\}$  and  $\text{alphax} = \alpha$

$$dAb0 = \frac{\alpha}{r^3}, \quad dAb2 = \frac{i}{\sin \theta}, \quad dAb1 = 0, \quad dAb3 = 1$$

After inserting this result into *eqtoievnu3w* the wave part of the AK-equations, we get new equations *eqtoievnu3wdA*, which do not depend on the constants *Aijc*, only on *As*, *Es*,  $\alpha$ , *k*:

$$\begin{aligned} \text{eq1} &= \frac{3 r1^2 (-1 - i k r1) \text{As00}[r1, \text{th}] + 3 i k r1^3 \text{As10}[r1, \text{th}] - 6 \text{alphax As11}[r1, \text{th}] + 6 \text{alphax As13}[r1, \text{th}] + r1^3 \text{Es20}[r1, \text{th}] + r1^3 \text{Es30}[r1, \text{th}] + 3 r1^3 \text{As00}^{(1,0)}[r1, \text{th}]}{3 r1^4} \\ \text{eq5} &= \frac{(3 + 3 i k r1) \text{As20}[r1, \text{th}] + 6 i r1 \text{As11}[r1, \text{th}] \text{Csc}[\text{th}] - 6 i r1 \text{As13}[r1, \text{th}] \text{Csc}[\text{th}] - r1 \text{Es00}[r1, \text{th}] + r1 \text{Es30}[r1, \text{th}] + 3 \text{As10}^{(0,1)}[r1, \text{th}] - 3 r1 \text{As20}^{(1,0)}[r1, \text{th}]}{3 r1^2} \\ \text{eq9} &= \frac{1}{3 r1} (-6 i k r1 \text{As21}[r1, \text{th}] + 6 i k r1 \text{As23}[r1, \text{th}] - 6 k r1 \text{As31}[r1, \text{th}] \text{Csc}[\text{th}] - 6 k r1 \text{As33}[r1, \text{th}] \text{Csc}[\text{th}] + i k r1 \text{Es00}[r1, \text{th}] - i k r1 \text{Es10}[r1, \text{th}] - 6 \text{As11}^{(0,1)}[r1, \text{th}] + 6 \text{As13}^{(0,1)}[r1, \text{th}] + \text{Es00}^{(0,1)}[r1, \text{th}] - \text{Es20}^{(0,1)}[r1, \text{th}] + 6 r1 \text{As21}^{(1,0)}[r1, \text{th}] - 6 r1 \text{As23}^{(1,0)}[r1, \text{th}] - 6 i r1 \text{Csc}[\text{th}] \text{As31}^{(1,0)}[r1, \text{th}] - 6 i r1 \text{Csc}[\text{th}] \text{As33}^{(1,0)}[r1, \text{th}] - r1 \text{Es00}^{(1,0)}[r1, \text{th}] + r1 \text{Es10}^{(1,0)}[r1, \text{th}]) \\ \text{eq13} &= \frac{3 i k r1^3 \text{As20}[r1, \text{th}] - 6 \text{alphax As21}[r1, \text{th}] - 6 \text{alphax As23}[r1, \text{th}] - 6 i r1^3 \text{As01}[r1, \text{th}] \text{Csc}[\text{th}] - 6 i r1^3 \text{As03}[r1, \text{th}] \text{Csc}[\text{th}] - r1^3 \text{Es10}[r1, \text{th}] + r1^3 \text{Es30}[r1, \text{th}] - 3 r1^2 \text{As00}^{(0,1)}[r1, \text{th}]}{3 r1^4} \\ \text{eq17} &= \frac{-6 r1 \text{As11}[r1, \text{th}] + 6 r1 \text{As13}[r1, \text{th}] - 3 \text{As30}[r1, \text{th}] - 3 i k r1 \text{As30}[r1, \text{th}] + r1 \text{Es00}[r1, \text{th}] + r1 \text{Es20}[r1, \text{th}] + 3 r1 \text{As30}^{(1,0)}[r1, \text{th}]}{3 r1^2} \\ \text{eq21} &= \frac{1}{3 r1^5} (6 r1^3 (-1 - i k r1) \text{As01}[r1, \text{th}] - 6 r1^3 (1 - i k r1) \text{As03}[r1, \text{th}] - 6 i k r1^4 \text{As11}[r1, \text{th}] - 6 i k r1^4 \text{As13}[r1, \text{th}] + 24 \text{alphax As31}[r1, \text{th}] + 6 i \text{alphax k r1 As31}[r1, \text{th}] - 24 \text{alphax As33}[r1, \text{th}] - 6 i \text{alphax k r1 As33}[r1, \text{th}] - i k r1^4 \text{Es00}[r1, \text{th}] + r1^3 \text{Es10}[r1, \text{th}] + i k r1^4 \text{Es10}[r1, \text{th}] + r1^2 \text{Es20}[r1, \text{th}] + 6 r1^4 \text{As01}^{(1,0)}[r1, \text{th}] - 6 r1^4 \text{As03}^{(1,0)}[r1, \text{th}] - 6 \text{alphax r1 As31}^{(1,0)}[r1, \text{th}] + 6 \text{alphax r1 As33}^{(1,0)}[r1, \text{th}] - r1^4 \text{Es10}^{(1,0)}[r1, \text{th}] - r1^4 \text{Es20}^{(1,0)}[r1, \text{th}]) \\ \text{eq25} &= \frac{1}{r1^4} (-i k r1^3 \text{Es00}[r1, \text{th}] + 2 \text{alphax Es01}[r1, \text{th}] - 2 \text{alphax Es03}[r1, \text{th}] - r1^2 \text{Es10}[r1, \text{th}] - i k r1^3 \text{Es10}[r1, \text{th}] - 2 i r1^3 \text{Csc}[\text{th}] \text{Es21}[r1, \text{th}] + 2 i r1^3 \text{Csc}[\text{th}] \text{Es23}[r1, \text{th}] - 2 r1^3 \text{Es31}[r1, \text{th}] + 2 r1^3 \text{Es33}[r1, \text{th}] + r1^2 \text{Es20}^{(0,1)}[r1, \text{th}] + r1^3 \text{Es10}^{(1,0)}[r1, \text{th}]) \\ \text{eq29} &= \frac{3 \text{alphax} (\text{Es10}[r1, \text{th}] + \text{Es11}[r1, \text{th}] + \text{Es12}[r1, \text{th}] + \text{Es13}[r1, \text{th}])}{r1^5} \\ \text{eq30} &= \frac{3 \text{alphax} (\text{Es00}[r1, \text{th}] + \text{Es01}[r1, \text{th}] + \text{Es02}[r1, \text{th}] + \text{Es03}[r1, \text{th}])}{r1^5} \end{aligned}$$

eq31=0

eq32=0

For simplicity, we show only the first equation of a 4-group, but here the symmetry

*column-index*  $\leftrightarrow$  *group-index* compared to the *eqtoievnu3w* in 4.3. is lost,

e.g.  $eq1 = eq1(\text{As00}, \text{As10}, \text{As11}, \text{As13}, \text{Es20}, \text{Es30})$  depends also on  $\{\text{As11}, \text{As13}\}$ , not only on *As10*, as in *eqtoievnu3w*.

We eliminate *Es3*, *Es0*, *Es1* from equations  $\{1...4\}$ ,  $\{5...8\}$ ,  $\{13...16\}$

and are left with 18 equs *eqtoievnu3wdAs2s3* for 20 variables *Es2*, *As*:

*eq1...8*, *eq13...16*, *eq31...32* vanish identically,

we show here resp. the first equation from the respective 4-group

$$\begin{aligned} \text{eq9} &= \frac{\text{As20}[r1, \text{th}]}{r1^2} - \frac{i k \text{As20}[r1, \text{th}]}{r1} + 2 i k \text{As21}[r1, \text{th}] - \frac{6 \text{alphax As21}[r1, \text{th}]}{r1^4} - \frac{2 i \text{alphax k As21}[r1, \text{th}]}{r1^3} - 2 i k \text{As23}[r1, \text{th}] + \frac{6 \text{alphax As23}[r1, \text{th}]}{r1^4} - \frac{2 i \text{alphax k As23}[r1, \text{th}]}{r1^3} - 2 k \text{As01}[r1, \text{th}] \text{Csc}[\text{th}] + 2 k \text{As03}[r1, \text{th}] \text{Csc}[\text{th}] - 2 k \text{As11}[r1, \text{th}] \text{Csc}[\text{th}] - 2 k \text{As13}[r1, \text{th}] \text{Csc}[\text{th}] - 2 k \text{As31}[r1, \text{th}] \text{Csc}[\text{th}] - 2 k \text{As33}[r1, \text{th}] \text{Csc}[\text{th}] - \frac{2 i \text{As11}[r1, \text{th}] \text{Cot}[\text{th}] \text{Csc}[\text{th}]}{r1} - \frac{2 i \text{As13}[r1, \text{th}] \text{Cot}[\text{th}] \text{Csc}[\text{th}]}{r1} - \frac{\text{As10}^{(0,1)}[r1, \text{th}]}{r1^2} + \frac{2 \text{alphax As11}^{(0,1)}[r1, \text{th}]}{r1^2} + \frac{2 \text{As11}^{(0,1)}[r1, \text{th}]}{r1} - \frac{2 i \text{Csc}[\text{th}] \text{As11}^{(0,1)}[r1, \text{th}]}{r1} + \frac{2 \text{alphax As13}^{(0,1)}[r1, \text{th}]}{r1^2} + \frac{2 \text{As13}^{(0,1)}[r1, \text{th}]}{r1} - \frac{2 i \text{Csc}[\text{th}] \text{As13}^{(0,1)}[r1, \text{th}]}{r1} - \frac{\text{As20}^{(0,1)}[r1, \text{th}]}{r1^2} + \frac{i k \text{As20}^{(0,1)}[r1, \text{th}]}{r1} - \frac{\text{As10}^{(0,2)}[r1, \text{th}]}{r1^2} - 2 i \text{Csc}[\text{th}] \text{As01}^{(1,0)}[r1, \text{th}] + 2 i \text{Csc}[\text{th}] \text{As03}^{(1,0)}[r1, \text{th}] + 2 i \text{Csc}[\text{th}] \text{As11}^{(1,0)}[r1, \text{th}] - 2 i \text{Csc}[\text{th}] \text{As13}^{(1,0)}[r1, \text{th}] + i k \text{As20}^{(1,0)}[r1, \text{th}] - \frac{\text{As20}^{(1,0)}[r1, \text{th}]}{r1} - 2 \text{As21}^{(1,0)}[r1, \text{th}] - \frac{2 \text{alphax As21}^{(1,0)}[r1, \text{th}]}{r1^3} - 2 \text{As23}^{(1,0)}[r1, \text{th}] - \frac{2 \text{alphax As23}^{(1,0)}[r1, \text{th}]}{r1^3} - 2 i \text{Csc}[\text{th}] \text{As31}^{(1,0)}[r1, \text{th}] - 2 i \text{Csc}[\text{th}] \text{As33}^{(1,0)}[r1, \text{th}] - \frac{\text{As10}^{(1,1)}[r1, \text{th}]}{r1} + \frac{\text{As20}^{(1,1)}[r1, \text{th}]}{r1} - \text{As20}^{(2,0)}[r1, \text{th}] \\ \text{eq17} &= \frac{i k \text{As00}[r1, \text{th}]}{r1} + i k \text{As10}[r1, \text{th}] + 2 \text{As11}[r1, \text{th}] - \frac{2 \text{alphax As11}[r1, \text{th}]}{r1^2} - 2 \text{As13}[r1, \text{th}] + \frac{2 \text{alphax As13}[r1, \text{th}]}{r1^2} - i k \text{As20}[r1, \text{th}] - \frac{\text{As20}[r1, \text{th}]}{r1} + i k \text{As30}[r1, \text{th}] - \frac{\text{As30}[r1, \text{th}]}{r1} - 2 i \text{As11}[r1, \text{th}] \text{Csc}[\text{th}] - 2 i \text{As13}[r1, \text{th}] \text{Csc}[\text{th}] - \frac{\text{As10}^{(0,1)}[r1, \text{th}]}{r1} - \text{As00}^{(1,0)}[r1, \text{th}] + \text{As20}^{(1,0)}[r1, \text{th}] - \text{As30}^{(1,0)}[r1, \text{th}] \\ \text{eq21} &= \frac{2 \text{As00}[r1, \text{th}]}{r1^2} + \frac{i k \text{As00}[r1, \text{th}]}{r1} - 2 i k \text{As01}[r1, \text{th}] - \frac{2 \text{As01}[r1, \text{th}]}{r1} - 2 i k \text{As03}[r1, \text{th}] - \frac{2 \text{As03}[r1, \text{th}]}{r1} - i k \text{As10}[r1, \text{th}] - 2 i k \text{As11}[r1, \text{th}] - \frac{8 \text{alphax As11}[r1, \text{th}]}{r1^4} - 2 i k \text{As13}[r1, \text{th}] - \frac{8 \text{alphax As13}[r1, \text{th}]}{r1^4} - 8 \text{alphax As21}[r1, \text{th}] - \frac{2 i \text{alphax k As21}[r1, \text{th}]}{r1^3} + 8 \text{alphax As23}[r1, \text{th}] - \frac{2 i \text{alphax k As23}[r1, \text{th}]}{r1^3} + 8 \text{alphax As31}[r1, \text{th}] - \frac{2 i \text{alphax k As31}[r1, \text{th}]}{r1^3} + 8 \text{alphax As33}[r1, \text{th}] - \frac{2 i \text{alphax k As33}[r1, \text{th}]}{r1^3} - 2 k \text{As01}[r1, \text{th}] \text{Csc}[\text{th}] - \frac{2 i \text{As01}[r1, \text{th}] \text{Csc}[\text{th}]}{r1} - 2 k \text{As03}[r1, \text{th}] \text{Csc}[\text{th}] - \frac{2 i \text{As03}[r1, \text{th}] \text{Csc}[\text{th}]}{r1} - 2 k \text{As11}[r1, \text{th}] \text{Csc}[\text{th}] - 2 k \text{As13}[r1, \text{th}] \text{Csc}[\text{th}] - \frac{2 \text{As00}^{(0,1)}[r1, \text{th}]}{r1^2} + \frac{i k \text{As00}^{(0,1)}[r1, \text{th}]}{r1} - \frac{i k \text{As10}^{(0,1)}[r1, \text{th}]}{r1} - i k \text{As00}^{(1,0)}[r1, \text{th}] - \frac{2 \text{As00}^{(1,0)}[r1, \text{th}]}{r1} + 2 \text{As01}^{(1,0)}[r1, \text{th}] - 2 i \text{Csc}[\text{th}] \text{As01}^{(1,0)}[r1, \text{th}] - 2 \text{As03}^{(1,0)}[r1, \text{th}] - 2 i \text{Csc}[\text{th}] \text{As03}^{(1,0)}[r1, \text{th}] - i k \text{As10}^{(1,0)}[r1, \text{th}] - 2 \text{alphax As11}^{(1,0)}[r1, \text{th}] - 2 \text{alphax As13}^{(1,0)}[r1, \text{th}] - 2 \text{alphax As21}^{(1,0)}[r1, \text{th}] - 2 \text{alphax As23}^{(1,0)}[r1, \text{th}] - \text{As00}^{(2,0)}[r1, \text{th}] - \frac{6 \text{As00}^{(0,1)}[r1, \text{th}]}{r1^2} - \frac{9 i k \text{As00}^{(0,1)}[r1, \text{th}]}{r1} - 6 i k \text{As01}[r1, \text{th}] - \frac{6 \text{alphax As01}^{(0,1)}[r1, \text{th}]}{r1^4} - \frac{6 \text{alphax k As01}^{(0,1)}[r1, \text{th}]}{r1^2} - \frac{6 \text{As01}[r1, \text{th}]}{r1} - 6 i k \text{As03}[r1, \text{th}] + \frac{6 \text{alphax As03}^{(0,1)}[r1, \text{th}]}{r1^4} + \frac{6 \text{alphax k As03}^{(0,1)}[r1, \text{th}]}{r1^2} - \frac{6 \text{As03}[r1, \text{th}]}{r1} - 6 k^2 \text{As10}[r1, \text{th}] - \frac{24 \text{alphax}^2 \text{As10}[r1, \text{th}]}{r1^6} - \frac{24 \text{alphax As10}[r1, \text{th}]}{r1^3} - \frac{3 i k \text{As10}[r1, \text{th}]}{r1} - 6 i k \text{As11}[r1, \text{th}] - \frac{12 \text{alphax}^2 \text{As11}[r1, \text{th}]}{r1^6} - \frac{24 \text{alphax As11}[r1, \text{th}]}{r1^3} - \frac{12 \text{alphax As11}[r1, \text{th}]}{r1^3} - \frac{6 i \text{alphax k As11}[r1, \text{th}]}{r1^3} - 6 i k \text{As13}[r1, \text{th}] - \frac{12 \text{alphax}^2 \text{As13}[r1, \text{th}]}{r1^6} - \frac{24 \text{alphax As13}[r1, \text{th}]}{r1^3} - \frac{12 \text{alphax As13}[r1, \text{th}]}{r1^3} - \frac{6 i \text{alphax k As13}[r1, \text{th}]}{r1^3} - 6 k^2 \text{As20}[r1, \text{th}] - \frac{6 i k \text{As20}[r1, \text{th}]}{r1} - \frac{18 \text{alphax As21}[r1, \text{th}]}{r1^4} - \frac{18 \text{alphax As23}[r1, \text{th}]}{r1^4} + 6 k \text{As01}[r1, \text{th}] \text{Csc}[\text{th}] - \frac{6 i \text{As01}[r1, \text{th}] \text{Csc}[\text{th}]}{r1} - 6 k \text{As03}[r1, \text{th}] \text{Csc}[\text{th}] - \frac{6 i \text{As03}[r1, \text{th}] \text{Csc}[\text{th}]}{r1} - \frac{24 i \text{alphax As10}[r1, \text{th}] \text{Csc}[\text{th}]}{r1^3} - 6 k \text{As11}[r1, \text{th}] \text{Csc}[\text{th}] - \frac{12 i \text{alphax As11}[r1, \text{th}] \text{Csc}[\text{th}]}{r1^3} - 6 k \text{As13}[r1, \text{th}] \text{Csc}[\text{th}] - \frac{12 i \text{alphax As13}[r1, \text{th}] \text{Csc}[\text{th}]}{r1^3} - 2 i k \text{Es20}[r1, \text{th}] - \frac{\text{Es20}[r1, \text{th}]}{r1} - 2 \text{Es21}[r1, \text{th}] - \frac{2 \text{alphax Es21}[r1, \text{th}]}{r1^3} - 2 i \text{Csc}[\text{th}] \text{Es21}[r1, \text{th}] - 2 \text{Es23}[r1, \text{th}] - \frac{2 \text{alphax Es23}[r1, \text{th}]}{r1^3} - 2 i \text{Csc}[\text{th}] \text{Es23}[r1, \text{th}] - \frac{6 \text{As00}^{(0,1)}[r1, \text{th}]}{r1^2} + \frac{3 i k \text{As00}^{(0,1)}[r1, \text{th}]}{r1} + \frac{3 i k \text{As10}^{(0,1)}[r1, \text{th}]}{r1} - \frac{6 \text{alphax As11}^{(0,1)}[r1, \text{th}]}{r1^4} + \frac{6 \text{alphax As13}^{(0,1)}[r1, \text{th}]}{r1^4} + \frac{\text{Es20}^{(0,1)}[r1, \text{th}]}{r1} - 9 i k \text{As00}^{(1,0)}[r1, \text{th}] - \frac{6 \text{As00}^{(1,0)}[r1, \text{th}]}{r1} - \frac{6 \text{As01}^{(1,0)}[r1, \text{th}]}{r1} - \frac{6 \text{alphax As01}^{(1,0)}[r1, \text{th}]}{r1^2} - 6 i \text{Csc}[\text{th}] \text{As01}^{(1,0)}[r1, \text{th}] - 6 \text{alphax As03}^{(1,0)}[r1, \text{th}] - \frac{6 \text{alphax As03}^{(1,0)}[r1, \text{th}]}{r1^2} + 6 i \text{Csc}[\text{th}] \text{As03}^{(1,0)}[r1, \text{th}] - 3 i k \text{As10}^{(1,0)}[r1, \text{th}] - \frac{6 \text{alphax As11}^{(1,0)}[r1, \text{th}]}{r1^3} - \frac{6 \text{alphax As13}^{(1,0)}[r1, \text{th}]}{r1^3} - 6 i k \text{As20}^{(1,0)}[r1, \text{th}] - \text{Es20}^{(1,0)}[r1, \text{th}] - \frac{3 \text{As00}^{(1,1)}[r1, \text{th}]}{r1} - 3 \text{As00}^{(2,0)}[r1, \text{th}] \\ \text{eq29} &= 3 i k \text{As00}[r1, \text{th}] - \frac{3 \text{As00}[r1, \text{th}]}{r1} - 3 i k \text{As01}[r1, \text{th}] - \frac{3 \text{As01}[r1, \text{th}]}{r1} - 3 i k \text{As02}[r1, \text{th}] - \frac{3 \text{As02}[r1, \text{th}]}{r1} - 3 i k \text{As03}[r1, \text{th}] - \frac{3 \text{As03}[r1, \text{th}]}{r1} - 3 i k \text{As10}[r1, \text{th}] + 3 i k \text{As11}[r1, \text{th}] + \frac{12 \text{alphax As11}[r1, \text{th}]}{r1^3} - 3 i k \text{As12}[r1, \text{th}] + 3 i k \text{As13}[r1, \text{th}] - \frac{12 \text{alphax As13}[r1, \text{th}]}{r1^3} + 3 i k \text{As20}[r1, \text{th}] - 3 i k \text{As21}[r1, \text{th}] - \frac{12 \text{alphax As21}[r1, \text{th}]}{r1^3} - 3 i k \text{As22}[r1, \text{th}] - 3 i k \text{As23}[r1, \text{th}] - \frac{12 \text{alphax As23}[r1, \text{th}]}{r1^3} - 12 i \text{As01}[r1, \text{th}] \text{Csc}[\text{th}] - 12 i \text{As03}[r1, \text{th}] \text{Csc}[\text{th}] - \text{Es20}[r1, \text{th}] - \text{Es21}[r1, \text{th}] - \text{Es22}[r1, \text{th}] - \text{Es23}[r1, \text{th}] + \frac{3 \text{As00}^{(0,1)}[r1, \text{th}]}{r1} - \frac{3 \text{As01}^{(0,1)}[r1, \text{th}]}{r1} - \frac{3 \text{As02}^{(0,1)}[r1, \text{th}]}{r1} - \frac{3 \text{As03}^{(0,1)}[r1, \text{th}]}{r1} - 3 \text{As00}^{(1,0)}[r1, \text{th}] + 3 \text{As01}^{(1,0)}[r1, \text{th}] + 3 \text{As02}^{(1,0)}[r1, \text{th}] - 3 \text{As03}^{(1,0)}[r1, \text{th}] \end{aligned}$$

The solution at infinity  $\{\text{Esi2i}, \text{Asi0i}, \text{Asi1i}, \text{Asi2i}, \text{Asi3i}\}$ , i.e. order  $O(1)$  in *r*-powers is



$$\begin{aligned}
& \{ Es20[r1, th] \rightarrow 0, Es21[r1, th] \rightarrow 0, Es22[r1, th] \rightarrow 0, Es23[r1, th] \rightarrow 0, As00[r1, th] \rightarrow As00[th], As01[r1, th] \rightarrow As00[th], As02[r1, th] \rightarrow -As00[th], As03[r1, th] \rightarrow As00[th], \\
& As10[r1, th] \rightarrow As00[th], As11[r1, th] \rightarrow As00[th], As12[r1, th] \rightarrow -As00[th], As13[r1, th] \rightarrow As00[th], As20[r1, th] \rightarrow 0, As21[r1, th] \rightarrow 0, As22[r1, th] \rightarrow 0, As23[r1, th] \rightarrow 0, As30[r1, th] \rightarrow 0, \\
& As31[r1, th] \rightarrow 0, As32[r1, th] \rightarrow 0, As33[r1, th] \rightarrow 0, Es00[r1, th] \rightarrow \frac{3(As00[th] - As00'[th])}{r1}, Es01[r1, th] \rightarrow -\frac{3(As00[th] - As00'[th])}{r1}, Es02[r1, th] \rightarrow \frac{3(As00[th] - As00'[th])}{r1}, \\
& Es03[r1, th] \rightarrow -\frac{3(As00[th] + As00'[th])}{r1}, Es10[r1, th] \rightarrow \frac{3(As00[th] + As00'[th])}{r1}, Es11[r1, th] \rightarrow -\frac{3(As00[th] + As00'[th])}{r1}, Es12[r1, th] \rightarrow \frac{3(As00[th] + As00'[th])}{r1}, \\
& Es13[r1, th] \rightarrow -\frac{3(As00[th] + As00'[th])}{r1}, Es30[r1, th] \rightarrow \frac{3As00[th]}{r1}, Es31[r1, th] \rightarrow -\frac{3As00[th]}{r1}, Es32[r1, th] \rightarrow \frac{3As00[th]}{r1}, Es33[r1, th] \rightarrow -\frac{3As00[th]}{r1} \}
\end{aligned}$$

with the free parameter variable  $As00(\theta)$ , which describes the wave  $As_{00}(r, \theta) = \frac{As_{00}(\theta)}{r} \exp(-ik(r-t))$

generated by the bgr.

Now we insert for the parameters  $k = \frac{1}{\sqrt{2r_0^3}}$  and  $\alpha = \frac{c_0}{r_0}$ , so the equations depend now only on

the bgr-parameter  $r_0$

$eqtoievnu3wdAs = eqtoievnu3wdAs(r_0, Es2, As0, As1, As2, As3)$

and in powers of  $r_0$  the dependence is

$eqtoievnu3wdAs = eqtoievnu3wdAs0 + eqtoievnu3wdAs1/r_0 + eqtoievnu3wdAs1/r_0^{3/2} + \dots$

the parameter variable  $As00(r, \theta, r_0)$  has to satisfy the equations also in  $r_0$ .

Our goal in the following subsection is to calculate  $As00(r, \theta, r_0)$  analytically in  $\{\theta, r_0\}$  as a series in  $r$ , and all other variables, too.

$$As00(r, \theta, r_0) = (As00n00(\theta) + \frac{As00n01(\theta)}{r_0} + \frac{As00n02(\theta)}{r_0^{3/2}} + \dots) + \frac{(As00n10(\theta) + \frac{As00n11(\theta)}{r_0} + \frac{As00n12(\theta)}{r_0^{3/2}} + \dots)}{r} + \dots$$

The first term in  $As00$  describes the wave at infinity and the dependence of the amplitude on the parameter  $r_0$  of the bgr. An important result of the following subsection is :

$As00(r, \theta, r_0)$

$$As00n00(\theta) = 0, \text{ i.e. in first approximation for } r_0 \rightarrow \infty \quad As00(r, \theta, r_0) = \frac{As00n01(\theta)}{r_0}$$

#### 4.7.2. Solution as a series in $r$ -powers by comparison of coefficients

we transform  $r \rightarrow 1/z$  and develop in a series in  $z$  around  $z=0$  :

$$Es_{20}[z, th] \rightarrow K_{1n0}[th] + z K_{1n1}[th] + z^2 K_{1n2}[th] + z^3 K_{1n3}[th] + z^4 K_{1n4}[th]$$

...

$$As_{33}[z, th] \rightarrow K_{20n0}[th] + z K_{20n1}[th] + z^2 K_{20n2}[th] + z^3 K_{20n3}[th] + z^4 K_{20n4}[th]$$

$\{K_{1n0}(\theta), \dots, K_{20n0}(\theta)\}$  is the solution at infinity  $\{E_{si2i}, A_{si0i}, A_{si1i}, A_{si2i}, A_{si3i}\}$  from above equations in a series in  $z$  and get 5 groups of equations, each for a coefficient of  $z^k$ ,  $k=0,1,2,3,4$

$$eq_{toievnu3wdAzKcn0} = coef(z^0)$$

$$eq_{toievnu3wdAzKcn1} = coef(z^1)$$

$$eq_{toievnu3wdAzKcn2} = coef(z^2)$$

$$eq_{toievnu3wdAzKcn3} = coef(z^3)$$

$$eq_{toievnu3wdAzKcn4} = coef(z^4)$$

In order to develop the 20 variables  $\{Es2i, As0i, As1i, As2i, As3i\}$  and the equations in a series in  $r$ -powers around  $r=\infty$ , we transform  $r \rightarrow l/z$  and develop in a series in  $z$  around  $z=0$ :

$$Es20[z, th] \rightarrow K1n0[th] + z K1n1[th] + z^2 K1n2[th] + z^3 K1n3[th] + z^4 K1n4[th]$$

$$\dots$$

$$As33[z, th] \rightarrow K20n0[th] + z K20n1[th] + z^2 K20n2[th] + z^3 K20n3[th] + z^4 K20n4[th]$$

$\{K1n0(\theta), \dots, K20n0(\theta)\}$  is the solution at infinity  $\{Esi2i, Asi0i, Asi1i, Asi2i, Asi3i\}$  from 4.7.1.

Then we develop the equations in a series in  $z$  and get 5 groups of equations, each for a coefficient of  $z^k$ ,  $k=0,1,2,3,4$

$$eqtoievnu3wdAzKcn0 = coef(z^0)$$

$$eqtoievnu3wdAzKcn1 = coef(z^1)$$

$$eqtoievnu3wdAzKcn2 = coef(z^2)$$

$$eqtoievnu3wdAzKcn3 = coef(z^3)$$

$$eqtoievnu3wdAzKcn4 = coef(z^4)$$

$eqtoievnu3wdAzKcn0$  vanishes identically, because the ansatz already solves the equations at infinity.

The remaining 4 equation groups have to be solved consecutively and the solution inserted in the next equation group, until  $eqtoievnu3wdAzKcn4$  is solved.

The solution of  $eqtoievnu3wdAzKcn1$  :

$rKvardAn1 =$

$$\{K1n1[th] \rightarrow \frac{3(-i As00 + 3k K10n1[th] - 3k K6n1[th])}{i + Csc[th]}, K2n1[th] \rightarrow \frac{3(-i As00 - k K10n1[th] + k K6n1[th])}{i + Csc[th]}, K4n1[th] \rightarrow \frac{3(-i As00 - k K10n1[th] + k K6n1[th])}{i + Csc[th]}, K5n1[th] \rightarrow -K10n1[th] + K6n1[th] + K9n1[th],$$

$$K12n1[th] \rightarrow K10n1[th] - K6n1[th] + K8n1[th], K13n1[th] \rightarrow \frac{Csc[th](i As00 - k K10n1[th] - (2i + k - 2 Csc[th]) K6n1[th] + 2i K8n1[th] + 2 Csc[th] K8n1[th])}{k(i + Csc[th])},$$

$$K14n1[th] \rightarrow \frac{Csc[th](i As00 - (2i + k - 2 Csc[th]) K10n1[th] + (2i - k - 2 Csc[th]) K6n1[th] - 2i K8n1[th] - 2 Csc[th] K8n1[th] - 2i K9n1[th] + 2 Csc[th] K9n1[th])}{k(i + Csc[th])},$$

$$K15n1[th] \rightarrow K11n1[th] - \frac{3i As00 - i K3n1[th] + 3k K7n1[th]}{3k}, K16n1[th] \rightarrow \frac{Csc[th](i As00 + (2i + k + 2 Csc[th]) K10n1[th] - k K6n1[th] - 2(i + Csc[th]) K9n1[th])}{k(i + Csc[th])},$$

$$K17n1[th] \rightarrow \frac{As00 - i k K10n1[th] + i(2i + k + 2 Csc[th]) K6n1[th] + 2 K8n1[th] - 2i Csc[th] K8n1[th]}{k(i + Csc[th])},$$

$$K18n1[th] \rightarrow \frac{As00 - i(2i + k - 2 Csc[th]) K10n1[th] + (2 + i k - 2 Csc[th]) K6n1[th] - 2 K8n1[th] - 2i Csc[th] K8n1[th] + 2 K9n1[th] - 2i Csc[th] K9n1[th]}{k(i - Csc[th])},$$

$$K19n1[th] \rightarrow \frac{i K3n1[th]}{3k}, K20n1[th] \rightarrow \frac{As00 - i(2i + k + 2 Csc[th]) K10n1[th] + i k K6n1[th] - 2 K9n1[th] + 2i Csc[th] K9n1[th]}{k(i + Csc[th])}$$

remaining free variables  $KvardAn1f$

$$\{K3n1[th], K6n1[th], K7n1[th], K8n1[th], K9n1[th], K10n1[th], K11n1[th]\}$$

The solution of  $eqtoievnu3wdAzKcn2$  :

$rKvardAn2 =$

$$\{K6n1[th] \rightarrow \frac{(As00 - i k K10n1[th])}{k}, K7n1[th] \rightarrow \frac{i(As00 + i k K11n1[th])}{k}, K3n1[th] \rightarrow 0,$$

$$K1n2[th] \rightarrow \frac{3k K10n2[th] - 3k K6n2[th]}{i - Csc[th]} - \frac{1}{4k(i + Csc[th])^2} \{3(-8i As00 - 8As00 Csc[th] - As00 Cot[th] Csc[th] + i As00 k Cot[th] Csc[th] -$$

$$i As00 Cot[th] Csc[th]^2 - 8k K10n1[th] - 8i k Csc[th] K10n1[th] - i k Cot[th] Csc[th] K10n1[th] - k^2 Cot[th] Csc[th] K10n1[th] - k Cot[th] Csc[th]^2 K10n1[th] -$$

$$i k Cot[th] Csc[th] K8n1[th] - k^2 Cot[th] Csc[th] K8n1[th] - k Cot[th] Csc[th]^2 K8n1[th] + 2i k Cot[th] Csc[th] K9n1[th] + 2k Cot[th] Csc[th]^2 K9n1[th]\},$$

$$K2n2[th] \rightarrow \frac{3k K10n2[th] - 3k K6n2[th]}{i - Csc[th]} - \frac{1}{4k(i + Csc[th])^2} \{3(-8i As00 - 8As00 Csc[th] - As00 Cot[th] Csc[th] + i As00 k Cot[th] Csc[th] - i As00 Cot[th] Csc[th]^2 -$$

$$8k K10n1[th] - 8i k Csc[th] K10n1[th] + i k Cot[th] Csc[th] K10n1[th] - k^2 Cot[th] Csc[th] K10n1[th] - k Cot[th] Csc[th]^2 K10n1[th] +$$

$$i k Cot[th] Csc[th] K8n1[th] - k^2 Cot[th] Csc[th] K8n1[th] + k Cot[th] Csc[th]^2 K8n1[th] - 2i k Cot[th] Csc[th] K9n1[th] - 2k Cot[th] Csc[th]^2 K9n1[th]\},$$

$$K3n2[th] \rightarrow \frac{6(-i As00 - k K11n1[th])}{k} - 3i k K11n2[th] - 3i k K15n2[th] - 3i k K7n2[th], K4n2[th] \rightarrow \frac{3k K10n2[th] - 3k K6n2[th]}{i + Csc[th]} - \frac{1}{4k(i + Csc[th])^2}$$

$$\{3(-8i As00 - 8As00 Csc[th] - As00 Cot[th] Csc[th] + i As00 k Cot[th] Csc[th] - i As00 Cot[th] Csc[th]^2 - 8k K10n1[th] - 8i k Csc[th] K10n1[th] - i k Cot[th] Csc[th] K10n1[th] - k^2 Cot[th] Csc[th]$$

$$K10n1[th] + k Cot[th] Csc[th]^2 K10n1[th] + i k Cot[th] Csc[th] K8n1[th] - k^2 Cot[th] Csc[th] K8n1[th] + k Cot[th] Csc[th]^2 K8n1[th] + 2i k Cot[th] Csc[th] K9n1[th] - 2k Cot[th] Csc[th]^2 K9n1[th]\},$$

$$K5n2[th] \rightarrow -K10n2[th] + K6n2[th] - \frac{2i(K10n1[th] + K9n1[th])}{k} - K9n2[th], K8n2[th] \rightarrow -K10n2[th] + K12n2[th] - K6n2[th] - \frac{2i(i As00 - k K10n1[th] - k K8n1[th])}{k^2},$$

$$K13n2[th] \rightarrow \frac{Csc[th](2i - k + 2 Csc[th]) K10n2[th] - 2 Csc[th] K12n2[th] - Csc[th] K6n2[th]}{k(i + Csc[th])} - \frac{1}{4k^3(i - Csc[th])^2}$$

$$\{16As00 Csc[th] + 8i As00 k Csc[th] - i As00 k Cot[th] Csc[th] - As00 k^2 Cot[th] Csc[th] - 32i As00 Csc[th]^2 + 8As00 k Csc[th]^2 - As00 k Cot[th] Csc[th]^2 -$$

$$16As00 Csc[th]^3 - 16i k Csc[th] K10n1[th] - 8k^2 Csc[th] K10n1[th] - k^2 Cot[th] Csc[th] K10n1[th] - i k^3 Cot[th] Csc[th] K10n1[th] - 32k Csc[th]^2 K10n1[th] -$$

$$8i k^2 Cot[th] Csc[th]^2 K10n1[th] - i k^2 Cot[th] Csc[th]^2 K10n1[th] - 16i k Csc[th]^3 K10n1[th] - 16i k Csc[th] K8n1[th] - k^2 Cot[th] Csc[th] K8n1[th] - i k^2 Cot[th] Csc[th]^2 K8n1[th] +$$

$$32k Csc[th]^2 K8n1[th] - i k^2 Cot[th] Csc[th]^2 K8n1[th] - 16i k Csc[th]^3 K8n1[th] - 2k^2 Cot[th] Csc[th] K9n1[th] - 2i k^2 Cot[th] Csc[th]^2 K9n1[th]\},$$

$$K14n2[th] \rightarrow \frac{Csc[th] K10n2[th] - 2 Csc[th] K12n2[th] - Csc[th] K6n2[th]}{k} - \frac{1}{4k^3(i - Csc[th])^2} \{-16As00 Csc[th] - 8i As00 k Csc[th] - i As00 k Cot[th] Csc[th] - As00 k^2 Cot[th] Csc[th] +$$

$$32i As00 Csc[th]^2 + 8As00 k Csc[th]^2 - As00 k Cot[th] Csc[th]^2 + 16As00 Csc[th]^3 + 8k^2 Csc[th] K10n1[th] - 3k^2 Cot[th] Csc[th] K10n1[th] + i k^3 Cot[th] Csc[th] K10n1[th] - 8i k^2 Csc[th]^2 K10n1[th] -$$

$$3i k^2 Cot[th] Csc[th]^2 K10n1[th] - 16i k Csc[th] K8n1[th] - k^2 Cot[th] Csc[th] K8n1[th] - i k^2 Cot[th] Csc[th]^2 K8n1[th] - 32k Csc[th]^2 K8n1[th] - i k^2 Cot[th] Csc[th]^2 K8n1[th] +$$

$$16i k Csc[th]^3 K8n1[th] + 16i k Csc[th] K9n1[th] + 2k^2 Cot[th] Csc[th] K9n1[th] + 32k Csc[th]^2 K9n1[th] - 2i k^2 Cot[th] Csc[th]^2 K9n1[th] - 16i k Csc[th]^3 K9n1[th]\} + \frac{2 Csc[th] K9n2[th]}{k},$$

$$K16n2[th] \rightarrow \frac{Csc[th](2i - k + 2 Csc[th]) K10n2[th] - Csc[th] K6n2[th]}{k(i + Csc[th])} - \frac{1}{4k^2(i - Csc[th])^2} \{8i As00 Csc[th] + 3i As00 Cot[th] Csc[th] - As00 k Cot[th] Csc[th] + 8As00 Csc[th]^2 +$$

$$3As00 Cot[th] Csc[th]^2 + 16i Csc[th] K10n1[th] - 8k Csc[th] K10n1[th] + k Cot[th] Csc[th] K10n1[th] + i k^2 Cot[th] Csc[th] K10n1[th] - 32Csc[th]^2 K10n1[th] -$$

$$8i k Csc[th]^2 K10n1[th] - i k Cot[th] Csc[th]^2 K10n1[th] - 16i Csc[th]^3 K10n1[th] - 3k Cot[th] Csc[th] K8n1[th] - i k^2 Cot[th] Csc[th] K8n1[th] - 3i k Cot[th] Csc[th]^2 K8n1[th] -$$

$$16i Csc[th] K9n1[th] - 2k Cot[th] Csc[th] K9n1[th] - 32Csc[th]^2 K9n1[th] - 2i k Cot[th] Csc[th]^2 K9n1[th] - 16i Csc[th]^3 K9n1[th]\} - \frac{2 Csc[th] K9n2[th]}{k},$$

$$\begin{aligned}
 K16n2[th] &= \frac{Csc[th](2i-k-2Csc[th])K10n2[th]}{k(i+Csc[th])} - \frac{Csc[th]K6n2[th]}{i+Csc[th]} - \frac{1}{4k^2(i-Csc[th])^2} (8iAs00Csc[th]+3iAs00Cot[th]Csc[th]-As00kCot[th]Csc[th]+8As00Csc[th]^2- \\
 & 3As00Cot[th]Csc[th]^2-16iCsc[th]K10n1[th]-8kCsc[th]K10n1[th]-kCot[th]Csc[th]K10n1[th]+k^2Cot[th]Csc[th]K10n1[th]-32Csc[th]^2K10n1[th]- \\
 & 8ikCsc[th]^2K10n1[th]-ikCot[th]Csc[th]^2K10n1[th]-16iCsc[th]^3K10n1[th]-3kCot[th]Csc[th]K8n1[th]-ik^2Cot[th]Csc[th]K8n1[th]-3ikCot[th]Csc[th]^2K8n1[th]- \\
 & 16iCsc[th]K9n1[th]-2kCot[th]Csc[th]K9n1[th]-32Csc[th]^2K9n1[th]-2ikCot[th]Csc[th]^2K9n1[th]-16iCsc[th]^3K9n1[th]) - \frac{2Csc[th]K9n2[th]}{k}, \\
 K17n2[th] &= \frac{(2-i-k-2iCsc[th])K10n2[th]}{k(i+Csc[th])} - \frac{2iK12n2[th]}{k} - \frac{iK6n2[th]}{i+Csc[th]} - \frac{1}{4k^3(i-Csc[th])^2} (-16iAs00-8As00k-32As00Csc[th]-8iAs00kCsc[th]-iAs00kCot[th]Csc[th]- \\
 & As00k^2Cot[th]Csc[th]-16iAs00Csc[th]^2-As00kCot[th]Csc[th]^2-16kK10n1[th]-8ik^2K10n1[th]+32ikCsc[th]K10n1[th]-8k^2Csc[th]K10n1[th]- \\
 & k^2Cot[th]Csc[th]K10n1[th]-ik^3Cot[th]Csc[th]K10n1[th]-16kCsc[th]^2K10n1[th]-ik^2Cot[th]Csc[th]^2K10n1[th]-16kK8n1[th]-32ikCsc[th]K8n1[th]- \\
 & k^2Cot[th]Csc[th]K8n1[th]-ik^3Cot[th]Csc[th]K8n1[th]-16kCsc[th]^2K8n1[th]-ik^2Cot[th]Csc[th]^2K8n1[th]-2k^2Cot[th]Csc[th]K9n1[th]-2ik^2Cot[th]Csc[th]^2K9n1[th]), \\
 K18n2[th] &= \frac{iK10n2[th]}{i+Csc[th]} - \frac{2iK12n2[th]}{k} - \frac{iK6n2[th]}{i+Csc[th]} - \frac{1}{4k^3(i+Csc[th])^2} (16iAs00-8As00k+32As00Csc[th]-8iAs00kCsc[th]-iAs00kCot[th]Csc[th]-As00k^2Cot[th]Csc[th]- \\
 & 16iAs00Csc[th]^2-As00kCot[th]Csc[th]^2-8ik^2K10n1[th]-8k^2Csc[th]K10n1[th]-3k^2Cot[th]Csc[th]K10n1[th]-i^3k^3Cot[th]Csc[th]K10n1[th]- \\
 & 3ik^2Cot[th]Csc[th]^2K10n1[th]-16kK8n1[th]+32ikCsc[th]K8n1[th]+k^2Cot[th]Csc[th]K8n1[th]-ik^3Cot[th]Csc[th]K8n1[th]+16kCsc[th]^2K8n1[th]- \\
 & ik^2Cot[th]Csc[th]^2K8n1[th]-16kK9n1[th]-32ikCsc[th]K9n1[th]-2k^2Cot[th]Csc[th]K9n1[th]-16kCsc[th]^2K9n1[th]-2ik^2Cot[th]Csc[th]^2K9n1[th]) - \frac{2iK9n2[th]}{k}, \\
 K19n2[th] &= \frac{2(As00-iK11n1[th])}{k^2} - \frac{K11n2[th]+K15n2[th]+K7n2[th]+K20n2[th]}{k(i-Csc[th])} - \frac{i(2i+k-2Csc[th])K10n2[th]}{k(i-Csc[th])} - \frac{iK6n2[th]}{i-Csc[th]} - \\
 & \frac{1}{4k^2(i-Csc[th])^2} (8As00-8iAs00Csc[th]+3iAs00Cot[th]Csc[th]-As00kCot[th]Csc[th]-3As00Cot[th]Csc[th]^2+16K10n1[th]-8ikK10n1[th]-32iCsc[th]K10n1[th]-8kCsc[th]K10n1[th]+ \\
 & kCot[th]Csc[th]K10n1[th]+ik^2Cot[th]Csc[th]K10n1[th]-16Csc[th]^2K10n1[th]-ikCot[th]Csc[th]^2K10n1[th]-3kCot[th]Csc[th]K8n1[th]-ik^2Cot[th]Csc[th]K8n1[th]- \\
 & 3ikCot[th]Csc[th]^2K8n1[th]-16K9n1[th]-32iCsc[th]K9n1[th]-2kCot[th]Csc[th]K9n1[th]-16Csc[th]^2K9n1[th]-2ikCot[th]Csc[th]^2K9n1[th]) - \frac{2iK9n2[th]}{k}
 \end{aligned}$$

remaining free variables  $KvardAn12f$

$$\{K8n1[th], K9n1[th], K10n1[th], K11n1[th], K6n2[th], K7n2[th], K9n2[th], K10n2[th], K11n2[th], K12n2[th], K15n2[th]\}$$

The solution of  $eqtoievnu3wdAzKcn3$  :

$rKvardAn31=$  3 variables  $K9n2(\theta)$ ,  $K10n2(\theta)$ ,  $K11n2(\theta)$

$$\begin{aligned}
 K9n2[th] &= \left( 24As00r0x^3-192As00r0x^6-384iAs00r0x^6Csc[th]-192As00r0x^6Csc[th]^2-12i\sqrt{2}r0x^3^2K12n2[th]-48r0x^3K12n2[th]-12\sqrt{2}r0x^3^2Csc[th]K12n2[th]-96i r0x^3^2Csc[th]K12n2[th]+ \right. \\
 & 48r0x^3^2Csc[th]^2K12n2[th]-4K12n3[th]-8i\sqrt{2}r0x^3^2K12n3[th]+4iCsc[th]K12n3[th]+16\sqrt{2}r0x^3^2Csc[th]K12n3[th]-8i\sqrt{2}r0x^3^2Csc[th]^2K12n3[th]-\frac{i\sqrt{2}K13n3[th]}{r0x^3^2}, \\
 & 4K14n3[th]-4iCsc[th]K14n3[th]+\frac{i\sqrt{2}K17n3[th]}{r0x^3^2}-4K18n3[th]+4iCsc[th]K18n3[th]-\frac{i\sqrt{2}K5n3[th]}{r0x^3^2}+4K6n3[th]-4iCsc[th]K6n3[th]-48r0x^3K8n1[th]-96i\sqrt{2}r0x^3^2K8n1[th]- \\
 & 48i r0x^3^2Csc[th]K8n1[th]-192\sqrt{2}r0x^3^2Csc[th]K8n1[th]+96i\sqrt{2}r0x^3^2Csc[th]^2K8n1[th]-12i\sqrt{2}r0x^3^2K9n1[th]-96i\sqrt{2}r0x^3^2K9n1[th]-192\sqrt{2}r0x^3^2Csc[th]K9n1[th]- \\
 & 96i\sqrt{2}r0x^3^2Csc[th]^2K9n1[th]+\frac{i\sqrt{2}K9n3[th]}{r0x^3^2}-8i\sqrt{2}r0x^3^2K9n3[th]-16\sqrt{2}r0x^3^2Csc[th]K9n3[th]-8i\sqrt{2}r0x^3^2Csc[th]^2K9n3[th]) / (6-48r0x^3-96i r0x^3^2Csc[th]-48r0x^3^2Csc[th]^2), \\
 K10n2[th] &= \left( 24As00r0x^3-192As00r0x^6+384iAs00r0x^6Csc[th]-192As00r0x^6Csc[th]^2-12i\sqrt{2}r0x^3^2K10n1[th]-96i\sqrt{2}r0x^3^2K10n1[th]-192\sqrt{2}r0x^3^2Csc[th]K10n1[th]- \right. \\
 & 96i\sqrt{2}r0x^3^2Csc[th]^2K10n1[th]+\frac{i\sqrt{2}K10n3[th]}{r0x^3^2}-8i\sqrt{2}r0x^3^2K10n3[th]-16\sqrt{2}r0x^3^2Csc[th]K10n3[th]+8i\sqrt{2}r0x^3^2Csc[th]^2K10n3[th]-12i\sqrt{2}r0x^3^2K12n2[th]-48r0x^3K12n2[th]- \\
 & 12\sqrt{2}r0x^3^2Csc[th]K12n2[th]+96i r0x^3^2Csc[th]K12n2[th]-48r0x^3^2Csc[th]^2K12n2[th]-4K12n3[th]+8i\sqrt{2}r0x^3^2K12n3[th]-4iCsc[th]K12n3[th]-16\sqrt{2}r0x^3^2Csc[th]K12n3[th]- \\
 & 8i\sqrt{2}r0x^3^2Csc[th]^2K12n3[th]-4K13n3[th]+4iCsc[th]K13n3[th]-\frac{i\sqrt{2}K14n3[th]}{r0x^3^2}-4K17n3[th]-4iCsc[th]K17n3[th]+\frac{i\sqrt{2}K18n3[th]}{r0x^3^2}-4K5n3[th]+4iCsc[th]K5n3[th]-\frac{i\sqrt{2}K6n3[th]}{r0x^3^2}- \\
 & 48r0x^3K8n1[th]-96i\sqrt{2}r0x^3^2K8n1[th]+48i r0x^3^2Csc[th]K8n1[th]-192\sqrt{2}r0x^3^2Csc[th]K8n1[th]+96i\sqrt{2}r0x^3^2Csc[th]^2K8n1[th]) / (6-48r0x^3-96i r0x^3^2Csc[th]-48r0x^3^2Csc[th]^2), \\
 K11n2[th] &= -\frac{24As00r0x^3+12i\sqrt{2}r0x^3K11n1[th]-i\sqrt{2}K11n3[th]+i\sqrt{2}K15n3[th]+i\sqrt{2}K19n3[th]+i\sqrt{2}K7n3[th]}{6r0x^3^2}
 \end{aligned}$$

$rKvardAn32=$  4 variables  $K15n2(\theta)$ ,  $K12n2(\theta)$ ,  $K6n2(\theta)$ ,  $K7n2(\theta)$

$$\begin{aligned}
 K15n2[th] &= \frac{1}{3}i\sqrt{2}r0x^3^2(K11n1[th]-K11n1'[th]), \\
 K12n2[th] &= \left( i\sqrt{2}K12n3[th]-24i\sqrt{2}r0x^3K12n3[th]-48\sqrt{2}r0x^3Csc[th]K12n3[th]-24i\sqrt{2}r0x^3^2Csc[th]K12n3[th]-4r0x^3^2K13n3[th]-8i\sqrt{2}r0x^3K13n3[th]-4i r0x^3^2Csc[th]K13n3[th]+ \right. \\
 & 16\sqrt{2}r0x^3Csc[th]K13n3[th]-8i\sqrt{2}r0x^3^2Csc[th]^2K13n3[th]-4r0x^3^2K14n3[th]+8i\sqrt{2}r0x^3K14n3[th]+4i r0x^3^2Csc[th]K14n3[th]+16\sqrt{2}r0x^3Csc[th]K14n3[th]- \\
 & 8i\sqrt{2}r0x^3^2Csc[th]^2K14n3[th]-i\sqrt{2}K16n3[th]-8i\sqrt{2}r0x^3K16n3[th]-16\sqrt{2}r0x^3Csc[th]K16n3[th]-8i\sqrt{2}r0x^3^2Csc[th]^2K16n3[th]-4r0x^3^2K17n3[th]-8i\sqrt{2}r0x^3K17n3[th]- \\
 & 4i r0x^3^2Csc[th]K17n3[th]-16\sqrt{2}r0x^3Csc[th]K17n3[th]-8i\sqrt{2}r0x^3^2Csc[th]^2K17n3[th]-4r0x^3^2K18n3[th]+8i\sqrt{2}r0x^3K18n3[th]+4i r0x^3^2Csc[th]K18n3[th]- \\
 & 16\sqrt{2}r0x^3Csc[th]K18n3[th]-8i\sqrt{2}r0x^3^2Csc[th]^2K18n3[th]-i\sqrt{2}K20n3[th]-8i\sqrt{2}r0x^3K20n3[th]-16\sqrt{2}r0x^3Csc[th]K20n3[th]-8i\sqrt{2}r0x^3^2Csc[th]^2K20n3[th]-4r0x^3^2K5n3[th]- \\
 & 8i\sqrt{2}r0x^3K5n3[th]-4i r0x^3^2Csc[th]K5n3[th]-16\sqrt{2}r0x^3Csc[th]K5n3[th]-8i\sqrt{2}r0x^3^2Csc[th]^2K5n3[th]-4r0x^3^2K6n3[th]-8i\sqrt{2}r0x^3K6n3[th]+4i r0x^3^2Csc[th]K6n3[th]- \\
 & 16\sqrt{2}r0x^3Csc[th]K6n3[th]-8i\sqrt{2}r0x^3^2Csc[th]^2K6n3[th]-12i\sqrt{2}r0x^3K8n1[th]-288i\sqrt{2}r0x^6K8n1[th]-576\sqrt{2}r0x^6Csc[th]K8n1[th]-288i\sqrt{2}r0x^6Csc[th]^2K8n1[th]- \\
 & i\sqrt{2}K8n3[th]-8i\sqrt{2}r0x^3K8n3[th]-16\sqrt{2}r0x^3Csc[th]K8n3[th]-8i\sqrt{2}r0x^3^2Csc[th]^2K8n3[th]) / (6r0x^3^2-1-24r0x^3-48i r0x^3^2Csc[th]-24r0x^3^2Csc[th]^2), \\
 K6n2[th] &= \left( -\text{Sin}[th](-3\sqrt{2}As00r0x^3Cot[th]Csc[th]-18iAs00r0x^3Cot[th]Csc[th]-72\sqrt{2}As00r0x^3Cot[th]Csc[th]-432iAs00r0x^3^2Cot[th]Csc[th]-18As00r0x^3^2Cot[th]Csc[th]^2- \right. \\
 & 144i\sqrt{2}As00r0x^6Cot[th]Csc[th]^2-1296As00r0x^6Cot[th]Csc[th]^2-72\sqrt{2}As00r0x^6Cot[th]Csc[th]^3-1296iAs00r0x^6Cot[th]Csc[th]^3+432As00r0x^6Cot[th]Csc[th]^4- \\
 & 3i r0x^3^2Cot[th]Csc[th]K10n1[th]-9\sqrt{2}r0x^3Cot[th]Csc[th]K10n1[th]-72i r0x^3Cot[th]Csc[th]K10n1[th]-216\sqrt{2}r0x^3Cot[th]Csc[th]K10n1[th]-9i\sqrt{2}r0x^3Cot[th]Csc[th]^2K10n1[th]- \\
 & 144r0x^3^2Cot[th]Csc[th]^2K10n1[th]-648i\sqrt{2}r0x^6Cot[th]Csc[th]^2K10n1[th]-72i r0x^3^2Cot[th]Csc[th]^3K10n1[th]-648\sqrt{2}r0x^6Cot[th]Csc[th]^3K10n1[th]- \\
 & 216i\sqrt{2}r0x^6Cot[th]Csc[th]^4K10n1[th]-2\sqrt{2}Csc[th]K10n3[th]-48\sqrt{2}r0x^3Csc[th]K10n3[th]-48\sqrt{2}r0x^3^2Csc[th]^2K10n3[th]-144i\sqrt{2}r0x^3Csc[th]^2K10n3[th]-144\sqrt{2}r0x^3Csc[th]^3K10n3[th]- \\
 & 48i\sqrt{2}r0x^3^2Csc[th]^4K10n3[th]-8i r0x^3^2Csc[th]K13n3[th]-48\sqrt{2}r0x^3Csc[th]K13n3[th]-16r0x^3^2Csc[th]^2K13n3[th]-144i\sqrt{2}r0x^3Csc[th]^2K13n3[th]-144\sqrt{2}r0x^3Csc[th]^3K13n3[th]- \\
 & 144\sqrt{2}r0x^3Csc[th]^4K13n3[th]-48i\sqrt{2}r0x^3Csc[th]^4K13n3[th]-2\sqrt{2}Csc[th]K14n3[th]-16i r0x^3^2Csc[th]K14n3[th]-48\sqrt{2}r0x^3Csc[th]K14n3[th]-48\sqrt{2}r0x^3^2Csc[th]^2K14n3[th]- \\
 & 32r0x^3^2Csc[th]^3K14n3[th]-144i\sqrt{2}r0x^3Csc[th]^2K14n3[th]-16i r0x^3^2Csc[th]^3K14n3[th]-144\sqrt{2}r0x^3Csc[th]^3K14n3[th]-48i\sqrt{2}r0x^3Csc[th]^4K14n3[th]+8i r0x^3^2Csc[th]K16n3[th]- \\
 & 48\sqrt{2}r0x^3Csc[th]K16n3[th]-16r0x^3^2Csc[th]^2K16n3[th]-144i\sqrt{2}r0x^3Csc[th]^2K16n3[th]-144\sqrt{2}r0x^3Csc[th]^3K16n3[th]-144\sqrt{2}r0x^3Csc[th]^4K16n3[th]-8i r0x^3^2Csc[th]K17n3[th]- \\
 & 48\sqrt{2}r0x^3Csc[th]K17n3[th]-48\sqrt{2}r0x^3^2Csc[th]^2K17n3[th]-16r0x^3^2Csc[th]^3K17n3[th]-144i\sqrt{2}r0x^3Csc[th]^3K17n3[th]-144\sqrt{2}r0x^3Csc[th]^4K17n3[th]+48i \\
 & i\sqrt{2}r0x^3Csc[th]^4K17n3[th]-2\sqrt{2}Csc[th]K18n3[th]-16i r0x^3^2Csc[th]K18n3[th]-48\sqrt{2}r0x^3Csc[th]K18n3[th]-2i\sqrt{2}Csc[th]K18n3[th]-32r0x^3^2Csc[th]^2K18n3[th]- \\
 & 144i\sqrt{2}r0x^3Csc[th]^2K18n3[th]-16i r0x^3^2Csc[th]^3K18n3[th]-144\sqrt{2}r0x^3Csc[th]^3K18n3[th]-48i\sqrt{2}r0x^3Csc[th]^4K18n3[th]-8i r0x^3^2Csc[th]K20n3[th]-48\sqrt{2}r0x^3Csc[th]K20n3[th]- \\
 & 16r0x^3^2Csc[th]^2K20n3[th]-144i\sqrt{2}r0x^3Csc[th]^2K20n3[th]-8i r0x^3^2Csc[th]^3K20n3[th]-144\sqrt{2}r0x^3Csc[th]^3K20n3[th]-48i\sqrt{2}r0x^3Csc[th]^4K20n3[th]-8i r0x^3^2Csc[th]K5n3[th]- \\
 & 48\sqrt{2}r0x^3Csc[th]K5n3[th]-16r0x^3^2Csc[th]^2K5n3[th]-144i\sqrt{2}r0x^3Csc[th]^2K5n3[th]-8i r0x^3^2Csc[th]^3K5n3[th]-144\sqrt{2}r0x^3Csc[th]^3K5n3[th]-48i\sqrt{2}r0x^3Csc[th]^4K5n3[th]- \\
 & 2\sqrt{2}Csc[th]K6n3[th]-48\sqrt{2}r0x^3Csc[th]K6n3[th]-384i r0x^3^2Csc[th]K6n3[th]-144i\sqrt{2}r0x^3Csc[th]^2K6n3[th]-1536r0x^3^2Csc[th]^2K6n3[th]-144\sqrt{2}r0x^3Csc[th]^3K6n3[th]- \\
 & 2304r0x^3^2Csc[th]^3K6n3[th]-48i\sqrt{2}r0x^3Csc[th]^4K6n3[th]-1536r0x^3^2Csc[th]^4K6n3[th]-384i r0x^3^2Csc[th]^5K6n3[th]-3i r0x^3^2Cot[th]Csc[th]K8n1[th]-9\sqrt{2}r0x^3Cot[th]Csc[th]K8n1[th]- \\
 & 72i r0x^3^2Cot[th]Csc[th]K8n1[th]-216\sqrt{2}r0x^6Cot[th]Csc[th]K8n1[th]-9i\sqrt{2}r0x^3Cot[th]Csc[th]^2K8n1[th]-144r0x^3^2Cot[th]Csc[th]^2K8n1[th]-648i\sqrt{2}r0x^6Cot[th]Csc[th]^2K8n1[th]- \\
 & 72i r0x^3^2Cot[th]Csc[th]^3K8n1[th]-648\sqrt{2}r0x^6Cot[th]Csc[th]^3K8n1[th]-216i\sqrt{2}r0x^6Cot[th]Csc[th]^4K8n1[th]-8i r0x^3^2Csc[th]K8n3[th]-8i r0x^3^2Csc[th]K8n3[th]- \\
 & 48\sqrt{2}r0x^3Csc[th]K8n3[th]-384i r0x^3^2Csc[th]K8n3[th]-16r0x^3^2Csc[th]^2K8n3[th]-144i\sqrt{2}r0x^3Csc[th]^2K8n3[th]-1536r0x^3^2Csc[th]^2K8n3[th]-8i r0x^3^2Csc[th]^3K8n3[th]- \\
 & 144\sqrt{2}r0x^3Csc[th]^3K8n3[th]-2304r0x^3^2Csc[th]^3K8n3[th]-48i\sqrt{2}r0x^3Csc[th]^4K8n3[th]-1536r0x^3^2Csc[th]^4K8n3[th]-384i r0x^3^2Csc[th]^5K8n3[th]-18\sqrt{2}r0x^3Cot[th]Csc[th]K9n1[th]- \\
 & 432\sqrt{2}r0x^6Cot[th]Csc[th]K9n1[th]-18i\sqrt{2}r0x^3Cot[th]Csc[th]^2K9n1[th]-1296i\sqrt{2}r0x^6Cot[th]Csc[th]^2K9n1[th]-1296\sqrt{2}r0x^6Cot[th]Csc[th]^3K9n1[th]- \\
 & 432i\sqrt{2}r0x^6Cot[th]Csc[th]^4K9n1[th]+4i\sqrt{2}r0x^3K11n1[th]-96i\sqrt{2}r0x^3Csc[th]K11n1[th]-8\sqrt{2}r0x^3Csc[th]K11n1[th]-384\sqrt{2}r0x^3Csc[th]K11n1[th]-4i\sqrt{2}r0x^3Csc[th]^2K11n1[th]- \\
 & 576i\sqrt{2}r0x^3Csc[th]^2K11n1[th]-384\sqrt{2}r0x^6Csc[th]^2K11n1[th]-96i\sqrt{2}r0x^6Csc[th]^4K11n1[th]-4i\sqrt{2}r0x^3K11n1[th]-96i\sqrt{2}r0x^3K11n1[th]-8\sqrt{2}r0x^3Csc[th]K11n1[th]- \\
 & 384\sqrt{2}r0x^3Csc[th]K11n1[th]-4i\sqrt{2}r0x^3Csc[th]^2K11n1[th]-576i\sqrt{2}r0x^6Csc[th]^2K11n1[th]+384\sqrt{2}r0x^6Csc[th]^4K11n1[th]) / \\
 & (12r0x^3^2(i-Csc[th])(1-24r0x^3-48i r0x^3^2Csc[th]+24r0x^3^2Csc[th]^2)), K7n2[th] = \frac{1}{36r0x^3^2(i+Csc[th])} \\
 & (12r0x^3^2(i-Csc[th])(1-24r0x^3+48i r0x^3^2Csc[th]+24r0x^3^2Csc[th]^2)), K7n2[th] = \frac{1}{36r0x^3^2(i+Csc[th])} \\
 Csc[th] &= \left( -9\sqrt{2}As00r0x^3Cos[th]-54iAs00r0x^3^2Cos[th]-54As00r0x^3^2Cot[th]-9i r0x^3^2Cos[th]K10n1[th]-27\sqrt{2}r0x^3Cos[th]K10n1[th]-27i\sqrt{2}r0x^3Cot[th]K10n1[th]+ \right. \\
 & 6i\sqrt{2}K11n3[th]-6i\sqrt{2}K15n3[th]-6i\sqrt{2}K17n3[th]-6i\sqrt{2}K18n3[th]-4r0x^3^2K1n3[th]-6i\sqrt{2}K20n3[th]-4r0x^3^2K2n3[th]-4r0x^3^2K3n3[th]- \\
 & 4r0x^3^2K4n3[th]-48r0x^3^2K6n3[th]-6i\sqrt{2}K7n3[th]-9i r0x^3^2Cos[th]K8n1[th]-27\sqrt{2}r0x^3Cos[th]K8n1[th]-27i\sqrt{2}r0x^3Cot[th]K8n1[th]- \\
 & 48r0x^3^2K8n3[th]-54\sqrt{2}r0x^3Cos[th]K9n1[th]-54i\sqrt{2}r0x^3Cot[th]K9n1[th]-6\sqrt{2}K11n3[th]Sin[th]+6\sqrt{2}K15n3[th]Sin[th]-6\sqrt{2}K17n3[th]Sin[th]- \\
 & 6\sqrt{2}K18n3[th]Sin[th]-4i r0x^3^2K1n3[th]Sin[th]-6\sqrt{2}K20n3[th]Sin[th]-4i r0x^3^2K2n3[th]Sin[th]-4i r0x^3^2K3n3[th]Sin[th]- \\
 & 4i r0x^3^2K4n3[th]Sin[th]-48i r0x^3^2K6n3[th]Sin[th]-6\sqrt{2}K7n3[th]Sin[th]-48i r0x^3^2K8n3[th]Sin[th]-12i\sqrt{2}r0x^3K11n1[th]- \\
 & 24\sqrt{2}r0x^3Sin[th]K11n1[th]-12i\sqrt{2}r0x^3Sin[th]^2K11n1[th]-12i\sqrt{2}r0x^3K11n1'[th]-24\sqrt{2}r0x^3Sin[th]K11n1'[th]+12i\sqrt{2}r0x^3Sin[th]^2K11n1'[th])
 \end{aligned}$$

$rKvardAn33=$  2 variables  $K3n3(\theta)$ ,  $K4n3(\theta)$

$$\begin{aligned}
 K3n3[th] &= \frac{3i\sqrt{2}K19n3[th]-2\sqrt{2}r0x^3K11n1'[th]+\sqrt{2}r0x^3K11n1''[th]}{2r0x^3^2}, \\
 K4n3[th] &= \frac{1}{4\sqrt{2}r0x^3^2(i-Csc[th])} \text{Sin}[th] (-18As00r0x^3Cot[th]Csc[th]+54i\sqrt{2}As00r0x^3^2Cot[th]Csc[th]+54\sqrt{2}As00r0x^3^2Cot[th]Csc[th]^2- \\
 & 9i\sqrt{2}r0x^3^2Cot[th]Csc[th]K10n1[th]-54r0x^3Cot[th]Csc[th]K10n1[th]+54i r0x^3Cot[th]Csc[th]^2K10n1[th]-12Csc[th]K17n3[th]-12iCsc[th]^2K17n3[th]+12Csc[th]K18n3[th]- \\
 & 12iCsc[th]^2K18n3[th]-4i\sqrt{2}r0x^3^2Csc[th]K13n3[th]-4\sqrt{2}r0x^3^2Csc[th]^2K13n3[th]-12Csc[th]K20n3[th]-12iCsc[th]^2K20n3[th]-4i\sqrt{2}r0x^3^2Csc[th]K2n3[th]- \\
 & 4\sqrt{2}r0x^3^2Csc[th]^2K2n3[th]-48i\sqrt{2}r0x^3^2Csc[th]K6n3[th]-48\sqrt{2}r0x^3^2Csc[th]^2K6n3[th]-9i\sqrt{2}r0x^3^2Csc[th]K8n1[th]-54r0x^3^2Csc[th]K8n1[th]+ \\
 & 54i r0x^3^2Csc[th]^2K8n1[th]-48i\sqrt{2}r0x^3^2Csc[th]K8n3[th]-48\sqrt{2}r0x^3^2Csc[th]^2K8n3[th]-108r0x^3Cot[th]Csc[th]K9n1[th]-108i r0x^3Cot[th]Csc[th]^2K9n1[th]- \\
 & 24i r0x^3K11n1[th]+48r0x^3Csc[th]K11n1[th]-24i r0x^3Csc[th]^2K11n1[th]+24i r0x^3K11n1''[th]+36r0x^3Csc[th]K11n1''[th]-12i r0x^3^2Csc[th]^2K11n1''[th])
 \end{aligned}$$

*eqtoievnu3wdAzKcn33*

```
eqtoievnu3wdAzKcn33: 8 equs, {9,10,12,21,24,25,26,28}
18 vars= 4 dvars Kin1 14 Kin3 :{1,2,5,6,8,9,10,12,13,14,16,17,18,20}
```

solution *rKvardAn33s2*= 8 variables

```
{K11n1''[th], K1n3[th], K2n3[th], K12n3[th], K14n3[th], K17n3[th], K18n3[th], K20n3[th]}
```

complexity(*rKvardAn33s2*) = 10309497

The first replacement in *rKvardAn33s2* is a differential equation (deq): this deq has to appended to the next equation group, the remaining replacements will be carried out.

partial solution *eqtoievnu3wdAzKcn3* :

```
rKvardAn3 = Join[rKvardAn31, rKvardAn32, rKvardAn33];
```

*eqtoievnu3wdAzKcn4* :

*eqtoievnu3wdAzKcn4s* =

```
(eqtoievnu3wdAzKcn4 /. rKvardAn12s1 /. rKvardAn3s) /. rKvardAn3s
```

### 4.7.3. Solution of $\text{coef}(1/r^4)$ as a series in $r_0$

$eqtoievnu3wdAzKcn0$  vanishes identically, because the ansatz already solves the equations at infinity we solve  $eqtoievnu3wdAzKcn1$ ,  $eqtoievnu3wdAzKcn2$ , and parts of  $eqtoievnu3wdAzKcn3$  and are left with  $eqtoievnu3wdAzKcn33$

```
eqtoievnu3wdAzKcn33: 8 equs, {9,10,12,21,24,25,26,28}
18 vars= 4 dvars Kin1 14 Kin3 :{1,2,5,6,8,9,10,12,13,14,16,17,18,20}
```

solution  $rKvardAn33s2=$  8 variables

```
{K11n1''[th], K1n3[th], K2n3[th], K12n3[th], K14n3[th], K17n3[th], K18n3[th], K20n3[th]}
```

$eqtoievnu3wdAzKcn4s$  is separated in different  $r_0$ -powers :

```
sr0Kcn4s = {sr03Kcn4s, sr02Kcn4s, sr01n5Kcn4s, sr00n5Kcn4s, sr0n0Kcn4s, sr0n1Kcn4s, sr0n1n5Kcn4s, sr0n2n5Kcn4s, sr0n3Kcn4s}
```

solution highest coefficient( $r_0^3$ )  $sr03Kcn4s$ : only solvable if

$$As00n00(\theta) = 0, \text{ i.e. for } r_0 \rightarrow \infty \quad As00(r, \theta, r_0) = \frac{As00n01(\theta)}{r_0}$$

solution coefficient( $r_0^{3/2}$ )  $sr1n5Kcn4s$ :

$K11n1=0$ ,

$sr1n5Kcn4s$  is solvable and a Ritz-Galerkin solution  $resr01n5Kcn4$  in  $\theta$  is calculated in variables

```
{K8n1[th], K9n1[th], K10n1[th], K10n3[th], K13n3[th], K16n3[th], K5n3[th], K6n3[th], K8n3[th], K9n3[th]}
```

$eqtoievnu3wdAzKcn4s$  is separated in different  $r_0$ -powers :

```
sr0Kcn4s = {sr03Kcn4s, sr02Kcn4s, sr01n5Kcn4s, sr00n5Kcn4s, sr0n0Kcn4s, sr0n1Kcn4s, sr0n1n5Kcn4s, sr0n2n5Kcn4s, sr0n3Kcn4s}
(* vars eqtoievnu3wdAzKcn4s: 4 Kin1, 18 Kin3, fixed(rKvardAn33s2) K11n1'' 7 Kin3 {K1n3,K2n3,K12n3,K14n3,K17n3,K18n3,K20n3} iweakvarsKcn4s={7,11,15,19};
iindepsvarsD2Kin3Kcn4s={1,2}: K1n3' K2n3' D1th only *)
```

**-solution highest coefficient( $r_0^3$ ) sr03Kcn4s**

$esr03Kcn4tv = \{simplify[sr03Kcn4s], deq(rKvardAn33s2[1])\}$  :  $sr03Kcn4s$  is simplified and  $K11n1''$ -deq from  $rKvardAn33s2$  appended.

$MatrixRank[mDdvsr03Kcn4tloce]=10$  derivative-matrix  $\frac{\partial esr03Kcn4tv}{\partial v(esr03Kcn4tv)}$  with  $As00$ -term as last column

where  $v(esr03Kcn4tv)$  are all variables in  $esr03Kcn4tv$  including derivatives

$MatrixRank[mDdvsr03Kcn4tloc]=9$  derivative-matrix  $\frac{\partial esr03Kcn4tv}{\partial v(esr03Kcn4tv)}$  without  $As00$ -term

This proves that

$$As00(r, \theta, r_0) = (As00n00(\theta) + \frac{As00n01(\theta)}{r_0} + \frac{As00n02(\theta)}{r_0^{3/2}} + \dots) + \frac{(As00n10(\theta) + \frac{As00n11(\theta)}{r_0} + \frac{As00n12(\theta)}{r_0^{3/2}} + \dots)}{r} + \dots$$

with  $As00n00(\theta)=0$  , and  $coeff(v(esr03Kcn4tv), r_0^0)=0$  i.e. the constant terms in  $r_0$ -power-series in the variables of  $esr03Kcn4tv$  are all zero.

**-solution coefficient( $r_0^{3/2}$ ) sr1n5Kcn4s**

```
(* solution extended esr01n5Kcn4t, esr01n5Kcn4tAz(As00==0) with rKvardAn33t from sr0n0 sr0n1n5;
rank=10 (full) Kn11n1==0 -> solvable with 3 Kin1 7 true Kin3 for As00>0 *)
```

```
ansatz As00=|As00c1/r0x, Kin=K0sin+K1sin+r0x^1/2 -> 0(r^2) == sr01n5Kcn4t(K1sin)+As00(sr03n5Kcn4t) solvable
```

We set  $K11n1=0$ ,

$sr1n5Kcn4s$  is solvable and a Ritz-Galerkin solution  $resr01n5Kcn4$  in  $\theta$  is calculated in variables

```
{K8n1[th], K9n1[th], K10n1[th], K10n3[th], K13n3[th], K16n3[th], K5n3[th], K6n3[th], K8n3[th], K9n3[th]}
```

#### 4.7.4. Complete solution of the $r$ -powers-series ansatz for $r_0=1$

complete solution (in order  $1/r^4$  and for  $Kcn4$  in highest order in  $r_0^{3/2}$ ) for  $r_0=1$ ,  $As00n01(\theta)=1$   
 $Sin^2(\theta) As00(r, \theta)$

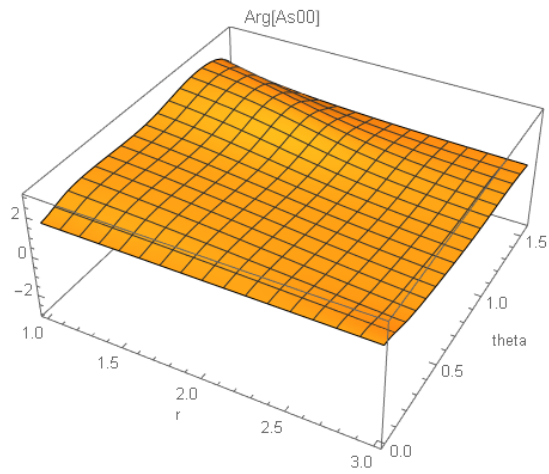
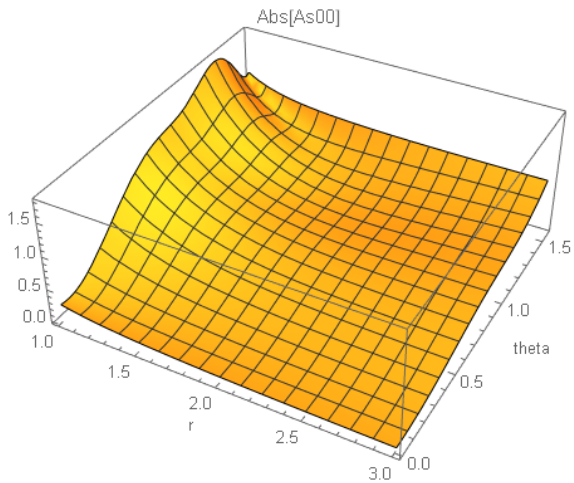

$Sin^2(\theta) Cos^2(\theta) As03(r, \theta)$

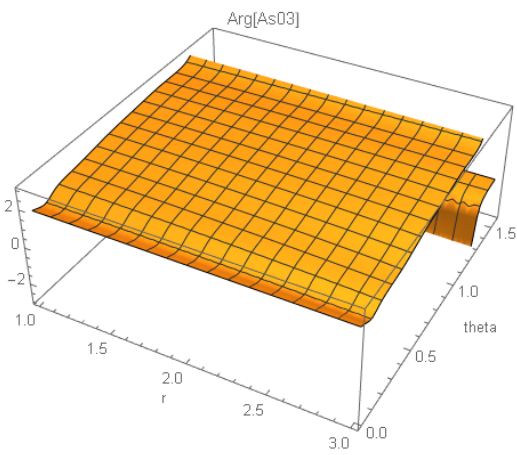
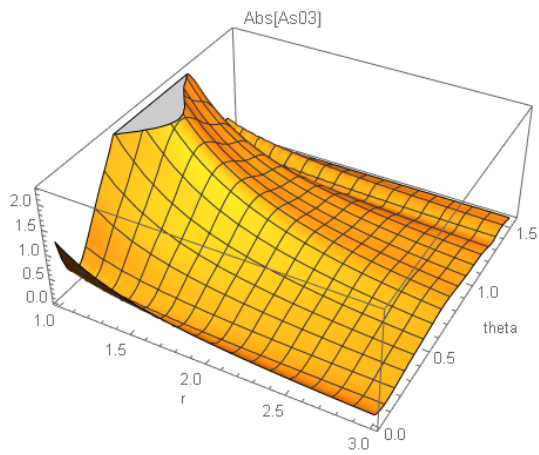



The solution  $resr0In5Kcn4$  is inserted in all previous replacements and we get the complete solution (in order  $1/r^4$  and for  $Kcn4$  in highest order in  $r_0^{3/2}$ ) for  $r_0=1$ ,  $As00n0I(\theta)=I$

$MEs3wdA$  for  $Es$

$MAs3wdA$  for  $As$

e.g.  $Mas3wdA[1,1]=As00$  is

$$\begin{aligned}
& 1 - \frac{1}{r_1^3} \left( (-0.214277 + 0.401952 i) - (0.135318 - 0.627472 i) \cos(\theta) - (0.479204 - 0.199967 i) \sin(\theta) + (0.526395 - 0.0617833 i) \cos(\theta) \sin(\theta) - (0.583865 - 0.620115 i) \sin(\theta)^2 + \right. \\
& (0.10498 - 0.851698 i) \cos(\theta) \sin(\theta)^2 - (0.636613 - 0.153096 i) \sin(\theta)^3 + (0.690141 - 1.1528 i) \cos(\theta) \sin(\theta)^3 - (0.984446 - 0.653405 i) \sin(\theta)^4 - (0.0582292 + 0.467155 i) \cos(\theta) \sin(\theta)^4 + \\
& (0.0194688 - 0.556248 i) \sin(\theta)^5 - (0.19275 - 0.932729 i) \cos(\theta) \sin(\theta)^5 - (0.747151 - 1.21643 i) \sin(\theta)^6 + (0.427625 - 0.456385 i) \cos(\theta) \sin(\theta)^6 - (0.641894 - 0.017984 i) \sin(\theta)^7 - \\
& (0.415868 - 0.734558 i) \cos(\theta) \sin(\theta)^7 + (0.511572 - 0.615912 i) \sin(\theta)^8 - (0.509515 - 0.0333464 i) \cos(\theta) \sin(\theta)^8 - (0.251391 + 0.884293 i) \sin(\theta)^9 - (0.117675 - 0.137756 i) \cos(\theta) \sin(\theta)^9 \left. \right) + \\
& \frac{1}{r_1^2} \left( -\csc(\theta)^2 \left( (-0.0747558 - 0.919005 i) - (0.0465821 - 0.879729 i) \cos(\theta) - (1.71841 - 0.000776895 i) \sin(\theta) - (1.03522 - 1.48218 i) \cos(\theta) \sin(\theta) + (0.852942 - 0.240585 i) \sin(\theta)^2 - \right. \right. \\
& (1.00934 + 0.682846 i) \cos(\theta) \sin(\theta)^2 + (0.787998 - 0.311227 i) \sin(\theta)^3 - (1.92443 + 0.722468 i) \cos(\theta) \sin(\theta)^3 + (2.29427 - 0.443691 i) \sin(\theta)^4 + (1.20618 - 0.721336 i) \cos(\theta) \sin(\theta)^4 + \\
& (2.87399 - 0.0337082 i) \sin(\theta)^5 - (1.9403 - 0.963655 i) \cos(\theta) \sin(\theta)^5 - (1.11581 - 0.546401 i) \sin(\theta)^6 - (0.670097 - 1.6069 i) \cos(\theta) \sin(\theta)^6 - (0.827886 - 0.212639 i) \sin(\theta)^7 - \\
& (0.613785 - 0.849093 i) \cos(\theta) \sin(\theta)^7 - (0.432301 - 0.820567 i) \sin(\theta)^8 - (1.31468 - 1.6337 i) \cos(\theta) \sin(\theta)^8 - (0.964969 - 0.105833 i) \sin(\theta)^9 - (1.96996 - 0.80871 i) \cos(\theta) \sin(\theta)^9 \left. \right) + \\
& \csc(\theta)^2 \left( (1.26314 - 0.381849 i) - (1.08584 - 0.496496 i) \cos(\theta) - (0.0575984 + 0.10324 i) \sin(\theta) - (1.90913 - 0.661022 i) \cos(\theta) \sin(\theta) + (0.519812 - 0.112087 i) \sin(\theta)^2 - \right. \\
& (0.314141 - 0.438765 i) \cos(\theta) \sin(\theta)^2 - (0.746799 - 0.0773919 i) \sin(\theta)^3 - (0.485853 - 0.0471345 i) \cos(\theta) \sin(\theta)^3 + (1.22474 - 0.879369 i) \sin(\theta)^4 - (0.100463 - 0.0193679 i) \cos(\theta) \sin(\theta)^4 - \\
& (0.388176 - 0.101549 i) \sin(\theta)^5 - (1.27041 - 0.427762 i) \cos(\theta) \sin(\theta)^5 + (0.389608 - 0.296234 i) \sin(\theta)^6 - (0.920518 - 0.847814 i) \cos(\theta) \sin(\theta)^6 - (0.875442 - 0.572627 i) \sin(\theta)^7 - \\
& (1.29347 - 0.22974 i) \cos(\theta) \sin(\theta)^7 - (1.20759 - 0.535636 i) \sin(\theta)^8 - (1.97164 - 1.11776 i) \cos(\theta) \sin(\theta)^8 - (0.0633593 - 0.483605 i) \sin(\theta)^9 - (1.79652 - 0.287437 i) \cos(\theta) \sin(\theta)^9 \left. \right) + \\
& \csc(\theta)^2 \left( (0.0280851 - 0.682847 i) - (0.241026 + 0.581927 i) \cos(\theta) - (2.53494 - 0.332641 i) \sin(\theta) + (0.0567167 + 0.504413 i) \cos(\theta) \sin(\theta) - (0.719888 - 2.0174 i) \sin(\theta)^2 - \right. \\
& (2.16061 - 1.16706 i) \cos(\theta) \sin(\theta)^2 + (0.736805 - 0.0369562 i) \sin(\theta)^3 + (0.747368 - 0.817301 i) \cos(\theta) \sin(\theta)^3 + (2.77527 - 1.14971 i) \sin(\theta)^4 - (1.14043 - 0.166546 i) \cos(\theta) \sin(\theta)^4 - \\
& (0.299551 - 0.500603 i) \sin(\theta)^5 - (0.781402 - 1.81289 i) \cos(\theta) \sin(\theta)^5 + (1.24979 + 0.11606 i) \sin(\theta)^6 - (1.1609 - 0.810648 i) \cos(\theta) \sin(\theta)^6 - (0.566841 + 0.641462 i) \sin(\theta)^7 - \\
& (0.855723 - 0.168206 i) \cos(\theta) \sin(\theta)^7 - (0.502473 - 0.188406 i) \sin(\theta)^8 - (1.27444 - 1.11982 i) \cos(\theta) \sin(\theta)^8 - (4.03928 - 1.30183 i) \sin(\theta)^9 - (1.14688 - 0.299056 i) \cos(\theta) \sin(\theta)^9 \left. \right) + \\
& 2 i \sqrt{2} \left( (-0.437719 - 0.869184 i) + (0.532478 - 0.619845 i) \cos(\theta) + (1.8992 - 0.629465 i) \sin(\theta) - (0.456469 + 0.079466 i) \cos(\theta) \sin(\theta) - (0.741301 - 0.374262 i) \sin(\theta)^2 - \right. \\
& (0.276706 - 0.251115 i) \cos(\theta) \sin(\theta)^2 + (0.793357 - 1.73568 i) \sin(\theta)^3 - (0.815736 - 1.19872 i) \cos(\theta) \sin(\theta)^3 + (1.38453 - 1.19319 i) \sin(\theta)^4 + (0.146301 - 0.521948 i) \cos(\theta) \sin(\theta)^4 - \\
& (1.65098 - 0.168388 i) \sin(\theta)^5 - (0.176357 - 0.0179296 i) \cos(\theta) \sin(\theta)^5 - (0.406018 - 0.750255 i) \sin(\theta)^6 - (0.588726 - 0.245566 i) \cos(\theta) \sin(\theta)^6 - (0.412843 + 1.39747 i) \sin(\theta)^7 + \\
& (1.27859 - 0.0992431 i) \cos(\theta) \sin(\theta)^7 - (0.597067 - 0.812797 i) \sin(\theta)^8 - (0.443353 + 0.92112 i) \cos(\theta) \sin(\theta)^8 - (0.0832039 - 0.755353 i) \sin(\theta)^9 - (0.121395 - 1.63319 i) \cos(\theta) \sin(\theta)^9 \left. \right) + \\
& \frac{1}{r_1} \left( (0.437719 - 0.869184 i) - (0.532478 - 0.619845 i) \cos(\theta) - (1.8992 - 0.629465 i) \sin(\theta) - (0.456469 + 0.079466 i) \cos(\theta) \sin(\theta) + (0.741301 - 0.374262 i) \sin(\theta)^2 - \right. \\
& (0.276706 - 0.251115 i) \cos(\theta) \sin(\theta)^2 - (0.793357 + 1.73568 i) \sin(\theta)^3 - (0.815736 - 1.19872 i) \cos(\theta) \sin(\theta)^3 - (1.38453 + 1.19319 i) \sin(\theta)^4 - \\
& (0.146301 - 0.521948 i) \cos(\theta) \sin(\theta)^4 + (1.65098 + 0.168388 i) \sin(\theta)^5 + (0.176357 - 0.0179296 i) \cos(\theta) \sin(\theta)^5 + (0.406018 - 0.750255 i) \sin(\theta)^6 - \\
& (0.588726 - 0.245566 i) \cos(\theta) \sin(\theta)^6 + (0.412843 - 1.39747 i) \sin(\theta)^7 - (1.27859 - 0.0992431 i) \cos(\theta) \sin(\theta)^7 - (0.597067 - 0.812797 i) \sin(\theta)^8 - \\
& (0.443353 - 0.92112 i) \cos(\theta) \sin(\theta)^8 - (0.0832039 - 0.755353 i) \sin(\theta)^9 + (0.121395 - 1.63319 i) \cos(\theta) \sin(\theta)^9 + i \sqrt{2} \\
& \left. \left( 1 - \frac{1}{\sqrt{2}} \left( (0.180954 - 0.71601 i) - (0.382319 - 0.70612 i) \cos(\theta) - (1.19742 - 0.184172 i) \sin(\theta) - (0.330503 - 0.0322737 i) \cos(\theta) \sin(\theta) - (0.964347 - 0.237862 i) \sin(\theta)^2 - (0.409494 - 0.131849 i) \right. \right. \right. \\
& \cos(\theta) \sin(\theta)^2 - (0.44212 - 1.10058 i) \sin(\theta)^3 - (0.902813 - 0.540556 i) \cos(\theta) \sin(\theta)^3 + (0.756807 + 0.3089 i) \sin(\theta)^4 + (0.873209 - 0.168857 i) \cos(\theta) \sin(\theta)^4 - (0.955147 - 0.0843793 i) \\
& \sin(\theta)^5 - (0.498497 - 0.0368275 i) \cos(\theta) \sin(\theta)^5 - (0.466096 - 0.0232202 i) \sin(\theta)^6 + (0.561349 - 0.35045 i) \cos(\theta) \sin(\theta)^6 - (0.0839046 - 0.776249 i) \sin(\theta)^7 - (0.284662 - 0.486005 i) \\
& \left. \left. \left. \cos(\theta) \sin(\theta)^7 - (0.593765 - 0.385675 i) \sin(\theta)^8 - (0.609705 - 0.100691 i) \cos(\theta) \sin(\theta)^8 + (0.0681245 - 0.487544 i) \sin(\theta)^9 - (0.0417809 - 0.910295 i) \cos(\theta) \sin(\theta)^9 \right) \right) \right)
\end{aligned}$$

$\text{Sin}^2(\theta) \text{As00}(r, \theta)$  for  $r=1$  as a function of  $\theta$

Abs[As00] r=1.

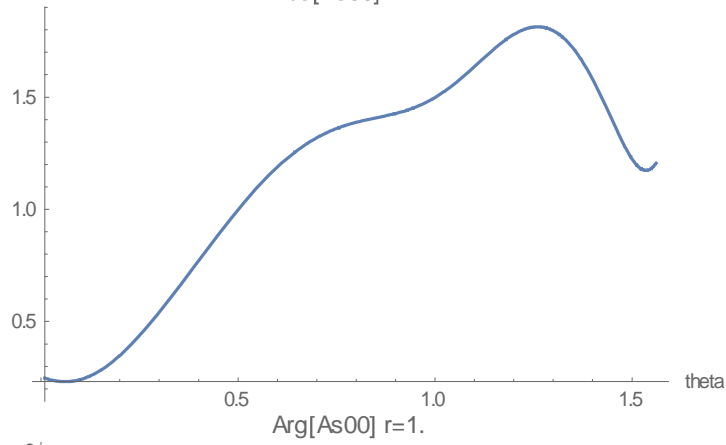

Arg[As00] r=1.

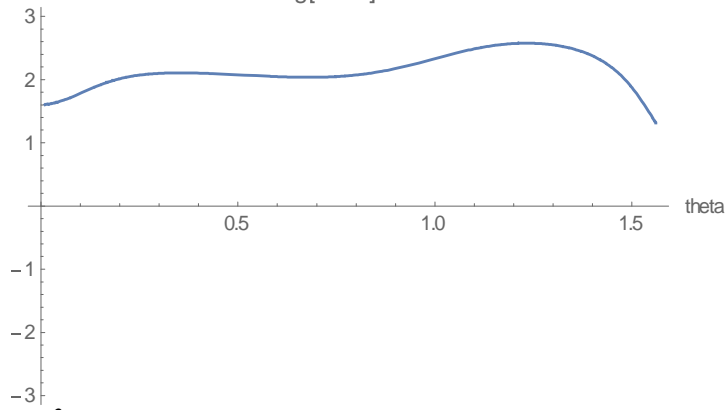

$\text{Sin}^2(\theta) \text{As00}(r, \theta)$  for  $r=20$  as a function of  $\theta$

Abs[As00] r=20.

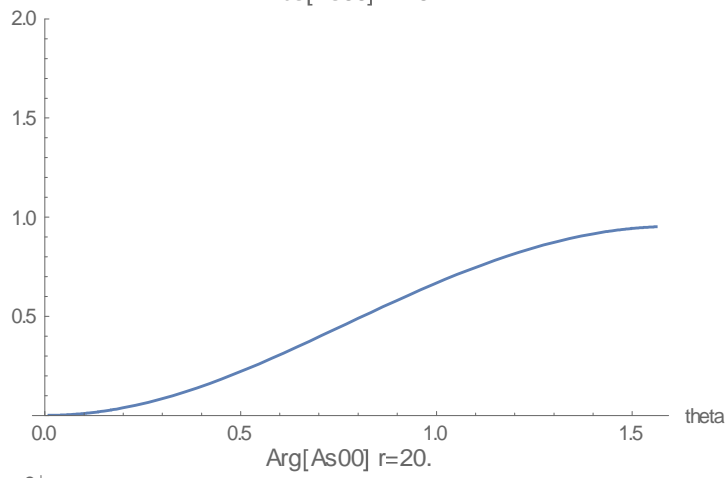

Arg[As00] r=20.

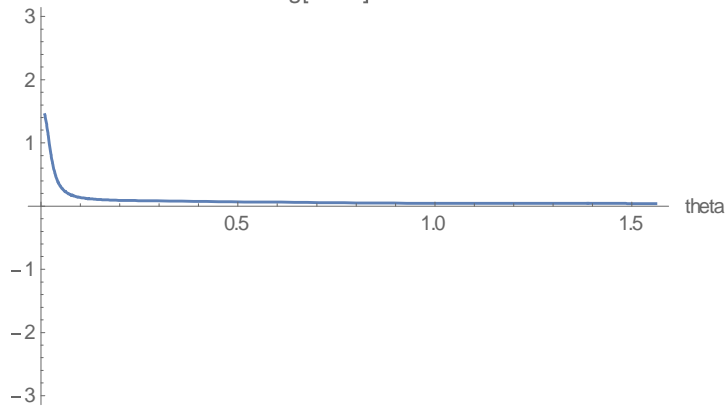

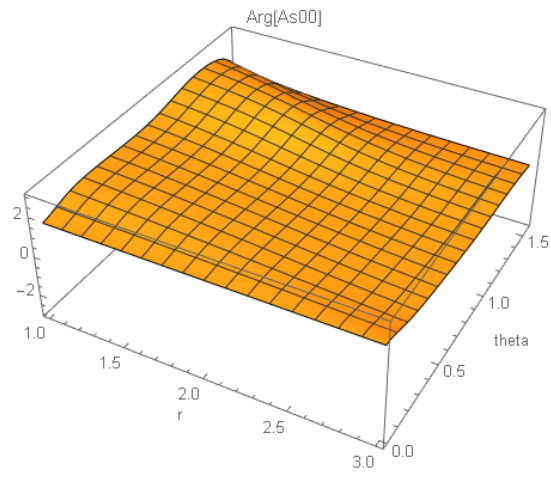
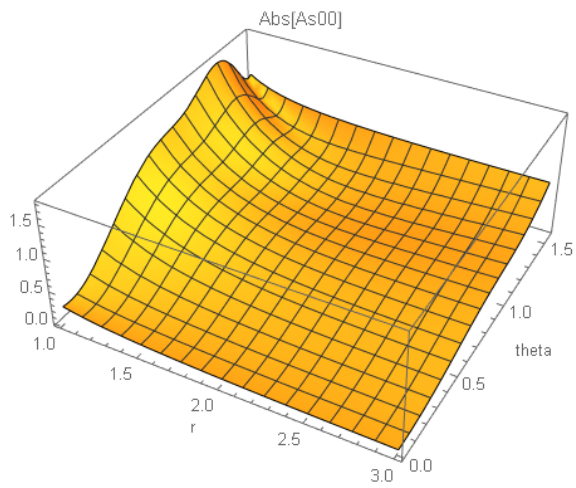
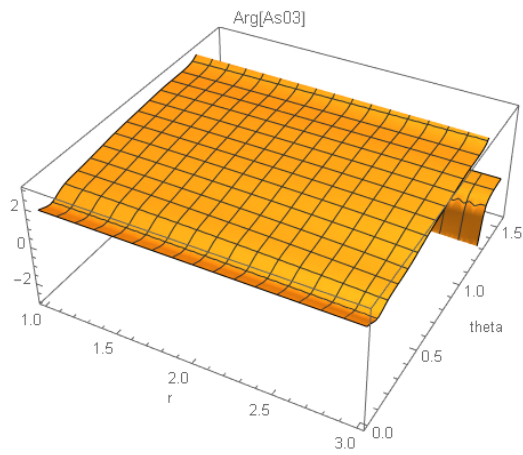
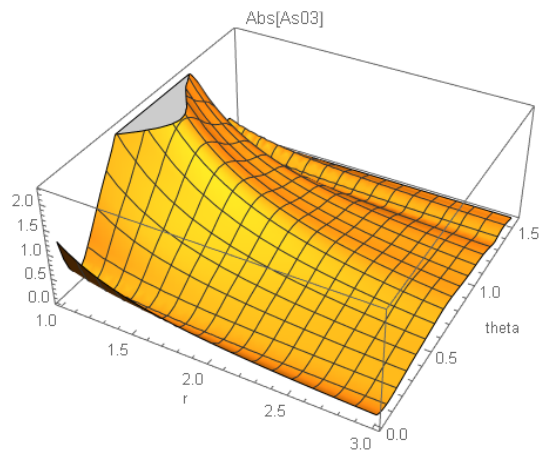
$\text{Sin}^2(\theta) \text{As00}(r, \theta)$  $\text{Sin}^2(\theta) \text{Cos}^2(\theta) \text{As03}(r, \theta)$ 

### B5. Numeric solutions of time-independent equations with coupling $\Lambda=1$

We consider the time-independent equations *eqtoiv* with full coupling ( $\Lambda=1$ ). In this case the Einstein equations are no longer valid, the metric condition at infinity is the flat Minkowski metric.

The calculation is carried out by Ritz-Galerkin method with trigonometric polynomials in  $\theta$

$\{\cos(\theta), \sin(\theta), \frac{1}{\sin(\theta)^{3/4}}\}$  and in  $r$  with polynomials of  $\{\frac{1}{\sqrt{r-1}}, \sqrt{r-1}\}$ , which can approximate the

Schwarzschild-singularity at  $r=1$ , in total 49 base functions.

The lattice is here a  $30 \times 12$   $\{r, \theta\}$ -lattice and the Ritz-Galerkin minimization runs in parallel with 8 processes on random sublattices with 100 points.

The processing time on standard 4GHz-processors was 58000s, minimal *RG-deviation*=0.0117, median equation error *mederr*=0.0034.

The resulting solution  $\{A00v(r, \theta), \dots, A33v(r, \theta), E00v(r, \theta), \dots, E33v(r, \theta)\}$  is shown below for some variables:

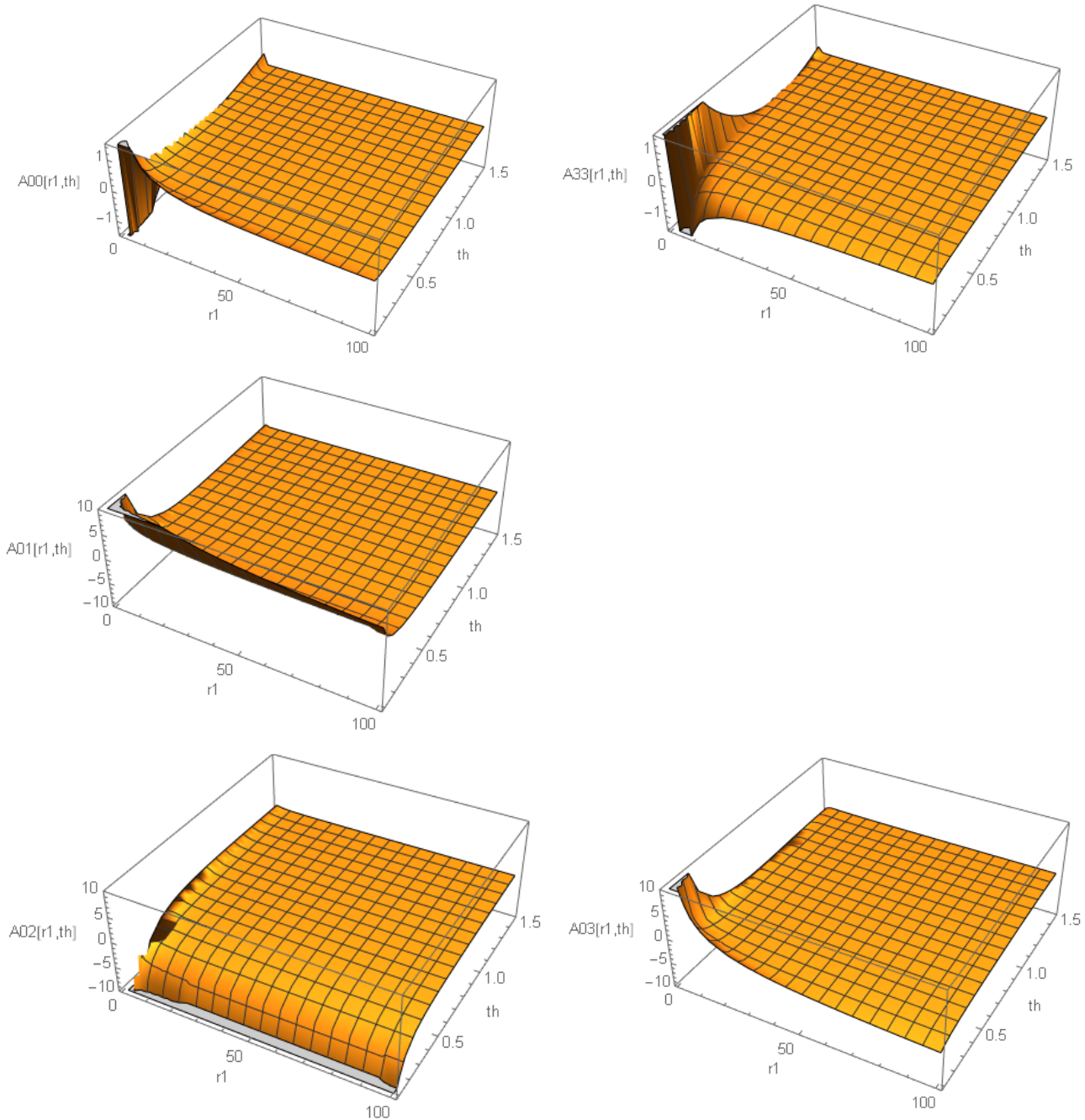

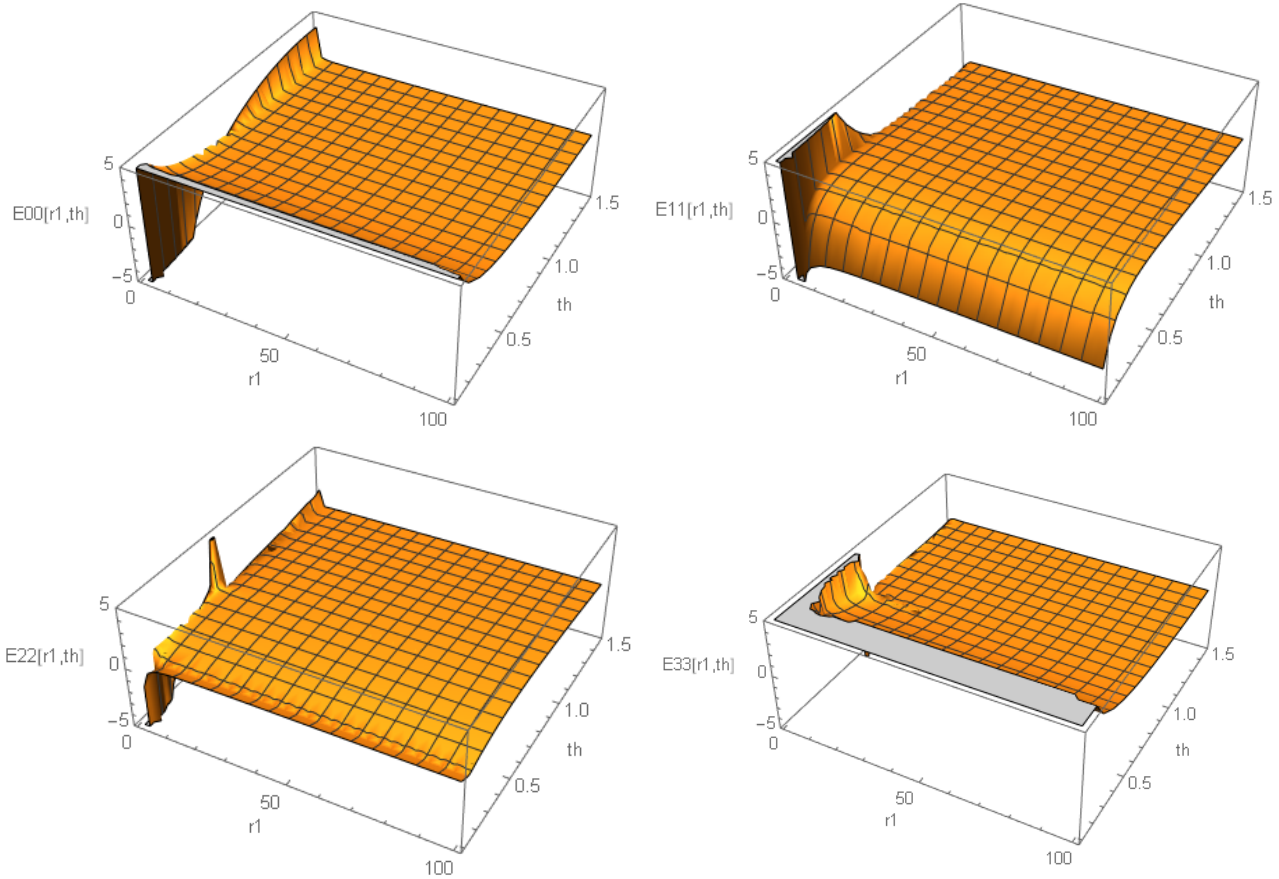

The overall behavior of the A-tensor and the E-tensor is as follows. Some components (e.g.  $A_{02}$ ,  $E_{11}$ ,  $E_{33}$ ) diverge like  $1/\sin(\theta)^k$  for  $\theta \rightarrow 0$ , as in the Gauss-Schwarzschild tetrad  $E_{GS}$ . But there is no apparent singularity for  $r \rightarrow 1$ , there are only some numerical artefacts near  $r=1$ , because some of the Ritz-Galerkin base functions are divergent at  $r=1$ .

**5.1. The metric in AK-gravity with coupling: no horizon and no singularity**

From the resulting solution  $\{A_{00v}(r, \theta), \dots, A_{33v}(r, \theta), E_{00v}(r, \theta), \dots, E_{33v}(r, \theta)\}$  the generated metric  $fg_{ijv}(r, \theta)$  is calculated.

$$\left( \frac{1}{g_{00}} - 1 \right)$$

Using this metric we can approximately calculate the velocity  $v \approx \frac{\left( \frac{1}{g_{00}} - 1 \right)}{g_{11}} \leq 1$  during th free fall to the horizon  $r=1$ . The result is  $\max(v)=0.43$  at  $r=2$ , i.e. there is no horizon, the velocity reaches a maximum, then there is a rebound.

This is to be expected, if we consider the absence of Schwarzschild-like singularity at  $r=1$  for the coupling-solution of eqtoiv in 3.2.

Now we calculate the Christoffel symbols  $\Gamma^{\lambda}_{\mu\nu} = \frac{1}{2} g^{\lambda\kappa} \left( \frac{\partial g_{\kappa\mu}}{\partial x^\nu} + \frac{\partial g_{\kappa\nu}}{\partial x^\mu} - \frac{\partial g_{\mu\nu}}{\partial x^\kappa} \right)$  from the metric and solve the

equations-of-motion for the free fall from  $r=10$ .

In GR, we have the following picture:

The proper time  $\tau(r)$  of fall in dependence of radius  $r$ : the fall time is  $\tau_f = \tau(r=1) = 48.98$  and of course  $v(r=1)=1$  and  $\tau(r=10)=0$ .

The proper fall-time from  $r=r_{02x}$  to  $r=1$  is

$$r \sqrt{\frac{1}{r} - \frac{1}{r_{02x}}} r_{02x} + \frac{1}{2} \int r_{02x}^{3/2} \text{Log}[-i r_{02x}^{3/2}] - \frac{1}{2} \int r_{02x}^{3/2} \text{Log}[-2 i r \sqrt{r_{02x}} + 2 r \sqrt{\frac{1}{r} - \frac{1}{r_{02x}}} r_{02x} + i r_{02x}^{3/2}]$$

The inverse function radius in dependence on the fall time  $\tau$  is  $r(t_0s(\tau))$ :

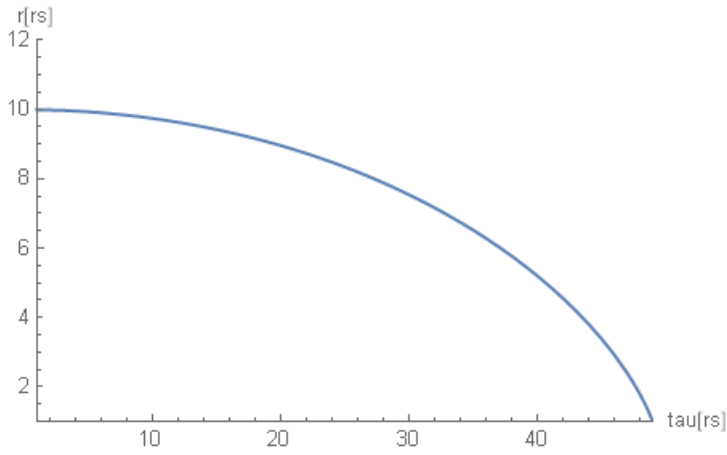

In AK-metric we have the following picture:

The radius in dependence on the fall time  $\tau$  is  $r_{l0s}(\tau)$  :

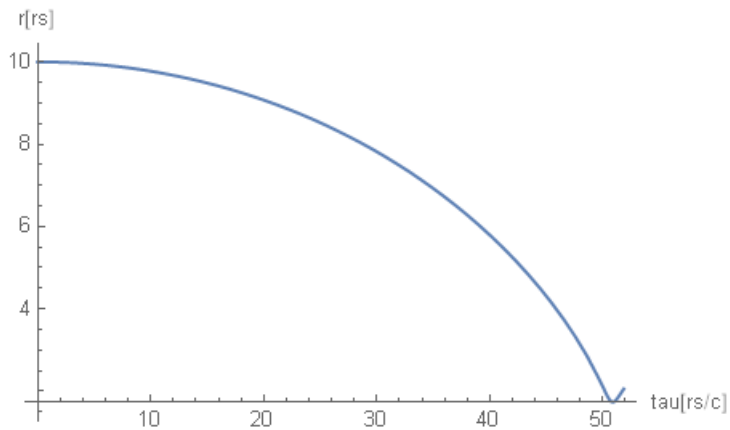

and the velocity  $v_{l0s}(\tau)$

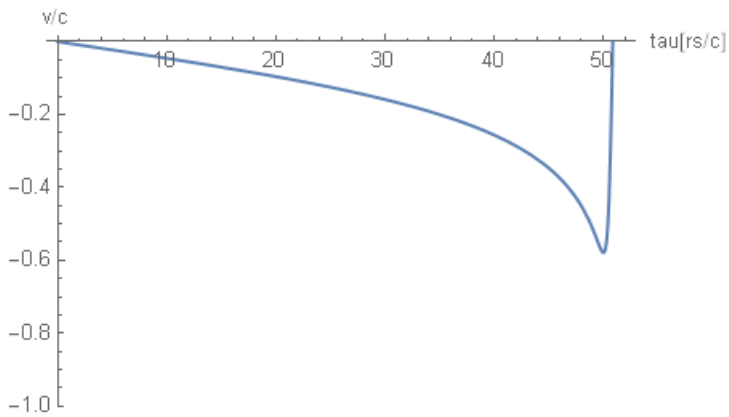

The fall-time is here  $\tau_f = 5l$  reached at  $r_f = 1.75$ , the maximal velocity is  $v_{max} = 0.60$  , then there is a rebound. So we see that in AK-gravitation with coupling ( $\lambda=1$ ) there is no horizon and no singularity.

## B6. Numeric solutions of time-independent equations with weak coupling and binary gravitational rotator

We consider the time-dependent equations *eqtoiev* with weak coupling ( $\Lambda=0.001$ ) and binary gravitational rotator (bgr).

We start, as in 4.1., with the  $\Lambda$ -scaled ansatz for the A-tensor

$$A_{\mu}^{\nu} = Ab_{\mu}^{\nu} + \Lambda \frac{As_{\mu}^{\nu}}{r} \exp(-ik(r-t)) \quad \text{and correspondingly for the E-tensor}$$

$$E^{\mu\nu} = Eb^{\mu\nu} + \frac{Es^{\mu\nu}}{r} \exp(-ik(r-t))$$

We introduce the disturbance  $dAb$  and  $Ab = A_{hab} + dAb$  from the bgr, as in 4.7.

With this ansatz we derive from *eqtoiev* the static part *eqtoievnu3b*( $dAb, Eb$ ) and the wave part *eqtoievnu3w*( $As, Es, dAb$ ), but without the limit  $\Lambda \rightarrow 0$ , we set  $\Lambda = \Lambda_0 = 0.001$  and the wave number

$$k = k_0 = \frac{1}{\sqrt{2r_0^3}} \quad \text{with } r_0 = l \quad \text{mean distance from the bgr.}$$

At  $r \rightarrow \infty$   $\{dAb, Eb, As, Es\}$  take the values derived for the bgr in 4.7.

$$\{As, Es\} \rightarrow \{Asinfv, Esinfv\} =$$

$$\left\{ As_{\theta 00} \rightarrow \frac{c\theta x}{r\theta x}, As_{\theta 02} \rightarrow \frac{c\theta x}{r\theta x} \right\}$$

$$\begin{aligned} rEsAsKc = & \{ Es_{20}[r1, th] \rightarrow 0, Es_{21}[r1, th] \rightarrow 0, Es_{22}[r1, th] \rightarrow 0, Es_{23}[r1, th] \rightarrow 0, As_{\theta 0}[r1, th] \rightarrow As_{\theta 0}, As_{\theta 1}[r1, th] \rightarrow As_{\theta 0}, As_{\theta 2}[r1, th] \rightarrow -As_{\theta 0}, As_{\theta 3}[r1, th] \rightarrow As_{\theta 0}, As_{10}[r1, th] \rightarrow As_{\theta 0}, \\ & As_{11}[r1, th] \rightarrow As_{\theta 0}, As_{12}[r1, th] \rightarrow -As_{\theta 0}, As_{13}[r1, th] \rightarrow As_{\theta 0}, As_{20}[r1, th] \rightarrow 0, As_{21}[r1, th] \rightarrow 0, As_{22}[r1, th] \rightarrow 0, As_{23}[r1, th] \rightarrow 0, As_{30}[r1, th] \rightarrow 0, As_{31}[r1, th] \rightarrow 0, \\ & As_{32}[r1, th] \rightarrow 0, As_{33}[r1, th] \rightarrow 0, Es_{\theta 0}[r1, th] \rightarrow \frac{3As_{\theta 0}}{r1}, Es_{\theta 1}[r1, th] \rightarrow -\frac{3As_{\theta 0}}{r1}, Es_{\theta 2}[r1, th] \rightarrow \frac{3As_{\theta 0}}{r1}, Es_{\theta 3}[r1, th] \rightarrow -\frac{3As_{\theta 0}}{r1}, Es_{10}[r1, th] \rightarrow \frac{3As_{\theta 0}}{r1}, Es_{11}[r1, th] \rightarrow -\frac{3As_{\theta 0}}{r1}, \\ & Es_{12}[r1, th] \rightarrow \frac{3As_{\theta 0}}{r1}, Es_{13}[r1, th] \rightarrow -\frac{3As_{\theta 0}}{r1}, Es_{30}[r1, th] \rightarrow \frac{3As_{\theta 0}}{r1}, Es_{31}[r1, th] \rightarrow -\frac{3As_{\theta 0}}{r1}, Es_{32}[r1, th] \rightarrow \frac{3As_{\theta 0}}{r1}, Es_{33}[r1, th] \rightarrow -\frac{3As_{\theta 0}}{r1} \}; \end{aligned}$$

$$dAb \rightarrow dAbinfv =$$

$$\left\{ dAb_{\theta 00} \rightarrow \frac{\text{alphax}}{r1^3}, dAb_{\theta 01} \rightarrow \frac{\text{alphax}}{r1^3}, dAb_{\theta 02} \rightarrow \frac{\text{alphax}}{r1^3}, dAb_{\theta 03} \rightarrow \frac{\text{alphax}}{r1^3}, \right. \\ \left. dAb_{10} \rightarrow 0, dAb_{11} \rightarrow 0, dAb_{12} \rightarrow 0, dAb_{13} \rightarrow 0, dAb_{20} \rightarrow i \text{Csc}[th], dAb_{21} \rightarrow i \text{Csc}[th], \right. \\ \left. dAb_{22} \rightarrow i \text{Csc}[th], dAb_{23} \rightarrow i \text{Csc}[th], dAb_{30} \rightarrow 1, dAb_{31} \rightarrow 1, dAb_{32} \rightarrow 1, dAb_{33} \rightarrow 1 \right\}$$

$$Eb \rightarrow Ebinfv = E_{GK} \quad \text{the Gauss-Kerr-tetrad from 4.7.1.}$$

The calculation is carried out by Ritz-Galerkin method with trigonometric polynomials in  $\theta$

$$\left\{ \cos(\theta), \sin(\theta), \frac{1}{\sin(\theta)^{3/4}} \right\} \quad \text{and in } r \quad \text{with polynomials of } \left\{ \frac{1}{r} \right\}, \quad \text{in total 40 base functions.}$$

The lattice is here a  $201 \times 31$   $\{r, \theta\}$ -lattice and the Ritz-Galerkin minimization runs in parallel with 8 processes on random sublattices with 20 points.

The processing time on standard 4GHz-processors was 150000s, minimal *RG-deviation* = 0.032, median equation error *mederr*(*eqtoievnu3b*) = 0.016 *mederr*(*eqtoievnu3w*) = 0.012 .

The metric  $g^{\mu\nu}(Eb)$  generated by the background  $Eb$  has a horizon at  $r \approx 1.9$  for the free fall, that means that for weak coupling ( $\Lambda = 0.001$ ) the singularity of GR still exists. So there is a  $\Lambda$ , ( $0.001 < \Lambda < 1$ ), where the singularity disappears.

The resulting solution  $\{dAb(r, \theta), Eb(r, \theta), As(r, \theta), Es(r, \theta)\}$  is shown below for some variables:

88

$\text{Sin}(\theta)^{3/4}$  As00 :

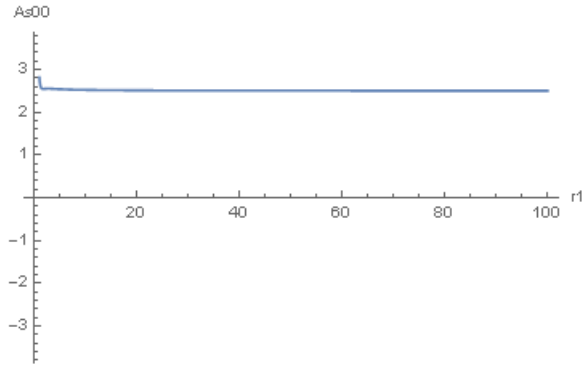
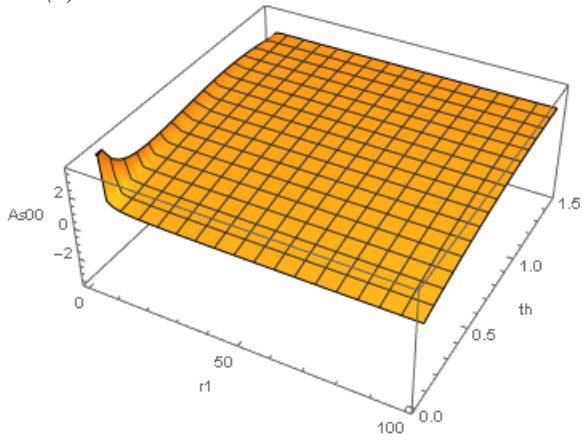

$\text{Sin}(\theta)^{3/4}$  As22 :

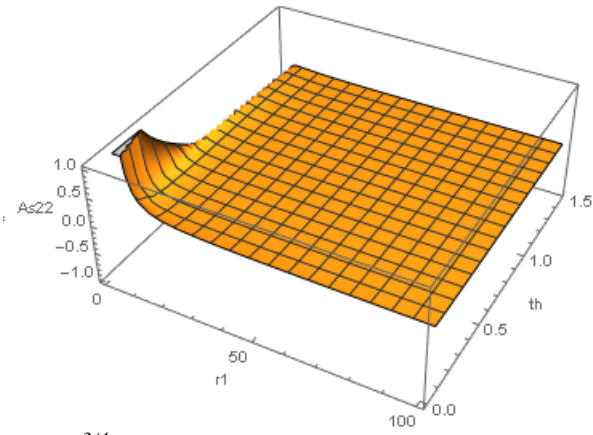

$\text{Sin}(\theta)^{3/4}$  As33 :

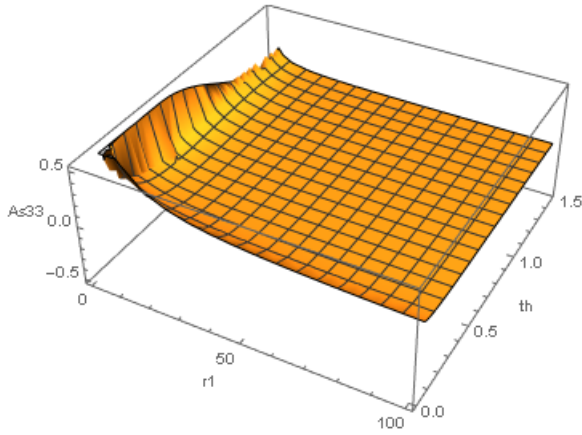

$\text{Sin}(\theta)^{3/4}$  Es00 :

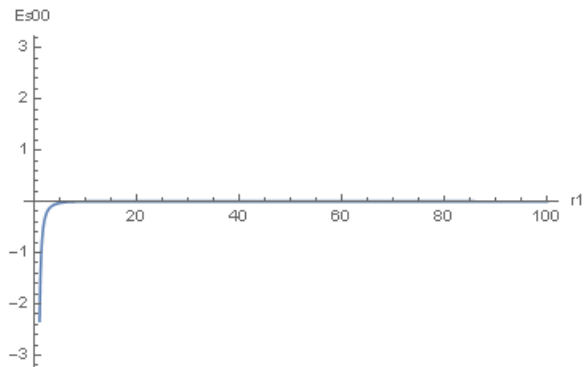
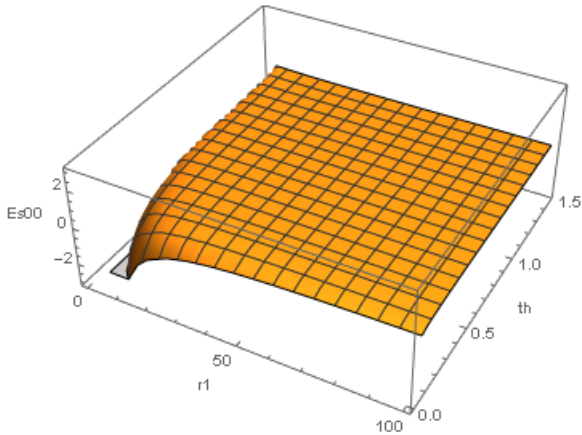

$\text{Sin}(\theta)^{3/4}$  Es03 :



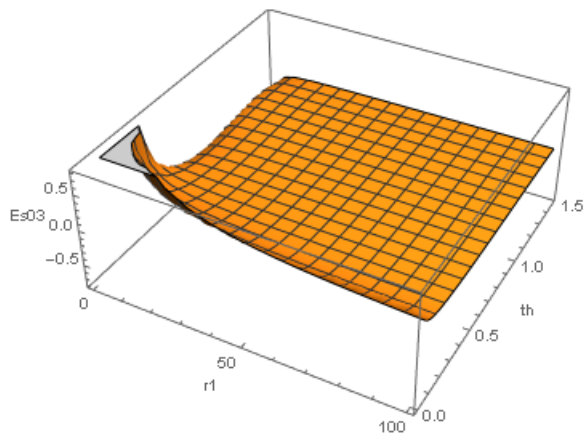

$\text{Sin}(\theta)^{3/4} Es11 :$

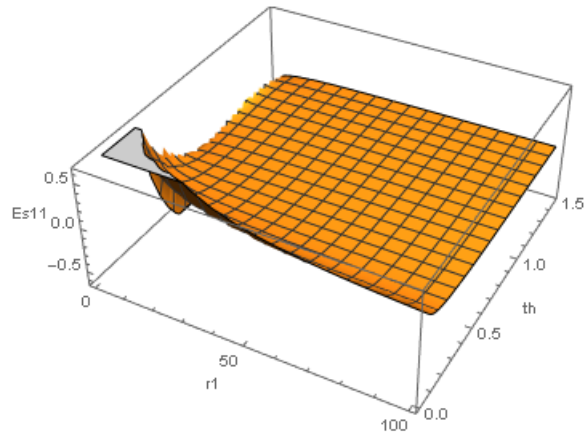

## B7. The energy tensor for the gravitational wave

### electromagnetic energy tensor

$$\epsilon_0 = \frac{1}{4\pi}, \quad \mu_0 = 4\pi$$

in cgs units

$$T^{\mu\nu} = \frac{1}{4\pi} [F^{\mu\alpha} F^\nu{}_\alpha - \frac{1}{4} \eta^{\mu\nu} F_{\alpha\beta} F^{\alpha\beta}].$$

[T]== energy/r<sup>3</sup>=endensity

$$T^{\mu\nu} = \begin{bmatrix} \frac{1}{8\pi} (E^2 + B^2) & S_x/c & S_y/c & S_z/c \\ S_x/c & -\sigma_{xx} & -\sigma_{xy} & -\sigma_{xz} \\ S_y/c & -\sigma_{yx} & -\sigma_{yy} & -\sigma_{yz} \\ S_z/c & -\sigma_{zx} & -\sigma_{zy} & -\sigma_{zz} \end{bmatrix}$$

$$\mathbf{S} = \frac{c}{4\pi} \mathbf{E} \times \mathbf{B}.$$

Poynting vector [S]=energy/(r<sup>2</sup> \*t)=energy-flux, [S/c]= energy/r<sup>3</sup>=endensity

$$\sigma_{ij} = \epsilon_0 E_i E_j + \frac{1}{\mu_0} B_i B_j - \frac{1}{2} \left( \epsilon_0 E^2 + \frac{1}{\mu_0} B^2 \right) \delta_{ij}$$

Maxwell stress tensor

conservation of momentum and energy

$$\partial_\nu T^{\mu\nu} + \eta^{\mu\rho} f_\rho = 0$$

where is the (4D) [Lorentz force](#) per unit volume on [matter](#).

electromagnetic energy density

$$u_{\text{em}} = \frac{\epsilon_0}{2} E^2 + \frac{1}{2\mu_0} B^2$$

electromagnetic momentum density

$$\mathbf{p}_{\text{em}} = \frac{\mathbf{S}}{c^2}$$

- It is a **symmetric tensor**:

$$T^{\mu\nu} = T^{\nu\mu}$$

- The tensor  $T^\nu{}_\alpha$  is **traceless**:

$$T^\alpha{}_\alpha = 0.$$

- The energy density is **positive-definite**:

$$T^{00} \geq 0$$

### gravitational Ashtekar-Kodama energy

GR grav. wave energy density (plane wave)  $t_{\mu\nu} = k_\mu k_\nu \left( (e^{\lambda\kappa})^* e_{\lambda\kappa} - \frac{1}{2} (e^\lambda e_\lambda)^2 \right) \frac{\hbar c}{16\pi l_p^2}$ ,

$$t_{\mu\nu}^{\text{grav}} = \frac{c^4}{16\pi G} k_\mu k_\nu \left( e^{\lambda\kappa*} e_{\lambda\kappa} - \frac{1}{2} |e^\lambda{}_\lambda|^2 \right) \quad ([2] 34.23)$$

$$t_{\mu\nu} = \frac{\hbar c}{16\pi l_p^2} k_\mu k_\nu \left( e^{\lambda\kappa*} e_{\lambda\kappa} - \frac{1}{2} |e^\lambda{}_\lambda|^2 \right)$$

dimension  $[t_{\mu\nu}] = \text{energy}/r^3 = \text{endensity}$  ([2]),  $e^{\lambda\kappa}$  is the polarization.

when the metric wave is spherical  $h_{\mu\nu} = \frac{e^{\mu\nu}}{r} \exp(-ik_\mu x^\mu)$

(transition from spherical wave  $A_r$  to plane wave  $A_p$  via energy condition:  $4\pi r^2 |A_r|^2 = r_s^2 |A_p|^2$ )

AK grav. wave energy density  $t_{\mu\nu} = D_\kappa A_\mu^\kappa D_\lambda A_\nu^\lambda \hbar c \left( \frac{1}{l_p^2 \Lambda^2 r_s^2} \right)$ , dimension  $[t_{\mu\nu}] = \text{energy}/r^3 = \text{endensity}$

(the dimensionless factor  $\frac{r_{p\Lambda}^2}{r_s^2} = \left( \frac{1}{l_p^2 \Lambda^2 r_s^2} \right)$  is inserted for compatibility with GR and to account for the  $\Lambda$ -

scaled wave ansatz), where  $r_{p\Lambda} = \frac{1}{l_p \Lambda} = 5.64 \cdot 10^{86} m$

Planck-lambda scale

second term: gravitational stress energy:  $t^e{}_{\mu\nu} = D_\kappa E_\mu^\kappa D_\lambda E_\nu^\lambda \Lambda \hbar c$  ( $\Lambda$  must be inserted for dimensional reasons), which is normally negligible

for the standard spherical wave  $k_\mu = (-k_0, k_0, 0, 0)$  x-y-polarization unit amplitude

$$\text{GR energy density } t_{\mu\nu} = k_0^2 \frac{e_{11}^2 r_s^2}{r^2} \frac{\hbar c}{4 l_p^2} \begin{pmatrix} 1 & -1 & 0 & 0 \\ -1 & 1 & 0 & 0 \\ 0 & 0 & 0 & 0 \\ 0 & 0 & 0 & 0 \end{pmatrix}$$

AK energy density

for a standard scaled spherical wave with a single r-t-amplitude

$$A_\mu^\nu = \frac{\Lambda A s_{00}}{r} \begin{pmatrix} 1 & 1 & -1 & 1 \\ -1 & -1 & 1 & -1 \\ 0 & 0 & 0 & 0 \\ 0 & 0 & 0 & 0 \end{pmatrix} \exp(-i k_0 (r-t))$$

$$t_{\mu\nu} = k_0^2 \frac{A s_{00}^2}{r^2 r_s^2} \hbar c \left( \frac{1}{l_p^2} \right) \begin{pmatrix} 1 & -1 & 0 & 0 \\ -1 & 1 & 0 & 0 \\ 0 & 0 & 0 & 0 \\ 0 & 0 & 0 & 0 \end{pmatrix}, \text{ which is identical to the GR expression apart from}$$

a dimensionless factor  $\frac{1}{4}$ , which can be incorporated in  $A s_{00}$

The AK energy density has the form:  $t_{\mu\nu} = s_\mu s_\nu \hbar c$ , where  $s_\mu = D_\kappa A_\mu^\kappa$  and dimension  $[s_\mu] = 1/r^2$

The current is  $j_\nu = c \frac{x^\kappa}{|x^\kappa|} t_{\kappa\nu}$ , where  $n^\kappa = \frac{x^\kappa}{|x^\kappa|}$  is a unit direction 4-vector,

the energy flux in the direction  $n_i$  is then ([2] 41.11)

$$S = \sum c t_{0i} n_i, \text{ dimension } [S] = \text{energy}/t^2$$

the total power of gravitational radiation for a quadrupole Q is in GR ([2] 42.21)

$$P = \frac{32G\omega^6 Q}{5c^5},$$

in the special case of a binary gravitational rotator with masses  $m_1$  and  $m_2$  (total mass  $m = m_1 + m_2$ ) and the mean orbit radius  $r_0$  we get

$$r_s = \frac{2mG}{c^2} \quad k = \frac{\omega}{c} = \frac{\sqrt{r_s}}{\sqrt{2} r_0^3} \quad P_{GR} = \frac{r_s^2 c^5}{2G} k^6 r_0^4 \left( \frac{m_1 m_2}{m^2} \right)^2 = P_0 \frac{r_s^5}{r_0^5} \left( \frac{m_1 m_2}{m^2} \right)^2, \text{ where } P_0 = \frac{\hbar c^2}{2l_p^2} \text{ is a constant with}$$

dimension of power.

In 4.7.2. we have shown that for bgr  $A s_{00}(r, \theta, r_0) = \frac{A s_{00} n_{01}(\theta)}{r_0}$ ,

we get  $t_{00} = k_0^2 \frac{As_{00}^2}{r^2 r_s^2} \hbar c \left( \frac{1}{l_P^2} \right)$  ,  $P_{KA} = t_{00} c 4\pi r^2 = k_0^2 As_{00}^2 4\pi \hbar c^2 \left( \frac{1}{l_P r_s} \right)^2$

Setting  $As_{00} = \frac{c_0}{r_0}$  , with  $k_0^2 = \frac{r_s}{2r_0^3}$  it follows from  $P_{KA} = P_{GR}$  ,  $c_0^2 = r_s^6 \frac{\left( \frac{m_1 m_2}{m^2} \right)^2}{32\pi}$  ,  $c_0 = r_s^3 \frac{\left( \frac{m_1 m_2}{m^2} \right)}{4\sqrt{2\pi}}$

So the amplitude of the gravitational wave of the binary gravitational rotator becomes

$$As_{00} = \frac{\left( \frac{m_1 m_2}{m^2} \right) r_s^3}{4\sqrt{2\pi} r_0} , \text{ where } r_s = \frac{2Gm}{c^2} \text{ is the Schwarzschild radius of the total mass } m , \text{ and}$$

$$f_m = \frac{m_1 m_2}{m^2} = \frac{m_r}{m} = \frac{\mu}{(1+\mu)^2} \text{ is the ratio of the reduced mass to the total mass } \mu = \frac{m_1}{m_2} \leq 1 .$$

This formula can be easily generalized to multiple masses rotating around their common center-of mass:

$$As_{00} = \frac{f_m}{4\sqrt{2\pi}} \frac{r_s^3}{r_0} \text{ with } f_m = \frac{m_1 m_2 \dots m_n}{m^n} = \frac{m_r}{m} \text{ and } r_0 \text{ the mean diameter of the rotator.}$$

## B8. Quantum AK-gravitation

We recall the Ashtekar-Kodama equations

$$\text{spacetime curvature (field tensor)} \quad F_{\mu\nu}{}^\kappa = \partial_\mu A_\nu{}^\kappa - \partial_\nu A_\mu{}^\kappa + \varepsilon^\kappa{}_{\kappa_1\kappa_2} A_\mu{}^{\kappa_1} A_\nu{}^{\kappa_2}$$

$$4 \text{ gaussian constraints} \quad G^\mu = \partial_\nu E^{\nu\mu} + \varepsilon^\mu{}_{\kappa\lambda} A_\nu{}^\kappa E^{\nu\lambda} \quad (\text{covariant derivative of } E^{\mu\nu} \text{ vanishes)}$$

$$4 \text{ diffeomorphism constraints} \quad I_\mu = E^\kappa{}_\nu F_{\mu\kappa}{}^\nu$$

$$24 \text{ hamiltonian constraints} \quad H_{(\mu,\nu)}{}^\kappa = F_{\mu\nu}{}^\kappa + \frac{\Lambda}{3} \varepsilon_{\mu\nu\rho} E^{\rho\kappa}$$

In this section, we will find the lagrangian, from which the AK equations can be derived.

### 8.1. Lagrangian of the hamiltonian equations

In electrodynamics, the lagrangian of the fundamental Maxwell equations is

$$L_{em} = -\frac{1}{4} F_{\mu\nu} F^{\mu\nu}$$

Therefore we make at first the analogous ansatz for the AK-lagrangian of the Hamiltonian equations

$$L_F = F_{\mu\nu}{}^\kappa F^{\mu\nu}{}_\kappa$$

The formal expression for the variation of action for the variables  $A_\mu{}^\nu$  is:

$$\frac{\delta L}{\delta A_\rho{}^\sigma} = \frac{\partial L}{\partial A_\rho{}^\sigma} - \partial_\tau \frac{\partial L}{\partial A_\rho{}^\sigma{}_{,\tau}}, \quad \text{where} \quad A_\rho{}^\sigma{}_{,\tau} = \frac{\partial A_\rho{}^\sigma}{\partial x^\tau}$$

We have 4 intermediate results

$$\frac{\partial F_{\mu\nu}{}^\kappa}{\partial A_\rho{}^\sigma} = \delta_{\mu\rho} \varepsilon_{\sigma\kappa_2}{}^\kappa A_\nu{}^{\kappa_2} + \delta_{\nu\rho} \varepsilon_{\kappa_1\sigma}{}^\kappa A_\mu{}^{\kappa_1}$$

$$\partial_\tau \frac{\partial F_{\mu\nu}{}^\kappa}{\partial A_\rho{}^\sigma{}_{,\tau}} = (\delta_{\mu\tau} \delta_\nu{}^\rho - \delta_{\nu\tau} \delta_\mu{}^\rho) \delta_\sigma{}^\kappa$$

$$\frac{\partial L_F}{\partial A_\rho{}^\sigma} = 2\varepsilon_{\sigma\kappa_1}{}^\kappa (\delta_\mu{}^\rho A_\nu{}^{\kappa_2} - \delta_\nu{}^\rho A_\mu{}^{\kappa_1}) F^{\mu\nu}{}_\kappa = 4\varepsilon_{\sigma\lambda_1\kappa} F^{\rho\nu\kappa} A_\nu{}^{\lambda_1}$$

$$\partial_\tau \frac{\partial L_F}{\partial A_\rho{}^\sigma{}_{,\tau}} = 2\partial_\tau (\delta_{\mu\tau} \delta_\nu{}^\rho - \delta_{\nu\tau} \delta_\mu{}^\rho) \delta_{\kappa\sigma} F^{\mu\nu\kappa} = 4\partial^\tau F_\tau{}^\rho{}_\sigma$$

and the result of the variation follows

$$\frac{\delta L_F}{\delta A_\rho{}^\sigma} = -4\partial^\tau F_\tau{}^\rho{}_\sigma + 4\varepsilon_{\sigma\lambda_1\kappa} F^{\rho\nu\kappa} A_\nu{}^{\lambda_1}$$

This is a *derived* equation  $\tilde{H}^\rho{}_\sigma = 4(-\partial^\tau H_\tau{}^\rho{}_\sigma + \varepsilon_{\sigma\lambda_1\kappa} H^{\rho\nu\kappa} A_\nu{}^{\lambda_1})$  from a 3-tensor  $H=F$ , which is the first term in the AK hamiltonian equations.

Now consider the following lagrangian

$$L_\Lambda = \varepsilon^\kappa{}_{\mu\lambda} E^{\lambda\nu} \partial_\kappa A_{\mu\nu} + \varepsilon_{\mu_2\lambda_2\kappa_2} \varepsilon^{\mu_1\lambda_1}{}_{\kappa_1} E^{\kappa_1\kappa_2} A_{\lambda_1}{}^{\lambda_2} A_{\mu_1}{}^{\mu_2}$$

One can show easily that for  $H_\Lambda(E)_{\rho\sigma}{}^\tau = \varepsilon_{\rho\sigma\lambda} E^{\lambda\tau}$

$$\frac{\partial L_F}{\partial A_\rho{}^\sigma} = -\partial^\tau H_\Lambda(E)_{\tau}{}^\rho{}_\sigma + \varepsilon_{\sigma\lambda_1\kappa} H_\Lambda(E)^{\rho\nu\kappa} A_\nu{}^{\lambda_1}$$

So the complete Lagrangian for the *derived* hamiltonian equations is

$$L_H = -\left(\frac{1}{4} L_F + \frac{\Lambda}{3} L_\Lambda\right) = -\left(\frac{1}{4} F_{\mu\nu}{}^\kappa F^{\mu\nu}{}_\kappa + \frac{\Lambda}{3} (\varepsilon^\kappa{}_{\mu\lambda} E^{\lambda\nu} \partial_\kappa A_{\mu\nu} + \varepsilon_{\mu_2\lambda_2\kappa_2} \varepsilon^{\mu_1\lambda_1}{}_{\kappa_1} E^{\kappa_1\kappa_2} A_{\lambda_1}{}^{\lambda_2} A_{\mu_1}{}^{\mu_2})\right)$$

The corresponding derived Hamiltonian equations are

$$\frac{\delta L_H}{\delta A_\rho{}^\sigma} = -\partial^\tau H\left(A, \frac{\Lambda}{3} E\right)_{\tau}{}^\rho{}_\sigma + \varepsilon_{\sigma\lambda_1\kappa} H\left(A, \frac{\Lambda}{3} E\right)^{\rho\nu\kappa} A_\nu{}^{\lambda_1}, \quad \text{where}$$

$H(A, \frac{\Lambda}{3} E)_{\mu\nu}{}^\kappa = F_{\mu\nu}{}^\kappa + \frac{\Lambda}{3} \varepsilon_{\mu\nu\rho} E^{\rho\kappa}$  are the AK hamiltonian equations.

Furthermore, we follow the ansatz of Smolin in [5] and let  $\Lambda$  be generated by a scalar field  $\varphi_\Lambda$  with the constraint  $\bar{\varphi}_\Lambda \varphi_\Lambda = \Lambda$

$$L_H = -\hbar c \left( \frac{1}{4} F_{\mu\nu}{}^\kappa F^{\mu\nu}{}_\kappa + \frac{\bar{\varphi}_\Lambda \varphi_\Lambda}{3} (\varepsilon^{\kappa\mu\lambda} E^{\lambda\nu} \partial_\kappa A_{\mu\nu} + \varepsilon_{\mu_2\lambda_2\kappa_2} \varepsilon^{\mu_1\lambda_1\kappa_1} E^{\kappa_1\kappa_2} A_{\lambda_1}{}^{\lambda_2} A_{\mu_1}{}^{\mu_2}) \right),$$

which brings the action to the correct dimension  $[L_H] = \frac{\text{energy}^* r}{r^4}$ , because  $[\varphi_\Lambda] = \frac{1}{r}$  and  $[\Lambda] = \frac{1}{r^2}$ , therefore this action is formally renormalizable.

If we carry out the variation for  $\varphi_{\mu\nu}$ , we get the following expression

$$\frac{\delta L_H}{\delta \varphi_{\rho\sigma}} = -\hbar c \left( \frac{\varphi_\Lambda}{3} (\varepsilon^{\kappa\mu\lambda} E^{\lambda\nu} \partial_\kappa A_{\mu\nu} + \varepsilon_{\mu_2\lambda_2\kappa_2} \varepsilon^{\mu_1\lambda_1\kappa_1} E^{\kappa_1\kappa_2} A_{\lambda_1}{}^{\lambda_2} A_{\mu_1}{}^{\mu_2}) \right),$$

which becomes the  $\Lambda$ -gauge condition for the AK equations in the form

$$G_\Lambda = \varepsilon^{\mu\nu}{}_\lambda E^{\lambda\kappa} \partial_\mu A_{\nu\kappa} + \varepsilon_{\mu_2\mu\kappa_2} \varepsilon^{\nu\mu\kappa_1} E^{\kappa_1\kappa_2} A_{\mu}{}^{\lambda_2} A_{\nu}{}^{\mu_2}, \quad G_\Lambda \neq 0$$

We use the Hamiltonian equations, and after some algebra we get the expression

$$G_\Lambda = -\frac{\Lambda}{3} \sum_{\lambda,\rho} (E \cdot \eta \cdot E^t)^{\lambda\rho} + \sum_{\kappa,\lambda} E^{\lambda\kappa} \sum_{(\mu,\nu)=C(\kappa,\lambda)} (A_{\mu\mu} A_{\nu\nu} - A_{\mu\nu} A_{\nu\mu}),$$

where  $(\mu,\nu)=C(\kappa,\lambda)$  is the complementary index pair.

For the classical case with  $\Lambda \approx 0$  with the constant half-antisymmetric background  $A_{hab}$  and the Gauss-Schwarzschild tetrad  $E_{GS}$  the first term in  $G_\Lambda$  is negligible and the second vanishes for  $A = A_{hab}$ .

In the general case,  $G_\Lambda$  is a single gauge condition, which fixes one free parameter of the AK-solution.

## 8.2. Lagrangian of the remaining equations

For the diffeomorphism equations  $I_\mu = E^\kappa{}_\nu F_{\mu\kappa}{}^\nu$ , we set simply the variable  $C_\mu := E^\kappa{}_\nu F_{\mu\kappa}{}^\nu$

and take the lagrangian  $L_I = \hbar c C_\mu C^\mu = \hbar c E^{\kappa_1}{}_{\nu_1} F_{\mu\kappa_1}{}^{\nu_1} E^{\kappa_2}{}_{\nu_2} F^{\mu}{}_{\kappa_2}{}^{\nu_2}$  as the corresponding lagrangian

As for the gaussian equations  $G^\mu = \partial_\nu E^{\nu\mu} + \varepsilon^\mu{}_{\kappa\lambda} A_\nu{}^\kappa E^{\nu\lambda}$ , they can be derived from the fact, that this is the covariant derivative for the tetrad  $E$ , so it must vanish.

$$\text{With } L_H = -\hbar c \left( \frac{1}{4} F_{\mu\nu}{}^\kappa F^{\mu\nu}{}_\kappa + \frac{\bar{\varphi}_\Lambda \varphi_\Lambda}{3} (\varepsilon^{\kappa\mu\lambda} E^{\lambda\nu} \partial_\kappa A_{\mu\nu} + \varepsilon_{\mu_2\lambda_2\kappa_2} \varepsilon^{\mu_1\lambda_1\kappa_1} E^{\kappa_1\kappa_2} A_{\lambda_1}{}^{\lambda_2} A_{\mu_1}{}^{\mu_2}) \right)$$

the complete AK lagrangian is then

$$L_{gr} = L_H + L_I = \hbar c \left( -\frac{1}{4} F_{\mu\nu}{}^\kappa F^{\mu\nu}{}_\kappa - \frac{\bar{\varphi}_\Lambda \varphi_\Lambda}{3} (\varepsilon^{\kappa\mu\lambda} E^{\lambda\nu} \partial_\kappa A_{\mu\nu} + \varepsilon_{\mu_2\lambda_2\kappa_2} \varepsilon^{\mu_1\lambda_1\kappa_1} E^{\kappa_1\kappa_2} A_{\lambda_1}{}^{\lambda_2} A_{\mu_1}{}^{\mu_2}) + E^{\kappa_1}{}_{\nu_1} F_{\mu\kappa_1}{}^{\nu_1} E^{\kappa_2}{}_{\nu_2} F^{\mu}{}_{\kappa_2}{}^{\nu_2} \right)$$

## 8.3. Dirac lagrangian for the graviton

The Dirac lagrangian for the photon reads where  $\alpha = \frac{e^2}{4\pi\varepsilon_0\hbar c}$  is the fine-structure-constant (in the following

$$\alpha = \frac{e^2}{4\pi} \text{ in natural units } \hbar = c = \varepsilon_0 = 1 \text{ used in particle physics})$$

$$L_{Dem} = \bar{\psi} (-\hbar c i \gamma^\mu D_\mu - mc^2) \psi - \frac{1}{4} F_{\mu\nu} F^{\mu\nu}, \text{ where } D_\mu = \partial_\mu + \frac{ie}{\sqrt{\hbar c}} A_\mu \text{ or } D_\mu = \partial_\mu + i\sqrt{4\pi\alpha} A_\mu \text{ in natural units}$$

is the covariant derivative of the photon (note the negative sign in the first term: we use here the metric  $\eta = \text{diag}(-1, 1, 1, 1)$ )

This describes the interaction of the photon with a fermion and yields the corresponding Feynman diagrams and cross sections.

The Dirac lagrangian for the graviton reads

$L_{D_{gr}} = \bar{\psi}(-\hbar c i \gamma^\mu D_\mu - mc^2)\psi + L_{gr}$ , where  $(D_\mu)^\lambda{}_\kappa = \partial_\mu + (\varepsilon_a)^\lambda{}_\kappa A_\mu^a$  is the covariant derivative of the graviton, where the generator matrix  $(\varepsilon_a)^\lambda{}_\kappa = \varepsilon^\lambda{}_{\kappa 1 a}$

The electron-graviton interaction term is

$\delta_I L_{D_{gr}} = -\hbar c i \bar{\psi}(\gamma^\mu (\varepsilon_a)^\lambda{}_\kappa A_\mu^a)\psi$ , where  $A_\mu^v = \Lambda \frac{As_\mu^v}{r} \exp(2i\theta) \exp(-ik(r-t))$  is the graviton quadrupole

wave function, so (background  $Ab \approx 0$ ), so the term is linear in  $As$ , like in the electromagnetic case.

The presence of  $\Lambda$  makes the term very small.

Let us compare this to the GR-Dirac lagrangian

$$L_{GRD} = -\frac{\sqrt{\det(-g)}}{2\kappa} (R - 2\Lambda) + \sqrt{-g} \bar{\psi} (i\hbar c \gamma^\mu(x) \nabla_\mu - mc^2) \psi$$

where

$$\nabla_\mu \psi = (\partial_\mu - \frac{i}{4} \omega_\mu^{ab} \sigma_{ab}) \psi \quad \text{and} \quad \sigma_{\mu\nu} = \frac{i}{2} [\gamma_\mu, \gamma_\nu]$$

and  $\omega$  the GR connection field in tetrad-expression

$$\omega_\mu^{ab} = \frac{1}{2} e^{av} (\partial_\mu e_\nu^b - \partial_\nu e_\mu^b) + \frac{1}{4} e^{a\rho} e^{b\sigma} (\partial_\sigma e_\rho^c - \partial_\rho e_\sigma^c) e_\mu^c - (a \leftrightarrow b)$$

with the tetrad  $e_\mu^a e_\nu^a = g_{\mu\nu}$  i.e.  $e \bullet \eta \bullet e = g$

compared to the metric condition for the inverse densitized background tetrad  $Eb$

$$Eb \bullet \eta \bullet Eb^t = g^{-1} / (-\det(g))^{3/4}, \text{ so } e = (Eb^{-1})^t / (-\det(g))^{3/8}$$

Here the interaction term is

$$\delta_I L_{GRD} = -\frac{\hbar c}{4} \sqrt{\det(-g)} \bar{\psi} (\gamma^\mu \omega_\mu^{ab} \sigma_{ab}) \psi = -\frac{\hbar c}{4} \sqrt{\det(-g)} \bar{\psi} (\sum_\mu \gamma^\mu f^\mu (Eb^{-1})) \psi$$

where the middle term  $\sum_\mu \gamma^\mu f^\mu (Eb^{-1})$  is a sum of  $\gamma$ -matrices with coefficients, which are quadratic functions of  $Eb^{-1}$  so  $\delta_I L_{GRD}$  is quite different from the AK-interaction term  $\delta_I L_{D_{gr}}$ .

#### 8.4. The graviton wave function and cross-sections

For the Compton effect, i.e. electron-photon scattering

$$\frac{8\pi\alpha^2}{3m^2} = 0.665 \times 10^{-24} \text{ cm}^2$$

the Thompson cross-section for small energies is  $\sigma_{Th} = \alpha^2 \left( \frac{\hbar c}{mc^2} \right)^2 \frac{8\pi}{3}$ , where  $m = m_e$

is the electron mass,

and

$$\text{the reduced de-Broglie wavelength of the electron } \tilde{\lambda}_e = \frac{\hbar c}{m_e c^2} = 0.38 * 10^{-12} \text{ m}.$$

So the electron-photon Thompson cross-section is with these denominations  $\sigma_{th} = \alpha^2 \frac{1}{\tilde{\lambda}_e^2} \frac{8\pi}{3}$

The photon wave function is here [20, 7.53]

$$(A_e)^\mu = \frac{\varepsilon^\mu}{\sqrt{2kV}} (\exp(-ik \bullet x) + \exp(ik \bullet x))$$

where  $\varepsilon^\mu$  is unit-polarization vector,  $k^\mu k_\mu = 0$  and  $\varepsilon^\mu k_\mu = 0$ .  $A^\mu$  is normalized to give the energy

$$E(A^\mu) = \hbar c \int (\nabla \times A)^2 d^3x = \hbar \omega = \hbar c k$$

We use the results from 4.3.1

$$As30 = As30c \exp\left(-\frac{4\sqrt{r}}{\sqrt{3}}\right) \frac{r^{17/12}}{6} \rightarrow 0$$

$$As10 = -\frac{As20c}{2} \exp(2i\theta)$$

$$As00 = -\frac{As20c}{2} \exp(2i\theta)$$

$$As20 = \frac{As20c}{r} \exp(2i\theta) \rightarrow 0$$

and from 7 and write the graviton wave function as a plane wave analogous to the photon (the quadrupole characteristics disappear in the plane wave, therefore  $\exp(2i\theta)$  is skipped)

$$(A_g)_\mu^\nu = \Omega_\mu^\nu \frac{1}{2} \Lambda f_m \frac{r_s^2 \sqrt{\pi}}{2\sqrt{2}r_0} \frac{r_s^{3/2}}{\sqrt{2V}} (\exp(-ik \cdot x) + \exp(ik \cdot x)), \text{ with the polarization matrix according to the}$$

results from 4.3.1 is a combination of the 4 columns of

$$\Omega_\mu^\nu = \begin{pmatrix} 1 & 1 & 1 & 1 \\ 1 & 1 & 1 & 1 \\ 0 & 0 & 0 & 0 \\ 0 & 0 & 0 & 0 \end{pmatrix}$$

According to 7 we get now for the energy density  $t_{00} = t_{11} = (2k As00)^2 \frac{\hbar c}{\Lambda^2 l_p^2 r_s^2}$

$$t_\mu^\mu = 8k^2 As00^2 \frac{\hbar c}{\Lambda^2 l_p^2 r_s^2}, \text{ and as } \int_V \frac{1}{2V} (\exp(-ik \cdot x) + \exp(ik \cdot x))^2 d^3x = 1 \text{ and } k = \sqrt{\frac{r_s}{2r_0^3}},$$

we get for the energy

$$E(A_g) = \int_V t_\mu^\mu d^3x = \frac{r_s \hbar c}{l_p^2} \frac{\pi f_m^2}{4^{2/3}} (kr_s)^{10/3}, \text{ now we demand that } E(A_g) = \hbar ck, \text{ so the normalization factor is}$$

$$c_n = \frac{1}{\frac{r_s}{l_p} \frac{\sqrt{\pi} f_m}{4^{1/3}} (kr_s)^{7/6}} \text{ and the normalized wave function becomes}$$

$$(A_{gn})_\mu^\nu = (A_g)_\mu^\nu c_n = \Omega_\mu^\nu \sqrt{\alpha_{gr}} \frac{1}{\sqrt{kr_s}} \frac{r_s^{1/2}}{\sqrt{2V}} (\exp(-ik \cdot x) + \exp(ik \cdot x)), \text{ where } r_s = r_{gr},$$

$$\sqrt{\alpha_{gr}} = \frac{r_{gr} \Lambda l_p}{\sqrt{2}} = 0.55 * 10^{-91} \text{ and } \alpha_{gr} \text{ is the gravitational fine structure constant and the photon-like wave}$$

function can be written

$$(A_{gn})_\mu^\nu = \sqrt{\alpha_{gr}} (A_p)_\mu^\nu$$

The covariant derivative is then  $(D_\mu)^\lambda_\kappa = \partial_\mu + (\varepsilon_a)^\lambda_\kappa \sqrt{\alpha_{gr}} (A_p)_\mu^a$

where  $A_p$  is completely analogous to the photon wave function  $A_e$ , and matrices  $(\varepsilon_a)^\lambda_\kappa = \varepsilon^\lambda_{a\kappa}$   $a=0,1,2,3$  in analogy to the Dirac gamma-matrices, and we have the correspondence  $\alpha_{gr} \leftrightarrow 4\pi\alpha$  between the gravitational and the electromagnetic fine structure constants.

By analogy we can then assess the electron-graviton scattering cross-section  $\sigma_{eg} \approx \left(\frac{\alpha_{gr}}{4\pi}\right)^2 \frac{1}{\tilde{\lambda}_e^2}$ ,

ignoring the tensor form and the  $\theta$ -dependence.

$\alpha_{gr}$  above is calculated with the cosmological  $\Lambda$ , but, as  $\Lambda$  is generated by a scalar field, it is expected to be

different in the quantum regime. We expect the quotient  $\frac{\alpha_{gr}}{\alpha_{em}} \approx 10^{-40}$  as results from the classical assessment of

the ratio of the electrostatic and gravitational potential for the electron.



We demand  $\frac{\alpha_{gr}}{r} \stackrel{!}{=} \frac{m_0^2 G}{r \hbar c} = \frac{E_{grav}}{\hbar c}$  for a mass-constant  $m_0$ , so  $\alpha_{gr} = \frac{(r_{gr} \Lambda l_p)^2}{2} \stackrel{!}{=} \frac{m_0^2 G}{\hbar c} = \frac{m_0^2 c^4 l_p^2}{\hbar^2 c^2} = \frac{l_p^2}{\tilde{\lambda}_0^2}$

where  $\tilde{\lambda}_0 = \frac{\hbar}{m_0 c}$  is the reduced de-Broglie wavelength of  $m_0$ . If we set  $m_0 = m_e$ , we get

$$\alpha_{gr} = \frac{l_p^2}{\tilde{\lambda}_0^2} = \left( \frac{1.61 * 10^{-35}}{0.38 * 10^{-12}} \right)^2 = 1.78 * 10^{-45} \quad \text{and} \quad \frac{\alpha_{gr}}{\alpha_{em}} = 0.243 * 10^{-42}, \quad \text{which is approximately the expected ratio.}$$

In this case  $\Lambda = \Lambda_1 = \frac{\sqrt{2}}{\tilde{\lambda}_0 r_{gr}} = 1.2 * 10^{17} m^{-2}$ , so dimensionless  $\Lambda_{dl} = \Lambda r_{gr}^2 = 1.15 * 10^8 \gg 1$  and we have a

*very strong coupling* in the AK-equations, with the ratio  $\frac{\Lambda_{quantum}}{\Lambda_{classical}} = \frac{1.2 * 10^{17} m^{-2}}{1.1 * 10^{-52} m^{-2}} = 1.09 * 10^{69}$ .

That would suggest to identify the  $\Lambda$ -generating scalar field  $\varphi_\Lambda$  with the *cosmological dilaton field*, which is responsible for the inflation in the early universe: it is well known, that  $\Lambda$  is driving the present cosmological expansion on large scales as a repulsive force, and according to the above assessment, its repulsive influence must have been stronger by 69 orders of magnitude in the early universe.

## 8.5. The graviton propagator

As is well known, the photon propagator in QFT is [20]

$$D_F(q^2) = \frac{-1}{q^2 + i\epsilon}, \quad \text{which follows from the Maxwell equations} \quad \square A^\mu(x) = J^\mu(x)$$

We consider the wave equations *eqgravlxA0*, *eqgravlxA3* and *eqgravlxEn* in the momentum representation, i.e. in the  $k$ -space. Then the  $r$ -derivatives transform into  $k$ -powers

$$\partial_r^n f(r, k) = (i k)^n f(r, k)$$

We write the equations as polynomials in  $k$ :

$$\text{eqgravlxEninf} \quad P(ES1) = 2ik^3 lx - 2ik^4 r + 3ik^4 r - ik^4 r = 2ik^3 lx$$

$$\text{eqgravlxA0} \quad P(As0) = 3(1 + ilx - irk)(lx + kr)^2 +$$

$$P(As0ES1) = r((-1 + lx^2 + 2lx(-i + kr)) + ikr(1 + 2ilx + 2ikr) + k^2 r^2)$$

at  $r$ -infinity:  $P_{inf}(As0) = -3ik^3 r^3 + P_{inf}(As0ES1) = -k^2 r^3$ , so

$$As0 = -P_{inf}(As0)^{-1} P_{inf}(As0ES1) ES1 = \frac{i}{3k} ES1$$

$$ES1 = P(ES1)^{-1} \delta ES = \frac{\delta ES}{2ilxk^3} \quad As0 = \frac{\delta ES}{6lxk^4}, \quad \text{so the } As0\text{-propagator is } D_F(As0, q^2) = \frac{1}{6lx(q^4 + i\epsilon)}$$

$$\text{eqgravlxA3} \quad P(As3) = 6k lx(1 + ikr - ikr) = 6k lx +$$

$$P(As3ES1) = (-2k^2 r^2 + 3k^2 r^2 - k^2 r^2) + ((i - lx)kr - (i - lx)kr) + (1 + ilx) = 1 + ilx, \quad \text{so}$$

$$As3 = \frac{i(1 + ilx)\delta ES}{12lx^2 k^4}, \quad \text{so the } As3\text{-propagator is } D_F(As3, q^2) = \frac{(i - lx)}{12lx^2(q^4 + i\epsilon)}$$

The  $As$ -propagators are identical apart from a constant factor and are finite-integrable in  $q^2 dq$ .

## 8.6. The gravitational Compton cross section

For the Compton effect, i.e. electron-photon scattering

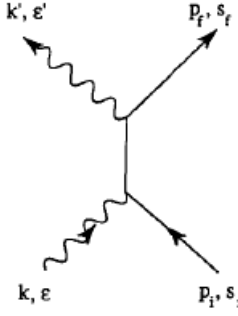

the total Klein-Nishina cross-section [22]  $\sigma =$

$$= \left( \frac{8\pi\alpha^2}{3m^2} \right) (3/4) \left[ \frac{1+a}{a^3} \left( \frac{2a(1+a)}{1+2a} - \log(1+2a) \right) + \frac{\log(1+2a)}{2a} - \frac{1+3a}{(1+2a)^2} \right]$$

where  $a = k/m$ , for small energies it becomes the

$$\frac{8\pi\alpha^2}{3m^2} = 0.665 \times 10^{-24} \text{ cm}^2$$

Thompson cross-section  $\sigma_{\text{Th}} =$

$$= \alpha^2 \left( \frac{\hbar c}{mc^2} \right)^2 \frac{8\pi}{3}, \text{ where } m = m_e \text{ is the electron mass,}$$

$\alpha$  is the fine-structure-constant and the *reduced de-Broglie wavelength* of the electron

$$\tilde{\lambda}_e = \frac{\hbar c}{m_e c^2} = 0.38 \times 10^{-12} \text{ m}.$$

so  $\sigma_{\text{th}} = \alpha^2 \tilde{\lambda}_e^2 \frac{8\pi}{3}$  with these de nominations.

The start formula for the calculation of the differential cross-section according to the Feynman rules is [20 7.7.2], [21 4.218]

$$\begin{aligned} \frac{d\bar{\sigma}}{d\Omega} &= \frac{1}{2} \sum_{\pm s_i, s_f} \frac{d\sigma}{d\Omega} \\ &= \frac{\alpha^2}{2} \left( \frac{k'}{k} \right)^2 \text{Tr} \frac{\not{p}_f + m}{2m} \left( \frac{\not{\epsilon}' \not{\epsilon} k}{2k \cdot p_i} + \frac{\not{\epsilon} \not{\epsilon}' k'}{2k' \cdot p_i} \right) \frac{\not{p}_i + m}{2m} \\ &\quad \times \left( \frac{k \not{\epsilon} \not{\epsilon}'}{2k \cdot p_i} + \frac{k' \not{\epsilon}' \not{\epsilon}}{2k' \cdot p_i} \right) \end{aligned}$$

with the initial and final momenta  $p_i$   $p_f$  of the electron,  $k$   $k'$  momenta of the photon and polarizations  $\epsilon$   $\epsilon'$  of the photon. The following conditions have to be satisfied:

$$p_i \cdot p_i = m^2 \quad p_f \cdot p_f = m^2 \quad k \cdot k = k' \cdot k' = 0 \quad \text{energy relations}$$

$$p_f + k' = p_i + k \quad \text{4-momentum conservation}$$

$$k_0' = \frac{k_0}{1 + \frac{k_0}{m}(1 - \cos \theta)} \quad \text{Compton condition for the photon energy}$$

There is 3 degrees of freedom in the choice of the polarization, the choice is made to simplify the expression above

$$\epsilon \cdot \epsilon = \epsilon' \cdot \epsilon' = -1 \quad \epsilon \cdot k = \epsilon' \cdot k' = 0 \quad \epsilon \cdot p_i = \epsilon' \cdot p_i = 0$$

After some manipulations using the conditions and commutation rules for Dirac matrices, the famous Klein-Nishina formula results [20 7.74]

$$\frac{d\bar{\sigma}}{d\Omega} = \frac{\alpha^2}{4m^2} \left( \frac{k'}{k} \right)^2 \left[ \frac{k'}{k} + \frac{k}{k'} + 4(\epsilon' \cdot \epsilon)^2 - 2 \right], \text{ where the scalar denomination } k \text{ } k' \text{ is used for the energy } k_0 \text{ } k_0'$$

We get the total cross-section using the Compton condition and integrating over  $z = \cos \theta$

$$\bar{\sigma} = \frac{\pi\alpha^2}{m^2} \int_{-1}^1 dz \left\{ \frac{1}{[1 + (k/m)(1-z)]^3} + \frac{1}{[1 + (k/m)(1-z)]} - \frac{1-z^2}{[1 + (k/m)(1-z)]^2} \right\}$$

and averaging over polarizations [21 4.221]  $\overline{(\varepsilon' \cdot \varepsilon)^2} = \frac{1}{2} \left( \delta_{ij} - \frac{k^i k^j}{k^2} \right) \left( \delta_{ij} - \frac{k'^i k'^j}{k'^2} \right)$

for small energies  $\frac{k}{m} \rightarrow 0$ , the Thomson cross section arises

$$\sigma_{th} = \alpha^2 \left( \frac{\hbar c}{mc^2} \right)^2 \frac{8\pi}{3} = \alpha^2 \tilde{\lambda}_e^2 \frac{8\pi}{3}$$

For the graviton, we insert the photon-like (dimensionless, dropping the scale  $r_s = r_{gr}$ ) wave function

$$(A_p)_\mu^v = \Omega_\mu^v \frac{1}{\sqrt{2Vk}} (\exp(-ik \cdot x) + \exp(ik \cdot x))$$

with the covariant derivative  $(D_\mu)^\lambda{}_\kappa = \partial_\mu + (\varepsilon_a)^\lambda{}_\kappa \sqrt{\alpha_{gr}} (A_p)_\mu^a$

and again the starting formula above, where the only change is in the polarization terms  $\mathcal{E} = \varepsilon_\mu \gamma^\mu$  and

$$\mathcal{E}' = \varepsilon'_\mu \gamma^\mu, \text{ which, with the setting } \Omega_\mu^v = \begin{pmatrix} e_0 & e_1 & e_2 & e_3 \\ e_0 & e_1 & e_2 & e_3 \\ 0 & 0 & 0 & 0 \\ 0 & 0 & 0 & 0 \end{pmatrix} \text{ and the new initial polarization } e_\mu = (e_0, e_1, e_2, e_3)$$

and final polarization  $e'_\mu = (e'_0, e'_1, e'_2, e'_3)$

$\|e'\| = \sqrt{e_0^2 + e_1^2 + e_2^2 + e_3^2} = \|e'\| = 1$ , and the totally antisymmetric matrices  $\varepsilon_a$ , become

$\varepsilon_a^{\lambda_1 \kappa} \Omega_\mu^a (\gamma^\mu)^{\lambda_2} = e^\alpha (\varepsilon_a) (\gamma^0 + \gamma^1) = e^\alpha g_\alpha$ , where  $g_\alpha = \varepsilon_a (\gamma^0 + \gamma^1)$  are the matrices analogous to the  $\gamma$ -matrices in the ‘‘Dirac-dagger’’  $\mathcal{E} = \varepsilon_\mu \gamma^\mu$  in the quantum-electrodynamics.

After going into the rest frame of the electron  $p = (m, 0, 0, 0)$  and some manipulations we get

$$\frac{d\bar{\sigma}}{d\Omega} = \left( \frac{\alpha_{gr}}{4\pi} \right)^2 \frac{1}{32m^2} \left( \frac{k_0'}{k_0} \right)^2 \left( d_{s0}(e, e', \theta) + \frac{k_0}{m} d_{s1}(e, e', \theta) + O\left( \frac{k_0^2}{m^2} \right) \right), \text{ where the functions } d_{s0}(e, e', \theta) \text{ and}$$

$d_{s1}(e, e', \theta)$  are series-coefficients in the  $\frac{k_0}{m}$ -series.

Now perform the integration over  $\theta$  and averaging over  $e_\mu$  and  $e'_\mu = e_\mu$

to get the total cross-section

$$\bar{\sigma} = \frac{\alpha_{gr}^2}{2\pi} \tilde{\lambda}_e^2 \left( 1.170 + \frac{k_0}{m} 0.400 + \dots \right) \approx 1.170 \frac{\alpha_{gr}^2}{2\pi} \tilde{\lambda}_e^2, \text{ where the last expression is the gravitational low-energy}$$

Thomson cross-section.

The different form of the bracket expression in the differential cross-section as compared to the electromagnetic cross-section is due to the different nature of polarization: for the photon the polarization is *transversal to the momentum*, so the averaging depends on  $k$  and  $k'$ , for the graviton the polarization is a *free parameter* independent of momentum.

## 8.7. The role of gravity in the objective collapse theory

The *objective collapse theory* put forward by Penrose [19], links the spontaneous collapse of the wave function to quantum gravitation, the limit being one graviton. In the formulation of Ghirardi-Rimini-Weber (GRW) the wave function collapse is characterized by the wave function width  $r_c$  and by the decay rate  $\lambda$ .

In the recent test of collapse models carried out by Bassi et al. [26], possible values of these parameters are measured:

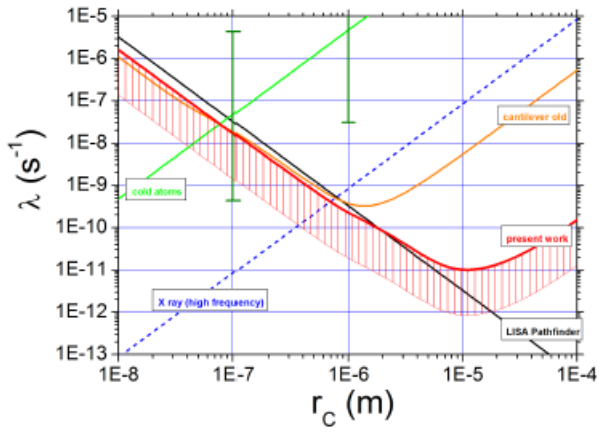

As shown above,  $\lambda(r_c)$  has a minimum at  $r_c = 10^{-5} m$ , which is a good candidate for the limit of the quantum regime, and there is  $\lambda(r_c) = 10^{-11} s^{-1}$ .

This is in good agreement with the quantum limit  $r_{gr} = \sqrt{l_p \sqrt{\frac{1}{\Lambda}}} = 3.1 * 10^{-5} m = 31 \mu m$  of the AK-gravitation.

The decay rate can be assessed from  $\lambda = \frac{E_{gr}}{\hbar} = 0.19 * 10^{-11} s^{-1}$ , where the gravitational energy

$E_{gr} = \frac{G m_e^2}{r_e} = 1.22 * 10^{-27} eV$ , where  $m_e$  is the electron mass and  $r_e = 2.8 * 10^{-15} m$  is the classical electron radius.

## References

- [1] S. Chandrasekhar, *The Mathematical Theory of Black Holes*, Oxford University Press 1992
- [2] T. Fliessbach, *Allgemeine Relativitätstheorie*, Bibliographisches Institut 1990
- [3] M. Visser, *The Kerr spacetime: a brief introduction* [arXiv: gr-qc/07060622], 2008
- [4] L. Freidel, *The linearization of the Kodama state* [arXiv hep-th/0310224], 2003
- [5] L. Smolin, *Quantum gravity with a positive cosmological constant* [arXiv hep-th/0209079], 2002
- [6] T. Thiemann, *Lectures on loop quantum gravity*, MPI Gravitationsphysik AEI-2002-087, 2002
- [7] C. Wüthrich, *Approaching the Planck scale from a general relativistic point of view*, Thesis University of Pittsburgh, 2006
- [8] H. Nicolai, K. Peeters, M. Zamaklar, *Loop quantum gravity: an outside view* [arXiv hep-th/0501114], 2005
- [9] J. Helm, *New solutions of the Tolman-Oppenheimer-Volkov (TOV) equation and of Kerr space-time with matter and the corresponding star models*, viXra 1404.0037, 2017
- [10] J. Helm, *New solutions of gravitational collapse in General Relativity and in the Newtonian limit*, viXra 1408.0117, 2014
- [11] J. Helm, *An exact GR-solution for the relativistic rotator*, viXra 1706.0200, 2017
- [12] M. Hersch, *The Wheeler-DeWitt equation*, wordpress.com, 2017
- [13] C. Kiefer, *Quantum Gravity*, Oxford University Press, 2012
- [14] D. Vey, *Gravity, self duality, BF theory*, Lecture Notes, Paris, 2013
- [15] L. Smolin, S. Speziale, *A note on the Plebanski action with cosmological constant and an Immirzi parameter* [arXiv gr-qc/0908.2288], 2010
- [16] L. Smolin, *The Plebanski action extended to a unification of gravity and Yang-Mills theory*, [arXiv hep-th/0712.0977], 2008
- [17] R. Durka, *Constrained BF theory as gravity*, Max Born Symposium, 2010
- [18] H. Kalka, G. Soff, *Supersymmetrie*, B.G. Teubner, 1997
- [19] R. Penrose, *On Gravity's Role in Quantum State Reduction*. *General Relativity and Gravitation*. **28** (5): 581–600. 1996
- [20] J.D. Bjorken, S.D. Drell, *Relativistic Quantum Mechanics*, McGraw-Hill 1964
- [21] H.-K. Quang, *Elementary Particles and their Interactions*, Springer 1998
- [22] M. Kaku, *Quantum Field Theory*, Oxford University Press 1993
- [23] Mathematica-notebook `WdWcov4Thnceta.nb`, [www.janhelm-works.de](http://www.janhelm-works.de): calculation and derivation of AK-gravity
- [24] Mathematica-notebook `QFTFeynDiag.nb`, [www.janhelm-works.de](http://www.janhelm-works.de): calculation and derivation of Compton cross-section for AK-gravity
- [25] I.A. D'Souza, C.S. Kalman, *Preons: models of leptons, quarks and gauge bosons as composite objects*, World Scientific 1992
- [26] A. Bassi et al., *Improved non-parametric test of collapse models*, [arXiv: qu-ph/1611.09776], 2017
- [27] J. Abedi et al., *Echoes from the abyss*, [arXiv: gr-qc/1612.00266], Dec. 2017