

Quantum FFF Theory, a Conscious String Theory with different Vacuum Trajectories for Axion-Higgs field/ Photons respectively Fermions, Gluons and Bosons.

Leo Vuyk,
Architect, design for physics,
the Netherlands.

Abstract,

This conscious string theory also called Quantum FFF Theory, (FFF = Function Follows Form) is a semi classical theory based on a symmetrical cold Big Bang evaporation into 8 or 12 CP (Charge Parity) symmetric copy (anti) material universes.

It can be called a semi classical theory because it describes reality by the real collision and shape transformation processes of real sub quantum shaped rigid stringy entangled particles.

Each particle is supposed to be conscious by its entanglement with 7 or 11 CP symmetric copy particles located inside the other 7 or 11 CP symmetric universal bubbles at long distance with raspberry shape.

The Q-FFF theory is called Semi classical because in addition to the ring shaped transformable rigid string particles, all universal bubbles are assumed to be each others Charge Parity (CP) mirror symmetric universal bubbles which are assumed to be instant entangled down to each individual string particle created out of the Axion Higgs splitting cold Big Bang. So each particle has to compete for wavefunction collapse with 7 or 11 anti copy particles and each person's choice (free will) also.

So: we live inside 8 or 12 quantum particle based instant entangled pinball machines making choices for our own reptile brain based flash intuition down to single particle slit interference.

However our frontal cortex seems to be able to make social corrections (Vetos) within 300 msec.

The sheer simplicity of such a system is perhaps the reason that I could not find comparable proposals for other theories.



Raspberry shaped entangled oscillating Pinball Multiverse with 2x different Photon– and Fermion/Boson/Gluon trajectories.



Figure 1, The raspberry multiverse combined with a flexible chiral tetrahedral shaped vacuum lattice is making complex choices for wavefunction collapse.

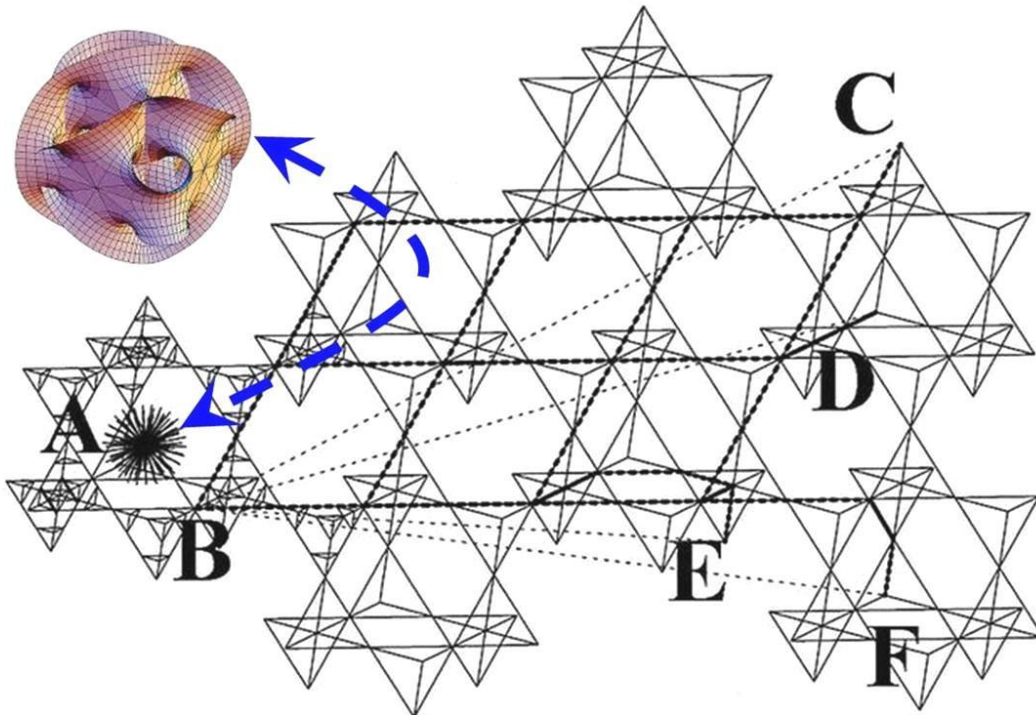

Path integral or Sum over Histories (Feynman) visual represented for the Axion-Higgs tetrahedral vacuum lattice, according to Quantum FFF Theory.

There are two field trajectory systems: one for Photon information transfer (black Lines: B,C,D.E and F) and one for real transportation of Fermions, Bosons and Gluons (A). The Gluons are assumed to mutate after about 1 cm (see: Babcock and Bergman experiment) into a monopole Photon, which does not travel but oscillate as local vacuum particle, transferring photon information with the local speed of light.

Fermions are propeller shaped and assumed to form a Calabi Yaw rotational surface.

If the chirality of all the tetrahedron ribs has a total of 60 degrees rotation, then at vertex points, the information transfer has only two equal choices to reach the next tetrahedron rib, as is assumed for the Path integral solution.

Figure 2, Path integral or Sum over Histories (Feynman) visual represented for the Axion-Higgs tetrahedral vacuum lattice, according to Quantum FFF Theory.

Path integral or Sum over Histories (Feynman) visual represented for the Axion-Higgs tetrahedral vacuum lattice, according to Quantum FFF Theory.

There are two field trajectory systems: one for Photon information transfer (black Lines: B,C,D,E and F) and one for real transportation of Fermions, Bosons and Gluons (A).

The Gluons are assumed to mutate after about 1 cm (see: Babcock and Bergman experiment) into a monopole Photon, which does not travel but oscillate as local vacuum particle, transferring photon information with the local speed of light.

Fermions are propeller shaped and assumed to form a Calabi Yaw rotational surface.

If the chirality of all the tetrahedron ribs has a total of 60 degrees rotation, then at vertex points, the information transfer has only two equal choices to reach the next tetrahedron rib, as is assumed for the Path integral solution.

Transfer systems through the vacuum lattice.

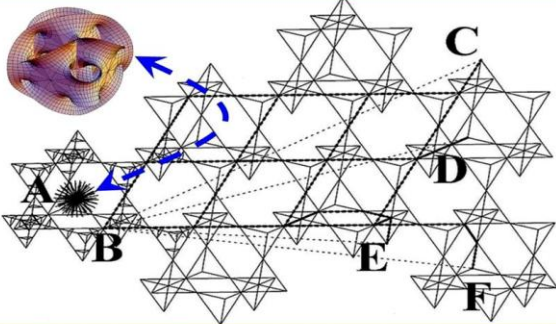

Two different tetrahedron space fill systems with left or right hand chirality, needed to make material or anti-material universes.

Path integral or Sum over Histories (Feynman) visual represented for the Axion-Higgs tetrahedral vacuum lattice, according to Quantum FFF Theory.

There are two field trajectory systems: one for Photon information transfer (black Lines: B,C,D,E and F) and one for real transportation of Fermions, Bosons and Gluons (A).

The Gluons are assumed to mutate after about 1 cm (see: Babcock and Bergman experiment) into a monopole Photon, which does not travel but oscillate as local vacuum particle, transferring photon information with the local speed of light.

Fermions are propeller shaped and assumed to form a Calabi Yaw rotational surface.

If the chirality of all the tetrahedron ribs has a total of 60 degrees rotation, then at vertex points, the information transfer has only two equal choices to reach the next tetrahedron rib, as is assumed for the Path integral solution.



Space fill unit with
RIGHT hand rotation.

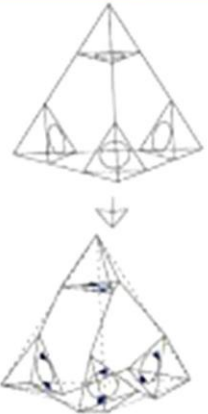

Space fill unit with
LEFT hand rotation.

Figure 3, Transfer systems through the chiral vacuum lattice.

Introduction.

Neil Turok recently said: "And so we have to go back and question those founding principles and find whatever it is, whatever new principle will replace them."

See: <http://www.cbc.ca/radio/ideas/the-ultimate-simplicity-of-everything-1.3490322>

My reaction is to look at forgotten or dissident ideas and anomalies without hesitation to turn around long term accepted ideas.

Examples:

(1) It was **Abdus Salam** who proposed that quarks and leptons should have a sub-quantum Planck level structure, and that they are compound particles with a specific non-zero sized form. See:

<http://vixra.org/pdf/1103.0002v4.pdf> and

<http://vixra.org/pdf/1711.0443v1.pdf>

(2) **Jean Paul Vigier** postulated that quarks and leptons are "pushed around" by an energetic sea of vacuum particles. See:

<http://vixra.org/pdf/1609.0407v1.pdf>

(3) **David Bohm** suggested in contrast with The "Copenhagen interpretation", that reality is not created by the eye of the human observer and second: elementary particles should be "guided by a pilot wave". (particle consciousness) see: <http://vixra.org/pdf/1210.0177v1.pdf>

(4) **John Bell** argued that the motion of mass related to the surrounding vacuum reference frame, should originate real "Lorentz-transformations", and also real relativistic measurable contraction. In my view also indicating to be the base for gravitational lightspeed drag (or LASOF) around massive objects. See: <http://vixra.org/pdf/1612.0365v1.pdf>

(5) **Michelson and Morley** made several lightspeed interference measurements at mountain summits but not in space itself .

It was Tae Suk Bae who did !! See:

<https://bigbang-entanglement.blogspot.nl/2017/01/variable-lightspeed-experiments-in.html>

(6) **Richard Feynman** postulated the idea of an all pervading energetic quantum vacuum. He rejected it, because it should originate resistance for every mass in motion, relative to the reference frame of the quantum vacuum.

However, I postulate counter intuitive possibility, that this resistance for mass in motion, can be compensated, if we combine the ideas of Vigier, Bell, Bohm and Salam, and a new dual universal Bohmian "pilot wave", which is interpreted as the EPR correlation (or Big Bang entanglement) between individual elementary anti-mirror particles, living in dual universes.

See:

<http://vixra.org/pdf/1706.0420v1.pdf>

So my proposal is based on a Rigid String Theory with real rigid strings at the Planck scale able to mutate and merge by form based interlocking with other particles to form Quarks and some bosons (Higgs Z and W) and Leptons.

Quantum FFF Theory.

According to Quantum FFF Theory, (Function Follows Form at the quantum scale) Mass is the potency of rigid string based Fermions and Bosons, to produce and radiate Gravitons by the collision process, between mass less but energetic oscillating transformable Axion Higgs vacuum field particles and.. more complex shaped compound Fermions or Bosons (W + Z+Higgs family).

Gravity is assumed to be the statistical result of local dual opposing graviton pressure (instead of attraction) with opposing Axion Higgs field particles on fermions.

A recent example of local vacuum pressure duality is called "Dipole Repeller" gravity by Yehuda Hoffman also suggested partly in line as Emergent Gravity by E. Verlinde.

More extended loops or "arms" of each rigid string particle is supposed to create more Axion transformation into Gravitons photons per Planck time unit.

Secondly, gravitons are assumed to exert not an attraction force on fermions and bosons but only a reduced pressure force in opposition to the vacuum pressure of the Axion Higgs field..

Black holes do not radiate gravitons but "eat" the local vacuum particles leading to a single repeller effect on the growing Black hole nucleus.

The ring shaped Axion Higgs field particles are supposed to oscillate in tandem (as the boxer engine pistons) along each vacuum lattice with the local Planck length and transfer information of monopole photons through the whole universe as long as they do not collide with fermions or bosons.

The new physics black hole nucleus is represented as a compact quantum knot of Axion Higgs particles, compressed together by the inflow of vacuum particles.

As a consequence the incoming Axion Higgs field pressure is the only origin of the Gravity pressure effect around each black hole nucleus .

In Quantum FFF Theory, the inertial mass effects of the earth and all atomic fermions is supposed to be originated by the real Lorentz polarization of all fermionic mass of the earth mainly pointing into the direction of motion around the sun, as the opposing effort for the resisting vacuum.

Rigid string shaped Fermions are assumed to have a real propeller shape able to plow into the direction of motion through the local space time creating vacuum lattice.

Bosons without a propeller shape (Higgs and Z) including black hole nuclei, seem to be not able to polarize and will present signals to be "stuck" in the local solar centered vacuum lattice.

According to Quantum FFF Theory, the new black hole nucleus is represented as a bunch of rigid string particles compressed by the oscillating Axion Higgs field vacuum particles.

All Fermions should be repelled at a new physics Black Hole (BH) repelling horizon which is supposed to have concentric globular shells of positive (inside) or negative charge (outside)

As a result, each black hole is assumed to have a globular shell of positron and proton based plasma at the inside and a negative electron based plasma shell outside this positive shell.

If we include the existence of small interference black holes (or Quantum Knots or WIMPs) then Ball lightning and micro comets (including Comets and sunspots) are to be explained as micro black holes violating also the second law of thermodynamics.

The form and microstructure of elementary particles, is supposed to be the origin of functional differences between Higgs- Graviton- Photon and Fermion particles.

As a consequence of the quantum gravity difference on fermions and black hole nuclei, the new splitting, accelerating and pairing massless black hole, is able to convert vacuum energy (ZPE) into real energy by entropy decrease. This explains quick Galaxy- and Star formation, down to Sunspots, (Micro) Comets, Lightning bolts, Sprites and Elves, Sprite Fireballs and Ball Lightning according to quantum.

In Quantum FFF Theory, the inertial mass effects of the earth is supposed to be originated by the real Lorentz polarization of all fermionic mass of the earth, on average pointing into the direction of motion around the sun, as the opposing effort for the resisting vacuum.

Conclusion some Bosons (Higgs and Z particles) seem to be not able to polarize and will present signals to be more or less "stuck" in the local solar centered vacuum lattice.

The LHC could perhaps be able to show this anti inertial mass effect created by the solar reference frame also called solar LASOF (Local Oscillating vacuum Frame, (Figure 28, ref. 3)

Secondly, Dark matter concentrations "stuck" in the middle of merger galaxies clusters is also supposed to be a smoking gun for non- inertial mass of dark matter black holes..

Emergent gravity as proposed by E.Verlinde and Dipole Rrepeller gravity by Yehuda Hoffman, (fig 4) are in line with dual rigid string pressure gravity on fermions and bosons.

General description of the Quantum-FFF model.

It is assumed that the vacuum is seeded with massive numbers of massless Axion-Higgs (A-Higgs) particles, all energetic oscillating inside a chiral vacuum lattice system and as such the origin and bearer of all energy in the universe.

If by a local energy excess, two A-Higgs particles collide with enough energy, it is assumed that an electron and positron emerges by internal hinge transformation.

Due to the propeller shape of the Fermions, these Fermions are assumed to spin by a constant collision and scattering process with the Higgs vacuum, changing A-Higgs particles continuously into different forms of Photon or Gluons.

This collision scattering process is proposed to be the base for the "eigen energy" of Fermions.

Thus Fermions are constantly transforming vacuum particle energy into photons and gluons.

Rigid String based information building blocks with Fermion Calabi Yaw propellers (right) and Boson non propellers (left)

Rigid String Quantum Knot suggestions for different configuration: 125-375-500-750-1600 GeV and More called dark matter black holes. (According to Quantum FFF Theory architecture)

Pair production by Axion Higgs Field particle collision at black hole horizons (Q-FFF Theory)

Figure 4, Fermionic propeller shaped Quantum Knots (above right) and Higgs Boson family based Quantum Knot-Black Hole (above, left) and pair production around black holes.

As a consequence, in Quantum FFF Theory photons should be the same as gluons and gluons become photons after collision with local fermions (atomic fermions) or after 1cm distance being absorbed by the local vacuum.

As a result, I suggest that many “elementary” (Quarks, Z and W) particles should not be elementary, but compound constructions or KNOTS of transformed A-Higgs particles. Even the Muon and Tau Lepton should be compound particles having the same shape as one of the different colored “naked” Down- respectively Charm Quarks. Thus, Muon- and Tau particles are supposed to be naked Quarks! Recent LHC (Large Hadron Collider) results are telling us that so called di-Higgs resonances lead to a variety of Higgs masses. In Quantum FFF Theory however the real building block of the universe should be only the Axion-Higgs vacuum particle without any mass.

Thus so called Higgs resonances are supposed to be the result of compound rigid string knots, such as Z Z WW knots based on electron positron strings ore combinations of three or four photon knots or -Photonic Molecules- as the result of photonic interference. (Figure 1 and 27) Non local realism and massless vacuum Axion-Higgs in the multiverse.

Quantum FFF Theory is based on Non-Local Realism and rigid stringy Axion-Higgs particles able to mutate into all other particles.

The CP(T)-symmetrical raspberry shaped multiverse (with 8-12 berries) is non local instant connected down to each quantum. Each quantum can be visualized as a deformed Higgs ring able to convert into other shapes and able to form compound structures like quarks, muons or even Tau leptons. So realism (cogwheels) connected by symmetric non-local instant entanglement.

The Wavefunction collapse in the (CP symmetric) raspberry multiverse by the entangled observation between (anti) copy particles

According to Quantum FFF Theory, the collapse of the wavefunction is assumed to be triggered by particle collisions with instant entanglement between (anti-) COPY universes. So there is Charge and Parity symmetry between the entangled particles living in opposing universes. Each particle is its own observer!! Each human has to deal with one or more opposing anti-COPY humans.

Mirror symmetry between CP symmetric universes

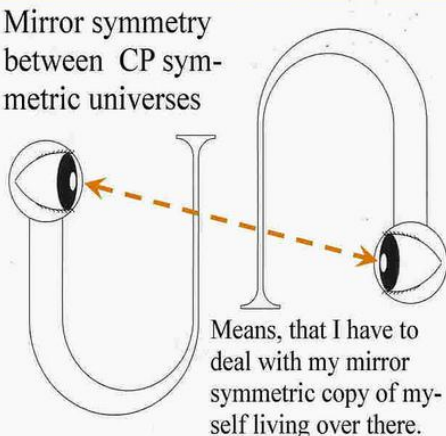

2-D Section through the raspberry multiverse, with huge void in the middle. The void in the middle is supposed to be originated by the start of the Fractal process, when the vacuum density of the former cyclic multiverse was still too high for a fine grained fractal process (see my book).

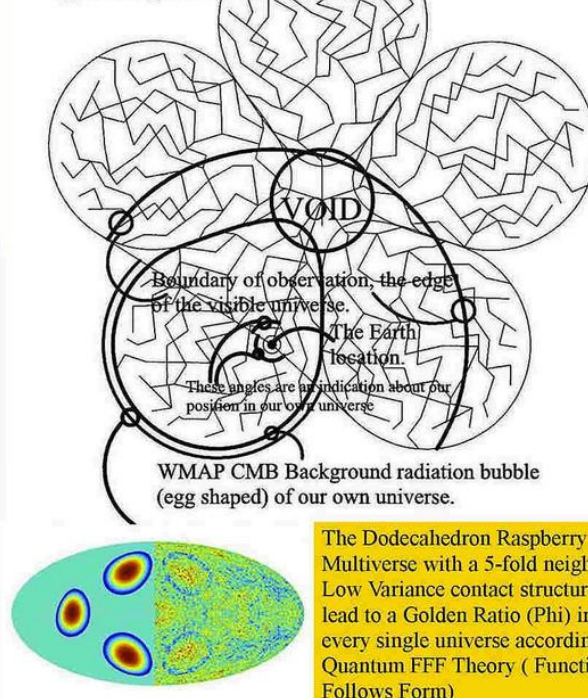

The Dodecahedron Raspberry Multiverse with a 5-fold neighbour Low Variance contact structure lead to a Golden Ratio (Phi) in every single universe according to Quantum FFF Theory (Function Follows Form)

Figure 5, wavefunction collapse between CP symmetric mirror particles by instant entanglement between multi universal bubbles located around the Big Bang central void.

The basic elements:

- 1: Black holes (BHs) are the same as Dark Matter, they all consume photons, even gravitons and the Axion-Higgs field, (for short: Higgs field) but REPEL Fermions due to their propeller shape polarization away from the BH. They produce electric charged plasma.
- 2: Dark Energy is the oscillating (Casimir) energy of the massless Axion-Higgs Field equipped with a tetrahedron lattice structure with variable Planck length around black holes..
- 3: Quantum Gravity = Dual Push gravity= Attraction (Higgs-Casimir opposing Graviton push).
- 4: The Big Bang is a Splitting dark matter Big Bang Black Hole (BBBH), splitting into

smaller Primordial Big Bang Splinters (PBBS) forming the Fractal Lyman Alpha forest and evaporating partly into a zero mass energetic oscillating Higgs particle based Higgs field.

5: Dual PBBSs hotspots, produce central plasma concentration in electric Herbig Haro systems as a base for star formation in open star clusters as a start for Spiral Galaxies.

6: Spiral Galaxies will keep both Primordial Dark Matter Black Holes as Galaxy Anchor Black Holes (GABHs) at long distance.

7: After Galaxy Merging, these GABHs are the origin of Galaxy- and Magnetic field complexity and distant dwarf galaxies .

8: Black Holes produce Plasma direct out of the Higgs field because two rigid massless but mutable Higgs particles are convertible into symmetric electron and positron (or even dual quark-) propellers (by BH horizon fluctuations).

9: The chirality of the (spiraling) vacuum lattice is the origin our material universe. (propeller shaped positrons merge preferentially first with gluons to form (u) Quarks to form Hydrogen with electrons.

10: The first Supernovas produce medium sized Black Holes as the base for secondary Herbig Haro systems and open star clusters.

11: ALL Dark Matter Black Holes are supposed to be CHARGE SEPARATORS with internal positive charge and an external globular shell of negative charged Quark electron plasma.

12: The lightspeed is related to gravity fields like the earth with long extinction distances to adapt with the solar gravity field. (See the o'Connell effect, ref. 39)

13. Quantum FFF Theory states that the raspberry shaped multiverse is symmetric and instant entangled by so called WORMHOLE BRIDGES (ER=EPR) down to the smallest quantum level between different raspberry berries=universes. Nonlocal entangled down to each quantum and even living or dying CATS in BOXES.

14 Large Primordial Big Bang Splinters (PBBS) are responsible for the creation of the Lyman Alpha forest structure and first spiral galaxy forming of the universe, but they seem to be also responsible for the implosion of the universe at the end in the form of Galaxy Anchor Black Holes (GABHs) located mainly outside galaxies. see: (Quasisoft Chandra sources)

15, As a consequence of 12-14, Time is always local time in combination with cyclic period time of the multiverse.

16, If our material universes has a chiral left handed oscillating Higgs field, then our material Right Handed DNA helix molecule could be explained.

However it also suggests that in our opposing symmetric ANTI-MATERIAL entangled neighbor universe the DNA helix should have a Left handed spiral.

According to Max Tegmark: in an entangled multiverse we may ask: is there COPY PERSON over there, who is reading the same lines as I do?

If this COPY person is indeed living over there, then even our consciousness should be shared in a sort of entangled DEMOCRATIC form.

Then we are not alone with our thoughts and doubts,

See also: "Democratic Free Will and Telepathy in the Instant Entangled Multiverse."

<http://vixra.org/pdf/1612.0026v3.pdf>

17, All particles and waves should be entangled with anti-copy particles and Higgs field based waves in our opposing anti universes.

Then wave particle duality and the so called one particle double slit interference could be

explained by accepting that real shaped 3D photon particles only exist in their function of Gluons. However Gluons should transfer form information to the oscillating luminiferous Higgs field ether, within about 1 cm distance from a Fermion.(see: Babcock and Bergman anomaly,1964)

18, Different elementary particles have different qualities by their different complex stringy shape. Leptons and Quarks have a propeller shape with left or right handed pitch creating charge difference. Gluons, Photons and Neutrino particles have no pitch.

20 All particles can be converted to one or more Higgs particles, Lepto Quarks are also compound particles with an exception for the electron and positron..

21 All particles are assumed to be present as Axion-Higgs particles already in the cyclic Big Bang Black Hole (BBBH) after the former multiverse has collapsed into a Big Crunch Black Hole.

22, We seem to live inside one material universal bubble of an instant entangled (Charge Parity Time) CPT symmetric raspberry bubble multiverse. Each quantum jump or wave function collapse or human choice is guided by this instant entanglement at long distant. If our material universes has a chiral oscillating Higgs field, then our material Right Handed DNA helix molecule could be explained.

However it also suggests that in our opposing ANTI-MATERIAL multiverse neighbour universe the DNA helix should have a LEFT HANDED spiral.

According to Max Tegmark: in an entangled multiverse we may ask: is there COPY PERSON over there, who is reading the same lines as I do?

If this COPY person is indeed living over there, then even our consciousness should be shared in a sort of DEMOCRATIC form,

Then we are not alone with our thoughts and doubts, see:

Democratic Free Will in the instant Entangled Multiverse.

Conclusion, Quantum FFF Theory is based on Non-Local Realism. The CP(T)-symmetrical raspberry shaped multiverse (with 8-12 berries) is non local instant connected down to each quantum. Each quantum can be visualized as a deformed Axion-Higgs ring able to convert into other shapes and able to form compound structures like quarks, muons or even Tau leptons. So realism (cogwheels) connected by symmetric non-local instant entanglement.

<http://vixra.org/pdf/1401.0071v2.pdf>

See also: "Democratic Free Will and Telepathy in the Instant Entangled Multiverse."

<http://vixra.org/pdf/1612.0026v3.pdf>

Feynman for Di-Monopole Repeller Forces

Attraction and Repulsion forces created by Dipole Repeller effects between the Higgs Field vacuum (OOO) and 5x opposing Photons. (UOU, ROU, LOU, ROR, LOL)

According to Quantum FFF Theory. Feynman diagrams

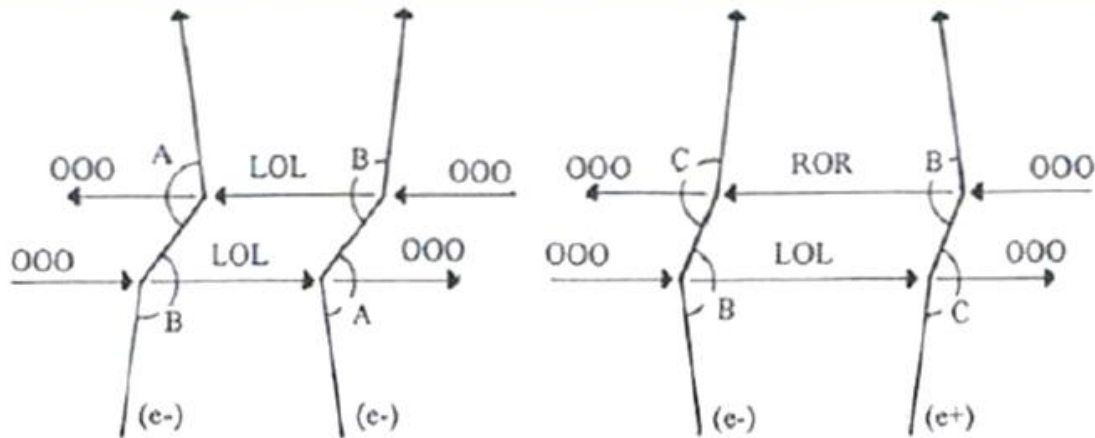

(Above) Alternative Feynman diagrams for electron-positron attraction and electron– electron repulsion by Dipole Repeller system.

Explanation of the codes:
 U= Up rotation (180 degrees)
 O= Unchanged circle.
 L= Left rotation (90 degrees)
 R= Right rotation (90 degrees)

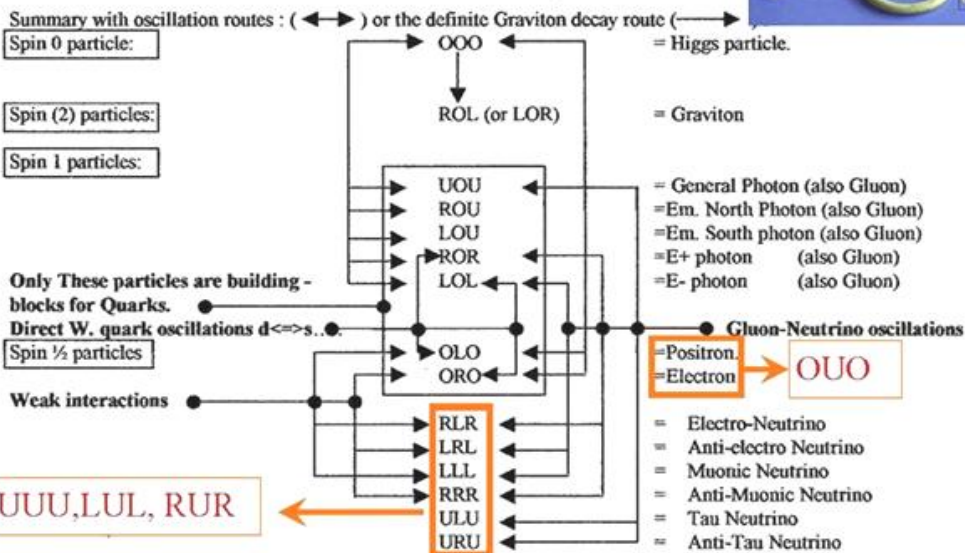
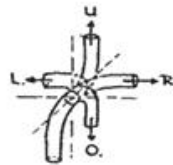

Higgs particles are supposed to oscillate in Tandem along so called linear Vacuum Lattices, two by two in opposite directions, as the symmetrical opposite pistons of a boxer engine, as the origin of all energy, spin and mass effects. This enables the Tandem Higgs particles to change the form of their own Torus into an Electron and Positron pair at

Figure 6. Alternative Feynman diagrams for di-monopole repeller forces. 5x monopole photons are also Gluons active for the Strong Force.

Entropic or Emergent Gravity and Dipole Repeller Gravity seem to be Opposing Repeller Gravity of Axion Higgs field and Graviton pressure information.

According to Quantum FFF Theory, empty space is filled with a fast oscillating lattice of massless Axion-Higgs field particles as a half base for our opposing dipole pressure Higgs-graviton gravity on earth. Now prof. Yehuda Hoffman shows us a support for this hypothesis.

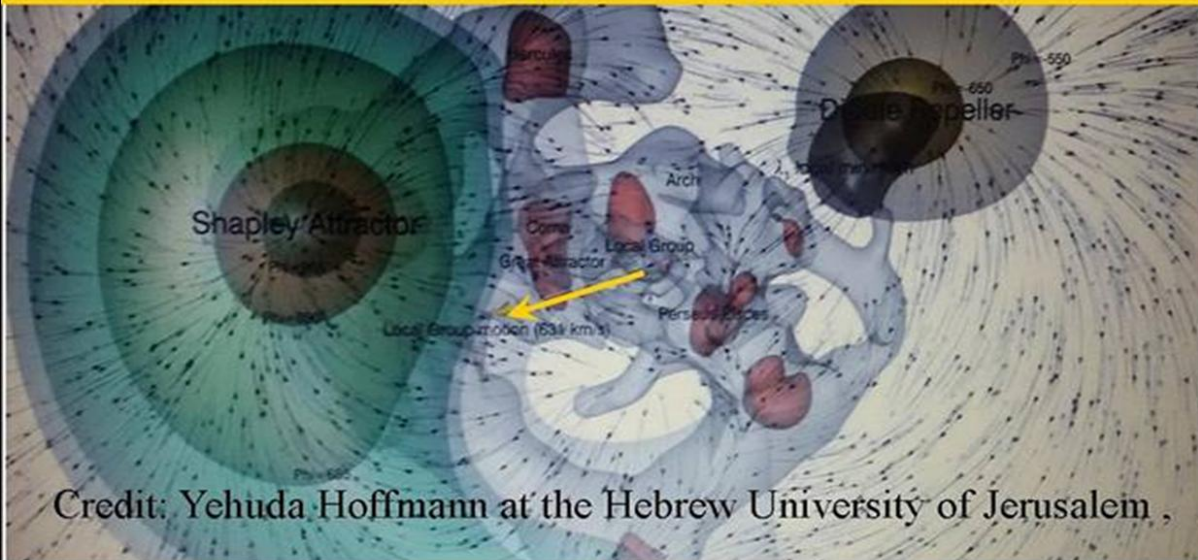

Credit: Yehuda Hoffmann at the Hebrew University of Jerusalem ,

Quantum Gravity as pressure distribution of the oscillating dual Higgs/Graviton vector field.

New Dark Matter Black Hole, "Eat" the chiral oscillating Higgs vacuum.(Quantum-FFF Theory)

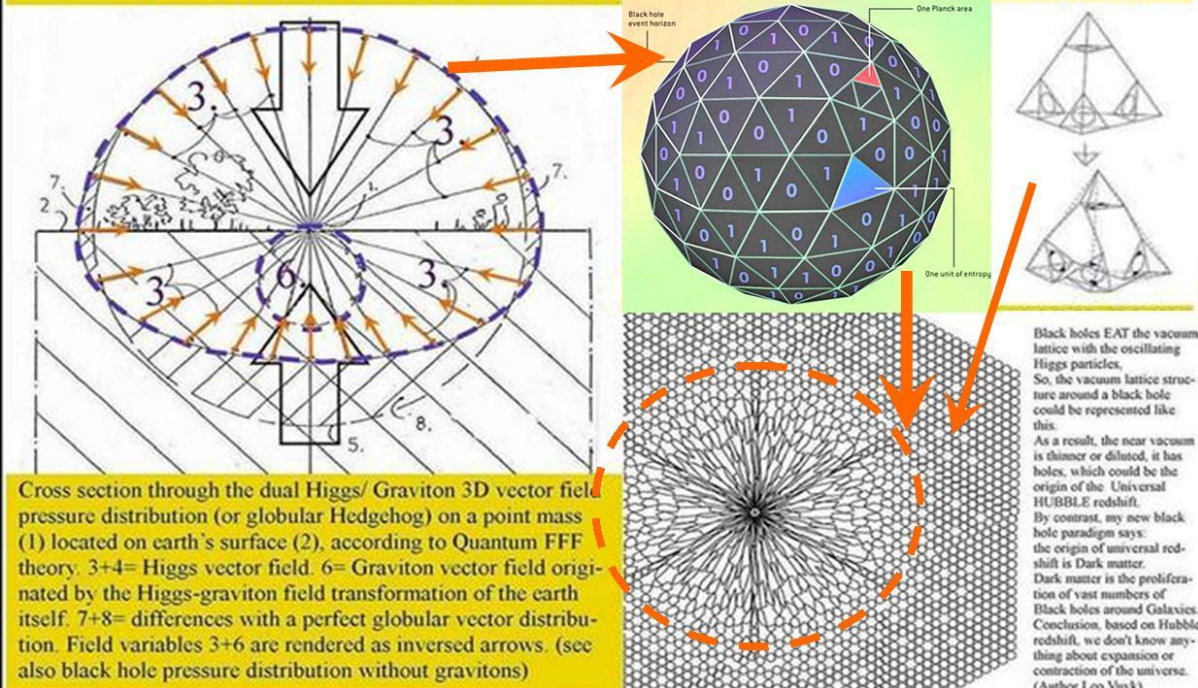

Figure 7. Di-monopole repeller gravity and or entropic emergent gravity combined. Yehuda Hoffmann and Erik Verlinde.

Recent References by the author at: http://vixra.org/author/leo_vuyk ..

[102] viXra:1711.0379 The Raspberry Shaped Multiverse, Pulsating Between Big Crunch and Big Bang, Based on Rigid Transformable Massless Axion Higgs Particles.

[101] viXra:1711.0327 The Einstein Cross Lensing Effect Explained by the Quadruple Dark Matter Formation Process of Edge-on Spiral Galaxies, According to Quantum FFF Theory.

[100] viXra:1711.0237 Higgs Particle Based SIMPs for Ancient and Future (Stone) Cutting Technology.

[99] viXra:1711.0112 Higgs Quantum Knots is Dark Matter is Black Holes or: Higgs Dark Matter Black Holes.

[98] viXra:1710.0257 Kilonova Merger Black Holes as the Origin of Dark Matter Black Hole Halo Population.

[97] viXra:1710.0115 Grand Unification of 4 Forces According to the Quantum FFF Model by di-Monopole Repeller Rigid String Pressure.

[96] viXra:1710.0050 Emergent Gravity by Dipole Repeller Rigid String Pressure the Origin of Quantum Gravity and Non Inertial Black Holes.

[95] viXra:1710.0034 The New Physics Black Hole Nucleus: Gravity Without Inertial Mass Effects.

[94] viXra:1709.0396 Dual Solar Anchor Black Holes or Herbig Haro Hotspots, the Origin of Quick Star Formation.

[93] viXra:1709.0388 Splitting Dark Matter Black Hole Big Bang as the Origin of Ultra-Energetic-Cosmic-Rays-From Far-Away

[92] viXra:1709.0216 Photonic Molecule based Higgs Photonic Knots of Different Masses the Origin of Future Lightsaber use?

[91] viXra:1708.0296 The Origin of "Ultra Diffuse Galaxies" in Galaxy Cluster Centers.

[90] viXra:1708.0170 Action Without Reaction Symmetry for em Space Propulsion Thruster Technology.

[89] viXra:1708.0083 Dipole Repeller Gravity Effects at Different Universal Scales as the Origin of Large Scale and Local Quantum Gravity and Hubble Redshift.

[88] viXra:1707.0224 The Magic of the New Electric Dark Matter Black Hole on Earth and Space.

[87] viXra:1707.0189 Black Hole Nuclei as a Bunch of Rigid Transformable Higgs Strings Splitting by Relative Small Companion Mergers or Decreased Vacuum Pressure.

[86] viXra:1706.0490 The Origin of "Dead" Galaxies.

[85] viXra:1706.0420 Mass in Motion According to Quantum FFF Theory.

[84] viXra:1706.0413 Magnetic Monopole Test to Demonstrate the Existence of a Anti Maxwell Dead Zone Around a Current in a Wire.

[83] viXra:1705.0153 A Different Black Hole Horizon Interpretation Leading to Entropy Reduction and Violation of the Second Law.

[82] viXra:1705.0026 The Magic of Life- and Matter Creating Self Propelled Electric Dark Matter Black Holes Guided by a Holographic Entangled Symmetric Multiverse System.

Books: The New God Particle and Free Will. Author: Leo Vuyk, LuLu publishers, 2008.

ISBN number 978-1-4092-1031-3 <http://www.lulu.com/spotlight/LeoVuyk>

Quantum FFF Theory is also published in the form of POSTERS at the Flickr site:

<http://www.flickr.com/photos/93308747@N05/>

=====