

The Raspberry Shaped Multiverse, Pulsating Between Big Crunch and Big Bang, Based on Rigid Transformable massless Axion Higgs particles.

Leo Vuyk,
Architect,
Rotterdam, the Netherlands.

Abstract,

In particle physics it is an interesting challenge to postulate that the rigid FORM and topological structure of elementary particles is the origin of different FUNCTIONS of rigid transformable string particles.

The resulting model is called “Quantum FFF Theory” (FFF=Function Follows Form).

As a consequence however, the standard model should be extended with an alternative Higgs boson of different mass series (recent LHC measurements) as a base for unstable microscopic dark matter black hole (DMBH) nuclei (for Ball Lightning as interference Higgs knots) up to stable (Sunspot and S-Nova) black hole nuclei merging into a cyclic Big Crunch/ Big Bang nucleus.

Dark Energy of the vacuum is assumed to be created by an oscillating massless springy stringy Axion/Higgs field virgin vacuum particle, being one half of a new emerging quantum gravity system combine with the opposing pressure of a pushing graviton. .

The vacuum particles are assumed to oscillate in tandem inside spiral (chiral) flux tubes between photon communication nodes with a variable Planck length as a base, creating a tetrahedron based chiral vacuum lattice connected by nodes between two tetrahedrons.

As a result, the dark matter black hole Big Bang was the cold explosion into dark matter black hole splinter chunks evaporating into the oscillating Axion/ Higgs field and series of smaller chunks, leaving a trail of Hydrogen creating stable black holes behind, also called the Lyman Alpha forest.

So, the new extended standard model is based on different geometrical string structures for Higgs based dark matter black holes but also extended with a monopole photon/ Gluon system.

Introduction.

In this paper I present possible 3D particle solutions based on only one complex 3-D ring shaped Axion-Higgs particle, which is equipped with three point like hinges and one splitting point, all four points divided equally over the ring surface.

The 3-D ring itself is postulated to represent the “Virgin Mother” of all other particles and is coined Axion-Higgs particle, the ring is equipped with 3-hinges coded (OOO), which gives the particle the opportunity to transform after real mechanical collision with other particles into a different shape, with a different function and interlocking abilities with other particles to form Quarks quantum knots and all other particles.

Thus in this Quantum Function Follows Form theory, the Axion-Higgs vacuum particle is interpreted as a massless singular transformer but rigid string particle able to create the universe by transforming its shape after real mechanical collision and merging with other shaped particles into complex and compound knots like quarks, W Z and Higgs particles of different masses and even ball lightning and other black hole nuclei.

If we assume that different massive Higgs particle knots are the origin of different evaporation times, then there is reason to assume that the trajectory lengths measured from the source, before evaporation are covariant, without any radiation curvature.

It is assumed that the vacuum is seeded with massive numbers of massless Axion-Higgs (A-Higgs) particles, all energetic oscillating inside a chiral vacuum lattice system and as such the origin and bearer of all energy in the universe.

If by a local energy excess e.g. at black hole horizons, two A-Higgs particles collide with enough energy, it is assumed that an electron and positron emerges by internal hinge transformation.

Due to the propeller shape of the Fermions, these Fermions are assumed to spin by a constant collision and scattering process with the Higgs vacuum, changing A-Higgs particles continuously into different forms of Photon or Gluons.

This collision scattering process is proposed to be the base for the “eigen energy” of Fermions.

Thus Fermions are constantly consuming and transforming vacuum particle energy into photons and gluons.

As a consequence, in Quantum FFF Theory photons should be the same as gluons and gluons become photons after collision with local fermions (atomic fermions) or after 1cm distance being absorbed by the local vacuum.

As a result, I suggest that many “elementary” (Quarks, Z and W) particles should not be elementary, but compound constructions or knots of transformed A-Higgs particles.

Even the Muon and Tau Lepton should be compound particles having the same shape as one of the different colored “naked” Down- respectively Charm Quarks.

Thus, Muon- and Tau particles are supposed to be naked Quarks!

Recent LHC (Large Hadron Collider) results are telling us that so called di-Higgs resonances lead to a variety of Higgs masses.

In Quantum FFF Theory however the real building block of the universe should be only the Axion-Higgs vacuum particle without any mass.

Thus di Higgs resonances are supposed to be the result of compound rigid string knots, such as Z Z WW knots based on electron positron strings or combinations of three or four photon knots or -Photonic Molecules- as the result of photonic interference. (Figure 1 -4)

Non local realism and massless vacuum Axion-Higgs in the multiverse.

Quantum FFF Theory is based on Non-Local Realism and rigid stringy Axion-Higgs particles able to mutate into all other particles.

16, If our material universes has a chiral left handed oscillating Higgs field, then our material Right Handed DNA helix molecule could be explained.

However it also suggests that in our opposing symmetric ANTI-MATERIAL entangled neighbor universe the DNA helix should have a Left handed spiral.

According to Max Tegmark: in an entangled multiverse we may ask: is there COPY PERSON over there, who is reading the same lines as I do?

If this COPY person is indeed living over there, then even our consciousness should be shared in a sort of entangled DEMOCRATIC form.

Then we are not alone with our thoughts and doubts, see:
Democratic Free Will in the instant Entangled Multiverse.

17, All particles and waves should be entangled with anti-copy particles and Higgs field based waves in our opposing anti universes.

Then wave particle duality and the so called one particle double slit interference could be explained by accepting that real shaped 3D photon particles only exist in their function of Gluons. However Gluons should transfer form information to the oscillating luminiferous Higgs field ether, within about 1 cm distance from a Fermion.(see: Babcock and Bergman anomaly,1964)

18, Different elementary particles have different qualities by their different complex stringy shape. Leptons and Quarks have a propeller shape with left or right handed pitch creating charge difference. Gluons, Photons and Neutrino particles have no pitch.

20 All particles can be converted to one or more Higgs particles, Lepto Quarks are also compound particles with an exception for the electron and positron..

21 All particles are assumed to be present as Axion-Higgs particles already in the cyclic Big Bang Black Hole (BBBH) after the former multiverse has collapsed into a Big Crunch Black Hole.

22, We seem to live inside one material universal bubble of an instant entangled (Charge Parity Time) CPT symmetric raspberry bubble multiverse. Each quantum jump or wave function collapse or human choice is guided by this instant entanglement at long distant. If our material universes has a chiral oscillating Higgs field, then our material Right Handed DNA helix molecule could be explained.

However it also suggests that in our opposing ANTI-MATERIAL multiverse neighbour universe the DNA helix should have a LEFT HANDED spiral.

According to Max Tegmark: in an entangled multiverse we may ask: is there COPY PERSON over there, who is reading the same lines as I do?

If this COPY person is indeed living over there, then even our consciousness should be shared in a sort of DEMOCRATIC form,

Then we are not alone with our thoughts and doubts, see:
Democratic Free Will in the instant Entangled Multiverse.

Conclusion, Quantum FFF Theory is based on Non-Local Realism. The CP(T)-symmetrical raspberry shaped multiverse (with 8-12 berries) is non local instant connected down to each quantum. Each quantum can be visualized as a deformed Axion-Higgs ring able to convert into other shapes and able to form compound structures like quarks, muons or even Tau leptons. So realism (cogwheels) connected by symmetric non-local instant entanglement.

vixra.org/pdf/1401.0071v2.pdf

Historic references.

It was Abdus Salam who proposed that quarks and leptons should have a sub-quantum level structure, and that they are compound hardrock particles with a specific non-zero sized form. Jean Paul Vigié postulated that quarks and leptons are "pushed around" by an energetic sea

of vacuum particles.

David Bohm suggested in contrast with The "Copenhagen interpretation", that reality is not created by the eye of the human observer, and second: elementary particles should be "guided by a pilot wave".

John Bell argued that the motion of mass related to the surrounding vacuum reference frame, should originate real

"Lorentz-transformations", and also real relativistic measurable contraction.

Richard Feynman postulated the idea of an all pervading energetic quantum vacuum. He rejected it, because it should originate resistance for every mass in motion, relative to the reference frame of the quantum vacuum.

However, I postulate the strange and counter intuitive possibility, that this resistance for mass in motion, can be compensated, if we combine the ideas of Vigier, Bell, Bohm and Salam, and a new dual universal Bohmian "pilot wave", which is interpreted as the EPR correlation (or Big Bang entanglement) between individual elementary anti-mirror particles, living in dual universes.

15 particles transformed from only one massless Axion/Higgs “Virgin” particle coded: (OOO) able to Interlock with each other.

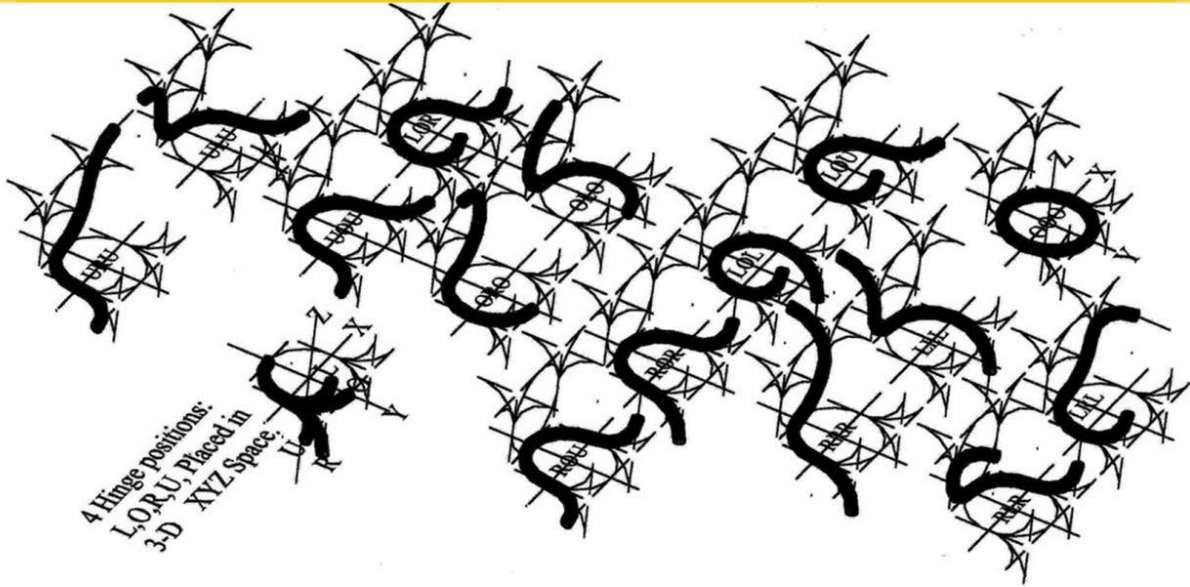

Fermionic propeller shaped Quantum Knots (right) and Higgs Boson based Quantum Knot-Black Holes (left)

Rigid String Quantum Knot suggestions for different configuration: 125-375-500-750-1600 GeV and More called dark matter black holes. (According to Quantum FFF Theory architecture)



$125\text{GeV} + 375\text{GeV} = 500\text{GeV}$ And More

500GeV

$375\text{GeV} + 375\text{GeV} = 750\text{GeV}$

$2 \times 750\text{GeV} + 125 = 1625\text{GeV}$

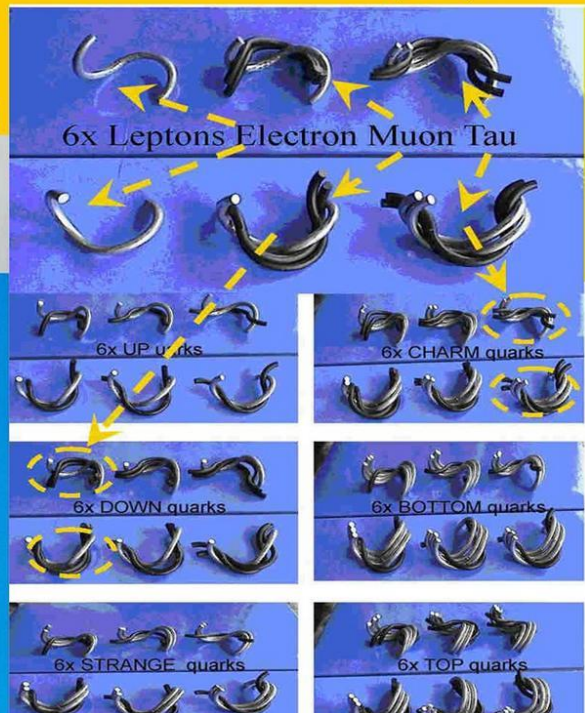

Figure 1 Multiple combination of quantum knots. Knot 1: left: three magnetic monopole photons (125 GeV, silver) Knot 2: right: 4x x-ray photons (375 GeV, black)



Figure 2 Geometric proposal for the Z and W particles. Z particles are symmetrical without propeller spin effects. W particles are not symmetrical with propeller spin effect left or right spin.

A combination of multiple Z particles could lead to Z-Z decay with 650 GeV as measured by the LHC.

Dual Z particles: a combination of 2x electrons and 2x positrons, according to the Quantum FFF Model.

LHC-CMS in ZZ channel. The massless transformable ring shaped Axion /Higgs vacuum particle is supposed to act as the mother of all single and compound rigid string particles fermions/neutrinos, photons etc. Massive ZZ particles are compound electron /positron interlockers, with 650 GeV in the LHC-CMS (example below)



Figure 3, the massive ZZ channel particles.

Rigid String Quantum (3 or 4x) Ring Knots, adding up to higher mass unstable micro quantum black hole nuclei.

Rigid String Quantum Knot suggestions for different configuration: 125-375-500-750-1600 GeV and More called dark matter black holes. (According to Quantum FFF Theory architecture)

125GeV+375gEv=500GeV And More

500GeV

375GeV+375gEv=750GeV

2x750GeV+125=1625GeV

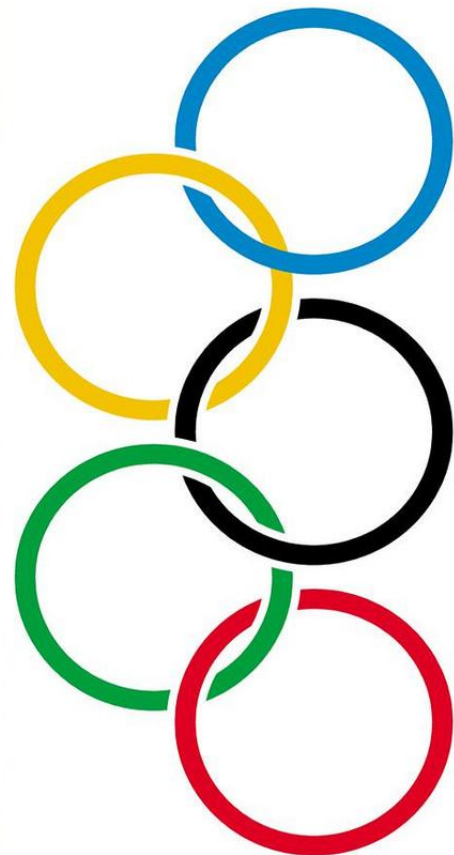

Some suggested ring configurations

Some other combinations

2x mirror Symmetric Z particle left (1xElectron+1xPositron,),
 rightside: 2x mirror A-symmetric W+/- particles. (W-:2x electron+ 1x Positron, W+: 2x Positron and 1x Electron)

Figure 4, The geometric principle of Quantum FFFModel.

Feynman for Di-Monopole Repeller Forces

Attraction and Repulsion forces created by Dipole Repeller effects between the Higgs Field vacuum (OOO) and 5x opposing Photons. (UOU, ROU, LOU, ROR, LOL)

According to Quantum FFF Theory. Feynman diagrams

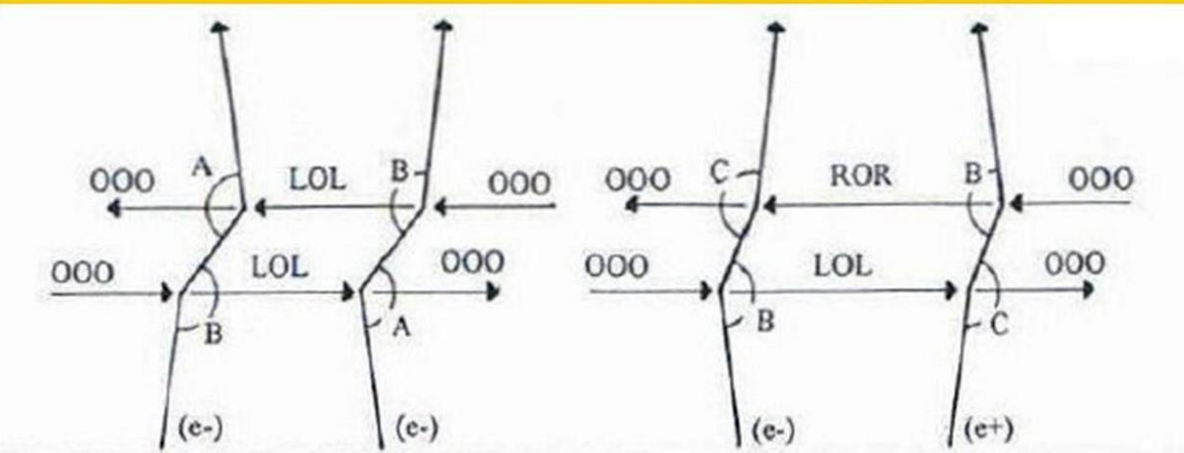

(Above) Alternative Feynman diagrams for electron-positron attraction and electron– electron repulsion by Dipole Repeller system.

Explanation of the codes:
 U= Up rotation (180 degrees)
 O= Unchanged circle.
 L= Left rotation (90 degrees)
 R= Right rotation (90 degrees)

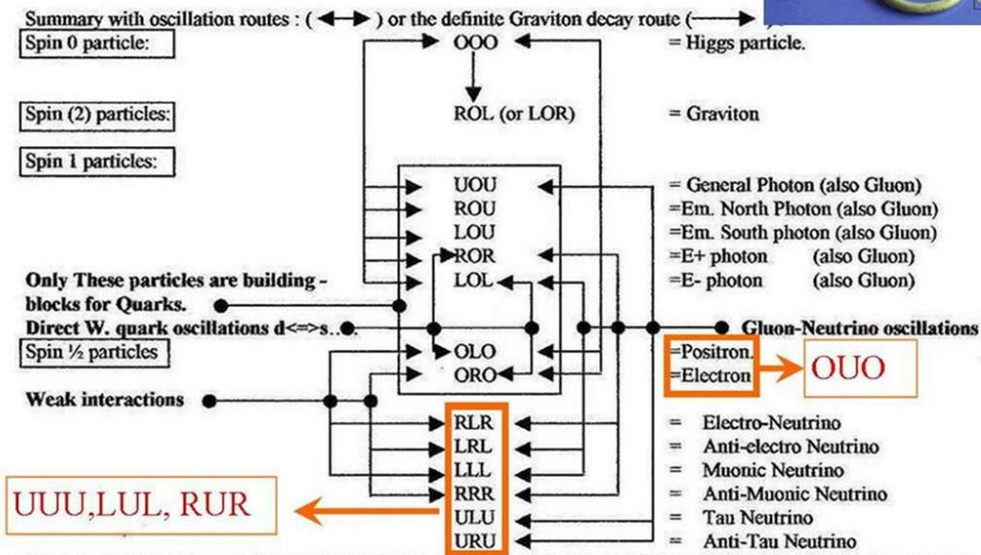
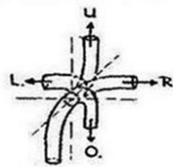

Higgs particles are supposed to oscillate in Tandem along so called linear Vacuum Lattices, two by two in opposite directions, as the symmetrical opposite pistons of a boxer engine, as the origin of all energy, spin and mass effects. This enables the Tandem Higgs particles to change the form of their own Torus into an Electron and Positron pair at

Figure 5, The geometric particle principle of the Quantum FFF Model with adapted Feynman diagrams.

Composite rigid transformable string models based on 3x internal-90 degr. step rotation of the Axion-Higgs Torus made of primordial matter.

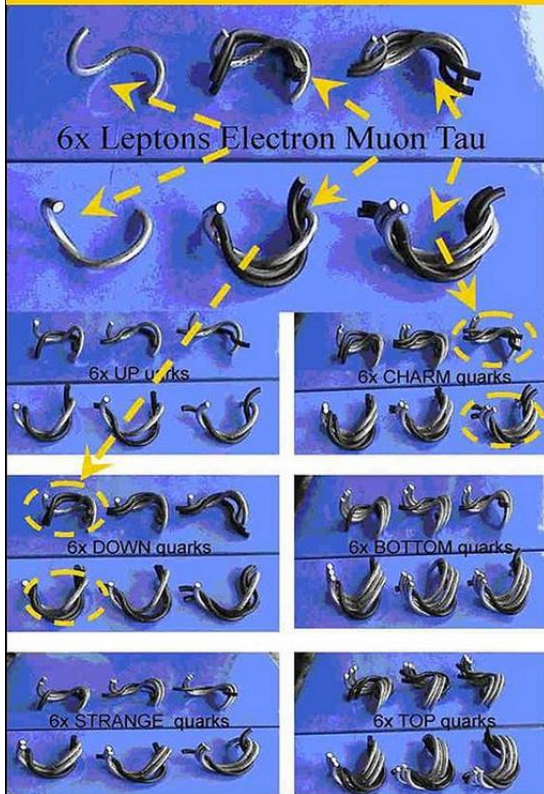

Geometrical proposal for the sub-quantum structure of 6 Leptons and Quarks interpreted as compound Photon/Electron Positron propeller combinations. Muon- and Tau particles seem to show up as family members of the Down respectively Charm Quarks.

The basic rigid transformable Axion string Torus with aspect ratio (=7) and 1x splitting and 3x hinges made of primordial matter, according to Quantum FFF Theory.

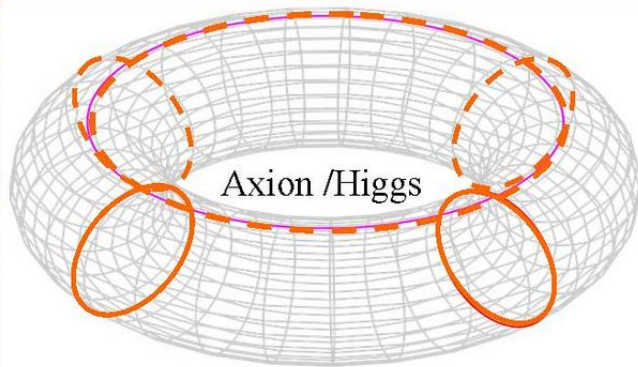

All Photons (1x graviton, 2x electric-, 2x magnetic and 1x general x-gamma-ray photon) and two Fermions, are transformed direct out of the massless Axion/Higgs ring, by internal hinge rotation over 90 degree steps. Electric Dark Matter Black Holes (EDMBHs or EREBONS (Penrose) are formed by 3 or 4 photon knots (ball lightning). Neutrinos are single transformed photons or fermions.

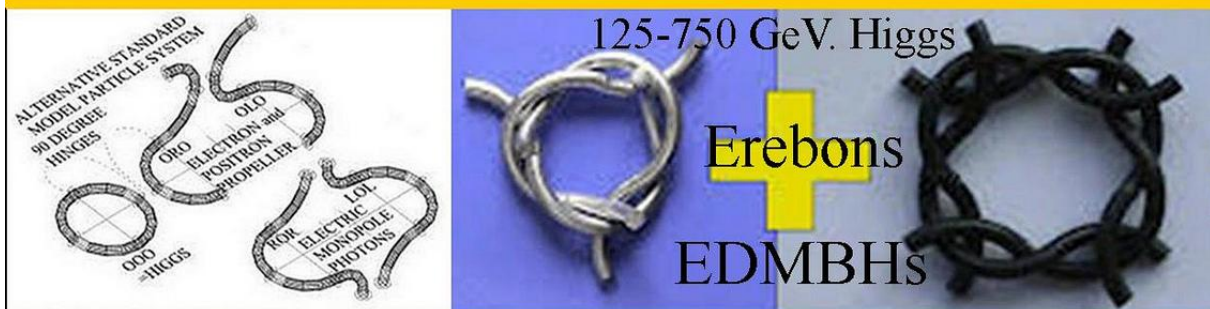

Figure 6, The principle based on 3x hinge rotations of 90 degrees.

The Beginning and End of Time.

Raspberry Multiverse cycle time versus quantities of Total rigid string particles subdivided into Dark Matter Black Hole (DMBH) particles, massless oscillating Dark Energy (DE) Axion/Higgs particles and Real particles. (matter and anti-matter)

The cyclic Multiverse depicted as continuous flow of increasing and decreasing numbers of Axion/Higgs particles, located inside DMBHs or as DE vacuum system or derived as real extended standard model particles.

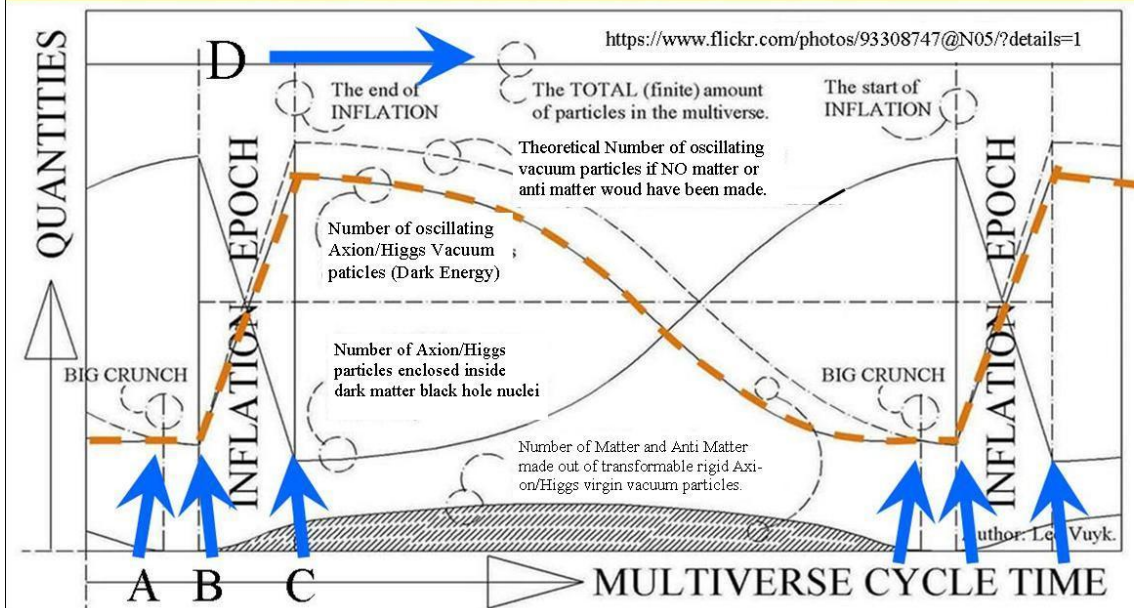

Figure 7, The beginning and end of time.

A= The end of time of the former multiverse.

B= The beginning of time of the next multiverse.

C= The start of the multiverse vacuum absorption by the growing number of dark matter black holes (supernova or kilonovas)

D= The total constant number of particles during the extended cyclic process.

Figure 7: The Beginning and End of Time and the cyclic multiverse in between. Raspberry Multiverse cycle time versus quantities of the total number of rigid string particles sub divided into Dark Matter Black Hole (DMBH) particles, massless oscillating Dark Energy (DE) Axion/Higgs particles and Real particles. (matter and anti-matter)

The cyclic Multiverse depicted as continuous flow of increasing and decreasing numbers of Axion/Higgs particles, located inside DMBHs or as DE vacuum system or derived as real extended standard model particles.

The Origin of energy overdensities in the CMB

The Cosmic Background (CMB) energy overdensities can be explained by a Big Bang Black Hole splitting and evaporation process, according to Quantum FFF Theory.

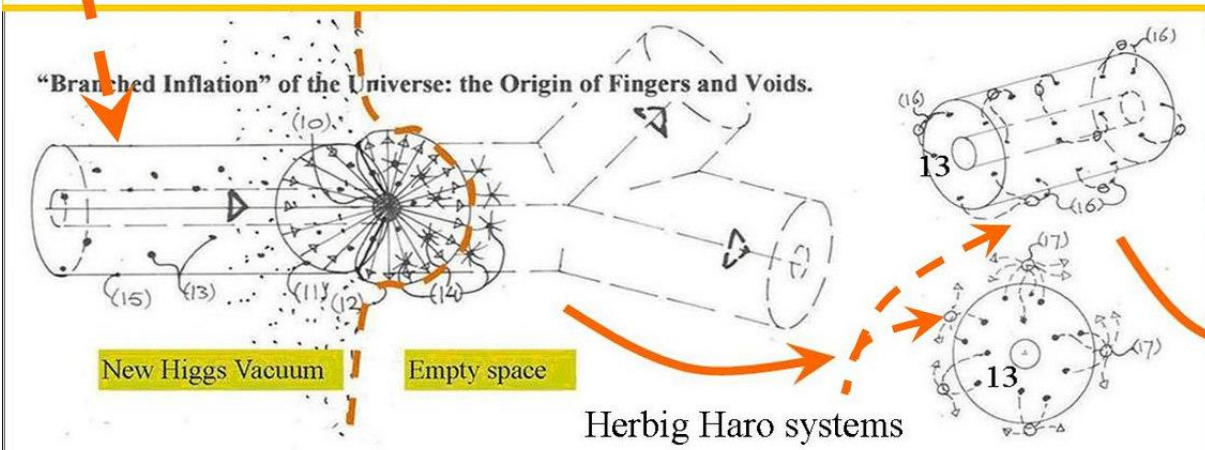
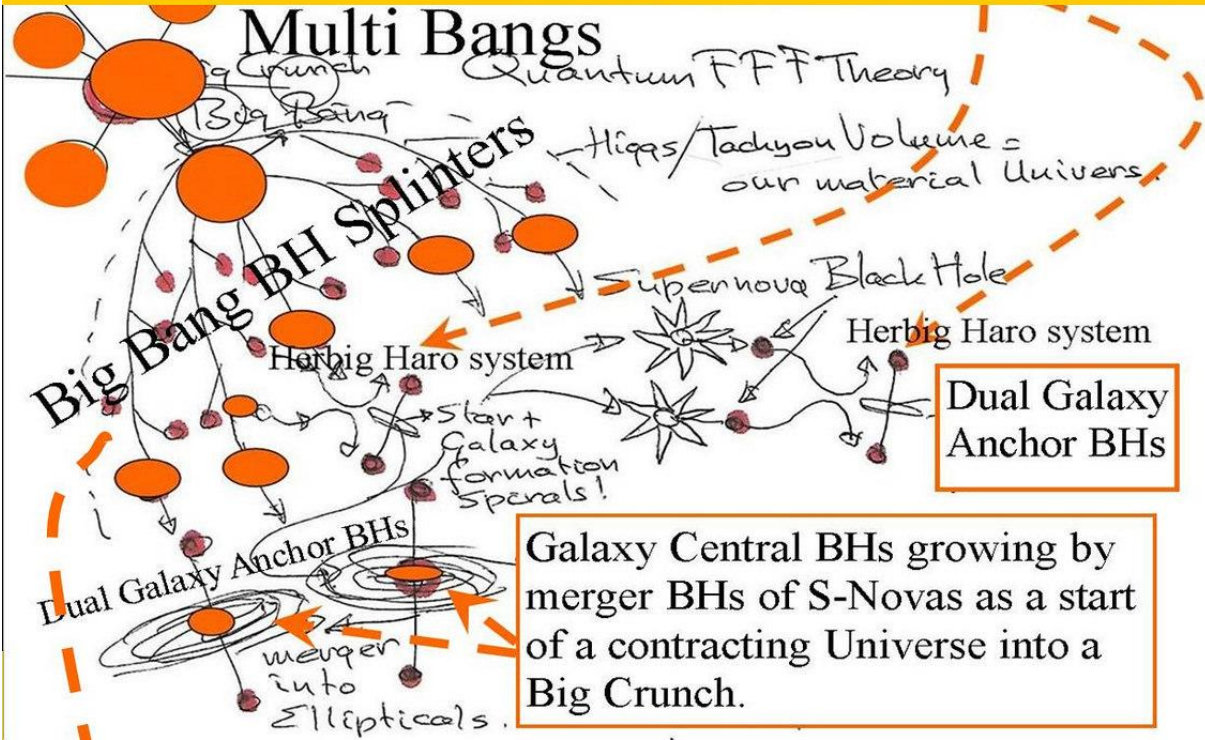

The origin of the Lyman Alpha Forest (15) and Higgs vacuum, by the splitting of the Big Bang Black Hole (BBBH) into smaller Splinter BHs (10). The splinter BHs (10) evaporate into smaller evaporating black holes at the Front (14) which compensate the pressure from the Backside splinter BHs (11). The BHs (11) are assumed to partly evaporate like BHs (14) also into a newly formed oscillating Higgs vacuum until the Higgs vacuum pressure stops the evaporation and leave Galaxy Forming BHs (13) behind. However single BH will pair (16) with the nearest other BHs to form Dumbbell systems, which efficiently form Giant Stars and Galaxies (17) in between. (author: Leo vuyk)

Figure 8, The origin of overdensities in the CMB radiation. And the formation of black hole driven Herbig Haro systems to form new open star clusters.

Chiral oscillating Axion-Higgs vacuum structure.

Big Bang Supersymmetry between two entangled universes means that propeller shaped fermions have magical entangled mirror partners in the other anti mater universe.

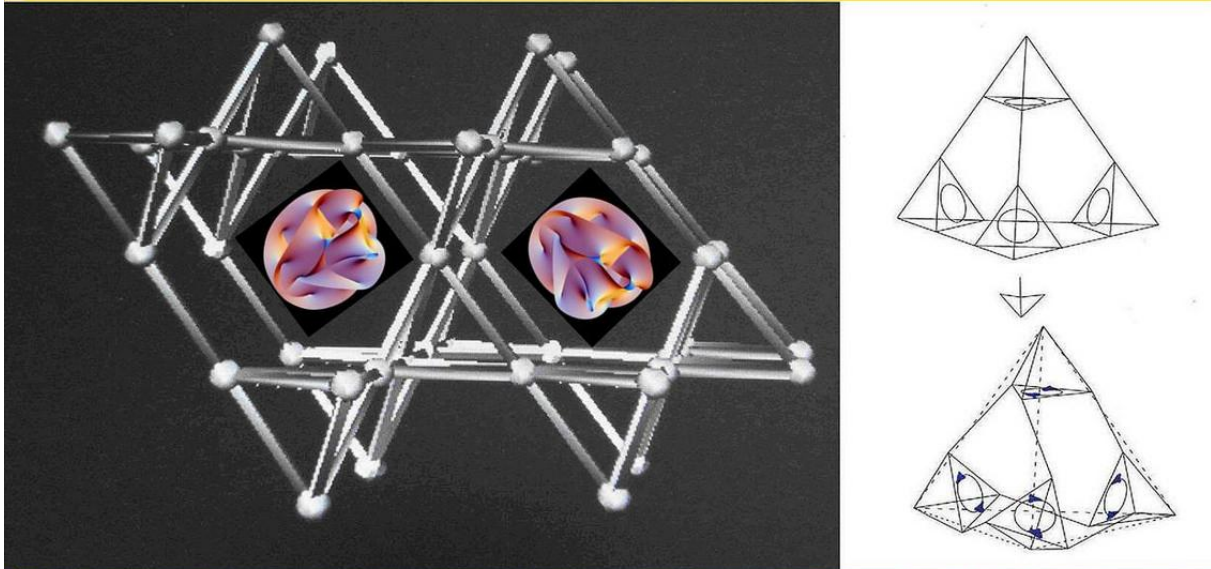

Simplified tetrahedral vacuum lattice structure (left), constructed by complex chiral tetrahedral building blocks (right). Each universe has to choose between a left- or righthanded rotation of its tetrahedral building blocks. Each chiral lattice has the Planck length and is supposed to be equipped with at least two oscillating massless new Higgs particles.

Synchrotron radiation by Polarized Fermion spin combined with high speed motion through the resistive oscillating Higgs vacuum (according to Quantum FFF theory)

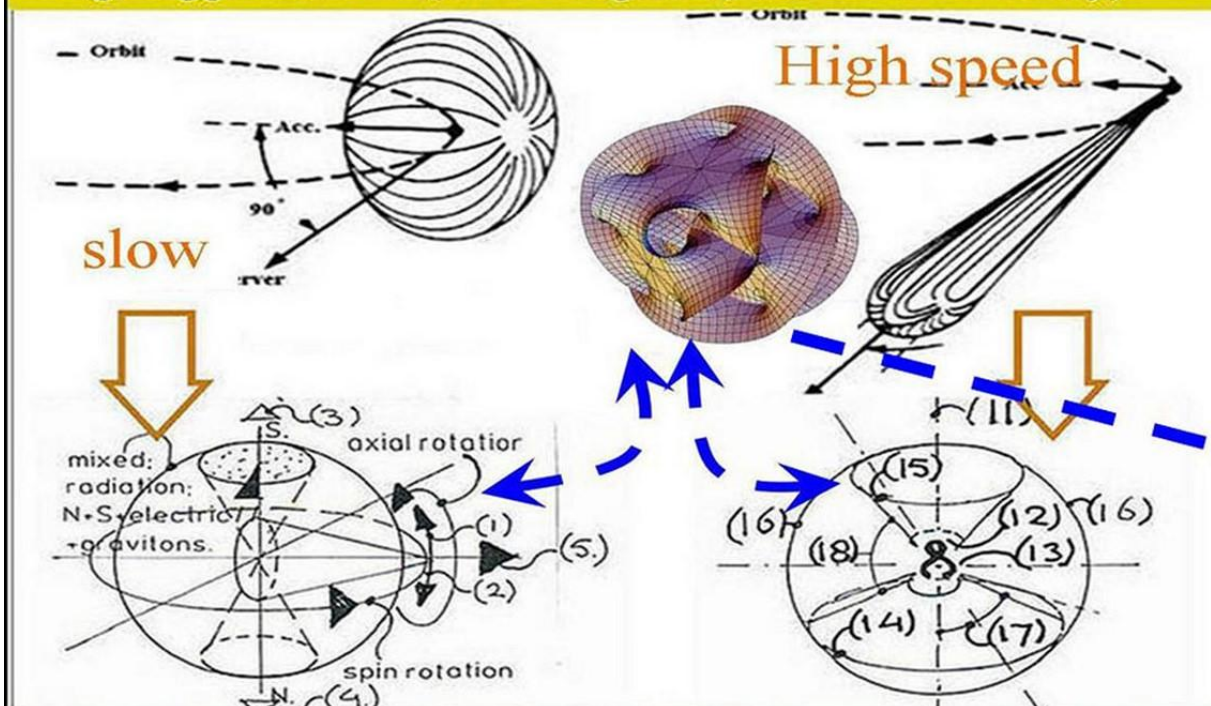

Figure 9, Chiral oscillating Axion/Higgs vacuum system. With Calabi yaw surfaces for Fermion propellers.

Pair production by Axion Higgs Field particle collision at black hole horizons (Q-FFF Theory)

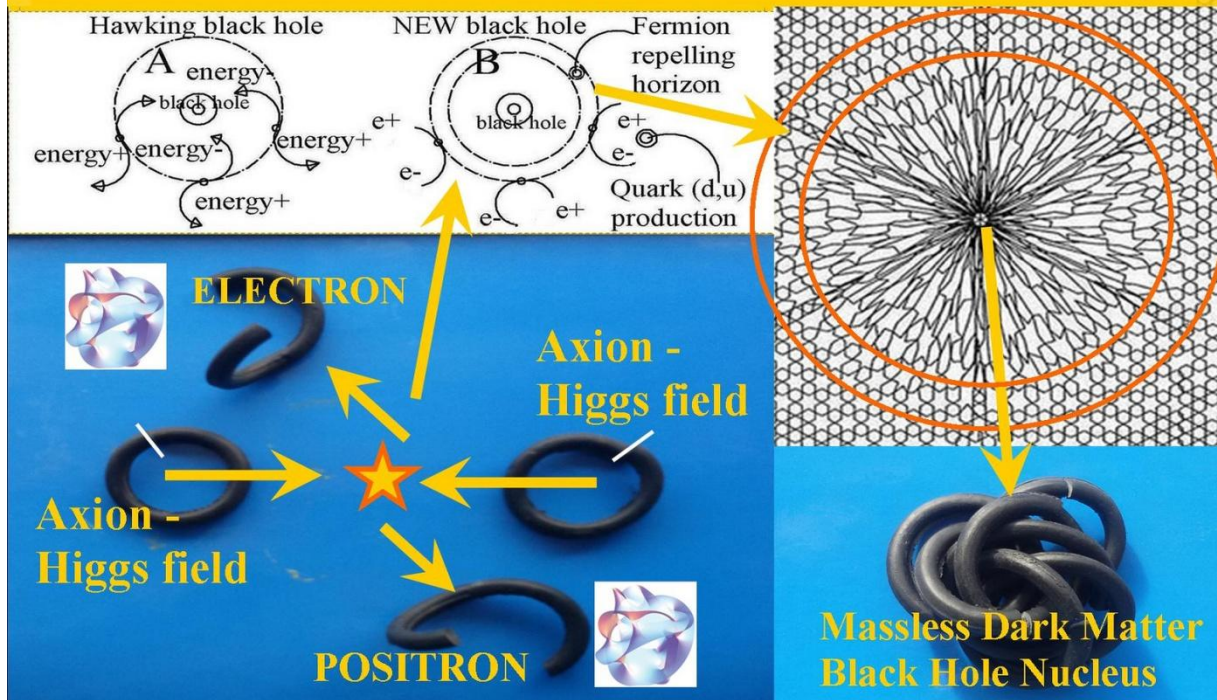
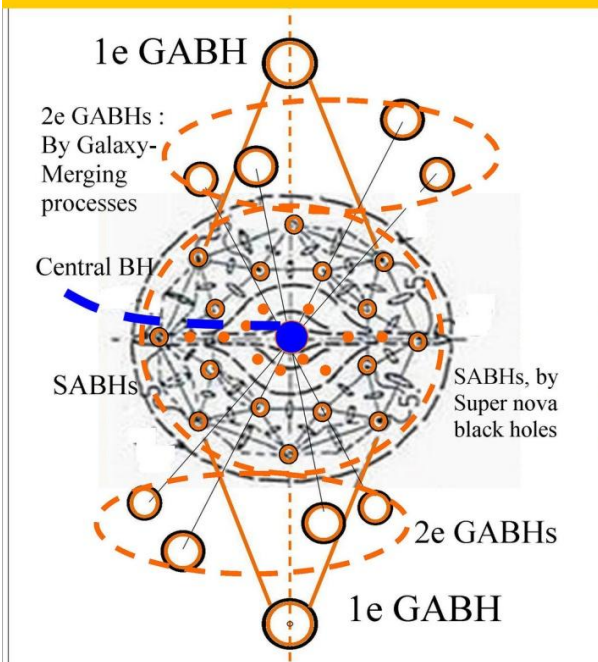

Figure 10, Pair production by collision of Axion Higgs field particles mainly at black hole horizons.

Four main Dark Matter Black Hole families.

Primary- Secondary Galaxy Anchor BlackHoles (GABHs), (Globular Dwarfs) Central BH and Stellar/Dwarf Anchor Black Holes, (SABHs), According to Quantum FFFTheory



According to Quantum FFF Theory, Black holes create Proton-Electron plasma at the Fermion repelling horizon. As a consequence dual black hole systems like Herbig Haro objects are equipped with dual EM jets, supported by cone shaped Casimir pressurized Higgs field vacuum polarization. Birkeland and Alfvén current circuits are supposed to be the result. Higgs-Casimir pressure vectors are depicted above and below.

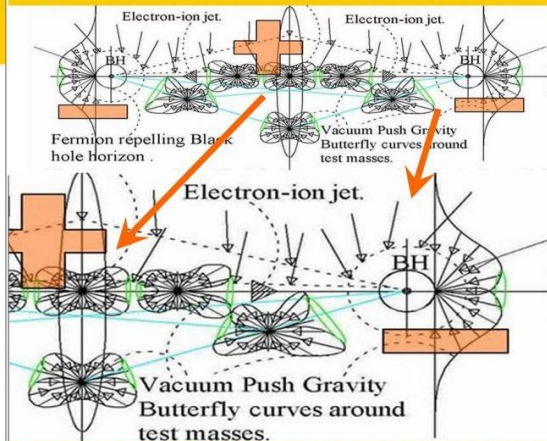

Below: Merging of spiral galaxies to form elliptical galaxies according to Quantum FFF Theory.

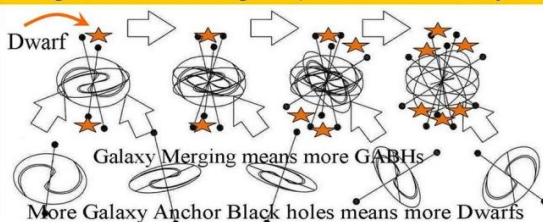
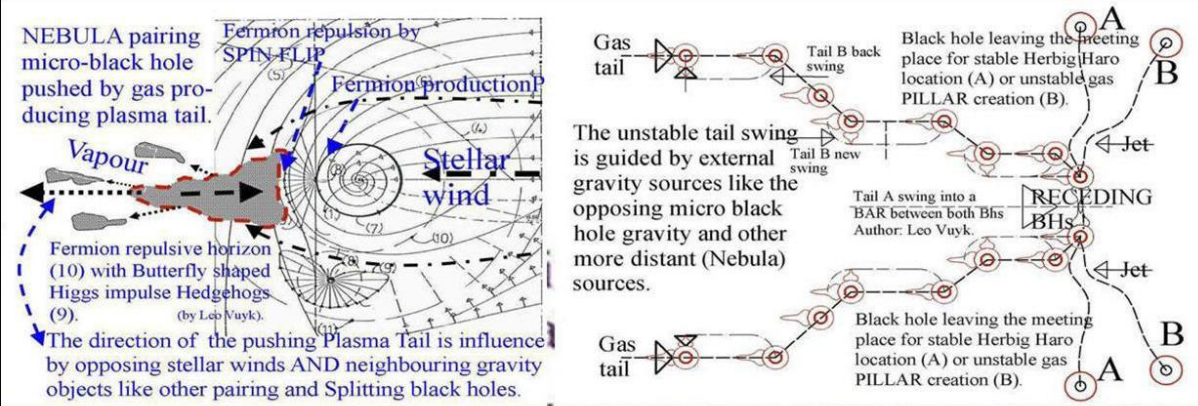

Figure 11, 4x main black hole families 1st GABHs 2nd GABHs Central Galaxy BHs and Supernova BHs. See also: interference BHs. (fig.16)

Splitting and pairing electric dark matter black holes. Magic self propelling in space and even on earth according to Quantum FFF theory.



Several accelerating pairing and receding micro black holes, as the start of HH objects, in the Carina nebula, with temporary meeting place (A) and ionised plasma tail.(Quantum-FFF Theory)

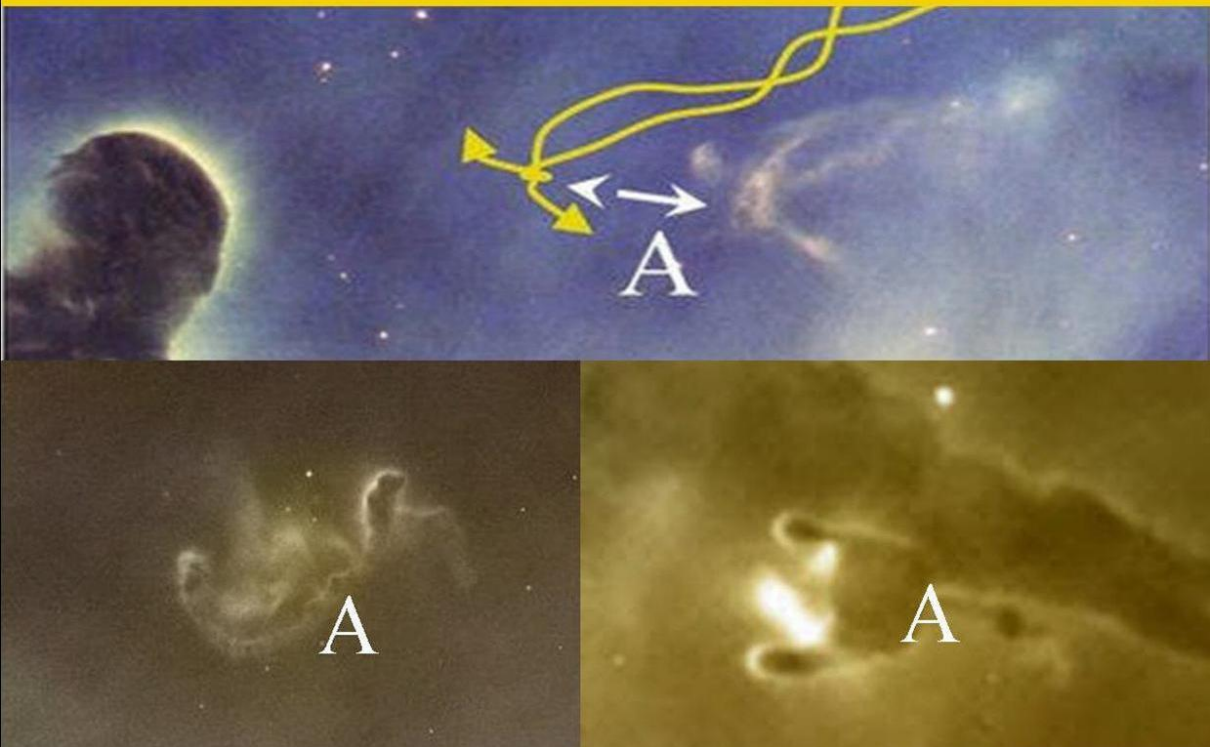

Figure 12, Splitting and Pairing Electric Dark Matter Black Holes.

“Monster colliding black holes might lurk on the edge of spiral galaxies”. Supported by Quantum FFF Theory.

The Contribution Of Outer HI Disks To The Merging Binary Black Hole Population see: <https://arxiv.org/abs/1710.09407>

BH Overdensity origin at the Spiral edge by plasma tail propulsion of new physics black holes.

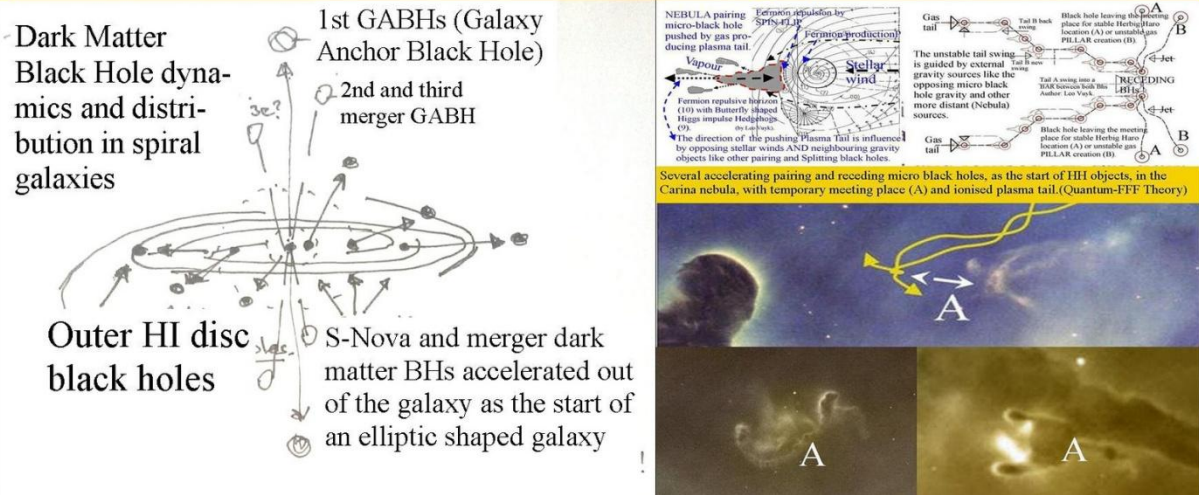

Figure 13, Black holes may lurk at the edge of each spiral galaxy.

The New Black Hole according to the Quantum-FFF Model: Negative Charged (outside) and Fermion (Plasma) Creation out of the massless Axion-Higgs String vacuum. (Fermion repulsion).

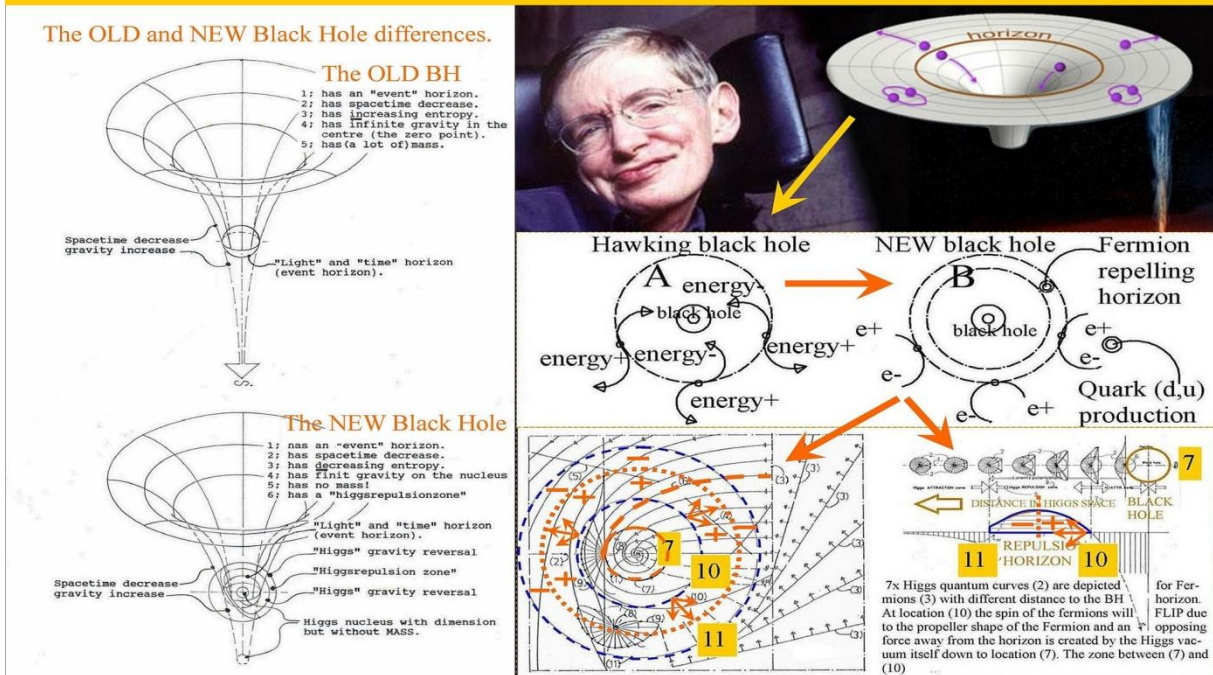

Figure 14, The new physics electric dark matter black hole different from Hawking's BH.

'Black Hole Splitting for (TDRG)' J1216+0709

Black hole splitting as the origin of spiral Galaxies after a double or multiple lobed Quasar process.

Markarian 231 as the Infant Stage of Cygnus-A Quasar. By EDM Black Hole



'Triple-Double Radio-Galaxy (TDRG)' J1216+0709

In Quantum FFF theory, stars and galaxies need at least two new physics Electric Dark Matter Black Holes (EDMBHs) for a Herbig Haro system (or dual lobed Quasar). However multiple symmetric lobed systems seem also possible by a repeated central black hole splitting process.

LIGO based Black Hole ratios and the ability to merge or split into two equal BH parts, able to create Herbig Haro systems and Gamma Ray Bursts. Such splitting systems are observed in the so called Spire part of the Eagle nebula.

The origin of Gamma Ray Bursts, by splitting black holes of different size, leaving three BHs behind. Two of them could form a Herbig Haro Object with a dumbbell structure. (Quantum FFF theory@Leo Vuyk).
Dual black hole merger nominal mass contents observed by LIGO in 2015 and 2016 resp. 29/36x and 7.5/14.2x sun masses. see: Quantum FFF Theory. The related ratios are: 1/1.24 resp. 1/1.9.

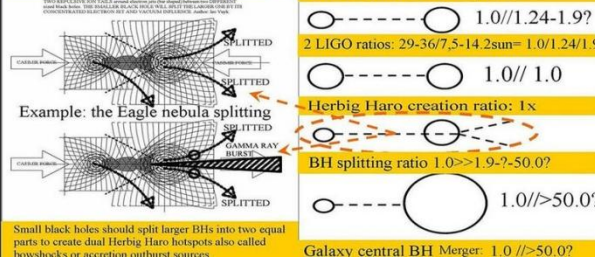

Markarian 231

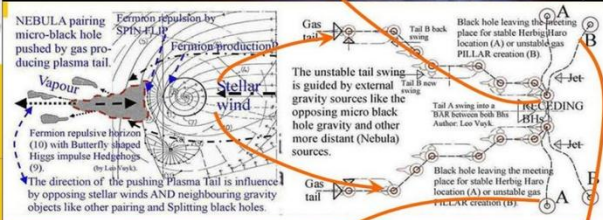

EDM-BHs: Electric Dark Matter -Black Hole systems seem to be active at all scales.

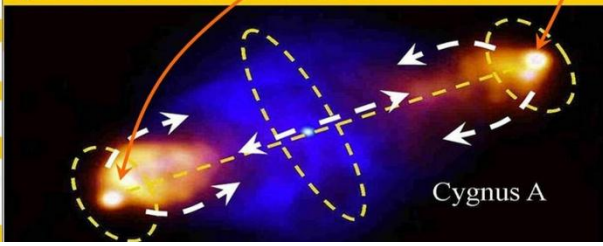

Cygnus A

Figure 15, Black hole splitting also active for TDRG galaxies.

Examples of evaporating Photonic Molecules or Quantum Knots or Ball Lightning or Micro Comets .

Kugelblitz - hochaufgelöst / Ball lightning in high resolution. Max-Planck-Institut für Plasmaphysik (youtube 2014)
As shown by the high-speed camera, first a surface discharge with thread-like plasma structures is generated.
As is typical of hot gases rising, this changes into a mushroom-like form and finally into a luminescent cloud. After about three blinks of an eyelash or 0.5 seconds the plasma vanishes. For further particulars:
<http://www.ipm.mpg.de/91559/kugelblitze>

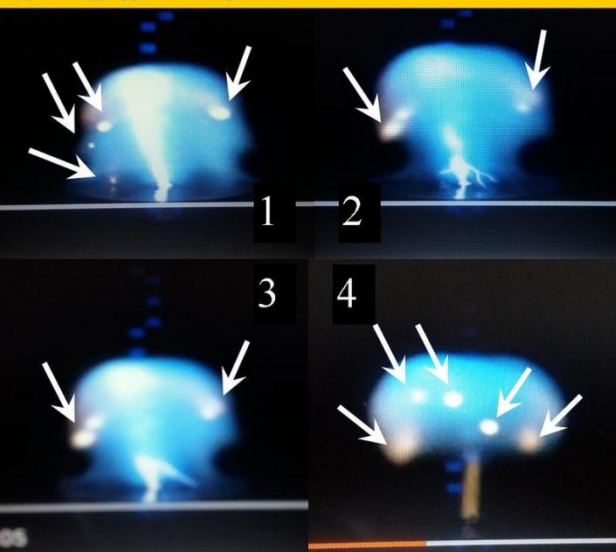

The creation of MICRO-Electric Dark Matter Black Holes (quantum knots, falling down) by magnetic lightning interference, according to Quantum FFF Theory.

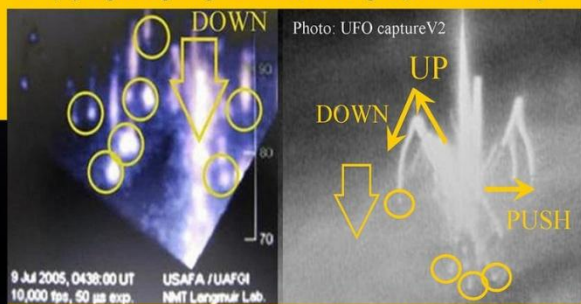

The UP direction is assumed to be the interference trajectory ending into the quantum knot (micro BH), falling down by gravity influence, but PUSHED away by the electric anode effect. The quantum knot is supposed to have a negative charged electron Shell, around a positive charged ionised nucleus.



Figure 16, unstable Interference black holes like ball lightning and micro comets.

Merger BHs seem to have specific mass ratios: between 1: 1.25 --1.9, as Quantum FFF Theory predicts.see below. and: <http://vixra.org/pdf/1710.0257v1.pdf>
 Equal sized BHs are not supposed to merge, but repel from each other and form a "Herbig Haro system" with star formation in the middle. However, If the ration is $1 \gg$ than 1.9, up to say 50. we may expect to find a splitting BH. system creating equal sized BHs for a Herbig Haro system. If the ratio is much higher I suggest: above $1: \gg 50$ the direct absorption by the larger BH should be happening .

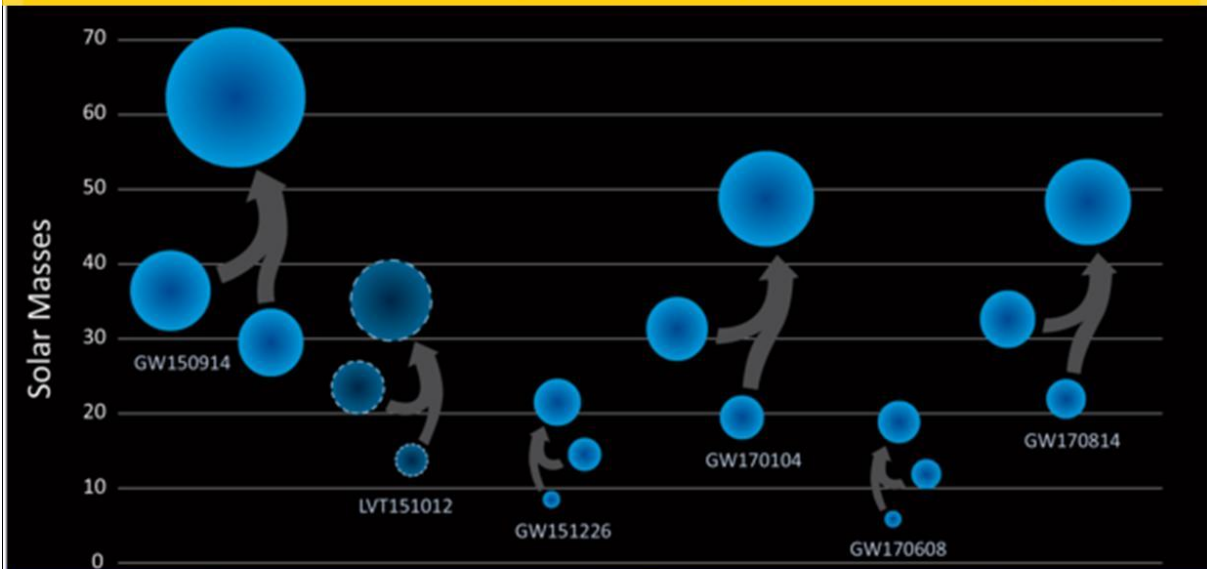

LIGO based Black Hole ratios and the ability to merge or split into two equal BH parts, able to create Herbig Haro systems and Gamma Ray Bursts. Such splitting systems are observed in the so called Spire part of the Eagle nebula.

The origin of Gamma Ray Bursts, by splitting black holes of different size, leaving three BHs behind. Two of them could form a Herbig Haro Object with a dumbbell structure. (Quantum FFF theory@Leo Vuyk).

Dual black hole merger nominal mass contents observed by LIGO in 2015 and 2016 resp. 29/36x and 7.5/14.2x sun masses. see: Quantum FFF Theory. The related ratios are: 1/1.24 resp. 1/1.9.

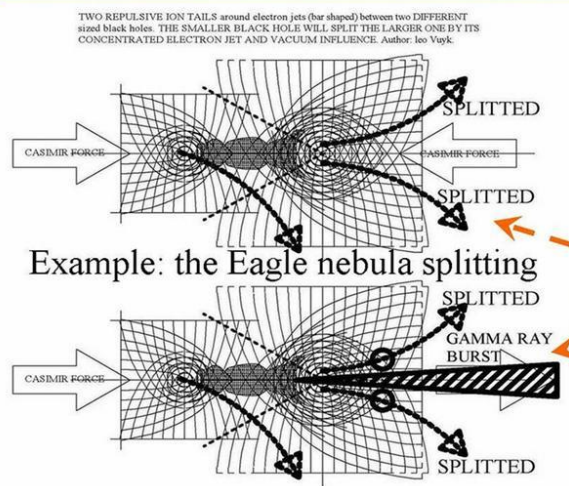

Small black holes should split larger BHs into two equal parts to create dual Herbig Haro hotspots also called

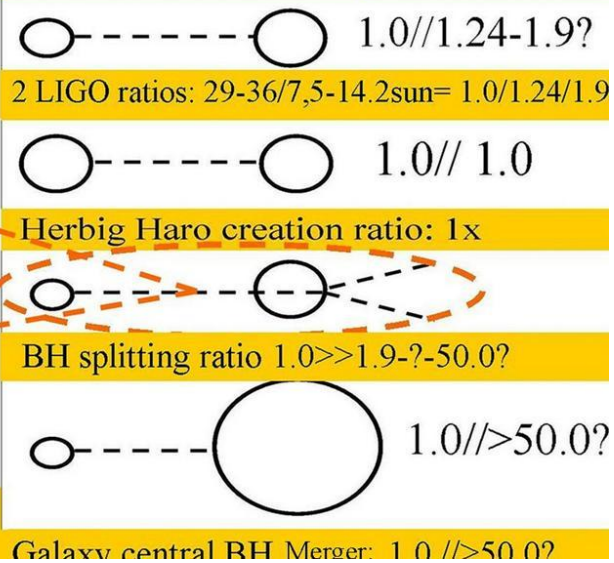

Figure 17, LIGO black hole ratios between certain boundaries.

PSR B1509-58 Pulsar nova (blue)with ejected ring of Starspot black holes (x-ray, orange)

According to Quantum FFF Theory, (Function Follows Form) sunspots are micro (new physics) Electro Dark Matter Black Holes (EDM-BHs), also found in the Helix Supernova remnants see below. The central neutron star is clearly shifted out of the center of the of the BH ring, which supports the quantum gravity difference between BHs and Neutron fermionic matter.

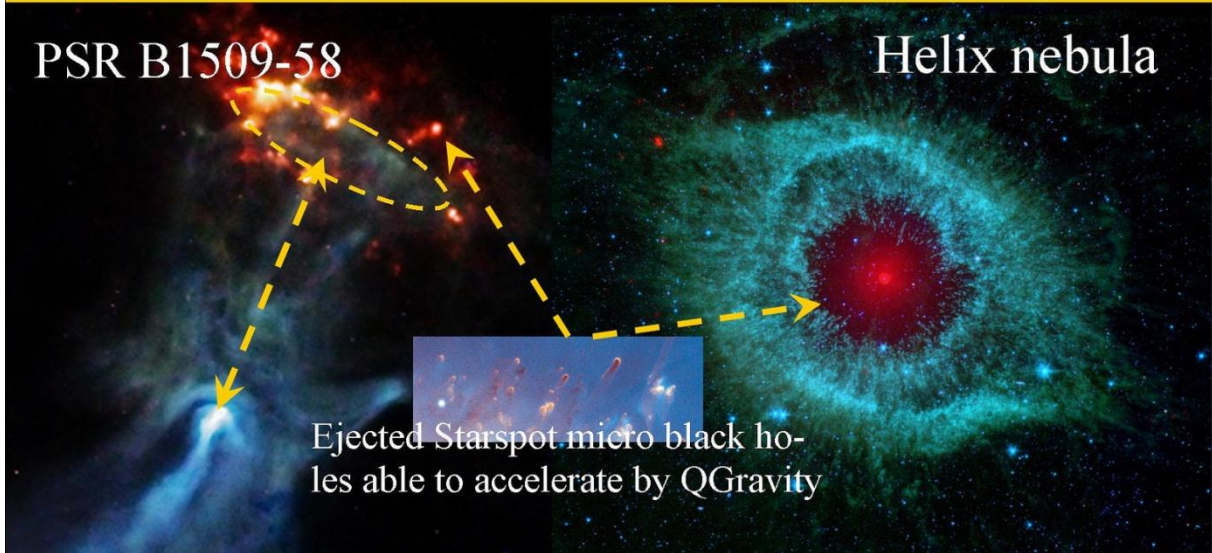

Figure 18, Starspot BHs observed at pulsar nova and Helix nebula.

Multiple Horizons created around Supernova Black Holes.

Proposal for the relation between different S-Nova shapes and the external primordial black hole configuration called Herbig Haro hotspot or Stellar Anchor Black Holes (SABHs)

Different Super Nova shapes are created around two star types:
 A: Stars with distant “dual or quadrupole Stellar Anchor Black Holes” assumed to be located in the center of a former open star cluster. (SN1987, NGC2440, Crab Nebula)
 B: stars without SABHs. (SN1572) Our sun is equipped with two sunspot rings assumed to be of type A, with two SABHs, according to Quantum Function Follows Form Theory.

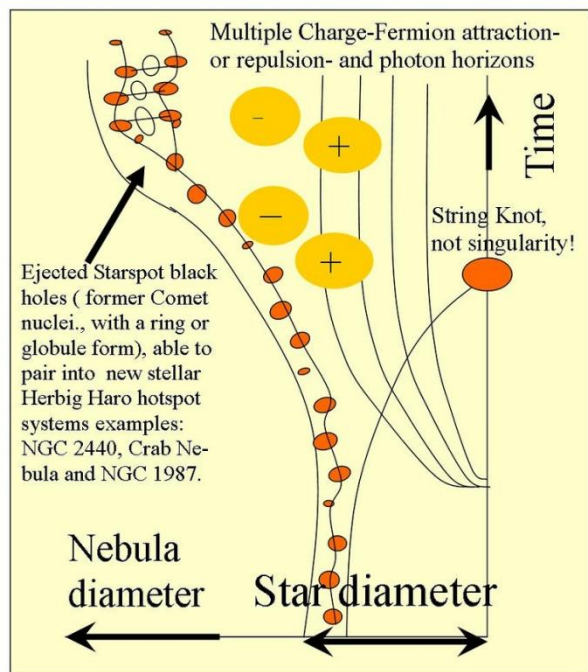
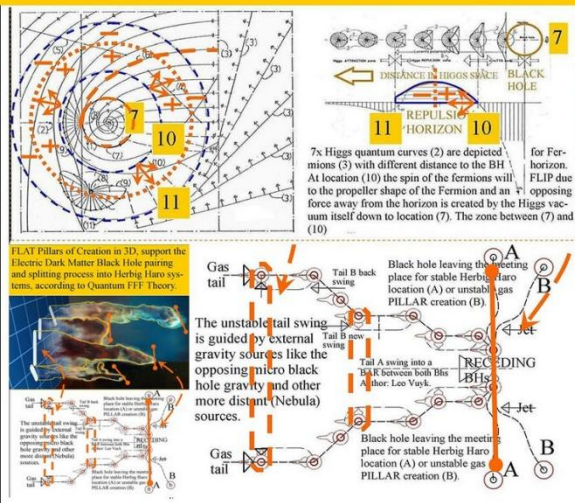
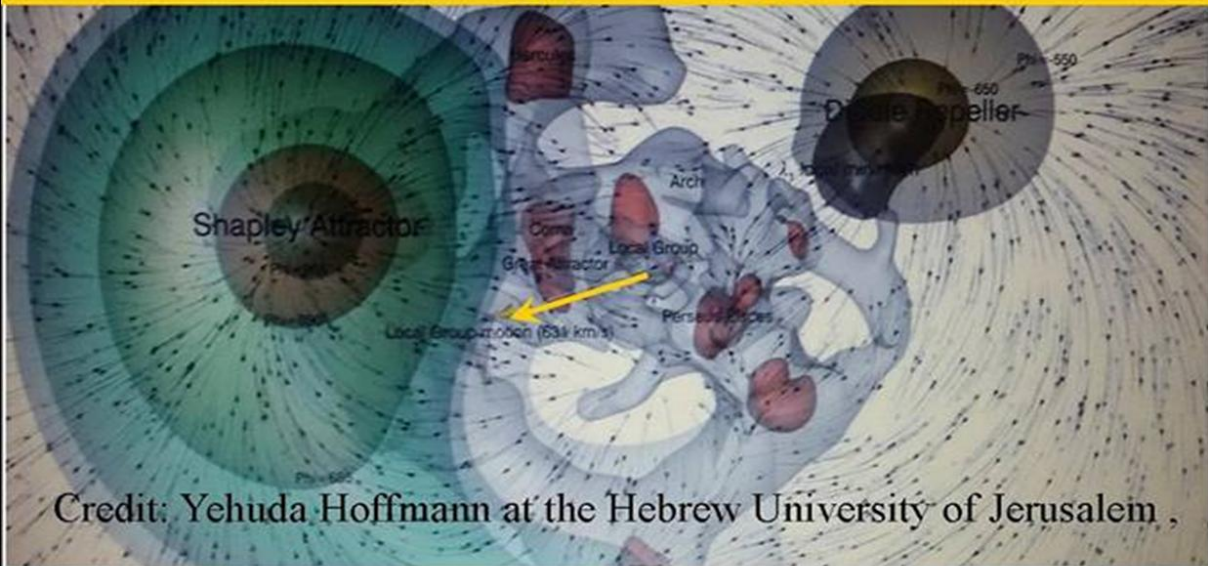

Figure 19, Multiple horizons around black holes.

Entropic or Emergent Gravity and Dipole Repeller Gravity seem to be Opposing Repeller Gravity of Axion Higgs field and Graviton pressure information.

According to Quantum FFF Theory, empty space is filled with a fast oscillating lattice of massless Axion-Higgs field particles as a half base for our opposing dipole pressure Higgs-graviton gravity on earth. Now prof. Yehuda Hoffman shows us a support for this hypothesis.



Credit: Yehuda Hoffmann at the Hebrew University of Jerusalem ,

Quantum Gravity as pressure distribution of the oscillating dual Higgs/Graviton vector field. New Dark Matter Black Hole, "Eat" the chiral oscillating Higgs vacuum.(Quantum-FFF Theory)

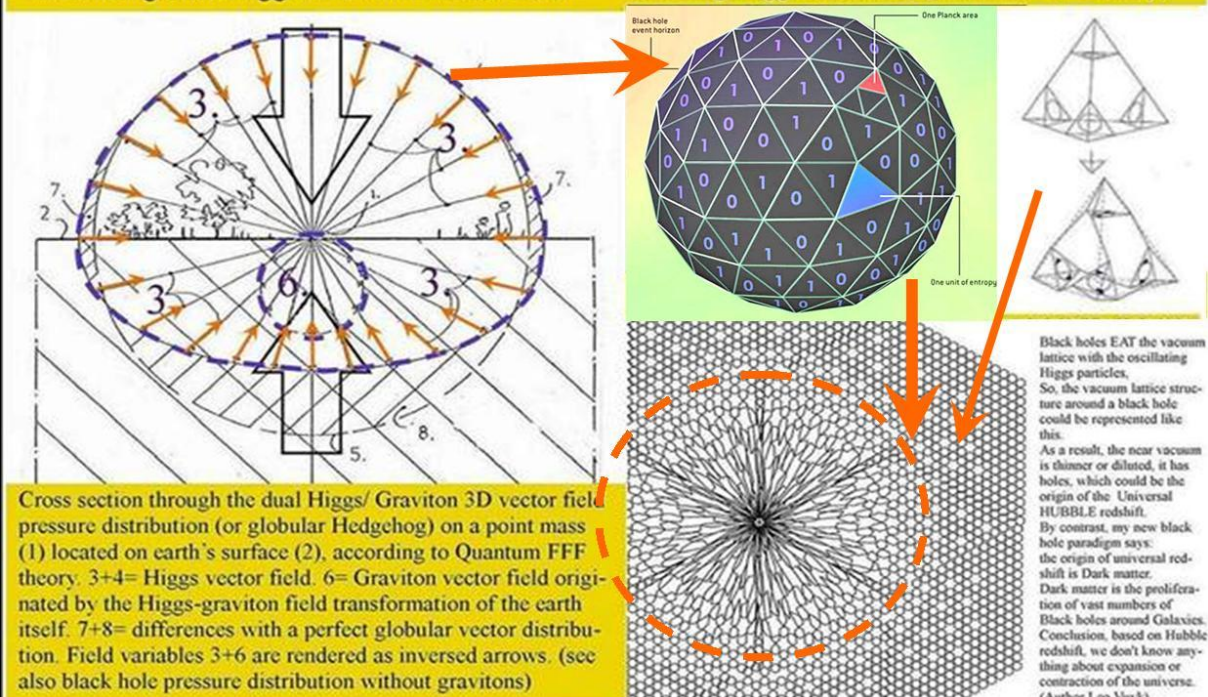
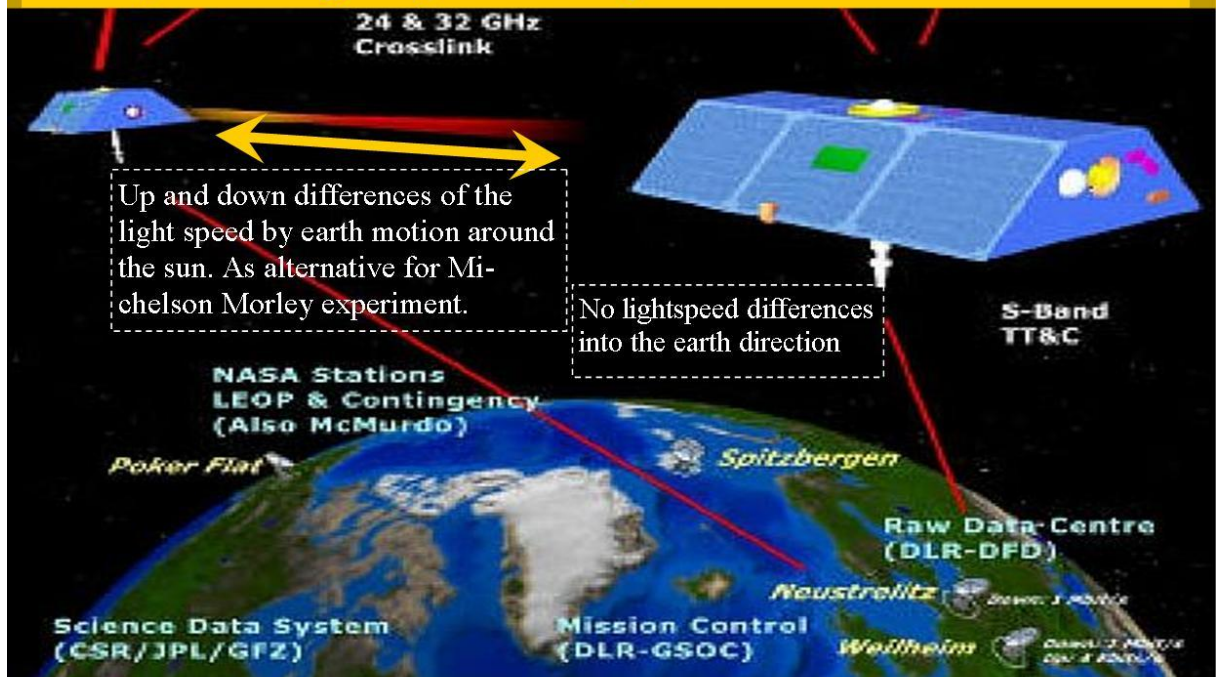

Figure 20, Entropic or emergent quantum gravity according to Quantum FFF Theory.

Future Grace satellite experiment as alternative for the Michelson Morley etherwind experiment, reduced by Earth light-speed drag of the Lasof: Local Asymmetric Oscillating vacuum Frame) according to Q-FFF theory.



Incidental variable lightspeed already found in CHAMP-GPS outliers parallel to earth motion.?

A clear example of GPS failure for sat-sat signals at higher altitudes (CHAMP: 430 km, GPS: 20.000km) Kinematic orbit solution comparison showing GPS data outliers up to 180 meters, (2x) during a CHAMP flight long 24 hours with 15 earth revolutions in 2003.

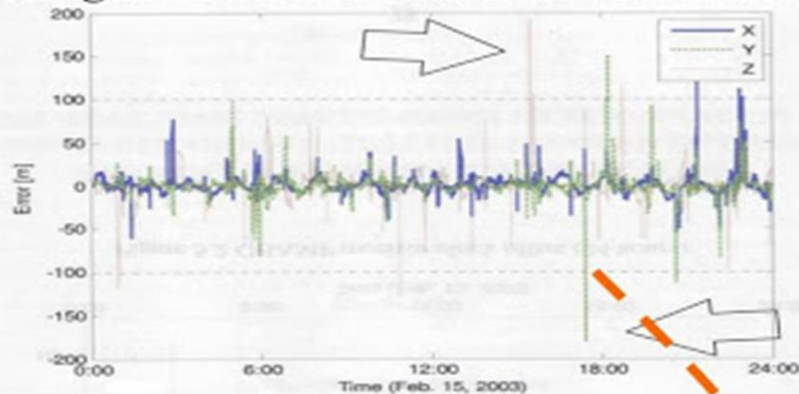

Figure 5.3 Comparison of the absolute kinematic orbit solution, w.r.t. RSO.

Credit: Tae Suk Bae, 2003, Ohio State university.

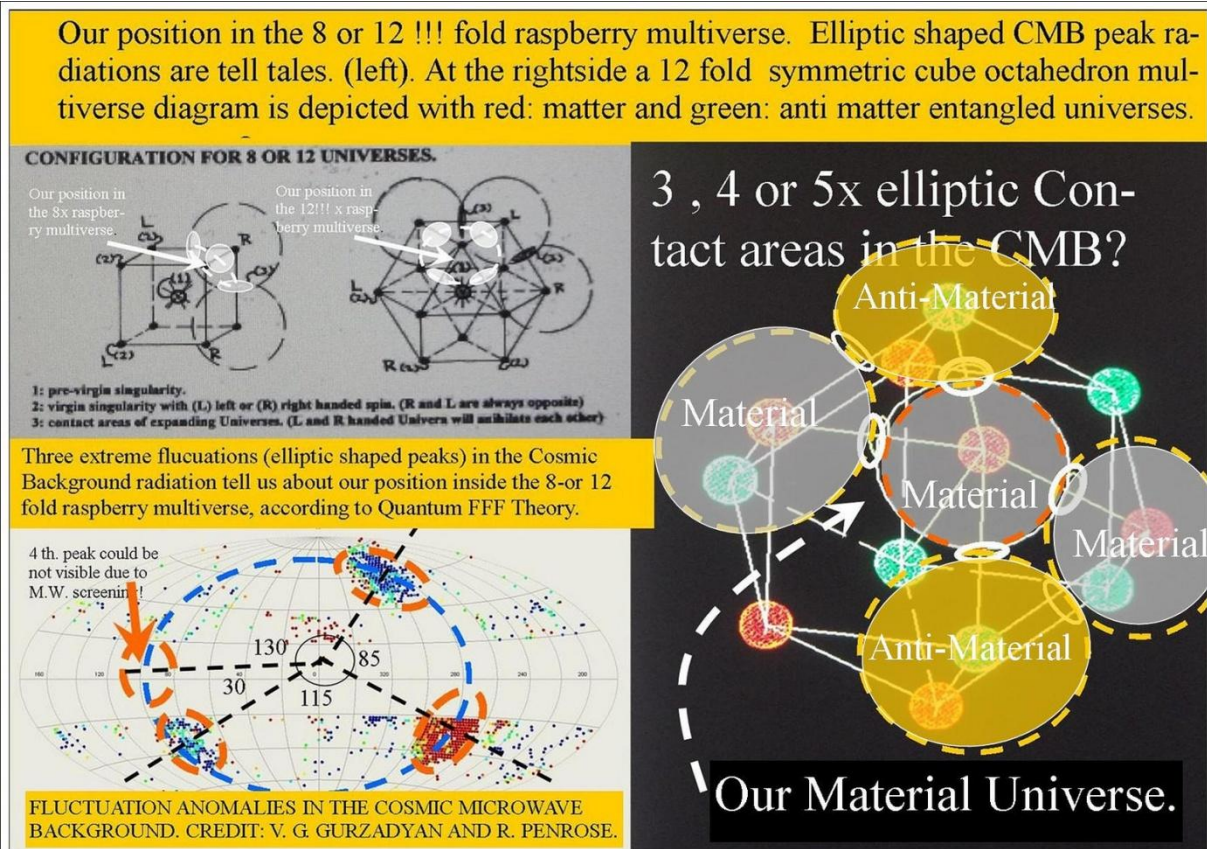

Figure 22, How we could measure our position inside our universal bubble of the raspberry shaped multiverse.

The Great Misconception in Astronomy and Physics. 2.

According to Quantum FFF Theory, we live inside a bouncing Electric Dark Matter Black Hole with Cyclic Entropy, based on rigid transformer-string particles guided by multiverse entanglement.

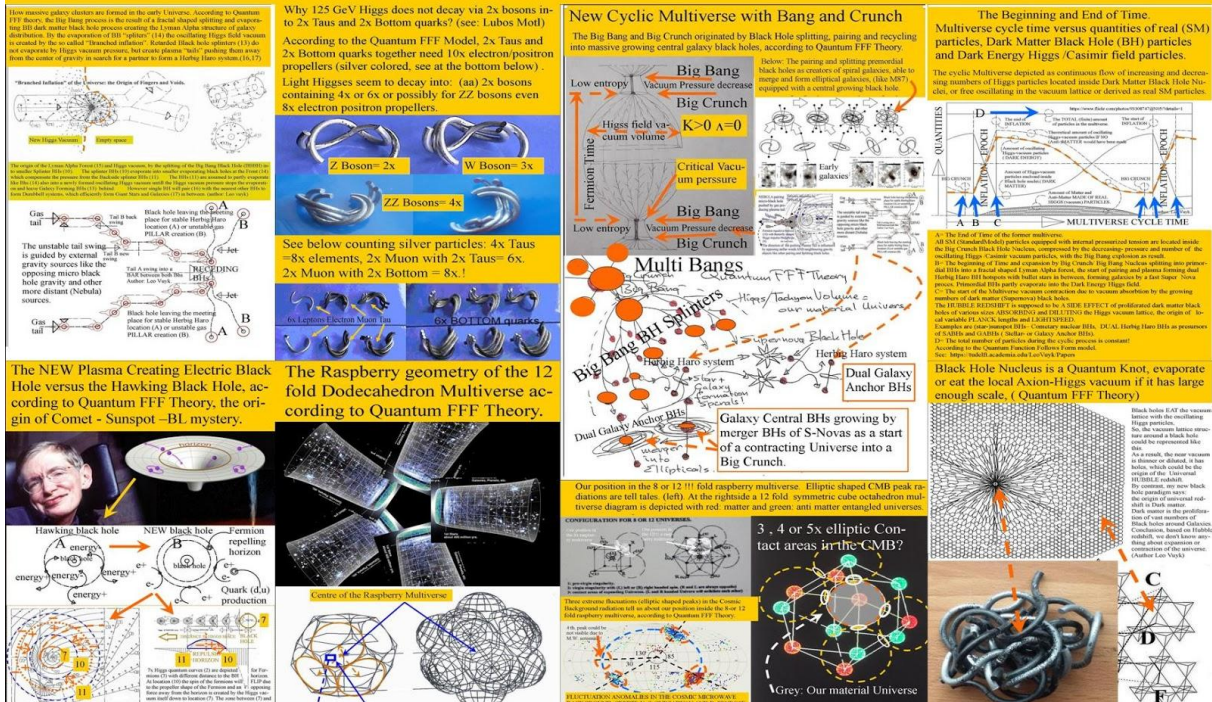

Figure 23, The great misconception

References:

Books: The New God Particle and Free Will. Author: Leo Vuyk, LuLu publishers, 2008.

ISBN number 978-1-4092-1031-3 <http://www.lulu.com/spotlight/LeoVuyk>

Quantum FFF Theory is also published in the form of POSTERS at the Flickr site:

<http://www.flickr.com/photos/93308747@N05/>

[99] viXra:1711.0327 The Einstein Cross Lensing Effect Explained by the Quadruple Dark Matter Formation Process of Edge-on Spiral Galaxies, According to Quantum FFF Theory.

[98] viXra:1711.0237

Higgs Particle Based SIMPs for Ancient and Future (Stone) Cutting Technology.

[97] viXra:1711.0112 Higgs Quantum Knots is Dark Matter is Black Holes or: Higgs Dark Matter Black Holes.

[96] viXra:1710.0257 Kilonova Merger Black Holes as the Origin of Dark Matter Black Hole Halo Population.

[95] viXra:1710.0115 Grand Unification of 4 Forces According to the Quantum FFF Model by di-Monopole Repeller Rigid String Pressure.

[94] viXra:1710.0050 Emergent Gravity by Dipole Repeller Rigid String Pressure the Origin of Quantum Gravity and Non Inertial Black Holes.

[93] viXra:1710.0034 The New Physics Black Hole Nucleus: Gravity Without Inertial Mass Effects.

[92] viXra:1709.0396 Dual Solar Anchor Black Holes or Herbig Haro Hotspots, the Origin of Quick Star Formation.

[91] viXra:1708.0296 The Origin of “Ultra Diffuse Galaxies” in Galaxy Cluster Centers.

[90] viXra:1708.0170 Action Without Reaction Symmetry for em Space Propulsion Thruster Technology.

[89] viXra:1708.0083 Dipole Repeller Gravity Effects at Different Universal Scales as the Origin of Large Scale and Local Quantum Gravity and Hubble Redshift.

[88] viXra:1707.0224 The Magic of the New Electric Dark Matter Black Hole on Earth and Space.

[87] viXra:1707.0189 Black Hole Nuclei as a Bunch of Rigid Transformable Higgs Strings Splitting by Relative Small Companion Mergers or Decreased Vacuum Pressure.

[86] viXra:1706.0490 The Origin of “Dead” Galaxies.

[85] viXra:1706.0420 Mass in Motion According to Quantum FFF Theory.

[84] viXra:1706.0413 Magnetic Monopole Test to Demonstrate the Existence of a Anti Maxwell Dead Zone Around a Current in a Wire.

[83] viXra:1705.0153 A Different Black Hole Horizon Interpretation Leading to Entropy Reduction and Violation of the Second Law.

[82] viXra:1705.0026 The Magic of Life- and Matter Creating Self Propelled Electric Dark Matter Black Holes Guided by a Holographic Entangled Symmetric Multiverse System.

[81] viXra:1704.0272 Interference Black Holes, Ball Lightning, Micro Comets, Sprite Fireballs

and Sunspots According to Quantum FFF Theory.

[80] viXra:1704.0150 The Origin of Life and the Need for a Rigid String Propeller Fermion Model Combined with a Chiral Vacuum Lattice and Micro Interference Black Holes

[79] viXra:1704.0133 2. Signals for Retarded Single Big Bang Black Hole Nucleus Splitting and Pairing into Dual Black Hole Herbig Haro Systems

- [78] viXra:1704.0047 Bohmian Double Slit Interpretation by Dual Entangled Universes, and the Benjamin Libet Experiment.
- [77] viXra:1704.0003 A Testable CP Symmetric Multiverse Model by Extended Experiments, Done by the Late Benjamin Libet in 1964.
- [76] viXra:1702.0109 CP Symmetry Between Material and Anti Material Copy Universes Combined with Local- and Multi-Universal Cycle Time.
- [75] viXra:1702.0040 The Alternative Origin of Hubble Redshift : Vacuum Absorption by black holes as a Support for Quantum Dipole Repeller Gravity and a Contracting Universe.
- [74] viXra:1701.0633 Local and Multi-Universal Cycle Time According to Quantum FFF Theory. (FFF= Function Follows Form)
- [73] viXra:1612.0365 John S. Bell Was Right: “How to Teach Special Relativity” and Atomic Pear Shaped Contraction.
- [72] viXra:1612.0026 Democratic Free Will and Telepathy in the Instant Entangled
- [71] viXra:1611.0226 Galaxy Cluster Merging and Vacuum Absorption by black holes as a Support for Quantum Dipole Repeller Gravity and a Contracting Universe.
- [70] viXra:1611.0101 Observed Dual Higgs Mass 124-126 Gev and the Chirality of the Vacuum Lattice.
- [69] viXra:1611.0031 Rigid String Cosmology with a Massless Axion-Higgs Oscillating Photon Vacuum Lattice and Massive Quantum Knots.
- [68] viXra:1611.0005 Electric Dark Matter Black Holes in the Moon (Orientale Basin)
- [67] viXra:1609.0407 New Physics Elements in the Quantum Function Follows Form Model.
- [66] viXra:1608.0329 God Seems to Play Dice with Dual Entangled Pinball Machines in a Super symmetric (Susy) Multiverse
- [65] viXra:1607.0376 Axion-Higgs 3-Dimensional Rigid Transformable Strings and the Compound 650 GeV Z-Z Decay into Quarks/Lepto quarks.
- [64] viXra:1605.0257 Reaction Less Drive by Anti Maxwell Dead Zone Around a Wire.
- [63] viXra:1604.0372 Herbig Haro Hotspots or Bow shocks Are the Origin of Star Formation, not the Result as the Mainstream Suggest.
- [62] viXra:1604.0229 Er=epr in the Super symmetric Cyclic Multiverse and in the Lab Without Strange Cats.
- [59] viXra:1505.0101 The Origin of Bok Globules and Molecular Clouds, Splitting and Pairing Electric Dark Matter Black Holes.
- [58] viXra:1503.0186 Primordial Dark Matter Black Holes Outside Galaxies Responsible for the Creation and Contraction of a Cyclic Universe? 22
- [57] viXra:1503.0097 Quantum FFF Theory, Poster News 4.2
- [56] viXra:1502.0086 Parity and Chirality as a Base for Quark-Gluon Plasma and Dust Creating Black Holes and the Beginning and End of Time..
- [55] viXra:1411.0039 Quantum FFF Theory, Poster News 2
- [54] viXra:1410.0039 Evidence for Dark Matter Black Hole Based Plasma, Dust and Ice Production Inside Comets Like 67P,C-G. and the Growing Earth.
- [53] viXra:1409.0164 The O’Connell Effect in Eclipsing Binaries Explained by Mass Related Light Speed Extinction Distances (Lasof) of Stars and Even Planets.
- [52] viXra:1407.0001 Evidence for Evaporating Dark Matter Particles in Silicon Fireballs.
- [51] viXra:1406.0076 Galaxy Formation and Evolution According to Quantum FFF Theory.
- [50] viXra:1406.0019 Quantum FFF Theory Proposals for Some Unsolved Physics Problems.
- [49] viXra:1405.0224 Dual Star Ejection in Open Star Clusters by the Central Star.
- [48] viXra:1404.0151 Future Free Energy of New Physics Ball Lightning Black Holes, the Origin of a Super Social Society or the Opposite?
- [47] viXra:1404.0002 Proposal for the Origin of Unexpected Large B-Modes Found in the Bicep2 Measurements.

- [46] viXra:1402.0132 Reconciliation of GR and QM by a New Gravity-Black Hole and Lightspeed Model Called Quantum- FFF Theory.
- [45] viXra:1402.0044 The Impossible Zero Point Electric Black Hole as the Origin of New Physics even for Comets like 67P,C-G.
- [44] viXra:1401.0115 Calabi Yau Shaped Double Fermion Spin States.
- [43] viXra:1401.0071 Democratic Free Will in the Instant Entangled Multiverse.
- [42] viXra:1312.0143 The Navel Cord Multiverse with Raspberry Shape, a Super Symmetric Entangled 12 Fold Bubble Universe.
- [41] viXra:1312.0076 Are Sunspots Made of Gravitating Dark Matter Black Holes?
- [40] viXra:1310.0101 The New Nuclear Magic Number (34) Explained by the Polar Coaxial Ring System of Quantum FFF Theory.
- [39] viXra:1310.0059 The Semi Relativistic Higgs Field Aether with Mass Related Lightspeed Adaptation.
- [38] viXra:1309.0081 New Physics by Table Top Experiments.
- [37] viXra:1308.0083 23 The Raspberry Shaped Super Symmetric Multiverse
- [36] viXra:1307.0068 Quantum Function Follows Form Theory, the Small Scale, Posters part 1.
- [35] viXra:1307.0067 Quantum Function Follows Form Theory, the Large Scale, Posters part 2.
- [34] viXra:1306.0218) Dark Matter UFO Dust Particles or Quantum Knots in the LHC at CERN ?
- [33], viXra:1306.0065 The Splitting Dark Matter- Black Hole- Big Bang and the Cyclic Multiverse.
- [32], viXra:1305.0140 Quantum FFF Theory Experiments, a Summary.
- [31], viXra:1305.0041 The Shnoll Effect Explained by Quantum FFF Theory.
- [30], viXra:1304.0022 The Self Organizing Universe in the Carina Nebula.
- [29], viXra:1303.0211 Hubble Redshift Combined with Universal Contraction is Possible.
- [28], viXra:1303.0053 Micro Birkeland Currents Between Two RF Generated Plasma Balls in the Laboratory.
- [27], viXra:1302.0172 Silicon Based Ball Lightning Globule Structures and Signs for Accumulation and Retarded Decrease of Tunneling Energy Bullets.
- [26], viXra:1301.0088 Two or Three Large Quasar Groups (LQGs) Located at the Start of Two or Three Lyman Alpha Systems and a Part of the Raspberry Multiverse?
- [25], viXra:1301.0050 Dwarf Galaxies and Their Relation with Dark Matter Based Galaxy Anchor Black Holes (Gabhs).
- [24], viXra:1210.0177 Instant Broglie Bohm Pilot Waves, the Origin of All Entanglement Effects in the Lab and Wavefunction Collapses in Our Universe as Related to Our Opposing Anti-Copy Universe(s) According to Quantum FFF Theory.
- [23], viXra:1209.0092 New Dark Matter Black Holes and a New Dark Energy Higgs Field, Lead to a Bouncing CP Symmetrical Multiverse, and New Experiments.
- [22], viXra:1209.0061 Birkeland Currents, Sunspots, Comets and Ball Lightning Originated by New Paradigm Dark Matter Black Holes.
- [21], viXra:1209.0030 Majorana and Sterile Neutrino Solutions in the Quantum-FFF Model.
- [20], viXra:1208.0031 Clumpy Dark Matter Around Dwarf Galaxies a Support for an Alternative Black Hole Theory According to the Quantum Function Follows Form Model.
- [19], viXra:1202.0091 Earth Magnetic Monopole Array Field Interaction with Cyclotron – Synchrotron Electrons and Muon Conversion Used for Levitation Systems.
- [18], viXra:1201.0092 Earth Magnetic Monopole Array Field Interaction with Cyclotron Electrons used for Levitation Systems.

- [17], viXra:1112.0065 24 LHC Signals Between 121-130 GeV Interpreted with Quantum-FFF Theory
- [16], viXra:1111.0096 Reconciliation of QM and GR and the Need for a Pulsating Entangled CPT Symmetric Raspberry Shaped Multiverse.
- [15], viXra:1111.0061 Black Hole Horizon Curvature Dependent Balance Between Plasma Creation and e-e+ Annihilation in Quantum FFF Theory.
- [14], viXra:1108.0036 Artificial Ball Lightning Production and Exploitation Device for Zero Point Electric Energy Usage.
- [13], viXra:1108.0006 Mass in Motion in Quantum FFF Theory
- [12], viXra:1104.0083 Quantum FFF Theory in Posters.
- [11], viXra:1104.0044 Ball Lightning, Micro Comets, Sprite-Fireballs and X-Ray/gamma Flashes According to Quantum FFF Theory.
- [10], viXra:1104.0002 Stellar Anchor Black Holes as the Remnants of Former Herbig Haro Objects
- [9], viXra:1103.0097 ZPE Zero Point Energy Examples Around Black Holes.
- [8], viXra:1103.0068 Function Follows Form, at the Quantum Scale and Beyond.
- [7], viXra:1103.0024 Quantum Gravity and Electro Magnetic Forces in FFF Theory
- [6], viXra:1103.0015 Wavefunction Collapse and Human Choice-Making Inside an Entangled Mirror Symmetrical Multiverse.
- [5], viXra:1103.0011 An Alternative Black Hole, Provided with Entropy Decrease and Plasma Creation
- [4], viXra:1103.0002 3- Dimensional String Based Alternative Particles Model
- [3], viXra:1102.0056 Experiments to Determine the Mass Related Lightspeed Extinction Volume around massive objects.
- [2], viXra:1102.0054 Atomic Nuclear Geometry Based on Magic Number Logic.
- [1], viXra:1102.0052 Construction Principles for Chiral “atoms of Spacetime”
- =====