

Emergent Gravity by Dipole Repeller Rigid String Pressure the Origin of Quantum Gravity and Non Inertial Black Holes.

Leo Vuyk,
Architect,
Rotterdam, the Netherlands.

Abstract,

According to Quantum FFF Theory, mass is the potency of rigid strings, to produce and radiate Gravitons to be produced by the collision process, between mass less ring shaped Axion Higgs vacuum field particles and Fermions or Bosons also called Dipole Repeller gravity or Emergent Gravity.

More extended loops or "arms" of each rigid string particle is supposed to create more Axion transformation into Gravitons or other electromagnetic monopole photons per time unit. Secondly, gravitons are assumed to exert not an attraction force on fermions and bosons but only a reduced pressure force in opposition to the vacuum pressure of the Axion Higgs field..

So, Gravity can be described as the statistical difference between the collision pressure of "new" gravitons opposing the pressure of Axion Higgs field particles all around us.

Emergent gravity as proposed by E. Verlinde and Dipole Repeller gravity by Yehuda Hoffman, are in line with this assumption.

Non inertial black hole effects are the other side of the coin..

The ring shaped Axion Higgs field particles are supposed to oscillate in tandem (as the boxer engine pistons) along each vacuum lattice with the local Planck length and transfer information of monopole photons through the whole universe as long no fermion or boson comes too close.

So if the new physics black hole nucleus is represented as a compact quantum knot then there is no graviton production supposed.

As a consequence the incoming Axion Higgs field pressure is the only origin of the Gravity pressure effect around each black hole nucleus and the result of the Casimir absorption effect of the vacuum by the black hole nucleus.

At the same time, gravitons are not leaving the black hole at all.

In Quantum FFF Theory, the inertial mass effects of the earth and all atomic fermions is supposed to be originated by the real Lorentz polarization of all fermionic mass of the earth mainly pointing into the direction of motion around the sun, as the opposing effort for the resisting vacuum.

Rigid string shaped Fermions are assumed to have a propeller shape able to plow into the direction of motion through the local spacetime creating vacuum lattice.

Conclusion Bosons (Higgs, W and Z particles) seem to be not able to polarize and will present signals to be "stuck" in the local solar centered vacuum lattice. The LHC could perhaps be able to show this anti inertial mass effect created by the solar reference frame or solar LASOF (Local Oscillating vacuum Frame).

Introduction.

According to Quantum FFF Theory, (Function Follows Form at the quantum scale), the new black hole nucleus is represented as a bunch of rigid string particles compressed by the oscillating Axion Higgs field vacuum particles.

All Fermions should be repelled at a new physics Black Hole (BH) repelling horizon which is supposed to have two globular shells of positive or negative charge!

As a result, each black hole is assumed to have a globular shell of positron and proton based plasma at the inside and a negative electron based plasma shell outside this positive shell.

If we include existence of small interference black holes (or Quantum Knots) then Ball lightning and micro comets (including Comets and sunspots) are to be explained as micro black holes violating the second law of thermodynamics.

The form and microstructure of elementary particles, is supposed to be the origin of functional differences between Higgs- Graviton- Photon and Fermion particles.

As a consequence of the quantum gravity difference on fermions and black hole nuclei, the new splitting, accelerating and pairing massless black hole, is able to convert vacuum energy (ZPE) into real energy by entropy decrease. This explains quick Galaxy- and Star formation, down to Sunspots, (Micro) Comets, Lightning bolts, Sprites and Elves, Sprite Fireballs and Ball Lightning according to quantum.

In Quantum FFF Theory, the inertial mass effects of the earth is supposed to be originated by the real Lorentz polarization of all fermionic mass of the earth, on average pointing into the direction of motion around the sun, as the opposing effort for the resisting vacuum.

Conclusion Bosons (Higgs, W and Z particles) seem to be not able to polarize and will present signals to be "stuck" in the local solar centered vacuum lattice.

The LHC could perhaps be able to show this anti inertial mass effect created by the solar reference frame also called solar LASOF (Local Oscillating vacuum Frame, (ref. 53.)

Secondly, Dark matter concentrations "stuck" in the middle of merger galaxies clusters is also supposed to be a smoking gun for non- inertial mass of dark matter black holes. (fig.1).

Emergent gravity as proposed by E.Verlinde and Dipole Repeller gravity by Yehuda Hoffman, (fig 24) are in line with dual rigid string pressure gravity on fermions and bosons.

Black hole mass related merger dynamics.

6000 small S-Nova black holes in the Milky Way center (green spots below) is a support for the BH family distribution according to Quantum FFF Theory. (see right below). However Abell 520 cluster seems to centralize massive 1e an 2e Galaxy Anchor BHs (GABHs) in a DM core after merging of three clusters.(below left).

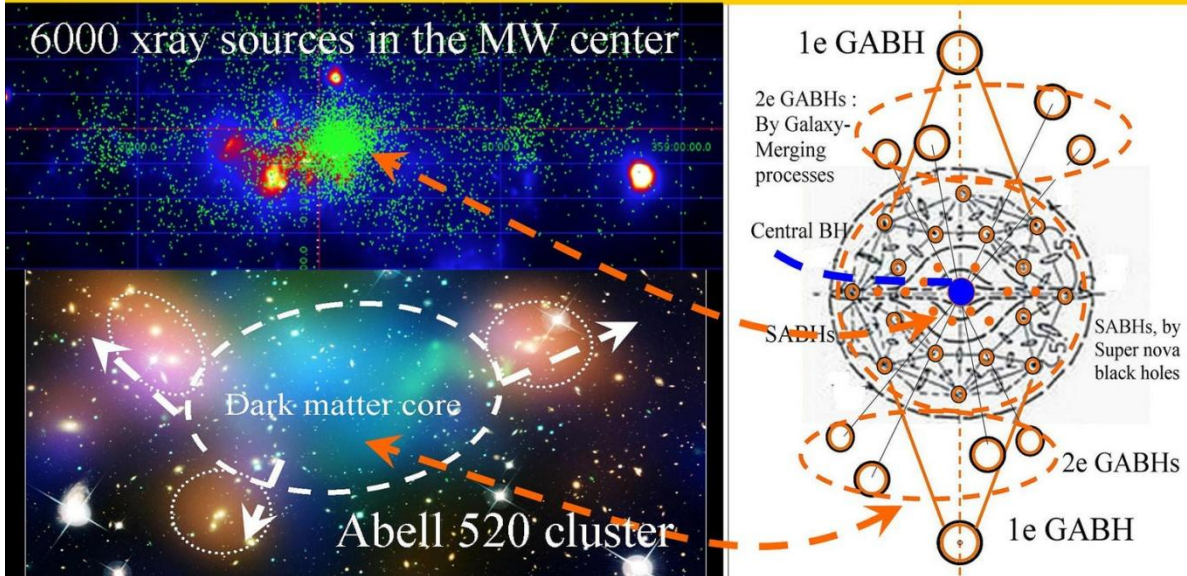
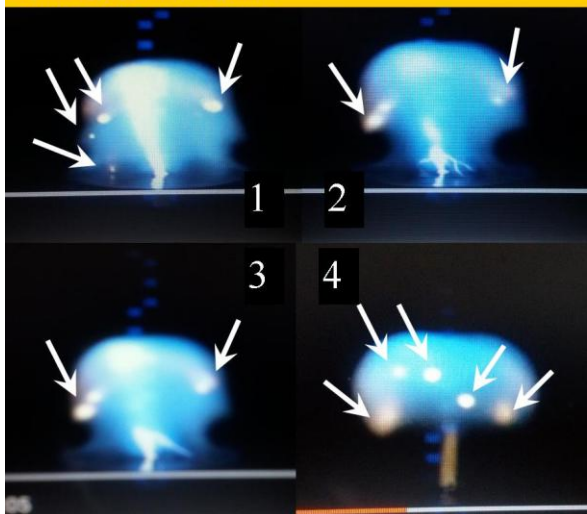

Figure 1, Merger dynamics of NON inertial Dark Matter black holes left behind after merging in the middle.

Examples of evaporating Photonic Molecules or Quantum Knots or Ball Lightning or Micro Comets .

Kugelblitz - hochaufgelöst / Ball lightning in high resolution.
 Max-Planck-Institut für Plasmaphysik (youtube 2014)
 As shown by the high-speed camera, first a surface discharge with thread-like plasma structures is generated.
 As is typical of hot gases rising, this changes into a mushroom-like form and finally into a luminescent cloud. After about three blinks of an eyelash or 0.5 seconds the plasma vanishes.
 For further particulars:
<http://www.ippp.mpg.de/91559/kugelblitze>



The creation of MICRO-Electric Dark Matter Black Holes (quantum knots, falling down) by magnetic lightning interference, according to Quantum FFF Theory.

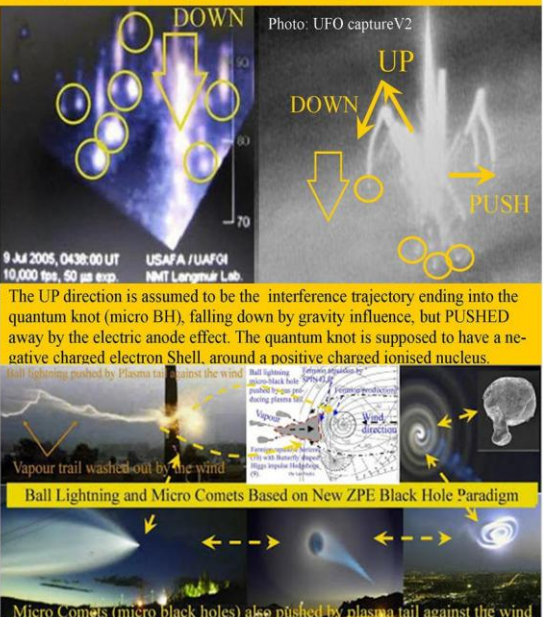

Figure 2, Microscopic Black Holes on Earth.

Rigid String based information building blocks with Fermion Calabi Yaw propellers (right) and Boson non propellers (left)

Rigid String Quantum Knot suggestions for different configuration: 125-375-500-750-1600 GeV and More called dark matter black holes. (According to Quantum FFF Theory architecture)

125GeV+375GeV=500GeV And More

500GeV

375GeV+375GeV=750GeV

2x750GeV+125=1625GeV

6x Leptons Electron Muon Tau

6x UP quarks

6x CHARM quarks

6x DOWN quarks

6x BOTTOM quarks

6x STRANGE quarks

6x TOP quarks

Pair production by Axion Higgs Field particle collision at black hole horizons (Q-FFF Theory)

Hawking black hole A

NEW black hole B

Fermion repelling horizon

Quark (d,u) production

ELECTRON

POSITRON

Axion - Higgs field

Massless Dark Matter Black Hole Nucleus

Figure 3, Fermionic propeller shaped Quantum Knots (right) and Higgs Boson based Quantum Knot-Black Holes (left) and pair production around black holes.

No Fermion Information Loss in Black Holes by Fermion Repelling Horizon.

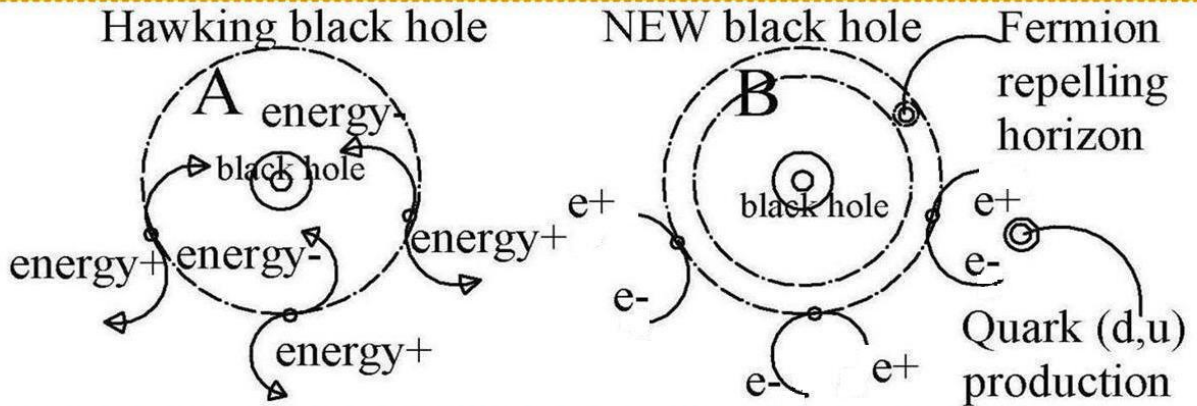

According to Quantum FFF Theory, there is no fermion information loss, only photonic information loss in a black hole. Quantum fluctuations around the BH horizon produce pairs of leptons, e^- , e^+ and even compound quarks (d,u, etc, see Fermion 3D string propeller theory: Fermion repelling by spin flip). For tripple BH horizons see image nrs 7, 10 and 11. Event horizon=7, Inner photon ring = 10, Outer photon ring = 11. Conclusion The Big Bang did not produce instantly all the Fermions in the universes. Even now lots of Fermions are produced by all BHs even the largest primordial Big bang splinters located outside large galaxies. see also: <<http://vixra.org/abs/1410.0039>

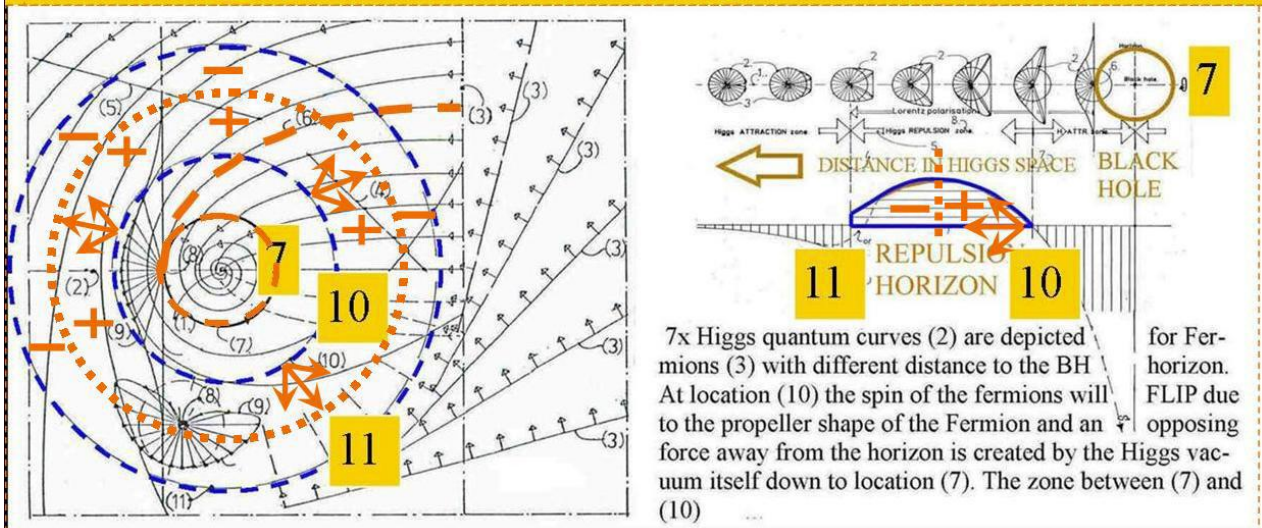
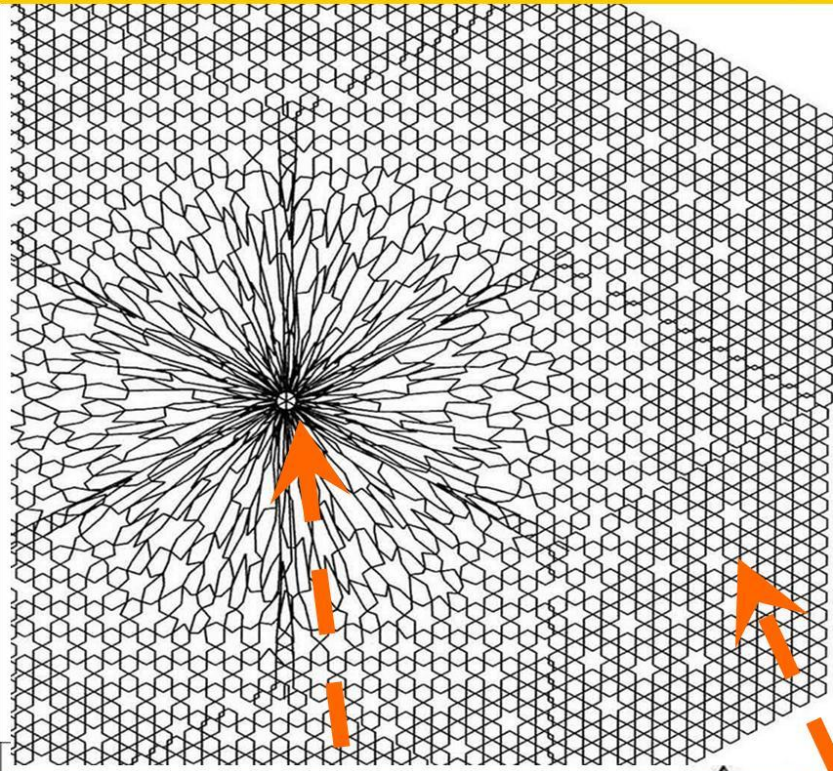

Figure 4, Electric Dark Matter Black Holes (EDMBHs) have a Fermion repelling horizon and are negative charged in our part of the multiverse.

Black Hole Nucleus is a Quantum Knot, evaporate or eat the local Axion-Higgs vacuum if it has large enough scale, (Quantum FFF Theory)



Black holes EAT the vacuum lattice with the oscillating Higgs particles, So, the vacuum lattice structure around a black hole could be represented like this.

As a result, the near vacuum is thinner or diluted, it has holes, which could be the origin of the Universal HUBBLE redshift.

By contrast, my new black hole paradigm says: the origin of universal redshift is Dark matter.

Dark matter is the proliferation of vast numbers of Black holes around Galaxies. Conclusion, based on Hubble redshift, we don't know anything about expansion or contraction of the universe.

(Author Leo Vuyk)

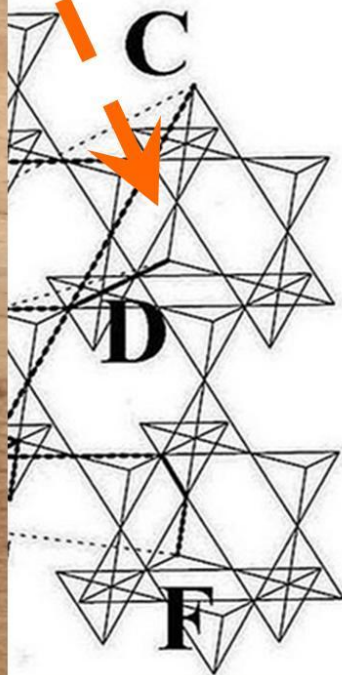

Figure 5, A stable black hole nucleus is large enough to “eat” the vacuum particles and grow by it.

“One of the big mysteries of this object (B1509 “The hands of God”) is whether the pulsar Fermion particles are interacting with the material in a specific way to make it look like a hand (NASA)

In this paper I support the idea that the orange x-ray elements of B1509) represent a ring of star spot black holes ejected from the exploding star

The micro black hole ring looks as hotspots accelerating away, with the white Pulsar (white) far relocated by the different quantum vacuum gravity effects on Fermion matter and Black hole nuclear matter, assumed to be a bunch of Higgs string particles with resistance in space for motion through the oscillating vacuum lattice.

In Quantum FFF Theory, (Function Follows Form) black hole nuclei are assumed to be a bunch of massless rigid strings compressed by the surrounding oscillating Axion-Higgs vacuum lattice. Fermion mass however is assumed to be created by the ongoing interaction with the same surrounding oscillating vacuum lattice including the collision production of photon/gluons and gravitons. Black hole nuclei can move through the vacuum lattice only by the deformation of its horizon system by horizon deforming and repelled plasma tails observed in so called Tadpoles, often found inside nebula.

Fermionic mass like neutrons however feel the gravitational influence of the local vacuum lattice polarization and graviton influence of local Fermionic matter.

In the shape of “the hands of God” (B1509) we observe a clear relocation of the central Fermionic Neutron star (white) and the ejected elliptic star spot black hole system (orange).

This in contrast with black hole supernovas where we observe often a symmetric ring or globular shell nebula around the just formed central black hole.

PSR B1509-58 Pulsar nova (blue)with exploded ring of Starspot black holes (x-ray, orange)

According to Quantum FFF Theory, (Function Follows Form) sunspots are micro (new physics) Electro Dark Matter Black Holes (EDM-BHs), also found in the Helix Supernova remnants see below. The central neutron star is clearly shifted out of the center of the of the BH ring, which supports the quantum gravity difference between BHs and Neutron fermionic matter.

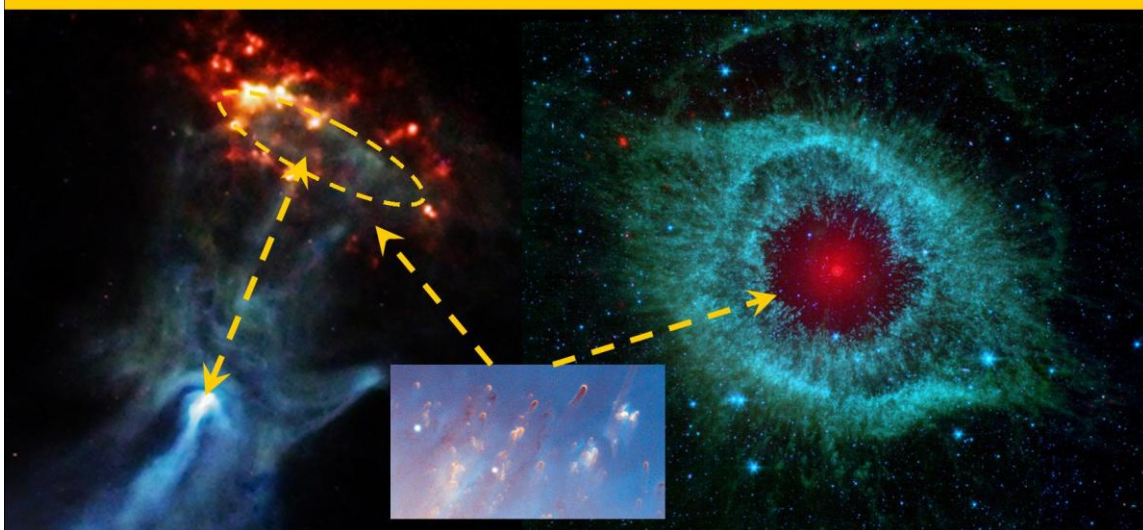

Figure 6, The A-symmetric B 1509-58 nebula , and symmetric Helix nebula as examples of the difference between Fermion and Black hole Quantum Gravity effects.

Multiple Horizons created around Supernova Black Holes.

Proposal for the relation between different S-Nova shapes and the external primordial black hole configuration called Herbig Haro hotspot or Stellar Anchor Black Holes (SABHs)

Different Super Nova shapes are created around two star types:
 A: Stars with distant “dual or quadrupole Stellar Anchor Black Holes” assumed to be located in the center of a former open star cluster. (SN1987, NGC2440, Crab Nebula)
 B: stars without SABHs. (SN1572) Our sun is equipped with two sunspot rings assumed to be of type A, with two SABHs, according to Quantum Function Follows Form Theory.

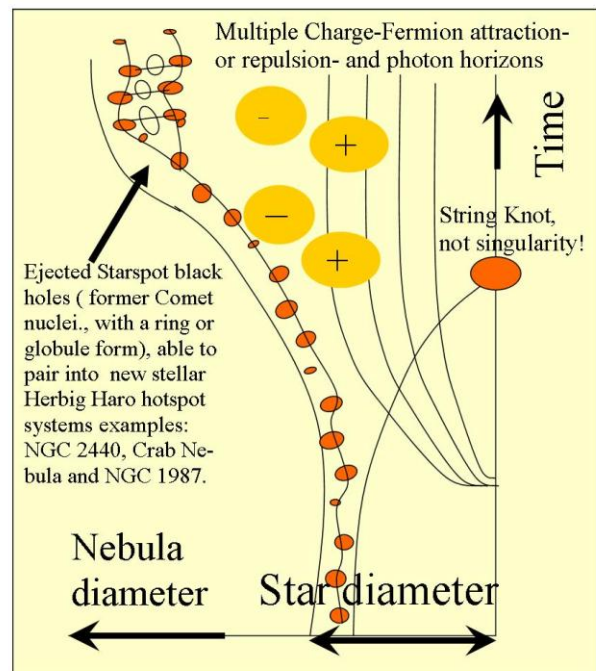
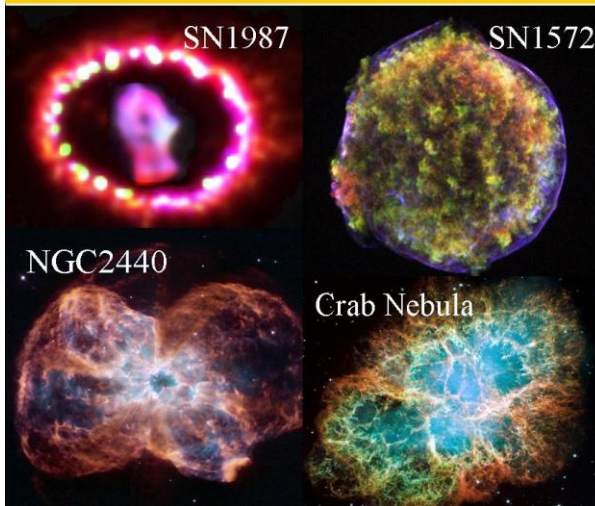

Figure 7, Other examples of Quantum Gravity effects on ejected rings of micro black hole starspots at work in different nebula .

New physics black holes

Complex galaxy / star evolution seems to be not only created by galaxy or star merging, but even by central galaxy- and stellar mass black hole chopping into two equal parts to form black hole based Hotspots for Herbig Haro systems or even for Double Radio Galaxies.

This process is supposed to be the consequence of the new physics Electric Dark Matter Black Hole (EDM-BH) principle of Quantum FFF Theory (Function Follows Forms) and supported by observation of Triple Double Radio Galaxies and even by BH splitting in the Spire Eagle nebula. (Figure 8)

The EDM-BH is assumed to contain a real particle nucleus of so called Axion-Higgs rigid transformable strings , which are compressed together by the pressure of the oscillation Axion Higgs vacuum lattice. Even the Big Bang nucleus is assumed to contain only compressed Axion Higgs strings which could explode into splinters and dual vacuum particles by the reduced vacuum pressure

around the Big Crunch nucleus of a former universe.

There seems to be a EDM- BH Ratio related black hole ability to merge (see LIGO) or split into Equal parts if the dual BH ratio is smaller than a LIGO BH ratio boundary which will be found in the future.

Until now, the smallest LIGO ratio is found to be: $1/1.9$. (or 0.52: LIGO 2016), however future LIGO results could shift this boundary to lower ratios. (Figure 8)

As a consequence for increasing galaxy- and star complexity there is a need for different sized primordial dual black holes instead of two equal sized.

Consequently for the first star formation between the equal BH hotspots (bow shocks) of a Herbig Haro system , the equal nuclear mass/size ratio of both i black holes is important. (fig 8)

Quasars such as Cygnus A are supposed to be a larger copies of a Herbig Haro system with larger BHs observed also as (radio) hotspots.

Markarian 231 seems to represent a large scale multiplying BH chopping system for symmetric so called Galaxy Anchor Black Hole (GABH) complexity, forming a Triple-Double lobed Radio Galaxy (TDRG).(Figure 9,10)

The Spire nebula of the seems to show a more complex BH. splitting process. (Figure 8)

For 3D rigid string particle models see: (figure 23,25).

LIGO based Black Hole ratios and the ability to merge or split into two equal BH parts, able to create Herbig Haro systems and Gamma Ray Bursts. Such splitting systems are observed in the so called Spire part of the Eagle nebula.

The origin of Gamma Ray Bursts, by splitting black holes of different size, leaving three BHs behind. Two of them could form a Herbig Haro Object with a dumbbell structure. (Quantum FFF theory@Leo Vuyk).

Dual black hole merger nominal mass contents observed by LIGO in 2015 and 2016 resp. 29/36x and 7.5/14.2x sun masses. see: Quantum FFF Theory. The related ratios are:1/1.24 resp.1/1.9.

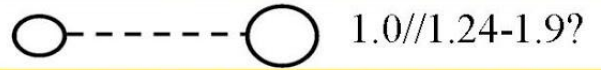
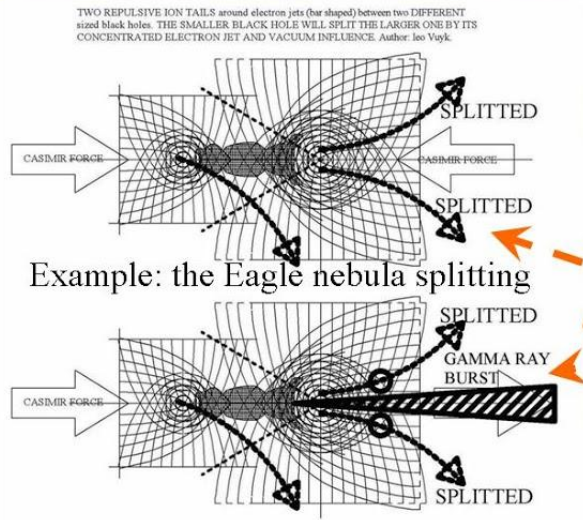

2 LIGO ratios: 29-36/7,5-14.2sun= 1.0/1.24/1.9



Herbig Haro creation ratio: 1x

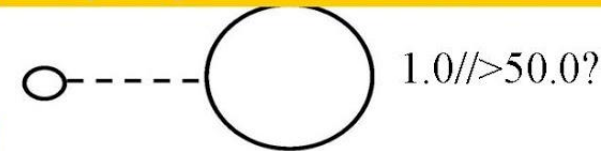

Small black holes should split larger BHs into two equal parts to create dual Herbig Haro hotspots also called bowshocks or accretion outburst sources.

Galaxy central BH merger: 1.0 //>50.0?

Black hole splitting in the Spire Eagle nebula

According to the Quantum Function Follows Form Model, small black holes split larger BHs in equal halves, (A) which are able to repel each other and form Dumbbell shaped Herbig Haro systems (B,C) with star formation in between.

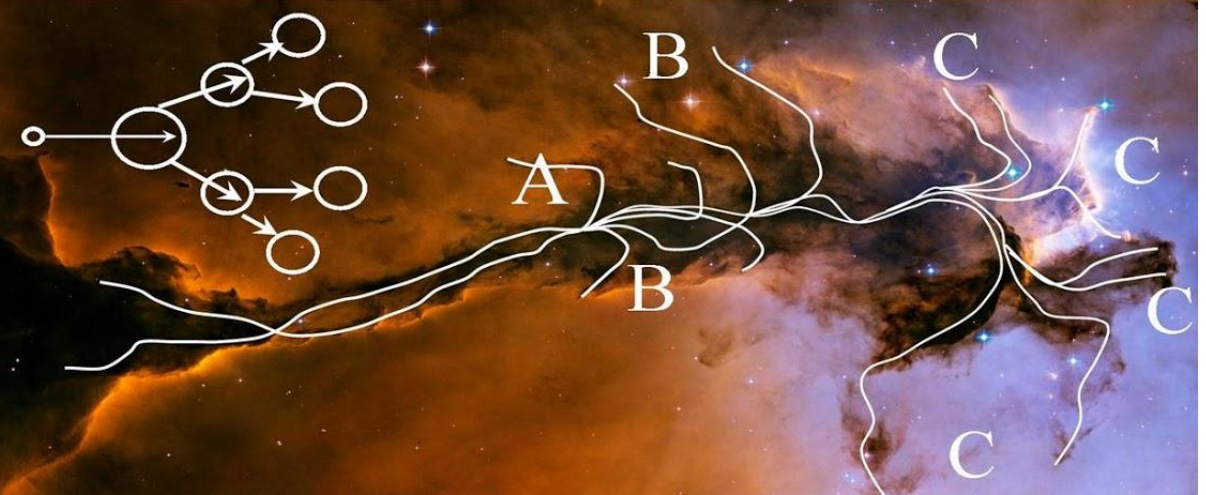

At location (A) both unequal sized black holes seem to split into 4x dual sets of smaller BHs one dual set has even evolved into a second 4x dual sets of BHs.

Figure 8, LIGO BH ratios and the BH multiplier splitting process in the Spire- Eagle nebula.

Markarian 231 as the Infant Stage of Cygnus-A Quasar. By EDM Black Hole



Markarian 231

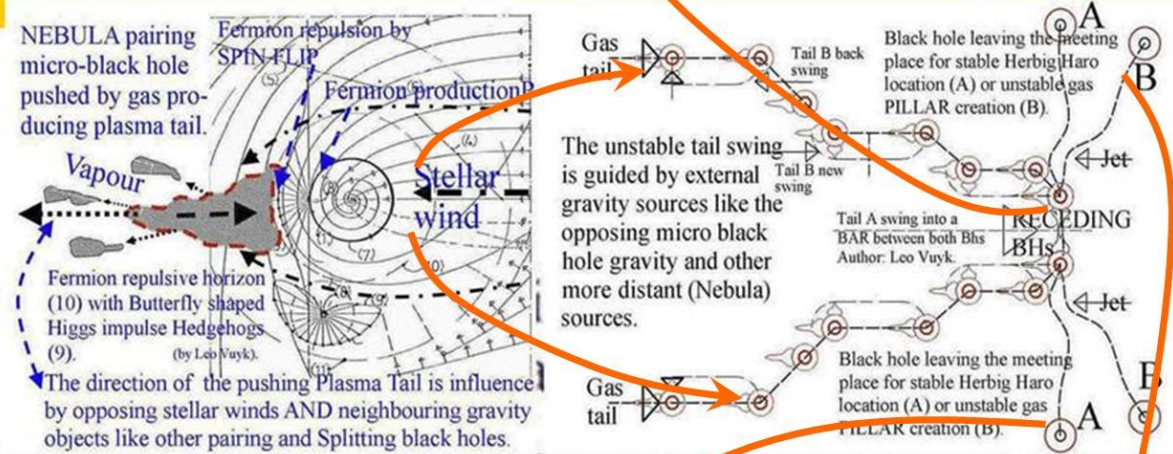

EDM-BHs: Electric Dark Matter -Black Hole systems seem to be active at all scales.

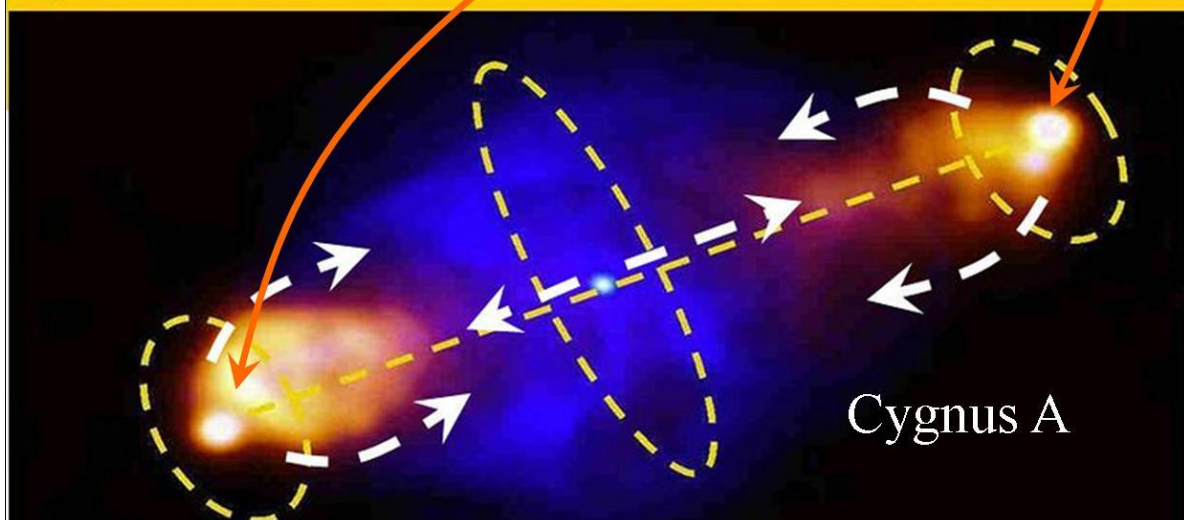
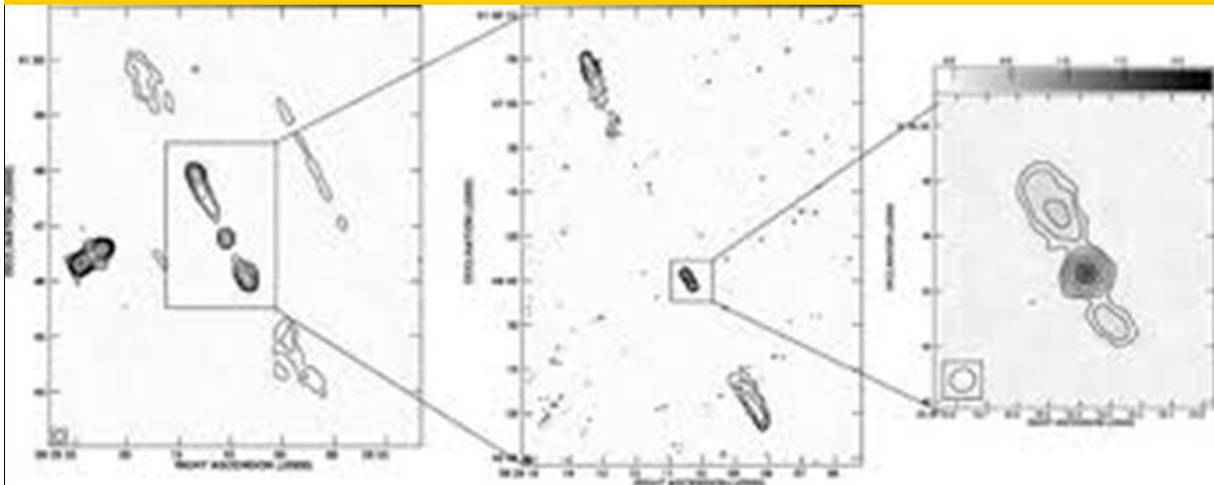

Figure 9. . the relation between Markarian 231 and other BH splitting systems

Black hole splitting as the origin of spiral Galaxies after a double or multiple lobed Quasar process.



In Quantum FFF theory, stars and galaxies need at least two new physics Electric Dark Matter Black Holes (EDMBHs) for a Herbig Haro system (or dual lobed Quasar) . However multiple symmetric lobed systems seem also possible by a repeated central black hole splitting process.

LIGO based Black Hole ratios and the ability to merge or split into two equal BH parts, able to create Herbig Haro systems and Gamma Ray Bursts. Such splitting systems are observed in the so called Spire part of the Eagle nebula.

The origin of Gamma Ray Bursts, by splitting black holes of different size, leaving three BHs behind. Two of them could form a Herbig Haro Object with a dumbbell structure. (Quantum FFF theory@Leo Vuyk).

Dual black hole merger nominal mass contents observed by LIGO in 2015 and 2016 resp. 29/36x and 7.5/14.2x sun masses. see: Quantum FFF Theory. The related ratios are: 1/1.24 resp. 1/1.9.

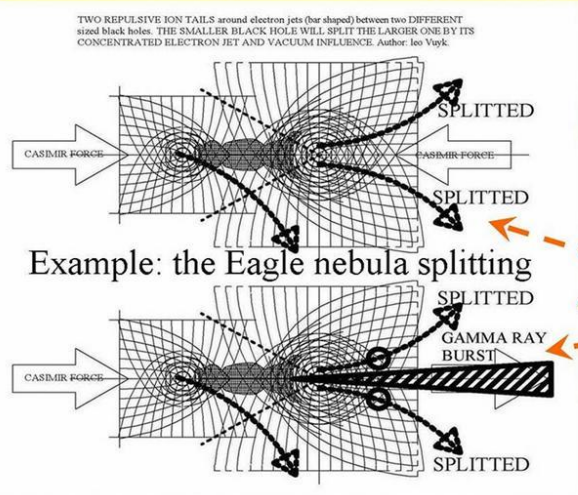

$$1.0 // 1.24 - 1.9?$$

$$2 \text{ LIGO ratios: } 29-36 / 7.5-14.2 \text{ sun} = 1.0 / 1.24 / 1.9$$

$$1.0 // 1.0$$

Herbig Haro creation ratio: 1x

$$\text{BH splitting ratio } 1.0 \gg 1.9 - ? - 50.0?$$

$$1.0 // > 50.0?$$

Small black holes should split larger BHs into two equal parts to create dual Herbig Haro hotspots also called bowshocks or accretion outburst sources.

Galaxy central BH Merger: $1.0 // > 50.0?$

Figure 10, Markarian 231 at a larger scale with triple- double lobed radio sources.

Quantum FFF Theory effects.

According to Quantum FFF Theory, early Galaxies have growing potential by the number and size of external primordial dark matter black holes initially formed as big bang splinters able to pair into Quasars with star forming galaxies in between the so coined “Galaxy Anchor Black Holes” (GABHs) The galaxies can merge with other galaxy-systems into complex spirals and elliptical OR produce complexity by the BH splitting (chopping) process. Irregular galaxies and Dwarf galaxies are supposed to be the result of secondary star forming interaction between GABHs.

After Supernova black hole production these smaller black holes are able to pair as hotspots or “bow shocks” into new Herbig Haro systems,.

If no galaxy merger candidates are available in the neighborhood, or no BH ratio differences are able to split larger BHs into two halves for HH systems, then galaxy will soon reach a maximum size and die. (dead galaxies: figure 16)

Also according to Quantum FFF (Function Follows Form) Theory, all star forming molecular clouds are the result of one or more Herbig Haro systems, equipped with so called dual hotspots which are assumed to be the result of dual new physics “electric dark matter black holes” in contrast with general accepted black hole theories. As a consequence there is a great misconception in mainstream Astronomical theories.

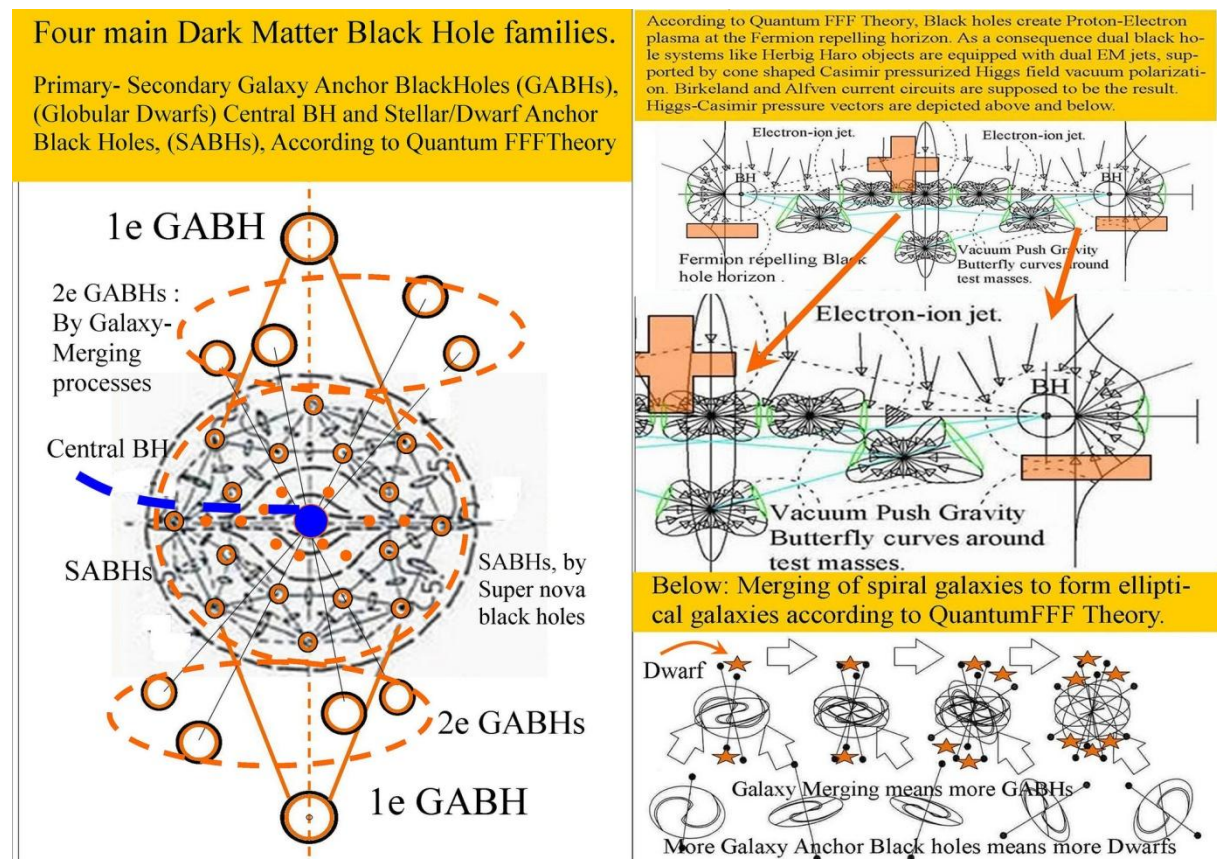
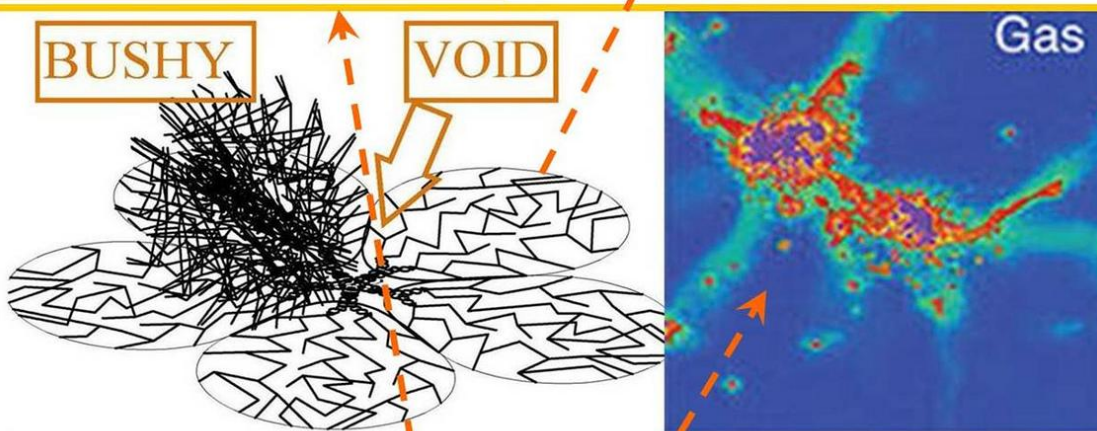
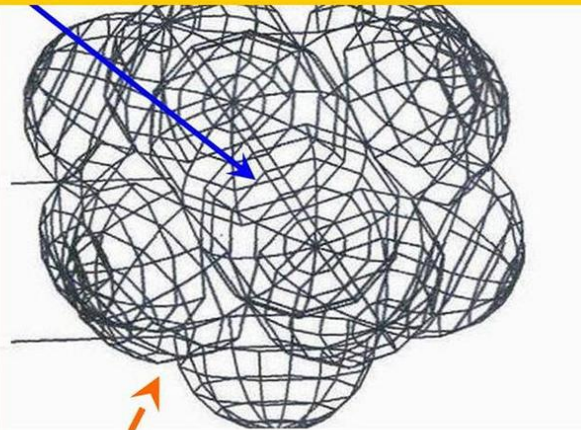

Figure 11, GABHs as the largest unit of Dark Matter black hole families

According to Quantum FFF Theory, the Big Bang can be described as the explosion of a giant Dark Matter Black Hole nucleus which is assumed to contain all the particles and smaller black hole nuclei of a former multiverse after a big crunch process.

How the symmetric Dark Matter Big Bang of the Raspberry Multiverse produced accelerating Big Bang Black Hole (BBBH) splinters in a fractal structure, forming dual Herbig Haro systems (HH) and the oscillating Higgs field by BH evaporation, according to Quantum FFF Theory.

Explanation of the numbers: 10, splitting Dark Matter BBBH splinter. 11, Higgs field pressure. 12, forward pressure area. 13, stable BH splinters. 14, Evaporating BH splinters. 15, Higgs BH gravity funnel. 16, Dual HH system formation. 17, Multiple HH system formation around the Higgs BH gravity funnel.



"Branched Inflation" of the Universe: the Origin of Fingers and Voids.

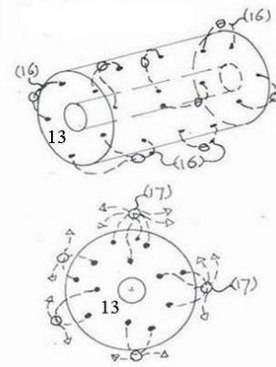
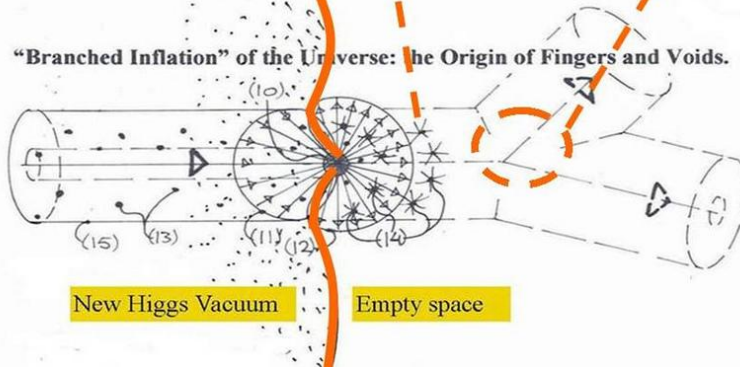

Figure 12 , BBBH , the Big Bang Black Hole splintering into smaller BHs and evaporating into the oscillating Axion Higgs Vacuum lattice .

The Big Bang Inflation epoch.

In contrast with the standard inflation model, in Q-FFF Theory, the inflation is described as the splitting and evaporation process of the Dark Matter Big Bang Black Hole Nucleus.

The splitting travelling process is also a pairing process into Herbig Haro systems forming stars and galaxies along the Lyman Alpha forest.

The evaporation process is assumed to be responsible for the evaporation of single Axion Higgs field particles from the BB nucleus, to form the self energetic oscillating Vacuum lattice. (fig 12)

The smaller exploded black hole splinters (fig 14, 15) are assumed to be responsible for the fractal

structure of the universe by splitting in succession into smaller nuclei to pair and form huge primordial Herbig Haro systems (Quasars) with star and later galaxy formation in the middle between

the stable paired equally sized hotspot black holes.

After supernova explosions of the large early giant stars, new black holes are formed which are supposed to be able to form smaller dual Herbig Haro systems by splitting processes.

By the ever reducing black hole nuclei als smaller star formation in between will be the standard process as a start for the internal structure of the spiral galaxy.

At the same time such a splitting and pairing process is assumed to happen at all scales in the current universe (entangled copy mirror multiverse) even down to molecular clouds and even inside Bok globules.

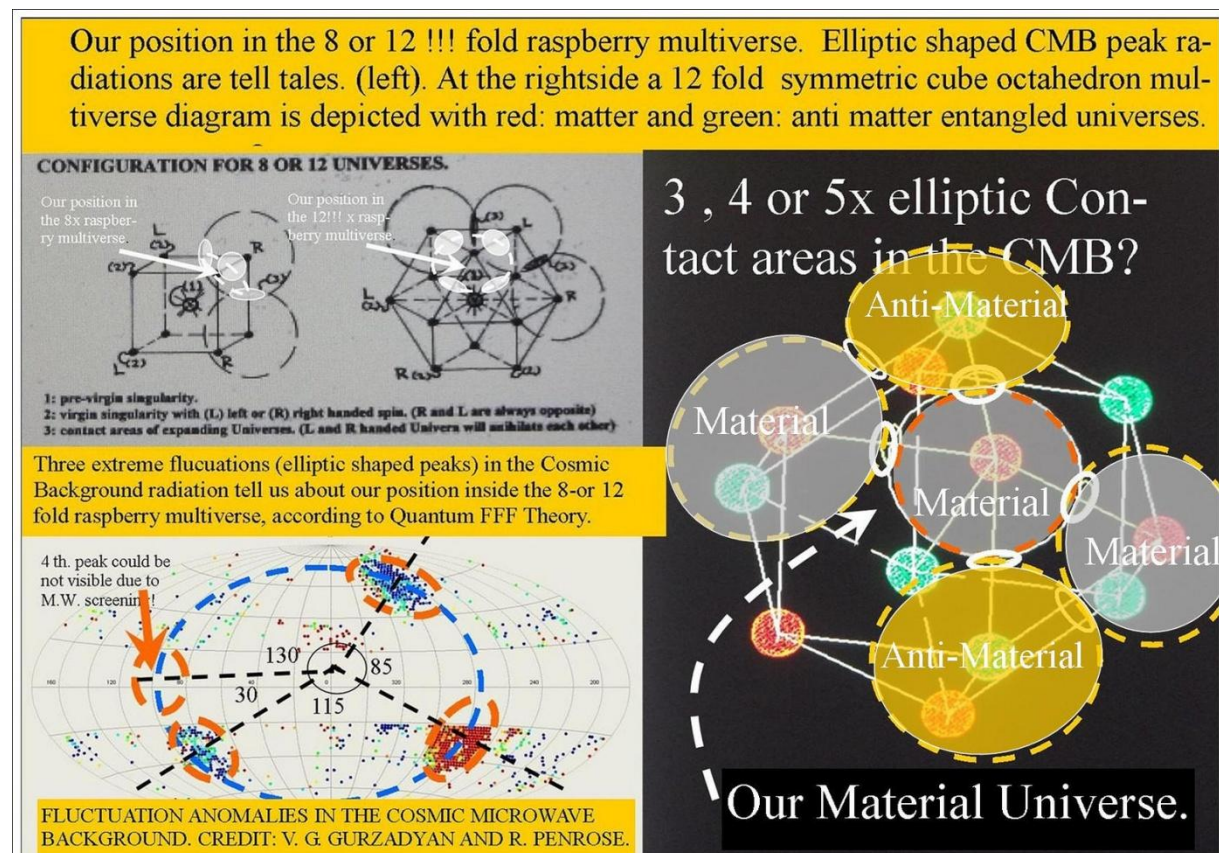
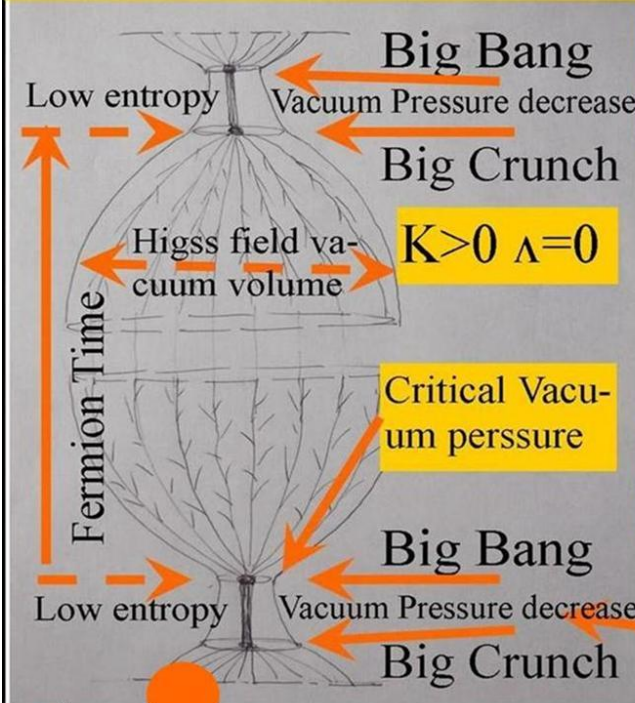

Figure13, The Multiverse with 8-12 Charge Parity (time) symmetric Universal bubbles.

Bouncing/ Cyclic Multiverse.

The Big Bang and Big Crunch originated by Black Hole splitting, pairing and recycling into massive growing central galaxy black holes, according to Quantum FFF Theory.



Below: The pairing and splitting primordial black holes as creators of spiral galaxies, able to merge and form elliptical galaxies, (like M87) equipped with a central growing black hole.

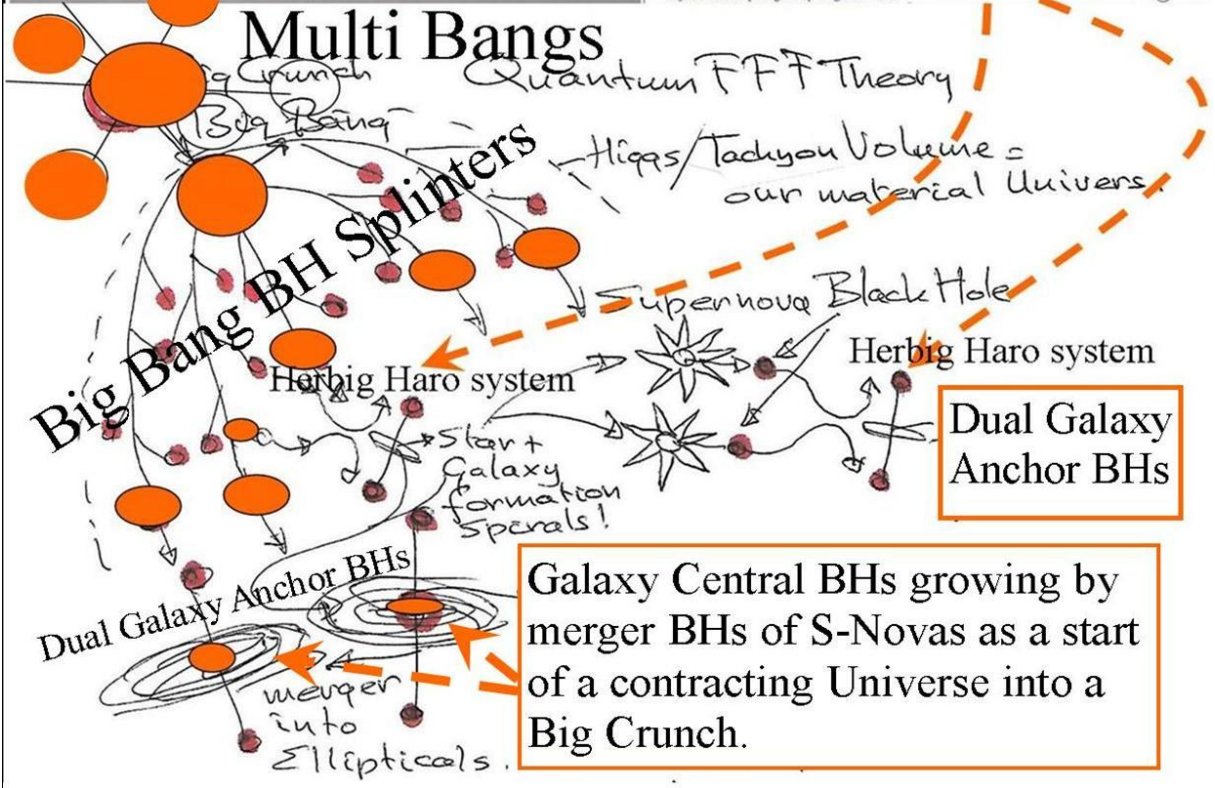
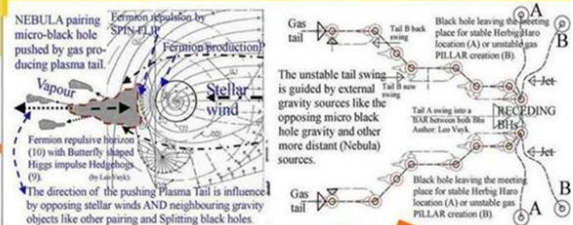
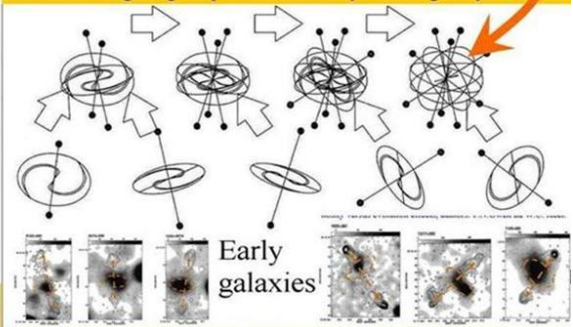
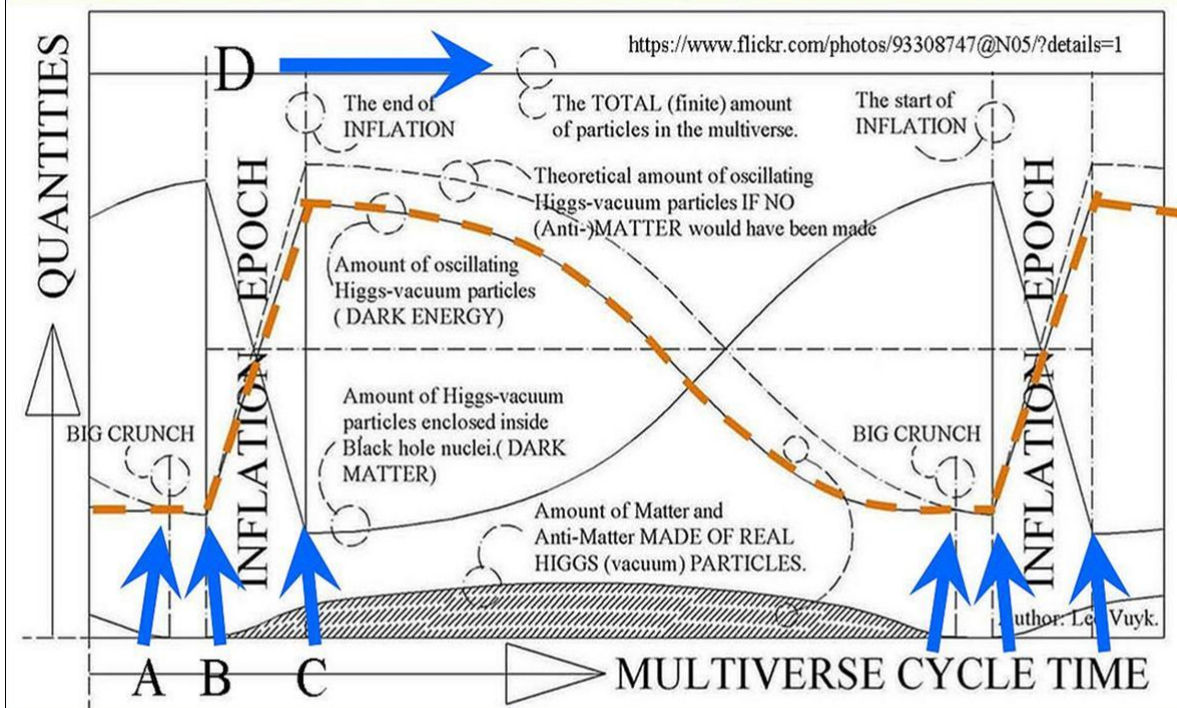

Figure 14, The Cyclic Multiverse.

The Beginning and End of Time.

Multiverse cycle time versus quantities of mass carrying particles, Dark Matter Black Hole particles and Dark Energy Oscillating Vacuum Lattice (Axion Higgs field) particles. All particles and fields are assumed to be based on rigid string particles. Negative and Positive charged Fermions should have propeller shapes with opposite pitch.



A: The end of matter based time. (Big Crunch) All rigid string matter is through merger Super Nova black holes concentrated into one BH nucleus, which is compressed by the remaining-but absorbing- deluting-dark energy vacuum. If the deluted vacuum pressure comes into equilibrium with the total internal string tension of the nucleus, the Big Bang BH splits symmetrical into 8 or 12 entangled BH nuclei.

B: The beginning of matter based time and the splitting of the Big Bang Black Hole string nucleus into series of minor secondary primordial BHs, building the fractal shaped Lyman Alpha Forest and the start of dual pairing BHs into primordial Herbig Haro systems with vast galaxy formation in between.

All New physics BHs (even micro interference BHs) are postulated to create not only pair production at the horizon, but even entire protons. (plasma)

C: The end of primary Big Bang black hole splitting and the end of vacuum expansion (vacuum inflation)

D: The Total number of particles during the cycle process is constant.

According to the Quantum Function Follows Form model.

Figure 15, The beginning and end of time, with an inflation era strongly differ from the standard model.

The origin of “dead” galaxies: Simple external dark matter black hole configuration



According to Quantum FFF Theory, Galaxies have maximum growing potential by the number and size of external primordial dark matter black holes formed as big bang splinters able to pair into primordial Quasars or Herbig Haro like galaxy systems, which can merge with others. If no galaxy merger candidates are available in the neighborhood, the galaxy will soon reach a maximum size and die. Some Elliptic galaxies die also by reaching maximum merger potential.

Figure 16, The origin of Dead galaxies.

The great misconception in Astronomy:

Herbig Haro Bowshocks and Cometary Globules, are not interpreted as Dark Matter Black Holes. See below: Bok- and Cometary Globules with young Herbig Haro Bowshocks in the making in the Carina nebula.

Splitting and pairing electric dark matter black holes. Magic self-propelling in space and even on earth according to Quantum FFF theory.

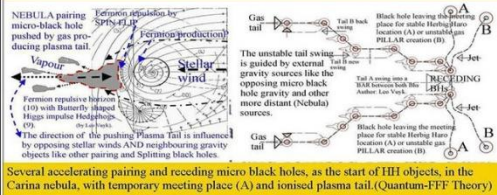

Several accelerating pairing and receding micro black holes, as the start of HH objects, in the Carina nebula, with temporary meeting place (A) and ionised plasma tail. (Quantum-FFF Theory)



The pairing and splitting of Electric Dark Matter Black Holes into dual Herbig Haro bowshocks, as the fast creation and proliferation of Stars and galaxies after the splitting bigbang.

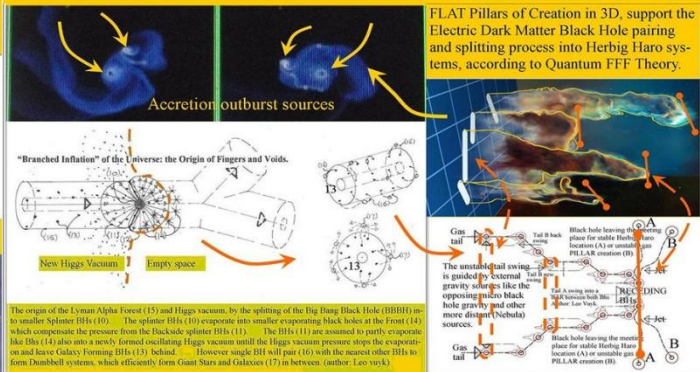

The origin of the Lyman Alpha Forest (15) and Higgs vacuum, by the splitting of the Big Bang Black Hole (BBBH) into smaller Splinter BHs (10). The splinter BHs (10) evaporate into smaller evaporating black holes at the Frost (14) which compresses the pressure from the back-side splinter BHs (11). The BHs (11) are assumed to partly evaporate like BHs (14) also into a newly formed oscillating Higgs vacuum until the Higgs vacuum pressure stops the evaporation and leaves Galaxy Forming BHs (13) behind. However single BH will pair (16) with the nearest other BHs to form Dumbbell systems, which efficiently form Giant Stars and Galaxies (17) in between. (author: Leo York)



Figure 17, The great misconception in astronomy.

Giant galaxies die from the inside out: Star formation shuts down in the centers of elliptical galaxies first.

According to Quantum FFF Theory, Galaxy- and Cluster black hole hierarchy is the origin of dying galaxies where star formation in the center stops. X-ray point sources (Dark matter black holes) in Virgo and Perseus cluster centers present evidence for black hole hierarchy: the smallest BHs are located in the centers and are not any more able to create Supernova black holes large enough to form Herbig Haro systems with star formation in between. The result: Dying "red and dead" galaxies as the start of Universal contraction and collapse (Big Crunch) in a cyclic multiverse.

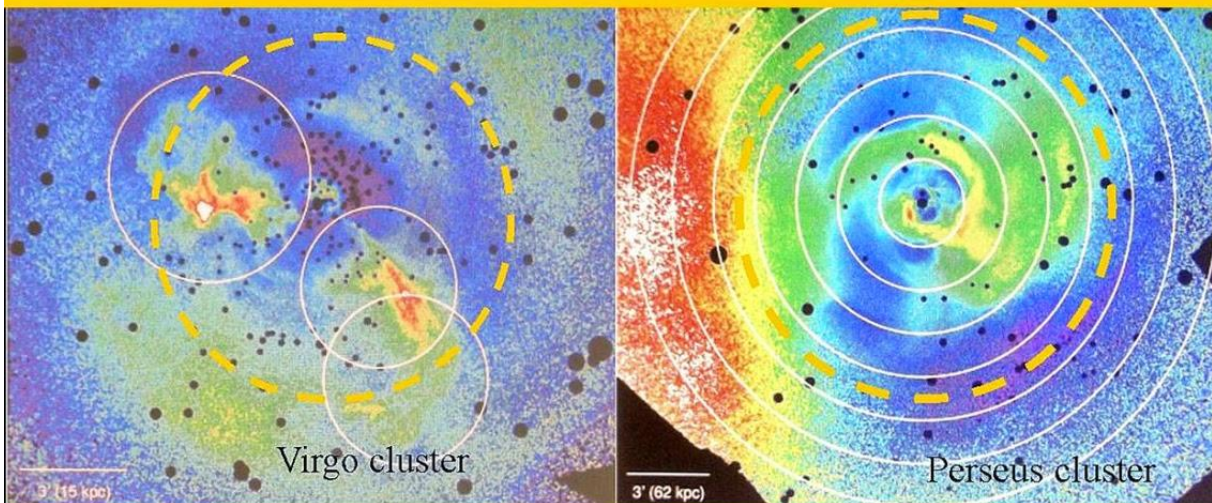

Below: Example of the galaxy black hole hierarchy model observed at Andromeda (M31 below left) and the Sombrero galaxy (M104 right).

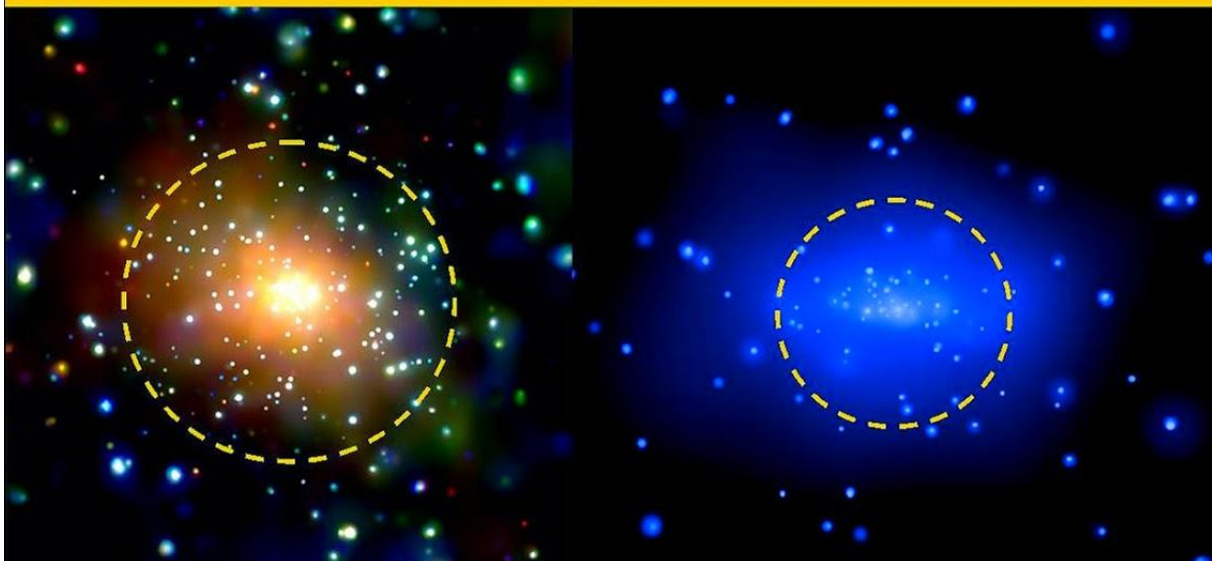

Figure18, Star formation seem to shut down in the center of galaxies.

SABH cosmic ray hotspots (electric dark matter black holes) as the origin and future slingshot accelerators of Brown Dwarfs expelled by the sun.

New giant gas planets expelled by the sun, moving away to the south, into the direction of the Southern cross SABH hotspot.

A hotspot for powerful cosmic rays found under the Big Dipper, by the University of Utah. The mysterious source of cosmic rays is also reason to look at the southern hemisphere to observe the opposing second Stellar Anchor Black Hole (SABH) (Cosmic ray production by NEW black hole paradigm according to Quantum-FFF Theory).



Dates 10Jan.2014 (below) and 11March.2012 (above). "Brown Dwarfs ?" according to Q-FFF .

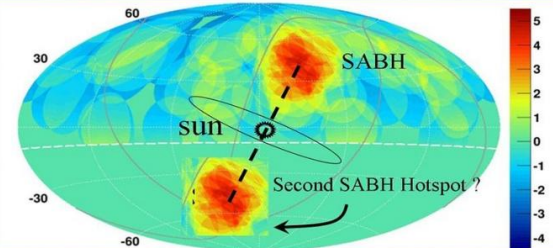

According to Quantum FFF Theory, "New Black Holes produce Proton-Electron plasma. By the strong Casimir vacuum push gravity on the BH, the "Lighter" electrons will stay outside the "heavier" proton horizon (blue). As a consequence BHs have a strong electric potential, which is liberated by asymmetric processes in dual BH systems like Herbig Haro objects showing strong electro magnetic effects in open cluster star formation and Birkeland Alfvén circuits around the earth and even in the so called BICEP 2 results.

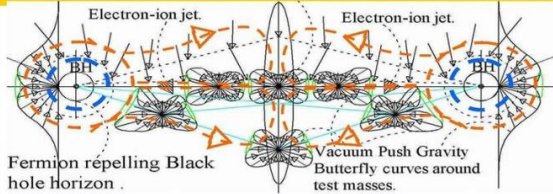

Scheme of the electric SABH principle around the sun.

Figure 19, Even the sun seems to have polar dual black hole Herbig Haro remnants and is able to produce and expel gas planets (failed stars) at this age.

Equivalence between gravity and acceleration does not hold in Quantum FFF Theory. Mass in motion needs a reference frame of ZPE oscillating Higgs field and Lorentz polarization of conscious propeller Fermions (s) to keep a non accelerated flight.

Quantum Gravity as pressure distribution of the oscillating dual Higgs/Graviton vector field.

Polarized Fermion Mass in motion through the resistive, but also pushing oscillating Higgs vacuum (according to Quantum FFF theory)

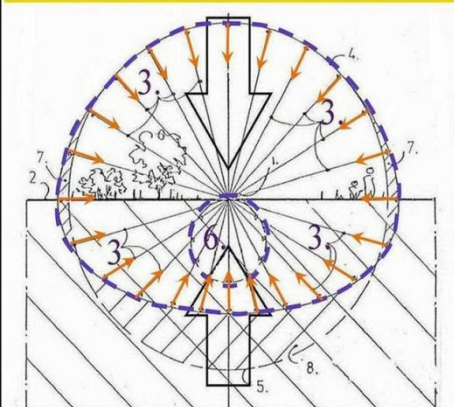

Cross section through the dual Higgs/Graviton 3D vector field pressure distribution (or globular Hedgehog) on a point mass (1) located on earth's surface (2), according to Quantum FFF theory. 3+4= Higgs vector field. 6= Graviton vector field originated by the Higgs-graviton field transformation of the earth itself. 7+8= differences with a perfect globular vector distribution. Field variables 3+6 are rendered as inversed arrows. (see also black hole pressure distribution without gravitons)

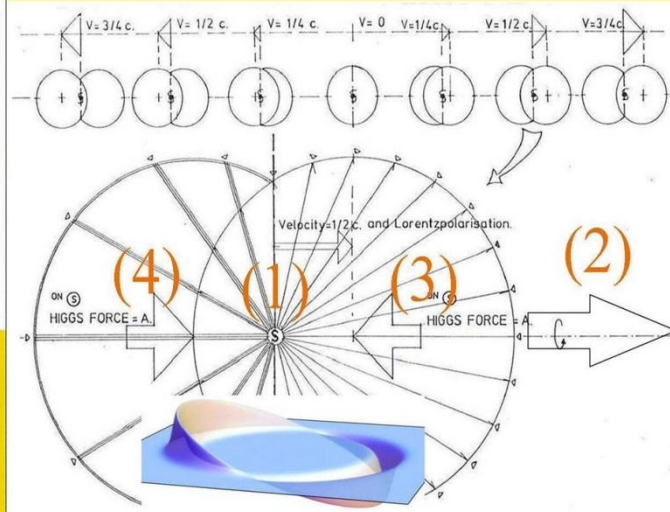

Figure 20, Quantum Gravity and Mass in motion. (Quantum FFF Theory)

Lorentz Fitzgerald Contraction is real!

A real Lorentz Fitzgerald contraction does not fit into Einsteins Special Relativity. However recent findings of atomic nucleons polarized into one fixed spacetime direction should tell us differently.

Polarized Fermions (Nuclear Quarks) as the origin of non accelerated motion through the resistive oscillating vacuum Higgs field.

Pear shaped atomic nuclei is reason to assume John Bell was right! With Lorentz contraction in special relativity.

Polarized Fermion Mass in motion through the resistive, but also pushing oscillating Higgs vacuum (according to Quantum FFF theory)

Nucleon polarisation based on Fermion (Quark) propeller polarisation

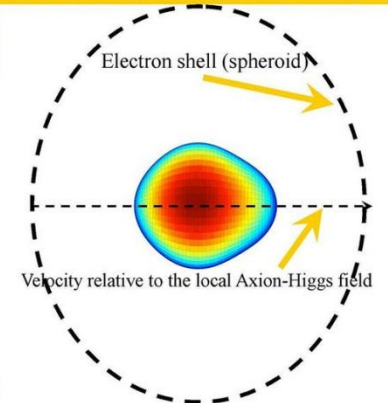
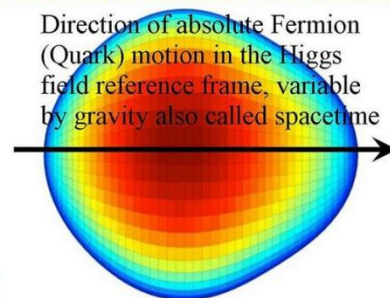
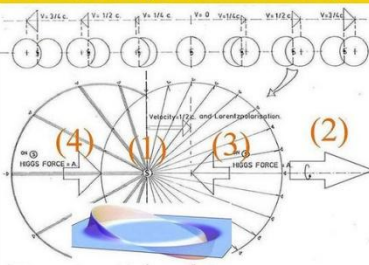

Cross section through the 3D vector field pressure distribution on a Fermion point mass (1). Propeller shaped spinning Fermions are supposed to be Polarized into the direction of flight through the vacuum lattice (2). As a result, the resistive vacuum Higgs force (3) is compensated by the Higgs Pushing force (4) from the "backside" of the Fermion. However every Fermion need to have polarization memory consciouness. (by a multi universal entanglement system see: Quantum-FFF theory)

Polarized nucleons found by B. Bucher et al. (LHC Geneva) see:<https://arxiv.org/pdf/1602.01485v1.pdf>

The atom nucleus is an ellipsoid with elongated central axis. The electron shell is a spheroid with shortened central axis, according to the Quantum FFF Model.

Figure 21, Lorentz Fitzgerald contraction is real (John Bell)

Pear Shaped Nucleons, as the result of non-accelerated motion through the massless but resistive oscillating Axion-Higgs field vacuum.

Polarized Fermion Mass in motion through the resistive, but also pushing oscillating Higgs vacuum (according to Quantum FFF theory)

Nucleon polarisation based on Fermion (Quark) propeller polarisation

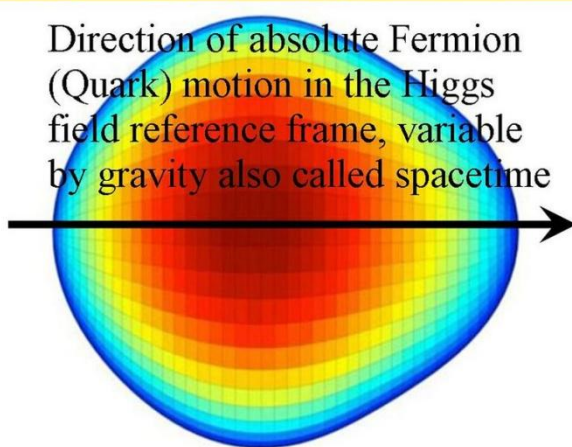
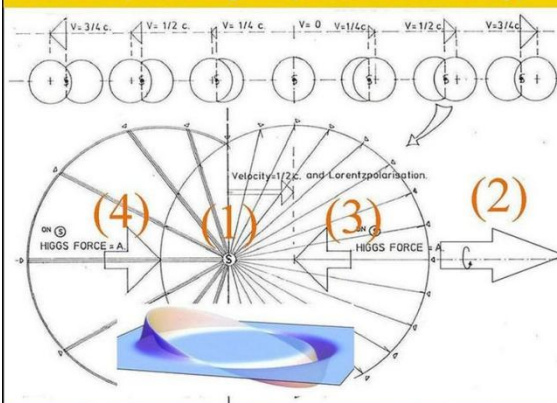

Cross section through the 3D vector field pressure distribution on a Fermion point mass (1). Propeller shaped spinning Fermions are supposed to be Polarized into the direction of flight through the vacuum lattice (2). As a result, the resistive vacuum Higgs force (3) is compensated by the Higgs Pushing force (4) from the "backside" of the Fermion. However every Fermion need to have polarization memory consciouness. (by a multi universal entanglement system see: Quantum-FFF theory)

Polarized nucleons found by B. Bucher et al. (LHC Geneva) see:<https://arxiv.org/pdf/1602.01485v1.pdf>

Figure 22, Lorentz Fitzgerald contraction by nucleon pear shaping.

Why 125 GeV Higgs does not decay via 2x bosons into 2x Taus and 2x Bottom quarks? (see: Lubos Motl)

According to the Quantum FFF Model, 2x Taus and 2x Bottom quarks together need 10x electron/positron propellers (silver colored, see at the bottom below) .

Light Higgses seem to decay into: (aa) 2x bosons containing 4x or 6x or possibly for ZZ bosons even 8x electron positron propellers.



Z Boson= 2x



W Boson= 3x



ZZ Bosons= 4x



See below counting silver particles: 4x Taus = 8x elements, 2x Muon with 2x Taus = 6x. 2x Muon with 2x Bottom = 8x.!



6x Leptons Electron Muon Tau



6x BOTTOM quarks

Figure 23, Some examples of 3D particle structures according to Quantum FFF Theory.

Quantum Dipole Repeller Gravity pushing our Galaxy.

According to Quantum FFF Theory, empty space is filled with a fast oscillating lattice of massless Axion-Higgs field particles as a half base for our opposing dipole pressure Higgs-graviton gravity on earth. Now prof. Yehuda Hoffman shows us a support for this hypothesis.

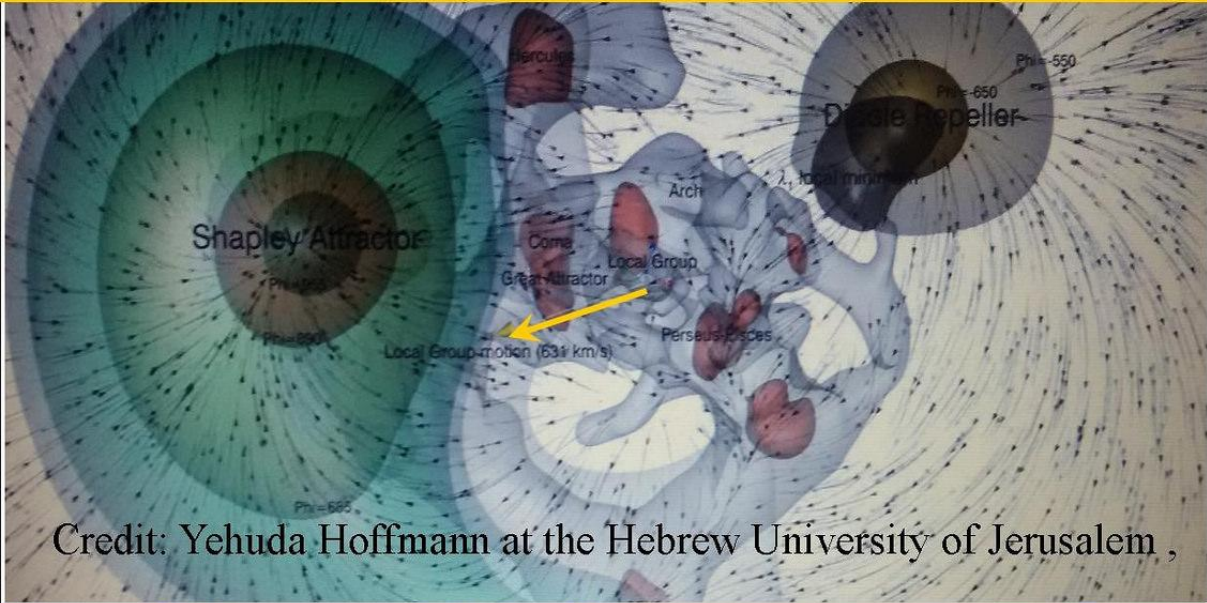

Credit: Yehuda Hoffmann at the Hebrew University of Jerusalem ,

Quantum Gravity as pressure distribution of the oscillating dual Higgs/Graviton vector field.

New Dark Matter Black Hole, "Eat" the chiral oscillating Higgs vacuum.(Quantum-FFF Theory)

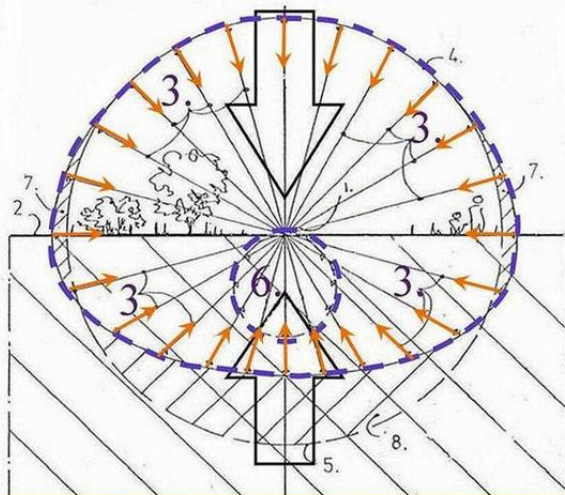

Cross section through the dual Higgs/ Graviton 3D vector field pressure distribution (or globular Hedgehog) on a point mass (1) located on earth's surface (2), according to Quantum FFF theory. 3+4= Higgs vector field. 6= Graviton vector field originated by the Higgs-graviton field transformation of the earth itself. 7+8= differences with a perfect globular vector distribution. Field variables 3+6 are rendered as inversed arrows. (see also black hole pressure distribution without gravitons)

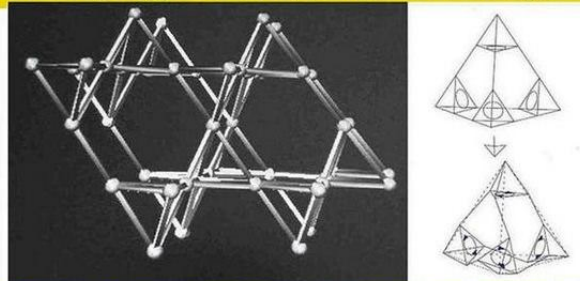

Simplified tetrahedral vacuum lattice structure (left), constructed by complex chiral tetrahedral building blocks (right). Each universe has to choose between a left- or righthanded rotation of its tetrahedral building blocks. Each chiral lattice has the Planck length and is supposed to be equipped with at least two oscillating massless new Higgs particles.

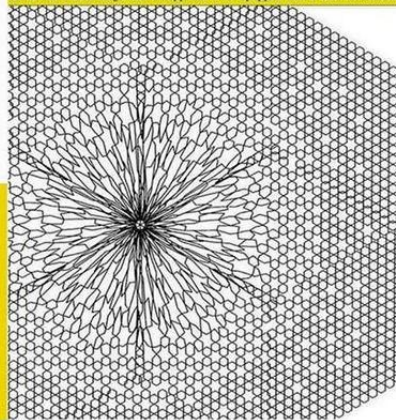

Black holes EAT the vacuum lattice with the oscillating Higgs particles. So, the vacuum lattice structure around a black hole could be represented like this. As a result, the near vacuum is thinner or diluted, it has holes, which could be the origin of the Universal HUBBLE redshift. By contrast, my new black hole paradigm says: the origin of universal redshift is Dark matter. Dark matter is the proliferation of vast numbers of Black holes around Galaxies. Conclusion, based on Hubble redshift, we don't know anything about expansion or contraction of the universe. (Author Leo Vuyk)

Figure 24, Quantum dipole repeller gravity (the oscillating Casimir vacuum) combined with less pressure from pushing gravitons.

Feynman Diagrams for Dipole Repeller Forces

Attraction and Repulsion forces created by Dipole Repeller effects between the Higgs Field vacuum (OOO) and 5x opposing Photons. (UOU, ROU, LOU, ROR, LOL)

According to Quantum FFF Theory.

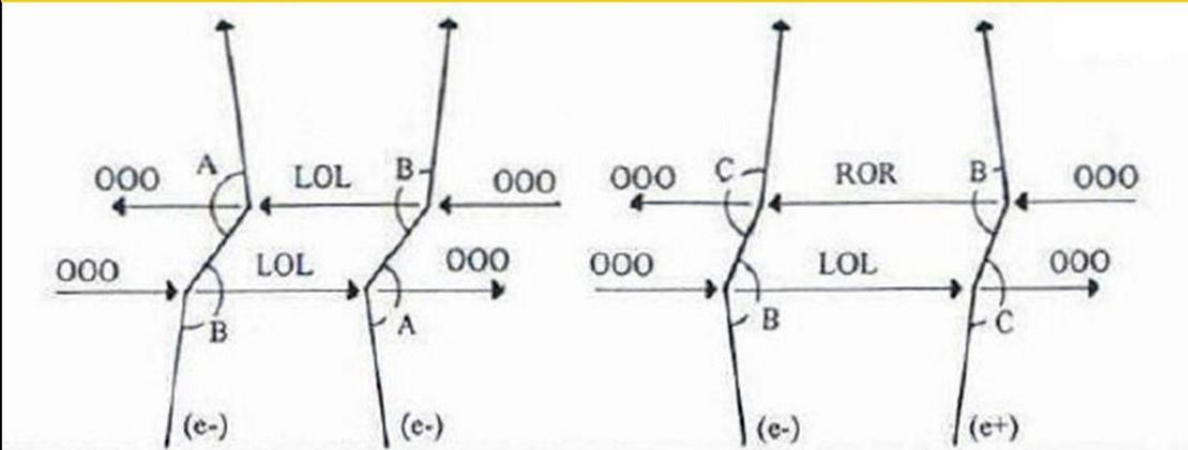

(Above) Alternative Feynman diagrams for electron-positron attraction and electron– electron repulsion by Dipole Repeller system.

- Explanation of the codes:
 U= Up rotation (180 degrees)
 O= Unchanged circle.
 L= Left rotation (90 degrees)
 R= Right rotation (90 degrees)

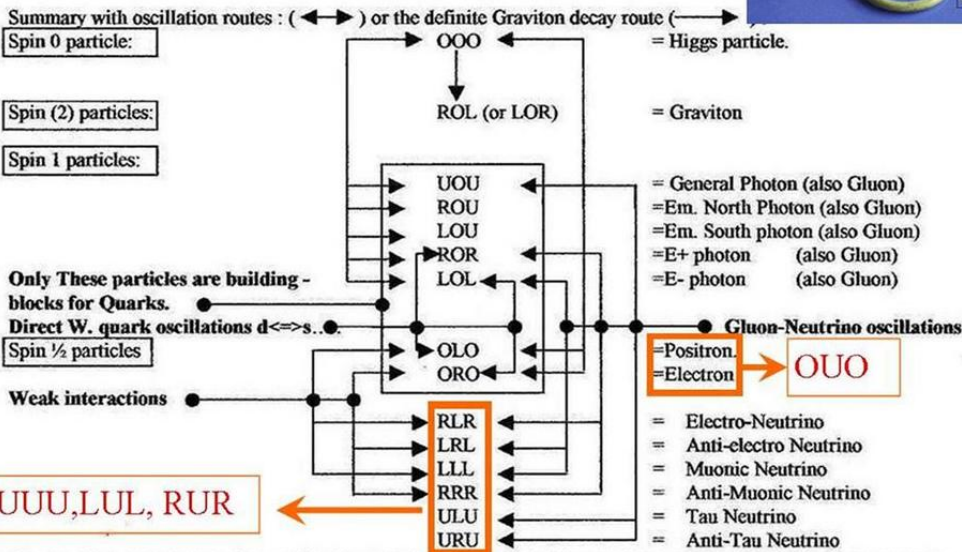
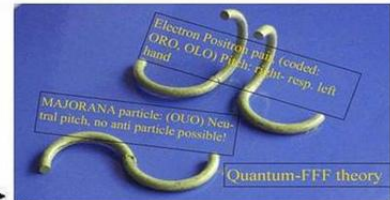
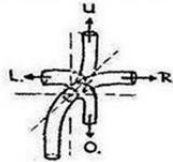

Higgs particles are supposed to oscillate in Tandem along so called linear Vacuum Lattices, two by two in opposite directions, as the symmetrical opposite pistons of a boxer engine, as the origin of all energy, spin and mass effects. This enables the Tandem Higgs particles to change the form of their own Torus into an Electron and Positron pair at

Figure 25.

QUANTUM FFF THEORY.

According to Quantum FFF Theory, (Function Follows Form) the FORM and microstructure of elementary particles, is supposed to be the origin of FUNCTIONAL differences between HiggsGraviton- Photon- and Fermion particles.

As a result, a NEW paradigm of splitting-,accelerating- and pairing Black Hole seems to be able to accelerate itself by a -Zero Point Energy driven-self created plasma tails (by a new Quantum Fluctuation process), to form dumbbell systems, of two or even more black holes. Inside Nebula these dumbbell systems are called Herbig Haro systems.

I think that Stephen Hawking did not calculate with the possibility of a chiral oscillating Higgs field vacuum lattice combined with propeller shaped Fermions. Then, due to Vacuum Chirality, Electron- and Positron propellers could both pushed away from the BH horizon after

spin flip polarization at different distances, forming two charged separated spheres. With quark (plasma) formation in between.

Based on such a simple object (propeller and process) oriented ontology, Black Holes could be imagined as charge splitters violating the 2e law af thermodynamics, combined with a continuous microscopic big bang plasma creation process!

The result I try to describe :

1: Black holes are the same as Dark Matter, they all consume photons, even gravitons and the Higgs field, but REPEL Fermions due to their propeller shape. They produce electric charged plasma.

2: Dark Energy is the oscillating (Casimir) energy of the Higgs Field equipped with a tetrahedron lattice structure with variable Planck length..

3: Quantum Gravity = Dual Push gravity= Attraction (Higgs-Casimir opposing Graviton push).

4: The Big Bang is a Splitting dark matter Big Bang Black Hole (BBBH), splitting into smaller Primordial Big Bang Spinters (PBBS) forming the Fractal Lyman Alpha forest and evaporating partly into a zero mass energetic oscillating Higgs particle based Higgs field.

5: Dual PBBSs hotspots, produce central plasma concentration in electric Herbig Haro systems as a base for star formation in open star clusters as a start for Spiral Galaxies.

6: Spiral Galaxies will keep both Primordial Dark Matter Black Holes as Galaxy Anchor Black Holes (GABHs) at long distance.

7: After Galaxy Merging, these GABHs are the origin of Galaxy- and Magnetic field complexity and distant dwarf galaxies .

8: Black Holes produce Plasma direct out of the Higgs field because two Higgs particles are convertible into symmetric electron and positron (or even dual quark-) propellers (by BH horizon fluctuations).

9: The chirality of the (spiraling) vacuum lattice is the origin our material universe. (propeller shaped positrons merge preferentially first with gluons to form (u) Quarks to form Hydrogen.

10: The first Supernovas produce medium sized Black Holes as the base for secondary Herbig Haro systems and open star clusters.

11: ALL Dark Matter Black Holes are supposed to be charge separators with internal positive charge and an external globular shell of negative charged Quark electron plasma.

12: The lightspeed is related to gravity fields like the earth with long extinction distances to

adapt with the solar gravity field.

13. Quantum FFF Theory states that the raspberry shaped multiverse is symmetric and instant entangled down to the smallest quantum level. Also down to living and dying CATS in BOXES.

14 Large Primordial Big Bang Spinters (PBBS) are responsible for the creation of the Lyman Alpha forest structure and first spiral galaxy forming of the universe, but they seem to be also responsible for the implosion of the universe at the end in the form of Galaxy Anchor Black Holes (GABHs) located mainly outside galaxies. see: (Quasisoft Chandra sources)

15, As a consequence of 12-14, Time is always local time in combination with cyclic period time of the multiverse.

16, If our material universes has a chiral left handed oscillating Higgs field, then our material Right Handed DNA helix molecule could be explained. However it also suggests that in our opposing symmetric anti-material entangled neighbor universe the DNA helix should have a Left handed spiral.

According to Max Tegmark: in an entangled multiverse we may ask: is there COPY PERSON over there, who is reading the same lines as I do? If this copy person is indeed living over there, then even our consciousness should be shared in a sort of entangled democratic form. Then we are not alone with our thoughts and doubts, see: Democratic Free Will in the instant Entangled Multiverse.

17, All particles and waves should be entangled with anti-copy particles and Higgs field based waves in our opposing anti universes. Then wave particle duality and the so called one particle double slit interference could be explained by accepting that real shaped 3D photon particles only exist in their function of Gluons. However Gluons should transfer form information to the oscillating luminiferous Higgs field ether, within about 1 cm distance from a fermion.(see: Babock and Bergman anomaly,1964)

18, Different elementary particles have different qualities by their different complex stringy shape. Leptons and Quarks have a propeller shape with left or right handed pitch creating charge difference. Gluons, Photons and Neutrino particles have no pitch.

20 All particles can be converted to one or more Higgs particles, Lepto Quarks can be compound particles.

21 All particles are assumed to be present as Higgs particles already in the cyclic Big Bang Black Hole (BBBH) after the former multiverse has collapsed into a Big Crunch Black Hole.

22, We seem to live inside one material universal bubble of an instant entangled (Charge Parity Time) CPT symmetric raspberry bubble multiverse. Each quantum jump or wave function collapse or human choice is guided by this instant entanglement at long distant.

If our material universes has a chiral oscillating Higgs field, then our material Right Handed DNA helix molecule could be explained. However it also suggests that in our opposing Anti materialmultiverse neighbour universe the DNA helix should have a left handed spiral.

According to Max Tegmark: in an entangled multiverse we may ask: is

There copy pesron over there, who is reading the same lines as I do? If this copy person is indeed living over there, then even our consciousness should be shared in a sort of democratic form,

References:

- Books: The New God Particle and Free Will. Author: Leo Vuyk, LuLu publishers, 2008. ISBN number 978-1-4092-1031-3 <http://www.lulu.com/spotlight/LeoVuyk>
Quantum FFF Theory is also published in the form of POSTERS at the Flickr site: <http://www.flickr.com/photos/93308747@N05/>
Numbered listing (latest) of Vixra essays by Leo Vuyk. http://vixra.org/author/leo_vuyk
- [81] viXra:1704.0272 Interference Black Holes, Ball Lightning, Micro Comets, Sprite Fireballs and Sunspots According to Quantum FFF Theory.
- [80] viXra:1704.0150 The Origin of Life and the Need for a Rigid String Propeller Fermion Model Combined with a Chiral Vacuum Lattice and Micro Interference Black Holes
- [79] viXra:1704.0133 2. Signals for Retarded Single Big Bang Black Hole Nucleus Splitting and Pairing into Dual Black Hole Herbig Haro Systems
- [78] viXra:1704.0047 Bohmian Double Slit Interpretation by Dual Entangled Universes, and the Benjamin Libet Experiment.
- [77] viXra:1704.0003 A Testable CP Symmetric Multiverse Model by Extended Experiments, Done by the Late Benjamin Libet in 1964.
- [76] viXra:1702.0109 CP Symmetry Between Material and Anti Material Copy Universes Combined with Local- and Multi-Universal Cycle Time.
- [75] viXra:1702.0040 The Alternative Origin of Hubble Redshift : Vacuum Absorption by black holes as a Support for Quantum Dipole Repeller Gravity and a Contracting Universe.
- [74] viXra:1701.0633 Local and Multi-Universal Cycle Time According to Quantum FFF Theory. (FFF= Function Follows Form)
- [73] viXra:1612.0365 John S. Bell Was Right: “How to Teach Special Relativity” and Atomic Pear Shaped Contraction.
- [72] viXra:1612.0026 Democratic Free Will and Telepathy in the Instant Entangled
- [71] viXra:1611.0226 Galaxy Cluster Merging and Vacuum Absorption by black holes as a Support for Quantum Dipole Repeller Gravity and a Contracting Universe.
- [70] viXra:1611.0101 Observed Dual Higgs Mass 124-126 Gev and the Chirality of the Vacuum Lattice.
- [69] viXra:1611.0031 Rigid String Cosmology with a Massless Axion-Higgs Oscillating Photon Vacuum Lattice and Massive Quantum Knots.
- [68] viXra:1611.0005 Electric Dark Matter Black Holes in the Moon (Orientale Basin)
- [67] viXra:1609.0407 New Physics Elements in the Quantum Function Follows Form Model.
- [66] viXra:1608.0329 God Seems to Play Dice with Dual Entangled Pinball Machines in a Super symmetric (Susy) Multiverse
- [65] viXra:1607.0376 Axion-Higgs 3-Dimensional Rigid Transformable Strings and the Compound 650 GeV Z-Z Decay into Quarks/Lepto quarks.
- [64] viXra:1605.0257 Reaction Less Drive by Anti Maxwell Dead Zone Around a Wire.
- [63] viXra:1604.0372 Herbig Haro Hotspots or Bow shocks Are the Origin of Star Formation, not the Result as the Mainstream Suggest.
- [62] viXra:1604.0229 $E_r = epr$ in the Super symmetric Cyclic Multiverse and in the Lab Without Strange Cats.
- [59] viXra:1505.0101 The Origin of Bok Globules and Molecular Clouds, Splitting and

Pairing Electric Dark Matter Black Holes.

[58] viXra:1503.0186 Primordial Dark Matter Black Holes Outside Galaxies Responsible for the Creation and Contraction of a Cyclic Universe? 22

[57] viXra:1503.0097 Quantum FFF Theory, Poster News 4.2

[56] viXra:1502.0086 Parity and Chirality as a Base for Quark-Gluon Plasma and Dust Creating Black Holes and the Beginning and End of Time..

[55] viXra:1411.0039 Quantum FFF Theory, Poster News 2

[54] viXra:1410.0039 Evidence for Dark Matter Black Hole Based Plasma, Dust and Ice Production Inside Comets Like 67P,C-G. and the Growing Earth.

[53] viXra:1409.0164 The O'Connell Effect in Eclipsing Binaries Explained by Mass Related Light Speed Extinction Distances (Lasof) of Stars and Even Planets.

[52] viXra:1407.0001 Evidence for Evaporating Dark Matter Particles in Silicon Fireballs.

[51] viXra:1406.0076 Galaxy Formation and Evolution According to Quantum FFF Theory.

[50] viXra:1406.0019 Quantum FFF Theory Proposals for Some Unsolved Physics Problems.

[49] viXra:1405.0224 Dual Star Ejection in Open Star Clusters by the Central Star.

[48] viXra:1404.0151 Future Free Energy of New Physics Ball Lightning Black Holes, the Origin of a Super Social Society or the Opposite?

[47] viXra:1404.0002 Proposal for the Origin of Unexpected Large B-Modes Found in the Bicep2 Measurements.

[46] viXra:1402.0132 Reconciliation of GR and QM by a New Gravity-Black Hole and Lightspeed Model Called Quantum- FFF Theory.

[45] viXra:1402.0044 The Impossible Zero Point Electric Black Hole as the Origin of New Physics even for Comets like 67P,C-G.

[44] viXra:1401.0115 Calabi Yau Shaped Double Fermion Spin States.

[43] viXra:1401.0071 Democratic Free Will in the Instant Entangled Multiverse.

[42] viXra:1312.0143 The Navel Cord Multiverse with Raspberry Shape, a Super Symmetric Entangled 12 Fold Bubble Universe.

[41] viXra:1312.0076 Are Sunspots Made of Gravitating Dark Matter Black Holes?

[40] viXra:1310.0101 The New Nuclear Magic Number (34) Explained by the Polar Coaxial Ring System of Quantum FFF Theory.

[39] viXra:1310.0059 The Semi Relativistic Higgs Field Aether with Mass Related Lightspeed Adaptation.

[38] viXra:1309.0081 New Physics by Table Top Experiments.

[37] viXra:1308.0083 23 The Raspberry Shaped Super Symmetric Multiverse

[36] viXra:1307.0068 Quantum Function Follows Form Theory, the Small Scale, Posters part 1.

[35] viXra:1307.0067 Quantum Function Follows Form Theory, the Large Scale, Posters part 2.

[34] viXra:1306.0218) Dark Matter UFO Dust Particles or Quantum Knots in the LHC at CERN ?

33, viXra:1306.0065 The Splitting Dark Matter- Black Hole- Big Bang and the Cyclic Multiverse.

32, viXra:1305.0140 Quantum FFF Theory Experiments, a Summary.

31, viXra:1305.0041 The Shnoll Effect Explained by Quantum FFF Theory.

30, viXra:1304.0022 The Self Organizing Universe in the Carina Nebula.

29, viXra:1303.0211 Hubble Redshift Combined with Universal Contraction is Possible.

28, viXra:1303.0053 Micro Birkeland Currents Between Two RF Generated Plasma Balls in the Laboratory.

27, viXra:1302.0172 Silicon Based Ball Lightning Globule Structures and Signs for Accumulation and Retarded Decrease of Tunneling Energy Bullets.

- 26, viXra:1301.0088 Two or Three Large Quasar Groups (LQGs) Located at the Start of Two or Three Lyman Alpha Systems and a Part of the Raspberry Multiverse?
 - 25, viXra:1301.0050 Dwarf Galaxies and Their Relation with Dark Matter Based Galaxy Anchor Black Holes (Gabhs).
 - 24, viXra:1210.0177 Instant Broglie Bohm Pilot Waves, the Origin of All Entanglement Effects in the Lab and Wavefunction Collapses in Our Universe as Related to Our Opposing Anti-Copy Universe(s) According to Quantum FFF Theory.
 - 23, viXra:1209.0092 New Dark Matter Black Holes and a New Dark Energy Higgs Field, Lead to a Bouncing CP Symmetrical Multiverse, and New Experiments.
 - 22, viXra:1209.0061 Birkeland Currents, Sunspots, Comets and Ball Lightning Originated by New Paradigm Dark Matter Black Holes.
 - 21, viXra:1209.0030 Majorana and Sterile Neutrino Solutions in the Quantum-FFF Model.
 - 20, viXra:1208.0031 Clumpy Dark Matter Around Dwarf Galaxies a Support for an Alternative Black Hole Theory According to the Quantum Function Follows Form Model.
 - 19, viXra:1202.0091 Earth Magnetic Monopole Array Field Interaction with Cyclotron – Synchrotron Electrons and Muon Conversion Used for Levitation Systems.
 - 18, viXra:1201.0092 Earth Magnetic Monopole Array Field Interaction with Cyclotron Electrons used for Levitation Systems.
 - 17, viXra:1112.0065 24 LHC Signals Between 121-130 GeV Interpreted with Quantum-FFF Theory
 - 16, viXra:1111.0096 Reconciliation of QM and GR and the Need for a Pulsating Entangled CPT Symmetric Raspberry Shaped Multiverse.
 - 15, viXra:1111.0061 Black Hole Horizon Curvature Dependent Balance Between Plasma Creation and e-e+ Annihilation in Quantum FFF Theory.
 - 14, viXra:1108.0036 Artificial Ball Lightning Production and Exploitation Device for Zero Point Electric Energy Usage.
 - 13, viXra:1108.0006 Mass in Motion in Quantum FFF Theory
 - 12, viXra:1104.0083 Quantum FFF Theory in Posters.
 - 11, viXra:1104.0044 Ball Lightning, Micro Comets, Sprite-Fireballs and X-Ray/gamma Flashes According to Quantum FFF Theory.
 - 10, viXra:1104.0002 Stellar Anchor Black Holes as the Remnants of Former Herbig Haro Objects
 - 9, viXra:1103.0097 ZPE Zero Point Energy Examples Around Black Holes.
 - 8, viXra:1103.0068 Function Follows Form, at the Quantum Scale and Beyond.
 - 7, viXra:1103.0024 Quantum Gravity and Electro Magnetic Forces in FFF Theory
 - 6, viXra:1103.0015 Wavefunction Collapse and Human Choice-Making Inside an Entangled Mirror Symmetrical Multiverse.
 - 5, viXra:1103.0011 An Alternative Black Hole, Provided with Entropy Decrease and Plasma Creation
 - 4, viXra:1103.0002 3- Dimensional String Based Alternative Particles Model
 - 3, viXra:1102.0056 Experiments to Determine the Mass Related Lightspeed Extinction Volume around massive objects.
 - 2, viXra:1102.0054 Atomic Nuclear Geometry Based on Magic Number Logic.
 - 1, viXra:1102.0052 Construction Principles for Chiral “atoms of Spacetime”
-
-