

Energy Body Theory Opens New Frontiers of Physics in the 21st Century

Ichiro Nakayama

Yazu-cho, Yazu-gun, Tottori-ken, Japan

エネルギー一体理論

21世紀物理学の扉を開き

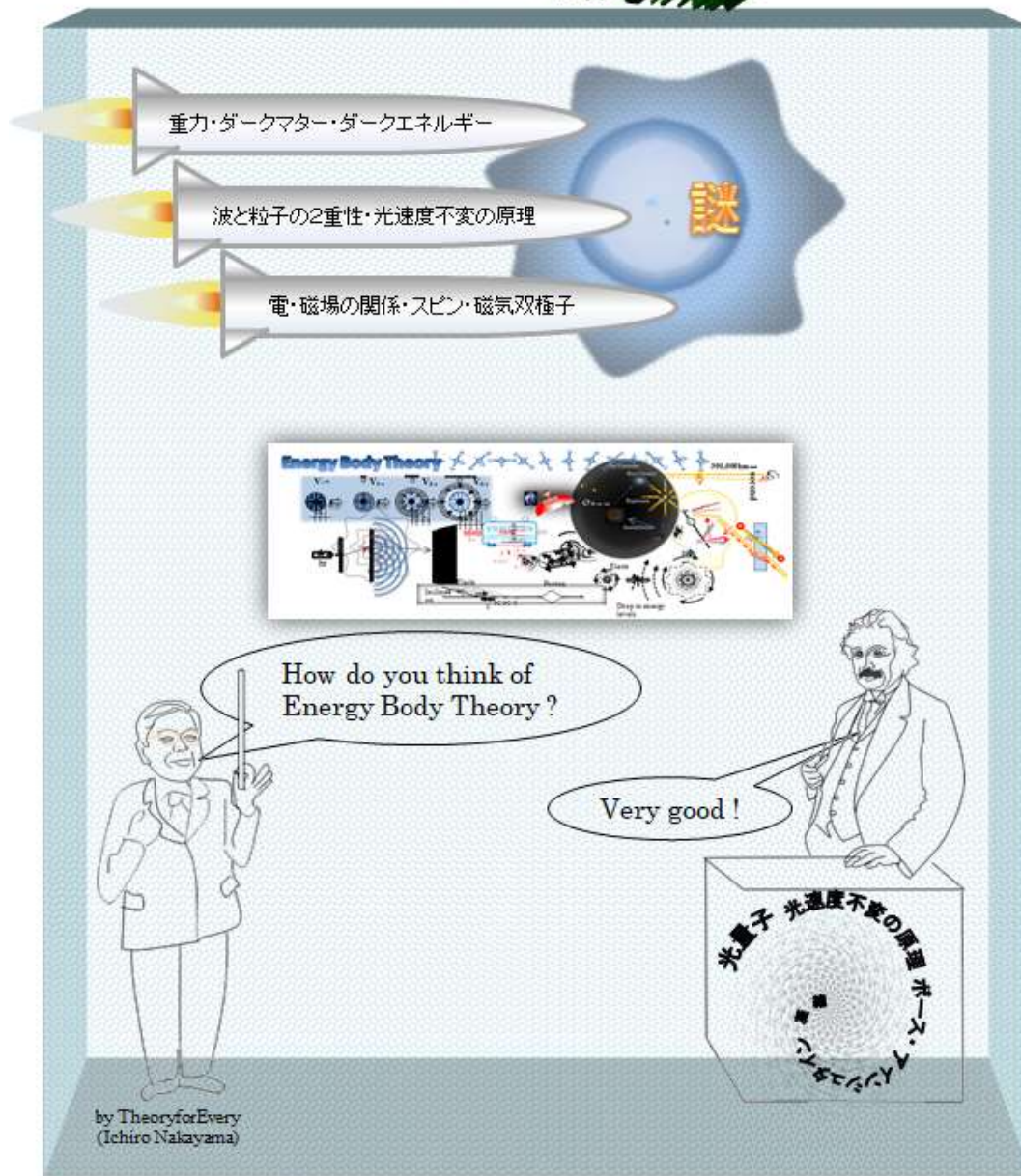

Common

1. Summary

There are four kinds of force in the natural world, which are electromagnetic force, weak force, strong force and gravity. To unify them, the "Theory of Everything" is looked for. More, there are also "Dark Matter" and "Dark Energy" which are still mysterious. But, "Energy Body Theory" will unify them on the base of one axiom including dark matter and dark energy. It describes that the whole universe including elementary particles is made of just only energy body. As a result, the conclusion that all interactions are caused by the difference of energy level of energy body is drawn.

Energy body theory also contrives an elementary particle model according to the axiom. The model draws the shape like that energy body is revolving as a wave motion focusing on a self-axis, and attenuates from the center part in high energy state to the foot area of the expanse part in low energy state, and becomes one with space. The spherical part of the center shows the character of a particle and the foot area part shows the character of field. A rise or a descent of energy is caused by the direction of a mutual wave motion, and repulsive force or attractive force is caused. Then, it is conceivable that light and electromagnetic waves are the transcriptions which are made when electronic posture changes and is transcript into static energy body (space).

I inspected if this idea is right applying to the basic physical phenomena which are electromagnetism, an elementary particle, gravity, dark energy and the structure of the universe, etc. And I am successful in all cases that I inspected up to now. More, basic physical phenomena which are not shown the reasons now by the present physics was explained.

For example, they are the reasons that an elementary particle has a character of electrical charge, that an electrical charge is plus or minus, that magnetic field occurs around electrical current, that an elementary particle and light have the character of duality of particle and wave, that light velocity is invariable, that Bose and Einstein condensation occurs, and what is a spin of an elementary particle.

More, the universe expansion is also too.

Energy body theory explains what gravity and the dark energy are, and even advocates the structure of the universe that the universe circulation system functions instead of big-bang theory.

2. Axiom

I found that the structure of the universe and all basic physical phenomena are explained by the next axiom.

- I. All existence in the universe and phenomena consist of only one element (It's called energy body.) Space and elementary particles are the same energy body.
- II. Energy body consists of the organization quite smaller than elementary particles (It's called energy cell bodies.) and is vibrating. This vibration is perceived as energy.
- III. All interactions are caused by the difference of energy level between the systems of energy body.

3. Introduction

3.1. Introduction

Why does gravity attract everything? Why can an object continue to move at a constant velocity in the vacuum space? These two questions were investigated, and it was discovered that the whole universe, vacuum space and elementary particles are energy body which consists of infinitesimal energy cell bodies of the Planck length scale (See: Common division, 4. Concept of energy body, "4.1 energy body").

A big theme of the present physics is to unify all four fundamental forces in the natural world. Four forces are gravity, electromagnetic force, strong force and weak force. It is thought that the theory into which general theory of relativity and quantum mechanics is integrated is necessary for it. (Reference: Wikipedia, Superstring theory)¹ Superstring theory is studied as the

strongest theory, but It does not come to success yet. Energy body theory unifies these four forces by one axiom (See: common Division, "2. axiom.") "All interactions are caused by the difference in energy level between the systems of energy body."

More, the dark matter and the dark energy just mysterious at present are unified as well by energy body theory. Moreover, inertia force, wave-particle duality, the postulate that the velocity of light becomes invariable, the reason electric charge is a plus or a minus, what is a spin, the reason of phenomena that the numerical value becomes discrete, and etc, these cannot be explained by the present physics, but energy body theory gives apparent reasons to these things and many other mysteries. So, energy body theory is the remarkable theory.

HP1

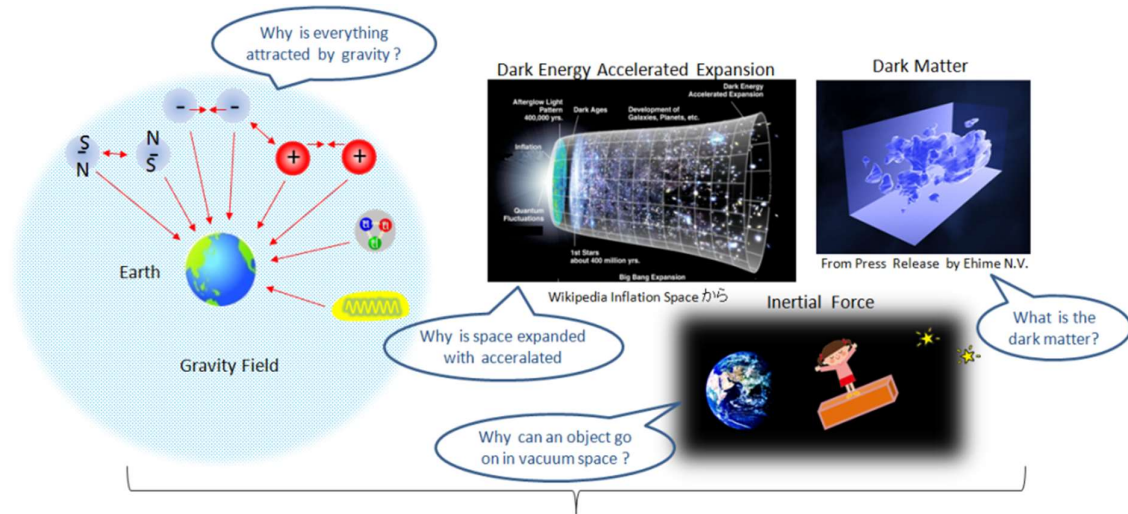

Because of energy body. All interactions are caused by the different energy levels of energy body.

3.2. Essence of energy

Energy body theory is completely new theory, so, it might be easier for you to accept it, if kind of energy will be considered only a little.

The mass of an elementary particle is equivalent to energy. This is to be able to say from famous $E=mc^2$ indicated by Einstein's special relativity. But even if it is indicated that the mass changes to the energy or the energy changes to the mass, it cannot be imagined. A substance of a particle was becoming vague. More than that, the question to what the energy is should spring. Also, the question that the huge energy will exist in a minimal particle in what kind of shape should spring.

In short, the energy does not exist with the outward form in independent way, and it can probably be said that it lurks in the existence with the outward form. In other words, even though energy itself does not come out on the table, it has come out on the table; because of special relativity that says mass is equivalent to energy. So, people were certainly surprised with it saying, "Is mass and energy the same?" But coming to think of it, it is the mass that is equivalent to the energy. The mass does not have the outward form. It can probably be said that mass is the existence that lurks in the existence with the outward form, like energy. Then what is the outward form of an elementary particle which makes energy and mass inhere (model image)? I will consider again the explanation of "Koto bank" which says, "When something has the ability to act on other ones, this is called the energy of the system." This would be able to be paraphrased to the ability to interact with each other systems. So, let me think what the ability of elementary particles to interact with each other systems.

An elementary particle has antithetical bilateral character, a wave and a particle. If so, due to which character an elementary particle is likely to interact, in other words, if you care whether

the energy is a particle (rigid body) or a wave, there would be nothing except only a wave. I think it is rational to guess "The energy is a wave." When it is a wave, a question, "What is a medium?", comes along. But please think. Energy exists anywhere from our close location to the space limit, even in the vacuum space. To say so, the medium of energy also must exist anywhere, in the vacuum space from the close location to the space limit even in the vacuum space. Moreover, an elementary particle, itself also must be a medium.

An elementary particle is also vibrating as a wave. Everything which exists in the universe including vacuum space is a medium. Moreover, it must be a medium common to everyone. When you think up to here, the idea to say an energy body should be caught with the considerable rationality. And when the consideration comes to gravity and the structure of the universe, that should become decisive. Next the point to be considered about is a medium. Now that it vibrates, the inner structure is necessary for a medium. And the size of the inner structure must be smaller than the amplitude of the wave. Because an elementary particle is also vibrating, it's the structure quite smaller than an elementary particle. Energy is the vibration of the unknown medium. The energy exists anywhere, in the vacuum space, in an elementary particle, from in the close location to in the space limit even. You have approached the energy body I advocate. When you come here, the concept that a particle is a rigid body would melt away. I say there is no possibility that a wave coexists with a rigid body. A particle of a rigid body is vibrating. It is a wave. It is a circumstance that a particle is a rigid body from a distance because of a lump of mighty energy. And the energy is vibration of energy cell bodies.

3.3. Kinds of elementary particles

Let us consider an elementary particle this time.

A material elementary particle is classified into 2 kinds, a quark (which makes a hadron.) and a lepton (They are an electron, a neutrino and a muon, do not have a strong force.) A hadron (proton and neutron) has a baryon and a meson, and by the combination of these two kinds, you can classify hundreds of hadrons (being found) and predict its nature. There are gauge bosons (gluon, photon, WZ boson and graviton) which carry fundamental interactions between elementary particles and Higgs bosons which appears in relation to the higgs mechanism to give the mass to an elementary particle. (Energy Accelerator Research Organization, KEK)

HP2

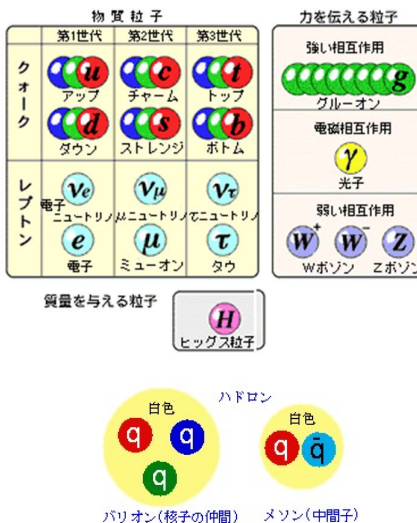

(By: Energy Accelerator Research Organization, KEK, in Japanese)²

Do not you feel a doubt as to there being many kinds of elementary particles like this, even though they should be the smallest unit of which a substance is composed? Moreover, they have the nature of electric charge, magnetic dipole and spin too! Even if you can accept that there

are so many kinds of elementary particles, you might presume that there must be common ingredient among various kinds of elementary particles. And there is something which produces its difference?

Is that spatial undulation or energy? That should be the last element of the natural world.

3.4. Kinds of energy body system

Classification of an energy body is tried so that it will be the help to understand energy body theory here. I think the meaning of the classification will be understandable after the whole energy body theory is grasped, so run your eye's over this chapter. First, in front of elementary particles, there is energy body as the only element which makes the universe. And energy body is classified into a kinetic energy body (which is an elemental particle) and static energy body (which is space).

HP3

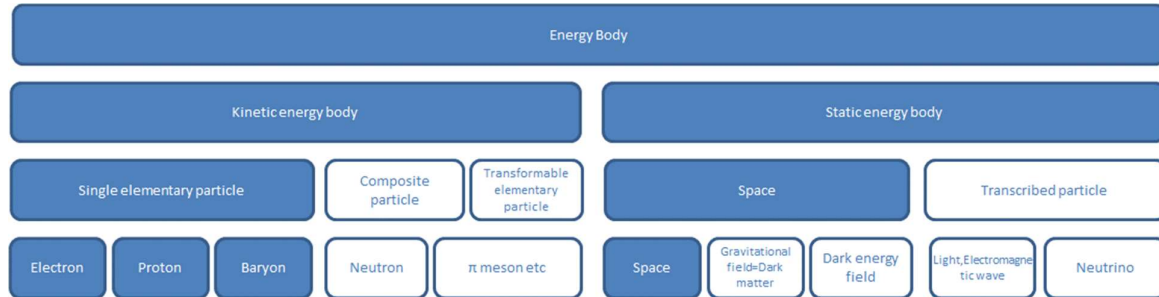

“A single elementary particle” is the basic elementary particle of which a substance is composed, and its body is a closed wave of energy body revolving clockwise or counterclockwise to a progress axis on focusing a self-axis.

“An electron” is the wave of energy body revolving counterclockwise to a progress axis focusing on a self-axis.

“A proton” is the wave of energy body revolving clockwise to a progress axis focusing on a self-axis.

“A baryon” is an elementary particle mainly generated artificially, which does not exist in stable way at the natural world.

“A composite particle” is an elementary particle formed out of more than two basic particles or more than one basic particle from which the form was made changed by external force.

“A neutron” is an elementary particle with composite waveforms of proton’s wave and electron’s wave which entered in the proton.

“π meson B” is also included.

“A transformable elementary particle” is an elementary particle that its shape is changed in the state like foot area of its wave being made disappearing by external force.

“π meson etc.” include the next elementary particles.

“π meson A” is an electron in the high energy state shut in a nucleon. It does not have the foot area of circulating wave.

“π meson B” is a composite wave from two electrons faced to the front and back which one is at high energy state being shut in a nucleon and the other is at usual energy state. It does not have the foot area of circulating wave. (※ Inspection is needed)

“Elementary particles on Bose-Einstein condensation” is a complex of electrons and protons at joined around the absolute zero-point. It does not have the foot area of circulating wave

“Space” is made up of static energy body vibrating as a wave.

“Space” is here, especially in the state of standard energy level.

“Gravitational field” is also a dark matter. The static energy body condenses by the fixed rate to the stellar center; then the energy of the space is decreasing toward the inside.

“Dark energy field” is the space where the static energy body diffuses by the fixed rate to the space verge; then the energy of the space is decreasing toward the outside.

“A transcribed particle” is the elementary particle which is copied a change in the posture of the elementary particle (mainly, electron) into static energy body.

“Light and electromagnetic waves” are the elementary particle which is copied a change in the posture of an electron into static energy body. Further, “Bose- Einstein condensed light” is the light which is copied a change in the posture of Bose- Einstein condensed particles into static energy body.

“A neutrino” is the elementary particle which is copied a change in the posture of the π meson into static energy body. It does not have the foot area of circulating wave.

※* If the essence of elementary particles is inquired, it is classified only two kinds, an electron and a proton.

* A quark and a graviton come to disuse as a virtual particle.

4. Concept of energy body

4.1. Energy body

On "Axiom" then, both space and elementary particles are assumed energy body. In other words, a basic component of this world is only one kind. But elementary particles are classified into total of seventeen kinds which are twelve kinds of fermion and five kinds of Bose particles by the present physics, except space.

(The superstring theory being studied extensively at present as the strongest ticket for grand unified field theory looks on the string as an element of the world.)

Then, why is it possible that fundamental elements of this world are limited to one kind? That's because it was found out there is a close relation between the gravitational field and the existence of an elementary particle. Saying excessively, if there is no gravitational field, an elementary particle can't also exist. So, energy body is needed as the element which makes the relation between the gravitational field and elementary particles be formed.

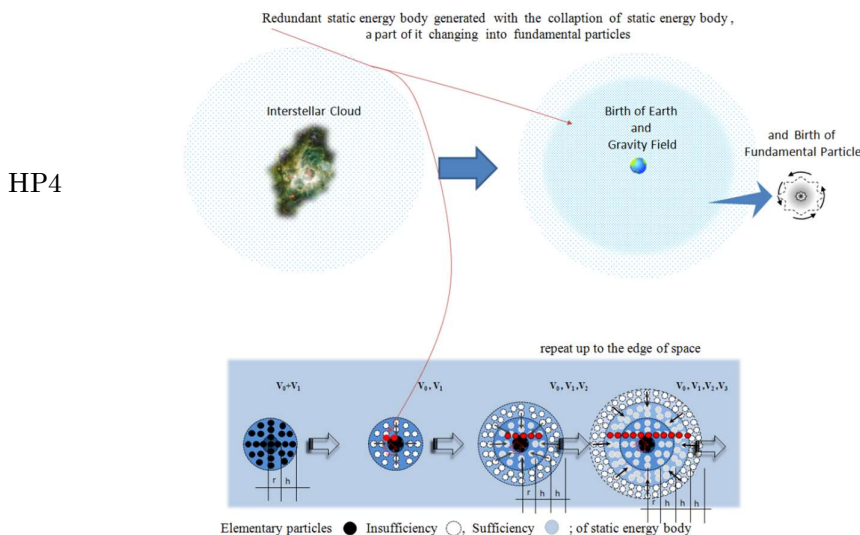

It's also learned by the present quantum theory that relationship is between space and elementary particles. From vacuum space, a particle and an antiparticle generate in pairs. But the relationship between gravitational field and elementary particles isn't understood. It is just expected that gravity, electromagnetic force, strong power and weak power might be unified. A hypothesis of energy body changed this situation. The process in which the energy body makes

gravitational field came to light. And simultaneously, it is expected that a lot of elementary particles are newly formed with generation of gravitational field. (See: The Universe Division, "2.1 gravity occurrence 1", and "2.2. gravity occurrence 2".) And the generated elementary particles are maintained by gravitational field. In other words, it is thought that many elementary particles can keep their forms and energy in the gravitational field. So, the ones brought out inevitably are a space model and an elementary particle model of energy body (See: Common Division, 4. Concept of energy body, "4.2. Space model", "4.3. Elementary particle model"). By this model, it came to be explainable about the duality of an elementary particle that is a particle and a wave, the interaction of elementary particles and gravitational field, and the dark energy. It's transferred to each chapter for details, but concepts of energy body are summarized as follows.

[The outline of energy body]

Energy body is the fundamental element of this space which explains that the universe exists, that a microscopic elementary particle has the enormous energy, that space relates to an elementary particle and that gravity attracts the whole creation. In other words, everything of this world is energy body, space, an elementary particle and energy. In other words, from the universe on a vast scale to an elementary particle in a quite micro world which is the smallest unit of the substance, all of them are made of energy body.

Also, energy body consists of minimal energy cell bodies of the Planck length scale. Energy cell bodies are vibrating, so they have the energy. No, vibration of energy cell bodies can be called the energy. The energy body of space is called static energy body. The energy body of an elementary particle is called a kinetic energy body. The standard energy level of energy body is of static energy body in the place where no gravitational field or no dark energy is. When the standard energy level of the static energy body is expressed in the temperature, it will be the absolute zero-point (It's regarded as 0 kelvins or a little below the absolute zero-point (The correct temperature is unclear.)) (See: Particle Physics Division, "2.6 Absolute zero- particle"). But, the energy of static energy body isn't zero, even if it is the absolute zero-point. The absolute zero-point is often regarded as the state of no energy, but is in the state that electromagnetic force does not interact because the foot area of an elementary particle disappears. An elementary particle model of energy body is like that the waves of energy body spin around their own axis and spread out from the center in a spherical shape to the foot area while attenuating. The central high energy part shows the character of a particle and the foot area shows the field. And the waves of an elementary particle are integrated with static energy body at the tip of the foot area of them. (See: Common Division, "4.3 Elementary particle model")

4.2. Space model

"I thought the space model by energy body theory was a little different from spatial understanding by Einstein's the theory of relativity. It's because it's said that Einstein's special relativity denied ether perfectly. However, recently, I knew that Einstein wasn't abandoning his ether idea."

It has been guessed that vacuum space is filled with some substance from the old time. In the 17th century, the existence of ether as a medium by that force and light are transmitted through vacuum space came to be supposed. Many genius scientists like Descartes and Newton tried theories and experiments. But when ethereal existence was supposed, various illogicalities appeared. The most difficult was that Maxwell's equation was not transformed by a Galilei transformation. So, the world coordinate system which was made the motion of ether the standard was proposed, and many experiments were conducted to check this effect of "ethereal wind" in the second half in the 19th century. It was confirmed that an ethereal wind isn't detected by Michelson Morley experiment in 1887. And that invented the opinion by which an ethereal concept denies itself. After that Einstein's special relativity was announced in 1905, and ethereal existence was denied. Thus, it's a common view to say that ethereal existence was denied. **Instead of that, the description system is formed, that electromagnetic field, gravitational field, quantum field and higgs field, are filled in space. They are incomprehensible**

to ordinary people. (Reference: Wikipedia, "Space", and "Ether", in Japanese)³ But, well, Einstein who should have denied ether proposed at that time that the ethereal concept would be made a change a little and didn't deny ether. He proposed that calling "ether" as the "ether" which is the space where gravitational field and an electromagnetic field exist, not a substance was being proposed. A concept as the location doesn't exist in this ether, and it becomes empty for following and considering "relative motion to ether". (Reference: Wikipedia, "Ether", in Japanese)

And it's the explanation of space model by energy body theory from here. On the contrary to a common view, ethereal substantiality isn't denied perfectly. Because it's necessary to explain that light and a radio wave propagate in vacuum space, and gravitational field and inertia force exist. So, energy body theory regards such space as energy body and energy body itself as space. It connects with the concept of "ether, which does not have a character as substance", that Einstein proposed. Energy body theory doesn't get the way of thinking by which we assume that space is filled with ether. The reason is because of the way of thinking that space itself is energy body. When you make the total volume of the ether decrease by thought experiment temporarily, a gap is built in space by ethereal hypothesis. On the other hand, in the case of space model by energy body, when you make the total volume of energy body decrease, space itself shrinks. It is because energy body is space itself.

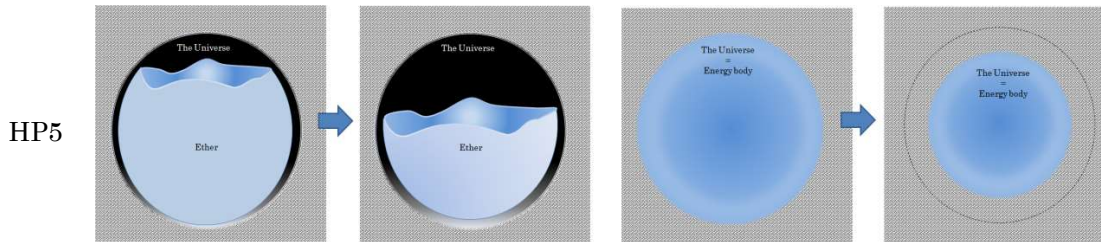

Then in what state is the outside of energy body? It is not known what happens there by even energy body theory. But I'm thinking that there is nothing outside of energy body. In other words, it is nonsense to think about that the outside universe is or not, that what happens there. Of course, it is not possible to deny that there is different universe at the place different from this universe....

When energy body is supposed to be space, the person may appear, who thinks a problem of the ethereal wind denied by Einstein's special relativity may be rehashed. I'm sorry to repeat it many times, Einstein doesn't deny ether. When the velocity of light adopts an invariable principle, even if ether is ignored, special relativity stands up.

In Michelson Morley experiment, there was no change in the velocity of light radiated from the earth, regardless of the direction of the earth movement. Einstein did not find out the reason, but recognized the fact that the velocity of light adopts an invariable principle at any inertia systems. Despite that, he thought time changes. And great progress was brought to physics. But, "velocity of light, invariable principle" involves various paradoxes, so that's giving a basis of relativism denial to a negativist of relativism. Even if a scientific society also insists on the right of the theory of relativity, it does not have the direct and effective refutation to the negativism of an invariable principle of light. So, it is the turn of energy body theory. When using the energy body theory that assumes "Energy body is a raw material of both space and an elementary particle.", the reason that velocity of light is invariable can be explained. (See: Particle Physics Division, "4.1. Generation of light", "4.3. Principle of light speed invariable 1", and " 4.4. principle of light speed invariable 2".) And this thing raises the problem of saying that the whole space (energy body) may be "the absolute standard" as the only exception of the principle that is "All inertial reference system is equal and the privileged standard system is not." by which Einstein is special relativity.

Next a summary of space model by energy body is explained. For details, please see the explanation in each chapter.

[1 Comparison with ether]

If it is assumed that energy body is space, someone might think the revolution speed of the earth around the sun may fall, in the same way as ether too. On the other hand, energy body theory can indicate the response called inertia force. (See: The Universe Division, "1.1. inertia force", and "1.2. Uniform motion")

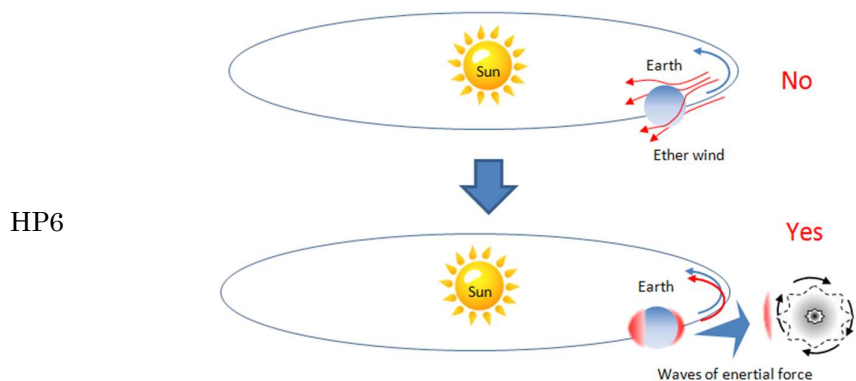

In other words, when external force is added to an object (elementary particles), the rise of the same energy appears in front and behind space (energy body) the object and moves in a straight line at constant velocity as waves, so the object moves being drawn by the wave of energy. Because the energy rise of energy body moves as a wave motion, there is no resistance. The earth revolution is also same. And the energy body theory makes it clear what the field, which present-day physics took in instead of ether, clear from an elementary principle. Physics seems to catch a field with the nature of the space caused by an elementary particle or of the space in a body with an elementary particle. An elementary particle and space are the same material of energy body in energy body theory, so there is no essential difference between an elementary particle and space. It's the difference in whether the vibration of energy body is revolving or not as undulation. An elementary particle and a field are a part of circulating undulation of energy body and are a result of observation. It's an elementary particle that undulation of energy body is revolving around on a self-axis. (See: Common Division, "4.3. Elementary particle model") The central part shows a character of a particle, and the plain area, where the undulation attenuates into space, shows a character of field. The direction of rotation of the mutual wave indicates the nature of the electric charge. And an electronic pair generates the nature of the magnetic pole of N and S.

It is assumed that a change in the posture of an electron to the flat surface direction is copied to space (energy body), and after that, light and electromagnetic waves are generated. Energy body does not have considered problems by ether in the past.

For example, the 19th century physicist youngster and Fresnel regarded light as a side wave. Because the nature of the polarization of light can be explained well, if light is a side wave. But, each ethereal particle combines hard, and must be something like string to transmit a side wave. It was strange to think string-like ether with this firm combination did not interact with an ordinary substance. (Reference: Wikipedia, "Ether")³

On the other hand, each energy cell body is combined hard in the space model of energy body, but it does not interact with an ordinary substance (fundamental particle). Because the difference of the energy levels between the systems of energy body causes a reciprocal action. (See: Common Division, "2. axiom") Unless the rise or the drop of the energy level caused for the direction of the wave motion between the systems, and any interaction does not occur. But, inertia force (See: The Universe Division, "1.1. Inertia force", and "2.3. Gravitational acceleration") etc. act between a substance (elementary particle) and space.

[2. Gravitational filed]

The space model in the energy body theory also makes its cause clear about gravitational filed. Energy body theory explains that when a star is formed, gravitational field is generated by energy body (space) being compressed. (See: The Universe Division, "2.1. Gravity occurrence 1", and "2.2. Gravity occurrence 2".) In other words, after energy body was dragged toward the stellar center (to the inner small space from the outside large space), the compression (collapse) of energy body created at a fixed rate. And the space where the energy level of energy body decreases gradually is created. I think the explanation that "energy body decreases gradually, even though it is condensed", is not plain. But it means that the total volume of the redundant energy body increases, according to the distance from the earth. It is explained why gravity acts on any kind of substances by this model. It is because that the principle works on the same axiom "all of interactions work on the difference of energy level between the energy body systems", through electromagnetic force, strong force and weak force. The next figure expresses the state that the energy body of the whole universe condenses by a fixed rate to one point in stellar formation.

HP7

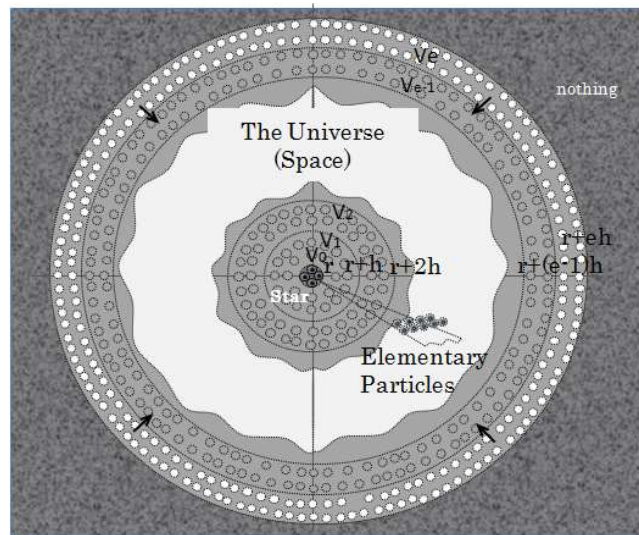

[3. Dark matter and Dark energy]

Moreover, the dark matter and the dark energy which are just mysterious at present become clear through consideration of gravitational filed by energy body theory. The form that energy body condenses and forms gravitational filed can regard a dark matter as itself. (See: The Universe Division, "4. Dark matter") It is thought by present-day physics that gravity field should spread infinitely. When not considering some elements, certainly, gravity filed is theoretically spread out infinitely in energy body theory too. But energy body theory shows that there are some elements from which gravitational field do not spread out infinitely. That's the transference of the energy by which tries to correct maldistribution of energy body. Gravitational field is the place which energy body condenses and becomes a high-energy state more than standard space. Then on the other hand, the space which becomes a low energy state is created due to swelling of energy body, And, reversely, energy body starts to spread out from the inner small space to the outer large space in this time. Therefore, an aftershock of the energy level happens, and the limit forms in an expanse of gravitational filed. The next figure is drawn the energy level of energy body from a stellar center in gravitational filed to the space edge. The average temperature (energy level) of space is the absolute zero-point. The temperature (energy level) of gravitational field is higher than the absolute zero-point.

And the temperature of dark energy field is lower than the absolute zero-point. (See: Particle Physics Division, "2.6. Absolute zero particle", and The Universe Division, "2.6. Temperature of gravity field".)

HP8
(HP166)

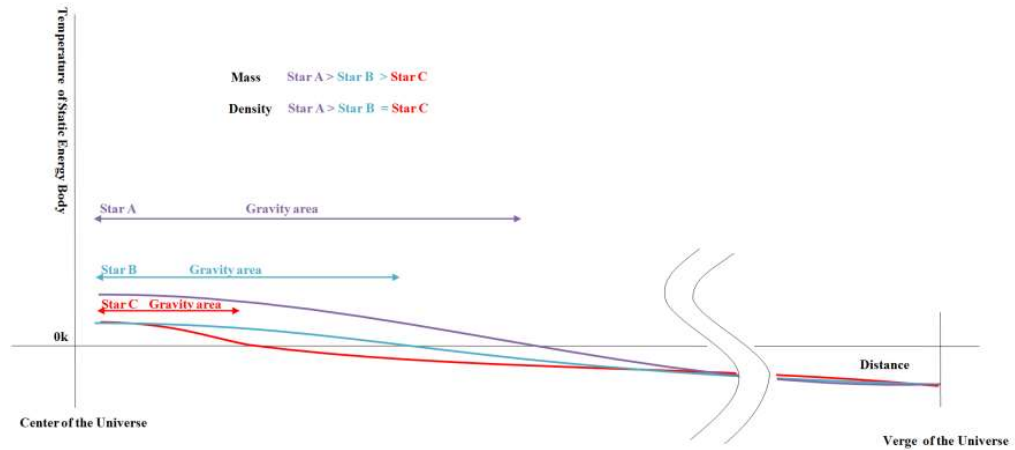

The swelled energy body is in the low energy state around space edge. The energy of energy body is dwindling to the space edge so a star at a high-energy state slips down toward the space edge. This is the dark energy. (See: The Universe Division, "3.1. Generation", and "3.3. Difference between gravity and dark energy") The next figure shows the situation that energy body is spreading out to the space edge.

HP9

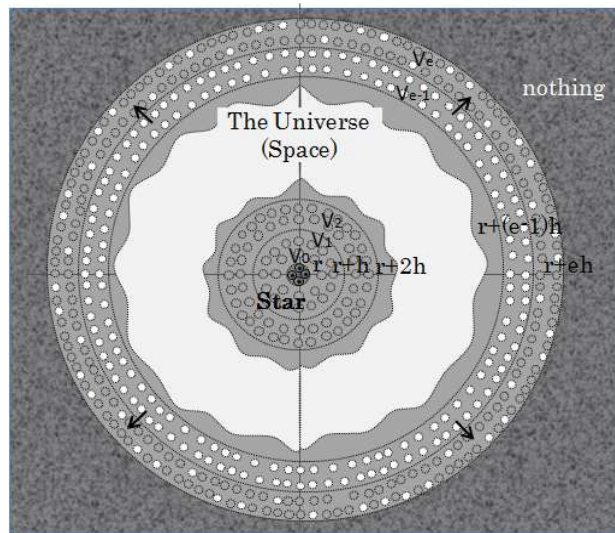

[4. The universe circulation system]

As a result, it is found out that the universe was not formed with a Big Bang, but energy goes to the space edge as stars and returns to around the space center as energy body because of the maldistribution of ups and downs of the energy level in space. And it is repeating.

This is called the space circulation system by energy body theory. (See: The Universe Division, "5.3. Universe circulation system")

HP10 (HP183)

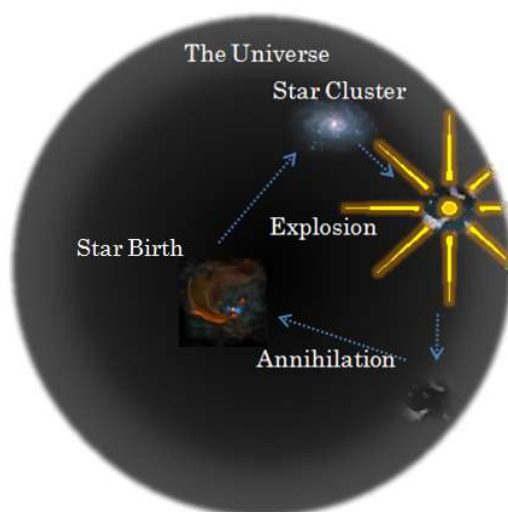

Star Birth: Credit 国立天文台

Then what is the vibration (undulation) of the energy body which generates electromagnetic waves and inertia force and makes elementary particles? Well, I think energy body is made of energy cell bodies.

[5. Approach of energy cell body and superstring theory]

Energy cell bodies are space itself, so a gap is not. The gap where there is no energy body means being in the state of nothing and not existing in this world, in energy body model. Elementary particle theory says that space is closely filled with Higgs bosons. Then that image is like energy cell bodies, but Higgs boson is not space, it is a particle (or, field) to the end.

Then let's consider a little how an elementary particle (as which is a substance) moves through the space made of energy cell bodies. The reason that is mentioned to is because there are no gaps among energy cell bodies. As a matter of fact, energy cell bodies are not yet well understood even by energy body theory. In other words, those are the questions that how energy cell bodies have energy and vibrate; and what shapes they have etc. Up to now, I am thinking the movement of an elementary particle is like that an elementary particle moves by transmitting energy to one of energy cell bodies after another as undulation by the medium of static energy body. It is reminded the phenomenon, when a substance is pushed toward strongly in a moment in the water, a lump of water is made and moves toward. In other words, it can be said that all these worlds are a wave. I feel maybe that superstring theory makes the source of vibration of energy body clear. Superstring theory is the theory which makes the vibrations of string in the Planck length scale a root of the world and is studied extensively at present all over the world. **Whether an energy cell body is formulated as a super-handle string, in the similar way of the center of gravity in dynamics, a point particle in quantum field theory, or it is thought that there is a string in a energy cell body and is vibrating. Anyway I feel energy cell bodies and superstring theory will be approaching.** Can the super-handle model such as the one beginning to revolve if a lump of super strings is compressed be thought? But when I think there is a string like a spring in an energy cell body and vibrating, it seems to be a gene in the cell of a creature, and is very interesting.

The next figure combined a Calabi-Yau manifold with an energy cell body by my delusion. An elementary particle is vibrating as one string in superstring theory. And superstring theory says that one of their forms is a Calabi-Yau manifold, so it's different from the energy body model by which the whole of one elementary particle is assumed the wave that energy cell bodies are condensed and revolving around its axis. But the whole is partial assembly. If it is admitted that an energy cell body is a Calabi-Yau manifold, an elementary particle which are gathering of energy cell bodies should be able to be considered as a Calabi-Yau manifold too. In that case, it might be found as follows. Although one elementary particle looks like consisting of one string,

but it does of a lot of strings. Anyway, nothing is being separated up to now about energy cell bodies.

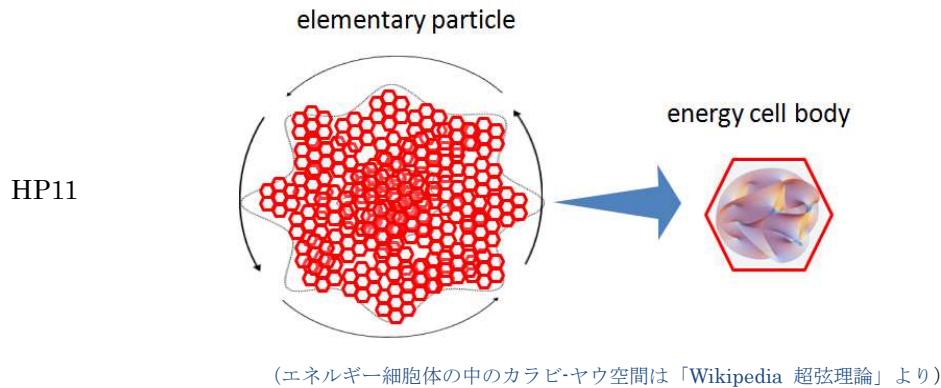

4.3. Elementary particle model

An elementary particle is the most basic element of which a substance is composed. The kinds of elementary particles were the same as the ones explained in "Common Division, 3.4 Kinds of elementary particles", but it's explained easily again.

If an elementary particle is classified by the nature of the reciprocal action, they are shared with a hadron which does a strong reciprocal action (a family of a nucleon, like a proton and π meson), a lepton of six kinds which don't do a strong reciprocal action (a family of an electron and a neutrino) and the gauge particles which mediate an interaction. Moreover, a hadron consists of more basic particles which are six kinds of quark and one kind of gluon. There is an electric charge, mass, a spin and lifetime as nature peculiar to an elementary particle. Also, an antiparticle exists in each. (Reference: Koto bank, in Japanese)⁴

It is measured up to an atom by using an electron microscope, but the size of an elementary particle is not done. There are two theories now. One is that an elementary particle (which is a point particle) has no size. The other one is that it has a microscopic size. (Reference: "Monogatari science", and "Wikipedia elementary particle", in Japanese)⁵

Thus, it is inspected in detail about an elementary particle. Even so, the essential shape of an elementary particle is not known at present. Therefore the shape of an elementary particle is dim. By the way it is known the fact that an elementary particle has an antithetical character (Wave-particle duality). The quantum theory was born to be described this antithetical character of elementary particle. The quantum theory is towing present-day physics and is obtaining many results. But, on the other hand it has not answered about the fundamental question that an elementary particle has the nature with "wave-particle duality". An elementary particle model by energy body theory is embodied this "wave-particle duality". The central spherical part shows the character of a particle and the infinitely spreading foot area shows the character of field. The model is only able to be made from the idea that space and an elementary particle are the same substance. The character they can have by assuming that space and an elementary particle were the same energy body. An elementary particle model by energy body theory makes the most fundamental form of an elementary particle clear. And it makes clear why an elementary particle has the natures like the electric charge, the mass, the spin and the lifetime. And you will find out that an elementary particle does not perform independently from space, but does in a body with space.

[1. The shape of elementary article]

The kinds of elementary particles were found more than the kinds of ninety-two atoms existing

in the natural world, but it's reduced to six quarks, six leptons and five bosons at present. But I think there may be too much twelve kinds. I think, an elementary **particle** should be one kind. For example, we assume that there are two of elementary particles A and B in the next figure. A and B share the common element called an elementary particle. Also, they share the common element like an electric charge, mass and a spin. And the source which produces these common elements should be imperative construct of the world. This thought will not be of myself-righteous alone. Probably many researchers ought to study feeling like so.

HP12

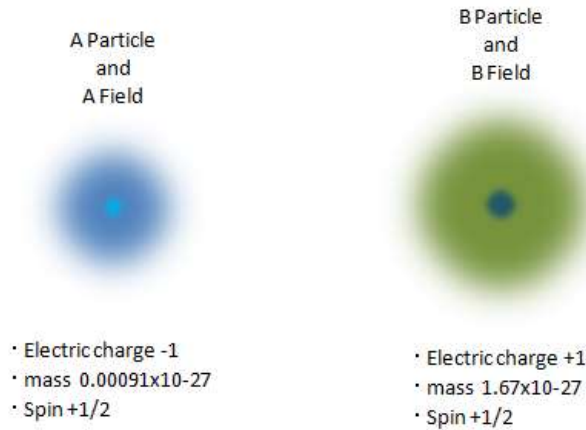

Energy body theory penetrated the imperative construct of this world into just only one kind element which is energy body. Only one kind of element forms the world filled with strangeness of elementary particles and the complicated universe. Energy body is space itself. That consists of microscopic energy cell bodies beyond Planck scale and is vibrating. When the place (gravitational field) where energy cell bodies are distributed more than the standard is generated, the energy is shut and begins a revolution as a wave motion. This will be an elementary particle.

HP13

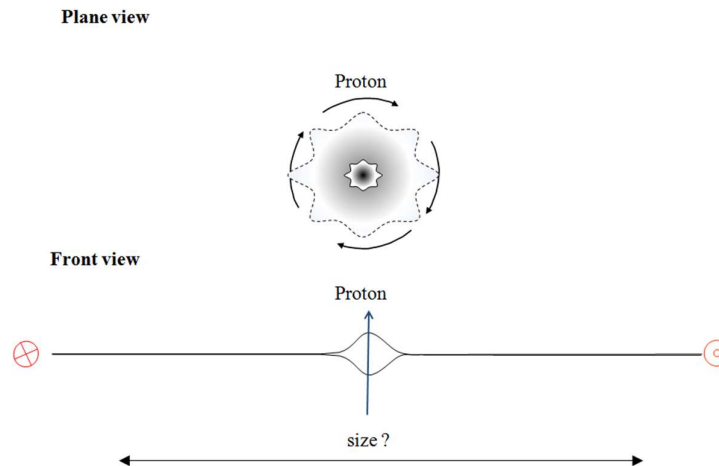

Undulation of energy body is circulating focusing on a self-axis, and the energy level (the amplitude of the wave) attenuates to the outside of the foot area from the center. The shape is summarized as follows.

【Elementary particle model of energy body】

- * Undulation of energy body is circulating focusing on a self-axis.
- * The foot area of the wave spreads out attenuating from the center.
- * When countless elementary particles are collected, they are excited each other and the foot

area of wave spreads out infinitely.

* It even attenuates to the standard energy level of the static energy body, and the tip of wave becomes in a body with static energy body.

* The central spherical part shows as the nature of the particle and the foot area of wave shows the nature of the field.

* The frequency is peculiar to each kinds of elementary particle.

* As it gets away from the center, the wavelength becomes long, but the frequency is same.

* Attractive force or repulsive force works on account of the direction of mutual wave in the contacted part. (See: Particle physics Division, "1.2. Electron-proton coupling")

The size of an elementary particle is not known by the present physics.

It's difficult to express numerically the size of an elementary particle by energy body model. The reason is that there are no ways to measure it, but that is not all; originally it is not possible to say the size because of its shape. When throwing a stone into a pond, waves occur to a surface of the water. The shape of an elementary particle by energy body theory is like that, so it isn't possible to say the size. The tip the foot area of the revolving wave becomes in one body attenuating with space. When numerous elementary particles assemble, the foot area of elementary particles expands by excitation (resonance). It's for this that present-day physics cannot decide the size of an elementary particle. In fact, it would be convenient to deal with as the point that an elementary particle has no size in quantification. Starting point of the wave which begins to attenuate is handled as an elementary particle. With the center of gravity of the dynamics, like, it's a way of thinking. Next, electromagnetic waves (photons) and neutrinos are the formations which are copied a change and a movement in the posture of an elementary particle (mainly, electron) into energy body which is space. (The next figure) they are secondary products, so regarded as something different from an elementary particle to make a substance.

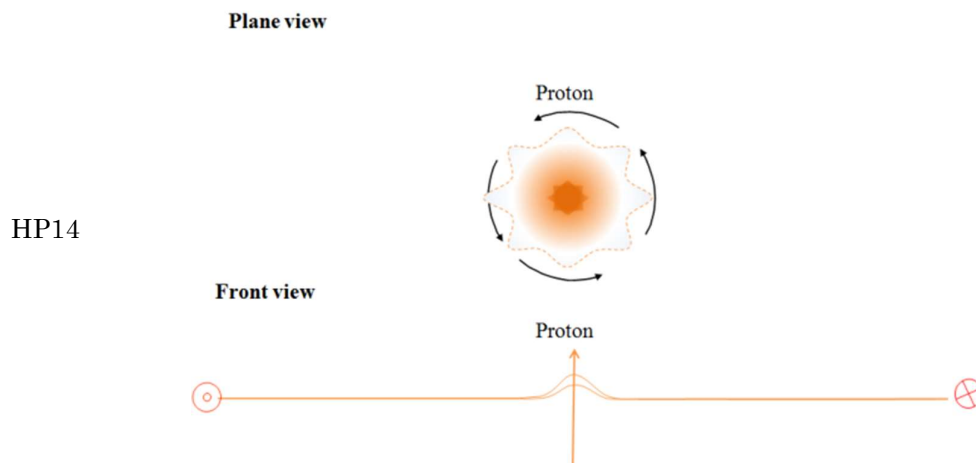

2 Character of elementary particle.

An elementary particle has the peculiar characters of an electric charge, mass and spin. It isn't possible to explain why an elementary particle has such characters by the present physics. But, an elementary particle model which is consist of just only one element of energy body can explain why an elementary particle has these characters.

You will see at each chapter for details, and a survey of the character of an elementary particle model by energy body theory is explained next.

* Electric charge: An electric charge is caused by the difference in the direction of movements of the revolving wave of an elementary particle (mainly, electron and proton). A pair of elementary particles in the same direction of the wave repulses each other. A pair of elementary particles in the different direction of the wave attracts each other. The wave rotates clockwise acts as negative charge, and the wave rotates counterclockwise acts as positive charge. (Addition: If it

will be seen from reverse side, the direction of rotating wave in the left or in the right direction on the progress axis will be the reverse one in the right or in the left. And it cannot be distinguished. Then a progress axis is established to decide the direction of rotation. And then, the relation in both sides will be a relation between a particle and an antiparticle. (See: Common Division, 4.4. "C.P. violation")

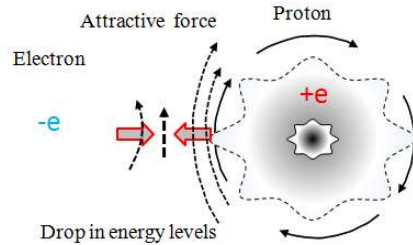

HP15

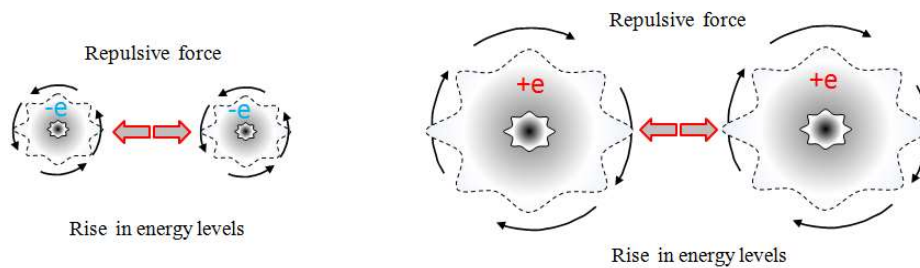

* Electric field: When the posture of free electrons and protons become parallel on a flat surface, the spread of the wave revolving around which both is an electric field.

HP16

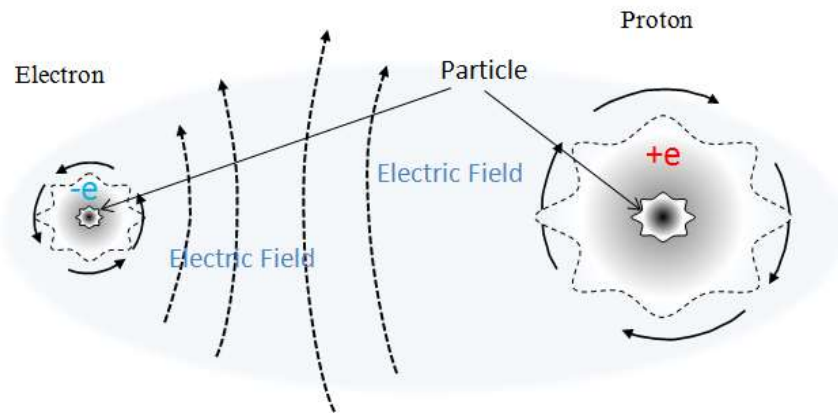

* Magnetic field: When a free electron in an electric field moves, electron's track bends to the right-angle direction to the direction of movement of electron.

In other words, the revolving wave of an electron becomes perpendicular to the electric field.

The foot area of the electron's revolving wave at this time will be a magnetic field.

A magnetic pole doesn't appear with a single electron. But N pole and S pole show up when an electron of the posture of the back and the table makes a pair by a loop electric current etc.

(Adding: There are no magnetic electric dipoles by an energy body model.)

The next figure shows the state that an electron which moves in the electric field creates a magnetic field.

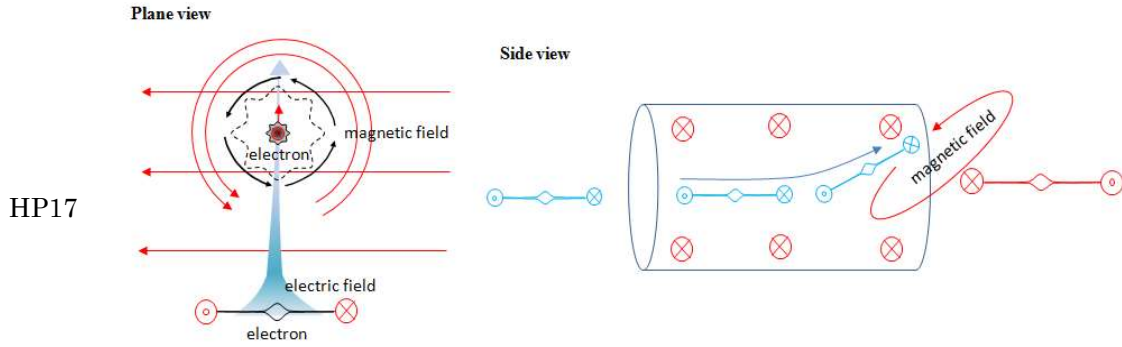

The electronic pair around which the posture revolved 180 degrees (loop electric current) is drawing the state which makes N pole and S pole between them on the next figure.

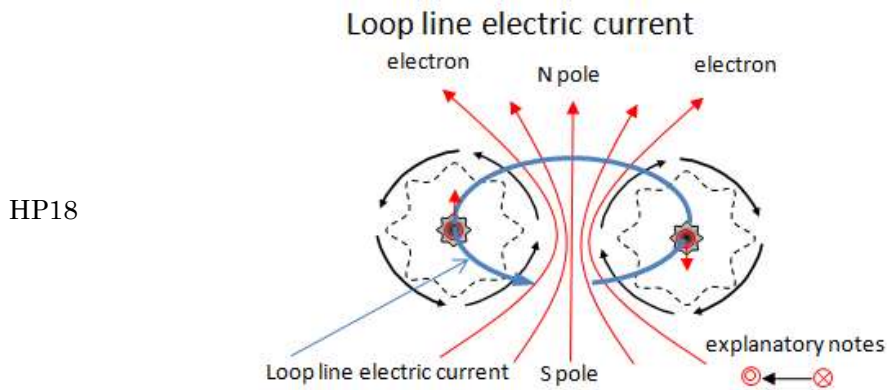

* Spin: Spin is the phenomenon that the movement of an elementary particle (mainly, electron) changes according to the direction of the revolving wave of an elementary particle and of the magnetic field. The next figure shows as follows. When the electron on the orbit of a proton makes transition, the wave direction of an electron is reverse to the one of the opposite side, so the energy of transition is different each other. As a result, the emission spectrum line is divided into several spectral series.

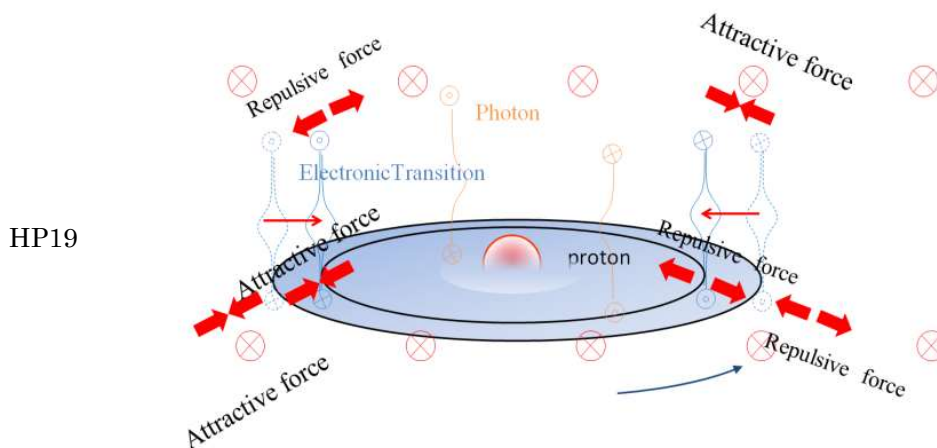

The next figure shows the situation that the electron which was put in the heterogeneous magnetic field receives the force of up direction or down direction according to the relation between the direction of magnetic field and the direction of the revolving wave of an electron.

Electrons polarized by lines of magnetic force in front view

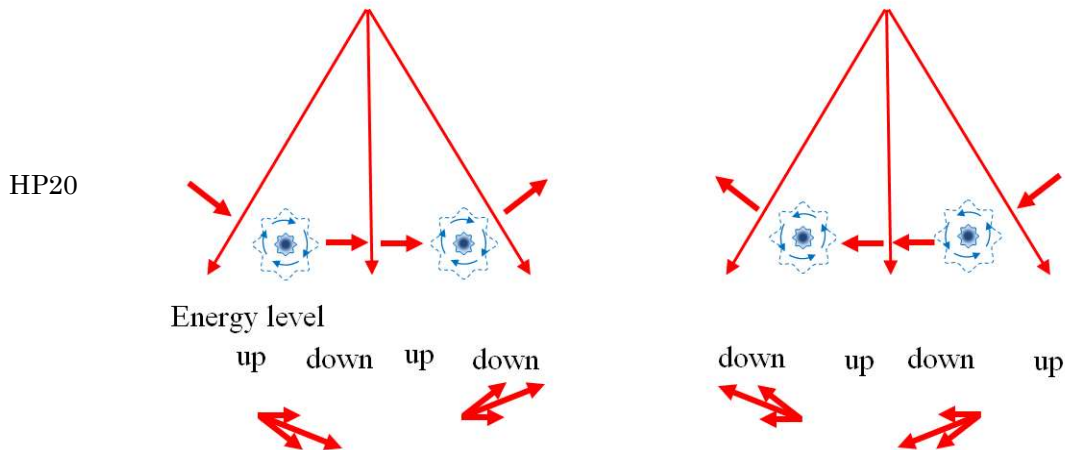

Electromagnetic wave (light): Electromagnetic wave is the one which was copied the energy of the electronic movement to its face direction into static energy body (space). Therefore, it's almost impossible to give the acceleration to an electromagnetic wave after it was emitted. The next figure shows the situation that a photon is emitted when the electronic transference.

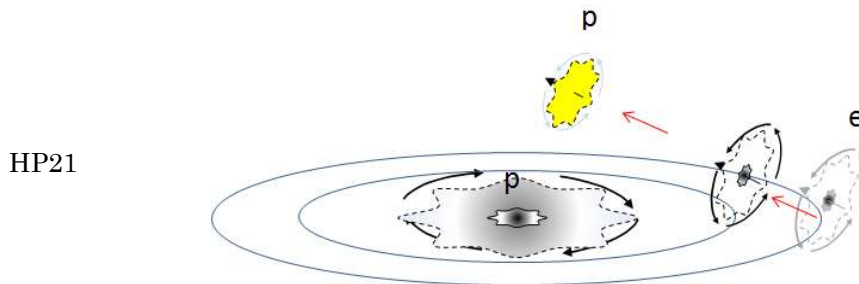

4.4. CP violation

An antiparticle exists in all elementary particles in the way that a counterpart of an electron is positron, and of a proton is an antiproton. An antiparticle is the pair particle such that the type of electric charge is different from a particle, and mass and the other nature are the same. A pair annihilation and a pair production occur by a particle and an antiparticle. A particle and an antiparticle are replaced to have CP symmetry, and it's meant that event probability of physical development is same in the world made mirror reflection. (Reference: Hyper Kamiokande, in Japanese)⁶

HP22

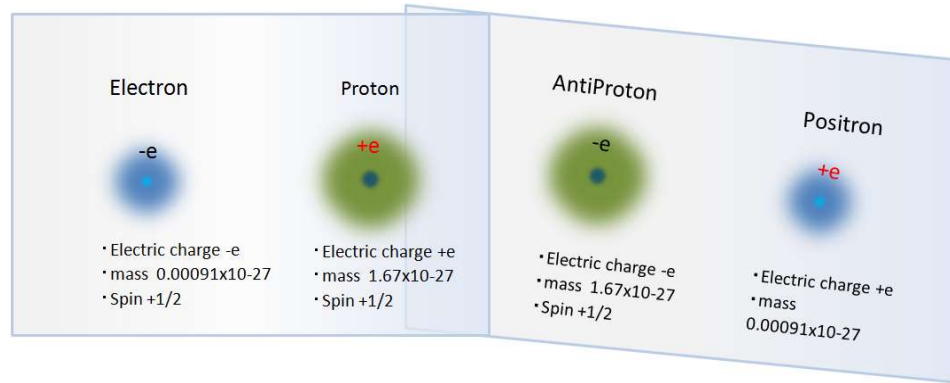

In other words, the same number of an antiparticle must exist as a particle. But, there are almost only particles, but no antiparticles for the substance in the universe at present. It is thought that the present universe was created by Big Bang 13,800,000,000 years ago, (and energy body theory denies Big Bang. (See: The Universe Division, "5.3. Universe circulation system") and a particle was created from its energy. hen being made with the energy, first there should be the same number of a particle and an antiparticle.

Why did an antiparticle become extinct and was a particle left? One of the theory which explains CP violation is Kobayashi Masukawa theory. It was mysterious why only weak force broke CP symmetry. One generation is made with two kinds of quark (an elementary particle) which composes a proton and a neutron. If six kinds of quark (two kinds multiplied by three generation) exist, CP symmetry will be ripped, was announced by both Kobayashi Masukawa in 1973. (Reference: The University of Tokyo, graduate school science system postgraduate course and the department of science, in Japanese)⁷

Both men won Nobel Prize in Physics in 2008 by this achievement. But it cannot be explained that there is quite a lot of matter more than antimatter at the present universe only with this explanation. Then, it is also one of the fields being studied aggressively by both theory physics and experimental physics at present. (Reference: Wikipedia, "CP violation", in Japanese)⁸

It's energy body theory that can give an answer to this problem as expected. The point is that the difference between a particle and an antiparticle is only an electric charge and the other nature is same. Let us change the previous figure for an energy body model. On the left side in the next figure are particles, and on the right side are antiparticles. Then electric charges turned opposite. An electric charge is the direction of the rotating wave of an elementary particle by an energy body model. That is to say the left revolution is - e and the right revolution is +e.

If this revolution is reversed, it is an antiparticle. Or the left revolution is + e and the right revolution is -e. When this will be considered calmly, it's so. It can also be said the difference is whether a particle was seen from the face or from the back.

HP23

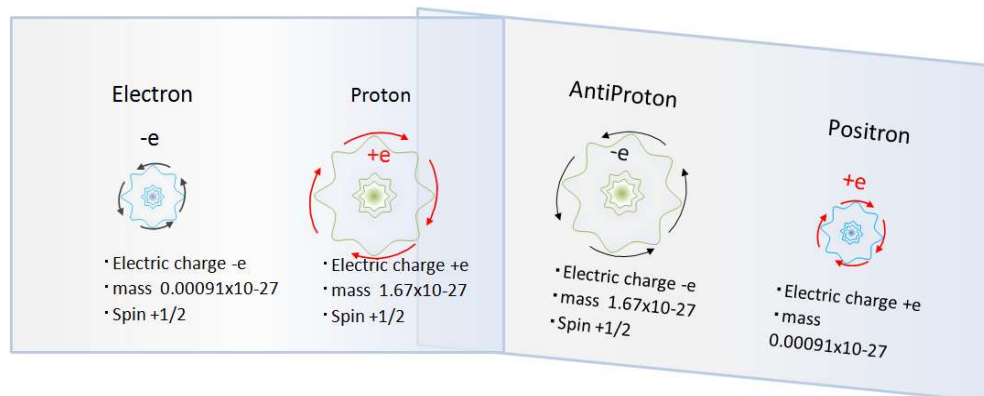

Well, it is not so significant to classify the wave of an elementary particle revolves in clockwise direction or in counterclockwise direction. Because it is convenient that an electron has the nature of minus electric charge and a proton has the nature. So, it is made rule that an electron has a revolving wave in counterclockwise and has an electric charge of minus e , and a proton has a revolving wave in clockwise and has an electric charge of plus e .

Electrons polarized by lines of magnetic force in plane view

HP24

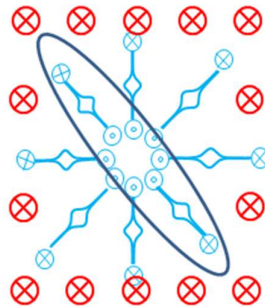

The figure above shows the posture of the electron put in the magnetic field. An electron strikes the pose which becomes parallel to a magnetic field in the magnetic field. But there is freedom of 360 degrees in the posture of the electron, when it becomes parallel to the magnetic field.

Therefore, the direction of rotation of the wave becomes reverse each other between the particles of the posture which revolved 180 degrees. This causes generation in a magnetic field (See: Particle Physics Division, "3.1. electromagnetic field"), reflection of light and refraction (See: Particle Physics Division, "4.5. Refraction and reflection of light"). The direction of rotation of the wave becomes reverse between the particles of the posture which revolved 180 degrees, so an electric charge becomes reverse each other. The reason is because the direction of wave makes the kind of electric charge. Of course, the elements except an electric charge are just same. This relation is the relation between a particle and an antiparticle. Then the next questions come up to.

- (1) Does pair annihilation occur and matter entirely becomes extinct?
- (2) Does the distinction of an electron and a proton also disappear?
- (3) Does a positron flow to the minus direction from the plus?
- (4) The magnetic field which forms around the electric current is always not counterclockwise but can be clockwise direction?

An answer to that is as follows.

- (1) "Does pair annihilation occur and matter entirely becomes extinct?"

A particle and an antiparticle of an energy body model do not become extinct in the natural world is understood by the next figure. It's being explained taking the electron for instance, but even a proton is the same thing.

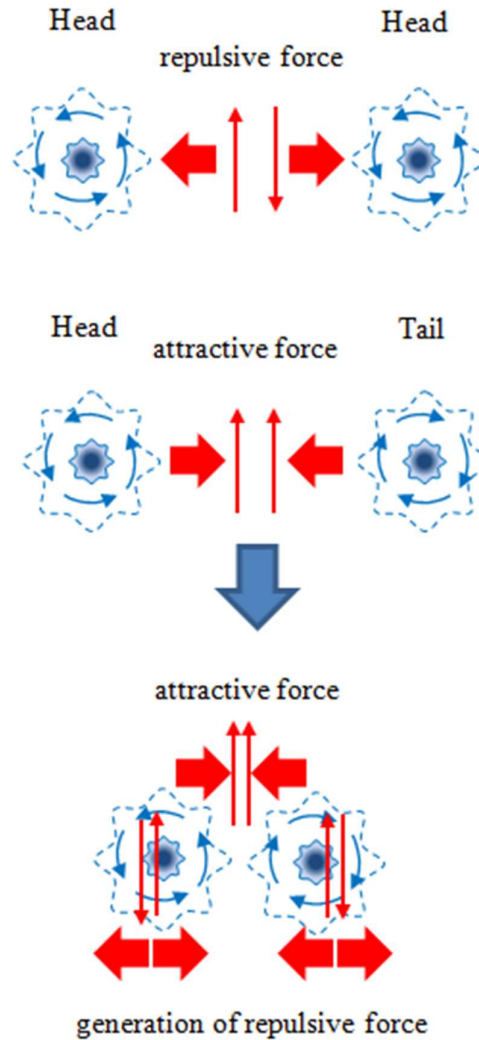

HP25

* When an electron of the front side comes close to another of the front side, the waves of the two electrons revolve in the different directions each other at the encounter point. So, repulsive force forms and it does not approach the other one closely.

*When two electrons of each front and back sides come close to, the waves of two electrons revolve in the same directions at the encounter point. So, attractive force forms and they connect. But when the partner's particle part is exceeded its radius, the two particle's waves go in the opposite directions each other, so an electron of the front side doesn't become united with the back.

* It's the same size, so I think that an electron of the front side cannot enter on the orbit of another electron of the back side. (※ but there are no bases to be able to be thought so at present.

(2) "Does the difference between an electron and a proton also disappear?"

An electron's electric charge is negative due to its wave revolving counterclockwise, and a proton's one is positive due to its wave revolving clockwise. But when this is seen from the back, an electron and a proton will be the just reverse explanation, and the meaning of electric charge for a distinction certainly disappears. But when it'll be a relation between an electron and a proton, the meaning comes out. An electron enters an orbit of a proton, and combines with a

proton and composes an atom. It is the relationship established with the reason that a proton is big overwhelmingly compared with an electron, In the next figure, it is considered what will happen by the direction of the rotating wave when a proton combines with an electron

It is found out that an electron and a proton combine only when the waves revolve in the opposite direction at close area. In other words, it can be said that the electric charge of an electron and a proton is different each other.

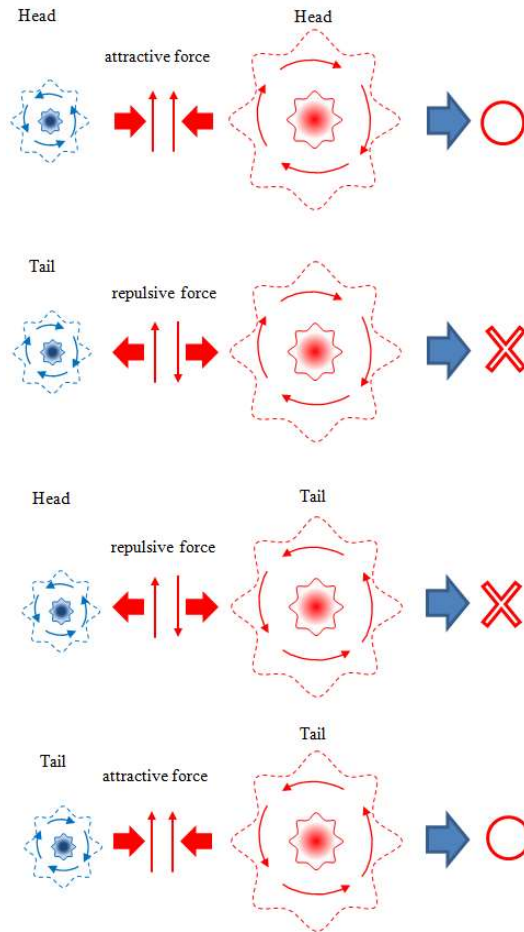

HP26

(3) "Does a positron move to the negative pole direction from the positive?"

The posture of the electrons in the conductor applied no voltage faces all spherical surfaces, but when the voltage is applied, all electrons strike the same pose. The reason is because an electronic wave in the conductor must be parallel with the direction of rotating waves which an electron of a cathode and a proton of an anode make. Therefore, a positron (the electron which strikes the pose in the electronic back) isn't made.

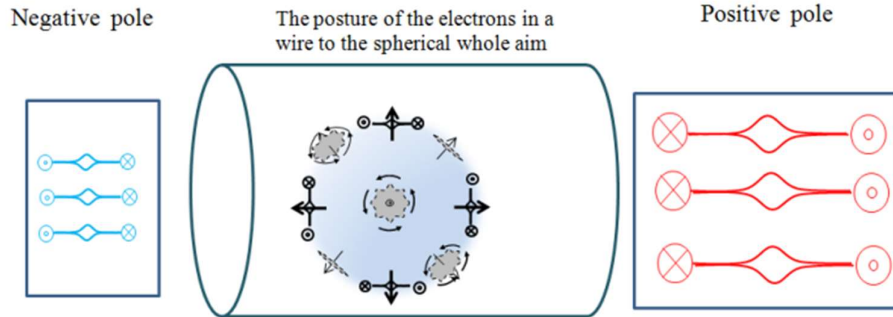

HP27

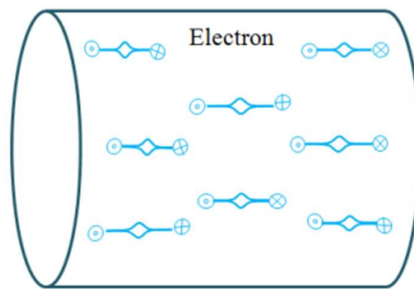

(4) "The magnetic field which forms around the electric current is always not counterclockwise to the direction of an electron's movement and there is also a clockwise direction?" A magnetic field forms around a closed loop to an electric current in the clockwise direction according to the Ampère's circuital law. Seeing it from a different angle, it becomes opposite counterclockwise to a movement of electron. (See: Particle Physics Division, "3.1. Electromagnetic field") I'll explain why a magnetic field becomes counterclockwise to the direction of an electronic flow. When a conductor is turned on and the voltage is applied, the posture of the electron in the conductor will be the same posture in other words the posture which had complete set of electrons on the face as follows. (See: Particle Physics Division, "3.2. Faraday's law of induction")

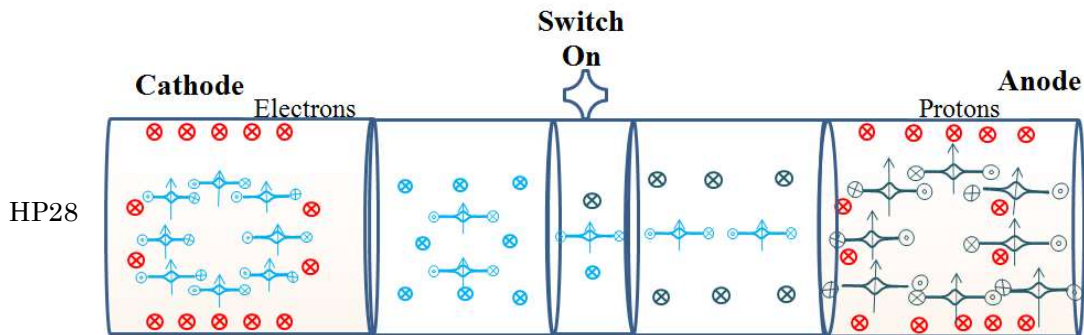

HP28

And an electron begins to move to the anode. (See: Particle Physics Division, "3.1. Electromagnetic fields".) The electron which has begun to move is crashed against energy-grade line and is opposed. And It goes to the outside while bending course. At this time, two locio are considered. It's upward or downward as being drawn in the next figure.

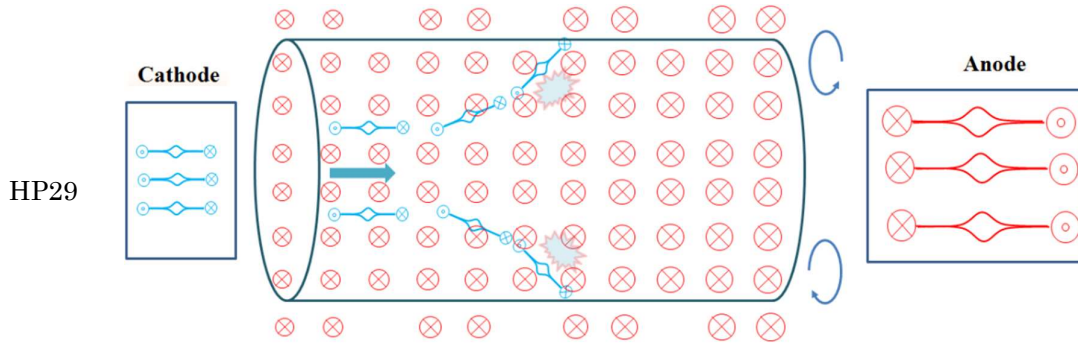

But, even if the posture and the other condition of these two electrons are truly same, they make a magnetic field circulating in the different direction. The electron which moves upward makes a counterclockwise magnetic field. The electron which moves downward makes a clockwise magnetic field. Two different results in the same situation can't exist at the same time. If so, it would be the birth of a new paradox. Therefore, in energy body model, the progress axis of electron is set to make a magnetic field counterclockwise according to an actual phenomenon. But the reason can't be explained why I must set this progress axis. It's being studied at present. Please inform me if someone has a clever idea. Lastly, CP violation "why an antiparticle did not exist in the universe, was explained by energy body theory. A problem as necessity of setting of a progress axis is also left from now on, but the relation between a particle and an antiparticle is the same relation as an elementary particle seen from backward or forward.

As a result, it isn't necessary to consider "CP violation".

4.5. Elementary particle model and gauge particle

I think you might feel an elementary particle model by energy body theory is completely different from the one of "quantum theory" which is the best arrival point of present-day physics, when you know an elementary particle model by energy body theory for the first time. That's because energy body theory is the theory that is constructed on a clear image and an axiom (See: Common Division, "2 axioms"), while quantum theory has not a clear image about an elementary particle and field. But if it is inquired well, it will be found out that both theories are very near. "Field" and "elementary particle" have been treated as a different concept in the history of physics.

But, in quantum theory, an elementary particle and field are treated overall in a body. Field is caught with the nature of space which became united with a particle. And the radius of an elementary particle is basically handled as infinite small size and the particle to transmit force (gauge particle) is assumed separately. And we assume that force is transmitted by gauge particle. For example, when an electron moves, a radio wave is generated. About this, it is thought that an electromagnetic wave propagates the energy of an electron as a photon which is a particle to transmit force. when an electron moves. (Reference: Wikipedia, "Quantum field theory", in Japanese)⁹

Maybe it is not appropriate to make a figure because quantum field theory has not an image but anyway it is the next figure that I created an image of the explanation of "the field is shaped like a particle, the particle is shaped like a field" (Reference: Wikipedia, "Quantum field theory", in Japanese)⁹.

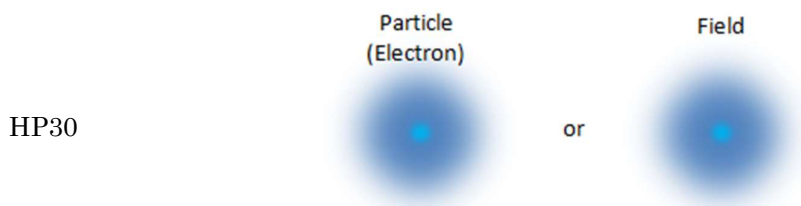

Moreover, it's the next figure that I created an image from the part of (Wikipedia, Quantum field theory, "A particle can be the medium to transmit force", in Japanese)⁹.



On the other hand, an elementary particle model by energy body theory is as follows. Undulation of an energy body (vibration) is circulating focusing on a self-axis, and its skirt area spreads out while attenuating from its center of high energy. A spherical central part shows the nature of an elementary particle and the skirt area shows the nature of field.

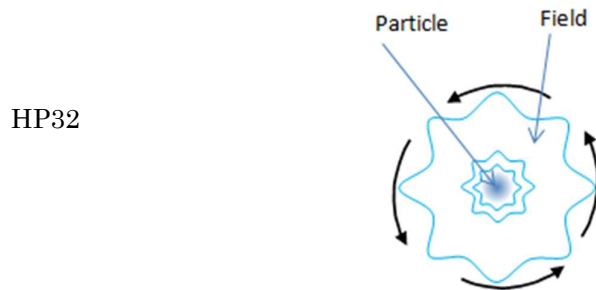

Moreover, electromagnetic wave (photon) is created when a change of the electron posture to the face direction transcripts into static energy body. (The next figure)
I'm astonished that "an elementary particle model" by both energy body theory and quantum field theory resembles very much.

(※ This surprise is because the elementary particle model which I contrived from consideration to gravity by myself, is similar to the one in quantum field theory which is the one discipline of ultramodern physics, even though I had not known about quantum field theory and the duality of an elementary particle. An elementary particle model of energy body theory is the concept that can be even expanded to gravity and the universe because the idea was thought out from consideration to gravity.)

A field and an elementary particle are treated overall as energy body in energy body theory, but the character of a field, a particle and space are made clear. Therefore "the phenomenon which generates an electromagnetic wave when an electron moves," is caught with the one copied the change of the posture of the electron into the static energy body. The electromagnetic wave formed by transmitting into static energy body progresses as the wave which the form of the electron was copied to. It is thought in energy body theory that the interaction is caused by the rise or the descent of energy level created according to the direction of each electron's revolving wave. In quantum field theory (gauge theories), force is caught as an indirect action, because a gauge particle to transmit force is assumed in it. On the other hand, force is caught as a direct action by energy body theory. In other words, I think experimental value is can be calculated

correctly, if it is assumed that a virtual particle exists. On the other hand, in energy body theory, force is caused by the difference of energy level between each system of energy body. Therefore, in energy body theory, because force acts directly, you do not need to presume a virtual particle of gauge theory and to think that force is transmitted in directly. That can be the way of thinking because an elementary particle is equivalent to space. It stems from the difference in the thinking whether a photon transmits force or a photon is created by force, even if it is the same phenomenon. Therefore, an elementary particle model of energy body theory matches very well with these points like mass is zero, an invariable principle of light speed and the form of an electromagnetic wave etc. Because it was understood that field is the part of an elementary particle, it could have an energy body model.

Particle Physics Division

1. Elementary particle

1.1. Electric charge

An electric charge is one of the properties which an elementary particle has, and the amount of the electric charge is called the quantity of electric charge. The fundamental property of electricity depends on workings of an electric charge. There are a positive and a negative in the quantity of electric charge, and a proton has +e of positive charge, an electron has -e of negative charge. A neutron does not have an electric charge. The electric force (Coulomb force) is the action transmitted by electric field and acts on it between the electric charge and the electric charge, and attractive force between different electric charges and repulsive force between the same electric charges. This force is called Coulomb's law, and it's proportional to the quantity of electric charge of each particle and in inverse proportion to a square of the distance between the particles. (Reference: Wikipedia, "Electric charge", and "Denki no Rekishi Irasutokan", in Japanese)¹⁰

An electric charge is looks like having been studied up, but it is difficult to explain why an electron and a proton have an electric charge. (Reference: Denki no Rekishi Irasutokan, in Japanese)¹⁰

The absolute value of the quantity of an electric charge carried by a single electron or a single proton is called an elementary charge. The elementary charge is shown in symbol e, a proton is +e, and an electron is -e. The magnitude of the elementary charge is as follows.

$$e = 1.602\,176\,6208(98) \times 10^{-19} \text{ C}$$

(Reference: Wikipedia "elementary charge")¹¹

In other words, a proton and an electron are completely the same e for the absolute value of the magnitude of elementary charge. A question should spring to everyone from here. A proton is about 1836 times as large as the mass of an electron. (Reference: Weblio dictionary, "Proton", in Japanese)¹²

Why the magnitude of elementary charge is both the same, even though the mass of a proton and an electron are just different? In that case, may both a proton and an electron have to have the same magnitude of an elementary charge each other? But an electron also has the aptitude of the magnetic dipole which is the base of the electromagnetic phenomenon. (But a magnetic dipole is denied by energy body model. (See: Particle Physics Division, "1.4. magnetic dipole") Also, a proton has the inner structure of a quark. But an electron does not have it.

When a quark is considered, moreover you will be confused. It's thought that a proton consists of two "up quarks" of +2/3e and "down quark" of -1/3e. Why is the electric charge of "up quark" plus? Why is the electric charge of "down quark" minus? Why doesn't an electron have three "down quarks" of -1/3e? If a proton and an electron do not have the inner structure which produces an elementary charge in it, it may be inconsistent with the theory of relativity. It's because the mass and the energy are equivalent according to the theory of relativity. If an elementary charge, which is the energy that produces an electromagnetic interaction, is

converted into mass and is compared, calculating simply, a proton must have 1836 times of the elementary charge of an electron. Even if it is supposed that there is inner structure in a proton and an electron, it is inconsistent. Also, even if it is supposed that there is not, it is inconsistent too. It looks both hellish circumstances.

Here, this is energy body theory' turn.

For a start, let me explain the reason that an elementary charge of a proton is the same of an electron. It was American Millikan that an elementary charge was measured correctly first. It's called Millikan's oil droplet experiment. Millikan's oil droplet experiment is the one like the next.

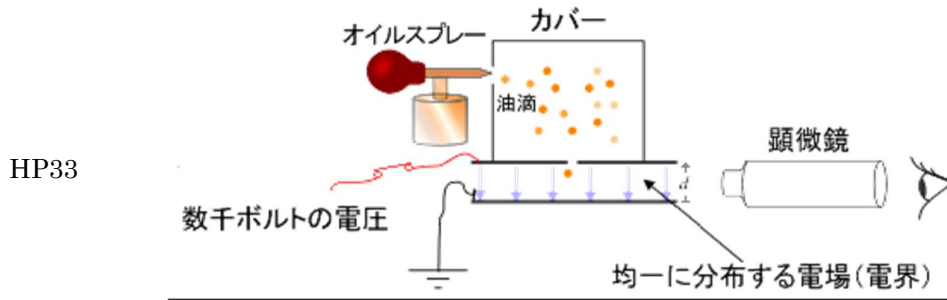

(By: Wikipedia "Millikan's oil-drop experiment")¹³

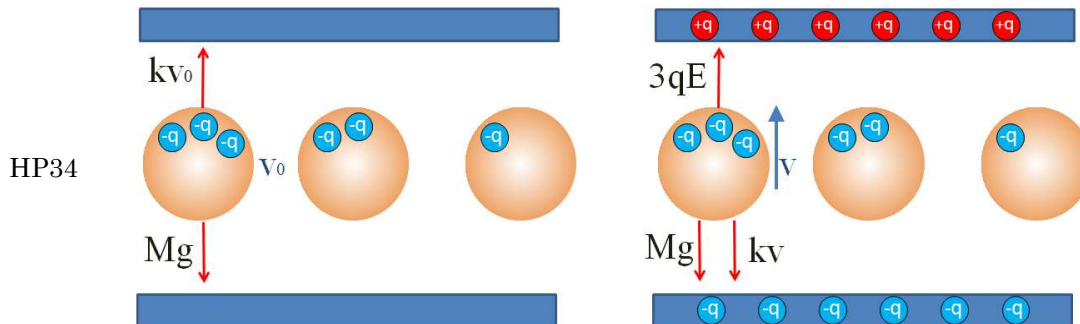

(By: "Nagatabi P to manabu koukoku buturi" in Japanese)¹⁴

When minute oil droplet is made with a sprayer, oil droplet is electrified a little. When the voltage is added to the space between the metallic polar plate and electrified oil droplets are puffed to, the oil droplets are electrified and an upward force generates. As the result, the descending speed of oil droplets becomes down. The voltage was changed and an electric charge was worked out by measuring the movement of oil droplets by gravity and Coulomb force. The size of the oil droplets is various, but the electric charges of them are an integral multiple of the numerical value of the elementary charge described previously. (Reference: "Nagatabi P to manabu koukoku buturi", in Japanese)¹⁴

It is an elementary charge of an electron, so it is $-e$. Then what magnitude is an electric charge of a proton? Of course, it's $+e$. A sign just becomes reverse to an electron, and the elementary charge is just similar. But how did they decide about an electric charge of a proton? I checked it before, but I was not able to find it. I guess it was decided as follows.

* The electric charge of the oil droplets is neutral before an experiment. The same positive

electric charge should be left because oil droplets were electrified in a negative.

*A neutron is transformed into one proton and one electron. This thing shows that a proton and an electron have the same elementary charge.

It is found that a proton and an electron have the same electric charge but each sign is different, from above mentioned two experimental facts.

So far, it's within the explanation of modern physics. Now, a model by energy body theory will be explained. By the way, the magnitude and the direction of the electric force are decided by Coulomb's law.

Coulomb's law is as follows.

The electric force that acts between two-point charges functions on the line connecting the two points and its direction will be an attractive force between the same kind of electric charge and a repulsive force between the different kinds. The magnitude of the force is in inverse proportion to a square of the distance between two electric charges. A numerical formula is shown in the next figure. Or attention is necessary to that a Coulomb force is not showing the independent force of only a proton or an electron.

Coulomb's Law

F: the size of the force is same.

: the direction is reverse

$$F = \frac{1}{4\pi\epsilon_0} \frac{q_1q_2}{r^2}$$

HP35

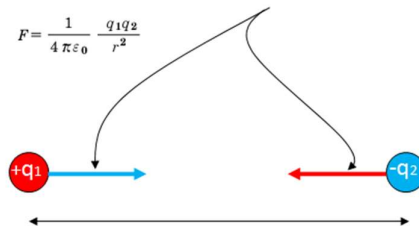

(By: Wikipedia, Coulomb's law, in Japanese) 15

This relation is akin to the man attracted by the earth, and the earth. The earth and a man pull each other with the same force.

But the overwhelming difference is between the gravity the earth makes and the gravity man makes. This thing can be similar to the relation between a proton and an electron. When the electric force of the proton and the electron is judged as being balance of an electric charge or action and reaction, a proton and an electron may be regarded as the same elementary charge. But the mass of a proton and an electron is absolutely different. An electric charge is the source of electric force and the source force is energy. And energy and mass are equivalent. Therefore, there should be the significant difference between the force by which a proton makes an electric charge and the force by which an electron makes an electric charge. The next figure draws the situation on the base of the force that makes an elementary charge of a proton and an electron of energy body model.

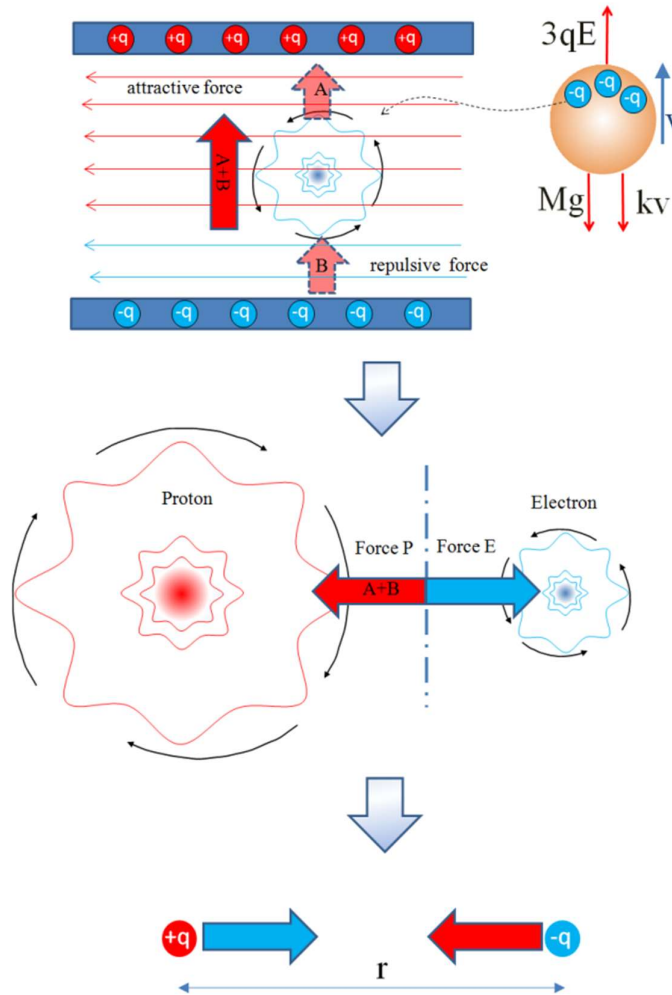

HP36

When a negatively electrified oil droplet enters in the space between two metallic polar plates, the oil droplet receives the upward force Coulomb force. (It can be reverse in the case of another polarity of a polar plate.)

Let me explain this by energy body model.

At the upper side, the direction of the undulation circulating counterclockwise of an electron coincides with the direction of the undulation of the electric field (which is formed by the undulation circulating clockwise of a proton and the undulation circulating counter clockwise of an electron) between the polar plates. So, the waves speed up, and the wavelengths get longer, then the energy level drop. Therefore the particle part of electron in high energy receives attractive force A. On the other hand, at the underside, the direction of the reciprocal wave becomes opposite. So, the waves speed down, and the wave length get shorter, then the energy level up. Therefore, the particle part of electron in high energy receives repulsive force B. The direction of the attractive force A and the repulsive force B is the same, so, the particle part of the electron receives the resultant force $A + B$. this is elementary charge e . The numerical value which is gotten by an experiment does not have to be changed, of course. This time, let us aim at one proton and one electron in the metal plate and think about an electric force of a proton and an electron. It is the figure of the middle berth on the upper figure. An electron receives the attractive force of $A+B$ described a short ago at the close area of a proton and an electron. A proton also receives the attractive force in the reverse direction to proton's one. A coulomb force is decided from the distance r between a proton and an electron, not the distance from a proton or the distance from an electron. So, a proton and an electron are regarded as a point, and the magnitude of the proton's energy and electron's energy is treated to be unrelated to it. It is drawn

in the lower berth of the above figure. Therefore, it can be that an elementary charge of a proton and an electron is the same. But, the magnitude of energy of a proton and an electron (an elementary charge) is greatly different. Further, the energy of the wave is attenuated around foot area away from the particle part of high energy, and there is little the difference of the energy between a proton and an electron. Therefore, the wave becomes neutral in a pair of a clockwise wave of a proton and a counterclockwise wave of an electron and the reciprocal action does not appear.

It is a response of energy body theory to such question that is "why does an elementary particle have an electric charge?" as modern quantum theory does not have the answer. A proton and an electron model of energy body theory are explained here once again. If the wave of an elementary particle is revolving counterclockwise on a self-axis, it is an electron and, if clockwise, it is a proton. At around the center, a revolving wave of energy body is in high energy state and appears to be a spherical shape of a particle; and at foot area, it is in low energy state and appears to be field while the wave spreads out attenuating infinitely. An electric charge stems from the change in the energy level which is caused for the direction of a revolving wave of a proton and an electron.

A counterclockwise wave of an electron functions as electric charge $-e$.

A clockwise wave of a proton functions as electric charge $+e$.

※ Progress axis; To classify a clockwise direction and a counterclockwise direction of wave, it was established.

1.2. Electron-proton coupling

An elementary particle model by energy body theory was indicated by "Common Division, 4.3. Elementary particle model". The structure of the atom by elementary particle model is explained here. When I say an atom, I think there are a lot of people who imagine a figure like the next which an electron revolves on the orbit of a proton.

HP37

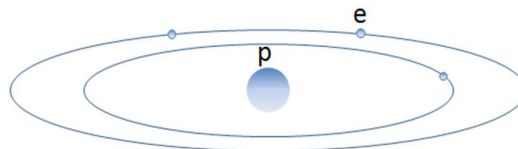

But, in quantum mechanics, it's said that an electron is the existence like a cloud that the location and the momentum of an electron are not able to be known only by a probability. But its existence probability is limited to the fixed area around the proton. And the wave function is called an orbit. The electronic number which can enter an orbit is decided every orbit, so this is called an electronic shell. (Reference: Wikipedia, "Electronic orbit", in Japanese)¹⁶

HP38

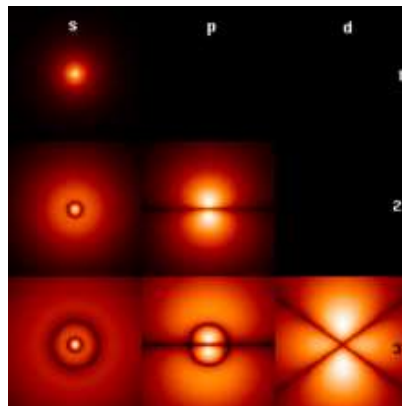

An electronic orbit in a hydrogen atom is natural mode function of the energy. (By: Wikipedia "Electronic orbit", in Japanese)¹⁶

In other words, an electron is expressed by the hazy fog of the probability, not a point. A figure expressed this next.

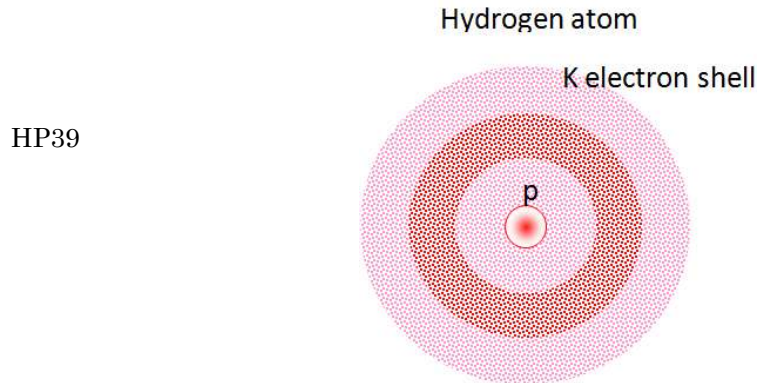

(Reference: Wikipedia, "Electric orbit", in Japanese) ¹⁶

And it's Schrodinger's wave equation by which the location and the momentum of an electron are worked out. It is decided how many electrons are disposed on the orbit of an atomic nucleus and on which orbit they are put according to the solution of Schrodinger's wave equation, which is obtained by designating three quantum values called the principal quantum number (the energy of the orbit) n , azimuthal quantum number (the shape of the orbit) l and magnetic momentum (the way to the orbit) m_l .

But, it's only a hydrogen atom, of which the atomic nucleus is composed of one atomic nucleus and one electron, that this equation can be solved strictly. An ordinary atom with a lot of electrons will be purchased by resemblance. Then various efforts are being made to the relation between the atoms (chemical bonding). (Reference: Zatugaku Noto, in Japanese)¹⁷ Moreover there is the next regularity in the electronic number disposed in an atomic nucleus.

* Pauli's exclusion principle: An electron is a fermion, so only two electrons with spin m_s of opposite direction can enter one orbit each other. (Reference: Wikipedia, "Electron configuration", in Japanese)¹⁸

* As far as it's permitted over the electron configuration, the arrangement which makes the spin parallel and puts an electron in a different orbit is the stablest electron configuration. (Reference: Wikipedia, "Hund's law", in Japanese)¹⁹

Thus, a complicated analysis is needed about atomic electron configuration with many electrons.

HP40

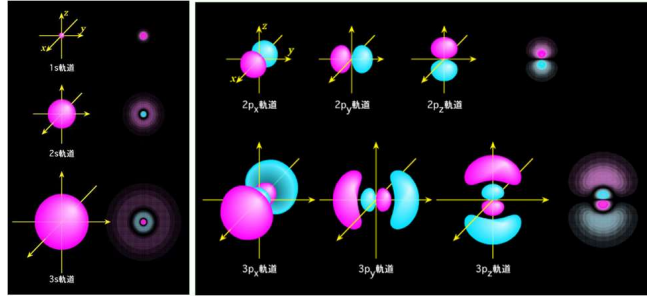

(By: Zatugaku noto -kagakuketugo no hanashi- in Japanese)

HP41

主量子数 (電子殻)	方位量子数	磁気量子数	軌道名	収容できる電子数
1(K殻)	0	0	1s	2
2(L殻)	0	0	2s	2
	1	0, ±1	2p	6
3(M殻)	0	0	3s	2
	1	0, ±1	3p	6
	2	0, ±1, ±2	3d	10
4(N殻)	0	0	4s	2
	1	0, ±1	4p	6
	2	0, ±1, ±2	4d	10
	3	0, ±1, ±2, ±3	4f	14

(Reference: Wikipedia, “Electron configuration”, in Japanese) 18

By an energy body model, the connected state of an electron and a proton will be explained using the simplest hydrogen atom. A hydrogen atom consists of one proton and one electron. An electron does a precession by a movement of the undulations of a proton which revolves in the right direction and of an electron which revolves in the left direction while revolving on the orbit of a proton. Therefore, the location of the high probability that an electron exists becomes belt like. It's the location of the red band in the next figure. The center of the precession is the highest existence probability, so it's made dark red.

HP42

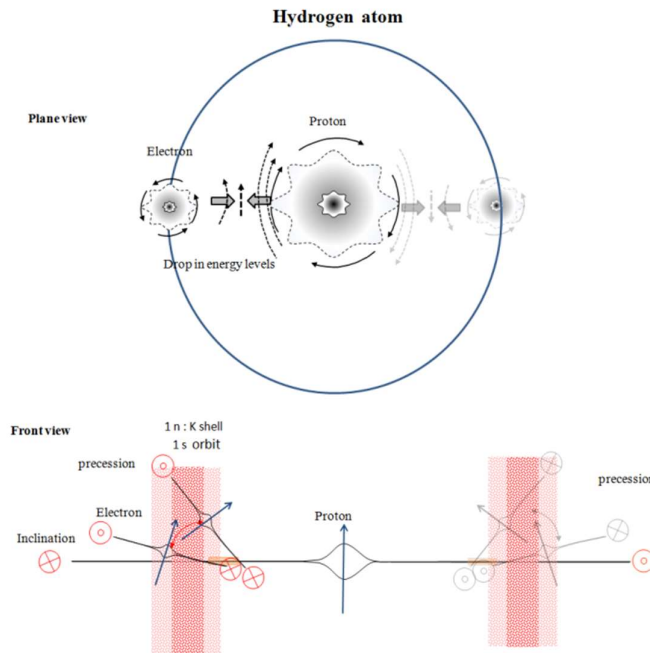

An electron tilts the posture, meets a proton and connects. The proton's revolving wave in the right direction and the electron's revolving wave in the left direction moves in the same direction between an electron and a proton. Therefore, their waves get faster and the wavelength develops, then the energy level will fall. As a result, the energy tries to move to the low energy area of the wave foot from the high energy area of the particle part of the wave. Attractive force is created by this and a proton combines with an electron. By the way, the reason why an electron tilts its posture is that the number of the nodes of the electron's knots must choose the location which becomes a numerical integral multiple of the nodes of the proton's wave.

The wavelength of electron's wave and proton's wave is spreading out while attenuating from its center, so it is possible to decide the location where the mutual energy level and the number of wave's node matches as an orbit.

But, the orbit is not a line, but is in some breadth, because, it undergoes the influence of a vertical motion of each circulating undulation of an electron and a proton. Moreover, the posture of the electron declines, and the waves of a proton and an electron spread out attenuating.

A plus one of a proton and a minus one of a proton deny each other, and an electric charge will be 0. However, an electric charge does not become zero only by one atom, but when countless atoms are collected, the waves face and move in the various, and as a result, an electric charge becomes zero. A hydrogen atom is the simplest shape. But this time, let us view an atom, helium which has one more electron than hydrogen in a figure next.

HP43

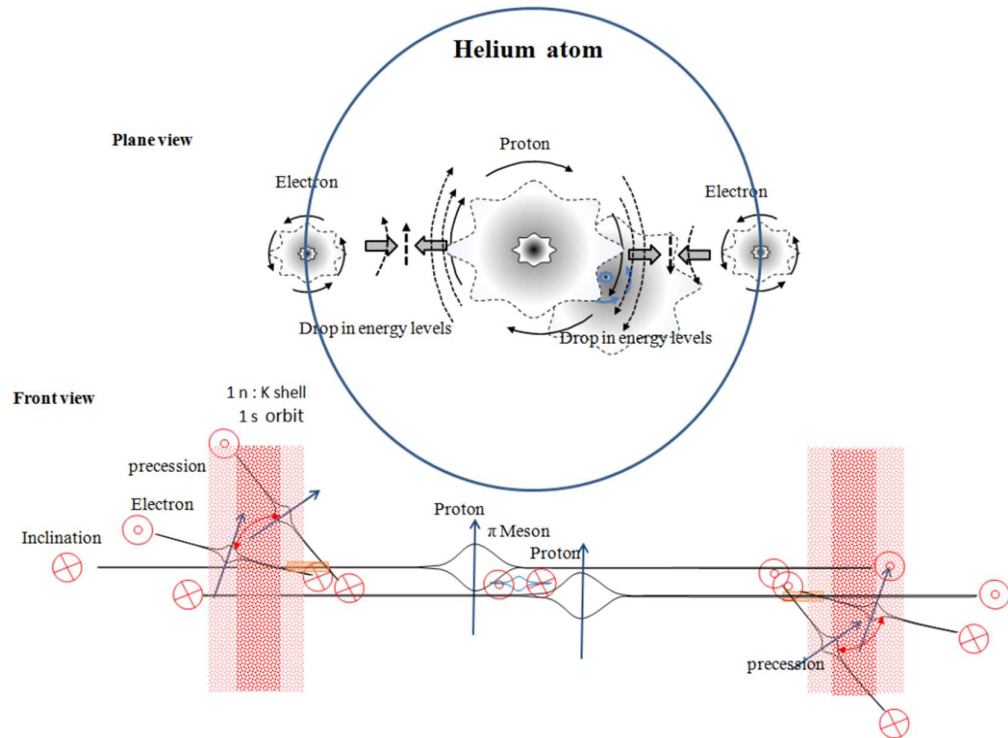

Plane view

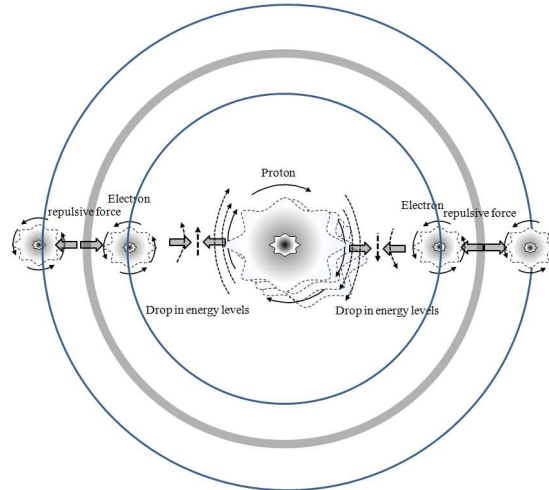

HP44

Front view

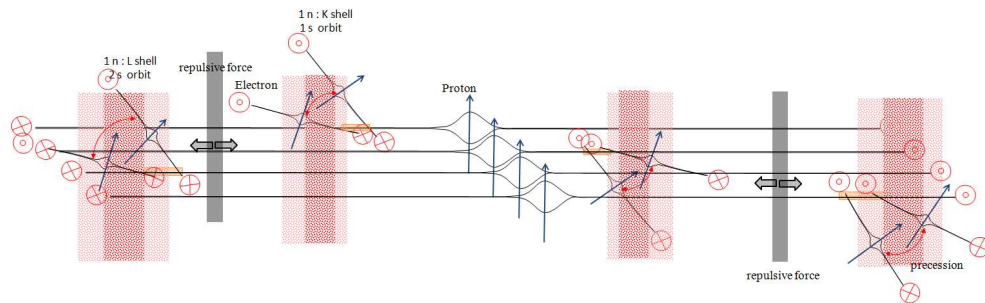

One electron increased, so two protons are needed. The increased electron will be to combine with the increased proton. In the case, the waves of two protons are synchronous, and it may be seen as one wave. It's Pauli's exclusion principle to remember here. The principle that says, "An electron is a fermion, so only two electrons with opposite direction of spin m_s each other can enter one orbit" The waves of the two electrons are both the same counterclockwise, but when it is judged from a proton, two electron's waves become reverse at the left side and the right side of the proton. The left side electron locates in the upper part of the proton's face and the right-side electron locates in the lower part, for a dynamic balance. And let us see the 2S orbit of a L shell where more electrons increased in 4. The P orbit is complicated and it cannot be predicted by an energy body model for the moment.

The feature of L shell is that an orbit becomes wide and the band where electron's existence probability is zero appears. That is a part of a black band on the upper figure. It is expected that the orbit is widen, because as the wave length of revolving wave of a proton becomes wider and wider according to the distance from the central part, an electron's precession gets larger and larger. The reason that the band where electron's existence probability will be a zero appears is also explained by an energy body model. The next is the atomic figure drawn typically.

The direction of the electron's wave between the orbit 1s and the orbit 2s revolves in an opposite direction each other at a place where they face each other. It is showed on the figure.

Therefore, the speed of the wave becomes slow and wavelength becomes short, so the energy level rises. As a result, repulsive force acts, and the electron is detached. This is the reason that the band where an electronic existence probability becomes zero is made.

By the way, I think a hydrogen molecule seems to be the next figure.

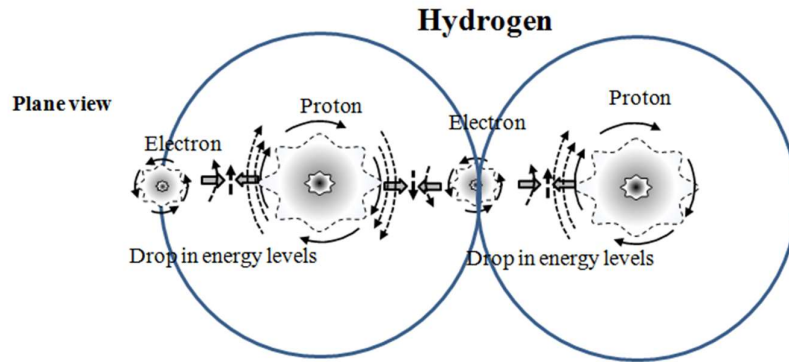

HP45

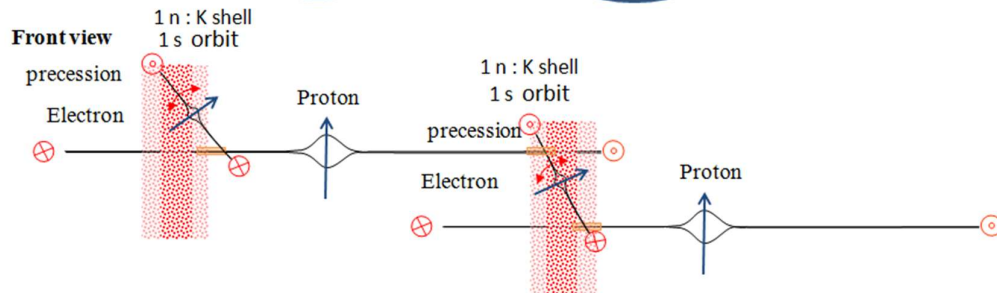

1.3. Electronic transition

HP46

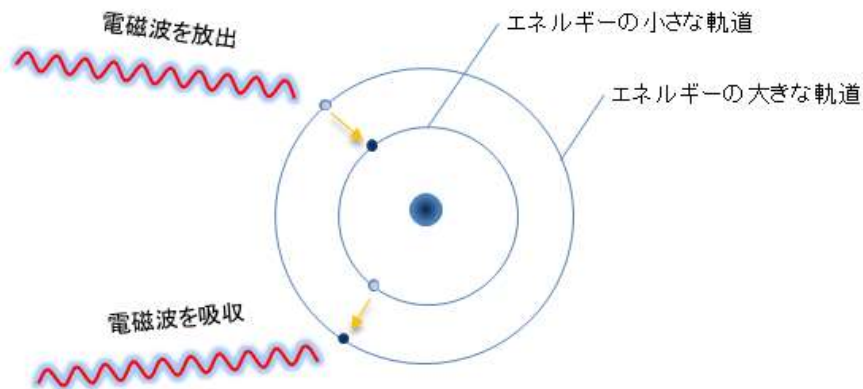

By the way when an electron reaches excited state, why it radiates light and returns to the orbit with the low energy level? It's possible to explain this as follows by an energy body model.

An electron's wave and a proton's wave spread over infinitely (in the countless electronic set) while attenuating the energy continuously, so its wavelength becomes longer proportionally to the distance from the center. In other words, the wavelength of a proton becomes longer and longer consecutively as it gets far and far away from the center, the wavelength of the electron is also same. The location where the nodes of both waves of a proton and an electronic will be an integral multiple can become stable. If a gear is stage-less, one rotary shaft follows the other, and revolves, so the location is not chosen, but the wave of a proton and an electron are circulating independently each other, so it should become unstable immediately. So, the posture of the electron must tilt to the way of the proton as shown in the figure. Because it is not possible to get the location where the nodes of the mutual wave will be an integral multiple, if not tilting. At this time, the character of the electron's polarization plays a significant role. The wave of an electron and a proton can strike the pose which becomes parallel each other, but the pose which

becomes right-angled cannot be struck.

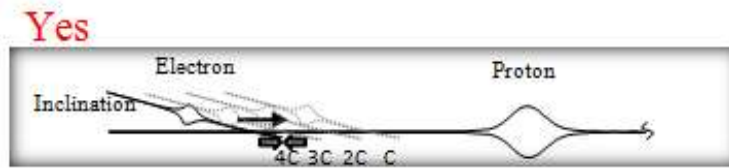

HP47



This character of polarization achieves the very important role in an electromagnetic phenomenon. Therefore, an electron connects a proton tilting to the horizontal plane of the proton. It is thought that an electronic orbit is unstable in the width which is multiplied the rake angle of the electron's posture and the amplitude of vibration of the wave together. When an atom gets in excited state, an electron shifts to the outside orbit with the higher energy level, but the reason is because the revolving waves of a proton and an electron spread while attenuating. Please see the next figure. When an atom is excited, the inclination of the amplitude of vibration of the wave in the foot part of a proton and an electron becomes sharp-angled.

HP48

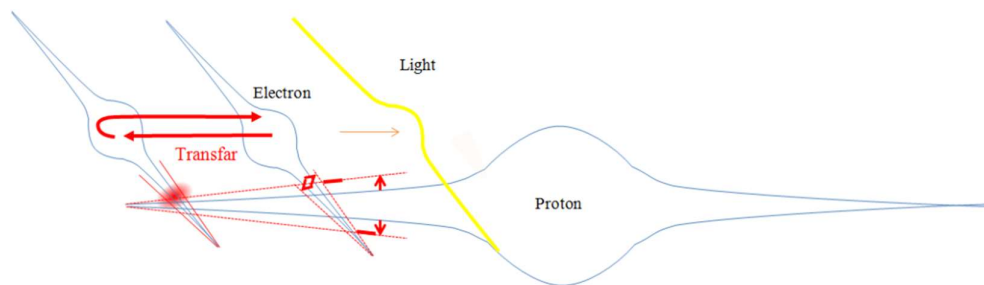

In other words, it looks like that the foot part of proton's wave which is regarded as one side of a seesaw is lifted. The electron on the foot part of proton's wave is unable to put up with the inclination and slips down. (Note: After lifting an electron, (After the energy was changed into an electron.) it returns in the original state, so a seesaw in the foot part of proton's wave is not still rising.) The proton and the electron face each other at acute-angle, so, when it's viewed from an electron, a reverse thing happens. At the time, the electron does not slip down smoothly because of nodes, so it halts halfway and the distortion left in the foot part of electron's wave. When an electron gives way under this distortion, it returns to the original location. The foot part of a proton's wave has transferred the energy to the electron and has returned in the normal state at the same time, so an electron returns to the original location momentarily without resistance. And an electron radiates the energy that it returns to the original location transcribing its shape into the static energy body as photon.

This is observed as a bright line spectrum (or emission spectrum).

Further, it's confirmed as attention once again that the posture of an electron turns its plane faces to the moving direction of an electronic transfer. (See: Particle Physics Division, "2.5. Phase transition")

Addition

Why an electron is deprived of the energy in a circular movement and is it not pulled to an atomic nucleus?

When a particle with an electric charge makes circular movements, it should radiate energy which is equivalent to the number of its revolutions. As a result, the particle should lose the energy and be pulled to an atomic nucleus, but it does not happen. Concerning it, there was no answer before 1913. Also, it was learned that an atomic emission spectrum is limited to only a specific spectrum. So, Niels Henrik David Bohr proposed a new atom model that the particle in a static state does not release an electromagnetic field, when the particle moves in an orbit, but the particle emits a specific spectral light, when the particle transfers the other orbit. (Reference: Wikipedia, "Niels Henrik David Bohr's atom model", in Japanese)²⁰

Niels Henrik David Bohr's atom model settled a spectral problem, but concerning an electronic movement, later, de Broglie made clear that an electronic movement is indicated by existence establishment, not that an electron revolves on an orbit. (Reference: Denki no Rekishi Irasutokan, in Japanese)²¹

Now, the answer to the first question "Why the electron in a circular movement is not deprived of its energy and is not pulled to an atomic nucleus?" is as follows. Movement to the progress axis direction of an elementary particle will be the face direction by an energy body model, so the electron's posture is copied into static energy body which is space, but the movement to the right-angle direction of a progress axis will be a line, so it cannot be copied into static energy body. Therefore, electromagnetic waves (light) are not emitted in the orbit direction of an electron, so the energy is not lost.

The next figure expresses the direction of electronic motion in the case that an electromagnetic wave is radiated in an electronic energy body model. Light (electromagnetic wave) is a transcription of the electron's posture into static energy body by an energy body model. (See: Particle Physics Division, "4.1. Generation of light") In other words, Light (electromagnetic wave) is a transcription of the electron's revolving wave into static energy body. But, it is a copy, so the energy of the particle part of an electron does not shift.

It is obvious that when an electron moves to the electronic progress axis direction, an electromagnetic wave is radiated, but an electron moves to the right-angle direction, an electromagnetic wave is not radiated.

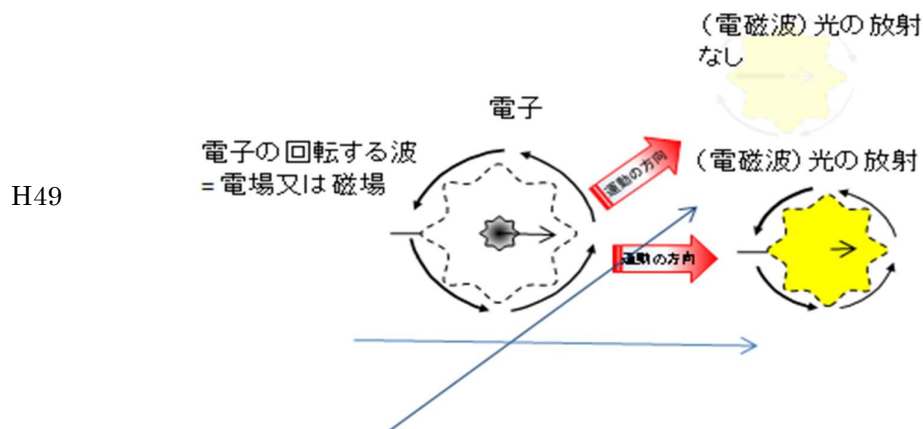

1.4. Magnetic dipole

There is a magnetic dipole in the important nature of an electron. The reason for the dipole is because there is no magnetic charge in magnetism like an electric charge. (See: Particle Physics Division, "3.1 Electromagnetic field") N pole and S pole are always observed in pairs. And its

smallest unit is regarded as a magnetic moment which derives from an electron's own spin. Moreover, another cause of magnetism is observed. It is a magnetic moment which derives from the orbital angular momentum of the electron in the atom. (Reference: Wikipedia, "Magnetic charge", in Japanese)²²

HP50

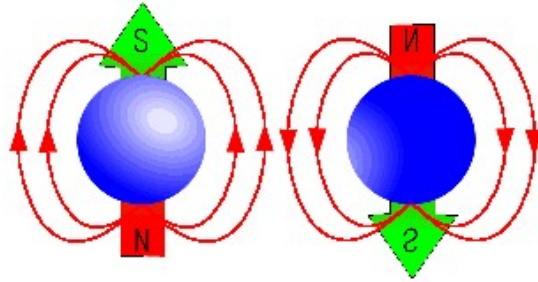

(Reference: Denki no Rekishi Irasutokan, in Japanese)²¹

The word called spin has come out. It is in the explanation that a magnet is made with the essential nature of an electron which is called the spin. A magnetic field is the foot area of electron's revolving wave by an energy body model. It is suitable for a spin of a quantum theory, including a particle part of an electron's wave in central area. The foot area and the central particle part are the cause of magnetism, and that is same in quantum theory and energy body theory. So, the consistency is kept. But, the spin in quantum theory is the one like the rotation that it's possible to take the value of an integer or of 1/2, and is a concept different from the electron's revolving wave of an energy body model. (See: Particle Physics Division, "1.5. Real nature of spin") Then an electron also have the nature of the magnetic dipole as well as the electric charge at the same time. There are two magnetic poles in one electron which is an elementary particle of the last smallest unit? Moreover, is there an electric charge in one electron? A question springs. It's impossible for an elementary particle (electron) which is the smallest unit of the substance, to have the three different aptitudes, which are an electric charge, N pole and S pole. But, an energy body model can remove this irrationality. See the figure of the next solenoid coil. The upper side figure is hard to see, so please check the underside figure.

HP51

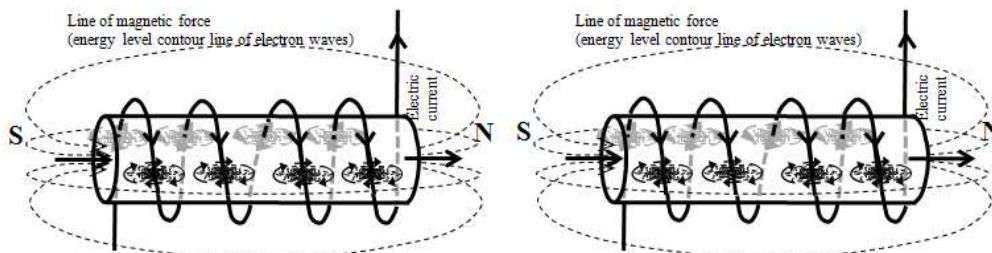

HP52

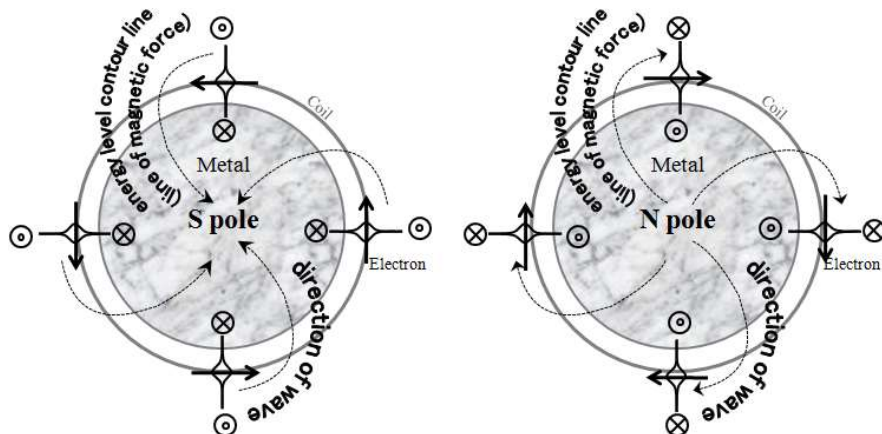

The posture of electrons which advance in the coil is averaged and expressed as an energy body model. Electron's posture as well as progress axis is reversed at 180 degrees at the opposite side of the solenoid coil and the near side. Therefore, the direction of the electron's wave which circulates focusing on an electronic self-axis is also reversed focusing on an axis of a solenoid coil. As a result, if the electron's wave is viewed from the whole solenoid coil, it goes out of the N side and enters the S side. An electron's wave is a magnetic field, isn't it? That's right, the N side is an N pole and the S side is an S pole. A solenoid coil became a magnet. Then, let an N pole and an S pole of two magnets bring close to. An electron's wave goes in the same direction. Therefore, the wave speeds up and the energy level falls. And high energy inside the solenoid coil tries to move to the low energy part. This is the cause that an N pole of a magnet and an S pole attract each other.

This time, let the same poles as N poles or S poles bring close to. An electron's wave goes in the opposite direction each other and repulsive force works. Oh? Someone would think that "magnetic dipole" of the nature an elementary particle has not come out in the explanation. That's right. The concept of a magnetic dipole is not necessary by an energy body model. I would like to do one of comment here. It's a slip to assume that an electron has the nature of a magnetic dipole by a present-day theory of elementary particles.

A pair of the electron which their postures are reciprocally in reverse forms an N pole and S pole, because the revolving wave of each electron goes in opposite direction between them.

HP53

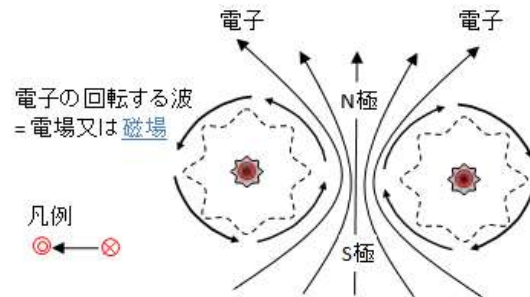

It is for this that a magnetic field is not generated by linear electric current, but it is by loop electric current. But, both ends of linear electric current are also connected after all, so it can also be called loop electric current... Thinking so, it is strange that an N pole and an S pole are not generated around a lead, regardless of linear electric current or loop electric current; if an electron has a nature of a magnetic dipole, in the way that modern theory of elementary particles admits. An energy body model can be also proved to be right from this thing.

Yes

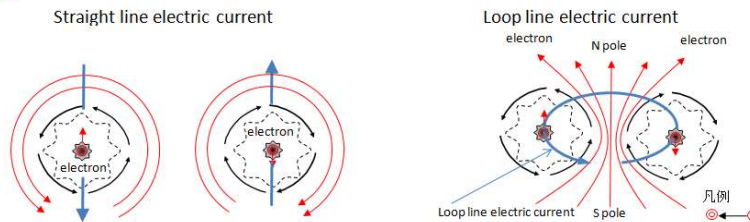

HP54

No

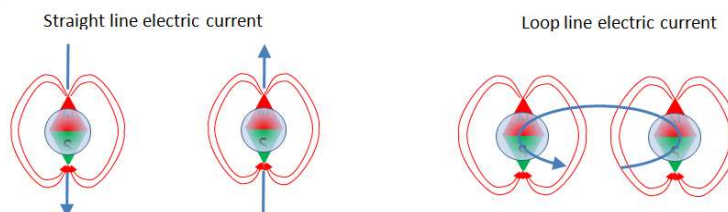

1.5. Real nature of spin

I touched a little about the spin angular momentum in the article of "1.4 magnetic dipole". An elementary particle has a character of spin angular momentum which causes a magnetic pole.

The spin angular momentum is the angular moment that a quantum mechanics-like particle has primarily, and it is explained that it is not possible to be described by the position and the momentum. Briefly speaking, it is thought like a rotation of an elementary particle. Being explained about an electron, an electron has a magnetic moment which corresponds to spin, so when an electron is put in the magnetic field, it has the energy different for a direction of spin. But, it is the point that the spin is not the same as a rotation on its axis. It's because if the spin angular momentum is derived from electronic rotation, an electron must have a size and rotate at beyond the light speed. And that is inconsistent with theory of special relativity. (Reference: Wikipedia, "Spin angular momentum", in Japanese)²³

It is explained that a loop-like electric current has a magnetic moment by "1.4 Magnetic dipole". The form and the posture of the electron of energy body model are related to that. Its nature of spin angular momentum and relation with magnetism have been investigated to the limit by modern physics, and elucidated. But, since a real nature of an elementary particle isn't caught yet, so its essential form is in the dimness as an intrinsic form of angular momentum in quantum mechanics. For that, it is not possible to answer to the more fundamental question, "When an electron carries spin, why is a magnetic action created?" The energy body theory which saw through a real nature of an elementary particle, answers to this question. Before that, let see the spin angular momentum a little more conversantly. In quantum field theory, an electron is not a particle but is described as an electronic field. And an electronic field has a property like the polarization of an electromagnetic field, (Does the direction of an electromagnetic field revolve clockwise or revolve counterclockwise?). This is spin and is something like a field rotating, so the angular moment is accompanied."

There is the description in "An electron is described as an electronic place, not a particle by a quantum theory in a place, and an electronic place has the attribute like polarized light (Does the direction of the electromagnetic field revolve clockwise or revolve counterclockwise?) of the electromagnetic field. This is spin and is something like a place's rotating, so the angular moment is involved." in the explanation of "Wikipedia, Spin angular momentum, in Japanese"²³.

In other words, spin has an attribution that resembles polarization of light, and is something like a rotation of a field. Almost all the cause of electromagnetic phenomena can be asked from the nature of polarization carried by an elementary particle model of energy body theory. The cause that an electron or a proton has the nature of the polarization is because the foot area of wave of an electron or a proton spread thinly and infinitely attenuating. In other words, the foot area of the wave is an electronic field or an electromagnetic field. And a wave of energy body is rotating. It's a wave motion, so contradiction with special relativity does not also form. By the way, there are two kinds of spin. One is the orbital angular momentum that an electron goes around the orbit of a proton. And the other one is spin angular momentum that looks like as if an electron itself is revolving in spin. These things will make sense when you think about an elementary particle model of energy body theory. The foot area of an electron's revolving wave is a magnetic field. So, an electron's movement on the orbit of a proton and the rotation of an electron itself undergo the influence in a magnetic field which is a wave of electrons. The spin angular momentum is that an electron has different energy for the direction of its spin, when an electron is put in the magnetic field.

Let us see the process until it is considered that an elementary particle has the nature of spin angular momentum, while looking back to "the experiment by which a spectrum of sodium is observed (Zeeman Effect)" and "experiment of a magnetic moment using Stern and Gerlach equipment" a little here.

Zeeman Effect is the phenomenon that the electromagnetic wave released from an atom is one spectrum line (the single wavelength) if the atom is in no magnetic field, but it splits into plural ones if the atom is put in magnetic field. Dutch physicist Peter Zeeman found that a spectrum of the D line is divided into several, when he made a sodium atom luminous in the magnetic field in 1896. It was found that there is also a more complicated split in the split of a D line of sodium which Zeeman found first, This was not able to be explained by classical electromagnetism, then after it was found, for a long time it had been a mystery. (Reference: Wikipedia, “Zeeman effect”, in Japanese)²⁴

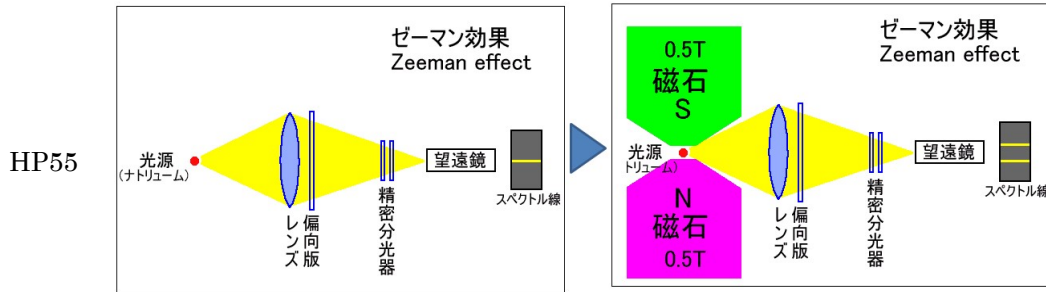

(Credit: Denki no Rekishi Irastokan, in Japanese) ²¹

HP56

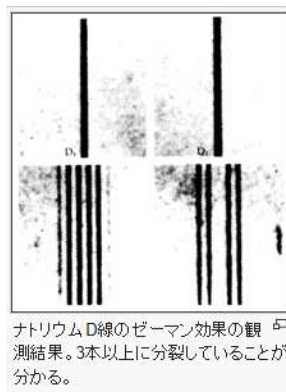

(By: Wikipedia, “Zeeman effect”, in Japanese)²⁴

But, it came to be interpreted that an electron has a magnetic moment, because of the "experiment of Stern = Gerlach" conducted by Stern (Otto Stern) and Gerlach (Walther Gerlach) in 1922. It was observed that a beam was divided into two as a result of the experiment. This means that there is only one state between the two states that the size of the magnetic moment of silver particle in the beam is equal, and the direction is pulled or repulsive to a magnetic field, so it is treated as an electron has the attribute of spin 1/2 by quantum mechanics. It is assumed that a particle gets only the state of two, "looking up" (+1/2) or "declining" (-1/2) to the direction, if an experimenter sets up a characteristic spindle (quantization axis) to a particle of spin 1/2 in the optional direction. (Reference: Wikipedia, “Experiment of Stern = Gerlach”, in Japanese)²⁵

HP57

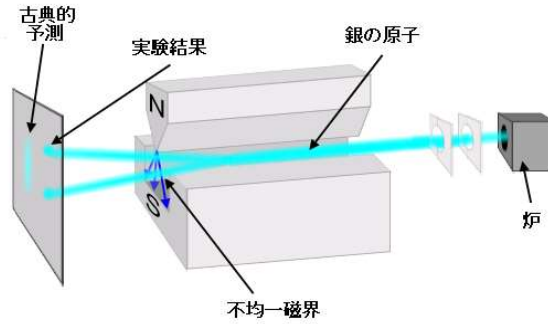

(By: Wikipedia, "Experiment of Stern = Gerlach", in Japanese) 25

In other words, an electron has a magnetic moment of two states that the size is the same and the direction is different; in one direction, an electron is pulled to a magnetic field and in another direction, an electron is repelled by a magnetic field, was understood from an experiment of Stern = Gerlach. More from this thing, the Zeeman Effect came into explanation for a D line of sodium splits. But, an electron has a magnetic moment, so it seems to be spinning but as I explained first it come to be inconsistent with theory of special relativity if it is really spinning. Therefore, the spin is said to be something like a field's rotating.

[1. Spin angular momentum]

It is not possible to explain why an electron magnetic moment takes the value of the magnetic quantum number+- of 1/2 by modern physics such as quantum field theory. Energy body theory also explains this. Let us begin from the experimental result of Stern = Gerlach. When an electric charge moves in a ring, a magnetic field occurs. At that time, the relation between the angular moment and the magnetic moment is on a figure next.

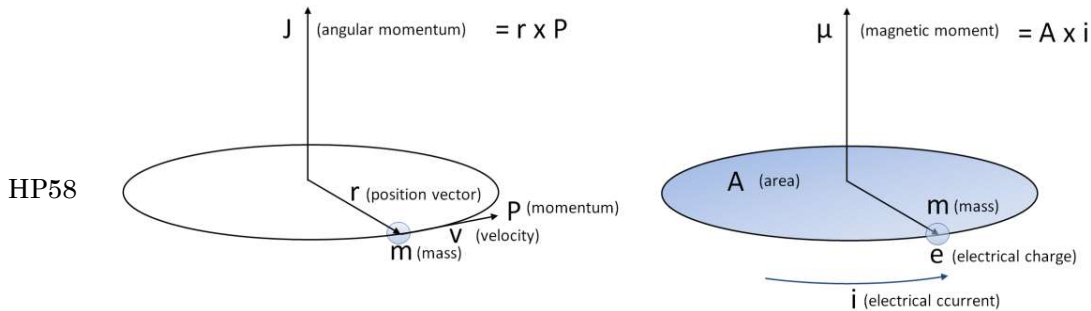

An experimental result of Stern = Gerlach showed that an electron has a magnetic moment, so the above figure of a circular electric current is applied and considered. Let an electronic revolution regard as equal to that an electric charge is revolving around the electronic surface. Let the upper figure revolve forward just 90 degrees, and it is made a plane of an electronic energy body model. A wave of an electron of an energy body model revolves counterclockwise. A magnetic force line faces to the lower parts from the top.

The direction of the electron's wave and the direction of the magnetic force line are same at the left side of the electron and opposite at the right side.

Therefore, energy level of energy body falls and attractive force occurs, but conversely at the right side of the electron, energy level of energy body rises and repulsive force occurs. If all magnetic force lines face just to the below, there will be no ingredient of force facing to the upper side, in attractive force and repulsive force which occur at electron's left side and right side. For that reason, the electron would go in the left direction. But, at the left side of the electron, the magnetic force lines tilt in the experiment as shown in the next right figure, so upward force occurs as an ingredient. But, at the right side of the electron, both upward force and downward force as an ingredient do not occur, and just only the repulsive force in horizontal direction occurs.

As a result, the magnetic moment of the electron occurs only at the one side of the electron. On the other hand, the spin angular momentum is made in the same size at the electron's left side and right side (the direction of the spin angular momentum is opposite each other.) as shown in the left figure. It is because that the spin angular momentum must be the same force at right and left. Therefore an electronic magnetic moment becomes 1/2 of the spin angular momentum.

HP59

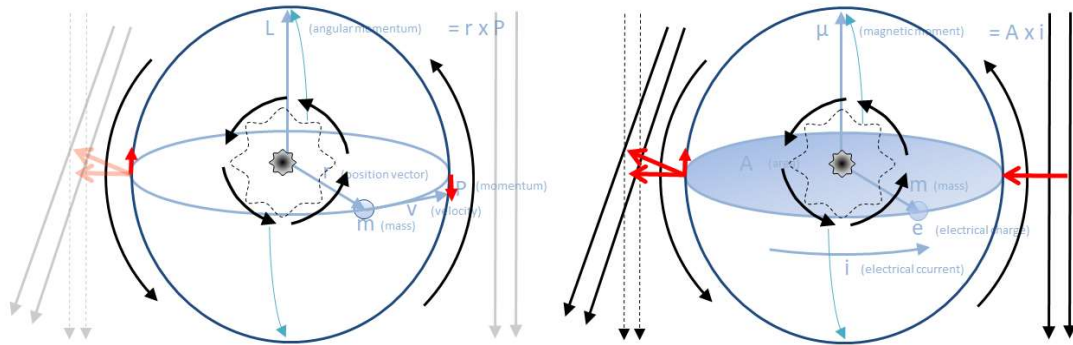

Again, it's explained from an experimental figure of Stern = Gerlach.

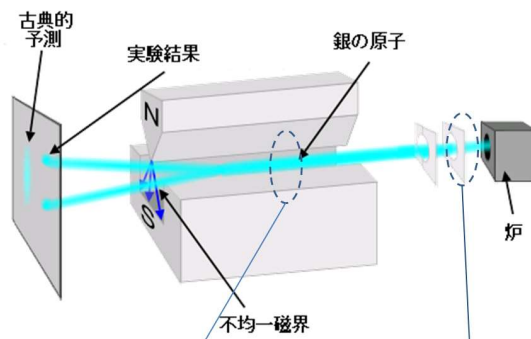

HP60

Electrons polarized by lines of magnetic force in plane view

The posture of the electrons in the spherical whole aim

Electrons polarized by lines of magnetic force in front view

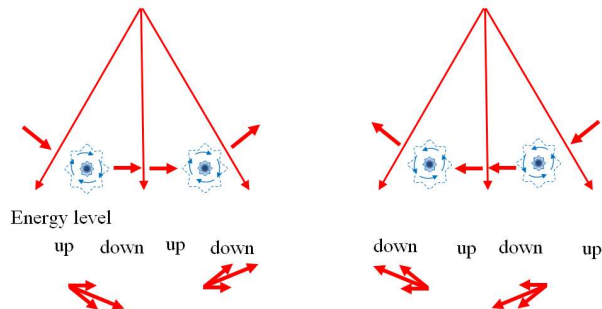

The silver electron which became steam in the hearth strikes the pose of spherical whole aim. And let it run through the magnetic field. An electron adjusts its posture parallel to a magnetic field in the magnetic field. But it is still possible that the posture of the electron parallel to a magnetic field revolves 360 degrees around a magnetic force line. Over the posture of this electron, the most standard posture is the posture which becomes perpendicular to the direction of silver's movement (the posture viewed from the left side of the device). In this case, there are two types of electron's posture revolved 180 degrees each other that is in the relation of the front and back. (See: Particle Physics Division, "4.5 Refraction and reflection of light") When an electron of these two types of posture is taken out and is put in the non-uniform magnetic field, there are 4 kinds of form as shown in the figure of the lowest berth in the figure above. Attractive force and repulsive force are generated according to the direction of revolving wave of an electron and a magnetic field, but a vector is two types of upward and downward. A magnetic moment of an electron becomes $\pm 1/2$ from the above-mentioned thing.

[2 Orbital angular momentum]

One thing causing an electronic magnetic moment is an orbital angular momentum. When an electric charge moves circularly, a magnetic field occurs. But I think a very important misunderstanding to the posture of the electron which revolves on the orbit might occur here, so attention is needed in particular. I suppose that people might be apt to think the posture of the electron on the orbit of an atomic nucleus tilts perpendicularly to its course as shown in the right figure of the next, because the magnetic field can be made a direction of movement of an electric charge (electron) perpendicularly by loop electric current. But this is a slip to the orbit of an atom. The posture of the electron strikes the pose which meets the proton which is the center of the orbit as shown in the left figure in the next.

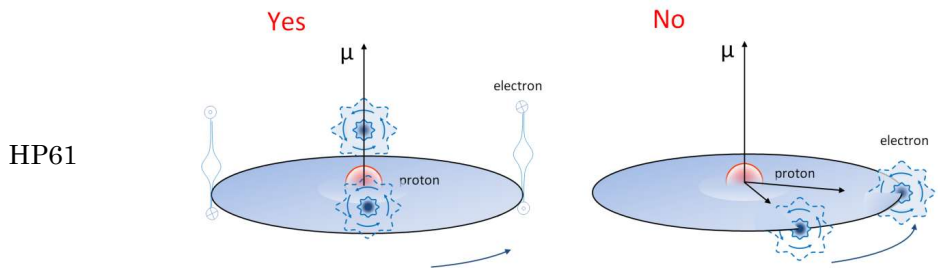

The reason is because the number of the nodes of the proton's wave must be an integral multiple of the nodes of the electron's wave. (See: Particle Physics Division, "1.2. Electron-proton coupling") it's different from loop electric current. (See: Particle Physics Division, "1.4. Magnetic dipole", and "3.2. Faraday's law of induction".) When a magnetic field is applied to the electron revolving on the orbit of a proton, an electron moves to the location where the electron's plane posture becomes parallel to a magnetic field, and the electron is fixed there. Its situation is shown in the next figure, and the electron is fixed on the left or on the right of an orbit of proton.

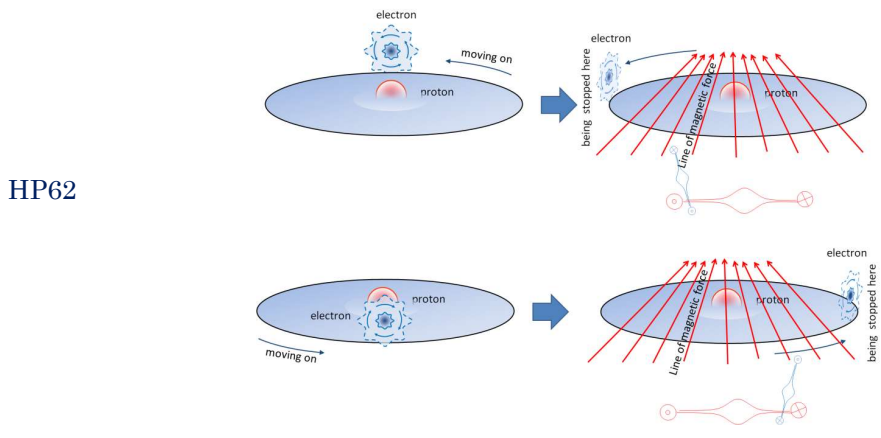

In the next figure, the location and the posture that an electron on the orbit of a proton can take in a magnetic field are drawn as a bird's-eye view. It is found that there are four kinds of posture at the top and the bottom of the left and the right.

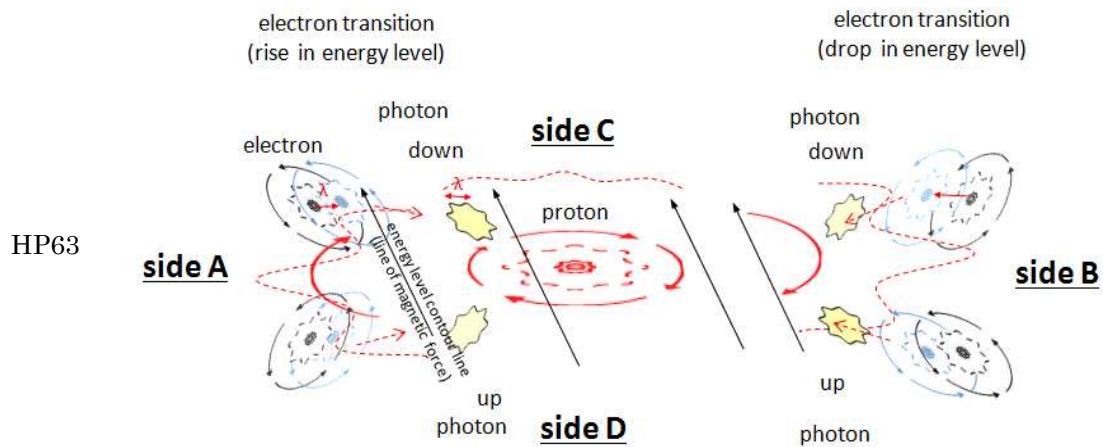

When an electron transfers in an orbit of the low-level energy level, light is radiated. (See: Particle Physics Division, "1.3. Electronic transition", and "4.1 Generation of light") Light (electromagnetic wave) is a transcription of the posture of an electron into static energy body that is made when an electron changes its posture or location, in energy body theory. It is like an arrow that is shot off, after drawing the bow to its full extent. Therefore, the distance to which an electron transferred is the thickness of the light in other words the wavelength. An electron's pose becomes parallel to a wave of a proton. When a magnetic field is applied here, the pose of an electron becomes parallel to both the wave of a proton and a magnetic force line. It comes to the location of the side A and the side B on the above figure. It does not come to the location of the side C and the side D. Moreover, the posture of the electron of the side A and the side B have the posture of each up and down, so there are four kinds of posture altogether. When an electron transfers in the inner orbit of the lower energy level, it results in advancing in the magnetic field, so the locus of the electron can warp a little in up direction or down direction because of tilting electron's posture. At this time, the change of an electron's posture is to the plane direction of an electron, so the form of an electron is copied into static energy body (which is space). As a result, light occurs. So, the spread of the light is equivalent to the electron's spread and the thickness (the wavelength) of the light is equivalent to the distance of the electron's transfer.

Light is drawn by a small circle of wave in the above figure, but in actual condition, it spreads over infinitely (When there are numberless electrons.)

It's little, but this wavelength is divided into 2 spectra.

The electronic transition at side A is bound for right side, so the direction of the electron's wave (point of a direction of movement) is also the same direction as the magnetic force line (both up and down). Therefore, electronic transition speed is accelerated and the wavelength of the radiated light becomes a little short.

The electronic transition at side B is bound for left side, so the direction of the electron's wave (point of a direction of movement) is the opposite direction to the magnetic force line (both up and down). Therefore, electronic transition speed is decelerated and the wavelength of the radiated light becomes a little long.

Further moreover there is a little energy difference between the light from side A and the light from side B, due to a relation between the direction of the electron's wave and the direction of the magnetic force line.

- The energy level of the side A is high a little.
- * The wave of an electron on the upper of side A is in the same direction as a magnetic force line at upper side, but in the opposite direction, at under side.
- * The wave of an electron on the under of side A is in the same direction as a magnetic force line at upper side, but in the opposite direction, at under side.
- The energy level of side B is low a little.
- * The wave of an electron on the upper of side B is in the same direction as a magnetic force line at upper side, but in the opposite direction, at under side.
- * The wave of an electron on the under of side B is in the opposite direction as a magnetic force line at upper side, but in the same direction, at under side.

The posture of an electron on a proton's orbit in the magnetic field was drawn as a front view once again. A figure of the upper berth in the next figure is the electron on a higher energy orbital in excited state. And the figure of the lower berth shows the situation that an electron gets in ground state and transferred to a lower energy orbital.

HP64

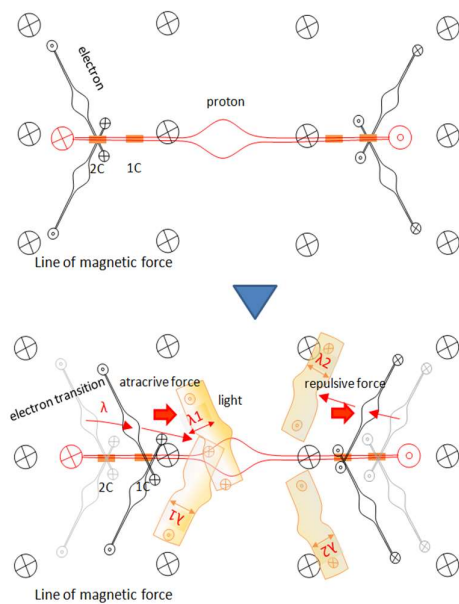

1.6. Wave-particle duality of electron

Light (electromagnetic wave) is a transcription of the posture of an electron into static energy body that is made when an electron changes its posture or location, in energy body theory.

(See: Particle Physics Division, "1.3 Electronic transition", "3.1 Electromagnetic field", "3.3 Electromagnetic wave", "4.1 Generation of light", "4.2 duality of particle and wave", "4.4 Principle of light speed invariable 2", and "4.6 Doppler effect") So first, I would like to explain wave-particle duality of electron by an energy body model. There is a famous experiment which shows that an electron has the character of a wave motion and a particle.

A double slit experiment is the experiment which indicates a duality of a particle and a wave motion typically. Richard Phillips Feynman called this "quintessence of quantum mechanics". One electron was used instead of the light used in Young's experiment. Electrons are shot from an electron gun and are made reach a dry photographic plate. A board with two slits is put on the way of the electrons where is vacuum. When electrons through a slit reached at a photographic plate, punctuated scars are left on the photographic plate. When a lot of electrons are launched, punctuated scars of electron are drawn on the photographic plate as striped pattern of the shade. The striped pattern is the same as an interference fringe of a wave, so it indicates that an electron has a nature of wave. There was an opinion that "Behavior of a lot of particles formed the nature of a wave." as interpretation on this. But even if electrons are shot

one by one in this experiment, the same result is obtained, or after it is repeated many times to make them shoot one electron at one time, if the aggregate of punctuated scars of electron is watched, a similar interference fringe has formed as expected. (Reference: Wikipedia, "Double slit experiment", in Japanese)²⁶

The next figure is a schematic diagram of an electronic double slit experiment.

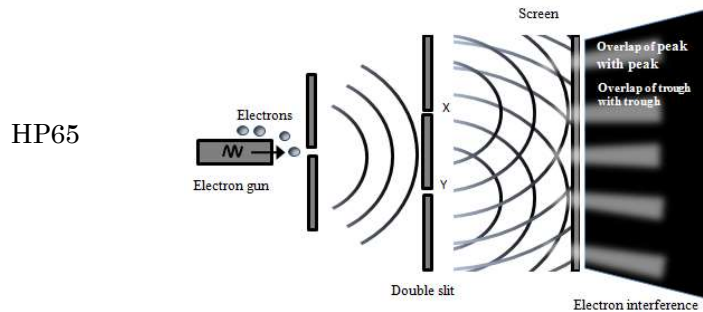

The most mysterious point of this experiment is that even if electrons are released one by one, an interference fringes are formed. This mystery is considered in detail by (Tetugakutekina nanika, ato kagakutoka", in Japanese)²⁷, so refer to the site, if you want to know more.

It is summarized by the following two points as a standard interpretation of quantum mechanics (Copenhagen interpretation).

- * Before being observed, an electron (substance) is existence like a wave, but when it's observed, it will be a particle.
 - * A wave before being observed indicates a probability where a particle is observed.
- (Reference: "Tetugakutekina nanika, ato kagakutoka", in Japanese)²⁷

It's a very skillful expression, not to say that Copenhagen interpretation comes off a correct answer. But, actually it is not right that "Before being observed, an electron is the existence like a wave and when it is observed, an electron turns into a particle." Then I will explain by an energy body model.

An elementary particle model by energy body theory is as follows. Undulation of an energy body (vibration) is circulating focusing on a self-axis, and its skirt area spreads out while attenuating from its center of high energy. And this field area of an electron shows the nature of electromagnetic field, in some situation electric field or magnetic field. After all, a spherical central part shows the nature of an elementary particle and the skirt area shows the nature of field. A next figure shows interpretation to "electronic double slit experiment" by an energy body model.

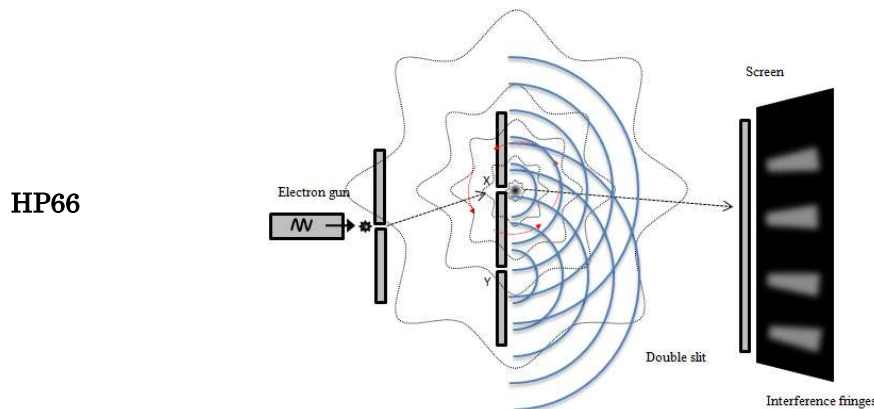

Let it assume that an electron passed the slit X which is one of the double slit. The expanse of the electron touches the other slit Y. Therefore, a diffraction phenomenon occurs at the exit of slit X and slit Y by Huygens's principle, and an interference of two waves happens. And the particle part of the electron makes its way through a valley of an interference fringe. It is because the energy of the wave becomes lower at the valley of interference fringe. On the assumption that an electron is an expansive wave, the reason that a trace of the wave is not left on the screen is that there is no equipment by which electron's particle part and expanse can be observed at the same time, because there is an overwhelming difference between the energy levels of the two. In other words, there is no equipment which can observe directly the spreading expanse of electron's wave up to now.

Also, the reason that the location of an electron's particle part can be grasped only by probability, is that because an electron's wave spreads while attenuating and is revolving, so, an electron's expanse of wave touches the slit wall with various postures, then an electron goes in various direction of up, down, left or right ward and cannot be estimated. But even if the direction that electrons advance in is random, the frequency of the revolving wave of electron is common to every electron. Therefore, when countless electrons pass a slit, the frequency which is peculiar to an electron appears. And more, even though countless electrons pass through the slits with various direction and angle, an interference fridge appears on the screen in fixed wave length. The reason is because the secondary wave caused by interference of an electron's wave makes the slits its starting point. The above explanation shows that an electron model by energy body theory with the double characters of the particle and the wave can explain the phenomenon of an interference fringe in an electron's double slit experiment successfully.

Lastly there is a question why a particle part of an elementary particle, like an electron and a proton, which is the revolving energy body as wave in the super-high-pressure state, does not melt into static energy body. It is because the energy that lost the place to go in the compressed space (static energy body), begins to circulate and as a result forms an elementary particle, so it exists in stable way without fusing, if an elementary particle exists (is confined) in a compressed space. (See: Particle physics Division, "2.6. Absolute zero particle", and Universe division, "2.1. Gravity occurrence 1".)

The next figure is that image.

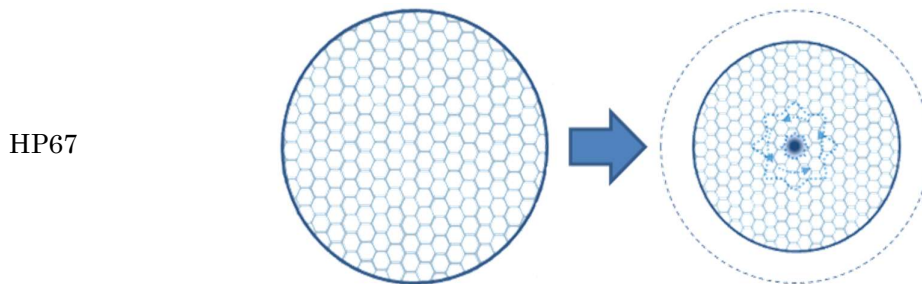

2. Interaction

2.1. Electromagnetic force

Electromagnetism is explained at "3 Electromagnetism", so here, it is explained here an electric charge over an electromagnetic force.

2.1.1. Electric charge

An electric charge is the nature carried by an elementary particle, and while repulsive force acts between the same electric charges, attractive force acts between the different electric charges. It is often learned that an electron which is a lepton, has negative charge of -1, a proton which is a baryon, has positive charge +1, and a neutron which is a baryon, has no charge. But why does an elementary particle have an electric charge? Why is there a distinction of plus or minus in an electric charge? Why does the different charge attract each other and the same charge repel each other? What is the force that an electric charge acts by? A question is springing one after another. Modern physics only answers that it is the nature carried by an elementary

particle to these questions. It is becoming to be thought that a hadron (proton and neutron which compose an atomic nucleus) consists of quarks in recent years. Therefore, an electric charge is also divided and it is said that a quark has an electric charge of $+1/3$ etc. (Reference: Wikipedia, "Electric charge" in Japanese)²⁸

Energy body theory, that says space and an elementary particle are both same energy bodies, answers these questions. If the revolving energy body wave focusing on a self-axis of an elementary particle is the counterclockwise direction to a progress axis, is an electron, and the clockwise direction is a proton. The spherical center in high energy state of an elementary particle shows a character of particle, and the skirt area spreading infinitely while attenuating in low energy state shows a character of wave (or field). An electric charge depends on workings of the revolving wave in the skirt area.

A counterclockwise wave of an electron functions as electric charge of -1.

A clockwise wave of a proton functions as electric charge of +1.

The energy of the wave of a proton and an electron attenuates due to spreading out from its center, so it is found out that the Coulomb's law is applied. The coulomb's law is proportional to the electric charge amount of each particle (the frequency of the wave and the amplitude of vibration) and in inverse proportion to a square of the distance between the particles. The different wave direction revolving on a progress axis of an elementary particle is the origin of an electric charge, so it cannot be divided into $+1/3$ etc. Further a quark is not necessary for an energy body model, because it can be explained without quarks. (See: Particle Physics Division, 2.1.4. "Neutron") But, the reason that setting of a progress axis is necessary, is not found yet.

2.1.2. Attractive force

Attractive force acts between different electric charges of elementary particles. The wave of which energy body is revolving in counterclockwise direction focusing on a self-axis of an electron and the wave revolving in clockwise direction of a proton, advance in the same direction at around contact point between the two. Therefore, the waves get faster, and the wavelength gets longer, and the energy level falls. As a result, the high energy on the center side shifts to the low energy part between the two. This is the cause of attractive force.

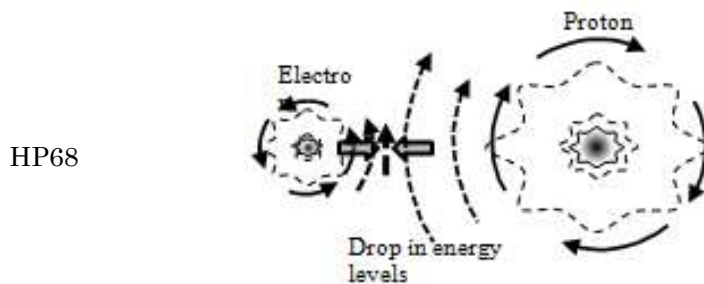

Further, it is not drawn on the upper figure, but an electron connects with a proton tilting to a proton's plane side.

An electron chooses the location at which the number will be an integer, when the wavelength of the proton is divided by the wavelength of the electron. (See: Common Division, "4.3 Elementary particle model", and Particle Physics Division, "1.3 Electronic transition".)

2.1.3. Repulsion force

Repulsive force acts between the same electric charges of elementary particles. The wave of which energy body is revolving in counterclockwise direction focusing on a self-axis of an electron and the same one, or the wave revolving in clockwise direction of a proton and the same one, advance in the different direction at around contact point between the two. Therefore, the waves get slower, and the wavelength gets shorter, and the energy level rises. As a result, the low

energy part between the two becomes high energy, so the energy shifts to the center side. This is the cause of repulsive force.

HP69

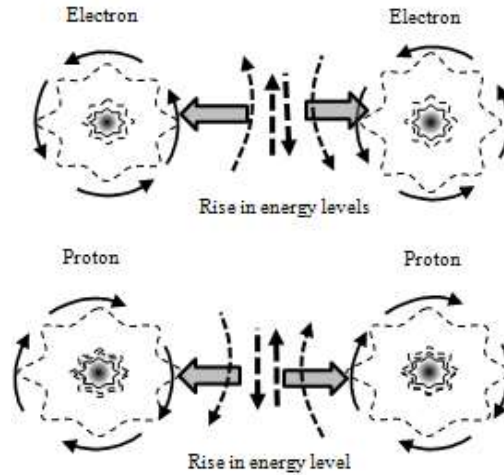

2.1.4. Neutron

A neutron does not have an electric charge. How can it be explained by energy body theory?

A neutron is unstable outside the atomic nucleus, and average life expectancy will be in about 15 minutes, and it changes into a proton by beta-decay. The β -decay of a neutron mainly indicates that a neutron changes to a proton emitting an electron and anti-electron neutrino. The released electron at this time is called beta-ray. This β -decay includes the other β -decays that are β^+ decay which emits a positron and an electron neutrino, an electron captures that an atomic nucleus takes in an orbit electron and emit an electron neutrino, a double beta decays and a double electron capture. By whichever mode it collapses, an atomic mass number does not change. In other words, a beta decay is the phenomenon which an isobar changes to another isobar. (Reference: Wikipedia, "Beta decay", in Japanese)²⁹

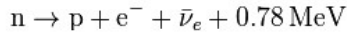

中性子 (n) 陽子 (p) 電子 (e^-) 反ニュートリノ ($\bar{\nu}_e$)

It is the explanation by energy body theory from here. It is inferred that a neutron is made of a proton and an electron from a beta decay of a neutron. First let us consider the origin of a neutron. The waves of an electron and a proton advance in the same direction at a contact place, so they combine. It was explained before. The combination part of them is each skirt area of wave (by a quantum theory, field), so it is considered that the both energy levels are almost same. Then, if an electron and a proton are forced to be close each other, what will happen? (See: Particle Physics Division, "2.3 Weak interaction", and "2.6 Absolute zero particle") Attractive force still continues to act, so the electron would be able to go into the proton by relatively weak force. But if an electron enters into a proton entirely, the waves of an electron and a proton are an opposite direction each other. The medium of an electronic wave and a proton wave is the same energy body, so a composite wave is formed at the stage when an electron entered in a proton. A proton is bigger overwhelmingly than an electron, so the spherical part of a proton shows the nature of a proton, in other words, the feature of the clockwise wave still appears near around the spherical part. (It's mentioned that a neutron has a strong magnetic moment in the reason that a quark was imagined. (See: Particle Physics Division, "2.2.1. Strong force") On the other hand, how about skirt area of a proton (field)? The energy level of an electronic wave and a proton wave are almost same, so it would deny each other. And it is changed into an elementary particle with no skirt area (field). Because there is no skirt area (field), then there is no electric charge. (See: Particle Physics Division, "2.1.1. Electric charge") It is a birth of a neutron. Also, it is assumed that the added energy when an electron is forced to enter in the proton is preserved

as increase of the energy in the wave of a proton.

It was to adjust the number of the spin of a left side to a right side of a reaction formula that the neutrino from which emerges at the time of a beta decay is made an anti-neutrino. (Reference: Buturigaku kittsashitu, in Japanese)³⁰

But, in energy body theory, the reason that the spin angular momentum becomes 1/2 is, because the location of a lepton (electron) in the atomic nucleus in a magnetic field cannot be taken two points. (See: Particle Physics Division, "1.5 Real nature of spin")

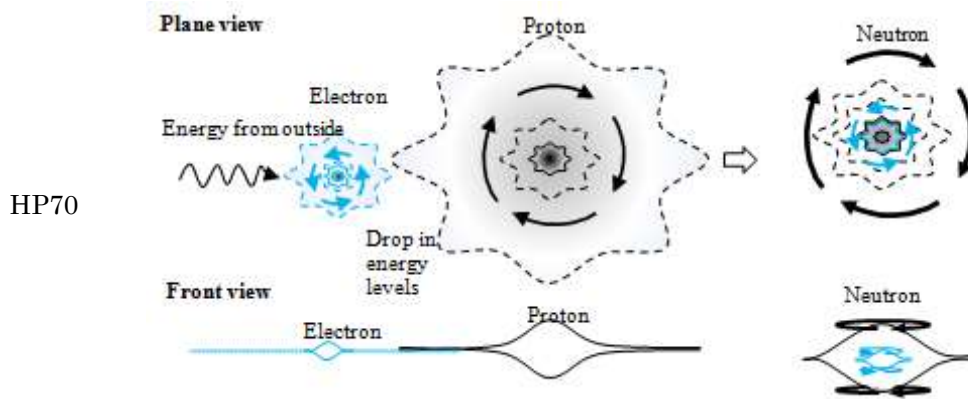

An electric charge went off, because both the expanse of a proton's clockwise wave and an electron's counterclockwise wave had disappeared. But, still a neutron reacts to a magnetic field (it has a magnetic moment), because a proton's clockwise wave remains as spherical part, the particle part of a neutron directly acts with a magnetic field (an electron's counterclockwise wave)

Therefore, it is not necessary to match numbers of spin.

By the way a neutron and a proton are a baryon. An electric charge will be considered by a quark this time. A proton of a baryon consists of two up quarks and one down quark, a neutron consists of one up quark and two down quarks. An electric charge of a proton is +1, but an electric charge of a quark in a proton is +2/3, +2/3 and -1/3 respectively. (Reference: Buturigaku kittsashitu, in Japanese)³⁰

In natural fundamental element, are there fractions? This is unnatural, isn't it? By an energy body model, it is not necessary to consider a fractional electric charge. In other words, there is no need to think a quark of a virtual particle.

The next figure is combined a figure of the blog "Banshosuiho in Japanese" and the figure of

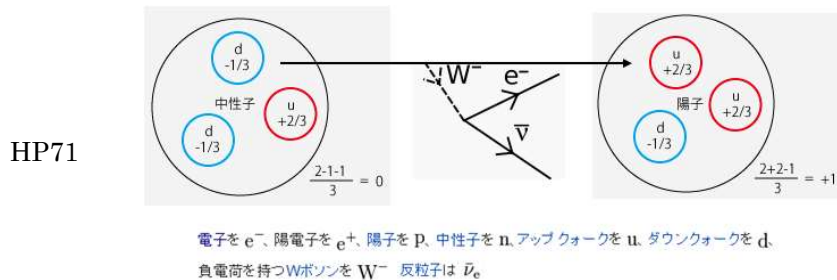

(Wikipedia, "Beta decay", in Japanese)²⁹.

(Reference: I found an interesting article in the brog of "Banshosuiho, in Japanese"³¹, let me introduce it.)

HP72

陽子と電子と中性子の原始的イメージ

小さなころ読んだ本では、「陽子に電子が入り込んだものが中性子」となっていました。何という本だったかは覚えていません。

電氣的に引き合う力以上の「壁」のような反発域が陽子にあり、通常は電子は陽子の中に入り込むことはありませんが、強いエネルギーにより陽子の中に入ってしまつと、今度はその壁のため外には出られないといった形です。

以来、そのイメージをずっと持っています。

古いイメージであるとはいえ、電子が円軌道を描いているというイメージではありません。電子は適当にうろちります。

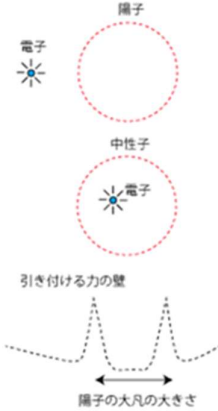

Primitive image of proton, electron and neutron

In my childhood, a neutron was a particle in the state that an electron entered into a proton" by a book I read. I don't remember the book title. There is a rebellion area like "wall" in a proton, and it is stronger than the attractive force of electromagnetism, so an electron usually does not enter in a proton. If an electron enters in a proton by high energy, on the contrary, an electron cannot go out from a proton because of the wall. Since then, the image has been in my mind all the while. An electron is an old image but not the image drawing a circle orbit. An electron is hanging around.

There was something near a neutron model by energy body theory in the old physics already.

2.2. Strong interaction

2.2.1. Strong force

The strong force which is one of the four fundamental interactions is the force that ties quarks up and makes a nucleon of a proton and a neutron etc, also combines a hadron of a proton and a neutron in an atomic nucleus. (Reference: Wikipedia, "Strong interaction", in Japanese)³²

There are two kinds of example on which the strong force operates. The one is a gluon that ties quarks up and makes a nucleon of a proton and a neutron etc.

HP73



(By: Physics at International Linear Collider, in Japanese) ³³

The other one is the force that ties a hadron of a proton and a neutron etc, and π meson transmits this force. π meson consists of a pair of a quark and an anti-quark and is bound by a gluon (an elementary particle to transmits force). But, it can be said that a nuclear force by exchange of π meson is also the force by a gluon when investigating.

HP74

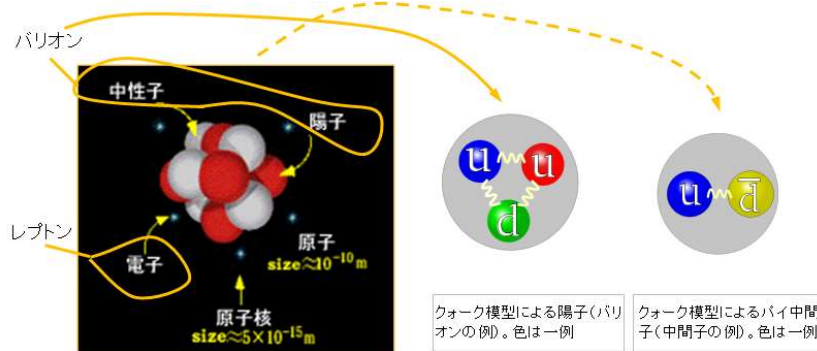

(By: kizzusaientisuto in Japanese, and Wikipedia hadron) ³⁴

The strong force = an exchange of a gluon
A charge of the strong force is a color charge.

There are three primary colors of red, blue and green (It isn't the true color, of course.) in color charges of a quark. There are eight kinds of combination with color, "3 (red, blue and green) x 3 (anti-red, anti-blue and anti-green) - 1 (white) = 8" in a gluon which mediates the strong force. Any gluons have no mass. But a gluon, itself has color charges, and tosses a gluon, so when the distance between gluons becomes longer and longer, the force becomes stronger and stronger, but if the distance reaches beyond the size of a nucleon (a proton, a neutron), only the white state can exist in stability as the whole (confinement of a color).

Therefore, though a gluon does not have the mass, the reach of the strong force is short. So, the strong force is not felt daily. (Reference: Physics at International Linear Collider, in Japanese)³³

In the long run, an atomic nucleus consists of a quark and a gluon to transmit the force, but a quark and a gluon are regarded as a virtual particle. Since putting it in the standard model, quantum chromodynamics is complete, but the combination seems to be uniting a jigsaw puzzle.

It was assumed that a hadron consists of smaller components, because a neutron had a strong magnetic moment even if it has no electric charge, and the discovery of a new hadron continued. And then, a quark and a gluon were considered. (Reference: Wikipedia, "Quark", in Japanese)³⁵

An atomic nucleus model by energy body theory does not require these quark and gluon. The reason is as follows. The main reason needed a quark is because "A neutron has a strong magnetic moment". Concerning that, it is explained by energy body theory that if an electron enters in a proton and then a neutron is formed, each wave of an electron and a proton revolve in the opposite direction, so both wave negates each other and their expanse disappear, but the central particle part of a proton's wave remains without negating. The expanse of an elementary particle is the cause of the electromagnetic interaction. (See: Particle Physics Division, "2.1.4. Neutron") Also it explains about discovery of a new hadron that when making the energy state of static energy body high artificially, it's a moment, but you can expect an elementary particle to be generated. It is given that the feature of the strong force is quite stronger than the electromagnetic force.

Moreover, although the strength of the strong force is very strong, but if a nucleon and a nucleon do not approach enough short distance, the strong force does not work. Further, if a nucleon and a nucleon approaches extremely, conversely also, strong repulsion (repulsive force) functions. When the strong power is explained by an energy body model, this nature can be explained well. If a π meson of which wave is revolving counterclockwise is put between the two

protons of which wave is revolving clockwise, the both waves advance in the same direction between a π meson and a proton, then the energy level falls there, and combines each other by attractive force. (Reference: Invitation to the internet seminar Seminar person in charge: Kenjiro Takada (Kyushu University honorary professor) (5) The micro world - world of the 3 - (atomic nucleus) 3-2: Nuclear force (the interaction between the nucleon), in Japanese)³⁶

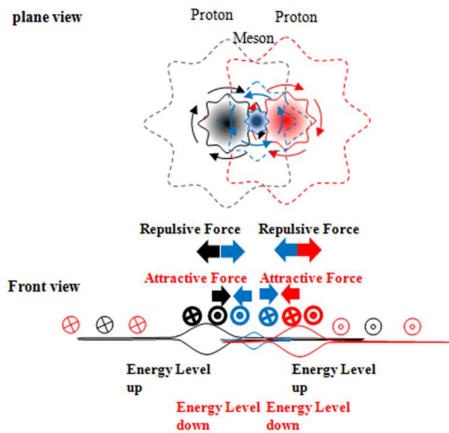
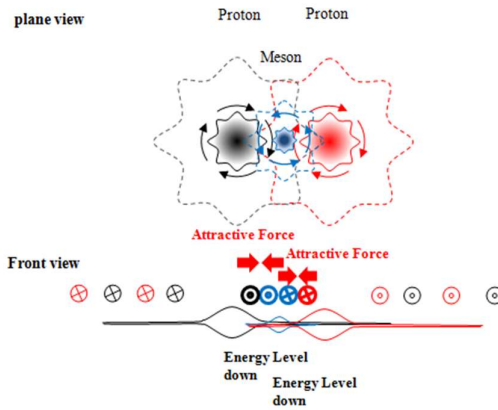
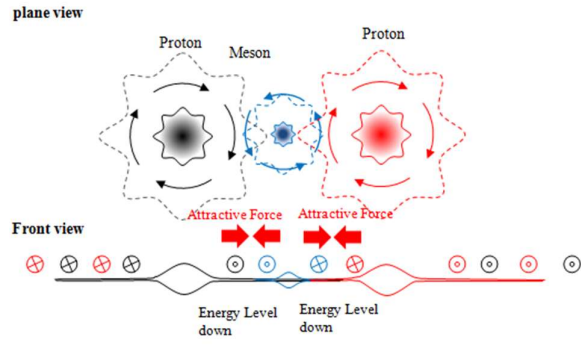

HP75

When two protons are forced to come close to each other, one proton's particle part of the wave directly acts the other's one as shown with the second figure from the top in the figure above.

The amplitude and the circulation speed of the particle part of the wave are big and high, so the waves in the same direction between a proton and π meson advance at very high speed, for this the energy falls and attractive force becomes very strong. This is the strong force. When two protons are forced to come much closer to each other, one proton's particle part of the wave spans the other side beyond the center of π meson as shown with the third figure from the top in the figure above. Then the waves of a proton and π meson advance in the opposite direction each other, so the speed falls and the energy level rises, and repulsion force acts. In other words, when a proton's wave exceeds the radius of π meson, the attractive force starts not to act any more, and instead of it, the repulsive force begins to act. It is the force from a high-energy state in the particle part, so it will be the very strong force. By the way the nodes of the wave of a proton must be an integral multiple of the nodes of the wave of π meson for the combination of circulating wave. Therefore, π meson would climb up or down a valley of the wave between protons and, look for the location which becomes an integral multiple.

HP76

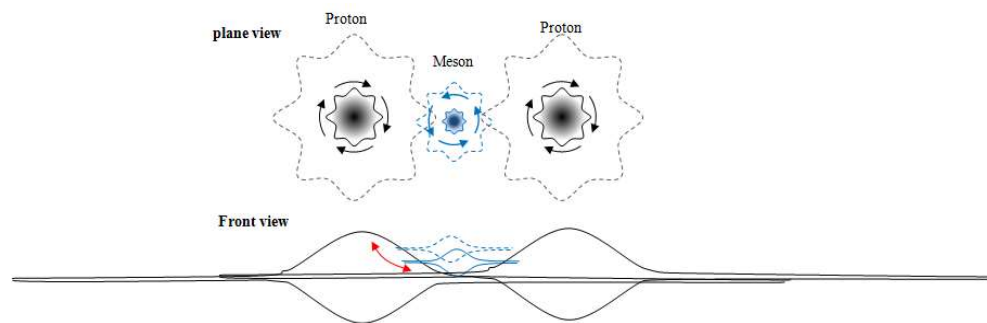

The explanation of the strong force by the upper energy body model completely falls on the explanation on press release of "The origin of "the strong force" in an atomic nucleus is elucidated 2007/6/20 (the University of Tokyo, graduate school science system postgraduate course and the department of science)", in Japanese.³⁷

H77

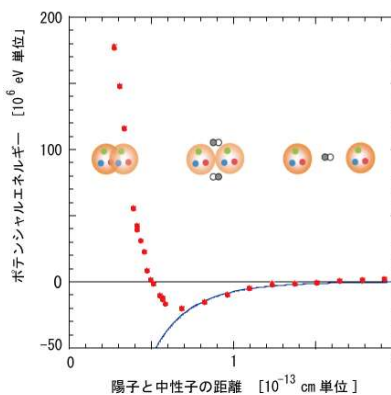

Figure 1: The form of the nuclear force (red circle) obtained for the first time in the world using a supercomputer. A prediction of Yukawa meson theory is a blue solid line. A diagram in the figure shows that a proton and a neutron which consist of three quarks exchange a pi meson over a long distance and exert directly the force each other at close range. ~ omission ~ Does a repulsion core exist universally? What is the essential mechanism which produces a repulsion core? If we can answer these questions theoretically by our way, we might be able to answer the last question that "Why can a space baryon substance exist in stability?" finally. (Reference: "The origin of "the strong force" in an atomic nucleus is elucidated 2007/6/20 (the University of Tokyo, graduate school science system postgraduate course and the department of science)", in Japanese)³⁷

The question "What is the essential mechanism which produces a repulsion core?" on the press release of "The University of Tokyo graduate school science system postgraduate course and the department of science" was answered by the explanation of energy body theory for the strong force, right?

2.2.2. π meson

There are two 2 kinds of example on which the strong force is acting. They are "a gluon" which ties quarks and makes a nucleon of a proton and a neutron etc, and "a π meson" which ties a hadron of a proton and a neutron etc. But, there is nothing that draws a π meson in the figure of various sources that shows an atomic nucleus.

"Oh? π meson was found, and Dr. Yukawa won Nobel prize in 1949, didn't he?"

"Yes, he did. The reason of winning a prize was for the discovery of a π meson."

In 1947, British physicist Cecil Powell found a π meson from the inside of cosmic rays and won Nobel prize in 1950. Now that, a π dynatron is generated by a particle accelerator of high energy present. (Reference: Wikipedia, " π meson", in Japanese)³⁸

Further, the life of π meson is very short. It appears in a moment and immediately collapses into an anti-muon and mu neutrino. (Reference: Wikipedia, " π meson", in Japanese)³⁸ Then why isn't a π meson drawn in a figure of an atomic nucleus? The reason is because it's a virtual particle when a π meson is in an atomic nucleus.

"Umm. You don't know well whether it's a real particle or a virtual particle."

A particle of force to tie a nucleon up (nuclear force) is a π meson which Dr. Yukawa predicted. A π meson consists of a pair of a quark and an anti-quark, and it's a gluon to tie those up. In the final analysis, it can be said that the nuclear force by meson exchange is also the force by a gluon when investigating. (Reference: Physics at International Linear Collider, in Japanese)³⁹

It can be thought that a real meson lies between hadrons as the force which ties a hadron by an energy body model. A π meson can exist in stable state in an atomic nucleus according to the study by "Advanced Meson Science Laboratory RIKEN Nishina Center for Accelerator-Based Science, in Japanese"⁴⁰.

The next figure shows that the combination of a proton and a proton is made possible by a meson coming in between protons.

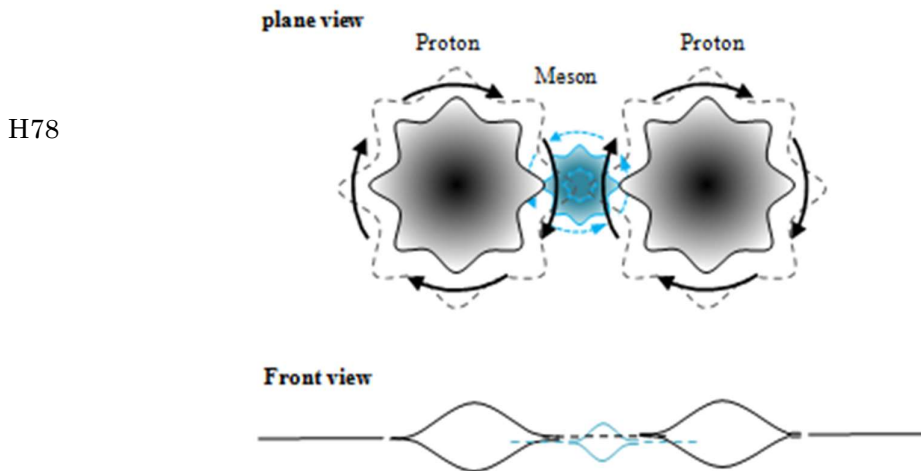

When a proton and proton are close to each other, a mutual wave advances in an opposite

direction, so the wavelength becomes shorter and the energy level rises, and the repulsive force acts. Then protons are not possible to combine. But when a meson like electron of which wave is revolving in the opposite direction of proton's is put between protons, the both wave between a meson and a proton advance in the same direction, so the wavelength becomes longer and the energy level fall, and the attractive force acts. Then protons can combine owing to the meson.

Further I'm thinking a π meson is an independent electron deformed by the way that an electron is under pressure of protons between those and its expanse of the wave becomes at high energy state because of being compressed and being made the expanse disappear, except for π meson of an electric charge zero. The reason is because an elementary particle which comes out after a β -decay is only an electron and a neutrino after all. In energy body theory, it is thought that a neutrino is the one that a change in the posture of an elementary particle (electron) is transcribed into static energy body, so it is different from the particle which composes a substance.

A π meson of an electric charge zero is created, when protons are made other protons collide. (Reference: RIKEN press release material "Accurate measurement of the direction of the gluon inside the proton," on January 8, 2016, in Japanese.)⁴⁰

It is thought that a π meson is created by the way that a static energy body is momentarily compressed by collision between protons and becomes high energy state, by energy body theory. In other words, there is no elementary particle as core. The reason is because an elementary particle which comes out after a β -decay is only a neutrino after all.

Therefore, the wave loses the place to go, instead of that, it starts to circulate, and forms an elementary particle (a π meson). But the π meson has no expanse of the wave.

For this, there is no electric charge carried by π meson. (See: Particle physics Division, "2.1.1. Electric charges".)

The situation that neutrons are combined by a π meson between those is shown in the next figure.

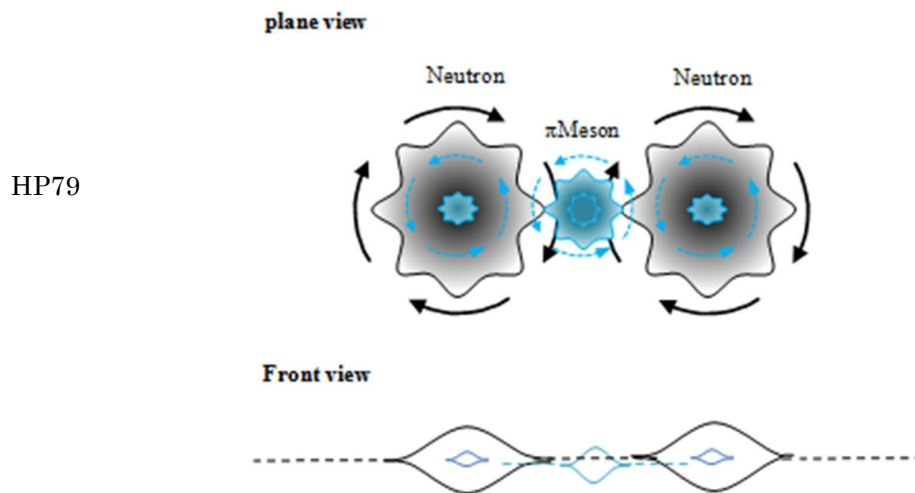

A neutron is the one that a proton absorbed an electron.

There is no significant difference between an electron and a proton for the energy level at the wave of its expanse. Therefore an expanse of the wave of a proton is neutralized by an electron's, and an electric charge goes off. But, the nature of a proton remains deeply around the spherical part (particle part) of the wave of a neutron. As a result, the combination of a neutron and a proton is same as the combination of a proton and a proton basically. But, a proton has an electric charge because there is the expanse of the wave but neither a neutron nor a meson has an electric charge because there is no expanse of wave. So far, the nature of a gluon by gauge theory does not appear, in the case of the combination of nucleons by putting a meson between those.

Or, the nature that "the force becomes so strong in the distance that it gets away." does not appear.

2.2.3. Gluon

A gluon is a Bose particle which transmits the strong interaction. And it is the force which ties a quark and makes a nucleon of a proton and a neutron (See: Particle physics Division, "2.2.1 Strong force"). Also, a gluon is a Bose particle of spin 1 that transmits the strong interaction inside a hadron. The mass is zero and the electric charge is neutral. A gluon has the quantum value called "color charge", and by the difference of that, eight kinds of gluon exist altogether. It is not impossible to take out a gluon independently like a quark at usual temperature and density. Because a gluon itself has a color charge, the interaction acts between the gluons too. That is the property of a photon which transmits an electromagnetic interaction does not have. (Reference: Wikipedia, "Gluon", in Japanese)⁴¹

A gluon is the gauge elementary particle to transmit the "strong force" with which a quark is tied up, but the feature is in its force. That is the property that although the force is very strong, it does not act when the distance between nucleons is not enough short, conversely when the distance between nucleons is extremely short, strong repulsive force acts. (Reference: Invitation to the internet seminar Seminar person in charge: Kenjiro Takada (Kyushu University honorary professor) (5) The micro world - world of the 3 - (atomic nucleus) 3-2: Nuclear force (the interaction between the nucleon, in Japanese)⁴², (See: Particle Physics Division, "2.2.1 Strong force")

More, when it is made two protons closer beyond a repulsion core, a π meson enters a proton and forms a neutron. But, neither a quark nor a gluon are necessary to energy body theory.

Again, let us see a neutron.

In energy body theory, an electron enters in a proton, and a neutron is made. It is thought that an electron entered in a neutron is usually located at the center of the neutron as is showed in the next figure. When applying the force like electromagnetic force to take out an electron inside a neutron, the higher energy is needed as the electron approaches the outside of a neutron. I am sorry the figure is small to watch.

If the electron inside a neutron approaches to the outside of a neutron in the left half and in the right side of the neutron, waves of an electron and a proton advance in an opposite direction, so repulsive force acts in the direction of the inside and attractive force acts in the direction of the outside. As a result, the resultant force faces to the inside. More, both force becomes stronger as the electron approaches the outside, therefore, a gluon appears.

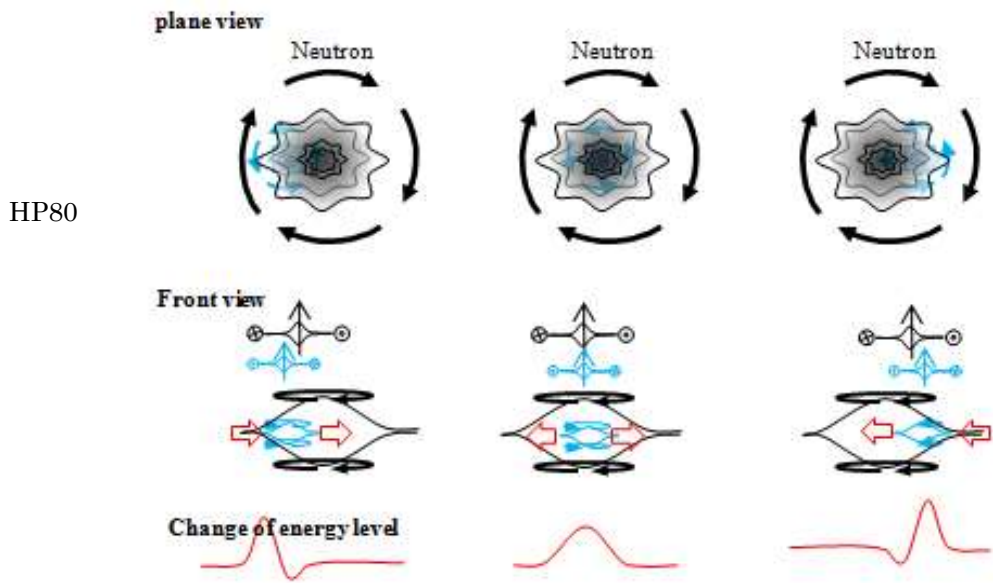

HP80

2.3. Weak interaction

A weak interaction works between elementary particles. There is "β-decay" as the typical effect by this interaction. A β-decay is the phenomenon that a proton changes to a neutron and a neutron changes to a proton, in an atomic nucleus. That was named, because the force is very weak in comparison with an electromagnetic interaction. While a gravitational interaction and an electromagnetic interaction are the force which works infinitely, the weak interaction works on the very narrow range of the elementary particle level. A weak interaction works on an elementary particle with mass zero, so it is different from the other fundamental interaction of attractive force and repulsive force, and is not classified into attractive force and repulsive force. (*It is revealed by standard model that a neutrino made mass zero has the mass.)

A weak interaction is unified with an electromagnetic interaction by Weinberg-Salam theory. A weak interaction is the only force that violates the parity symmetry and the electric charge symmetry. A mediation particle W boson/Z boson has the very big mass on account of the spontaneous symmetry breaking. (Reference: Wikipedia, "Weak interaction", in Japanese)⁴³ A weak boson is an elementary particle which mediates the weak interaction. A weak boson is a vector boson of spin 1 and there are two kinds of W boson and Z boson. W boson has the about eighty times bigger mass than a proton, and Z boson has the about ninety times bigger mass than a proton. Like those, a weak boson has the property that has the big mass compared with the other elementary particle, and decays into a different particle over the brief time.

W boson has electric charges ± 1 (W^+ , W^-), which are in a relation of an antiparticle each other. Z boson has an electric charge 0 and an antiparticle of it is itself. (Reference: Wikipedia, "Weak boson", in Japanese)⁴⁴

A neutron can change to a proton outside the atomic nucleus, but a proton cannot change to a neutron outside the atomic nucleus. Well, the weak force is the thing that a nucleus and a weak boson reciprocally act. In other words, when a virtual weak boson reciprocally acts with a nucleon, a nucleon converts (a neutron converts into a proton, a proton converts into a neutron.), and splits into an electron and a neutrino in a brief time, while a virtual weak boson is made substantial. It must be thought that a virtual weak boson does not cause the attractive force and the repulsive force, but makes the nucleon absorbing electron decay. (Reference: Buturigaku Kissashitu, in Japanese)⁴⁵

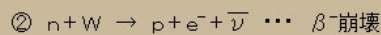
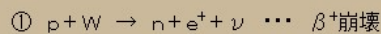

In conclusion, a virtual weak boson makes nucleon cause beta decay; this is "weak force". And the amount of the origin which makes a weak boson occur is called "weak isospin". After all, an elementary particle which has a character of weak isospin is a nucleon, an electron and a neutrino (It is just as beta decay it is.), then a nucleon causes a beta decay at a weak boson field. (Reference: Buturigaku Kissashitu, in Japanese)⁴⁵

Why was it necessary to think of weak force? That is because there was the time it was thought that the force which causes beta decay is the nuclear force. In other words, it is the logic that the attractive force is born by the conversion that p converts n, and n converts p in an atomic nucleus. Exchanged particles are an electron (positron) and anti-neutrino (neutrino). But there was also a doubt. That is to be different in the both particles being exchanged both. But, the force occurred from beta decay is much smaller than the electromagnetic force was found, when it was calculated. So, it was named "weak force" as the force which encourages β-decay. (Reference: Buturigaku Kissashitu, in Japanese)⁴⁵

The weak force is not the kind of force classified in attractive force and repulsive force, so it is different from the understanding to the usual force. The weak force is unified with electromagnetic interaction by Weinberg-Salam theory, but it carries the so-called strange character. Let me enumerate strange points.

- * The only force to violate the parity symmetry and the electric charge symmetry.
- * The CP symmetry violation also happens.
- * W boson/Z boson which is the particle to mediate force has the very big mass (W boson is about 80 times and Z boson is about 90 times bigger than a proton.) by spontaneous symmetry breaking.
- * It acts only on the very near range of an elementary particle level.
- * W boson/Z boson is a virtual particle.

※ The reason why W boson/Z boson, which mediates force, has very big mass is not explained, so it cannot be concluded here, But it is very strange that the mass of W/Z boson is each about 80 times/ 90 times bigger than a proton, even though W/Z boson is absorbed in a proton.

According to my guess, the force needs that magnitude, because the force acts only very near and narrow range. Is that right?

On the other hand, in energy body theory, a β -decay can be understood in the flow of the all-natural course.

First let me review the composition of a neutron by an energy body model. A neutron is the particle in the state that an electron is entirely absorbed in a proton.

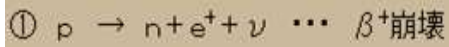

An electron and a proton combine at a contact place, because the direction of both waves becomes same.

More, if an electron is compelled to enter in a proton by outside force, the electron can be absorbed in the proton. And the force cannot be big, because the attractive force keeps working. But the force does not act only until the whole electron is completely absorbed in the proton. In other word, the force acts only very narrow range. And when the electron is absorbed in a proton, the wave direction of the electron and the proton becomes opposite. Then a neutron (synthetic wave) is formed at the time.

The proton is big overwhelmingly at the spherical central part, so the character of proton, in another ward the feature of the wave revolving clockwise, appears there.

On the other hand, the waves of an electronic and a proton become almost the same energy level at the expanse, so both waves deny each other. In other words, there is no electric field. An electron entered in a proton, so a positron occurs. (A negatron has disappeared.) The external force is a neutrino.

In energy body theory, it is considered that a neutrino is a transcription of the motion of an elementary particle into static energy body in the same way of electromagnetic waves.

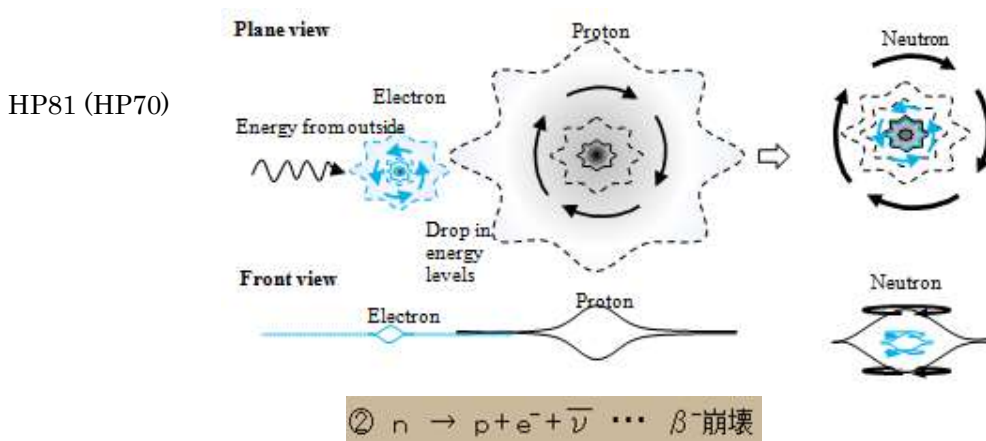

A proton's wave is clockwise, and an electron's wave is counterclockwise, then each wave is revolving in an opposite direction. It is natural for the electron in a proton to try to be separate each other when the external force (neutrino) is removed, therefore only the small force is

necessary to flow and separate. External force (neutrino) disappears, so anti-neutrino occurs. When an electron goes out of the inside of a proton, the expanse of the wave of an electron and a proton, in other words an electric field restores, so the weak force does not work anymore. In other words, the weak force reaches only very near range.

Weak force is the force that works by the direction of each wave through the process of the neutron formation, so that it may be understood above.

There is no force to make an electron into the proton outside of an atom nucleus is an answer to the question that "if the neutron outside of an atom nucleus is left alone, the neutron is transformed into a proton by β -decay." but, "then why the proton outside of an atom nucleus is never transformed into a neutron." of question in "Buturigaku Kissashitu, in Japanese"⁴⁵. In the atomic nucleus crammed neutrons excessively, β minus decay occurs, and in the atomic nucleus crammed protons excessively, β plus decay occurs. What is the difference between these causes? A neutron is the form that a proton absorbed an electron by an energy body model, so β minus decay which a neutron transforms into a proton emitting out an electron from an atomic nucleus of neutrons excess is smoothly understood. Then, where was the electron which would be absorbed in a proton, at the time β plus decay that a proton absorbed an electron, and transforms in a neutron in an atomic nucleus of protons excess occurs? It is remembered to say, "a neutron outside of an atom nucleus transforms in a proton by β minus decay, but a proton outside of an atomic nucleus does not transform in a neutron." In other words, a neutron transforms to a proton in an atomic nucleus, but it does not transform outside an atomic nucleus. Then, a proton is supplied an electron in an atomic nucleus. And I am thinking the supply source is a π meson. What kind of particle is a π meson? After a π meson decays, it splits in an electron and a neutrino in the end. A π meson has three kinds of electric charge of plus, zero and minus. A π meson with electric charge collapses in a muon and a neutrino. More a muon collapses in an electron and a neutrino. A π meson of electric charge zero collapses in a photon. A π meson is conceivable the state that an electron is compressed into a high-energy state. The high-energy state is not the vibration of the plane face of an electron (like a board vibration), but the rise of the amplitude of the wave circulating and focusing on the self-axis out of which an electron is formed. But the expanse of the wave of a π meson does not have a property of electric field, because it is reduced under the pressure being enclosed over two nucleuses. The reason I did not think that a π meson is a complex particle is because an elementary particle except an electron is not emitted, after π meson decay.

You would say that a neutrino appears, but in energy body theory, a neutrino is a transcription of a change of the posture of an elementary particle made in static energy body, then a neutrino is not an elementary particle as matter.

Next, let us watch beta decay paying attention to a π meson.

[1 β plus collapse from which a proton changes into a neutron]

The next figure is a model figure of β plus collapse of an atomic nucleus by an energy body model.

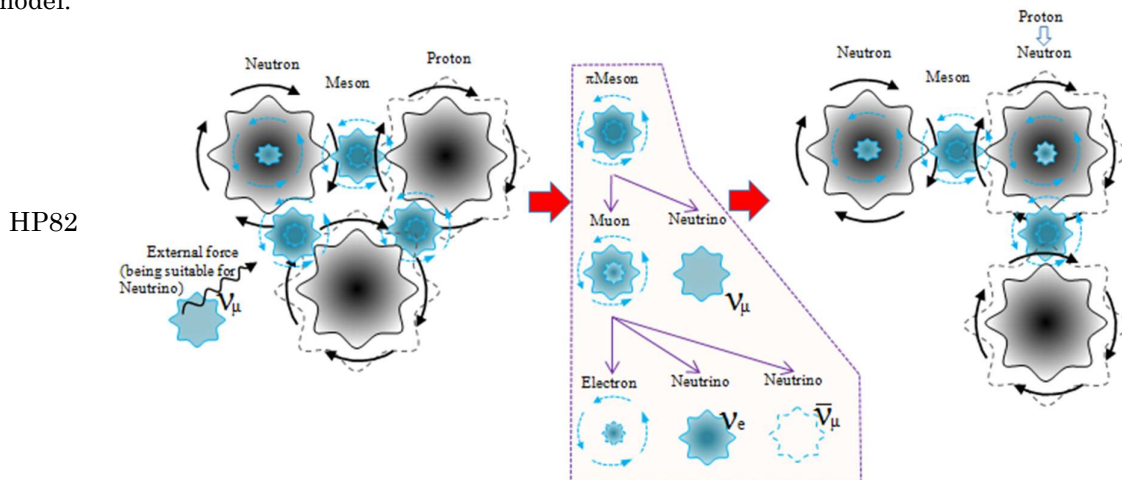

HP82

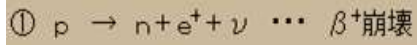

If external force adds an atom nucleus, for example in the case that an external proton collides against an atom nucleus, the energy equivalent to mu neutrino is taken in an atomic nucleus, and an atomic nucleus decays. At the same time, the energy of the external force (equivalence to a mu neutrino) is added to a π meson (the electron shut in a high-energy state). Therefore, the energy of a π meson (the electron shut in a high-energy state) increases in the energy of the external force (equivalence to a mu neutrino), and it leaves away from the chain of a nucleon by the impact. And the vibration is transcribed into static energy body immediately, and it becomes a mu neutrino. As a result, external force (the energy equivalent to a mu neutrino) is removed from a π meson, and a π meson (the electron shut in a high-energy state) is transformed in to a muon. Well, a muon is the same one as a π meson in an atom nucleus originally (The one which removed external force (equivalence to a mu neutrino) from a π meson outside an atom nucleus.) as it was explained a short while ago. In other words, after removing a π meson from a nucleon, external force becomes a mu neutrino immediately, and goes out. And a π meson returns in the original state. An electron of this state is called a muon. A muon is an electron of the high-energy state restricted to a nucleon, in other words a π dynatron, so when it frees itself from the restriction of a nucleon, it returns to an electron of a usual energy state.

At the same time, a muon vibrating makes its energy (which made the electron at a high-energy state.) transcript into static energy body. This is an electron neutrino. After an electron neutrino was released, a muon returns to a usual electron. Further, the external force (equivalence to a mu neutrino) has already been outside, an anti-mu neutrino occurs. And an electron is absorbed in a proton by weak force, and it transforms into a neutron. In this way, a π meson decays in an electron and an electron neutrino. And the proton which absorbed an electron, transforms into a neutron. (A mu neutrino is formed after external force is taken in, so it was excluded from a decay result.)

[2 Beta minus decay A neutron transforms into a proton]

The next figure is a model figure of β minus decay of an atomic nucleus by an energy body model.

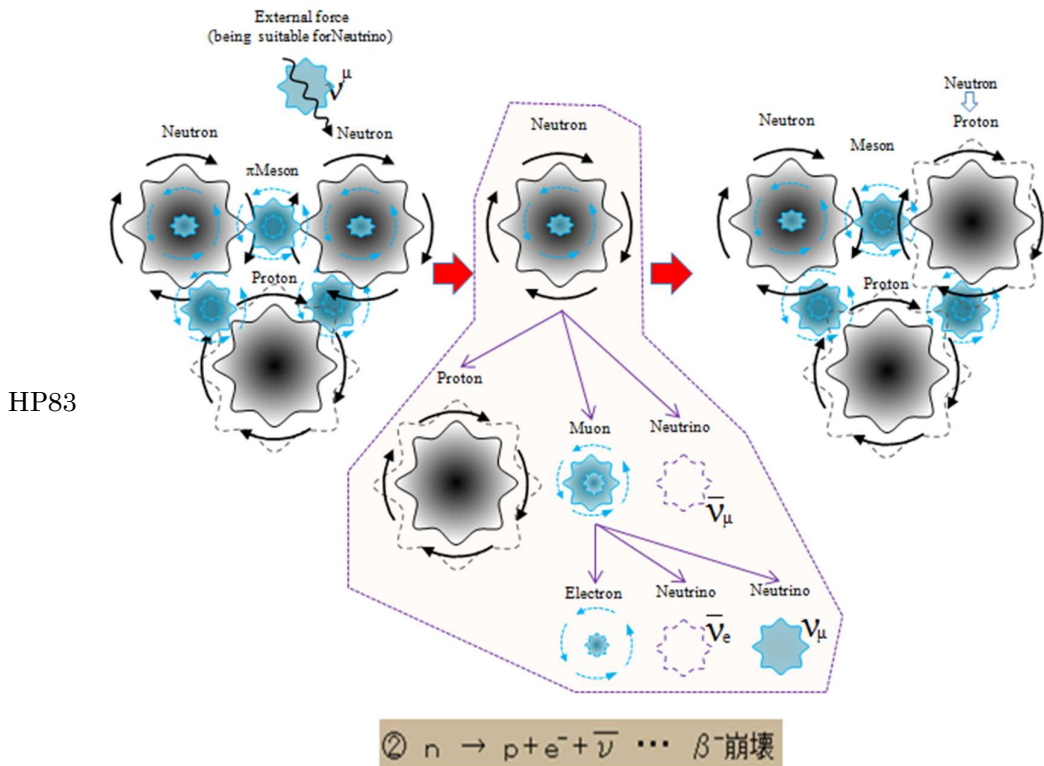

If external force adds an atom nucleus, for example in the case that an external proton collides against an atom nucleus, the energy equivalent to mu neutrino is taken in an atomic nucleus, and an atomic nucleus decays.

At the same time, because the external force (the energy of equivalence to a mu neutrino) adds to the neutron, an electron which is shut in a neutron transforms to a muon (the electron shut in a high energy state) and leaves out of a neutron. On the other side, the external force (equivalence to a mu neutrino) transforms into an anti-mu neutrino, because it is absorbed in a muon. Also, because an electron left out of a neutron, the neutron transforms to a proton. Through those process, a neutron decays into a proton, a muon and an anti-mu neutrino. At the same time, a muon vibrates with the impact. And the vibration is transcribed into static energy body immediately, and it becomes a mu neutrino. As a result, external force (the energy equivalent to a mu neutrino) is removed from a muon, and a muon is transformed in to an electron of usual energy state. As a muon transforms to a usual electron, anti- electron neutrino occurs. Like this a muon decays into an electron, anti-electron neutrino and a mu neutrino.

As a result, a neutron decays in a proton and an electron.

(A mu neutrino is formed by external force, so it is excluded from a decay result.)

2.4. Gravity, (See: Space Division 2 Gravity)

2.5. Phase transition

From the fact that a neutron and a proton cause a β -decay, a proton absorbs an electron and then a neutron is formed is found. What situation is that a proton absorbs an electron? If an electron in the atom is excited by the external force (the energy), will it transfer to the inner orbit nearer a proton?

In an instant you might think so, but the fact is reverse. If an electron is excited, it transfers to the outside orbit. (See: Particle Physics Division, "1.3. Electronic transition")

Then conversely, if the energy is taken away from the electron, what will happen? It is expected that the electron transfers to the inner orbit. Actually, it goes so. Moreover, the energy is taken away more and more from the electron, and when the temperature goes down at the absolute zero-point, what would happen? When it is the absolute zero-point, a movement of an atom and a molecule becomes small, and those energy becomes lowest.

From here the explanation of an energy body model starts. The expanse of the wave which circulates focusing on a self-axis of an elementary particle spreads out (innumerable elementary particles; infinitely), if it is at normal temperature. A movement of an atom and a molecule happens by the expanse of an elementary particle's revolving wave acts reciprocally. By the way an elementary particle's revolving wave is energy body including its expanse. This is called a kinetic energy body. It means that the energy of an elementary particle decreases and the vibration becomes small, because the temperature of a kinetic energy body falls. In other words, expanse of an elementary particle's revolving wave becomes small. Therefore, a chance of the interaction among a molecule and an atom is less, and the movement of those becomes small.

On the next figure, the molecule shape at normal temperature and the molecule shape of a phase transition at low temperature is drawn...

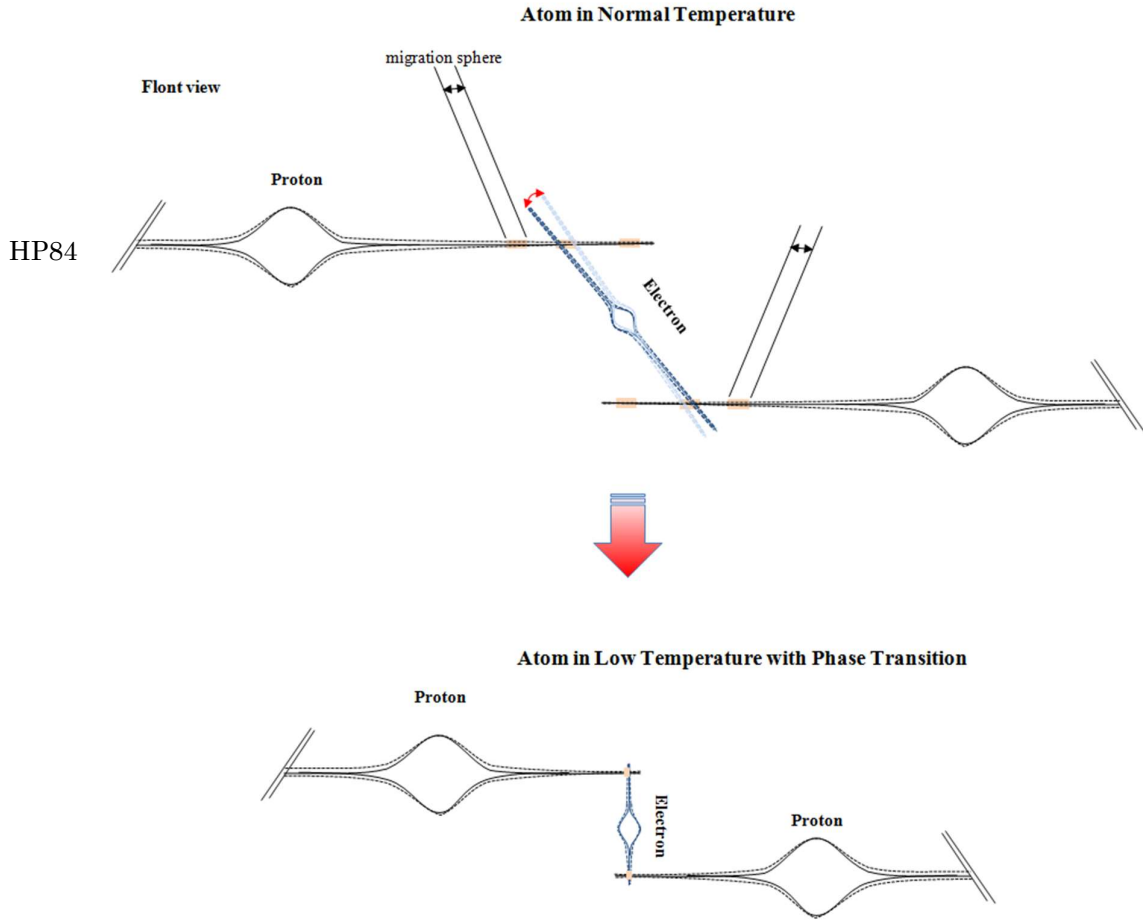

Two protons combine around one electron. When combining at normal temperature, an electron tilts slantingly to a proton, and it combines. The reason is because the electron and the proton choose the location where the nodes of the mutual revolving wave become an integral multiple. Though the electron is not fixed with that point, but its posture is swinging. The reason is because a proton's and an electron's wave are circulating. In other words, the mutual waves at the joint point fluctuate rising high and falling low. And because those attenuate to the outside from the center, those are moving at a fixed margin (migration sphere) like a so-called seesaw. (See: Particle Physics Division, "1.2 Electron-proton coupling", "1.3 Electronic transition", and "4.6 Doppler effect") But when the temperature falls, the vertical motion of the vibration becomes small, and the "play" disappears, and is fixed. This is in the state of the phase transition. It was explained that when the temperature falls, a phase transition occurs on a substance. For example, it is the phenomenon which water changes to ice. Probably, if not using an energy body model, the principle would not be able to understand perfectly. It was not inspected conversantly, but the reason that the volume of water increases when water transforms to ice may be able to be given by the combination angle of a proton and an electron.

2.6. Absolute zero particle

It's the next figure, following "2.5 Phase transition".
 When the energy level of energy body falls (vibration and temperature) and it reaches near the absolute zero-degree, the expanse of elementary particle's revolving wave shrinks back to the particle part.

HP85

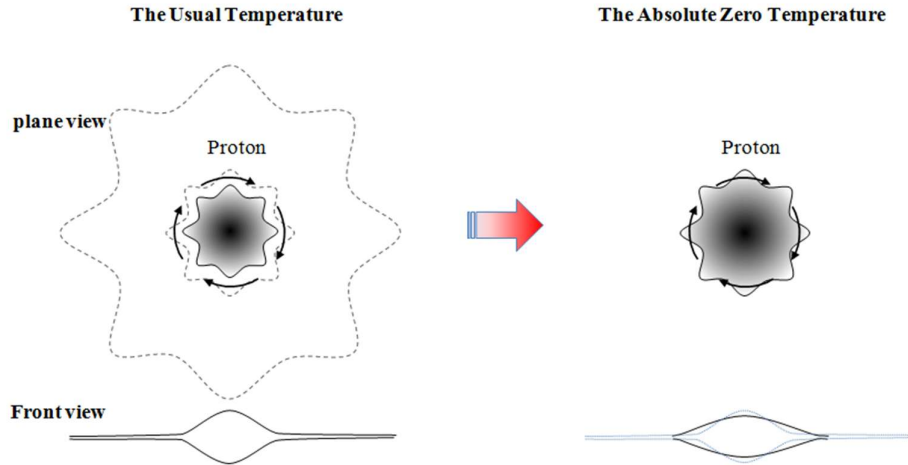

Moreover, the thickness of the particle part of an elementary particle becomes thinner, and spreads out and becomes flat. The elementary particle 's revolving wave is attenuating and is united with static energy body which is space. Space (static energy body) is also the same energy body as an elementary particle (kinetic energy body), so it is natural that the verge of the wave becomes in a body with static energy body. This thing shows that the standard energy level of static energy body is the absolute zero-degree. A movement of an atom and a molecule is the smallest at absolute zero-degree, and the energy is in the lowest state. In an energy body model, the expanse of the revolving wave of an elementary particle dwindles, and only the spherical part of the wave remains, and the interaction becomes very weak. This situation is absolute zero-degree. The dwindled wave leads to static energy body. Then why does the particle part of an elementary particle attenuate at absolute zero-degree and doesn't it return to static energy body? The reason is because the expanse is very thin, and the particle part is very thick. The particle part of an elementary particle is in the state that energy body is condensed by the super-high-pressure, so unless the energy of compression disappears, the particle part of an elementary particle does not fuse. The compressing energy is static energy body which is space, so this does not disappear. So, an elementary particle (except gauge particles of quantum theory) does not also disappear. But it is always not so that the whole an elementary particle never fuses. There is a place where static energy body is below the absolute zero-degree. Static energy body becomes lower than the absolute zero-degree around a space edge, so an elementary particle fuses (See: The Universe Division, "2.6 The temperature of gravity filed") and it returns to static energy body.

2.7. Bose Einstein condensation

As the temperature falls, the revolving wave of an elementary particle dwindles. And if it reaches at the absolute zero-degree, the expanse of the wave disappears, and the particle part of the wave becomes flat in energy body theory. This was explained in "2.6 Absolute zero particle"

Atom near at Absolute Zero

HP86

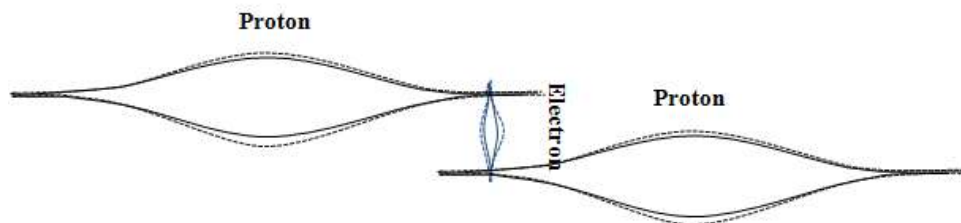

The expanse of an elementary particle's revolving wave is the cause of the interaction between elementary particles, so if the expanse disappears, interaction does not occur any more. (See: Common Division "4.3 Elementary particle model") Therefore elementary particles come to be easier to approach each other. So, when a lot of atoms are crammed into firmly in this utmost cold circumstance, a strange phenomenon occurs. That is Bose and Einstein condensation. Bose and Einstein condensation is the state of the substance which appears, when a lot of Bose particle occupy one of quantum states. And this calculation is called the Bose statistics.

Bose Einstein condensation occurs, when the thin gas of the Bose particle combined weakly and confined by external potential is cooled to the low temperature near the absolute zero-degree ($0\text{K} = 273.15\text{ }^{\circ}\text{C}$). A group which consists of a lot of Bose particle falls in the lowest quantum state of external potential under such condition. At this time, the effect of the microscopic quantum state of each particle is manifested as a condensation phenomenon of particles aggregation of the macroscopic scale. (Reference: Wikipedia, "Bose and Einstein condensation", in Japanese)⁴⁶

Let me explain a little more.

An atom behaves as a very small particle at room temperature (the left figure), but when the temperature is made fall to the temperature lower than 1/1,000,000 of room temperature by laser cooling, the nature of the wave appears conspicuously, an atom behaves as wave packets rather than a particle (the center figure).

When the temperature is made fall more, the wave packets of adjacent atoms begin to pile up, and all many atomic wave packets become identical.

This is the phenomenon called Bose and Einstein condensation, and the existence was predicted by Bose and Einstein in 1924. (Reference: Nakagawa laboratory of The University of Electro-Communications, in Japanese)⁴⁷

HP87

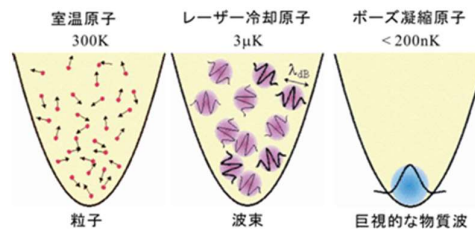

Atomic behavior at the various temperatures

(Nakagawa laboratory of University of Electro-Communications, in Japanese)⁴⁷

In Bose and Einstein condensation, the phenomenon of super-flow, superconductivity and laser beam appears. It is the mechanism that, as a result that each particle of which the system is composed is synchronous perfectly and moves the quantum mechanical property which rules the micro world is amplified to macro. Here, the quantum mechanical property is that an atom which was thought as it behaves like a particle behaves like a wave, and indicates interference effect, also light which was thought as wave behaves like a particle by way of a lump of energy called a photon. Quantum mechanics unified these Newtonian mechanics and wave theory using "Wave-particle duality". Atoms which compose the system usually behave capriciously, so the effect as wave is denied, and is invisible. But when Bose and Einstein condensation happen, an atom's micro wave strengthens each other, and becomes a macro wave. Both an atom and a photon cause BEC, but there are the differences between those. Attractive force and repulsive force do not work between photons. Then, a photon keeps going straight in vacuum space, while, when there is a thing, a photon is dispersed easily. When Bose and Einstein condensation happen

once, its state does not break easily, because the interaction works between atoms and atoms move as a group. (Reference: "Bose and Einstein condensation" by Masahito Ueda, Department of Physics, The University of Tokyo, in Japanese)⁴⁸

Protons near at normal Temperature

Protons near at Absolute Zero

HP88

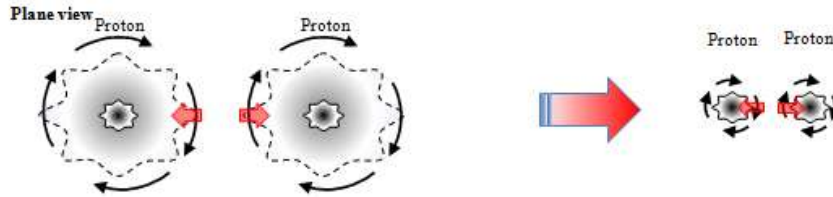

Thus, Bose and Einstein condensation is the phenomenon that when the high-density atom in the very-low temperature near the absolute zero-degree begins to be piled up, many atomic wave packets become in a body, and begin to behave as a group of particles. The strange phenomenon explained as a quantum mechanical property will be simple by energy body theory. The expanse of an elementary particle's revolving wave disappears at near the absolute zero-degree, so the interaction which is caused by the reciprocal touch of the expanse of revolving wave between elementary particles does not occur any more.

Therefore, even if an atom is close each other, the interaction does not occur. Moreover, if the distance between atoms is made very close, the particle part of elementary particles starts to act on it directly. For example, let me explain by a proton. The revolving waves between a proton and a proton advance in the opposite direction each other, even if those are near to each particle part of the wave, then repulsive force does not occur.

But the state is different in the world of very-low temperature near the absolute zero-degree. The expanse of a proton not only fades out, but the particle part becomes flat, is crushed and spreads.

Atom near at Absolute Zero

HP89

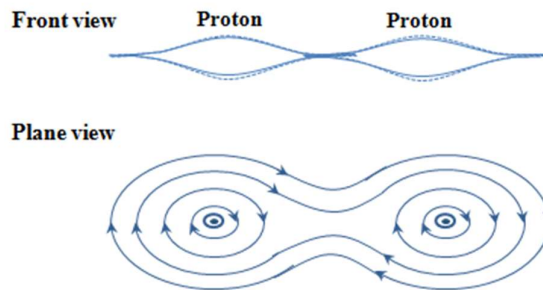

In other words, the end of the particle part of a proton is immediately before beginning to melt, and when two elementary particles (proton) are made close, those are attached and become in a body.

Oh? You must have seen the figure somewhere. That's right. It is the figure which has come out in Particle Physics Division, "3.4. Force between two parallel conductors". It also seems to be the pole (aggregate of protons or aggregate of electrons) in Particle Physics Division, "3.1. Electromagnetic field". It is produced the phenomenon that an aggregate of elementary particles (proton or electron) also behaves like one body in room temperature, when it is at room temperature, the expanse of elementary particle's revolving wave is not drawing back, so moving

atoms in free posture cannot come close each other, because the reciprocal expanse of atom's wave bothers. Therefore, it is not possible to behave as one group of particles. But, there is only one case that elementary particles can behave like one group of particles. That's the group of electrons or protons which are made arrange the posture by a magnetic field or an electric field.

HP90

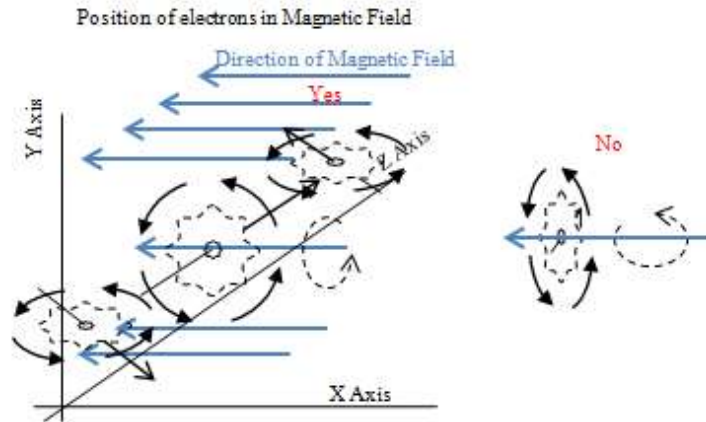

The shape of an elementary particle (electron or proton) looks like a thin circular board. It should be piled up so that a thin board may become parallel to group a board as efficiently as possible. That's the elementary particles (electron or proton) put in the magnetic field or the electric field. (See: Particle Physics Division, 3.1. Electromagnetic force)

When doing this way, even though the elementary particles are not possible to behave as a group of one particle like Bose and Einstein condensation, but it's possible to gather waves as one group. Now, it was a deviation touch a little, so I return talk to the beginning. The atoms, which behave dispersively at room temperature, are gathered to be in high-density, and are made be cool down in the very low temperature near the absolute -temperature. Then Bose and Einstein condensation are achieved. It is shown in the next figure.

HP91

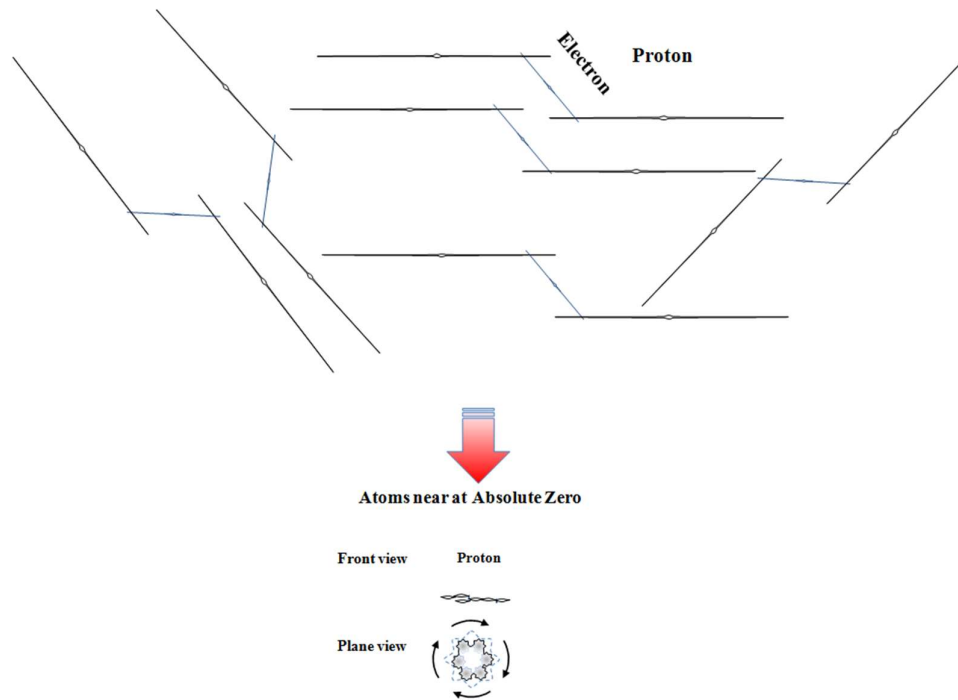

It's difficult to draw the particle part and the expanse of wave of an elementary particle in an atom by the actual scale, but those are drawn by the more actual scale than the former figure. You might feel that the particle part is away from the joint point. Atom's shape looks like a circle

board spreading thinly at room temperature, but a lot of atoms condense near at the absolute zero-degree, and become in one body. And as the result that a lot of elementary particles (proton) are attached, those seem to be one huge elementary particle. And micro world is expanded, and comes to be visible.

But, the atom cluster made into Bose and Einstein condensation does not have the expanse of revolving wave. Therefore, it has the special property which an atom in normal temperature does not have. The one is superfluidity.

Friction disappears because the atom cluster made into Bose and Einstein condensation does not have the expanse of the elementary particle 's revolving wave which does the interaction.

By the way, photons do Bose and Einstein condensation, too. (Reference: "Bose and Einstein condensation" by Masahito Ueda, Department of Physics, The University of Tokyo, in Japanese)⁴⁹

"Oh? Photons do, too?"

"Yes, photons do Bose and Einstein condensation, too."

In energy body theory, a photon is a transcription of the change of an electron's posture in the face direction, into the static energy body (which is space). Therefore, photons are not possible to attach each other. But, photon's Bose and Einstein condensation can be said it only looks like in the state of Bose and Einstein condensation. In other words, it can be thought that an original electronic group was in Bose and Einstein condensation, so the change of its posture transcribed into static energy body, and a group of photons in Bose and Einstein condensation occurs.

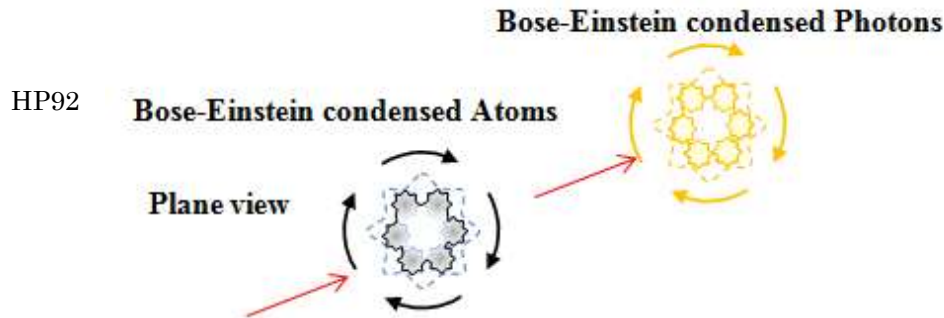

It's natural that attractive force and repulsive force do not work between photons, doesn't it? I have not inspected yet about this, so I'd like to stop it with this.

A group of these photons is transcribed the no expanse of an electron's revolving wave into static energy body, so the group of these photons might be not applied to the principle of invariable light velocity.

(You might be able to use this for a judge of right or wrong of energy body model.)

2.8. Formation of atomic nucleus

This article aims to reply to the question that "Why does a neutron exist?" and "Why does an atomic nucleus contain a neutron?" The revolving wave of energy body focusing on a self-axis forms an elementary particle and consists of the particle part and expanse. If it is cooled down to the absolute zero-degree, its energy level falls, wavelength becomes short, and the amplitude becomes small. But, the frequency does not change, because the wave is closed in the circular shape. For this, the expanse draws back, and the particle part becomes flat, so elementary particles tend to approach closely each other. It is because there are no expanses of revolving waves which cause the interaction to elementary particles.

Imagine the space around such absolute zero-degree. That space is not the one like gravitational field where the temperature is higher than the absolute zero-degree, but the space before stars are formed. An elementary particle in the primitive state that neither an atom nor

an atomic nucleus is formed is considered here. In other words, it is an independent electron and proton. And it is assumed that countless electrons and proton are wandering space.

The next figure shows, from the top to the bottom, that the relation between protons of which waves draw back, between electrons and protons and electrons, which approach closely each other and make neutrons, mesons, and nucleons.

Let us assume that two protons and two electrons are floating on this space. An electron and an electron pair, or a proton and a proton pair repel each other, and a proton and an electronic pair attract each other. In room temperature, a proton and an electron pair will combine soon, due to the interaction of both waves. In around absolute zero-degree, that relation stands up, but both do not easily approach each other, because those waves do not have the expanse of wave. But if elementary particles are in the high-density state like a nebula, electrons and protons easily approach. Moreover, it's different from the time when there is the expanse of wave in room temperature, both proton and electron can approach to the right side of the particle part of those. Then, the both particle part of revolving wave directly interact each other. And a proton and an electron should begin to make pairs alternately. The temperature of that time is around the absolute zero-degree. The expanse of a proton and an electron is not only drawing back, but also the particle part becomes flat. Would Bose and Einstein condensation be caused?

HP93

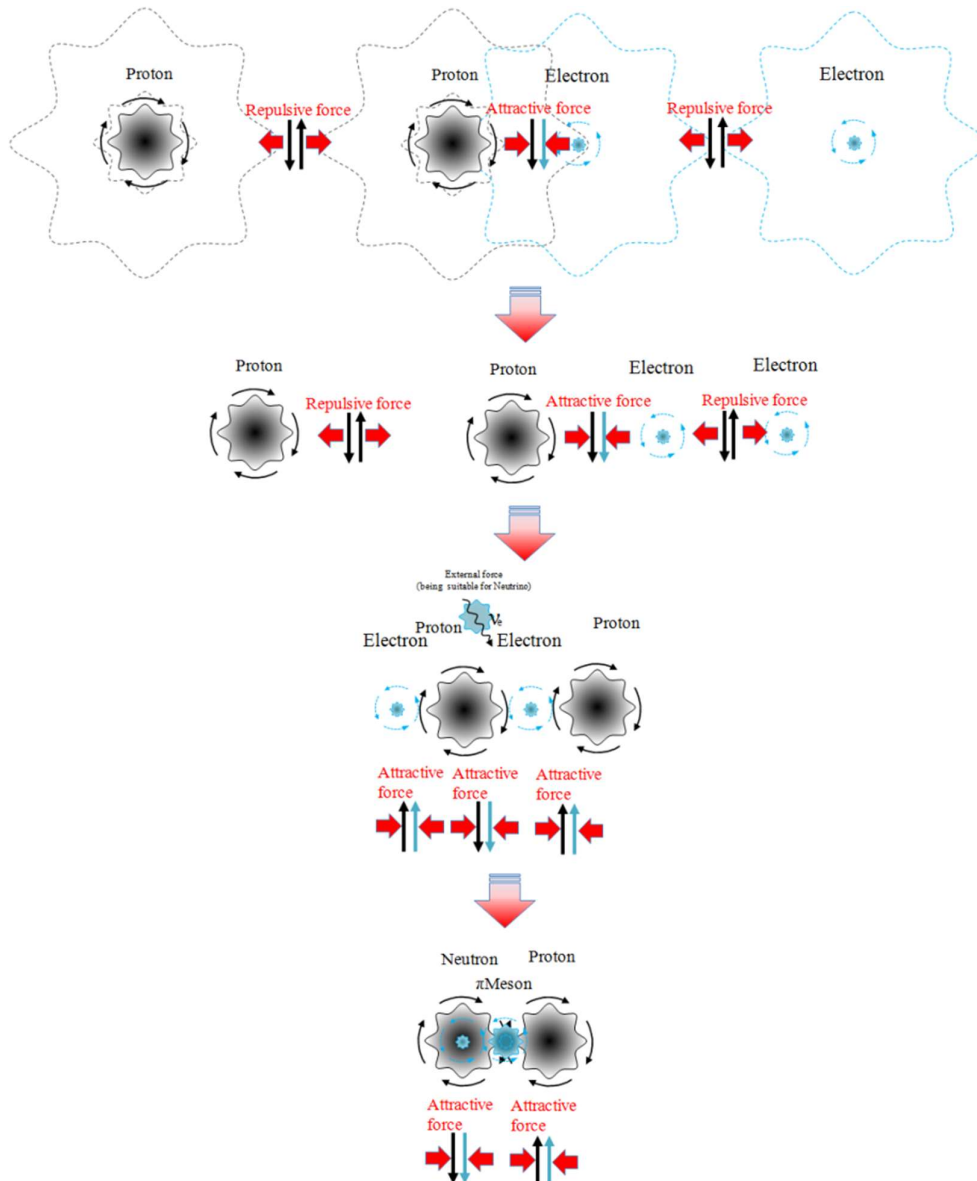

No, Bose and Einstein condensation will not occur.

It is because that an electron's wave is revolving in a counterclockwise direction, and a proton's wave is revolving in a clockwise direction. For Bose and Einstein condensation is that elementary particles which have the wave revolving in the same direction are united and begin to behave oneself like one big particle. It is not possible that elementary particles which have the wave mutually revolving in the different direction behave oneself like one big particle.

Then what happens?

Well, if an electron made a pair with a proton, the electron and the proton bond, and moreover the electron is absorbed in the proton, and a neutron is formed. (See: Particle Physics Division, "2.1.4. neutron"). At this time, weak force to push the electron in the proton is needed. The force is external force of a photon and a neutrino. The other electron between two protons cannot move, because the electron is pulled from both the left and right sides.

And the necessary energy is taken in the electron from a photon and a neutrino, and it transforms to a π meson. And a proton and a neutron combine by the medium of their meson. Through this process, countless elementary particles accumulate, and stellar eggs are born. At the same time, static energy body begins to collapse (be compressed). It is the creation of gravitational field. (See: The Universe Division, "2.1. Gravity occurrence 1", and "2.2. Gravity occurrence2") As countless atomic nucleuses are formed and static energy body collapses, the temperature of static energy body rises with gravitational field forming. Because, static energy body collapses (is compressed), so energy density in energy body rise. Then a proton and an electron expand the expanse of its wave, and make a movement active. But, the expanse of a π meson's wave does not spread, under the pressure of two nucleons of a proton and a neutron. A neutron is born and combines with a proton near the absolute zero-point in this way, and an atomic nucleus is formed.

After that, the expanse of elementary particle's revolving wave spreads out with the generation of gravitational field, and interaction of elementary particles becomes lively. When understanding the universe at present, it is said that an atomic nucleus is made with hotness near 10,000 degrees in the big-bang theory which is the mainstream, so indeed energy body theory indicates the reverse process.

After all energy body theory is advocating the universe circulation system, so the beginning of space like a Big Bang is not considered. (See: The Universe Division, "5.3. Universe circulation system")

3. Electromagnetism

3.1. Electromagnetic field

When the voltage is applied to a conductor, an electric field is formed in the conductor, and a free electron in the conductor moves to the anode side. A flow of this free electrons is an electric current. An electric current and an electronic flow are an opposite direction, so attention is necessary. When an electric current (which goes in the direction of a right screw) is let run, a magnetic field causes around the way of the electric current in the direction the right screw goes.

(Law of Ampere's right-hand thread)

HP94

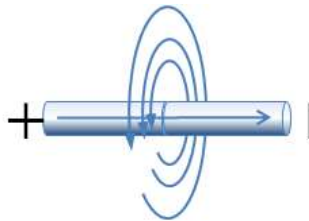

The reason that magnetic charge does not exist, while a magnetic field exist is explained in "1.4 Magnetic dipole", so please refer to that.

It was indicated by Ampere's achievement with Faraday that the magnetic field which

fluctuates with time produces an electric field, and the electric field which fluctuates with time produces a magnetic field. In other words, when an electric field or a magnetic field changes with time, the other field is induced inevitably. Such phenomenon has the nature of the undulation, and is generally called an electromagnetic wave. James Clark and Maxwell theoretically analyzed about an electromagnetic wave in 1864. Maxwell derived a sequence of equation which clearly indicates a relation of an electric field, a magnetic field, an electric charge and an electric current. He proved that electromagnetic waves are transmitted by light speed, and indicated that light is also one kind of electromagnetic waves. Light, a field and an electric charge are integrated by Maxwell's equation and Maxwell's equation was important progress in theoretical physics. (Reference: Wikipedia, "Electricity", in Japanese)⁵⁰

Maxwell clearly indicated the relationship that an electric field, a magnetic field, an electric charge and an electric current are not each independent phenomenon by Maxwell's equation. Now, let me explain the main subject of an electromagnetic field by energy body theory. Before that, to be accustomed to an electromagnetic field of an energy body model, a simple scheme is given next.

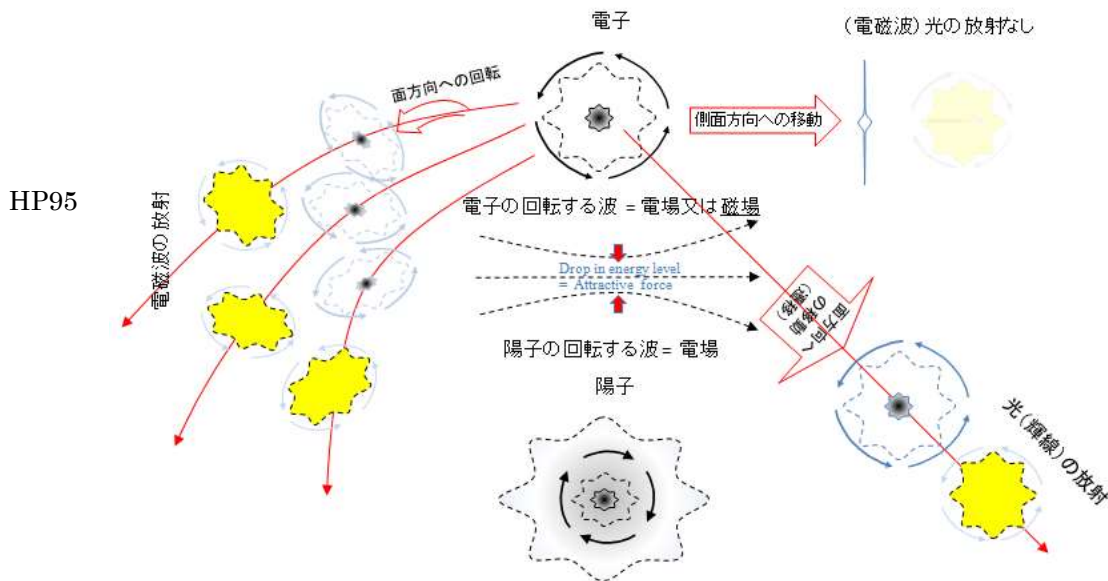

To apply the voltage, electrons are made assemble in one side of a conductor and in the other side, protons. When turning on a conductor, an electric field is formed in an instant, and all free electrons in the conductor undergo influence in an electric field and move. An electric field is formed in an instant, but the movement speed of the electron is not that fast. It was the image that an electron moves in an instant, but it's unexpected, isn't it? Energy body theory shows the reason that an electric field is formed in an instant. It is explained by the next figure.

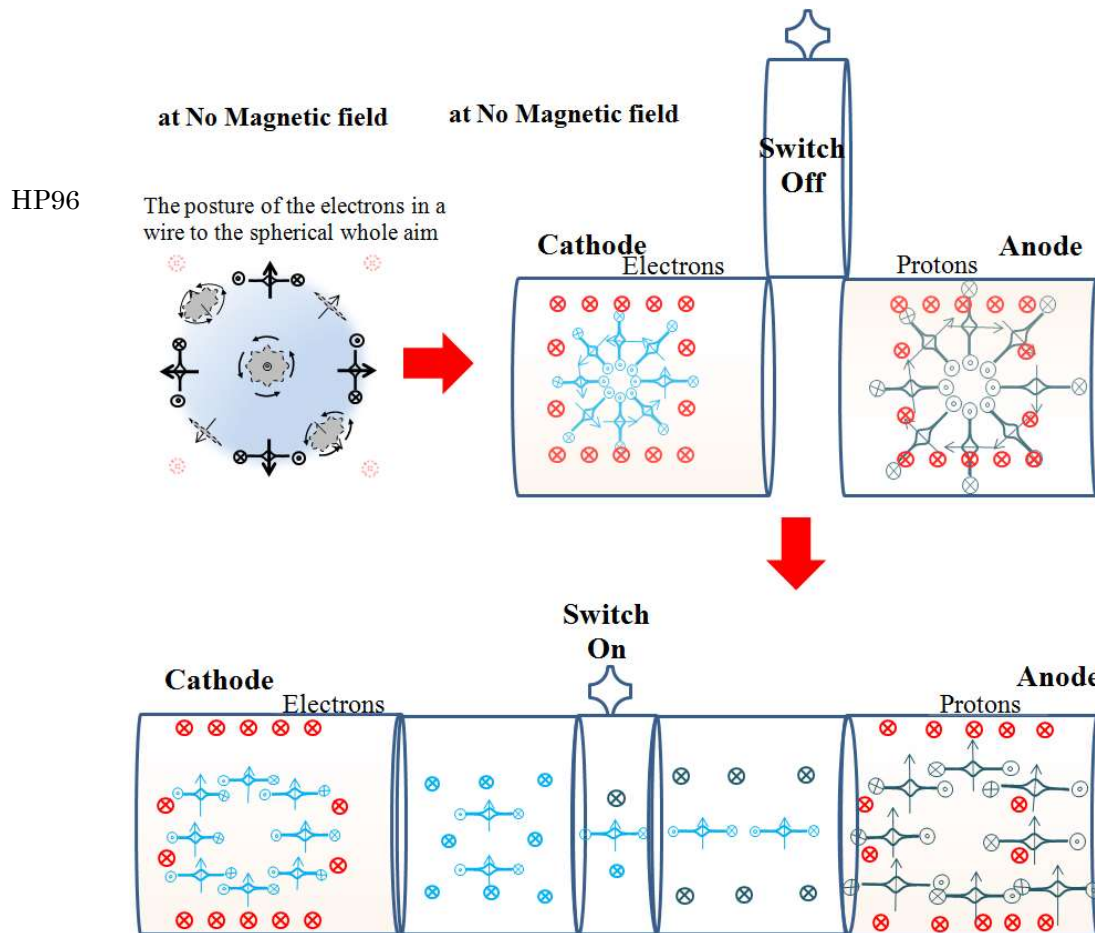

The left illustration in the upper figure shows the state of the free electrons in the conductor. The electrons are taking the posture in the various angles, because each electron is moving to the various directions (spherical whole aim). Electrons in the electrode are like this.

The next is the right illustration in the upper figure. The switch is cut at this stage.

When a magnetic field is applied to this pole, electrons in the conductor take the posture parallel to the magnetic field. As a result, the posture of the electrons was arranged to be parallel to the magnetic field, but the degree of freedom to revolve 360 degrees focusing on the magnetic line remains.

The next is the lower illustration in the upper figure. When the conductor is switched on, the posture of the electrons, which had the degree of freedom to revolve 360 degrees focusing on the magnetic line, takes the parallel posture each other to the electric field along a conductor. The reason is because the wave of a group of protons in an anode and the wave of an electrons group in a cathode becomes the same direction between the anode and the cathode, so, the wave speeds rise, the energy level falls and attractive force works. And this is the formation in an electric field. When an electric field is formed, all free electrons in the conductor strike the pose parallel to an electric field in an instant, and as a result, the attractive force and the repulsive force are generated before and behind each electron, and electrons are moved by the force. This is an electric current.

A magnetic field is formed around the electric current at the same time which starts to flow. But the reason why a magnetic field is formed around the electric current is not explained by a quantum theory and electromagnetism. Energy body theory makes this problem clear by only the next one figure. Protons in a positive terminal of a conductor and electrons in a negative terminal of the other side are assembled. Then each aggregation of protons and electrons makes a big wave in clockwise direction and in counterclockwise direction respectively. This is an

electric field. What will happen to a free electron in the conductor, if it is put in the electric field at the time? The property of polarization of an electron, which was explained a short while ago, does important work here. Polarization of light is well-known, but an electron also has the property of polarization. But, it is on the energy body theory. It is originally explained by energy body theory that the light is the one that a change of an electron's posture is transcribed into static energy body, so it's natural that an electron has the property of the polarization. The next figure shows the property of the electronic polarization.

HP97

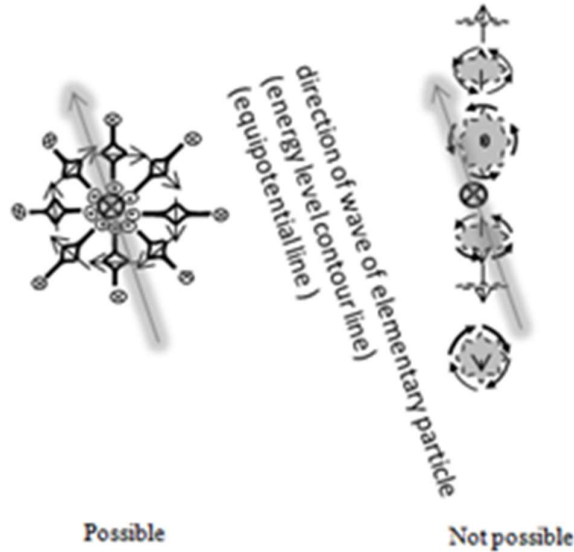

A figure cannot be drawn well, so it may be incomprehensible, but it draws an energy contour line (equipotential line) which heads for the inside from front. Arrows indicate the direction of revolving wave of electrons and protons of an electric field. Before applying an electric field, a free electron is taking various postures, but when applying an electric field, it takes the posture of which expanse of its wave becomes parallel to an energy contour line (equipotential line), trying not to intersect the energy contour line. The left side illustration of the above figure shows its situation. Therefore, an electron does not take the posture that the spread expanse of an electron's revolving wave intersects an energy contour line (equipotential line). The right-side illustration of the above figure. (Note: An energy contour line (equipotential line) is the line which tied the location of the same energy level by energy body model. That is a substitute of an equipotential line of electromagnetism.) The property of the electron's polarization is very important. And it is not overstatement that everything of an electromagnetic phenomenon is concerned in the property of the electron's polarization. The next figure is typically drawing the state out of which the electron put in the electric field begins to move, and a magnetic field is formed around the electric current.

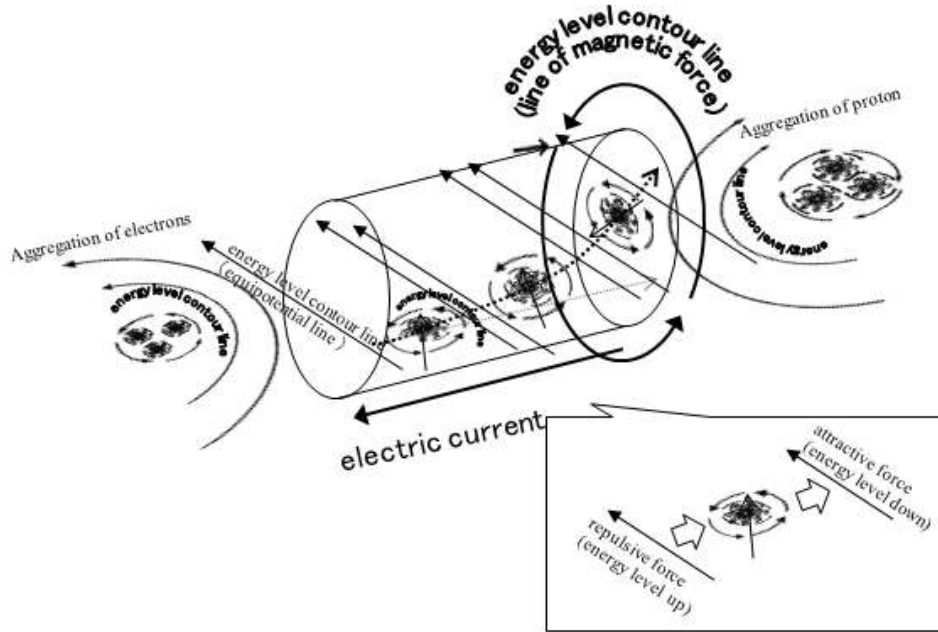

A free electron put in the electric field arranges itself to make the posture parallel to the energy contour line which an electric field produced, because of the property of the polarization. Then the wave of an electron and the wave of the cathode become an opposite direction at the cathode side, and a repulsive force occurs. The wave of an electron and the wave of the anode become the same direction at the anode side, and attractive force occurs. As the resultant force which is composed of repulsive force in the electron's back side and attractive force in the electron's front side makes the electron advance to the anode side. But, when the electron begins to move, heightening with the faint energy occurs between the electron's wave in the front side and the energy contour lines in the electric field. Therefore, the posture of the electron tilts to the electric field in the vertical direction, and its orbit deviates from straight line trajectory and draws a curve. When averaging a lot of electronic movements, it can be regarded the electron as tilting to the right-angle direction of a conductor (or, flow of an electric current). The wave revolving in counter clock wise direction of the electron at that time is caught as a magnetic field.

Let it be summarized.

- * A clump of the counterclockwise wave of an electron forms "cathode".
- * A clump of the clockwise wave of a proton forms "anode".
- * The wave of an electron and a proton forms "electric field" together.
- * A sole electron's wave forms "magnetic field".
- * The electron's waves in pair with both sides form N and S of magnetic pole. (See: Particle Physics Division, "1.4. magnetic dipole")

3.2. Faraday's law of induction

"When electric current flows, a magnetic field is formed around the conductor. (Ampere's circuital law, Right-hand rule)". By thinking to explain this thing by an elementary particle of an energy body model, the result was acquired that "an electron's orbit bends, and a magnetic field should be generated." This thing is as I explained by "3.1 electromagnetic fields". The reason that an electronic orbit bends is explained as Lorentz force by electromagnetism.

Lorentz force is the force that is applied to the charged particle when it moves in the electromagnetic field. (Reference: Wikipedia, "Lorentz force", in Japanese)⁵¹.

Ell Stead found magnetic force by an electric current in 1820, and in 1831, Faraday proved an electric current flows owing to a relative motion of a magnet and a coil. That was the phenomenon called electromagnetic induction. He found that when a magnet is put in and out of a coil, electric current flows in a coil, and conversely when electric current flows in a coil, the force occurs to a magnet. In other words, it is the phenomenon that when the magnetic flux is changed, it's possible to move an electric charge, and when an electric charge moves (An electric current is let run.), a magnetic field occurs, and it exerts the force on a magnet. And it is the principle of a generator and a motor. When the conductor which is put in the space between these magnets is moved, an electric current occurs. (Reference: Denki no Rekishi Irasutokan, in Japanese)⁵²

The reason that this electric current flow is explained by Lorentz force in many textbooks. But, there might be a slight doubt. Lorentz force is the force which the charged particle moving in the electromagnetic field receives. The magnetic field which appears in Faraday's law of induction is the magnetic field it fluctuates with time. But, even if a conductor is moved in the constant magnetic field without fluctuation with time, electric current flows. It is because there is a significant factor in the case that the force of the outside is added. According to energy body model, an electron moving in the electromagnetic field strikes an energy contour line, then receives the repulsive force (rise of the energy level), and changes its orbit. Lorentz force cannot be the force which moves an electron. As expected, the cause is the first principle-like that the outside force is added. It is thought finally that electric current flows, because the track of the electron is bent by Lorentz force. A lower figure is drawn that the conductor put in the magnetic field and the possible posture of a free electron in it by an energy body model.

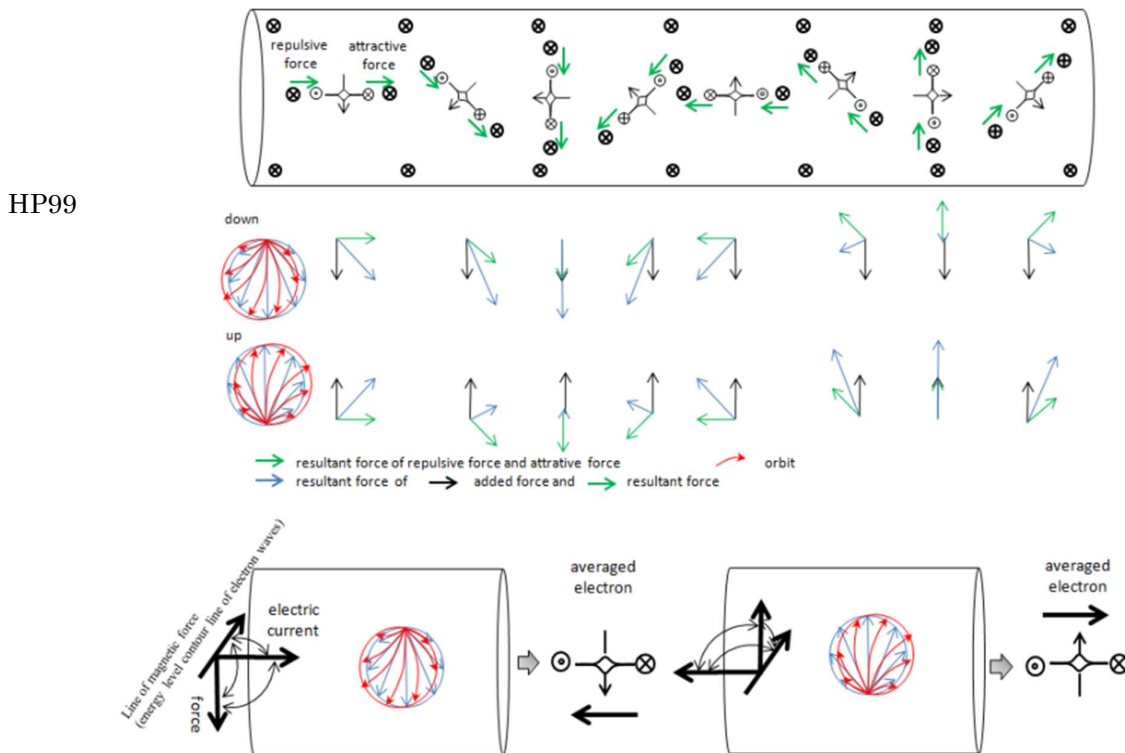

[Figure in the conductor]

A magnetic force line is drawn to the inside from the front. When an electron is put in the magnetic field, the electron arranges its posture to be parallel to a magnetic force line. The posture of the electron should be parallel to a magnetic force line, so the electron can take every posture of 360 degrees around a magnetic force line. The next figure shows the electron's posture of every 45 degrees. Then in the case that the direction of the magnetic force line and the

direction of the electron's wave are same, attractive force occurs to the same side. (Green vector)
In the case that the direction of the magnetic force line and the direction of the electron's wave are opposite, repulsive force occurs to the different side. (Green vector)

※ In the case that the direction of the magnetic force line (electron's wave) and the direction of the electron's wave are same, the energy level of energy body falls, then attractive force works. In the case that the direction of the magnetic force line (electron's wave) and the direction of the electron's wave are opposite, attractive force works.

[The figure which draws only vectors]

Both vectors (Green) are the same direction, so an electron advances towards the direction where two forces are added. In the case of not moving a conductor, if all vectors are put together, all vectors are balanced, so an electric current does not flow. When the forcer (black vector) is added to a conductor and it's moved to the underside or the upper side, a resultant vector (blue vector) with a black vector and a green vector is added to an electron.

[The figure that vectors are assembled around the magnetic force line]

The one which is collected these blue vectors around one magnetic force line is the most left figure. Even if all blue vectors are synthesized, it doesn't swing in left and right at the straight downward direction. In other words, it is a bilateral symmetry, so an electric current does not flow at this stage. But, an electron received Lorentz force and bent the track. The track is a red-line. The movement direction of an electron wings in left and right on the whole.

When pulling a conductor to the underside, it is possible to think an electron moves to the left side as a whole.

When pulling a conductor to the upper side, it is possible to think an electron moves to the right side as a whole.

[The figure of an electronic movement standardized]

The standard electron model on average of all electron's movements and postures in the conductor is made this time. That's the figure of the lower berth. The posture of the standard electron is reversed through 180 degrees in the time when a conductor moves upward and the time when a conductor moves downward.

In other words, in one cycle of alternating current, the posture of the standard electron makes one revolution to the plane direction, also, simultaneously, the movement direction of the standard electron changes to an opposite direction. When this electric current is taken out just as it is, it will be alternating current. In other words, one revolution of a coil is synchronous with one turn of an electron's flow and the revolution of the standard electron's posture. This thing has important something to do with the following "3.3 electromagnetic wave". By this figure, it is found that an electric current (electron's movement) is very inefficient, right?

3.3. Electromagnetic wave

An electromagnetic wave is the wave formed by a change in spatial electric field and magnetic field (undulation), and light is also included in an electromagnetic wave. As a study of electromagnetism was developed, a phenomenon contrary to classic electromagnetism started to be learned about, and quantum mechanics were built in the try which corrects electromagnetism. Theory of an electromagnetic wave was also described by quantum mechanics, in particular the quantum field theory. For example, the phenomena emitting an electromagnetic wave of spontaneous emission and stimulated emission are explained by the interaction of the quantum mechanics-like particle and field. An electric field and a magnetic field can also exist in a vacuum space, and so an electromagnetic wave can transmit even in the vacuum space where no medium (substance) of wave exists. The direction in which an electric field and a magnetic field of an electromagnetic wave vibrates crosses at right angles each other, and the direction in which electromagnetic wave moves crosses at right angles to the direction of movement of an

electromagnetic wave. In other words, an electromagnetic wave is a transverse wave. (Reference: Wikipedia, “Electromagnetic Wave”, in Japanese)⁵³

An electric wave with long wavelength, the ultraviolet rays and an X ray with the very short wavelength are included in an electromagnetic wave. The electromagnetic wave transmits at speed of constant 299,792,458 m/s (about 300,000 kilometers per second) in a vacuum space, even if an observer gauges it in whatever kind of direction while moving at whatever kind of speed. This is called as “principle of constancy of light velocity.” (Reference: Wikipedia “Electromagnetic Wave”, in Japanese)⁵³

The electromagnetic wave will be considered here, which occurs when alternating current flows.

HP100

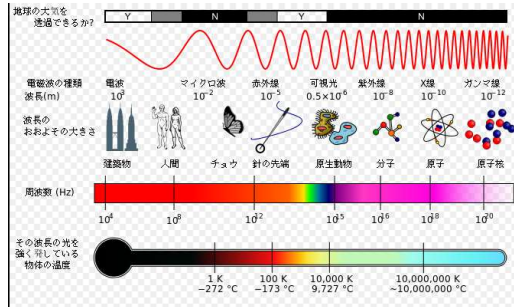

(By Wikipedia, Electromagnetic Spectrum, in Japanese)

It is the name called an electric wave, but it is an electromagnetic wave, so a magnetic wave is also involved. The electric wave and the magnetic wave are transmitted at the right-angle each other in the same cycle.

Electromagnetic wave which being transmitted in space. The wavelength is λ , the amplitude of electric field is E , and the amplitude of magnetic field is M .

The horizontal axis shows the distance and points at a direction of movement of an electromagnetic wave. The vertical axis shows an electric field and a magnetic field, and the axis of a magnetic field is drawn in the shape of being pushed down in the depth direction. An electromagnetic wave propagates as a transverse wave, so that it is shown on a figure. (Reference: Wikipedia, “Electromagnetic Wave”, in Japanese)⁵³

HP101

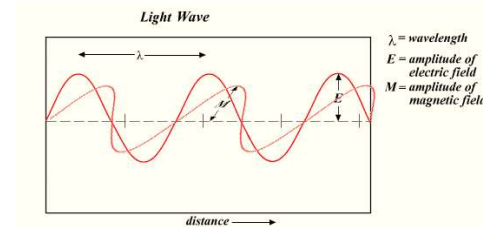

It was explained in "3.2 Faraday’s law of induction" that a standard electron (The one which is averaged the posture of all electrons in the place.) goes back and forth between while making its posture revolve one time in the plane direction in one cycle of alternating current. The reason that an electron changes the posture into the plane direction is because of the nature of the polarization of an electron. In other words, an electron arranges its posture to become parallel to magnetic force lines when an electron enters in the magnetic force lines. The next figure shows its state typically. The electron written “No” shows that its posture is not taken.

HP102

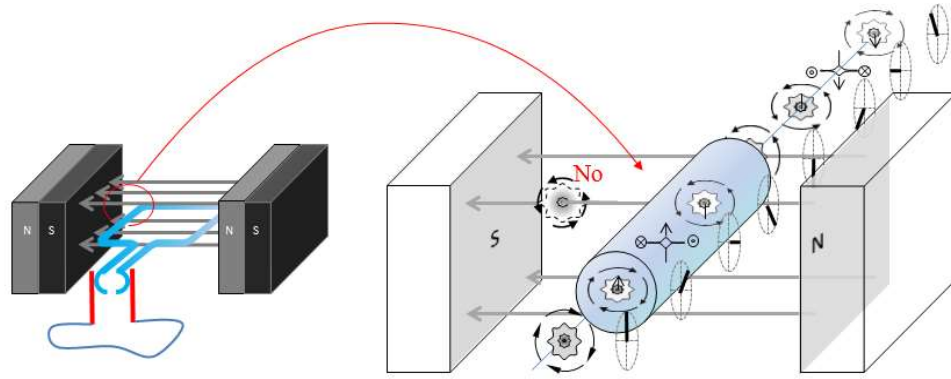

An electromagnetic wave is the transcription of the change of an electron's posture or the movement into static energy body, in energy body theory. The next figure shows the posture of an electromagnetic wave and its movement typically, but to say nothing that it is the same as the posture of the standard electron and its movement.

Therefore, a frequency of an electromagnetic wave becomes the same as a frequency of alternating current (the rotating speed of a generator). In other words, the one reciprocation of a standard electron copied into static energy body is an electromagnetic wave. The one rotary motion of a standard electron (the revolution in the direction of the progress axis) copied into static energy body is magnetic wave. Both are a change in the posture to the electron's plane direction. Further, it can be understood from the figure that magnetic wave is the same as an electric wave. Further, be careful that a frequency of an electromagnetic wave is not the frequency of the electron's own revolving wave. The electron's wave spreads infinitely (on the occasion with a lot of electrons), so, like light, a change in the posture of the electron even reaches infinity (There is investigation bending.) in an instant. The explanation of an electromagnetic phenomenon by an elementary particle model of an energy body is finished with this.

HP103

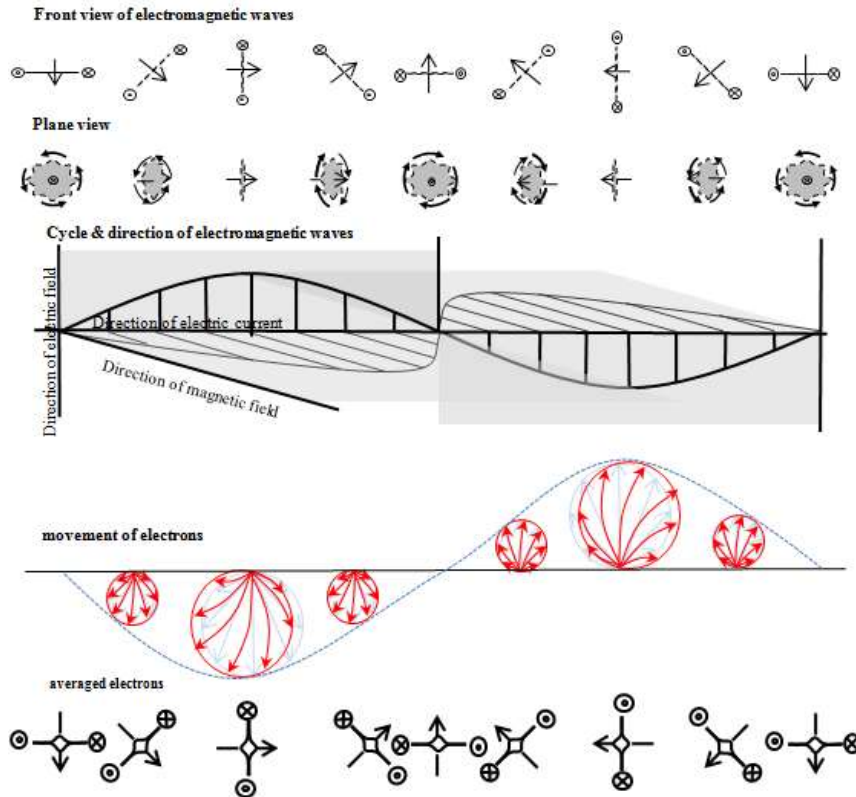

Fig :Movement of electrons & creation of electromagnetic waves in alternating current

The electromagnetic force stems from the difference in the energy level which is caused by each direction of an electron's energy body wave or a proton's which circulates focusing on its self-axis in the center.

The spread of the wave of the energy body which circulates focusing on a self-axis of an electron or a proton generates the nature of the polarization and caused various electromagnetic phenomena. Moreover, parallel movement and a revolution of an electron to its plane direction copied the energy into the static energy body and made light and an electromagnetic wave form. Thus, I think a main electromagnetic phenomenon could be explained based on the axiom which was put up at the beginning, that "All interactions are caused by the difference in the energy levels during the system of the energy body."

3.4. Force between two parallel conductors

When I began to consider about a way of a gravity control, I bumped against a problem of "The force which works between two parallel conductors". It is the phenomenon that two conductors pull against each other in the case that the electric current in the conductors flows in the same direction, but two conductors push away each other in the case of opposite direction. It should be the next explanation by an energy body model.

In the case that each electric currents of the two conductors flow in the same direction, the electron's wave moves in the opposite direction each other between the two conductors, and the energy level rises, and repulsive force is born.

In the case that each electric currents of the two conductors flow in the opposite direction, the electron's wave moves in the same direction each other between the two conductors, and the energy level falls, and attractive force is born. But, actual condition will not be so. Is this a collapse of an energy body model? The significant issue you can say.

Please see the next quotation of "Wakariyasui Koukou Buturi no Heya, in Japanese"⁵⁴. This thing is often explained as follows.

When electric currents are in the same direction, the partial magnetic field between two conductors is different in direction, so it's weakened each other and it comes to have little density of the magnetic force line, and a conductor tries to approach in order to cancel that.

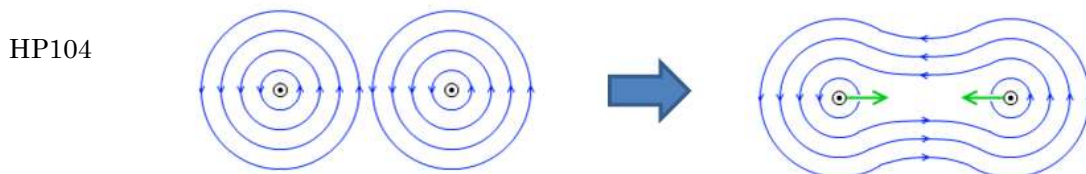

When electric currents are in the opposite direction, the partial magnetic field between two conductors is the same in direction, so it's strengthened each other and it comes to have much density of the magnetic force line, and a conductor tries to leave in order to cancel that.

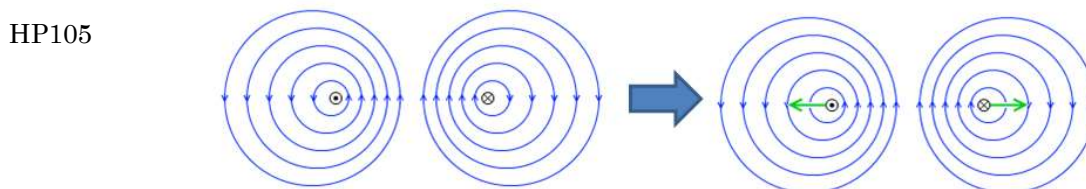

(By Wakariyasui Koukou Buturi no Heya, in Japanese) ⁵⁴

But when I'll become calm and think, it's a little strange.

Please consider one in case of a magnetic force line in a N and S pole of a magnet.

When a N pole and a S pole are brought close, the direction of the magnetic force line becomes same (A magnetic force line increases.), and attracts each other.

When a N pole and a N pole or a S pole and a S pole are brought close, the direction of the magnetic force line becomes opposite (A magnetic force line decreases.), and repulses each other.

Please see the next figure.

HP106

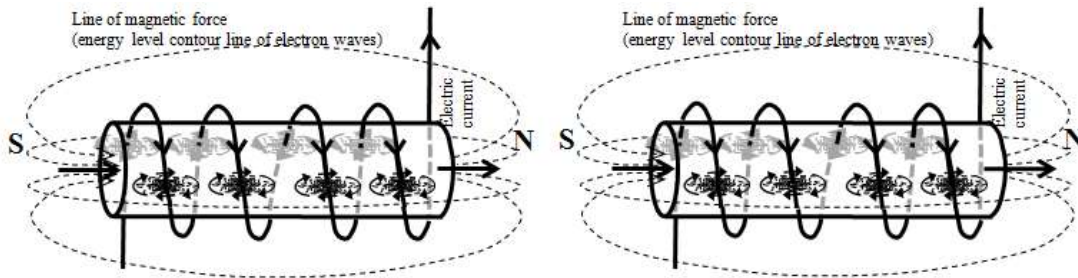

How should it be thought?

In energy body theory, so far it has been explained that if the directions of the revolving wave of two elementary particles are same at the space between two elementary particles, the energy level falls, and attractive force acts, also, if the directions of the revolving wave of two elementary particles are different, the energy level rises, and repulsive force acts.

But, it will be the just reverse explanation by the force which works between two parallel conductors. I thought a crisis of an energy body model was met, but after it was considered, I found out that the explanation of electromagnetism was not a little correct.

Its cause is because electromagnetism has not yet answer the question why a magnetic field forms around the electric current when an electric current flows.

Then from here, it is explained by an energy body model. The point is that an electron is not standing, but is moving along an electric current.

In other words, the cause is not the direction of revolving wave of an electron (the direction of the magnetic force line), but is an electronic movement. When electric current flows, a magnetic field is generated. At that time, an electron changes the posture from parallel to an electric field to right angle direction while moving.

HP107
(HP98)

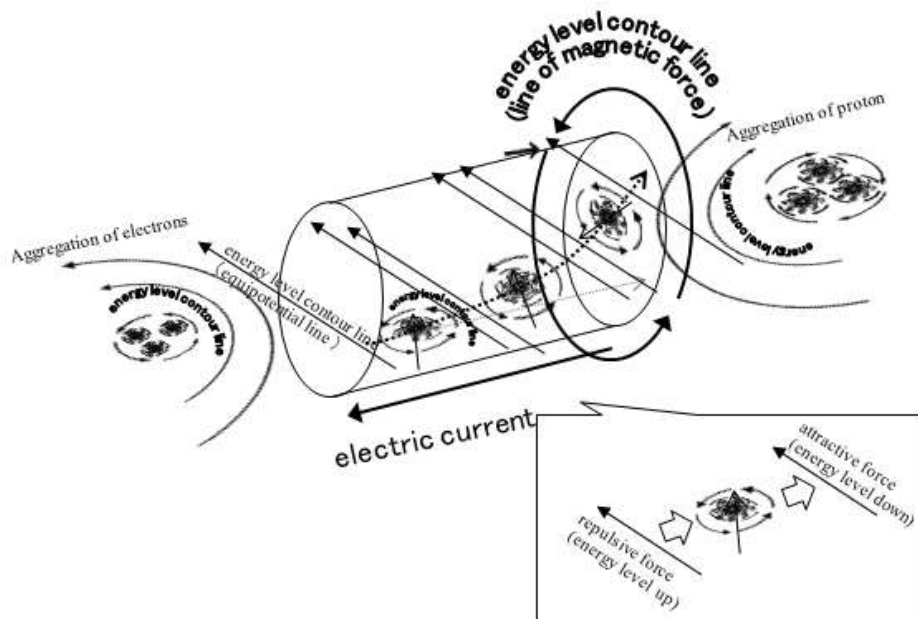

Please see the next figure.

It is the explanation of the phenomenon that two conductors part each other, in the case that the electric current which flows in opposite direction in two parallel conductor A and B.

HP108

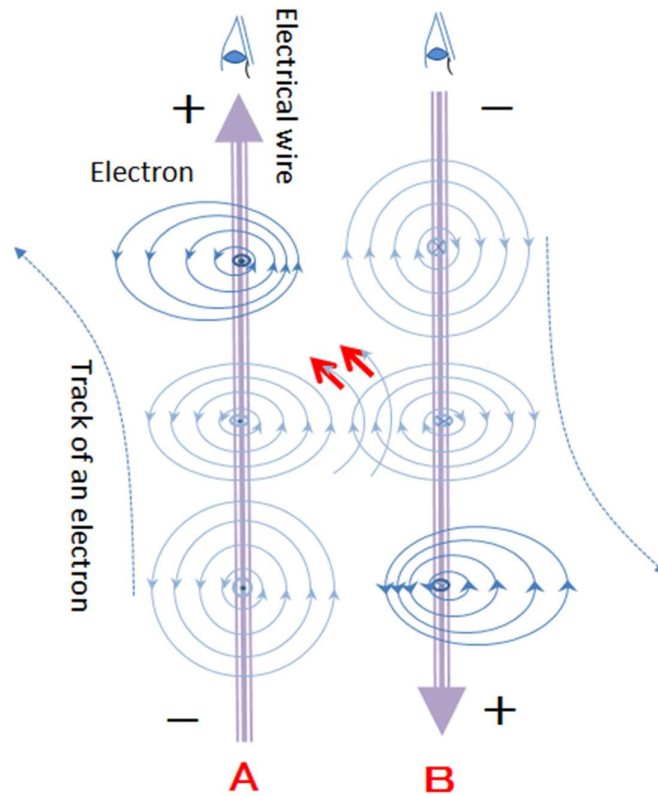

An electron is advancing in the conductor of A towards plus direction. Then the posture of the electron tilts to the right-angle direction of an electric current. An electron in the conductor of B tilts in the same way too. An electron's wave of A collides with an electron's wave of B.

The expanse away from the particle part of a revolving wave of an electron in A is crashed against the part near the particle part of a revolving wave of an electron in B.

The wave of the electron in A is pushed by the wave of the electron in B, so, the electron in A gets away because the energy of B is bigger than A.

A bump of this electron's wave is the cause which makes the mutual magnetic force line which has formed around the conductor apart.

It is said that the impact caused by a bump between the electrons is bigger than the attractive force caused by the decline of energy level when the directions of two electron's waves (the magnetic force line direction) between two conductors are same.

The same thing happens to an electron in B, so B conductor gets away from A.

This time, it is the case that electric current flows to the same direction.

Please see the next figure.

It shows the phenomenon that two conductors attract each other, in the case that the electric currents which flow in two parallel conductor A and B are in the same direction.

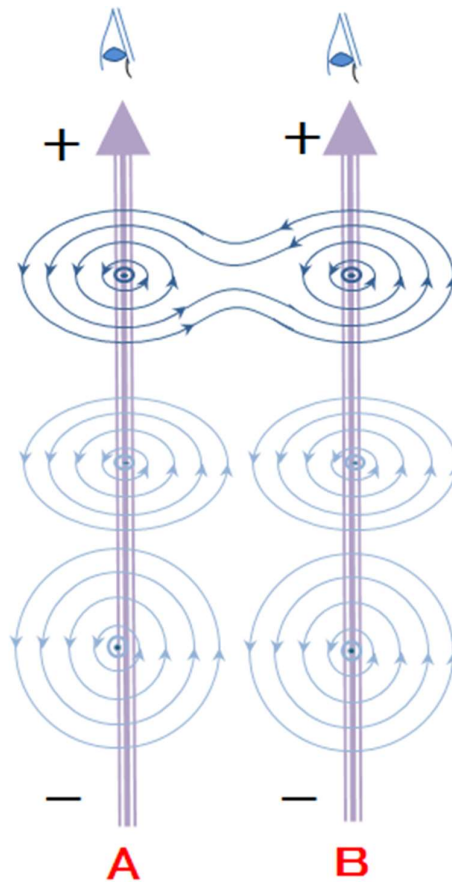

An electron is advancing in the conductor of A towards plus direction. Then the posture of the electron tilts in the right-angle direction to an electric current. An electron in the conductor of B tilts in the same way too. An electron of A and an electron of B do not collide, because those are moving in the same direction.

But the mutual wave of electron is moving in an opposite direction between the A and the B. Therefore, repulsion functions originally, and two conductors should be left apart, but the electrons cannot leave from the conductors because electrons are shut in the conductor. Therefore, a flow of a wave in an opposite direction disappears, and the wave speed rises, and the energy level falls. On the other hand, mutual undulation is circulating in the same direction outside the A and the B, so the force which tries to unite with each other in one body works.

4. Light

4.1. Generation of light

The world brims over with light and is close for us like air and existence indispensable for our living. Light has various character like refraction, reflection, interference, diffraction, polarization, propagation direction, invariable principle of light speed, mass zero, and propagation in vacuum space etc.

Using such nature, light is often used for the most advanced equipment of optical communication and solar photovoltaics, etc, in the various shapes. But, understanding of the nature of the light is developed, but the true form isn't caught by present-day physics yet.

It can be thought that the reason derives from two characters of light. Light is not only wave, but also a particle. But, although light is a particle, we cannot even grasp it. It does not exist as a substance. What time is such light released? It is explained in "1.3 electronic transition", etc, so you can touch easily here.

When for example an electron in the atom is heated up and is excited, the energy given to the electron presses the electron up on a higher energy excited orbit. When an electron falls from the orbit, and escapes from excited state, the energy is released again as the shape of a photon. The wavelength of a photon is decided by the difference in the energy during two situations.

These emission photons will be an emission spectrum of the element. (Reference: Wikipedia, "Emission spectrum", in Japanese)⁵⁵

when an electron in high energy moves in the inside of a magnetic field, an electron can receive the force to the center of the circular motion and bend its orbit. At this time, an electromagnetic wave is radiated in tangential direction to circular orbit. (Reference: KEK, in Japanese)⁵⁶

In energy body model, the reason that light is emitted is because a change of an electron's posture in its plane direction is transcribed to static energy body. This explanation is the same as an electromagnetic wave. The different point between light and electromagnetic wave is the difference of the wavelength which stems from the distance in which an electron changed its posture to its plane direction. Because the wavelength is electron's moving distance. Also, the speed of the change will be the magnitude of the energy which light has.

For example, light of an emission spectrum line is emitted when an electron in an atom escapes from excited state. It is necessary to give attention to that light is not emitted when an electron is in excited states. The reason that light is emitted when an electron escapes from excited state, is because an electron moves in a short time to its face direction when an electron transmits to the orbit with lower energy state, compared with transmitting to a higher energy excited orbit.

An electron transition momentarily presses static energy body, so an energy rise with the short wavelength occurs in static energy body. This is generation of light.

Light has a shape like the board with an expanse, and is the gathering of countless grain of light (board), so the various shape is shown by an observation method. For example, in invariable principle of light speed, a light speed is the recovery time of the bending in the expanse of a revolving wave of light, and the energy in the center of the board of light mainly functions as photo-electric effect.

4.2. Duality of particle and wave

Light is a wave and is also a particle. It is said that "light is a quantum which has both nature of a particle and wave". Because light has two directly-opposed characters, the quantum theory that states "When one is definite, the other becomes indefinite." developed.

In recent years, it is called "photon" in the case putting emphasis on the point that light has a character of a particle, it is called "light wave" in the case putting emphasis on the point that light has a character of undulation, and it is called "light quantum" in the case putting emphasis on the point that light has a character of particle-wave duality. A photon is one of elementary particles and is a quantum state of all electromagnetic waves and a force carrier of the electromagnetic force including light. (Reference: Wikipedia, "Light", and "photon", in Japanese)⁵⁷

The interference fringe observed by Young's experiment (double slit) shows that light is a wave.

Young's experiment is the experiment which indicates the coherency of the light using a double slit. Around 1805, Thomas and a youngster, when light from a light source were let through two parallel slits, it showed that an interference fringe is caused on the screen. The phenomenon which shows that light is a wave motion. (Reference: Wikipedia, "Young's experiment", in Japanese)⁵⁸

HP110

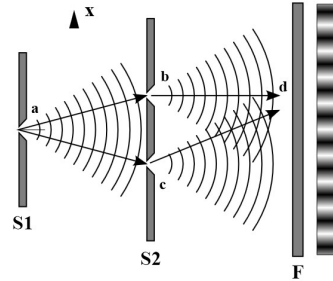

(By Wikipedia, “Young's experiment”, in Japanese)⁵⁸

But, after that, the wave motion of the light which should have been confirmed by Young's experiment is seriously shaken by discovery of photo-electric effect. Photo-electric effect could not be explained only by a wave motion of light.

Photo-electric effect is the phenomenon that an electron (photoelectron) is emitted from the material surface, when light is applied to a substance, and has the next feature.

* Electronic release does not happen, if the frequency of light is not bigger than some fixation. And even if a material is exposed by the smaller frequency of light than some fixation, an electron is not emitted.

*If a material is exposed by the bigger frequency of light, kinetic energy of a photoelectron changes, but there are no changes in the electronic number which is flicked out.

* If strong light is applied, a lot of electrons are flicked out, but there are no changes in kinetic energy per one electron. (Reference: Wikipedia, “Photo-electric effect”, in Japanese)⁵⁹

It is incomprehensible only by sentences, so it was made a figure.

HP111

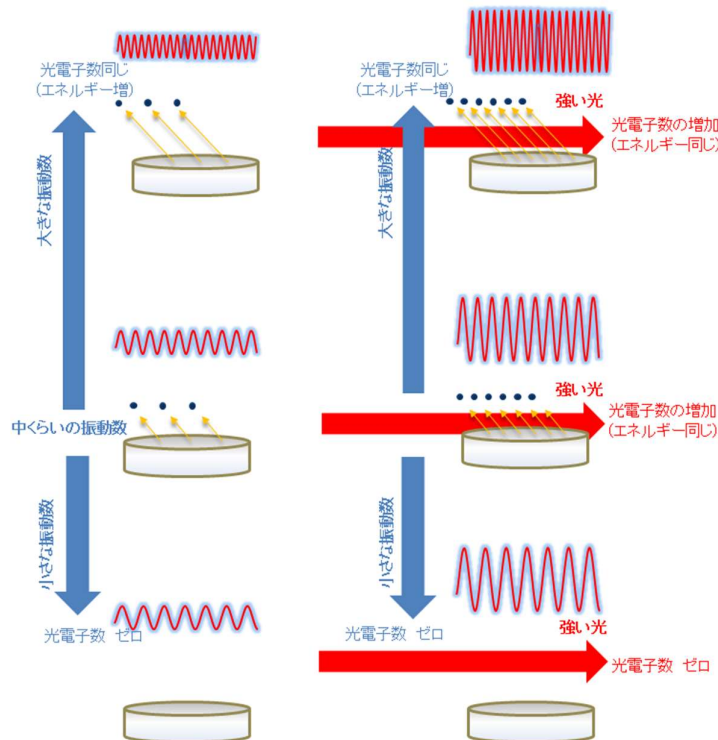

If light is a wave, an electron should get the energy and rush to outside, as long as the wave of light is made strong, if small frequency, but it will not be so. Also, weak light does not have much

energy, if big frequency, so an electron should not rush to outside, but it does actually.

It was the big problem which disturbs the physics world. Einstein insisted that "Light should be regarded as a particle which has the energy multiplied Plank constant h and frequency ν ." (Reference: Einstein no Kagaku to shogai)⁶⁰, and announced that the light quantum hypothesis which calls a particle of light "light quantum", and explained photo-electric effect.

The one which rewrote the figure a short while ago based on a light quantum hypothesis is the next figure.

HP112

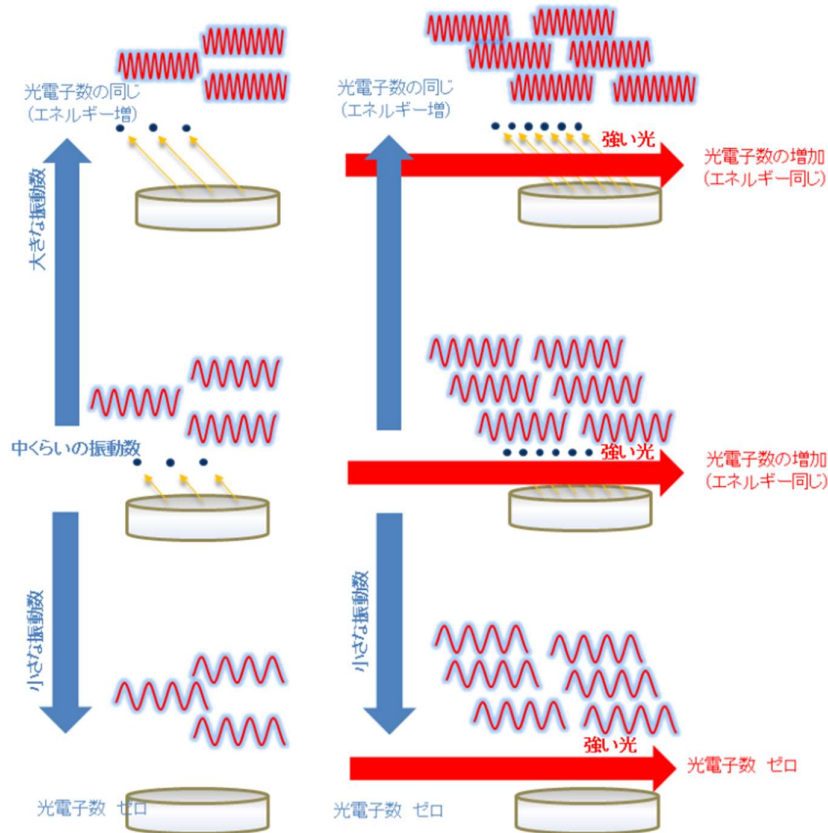

Even if light is strong, but if its frequency is small, an electron cannot rush to outside.
Even if light is weak, but if its frequency is big, an electron can rush to outside.

- Light exchanges energy as a lump.
- The light of the long wavelength has small energy, and the light of short wavelength has big energy.
- The strength of light owes to a quantity of photons. But, even if photons are numerous, there is only one photon which hits one electron. Therefore, if the wavelength of a photon is long, the energy which the photon gives to an electron is small, and cannot exceed the energy by which an electron is made rush to outside.
- If the wavelength of photon is short, the energy which one photon has is large, then, even if photons are few, an electron accidentally hit by one photon can get the energy to rush to outside.

(Reference: Open class Brochure "World physics year Memorial Lecture (August 27, 2005)", Department of Physics and Earth Sciences, University of the Ryukyus, in Japanese)⁶¹

But Explanation does not end with this. Light is a particle and is also a wave.

The bad feeling is left in mind that two antithetical characters of a wave and a particle exists together. Its mystery also appears by the Young's double slit experiments explained first.

In the same way of the experiment to an electron, when each one particle of light is released, what would happen? If one particle of light is released, only one point remains on a screen, and the nature of particle appears. If a lot of particles of light are released, something like an interference fringe of a wave appears.

HP113

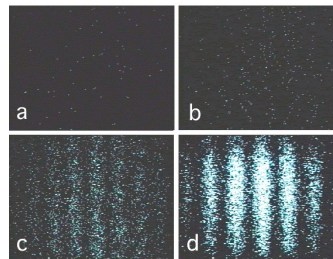

(By Einstein no Kagaku to Shogai, in Japanese) 60

Energy body theory settles mystery to light's having two different nature, a wave and a particle at the same time. A light model by energy body theory is the one that a change of the posture of an electron is transcribed into a static energy body. and it can draw the same figure as "1.6 Wave-particle duality of electron." Light of an energy body model is a transcription of a change of an electron's posture copied into the static energy body. (See: Particle Physics Division "4.1 Generation of light") Therefore, the center part, which shows a character of a particle, and the expanse, which spreads while attenuating, of an electron's revolving wave is transcribed to light.

Even if it is a transcription, an electron itself is not completely transcribed. It might be better to say that a trace of an electron's motion is left in static energy body by being pressed. Therefore, there are also central particle part and expanse in light generated by transcribing.

And the particle part of light (board) which is transcribed the electron's particle part in high energy state becomes a scar of dot which appears on a screen, when each one particle of light (board) is released by Young's experiment.

The more important point is that light is the set of the small countless particles with an expanse (It should be regarded as a board with a particle center.). Therefore, one light (board) and one light (board) is independent respectively. Therefore, light is also observed as a particle.

Further when countless particles of light (board) are collected infinitely, the, the revolving waves are excited each other and spreads infinitely though it attenuates. And a response to the question that one particle of light which passed through one of double slit appears as an interference fringe, when a lot of light (board) released, is the next figure.

HP114
(HP66)

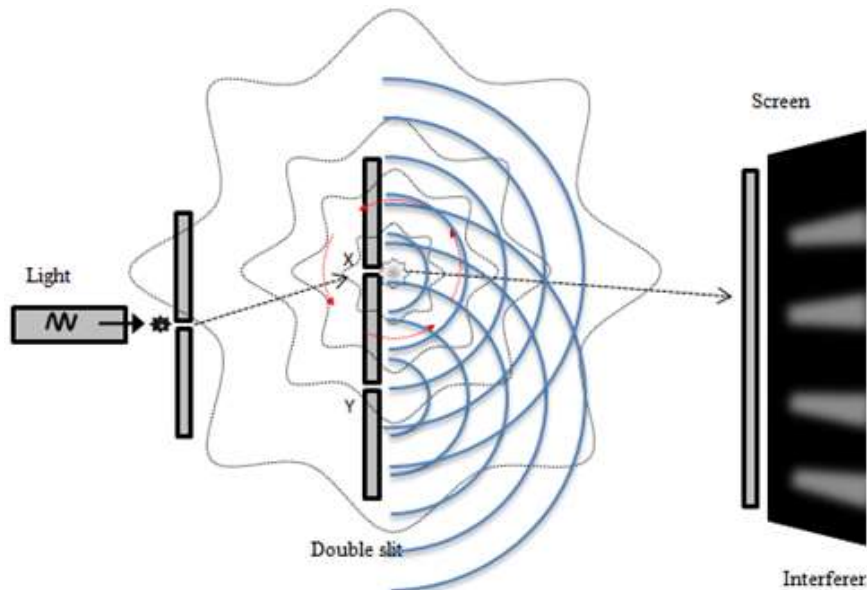

The explanation for this is the same as "1.6 Wave-particle duality of electron." by replacing an electron for a photon. But it'll be the same explanation.

Let it assume that a photon passed the slit X which is one of the double slit. The expanse of the photon touches the other slit Y. Therefore, a diffraction phenomenon occurs at the exit of slit X and slit Y by Huygens's principle, and an interference of two waves happens. And the particle part of the photon makes its way through a valley of an interference fringe. It is because the energy of the wave becomes lower at the valley of interference fringe. On the assumption that a photon is an expansive wave, the reason that a trace of the wave is not left on the screen is that there is no equipment by which electron's particle part and expanse can be observed at the same time, because there is an overwhelming difference between the energy levels of the two. In other words, there is no equipment which can observe directly the spreading expanse of photon's wave up to now.

Also, the reason that the location of a photon's particle part can be grasped only by probability, is that because an electron's wave spreads while attenuating and is revolving, so, a photon's expanse of wave touches the slit wall with various postures, then a photon goes in various direction of up, down, left or right ward and cannot be estimated.

I had only old-fashioned images to an atom that was in the time of "atom boy" 50 years ago; (But, I knew energy is equivalent to mass). Suddenly, 8 years ago, I thought of an elementary particle model of energy body theory that "Undulation of energy body circulates focusing on a self-axis, and spreads while attenuating." through the process considering gravity. And, after that, I found in the inspection work that it had been already knew that an elementary particle also has the nature of wave. But, I have wondered why a researcher did not think of an idea like an elementary particle model of energy body when they found that an elementary particle has a dual character of a particle and a wave. Even I thought of an elementary particle model of energy body, although I had no knowledge that an elementary particle has a character of wave.

It must be easier for a researcher to think of it than me.

But, recently, I was checking on the internet, and I found that Einstein who elucidated photo-electric effect had been thinking already.

Four years later from discovery of a particle of light "light quantum", in 1909, Einstein indicated one of merged models of a particle and a wave. It's the way of thinking that energy has a character of wave, spreads like a circle and "special point" with the nature of a particle is on the top. But physical law did not apply to this "special point", so, Einstein could not help abandoning this model. (Reference: Einstein no Kagaku to Shogai, in Japanese) ⁶⁰

Did he think that even a special point is a wave?

Or, didn't he think of a revolution of a wave?

A detailed thing is not known, but it is certain that the model similar to an elementary particle of an energy body model was considered by Einstein in the past. Genius Einstein deserted the model, so maybe, anyone did not think back to the model after that.

4.3. The Principle Light Speed Invariable 1

Speaking of "The velocity of light invariable principle", Many people might think it would be the explanation on "special relativity", but it is not aimed at "special relativity" for itself. "The velocity of light is fixed." is not known why, but it is accepted as a principle (observational evidence). It is aimed that the puzzle is explained and is solved with energy body theory here.

In the first place, I'd like to explain the "The velocity of light invariable principle". Even if you hear "The velocity of light invariable principle", you will not feel any wonders, just understanding that light speed is fixed. But well, deep mystery is hidden in the back. The velocity of light invariable principle is as follows.

1. The laws of physics are invariant (i.e. identical) in all inertial systems (non-accelerating frames of reference).
2. The speed of light in a vacuum is the same for all observers, regardless of the motion of

the light source.
 (Reference: Wikipedia, "Special relativity", in Japanese)⁶²

Inertial frame of references (Inertial systems) are in the cases like that an observer is in the train doing a uniform motion. When this will be considered deeply, it is really strange. This mysteriousness sometimes becomes the basis for insistence that the theory of relativity is wrong. It is incomprehensible only by the upper explanation, so I'll give the example which is often used.

[1. Light source in uniform motion]

If a light is emitted from a rocket flying in uniform speed V , forward and backward, would the light speed C change to $C+V$ and $C-V$ (synthetic law of speed)? No, the speed is still same C .

(1) an observer in the rocket.

An observer in the rocket observes that the light flies forward in speed C , and backward in speed C .

(2) an observer outside the rocket.

An observer outside the rocket (an observer at a standstill) observes that the light flies forward in speed C , and backward in speed C .



Why does this occur? One of these solution is that we assume that light transferred from inertial rest system to absolute rest system. It is the theory that ether of absolute rest system transmits a wave motion. Even if a light source has moved when it's a wave, there are no changes in the wave speed.



If light moves as a wave, it can be explained that the speed of light emitted from the moving light source does not change.

[2 Observer in Uniform Motion]

But, a further wonder of light speed waited for us. A light source was moving, up to now, but this time, an observer is moving.

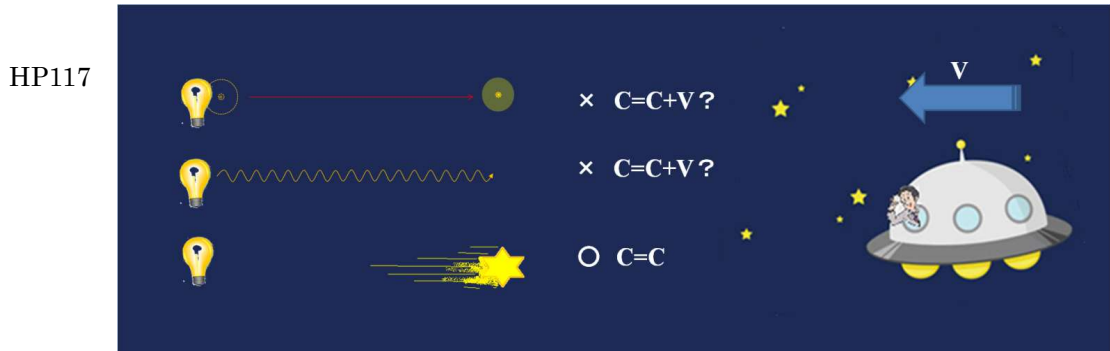

Light is observed from the UFO which flies in speed V.

There is a light source in front of the UFO. An observer in the UFO which is advancing to the light source observes the light which is emitted from the light source. Then, the light speed is observed as C, not C + V.

On the contrary, this time, the UFO is leaving from the light source.

The observer in the UFO observes the light which is emitted from the light source. Then, the light speed is observed as C, not C - V.

This time, it cannot be explained by the theory that a wave motion is spread in the ether.

The theory that a wave of light is advancing by a medium of the ether which is the absolute rest system was denied by the experimental result that Morley announced and Maikeruson in 1887. Even if an observer was moving, the light was same. (The result that the light speed does not change, if an observer is moving in the direction of light advancing and even if in the opposite direction.)

In the optical theory of physics, in the beginning of the 19th century, it was thought that "ether" existed as the medium to transmit a wave motion of light. And, many theoretical and experimental tries were done, but it was not possible to find any kind of evidence about the essential ethereal existence. But, Maxwell who made electromagnetic theory in the stationary ether and made the opinion that light is an electromagnetic wave in 1871 noticed being able to detect global movement in the stationary ether by an experiment on the suitable optics.

Maikeruson who knew that began the experiment in 1881 that light was divided in two, and after being made run in separate routes, two lights were made return, again and intervene.

He thought "If the earth is revolving around the sun in the ether, the light on the earth would change the speed according to the advancing direction of the earth. If the light movement is same as the direction of the earth movement, the light speed should be late only as much as the earth speed. Then, If the light speed, that is made run respectively in the different directions could be detected, ethereal reality would also be confirmed." But a difference in detected interference fringes was smaller than expectation. So, after that, it came to be regarded as the reach of error. But, the experimental failure did not just only deny ethereal existence. But instead of that, it also found the particularity of light saying, "The Principle Light Speed Invariable" that the light speed is fixed if it is emitted in any directions from the moving object. And it was a major premise of Einstein's theory of relativity. For that, it is the most significant and most famous "failed experiment" in scientific history. (Reference: "JAXA Space Information Center", and "Wikipedia Michelson Morley experiment", in Japanese)⁶³

HP118

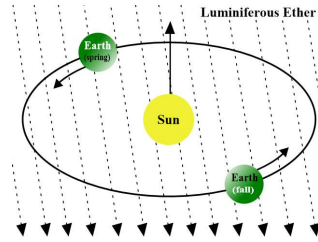

(By Wikipedia, "Michelson Morley experiment", in Japanese) ⁶⁴

Ethereal existence was denied by this experiment, but it is said to be the special relativity that denied its existence perfectly.

But there is also insistence that ethereal existence became unnecessary, not that ethereal existence was denied, apart from general understanding. (Reference: Wikipedia, "Special relativity", in Japanese)⁶⁵

I enter the explanation of energy body theory from here.

This experimental result just indicates the fact that the interfacial wave of a wave of light did not shift at every direction.

Should the experimental result be thought to be denied that light advance in the way of the next figure, rather than to be denied ethereal existence?

HP119

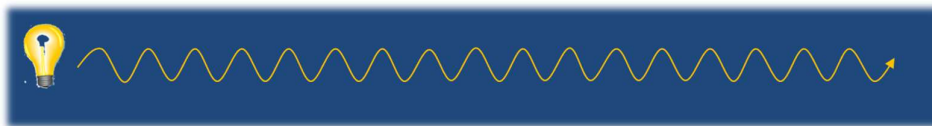

It is not related to the speed of the moving light source, so it should be thought a substance (an elementary particle) which is obeyed the law of inertia was also denied. Therefore, the physics world has recognized "The Principle of Invariant Light Speed", even though they do not know the reason why.

This is strange, isn't it?

"Good?"

"Light is not a wave, also is not a particle, isn't it?"

"Light has a character of wave and particle duality.

isn't it common sense of quantum mechanics?"

"An energy body model of the light I propose is also a wave and is also something like a particle (But, it is not a particle.) as it was explained by the former article."

4.4. Principle of light speed invariable 2

Einstein completed "the theory of relativity" based on the principle of invariant light speed.

What kind of image did Einstein have about how to advance light?

He called a particle of light "light quantum".

When it is inferred from this thing, is it like this, a particle of light flies?

The way of "light quantum" flying which Einstein seems to have considered is expressed, in the next figure based on my guess.

HP120

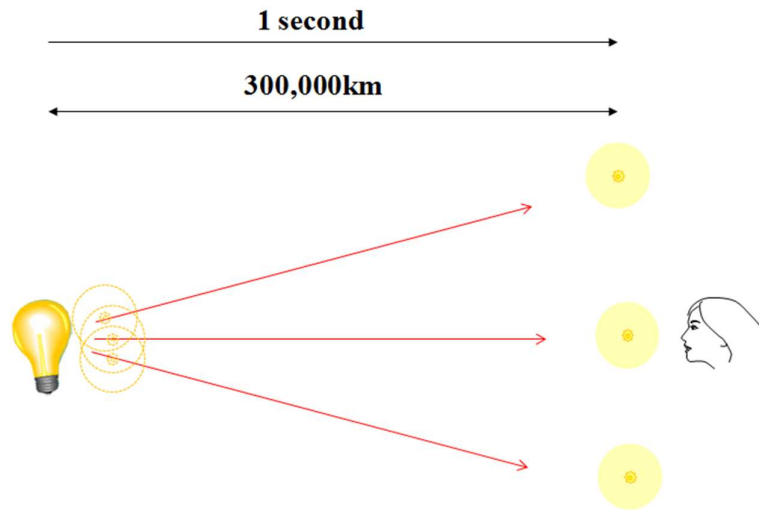

But "The Principle of Invariant Light Speed" cannot be explained no matter what by this image.

Light advances to an observer from a light source. "The Principle of Invariant Light Speed" is that "Even if light is observed from any inertial systems, it is judged that the velocity of light is the fixed number of the same value.". But, when an observer of inertial frame (the observer in motion of uniform velocity) observes the velocity of light, it must be the relative speed certainly.

Does light move instantly by supernatural power?

If an observation is begun, does light appear anytime in front of the observer exactly by warp?

There is no such possibility.

Light goes straight, certainly.

There is only one answer to solve this mystery.

There is not a movement vector of light between the light source and the observer.

That is the only solution and the other solution is not possible.

If there is a light model which can satisfy this solution temporarily, the light model should be called a light model of truth.

"What kind of thing is that on earth?"

"In other words, it is needed the light model that does not advance in the direction considered at present.

"? I do not understand."

"I have that.... By the model which can satisfy the above solution... "

"That is a light model of energy body theory."

If a new model of light which gives a ground to "The Principle of Invariant Light Speed" which has been made mystery for more than 100 years, we may probably think the true form of light to have caught.

Moreover, the light model of energy body theory has the character of a particle and a wave at the same time and also solves the mystery of the double slit experiment by which this has been also made a strange phenomenon for more than 100 years. (See: Particle Physics Division, "4.2. Duality of particle and wave")

The light model of energy body theory is not that alone.

"Photo-electric effect", "Doppler effect" and the "Polarization of light" etc, can be explained.

"The Principle of Invariant Light Speed" which has been made mystery for more than 100 years was made clear. From here, the explanation of "The Principle of Invariant Light Speed" by energy body theory starts. Light (electromagnetic wave) is the transcription that a change of an electron's posture to the electronic plane direction copied into static energy body (space). (See: Particle Physics Division, "1.3. Electronic transition", and "3.1. Electromagnetic field".) An electron of which wave is revolving while focusing on a self-axis, and its center part in quite high

energy state shows a character of a particle, and from there the wave spreads over its expanse while attenuating, and the expanse like a thin plane has a character of electric field or magnetic field. Therefore, also light copied an electron's shape forms the wave of energy body which is revolving around and spreads over the expanse from the center while attenuating.

The quantum theory indicates that light is a particle and a wave too. And its particle image seems to be imagined this center part. But, it is necessary to regard the whole expanse of the wave revolving while focusing on a self-axis as one particle of light, not only its center part.

Saying one particle of light, it is the one like a thin and infinitely wide board with a center.

So, let me express it with a board of light to be easier to imagine from now on. The next figure is that image.



Light is not one board of light.

Light or electromagnetic wave is emitted at every electron transition or electronic vibration, so countless board of lights are radiated.

Light is made of countless board of light.

The posture of the electron gets all angles.

Therefore, a board of light is also radiated at all angles.

Therefore, light is called a spherical wave.

The following figure expresses its state.

But, it is expressed by a small circle, because a board of light spreads infinitely (in the case of countless lights), then, it is not possible to draw them on a figure.

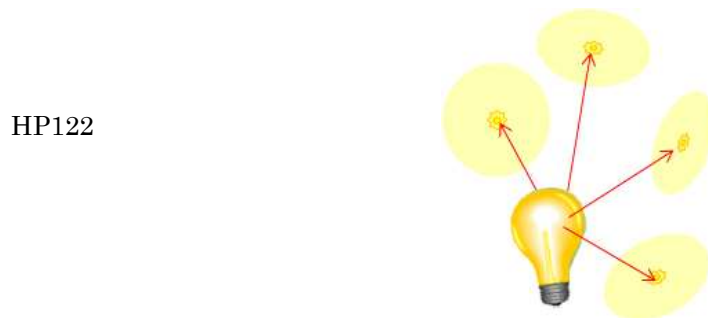

And a board of light advances to the plane direction.

Light is the transcription of a change of electron's posture to its plane direction, so it is natural, isn't it?

So, light does not advance in the direction of board side. But it is the flank that we observe as a board of light. The thickness of the board will be the wavelength of the light. It is convinced that the wave length of light is very short, isn't it?

It is not the wavelength of the revolving wave, so attention is needed.
 If it's the wavelength of the wave seen from the face direction, it should be the very long wavelength.

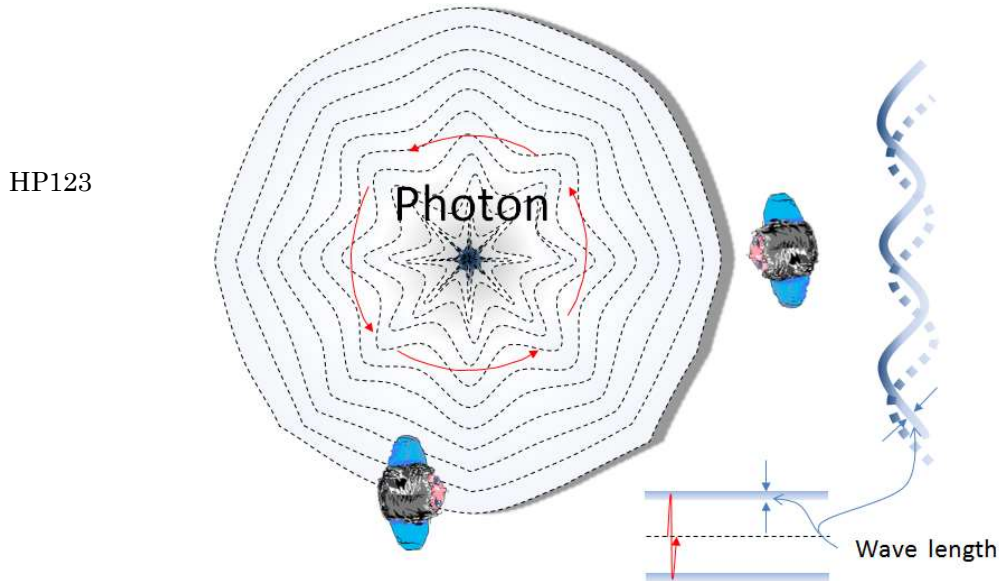

A board of light transcribed an electron's posture advances in the direction of its plane.
 In other words, light comes from the right-angle direction to the line (vector) which links an observer and a light source.
 An electron's expanse spreads infinitely, so a board of light transcribed an electron's posture also spreads infinitely, and reaches even the infinite distance in an instant. But, inertia force functions, then a board of light is bent, for that, one second per 300,000 kilometers is necessary for recovery. Even if an observer of inertial system (the observer doing a uniform motion) observes velocity of light, it will not be the relative speed, isn't it?

"Make! It's consent."

The next figure shows the thing.

Bending of a board of light is not drawn, but it is emphasized that light comes from the right-angled direction of the line which connects an observer and a light source.
 This is the reason of "The Principle of Invariant Light Speed".

"But... Then, does not light itself advance with the velocity of the light?"

"That's right."

" It is like this. When a switch is turned on, an electric field transmits through long distance in an instant, but the speed of electron is very slow. "

HP124

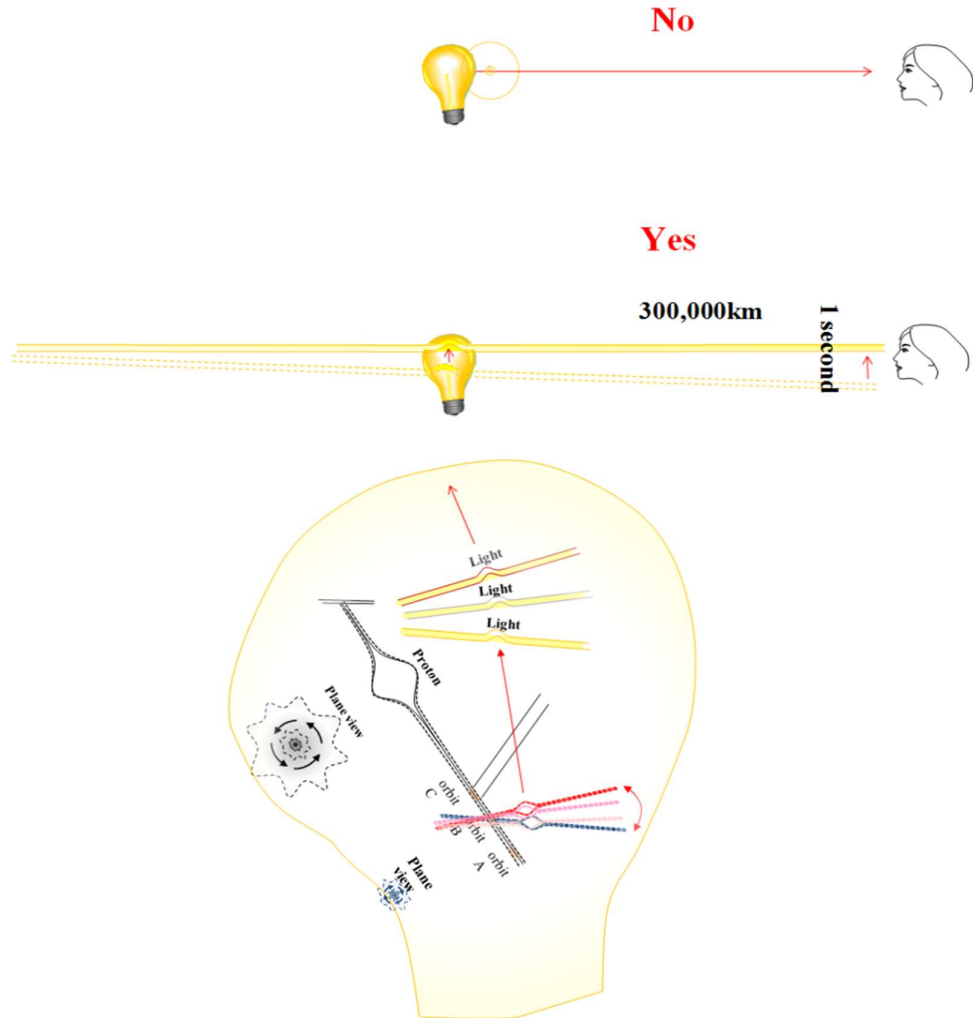

The expanse of an electron and a proton which forms an electric field spreads infinitely, so even if poles (electron and proton) are far and away, an electric field is formed in an instant, by the postures of an electron and a proton changing.

"Even if light speed is slow, it is different from the occasion of an electric current, and I think light advances at considerable high speed."

"I was surprised."

"An image of light has changed."

In conclusion, the next can be said.

This strange nature of light is caused by a board of light is being made of two wave motions.

Or, the wave of energy body of light which is circulating while focusing on a self-axis mainly shows the nature of the wave, (polarization, interference, diffraction, refraction, and reflex). On the other hand, compression wave which is occurred to the change direction of the electron's posture shows the nature of the particle, (photo-electric effect, invariant light speed, optical linearity, and spectrum). Moreover, light has another wave. Countless boards of light (electromagnetic wave) are radiated simultaneously with electronic vibration, but this vibration can be also said the vibrations of a board of light. Light which is a gathering of countless board of light can be regarded collectively as a wave. An electron makes its posture revolve one time per one cycle of alternating current.

So, the electromagnetic wave which is radiated from the electron also makes its posture revolve one time per one cycle of alternating current. (See: Particle Physics Division, "3.3. Electromagnetic wave")

Please pay attention to the next point. What comes to mind regarding to a wave character of wave is when a particle of light is emitted one by one in the double slit experiment, a scar is left respectively on the screen. But this one by one scar should not be thought as the phenomenon that a character of particle of light appeared. Has physics been confused by this?

A particle of light is respectively independent, but light is like a board which infinitely spreads over, not a point. And this board has the character of a particle.

4.5. Refraction and reflection of light

When Light ray enters in the water, it refracts, also reflects.

A relation between an incident light ray, a reflection light ray and a refraction light ray is expressed in Fresnel formulas.

When a light ray is incident on interface between the substance in the different refractive index, Light ray reflects the part and makes penetrate refracting through the part.

It's Fresnel formulas to describe this behavior.

From this, the law of reflection which states that an angle of reflection is equal to an angle of incidence α is led. And, as to an angle of refraction, the Snell's law which states $n_1 \sin \alpha = n_2 \sin \beta$ is led.

To which I say since a reflection angle will be concerned with the reflection law and the angle of refraction equal to incidence angle α β now is led. But, n_1 and n_2 are the refractive index of the incident side and the penetration side respectively. (Reference: Wikipedia, "Fresnel equations", in Japanese)⁶⁶

HP125

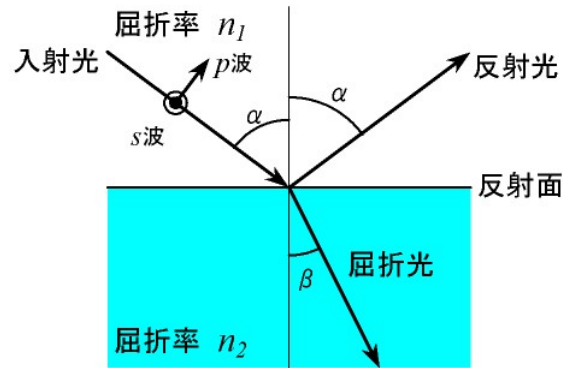

P wave is one kind of polarization.

The polarized light ingredient to which an electric field ingredient is parallel to the plane of incidence in the optics. (Reference: Wikipedia, "Primary wave", in Japanese)⁶⁷

S wave is one kind of polarization.

The polarized light ingredient to which an electric field ingredient is vertical to the plane of incidence in the optics. (Reference: Wikipedia, "Secondary wave", in Japanese)⁶⁸

Huygens-Fresnel principle is the method to analyze a spread problem (limit of far field and diffraction of near field) of a wave motion.

Each point in a wave front of forward travelling wave will be a wave source of the new wave called a secondary wave according to Huygens-Fresnel principle, and forward travelling wave as the whole will be the one on which all secondary waves (which is formed from the medium spread already) were piled up.

Light is a wave, so the method to analyze a spread problem of a wave motion is applied. (Reference: Wikipedia, "Principle of Huyghens = Fresnel", in Japanese)⁶⁹

HP126

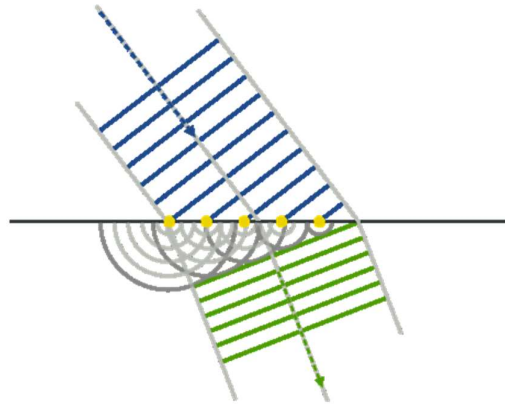

(By Wikipedia, "Principle of Huyghens = Fresnel Reference", in Japanese)⁶⁹

But when light ray enters in the water, why is it to split up into light which refracts and reflects?

This reason is explained by a light model of energy body theory.

Light is a spherical wave, so the posture of the board of light takes the various poses as shown in the next figure, but among these, boards of light drawn by a red line are incident lights.

It is known that there are two kinds of light ray of which moving direction is directly-opposed, even though those are at the same incident angle.

HP127

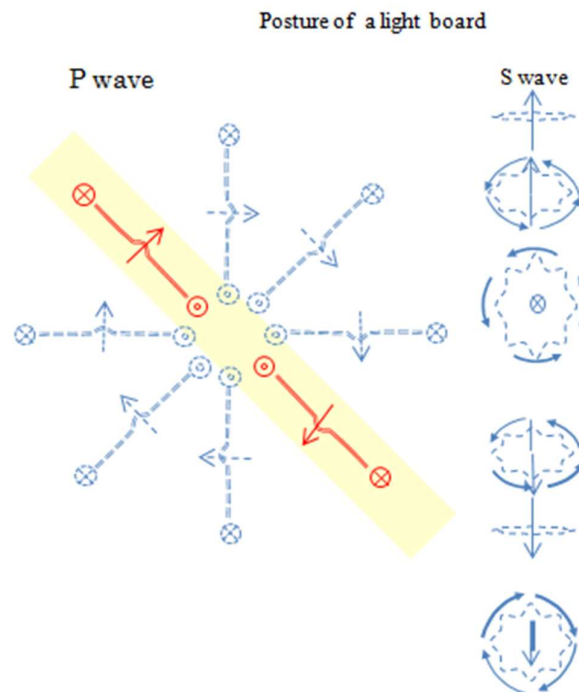

The explanation that a board of light is incident on interface between the different substance and refraction are as it is Huygens-Fresnel principle. The reason of refraction is explained that the velocity of light is different between the different

substance.

"The velocity of light is different between the different substance?"

"Where did the light speed invariable principle go?"

Certainly, a light model of energy body theory varies the velocity of light.

For easy, let it assume that a board of light enter in the water from the air. A board of light is developed to the plane direction.

Two boards of light which advance in opposite direction each other is drawn in the next figure.

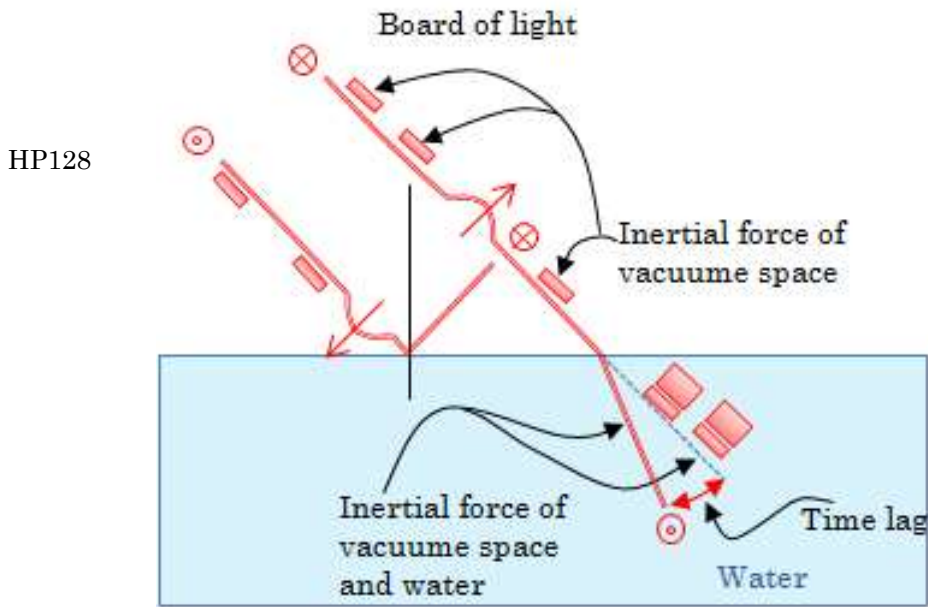

The board of light which goes away from the water surface enters in the water and refracts.

A board of light advances towards the its plane direction, so a light of board pushes water which has more energy density than the air with the plane of board. Therefore, it is understandable intuitively that light is made bent.

Conversely, it shows the fact that a board of light is advancing towards its plane face direction.

And inertia force functions and a board of light bends being delayed for one second per 300,000km in a vacuum space.

In the water, the delay becomes one second + α occurs, because inertia force of water is added to inertia force of vacuum space.

Inertia force is a rise of the energy which occurs to space.

In other words, bending of a board of light becomes bigger, and the speed of advance becomes slow.

This causes the refractive index.

A board of light is a transcription which is the one that a change to its plane direction, of an electron's posture is transcribed into static energy body.

When being pressed, the thickness which becomes a spectrum is given to a board of light.

A light of board is refracted because this thickness of a board of light as it explained in the figure of (Wikipedia "Principle of Huyghens = Fresnel", in Japanese)⁶⁹.

There is also something to which the direction of movement is reverse in a board of light.

The board of light going to the surface of the water reflects, then does not enter in the water.

Light advances to its plane direction, so light collides the surface of the water which has higher energy level than the air.

Therefore, it can be understood naturally that light is refracted.

This indicates the fact that light advances to its plane direction as expected. But, there is the case that a board of light enters just in case of the hard-reflective substance.

4.6. Doppler effect

When a light source moves at high speed, emitted light from there causes a red shift by “Doppler effect”.

Why is this?

Light should not move in the same way of a sound wave.

Present-day physics such as quantum mechanics seems probably not to have an answer about this problem. I think that a red shift of “Cosmic Microwave Background Radiation” was explained as the same thing as “Doppler effect” of sound by several sites related to the universe expansion. So, I was perplexed. But indeed, “Doppler effect of light” can be analyzed by the same way of thinking (a numerical formula) of the sound wave.

In case of light, the same kind of effect is observed, and light from the light source which goes backs away looks like red (red shift) and light from the light source which approaches look like blue (blue shift). The most important point is that even if a light source is moving vertically to the observer’s eye direction, and not having the velocity of the eye’s direction (=90 degree), the frequency of light is seen like changing. This is called “transverse Doppler effect”. (Reference: Wikipedia, “Doppler effect”, in Japanese)⁷⁰

Doppler effect of light occurs to a crosswise direction as well as the lengthwise direction.

Then let me explain energy body model.

When an electron makes a change or a movement of its posture, its posture is copied into static energy body, and it is light. Therefore, the wavelength of a light will be the distance which the posture of the electron has moved. A change in the posture of the electron is the plane direction.

The electron’s expanse spreads infinitely (But when the countless electrons are gathered.), so light’s expanse reaches to the far distance in an instant too.

The next figure shows the generation mechanism of light with an emission spectrum. When an electron transitions to orbit C with the smaller energy from orbit B, its posture and a movement are copied into static energy body.

It is a parallel movement mostly, so light will have a spectrum of the specific wavelength.

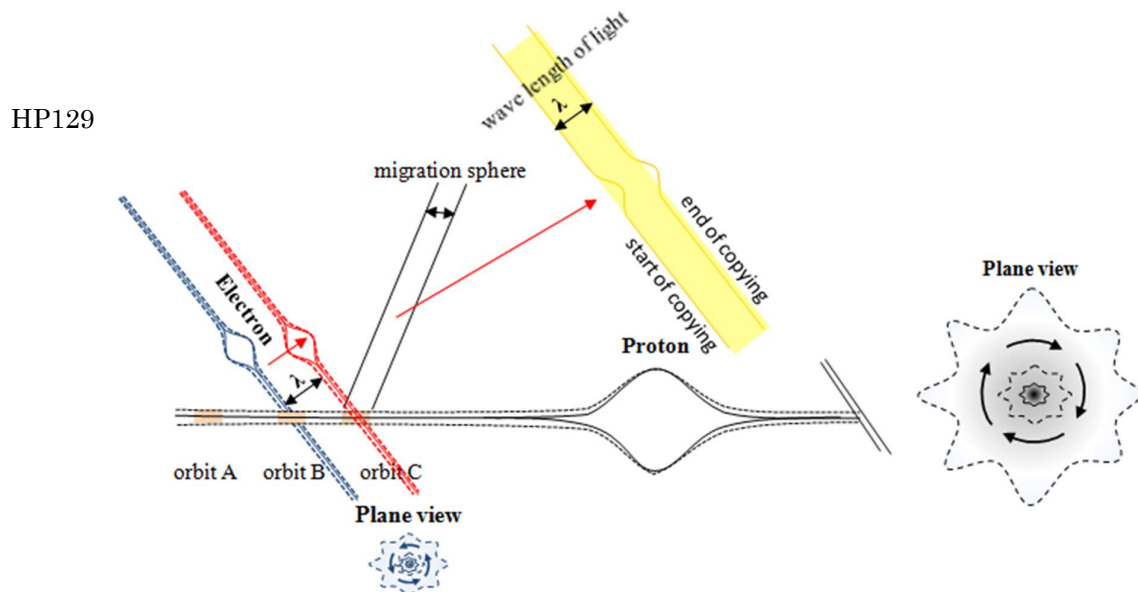

The next figure shows the mechanism light with the various wavelengths generates, when an atom is excited by heat. The expanse of an electron’s wave runs into the expanse of a proton’s wave. Because, mutual revolving wave has wave peaks and troughs, and runs into mutual wave in the slanting posture, the posture of the electron is unstable. Even if an electro is on the orbit, the same posture always is not kept.

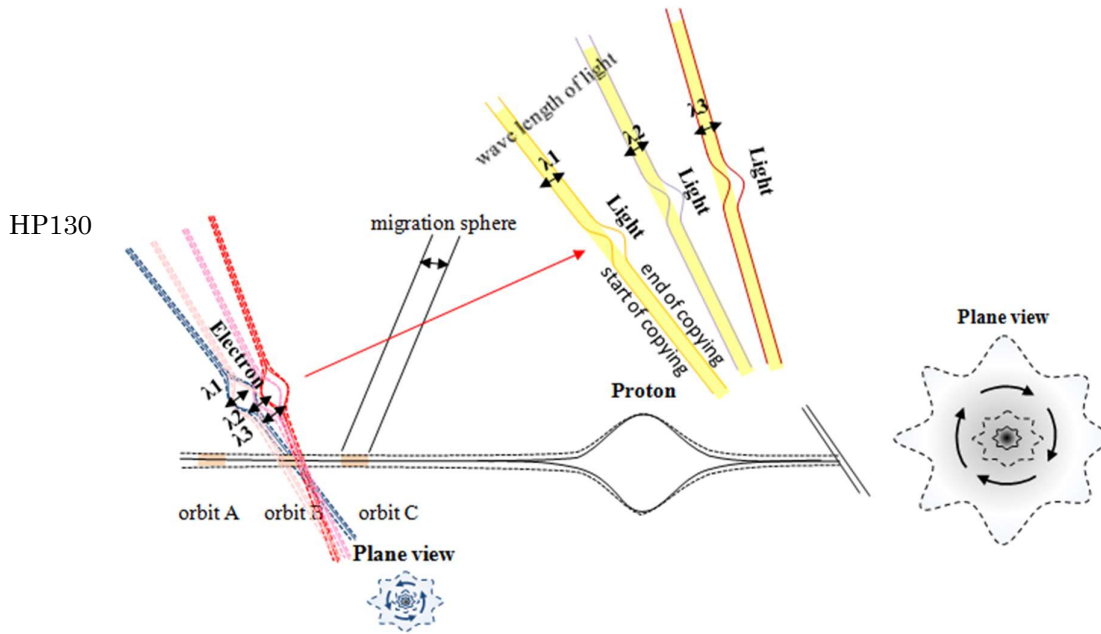

An electron's slanting posture vibrates in the migration sphere colored hazel, in the upper figure. When being excited by a high fever, it will vibrate more intensely. This electron's vibration is copied into static energy body, one after another, and the light of various wavelength is emitted, one after another. But, light is the form of which is copying a change of the posture of an electron, so a change of the energy level is brought to static energy body. In other words, light has energy. Inertia force operates on the movement of energy.

The next left figure expresses the situation that light is bent by inertia force.

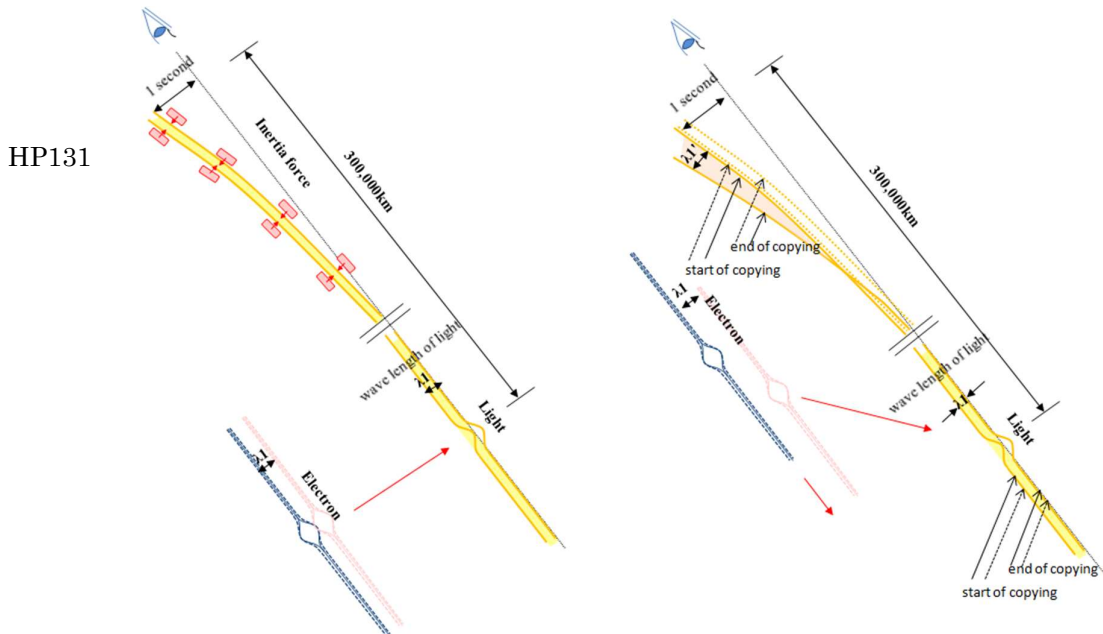

A subtle difference in occurrence of this inertia force makes light bend like a bow.

Therefore, it takes light one second per 300,000 kilometers to be observed.

If a light source is leaving with high-speed, what would happen?

It will take an electron longer time and longer distance to transit, because the orbit will have

been shifted before the electron reach.

Then, the light created by the electron's transition will take longer time and longer distance, thus, the wavelength of the light becomes longer. Also, the wavelength of the light emitted perpendicularly to the line of an observer and the light source becomes longer because of bending.

The upper figure shows that. Transverse Doppler effect can also be explained equally.

The next figure shows the situation that the wavelength becomes longer, for the location where the transcription of an electron's posture ends moves to the right side.

HP132

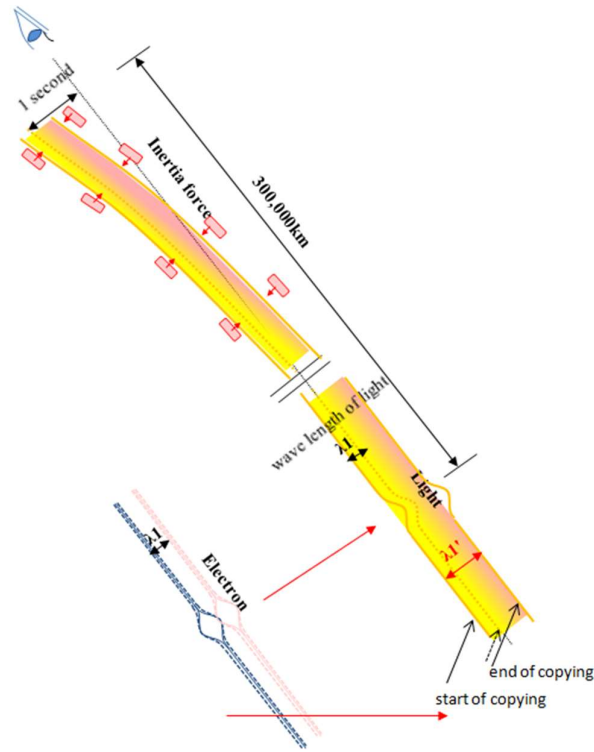

The principle, by which light is emitted and of Doppler effect can understand more easily, when it is illustrated by an energy body model, can't it?

Further, the next figure is expressed the wave of light by an energy body model.

HP133

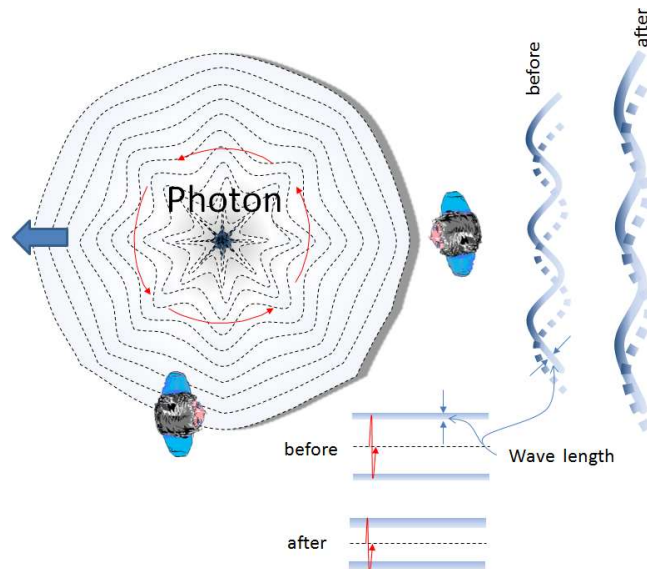

4.7. Theorem of Fermat

The phenomenon which shows that a light model of energy body is right was explained by the former article, and more, there is "Fermat's principle" by French physicist, Fermat.

Fermat's principle is that light chooses the shortest course to arrive at its destination.

It is not the shortest distance is important.

Please see a figure next.

Light is emitted to B spot from A spot. It passes through the water tank on the way.

HP134

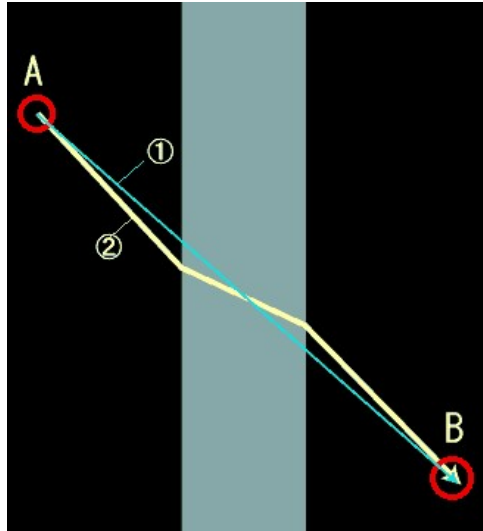

(By IllustratorKisokoza, in Japanese) ⁷¹

When you predict the course that the light will take, you naturally forecast that the light must take the straight green line course of ① which is the shortest distance. But actually, the light takes the bending yellow course of ②.

Light speed becomes slow in the medium.

Therefore, in shortest time, light takes the course which becomes the shortest, so that it arrives at B spot. (Reference: IllustratorKisokoza, in Japanese) ⁷¹

It is really strange, isn't it?

Naturalness is so made rationally that human intelligence does not come.

But when knowing a light model of energy body theory, you would be convinced whether it was so.

Before explaining it, let us see that a wonder of the surface tension of the soap water.

A ring-shaped line attached two pillars is made sink into soap water, after that, refloat quietly. Then, a film of soap water forms between the pillar and the pillar. When the ring-shaped line is seen from the top, the film of soap is a red-line in the next (left) figure. The film of soap tries to be minimum because of the surface tension, so, the red-line expressed the film of soap is the straight line between two pillars. when the ring-shaped line is seen from the top,

A slightly strange film of soap is made at four pillars. (The right figure). This is the answer that a total of the line length which ties four points is shortest. (Reference: Tone nikki, in Japanese)⁷²

HP135

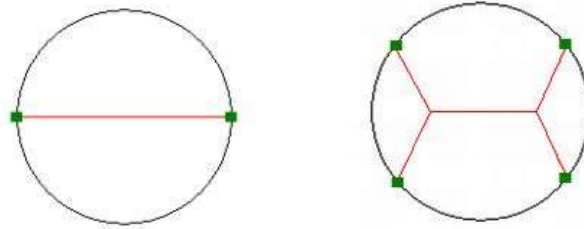

(By Tone nikki, in Japanese)⁷²

When the force which tries to be a minimum, is working on one body, it can be done easily that even a mathematician seems to be second, can't it?

Light is also so. It is because light is received inertia force that light takes the course by which light arrives in the shortest time. Light is going to B spot from A spot in the upper figure.

Then, it means that light is advancing beforehand researching the course to arrive in the shortest time. The strangeness increases whether light has a sensor or artificial intelligence. But it is not strange thinking by a light model of energy body theory.

A light model of energy body theory is that light is advancing at right angle to a straight line between A and B. Light advances in the plane direction of a board of light, so when the plane of its board enters the heterogeneous object, for example the water, it is received bigger inertia force. Therefore, the plane of the board of light bends.

If a bending of body is smaller, it is surely better, isn't it?

In other words, light try to hold bending of a body to a minimum.

The total of the inertia force which a board of light receives becomes smallest.

The recovery time from the bending of a board of light is the velocity of light, so the bending is smallest is to say that the course of light takes the shortest time.

HP136

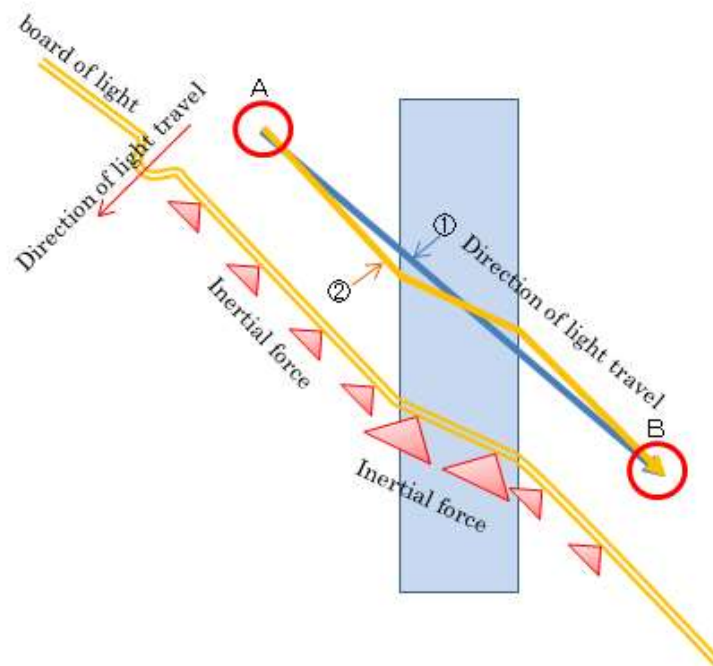

It can also be said conversely, that a light model of energy body theory by which we assume "Light (board) advances to its plane direction." was endorsed by "Theorem of Fell Marr", "The Principle Light Speed Invariable", and "Refraction and reflection of light". (See: Particle physics Division "4.7 Theorem of Fell Marr", "4.3 Principle of light speed1, "4.4 Principle of light

speed 2, and “4.5 Refraction and Reflection of light”)

5. Neutrino

A neutrino is one kind of elementary particles classified into a lepton.

Specially, there are no strong interactions and electromagnetic interactions, and a neutrino has a feature that "it passes all substances." Also, a neutrino has no mass. But, the mass which is not zero was observed by Takaaki Kajita, a director and a professor of Institute for Cosmic ray Research University of Tokyo, and Research Center for Cosmic Neutrinos, and he won 2015 Nobel Prize in Physics. But much mystery is still left.

A neutrino is the name of a neutral lepton among elementary particles. It is thought that there are three kinds of electron neutrino, muon neutrino, and tau neutrino or six kinds together with the respective antiparticles. Wolfgang Pauli advocated the existence hypothesis to keep the law of the conservation of energy and the law of the angular momentum conservation as to a β -decay of a neutron. And the existence was proved by an experiment of Frederick Rye Ness and others.

A neutrino does not have an electric charge and has spin of $1/2\hbar$. The mass is very small, but is not zero. A neutrino does not strong interaction and electromagnetic interaction, and only does weak interaction and gravity interaction. But, a neutrino does almost no gravitational interaction because the mass is very small, and therefore a reaction with other elementary particles is little, and permeability is very high, of a particle. It was general understanding that a neutrino has no mass, but it was found a neutrino has the mass which is not zero by the observation of neutrino vibration by Takaaki Kajita. (Reference: Wikipedia, “Neutrino”, in Japanese)⁷³

It is thought that the standard theory which explains the mechanism of an elementary particle was completed by the discovery of a Higgs boson. But it is thought that there is a rip of the standard theory of an elementary particle, because the mass of the neutrino which has been known so far, and the mixture condition are very different compared with those of a quark. (Reference: Super-Kamiokande, in Japanese)⁷⁴

A neutrino is classified into the same kind of electromagnetic wave by an energy body model. An electromagnetic wave is the transcription copied a change, to its plane direction, of the posture of an elementary particle (electron) into static energy body. But, an electromagnetic wave cannot freely penetrate a substance. The reason is that the expanse of an elementary particle's (electron) revolving wave spreads out, so, an electromagnetic wave which is a transcription of an elementary particle's (electron) change of posture also spreads out. Therefore, the spreading expanse of an electromagnetic wave interacts with the expanse of revolving wave of an elementary particle which consists of a substance, so, the interaction becomes an obstacle.

On the other hand, a neutrino is also the transcription copied a change, to its plane direction, of the posture of an elementary particle (π meson) into static energy body. But the different point from an electromagnetic wave is that a change of the posture of π meson, not a change of the posture of electron copied into static energy body.

In energy body theory, π meson is the one into that an electron transformed, because the electron was sandwiched between hadrons of a proton etc in the atomic nucleus, and the expanse of its revolving wave was pressed back, as a result, an electron changed into π meson of a high energy state. In other words, π meson does not have the expanse of the revolving wave.

And when a β -decay happens, the energy of π meson is freed, and π meson returns to the form of the original electron. At the same time, a change of the posture of π meson is transcribed to static energy body and it is a neutrino. (See: Particle Physics Division, “2.3. Weak interaction”) Therefore, a neutrino which is transcribed a change of the posture of the π meson into static energy body does not have the expanse of its wave. Therefore, a neutrino is transcribed only a particle part of an elementary particle. Then, a neutrino cannot interact with the expanse of an elementary particle of a substance, because it has no expanse of its revolving wave. Thus, when a neutrino passes through a substance, it almost encounters no obstacles.

Further, there might be another occasion to inspect the speed of a neutrino, but “The Principle of Invariant Light Speed” might be not applied to the speed of a neutrino, because it has no expanse of revolving wave. It can be thought that a neutrino is generated besides by a β -decay. The expanse of an elementary particle’s revolving wave is narrowed and only a particle part remains in the space where is far from the gravity field and is under absolute zero degree. When these elementary particles are intensely quivered by a stellar explosion, its posture is transcribed into static energy body, and a neutrino is generated. It is different from an electromagnetic wave is generated, a neutrino does not have an expanse of its revolving wave, because an elementary particle does not have an expanse of revolving wave in the space of absolute zero degree.

6. Mass (Inertial mass and Gravitational mass)

The mass is the amount which indicates the magnitude of the inertia of an object, or the amount of the cause which generates gravity. (Reference: Wikipedia, “Mass”, in Japanese)⁷⁵

The former is an inertial mass and the latter is a gravitational mass.

慣性質量 (inertial mass) m_I は、ニュートンの運動方程式において導入される量である。物体に作用する力 F と物体の加速度 a の比例係数として次の様に表される。

$$m_I \times a = F$$

重力質量 (gravitational mass) m_G は、重力 (万有引力) を起こす質量のことである。物体に作用する重力 F_G とその場所での重力加速度 g により次の様に表される。

$$F_G = m_G \times g \quad (\text{Wikipedia 質量})$$

The inertial mass and the gravitational mass are a just different definition. But Einstein found the "Equivalence principle" by a thought experiment of an elevator, which was later called "the best idea in his life" by Einstein. The "equivalence principle" is considered that an inertial mass cannot be classified as a gravitational mass. Einstein completed “General theory of relativity” based on this idea. (Reference: Einstein no Kagaku to shogai, in Japanese)⁶⁰

But, the reason why a gravitational mass takes the same value as an inertial mass is not understood even at present. The Higgs mechanism by the Higgs boson is advocated regarding to the mechanism which makes an inertial mass generate, but this does not apply to a gravitational mass. It is thought that the mechanism of a gravitational mass generation depends on exchange of a graviton. (Reference: Wikipedia, “Mass”, in Japanese)⁷⁵

From here, the explanation by energy body theory begins.

The present physics takes the approach to understand an inertial mass and a gravitational mass as different factors of a Higgs boson and a Graviton, in Gauge theory, even though they should be the same. Then, it seems not possible to arrive at an answer to the question “why are an inertial mass and a gravitational mass the same value?” The inertia force is not apparent force, but real force” is advocated in energy body theory. (See: The Universe Division, "1.1 Inertia force", "1.2 Uniform motion", and "1.3 Relation between inertia force and gravity")

Let us suppose that the external force with acceleration is added to an object. An object is an aggregate of an elementary particle, so one elementary particle is thought here. When external force is added to an elementary particle, the energy level of the space, or the static energy body between the external force and the elementary particle rises. At the same time, the elementary particle tries to move, and pushes the space, or the static energy body in the opposite side of the elementary particle, so, the energy level rises there. The two increases of energy level of static energy body advance as waves, so, the elementary particle also advances with the same speed as the waves of static energy body. The increase of energy level of static energy body is observed as the mass of an elementary particle. When the object accelerates, the inertia force increases proportionally to that, in other words, the mass also increases. Therefore, when the speed accelerates, the mass also increases.

HP137

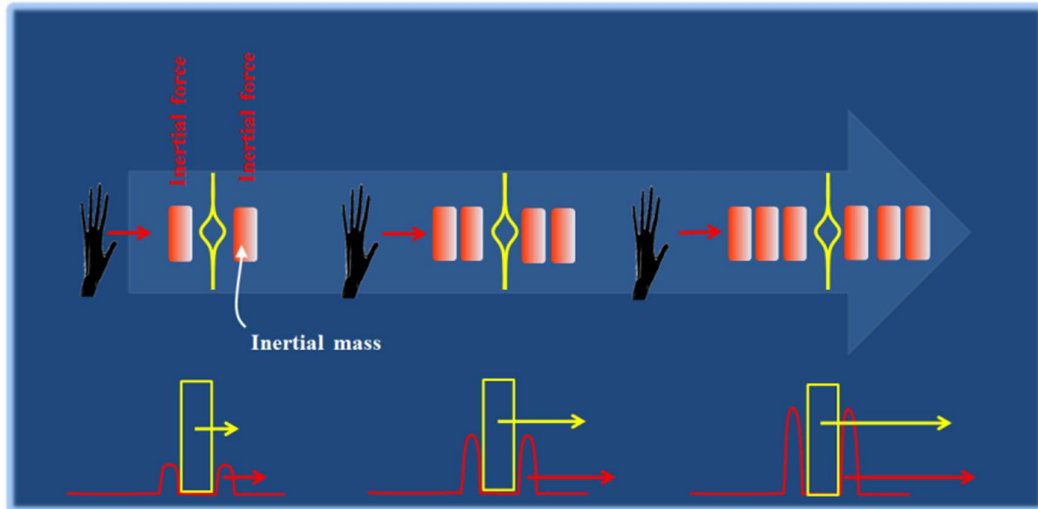

HP138

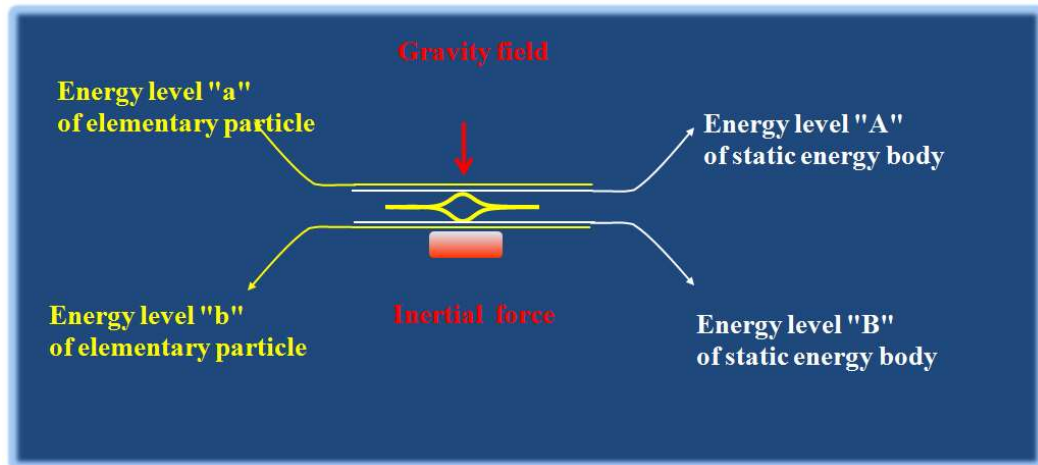

Then, let us see the case of gravity this time.

The gravity case is different from the case of inertia force, and no external force is added to an object. The energy level difference of static energy body functions as gravity, instead of external force as shown in the next figure. (See: The Universe Division, "2.3. gravitational acceleration")

$$g = \frac{D_n}{E_s} \times e_u = \frac{\{(A-a) - (B-b)\}}{E_s} \times e_u = \frac{(A-B)}{E_s} \times e_u$$

Because, $a = b$

宇宙編「2.3重力加速度」より、次の結果となる。

$$= G \frac{M}{R^2}$$

D_n : 重力の中心から R 離れた位置における静的エネルギー体のエネルギーの変化量

E_s : 重力の中心から R 離れた位置までの静的エネルギー体のエネルギーの総量

e_u : 静的エネルギー体の標準エネルギー量

A,B : 素粒子の上側または下側の静的エネルギー体のエネルギー量 (レベル)

a,b : 素粒子の上側または下側の素粒子のエネルギー量 (レベル)

Mass m of an object (an elementary particle) is not related to the acceleration of this gravitational field which is created by mass M of the globe. But the energy level difference of static energy body is made between the upper side and the underside of an elementary

particle. When the elementary particle receives the force caused by the energy level difference of static energy body, and starts to fall in the global center direction, the increase of energy of static energy body generates underside of the elementary particle. This state is expressed in the figure next.

HP139

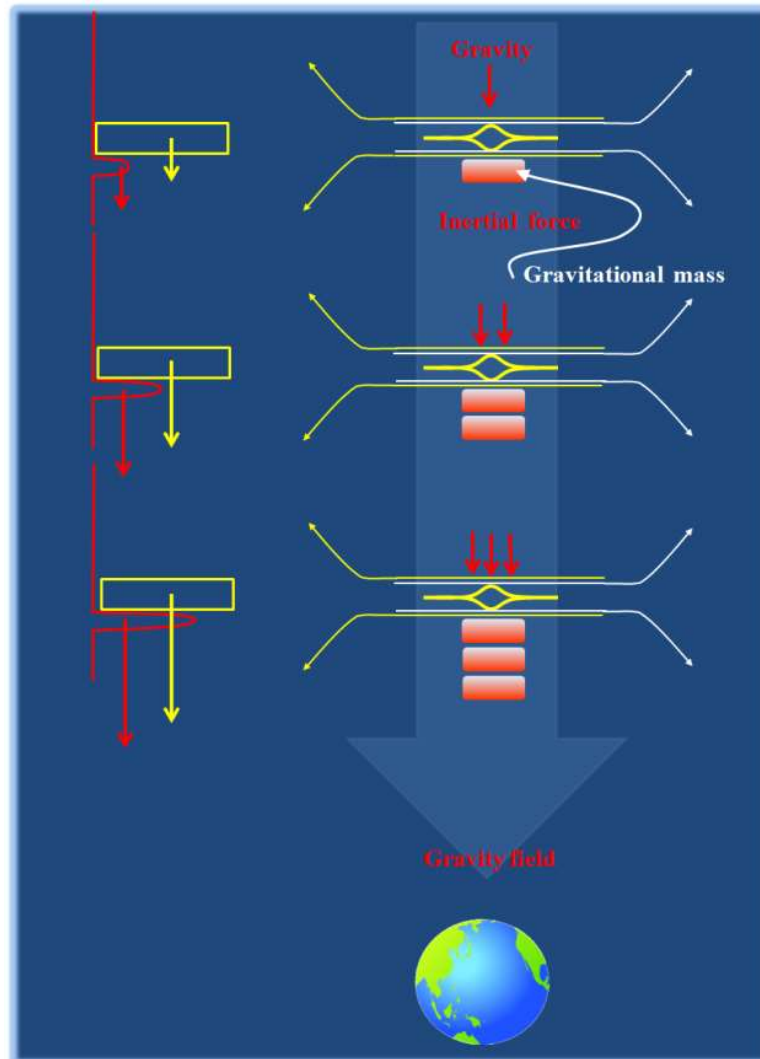

This energy increase of static energy body is observed as the gravitational mass. And rise of the energy level of static energy body which occurred underside of the elementary particle advances as a wave, so the elementary particle can also advance to the global center. It's the gravity of course, so the mass will be added. The increase of energy of static energy body, which is observed as a gravitational mass and as an inertial mass is understood as the same nature, because both are occurred when the static energy body is pressed by an elementary particle. But, strictly speaking, if an inertial mass is gaged outside of gravitational field, while a gravitational mass is gauged inside of gravitational field, then, it will be different. Because, the energy level of static energy body is different inside of gravitational field and outside.

"When saying what is the mass, which is stated about by general relativity, the mass will be just only the numerical value which shows the energy when an object is at a standstill. In other words, even the mass is only an illusion." (Reference: EMAN no Buturigaku, in Japanese)⁷⁶

Indeed, that explanation indicates this thing, doesn't it? (See: The Universe Division, "2.4. Bending of light by gravity")

The Universe Division

1. Inertia force

1.1. Inertia force

HP140



When imagining the utterly dark universe, it is wonder of the uniform linear motion to remember first. When the ordinary wooden block is pushed out into space, it keeps moving smoothly just as it is and moreover.

"Who keeps pushing it?"

"Because there is no friction, even if I do not keep pushing it, it keeps moving."

Such conversation is heard from brother and sister who are seeing an upper picture.

"When pressing, where did the used energy go?"

"Energy of the reaction from the wooden block stays in hand."

"Then, does not a wooden block have energy?"

"Because I will receive an impact if I try to stop it, it should have the energy."

Your elder brother and elder sister joined too and more argument continues.

I really feel strange and it is the strangest one in me.

But, the law of inertia is that it is always experienced in daily life as well as the universe.

Even if you jump when you are in the train which runs by 80 kilometers per hour, you fall on the original location neatly. But it is not felt strangely for some reason.

Because it is a momentary affair?

Because the force is not felt in the train, even if the train is moving by 80 kilometers per hour.

But, it is nearly overthrown in the rear at the time of acceleration, and leaning forward, at the time of deceleration, and the force is felt. "The law of inertia" is the first law of Newton's three laws.

First law:

In an inertial reference frame, an object either remains at rest or continues to move at a constant velocity, unless acted upon by a force.

Second law:

In an inertial reference frame, the vector sum of the forces F on an object is equal to the mass m of that object multiplied by the acceleration a of the object: $F = ma$.

Third law:

When one body exerts a force on a second body, the second body simultaneously exerts a force equal in magnitude and opposite in direction on the first body.

(Reference: Wikipedia, "Newton's laws of motion", in Japanese)⁷⁷

There is “inertia force” in a word like “The law of inertia”. Well, “the inertia force” is different from “the law of inertia”. I think a lot of people well know “the law of inertia”, but on the other hand, a few people know the inertia force. Then, I will explain inertia force first. The inertia force is said to be the apparent force. It is no wonder the inertia force is not felt its existence.

It is only in the case that the object is observed from inertial system, that an object moves according to “Newton’s equation of motion”. When an observer accelerates, or circulates, or does both to inertial system, the apparent force which depends on an observer’s movement acts, besides the force observed from inertial system. This apparent force is called “the inertia force”.

By introducing the inertia force, movement of an object can be described using “Newton’s equation of motion”, also in a non-inertial reference frame. It is guaranteed by “D’Alembert’s principle” that the movement in a non-inertial reference frame can be described using “Newton’s equation of motion” like a “inertial reference frame”. It is necessary to know about the system which preserves the momentum, to distinguish the inertia force from the other force.

True force is certainly accompanied by reaction according to “the law of action and reaction”, but there is no object regarding inertia force, so, the inertia force from the other force can be distinguished. (Reference: Wikipedia, “The inertia”, in Japanese)⁷⁸

It's incomprehensible only by the upper explanation, so refer to a plain example.

HP141

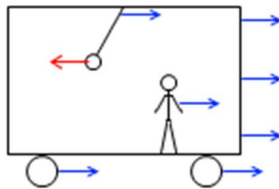

A glob is suspended from the ceiling of a train. If the train is running by uniform velocity, the glob hangs down straight. But, while the train is accelerating, the glob is tilting to the back, while applying the brake, the glob is tilting to the front. This is because, although the joint of thread of the glob is receiving the rightward force, the glob tries to remain there. It's because “The law of inertia” is functioning. This is the case that the observer is outside the train. When the observer is inside the train, the observer feels the glob receiving the leftward force and tilting.

The observer, the train, the wheels, the ceiling, the windows, the floor, the seats and the joint of thread of the train receive the rightward force, and all of those are advancing with the same acceleration. Therefore, the observer feels the ceiling, the windows, the floor, the seats and all of those to be stationary. So, the observer feels the glob receiving the leftward force.

Like this, the apparent force that an observer in the accelerating train feels is called “inertia force”. It is the force which an object tries to remain by “The law of inertia” And it is the force in the opposite direction to acceleration of the vehicle in which an observer is. (Reference: Wakariyasui Koukou Buturi no Heya, in Japanese)⁷⁹

It is common that the inertia force is regarded as apparent force, like this. But, conversely, there is an insistence that “inertia force” is like the incarnation of momentum and kinetic energy, and more than that, it is the central existence of mechanics. The contents which “D’Alembert’s principle” means are also misunderstood. “Inertia force” is not static balance of force, but the response to the acceleration of the accelerated motion by external force.

So to speak, “inertia force” ma appears in compensation for the change of momentum and kinetic energy. A mechanic balance through inertia force consists in a mechanic phenomenon.

Or, the energy and the momentum are correctly transmitted to the other systems by inertia force, in case of acceleration. (Reference: Watson's Page, in Japanese)⁸⁰

I think inertia force should be applied to everything, not for only the rings, too.

HP142

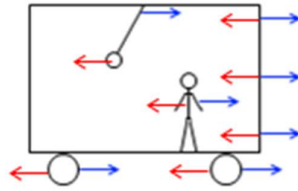

Then, the inertia force and the acceleration balance, and the train results in its being not moving.??? But the train is moving wonderfully at the real world.

Then, it should be dealt that the inertia force is seen only inside of the train (acceleration system)?

And, inertia force was made apparent force. --?

It would not be possible to settle this problem by a structure of present-day physics.

Then a solution of this problem is tried by energy body theory.

The real value of energy body theory is shown by the problem that present-day physics do not have an answer.

The figure shows the situation that the train departs while accelerating in the right side.

HP143

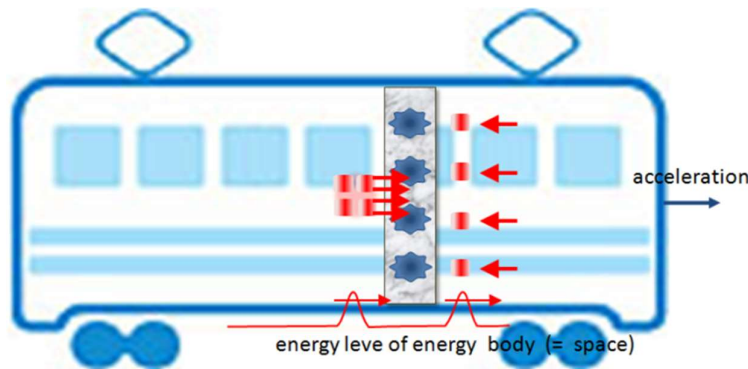

The part of the wall on the train is taken out, and an atom as the component of the wall is emphasized typically and is drawn in it. The figure shows that the moment, when external force is added to the wall and the acceleration generates. When it is seen in the minimal world, external force (in right direction) is added to an atom in the wall, and the atom begins to move to the right side.

At that moment, the energy level of static energy body at the right side of the atom rises, because it is pushed by the atom. The rise of this energy level acts as repulsion to the atom.

Of course, a total repulsion (in left direction), which all atoms receive from the rise of energy level of static energy body and the external force (in right direction) is equal.

External force (in right direction) = whole atoms x whole repulsion (in left direction)

As a result, the force in left direction balances the one in right direction.

Then, the train is at a standstill, and the result is different from actuality.

Well, the rise of the energy level of static energy body advances in the same direction as the external force, as a wave and it goes to right.

Of course, the acceleration of the wave is the same value as the acceleration added to the train by external force.

Then, even though the train receives the repulsion force, it advances like there is no repulsion force.

The part of the wall of a bus is made like a pendulum in the next figure.

HP144

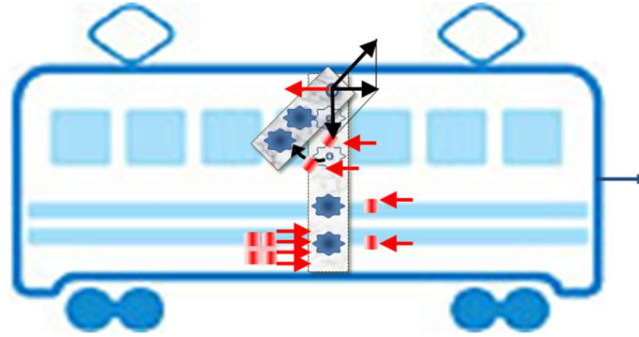

Static energy body is not pushed by the rotary shaft of a pendulum, because it does not take external force. Therefore, even if a train moves, the tip of a pendulum tries to remain at the place. And it looks like as if the pendulum tilts.

But, finally, it takes external force because the shaft of a pendulum is fixed.

Then, an atom in the pendulum receives repulsion by a rise of energy level of static energy body and takes balance with the resultant force of centripetal force and gravity.

Even at such time, the wave that the energy level of static energy body rose advances at the same acceleration as the train.

Addition

When an atom is pushed by external force, in surrounding space of the atom, the energy level of static energy body rises. Its reason is still guess, but I think that static energy body consists of microscopic energy cell bodies and space is filled up closely by them.

In other words, energy cell bodies forms space, so a gap is not supposed to be made.

When being pressed, I can think the distortion will be made, of course.

HP145

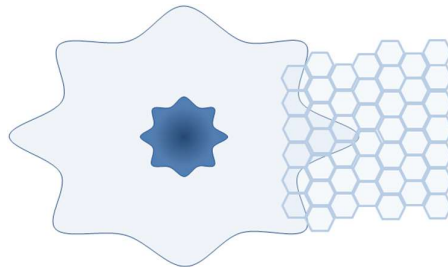

The inertia force applied to a wall in the train was explained, and in it, while external force concentrates on one place, inertia force is dispersed to all atoms equally.

The reason that external force concentrates on one point is, because its source is produced by a motor which makes the railroad track and the wheel touch.

On the other hand, the reason that inertia force is added to all atoms in the train is. because it is the force like the resistance of static energy body.

So, external force is proportionally divided into the force corresponding to the part of the wall and it is drawn in the figure of the train.

But the amount of physical work (the energy) which is done by external force is not expressed.

Then, this time, I would like to add the energy accompanied with external force, and explain a change in the energy of static energy body.

Because a train is given speed by being added force, in other words, works, so, energy is needed.

The energy of the external force is also preserved by the shape as the increase of energy in static energy body on the atomic left side of the wall.

HP146

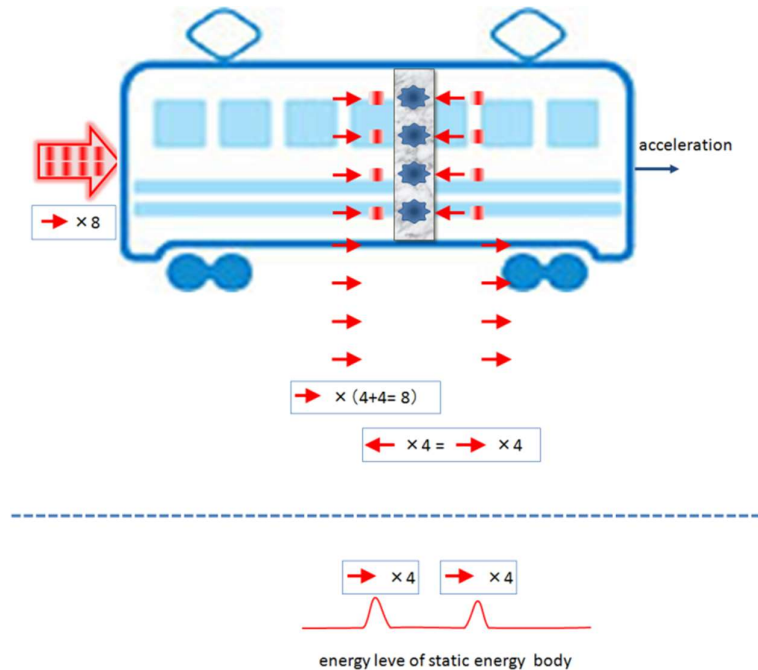

The external force which makes a train accelerate for right side is applied.

At this time, let us suppose that the external force 8 for right side is applied to the atoms in the wall part of the train. A rise of energy is equivalent to 8. (It's because the energy level of static energy body rises at this side of the atoms, that the external force pushes atoms.)

While to push the atoms for right sides, the energy level of static energy body rises to 8 between the external force and the atoms (the atomic left side).

The pushed atoms try to move for right side at the same time, the energy level of static energy body rises to 4 at the right side of the atoms.

A rise of the energy of this energy body acts on atomic movement for right sides as resistance. The power of this resistance is 4.

The reason the force becomes 4 is that the energy rise at the left side of the atoms heads for right side, and the energy rise at the right side for left side, then both balance and become equal.

By the way, the force 8 for right side which is applied to the left side of the atoms is set off against resistance force 4 which occurs to the right side of the atoms and becomes 4.

But the force 4 for right side which made the energy 4 rise at the right side of the atoms is left, then, the force of total of 8 acts on the atoms.

This force 8 for right side makes the energy rise of static energy body which is each 4 at left side and right side move as wave.

Because the energy level of static energy body moves, the atoms move at the same time to try to get rid of the energy difference.

1.2. Uniform motion

Uniform motion can be explained in the same way as acceleration. The explanation is omitted and only a figure is put.

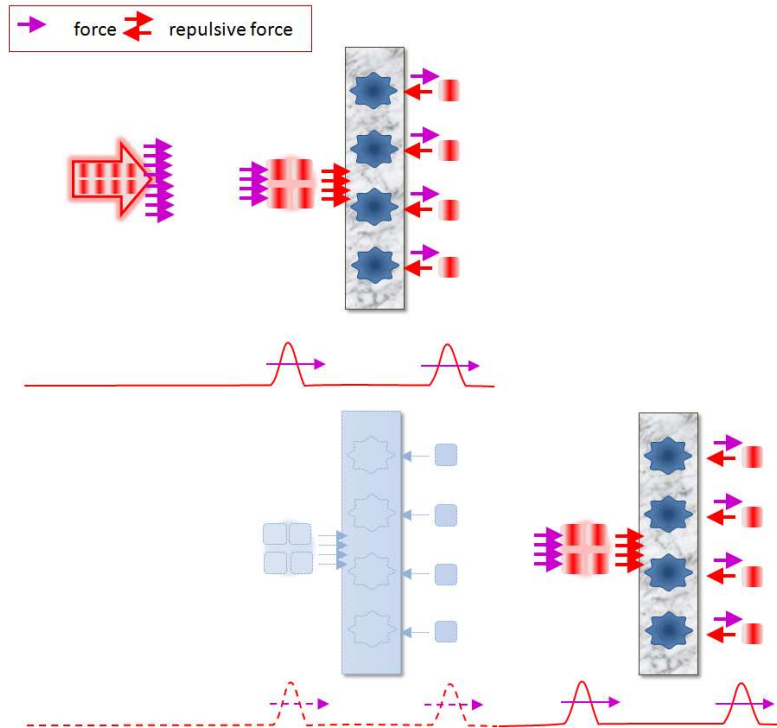

HP147

In short, the energy level rise of static energy body around an object, which is increased by external force advances as waves, then, an object also advances along with the waves and as a result, the uniform motion continues.

Of course, vacuum space is also energy body, so, wave advances in it.

The wonder of the wooden block smoothly advancing in the utterly dark universe can be understood that the wooden block is on the wave of static energy body, and advances along with it.

HP148



1.3. Relation between inertia force and gravity

The law of inertia and inertia force are profound, and concerned with the structure of the universe. Before explaining how gravity is generated, I will consider a relation between gravity and inertia force applied to an object in space.

Ernst Mach (1838-1916) said that "We had to consider inertia force as action of the whole mass of the universe.". For example, Mach thought that "The reason that inertia force was generated is, not because a bucket turned around to an absolute space, but a substance of space made some

act to the revolving bucket." and then, said that "It is equivalent that a bucket is turned around and that the universe is turned around a bucket in the opposite direction, after a bucket is stopped." (Mach's principle). Mach's principle was systematized by Albert Einstein's general relativity. Universal gravitation and inertia force are equivalent (equivalence principle), and both are "Changes in the GODESIC" by the "Spatial-temporal distortion" according to the "General theory of relativity". It is only different in the cause of distortion with the universal gravitation and the inertia force. (Reference: Wikipedia, "Gravity", in Japanese)⁸¹

Mach's way of thinking is wonderful that "You make the universe turn around the bucket in the opposite direction." But he seems to have already foreseen that inertia force relates to the universe.

Einstein found that gravity is equivalent to inertia force, and made general relativity.

Speaking the biggest feature of gravity, it will be to say that it equally acts on the mass of everything as expected. But, though it is minor, inertia force also has the nature like the gravity. It has been explained about inertia force up to now, but it is a surprise afresh, isn't it?

There is the assertion that the inertia force is "the apparent force", and is "the true force".

It was thought that both are proper, in energy body theory.

Then, how about gravity?

There is another unique feature in gravity.

When a free fall is done, gravity becomes zero. It is the fact everyone knows. But, it might be difficult to explain this reason by present-day physics. (I am inattentive to my studies, so it is the selfish guess.)

One person is in an elevator in the next figure.

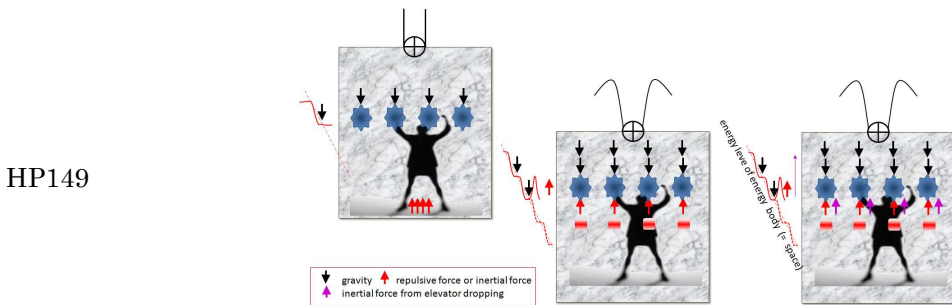

It is assumed that this person is made of only four atoms.

(It's exaggerated too much here.) The left figure shows the state that an elevator is stopped.

It is balanced by reaction from the floor with gravity.

The middle figure shows that the elevator has begun a free fall, because the wire from which the elevator is suspended broke.

The gravity force is added. (four black downward arrows)

At the same time, inertia force is generated as the force in the opposite direction.

Here, a slight attention is needed.

In the case that a train is accelerated, the force is the one to push the train.

Then, there is a rise of the energy level of static energy body at the back side of the atomics, but there is not in the case of gravity, because gravity is attractive force.

Thus, there are four arrows too many in the gravity case than in the train case.

(8 down arrows – 4 up arrows = 4 down arrows)

Therefore, the fall is continued, but the people does not receive resistance from the floor, so does not he or she feel gravity?

I have been thinking so, too, but it seems different.

Please see the right figure.

Four up arrows are added, and the up and down arrows balance.

(8 down arrows – 8 up arrows = 0)

This is in the state of the zero gravity.

The reason why four up arrows increased is in static energy body.
Because, the energy level of static energy body is decreased in gravitational field.
It is decreasing in linear taper, but to emphasize waves, it is drawn like stairs.
It is found that the elevator falls across the waves of stairs-like energy level of static energy body.

The waves are different from the case of the train and fixed, but the waves relatively go up to the elevator, because the elevator falls.

In case of a train, the waves of static energy body advance in a direction of train movement, in case of gravity, the waves of static energy body advance in an opposite direction of an elevator movement.

The object which falls freely becomes weightlessness by this.

2. Gravity

2.1. Gravity occurrence 1

Gravity is the force that we feel most closely in our life, but it is the most difficult problem in physics, because it attracts every substance, of any kinds of electric charge, of magnetic pole, and has influences until the space end beyond our imagination.

Then, what is a problem?

Gravitational field is considered by theory of elementary particles. An elementary particle acts on space, and makes gravitational field occur, and a gravity particle (graviton) transmits force (gravity wave) and does gravitational interaction. But the unified theory of this force is incomplete. (Reference: Wikipedia, "Gravity", in Japanese)⁸¹

Einstein expressed that "Gravity is the spatial-temporal distortion.", in general theory of relativity. But ethereal existence in vacuum space is denied. "What is meant with the spatial-temporal distortion? Einstein's equations show that the source of the spatial-temporal distortion is decided by energy-momentum tensor which consists of energy and momentum, not mass.

In other words, the momentum as well as the mass (It's proportional to the energy.) also distort time and space, then bear gravity. While mass generates gravity, the gravity generated by momentum takes the form of "frame-dragging" that is neither attractive force nor repulsive force.

There is a point of view that inertia force can also be explained by "frame-dragging" of inertial frame by a metagalaxy outside the earth. (Reference: Wikipedia, "Gravity", in Japanese)⁸¹

The general theory of relativity is based on the idea of equivalence principle that gravity is tied up with inertia force. Equivalence principle is that briefly speaking, if there is a box in which an observer cannot observe outside and an observer is in it, the observer cannot distinguish the force applying to oneself, from inertia force owing to the box uniformly accelerated, or gravity force due to the mass outside of the box. Space is space-time continuum according to relativism, and the space-time continuum is not homogeneous and is distorted according to general theory of relativity. In other words, it is thought that gravity is generated by that mass makes space-time distort. Light does not go straight, and a flow in time is also affected, because space-time around the large mass is distorted. This becomes observed as phenomena such as gravitational lens and delay in time. When mass moves, it is also predicted that gravity wave is created, because the spatial-temporal distortion moves and spreads along the movement. (Reference: Wikipedia, "General relativity")⁸²

"The spatial-temporal distortion" is the expression which cannot be understood by our daily sense. Energy body theory already pressed for inertia force and will press for this difficult problem too. The difficult problem is led by the axiom of energy body theory, which is "All interactions are caused by the different energy levels during the system of the energy body."

The meaning of "the spatial-temporal distortion" will be elucidated.

First, gravity exists, because an elementary particle exists.

Then, does an elementary particle, with which gravity exists, originally have its character?
Or, is gravity generated by a cause on the space side?

Let us think around there.

We can understand by our daily sense that a star of huge mass has gravity. Then, does a small substance like a stone also have gravity? A globule of lead probably seems to have gravity.

British scientist Henry Cavendish measured, that gravity acts between lead balls, by using the laboratory equipment called "a torsion balance". (Reference: "What is gravity?" (Ooguri Hiroshi work) Gentosha Shinsho 260, in Japanese)

The distortion of space in the general theory of relativity is not distinguished by the size of the mass, also in the energy body theory too. So, it reaches the question that "dose an elementary particle have gravity?" in other words, "does an elementary particle have the character which influences space and makes gravity occur?". At least, the answer of energy body theory is that an elementary particle does not have its nature. Then, when does an object come to have gravity?

The answer is in stellar generating process.

Briefly speaking, when the density of the core of a molecular cloud is increased, and then, gravity is generated, it begins to shrink by the gravity of itself.

In energy body theory, gravity is created by accumulation of a large quantity of elementary particles (a stellar birth). So, the cause by which the density of molecular cloud is increased is electromagnetic force or something, not gravity.

From my recent study, it comes to be found that it is related to the dwindling of the spread of the skirt part of an elementary particle's revolving wave in the absolute zero-point. (See: Particle Physics Division, "2.6. Absolute zero particle")

Anyway, because it is not the purpose to look for the early stage stage of this stellar formation, this is not examined.

In other words, a great deal of gas swarms in high-density, then stars are formed.

Then, the first layer of the space where a great deal of gas was originally drifting becomes vacant (or unnecessary).

In other words, the energy level of static energy body goes down there.

To replenish the decreased energy of the first layer of the space, the static energy body of the surrounding space, that is the second layer of the space, falls in.

Thus, a chain of movement of static energy body happens according to the accumulation of gas, and spreads.

A chain of movement of static energy body spreads far from the space where a molecular cloud was originally, because of "frame-dragging".

In other words, while "frame-dragging" of static energy body is expanded, static energy body moves to the inner space, heading for one point.

It is conjectured that "frame-dragging" is created by the pressure of static energy body which is space around the stellar egg.

But it is also considered that the newly generated gravity contributes to the growth of stellar egg.

Its situation is similar to the state that the sand in a sandglass falls, so, it is named "the collapse of static energy body".

But, the whole static energy body of the outside space layer does not collapse, the part of static energy body in proportion to the density of elementary particles does.

Static energy body collapses to the small space from wide space, so the static energy body which does not enter in the small space is made. In other words, surplus static energy body is.

This surplus static energy body is compressed, so the energy level becomes higher than the energy level of the surrounding static energy body.

This raised energy level of static energy body is gravity field. It is observed as a dark matter (It is said to be a mysterious substance at present.)

Moreover, a part of static energy body is made lost its space to be present, and is enough condensed.

Then, the vibration of energy cell bodies begins to revolve as a wave.

The next figure cuts the part of the space off, and indicates its state.

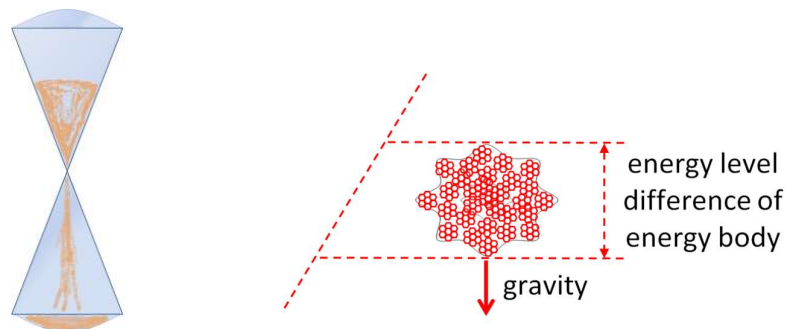
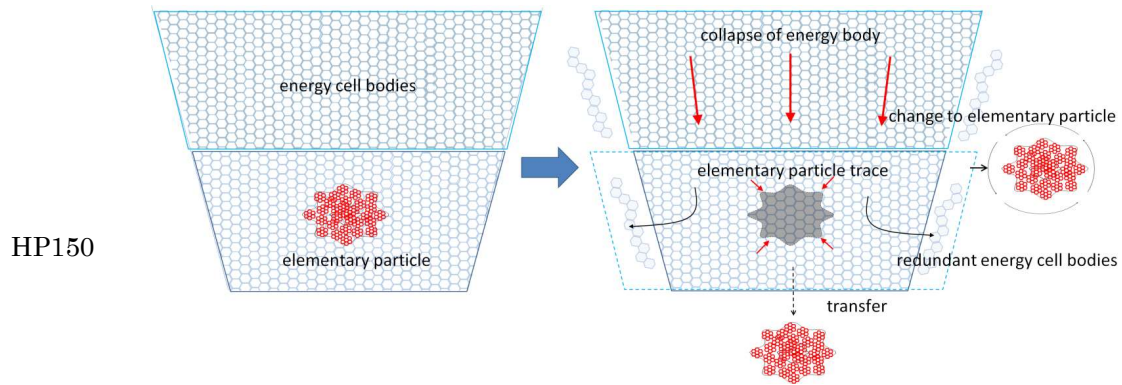

But, the shape of an energy cell body is yet known, so it is drawn as a temporary shape. An elementary particle is made of surplus static energy body, but it is not also certain how energy cell bodies form an elementary particle.

In the next figure, surplus static energy body goes out of space, and forms an elementary particle there. But, it is just so to express surplus.

Of course, redundant energy cell bodies and elementary particles stay in the space. (Anyway, to plow through, this neighborhood was made a little ambiguous, but I am now convinced that redundant static energy body is gravity filled and is dark matter.)

Because energy cell bodies beyond the capacity enter fixed space, redundant energy cell bodies become smaller, and are made in high energy state, and begin to circulate as undulation.

In the upper figure, static energy body collapses to the under-side layer of space from the upper-side layer of space, as a result, certain quantity becomes surplus static energy body, and its part forms elementary particles. These collapses of static energy body and occurrence of surplus energy body lead to the space edge.

In other words, redundant static energy body increases in the direction of the space edge, from a stellar center.

Thus, static energy body increases at the fixed rate, with the distance from the center of a stellar.

The substance put in this space (an elementary particle) receives the force by the difference of energy level of static energy body at the top and at the bottom of an elementary particle (See: The Universe Division, "2.4. Bending of light by gravity"), and is attracted downward. This is gravity.

The next attention is needed so that it is not misunderstood first here.

Gravity gradually decreases by the distance from a star.

So, it might tend to be thought that static energy body gradually decreases by the distance from

a star. But, it is wrong.

If it is, an object in the gravity field goes away, not pulled to a stellar, by the axiom of energy body theory.

It is not so, then, attention is needed. The next left figure is right, but right figure is wrong.

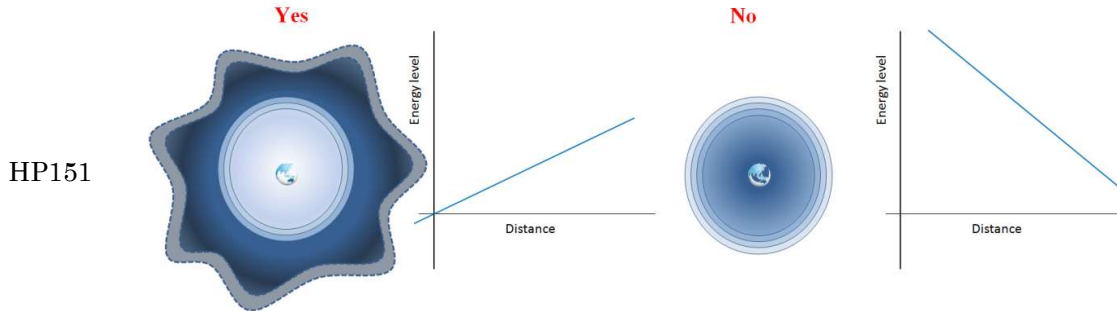

On the contrary to a commonsense, the amount of static energy body increases with the distance from a star.

As a result, the situation that the amount of static energy body becomes least at the stellar center is made.

Therefore, an object in gravity field falls toward the stellar center, consistently to the axiom.

The upper left figure.

Further, the gravity field very far from a star is finally spread over dark energy field, so the gravity field does not expand infinitely.

Please see the next figure.

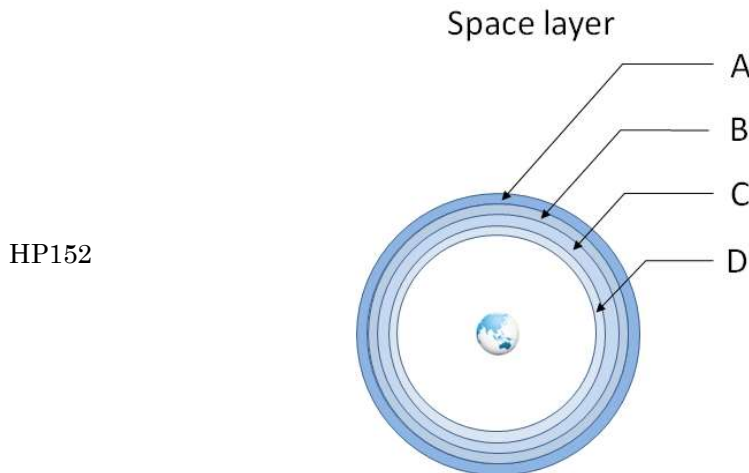

Static energy body collapses at fixed rate r (the density of elementary particles (interstellar cloud) occupied in the space before stellar formation).

- A ---> B
- B ---> C
- C ---> D

It successively falls in small space layer from big space one, so, at every collapse, surplus static energy body increases.

In other words, the amount of collapsed static energy body increases, D than C, C than B, B

than A, at fixed rate.

The energy level of the static energy body can rise and do a downhill of the energy to the star so that I back away from the result and spot.

You might have a question that the amount of static energy body increases at fixed rate is, because the volume of space increases, and is not, because the energy level of static energy body does not rise.

It is so.

The reason that the amount of the collapsed static energy body increases is a result of the increased volume of the space layer.

Therefore, space layer of C, B and A are same for the density of static energy body.

In other words, wherever the unit space in the space of gravity field is, the density of static energy body is same.

Then, why does an object (elementary particles) receive more energy level difference of static energy body, when the object is far and far from a star?

I would like to explain this in the next.

Maybe it becomes slightly long-winded, but please permit.

When static energy body collapses, surplus static energy body is generated at the fixed rate, and part of it forms elementary particles.

Surplus static energy body is generated littler, when the distance from a star is shorter.

Conversely, when the distance is longer, surplus static energy body is generated more.

If surplus static energy body is not generated, the space layer where static energy body collapsed is filled by the outside static energy body, and is recovered as before.

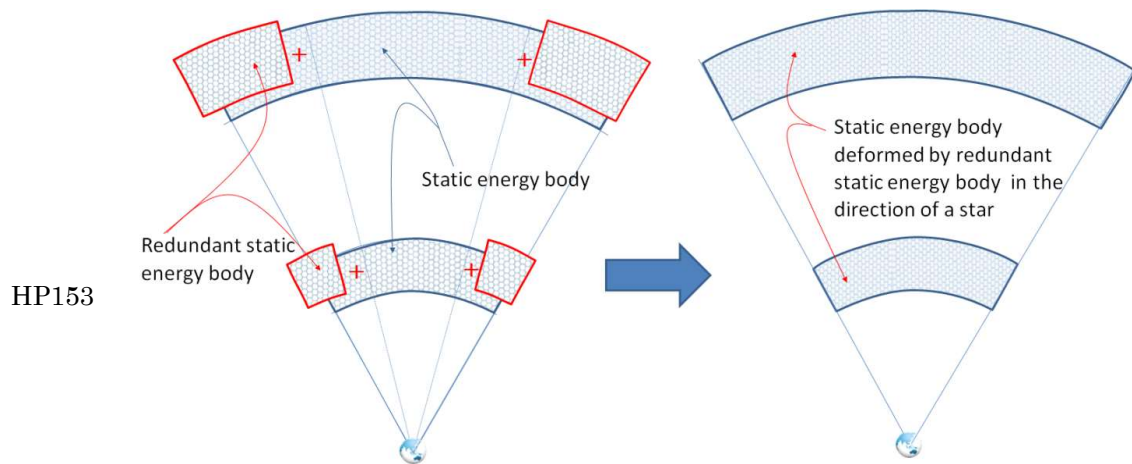

But redundant static energy body is generated as it was explained. Please see the upper figure. Redundant static energy body is added to usual static energy body, and is compressed

There is a directional property in that compression.

It is very important to be directional property in that compression.

Surplus static energy body gradually increases toward outer space from a star.

When saying conversely, it can be said that surplus static energy body gradually decreases toward inner space to a star.

Or, gradual decrement of static energy body head for a stellar center.

Please refer to the figure of the stone bridge. (See: The Universe Division, "3.3. Difference between gravity and dark energy").

This is the reason that "the spatial distortion" is subordinated to a star as gravity filed.

It is thought that this directional property in the compression of static energy body is made by deformation of an energy cell body.

This distortion causes a rise of the energy level with the directionality, and gravitational field is formed.

The energy cell bodies of an object put in the gravity field receives pressure from the distortion of static energy body (energy cell bodies).

The compressibility of static energy body is fixed in spite of the distance from a star, but the quantity of compression is proportional to the distance from a star.

The elementary particles in the space layer A belongs to the distortion of static energy body of the whole space layer A, in the next figure.

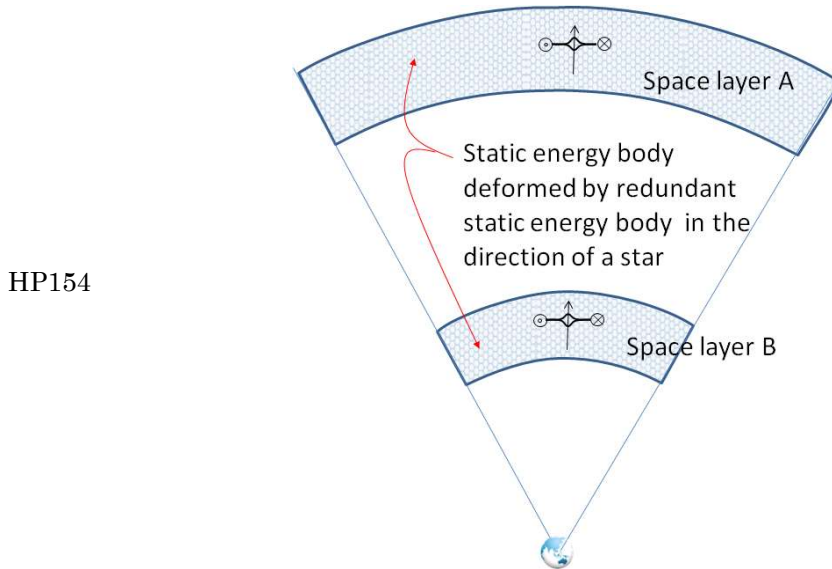

The elementary particles in the space layer B belong to the distortion of static energy body of the whole space layer B.

As a result, the force in the direction of a star, caused by the energy level difference between static energy body of space layer A and B (the distortion with the directionality of static energy body, which the energy level is high) acts, and an object (fundamental particle) falls to the stellar direction.

2.2. Gravity occurrence 2

The process that the distortion of static energy body is made on, was explained in "2.1 Gravity occurrence, 1".

When it is seen the outer space from the inner space, it can be said that static energy body gradually increases. When it is seen the inner space from the outer space conversely, it can also be said that static energy body gradually decreases.

In the case of saying gradual increase, does it come off an image of gravity as expected?

Decrease is used this time.

Because static energy body is gradually decreased, when an object is put there, each elementary particle which compose the object receives the force by the energy level difference of static energy body between the outside and the inside. This force is gravity

Gravity is got by the following equation.

$$g = GM/R^2$$

Gravity = decreasing rate of static energy body (inclination) = redundant static energy body of the space layer where an object is put / whole static energy body in sphere with the radius of distance from a star to an object

It's simple calculation, but I would like to explain separately.

The next figure shows the situation that interstellar cloud shrinks, star formation takes place, and static energy body of space collapses.
 It's a schematic diagram which is simplified and exaggerated extremely, but it is appropriate to imagine the collapse of static energy body.

HP155

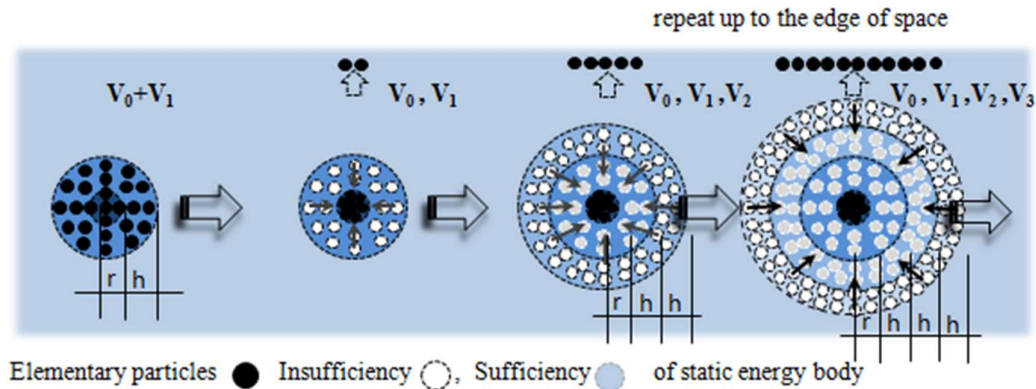

The most left figure in the upper figure shows interstellar cloud.
 Black points are elementary particles of interstellar cloud.
 It is distributed in the sphere of radius $r + h$ and the volume of V_0+V_1 .
 The second figure shows the situation that interstellar cloud (elementary particles) shrinks, and then, a star of radius r and the volume of V_0 forms.
 The elementary particles in space layer V_1 (the layer where thickness is h) shifts to space V_0 , so the gaps can be made in static energy body of space layer V_1 .
 The third figure shows the situation that static energy body collapses to the gaps of the space layer V_1 (thickness h) from the outer space layer V_2 (thickness h).
 The amount of static energy body collapsed from V_2 is proportional to the volume of V_1 and V_2 .
 More static energy body than the gaps of the space layer V_1 (thickness h) collapses from the outer space layer V_2 (thickness h), so, redundant static energy body is generated in the space layer V_1 .
 Thus, the redundant static energy body is compressed into high energy state, and a part of it forms elementary particles.
 At the same time, the gaps are made in the space layer V_2 (thickness h).
 The fourth figure shows the situation that static energy body collapses to the gaps of the space layer V_2 (thickness h) from the outer space layer V_3 (thickness h).
 In the same way, redundant static energy body is generated in the space layer V_2 (thickness h), and is compressed, then a part of it forms elementary particles.
 Because, static energy body collapsed, so, the gaps are made in the space layer V_3 (thickness h)
 These occurrences of gaps, collapses, and redundancy of static energy body, also conversion into elementary particles, are propagated repeating
 After all, the static energy body of the fixed rate shifts to the inner space layer (thickness h) from the outer space layer (thickness h), focusing on a star.
 Let me summarize and explain once again.
 When interstellar cloud condenses and a star forms, static energy body of outer space layer collapses.
 It collapses to small space layer from large space layer, so, surplus static energy body is excessively packed in the small space layer
 The energy which lost room to exist in the small space layer, rises its density, and begins to revolve. And the its part forms an elementary particle.

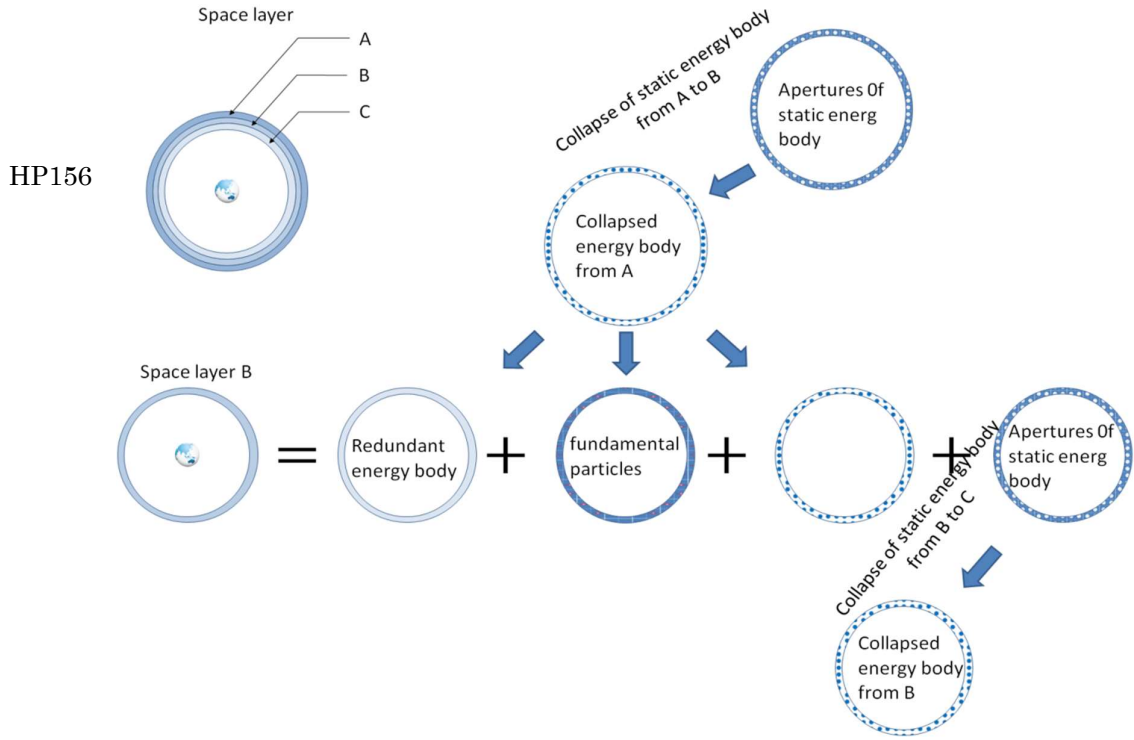

And the rest surplus static energy body generates gravity field.
 In other words, consequently, the energy level of static energy body becomes lowest at a stellar center.

All interactions are caused by the difference of energy level between the systems of energy body.
 Because static energy body and a kinetic energy body are the same one, it is not impossible to control a reciprocal action, in other words gravity.

2.3. The gravitational acceleration

Calculation of the gravity.

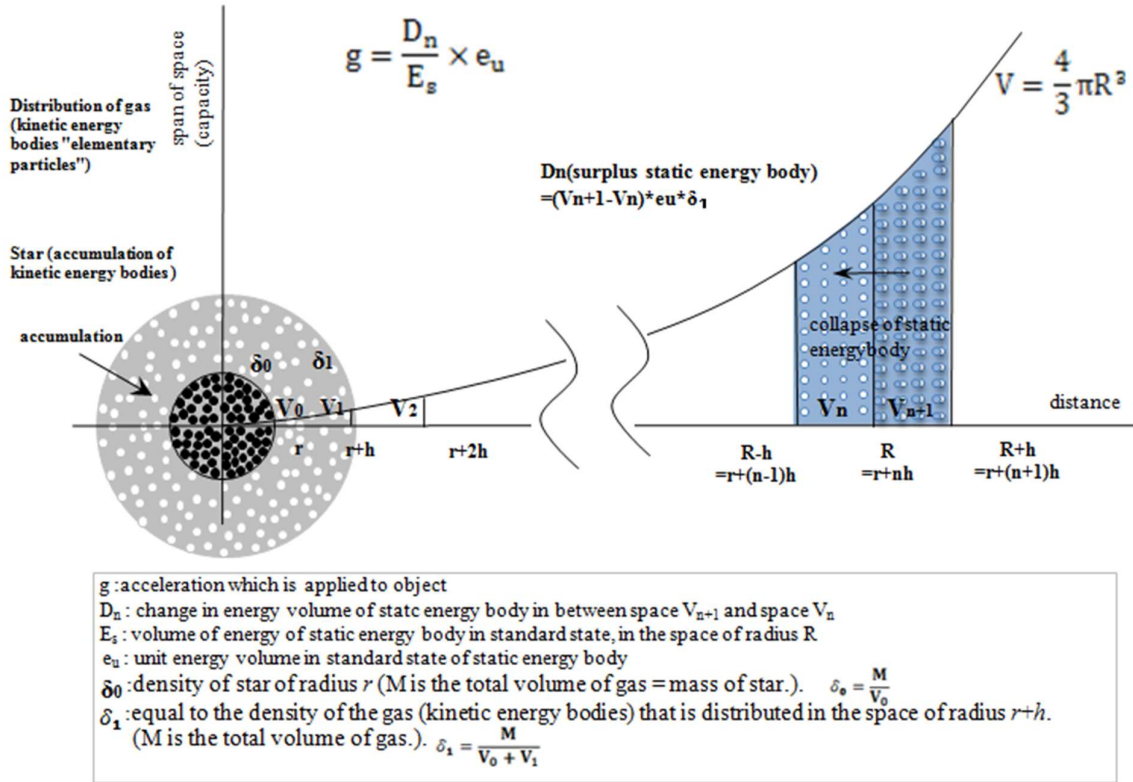

When static energy body collapses to the inner space layer V_n from the outer space layer V_{n+1} , at the location where is $R (=r+nh)$ away from the stellar center, the amount of the static energy body D_n which becomes surplus is calculated as following.

This D_n is the distortion.

The energy unit of the static energy body is e_u .

$$D_n = (V_{n+1} - V_n) \times e_u \times \delta_1$$

$$= \left\{ \left[\frac{4}{3} \pi (R+h)^3 \right] - \left[\frac{4}{3} \pi (R)^3 \right] \right\} - \left\{ \left[\frac{4}{3} \pi (R)^3 \right] - \left[\frac{4}{3} \pi (R-h)^3 \right] \right\} \times e_u \times \delta_1$$

$$= 8 \pi R h^2 \times e_u \times \delta_1 \quad \text{-----1)}$$

Next when this spatial distortion D_n is divided in the static energy body E_s of radius $R (=r+nh)$, distortion rate is obtained.

Moreover, when energy unit e_u of static energy body is multiplied, decreasing rate of static energy body g is obtained. This is gravity.

$$g = \frac{D_n}{E_s} \times e_u$$

$$= \frac{8 \pi h^2 R \times e_u \times \delta_1}{\frac{4}{3} \pi R^3 \times e_u} \times e_u \quad \text{-----2)}$$

By the way, the next relation is made between the density of interstellar cloud and of a star.

$$(V_0+V_1) \times \delta_1 = V_0 \times \delta_0 \quad \text{-----3)}$$

When this is calculated, the next is obtained.

$$\therefore h \cong r \times \left(\frac{\delta_0}{\delta_1} \right)^{\frac{1}{3}} \quad \text{-----4)}$$

When this is substituted for 2), and is arranged, it becomes the next equation.

$$g = \frac{\frac{4}{3} \pi r^3 \times \delta_0 \times \frac{6}{r} \times \delta_0^{-\frac{1}{3}} \times \frac{3}{4\pi} \times \delta_1^{-\frac{1}{3}}}{R^2} \times e_u$$

$$= G \frac{M}{R^2} \quad \text{-----5)}$$

Decreasing rate of static energy body g became the same shape as the gravity.

All kinds of interactions are caused by the energy level difference between systems of energy body, in energy body theory.

In other words, the energy body in high energy level tries to move toward the energy body in low energy level, this is regarded as a truism.

Well, a substance (an elementary particle) is not attracted by a star, but it moves by the interaction with the distortion created by gradually decreasing static energy body around a star.

This thing can be thought that a substance (an elementary particle) slips down, because it is on a slant of energy level of static energy body decreasing successively.

This is the true character of "the spatial-temporal distortion" explained by general theory of relativity.

Interaction between an elementary particle and gravity field is explained a little further as follows.

Force is the one that "the energy level difference between gravity field and an elementary particle at upper side of an elementary particle" is deducted by "the energy level difference between gravity field and an elementary particle at lower side of an elementary particle".

But, the energy level of an elementary particle is same at upper side and lower side.

So, after all, the difference between the upper side and the lower side of static energy body, in other words, the tilt is gravity.

2.4. Bending of light by gravity

Einstein announced the general theory of relativity 100 years ago, in that light is bent by gravity.

I am used to energy body theory, so, I do not think it is strange that the course of light is bent by gravity.

But, it would be big surprise for people in those days.

It is because the completely new concept was forced on people that "the course of light, which has no mass, is bent by the distortion of space-time continuum."

It is the phenomenon derived from general theory of relativity that light course is bent.

And, that is one of the phenomenon that proved the justice of general theory of relativity.

Light course is not bent being attracted by gravity, but is bent to travel through distorted space-time continuum created by a heavy object. When there is a big gravity source between a target thing and an observer, light course is bent. Then, there is cases that lights through some courses reach an observer. An identical target is observed as more than one image, by this.

It is called gravitational lens because the state that light bends is like refraction of light by optical lens. (Reference: Wikipedia, "Gravitational lens", in Japanese)⁸³

The idea, "the distortion of the space-time continuum" is too much far from a daily sense, and is imaginary.

The image is elusive.

But the idea of "the distortion of the space-time continuum" is admitted as right thing by observations of gravitational lens effect and movement of the comet perihelion, etc. Then what is "the distortion of the space-time continuum"?

It is often explained by a figure like the next funnel, but it cannot be easy to understand.

HP159

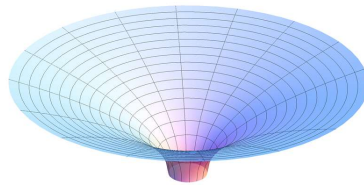

(By: Wikipedia, The general theory of relativity, in Japanese) ⁸⁴

The distortion of space is explained a little more specifically by energy body theory.

The cause of gravity and interaction of an object is also explained.

First, let me look back to the explanation of gravity by energy body theory.

Space is static energy body.

The surrounding static energy body collapses with an interstellar formation.

Static energy body collapses to the small space layer from large space layer, so, surplus static energy body occurs at the fixed rate.

As a result, gravity filed which static energy body decreases at a fixed rate focusing on a star center is generated.

An object is composed of elementary particles, in other words kinetic energy bodies.

When an object is put in gravity filed where energy level of static energy body drops focusing on a star center, the object falls to the star center.

Energy of high-level moves to energy of low-level, and tries to maintain the balance of energy level.

This is a truism.

In other words, an elementary particle of kinetic energy body tries to compensate the lower energy level of static energy body underside of an elementary particle (the stellar center side), and moves (falls).

But, when the elementary particle fell, next lower energy level appears again, then, the elementary particle must fall more.

After all, like this, the elementary particle is not able to compensate lack of energy of static energy body forever.

HP160

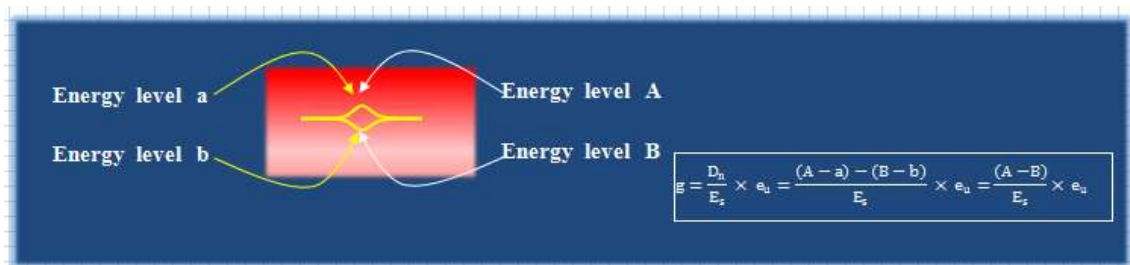

How about light? Light has no mass.

Though light has no mass, is light influenced by gravity?

But the mass has not come out in the explanation of an elementary particle a short while ago.

So, if replacing an elementary particle with light, in the explanation of an elementary particle a short while ago, the same explanation can be done.

(※Actually, it is predicted that light course is bent by gravity, by using Newton's laws.)

It is because light has energy.

Light is the one that an energy rise in static energy body moves as a wave. But, attention is needed.

Light does not head for an observer from a light source. Light is advancing in the right-angle direction. Please see a figure next.

HP161

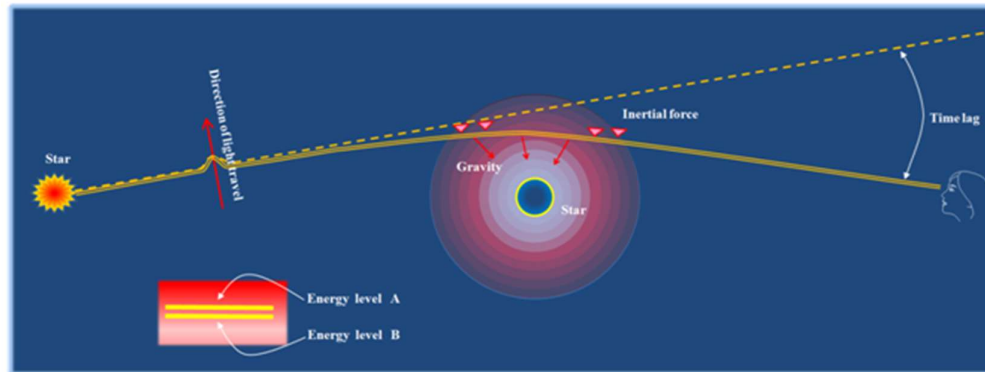

Light spreads its wings infinitely, and flies.

It looks like Chinese phoenix flying eternally.

Because countless light boards are excited each other, light reaches to the far place.

And the part of the light in the gravity field moves to a stellar center (Light, which is a wave of static energy body slips down along decreasing energy of static energy body).

Therefore, light bends.

Moreover, the reason that light is bent is not only that.

Gravity field is formed by redundant static energy body (dark matter candidate).

The opened feather of a Chinese phoenix receives resistance (or, inertia force) from here.

And more feathers bend.

A recovery time of a bent course is the light velocity, in energy body theory.

It needs time more than one second per 300,000km. Therefore, light velocity becomes slow, when it passes gravity filed.

2.5. Energy level of Gravity filed

It is explained that gravity filed is the space where the energy level of static energy body is becoming lower toward a stellar center.

Then, how much is the energy level of the space (the universe)?

In other words, it is the problem how to consider the energy level of static energy body.

An elementary particle is the revolving wave of energy body focusing on a self-axis according to energy body theory.

This energy body is called a kinetic energy body.

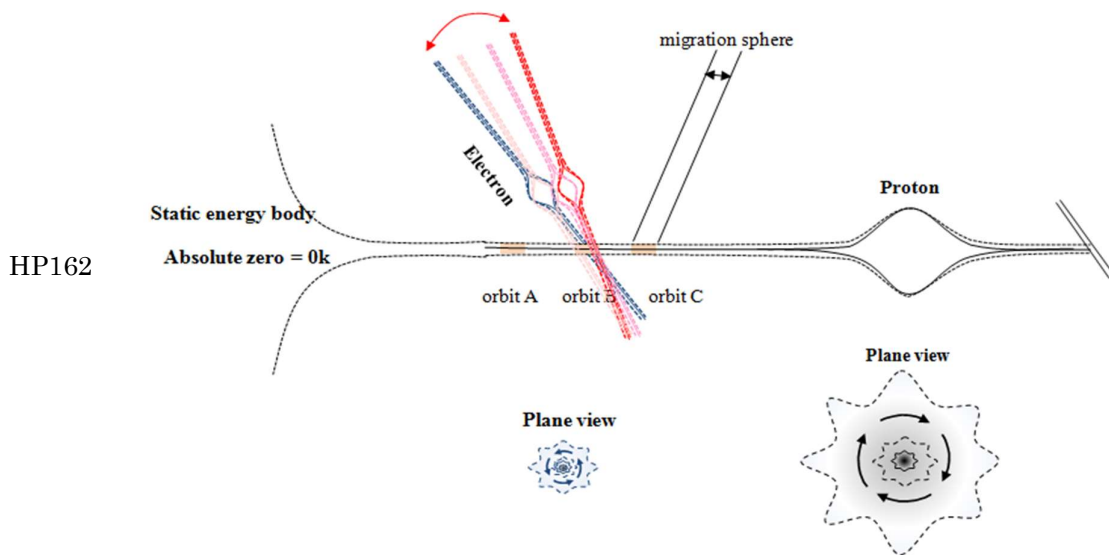

And the wave of an elementary particle is spread in space while attenuating. It means that the wave is attenuating and, becomes united with static energy body at the end. It is possible to understand that the vibration of an elementary particle's wave is "heat energy" in physics.

When the tip of attenuated vibration of an elementary particle's wave is the energy level of static energy body, the point, that the heat of an elementary particle falls to the limit, or, interaction does not occur, or, the expanse of an elementary particle's revolving wave shrinks to the limits, is the energy level of static energy body.

In other words, when the energy level of static energy body is converted by the temperature, it will be zero kelvins, or, absolute zero-point.

By the way, gravity field is the space where the energy level of static energy body is higher than the standard.

When this place is cooled to the absolute zero-degree, what would happen?

It becomes lower than the energy level of static energy body of gravity field.

In other words, when the tilting energy level of static energy body can be made lower, even partially, at the space where the energy level of static energy body decreases, it is possible to control gravity.

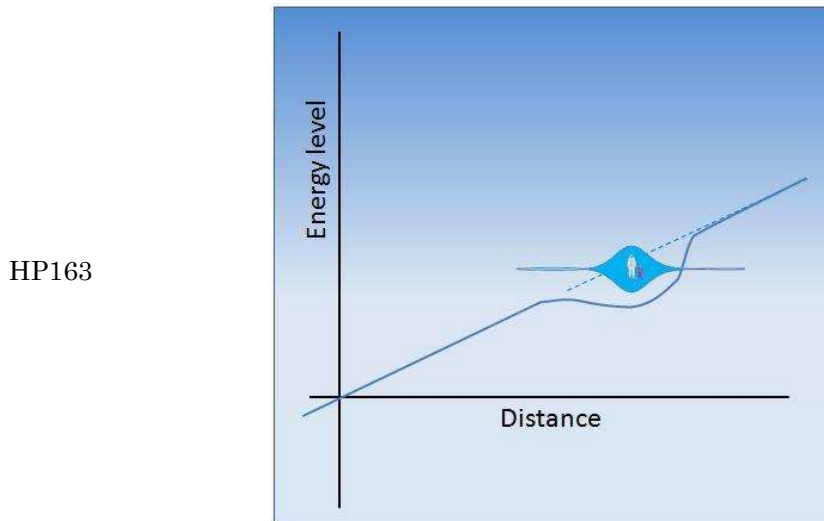

But, it can be achieved even to control the temperature. And the article that this was achieved by an experiment was found. What kind of thing happens in the lower temperature than the

absolute zero-degree?

An atomic group is usually pulled downward by gravity, but at the lower temperature than the absolute zero-degree. It can be seen that some atoms rise up against gravity, in the experiment conducted by theoretical physics Achim Rosch in a German Koln university. (Reference: Buzzap.jp, in Japanese)⁸⁵

Let us consider gravity filed again.

I pointed out that the energy level of the vacuum space of static energy body is the absolute zero-degree.

Absolute zero is the state that thermal oscillation (atomic vibration) is small, and energy became lowest. The state, that energy is lowest indicates the state that atomic vibration stops perfectly, in classical dynamics. But, in quantum mechanics, atomic vibration does not stop, and is doing a zero-point motion, even in the state that the energy is lowest, because of indeterminacy principle. (Reference: Wikipedia, "Absolute zero", in Japanese)⁸⁶

A zero-point vibration is the state that an atom is vibrating without being stationary because of indeterminacy principle, in absolute zero-degree. Helium does not solidify at around absolute zero-degree, because of this zero-point motion. (When the pressure is applied, it solidifies.) (Reference: Wikipedia, "Zero-point motion", in Japanese)⁸⁷

The energy level of gravity filed is higher than the standard energy level of static energy body, because redundant static energy body is added to usual static energy body.

In other words, the gravity field is hotter than absolute zero-degree.

And the temperature of the gravity filed is not particular about the distance from the star, and everywhere is the same fixed temperature.

Attention is needed here.

Gravity becomes weaker according to the distance from a star, but static energy body in gravity field increases.

. The reason is because redundant static energy body is added much.

But, that increases with spatial expanse, and is not that the density of static energy body becomes higher.

In other words, as a spherical surface becomes bigger, static energy body (redundant static energy body) increases, when spatial expanse is considered as spherical surface of centering a star.

The total volume of static energy body included in this thin spherical surface is energy level.

Therefore, when the temperature of the space which surrounds an elementary particle is made fall to absolute zero-degree, an elementary particle is not attracted by gravity.

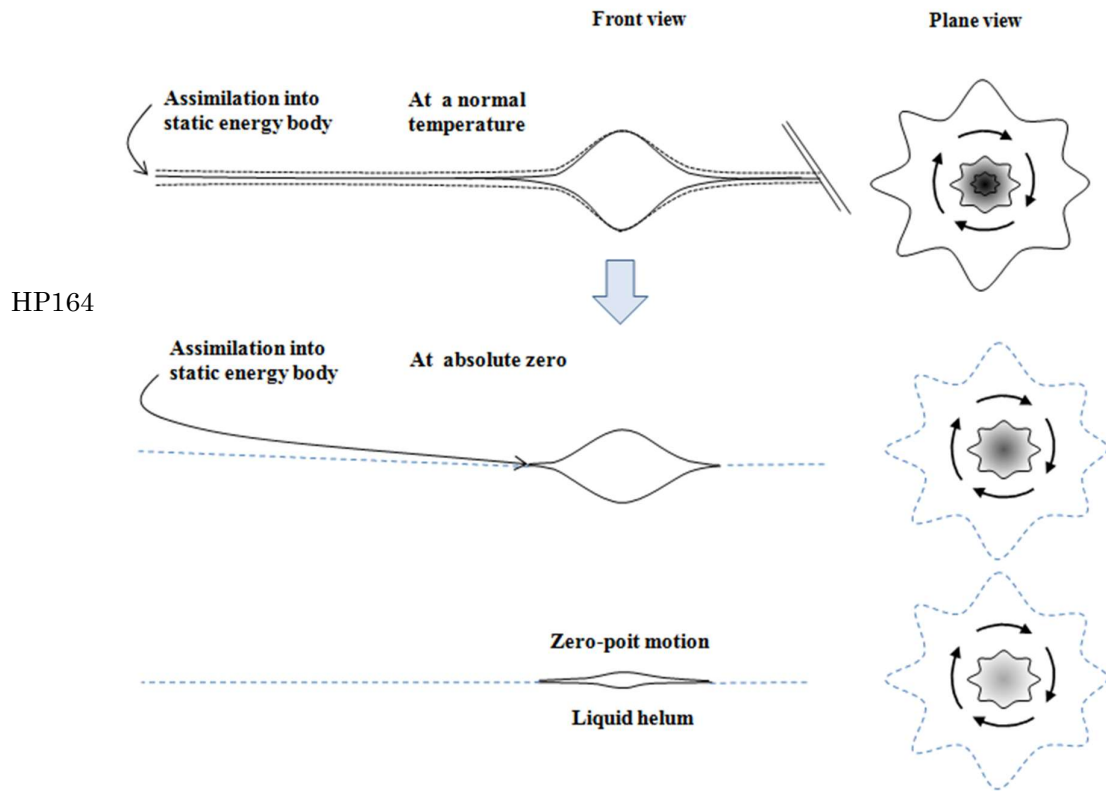

2.6. Temperature of gravity filed

So far, I have explained that the standard temperature of the space is the absolute zero-degree. The expanse of the revolving wave of an elementary particle shrinks back at around the absolute zero-degree, and the particle part becomes flat.

Therefore, there are no interactions between elementary particles, and elementary particles like a proton and an electron are come to close to each particle's part, and they become attached and form bigger particles.

This leads to the generation of a neutron and, atomic nucleus.

(※I have been explaining many times, that interactions are caused by the energy level difference which are made by each wave direction of elementary particles. (See: Common Division, 4.3. Elementary particle model)

And the density of an elementary particle increases on leaps and bounds in the space like interstellar cloud.

Then, static energy body collapses into the inner space layer, where the density is decreased, from the outer space layer, and are compressed.

This was the cause of the gravity generation. (See: The Universe Division "2.1. Gravity occurrence1", and "2.2. Gravity occurrence2")

The rate of collapses of static energy body is proportional to the distribution density of elementary particles.

The amount that static energy body collapses is proportional to the spherical surface focusing on a star.

Therefore, gravity is in inverse proportion to a square of the distance from a stellar center.

Static energy body is compressed toward one point at a fixed rate, so the energy density of the space becomes higher at fixed rate.

In other words, the temperature rises.

Therefore, the temperature of gravity field is higher than absolute zero-degree.

(※ When gravity field is cooled to absolute zero-degree, gravity does not work. (See: The Universe Division, "2.5. Energy level of gravitational filed")

Now, collapses of static energy body are continued to the space edge, and after that, the density of static energy body becomes low toward space edge.

In other words, the temperature becomes lower than absolute zero-degree.

So, this time, reversely, static energy body flows toward the space edge from gravity filed of elevated temperature. (See: The Universe Division, "3.1. Generation")

Therefore, the spread of the gravity filed is limited. (※ In energy body theory, energy body is space, so, it is considered that the universe is limited.)

HP165

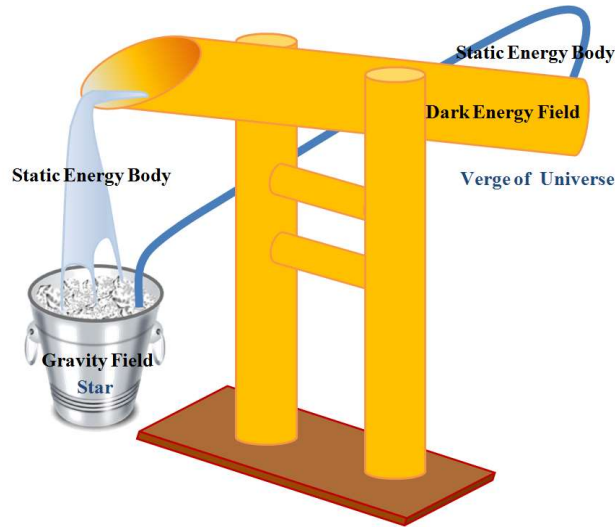

The space is expressed typically paying attention to the temperature, in the next figure.

HP166
(HP8)

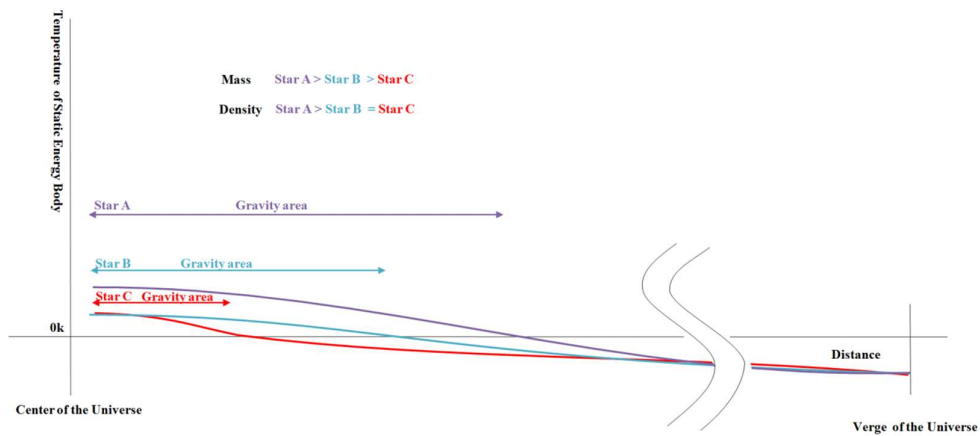

The temperature of the gravity field is higher, when the density of a star is higher.

The expanse of elevated temperature of gravity field is more extensive, when the mass of a star is larger.

It was explained by a series of this article that the accumulation of elementary particles increases at around absolute zero-degree, and the temperature of gravity field is higher than absolute zero-degree.

3. The dark energy

3.1. Generation

I was skeptical about the idea of gravity model by energy body theory, when I made it.

Static energy body collapses to the space edge focusing on a star, with a star formation. Is that right?

"Is it the one with which you have such stupid unrealistic something to discuss!"

But, quickly, it is felt realistic, if it is thought as following.

Is that a figure of speech?

"The energy in vacuum space is pulled to a star, as a star is formed."

But after static energy body collapsed to the space edge, what happens?

No, after all what will happen outside the universe?

If the universe is limited spatially, isn't it illogical that further space does not spread outside?

I was not able to find the answer, so I made it unintended for a while.

When coming to a deadlock in a consideration, it will be often an effective way to stop a consideration.

When having that, I noticed suddenly.

Static energy body is space itself, so when static energy body disappears, space may also disappear.

In other words, I noticed that there would be no space and no time outside of space, the universe.

Static energy body is space itself.

Therefore, space is limited.

Then, after static energy body collapsed up to the space edge, will space get smaller?

If it is right, space gets smaller and smaller, when many stars are formed.

If space could get smaller, indeed, it is the reverse version of the Big Bang, isn't it?

HP167

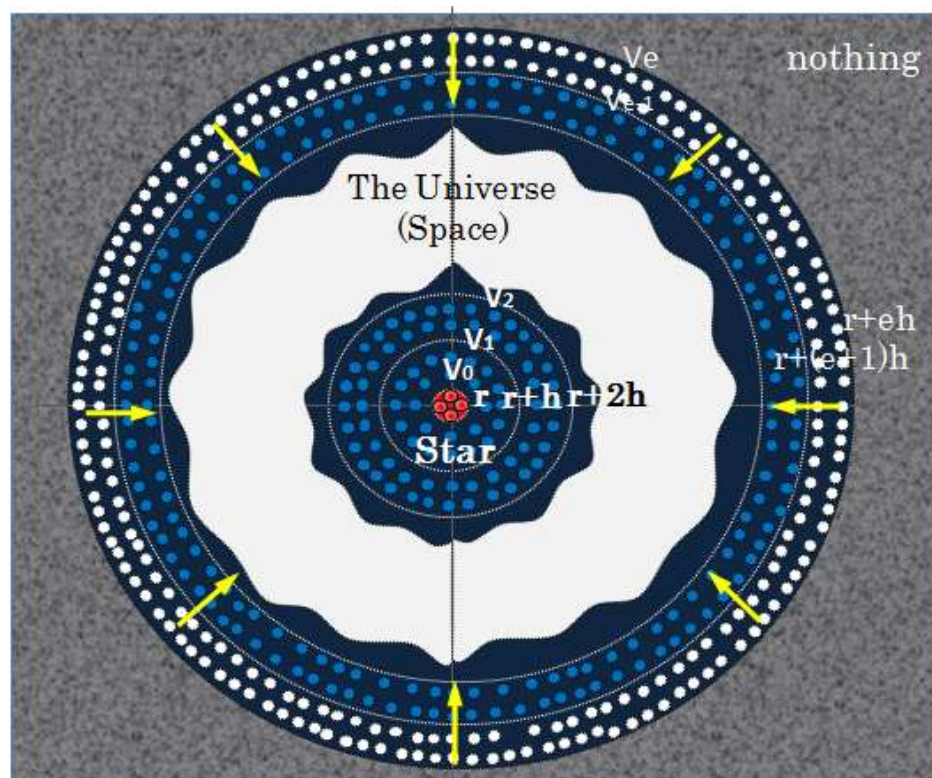

The upper figure is simplified and extremely exaggerated.
The biggest circle shows the space edge.
It shows that the part of static energy body is collapsing to the space edge.
I knew that space is not just only expanding, but is expanding at acceleration -like speed.
This was discovery of the generation cause of the dark energy.

3.2. Calculation of acceleration

After static energy body collapsed to the space edge, what will happen? This was my question.
But, it was solved by "Expansion of the universe being accelerating".

Parumutta professor in University of California Berkeley school in the US led Supernova Cosmology project (SCP) team, and Prof. Schmidt of Australian National University and Lease professor of John Hopkins university in the US led High-Redshift supernova exploration team (HZT). Two experiment teams observed a lot of the distant Ia type super nova explosions and, ascertained the fact that its brightness becomes darker than expectation from the so far considered slowdown in expanding universe and, found Space by accelerating expansion. Two teams announced those research results almost at the same time in 1998. Why does accelerating expansion occur? One of the theories which explain mechanism of accelerating expansion is that the universe is filled with the energy which has different nature from ordinary substance "Dark energy". Dark energy is mysterious energy which exerts repulsive gravity on an object and, denies an action of attractive force, which decelerates the universe expansion, by ordinary substance. The universe must be filled with the energy which has the nature different from ordinary substance called cosmological or cosmological constant because of causing accelerating expansion. Existence of such cosmological constant is suggested by discovery of accelerating expansion. If the size of the universe becomes double, the energy density of ordinary substance becomes half. On the other hand, the energy density of cosmological constant does not change at all. Prof. Michael Turner of Chicago university in the US extended such energy form to a broad concept and, named "Dark energy". (Reference: KEK "Kasoku bochosuru uchu" 2011 nen "Nobel Prize in Physics" no igi, in Japanese)⁸⁸

Does the universe expand accelerating?

Indeed, this is the solution to the problem how to consider redundant static energy body being generated by collapse (compression) of static energy body, when gravity generates.

If the universe is limited, the static energy body of the most outside space layer will not be replenished, after static energy body collapsed up to the last space layer.

Therefore, if the static energy body of the most outside space layer is not replenished, the balance of energy level of static energy body cannot be maintained.

So, conversely, static energy body of the inside space layer is diffused.

Continuously, static energy body is diffused from more inner space layer to the space layer of decreased energy level.

It is different from gravity generation that static energy body collapses to a small space layer from a large space layer.

Because static energy body is diffused to a large space layer from a small space layer, static energy body becomes insufficient at fixed

In this way, the space where static energy body decreases less and less toward space edge is formed. (See: Particle physics Division, "2.6. Absolute zero particle")

An object put in this space falls to the space edge by the same principle as the explanation in gravity filed.

A star which produced the dark energy field cannot run away from the dark energy field, either.

When doing the reverse calculation of gravity, something which should also be called the dark energy acceleration is calculated just in case.

HP168

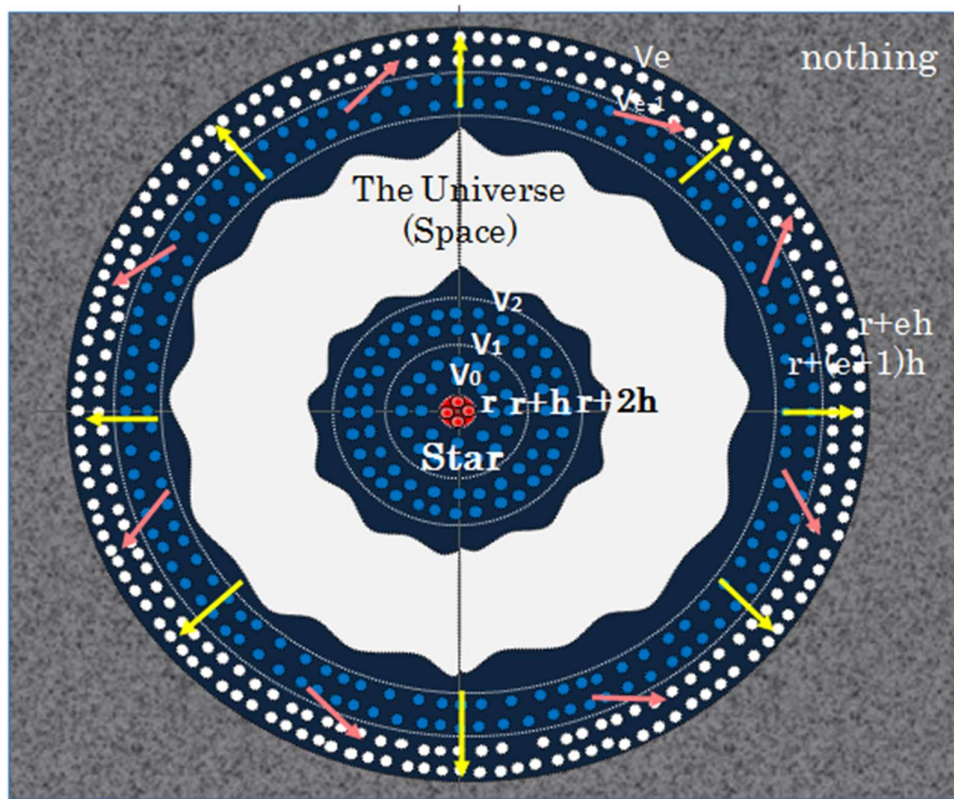

The distance from a star to the space edge, R_1 and the distance from a star to some space layer, R_2 and the distance from the space edge to some space layer, R are considered. When the dark energy acceleration at the location where is $R(= (R_1 - R_2))$ far away from the space edge is considered g_B , the next formula is made.

$$g_B = -G \frac{M}{R_2^2} = -G \frac{M}{(R_1 - R)^2}$$

But, unfortunately, this formula cannot be used.

Because the diffusion of static energy body is not only caused by one star, but by countless stars, and all of them are integrated in one body.

But, it can be deduced that the dark energy field is the place where acceleration acts.

Static energy body is diminished gradually toward the space edge.

Then, an object put in the dark energy field is drawn to the space edge, in the same logic as gravity acceleration.

"Please wait a moment. If static energy body is diffused through the reverse process to collapse, after all, energy level becomes flat, and there is neither gravity nor dark energy? "

"Hear. In the case that the universe is a perfect globular shape and one star is the perfect center of the universe, it will be so."

"But stars are many, so almost all stars come off from a space center."

"Please see the figure. A pink arrow as well as a yellow arrow which faces to the stellar direction are also drawn."

"This shows that static energy body is being also diffused from the direction in the side.

Therefore, there is no case that it returns in the original state."

Gravity and dark energy are generated at the same time of star formation, but they have entirely different characters.

I would like to explain about this thing in "3.3 Difference between gravity and dark energy".

The problem is solved, that “If the size of the universe becomes double, the energy density of ordinary substance becomes half. On the other hand, the energy density of cosmological constant does not change at all.”, isn’t it?

It is deduced that dark energy is the cause of accelerated expansion of the universe, and dark energy is the same decrease of static energy body as gravity, is it unexpected, isn’t it?

I think you already noticed that energy body theory is different from the big-bang theory, and it indicates that the size of the universe does not change.

After this, the new structure of the universe will be proposed for the Big Bang.

3.3. Difference between gravity and dark energy

Gravity field and dark energy field are both gradual decreasing of static energy body, and both are generated at the same time of a stellar formation, but there are big differences in the feature.

[1. The difference in the direction of the distortion]

The most different point is that, in gravity field, the distortion of static energy field is focusing on one point, while, in dark energy field, the distortion of static energy field is bound for isotropic space edge from inner space.

Gravity field is subordinated to a star and moves with a star.

The reason is because the distortion of static energy body faces to one point (stellar center).

It's possible to associate this thing from stone arrangement of a stone bridge.

If the stones arranged like an arch are pressured from the upper side, they become stronger.

But, if they are pressured from the underside, stones collapse dispersively.

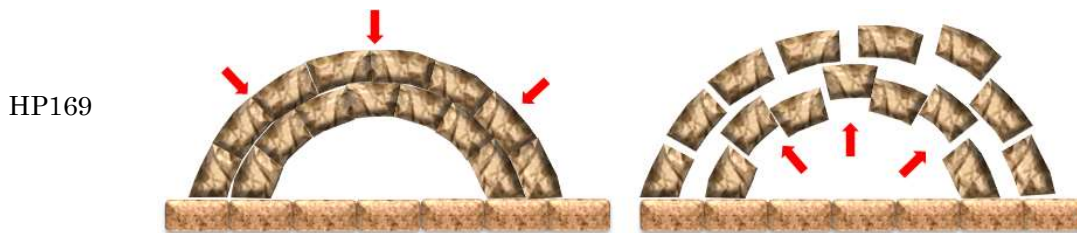

Therefore, the dark energy field exists independently from a star, and even if a star moves, it stops at the place. Then, the star which generates the dark energy field receives the force of the dark energy field, too. The reason is because the distortion of the static energy body disperses in isotropic space edge.

[2. Energy level of static energy body]

The energy level of gravity field is high.

On the other hand, the energy level of dark energy field is low.

[3. Non-synthesis and synthesis]

Every time a star is formed, gravity and dark energy are generated.

In what kind of relation will a gravitational field and a dark energy field be with other gravitational field and dark energy field in the universe where a lot of stars are formed?

Because the direction of the distortion of dark energy field is isotropic space edge, a dark energy field is united with other dark energy field and becomes one system static energy body in the whole universe.

Because the direction of the distortion of gravity field is concentrated, gravity field becomes independent of other gravitational field.

The next figure shows the energy level of static energy body in dark energy field.

HP170

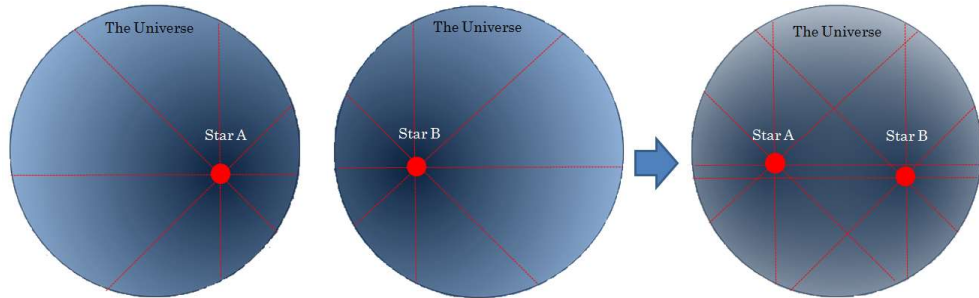

Stellar A is located at the right side in the space for a left figure.

The energy level of static energy body is lower more widely at the left side in the space.

Stellar B is located at the left side in the space for a medium figure.

The energy level of static energy body is lower more widely at the right side in the space.

stellar A and stellar B is synthesized in the right figure.

The dark energy fields in the left figure and in the medium figure are united and a new dark energy field in the right figure is formed.

The low energy area of static energy body was made the same expanse in the left area and the right area where influence is the same place.

4. Dark matter

It is explained by energy body theory, what gravity and the dark energy are.

How about dark matter that is the biggest mystery unsolved in space theory?

Well, a candidate for the dark matter by energy body theory is suited to the feature of the dark matter caught by the present physics.

The candidate for the dark matter is the redundant static energy body which was generated with gravity filed. The part of the redundant static energy body changes into an elementary particle, but a lot of it does not reach the needed energy level that it changes into an elementary particle. And, because there is redundant static energy body, the energy level of static energy body is high around in the space centering a star and forms gravity field.

But the redundant static energy body far from a star is consumed by dark energy field, then the level of static energy field far from a star goes down to the standard level or lower to minus level. Therefore, it is conceivable that the existence of redundant static energy body is limited to gravity filed near a star. (See: The Universe Division, "2.6 Temperature of gravity filed")

HP171

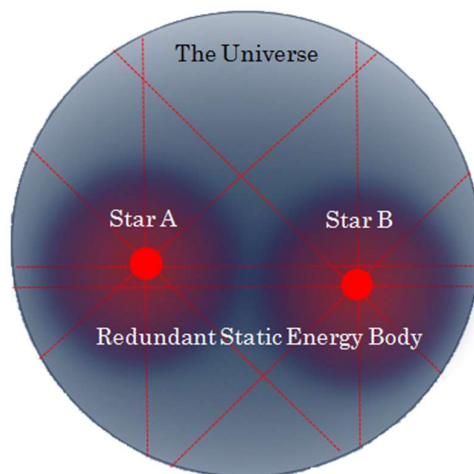

By the way what is a dark matter?

It is not visible, but space title role, dark matter is the mysterious existence which is there certainly. It is not possible to detect it directly by the present observation method, because it does not radiate light and electric wave.

But its existence is guessed through several phenomena which are caused by the mass of dark matter. For example, it is learned that in a spiral galaxy, the mass of a spiral galaxy calculated from the speed of stars moving in the spiral galaxy is larger than the one calculated from the brightness. It is also known that the mass of a cluster of galaxies calculated from the movement of its each galaxy is larger than the one presumed from the brightness of its each galaxy.

The dark matter plays more important role in the universe, than the substance in the daily life does.

Dark matter is mysteriously cloaked, but it is known that ordinary substance (baryon) and neutrino are not enough, to explain the existence amount of dark matter. (Reference: JAXA, The universe information center, in Japanese)⁸⁹

It was announced that the three-dimensional special distribution of dark matter was made clear as the next, by COSMOS project using National Astronomical Observatory of Japan Subaru telescope.

The emphasis program in which it cooperates with a COSMOS project was adopted and a multicolored imaging observation in a COSMOS field was performed using a hyper supreme camera by National Astronomical Observatory of Japan Subaru telescope.

It succeeded to presume the distance between about 500,000 galaxies used for the result and analysis.

If this result is analyzed together with a result of the Hubble space telescope, the distance of the dark matter which is causing a gravitational lens phenomenon can be presumed.

By this, three-dimensional special distribution of dark matter (figure 1 referring) was made clear first time in the world, and it became clear that dark matter also forms large-scale structure.

And after this was compared with the three-dimensional distribution of the galaxy, it was found out that galaxies are distributed during the large-scale structure that dark matter makes surely (figure 2 referring: The two-dimensional figure projected onto celestial sphere).

The scenario that "A galaxy was formed in the large-scale structure which dark matter makes, and it had evolved." was inspected in observing way by this observation. (Reference: COSMOS Press Release Prof. Yoshiaki Taniguchi Graduate School of Science and Engineering Ehime University, in Japanese)⁹⁰

HP172

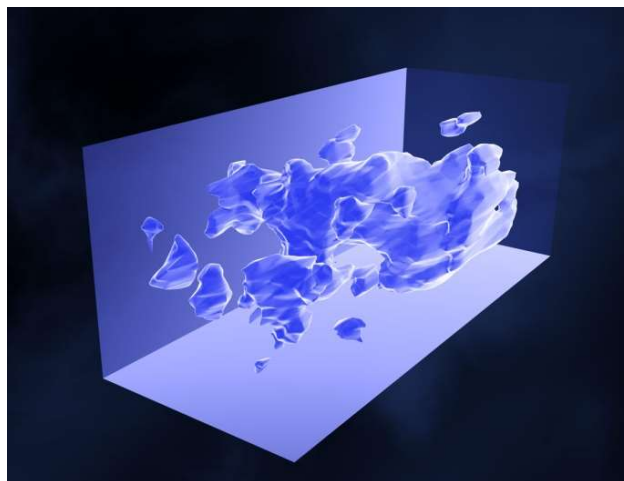

The three-dimensional structure of the dark matter in a figure 1 COSMOS celestial sphere. This side on the left is the universe in the neighborhood, and as you go to inside on the right,

the distance from us becomes far. When you go to the most far inside on the right, you will reach about 8,000,000,000 light-years of distance.

And you will see 270,000,000 light-years of territory in the (84Mpc) square there. (Massey et al. 2007, Nature in press) [STScI, Ray Villard] (By: COSMOS Press Release Prof. Yoshiaki Taniguchi Graduate School of Science and Engineering Ehime University, in Japanese)⁹⁰

HP173

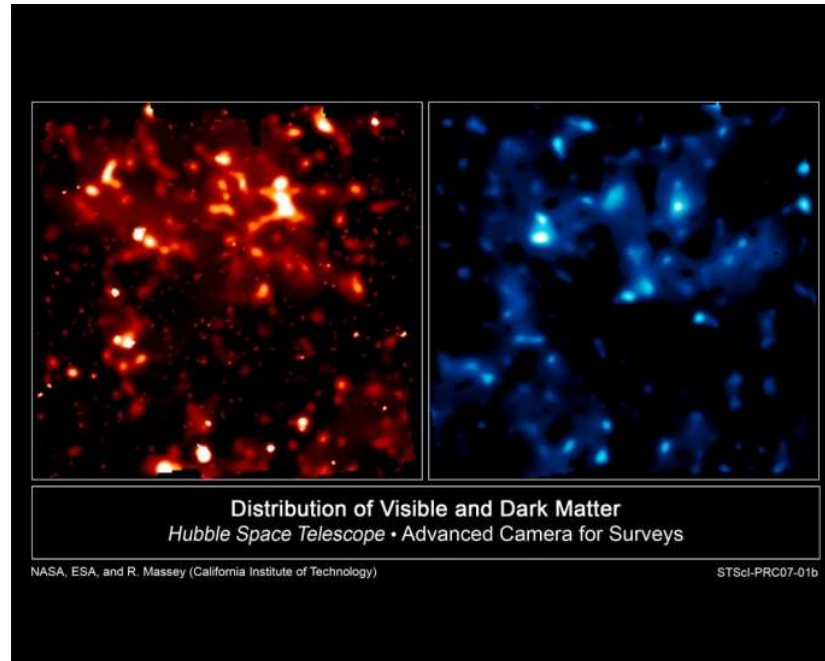

The figure 2

The distribution (the left) of the galaxy seen COSMOS celestial sphere and the distribution of the dark matter (the right). Both images of the two-dimensional distribution are very similar.

(Massey et al. 2007, Nature, in press) [STScI, Ray Villard] (By: COSMOS Press Release Prof. Yoshiaki Taniguchi Graduate School of Science and Engineering Ehime University, in Japanese)⁹⁰

It is guessed that the mysterious mass much bigger than a galaxy and a galaxy cluster clings to a galaxy and a galaxy cluster.

The feature of a dark matter that it clings to a galaxy and a galaxy cluster is akin to the surplus static energy body explained in the gravity field.

There is also next feature.

The character of the dark matter is not known, but some natures are inferred from the former observational evidence. (1) It does not have an electric charge (2) and, has weight (3) and, it is stable. Such substance cannot be explained by elementary particles which we know at present. (Reference: Kamioka Observatory, Institute for Cosmic Ray Research, University of Tokyo, XMASS, in Japanese)⁹¹

Surplus static energy body also matches to the feature that dark matter does not have an electric charge, has weight and, is stable.

Surplus static energy body does not have the nature of the revolving wave of energy body, because it does not have the energy accumulation to change into an elementary particle.

In other words, surplus static energy body does not have the nature of electromagnetism.

But it can be thought that surplus static energy body has mass (difficulty in moving) because of increasing energy level.

I would like to consider about mass some other time.

Surplus static energy body has stable character, because surplus static energy body is subordinate to a star as it was explained in gravity field.

"After all, dark matter is gravity field."

"Oh? Is dark matter gravity field?"

"Yes, it is."

"Decreasing of energy of static energy body continues to the stellar center, so the object put in this space slips to the stellar center."

"In other words, gravity is the one that a phenomenon inside gravity field was caught."

"On the other hand, when gravity field is viewed from outside, it is accumulation of static energy body."

Spiral motion of a galaxy is the accelerating motion, so, gravity field was viewed from outside. And the existence of dark matter was surfaced.

5. The universe circulation system

5.1. The universe expansion

It is not that the universe circulation system by energy body theory was worked out to try to make a new model against big bang theory because of a doubt.

Anyway, my interest was only gravity.

To make the cause of the gravity occurrence which came out in my mind certain, I have been expanding the inspection into an elementary particle, electromagnetism and the universe.

And, I unexpectedly reached one result, after I walked along one way considering gravity.

But, if I insist on the universe circulation system of energy body, it is opposed to big-bang theory. Big-bang theory is the mainstream of space theory.

But, there is a rumor on the net that Big-bang theory is the mainstream of space theory only in Japan, it is not so in foreign country.

It seems that Steady State Theory and Plasma Cosmology, besides the big-bang theory are considered.

But there is no theory which replaces big-bang theory and becomes the mainstream yet.

Therefore, I would like to consider Big Bang theory and the observation results which supports big bang theory. First "What is Big Bang?".

The one important paper which will be left in astronomy history is published in 1929.

The contents of the thesis announced by Edwin Hubble was that a farther galaxy goes away from us faster by Hubble's law.

It is interpreted that the universe is expanding by application of general theory of relativity at present. It is interpreted that because the universe is expanding, a farther and farther galaxy goes away faster and firmer, but this thing was indicated in observing way for the first time.

The fact that the universe is expanding means that, when going back in the past, the universe was small. The idea that the universe had started like this was already pointed out by Gorge Lemaitre, but the observing evidence to endorse that was showed by Hubble's discovery.

George Gamow made Lemaitre universe model more developed, and advocated the Elemental composition of model that an element was made quickly at the beginning of Big Bang.

Gamow predicted that, if big bang had occurred, its ember would be observed as Cosmic background radiation of 5 degrees of absolute temperature.

After 16 years from the prediction of Gamow, Arno Allan Penzias and Robert Wilson of Bell Labs noticed the radio existence which comes from the whole universe and is isotropic.

It was found that the radio wave intensity spectra coincide with black-body spectrum of 5 degrees of absolute temperature.

Big bang theory was made its status something immovable by this. (Reference: JAXA, The universe information center, and Wikipedia "Big Bang", in Japanese)^{89,92}

The basis of maximum that the universe is expanding is "the observation result that every galaxy is going away from us".

Thinking that stars are spreading, as it is shown in the next figure, so that stars may be explosive centering on the earth in the space is denied as unnaturalness.

HP174

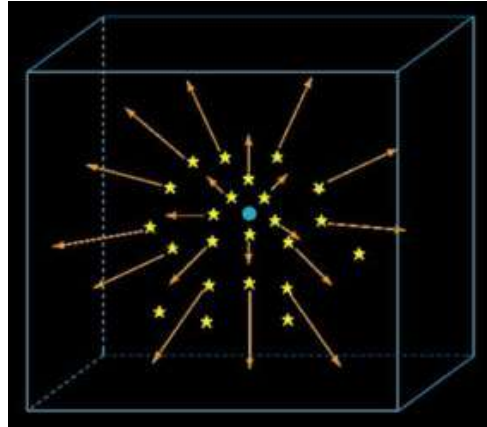

(By: Graduate School of Science and Engineering Saga University, Uchu no Bushitu no Kigen, in Japanese) ⁹³

It is most natural to think that the universe is expanding as shown in the figure next.

HP175

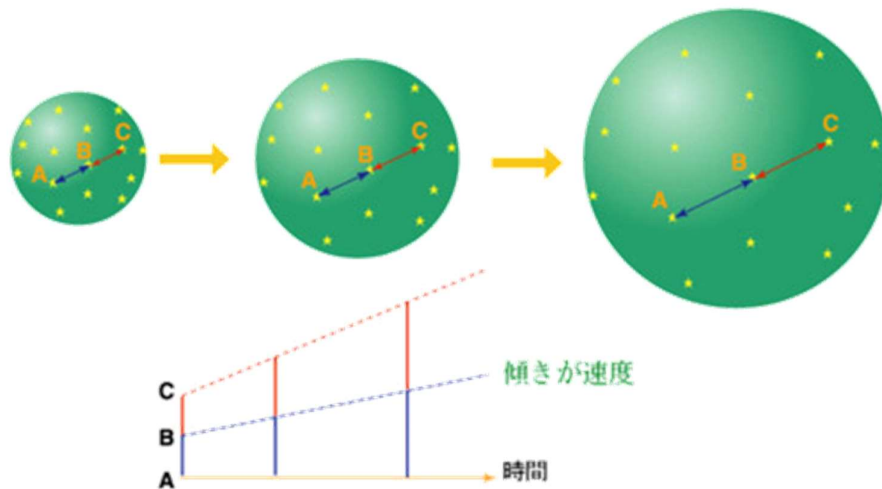

As swells, two points in the spherical surface of a balloon are going away each other, in the upper figure, but those speeds become so faster and faster, when two points are farther and farther. When C is seen from A, the distance is two times far than the distance between A and B, so, the moving back speed of C is two times faster than B. In other words, Hubble's law stands up!

This situation stands up at not only A, but also everywhere at this spherical surface.

The spherical surface is because everywhere is equal. (Reference: Graduate School of Science and Engineering Saga University, Bochosuru Uchu, in Japanese)⁹³

But, plural independent observations of Ia type supernova was showing that universe expansion is doing nonlinear acceleration, not to follow strictly Hubble's law.

It is requested from general theory of relativity that most space consists of ingredient with big negative pressure to explain this acceleration. It is thought at present that this dark energy accounts for the remaining, 70% of a space energy density. The true character of dark energy is left as big mysterious one of big-bang theory. (Reference: Wikipedia, "Big Bang", in Japanese)⁹²

Then, would it be able to be explained "the observation result that every galaxies are going

away each other" by the universe circulation system of energy body theory?

When you are thinking that the universe is expanding, the stellar movement is in the direction of the universe expanding at all places.

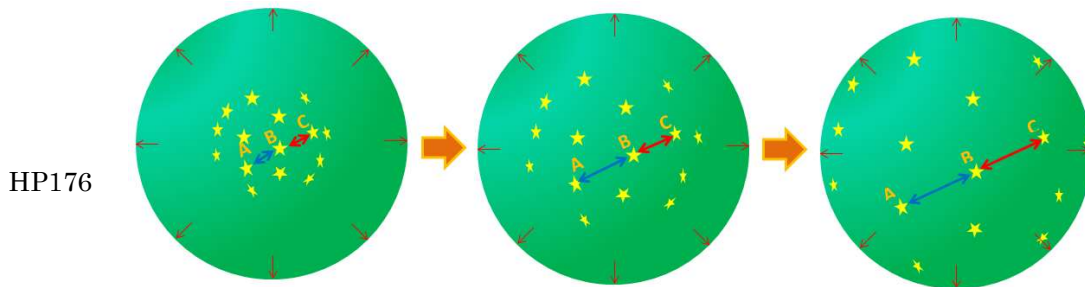

This is the same movement as all-stars move to the nearest space edge in a straight line, under the same condition, in the dark energy field of the universe circulation system.

Dark energy field is the place where static energy body is gradually decreasing, and forms one system of energy body as the whole universe.

Moreover, the accelerating expansion which is difficult to explain by big-bang theory is also explained by the universe circulation system of energy body theory.

5.2. Cosmic background radiation

It was explained by the last article about a law of Hubble expansion among the observing prop which supports big-bang theory. I would like to think about cosmic microwave background radiation in this article.

It is generally said that there are three observing prop which support big-ban theory in space theory. Those are the law of Hubble expansion observed as a red shift of a galaxy, the detailed observation of cosmic microwave background radiation and the amount of existence of light elements. (Reference: Wikipedia, "Big Bang", in Japanese)⁹²

The tide of argument between the steady-state theory and the big-bang theory was turned to the big-bang theory by discovery of cosmic microwave background radiation.

Because the early universe was in the thermal equilibrium, radiation in this time is freely flying in space with a black body radiation spectrum up to now. But, its wavelength is increased by red shift on space Hubble expansion of the universe. The originally hot temperature of black-body spectrum becomes low by this. It can be observed that this radiation comes from all directions at all locations of the universe. Arno Allan Penzias and Robert w. Wilson found space background radiation, when they were doing a series of test observation using the new-style microwave antenna in the Bell Laboratories in 1964. This discovery backed up the expectation of general CMB certainly. The found radiation was isotropy, and coincided with about 3 K of black-body spectrum. Opinions going around the universe theory inclined to the person who supports a Big Bang hypothesis by this discovery. (Reference: Wikipedia, "Big Bang", in Japanese)⁹²

But this cosmic microwave background radiation can be evidence of the universe circulation system of energy body theory.

Galaxies and clusters of galaxies go to the space edge, and explode there, and after that return to static energy body.

This process is multistory and extensive.

Because, dark energy field consists of one system of energy body in the whole universe, the direction which galaxies and galaxy clusters move in is isotropic to the edge of the universe.

It spends incredibly long time for galaxies and clusters of galaxies to arrive at the space edge,

and those melt, and as being released from a restriction of gravity, galaxies and galaxy clusters widely spread over, and return to static energy body.

When more are overlooked, great wall will be swallowed in the space edge just as it is.

In this way, it can be thought that the space edge of the uniform energy level is made.

Please compare the figure of the cosmic background radiation with the figure of the Great wall.

Those figures are very similar.

It was assumed that cosmic background radiation noise grew to great wall in big-bang theory.

But, it is reverse.

Great wall caused Cosmic background radiation noise.

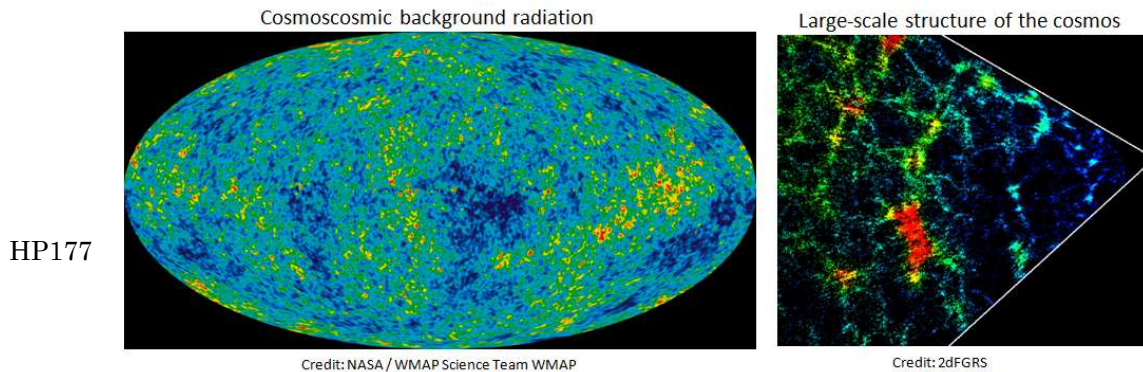

(By: Left figure Wikipedia Big Bang, The right figure Chronological table of science official site, in Japanese)⁹⁴

This process would be long time incredibly.

When galaxies and galaxy clusters return to static energy body, its energy is freed, and spreads getting cold.

The electromagnetic wave emitted at the time of this energy release is regarded as cosmic microwave background radiation.

By the way, cosmic microwave background radiation is observed as a spectrum correspond to a black body radiation of about 3 k from all space directions.

Why is a spectrum of the same wavelength observed from all space directions?

The earth cannot be located in a space center.

The space heat emission which got cold up to 3000k is cooled to about 3 k (wavelength development) for a red shift by universe expansion, and is observed (arrival at the earth), in big-bang theory.

By the way, the distance traveled by light is expressed by " distance trveled by light = (light speed - cosmic expansion speed) *time".

We are now observing the light which was radiated at the time that the universe clears up, and light has begun to move (from Big Bang, 400,000 years later)

When the radius of that case is set to 400,000 light-years temporarily, the microwave observed at present traveled very slowly the distance of 400,000 light-years, and approached the earth after 13,700,000,000 years.

Then, it results in observing by chance.

HP178

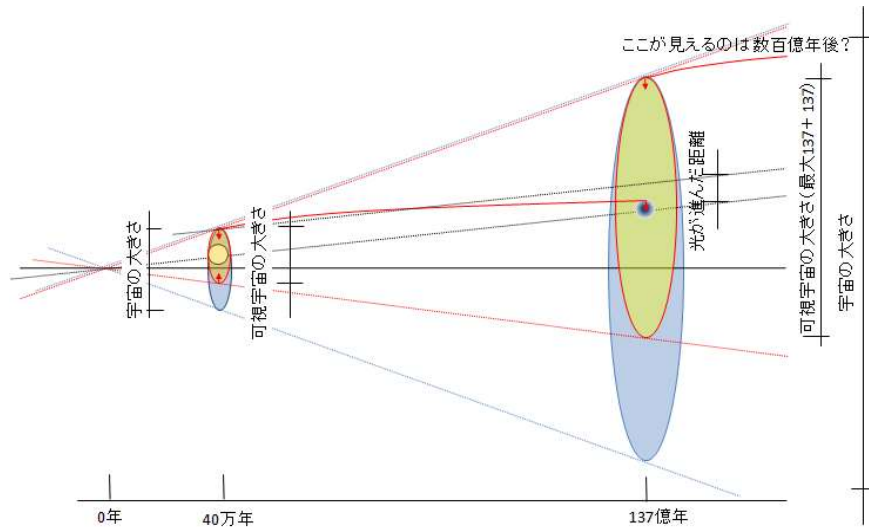

But, when inflation theory is taken in, this problem disappears. Anyhow it is because the universe momentarily expanded to the size as much as present one at early stage of Big Bang in inflation theory. But it is not explained why now there is the light of 13,800,000,000 years ago, and why the second inflation occur.

HP179

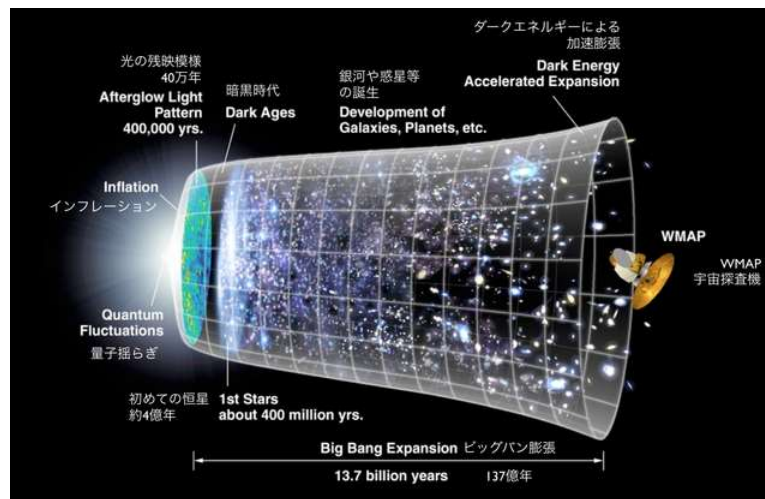

(By: Wikipedia, "Cosmic Inflation" , in Japanese) 95

Such contradiction and irrationality are not formed by the universe circulation system of energy body theory.

Because, it is conceivable that cosmic microwave background radiation is always released in elevated temperature, and its state always exists.

I would like to explain by energy body theory why cosmic microwave background radiation is observed at the low temperature of 3k, as the same wavelength, and from isotropic directions of the universe, because the earth should not be in the universe center.

Galaxies and galaxy clusters approach the space edge at high speed and advance in thin static energy body while keeping its speed.

Soon, they explode and break to atoms, and return to static energy body before reaching the space edge.

The periphery of the stars would be wrapped in very hot energy at the time.

Wreckage of the stars of this super-hot temperature state is diffused while approaching the

space edge, and the temperature gets cold to 3,000k. (The explanation that light began to move at 3,000k was borrowed from big-bang theory.)

The light radiated from wreckage of the stars is reduced to microwaves of about 3 k, because of doppler effect which is caused by wreckage of the stars going to the space edge. and

The doppler effect of light is as follows.

In case of light, similar effect is observed.

The light emitted from a light source going back away looks like red (red shift), and the light emitted from a light source approaching looks like blue (blue shift). But propagation of light shows a different phenomenon from doppler effect of usual wave, because the propagation of light is based on special relativity. The cause of Doppler effect is owing to the change in interval between tops of waves for an observer moving relative to its source. But it is observed that light propagates at light speed, despite the speed of a wave source and of the observer, then, the change in interval between tops of waves is different from usual wave. In case of light, when a wave source is moving, time on the wave source is delayed and is observed by the effect of the theory of special relativity. By that, it is added that the frequency of the light from a wave source is observed being smaller. (Reference: Wikipedia, "Doppler effect", in Japanese)⁹⁶

This microwave is observed as Cosmic Microwave Background Radiation at the earth.

In other words, a microwave is already about 3 k at the time when it was radiated at a space edge.

Therefore, every microwave is the same 3k despite the distance to the earth.

※The big-bang theory that the light emitted off at 3,000k becomes a microwave of 3k (black body radiation) by doppler effect and has reached the earth is quoted, in this article, but there is also a possibility of the electromagnetic wave emitted off from gravity filed (dark matter), so, I am thinking further inspection is necessary.

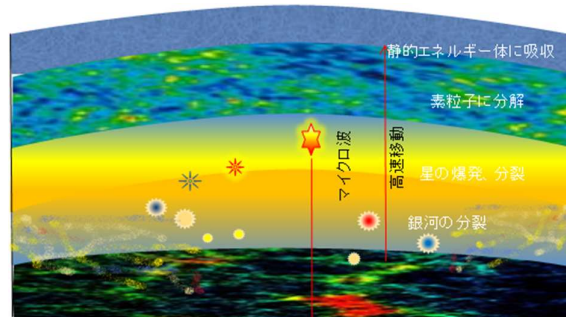

HP180

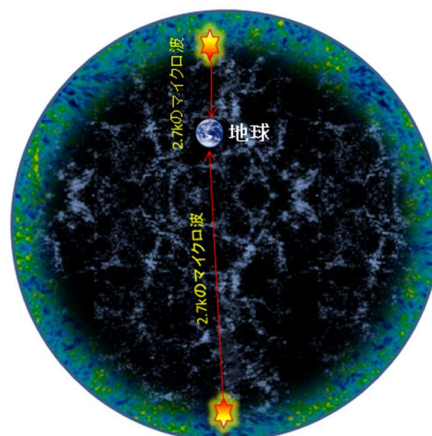

5.3. The universe circulation system

What kind of fate will the stars follow, after falling to space edge due to dark energy field?

In big-bang theory, it is thought that the universe is spreading.

But, in energy body theory, the universe does not expand.

Generation of gravity and dark energy was rationally explained, because it was thought the universe is limited.

Then, does the stars stay in a space edge?

Or, do the stars fall in somewhere outside of the universe, like that European people before the Middle Ages used to think everything fall over horizon where is a waterfall?

HP181

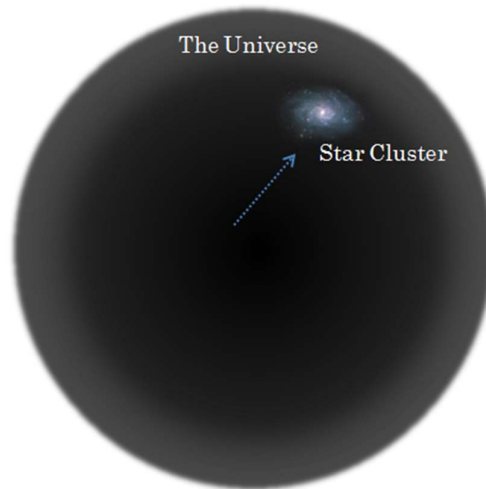

The magnificent universe circulation system of energy body is assumed with energy body theory. Approaching the space edge, the energy level of static energy body becomes lower.

On the other hand, the stars are kinetic energy body in high energy state.

Therefore, to get balance of energy level,

energy starts to the low energy level area from high energy level area.

First, gravity field surrounding a star would not be able to maintain the gravitational field.

Next, a star cannot maintain its form any more.

And a star explodes and becomes gas.

Elementary particles of gas cannot also maintain its form any more, and they return to static energy body.

HP182

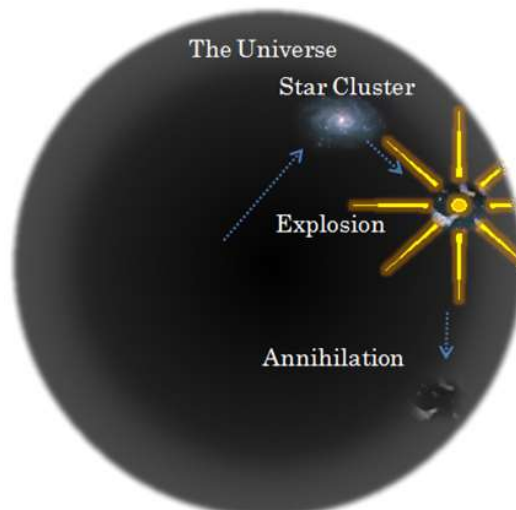

On the other hand, the stars are formed one after another around the space center. Stellar formation starts from the huge cloud of gas and dust which floats between the stellar interspace. When stars are formed, the density of static energy body increases. As a result, gravity fields are born, and elementary particles are generated. The stars absorbed in static energy body of space at around space edge will be a supply source of the static energy body which is consumed by stars formed around the space center.

HP183 (HP10)

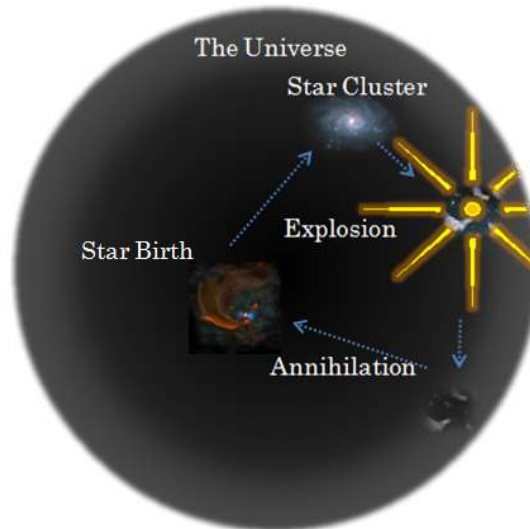

Star Birth: Credit 国立天文台

In other words, a circulation system of energy body is organized on the cosmic scale. It is a surprise, isn't it? That a beyond imagination so magnificent system stands up!

There is neither a starting nor an ending of the universe. The universe exists eternally.

The universe is living existence in which various workings and changes are performed in the eternal time.

It was not wrong necessarily that I named space energy cell bodies.

Space exists with time. So, there is also neither a starting nor an ending of time. Yes! I was relieved.

【Reference】

① Wikipedia Superstring theory

<https://ja.wikipedia.org/wiki/超弦理論>

② Energy Accelerator Research Organization, KEK

<https://www2.kek.jp/kids/class/particle/class01-10.html>

③ Wikipedia Ether

[https://ja.wikipedia.org/wiki/エーテル_\(物理\)](https://ja.wikipedia.org/wiki/エーテル_(物理))

③ Wikipedia “Space”

<https://ja.wikipedia.org/wiki/空間>

④ Koto bank, in Japanese

<https://kotobank.jp/word/%E7%B4%A0%E7%B2%92%E5%AD%90-90424>

⑤ “Monogatari science” in Japanese

<http://book.geocities.jp/cfnrx387/story8.html>

- ⑤ “Wikipedia elementary particle”
<https://ja.wikipedia.org/wiki/素粒子>
- ⑥ Hyper Kamiokande Reference
<http://www.hyper-k.org/physics/phys-cp.html>
- ⑦ The University of Tokyo, graduate school science system postgraduate course and the department of science Reference
<https://www.s.u-tokyo.ac.jp/ja/story/newsletter/40/4/features/06.html>
- ⑧ Wikipedia CP violation
https://ja.wikipedia.org/wiki/CP_対称性の破れ
- ⑨ Wikipedia “Quantum field theory”
<https://ja.wikipedia.org/wiki/場の量子論>
- ⑩ Wikipedia “Electric charge”
<https://ja.wikipedia.org/wiki/電荷>
- ⑩ Denki no Rekishi Irasutokan in Japanese
<http://www.geocities.jp/hiroyuki0620785/k1dennki/denkai.htm>
- ⑪ Wikipedia “elementary charge”
<https://ja.wikipedia.org/wiki/電気素量>
- ⑫ Weblio dictionary “Proton”
<http://www.weblio.jp/content/陽子>
- ⑬ Wikipedia Oil drop experiment
https://en.wikipedia.org/wiki/Oil_drop_experiment
- ⑭ “Nagatabi P to manbun koukopu butyric” in Japanese
<https://nagatabi-p.jimdo.com/%E7%AC%AC5%E7%B7%A8-%E5%8E%9F%E5%AD%90/1-%E9%9B%BB%E5%AD%90/>
- ⑮ Wikipedia Coulomb's law
<https://ja.wikipedia.org/wiki/クーロンの法則>
- ⑯ Wikipedia “Electronic orbit”
<https://ja.wikipedia.org/wiki/電子軌道>
- ⑰ Zatugaku Noto in Japanese
<http://hr-inoue.net/zscience/topics/chemicalbond/chemicalbond.html>
- ⑱ Wikipedia “Electron configuration”
<https://ja.wikipedia.org/wiki/電子配置>
- ⑲ Wikipedia “Hund’s law”
<https://ja.wikipedia.org/wiki/フントの規則>
- ⑳ Denki no Rekishi Irastokan in Japanese
<http://www.geocities.jp/hiroyuki0620785/ryosi/bohrmodel.htm>
- ㉑ Wikipedia “Niels Henrik David Bohr's atom model”
<https://ja.wikipedia.org/wiki/ボーアの原子模型>
- ㉒ Wikipedia “Magnetic charge”
<https://ja.wikipedia.org/wiki/磁荷>
- ㉓ Wikipedia “Spin angular momentum”

<https://ja.wikipedia.org/wiki/スピン角運動量>

②4 Wikipedia “Zeeman effect”

<https://ja.wikipedia.org/wiki/ゼーマン効果>

Denki no Rekishi Irastokan, in Japanese

<http://www.geocities.jp/hiroyuki0620785/ryosi/zeemaneffect.htm>

②5 Wikipedia “Experiment of Stern = Gerlach”

<https://ja.wikipedia.org/wiki/シュテルン＝ゲルラッハの実験>

②6 Wikipedia “Double slit experiment”

<https://ja.wikipedia.org/wiki/二重スリット実験>

②7 "Tetugakutekina nanika, ato kagakutoka" in Japanese

<http://www.h5.dion.ne.jp/~terun/doc/slit.html>

②8 Wikipedia Electric charge

<https://ja.wikipedia.org/wiki/電荷>

②9 Wikipedia “Beta decay”

<https://ja.wikipedia.org/wiki/ベータ崩壊>

③0 Buturigaku kittsashitu in Japanese

http://www1.odn.ne.jp/~cew99250/html/S_4.html

③1 "Banshosuiho in Japanese"

<http://k-hiura.cocolog-nifty.com/blog/2012/12/post-85f3.html>

③2 Wikipedia “Strong interaction”

<https://ja.wikipedia.org/wiki/強い相互作用>

③3 Physics at International Linear Collider

<http://www-jlc.kek.jp/ilcphys/>

③4 kizzusaientisuto in Japanese

<https://www2.kek.jp/kids/class/nucleus/class03-02.html>

③5 Wikipedia Quark

<https://ja.wikipedia.org/wiki/クォーク>

③6 Invitation to the internet seminar Seminar person in charge: Kenjiro Takada (Kyushu University honorary professor) (5) The micro world - world of the 3 - (atomic nucleus) 3-2: Nuclear force (the interaction between the nucleon

③7 "The origin of "the strong force" in an atomic nucleus is elucidated 2007/6/20 (the University of Tokyo, graduate school science system postgraduate course and the department of science)"

<https://www.s.u-tokyo.ac.jp/ja/press/2007/10.html>

③8 Wikipedia “ π meson”

<https://ja.wikipedia.org/wiki/パイ中間子>

③9 Physics at International Linear Collider

http://www-jlc.kek.jp/ilcphys/hep_intro/force/force5

④0 “Advanced Meson Science Laboratory RIKEN Nishina Center for Accelerator-Based Science”

<http://ag.riken.jp/eta-pi/index-j.html>

④1 Wikipedia “Gluon

<https://ja.wikipedia.org/wiki/グルーオン>

④② Invitation to the internet seminar Seminar person in charge: Kenjiro Takada (Kyushu University honorary professor) (5) The micro world - world of the 3 - (atomic nucleus) 3-2: Nuclear force (the interaction between the nucleon),
<http://ne.phys.kyushu-u.ac.jp/seminar/>

④③ Wikipedia Weak interaction

<https://ja.wikipedia.org/wiki/弱い相互作用>

④④ Wikipedia Weak boson

<https://ja.wikipedia.org/wiki/ウィークボソン>

④⑤ Buturigaku Kissashitu in Japanese

http://www1.odn.ne.jp/~cew99250/html/S_2.html

④⑥ Wikipedia Bose and Einstein condensation

<https://ja.wikipedia.org/wiki/ボース=アインシュタイン凝縮>

④⑦ Nakagawa laboratory of The University of Electro-Communications

http://www.ils.uec.ac.jp/~naka_lab/news/research1_j.html

④⑧ “Bose and Einstein condensation” by Masahito Ueda, Department of Physics, ④⑨ The University of Tokyo

http://cat.phys.s.u-tokyo.ac.jp/publication/BEC_koudansha.pdf

⑤⑩ Wikipedia Electricity

<https://ja.wikipedia.org/wiki/電気>

⑤⑪ Wikipedia “Lorentz force”

<https://ja.wikipedia.org/wiki/ローレンツ力>

⑤⑫ Denki no Rekishi Irasutokan, in Japanese

<http://www.geocities.jp/hiroyuki0620785/k2jiki/maginduction.htm>

⑤⑬ Wikipedia “Electromagnetic Wave”

<https://ja.wikipedia.org/wiki/電磁波>

⑤⑭ Wakariyasui Koukou Buturi no Heya, in Japanese

<http://wakariyasui.sakura.ne.jp/p/elec/jibauke/heikou.html>

⑤⑮ Wikipedia Emission spectrum

<https://ja.wikipedia.org/wiki/放出スペクトル>

⑤⑯ KEK

<http://pfwww.kek.jp/outline/pf/pf1.html>

⑤⑰ Wikipedia “Light”

<https://ja.wikipedia.org/wiki/光>

⑤⑰ “photon”

<https://ja.wikipedia.org/wiki/光子>

⑤⑱ Wikipedia “Young's experiment”

<https://ja.wikipedia.org/wiki/ヤングの実験>

⑤⑲ Wikipedia “Photo-electric effect”

<https://ja.wikipedia.org/wiki/光電効果>

⑥⑰ Einstein no Kagaku to Shogai, in Japanese

<http://koshiro56.la.coocan.jp/contents/relativity/contents/relativity1021.html>

- ⑥1 Open class Brochure "World physics year Memorial Lecture (August 27, 2005)",
Department of Physics and Earth Sciences, University of the Ryukyus
<http://www.phys.u-ryukyu.ac.jp/WYP2005/koudenpamph.html>
- ⑥2 Wikipedia "Special relativity"
<http://eman-physics.net/relativity/einstein.html>
- ⑥3 "JAXA Space Information Center"
http://spaceinfo.jaxa.jp/ja/kagaku_kag108_michelson.html
- ⑥4 Wikipedia Michelson Morley experiment
<https://ja.wikipedia.org/wiki/%E3%83%9E%E3%82%A4%E3%82%B1%E3%83%AB%E3%82%BD%E3%83%B3%E3%83%BB%E3%83%A2%E3%83%BC%E3%83%AA%E3%83%BC%E3%81%AE%E5%AE%9F%E9%A8%93>
- ⑥5 Wikipedia "Special relativity"
<https://ja.wikipedia.org/wiki/特殊相対性理論>
- ⑥6 Wikipedia "Fresnel equations"
<https://ja.wikipedia.org/wiki/フレネルの式>
- ⑥7 Wikipedia "Primary wave"
<https://ja.wikipedia.org/wiki/P波>
- ⑥8 Wikipedia "Secondary wave"
<https://ja.wikipedia.org/wiki/S波>
- ⑥9 Wikipedia "Principle of Huyghens = Fresnel"
<https://ja.wikipedia.org/wiki/ホイヘンス＝フレネルの原理>
- ⑦0 Wikipedia "Doppler effect"
<https://ja.wikipedia.org/wiki/ドップラー効果>
- ⑦1 IllustratorKisokoza
<http://illustrator-ok.com/kisokoza/color/e-wave/e-wave4.html>
- ⑦2 Tone nikki
<http://blog.goo.ne.jp/ktonegaw/e/37de3579b7802d92fc837a9ef6e2095b>
- ⑦3 Wikipedia "Neutrino"
<https://ja.wikipedia.org/wiki/ニュートリノ>
- ⑦4 Super-Kamiokande
<http://www-sk.icrr.u-tokyo.ac.jp/sk/sk/neutrino.html>
- ⑦5 Wikipedia Mass
<https://ja.wikipedia.org/wiki/%E8%B3%AA%E9%87%8F>
- ⑦6 EMAN no Buturigaku
<http://eman-physics.net/relativity/illusion.html>
- ⑦7 Wikipedia Newton's laws of motion
<https://ja.wikipedia.org/wiki/%E3%83%8B%E3%83%A5%E3%83%BC%E3%83%88%E3%83%B3%E5%8A%9B%E5%AD%A6>
- ⑦8 Wikipedia The inertia
<https://ja.wikipedia.org/wiki/慣性>
- ⑦9 Wakariyasui Koukou Buturi no Heya, in Japanese
<http://www.wakariyasui.sakura.ne.jp/b2/53/5321kannsei.html>

- ⑧⑩ Watson's Page
<http://www.geocities.jp/watsns/kanseir1.html>
- ⑧⑪ Wikipedia Gravity
<https://ja.wikipedia.org/wiki/重力>
- ⑧⑫ Wikipedia General relativity
<https://ja.wikipedia.org/wiki/一般相対性理論>
- ⑧⑬ Wikipedia Gravitational lens
<https://ja.wikipedia.org/wiki/%E9%87%8D%E5%8A%9B%E3%83%AC%E3%83%B3%E3%82%BA>
- ⑧⑭ Wikipedia The general theory of relativity
<https://ja.wikipedia.org/wiki/一般相対性理論>
- ⑧⑮ Buzzap.jp
<http://buzzap.jp/news/20130108-under-absolute-zero/>
- ⑧⑯ Wikipedia Absolute zero
<https://ja.wikipedia.org/wiki/絶対零度>
- ⑧⑰ Wikipedia Zero-point motion
<https://ja.wikipedia.org/wiki/零点振動>
- ⑧⑱ KEK "Kasoku bochosuru uchu" 2011 nen "Nobel Prize in Physics" no igi, in Japanese
<https://www.kek.jp/ja/NewsRoom/Highlights/20111216160000/>
- ⑧⑲ JAXA The universe information center
http://spaceinfo.jaxa.jp/ja/dark_matter.html
- ⑧⑳ COSMOS Press Release Prof. Yoshiaki Taniguchi Graduate School of Science and Engineering Ehime University
<http://cosmos.phys.sci.ehime-u.ac.jp/~tani/Cosmos/PressRelease/index.html>
- ⑧㉑ Kamioka Observatory, Institute for Cosmic Ray Research, University of Tokyo, XMASS
<http://www-sk.icrr.u-tokyo.ac.jp/xmass/darkmatter.html>
- ⑧㉒ Wikipedia Big Bang
<https://ja.wikipedia.org/wiki/ビッグバン>
- ⑧㉓ Graduate School of Science and Engineering Saga University , Uchu no BuShitu no Kigen,inJapanese
<http://astr.phys.saga-u.ac.jp/~funakubo/BAU/chapter1/chapter1-3.html>
- ⑧㉔ Chronological table of science official site
https://www.rikanenpyo.jp/kaisetsu/tenmon/tenmon_031.html
- ⑧㉕ Wikipedia Cosmic Inflation
<https://ja.wikipedia.org/wiki/%E5%AE%87%E5%AE%99%E3%81%AE%E3%82%A4%E3%83%B3%E3%83%95%E3%83%AC%E3%83%BC%E3%82%B7%E3%83%A7%E3%83%B3>
- ⑧㉖ Wikipedia Doppler effect
<https://ja.wikipedia.org/wiki/ドップラー効果>

Note: Passages cited in this paper are translated by Ichiro Nakayama.