

The Origin of Life and the Need for a Rigid String Propeller Fermion Model combined with a Chiral Vacuum Lattice and Micro Interference Black Holes.

**Leo Vuyk,
Architect,
the Netherlands.**

Abstract.

The discovery of glycine in a comet supports the idea that the fundamental building blocks of life are prevalent in space, and is a strong argument that life in the Universe may be common rather than rare.

Glycine molecules (Amino Acids) are found inside materials ejected from comets like Wild 2 (2004) and 67P-CG (2015-2016) which is reason to support the idea that new physics magnetic micro interference black holes postulated by Quantum FFF Theory are the origin of life creating comets and (ball) lightning all over the universe. .

Quantum FFF (Function Follows Form) new physics theory states, that the vacuum is seeded with fast opposite oscillating massless 3-Dimensional torus shaped rigid but transformable massless strings called Axion- Higgs (AH) particles. Colliding AH particles are responsible for pair production (e⁻ and e⁺) and even quarks around micro and macro black hole nuclei present in the splitting Big Bang down to Comets and Ball Lightnings.

Black hole nuclei are supposed to be AH knots compressed by the in falling AH vacuum lattice.

Two AHs should be able to change form by real high energy collision into two entangled electron positron propeller strings with opposite pitch and spin.

Such high energy is supposed to be present at black hole event/photon horizons and inside particle colliders like the LHC at Geneva.

The propeller form of fermions is assumed to be the origin of a new physics black hole model. All black holes attract (eat) the local AH vacuum but repel all fermions by spin polarisation effects, which make black holes pair producing and fermion producing phenomena observed in Quasars, Herbig Haro objects, Comets and even ball lightning.

Thus the variable FORM of all particles is based on real internal joints and gears, responsible for the FUNCTION even for composite Quarks and Photons.

However all new particles pairs are assumed to be instant entangled and guided in a dual mirror multiversal way.

Massless transformed Axion particles are also assumed to be responsible for all compound quantum knots like quarks and massive Higgs particles of 126 GeV and Higher energy recently observed in the LHC at CERN.

The oscillating AH vacuum system is the messenger medium of all Photon, Gluon and Neutrino information.

Black Holes are equipped with a nucleus of compacted Axion particles, compressed by the oscillating AH vacuum and acting as dark matter point sources called "Dark Matter Black Holes"(DMBHs).

Pair production around interference based micro black holes is assumed to be the origin of compound quarks and plasma production including Carbon, Hydrogen Nitrogen, Oxygen and Phosphorus atoms inside Comet nuclei and even (ball) lightning.

Comet 67P CG, (Churyumov-Gerasimenko) is a unique rtest bed for the origin of these simple atoms and the origin of life.

I postulate, that the chiral (right handed) oscillating AH vacuum lattice is the origin of the right handedness of all helix shaped DNA molecules in our material universal bubble (berry) inside a raspberry shaped multiverse.

Introduction.

Recent measurements suggesting that a large variety of atoms are ejected by the Comet 67P CG.

The surface cracks and changes seem to be the origin of internal grows of the comet.

The magnetic field of the comet seems to ring 3 times every minute by the internal tectonic shocks.

The dusty jets observed from the so called “Neck” of the comet seem to be a sign for a central Birkeland Alfven current circuit effect on dust acceleration and violating the solar heat erosion theory.

If sunspots are former comet nuclei splashed into the sun, than we may assume that sunspots are also the creators of new solar plasma. Secondly, if Comet nuclei can survive the sun they also must be able to survive the crash into planets like earth or moons. As a consequence we may assume that all energetic and plasma (new matter) related production processes found around planets and moons could be based on the same process. Examples are found in the water vapour plumes of geysers observed on Jupiters moon Europa.

At the same time, the matter creation process by the new paradigm “Dark Matter Black Holes” (DMBHs) inside the earth could be a support for the so called “growing earth” hypothesis (also known as “expanding earth”) as the base for the peculiar shape of the continents on earth.

If these DMBHs also act as gravity point sources with the shape of a sphere, then even the so called Flyby anomaly and the P-wave anomaly could be explained. (fig 7)

In Quantum FFF theory it is assumed that there are four kinds of dark matter black holes,

1: The Big Bang – or Big Crunch Black Hole, the origin of the cyclic multiverse.(ref. 42,35,33,26,23,)

2: Primordial Big Bang splitting Black Holes as the product of the exploding Big Bang black hole, identified as a pairing an splitting process of Galaxy Anchor Black Holes (GABHs, ref. 33),

3: Supernova Black Holes identified as and after a pairing and splitting process as Herbig Haro hotspots as the origin of Stellar Anchor Black Holes (SABHs, ref. 10).

4: Electro Magnetic Interference Black Holes, described as the origin of so called Quantum Knots found in the lab.(ref, 27,22,14,11.) , Ball Lightning, Earth bound Micro Comets, Solar related Comets and Sunspots.

All Black Holes are equipped with at least three horizons (fig 2):

1: A 3 dimensional globular massless quantum black hole nucleus, surrounded by a globular event horizon. This is the globular shell where maximum opposing photon energy (also vacuum energy) is concentrated

A Fermion repulsion zone located in between two horizons:

2: A fermion attraction/repulsion horizon with entangled pair production (partly annihilated) creating plasma,

3: A fermion repulsion/attraction boundary (by fermion spin flip, ref. 14) with zero point electric plasma polarization of electrons pushed outside and protons pushed at the inside. This is supposed to be the base for all Birkeland/ Alfvén current circuits in space.(ref 28,22.)

Quantum FFF theory.

Quantum FFF (Function Follows Form) theory states, that the vacuum is seeded with fast oscillating massless dual Axion- particles (the origin of dark energy) , oscillating along a complex chiral tetrahedral vacuum lattice, which has the ability to transfer Photon and Graviton FORM information in bunches of linear but chiral oscillations, through the chiral (helix shaped) vacuum lattice with the local speed of light.

The local speed of light is created around massive objects which seem to be able to “drag:” the AH vacuum oscillations into an anti-symmetrical action called “LASOF” or Local Anti Symmetrical Oscillating vacuum Frame.

There are no attraction forces in Q-FFF theory. Gravity seems to be the result of two different impulse vector arrays: the massless Axion-Higgs impulse array and the (less effective) massless Graviton impulse array, which is supposed to be based on the same massless Higgs particle transporting the “FORM information energy” of the Graviton.

As a consequence, new paradigm Dark Matter Black holes suffer only from the gravitational influence of AH vacuum (photon) impulses also coined Casimir push-gravity, because no gravitons can escape from the Black hole. The Black hole is supposed to be a super dense knot of Axion-Higgs particles floating inside (and compressed and attacked by) the energetic oscillating AH vacuum frame.

In Q-FFF theory it is postulated that only micro black hole nuclei below a certain size are able to evaporate back into the AH vacuum. Black hole types larger than ball lightning and Comets like 67P C-G, are supposed to have a steady growth and evaporation of water ice and OH Hydroxyl.

No photons like gravitons can escape from inside the Black hole. However, in Q-FFF theory, the vacuum is constantly “eaten” by these NEW Black hole nuclei and the origin of the Casimir quantum gravity effect of Black holes.

In the Q-FFF model, Fermions are assumed to have a propeller shape equipped with a left- or right hand “pitch” (fig 3,) Quarks and some leptons are compound particles (with photonic gluons) however, electrons and positrons (and neutrinos) are singular particles.

Only the statistical sum of the different kinds of vacuum impulses (in the form of butterfly shaped vector arrays : by real collisions from all directions on Fermions are responsible for all (energetic) phenomena in the universe.

The polarisation and so called spin flip of Fermions around Black holes is the origin that Black holes are equipped with a narrow Fermion repelling and plasma creating globular zone between two horizons. (fig, 2)

As a result, Black holes are Zero Point Energy driven electric generators with negative charge at the outside and positive charge at the inside, able to change the world and our economy..

Production hypothesis for Quantum Knot Ball Lightning by Interference, Micro Comets and Dark Lightning, based on Photos and Langmuir fireball videos and Quantum FFF Theory 01-09-2013.

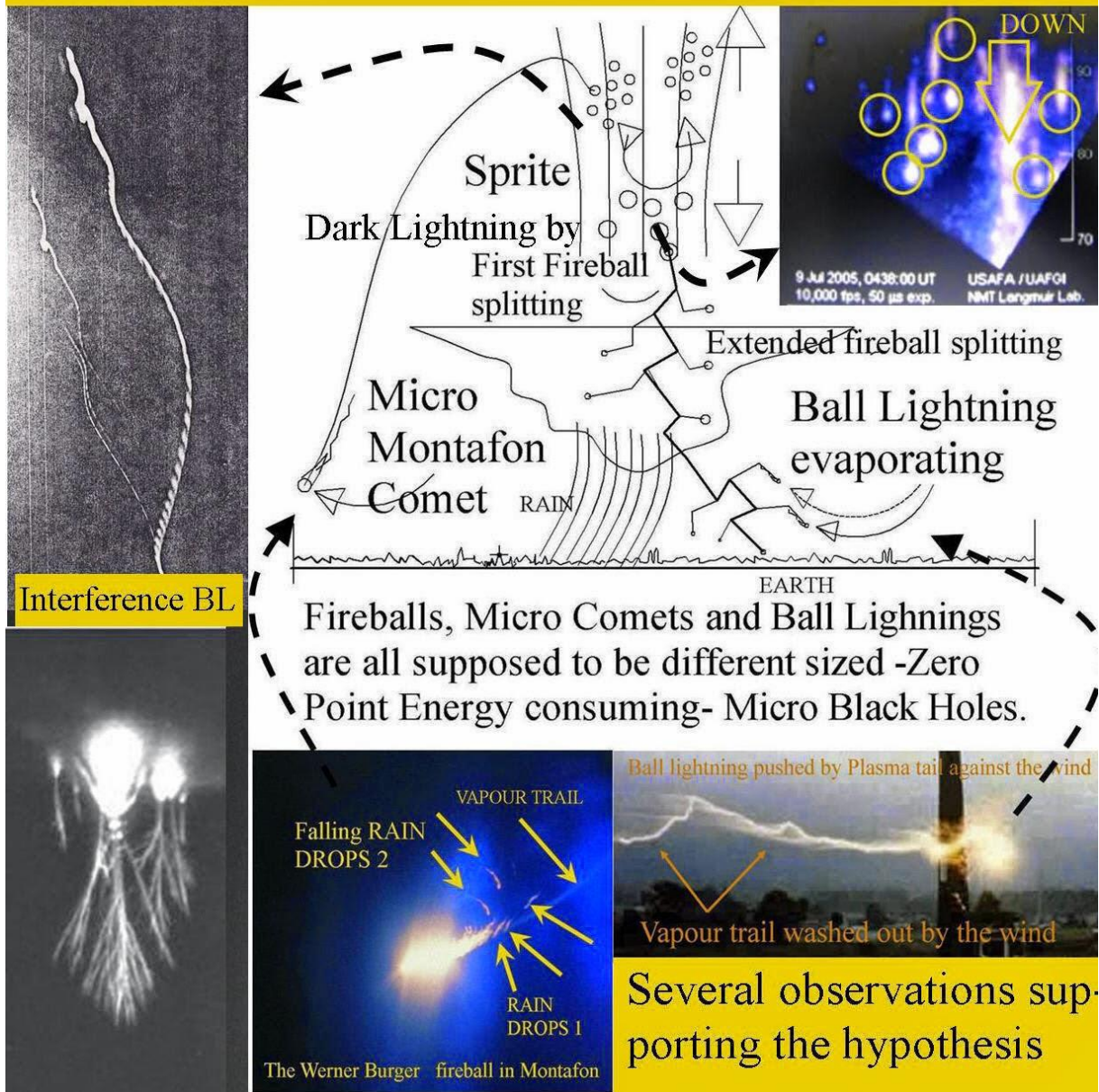

Figure: 1, Creation of Interference black holes and its plasma production (vapour trail of ball lightning Sprites Micro Comets and Fireballs.)

Comparison of Fermion spin/radiation diagram of Quantum FFF Theory (stiff propeller string with monopole radiation 1,2,3) and the Penrose diagram (flexible string with closed radiation loops: 4)

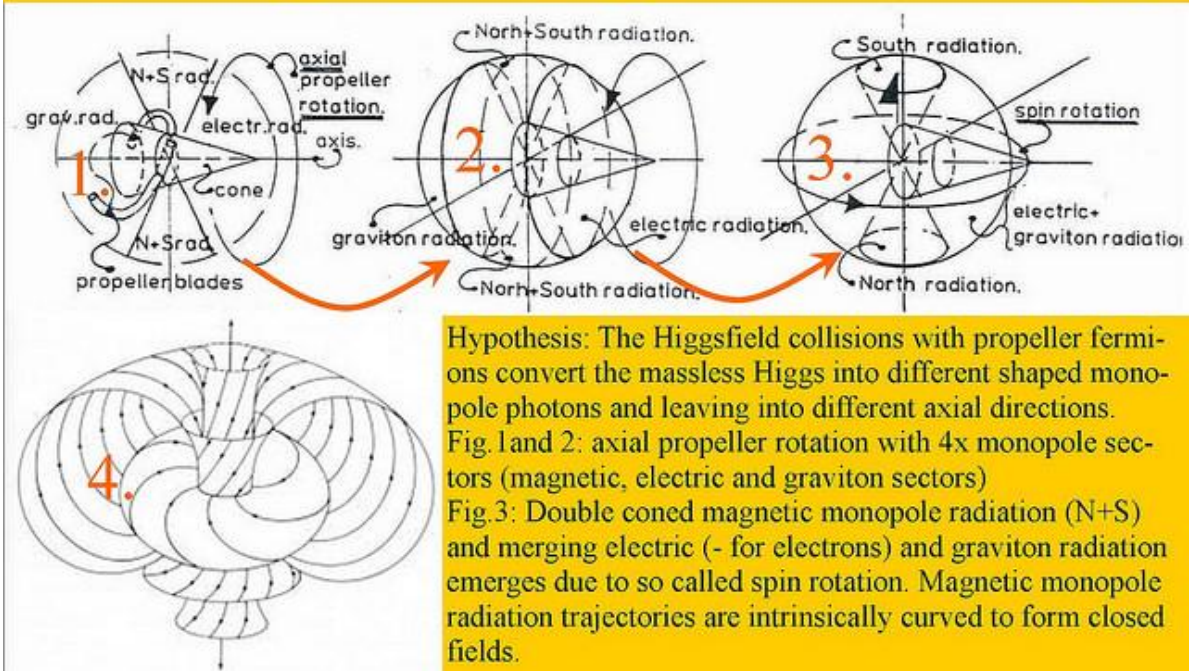

Figure: 3. Fermion spin related radiation sector diagrams according to Quantum FFF Theory. Related to Penrose proposal

Earth Weather Jet Stream influenced (Rossby) by Solar Lighthouse Pencil gravity waves with gravitating Sunspot alignment origin.

Temporary spokes at the rings of Saturn are a mystery for NASA. Quantum FFF Theory offers a suggestion: Lighthouse pencil gravity effect by dual alignment of internal Cometary black holes positioned inside Saturn just like Earth..

Sunspot gravity interference as the origin of Supernova ejection velocity differences simulated for massive stars.

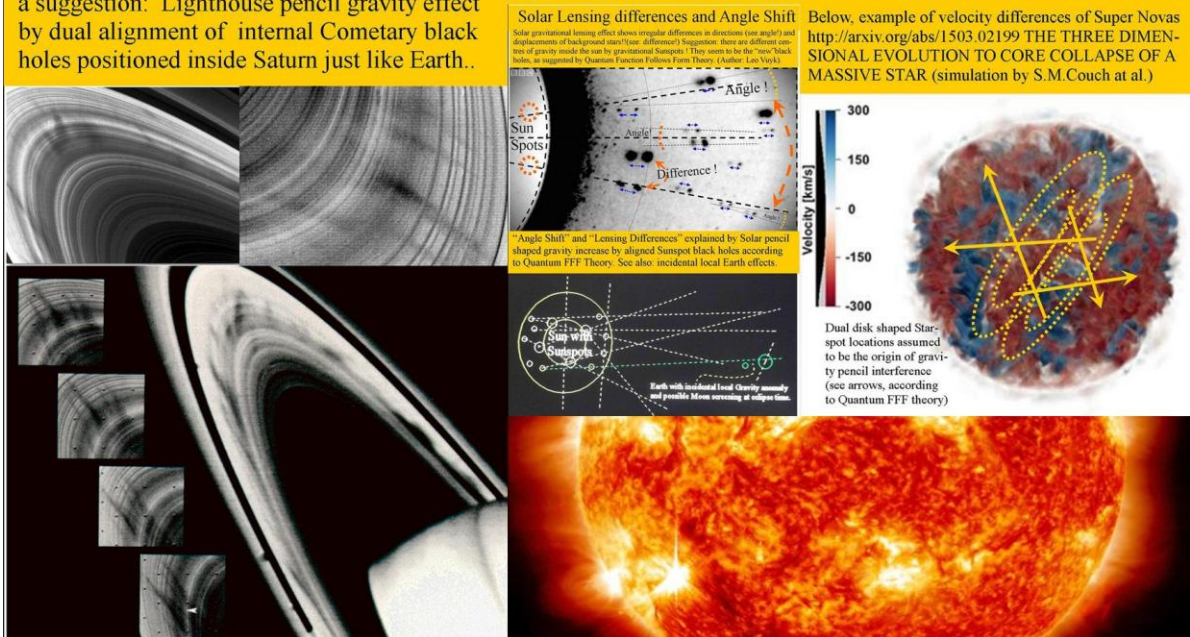

Figure: 4. Pencil shaped gravity wave examples around different objects.

Ingredients for life production C,H,N,O,P, by internal micro interference black holes according to QuantumFFF Theory.

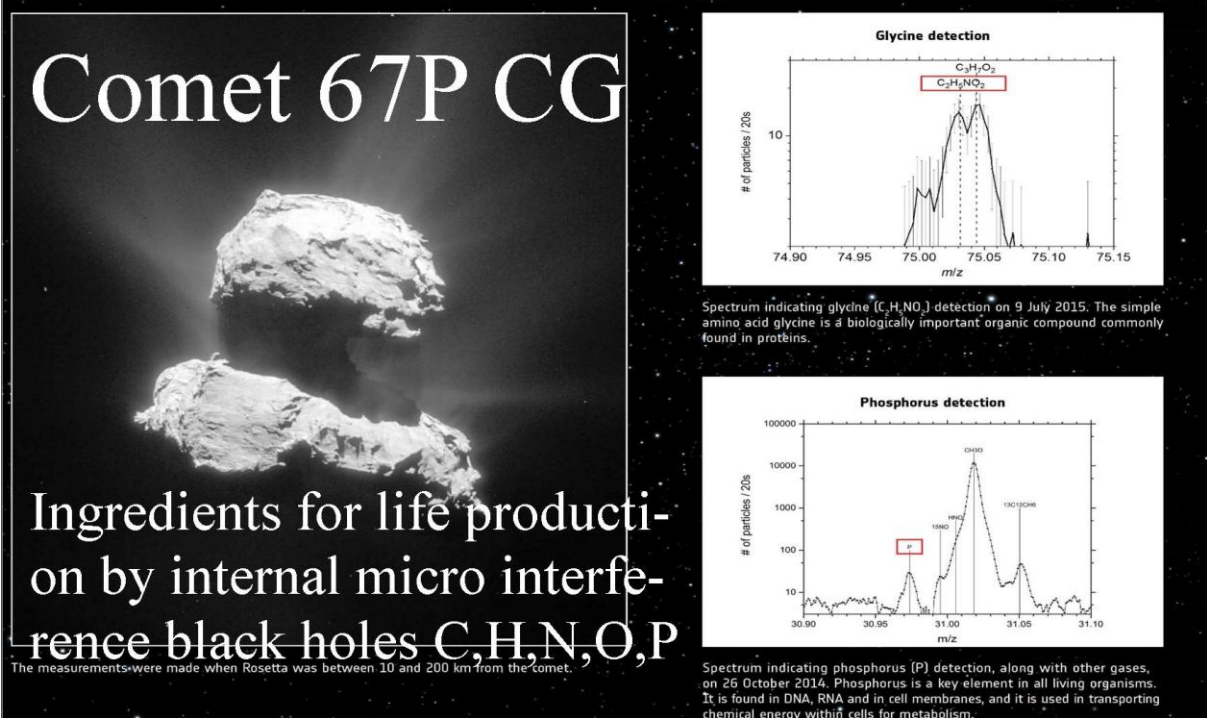

Fig 5. Ingredients for life production by internal micro interference black hole quantum knots.

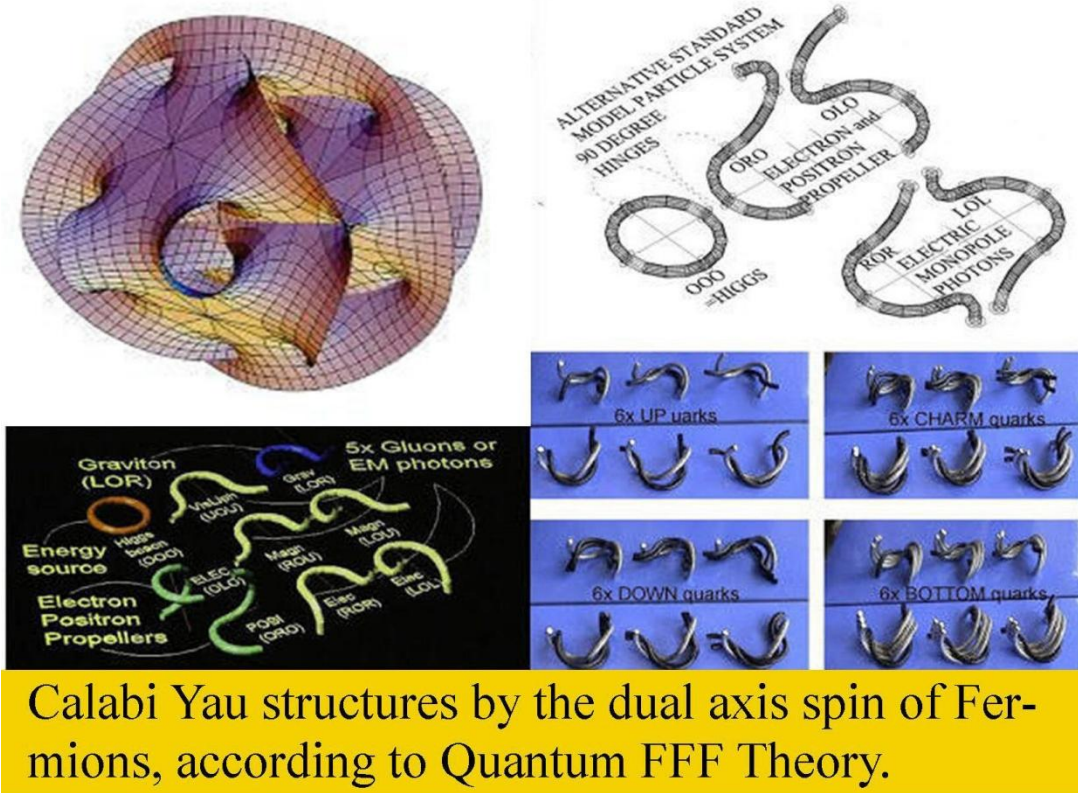

Figure: 6. Cog wheels, joints and hinges at the Quantum scale of spinning Fermion strings with double rotation axis forming Calabi Yau Manifolds.

Gravitating Crashed Comets in the earth

Just like gravitating sunspots the gravitating micro black hole based crashed comets (with internal new physics micro black holes) inside the earth are assumed to be positioned more or less around the equator. This is origin of the variable strength of the so called FLYBY anomaly.

Aligned Crashed Comets create a pencil shaped gravity beam and heating effect. Volcano and deep sea funnel activity should be related. According to Quantum FFF Theory.

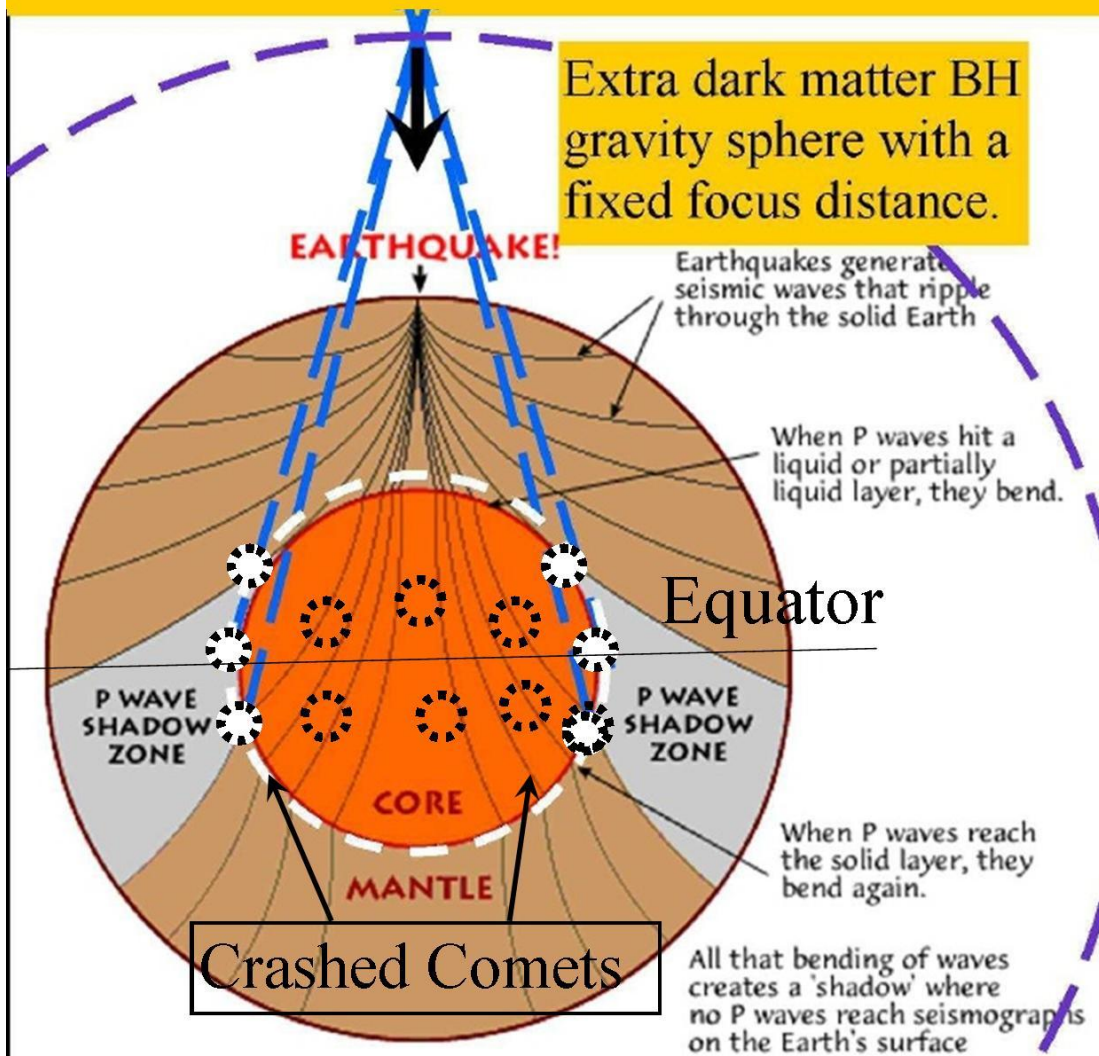

Figure: 7.

Just like gravitating sunspots the gravitating and heating micro black hole based crashed comets (with internal new physics micro black holes) inside the earth are assumed to be positioned more or less around the equator.

This is origin of the variable strength of the so called FLYBY anomaly.

Aligned Crashed Comets create a pencil shaped gravity beam and heating effect. Volcano and deep sea funnel activity should be related. According to Quantum FFF Theory.

Not only C,H,N,O,P is needed for DNA RNA molecules but also SULFUR and other elements from the earth interior, formed earlier in supernova explosions and buried inside planets.

Ingredients for life production C,H,N,O,P, by internal micro interference black holes according to QuantumFFF Theory.

Comet 67P CG

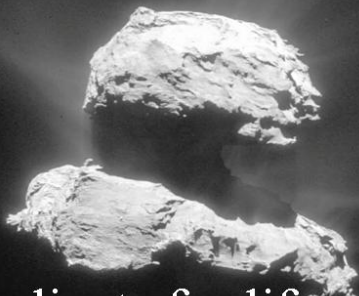

Ingredients for life production by internal micro interference black holes C,H,N,O,P

The measurements were made with the ROSINA mass spectrometer on board the comet lander.

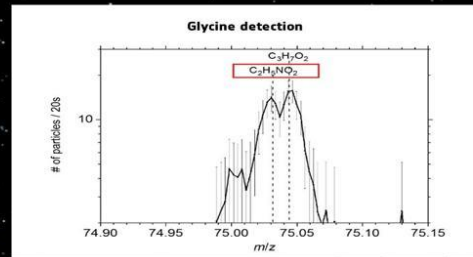

Spectrum indicating glycine [C₂H₅NO₂] detection on 9 July 2015. The simple amino acid glycine is a biologically important organic compound commonly found in proteins.

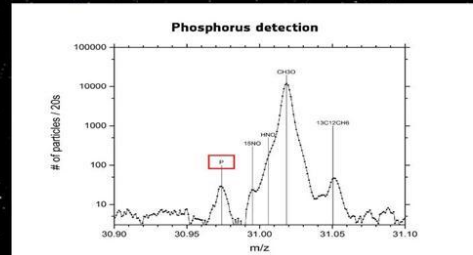

Spectrum indicating phosphorus [P] detection, along with other gases, on 26 October 2014. Phosphorus is a key element in all living organisms. It is found in DNA, RNA and in cell membranes, and it is used in transporting chemical energy within cells for metabolism.

Sulfur/ Iron (for mitochondrial iron-sulfur cluster biogenesis) is in addition needed out of the belly of the earth by a boiling process done by Comet based interference Black Holes.

Conclusion: Life on earth was created inside the seas.



Figure: 8.

Hydrogen production of Enceladus compared.

Not only C,H,N,O,P is needed for DNA RNA molecules but also SULFUR and other elements from the earth interior, formed earlier in supernova explosions and buried inside planets.

Ingredients for life production C,H,N,O,P, by internal micro interference black holes according to QuantumFFF Theory.

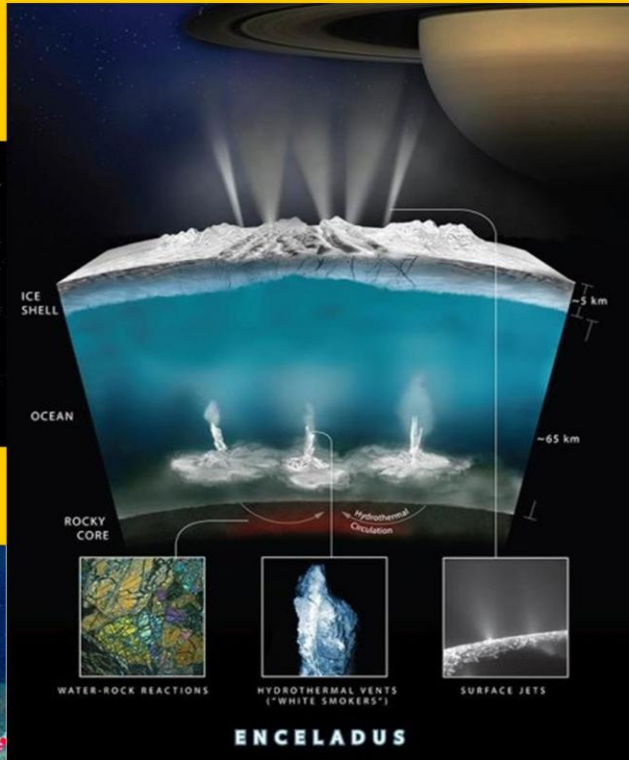
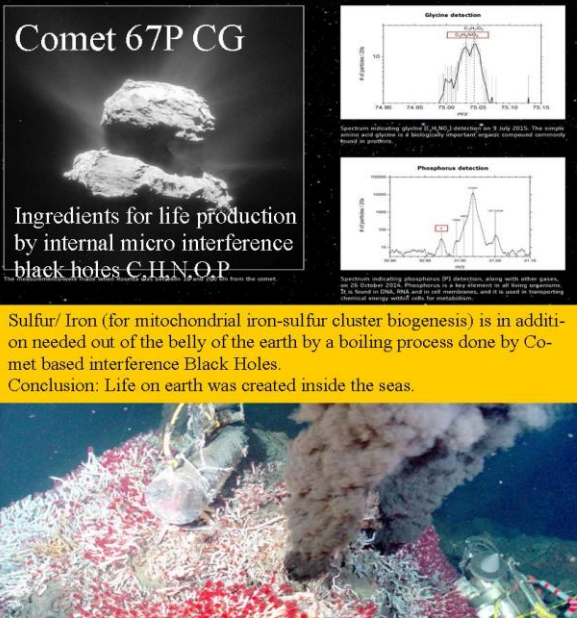
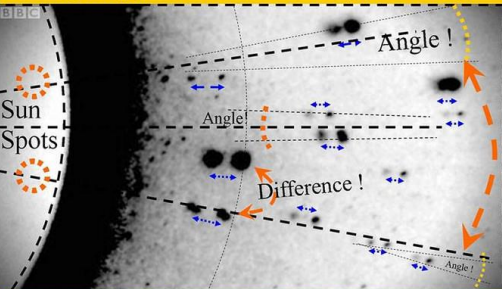

Figure: 9.

Sunspot gravity interference as the origin of Supernova ejection velocity differences simulated for massive stars.

Solar Lensing differences and Angle Shift

Solar gravitational lensing effect shows irregular differences in directions (see angle!) and displacements of background stars!!(see: difference!) Suggestion: there are different centres of gravity inside the sun by gravitational Sunspots! They seem to be the "new" black holes, as suggested by Quantum Function Follows Form Theory. (Author: Leo Vuyk)



"Angle Shift" and "Lensing Differences" explained by Solar pencil shaped gravity increase by aligned Sunspot black holes according to Quantum FFF Theory. See also: incidental local Earth effects.

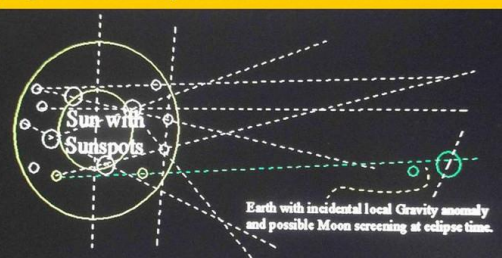

Below, example of velocity differences of Super Novas <http://arxiv.org/abs/1503.02199> THE THREE DIMENSIONAL EVOLUTION TO CORE COLLAPSE OF A MASSIVE STAR (simulation by S.M.Couch at al.)

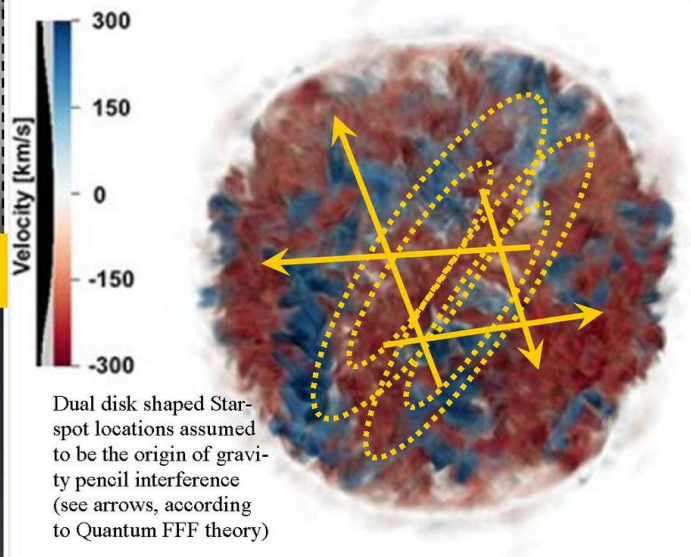

Figure: 10.



Figure 11, Impression of a micro interference black hole quantum knot based nucleus of the new paradigm Dark Matter Black Hole. The Quantum Knot is supposed to be compressed by the Dark Energy of the Axion/AH vacuum lattice attracted and absorbed by the nucleus. However black hole nuclei smaller than Comet- or Sunspot nuclei such as (Ball) Lightning are supposed to evaporate quickly due to the dark energy vacuum attack.

Dual pressure Quantum Gravity due to the oscillating massless Axion-Higgs chiral lattice vacuum, (dark energy) around material test masses (left) and around black hole nuclei. (right. BHs= stringy quantum knots= dark matter)

Quantum Gravity as pressure distribution of the oscillating dual Higgs/Graviton vector field. New Dark Matter Black Hole, “Eat” the chiral oscillating Higgs vacuum.(Quantum-FFF Theory)

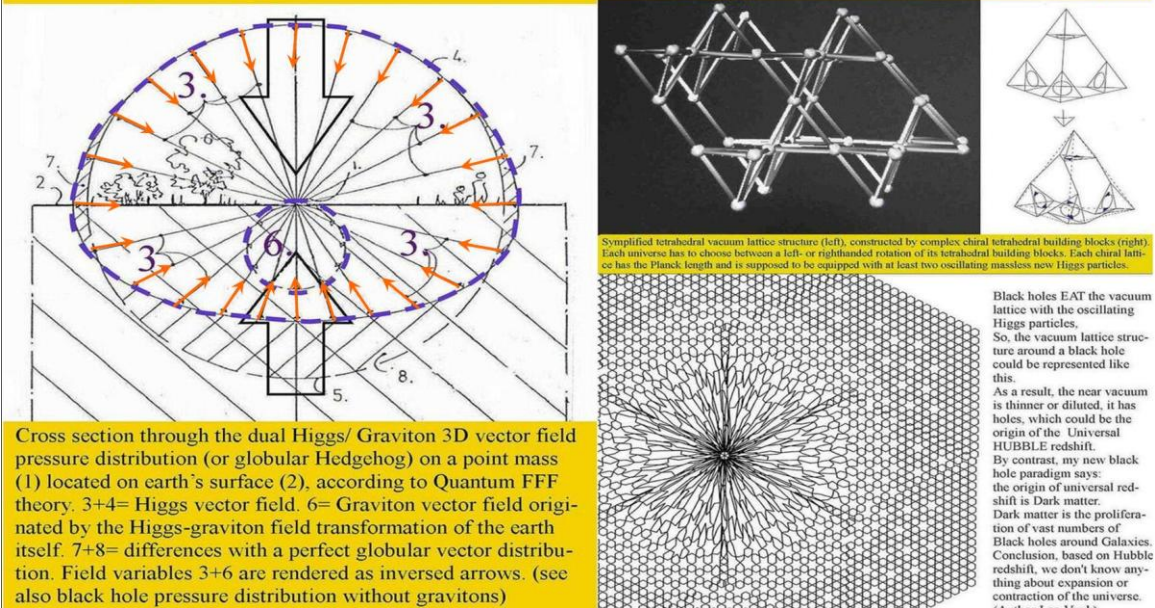

Figure: 12, The massless Axion-Higgs chiral vacuum based on dual oscillating Axion particles inside a a truncated tetrahedral Lattice.

Rigid String Quantum Knot suggestions for different configuration: 125-375-500-750-1600 GeV and More called dark matter black holes. (According to Quantum FFF Theory architecture)



125GeV+375gEv=500GeV And More

500GeV



375GeV+375gEv=750GeV

2x750GeV+125=1625GeV

Some suggested ring configurations

Figure: 13, variable configuration and assumed masses of Axion –Higgs quantum knots

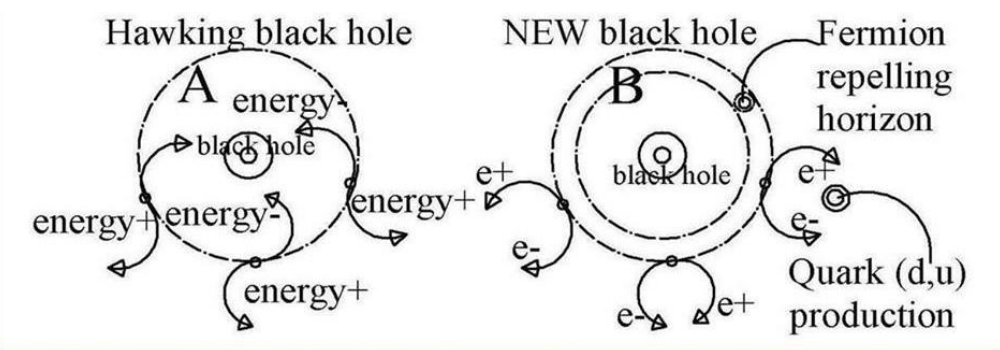

The NEW Black Hole is equipped with a Fermion repelling horizon. In addition Quantum Fluctuations produce twin Electron- Positron propeller shaped Fermion particles out of two convertible Higgsen. (See the 3D particle zoo of the theory) Quarks (d,u) are created by the “dressing up” these twins with Photon/Gluon particles. So BHs create simple plasma clouds like Bock Globules and plasma pillars in Nebula and Herbig Haro objects. (Author Leo Vuyk)

Figure 14, Quantum Fluctuations as the origin of pair production and Plasma creation (Quarks) around Dark Matter Black Holes.

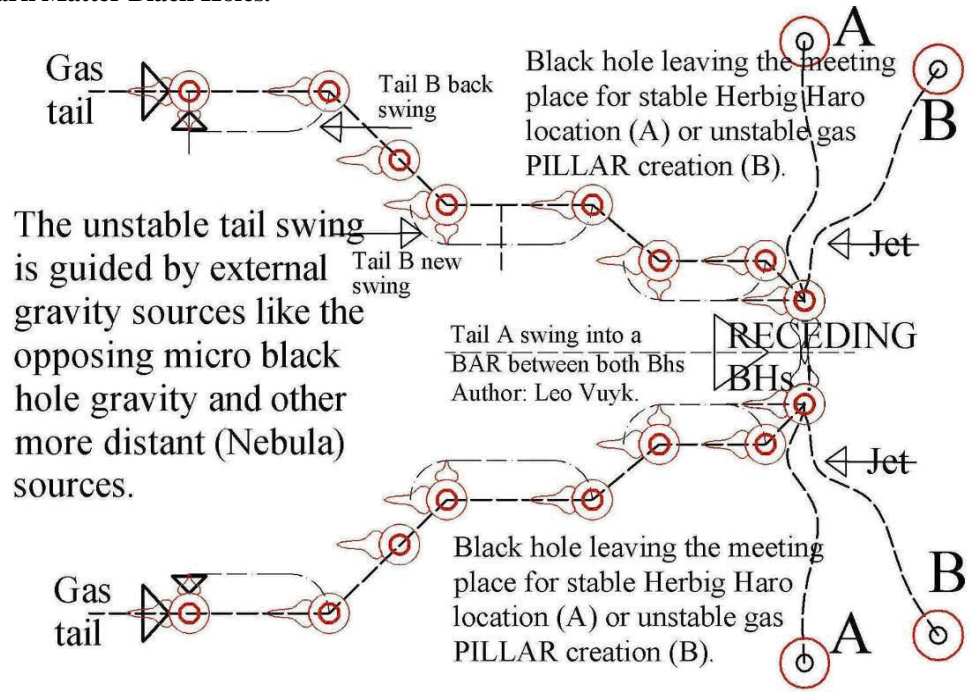

Figure 15, New Black hole propulsion principle by a self produced plasma-dust tail. As a consequence, New micro interference black holes do not merge to form larger nuclei, they even repel negative charged metal surfaces (observed by ball lightning) by their own exterior electron charge.

This Ball Lightning photo is an important piece of the new physics of Quantum FFF theory. It shows a self produced vapor trail washed out by the opposing wind of the massless BL nucleus, which seem to be pushed against the wind. Just as observed in multiple single- and pairing Black Hole examples in nebula like the Carina.

Ball lightning pushed by Plasma tail against the wind



Vapour trail washed out by the wind

Other examples of BLs with plasma tails



Figure: 16, Evidence for Plasma vapour and even energy production by an interference micro black hole such as ball lightning or earth bound micro Comet.

At the same time it seems a support for the new Black Hole paradigm (see first photo). The BL is propelled against the main wind direction because it left a vapour trail behind and the vapour trail is “washed out” by the wind showing “feathers” of gas.

Ball Lightnings DENY and violate the second law of thermodynamics and are examples of entropy decrease and even plasma creation around black holes..

Birkeland/ Alfvén circuit currents around stars and galaxies, are driven by new paradigm tandem black holes, producing an external excess of negative charged plasma accelerated by the Casimir polarized vacuum (or Higgs polarized oscillations, according to Q-FFF Theory)

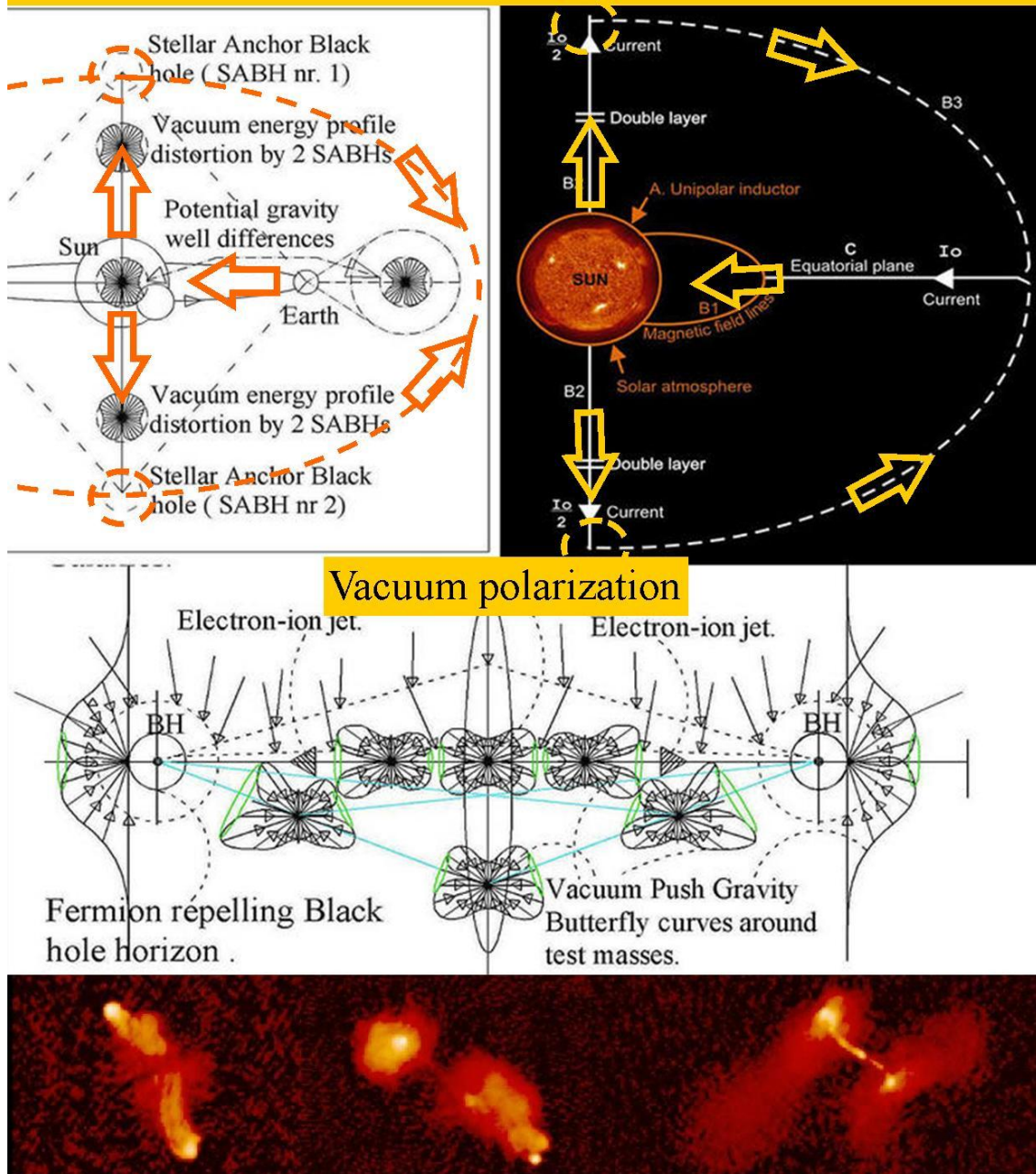
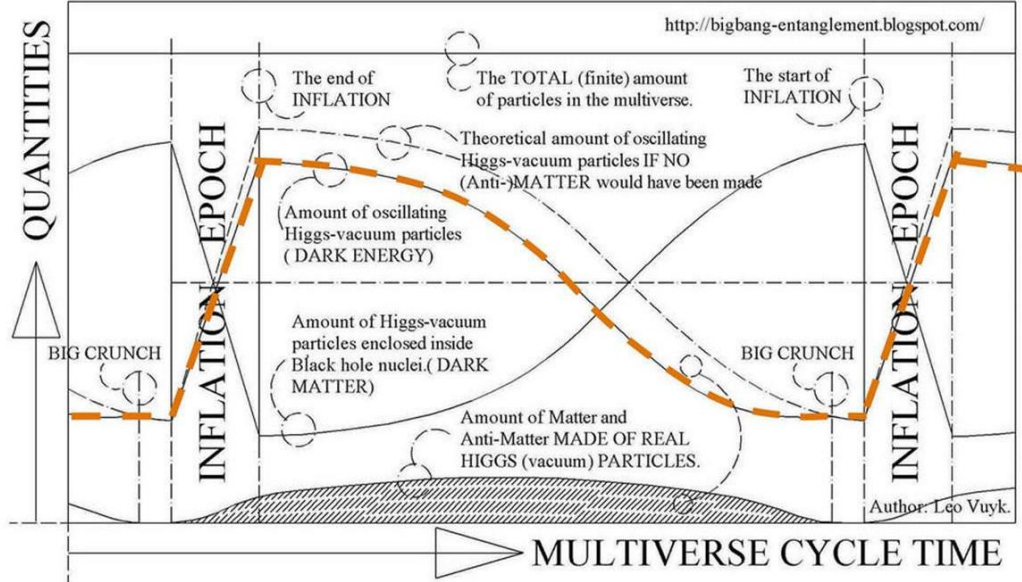

Figure: 17, Black hole propulsion and pairing principle of fig 15, seems to be the origin of dual Stellar or galaxy Anchor black holes (see figure 19) and even so called Birkeland /Alfvén current circuits around stars and galaxies by vacuum polarization. The energetic polarized vacuum oscillation spectrum is the motor for fast gas and electron transport starting direct after the big bang.

The CPT SYMMETRIC MULTIVERSE CYCLE.

The Inflation epoch starts if the decreasing vacuum pressure equals the increasing Higgs tension of the Big Crunch black hole nucleus. Inflation epoch ends if all splintered black hole nuclei are evaporated, or left behind as Galaxy Anchor Black Holes.



The Pulsating Multiverse depicted as a continuous flow of increasing and decreasing numbers free oscillating- and Black hole condensed Higgs particles and the amount of Quarks and leptons. The size of the pulsating multiverse vacuum is given in orange.

Figure: 18. Abundant Black Holes observed in the early universe by the CIB and CXB of Chandra and Spitzer space telescopes (2013). A strong support for the Quantum FFF theory based Black Hole splitting Big Bang and contracting Big Crunch Cycle of the Multiverse

The great misconception in Astronomy:

Herbig Haro Bowshocks and Cometary Globules, are not interpreted as Dark Matter Black Holes. See below: Bok- and Cometary Globules with young Herbig Haro Bowshocks in the making in the Carina nebula.

Splitting and pairing electric dark matter black holes. Magic self-propelling in space and even on earth according to Quantum FFF theory.

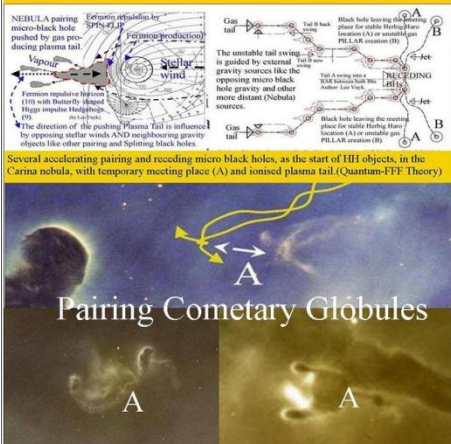

The pairing and splitting of Electric Dark Matter Black Holes into dual Herbig Haro bowshocks, as the fast creation and proliferation of Stars and galaxies after the splitting bigbang.

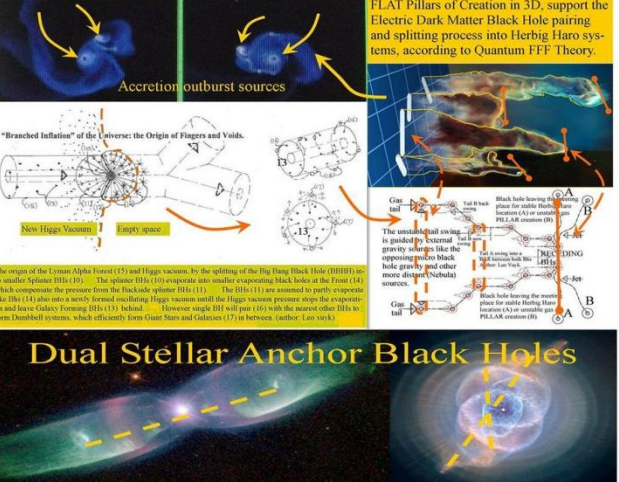

Figure: 19, The great misconception in astronomy and astrophysics.

Characteristics of Quantum FFF Theory.

1: The clear MICROSTRUCTURE or the 3D FORM of elementary particles, (also called 3D-Axions) made out of convertible Higgs particles, is responsible for “Bound states of Fermions” and composite Quarks. (ref. 4)

2: The massless Axion/Higgs is supposed to be energetic oscillating, it is the origin of all particle motion and spin states and Dark energy inside a truncated tetrahedron shaped chiral vacuum lattice. The lattice chirality (right handed) is the origin of our material universe. Higgs particles are zero point “Planck Oscillators” the origin of the Casimir force, waiting to be harnessed as free energy.

3: Nothing sucks in the new physics of Quantum FFF Theory.

Gravitons act counter intuitive with less pressure on Fermions than the AH vacuum (dark energy) and all particles and vacuum photonic information (radiation) is ENTANGLED by INSTANT communication between at least two anti-copy UNIVERSES or MULTIVERSE, being entangled since the big bang. (ref. 7)

4: Black holes of all sizes (down to ball lightning) do not emit gravitons, they feel only Casimir Gravity of the vacuum oscillations so they are massless but counter intuitively the origin of dark matter and producers of all Hydrogen by Electron and Positron pairs as horizon fluctuations and repel all Fermions even positrons at the double BH horizon. (ref. 9,10,11)

5: Black Holes are supposed to have a negative electron based surface charge in a material based universe and a positive charge inside an ANTI-material universe, due to the chirality (left or right handed vacuum lattice spiralling) of the oscillating dark energy AH vacuum. (ref. 27,28).

6: The Multiverse is Pulsating by two phenomena, A; vacuum (Higgs) eating new paradigm dark matter black holes (causing the Hubble redshift) and B: by universal expansion caused by the oscillation force (Dark energy) of the AH vacuum lattice. (ref: 33)

FUNCTION FOLLOWS FORM in Quantum FFF-Theory. The Microstructure of elementary particles, is supposed to be the origin of FUNCTIONAL differences between Higgs- Photon- and propeller shaped Fermion particles. Something SMALL is missing in mainstream physics: a NEW splitting and pairing MASSLESS BLACK HOLE, the origin of all dark matter, Ball Lightning Micro Comets , Comets, Sunspots up to Galaxy external Anchor Black Holes and the Big Crunch of the CP symmetric pulsating raspberry shaped multiverse.

The multiverse is a collection of huge entangled pinball machines, with dark energy in the form of linear oscillating double Higgs pins as the origin of photonic collision products with the propeller shaped Fermions running and spinning as balls.

All forces are the result of this entangled Pin-Ball interaction. The 126GeV Boson recently found in the LHC is not supposed to be a single but a double massless Higgs boson linear oscillating in tandem as opposing boxer engine pistons in a chiral truncated tetrahedron lattice.

The 126GeV energy is the base for universal dark energy, the frequency is the base for local time and the length a base for the Planck scale. (Twin Higgs, Dual Higgs, Duplex Higgs, or Tandem Higgs).

AS A RESULT, Free energy devices and electron-muon decay levitation is proposed. An unstable AH vacuum seems to be present around all black hole horizons by observed H₂ production and annihilation radiation created by pair production of positrons and electrons. (Instability of the AH field)

The main difference with mainstream physics is in short as follows:

A: That a "black hole" has no mass- it does not emit gravitons-, but is the origin of all "dark matter" in the universe and can exist at all scales from Quantum Knots (or Ball lightning) up to Comets, Sunspots, external Galaxy Anchor Black Holes, up to the Big Crunch- or Big Bang Black Hole.

B: That "dark energy" is based on microcopic massless vacuum (non SM) Higgs particles, energetic oscillating in opposing pairs and able to convert into pairs of electrons and positrons, e.g. at the horizon of black holes.

C: That the 126 GeV mass of the Higgs particle (found by the LHC in Geneva) could be translated into 126 GeV energy of the paired vacuum particles. (alternative non SM Higgs) (And is consequently supposed to be the first sign of "DARK ENERGY") The LHC found a first sign of Dark Energy!!

D: That as a result, the Universe is cyclic, super symmetric and has the form of a raspberry shaped pulsating symmetric Multiverse with finite cycle time.

E: That all matter and humans have their instant entangled copy symmetric counterpart living inside the opposing super symmetric lobes of the raspberry multiverse. which is supposed to be the base for consciousness.

F: That Humans have the ability to influence conscious acts by a small retardation or lagging effect (300 m.sec) in decision making. This lagging effect phenomenon is already found and described for humans by Benjamin Libet, called RPI and RPII (Readiness Potential 1 and 2) see: "Wavefunction Collapse and Human Choice-Making Inside an Entangled Mirror Symmetrical Multiverse." (Ref. 6,43.)

Dual opposite Pressure Vector Diagrams for all attraction and repulsion forces.

Alternative Feynman dual vector diagrams between Axion=Higgs (OOO) and all other photon information vectors like (UOU,ROU,LOU,ROR,and LOL) According to the Quantum Function Follows Form model.

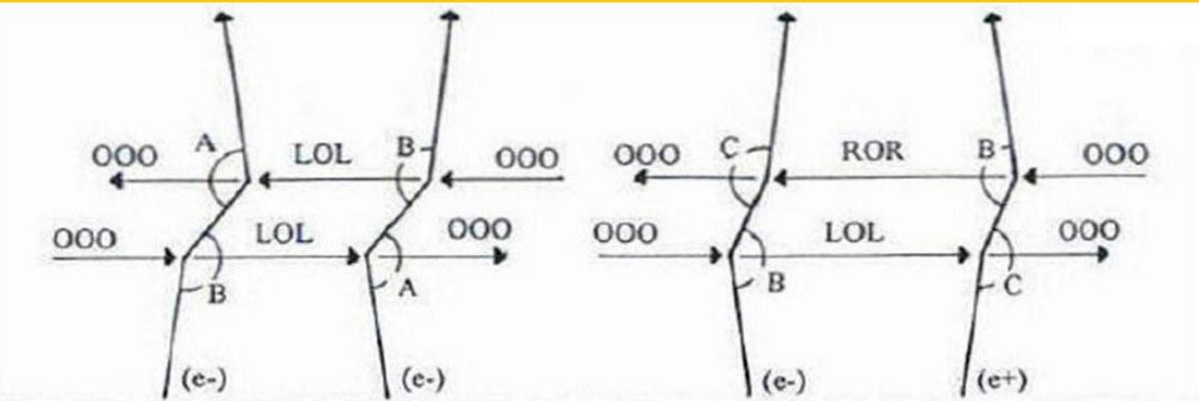

(Above) Alternative Feynman diagrams for electron-positron attraction and electron-electron repulsion by Dipole Repeller system.

Explanation of the codes:
 U= Up rotation (180 degrees)
 O= Unchanged circle.
 L= Left rotation (90 degrees)
 R= Right rotation (90 degrees)

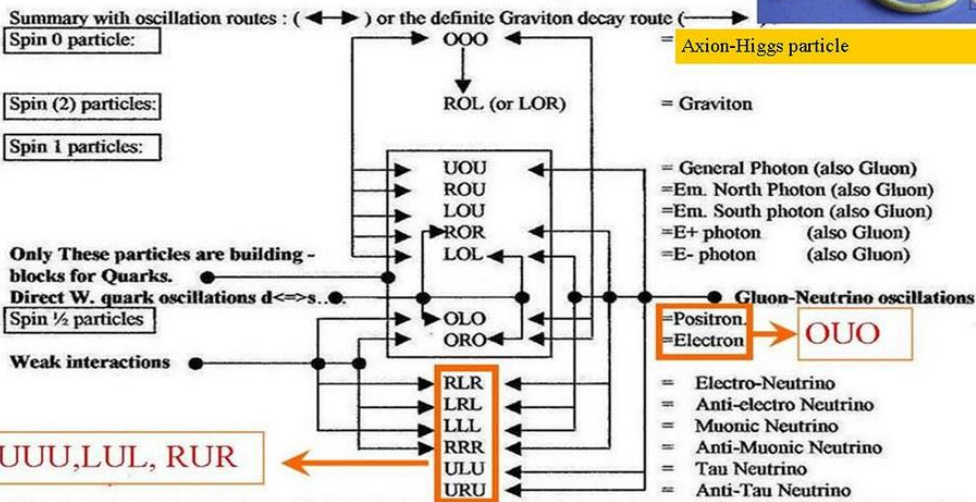
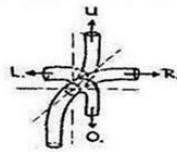

Higgs particles are supposed to oscillate in Tandem along so called linear Vacuum Lattices, two by two in opposite directions, as the symmetrical opposite pistons of a boxer engine, as the origin of all energy, spin and mass effects. This enables the Tandem Higgs particles to change the form of their own Torus into an Electron and Positron pair at

Figure 20, Alternative Feynman diagrams presenting all forces in nature. In combination with the particle zoo of single ELEMENTARY particles made out of ONE convertible Torus shaped Axion/ Higgs particle, equipped with three hinges of 90 degree rotation.

Quantum Function Follows Form Model

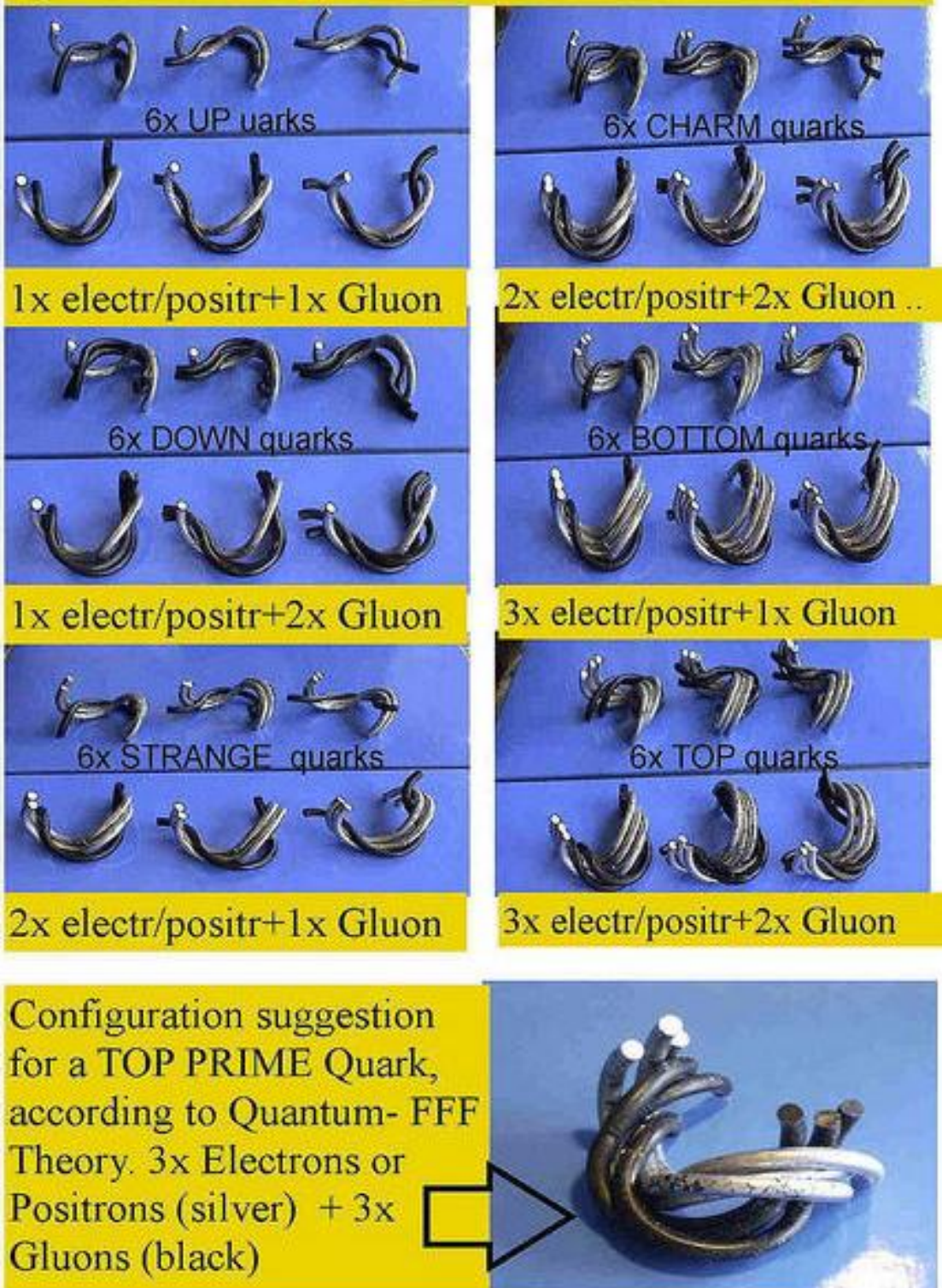
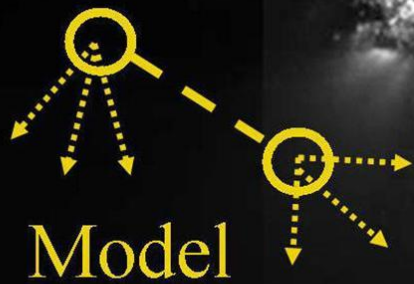

Figure 21, 5x different shaped Photon/Gluons can combine with the two propeller shapes of the Electron and Positron to form all coloured (QCD) Quarks and even a so called Top Prime Quark. The Muon and Tau particle are supposed to be the same as the Down quark, respectively the Charm quark.

Dual Nuclear Comets explained by new black hole physics of Quantum FFF theory. (Internal heating and H₂O production by two paired dark matter black holes)



New black hole physics seems to be present in dual nuclear comets like Hartley2 (above) and the 67P recently visited by the Rosetta probe. See photo below : (aug 2014) One important signal for internal heating is the surface temperature of 20.degr.C above calculation.



Figure 22: Dumbbell shaped Comets, 25 Hartley and Comet 67P C-G.

Dumbbell shaped Comets producing Hydroxyl and water ice by the internal dual Dark Matter Knots or micro black holes according to Q-FFF Theory.

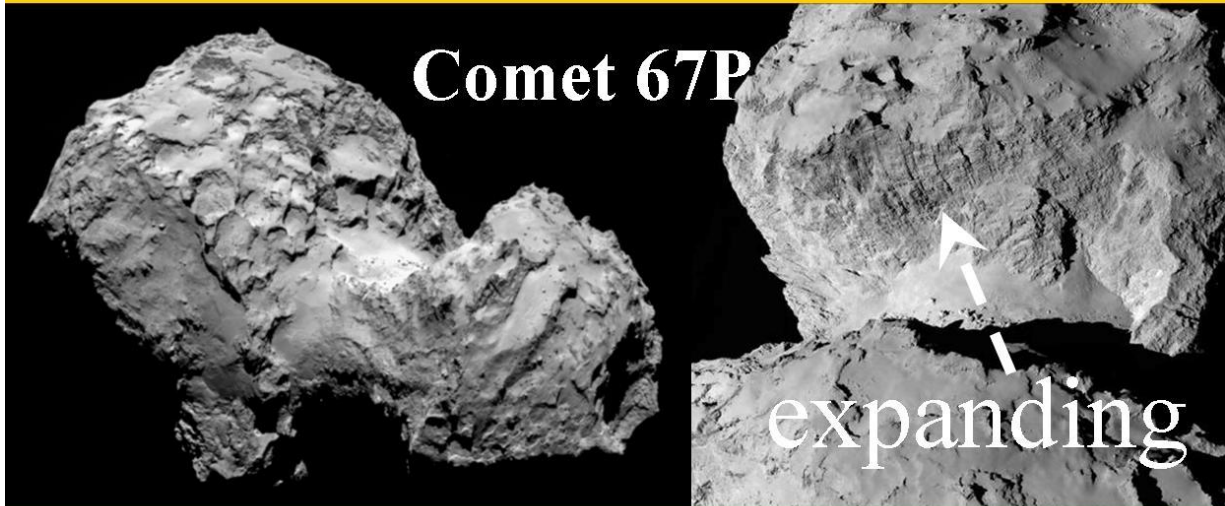

Quantum FFF theory assumes that micro dark matter black holes are the ZPE energy sources producing Hydroxyl (OH) and water ice nuclei of Comets, direct out of the Higgs field vacuum by “pair production” with a minimal annihilation effect into protons and electrons. TWO energy sources seem to be able to coexist and form exotic dumbbell comet nuclei with linear ice depressions as evidence for the expanding but also evaporating ice nucleus.

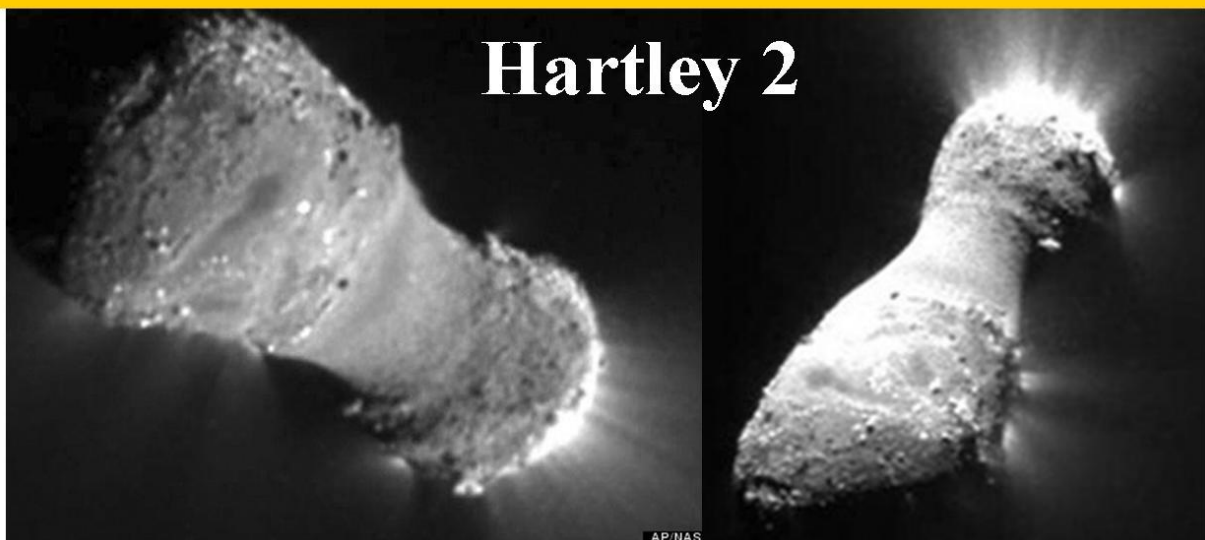
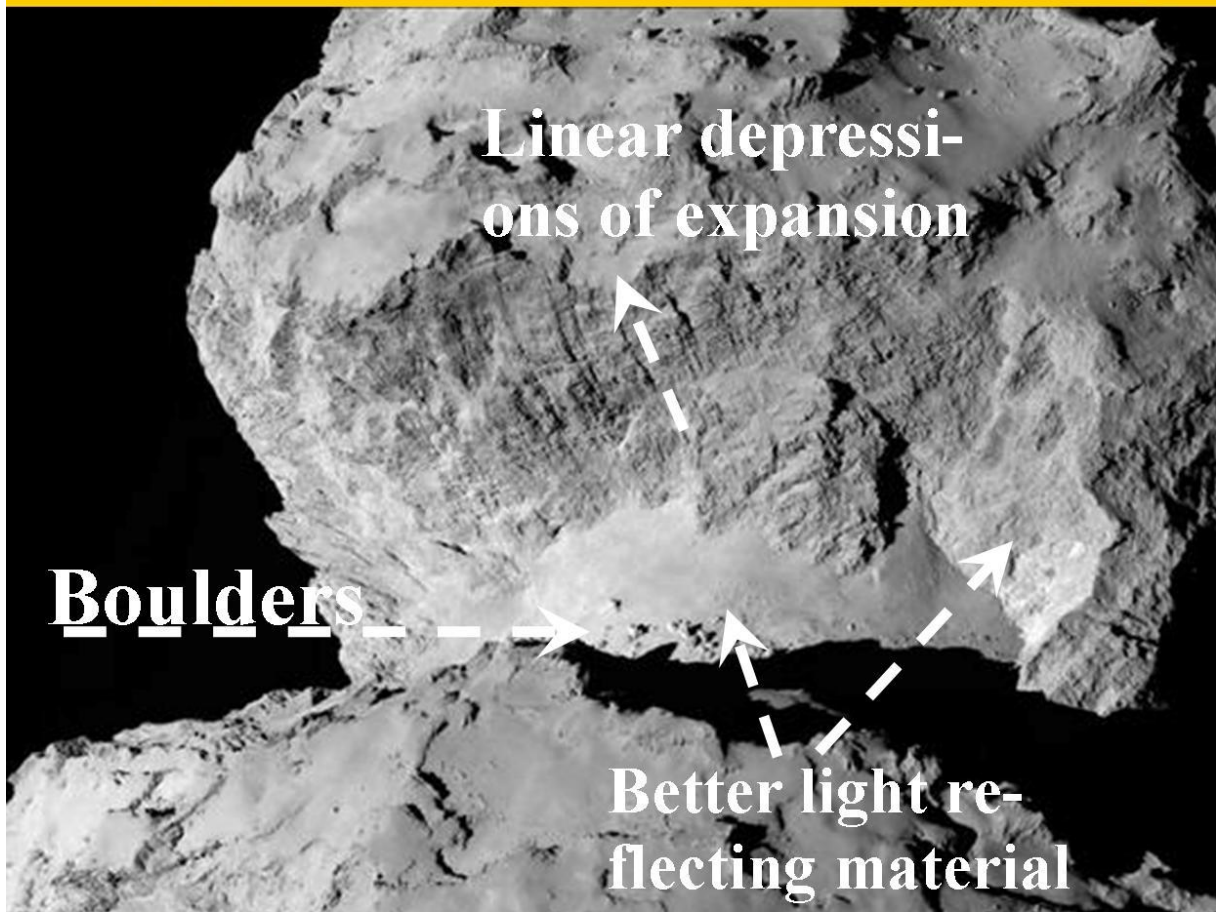

Figure: 23, both comets more in detail.

Comet 67P shows details of a new theoretical physics model, (Quantum FFF Theory)



Electrical model of a NEW physics dual dark matter black hole system with H O production of Dumbbell Comets.

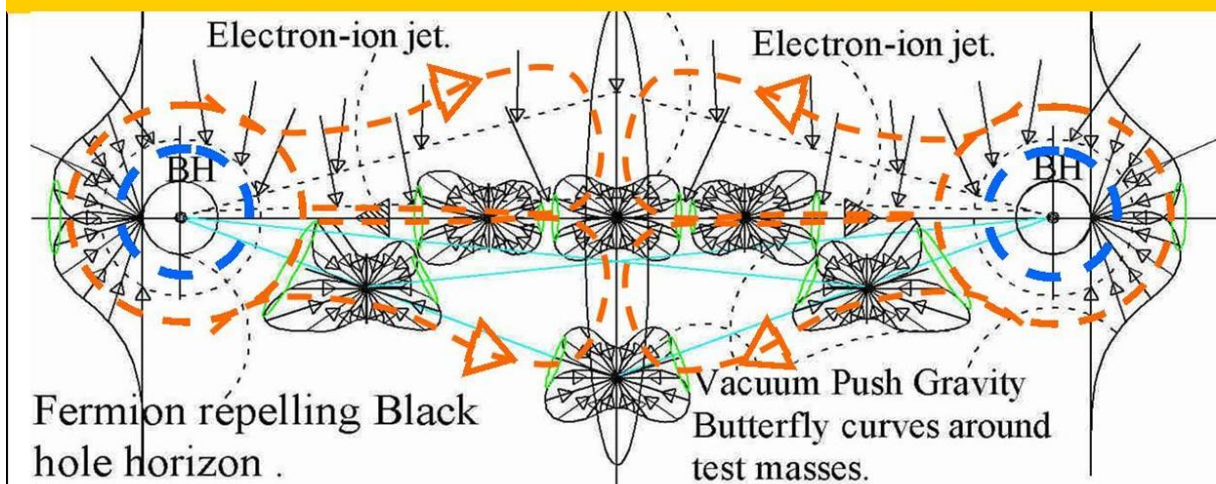
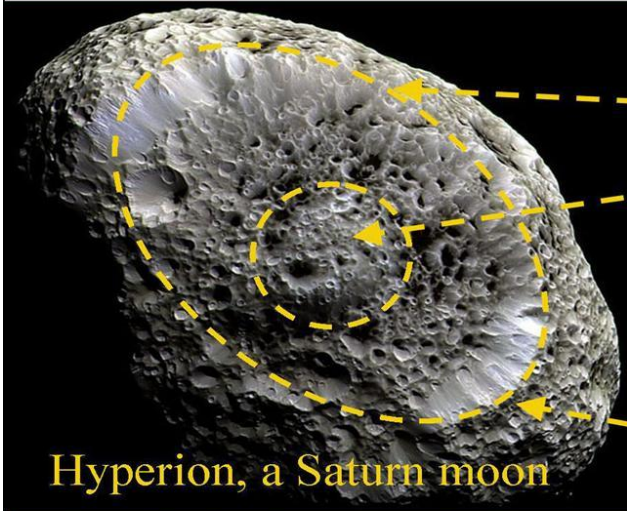
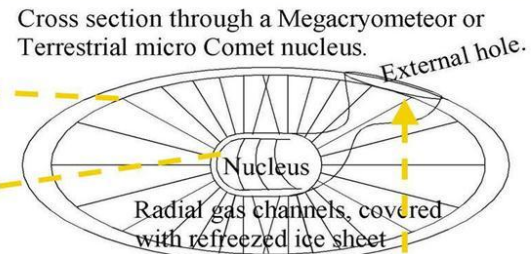

Figure: 24, Comet 67P C-G, with electrical model of the dual dark matter black hole system with O H Hydroxyl and water ice production.

Electric Dark Matter Black Hole Comets and Icy remnants (e.g. Hyperion)



Hyperion, a Saturn moon



Expected ice structure of the ellipsoidal ice chunk (Megacryometeor) found by J.M.Frais (Madrid). According to Quantum FFF theory this chunk should be the Nucleus of a Terrestrial Micro Comet, produced by a new paradigm black hole, which left the nucleus through the external hole, in consonance with the ice structure of the Hyperion moon. (author Leo Vuyk)

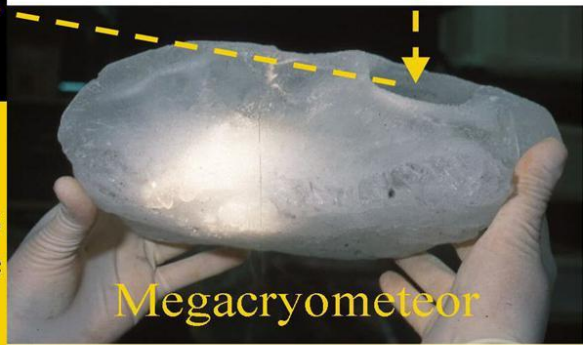

Megacryometeor

The relation between the Hyperion ice structure and the structure of a Megacryometeor as the result of Micro Black hole ice production inside both nuclei.

According to Quantum FFF Theory, even Nano interference Black Holes have a radial structured electric potential horizon layer (internal positive-protons and external negative electrons charged). They produce H₂ and water leading to the icy nuclei of Comets, Ball Lightning and Megacryometeors. The origin: a Fermion repulsion horizon of the black hole, see below.

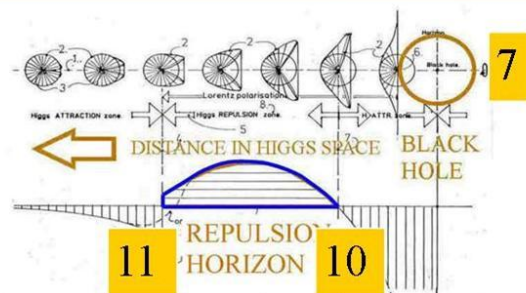
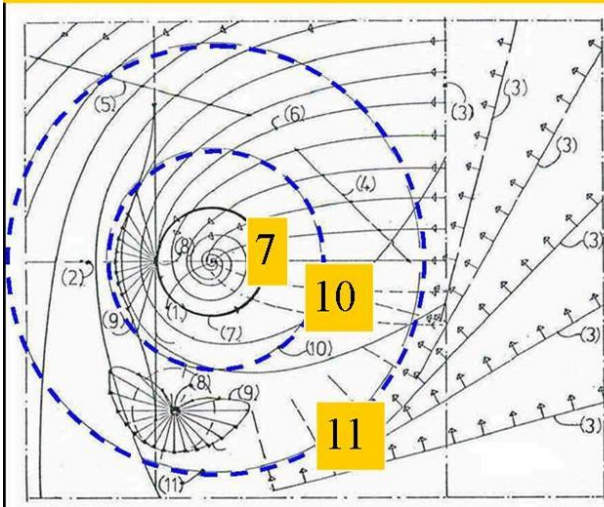

7x Higgs quantum curves (2) are depicted for Fermions (3) with different distance to the BH. At location (10) the spin of the fermions will FLIP to the propeller shape of the Fermion and an opposing force away from the horizon is created by the Higgs vacuum itself down to location (7). The zone between (7) and (10)

Figure: 25.. Fermion repulsion principle around dark matter black holes producing water ice Comets Megacryometeors. A special example of nuclear water ice production is found in the Moon Hyperion, which is assumed to be a former Comet, left alone by its Black Hole energy source.

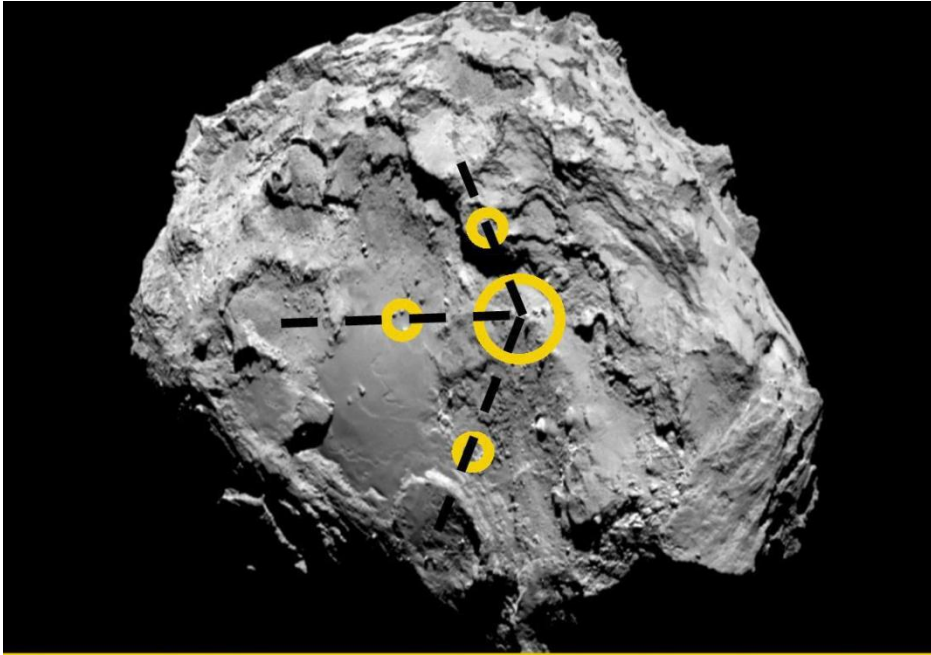

Comet 67P Craters originated by aligned gravity point sources according to Quantum FFF Theory.

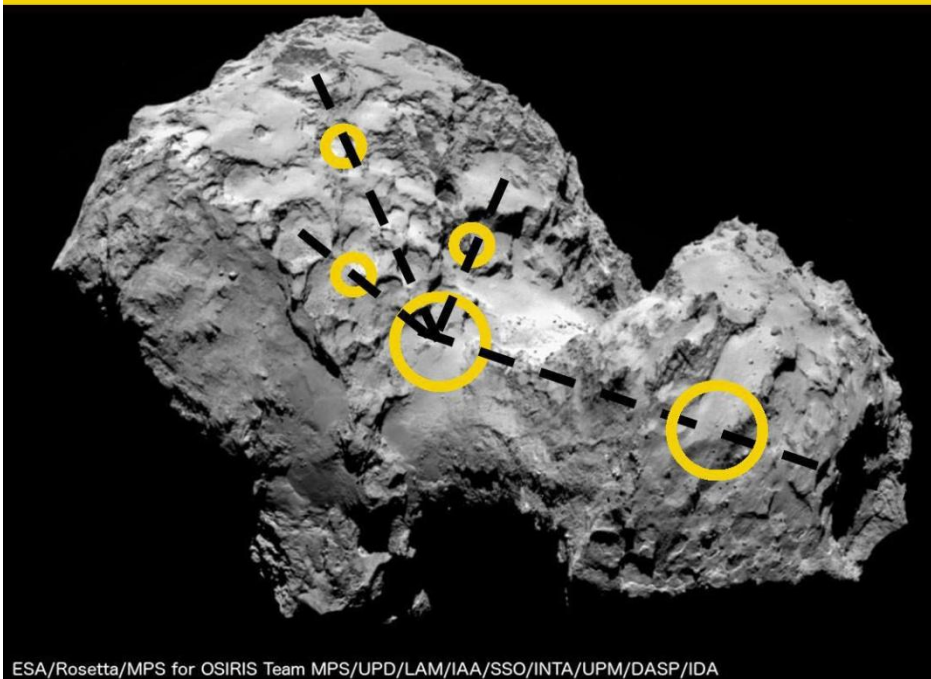

ESA/Rosetta/MPS for OSIRIS Team MPS/UPD/LAM/IAA/SSO/INTA/UPM/DASP/IDA

Figure: 26, Proposal for the origin of circular craters at Comet 67p C-G.

If we assume that all circular craters at the surface of comet 67P are originated by two aligned gravitating new physics fermion repelling micro black holes (BH), then we may get an impression of the inner BH structure of the comet responsible for the shape. I assume that the basic dumbbell form of the comet is realized by two larger BHs surrounded by several smaller BHs. .

The craters and so called trenches are a logic result of eclipsing BHs (see intermitted black lines), which are concentrated in the body of the ducky located around the central main BH. (indicated by yellow rings in the image above.)

www.flickr.com/photos/93308747@N05/?details=1

What can we learn from the Shoemaker Levy Comet 9 destruction into multiple energy point sources, about Comet 67P C-G craters? That the Quantum FFF Theory for crater formation at 67P, is in harmony. Conclusion: Comets are aggregations of multiple energetic dark matter point sources, coined new paradigm interference Black holes. The different sizes of Comets (see image) is an indication that Comets seem to grow by merging with other comets, based on one-two- or multiple dark matter point sources. However these point sources does not merge into bigger ones, but stay clear as individuals, probably each produced by strong solar flare interference (Q-FFF Theory) called solar bright spots (see image 155) fireballs.

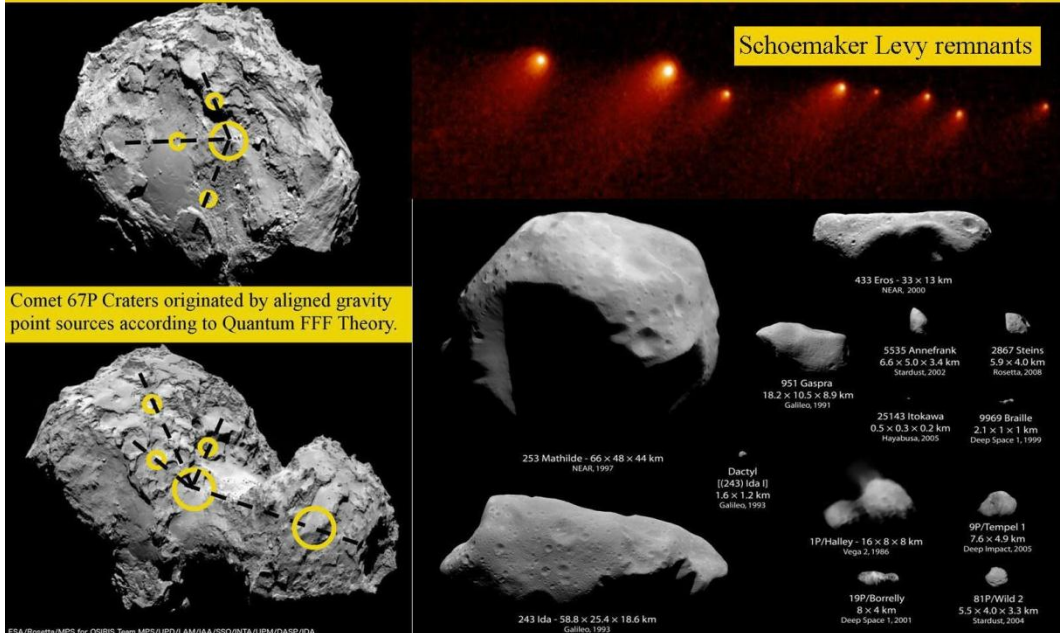

Figure 27, What can we learn about multiple nuclear comets?

Central growth of single nuclear Comets and Coral. Comparison Hyperion, a moon of Saturn but assumed to be a former Comet, left alone by its dark matter black hole nucleus (Diameter about 300 km) with a Coral structure. (Right image, diameter a few mm). According to Quantum FFF Theory.

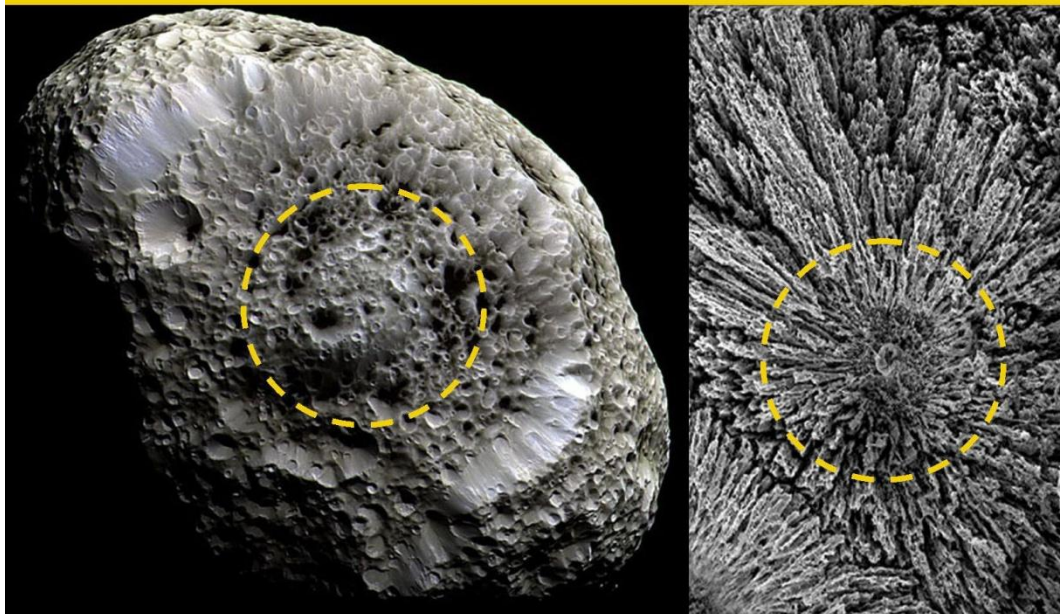
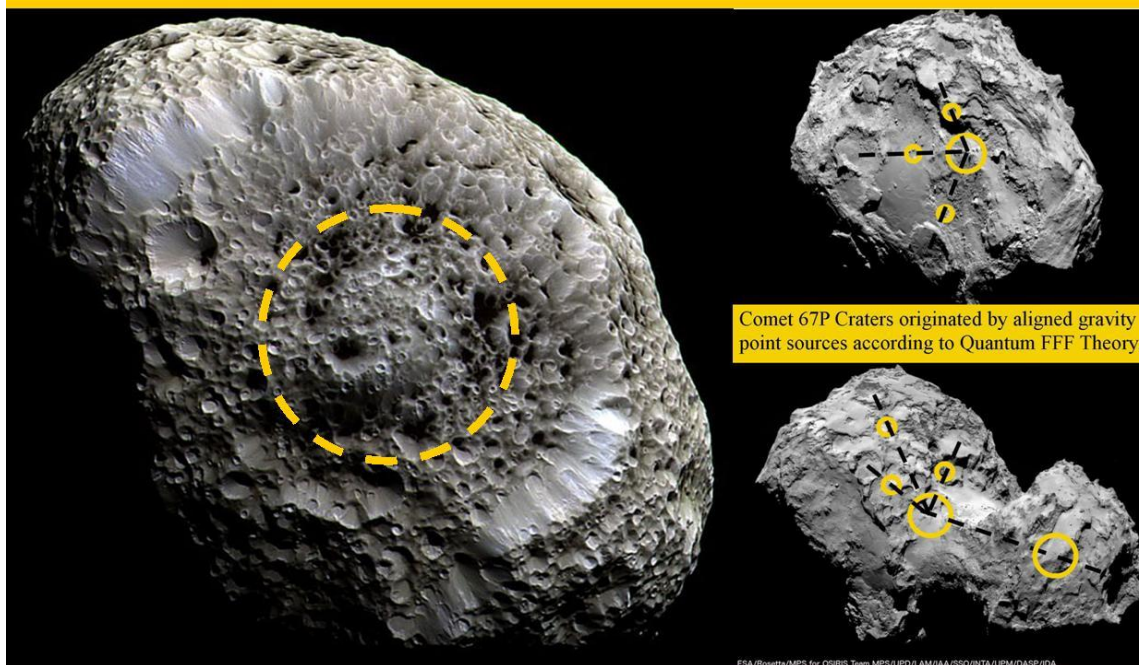

Figure 28, Hyperion , a former Comet.

The central Comet creation of matter (H, O, C and N) as the the origin of funnel tectonics at the Comet surface and internal sponge structure by new physics dark matter black holes.

Comparison Hyperion (a former Comet) with Comet 67P-CG.



According to Quantum FFF Theory, Hyperion (Saturn's moon) is a former icy Comet left alone by its SINGULAR central Dark Matter Black Hole point source. Comet 67P C-G however, is an example of a multi nuclear Comet, with two major nuclei and several smaller nuclei. As a consequence of multiple nuclei, Comet 67P-CG shows a much more rough surface (with craters, trenches and peaks) created by ice production from the inside point sources. The point source remnants of the exploded Comet Shoemaker-Levy, are a clear sign of multiple nuclear Comets.



Figure 29, Hyperion a single nuclear comet, in contrast with Shoemaker Levi multiple nuclear comet.

Sharp mountain peaks!

NOT by EROSION but by plate tectonics pushed from the inside .

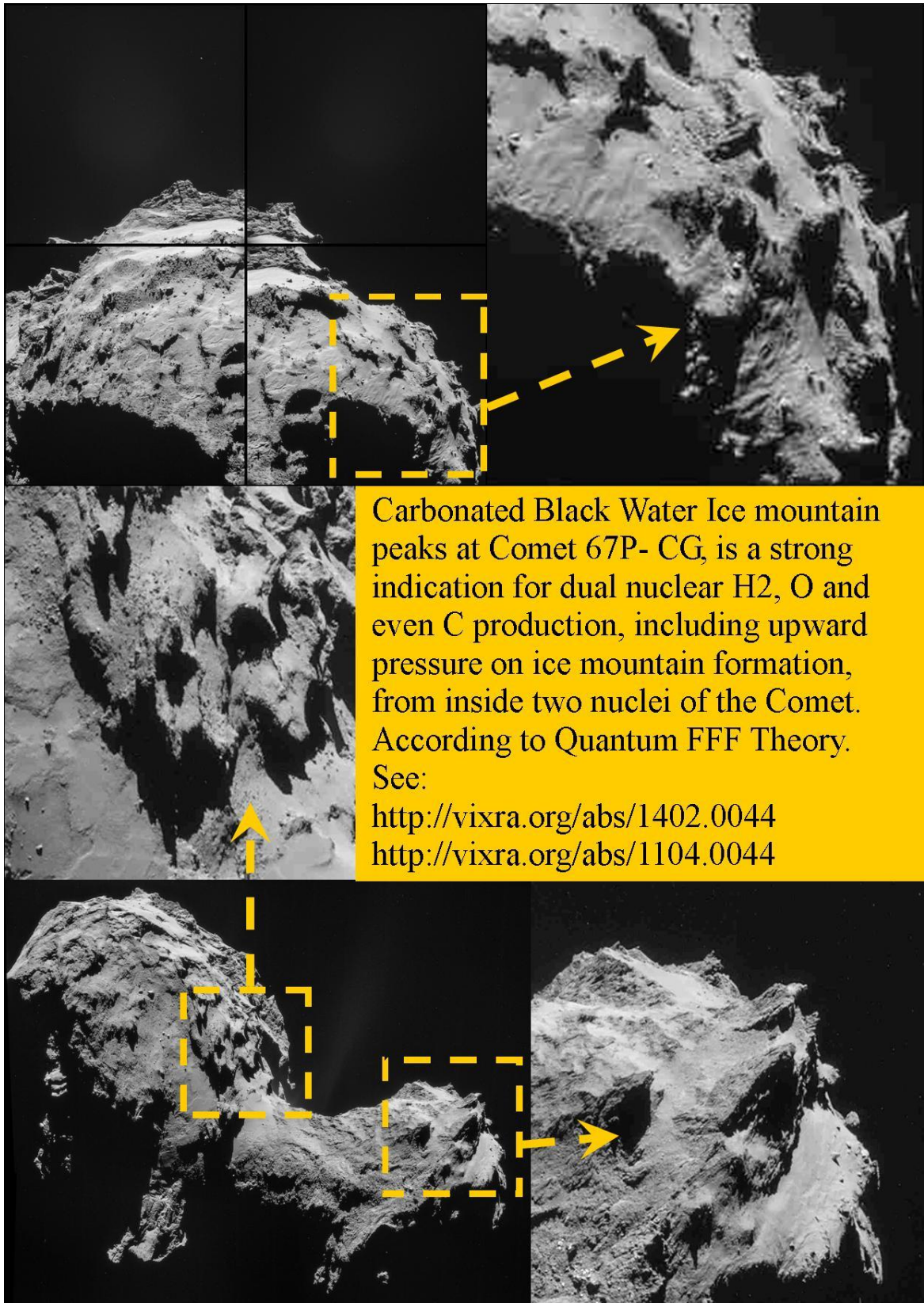
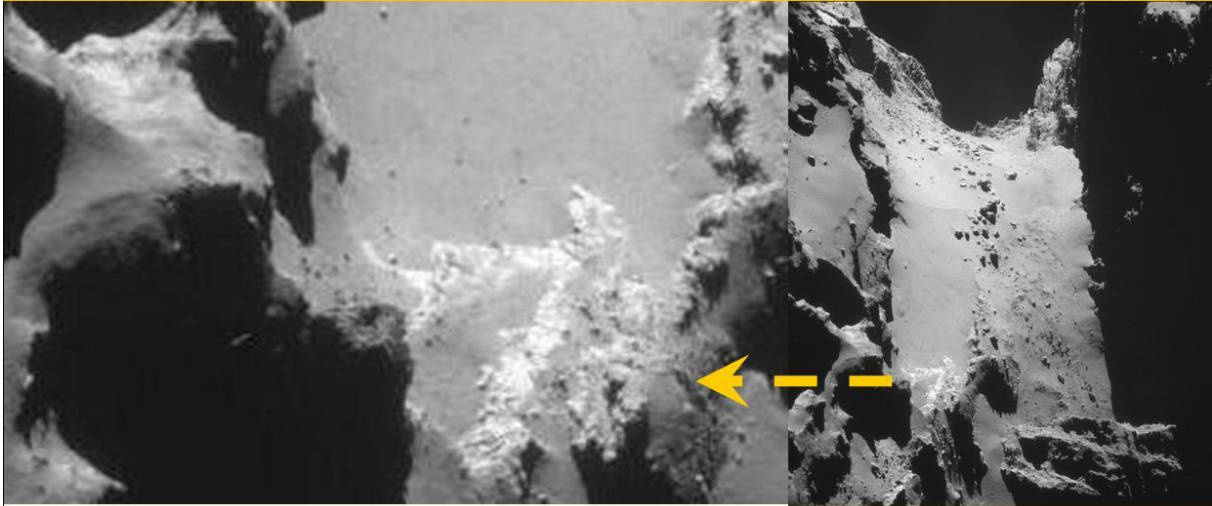

Figure 30,
NOT EROSION but Plate tectonics driven by the nuclear matter production of new paradigm dark matter black holes.

Increased Light reflection areas at comet 67P CG, due to Carbon dust surface layer cracks originated by funnel pressure tectonics.



According to Quantum FFFTheory, Comet 67P C-G has an internal Hyperion/ Coral funnel structure (volcano alike, see below) in combination with Central dust production (H₂, O, C and even N) As a consequence, 67P shows a rough surface (with craters, trenches and peaks) continuously deformed and created by the dust production from the inside point sources.

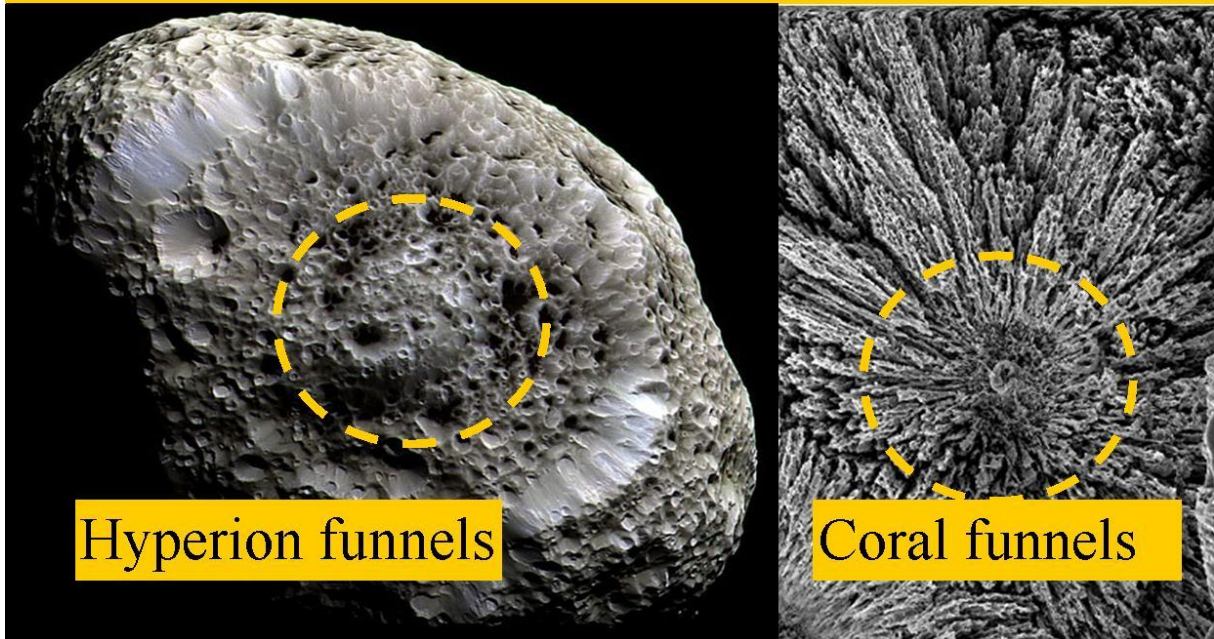
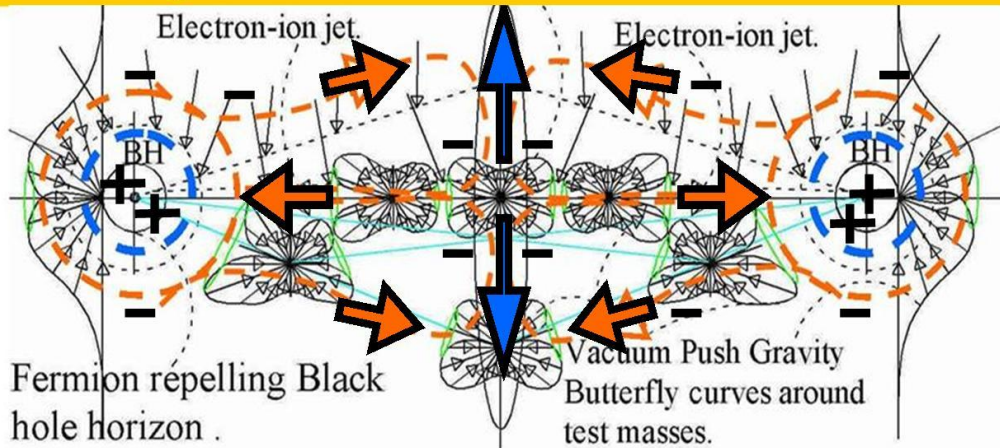

Figure , 31. Cracks in the Carbon dust layer.

Increased Light reflection areas at comet 67P CG, due to Carbon dust surface layer cracks originated by funnel pressure tectonics.

Birkeland Alfven current circuits of negative charged ions and electrons, between (New Physics) Dark Matter Black Hole nuclear charge splitters, will be found inside dumbbell shaped Comets like 67P C-G, also in Herbig Haro systems, Galaxies and even stellar systems (e.g. Eta Carina), according to Quantum FFF Theory.



Two Charge splitting new physics black holes are supposed to polarize the local oscillating Higgs field as the origin of negative charged Birkeland Alfven current circuits (Orange arrows) As a consequence jets of dust (Blue arrows) are observed from the “neck” of 67P and the neck of Eta Carina. (below)



Figure 32, Two Charge splitting new physics black holes are supposed to polarize the local oscillating AH field as the origin of negative charged Birkeland Alfven current circuits (Orange arrows) As a consequence jets of dust (Blue arrows) are observed from the “neck” of 67P and the neck of Eta Carina. (below)

Birkeland Alfven current circuits of negative charged ions and electrons, between (New Physics) Dark Matter Black Hole nuclear charge splitters, will be found inside dumbbell shaped Comets like 67P C-G, also in Herbig Haro systems, Galaxies and even stellar systems (e.g. Eta Carina), according to Quantum FFF Theory.

According to Quantum FFF Theory, Comet 67P C-G has an internal Hyperion/ Coral funnel structure (volcano alike, see below) in combination with Central dust production (H₂, O, C

and even N) As a consequence, 67P shows a rough surface (with craters, trenches and peaks) continuously deformed and created by the dust production from the inside point sources. The Birkeland Alfvén current circuits seem to be the origin of pinching the AH field around the “neck” of the comet, which is assumed to be the origin of peculiar dust jets coming from the neck of comet 67P.

Criss Cross Scratches at (water ice) rocky Comet 67P CG. by plate tectonic motion and internal growth?

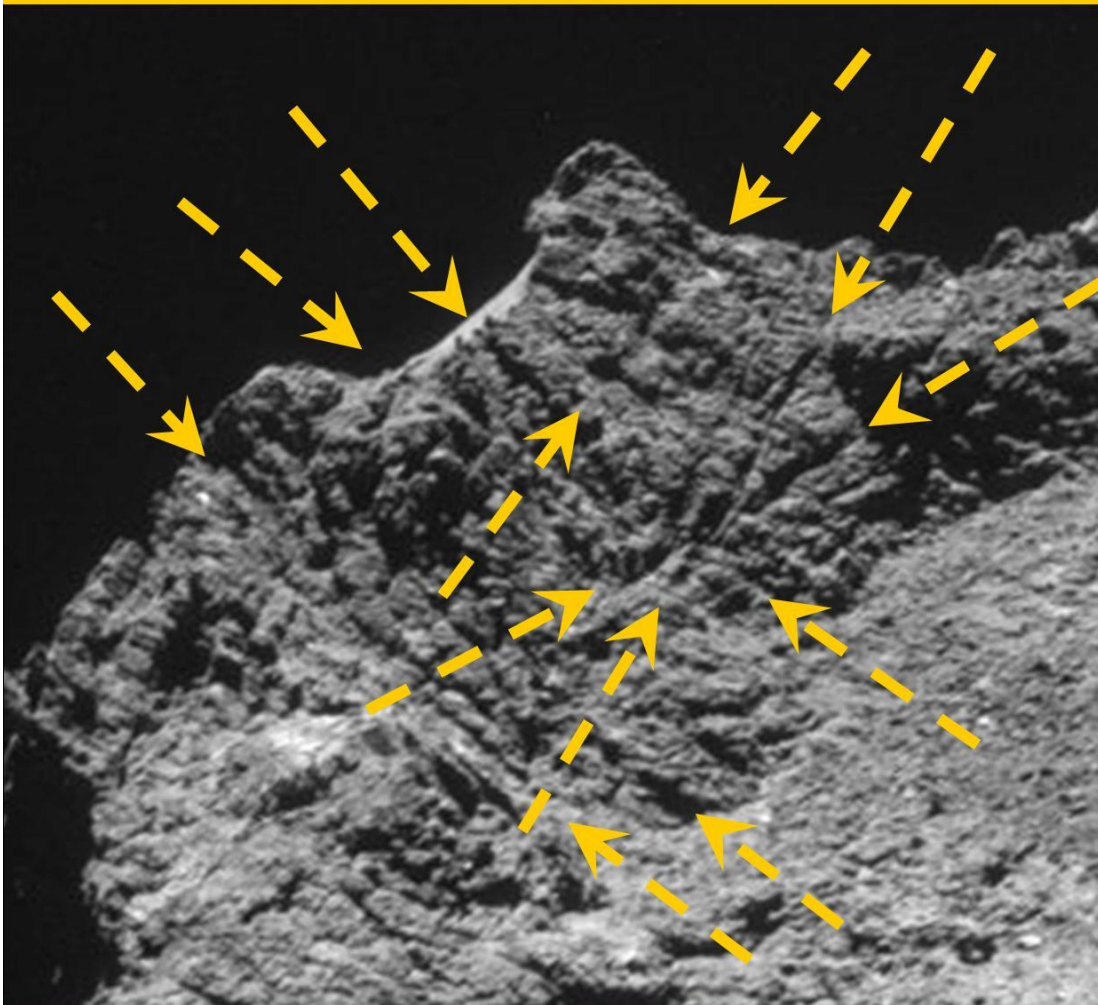

According to Quantum FFF Theory, comets are not only eroding ice-balls heated by the sun. They also CREATE MATTER like H₂O Carbon etc. by one or more internal NEW PHYSICS Dark Matter Black Hole. Criss cross scratches seem to be the evidence of the tectonic growing process of ice plates into different directions. The result: Comet 67P CG is trembling, shaking and quaking, by tectonic motion. Even the magnetic field seems to show 3 quakes per minute.

Figure 33, Criss cross scratches at comet 67P CG, as evidence for internal ice growing and plate tectonic motion into different directions.

According to Quantum FFF Theory, comets are not only eroding ice balls heated by the sun. They also CREATE MATTER like H2O Carbon etc. by one or more internal NEW PHYSICS Dark Matter Black Hole. Criss cross scratches seem to be the evidence of the growing process of ice plates into different directions.

Potential Rosetta lander gravity problem by tilted (non perpendicular) gravity vector from the snowy surface of Comet 67P CG.

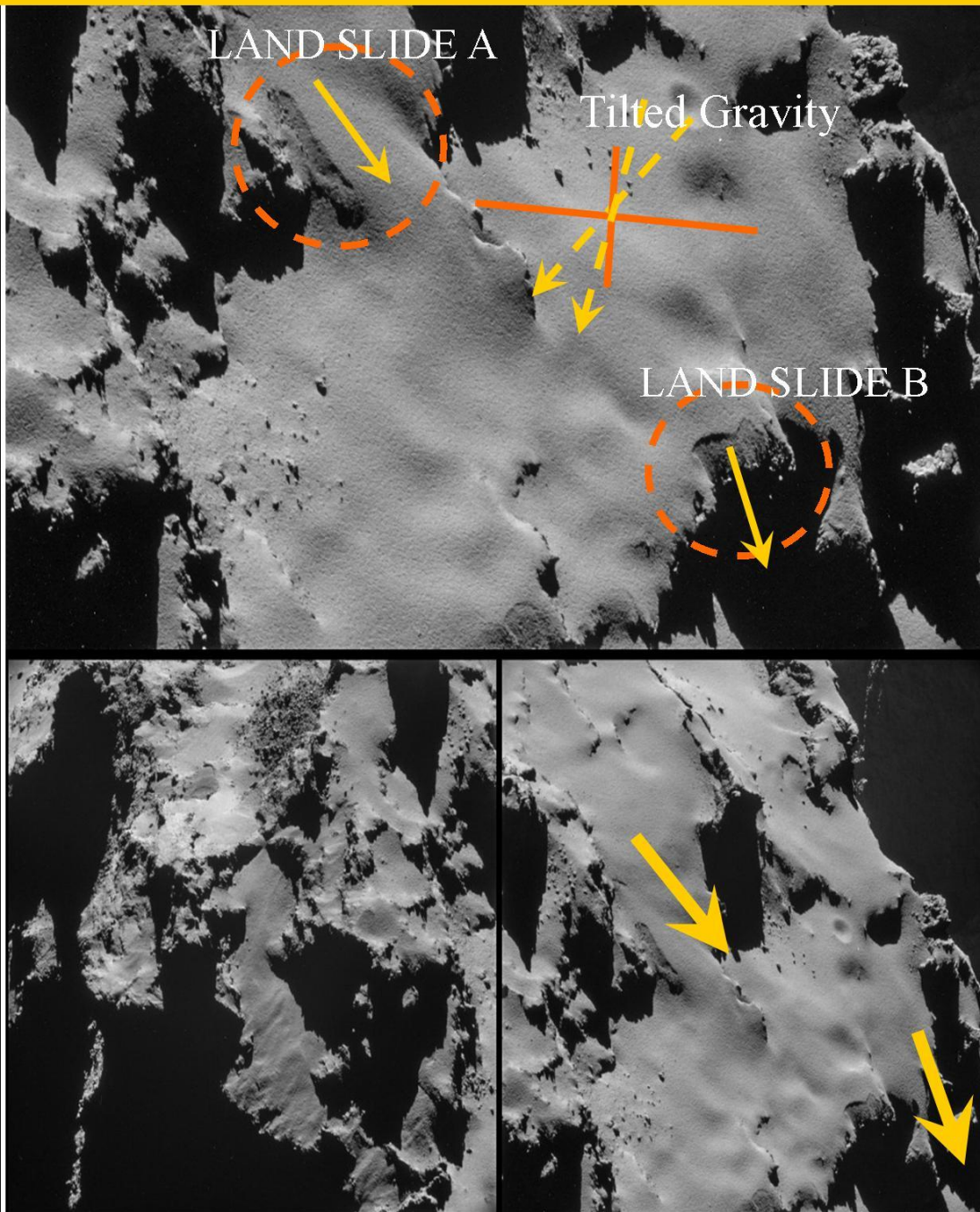

Figure34, Anomalous non perpendicular surface Gravity problem.

Cometary Conclusions.

1. As a consequence of cometary constant dust and water (ice) production it is assumed that the surface of 67P has a layered dusty structure filling in between water ice sculptured “rocky” peaks, assumed to be pushed upwards and shaped -more or less- around the funnel structures, with scratching effects.
2. The funnel structure is supposed to be created by a pencil alike gravity effect originated by the alignment of two “eclipsing” internal Dark Matter Black Holes.
3. The surface of 67P is in constant change by the internal matter production pressure and out gassing of dust. Boulders seem to be the product of broken top edges of the growing water/ icy funnels.
4. The peculiar dust jets originating from the neck of the comet are supposed to be accelerated and guided by the shape of the local oscillating AH field. just as it does for Eta Carina.
5. Anomalous landslide direction (avalanches fig 34.) are also evidence for non perpendicular surface gravity effects of the comet by the distribution of multiple gravity point sources (dark matter black holes).
6. If former matter/plasma production conclusions for comets like 67P, can be transposed to other cosmological locations like sunspots, planets and moons like Europa, then a series of anomalies seem to have the potential to be solved, even the so called Flyby anomaly.

Quantum FFF Theory.

According to Quantum FFF Theory, the fourth dimension (Local Time) seems to be the oscillation based photonic local transfer speed of the Axion-Higgs doublets along the local Cosmic lattice edges of the vacuum spin field. Axion- Higgs particle doublets are supposed to oscillate in "tandem" or doublets (like a boxer piston engine) along each vacuum lattice edge, to be able to transfer photonic information properly. This system need to have particle doublets because otherwise it would be impossible to have a decent information transfer along the nodes of the tetrahedron vacuum lattice. In this system, one lattice edges are supposed to equal one Planck length. The spiral structure of the vacuum lattices gives the vacuum a chiral influence on spinning and merging. Fermion particles and a photonic polarization. The chirality of this system is supposed to be the origin of our material universe as a member (8 or 12?) of the symmetric configuration of the raspberry shaped multiverse . Around black holes, the Higgs lattice system will be absorbed by the black hole and as a consequence, the vacuum is thinned and the Planck length will vary and locally even increase!!! As a consequence, the lightspeed of radiation passing the black hole, will decrease and suffer a redshift. However, if we assume that black holes are the same thing and origin of Dark Matter, then the Hubble redshift is not a tell tale of the expansion of the universe. TIME is assumed to run forward (right-handedness of clocks) because the universe is like a huge pinball machine. Spinning Fermions (the pinball) are driven by the oscillating AH field (the electric springs) which is supposed to be the origin of the general increase of entropy base of

the second law of thermodynamics. However dark matter in the form of black holes will eat the dark energy of the AH field and decrease entropy again, reason to postulate a pulsating and cyclic multi-universe. Universal Symmetry is not broken if we accept that each material universe is entangled at a long distance with an anti-material copy universe, equipped with opposite chirality inside the oscillating Higgs lattice field. As a consequence, Time never runs back in anti-material entangled universes, clocks have left handed rotation over there and my human copy me, has his hart in my observation at the right side of his body!. Being an architect, I am specially focussed on the geometrical part of construction principles of spacetime. I found out that spacetime geometry and the geometry of elementary particles could be linked if we consider wave particle duality as a mechanical conversion process inside a 3D energetic oscillating “Massless but energetic oscillating Higgs vacuum lattice” and elementary particles with real convertible shapes. I called it “Quantum Follows Form Theory” (Q-FFF) because the functions of each particle is based on its interaction possibilities with the oscillating Higgs vacuum lattice

The basic elements of Quantum FFF Theory:

- 1: Black holes (BHs) are the same as Dark Matter, they all consume photons, even gravitons and the Axion-AH field, (for short: AH field) but REPEL Fermions due to their propeller shape polarisation away from the BH. They produce electric charged plasma. 2: Dark Energy is the oscillating (Casimir) energy of the massless Axion-AH field equipped with a tetrahedron lattice structure with variable Planck length around black holes.. 3: Quantum Gravity = Dual Push gravity= Attraction (Higgs-Casimir opposing Graviton push).
- 4: The Big Bang is a Splitting dark matter Big Bang Black Hole (BBBH), splitting into smaller Primordial Big Bang Spinters (PBBS) forming the Fractalic Lyman Alpha forest and evaporating partly into a zero mass energetic oscillating Higgs particle based AH field.
- 5: Dual PBBSs hotspots, produce central plasma concentration in electric Herbig Haro systems as a base for star formation in open star clusters as a start for Spiral Galaxies.
- 6: Spiral Galaxies will keep both Primordial Dark Matter Black Holes as Galaxy Anchor Black Holes (GABHs) at long distance.
- 7: After Galaxy Merging, these GABHs are the origin of Galaxy- and Magnetic field complexity and distant dwarf galaxies .
- 8: Black Holes produce Plasma direct out of the Axion-AH field because two rigid massless but mutable Higgs particles are convertible into symmetric electron and positron (or even dual quark-) propellers (by BH horizon fluctuations).
- 9: The chirality of the (spiralling) vacuum lattice is the origin our material universe. (propeller shaped positrons merge preferentially first with gluons to form (u) Quarks to form Hydrogen with electrons.
- 10: The first Supernovas produce medium sized Black Holes as the base for secondary Herbig Haro systems and open star clusters.
- 11: ALL Dark Matter Black Holes are supposed to be CHARGE SEPARATORS with internal positive charge and an external globular shell of negative charged Quark electron plasma.
- 12: The lightspeed is related to gravity fields like the earth with long extinction distances to adapt with the solar gravity field.

13. Quantum FFF Theory states that the raspberry shaped multiverse is symmetric and instant entangled by so called WORMHOLE BRIDGES (ER=EPR) down to the smallest quantum level between different raspberry berries=universes. Nonlocal entangled down to each quantum and even living or dying CATS in BOXES.

14 Large Primordial Big Bang Spinters (PBBS) are responsible for the creation of the Lyman Alpha forest structure and first spiral galaxy forming of the universe, but they seem to be also responsible for the implosion of the universe at the end in the form of Galaxy Anchor Black Holes (GABHs) located mainly outside galaxies. see: (Quasisoft Chandra sources)

15, As a consequence of 12-14, Time is always local time in combination with cyclic period time of the multiverse.

16, If our material universes has a chiral left handed oscillating AH field, then our material Right Handed DNA helix molecule could be explained.

17 However it also suggests that in our opposing symmetric ANTI-MATERIAL entangled neighbor universe the DNA helix should have a Left handed spiral.

According to Max Tegmark: in an entangled multiverse we may ask: is there COPY PERSON over there, who is reading the same lines as I do? If this COPY person is indeed living over there, then even our consciousness should be shared in a sort of entangled DEMOCRATIC form. Then we are not alone with our thoughts and doubts, see: Democratic Free Will in the instant Entangled Multiverse.

18. All particles and waves should be entangled with anti-copy particles and AH field based waves in our opposing anti universes. Then wave particle duality and the so called one particle double slit interference could be explained by accepting that real shaped 3D photon particles only exist in their function of Gluons. However Gluons should transfer form information to the oscillating luminiferous Axion-AH field ether, within about 1 cm distance from a fermion.(see: Babock and Bergman anomaly,1964)

19, Different elementary particles have different qualities by their different complex stringy shape. Leptons and Quarks have a propeller shape with left or right handed pitch creating charge difference. Gluons, Photons and Neutrino particles have no pitch.

20. All particles can be converted to one or more Higgs particles, Lepto Quarks are also compound particles with an exeption for the electron and positron..

21. All particles are assumed to be present as Higgs particles already in the cyclic Big Bang Black Hole (BBBH) after the former multiverse has collapsed into a Big Crunch Black Hole.

22, We seem to live inside one material universal bubble of an instant entangled (Charge Parity Time) CPT symmetric raspberry bubble multiverse. Each quantum jump or wave function collapse or human choice is guided by this instant entanglement at long distant.

If our material universes has a chiral oscillating AH field, then our material Right Handed DNA helix molecule could be explained.

However it also suggests that in our opposing ANTI-MATERIAL multiverse neighbour universe the DNA helix should have a LEFT HANDED spiral. According to Max Tegmark: in an entangled multiverse we may ask: is there COPY PERSON over there, who is reading the same lines as I do? If this COPY person is indeed living over there, then even our consciousness should be shared in a sort of DEMOCRATIC form, Then we are not alone with our thoughts and doubts, see: Democratic Free Will in the instant Entangled Multiverse.

Conclusion,

Quantum FFF Theory is based on Non-Local Realism. The CP(T)-symmetrical raspberry shaped multiverse (with 8-12 berries) is non local instant connected down to each quantum. Each quantum can be visualised as a deformed Axion-Higgs ring able to convert into other shapes and able to form compound structures like quarks, muons or even Tau leptons. So

realism (cogwheels) connected by symmetric non-local instant entanglement.
 vixra.org/pdf/1401.0071v2.pdf

It was **Abdus Salam** who proposed that quarks and leptons should have a sub-quantum level structure, and that they are compound hardrock particles with a specific non-zero sized form. **Jean Paul Vigiér** postulated that quarks and leptons are "pushed around" by an energetic sea of vacuum particles. **David Bohm** suggested in contrast with The "Copenhagen interpretation", that reality is not created by the eye of the human observer, and second: elementary particles should be "guided by a pilot wave". **John Bell** argued that the motion of mass related to the surrounding vacuum reference frame, should originate real "Lorentz-transformations", and also real relativistic measurable contraction. **Richard Feynman** postulated the idea of an all pervading energetic quantum vacuum. He rejected it, because it should originate resistance for every mass in motion, relative to the reference frame of the quantum vacuum.

However, I postulate the strange and counter intuitive possibility, that this resistance for mass in motion, can be compensated, if we combine the ideas of Vigiér, Bell, Bohm and Salam, and a new dual universal Bohmian "pilot wave", which is interpreted as the EPR correlation (or Big Bang entanglement) between individual elementary anti-mirror particles, living in dual universes. See below.

Supervoid alignment with the Cold Spot in the Cosmic Microwave Background. (l,b: 209/-57 degr.) a strong support for a Charge Parity entangled symmetric multiverse big bang theory.

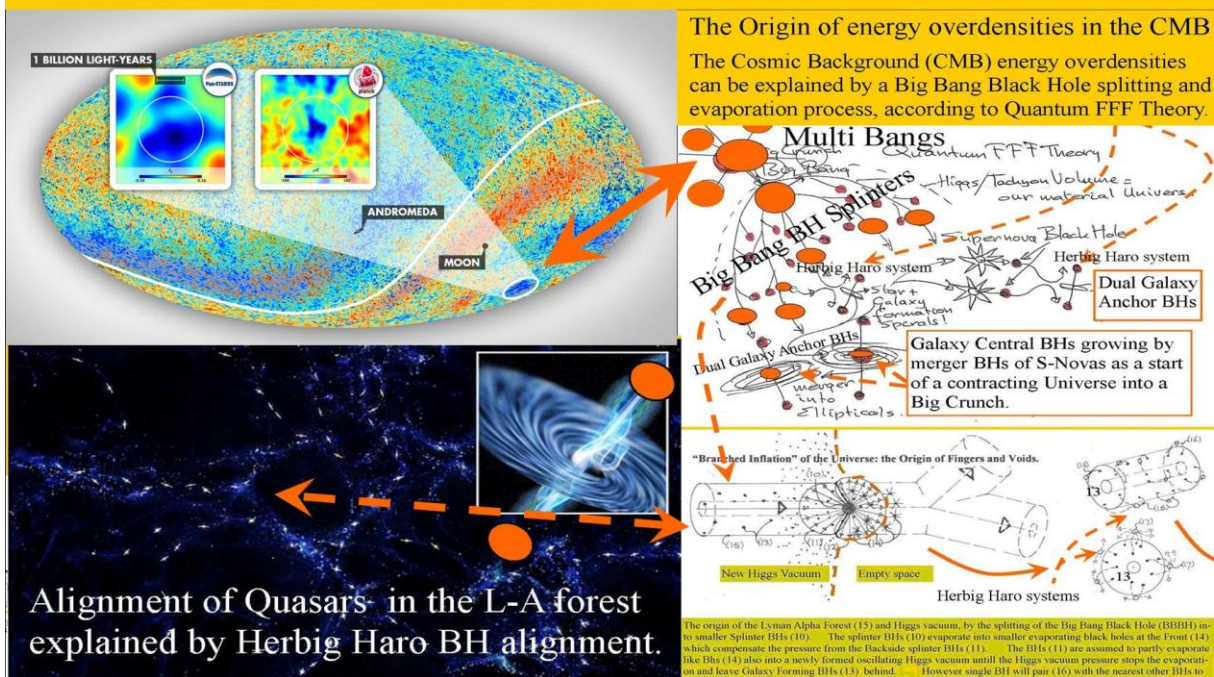
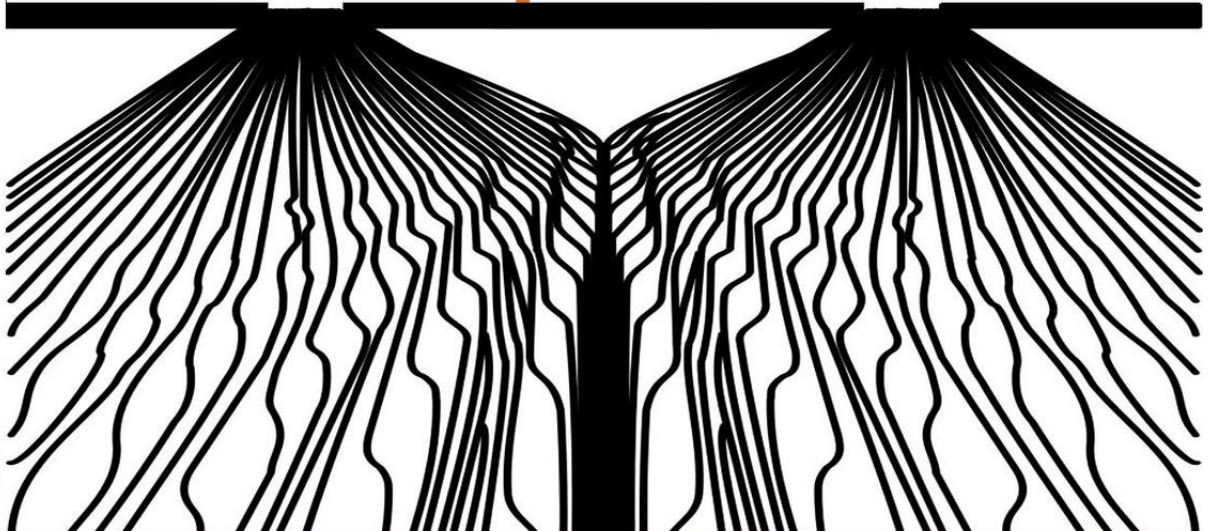
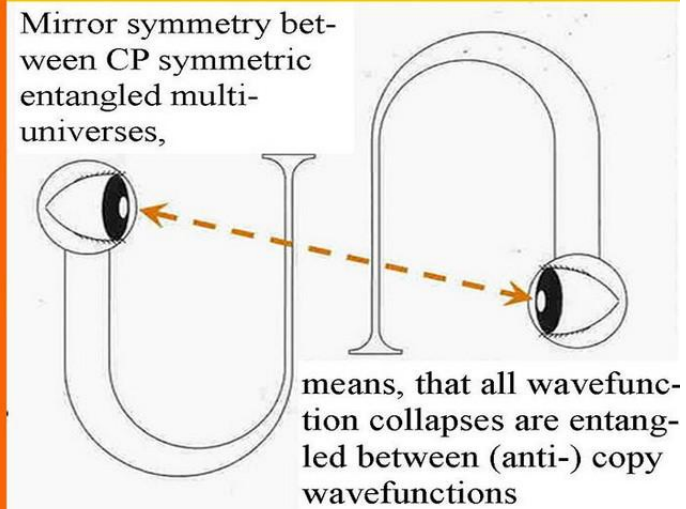
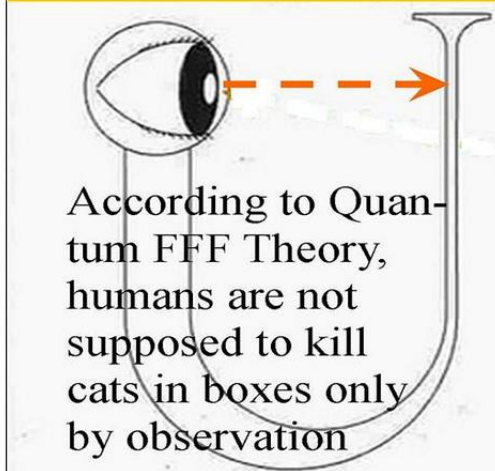

Figure: 35. Alignment of Supervoid and Cold spot including Quasars support the idea of branched inflation by Big Bang Black Hole nucleus splitting and evaporation process .

In dual entangled CP (Charge Parity) symmetric mirror universes all quanta have complementarity in the other universe. So even the left and right slit of the one photon double slit experiment.

One of the Copenhagen interpretations of human observation influencing wavefunction collapses. E.g. for human observation of dead or alive Cats in boxes.

The alternative Quantum Function Follows Form Model interpretation of (Charge Parity (CP) symmetric) instant entanglement based collapse between multiple universes. E.g. NO human influence on dead or alive cats in boxes.



Bohmian Mechanics suggested already such a non local reality.

Figure: 36, Dual symmetric entangled multi universes have complementarity and a support for Bohmian Mechanics.

References:

[47] **The New God Particle and Free Will.**

Author: Leo Vuyk, **LuLu publishers, 2008.**

ISBN number 978-1-4092-1031-3

<http://www.lulu.com/spotlight/LeoVuyk>

[46] **Quantum FFF Theory is also published in the form of POSTERS at the Flickr site:**

<http://www.flickr.com/photos/93308747@N05/>

[45] **Numbered listing of Vixra essays by Leo Vuyk (see below).**

http://vixra.org/author/leo_vuyk

[44] viXra:1401.0115

Calabi Yau Shaped Double Fermion Spin States.

[43] viXra:1401.0071

Democratic Free Will in the Instant Entangled Multiverse.

[42] viXra:1312.0143

The Navel Cord Multiverse with Raspberry Shape.

[41] viXra:1312.0076

Are Sunspots Made of Gravitating Dark Matter Black Holes?

[40] viXra:1310.0101

The New Nuclear Magic Number (34) Explained by the Polar Coaxial Ring System of
Category: Nuclear and Atomic Physics

[39] viXra:1310.0059

The Semi Relativistic AH field Aether with Mass Related Lightspeed Adaptation.

[38] viXra:1309.0081

New Physics by Table Top Experiments.

[37] viXra:1308.0083

The Raspberry Shaped Super Symmetric Multiverse

[36] viXra:1307.0068

Quantum Function Follows Form Theory, the Small Scale, Posters part 1.

[35] viXra:1307.0067

Quantum Function Follows Form Theory, the Large Scale, Posters part 2.

[34] viXra:1306.0218

Dark Matter UFO Dust Particles or Quantum Knots in the LHC at CERN ?

33, viXra:1306.0065

The Splitting Dark Matter- Black Hole- Big Bang and the Cyclic Multiverse.

32, viXra:1305.0140

Quantum FFF Theory Experiments, a Summary.

31, viXra:1305.0041

The Shnoll Effect Explained by Quantum FFF Theory.

30, viXra:1304.0022

The Self Organizing Universe in the Carina Nebula.

29, viXra:1303.0211

Hubble Redshift Combined with Universal Contraction is Possible.

28, viXra:1303.0053

Micro Birkeland Currents Between Two RF Generated Plasma Balls in the Laboratory.
27, viXra:1302.0172
 Silicon Based Ball Lightning Globule Structures and Signs for Accumulation and Retarded
 Decrease of Tunnelling Energy Bullets.
26, viXra:1301.0088
 Two or Three Large Quasar Groups (LQGs) Located at the Start of Two or Three Lyman
 Alpha Systems and a Part of the Raspberry Multiverse?
25, viXra:1301.0050
 Dwarf Galaxies and Their Relation with Dark Matter Based Galaxy Anchor Black Holes
 (Gabhs).
24, viXra:1210.0177
 Instant Broglie Bohm Pilot Waves, the Origin of All Entanglement Effects in the Lab and
 Wavefunction Collapses in Our Universe as Related to Our Opposing Anti-Copy Universe(s)
 According to Quantum FFF Theory.
23, viXra:1209.0092
 New Dark Matter Black Holes and a New Dark Energy AH field, Lead to a Bouncing CP
 Symmetrical Multiverse, and New Experiments.
22, viXra:1209.0061
 Birkeland Currents, Sunspots, Comets and Ball Lightning Originated by New Paradigm Dark
 Matter Black Holes.
21, viXra:1209.0030
 Majorana and Sterile Neutrino Solutions in the Quantum-FFF Model.
20, viXra:1208.0031
 Clumpy Dark Matter Around Dwarf Galaxies a Support for an Alternative Black Hole Theory
 According to the Quantum Function Follows Form Model.
19, viXra:1202.0091
 Earth Magnetic Monopole Array Field Interaction with Cyclotron –Synchrotron Electrons and
 Muon Conversion Used for Levitation Systems.
18, viXra:1201.0092
 Earth Magnetic Monopole Array Field Interaction with Cyclotron Electrons used for
 Levitation Systems.
17, viXra:1112.0065
 LHC Signals Between 121-130 Gev Interpreted with Quantum-FFF Theory
16, viXra:1111.0096
 Reconciliation of QM and GR and the Need for a Pulsating Entangled CPT Symmetric
 Raspberry Shaped Multiverse.
15, viXra:1111.0061
 Black Hole Horizon Curvature Dependent Balance Between Plasma Creation and e-e+
 Annihilation in Quantum FFF Theory.
14, viXra:1108.0036
 Artificial Ball Lightning Production and Exploitation Device for Zero Point Electric Energy
 Usage.
13, viXra:1108.0006
 Mass in Motion in Quantum FFF Theory
12, viXra:1104.0083
 Quantum FFF Theory in Posters.
11, viXra:1104.0044
 Ball Lightning, Micro Comets, Sprite-Fireballs and X-Ray/gamma Flashes According to
 Quantum FFF Theory.
10, viXra:1104.0002

Stellar Anchor Black Holes as the Remnants of Former Herbig Haro Objects
9, viXra:1103.0097
ZPE Zero Point Energy Examples Around Black Holes.
8, viXra:1103.0068
Funktion Follows Form, at the Quantum Scale and Beyond.
7, viXra:1103.0024
Quantum Gravity and Electro Magnetic Forces in FFF Theory
6, viXra:1103.0015
Wavefunction Collapse and Human Choice-Making Inside an Entangled Mirror Symmetrical
Multiverse.
5, viXra:1103.0011
An Alternative Black Hole, Provided with Entropy Decrease and Plasma Creation
4, viXra:1103.0002
3- Dimensional String Based Alternative Particles Model
3, viXra:1102.0056
Experiments to Determine the Mass Related Lightspeed Extinction Volume
2, viXra:1102.0054
Atomic Nuclear Geometry Based on Magic Number Logic.
1, viXra:1102.0052
Construction Principles for Chiral “atoms of Spacetime Geometry