

Cubic Lattice Structure of Universe – A Model

Tufail Abbas

(B. Tech - Electrical, MBA)

ABSTRACT

This paper proposes an introductory conceptual framework for developing explanation about the Universe based upon stationary cubic lattice structure arranged as infinite matrix of infinitesimal cubes.

The space and time moves through this lattice resulting into all mass, charge and energy that we see. It is envisioned that through developing of this model based upon base lattice structure it would be possible to express all physical properties (i.e. space, time, energy, charge, momentum, temperature, velocity, force etc.) , in terms of the geometric parameters (i.e. length, surface area, volume, angle, orientation, cycles) of the base structure. Physical reality being a function of perception, the paper discusses our general understanding of perception (of vision in particular), to make interpretations regarding the nature of observable reality and understanding about dimensions, based upon reasoning. Based upon these interpretation, concept of “velocity at rest” in introduced, which is envisioned to provide an explanation about rest mass and gravity.

KEYWORDS

Space, Time, Energy, Charge, Perception of Vision, Dimensions, Rest Velocity, Cubic Lattice.

INTRODUCTION

The question regarding the nature of Universe and/or its functioning has always been a vital one throughout the history of mankind. Different explanation exists in today’s scientific and philosophical literature to answer this question.

Classical, Relativistic and Quantum Physics are three major categorization of the Knowledge of Physics to explain the same Universe at different scales. Mathematical equations describing the reality in each of these categories are perfect in its respective domain, but they do not perfectly match with each other domain. Do we really need different explanations for different scales or we have some fundamental misunderstanding regarding the nature of reality that we are not able to find a coherence between these domains.

Based upon assumptions that the laws describing Universe at different scales are same, this paper derives a plausible model to describe the micro reality based upon observation of macro reality. Logical interpretation and simple reasoning have been utilized to probe our perception about the

Cubic Lattice Structure of Universe

physical reality, with a special emphasis on the perception of vision.

If not necessarily the first of its kind, this paper (on the proposed cubic lattice structure of Universe by author) is unique in its approach that interpretations are directly derived through observation of physically observable macro reality. Real life examples have been utilized to explain the model, which does not require familiarity with experimental setup and instruments.

The objective of this paper is to share the conceptual framework of the proposed model, which may find relevance in due course to contribute for advancing fundamental physics.

WHY A CUBICLE FRAME?

When we see the fibonacci sequence in the spiral geometry of all natural phenomenon, ranging from DNA, galaxies, flora, fauna and non-living beings, we say what an interesting curves are these!! Wow!! (See Fig 1.1)

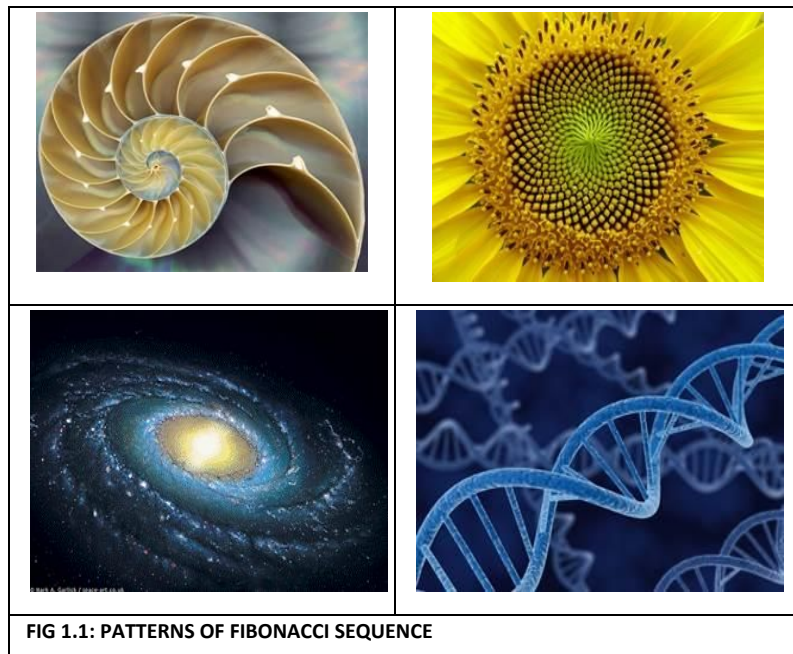

Let us focus our attention on this spiral geometry that is originating from an interesting background as shown in Fig 1.2 and Fig 1.3

Cubic Lattice Structure of Universe

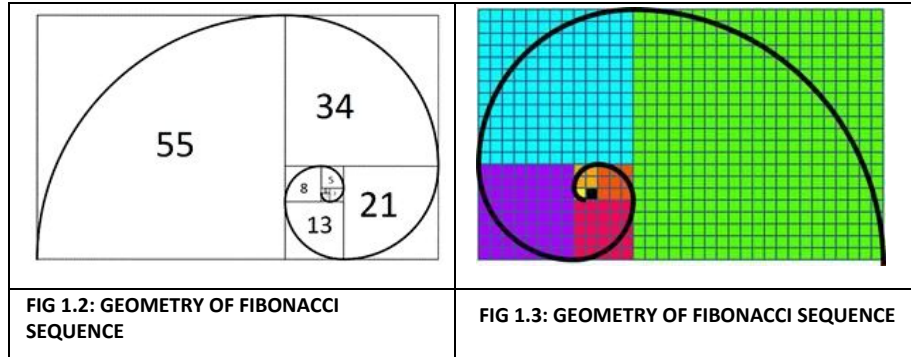

It's amazing to note that the most initial shape from which this shape is generated is a square in 2-dimension. To advance the creation of spirals from this basic grid of squares, we are simply moving outward by adding squares after squares. In this process we are like allowing the spirals of energy to flow through the cubicle grid of space-time.

Our sense of spiral, or curve or any other shape is the tangential realization of energy on the boundaries of these squares, whereas we are in effect unaware about the dimensions and possibilities within the void of these squares.

Though the curves of energy that has initially originated from the void of the square, it cannot follow any path at its will, but its flow is being guided and restricted by the surrounding square as per some laws of nature, resulting into changing the path of propagation from straight line to curved path. What kind of law, it could be?

For the time being let us examine the Fleming Left Hand and Right Hand Rule (Fig 1.4).

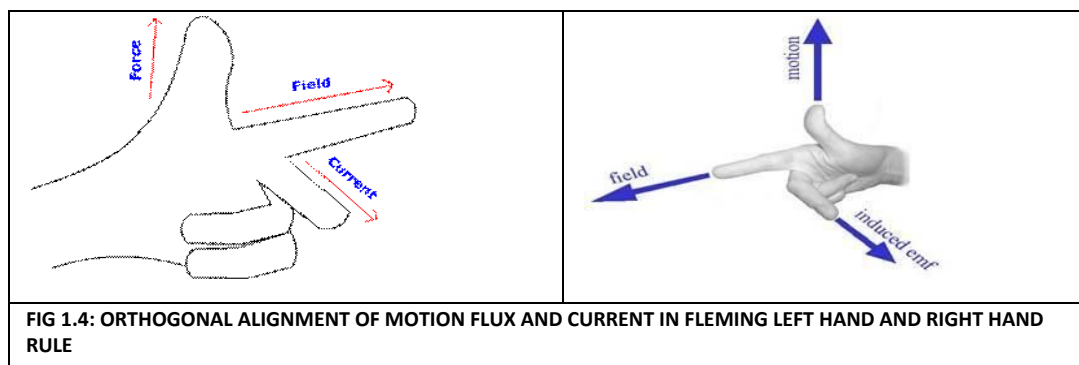

These rules holds good whether we are at the depth of dark sea or the heights of the illuminated space.

For any entity/particle to qualify as the building block of the Universe, it is necessary that we should be in a position to explain all physical laws on the basis of geometry of this most basic building block. After considering many permutation and combinations any other shape other

Cubic Lattice Structure of Universe

than a cube simply does not make sense. The perfect orthogonal alignment of motion, flux and current in three spatial orientation cannot be explained, except by an underlying cubicle structure.

Any discovery starts with a basic axiom / assumption and then we proceed with the testing that axiom / assumption by correlating various objective evidences and observations, to reach a conclusion that whether our basic assumption was correct or not. If our basic assumptions passes this test then we are assured that assumptions are not fantasies but they have some objective reality.

It's interesting to note that whenever we make assumption about an infinitesimal section of any curve, it is always a line dx . Similarly the approximation of an area of surface is taken as square dA and volume is approximated as Cube dV . (See Fig 1.5)

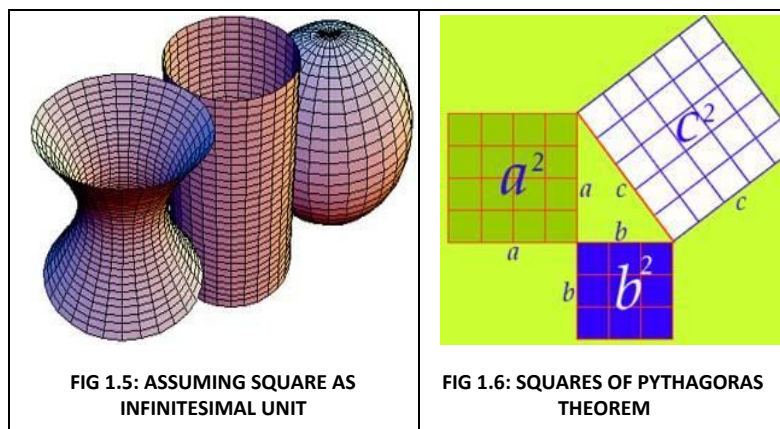

So why there is a repeated trend in our assumptions about infinitesimal scale, which perfectly guides our analysis so that when we integrate it to the macro reality, this approach always leads to logical results.

If the underlying reality would have been of any other shape than the cubes, then our basic assumption about infinitesimal scale, would have not provided a basis for logical results when integrating to macro reality.

It seems, human psyche/ consciousness is subconsciously aware about this basic underlying reality which is made of straight edges of square and cubes. Our mind being a subset of such a consciousness, it is difficult for it to easily accept a proposition/assumption which is contrary to its intrinsic knowledge.

The assumption about this infinitesimal scale as a square/cube is not just a trend of modern

Cubic Lattice Structure of Universe

calculus. Even the Pythagoras Theorem of 6th century BC was discovered only after assuming square as the basic unit of summing up the space (See Fig 1.6)

Protons are known to have 3 quarks, not 4, 5 or 6. As no free quarks are detected, the description of quark, resembles three orientation of a cube. Once we remove faces of the cube from a cube, it is no more a cube. The faces of a cube do not have an identity independent from the cube.

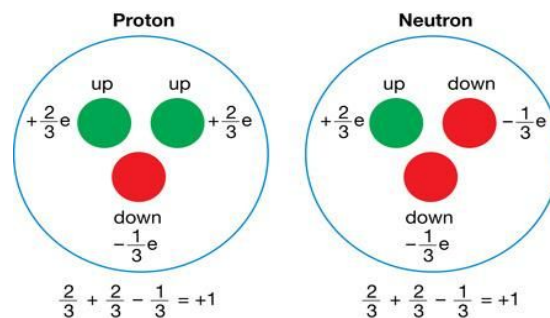

FIG 1.7: THREE QUARKS OF HADRONS

Similarly, once we remove quarks from each other, they lose their identity as quarks. Proton may not be cubical in shape wholly, but it will not be a surprise if quarks would turn out to be just a property originating from differing properties of three orientation of constituents cubes of proton.

It's a bit non-intuitive that building block of the Universe could be a cube, as everything that we see in the Universe is curved and waving. Earth is round, galaxies are spiral, sun seems to be spherical in shape, electron cloud is formed over a region of sphere, atomic radius is circular, gravity follows geodesics equipotential surface, electric fields also are inverse square, path of earth is elliptical, lot of interesting curves in human body, anisotropic growth of the plant, whirlpool, undulated mountains, flowing rivers, spiral cyclones and so many other objects in the universe apparently does not provide any clues for a possibility of underlying cubical structures.

It is difficult for a subscriber interested in the content of daily broadcasts, to intuitively figure out that screen is made up of tiny square pixels unless that subscriber is already aware about the digital technology. Let's suppose the screen of this television is so large that it is larger than our vision, so that it is only possible for subscriber to see just a part of the screen. Such is the case of this Universe that it is impossible for us to see the edge of the screen of the Universe.

Cubic Lattice Structure of Universe

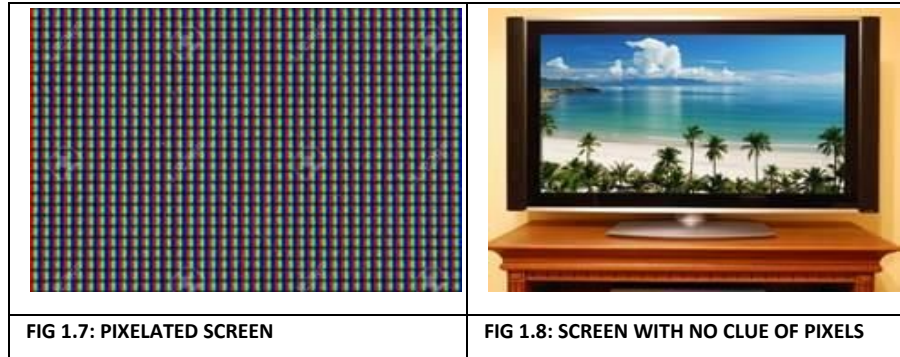

Any other shape can be created from cube, of course with surface irregularities, but it is difficult to create all possible shapes with any other 3-D shape other than Cube.

Whenever we want to make a stable building/structure, we rely on flat surfaces of either a cube or rectangle to achieve a perfect fit. If not cube then which other shape could explain the perfect balance of the Universe?

PERCEPTION THE REALITY

Reality is that which we perceive and reality is also that which we perceive not. Reality is, that it is.



FIG 2.1: LEMON OF PERCEPTION

So far as the existence/non-existence of an imperceptible reality is concerned, that is not at all verifiable by physical means or in other words through the interface of our physical senses. Here is a lemon of perception (Fig 2.1), which is yellow in colour and of particular shape which we perceive with our eyes, it has a sour taste which we perceive by our tongue, it will weigh like 20 gram which we perceive by pressure on our skin, it has a peculiar smell which we perceive through our nose. In a nutshell this lemon is nothing but function of our perceptions. There is no way for us to know whether lemon exists if we are devoid of these perceptions. In other words physical reality or objective reality is that which can be perceived through our physical senses.

Therefore any discussion about the physical reality should start with the discussion about physical senses. In our study about the Universe, whether it is study of quantum particles or the

Cubic Lattice Structure of Universe

study of cosmological movement, the sense that we mostly utilize to collect data, is our sense of Vision. This sense needs some scrutiny for sure.

Fig 2.2 shows the image of an object being projected onto the retina of the eyes as an inverted two (2) dimensional image which then further travels through neurotransmitters to a pitch dark portion of the brain as electrical signals, where the sense of 3-D reality is created by comparing the received data with previously learnt data. If there is no previously learnt data already stored within the brain / psyche of the human being, it is impossible to create a sense of 3-D reality from a 2-dimensional image.

For example, when we see the night sky, as a 2-dimensional image it looks like sparkling jewels stitched on the boundaries of our Universe. And then there are comparatively mammoth objects called Sun and Moon, which travels through them. This proposition perfectly makes sense unless we are aware through a previous set of knowledge stored within our brain that some stars that we see are many times larger than the Sun and distance of different stars from the earth is not constant but it is varying. Therefore our sense about a 3 dimensional reality cannot be created only by utilizing the perception of present moment. A meaningful appreciation of 3-dimensional reality is always contingent upon the memories of the past. In this way, we are actually perceiving the 2-dimensional space of the Universe through movement along dimension of time, thereby creating a sense of 3-dimensional Universe.

When a child is born, it will not have any sense of 3-dimensional characterised of up and down, far and near. They see a ball extend their hand to reach it and then they get it. Then they see the moon, again they repeat the same sequence of action, but this time they could not catch. They cry and we laugh and enjoy. Out of this pain, the child realizes that something is wrong with this world.

They cannot distinguish between yesterday and tomorrow. They observe this reality only at a precise moment of now, frame by frame , a 2-dimensional frame, which is getting continually stored as memory. Once they have gathered a large amount of frames, filed along with its associated pain, happiness, frustration , excitement, fulfillment, disappointment, sound, light pressure, taste etc, then they start comparing that open library of data with every new frame that they will now receive to create the sense of far, near , height and depth.

In a nutshell, two dimensional data at the precise moment of now, is the basic form of data that we as human being understand by default.

Cubic Lattice Structure of Universe

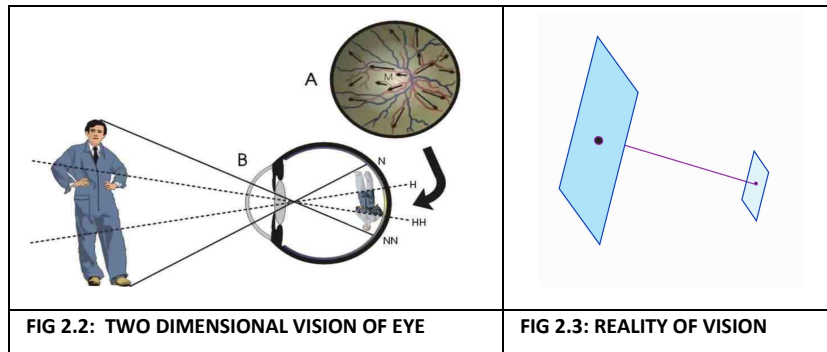

From the Fig 2.2, let us closely examine the reality of image before it has fallen on retina. The process utilizes a large number of incident one (1) dimensional array of light rays to assess the state of an equal number of tiny two (2) dimensional surfaces on the the body of the observed objects which again gets reflected back as one (1) dimensional array which travels through the medium of space-time (whatever is that) to converge and get mapped on the retina again as a two (2) dimensional image. If we remove the illusion created by complex interaction of surrounding environment the whole process can be summed up by the Fig 2.3.

In a nutshell, it is not all required that the physical reality (including its every particles) is a solid 3-dimensional reality accessible at every possible division. The reality as we see can easily create by infinite number of 2-dimensional planes separated by infinite number of one (1) dimensional connecting link in 3 spatial direction.

CUBE OF INFINITE DIMENSIONS

It may be appreciated from above discussion that in principle, a three(3) dimensional reality (as we see) can be created just by large number of two(2) dimensional surfaces connected through large number of one(1) dimensional connecting links. Hence it is now the time to introduce the “Cube of Infinite Dimensions” as shown in Fig 3.1.:

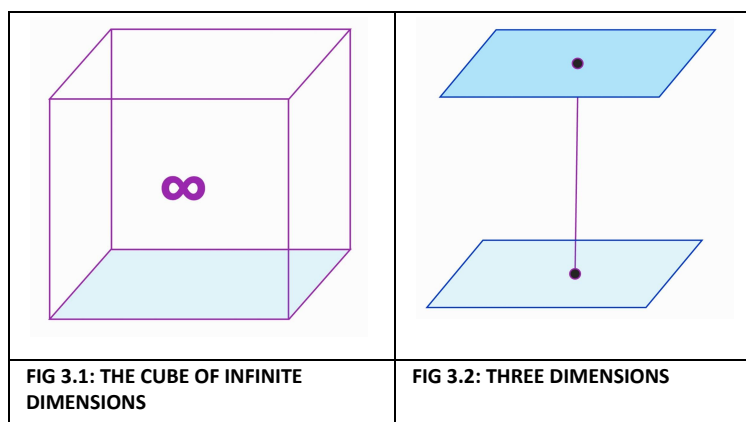

How amazing is this cube that it has three one-dimensional axes xyz passing through the centre

Cubic Lattice Structure of Universe

of surfaces, and 6 numbers 2-dimensional surfaces. Any creature with the knowledge about only axes and surfaces of zero volume is enabled to determine the volume of the cube, even without any knowledge about the other contents within the void of the cube.

Howsoever small the size of the cube is, the effective volume of its surface and the axes put together will always be zero as compared to the volume of the cube.

Similar is the case with many other shapes as shown in Fig 3.4. All of these shapes are made by drawing a one dimensional line through its two end points. Effective volume occupied by line itself here is zero. Despite the fact that line itself does not occupy any volume, and without knowing what is between lines, if we only know the position , angle etc of lines only wrt to other lines, then an **apparent perception** of area and volume can be created.

In this way, the infinite volume of void of the cube (relative to the surface) creates a zone within our 3-Dimensional Universe that can accommodate infinite dimensions. In effect the so called 3-dimensions are like image shown in Fig 3.2. One (1) dimensional connecting link between the surfaces of the cube.

When we stack these cube as a 3-D , one on top of the other from -infinity to +infinity in all three spatial direction, then we get a cubic lattice arrangement as shown in Fig 3.3.

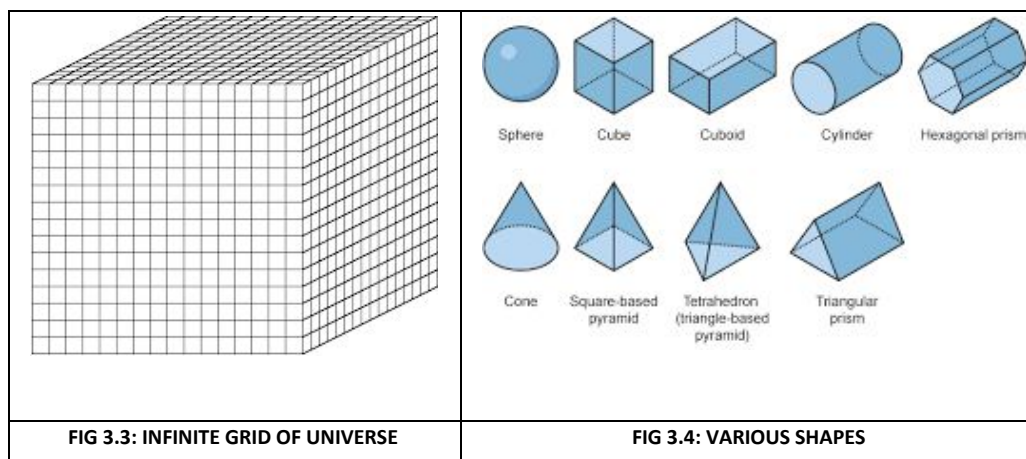

Do not get disappointed with this apparently simple cubic lattice arrangement to start worrying that how these simple cubes will create this grand Universe. These are the cubes of infinite dimensions they have some amazing properties as follows:

1. These cubes will have velocity without movement.
2. They will push the galaxies apart but they themselves will not move.
3. Both electromagnetic waves and matter would pass through them without dragging them

Cubic Lattice Structure of Universe

along.

4. Potential at surface of the cube will differ from cube to cube but the centre of every cube will be at equal potential.
5. Energy will pass through its surface without tearing it apart.

From inside, some of these cubes would like as those shown in Fig 3.5 and 3.6.

		<p>+C2 Cubit will create the property of +ve electrical charge</p> <p>-C2 Cubit will create the property of -ve electrical charge.</p> <p>+C4 Cubit will create the property mass as well as +ve electric charge.</p> <p>nC2 Cubit will create the property of permanent magnetism.</p> <p>C0 Cubit with no permanent charge is Free Space.</p>
<p>FIG 3.5:: ENERGY FLOWING ACROSS CHARGE</p>	<p>FIG 3.6: CHARGED SURFACE WITH SPIN (AS SEEN FROM INSIDE THE CUBE)</p>	

Some basic properties of the cube are as follows:

1. At any given moment of time the scalar sum of energy within the cube is constant = 12. That 2 Units passing through each surface at each tick of time.
2. Energy flows orthogonal to the surface of the cube, by piercing it through and direction of flow is determined by charge on the surface. Rules are as follows:
 - a. Positive Charge : 2 Units of energy will flow from outside of the cube to inside of the cube through that charged surface.(Black surface in Fig 3.5)
 - b. Negative Charge : 2 Units of energy will flow from inside of the cube to outside of the cube through that charged surface.(Blue surface in Fig 3.5)
 - c. No Charge: 1 unit of energy will flow from inside to outside and 1 unit will flow from outside to inside through that surface. The vector sum of energy at this surface would be zero.(Neutral surface in Fig 3.6, top right)
3. Flow and charge are mutually dependent properties. That means, if there is a net flow through the surface, the surface is automatically charged. And in case the surface is charged the energy will naturally pierce through it.
4. If the charge on the surface of cube is a permanent charge then these cubes will constitute the matter.
5. Cube with no permanent charge is free space or vacuum.
6. Virtual charge or temporary charge is created in vacuum (or the cube that constitute the vacuum) when vector sum of energy on its surfaces becomes non-zero due to current of energy flowing between permanent charges.

Cubic Lattice Structure of Universe

7. To establish this current of energy through this grid of cubes (ie. space-time), permanent negatively charged surfaces will continuously emit energy and positively charged surface will continuously absorb energy.

Based upon above basic properties of these Cube, only Four (4), configuration of permanently charged cubes are proposed in Fig 3.5, for a stable Universe. Fifth Cubit is the charge less Cubit of Free Space itself. Other permutation/combination have been discarded as they would not provide a basis for stable Universe.

As shown in Fig 3.5, the spin on the surface of the charge are cycles of energy. With completion of one (1) cycle there will be a movement of linear unit of energy (red arrow) perpendicular to the plane of the charge.

VELOCITY AT REST

Newton's Law of Inertia states that any object will remain at rest or in state of uniform motion unless acted upon by an external force.

We often take the wordings of this Law for granted, which implicitly grants equal status to both the state of rest and the state of uniform motion. Usually the state of rest and state of motion are considered to be totally different and opposite states. This Law suggests that there is some similarity between state of rest and state of uniform motion. What if the state of rest itself is some sort of uniform motion?

Whenever we discuss motion, it has to be described in terms of change in position of one object relative to other. Hence, intuitively the motion of a body at rest is a paradox. Here is a solution to this paradox demonstrated by Fig 4.1 and Fig 4.2.

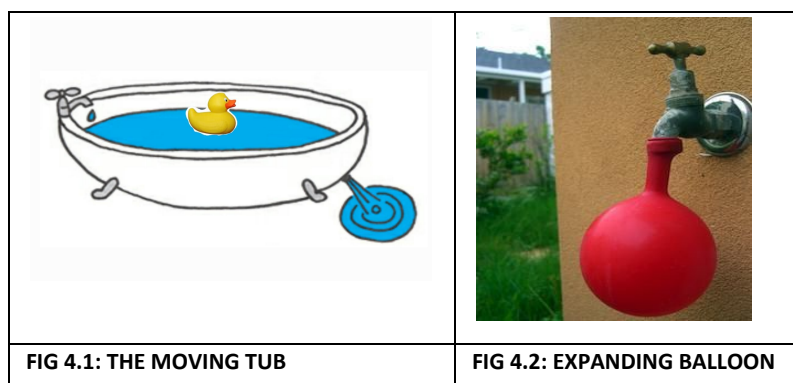

Following three kind of motion can be observed in these diagrams:

1. Motion of duck relative to the surface of water.

Cubic Lattice Structure of Universe

2. Expansion of the boundary of balloon due to filling of water inside it.
3. The water getting filled into the tub through the tap and simultaneously getting emptied through the leaking hole.

In the last example if the rate of filling is same as the rate of leaking and the duck do not see the tap, then it will assume that the water is at rest since the level of water is not changing. However, an observer simultaneously seeing the tap, leaking hole, water and duck will easily conclude that water is in state of motion with respect to tub. Conversely the tub is in motion with respect to water. Interestingly from inside the tub, the duck if with no clue about tap and leaking hole, will continue to believe that both tub and water are at rest. She will enjoy the motion of its own swimming, unaware about the condition of the tub which is in the **state of uniform motion at rest**.

Similar to the example of duck moving through the water in the above example, it is possible that all objects in the Universe are in state of motion with respect to space. And similar to the example of tub in state of rest at uniform motion with respect to water, mass of all object are also in state of uniform motion at rest with respect to space.

Movement of the boundary of balloon is similar to the expansion of Universe.

Let's correlate above example with the structure and properties of Cubits as shown in Fig 3.5. Here the Cubits are like that tub where the black surface is similar to the tap and blue surface is similar to the leaking hole. Well, you may object some of these tubs of Cubits only have taps and some other only have leaking hole. For the time being let's assume that similar to the situation of the duck we cannot see that missing counterpart but it exists. The existence of the counterpart will be discussed later.

The red arrows in the Fig 3.5 represent the flow of energy which is equivalent to one unit of space of length s as shown in Fig 3.6. The circular motion of energy on the surface of the charge, which is again of length s of its circumference, guides the direction of the flow of linear energy across the surface of the charge. With completion of one (1) cycle of this rotation, space (energy) moves linearly by a distance of s . Alternatively, we can say that one (1) unit of space is passing through charged surface per cycle of rotating energy. This rate is nothing but velocity of the charge at rest, where the linear motion is equivalent of the distance and circular motion is the equivalent of time. Rest velocity is hence created by this orthogonal movement of space with respect to cycles of time. We can say that:

For $nC_2, +C_2$ and $-C_2$ the velocity is Four(4) units of space per unit cycle.

For C_4 , Velocity is Eight (8) Units of space per unit cycle.

Cubic Lattice Structure of Universe

Even if no other particle exists, except one Cubit of $+C2$, it is deemed moving at a uniform velocity of Four (4) units of space per unit cycle. In this state, this Cubit can also be thought as continuously consuming space or adding space to the infinite pool of space surrounding it.

Taking these Cubits as ingredients any composite particle can be assembled. And if that particle is stable as a composition then it will provide a structure through which energy will flow in a particular pattern, thus shaping the reality. The duration of cycle for this composite particle may be totally different from base frequency (i.e. frequency cycles on the surface of Cubits)

One such hypothetical particle (though this is not a stable configuration) is demonstrated by Fig 4.3. The exposed surface of this particle has N units of negatively charged surface ($-C2$). That means for each rotation of base cycle, this particle is adding $2N$ units of space.

Let's assume that this particle is part of a particular Universe which has its own Clock Frequency determined by motion of energy in a circle larger than the base cycle. In this case the time of the Universe is πD times the time of the base cycle. Therefore one cycle of the Universe will be completed when the base clock has completed πD cycles. Hence the rest velocity of this particle with respect to clock of the Universe is $2\pi DN$ units of space per unit of Universe cycle.

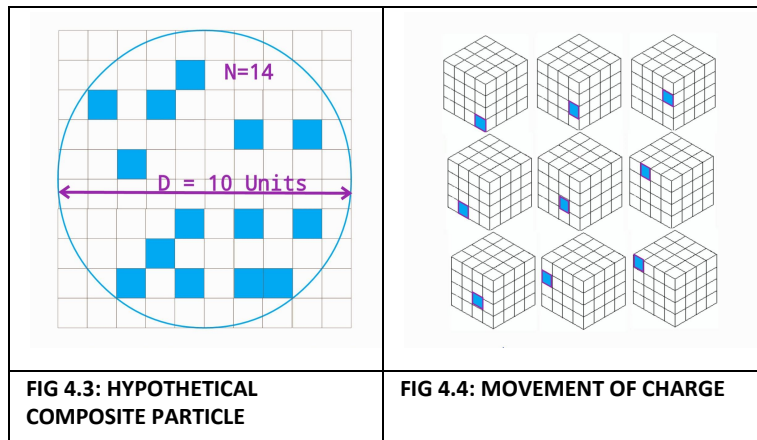

In this way, by varying N and D and assigning it to the consciousness of its inhabitants, it may be possible to create infinite number of Universes at-least in principle. However whether those Universes actually exists or not, no conclusion can ever be made about it, since the matter upon which our consciousness exercise authority belongs to this Universe, which will have a particular value of N and D . Let's not worry too much about other Universes so that we can concentrate on our Universe.

Now that we have discussed the concept of velocity at rest as the intrinsic property of particles of matter, it's time to transform this intrinsic velocity into relative motion.

Only the velocity of tub with respect to leaking water has been discussed from the movements of "The Moving Tub" of Fig 4.1. The discussion that is remaining is movement of duck with

Cubic Lattice Structure of Universe

respect to water. An idea about that movement is provided as Fig 4.4, indicating that linear motion of matter across space is only the motion of charge on the base grid, which is not changing it's position.

However, the intrinsic velocity would create a stress on the surrounding space (as shown in Fig 4.5 to Fig 4.8), which shall form the basis for creating relative motion. In these diagrams the stressed state of space is shown by various colors, whereas normal unstressed space is drawn as brown circles.

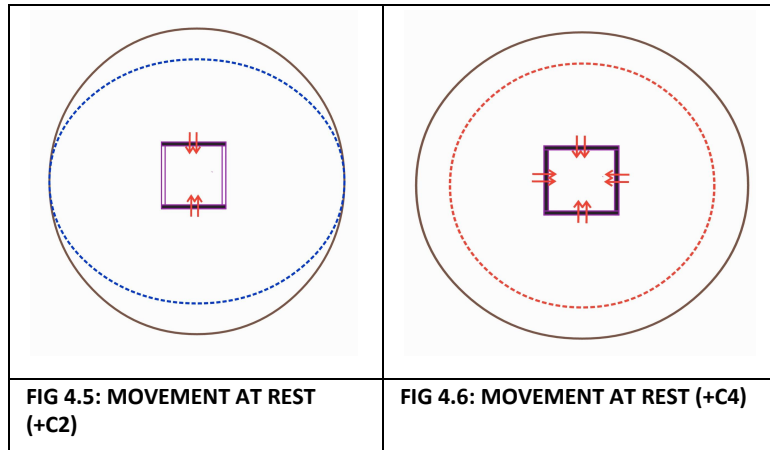

In above diagrams, both +ve charge and mass charge is inwardly pulling / absorbing the space (energy) at the rate determined by its rest velocity. In case of C4 Cubit this stress is symmetrical around the Cubit, whereas in case of +C2 Cubit, the stress is asymmetrical..

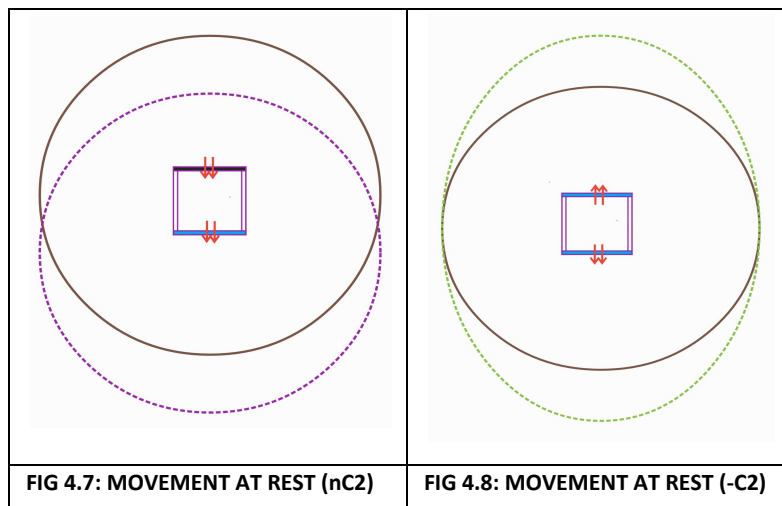

Similarly stress created by nC2 and -C2 Cubits are shown by Figure 4.7 and 4.8.

Cubic Lattice Structure of Universe

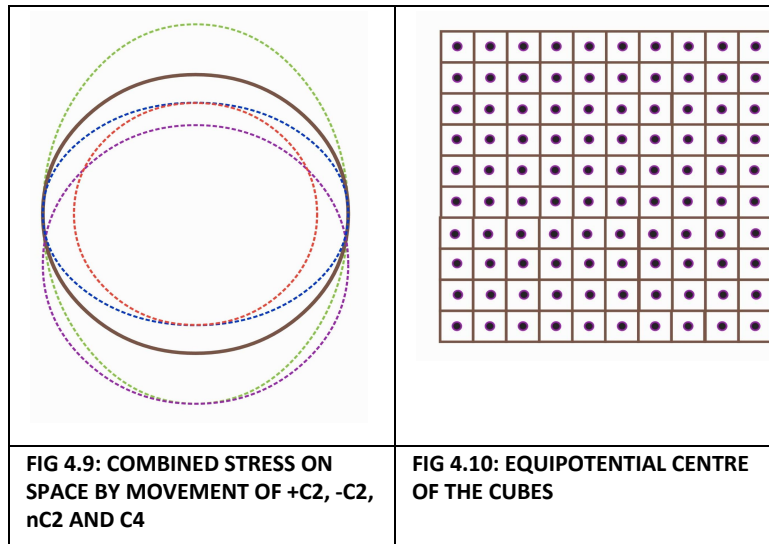

If we superimpose the stresses of all Four (4) permanently charged cubits, interesting stress profiles can be created as shown in Figure 4.9, which opens up the possibility of creating a beautiful Universe.

We have discussed previously that from where does the energy coming out of Cubits originating from and where the energy going into the Cubit does go.

This problem shall be resolved by “Equipotential Center of Cubes” as shown in Fig 4.10. These equipotential center of the cubes can be conceptualized as a common hub connected through a superconductor passing through the void of the cubes not intersecting with cyclic and linear dimensions of space as explained above. Any Cubit that allows more number of units of space to enter the void of the Cubit but less number of Cubit for exit (For Example:C4 Cubit), will have excess energy/space created within its void at every cycle of time. This excess space/energy shall have a mechanism to diffuse instantly, homogeneously and isotropically to the whole Universe through back-end superconducting path.

CONCLUSION

It shall be appreciated from above discussions that the key factor that is restricting us from discovering a unifying theory of physics, is possibly our misunderstanding about the fundamental nature of reality. Upon recognizing that the physical reality can be nothing more than our ability of perception, probing our physical senses is the first and the foremost step on the journey to unification. As such, the Cubic Lattice Structure derived from such probing of physical perception contribute to this first step by providing an alternative model to develop future theories which describes Universe as follows:

1. Universe is made of cubes(or Cubits) of infinitesimal minimum length which extends from $-\infty$ to $+\infty$ as 3-D matrix or cubic lattice structure

Cubic Lattice Structure of Universe

2. The Cubits of this infinite matrix may exist in five(5) possible geometries as C_0 , C_2 , $-C_2$, nC_2 and $+C_4$
3. Particles that are perceptible to us through our physical senses are composite macro particles made from these five(5) Cubits. It would be impossible to directly detect these Cubits but only the composite macro particles greater than a threshold size. As per this model all fundamental particles known till date are composite macro particles made from these base Cubits not directly perceptible.
4. Due to our inability to detect the base Cubits, it is also impossible to detect its actual alignment, though there exist an alignment which is indeterminate due to limitation of our perception. However relative alignment between macro particles are possible to be detected.

It is envisioned that through developing of this model, it would be possible to express all physical properties (i.e. space, time, energy, charge, momentum, temperature, velocity, force etc.) , in terms of the geometric parameters (i.e. length, surface area, volume, angle, orientation, cycles) of the base cubic lattice structure.

ACKNOWLEDGEMENT

Iffat Fatima (Wife of Author) did proofreading, formatting and first critical examination of the concept.

Ruud Loeffen (Author of Mind Blowing Gravitation), reviewed the paper and advised improvement in presentation and contents.

REFERENCES

Nil