

God seems to play dice with dual entangled pinball machines in a SuperSymmetric (SUSY) Multiverse.

Author: Leo Vuyk.
Architect. Rotterdam the Netherlands.

Abstract.

In a SUSY (Supersymmetric) multiverse, God seems to play dice with dual entangled distant Quantum pinball machines to let the quantum world and intelligent species like us humans make decisions.

Intelligent beings are lucky to become more time (0.5 sec.) to veto actions initiated by one of the other universes.

As a result:

The creation of a "democratic veto related free will" of each individual human!

In Quantum FFF Theory it is assumed that each quantum is instant entangled with one or more dual Charge Parity (anti) symmetric copy particles present in opposing multiverse bubbles embedded in the so called raspberry shaped multiverse.

Benjamin Libet measured the so called electric Readiness Potential (RP) time to perform a volitional act, in the brains of his students and the time of conscious awareness (TCA) of that act, which appeared to come 500 m.sec behind the RP.

In addition, I found recently support for a multiverse related quantum experiment done by **Giulia Rubino and Philip Walther** of Institute for Quantum Optics Vienna as a strong indication, that not only for humans but also for “ dead” quanta a possible multiverse relation could be postulated.

As a result we may say, that God seems to play dice with dual entangled distant Quantum pinball machines (universal bubbles like ours) to let the quantum world and intelligent species like us make more or less conscious decisions.

Introduction.

Benjamin Libet measured the so called electric Readiness Potential (RP) time to perform a volitional act, in the brains of his students and the time of conscious awareness (TCA) of that act, which appeared to come 500 m.sec behind the RP.

The “volitional act” was in principle based on the free choice to press an electric bell button. The results of this experiment gives still an ongoing debate in the broad layers of the scientific community, because the results are still (also in recent experiments) in firm contrast with the expected idea of Free Will and causality.

However in this essay I propose the absurd but constructive possibility that we are not alone for decision making in a multiverse as an individual person, but we seem to be entangled resulting in the possibility to initiate but also Veto an act which is even a base for Considering, Revolve, Meditate, or Ponder. Even Max Tegmark suggested already about the multiverse: “Is there a copy of you reading this article?”

We could be instant entangled with at least one instant entangled anti-copy person living inside a Charge and Parity symmetric copy Universe. In that case we could construct a causal explanation for Libet’s strange results.

New statistical difference research on RPI and RPII of repeated Libet experiments described here could support these ideas. Wikipedia says: “Democracy is a form of government in which all eligible citizens participate equally”. Free will in a multiverse seems to be based on: all entangled copy persons living in all CP symmetric copy universes, have the same possibility to Veto an act and participate equally.

The entangled multiverse solution.

If we assume that we are living inside one of the 12 copy universes, (as is proposed in ref 2) which are each others observer by “mutual instant entanglement” to trigger randomly and alternating the collapse of the copy wave functions inside all universes, (thus also to trigger a volitional act, like Libet's subjects) in the other 11 universes. Then as a consequence, we may expect that only a small part of the students will report to have had the conscious intention to act earlier. Thus in the case of 12 entangled universes we may expect that 1/12 part or 8,3 % of all (human) timing of conscious intention to act, will show a reversed timing sequence between the so called Time of conscious awareness (TCA) which will come before the electric Readiness Potential (RP). Indications of those percentages, are already found by Judy Trevena and Jeff Miller (Otago university NZ). See:

http://www.ncbi.nlm.nih.gov/entrez/query.fcgi?cmd=Retrieve&db=PubMed&list_uids=12191935&dopt=Abs

The Benjamin Libet percentage results of pre-planning (RPI) are very poor quantified in his and later experiments. Libet wrote to me in private, that these numbers where "buried" inside his files

and therefore, he was not able to produce them. In my view this is a good reason to do it again with more precision on the readiness potential percentage differences between RPI and RPII. If humans are entangled cooperating decision makers inside the postulated 8 or 12 entangled but separated universes, then for every decision we need always only one preplanning test-person who pre-plans his choice. The other 7 or 11 test copy-persons are only able to follow OR VETO this decision.

Free Will with Veto action, as a base for Considering, Revolve, Meditate, or Ponder. according to Q-FFF Theory inside a 12 fold instant entangled Multiverse.

2 Diagrams of a 12 fold Raspberry Multiverse showing preplanning (RPI) of one of the instant entangled copy subjects in the Benjamin Libet lab, with- and without a Veto action of one of the copy subjects.(according to Quantum FFF Theory)

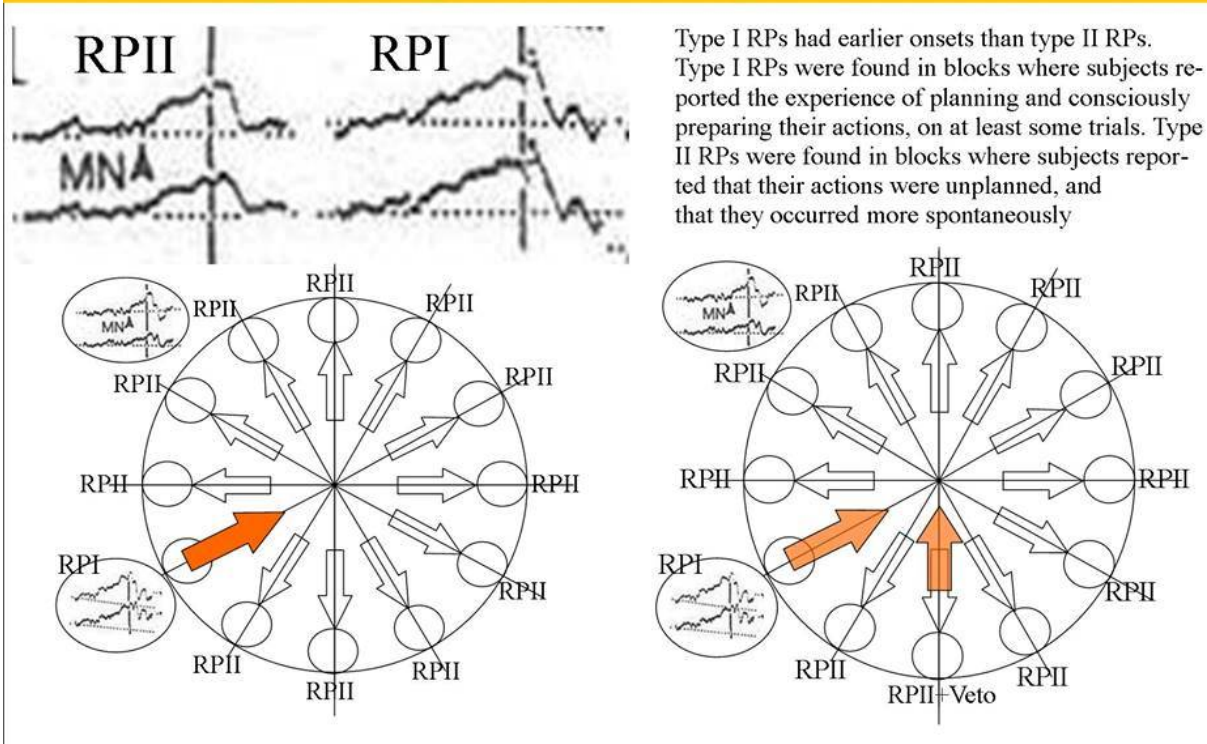

Figure: 1. Diagrams of a 12 fold Raspberry Multiverse showing preplanning (RPI) of one of the instant entangled copy subjects in the Benjamin Libet lab, with- and without a VETO action of one of the copy subjects.(according to Quantum FFF Theory)

The Veto subject closes the decision process but he or others could start a new process with a RPI action over again !!! as a base for : Considering, Revolve, Meditate, or Ponder. Type I RPs had earlier onsets than type II RPs. Type I RPs were found in blocks where subjects reported the experience of planning and consciously preparing their actions, on at least some trials. Type II RPs were found in blocks where subjects reported that their actions were unplanned, and that they occurred more spontaneously

Recent support for a multiverse related quantum experiment done by **Giulia Rubino** and **Philip Walther** of Institute for Quantum Optics Vienna as a strong indication, that not only for humans but also for “dead” quanta a possible multiverse relation could be postulated.

See also: "Experimental Verification of an Indefinite Causal Order"

<http://arxiv.org/pdf/1608.01683v1.pdf>

SUSY Multiverse: God plays dice with dual distant pinball machines. (Q-FFF Theory)

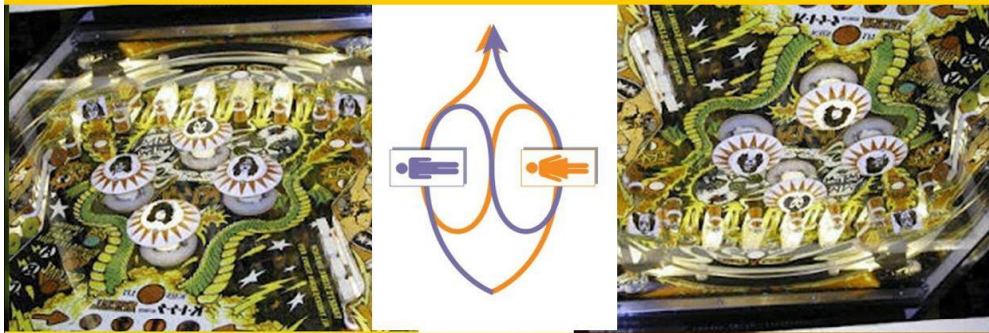

Authors: Giulia Rubino and Philip Walther of: Quantum Optics, -Nanophysics, -Information Group, Faculty of Physics, University of Vienna. Below: 2016.

Who's on first? It's hard to say...

Alice and Bob can both alter the quantum state of a photon as it passes them by, producing a different result depending on the order they act. But if the path of a photon is in a quantum superposition, it's impossible to say who went first

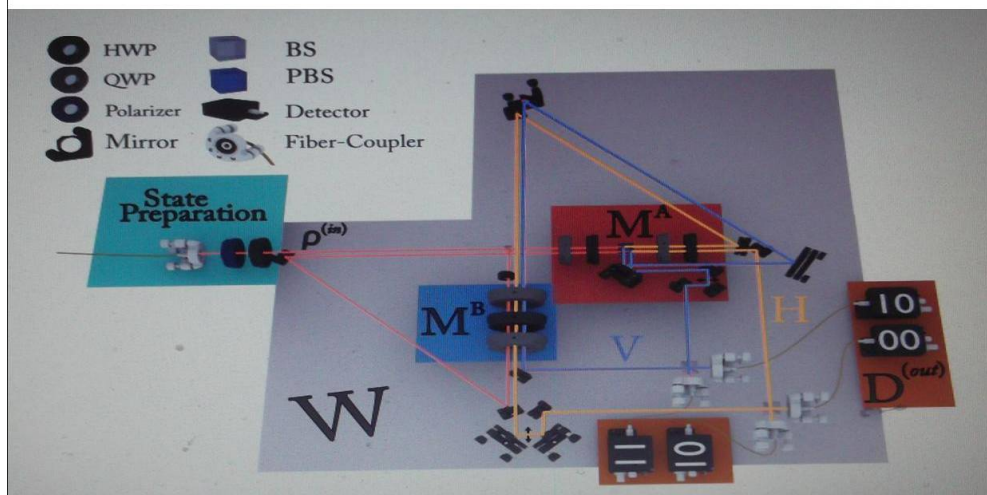
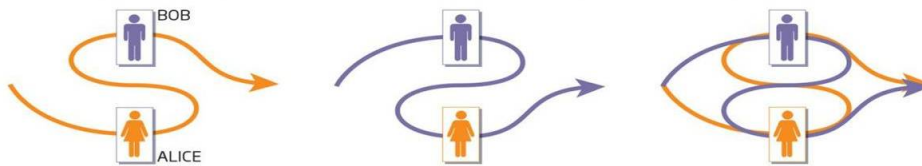

Figure 2. combined poster as indication for the



Raspberry shaped entangled oscillating Pinball Multiverse.

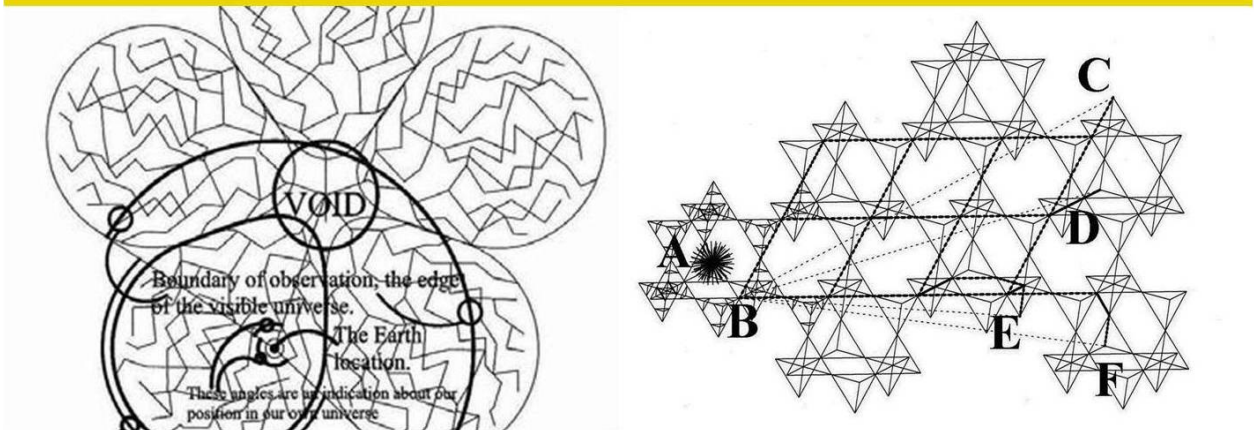
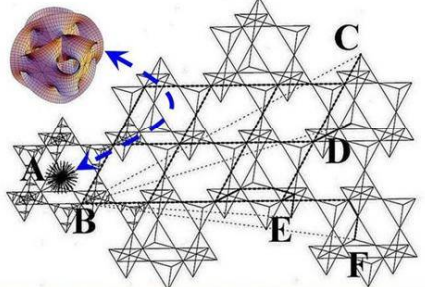

Figure 3. rough sketch as support for the multiversal pinball machines.

The massless chiral Axion/Higgs oscillating dark energy vacuum field with a Topological superconductor function.

The massless transformable Axion /Higgs particle is supposed to act as the mother of all single and compound rigid string particles fermions/neutrinos, photons etc.

Topology of the Oscillating Chiral Higgs field vacuum structure, with Dark Matter Quantum Knots inside Black Hole Nuclei, as the second energetic element to make the Multiverse a cyclic self organising system.



Photon trajectories through the tetrahedral oscillating Higgs vacuum lattice. (Acc. to Quantum FFF Theory)
 A: a real shaped Photon is created by Higgs collision with a dual axis spinning (Calabi Yau) Fermion propeller.
 B: that Photon transfers CODED form information (monopole photon info) and direction information into one Higgs particle which transfers this information by mutual Higgs collisionary oscillations through the vacuum in one specific direction. C,D,E,or F.
 I: Only magnetic photonic information (2x : North and South) are subject to curvature by an undisturbed symmetric oscillating vacuum
 II: Local Anti-Symmetric Oscillating vacuum Frames are influenced by massive objects like the earth and responsible for semi relativistic effects.
 III The vacuum lattice has helix- or chiral quality being the origin of our material universe.



Dark Matter Quantum Knots inside BH Nuclei.



New Dark Matter Black Hole, "Eat" the chiral oscillating Higgs vacuum. (Quantum-FFF Theory)

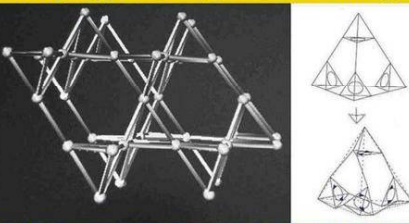

Simplified tetrahedral vacuum lattice structure (left), constructed by complex chiral tetrahedral building blocks (right). Each universe has to choose between a left- or righthanded rotation of its tetrahedral building blocks. Each chiral lattice...

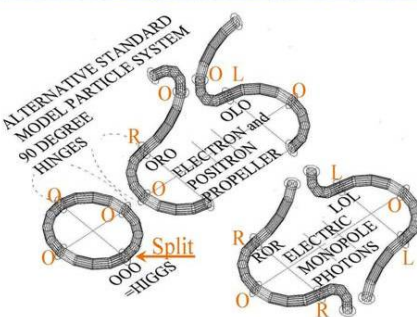

ALTERNATIVE STANDARD MODEL PARTICLE SYSTEM
 90 DEGREE HINGES
 ORO ELECTRON and POSITRON PROPPELLER
 OOO = SPLIT = HIGGS
 ROR ELECTRIC MONOPOLE PROTONS

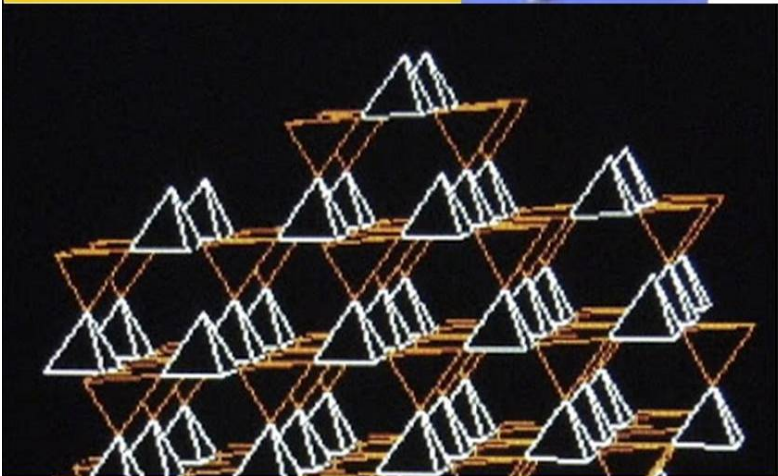

3-D image of TWO tetrahedron space fill units with chiral, left or right handed characteristics, the origin of our material universe and our opposite anti-matter universe.

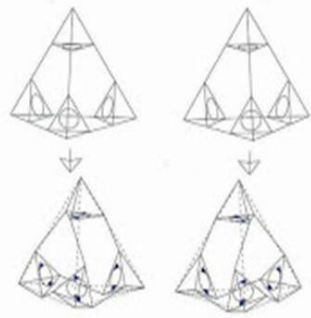

Space fill unit with RIGHT hand rotation. Space fill unit with LEFT hand rotation.

Truncated tetrahedron space according to the Quantum-FFF model. Each tetrahedron lattice has a spiral shape based on three linear units

Figure 4. Some elements of Quantum FFF Theory. (Function Follows Form)

Conclusion,

In an entangled multiverse, the base for Free Will is the possibility to VETO an act or decision. (as Libet also suggested) The intention or preplanning for a decision to make or an act seems in fact to be equal important for the decision as the possibility to VETO the act. As a result we may be able to measure (in the future) the number of copy universes involved for decision making, by counting the average percentages of preplanning persons (subjects) in test situation like the Libet test.

For 12 universes the RPI percentage will be $100/12=8,3\%$. For 8 universes RP I will be 12,5% For RP II it will be 91,7 respectively 87,5% The time span between RPI and RPII seems to be very important for the creation of free will, because if this time span decreases, then the chance of vetoing an act will become minimal. The Human quality of : Considering, Revolve, Meditate, or Ponder could be direct related to it.

In contrast, I assume that animals have smaller veto times than 0.5 sec to generate free will ?

Reference:: Democratic Free Will in the instant Entangled Multiverse

<http://vixra.org/pdf/1401.0071v2.pdf>