

Reaction less EM Drive Thruster by Anti Maxwell Dead Zone around a Wire.

Leo Vuyk,
Architect, Rotterdam, the
Netherlands

Abstract.

A so called EmDrive defy classical physics expectations because it shows repellent less or reaction less thruster qualities.

According to Quantum FFF Theory (Function Follows Form at the quantum level) the magnetic quantum field has always TWO different shaped monopole vector components: a North- and a South vector field component. This is comparable with the electric Quantum field, equipped with Plus and Minus vector components but it is in contrast with all other quantum fields like the neutrino- gravity-or x-gamma ray field.

After interference of the magnetic wave with a real spinning propeller shaped Fermion particle, TWO real monopole magnetic photon particle based waves from opposite direction will collapse and come to life as two real rigid shaped photons, as the result of two individual mutated oscillating Axion-Higgs field particles from the vacuum. These photons should do the magnetic job by interlocking temporarily with the Fermion, and give the Fermion a push to the left respectively a push to the right fully in line and according to the Lorentz force law. However, based on observation of iron filing-powder patterns close to direct currents in a wire, it is assumed that these monopole (N+S) particle/ wave dualities travel only locally parallel to each other without a magnetic field effect inside the Higgs field.

This in contrast with the natural opposing curvature of the so called B field. .As a result, the magnetic field strength- created by the wire itself-locally drops down to zero, with a up to zero reduced Lorentz force on the iron filing atoms.

As a consequence, this is in contradiction with Maxwell's magnetic field law around an electric direct current wire and I call it the "tubular local magnetic dropping zone" (dead zone) around the electric wire, which can be used for reaction less drive propulsion and Levitation in combination with different forms of strong tubular or spiral magnets.

Magnet optimisation is suggested to form spiral configurations of high performance magnet plating with spiraling electric coils in between.

The Lorentz force created on the wire by the static magnetic field of the tubular or spiral magnet (s) is supposed to be the only force in the system, by the absence of a reaction force on the magnet due to the local magnetic dropping zone.

Three circular anti-Maxwell propulsion systems in triangle configuration, should be enough to create stable piloting and flight Experiments with coiled magnetized iron tubes has already shown this new physics reaction less propulsion effect.

Introduction.

Recently professor, Neil Turok said about the problematic understanding of our world of physics: “And so we have to go back and question those founding principles and find whatever it is, whatever new principle will replace them”. see: <http://www.cbc.ca/radio/ideas/the-ultimate-simplicity-of-everything-1.3490322> By chance Quantum FFF Theory is based on some forgotten ideas of well known scientists.

It was **Abdus Salam** who proposed that quarks and leptons should have a sub-quantum level structure, and that they are compound rigid particles with a specific non-zero sized form.

Jean Paul Vigier postulated that quarks and leptons are "pushed around" by an energetic sea of vacuum particles.

David Bohm suggested in contrast with The "Copenhagen interpretation", that reality is not created by the eye of the human observer, and second: elementary particles should be "guided by a pilot wave".

John Bell argued that the motion of mass related to the surrounding vacuum reference frame, should originate real

"Lorentz-transformations", and also real relativistic measurable contraction.

Richard Feynman postulated the idea of an all pervading energetic quantum vacuum.

He rejected it, because it should originate resistance for every mass in motion, relative to the reference frame of the quantum vacuum.

However, I postulate counter intuitive possibility, that this resistance for mass in motion, can be compensated, if we combine the ideas of Vigier, Bell, Bohm and Salam, and a new dual universal Bohmian "pilot wave", which is interpreted as the EPR correlation (or Big Bang entanglement) between individual elementary anti-mirror particles, living in dual universes.

So my proposal is based on a Rigid String Theory with real rigid strings able to mutate and merge by form based interlocking.

See: <http://bigbang-entanglement.blogspot.nl/2016/03/the-quantum-fff-theory-function-follows.html>

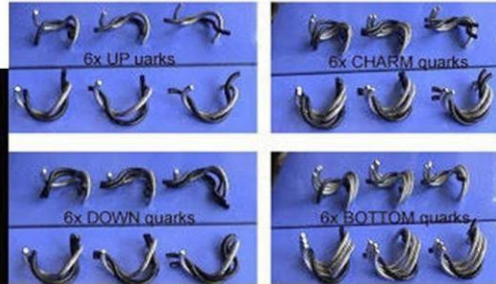
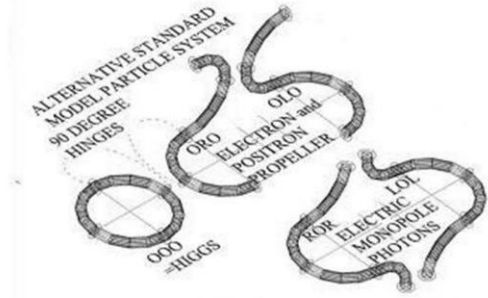
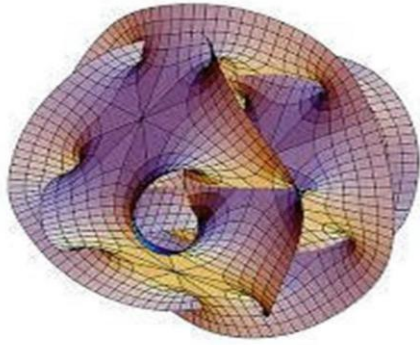

Calabi Yau structures by the dual axis spin of Fermions, according to Quantum FFF Theory.

Figure 1 Several sub quantum shaped particles suggested by Quantum FFF Theory

Anti Maxwell magnetic field reduction close to an electric wire.

Explained by detail observation of iron powder distribution (the ring shaped absence) around a wire or coil. Below: Several observations and explanation by the curvature of monopole quantum information arrays.

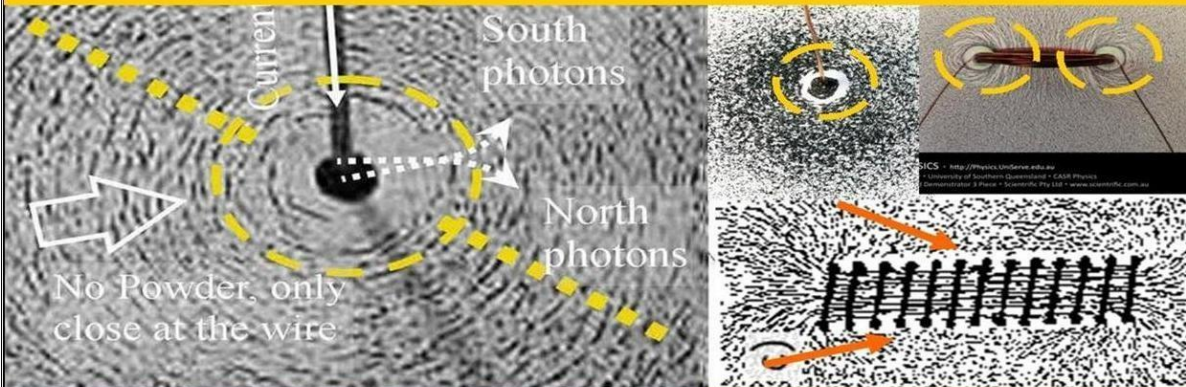

According to Quantum FFF theory, all magnetic fields can be presented as DUAL Magnetic Monopole Photon Vector Arrays. These monopole arrays undergo curvature. As a result, the magnetic field intensity around the Earth and a wire is NOT dropping off with the square of the distance from the source!! The field become stronger polarized away from the source (See images). Close to the current transporting wire the magnetic field strength is zero due to the parallel trajectories of North and South Photons before curvature and polarisation of iron powder (Author: Leo Vuyk)

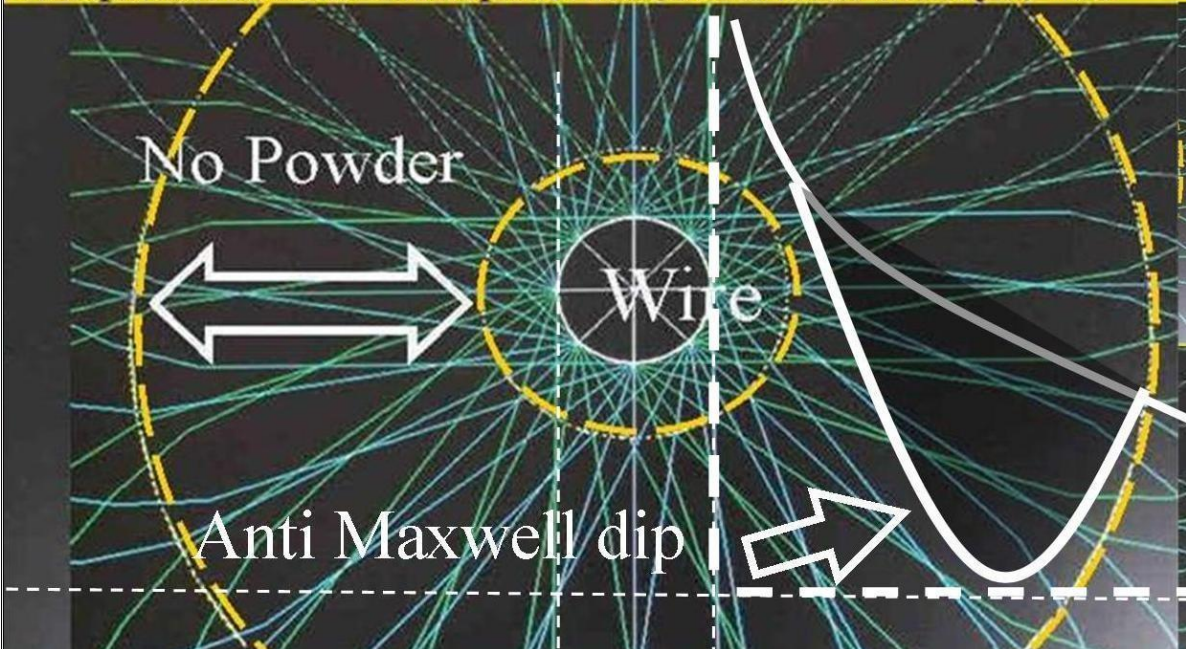
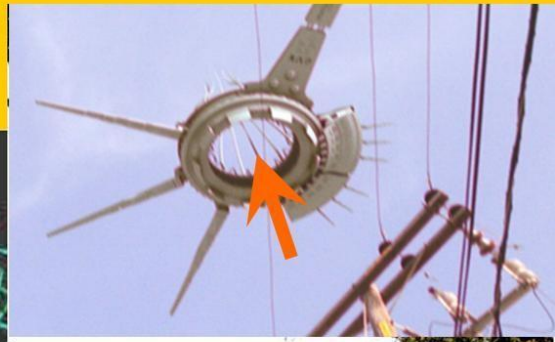

Figure 2 Anti Maxwell magnetic field strength reduction close to an electric wire.

Examples of Anti-Maxwell reactionless anti gravity propulsion by a direct current coil wound around coaxial magnetized metal rods (see Big Basin Ufos and Sundara Vimana ancient Babylon)

Reaction less space propulsion principle based on a so called "Anti Maxwell zone" around a direct current in a wire. According to Quantum FFF Theory based dual (North and South) magnetic photon monopole model.



Big Basin Ufo California

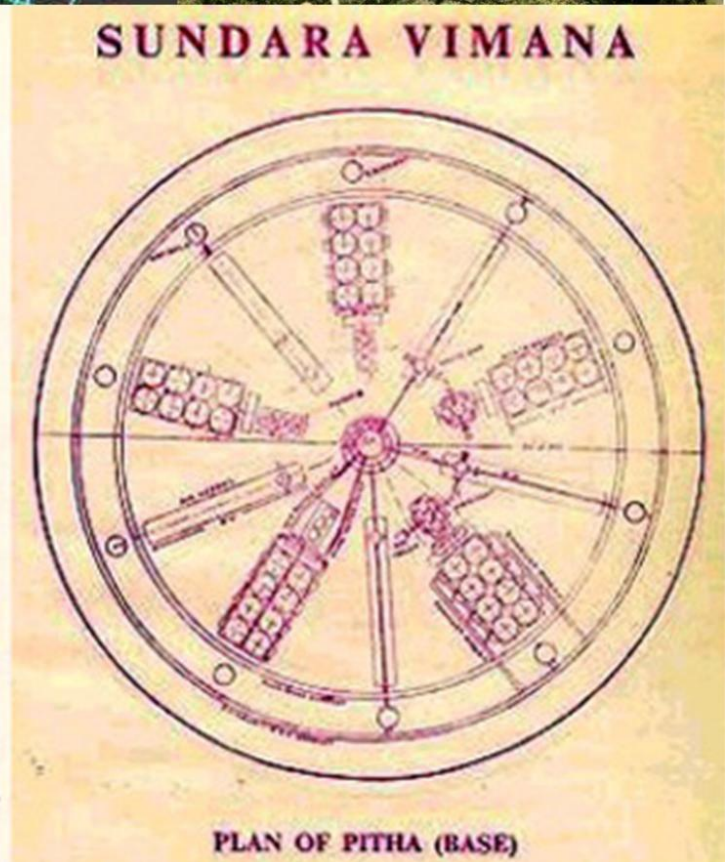
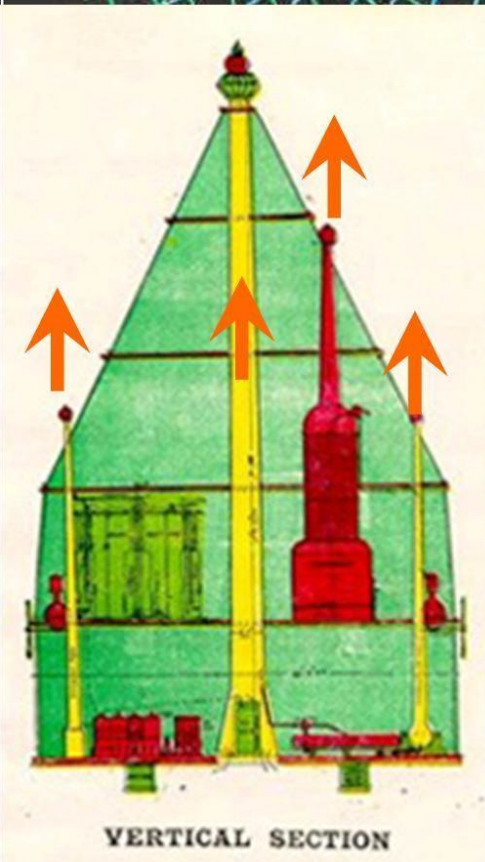

Figure 3. Examples of suggested historical Anti Maxwell reaction less space propulsion.

Construction phase of the LeoVuyk EM drive principle experiment, based on Q-FFF monopole theory.

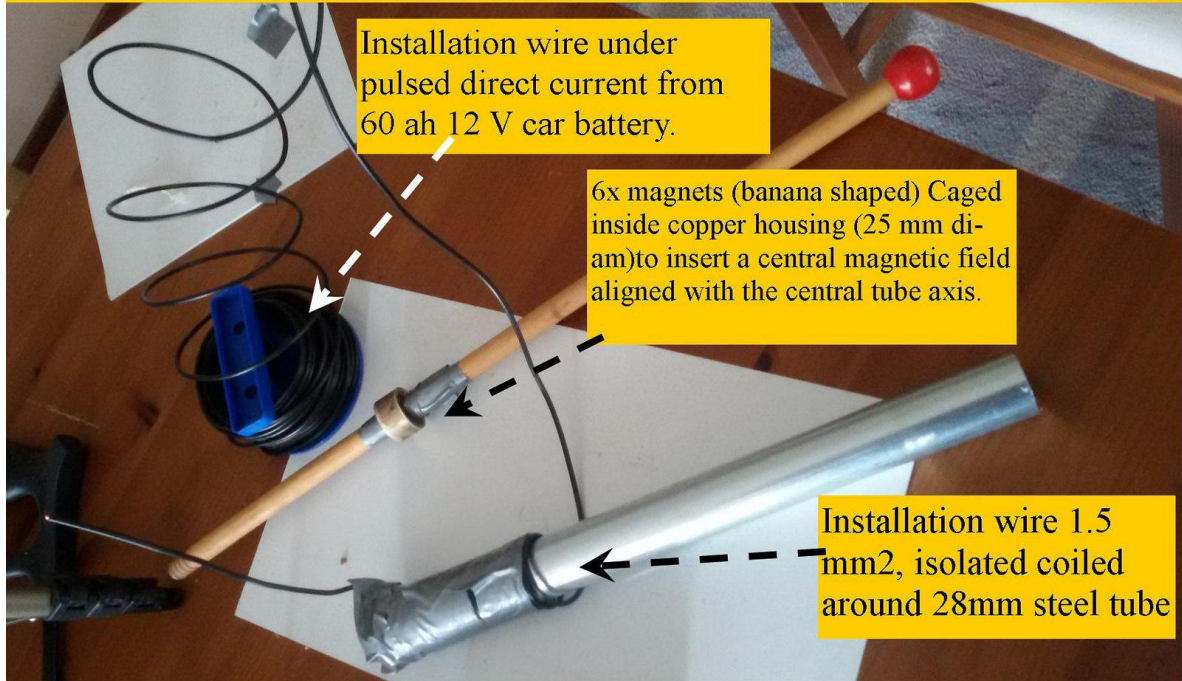

Figure 4,

Simple experiment to show EM drive effect between a 12 V car battery driven current in a coil around a magnetized tube according to Quantum FFF Theory.

Construction phase of the LeoVuyk EM drive principle experiment, based on Q-FFF monopole theory.

For the monopole principle see also: <http://vixra.org/pdf/1708.0170v1.pdf>

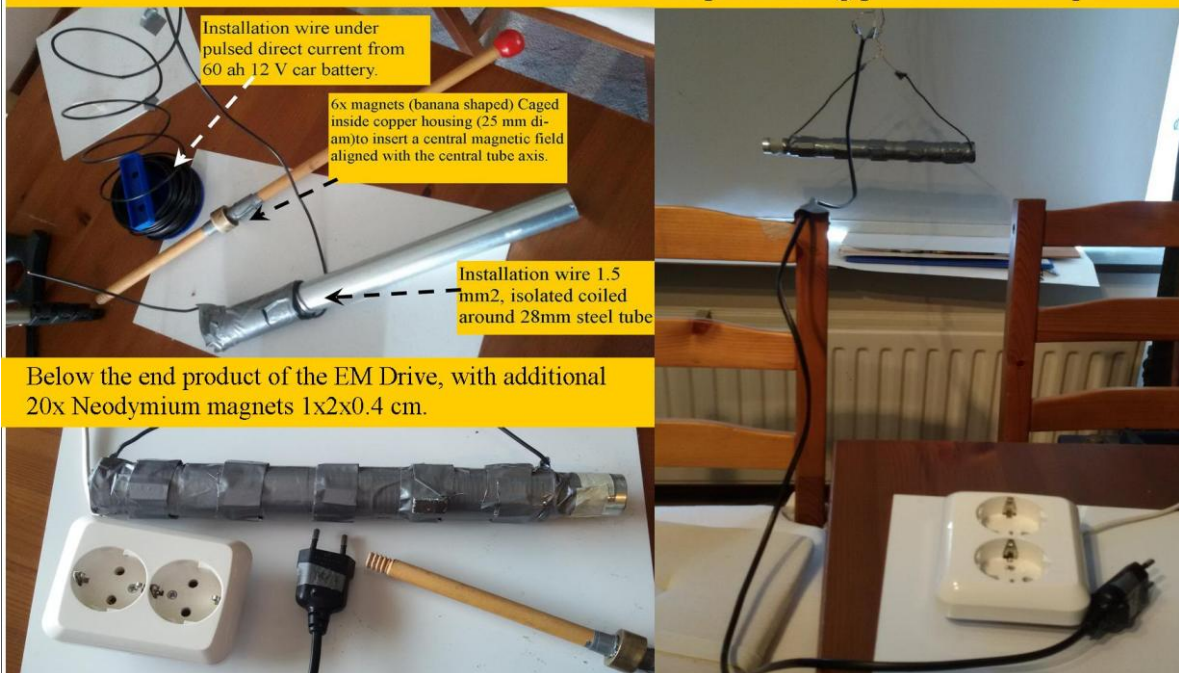
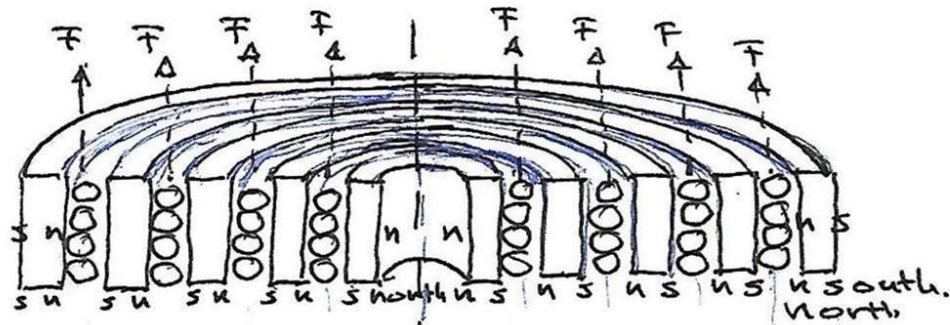
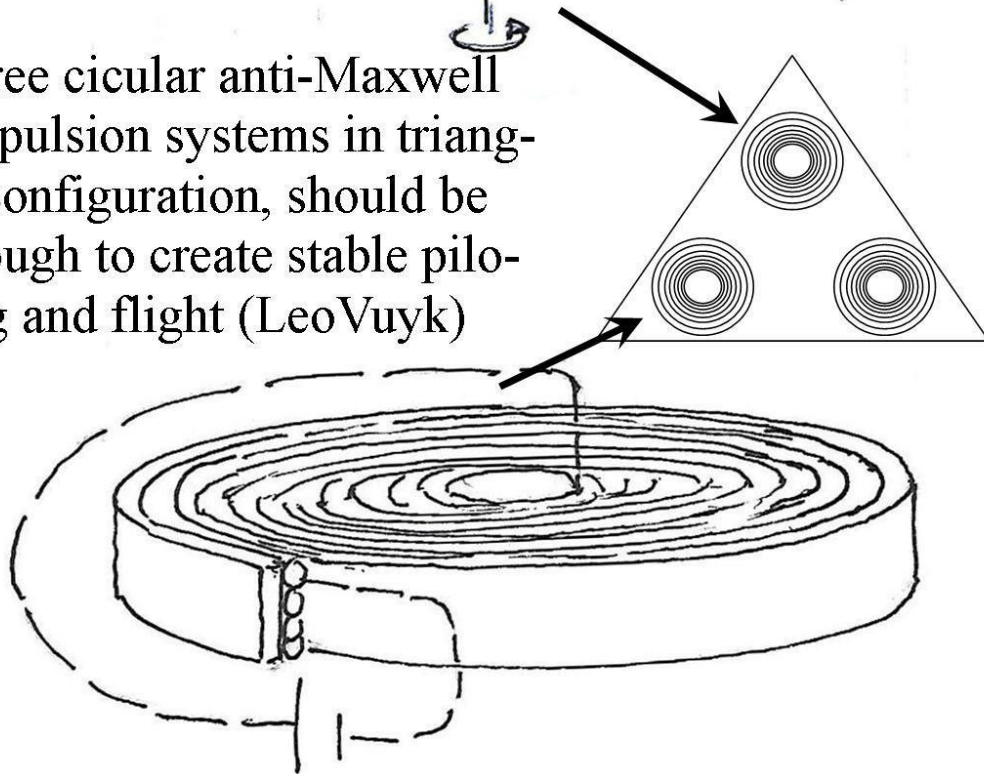

Figure 5,

Anti-Maxwell Magnetic dip around a wire, for reaction less space propulsion



Three circular anti-Maxwell propulsion systems in triangle configuration, should be enough to create stable piloting and flight (LeoVuyk)



New physics of Rigid String Theory called “Quantum FFF Theory”, as a base for new understanding of Anti-Maxwell magnetic field distribution around a wire. And reaction less propulsion.

Figure 6, improved Anti Maxwell reaction less space drive magnet in spiral form alternative..

Additional information about Q-FF Theory.

LHC 125,750+XXX GeV, Higgs presented as 3D Quantum knots.

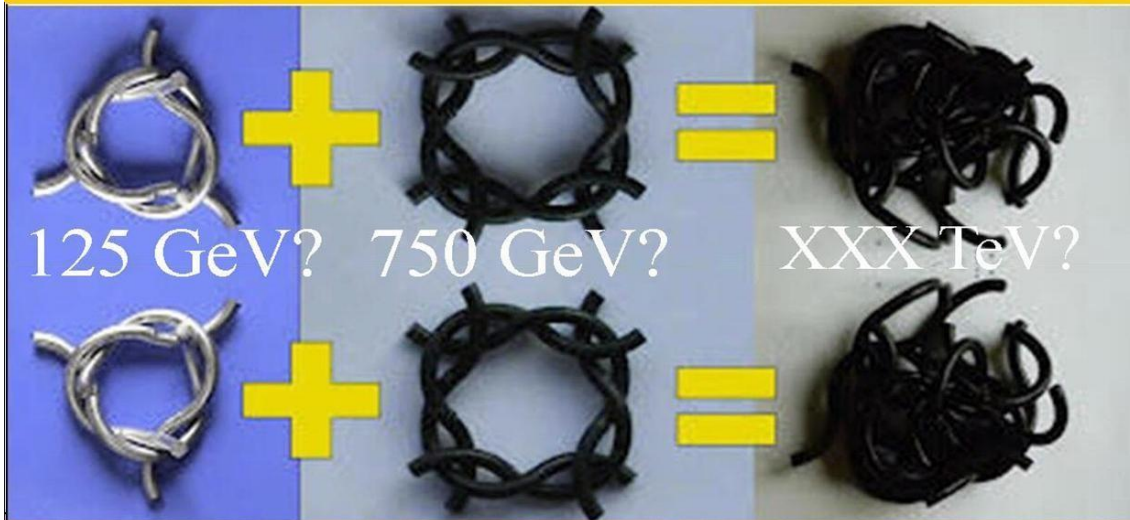

According to Q-FFF Theory, the single Higgs vacuum particle itself is massless. However merger particles could for different Quantum Knots with various masses and shapes.

MAJORANA particle's placed in the new extended standard model based on Q-FFF Theory. OOU is e-e+ related, UUU, LUL,RUR are Neutrino related. Called sterile Neutrinos.

The coding of Single Elementary Particles is based on the so called "rotational click positions" of the three hinges, which are assumed to be regularly placed over the ring shaped Higgs "Quasron Torus Particle" (page 2). This ring has one splitting point and three hinges which have consecutively four 90 degree click positions each. The best Torus ring diameter ratio to click-on is about 1/7. The ring coding of the hinge positions is as follows.

Explanation of the codes:
 U= 1/4 rotation (180 degrees)
 O= Unchanged circle
 L= Left rotation (90 degrees)
 R= Right rotation (90 degrees)

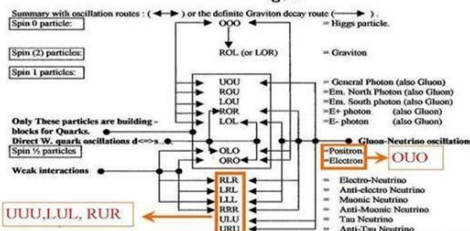

Higgs particles are supposed to oscillate in Tandem along so called linear Vacuum Lattices, two by two in opposite directions, as the symmetrical opposite pistons of a boxer engine, as the origin of all energy, spin and mass effects. This enables the "Tandem Higgs particles to change the form of their own" Torus into an Electron and Positron pair at

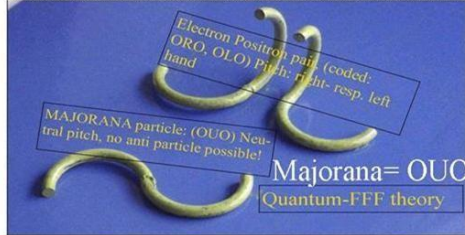

Geometrical proposal for most particles building the universe

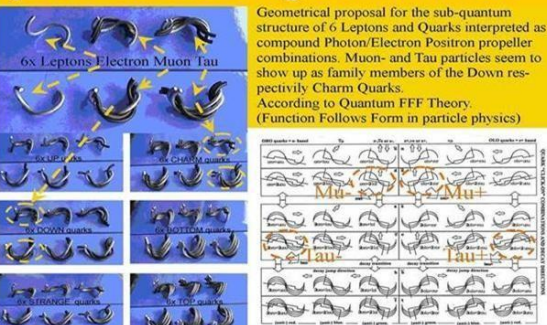

Geometrical proposal for the sub-quantum structure of 6 Leptons and Quarks interpreted as compound Photon/Electron Positron propeller combinations. Muon- and Tau particles seem to show up as family members of the Down respectively Charm Quarks. According to Quantum FFF Theory. (Function Follows Form in particle physics)

All Photons (1x. graviton, 2x electr.- 2x magnetic- and 1x general (x-gamma-ray) photon) and two Fermions (Electron + Positron) are formed direct out of the "Mother" ring shaped Higgs particle, by internal hinge rotation (below). Dark Matter particles are supposed to be formed by interlocking 3 or 4 photons (below). Neutrinos are deformed photons or fermions. (not shown) See Quantum FFF Theory. (Function Follows Form) <http://vixra.org/abs/1103.0002>



Figure 7, particle schemes of Quantum FFF Theory.

Quantum FFF Theory (Function Follows Form) is based on Non-Local Realism and Rigid String particles guided by dual copy-universal entanglement.

Quantum FFF Theory is based on Non-Local Realism and rigid stringy Higgs particles able to mutate into all other particles.

The CP(T)-symmetrical raspberry shaped multiverse (with 8-12 berries) is non local instant connected down to each quantum. Each quantum can be visualised as a deformed Higgs ring able to convert into other shapes and able to form compound structures like quarks, muons or even Tau leptons. So realism (cogwheels) connected by symmetric non-local instant entanglement.

The basic elements:

- 1: Black holes (BHs) are the same as Dark Matter, they all consume photons, even gravitons and the Higgs field, but REPEL Fermions due to their propeller shape polarisation away from the BH. They produce electric charged plasma.
- 2: Dark Energy is the oscillating (Casimir) energy of the Higgs Field equipped with a tetrahedron lattice structure with variable Planck length around black holes.
- 3: Quantum Gravity = Dual Push gravity= Attraction (Higgs-Casimir opposing Graviton push).
- 4: The Big Bang is a Splitting dark matter Big Bang Black Hole (BBBH), splitting into smaller Primordial Big Bang Spintars (PBBS) forming the Fractal Lyman Alpha forest and evaporating partly into a zero mass energetic oscillating Higgs particle based Higgs field.
- 5: Dual PBBSs hotspots, produce central plasma concentration in electric Herbig Haro systems as a base for star formation in open star clusters as a start for Spiral Galaxies.
- 6: Spiral Galaxies will keep both Primordial Dark Matter Black Holes as Galaxy Anchor Black Holes (GABHs) at long distance.
- 7: After Galaxy Merging, these GABHs are the origin of Galaxy- and Magnetic field complexity and distant dwarf galaxies.
- 8: Black Holes produce Plasma direct out of the Higgs field because two rigid massless but mutable Higgs particles are convertible into symmetric electron and positron (or even dual quark-) propellers (by BH horizon fluctuations).
- 9: The chirality of the (spiralling) vacuum lattice is the origin our material universe. (propeller shaped positrons merge preferentially first with gluons to form (u) Quarks to form Hydrogen with electrons.
- 10: The first Supernovas produce medium sized Black Holes as the base for secondary Herbig Haro systems and open star clusters.
- 11: ALL Dark Matter Black Holes are supposed to be CHARGE SEPARATORS with internal positive charge and an external globular shell of negative charged Quark electron plasma.
- 12: The lightspeed is related to gravity fields like the earth with long extinction distances to adapt with the solar gravity field.
- 13: Quantum FFF Theory states that the raspberry shaped multiverse is symmetric and instant entangled by so called WORMHOLE BRIDGES (ER=EPR) down to the smallest quantum level between different raspberry berries-universes. Nonlocal entangled down to each quantum and even living or dying CATS in BOXES.
- 14: Large Primordial Big Bang Spintars (PBBS) are responsible for the creation of the Lyman Alpha forest structure and first spiral galaxy forming of the universe, but they seem to be also responsible for the implosion of the universe at the end in the form of Galaxy Anchor Black Holes (GABHs) located mainly outside galaxies. see: (Quasisoft Chandra sources)

15. As a consequence of 12-14, Time is always local time in combination with cyclic period time of the multiverse.

16. If our material universes has a chiral left handed oscillating Higgs field, then our material Right Handed DNA helix molecule could be explained. However it also suggests that in our opposing symmetric ANTI-MATERIAL entangled neighbor universe the DNA helix should have a Left handed spiral.

According to Max Tegmark: in an entangled multiverse we may ask: is there COPY PERSON over there, who is reading the same lines as I do? If this COPY person is indeed living over there, then even our consciousness should be shared in a sort of entangled DEMOCRATIC form. Then we are not alone with our thoughts and doubts, see: Democratic: Free Will in the instant Entangled Multiverse.

17. All particles and waves should be entangled with anti-copy particles and Higgs field based waves in our opposing anti universes. Then wave particle duality and the so called one particle double slit interference could be explained by accepting that real shaped 3D photon particles only exist in their function of Gluons. However Gluons should transfer form information to the oscillating luminiferous Higgs field ether, within about 1 cm distance from a fermion.(see: Babcock and Bergman anomaly,1964)

18. Different elementary particles have different qualities by their different complex stringy shape. Leptons and Quarks have a propeller shape with left or right handed pitch creating charge difference. Gluons, Photons and Neutrino particles have no pitch.

20 All particles can be converted to one or more Higgs particles, Lepto Quarks can be compound particles.

21 All particles are assumed to be present as Higgs particles already in the cyclic Big Bang Black Hole (BBBH) after the former multiverse has collapsed into a Big Crunch Black Hole.

22. We seem to live inside one material universal bubble of an instant entangled (Charge Parity Time) CPT symmetric raspberry bubble multiverse. Each quantum jump or wave function collapse or human choice is guided by this instant entanglement at long distance.

If our material universes has a chiral oscillating Higgs field, then our material Right Handed DNA helix molecule could be explained.

However it also suggests that in our opposing ANTI-MATERIAL multiverse neighbour universe the DNA helix should have a LEFT HANDED spiral. According to Max Tegmark: in an entangled multiverse we may ask: is there COPY PERSON over there, who is reading the same lines as I do?

If this COPY person is indeed living over there, then even our consciousness should be shared in a sort of DEMOCRATIC form.

Then we are not alone with our thoughts and doubts,see: Democratic: Free Will in the instant Entangled Multiverse.

Conclusion, Quantum FFF Theory is based on Non-Local Realism. The CP(T)-symmetrical raspberry shaped multiverse (with 8-12 berries) is non local instant connected down to each quantum. Each quantum can be visualised as a deformed Higgs ring able to convert into other shapes and able to form compound structures like quarks, muons or even Tau leptons. So realism (cogwheels) connected by symmetric non-local instant entanglement. vixra.org/pdf/1401.0071v2.pdf

Figure 8, Quantum FFF Theory as Non- Local Realism and Rigid Strings.

The NEW Plasma Creating Electric Black Hole versus the Hawking Black Hole, according to Quantum FFF Theory, the origin of Comet - Sunspot -BL mystery.

How massive galaxy clusters are formed in the early Universe, according to Quantum FFF Theory, the Big Bang process is the result of a fractal shaped splitting and evaporating BB dark matter black hole process creating the Lyman Alpha forest of galaxy distribution, by the expansion of BH "spines" (14) the oscillating Higgs field vacuum is created by the so called "Branched inflation". Restricted black hole clusters (13) do not evaporate to Higgs vacuum pressure, but create plasma "balls" pushing them away from the center of gravity in search for a partner to form a Herbig Haro system (16,17).

"Branched inflation" of the Universe: the Origin of Filaments and voids.

New Super Novas, Black holes.

The origin of the Lyman Alpha forest is caused by the splitting of the Big Bang Black Hole (BBBH) into smaller Primordial Big Bang Spintars (PBBS) forming the Fractal Lyman Alpha forest and evaporating partly into a zero mass energetic oscillating Higgs particle based Higgs field.

The unstable tail swing is guided by external gravity sources like the opposing micro black hole gravity and other more distant (Nebula) sources.

Black hole leaving the propeller place for stable Herbig Haro location (A) or unstable gas PILLAR creation (B).

Gas tail

Gas tail

The new paradigm of star/galaxy formation and dying

Based on the new paradigm of Fermion repelling and creating black holes.

Electric dark matter black holes seem to have the intelligence to pair by self propulsion with other BHs of comparable size to form Herbig Haro systems with star formation in between. (according to Quantum FFF Theory)

Dwarf Galaxy formation between Galaxy Anchor Black Holes (GABHs) as the Origin of stellar migration forming Polar Ring Galaxies. More GABHs means more Dwarfs means more sources for Stellar migration and bulge formation, according to Quantum FFF Theory.

More Galaxy Anchor Black holes means more Dwarfs

Comparison between Polar ring galaxies and Primordial early galaxy formation between two Galaxy Anchor Black Holes

Dual electric Dark Matter Black Holes are the origin of gas creation, concentrated by electric currents and magnetic fields of Herbig Haro systems.

Below: Merging spiral galaxies with dual Herbig Haro object (Black Hole) systems, original connected by x-ray jets between multiple Electric Dark Matter Black Holes.

Galaxy Merging means more GABHs

More Galaxy Anchor Black holes means more Dwarfs

Galaxy Merging means more GABHs

More Galaxy Anchor Black holes means more Dwarfs

Giant galaxies die from the inside out. Star formation shuts down in the centers of elliptical galaxies first.

According to Quantum FFF Theory, Galaxy- and Cluster black hole hierarchy is the origin of dying galaxies where star formation in the center stops. X-ray point sources (Dark matter black holes) in Virgo and Fornax cluster centers present evidence for black hole hierarchy: the smallest BHs are located in the centers and are not any more able to create Supernova black holes large enough to form Herbig Haro systems with star formation in between. The result: Dying "red and dead" galaxies as the start of Universal contraction and collapse (Big Crunch) in a cyclic multiverse.

Below: Example of the galaxy black hole hierarchy model observed at Andromeda (M31 below left) and the Sombrero galaxy (M104 right).

New class of 'dark' globular star clusters discovered around giant galaxy Centaurus A. Evidence for GABHs of Quantum-FFF Theory.

Figure 9, New paradigms according to Quantum FFF Theory.

Gravity direction dependent Lightspeed differences around the earth by ellipsoidal LASOF shaped frame dragging, measured even already by the LISA Pathfinder?

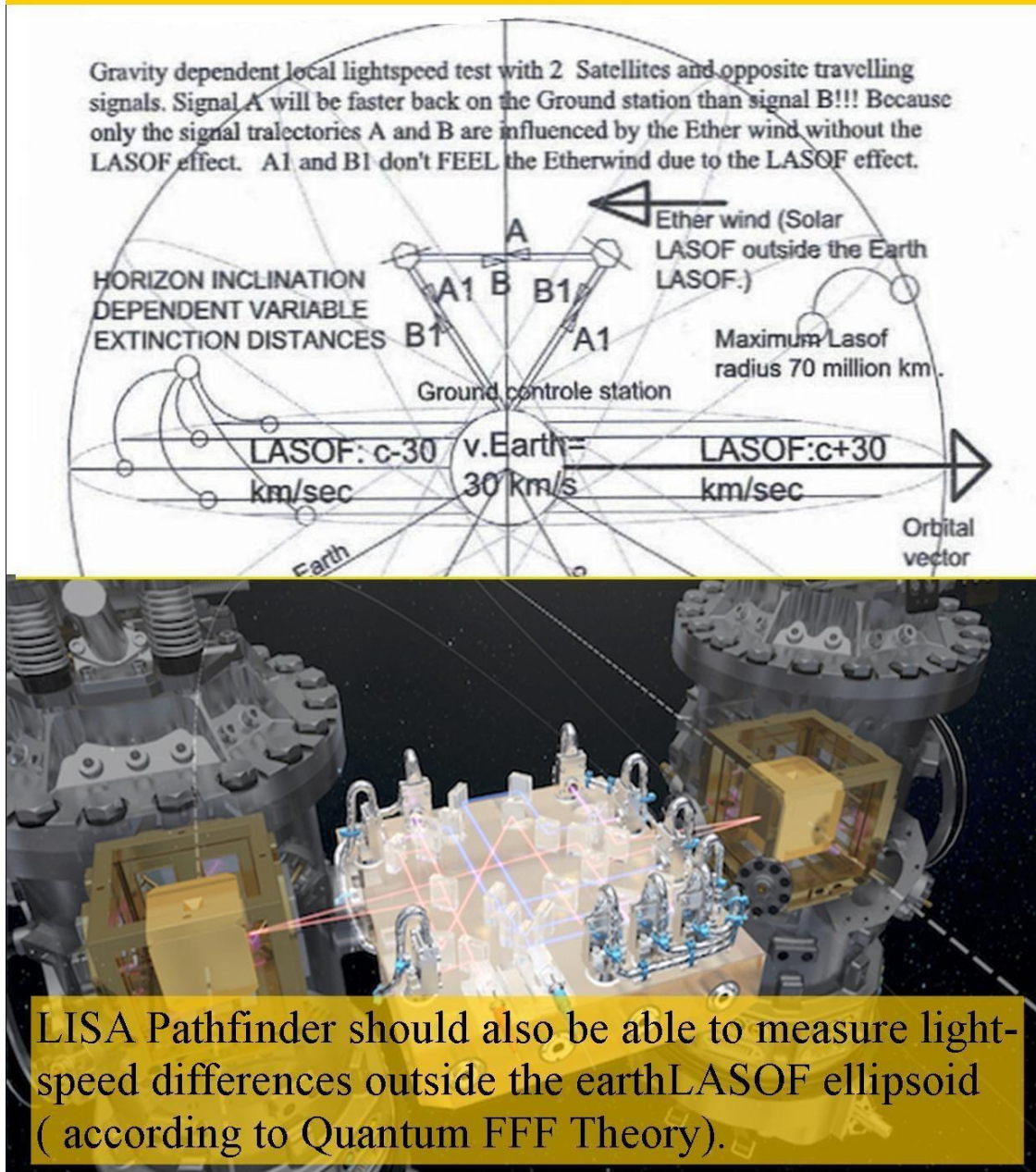

Figure 10, Gravity dependent lightspeed anomalies.

Pathfinder should also be able to measure lightspeed differences outside the earth LASOF ellipsoid (according to Quantum FFF Theory: Function Follows Form).

LASOF = Local A-Symmetrical Oscillating Frame.

sci.esa.int/lisa-pathfinder/57385-freely-floating-in-space/ see

also: the O'Connell LASOF effect: <http://vixra.org/pdf/1409.0164v2.pdf>

See also: Since the LISA is also has also gravity direction anomaly equipment, the so called satellite FLYBY anomalies could come to more clarity.

Dayton Miller suggested already in 1925, that the altitude of lightspeed measuring above the earth surface (Mount Wilson) has a direct positive effect on the ether wind measurement results, which is in line with the LASOF ellipsoid drag area around the earth.

The cyclic Multiverse according to Q-FFFTheory.

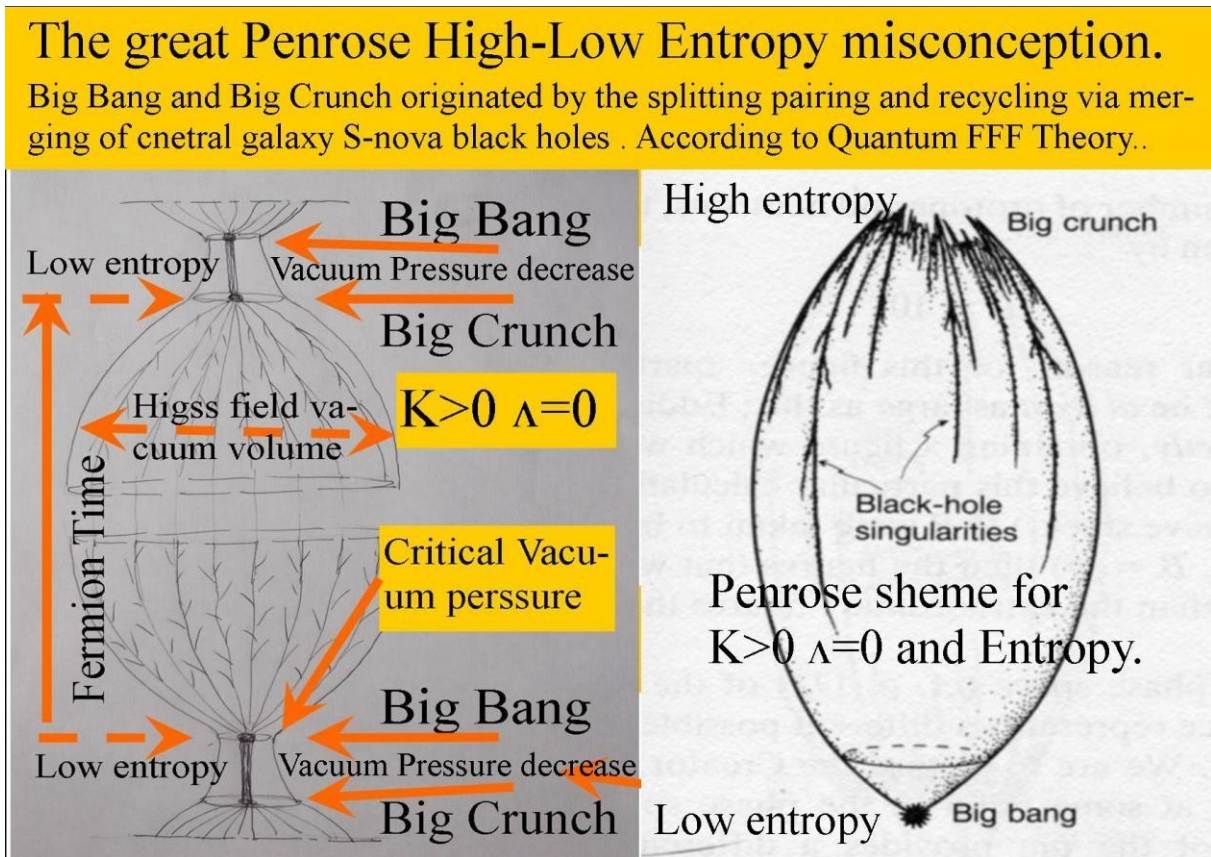

Figure 11, The cyclic Universe with Entropy development in contrast with Penrose.

According to the Quantum-FFF model, (Function Follows Form) Microscopic Dark Matter (singularity black holes) are proliferated inside stars (sunspots), comets and ball lightning. Recent study (B. Harris) suggest, that also around earth an equatorial dark matter ring is present as the origin of the “Flyby anomaly”. However a DM equatorial disc located inside the earth (like sunspots) could solve the Flyby anomaly better and perhaps even the so called P-Wave shadow zone.

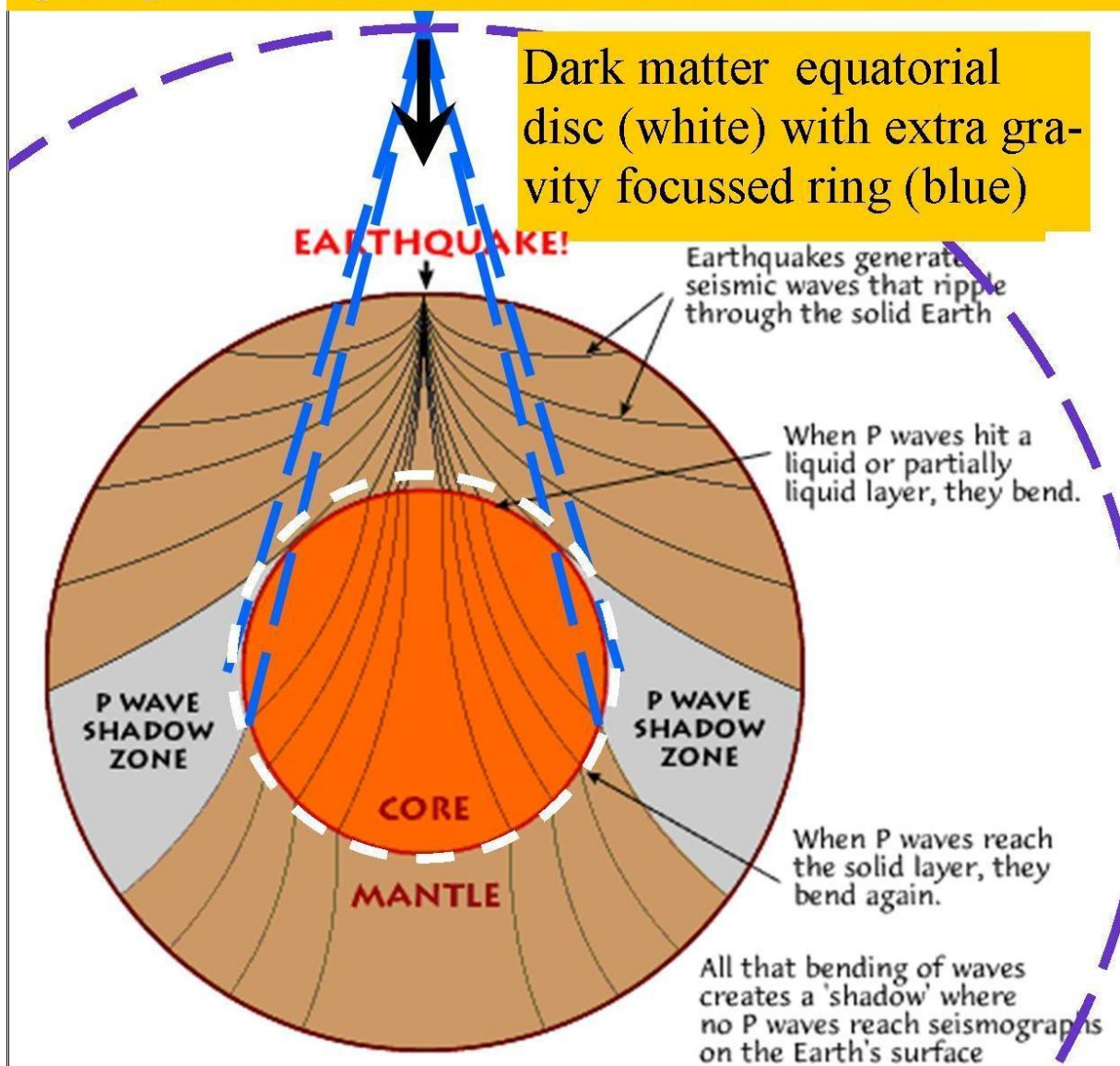

Figure 12, Flyby anomaly explained by earth internal rings of cometary dark matter black hole nuclei.

Sunspot gravity interference as the origin of Supernova ejection velocity differences simulated for massive stars.

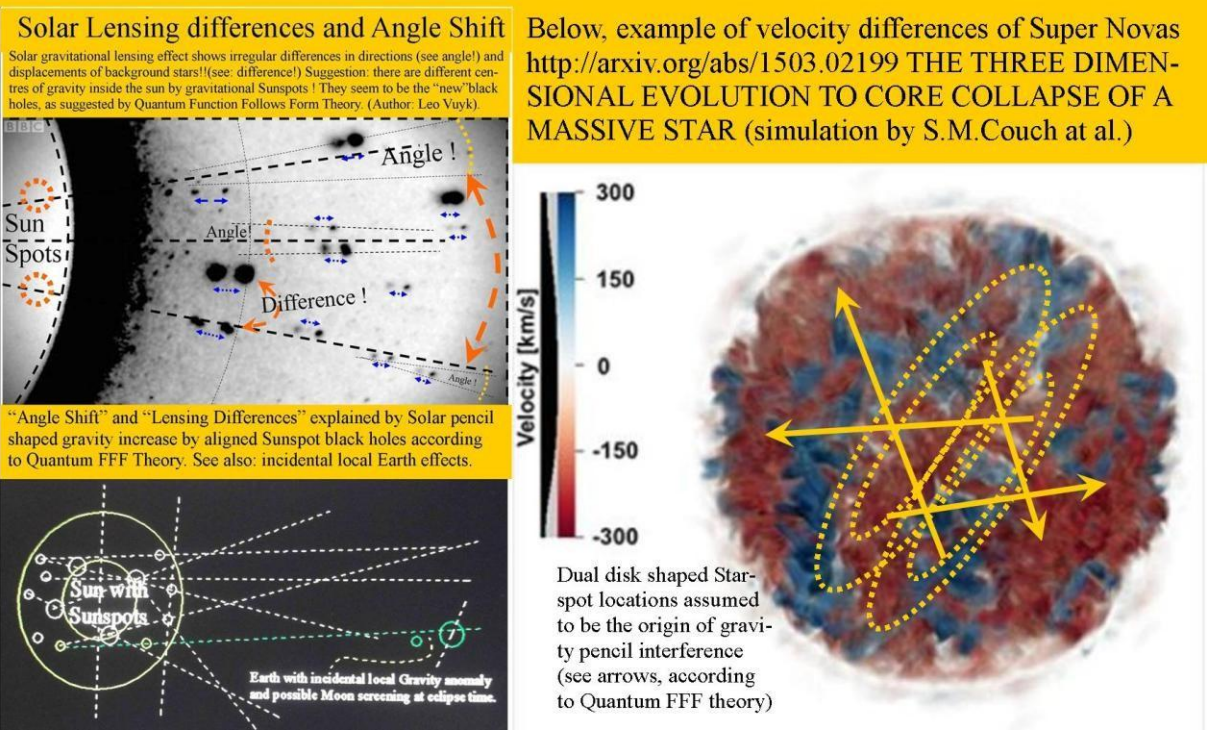

Figure 13, Sunspot dark matter black hole effect on background stellar lensing directions.

Gravity anomalies of Sinkholes related to the Expanding Earth by internal micro new paradigm electric dark matter black holes. According to Quantum FFF Theory.

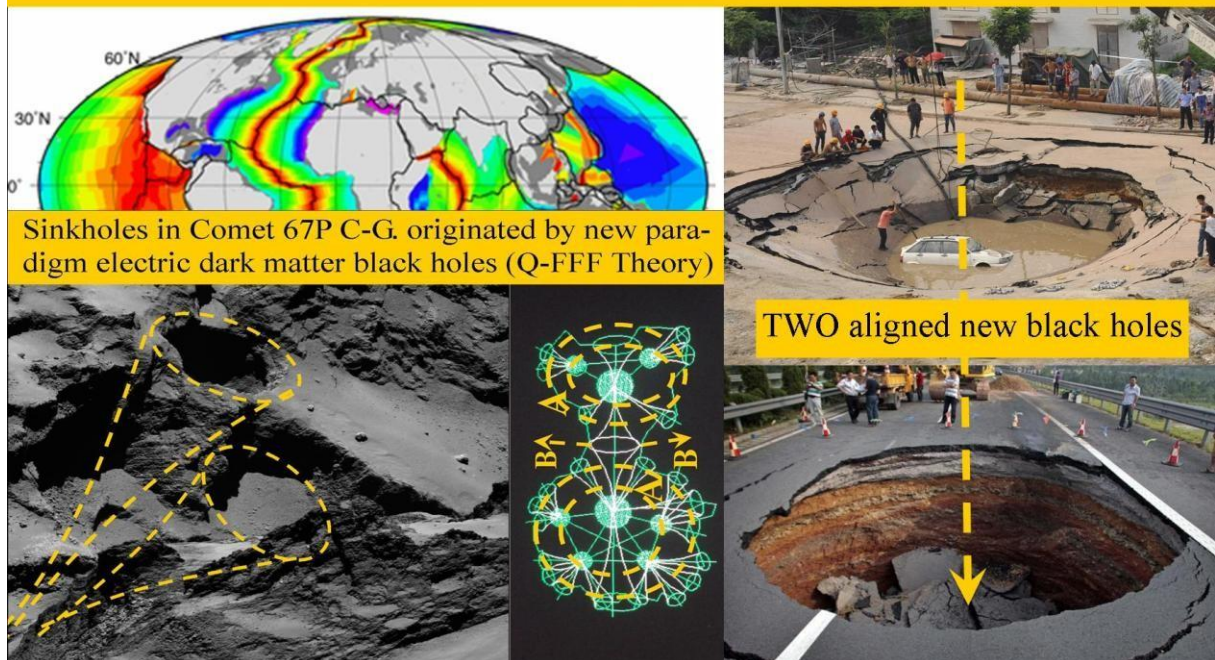

Figure 14, Gravity anomalies by aligned earth internal dark matter black holes.

Temporary spokes at the rings of Saturn are a mystery for NASA. Quantum FFF Theory offers a suggestion: Lighthouse pencil gravity effect by dual alignment of internal Cometary black holes positioned inside Saturn just like Earth..

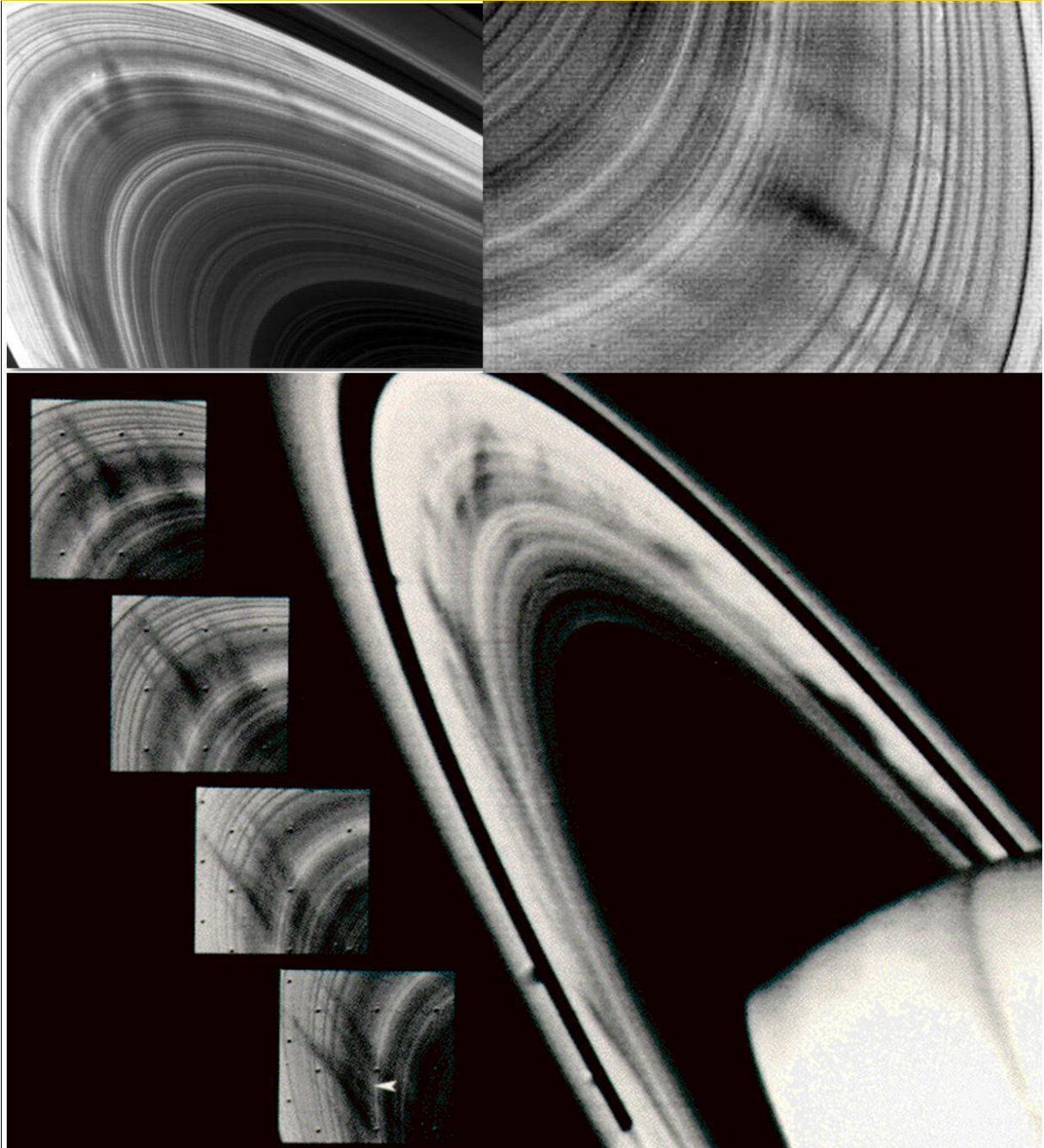

Figure 15, Temporary spokes inside Saturn's ring, by the pencil shaped gravity influence of aligned internal dark matter black holes. (former crashed Comet nuclei)

Spooky gravity lensing effects by dual micro black holes, as the remnants of crashed comet nuclei inside earth and moon

In general, Volcano-, Geyser- and sinkhole activity on planets and moons, could be also related to such dual alignment of internal remnants of crashed comets. According to Quantum FFF Model. ALSO ON EARTH we may expect such gravity anomalies called SPOOKY /magnetic /gravity hills. (see below) and also related to the FlyBy anomalies, . See also: LIST OF GRAVITY HILLS ON EARTH: https://en.wikipedia.org/wiki/List_of_gravity_hills

Gravity lensing anomalies related to multiple micro-dark matter black hole configurations left behind by crashed Comets on Earth (Mexico, left) and Moon (right).

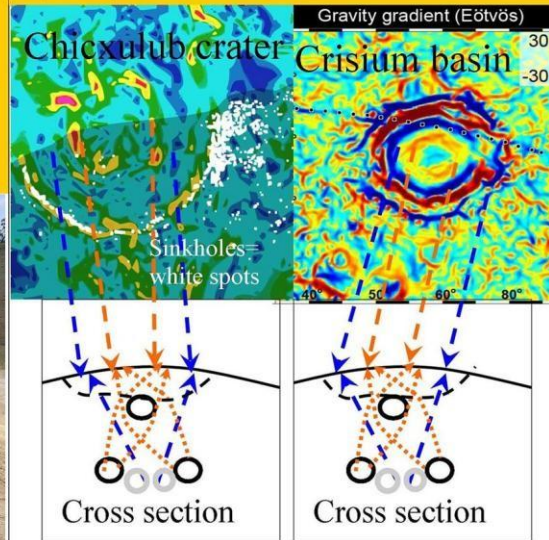

Figure 16, Anomalous gravity effects on Earth and Moon also by aligned internal dark matter black holes (former Comet nuclei)

Other recent Q-FFF posters:

Equivalence between gravity and acceleration does not hold in Quantum FFF Theory. Mass in motion needs a reference frame of ZPE oscillating Higgs field and Lorentz polarization of conscious propeller Fermions (s) to keep a non accelerated flight.

Quantum Gravity as pressure distribution of the oscillating dual Higgs/Graviton vector field.

Polarized Fermion Mass in motion through the resistive, but also pushing oscillating Higgs vacuum (according to Quantum FFF theory)

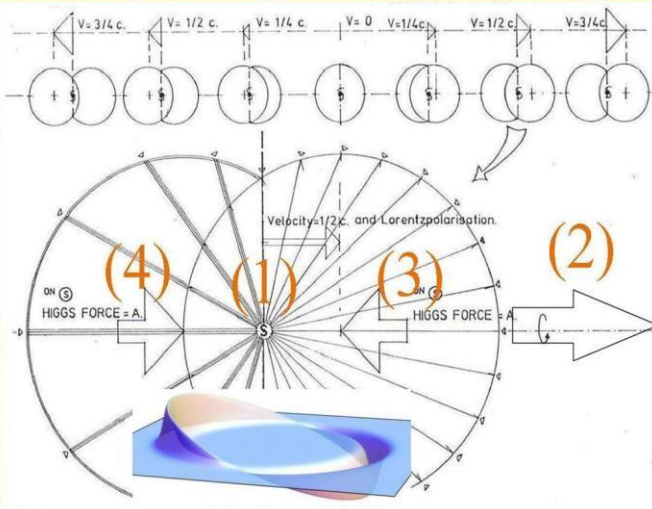
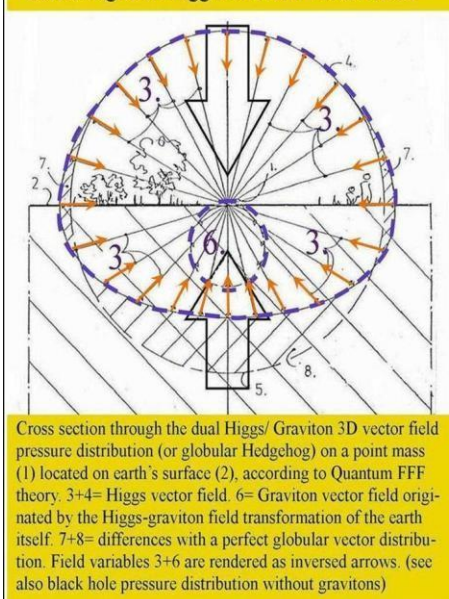
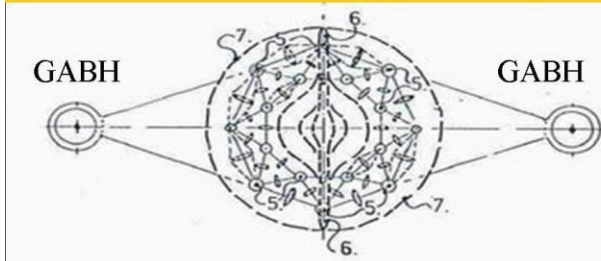

Figure 17, Quantum gravity.

Secondary and tertiary Dual BH Herbig Haro systems, as the origin of different shaped dwarf galaxies and Star clusters.

Below: Simplification of different sized dual black hole (5) based Herbig Haro Systems with dwarf and star formation in between, in the halo of the MW.

Dual Galaxy- and Stellar Anchor Black Holes (G-SABHs) as former Herbig Haro bowshocks, observed in deep space or Planetary Nebula.



Dual black hole systems of all scales, Galaxy and Stars are supposed to be the origin of the self organising universe according to a new electric dark matter black hole model called Quantum FFF Theory. See: Image credit: Prathamesh Tamhane/Yogesh Wadadekar

According to Quantum FFF Theory, Black holes create Proton-Electron plasma at the Fermion repelling horizon. As a consequence dual black hole systems like Herbig Haro objects are equipped with dual EM jets, supported by cone shaped Casimir pressurized Higgs field vacuum polarization. Birkeland and Alfvén current circuits are supposed to be the result. Higgs-Casimir pressure vectors are depicted above and below.

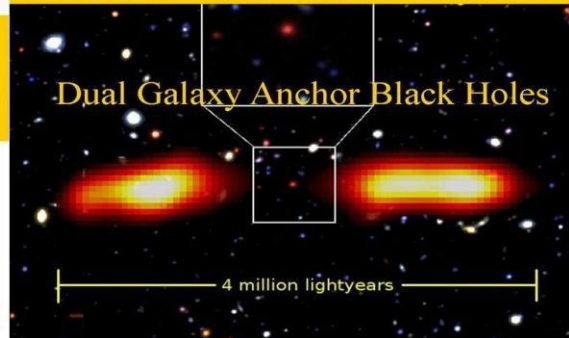
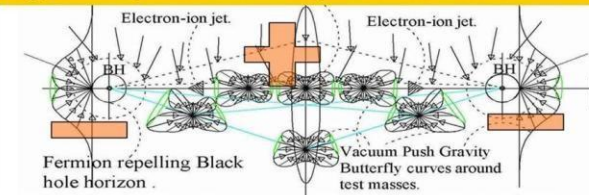
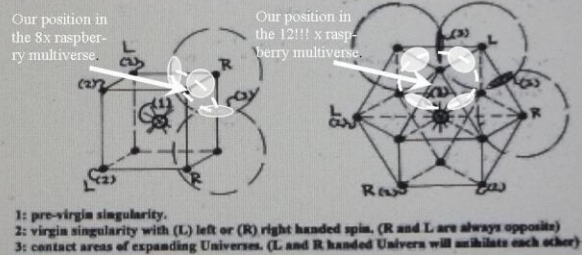

Figure 18, HH systems.

Our position in the 8 or 12 !!! fold raspberry multiverse. Elliptic shaped CMB peak radiations are tell tales. (left). At the rightside a 12 fold symmetric cube octahedron multiverse diagram is depicted with red: matter and green: anti matter entangled universes.

CONFIGURATION FOR 8 OR 12 UNIVERSES.



Three extreme fluctuations (elliptic shaped peaks) in the Cosmic Background radiation tell us about our position inside the 8-or 12 fold raspberry multiverse, according to Quantum FFF Theory.

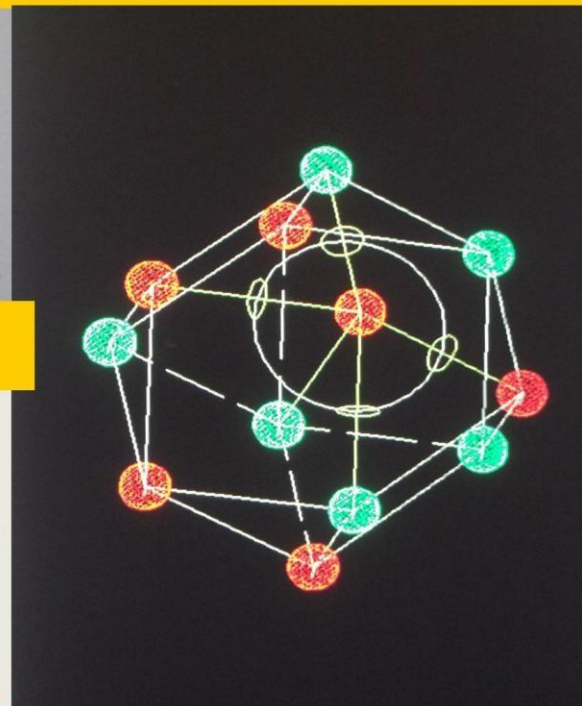
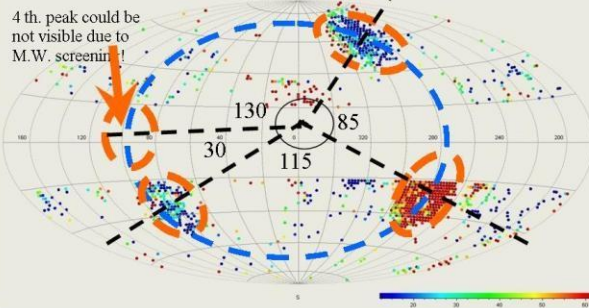
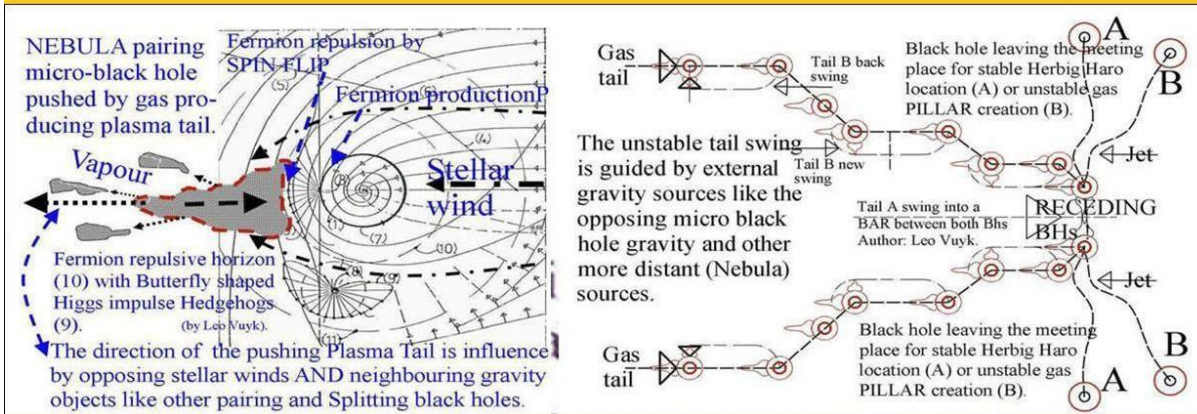

Figure 19, Cube Octahedron or Cube?

Splitting and pairing electric dark matter black holes. Magic self propelling in space and even on earth according to Quantum FFF theory.



Several accelerating pairing and receding micro black holes, as the start of HH objects, in the Carina nebula, with temporary meeting place (A) and ionised plasma tail.(Quantum-FFF Theory)

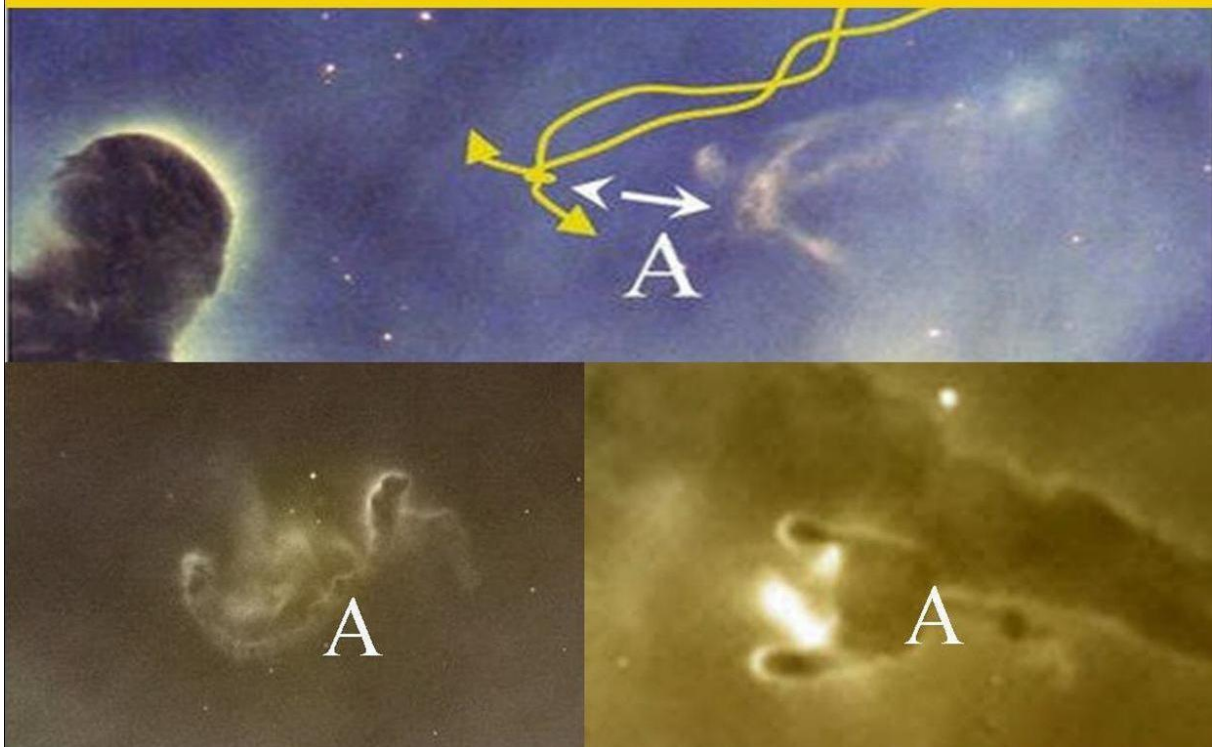

Figure 20, Splitting and pairing electric dark matter blackholes.

Dual micro black holes form macroscopic Casimir cavities, able to create INERTIAL acceleration (A) on a mass (B) located asymmetric at the mutual black hole axis. According to Quantum FFF theory. (For system principles, see Flickr nr: 348.)

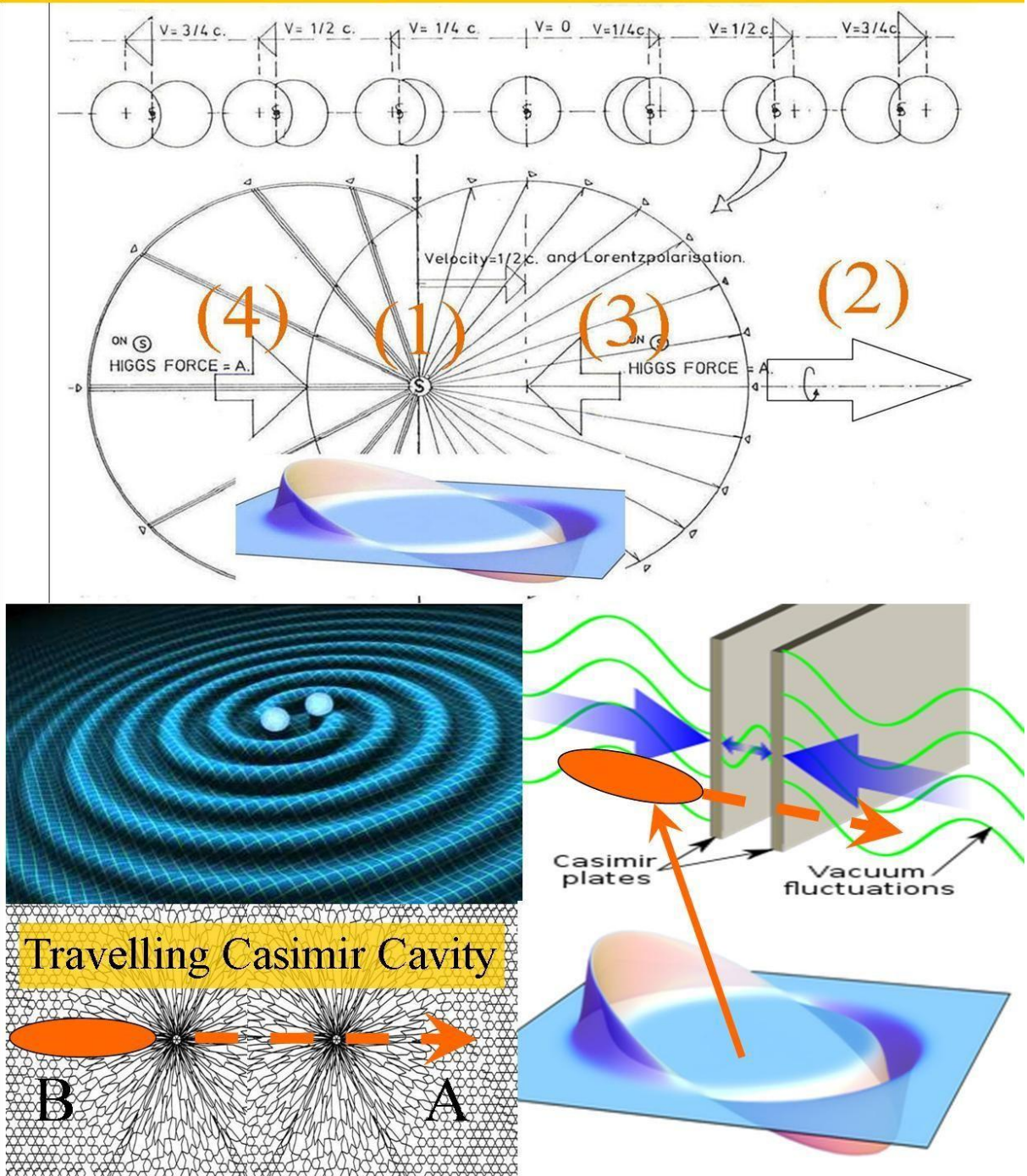
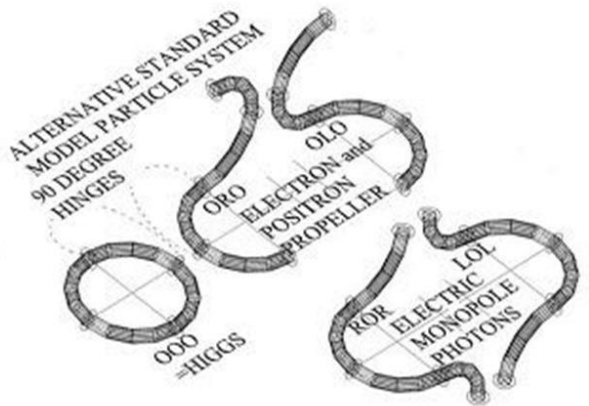
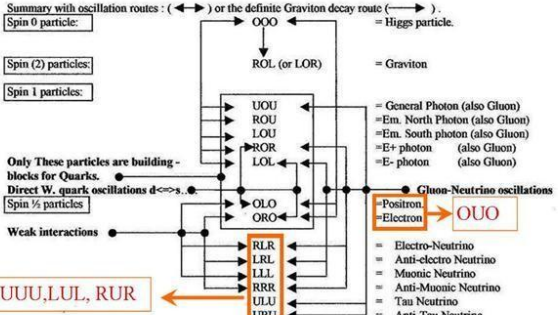
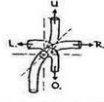

Figure 21, LIGO gravity lawn sprinkler effect.

4D Quaternion rotation resemblance with Rigid String Mutation by internal 90 Degree Rotations.

The coding of Single Elementary Particles is based on the so called "rotational click positions" of the three hinges, which are assumed to be regularly placed over the ring shaped Higgs "Quatron Torus Particle" (page 2). This ring has one splitting point and three hinges which have consequently four 90 degree click positions each. The best Torus ring diameter ratio to click-on is about 1/7. The ring coding of the hinge positions is as follows.

Explanation of the codes:
 U= Up rotation (180 degrees)
 O= Unchanged circle.
 L= Left rotation (90 degrees)
 R= Right rotation (90 degrees)



Higgs particles are supposed to oscillate in Tandem along so called linear Vacuum Lattices, two by two in opposite directions, as the symmetrical opposite pistons of a boxer engine, as the origin of all energy, spin and mass effects. This enables the Tandem Higgs particles to change the form of their own Torus into an Electron and Positron pair at

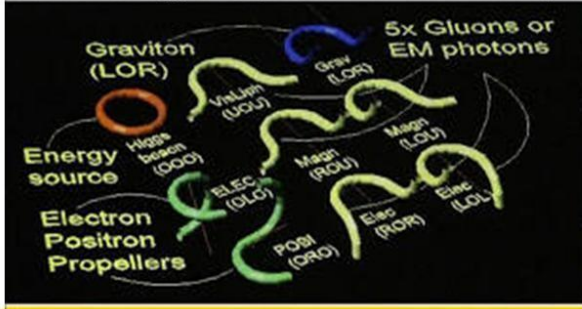

90 degree rotation of the rigid Higgs ring over three hinges, with interlocked merger Quarks (Quantum FFF Theory)

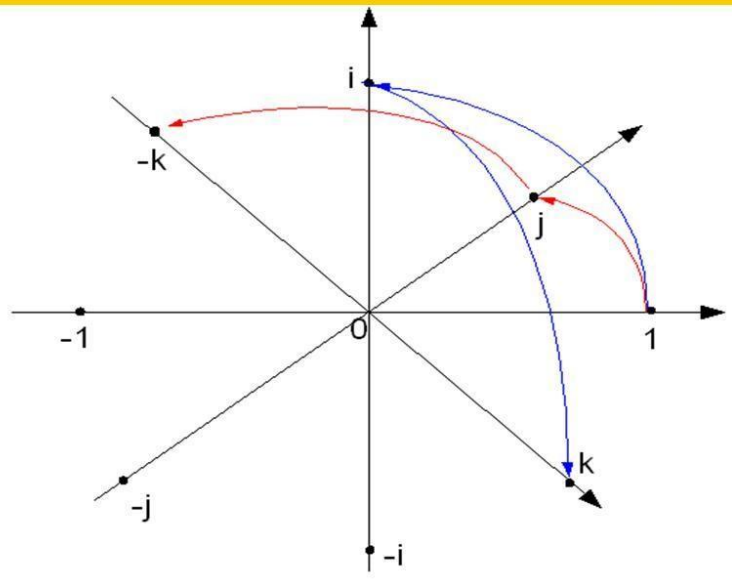

Graphical representation of quaternion units product as 90°-rotation in 4D-space

$$\begin{aligned}
 ij &= k \\
 ji &= -k \\
 ij &= -ji
 \end{aligned}$$

Figure 22, 4D Quaternion rotations compared with Quantum FFF 90 degr. hinging models.

Harvesting ZPE energy by a Vajra antenna

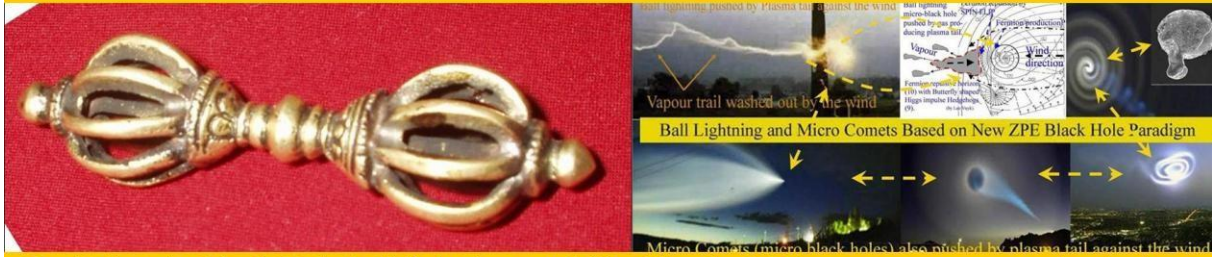

Dual Electric Black Hole ball lightnings stabilised by dual Vajra antennas seem to be the best possible option to harvest ZPE energy from the vacuum, according to QuantumFFF Theory

Dual Dark Matter Black Hole based sunspots seem to be responsible for strong magnetic field interference, just as observed for Herbig Haro objects and many other objects in the cosmos.

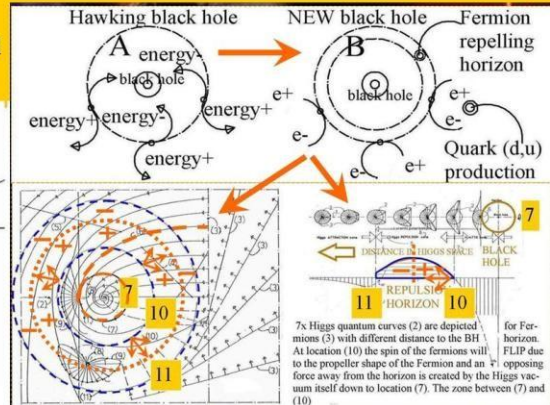
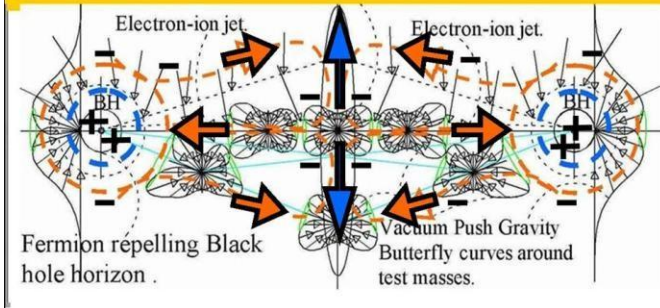
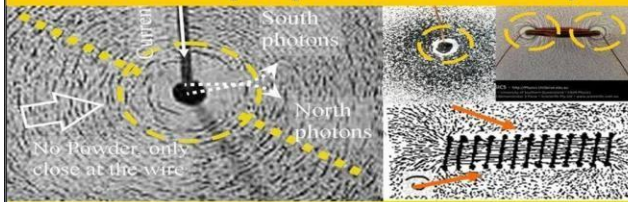

Figure 23, Harvesting vacuum energy by Vajra antenna.

The New Dual Magnetic String Physics of the Anti-Maxwell Magnetic dip around a wire, for reaction less space propulsion.

Explained by detail observation of iron powder distribution (the ring shaped absence) around a wire or coil. Below: Several observations and explanation by the curvature of monopole quantum information arrays.



According to Quantum FFF theory, all magnetic fields can be presented as DUAL Magnetic Monopole Photon Vector Arrays. These monopole arrays undergo curvature. As a result, the magnetic field intensity around the Earth and a wire is NOT dropping off with the square of the distance from the source!! The field become stronger polarized away from the source (See images). Close to the current transporting wire the magnetic field strength is zero due to the parallel trajectories of North and South Photons before curvature and polarisation of iron powder (Author: Leo Vuyk)

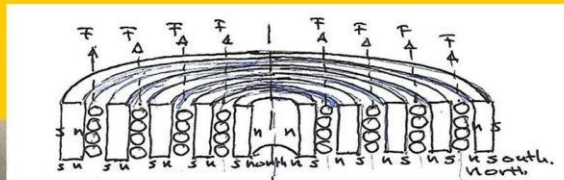
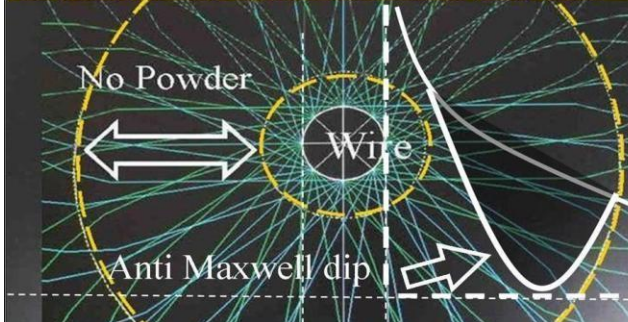

Three circular anti-Maxwell propulsion systems in triangle configuration, should be enough to create stable piloting and flight (LeoVuyk)

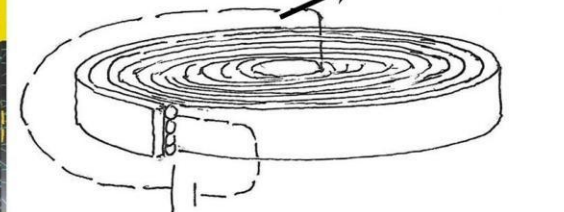

New physics of Rigid String Theory called "Quantum FFF Theory", as a base for new understanding of Anti-Maxwell magnetic field distribution around a wire. And reaction less propulsion.

Figure: 24.

Figure 22. improved Anti Maxwell reaction less space drive magnet in spiral form alternative..

References:

- [61.] The New God Particle and Free Will. Author: Leo Vuyk, LuLu publishers, 2008. ISBN number 978-1-4092-1031-3 <http://www.lulu.com/spotlight/LeoVuyk>
- [60.] Quantum FFF Theory is also published in the form of POSTERS at the Flickr site: <http://www.flickr.com/photos/93308747@N05/>
- [59.] Numbered listing of Vixra essays by Leo Vuyk. http://vixra.org/author/leo_vuyk [58] viXra:1503.0186 Primordial Dark Matter Black Holes Outside Galaxies Responsible for the Creation and Contraction of a Cyclic Universe? 22 [57] viXra:1503.0097 Quantum FFF Theory, Poster News 4.2
- [56] viXra:1502.0086 Parity and Chirality as a Base for Quark-Gluon Plasma and Dust Creating Black Holes and the Beginning and End of Time..
- [55] viXra:1411.0039 Quantum FFF Theory, Poster News 2
- [54] viXra:1410.0039 Evidence for Dark Matter Black Hole Based Plasma, Dust and Ice Production Inside Comets Like 67P,C-G. and the Growing Earth.
- [53] viXra:1409.0164 The O'Connell Effect in Eclipsing Binaries Explained by Mass Related Light Speed Extinction Distances (Lasof) of Stars and Even Planets.
- [52] viXra:1407.0001 Evidence for Evaporating Dark Matter Particles in Silicon Fireballs.
- [51] viXra:1406.0076 Galaxy Formation and Evolution According to Quantum FFF Theory.
- [50] viXra:1406.0019 Quantum FFF Theory Proposals for Some Unsolved Physics Problems.
- [49] viXra:1405.0224 Dual Star Ejection in Open Star Clusters by the Central Star. [48] viXra:1404.0151 Future Free Energy of New Physics Ball Lightning Black Holes, the Origin of a Super Social Society or the Opposite?

- [47] viXra:1404.0002 Proposal for the Origin of Unexpected Large B-Modes Found in the Bicep2 Measurements.
- [46] viXra:1402.0132 Reconciliation of GR and QM by a New Gravity-Black Hole and Lightspeed Model Called Quantum- FFF Theory.
- [45] viXra:1402.0044 The Impossible Zero Point Electric Black Hole as the Origin of New Physics even for Comets like 67P,C-G.
- [44] viXra:1401.0115 Calabi Yau Shaped Double Fermion Spin States.
- [43] viXra:1401.0071 Democratic Free Will in the Instant Entangled Multiverse.
- [42] viXra:1312.0143 The Navel Cord Multiverse with Raspberry Shape, a Super Symmetric Entangled 12 Fold Bubble Universe.
- [41] viXra:1312.0076 Are Sunspots Made of Gravitating Dark Matter Black Holes? [40] viXra:1310.0101 The New Nuclear Magic Number (34) Explained by the Polar Coaxial Ring System of Quantum FFF Theory.
- [39] viXra:1310.0059 The Semi Relativistic Higgs Field Aether with Mass Related Lightspeed Adaptation.
- [38] viXra:1309.0081 New Physics by Table Top Experiments.
- [37] viXra:1308.0083 23 The Raspberry Shaped Super Symmetric Multiverse
- [36] viXra:1307.0068 Quantum Function Follows Form Theory, the Small Scale, Posters part 1.
- [35] viXra:1307.0067 Quantum Function Follows Form Theory, the Large Scale, Posters part 2.
- [34] viXra:1306.0218) Dark Matter UFO Dust Particles or Quantum Knots in the LHC at CERN ?
- 33, viXra:1306.0065 The Splitting Dark Matter- Black Hole- Big Bang and the Cyclic Multiverse.
- 32, viXra:1305.0140 Quantum FFF Theory Experiments, a Summary.
- 31, viXra:1305.0041 The Shnoll Effect Explained by Quantum FFF Theory.
- 30, viXra:1304.0022 The Self Organizing Universe in the Carina Nebula.
- 29, viXra:1303.0211 Hubble Redshift Combined with Universal Contraction is Possible. 28, viXra:1303.0053 Micro Birkeland Currents Between Two RF Generated Plasma Balls in the Laboratory.
- 27, viXra:1302.0172 Silicon Based Ball Lightning Globule Structures and Signs for Accumulation and Retarded Decrease of Tunnelling Energy Bullets.
- 26, viXra:1301.0088 Two or Three Large Quasar Groups (LQGs) Located at the Start of Two or Three Lyman Alpha Systems and a Part of the Raspberry Multiverse?
- 25, viXra:1301.0050 Dwarf Galaxies and Their Relation with Dark Matter Based Galaxy Anchor Black Holes (Gabhs).
- 24, viXra:1210.0177 Instant Broglie Bohm Pilot Waves, the Origin of All Entanglement Effects in the Lab and Wavefunction Collapses in Our Universe as Related to Our Opposing Anti-Copy Universe(s) According to Quantum FFF Theory.
- 23, viXra:1209.0092 New Dark Matter Black Holes and a New Dark Energy Higgs Field, Lead to a Bouncing CP Symmetrical Multiverse, and New Experiments.
- 22, viXra:1209.0061 Birkeland Currents, Sunspots, Comets and Ball Lightning Originated by New Paradigm Dark Matter Black Holes.
- 21, viXra:1209.0030 Majorana and Sterile Neutrino Solutions in the Quantum-FFF Model.
- 20, viXra:1208.0031 Clumpy Dark Matter Around Dwarf Galaxies a Support for an

- Alternative Black Hole Theory According to the Quantum Function Follows Form Model.
19, viXra:1202.0091 Earth Magnetic Monopole Array Field Interaction with Cyclotron –
Synchrotron Electrons and Muon Conversion Used for Levitation Systems.
18, viXra:1201.0092 Earth Magnetic Monopole Array Field Interaction with Cyclotron
Electrons used for Levitation Systems.
17, viXra:1112.0065 24 LHC Signals Between 121-130 GeV Interpreted with Quantum-FFF
Theory
16, viXra:1111.0096 Reconciliation of QM and GR and the Need for a Pulsating Entangled
CPT Symmetric Raspberry Shaped Multiverse.
15, viXra:1111.0061 Black Hole Horizon Curvature Dependent Balance Between Plasma
Creation and e-e+ Annihilation in Quantum FFF Theory.
14, viXra:1108.0036 Artificial Ball Lightning Production and Exploitation Device for Zero
Point Electric Energy Usage.
13, viXra:1108.0006 Mass in Motion in Quantum FFF Theory 12,
viXra:1104.0083 Quantum FFF Theory in Posters.
11, viXra:1104.0044 Ball Lightning, Micro Comets, Sprite-Fireballs and X-Ray/gamma
Flashes According to Quantum FFF Theory.
10, viXra:1104.0002 Stellar Anchor Black Holes as the Remnants of Former Herbig Haro
Objects
9, viXra:1103.0097 ZPE Zero Point Energy Examples Around Black Holes.
8, viXra:1103.0068 Funktion Follows Form, at the Quantum Scale and Beyond.
7, viXra:1103.0024 Quantum Gravity and Electro Magnetic Forces in FFF Theory 6,
viXra:1103.0015 Wavefunction Collapse and Human Choice-Making Inside an Entangled
Mirror Symmetrical Multiverse.
5, viXra:1103.0011 An Alternative Black Hole, Provided with Entropy Decrease and Plasma
Creation
4, viXra:1103.0002 3- Dimensional String Based Alternative Particles Model
3, viXra:1102.0056 Experiments to Determine the Mass Related Lightspeed Extinction
Volume around massive objects.
2, viXra:1102.0054 Atomic Nuclear Geometry Based on Magic Number Logic. 1,
viXra:1102.0052 Construction Principles for Chiral “atoms of Spacetime Geometry

=====