

A Two-Step Integrated Theory of Everything – Revision B

Copyright © April 2017 by Antonio A. Colella*

Abstract. Two opposing Theory of Everything (TOE) visions are: a Two-Step Integrated TOE consisting of a fundamental physics step followed by a mathematics step; and the prevailing Hawking’s single mathematics step. Two steps are essential because of unknown answers to key outstanding physics questions upon which the mathematics step is dependent but cannot answer by itself. Furthermore, since Hawking’s single mathematics step TOE had near zero results after a century of attempts, it should be amplified to a Two-Step Integrated TOE.

The fundamental physics step of a Two-Step Integrated TOE had three goals. First, “Everything” was defined as 20 interrelated amplified theories and their **intimate physical relationships** with each other. The 20 theories were; superstring, particle creation, inflation, Higgs forces, spontaneous symmetry breaking, superpartner and Standard Model (SM) decays, neutrino oscillations, dark matter, universe expansions, dark energy, messenger particles, relative strengths of forces, Super Universe (multiverse), stellar black holes, black hole entropy, arrow of time, cosmological constant problem, black hole information paradox, baryogenesis, and quantum gravity. Second, all key outstanding physics questions were answered including: What are Higgs forces, dark energy, dark matter, stellar black holes, the seven extra dimensions, etc.; and what caused the start of our universe, hierarchy problem, black hole information paradox, baryogenesis, cosmological constant problem, etc.? Third, correct inputs were provided for the two part second mathematics step to follow, an E8 Lie algebra for particles and an N-body simulation for cosmology.

Higgs forces theory was the most important of 20 theories and its amplifications included: 32 associated super supersymmetric Higgs particles (17 Higgs forces and 15 Higgsinos); matter particles and their associated Higgs forces were one and inseparable; spontaneous symmetry breaking was bidirectional and caused by high universe temperatures, not Higgs forces; Higgs forces and W/Z’s were key to particle decay; mass was given to a matter particle by its Higgs force and gravitons; and the sum of 8 Higgs forces associated with 8 permanent matter particles was dark energy.

The subatomic counterpart of Mendeleev’s Periodic Table of elements is Fig. 9 Fundamental SM/supersymmetric/super symmetric matter and force particles on p. 18, which explicitly shows Higgs particles’ supremacy. A Two-Step Integrated TOE is consistent with both the SM for particles and the SM for cosmology (Lambda cold dark matter).

DOI:

PACS numbers: 14.80.-j, 98.80.-k, 11.25.-w, 95.36.+x

1 Introduction

A Two-Step Integrated TOE was modeled as a jigsaw puzzle. Initially, five independent existing theories (Higgs forces, string, particle creation, inflation, and dark energy) were modeled by five independent jigsaw puzzle pieces as shown in Fig. 20. The five theories were independent because physicists in each theory worked independently of each other. The shaded areas surrounding the 20 unshaded jigsaw puzzle pieces represented interrelated amplified requirements. For example, the unshaded area of the key Higgs forces jigsaw puzzle piece was amplified by its shaded area to provide compatible interface requirements with the four other jigsaw puzzle pieces (string, particle creation, inflation, and dark energy). After eleven years and 250 TOE article iterations, the number of independent existing jigsaw puzzle pieces expanded from five to twenty as described in this article. Each of the twenty theories’ requirements, or equivalently each of twenty jigsaw puzzle pieces was selectively amplified without sacrificing the theory’s integrity to provide twenty snugly fitting interrelated amplified theories of Fig. 20 and Table V.

Our universe’s 128 matter and force particle types were created from the super force and manifested themselves primarily during matter creation. The latter occurred from the beginning of inflation at $t = 5 \times 10^{-36}$ s to $t = 100$ s and at extremely high temperatures between 10^{27} and 10^{10} K. There were 13 SM matter particles and 3 SM force particles. There were 4 supersymmetric matter particles and 12 supersymmetric force particles. Each of these 32 matter and force particles had one of 32 super supersymmetric Higgs particles and each of those 64 had an anti-particle. The super force was the 129th particle. By $t = 100$ s and 10^{10} K, only 22 permanent matter and force particle

types remained. Atomic/subatomic matter or six permanent matter particles (up quark, down quark, electron, electron-neutrino, muon-neutrino, and tau-neutrino) constituted 5% of our universe's energy/mass. Dark matter or the zino, photino, and three permanent Higgsino types constituted 26%. Dark energy or eight Higgs forces associated with eight permanent matter particles (up quark, down quark, electron, electron-neutrino, muon-neutrino, tau-neutrino, zino, and photino) constituted 69%. Three SM force particles (graviton, gluon, and photon) existed but accounted for 0%. These percentages remained constant for 13.8 billion years, that is, there was no quintessence. At temperatures less than 10^{10} K, only these 22 permanent matter and force particle types existed in our universe.

Universes were created in the Super Universe's precursor universes via four sequential star gravitational collapse stages. In a white dwarf star, molecules decomposed to atoms. In a neutron star, atoms decomposed to neutrons, protons, and electrons. In a super supermassive quark star (matter), protons and neutrons decomposed to up and down quarks. In a super supermassive black hole (energy), up and down quarks decomposed or evaporated to super force particles. The above matter decomposition description was intimately related to and the reverse of our universe's matter creation.

2 Superstring theory

Via a single superstring theory solution, a Two-Step Integrated TOE unifies all known physical phenomena from the near infinitely small Planck cube scale (quantum gravity theory) to the near infinitely large super supermassive quark star (matter) scale (Einstein's General Relativity). Each of 129 fundamental matter and force particle types is defined by its unique closed superstring in a Planck cube. Any object in the Super Universe is defined by a volume of contiguous Planck cubes containing these 129 fundamental matter or force particle superstring types. Super force superstring doughnut physical singularities existed at the center of Planck cubes at the start of the Super Universe, all precursor universes, and all universes including our universe.

The Planck cube quantum was selected for two reasons, Planck units and superstring theory. Planck units consist of five normalized, natural, universal, physical constants: gravitational constant, reduced Planck constant, speed of light in a vacuum, Coulomb constant, and Boltzmann constant. The Planck length which defines a Planck cube is a function of the first three constants. In superstring theory, the Planck length is the size of matter and force particle superstrings.

Each of 129 fundamental matter and force particles is defined by its unique closed superstring in a Planck cube. Table I shows 129 fundamental SM/supersymmetric/super supersymmetric matter and force particles. There are 13 SM matter particles and 3 SM force particles including an added graviton force particle. There are 4 supersymmetric matter particles and 12 supersymmetric force particles. Each of these 32 matter and force particles has one of 32 super supersymmetric Higgs particles and each of those 64 has an associated anti-particle (see section 6.2 Fundamental SM/supersymmetric/super supersymmetric matter and force particles). Each of the 128 fundamental SM/supersymmetric/super symmetric particles and the super force particle are equivalently represented by: a dynamic point particle, its unique closed superstring, or its associated Calabi-Yau membrane. In traditional string theory descriptions, a one brane vibrating string generates a two brane Calabi-Yau membrane over time. String theory was amplified so that a zero brane dynamic point particle generates particle positions over time for both a one brane vibrating string and a two brane Calabi-Yau membrane. According to Greene, two basic Calabi-Yau membrane types are beach balls and doughnuts. Conifold transitions are the transformations of the two membrane types into each other. The Planck cube sized beach ball Calabi-Yau membrane contains periodic surface hills and valleys where particle energy/mass is proportional to amplitude displacement and frequency [1].

The energy/mass of a superstring is a function primarily of its diameter and secondarily the amplitude displacement and frequency of its hills and valleys. The only differences between the 129 matter and force particles are the amplitude displacement and frequency of their hills and valleys, or their energy/mass. Figure 1 (a) shows a simple representation of a graviton as a perfect circular superstring in a Planck cube. A superstring just touching the sides of a Planck cube with no amplitude displacement and frequency of its hills and valleys represents zero energy. In contrast, an up quark superstring has amplitude displacement and frequency of its hills and valleys shown in the simple representation of figure 1 (b), and its energy/mass is 2.3 MeV. The photon and gluon are perfect circles similar to the graviton superstring and their energies are also zero. All other matter and force particles having energy/mass (e.g., down quark, electron, zino, photino, W/Z's, Higgs, and super force particles) have superstrings similar to the up quark but with different amplitude displacement and frequency of their hills and valleys. A simple

TABLE I. Fundamental SM/supersymmetric/super supersymmetric matter and force particles.

Symbol	SM	Matter	Force	Symbol	Supersymmetric	Matter	Force
p ₁	graviton		x	p ₁₇	gravitino	x	
p ₂	gluon		x	p ₁₈	gluino	x	
p ₃	top quark	x		p ₁₉	stop squark		x
p ₄	bottom quark	x		p ₂₀	sbottom squark		x
p ₅	tau	x		p ₂₁	stau		x
p ₆	charm quark	x		p ₂₂	scharm squark		x
p ₇	strange quark	x		p ₂₃	sstrange squark		x
p ₈	muon	x		p ₂₄	smuon		x
p ₉	tau-neutrino	x		p ₂₅	stau-sneutrino		x
p ₁₀	down quark	x		p ₂₆	sdown squark		x
p ₁₁	up quark	x		p ₂₇	sup squark		x
p ₁₂	electron	x		p ₂₈	selectron		x
p ₁₃	muon-neutrino	x		p ₂₉	smuon-sneutrino		x
p ₁₄	electron-neutrino	x		p ₃₀	selectron-sneutrino		x
p ₁₅	W/Z's	x		p ₃₁	wino/zinos	x	
p ₁₆	photon		x	p ₃₂	photino	x	

16	SM	p ₁ ...p ₁₆
16	Supersymmetric	p ₁₇ ...p ₃₂
32	Higgs super supersymmetric particles	h ₁ ...h ₃₂
64	anti-particles	p _{1bar} ...p _{32bar} , h _{1bar} ...h _{32bar}
1	super force (mother)	p _{sf} (32 types)

129	total	

representation of an up quark Calabi-Yau membrane is shown in figure 2 in the shape of a Planck cube sized beach ball with amplitude displacement and frequency of its hills and valleys. The up quark Planck cube sized beach ball of figure 2 is the three-dimensional equivalent of the two-dimensional up quark superstring of figure 1 (b).

For a particle with spin (e.g., W⁻ has a spin of 1), its closed superstring is visualized as a coil of wire wrapped circularly around a Planck cube center. Each wire coil has superimposed periodic hills and valleys. A point on the circular coil defines a particle's (e.g. W⁻) dynamic point particle position. Quantum fluctuations modulate the W⁻ dynamic point particle position by Δx_p , Δy_p , and Δz_p (see Fig. 4). If the W⁻ dynamic point particle position is defined over a circular coil, the result is a vibrating closed superstring. If the W⁻ dynamic point particle position is defined by multiple coils around the Planck cube center, the result is a Calabi-Yau membrane or cloud.

Any object in the Super Universe is defined by a volume of contiguous Planck cubes containing the 129 fundamental matter or force particle closed superstring types. Planck cubes are visualized as near infinitely small, cubic, Lego blocks. For example, a proton is represented by a 10⁻¹⁵ m radius spherical volume of contiguous Planck cubes containing up quark, down quark, and force particle closed superstrings. By extension, any object in the Super Universe [e.g., atom, molecule, quark star (see Fig. 11 a), galaxy, our universe, or the entire Super Universe] is represented by a volume of contiguous Planck cubes containing the 129 fundamental matter or force particle superstring types. For our universe this implements the "It from Qubit (IfQ)" concept where spacetime (our universe) is composed of tiny chunks of information (contiguous Planck cubes containing the 129 fundamental matter or force particle closed superstring types) [2].

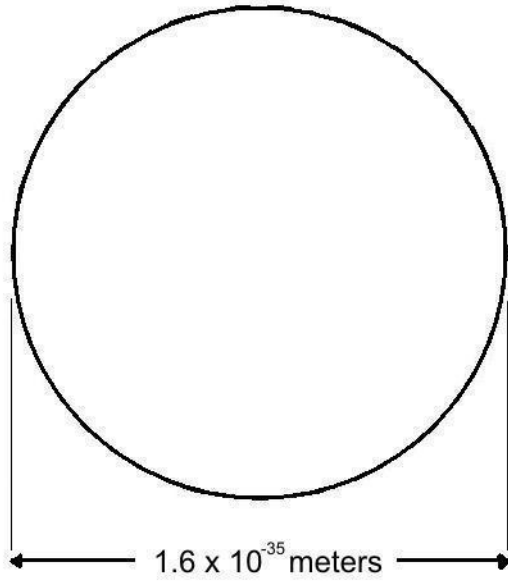

Energy = 0

(a) Graviton

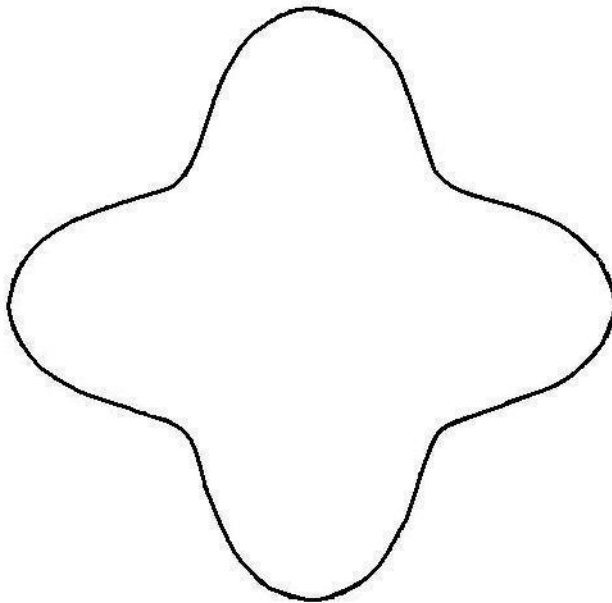

Energy/mass=2.3 MeV

(b) Up quark

FIG. 1. Graviton and up quark superstrings.

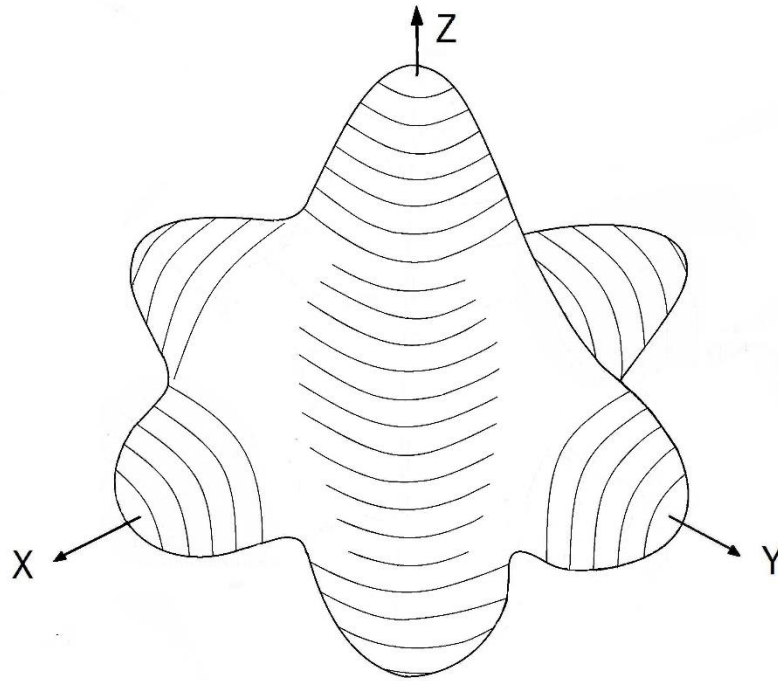

FIG. 2. Up quark Calabi-Yau membrane.

A Calabi-Yau membrane's potential energy/mass was represented by three springs aligned along the Planck cube's X, Y, Z axes and connected together at the Planck cube's center (see Fig. 4). A Calabi-Yau membrane's energy/mass was primarily a function inversely proportional to its radius and secondarily directly proportional to the amplitude displacement and frequency of its hills and valleys. A particle's energy/mass was amplified from two superstring parameters according to Greene to three via addition of the radius parameter. Radius defined the particle's basic energy/mass whereas the amplitude displacement and frequency parameters modulated it. A Calabi-Yau membrane just touching a Planck cube's sides with zero amplitude displacement and frequency defined zero tension or zero energy/mass. A range of amplitude displacements and frequencies about this zero energy/mass defined the 32 SM/supersymmetric matter and force particles' energy/masses, from the lightest photon (zero) to the top quark (173 GeV) to supersymmetric particles (100 to 1500 GeV) [3].

Super force superstring doughnut physical singularities existed at the center of Planck cubes at the start of the Super Universe, all precursor universes, and all universes including our universe. The big bang's doughnut physical singularity consisted of superimposed super force superstrings containing our universe's near infinite energy of approximately 10^{54} kg ($10^{24} M_{\odot}$, 10^{90} eV, or 10^{94} K) as calculated from critical density using a measured Hubble constant [4]. A doughnut physical singularity's potential energy was also represented by three springs connected

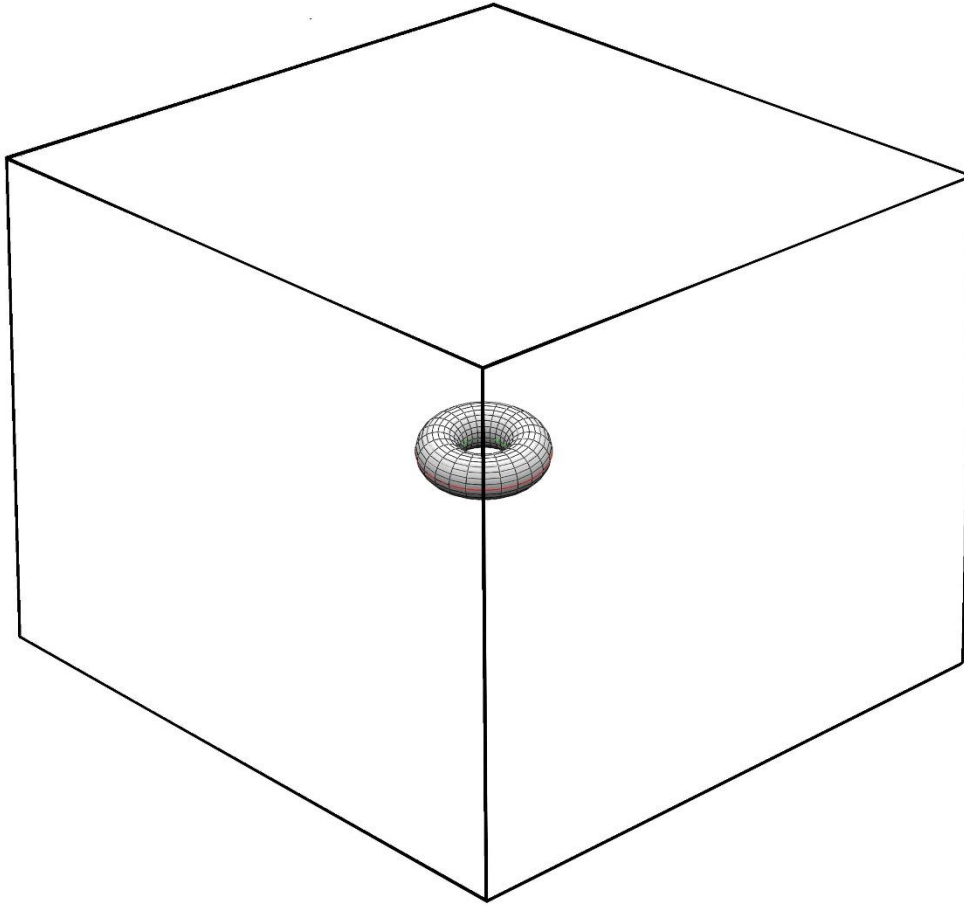

FIG. 3. Big bang doughnut singularity is a Planck cube.

together at the Planck cube's center. Energy was assumed inversely proportional to the doughnut physical singularity's radius (precise function is undefined) so that the smaller the physical singularity's radius, the greater was its energy. The size of the Super Universe's doughnut physical singularity was thus smaller than the size of our universe's doughnut physical singularity because the energy/mass of the Super Universe was 10^{120} times the energy/mass of our universe or $(10^{120})(10^{54} \text{ kg}) = 10^{174} \text{ kg}$ (see section 19 Cosmological constant problem). The doughnut physical super force singularity at the center of a Planck cube is shown in figure 3. The physical singularity is a rotating, charged, doughnut-shaped, Kerr-Newman black hole. As described in section 18 Arrow of time, this doughnut physical singularity was created by our precursor universe's maximum entropy super supermassive quark star's (matter) evaporation, deflation, and collapse to its associated minimum entropy super supermassive black hole (energy).

Pauli's exclusion principle states no two matter particles have identical quantum numbers, which was interpreted as no two matter particles can occupy the same Planck cube. In contrast, force particles can exist within the same Planck cube such as super force superstrings in the doughnut physical singularity. The relationship between quantum numbers and particle spatial location must be amplified. For example, the relationship between the four

quantum numbers of an electron in an atom [e.g., orbit size (n), orbit shape (k), orbit pointing direction (m), and spin (s)] and the electron's location must be amplified to include "free" fundamental particles such as electrons and up quarks in our early universe's plasma of particles.

The Super Universe was defined by a volume of contiguous Planck cubes containing the 129 fundamental matter or force particle closed superstring types. At the present time $t = 13.8$ billion years, the Super Universe consists of 10^{305} contiguous Planck cubes. That is our universe's 10^{185} Planck cubes multiplied by the relative size of the Super Universe to our universe (10^{120}) or $(10^{185})(10^{120}) = 10^{305}$. There was only one Super Universe superstring solution at time t , not 10^{500} solutions described by Susskind [5].

This integrated superstring with particle creation, universe expansions, Super Universe, stellar black holes, and quantum gravity theories (see Table V).

2.1 Universal rectangular coordinate system

Superstring theory's six extra dimensions are the dynamic point particle position and velocity coordinates in a Planck cube. The inertially stabilized X_u, Y_u, Z_u universal rectangular coordinate system of Fig. 4 originates at our universe's big bang at $x_u = 0, y_u = 0, z_u = 0, t = 0$, (see spacetime coordinates in section 16.2 Star factor products). A Planck length ($l_p = 1.6 \times 10^{-35}$ m) cube is centered at x_u, y_u, z_u at time t with the Planck cube's $X_p, Y_p,$ and Z_p axes aligned with the X_u, Y_u, Z_u axes. Any point within the Planck cube is identified by x_p, y_p, z_p coordinates measured from the cube's center with velocity components $v_{xp}, v_{yp},$ and v_{zp} . At $t = 0$, our universe consisted of a super force doughnut physical singularity centered in a Planck cube at $x_u = 0, y_u = 0,$ and $z_u = 0$.

2.2 Proposed SM/supersymmetric/super supersymmetric matter and force particle symbols

Two reasons for replacing inadequate existing matter and force particle symbols with proposed symbols were explicit Higgs particle representation and elimination of existing symbol ambiguities via standardization of subscripts and capitals.

Table I shows proposed symbols with SM particles on the left and supersymmetric particles on the right. The subscript xx explicitly identifies a specific matter or force particle (e.g. the subscript 11 identifies the up quark p_{11}). Adding 16 to the SM particle subscript identifies its supersymmetric partner (e.g., sup squark p_{27}). Replacing p with h identifies the associated super supersymmetric Higgs particle (e.g., h_{11} is the Higgs force associated with the up quark p_{11}). An anti-particle is identified by the subscript bar (e.g., the anti-up quark is $p_{11\bar{}}$). The proposed symbols are different than existing symbols. For example the up quark p_{11} replaces u , the down quark p_{10} replaces d , the up squark p_{27} replaces a u with a tilde over it, the anti-up quark $p_{11\bar{}}$ replaces a u with a bar over it, and the photon p_{16} replaces γ .

The first reason for replacing existing symbols is explicit Higgs particle symbols are required. In the proposed symbols, there is a Higgs particle for each of 32 SM/supersymmetric matter and force particles. Each SM/supersymmetric matter particle has an associated Higgs force and each force particle has an associated Higgsino or Higgs matter particle. Explicit Higgs particles are essential because as subsequently described, the sum of eight Higgs force energies associated with eight permanent matter particles is dark energy and three permanent Higgsino types are dark matter particles which experience spontaneous symmetry breaking. Since there are 16 SM particles, 16 supersymmetric particles, and 32 super supersymmetric Higgs particles, there are 64 anti-particles.

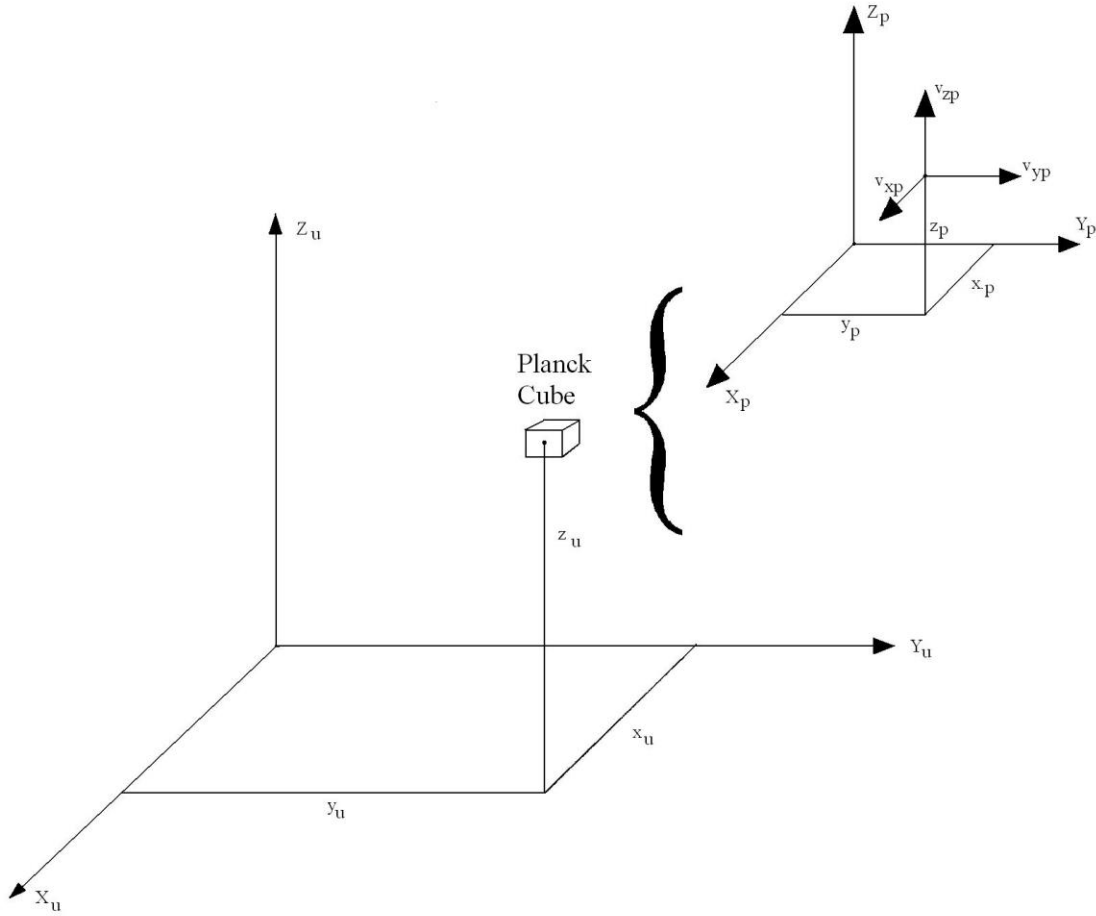

FIG. 4. Universal rectangular coordinate system.

The second reason for the proposed symbols is elimination of existing symbol ambiguities via standardization of subscripts and capitals as described in the following six examples.

The first example is eight types of gluons p_2 are explicitly represented by: p_{2a} , p_{2b} , p_{2c} , p_{2d} , p_{2e} , p_{2f} , p_{2g} , and p_{2h} . Eight explicit gluon symbols are not available in existing symbols.

A second example is the photon p_{16} which is categorized into two types: p_{16a} for electromagnetic radiation and p_{16b} for force carrier. Electromagnetic radiation is further subdivided into gamma ray p_{16a1} , X rays p_{16a2} , etc. for each electromagnetic radiation type. The photon symbol γ illustrates ambiguities of existing symbols because all electromagnetic and the specific gamma ray radiation are defined by γ . In addition, a force carrier photon to transmit for example Coulomb's force, is not defined in existing symbols.

A third example is the W/Z's (p_{15}) which are hybrid matter/force particles. W/Z's are transient matter particles associated with Higgs forces (h_{15}) but with force particle spins of 1. The three W/Z's are explicitly represented as W^+ (p_{15a}), W^- (p_{15b}) and Z^0 (p_{15c}). Their three wino/zino superpartners are explicitly represented as wino⁺ (p_{31a}), wino⁻ (p_{31b}) and zino⁰ (p_{31c}).

A fourth example is there are 32 super force types identified for example by $p_{sf p_{11}}$ where the subscripts (sf) signify super force and the following subscripts (e.g. p11) signify the up quark matter particle. The 32 super force types produce 32 matter and force particles and their 32 associated super supersymmetric Higgs particles. Since the same 32 super force types produce both particles and anti-particles, a total of 128 particles are produced. There is only one super force in existing symbols.

A fifth example is total particle energy/mass is represented by an upper case letter symbol. For example, total up quark (p_{11}) energy/mass for all up quarks in our universe is P_{11} . The big bang time line of Fig. 5 exclusively uses total energy/mass for 64 matter and force particle types. Total particle energy/mass is not available in existing symbols.

A sixth example is there are 32 super force energy densities which are identified for example by $P_{sfd p_{11}}$ where the subscripts (sfd) signify super force energy density and the following subscripts (e.g. p11) signify the up quark matter particle (see section 6 Spontaneous symmetry breaking). Only one super force energy density is available in existing symbols.

3 Particle creation

Our universe's 128 matter and force particle types were created from the super force and manifested themselves primarily during matter creation. This occurred from the beginning of inflation at $t = 5 \times 10^{-36}$ s to $t = 100$ s and at extremely high temperatures between 10^{27} and 10^{10} K as shown in Fig. 5 Big Bang time line of Rees [6]. For simplicity, the figure excluded 64 anti-particles. The X axis was shown both as time in seconds and temperature in Kelvins because of the intimate relationship between particle creation time and the particle's energy/mass or temperature (e.g., W^- at 10^{-12} s, 10^{15} K, and 80 GeV). Energy/mass in electron volts was related to temperature via $eV \sim 10^4$ K. Start of matter creation was amplified to be time synchronous with both inflation start time and the one to seven Planck cubes energy to energy/matter expansion.

At $t = 0$ our universe consisted of a doughnut physical singularity at a Planck cube center which transformed to a spherical physical singularity via Greene's conifold transition by $t = 5 \times 10^{-36}$ s. From the latter time on, our universe was spherical in shape. Our universe expanded from a spherical physical singularity smaller than a Planck cube at the start of inflation to an 8 m radius sphere consisting of a hot quark-gluon plasma with a temperature of approximately 10^{25} K at the end of inflation or 10^{-33} s. Currently, our spherical universe has a radius of 46.5 billion light years.

At $t = 5.4 \times 10^{-44}$ s, four fundamental forces were unified. Gravitons, their gravitino superpartners, and their two associated super supersymmetric Higgs particles condensed from the super force. At $t = 10^{-36}$ s, three forces were unified. Gluons, their gluino superpartners, and their two associated super supersymmetric Higgs particles condensed from the super force. At $t = 10^{-12}$ s, two forces were unified. Photons, their photino superpartners, and their two associated super supersymmetric Higgs particles condensed from the super force. Also, W/Z 's, their Wino/Zino superpartners, and their two associated super supersymmetric Higgs particles condensed from the super force. At $t < 10^{-36}$ s, 12 superpartner forces and their 12 associated Higgsinos (X bosons or inflatons) condensed from the super force. X bosons were the latent energy which expanded our universe during the inflationary period [7]. X bosons were to the inflation period as Higgs forces (dark energy) were to our universe's expansion from the end of inflation to the present.

Fig. 5 shows creation of our universe's 64 matter and force particle types from the super force P_{sf} having energy of 10^{34} kilograms. Upper case letters are exclusively used because particle creation involves total particle energy/mass, for example, total up quark energy/mass is P_{11} . Total energy/mass (e.g., P_{11}) consists of three types of energies: rest mass, kinetic (translational and rotational), and potential (gravitational, electromagnetic, nuclear binding) energies for each up quark particle p_{11} multiplied by the number of up quark particles n_{11} . Up quark energy density P_{11d} is total up quark energy/mass P_{11} divided by our universe's volume at the time of up quark creation.

Fig. 5 shows creation of energy/masses for gravitinos* (P_{17}^*)/gravitons (P_1) at $t = 5.4 \times 10^{-44}$ s or Planck time and gluinos* (P_{18}^*) /gluons (P_2) at $t = 10^{-36}$ s or Grand Unified Theory (GUT) time and their associated super supersymmetric Higgs particles ($H_{17}, H_{17}^*, H_{18}, H_{18}^*$). The asterisk (*) signifies matter particles which existed as energy before condensation to matter particles during matter creation. Twelve superpartner force energies (P_{19}, \dots, P_{30}) and their 12 associated Higgsino energies ($H_{19}^*, \dots, H_{30}^*$) were created at $< 10^{-36}$ s and were X bosons or

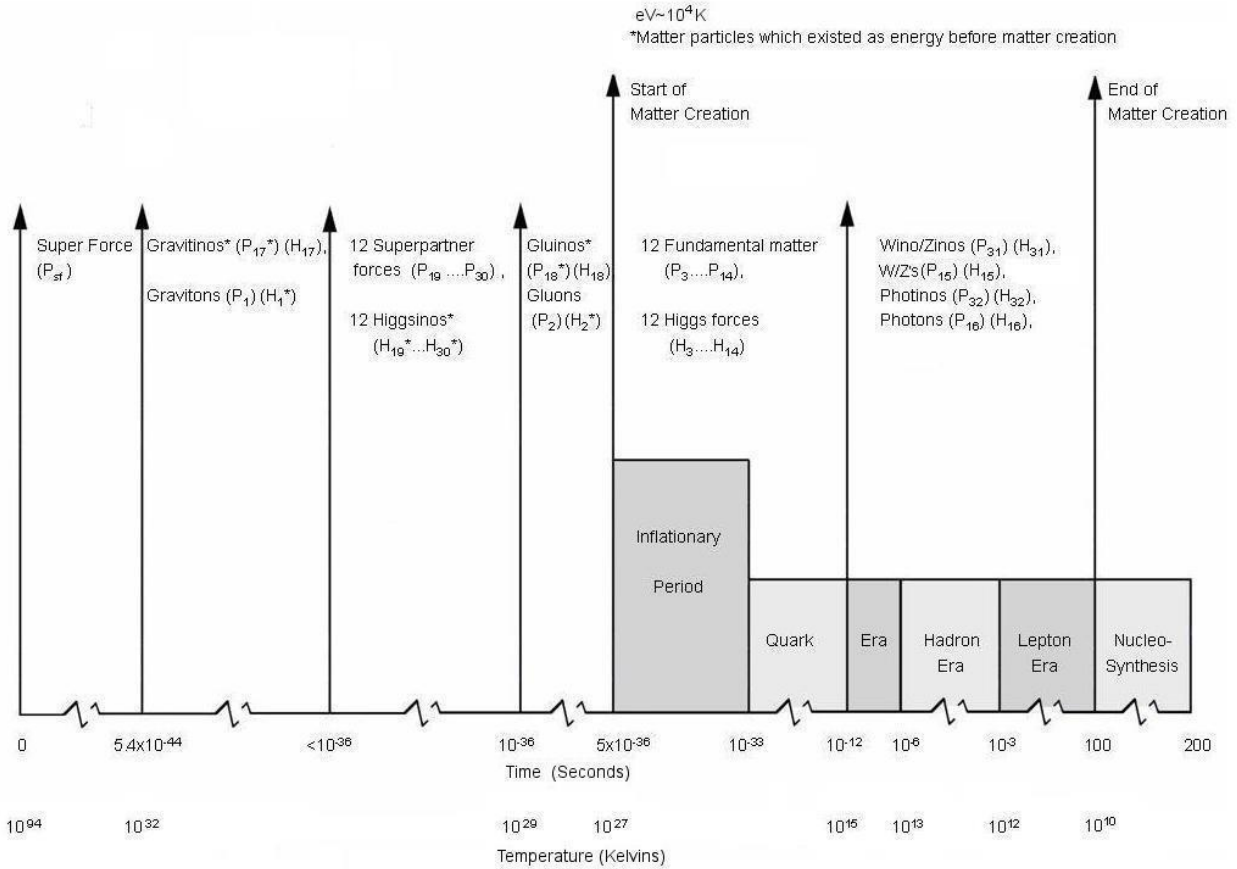

FIG. 5. Big bang.

inflations. Twelve fundamental matter ($P_3 \dots P_{14}$) and their associated super supersymmetric Higgs forces ($H_3 \dots H_{14}$) condensed during matter creation. Wino/zinos, W/Z's, photinos, and photons condensed at $t = 10^{-12}$ s with their associated super supersymmetric Higgs particles ($H_{31}, H_{15}, H_{32}, H_{16}$).

This integrated particle creation with superstring, inflation, Higgs forces, spontaneous symmetry breaking, superpartner and SM decays, neutrino oscillations, dark matter, universe expansions, dark energy, relative strengths of forces, stellar black holes, black hole entropy, black hole information paradox, baryogenesis, and quantum gravity theories, (see Table V).

4 Inflation

Matter creation theory was amplified to be time synchronous with both inflation start time (5×10^{-36} s) and the one to seven Planck cubes energy to energy/matter expansion. Since individual super force and matter particles existed as closed superstrings in Planck cubes, they could not exist when our universe was smaller than a Planck cube or when our universe's radius was smaller than $.8 \times 10^{-35}$ m, see Fig. 6. The one to seven Planck cubes energy to energy/matter expansion consisted of six contiguous Planck cubes attached to the six faces of our universe's original Planck cube. The original Planck cube contained a spherical physical singularity of superimposed super force superstrings part of which condensed into either individual super force or matter particle closed superstrings in the six contiguous Planck cubes. The first Planck cube shell was then pushed out and a second super force or matter particle Planck cube shell condensed between the center Planck cube and the first shell. This process continued until enough shells with enough Planck cubes existed to accommodate all our universe's individual super force or matter

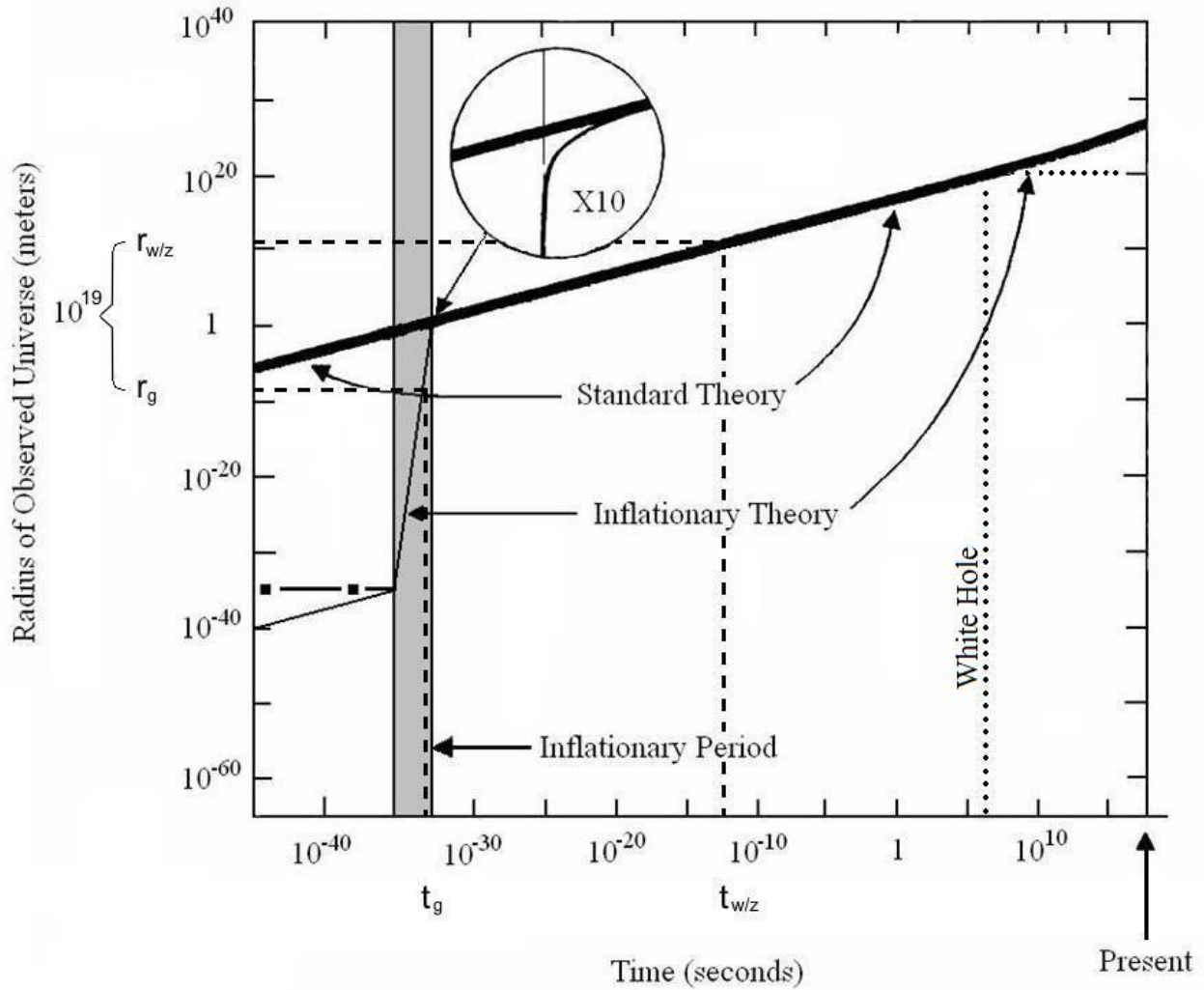

FIG. 6. Size of universe in the standard and inflationary theories.

particle closed superstrings. Fig. 6 had an inflationary period start radius of approximately $.8 \times 10^{-35}$ m with an exponential inflation factor of 10^{36} ($8/8 \times 10^{-35}$). Guth's comparable values were 10^{-52} m and 10^{53} ($8/8 \times 10^{-52}$) [8]. Liddle and Lyth specified an exponential inflation factor of 10^{26} [9]. Thus this article's exponential inflation factor of 10^{36} was between Guth's 10^{53} and Liddle and Lyth's 10^{26} . Future B-mode polarization measurements and analyses should define inflation and the correct exponential inflation factor from the above three estimates.

Eight of the created matter particles were permanent and included six atomic/subatomic matter particles (up quark, down quark, electron, electron-neutrino, muon-neutrino, and tau-neutrino) and two dark matter particles (zino and photino). Nine of the created matter particles were transient and included the top quark, bottom quark, charm quark, strange quark, tau, muon, gravitino, gluino, and W/Z's. By the end of matter creation at $t = 100$ s, all nine transient matter particles had decayed to eight permanent matter particles.

Following the start of matter creation, gravitinos* (P_{17}^*), gluinos* (P_{18}^*), and 12 fundamental matter (6 quarks and 6 leptons) particles ($P_3 \dots P_{14}$) energy/masses condensed to matter particles. At $t = 10^{-12}$ s, W/Z's (P_{15}), winos/zinos (P_{31}) and photino (P_{32}) energy/masses condensed to matter particles.

Particle/anti-particle pairs condensed from super force particles and evaporated back to them. As our universe expanded and cooled this baryogenesis process was predominantly from energy to matter rather than to anti-matter

(see section 6 Spontaneous symmetry breaking and section 21 Baryogenesis). Particles/anti-particles were the intermediate or false vacuum state prior to the permanent matter plus true vacuum state. During matter creation (5×10^{-36} to 100 s), our universe consisted of a time varying particle soup. The end of matter creation was defined as 100 s because only electrons remained following electron anti-electron annihilations during the lepton era. The end of matter creation was actually the end of the lightest anti-matter particle or the anti-electron-neutrino. Anti-electron-neutrinos existed after 100 s. However, since the end time of anti-electron-neutrinos was unknown, the end of matter creation was approximated as 100 s or the end of anti-electrons. Also at $t = 100$ s, nucleosynthesis began.

This integrated inflation with particle creation, Higgs forces, spontaneous symmetry breaking, dark matter, universe expansions, dark energy, relative strengths of forces, baryogenesis, and quantum gravity theories, (see Table V).

5 Higgs forces

Super force particles were God particles because they constituted 100% of our universe's total energy/mass at $t = 0$ s. Higgs particles were associate God particles because they constituted approximately 82% of our universe's total energy/mass between $t = 100$ s and 13.8 billion years. The sum of eight Higgs force energies associated with eight permanent matter particles was dark energy and 69% of our universe's energy/mass. Dark matter consisted of zinos, photinos, and three permanent Higgsino types (see section 9 Dark matter). Assuming three permanent Higgsino types were half of dark matter's energy/mass (26%), they were 13% of our universe's energy/mass. Eight Higgs forces plus three permanent Higgsino types constituted $69\% + 13\% = 82\%$ of our universe's energy/mass.

Amplifications to Higgs force theory were key to a Two-Step Integrated TOE and follow. The amplifications included 32 associated super supersymmetric Higgs particles, one for each of 32 SM and supersymmetric matter and force particle types. These 32 Higgs particles defined a "Super supersymmetry." If a standard or supersymmetric particle was a matter particle (e.g., up quark), its associated Higgs particle was a Higgs force. If a standard or supersymmetric particle was a force particle (e.g., graviton), its associated Higgs particle was a Higgsino.

Matter creation was a super force particle's condensation to a matter particle/Higgs force. The latter two were one and inseparable and modeled as an undersized porcupine (e.g., up quark Planck cube closed superstring) with overgrown spines (e.g., a three dimensional radial Higgs force quantized into Higgs force Planck cube closed superstrings). The Higgs force was a residual super force which contained the mass, charges, and spin of its associated matter particle. When a matter particle (e.g., up quark) condensed from the super force, the residual super force was the Higgs force associated with the matter particle.

Extremely high temperatures between 10^{27} and 10^{10} K in our early universe caused spontaneous symmetry breaking. The Higgs force was a product not the cause of spontaneous symmetry breaking which requires SM amplification. The super force condensed into 17 matter particles/Higgs forces at 17 different temperatures. There were nine transient matter particles (top quark, bottom quark, charm quark, strange quark, tau, muon, gravitino, gluino, and W/Z's) and eight permanent matter particles (up quark, down quark, electron, electron-neutrino, muon-neutrino, tau-neutrino, zino, and photino). The zino and photino were dark matter particles. Spontaneous symmetry breaking was similar to the three condensation phases of H₂O from steam, to water, to ice as temperature decreased from 212° to 32° F. Similarly the super force, down quark/Higgs force, up quark/Higgs force, three W/Z's/three Higgs forces etc., were the same but manifested themselves differently as temperature decreased from 10^{27} to 10^{10} K. There was an intimate relationship between matter creation time and the matter particle's energy/mass or temperature (e.g., 17 SM/supersymmetric matter particles and three permanent Higgsino types). The earlier the matter creation time, the greater was the matter particle's energy/mass. Ice also evaporated or melted to water which then evaporated to steam as temperature increased from 32° to 212° F. Similarly, particle creation was bidirectional as temperature increased, for example, the down quark/Higgs force evaporated back to the super force.

Spontaneous symmetry breaking was bidirectional. The super force condensed into a matter particle/Higgs force or a matter particle/Higgs force evaporated to the super force. In Beta minus decay, the down quark decayed to an up quark and a W⁻. The W⁻ then decayed to an electron and an anti-electron-neutrino. The Beta minus decay equation produced correct results with a misunderstood process because indivisible fundamental particles such as the down quark or W⁻ cannot be split into two other fundamental particles.

Particle decay was the evaporation of a heavy matter particle/Higgs force to the super force and the condensation of the super force to lighter and permanent matter particles/Higgs forces. In the Beta minus decay with Higgs force

amplification, the down quark/Higgs force evaporated to a super force particle. Division of energy not matter occurred as one portion of the super force condensed to the up quark/Higgs force, and a second portion to the W^- particle/Higgs force. The three W/Z 's (W^+ , W^- , and Z^0) were transient (hybrid) matter particles because, for example, within 10^{-25} s of its creation, the W^- transient matter particle/Higgs force evaporated back to a super force particle. The super force then condensed into an electron/Higgs force and an anti-electron-neutrino/Higgs force. Since the W/Z 's were reclassified as transient matter particles, this produced the asymmetrical number 17 instead of 16 matter particles, that is, 9 transient and 8 permanent matter particles. By 100 seconds after the big bang, the nine transient matter particles/Higgs forces decayed via evaporation/condensation cycles to and from the super force to eight permanent matter particles/Higgs forces. The latter included the: up quark, down quark, electron, electron-neutrino, muon-neutrino, tau-neutrino, zino, photino and their eight Higgs forces or dark energy.

Mass was given to a matter particle by its Higgs force and gravitons or gravitational force messenger particles (see section 12.1 Gravitational/electromagnetic). Graviton requirements were amplified to include embedded clocks/computers. The embedded graviton clock/computer calculated Newton's gravitational force by extracting masses of the transmitting and receiving matter particles from their Higgs forces, calculating the range factor $1/r^2$ as $1/[(t_r - t_t)(c)]^2$ from the graviton transmission (t_t) and reception (t_r) times, and providing gravitational force to the receiving particle. Permanent Higgs forces give mass to their permanent matter particles not transient Higgs forces (e.g., that associated with W^-) because the latter exist for only 10^{-25} s.

This integrated Higgs forces with particle creation, inflation, spontaneous symmetry breaking, superpartner and SM decays, dark matter, universe expansions, dark energy, messenger particles, arrow of time, baryogenesis, and quantum gravity theories, (see Table V).

6 Spontaneous symmetry breaking

Spontaneous symmetry breaking caused by extremely high temperatures in our early universe, created 22 permanent matter and force particles: eight permanent matter particles and their eight associated Higgs forces as described in this section 6; and three permanent Higgsinos and their three associated forces as described in section 6.1 Spontaneous symmetry breaking for Higgsinos.

Baryogenesis occurred for 17 transient and permanent matter particles, decay for nine transient matter particles, and spontaneous symmetry breaking for eight permanent matter particles. All three occurred during matter creation between 5×10^{-36} and 100 s and at temperatures between 10^{27} and 10^{10} K. Since baryogenesis was similar for 17 matter particles and spontaneous symmetry breaking was similar for eight permanent matter particles, only up quark baryogenesis and spontaneous symmetry breaking are described. Decay is described for both SM and superpartner matter particles.

Baryogenesis, superpartner/SM decays, and spontaneous symmetry breaking had the following time sequential phases.

1. Baryogenesis of nine transient matter particles
2. Decay of nine transient matter particles to eight permanent matter particles
3. Baryogenesis and spontaneous symmetry breaking of eight permanent matter particles.

Because of the intimate relationship between matter creation time and the matter particle's energy/mass, the three phases occurred for the heaviest matter particle (e.g., gravitino) at the earliest matter creation time and highest energy/mass and for the lightest matter particle (e.g., electron-neutrino) at the latest matter creation time and lowest energy/mass.

Baryogenesis of nine transient matter particles was similar to the permanent up quark's baryogenesis shown in Fig. 7 from Guth's amplified energy density of Higgs fields for the new inflationary theory [10]. The Z axis represented super force energy density allocated to up quarks/Higgs forces, the X axis a Higgs force (h_{11}) associated with an up quark, and the Y axis a Higgs force ($h_{11\text{bar}}$) associated with an anti-up quark. During up quark baryogenesis, the ball initially at its peak position ($x = 0, y = 0, z = 2$), moved down the baryogenesis and spontaneous symmetry breaking

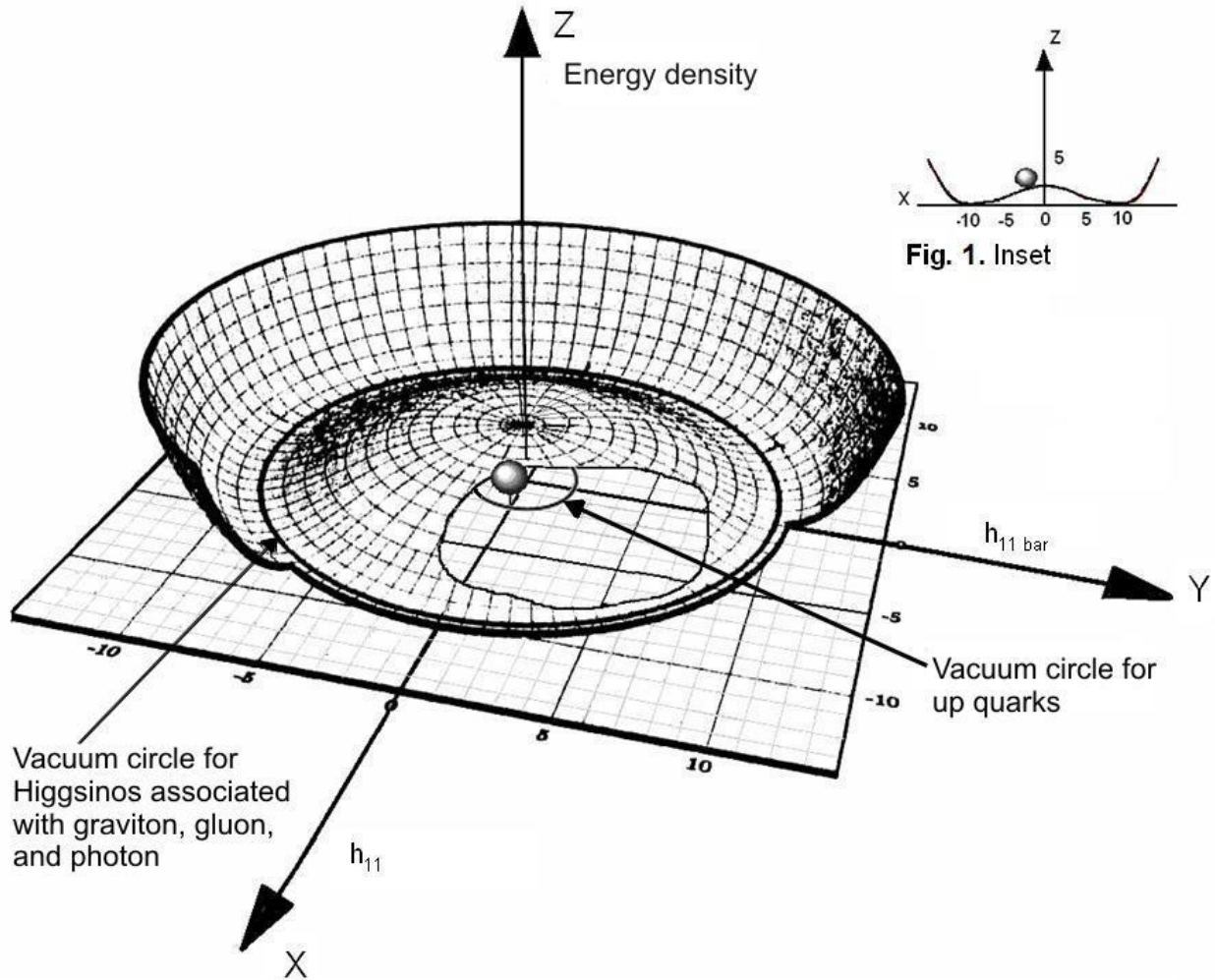

FIG. 7. Up quark baryogenesis and spontaneous symmetry breaking function.

function equidistant between the X and Y axes. Super force particles condensed in equal amounts to: up quarks and up quark Higgs forces; and anti-up quarks and anti-up quark Higgs forces. A portion of these four particles then annihilated by evaporating back to super force particles as the ball returned to its peak position. Another portion remained as up quarks/Higgs forces. During the second condensation/evaporation cycle, the ball moved down the baryogenesis and spontaneous symmetry breaking function closer to the X axis than the Y axis and then back to its peak position. After n of these condensation/evaporation cycles in the false vacuum state, the ball eventually moved to the Fig. 7 ball position ($x = -2, y = 0, z = 1.5$) or the true vacuum state. In the true vacuum state the super force condensed totally to the permanent up quark/Higgs force and none to the anti-up quark/Higgs force. Baryogenesis described above as n bidirectional condensation/evaporation cycles from and to the super force is significantly different than the prevailing two particle annihilation description (e.g., electron/anti-electron) to gamma ray photons.

Following baryogenesis of each of nine transient matter particles, each decayed as follows. Decays were gauge mediated where heavier matter particles/Higgs forces decayed in a cascading process to lighter energy/mass matter particles/Higgs forces and intermediate force particles. Intermediate force particles were W/Z's for SM particles and winos for supersymmetric particles (amplified requirement). For example, a SM bottom quark/Higgs force decayed to a charm quark/Higgs force and a W/Higgs force.

A superpartner decayed into a lower energy/mass superpartner and its intermediate force particle. The latter decayed to SM particles/Higgs forces. The decay chain ended with zinos/Higgs forces and photinos/Higgs forces of the stable

Lightest Supersymmetric Particles (LSP) and SM particles/Higgs forces. Stable LSPs or lightest neutralinos also included three permanent Higgsino types. Dark matter consisted of zinos, photinos, and three permanent Higgsino types [11] [12].

Following baryogenesis and decay of nine transient matter particles, baryogenesis and spontaneous symmetry breaking of eight permanent matter particles occurred. For the up quark, there were two key ball positions in Fig. 7. When the ball was in its peak position, up quark baryogenesis had not occurred. When the ball was in the Fig. 7 position, up quark baryogenesis had occurred and super force energy density had condensed to up quarks/Higgs forces. The z coordinate of the Fig. 7 ball position was the super force energy density condensed to up quark Higgs forces. The z coordinate of the peak ball position minus the z coordinate of the Fig. 7 ball position was the super force energy density condensed to up quarks. During the hadron era, the ball moved from its peak position to the Fig. 7 position. It took 13.8 billion years for the ball to move vertically down to its current position just above the vacuum circle for up quarks. As the ball moved vertically down, the up quark's Higgs force (ball's x coordinate) remained constant whereas the up quark Higgs forces' energy density (ball's z coordinate) slowly decreased as our universe expanded.

There were eight baryogenesis and spontaneous symmetry breaking functions associated with eight permanent matter particles. Each had the same generic up quark Fig. 7 Mexican hat shape but each had a different peak super force energy density (peak z coordinate) and Higgs force (ball x coordinate). By 100 s, only eight permanent matter particles/Higgs forces remained.

During matter creation (5×10^{-36} to 100 s), there were two time sequential false vacuum phases. First during baryogenesis for each of 17 matter particles, particle/anti-particle pairs condensed from and evaporated to the super force. As our universe expanded and cooled and after n of these condensation/evaporation cycles, this baryogenesis process was predominantly from energy to matter rather than to anti-matter. Particles/anti-particles were the intermediate, transient, or false vacuum state prior to the permanent matter/Higgs force or true vacuum state.

The second time sequential false vacuum phase occurred during the decay of nine transient matter particles to eight permanent matter particles. The super force condensed to a transient matter particle/Higgs force and bidirectionally evaporated back to the super force in the false vacuum state. Then, the super force condensed to lighter and stable matter particles/Higgs forces. This occurred for all nine transient matter particles. By 100 s, all nine transient matter particles/Higgs forces had condensed to eight permanent matter particles/Higgs forces. The true or permanent vacuum state consisted of space between matter particles, or the sum of eight permanent Higgs force energy densities.

Figure 5 shows total particle energy/masses of 32 matter and force particles designated as $P_1 \dots P_{32}$. These included gravitons P_1 , gluons P_2 , twelve fundamental matter particles ($P_3 \dots P_{14}$), W/Z's P_{15} , photons P_{16} , 4 supersymmetric matter particles (P_{17}^* , P_{18}^* , P_{31} , and P_{32}), and 12 supersymmetric force particles ($P_{19} \dots P_{30}$) energy/masses. The 17 Higgs force energies ($H_3 \dots H_{14}$, H_{17} , H_{18} , H_{31} , H_{32} , H_{15}) were super force energy residuals following condensations of 12 fundamental matter, four supersymmetric matter, and W/Z's. There were also 15 Higgs matter particles (14 Higgsinos* and 1 Higgsino) energy/masses (H_1^* , H_2^* , $H_{19}^* \dots H_{30}^*$, H_{16}) for a total of 32 Higgs particles. Sixty four anti-particles condensed at the same temperature and time as their identical energy/mass particles but were not explicitly shown in Fig. 5 because baryogenesis and inflation eliminated them as described above and in section 6.1 Spontaneous symmetry breaking for Higgsinos.

Two conditions are required for matter condensation, our universe must be larger than a Planck cube and the specific matter condensation temperature must exist. The one to seven Planck cube energy to energy/matter expansion began at the start of inflation when the size of our universe became larger than a Planck cube. During inflation the gravitino, assumed to be the heaviest supersymmetric matter particle and its Higgs force existed first as a super force particle (p_{sf17}) or ($p_{17} + h_{17}$). At the gravitino condensation temperature, p_{sf17} condensed to the gravitino p_{17} and its associated super supersymmetric Higgs force h_{17} (see section 13 Relative strengths of forces/Hierarchy problem).

Each of the 129 particles was assumed to exist within a Planck cube although each may exist in a larger augmented Planck cube defined by (l_{ap}). Scattering experiments revealed quarks and leptons to be smaller than 10^{-18} meters [13]. If higher resolution scattering reveals matter particles are larger than a Planck cube, the Planck cube must be replaced by an augmented Planck cube.

Spontaneous symmetry breaking was described as the condensation of super forces into eight permanent matter particles and their associated Higgs forces. Figure 10 shows an up quark particle p_{11} surrounded by quantized Higgs force particles h_{11} in two instead of three dimensions. The up quark/Higgs force are one and inseparable and modeled as an undersized porcupine with overgrown spines.

6.1 Spontaneous symmetry breaking for Higgsinos

Spontaneous symmetry breaking occurs for two of three types of matter particles, eight permanent SM and supersymmetric matter particles and 3 permanent Higgsino types.

Type 1 matter particles or eight standard and supersymmetric matter particles include the: down quark p_{10} , up quark p_{11} , electron p_{12} , tau-neutrino p_9 , muon-neutrino p_{13} , electron-neutrino p_{14} , zino p_{31b} , and photino p_{32} . These eight SM and supersymmetric matter particles and their eight associated Higgs forces experienced spontaneous symmetry breaking as described in the previous section.

Type 2 matter particles or three permanent Higgsino types (h_1 , h_2 , and h_{16}) associated with three SM force particles (graviton p_1 , gluon p_2 , and photon p_{16}), experienced baryogenesis as follows. Higgsino baryogenesis was similar to up quark baryogenesis. Super force particles condensed into four particles (e.g., Higgsino, associated SM force, anti-Higgsino, and associated SM force). In the true vacuum state the super force condensed totally to the Higgsino/SM force and none to the anti-Higgsino/SM force. By the end of Higgsino baryogenesis, the ball position in the Higgsino version of Fig. 7 was at $x = -10$, $y = 0$, $z = 0$ and on the vacuum circle for Higgsinos associated with the zero energy graviton, gluon, and photon. All a super force particle's energy condensed to a Higgsino and none to its associated force particle (graviton, gluon, or photon). In contrast to inseparable matter particles and their Higgs forces, the three permanent Higgsinos and their associated graviton, gluon, and photon forces became independent of each other following their associated creation.

Type 3 matter particles or 12 supersymmetric Higgsinos ($h_{19} \dots h_{30}$) associated with 12 superpartner forces ($p_{19} \dots p_{30}$) did not experience spontaneous symmetry breaking because their energy was expended prior to matter creation. The 12 superpartner forces, their 12 associated Higgsinos, and their 24 anti-particles were X bosons or inflatons. X bosons were the latent energy which expanded our universe during the inflationary period [14]. X bosons were to the inflation period as Higgs forces (dark energy) were to our universe's expansion following inflation.

This integrated spontaneous symmetry breaking with particle creation, inflation, Higgs forces, superpartner and SM decays, neutrino oscillations, dark matter, universe expansions, dark energy, baryogenesis, and quantum gravity theories, (see Table V).

6.2 Fundamental SM/supersymmetric/super supersymmetric matter and force particles

The subatomic counterpart of Mendeleev's Periodic Table of elements is the fundamental SM/supersymmetric/super symmetric matter and force particles of Table I and Fig. 9.

Figure 8 shows the SM matter and force particles. There are twelve matter particles: six quarks (up, down, strange, charm, bottom, and top); and six leptons (electron, muon, tau, electron-neutrino, muon-neutrino, and tau-neutrino). There are four force particles (photon, W/Z's, gluon, and Higgs). This figure misrepresents our universe's matter and force particles because it: does not emphasize Higgs particles' supremacy; does not differentiate between important permanent and less important transient particles; defines only a single Higgs force; does not include the graviton; and does not include: supersymmetry and super supersymmetry (32 Higgs particles consisting of 17 Higgs forces and 15 Higgsinos).

Figure 9 shows the Fundamental SM/supersymmetric/super supersymmetric matter and force particles which amplifies Fig. 8. The figure consists of a circular area surrounded by an annular area. The

	Matter			Force
Quarks	u up	c charm	t top	γ photon
	d down	s strange	b bottom	Z Z particle
Leptons	ν_e electron-neutrino	ν_μ muon-neutrino	ν_τ tau-neutrino	W W particle
	e electron	μ muon	τ tau	g gluon
				H Higgs force

FIG. 8. SM matter and force particles.

circular area represents 22 permanent matter and force particles. Matter and force particles are related to their associated Higgs particles via common subscripts (e.g., up quark p_{11} and associated Higgs force h_{11} , and photon p_{16} and associated Higgsino h_{16}). The outer circular area clockwise from the top consists of: atomic/subatomic matter particles (up quark p_{11} , down quark p_{10} , electron p_{12} , electron-neutrino p_{14} , muon-neutrino p_{13} , and tau-neutrino p_9) which constituted 5% of our universe's energy/mass between $t = 100$ s and 13.8 billion years; a portion of dark matter (zino p_{31} and photino p_{32} or approximately 12.5%; and the graviton p_1 , gluon p_2 , and photon p_{16} forces or 0%. The inner circular area clockwise from the top consists of: dark energy or the sum of eight Higgs forces (h_{11} , h_{10} , h_{12} , h_{14} , h_{13} , h_9 , h_{31} , h_{32}) associated with eight permanent matter particles (up quark p_{11} , down quark p_{10} , electron p_{12} , electron-neutrino p_{14} , muon-neutrino p_{13} , tau-neutrino p_9 , zino p_{31} , and photino p_{32}) or (69%); and a portion of dark matter or three permanent Higgsinos (h_1 , h_2 , h_{16}) associated with the graviton p_1 , gluon p_2 , and photon p_{16} or approximately 12.5%. The large inner circular area consists of Higgs particles (eight Higgs forces and three permanent Higgsinos) and emphasizes Higgs particles' supremacy because they constitute 82% of our universe's energy mass.

The annular area represents 44 transient matter and force particles, all of which were eliminated by 100 s after the big bang via inflation or decay. The outer portion of the annular area clockwise from the top consists of: nine transient matter particles (top p_3 , bottom p_4 , charm p_6 , strange p_7 , tau p_5 , muon p_8 , gravitino p_{17} , gluino p_{18} , and W/Z's p_{15}) and twelve transient force particles (stop p_{19} , sbottom p_{20} , stau p_{21} , scharm p_{22} , sstrange p_{23} , smuon p_{24} , stau-neutrino p_{25} , sdown p_{26} , sup p_{27} , selectron p_{28} , smuon-neutrino p_{29} , and selectron-neutrino p_{30}). The inner portion of the annular area clockwise from the top consists of: nine transient Higgs forces (h_3 , h_4 , h_6 , h_7 , h_5 , h_8 , h_{17} , h_{18} , and h_{15}) associated with nine

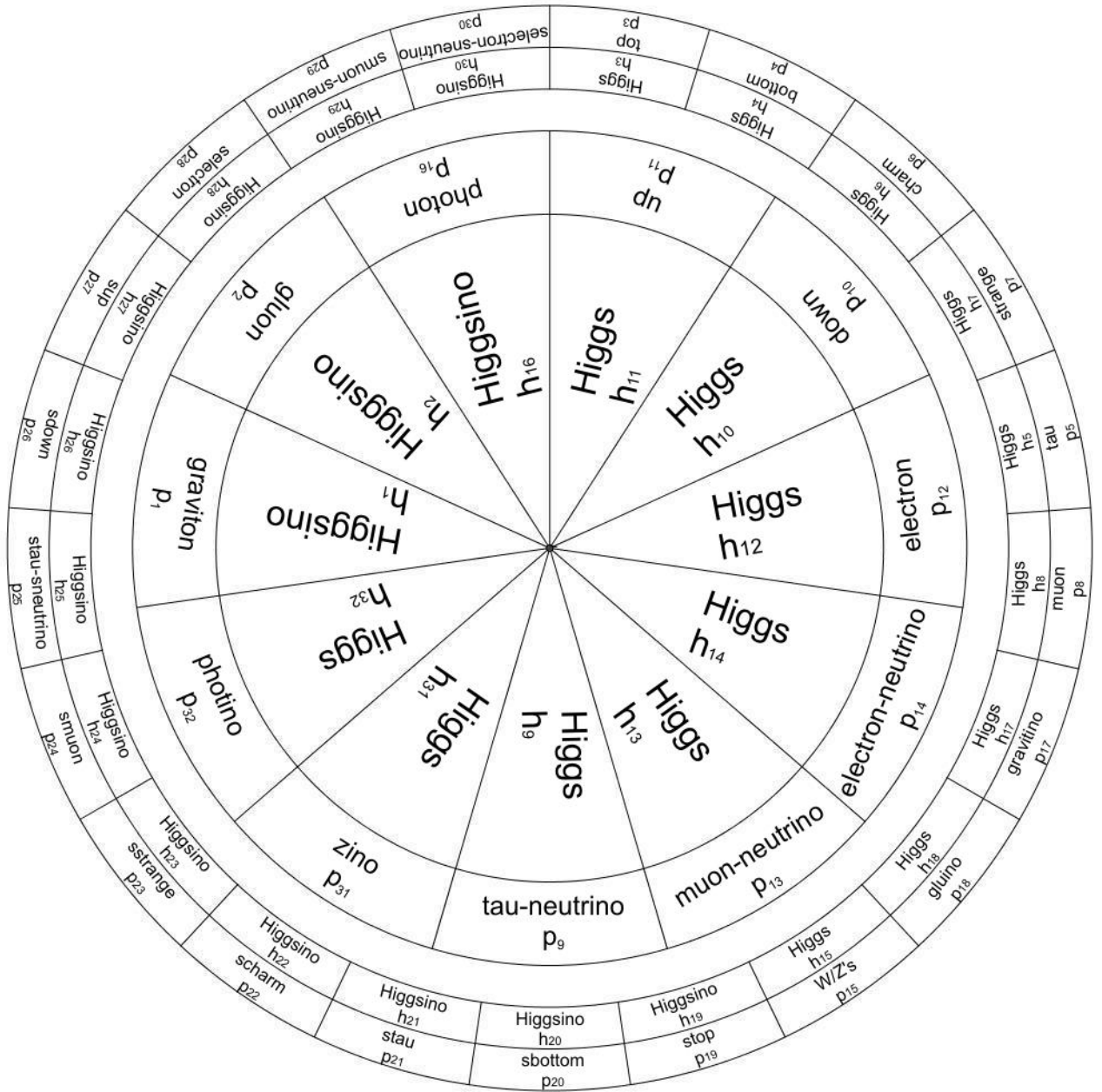

FIG. 9. Fundamental SM/supersymmetric/super supersymmetric matter and force particles.

transient matter particles and twelve transient Higgsinos (h_{19} , h_{20} , h_{21} , h_{22} , h_{23} , h_{24} , h_{25} , h_{26} , h_{27} , h_{28} , h_{29} , and h_{30}) associated with twelve transient force particles.

7 Superpartner and SM decays

Decays are series of evaporations/condensations of matter particles/Higgs forces to and from the super force. The theory of superpartner and SM decays is amplified to include supersymmetric intermediate force particles or winos and simultaneous decay of matter particles/Higgs forces.

The heaviest matter particles condensed directly from the super force. Lighter matter particles were created primarily via a heavier particle's decay. Decays were gauge mediated where heavier matter particles/Higgs forces decayed in a cascading process to lighter energy/mass matter particles/Higgs forces and intermediate force particles. Intermediate force particles were W/Z's for SM particles and winos for supersymmetric particles. For example, in a Beta minus decay, the transient intermediate force particle W^- decayed to an electron and an anti-electron-neutrino. Similarly, the transient wino intermediate force particle decayed to SM particles.

A superpartner decayed into a lower energy/mass superpartner and its intermediate force particle. The latter decayed to SM particles/Higgs forces. The decay chain ended with zinos/Higgs forces and photinos/Higgs forces of the stable Lightest Supersymmetric Particles (LSP) and SM particles/Higgs forces. Stable LSPs or lightest neutralinos also included three permanent Higgsino types. Dark matter consisted of zinos, photinos, and three permanent Higgsino types.

This integrated superpartner and SM decays with particle creation, Higgs forces, spontaneous symmetry breaking, and quantum gravity theories, (see Table V).

8 Neutrino oscillations

Neutrinos oscillated between three flavors via the seesaw model using a neutral heavy lepton (NHL). The three neutrino flavors were: electron-neutrino, muon-neutrino, and tau-neutrino. According to the seesaw model, neutrino mass was $(m_D)^2/M_{NHL}$, where m_D was the SM Dirac mass (i.e. p_{14} , p_{13} , p_9) and M_{NHL} was the neutral heavy lepton mass also referred to as a large right-handed Majorana [15]. The neutral heavy lepton appeared in some SM extensions and was assumed to be the stable fourth family neutrino, either a zino p_{31} or photino p_{32} , and a constituent of dark matter [16].

This integrated neutrino oscillations with particle creation, spontaneous symmetry breaking, dark matter, and quantum gravity theories, (see Table V).

9 Dark matter

Dark matter consisted of zinos, photinos, and three permanent Higgsino types. Dark matter agglomeration formed the framework of galaxies.

Superpartners decay into the zino and photino of the LSP and SM quarks and leptons. A prime candidate for dark matter is the LSP or neutralino which is an amalgam of the zino p_{31} , photino p_{32} , and three permanent Higgsino types h_1 , h_2 , and h_{16} .

Dark matter agglomeration formed the framework of galaxies and its start time was 30,000 years [17]. Start of dark matter agglomeration defined the transition between our universe's uniform and non-uniform distribution of matter expansions. Following this transition, galactic regions were represented by static spatial cubes whereas intergalactic regions were represented by dynamic spatial cubes. Between 30,000 and 380,000 years dark matter clumped together, whereas electrically charged matter particles did not. At 380,000 years, electrically neutral atoms formed and began clumping around the dark matter framework [18].

This integrated dark matter with particle creation, inflation, Higgs forces, spontaneous symmetry breaking, neutrino oscillations, universe expansions, dark energy, cosmological constant problem, baryogenesis, and quantum gravity theories (see Table V).

10 Universe expansions

There were four sequential universe expansion types. Entropy increase of the super force and its derivatives drove the expansion within our universe's first Planck cube. X bosons or inflatons' latent heat drove the inflationary period's exponential expansion. Dark energy drove both the uniform and non-uniform distribution of matter expansions. The product of our universe's non-uniform distribution of matter expansion rate and the graviton's intergalactic propagation time was superstring theory's seventh extra dimension. Universe expansions theory was amplified to include expansion within our universe's first Planck cube and identification of X bosons as the latent heat source during inflation.

During the first expansion type, our universe's size expanded from a doughnut physical singularity at a Planck cube center at $t = 0$, to a spherical physical singularity with a radius of less than $.8 \times 10^{-35}$ m at the start of matter creation (Figs. 5 and 6). Entropy increase of the super force, gravitinos*, gravitons, 12 superpartner forces, gluinos*, gluons, and 16 associated Higgs particles drove this expansion similar to the loosening of a smaller than a Planck cube sized knot of vibrating superstrings.

The second inflationary period expansion type was similar a water container freezing and bursting. More energy exists in liquid than frozen water. When water freezes, its temperature remains constant and latent heat is released. X bosons (12 superpartner forces, their 12 associated Higgsinos, and their 24 anti-particles) were the latent heat energy source during inflation.

Our universe's third and fourth expansion types occurred from 10^{-33} s to 30,000 years for the uniform distribution of matter and from 30,000 years to the present for the non-uniform distribution of matter. Dark energy (i.e., eight Higgs forces) drove both the uniform and non-uniform distribution of matter expansions.

Our universe's non-uniform distribution of matter expansion can be represented by a marbles/dough/balloon model consisting of marbles mixed in electromagnetically transparent rising dough in a balloon. Space between galaxies expands whereas space within galaxies does not. The rigid marbles (galaxies) do not expand, whereas the dough (intergalactic space) and the balloon (our universe) expand.

10.1 Superstring theory's seventh extra dimension

The product of the non-uniform distribution of matter expansion rate and the graviton's intergalactic propagation time is superstring theory's seventh extra dimension. Einstein's general relativity representation of static galactic spatial squares (cubes) on a rubber fabric must transition into dynamic spatial squares of intergalactic regions. Newton's gravitational force equation ($F = Gm_1m_2/r^2$) is valid for galactic regions. For intergalactic regions the radius (r) must be amplified as follows. The radius (r) consists of two components $r_1 + e_r t_i$. The first constant component (r_1) is the initial radius between two masses in two galaxies at a graviton's emission time. The second variable component ($e_r t_i$) is our universe's non-uniform distribution of matter expansion rate (e_r) multiplied by the graviton's intergalactic propagation time (t_i). The matter expansion rate (e_r) is itself a function of time because our universe decelerated during its first 8 billion years and accelerated during the last 6 billion years. The product ($e_r t_i$) is superstring theory's seventh extra dimension which dilutes the intergalactic gravitational force because of our universe's non-uniform distribution of matter expansion.

This integrated universe expansions with superstring, particle creation, inflation, Higgs forces, spontaneous symmetry breaking, dark matter, dark energy, relative strengths of forces, and quantum gravity theories, (see Table V).

11 Dark energy

By the end of matter creation or $t = 100$ s, our universe consisted of atomic/subatomic matter (5%), cold dark matter (26%), and dark energy (69%), and those percentages remained constant for 13.8 billion years. Dark energy was the sum of eight Higgs forces associated with eight permanent matter particles. The cosmological constant was proportional to vacuum or dark energy density. Dark energy density was the sum of eight permanent Higgs force energy densities.

By $t = 100$ s only 22 permanent matter and force particles remained, consisting of eight permanent matter particles/Higgs forces and three permanent Higgsino types/three SM forces. Following $t = 100$ s, baryonic matter was changed by big bang, stellar, or supernova nucleosynthesis which transformed neutrons into protons and vice versa. Nucleosynthesis changed total up and down quark rest mass without changing total baryonic energy/mass. This was because only 1% of a proton/neutron's energy/mass was rest mass and 99% was nuclear binding energy and the latter was a fraction of total kinetic and potential energies. Furthermore, when a particle's rest mass was converted to energy and radiation, they were absorbed by other baryonic particles in the first particle's immediate vicinity. Permanent dark matter creation/annihilation required the wino intermediate force at 10^{15} K which was greater than existing temperatures in our universe. Thus by the end of matter creation, our universe consisted of atomic/subatomic matter (5%), cold dark matter (26%), and dark energy (69%), and these percentages remained constant for 13.8 billion years. There was no quintessence or dynamic dark energy (see section 24 Conclusions, independent analyses/validations).

At $t = 200$ s or the start of the opaque era, our universe consisted of: eight uniformly distributed permanent matter particles or electrons, up quarks and down quarks in protons and helium nuclei, electron-neutrinos, muon-neutrinos, tau-neutrinos, zinos, and photinos; three permanent Higgsino types and their three forces (graviton, gluon, and photon); and eight Higgs forces in the space between matter particles (true vacuum). Our universe's uniform 10^8 K temperature caused radiation emission/absorption between electrons, protons, and helium nuclei. At 380,000 years, radiation ended and neutral atoms clumped around the dark matter framework. Galaxies formed after 200 million years and the temperature of intergalactic space decreased relative to galaxies. Currently, that vacuum temperature is 2.72 K. Dark energy was a constant for 13.8 billion years, however as our universe expanded dark energy density decreased.

Dark energy was the sum of eight Higgs forces associated with eight permanent matter particles (up quark, down quark, electron, electron-neutrino, muon-neutrino, tau-neutrino, zino, and photino). Since the zino and photino were two dark matter particles, there was an intimate relationship between Higgs forces, dark energy, and dark matter. Since the cosmological constant Λ was proportional to dark energy density, there was an intimate relationship between the cosmological constant and dark matter (see section 24 Conclusions, independent analyses/validations).

The cosmological constant Λ was proportional to the vacuum or dark energy density (ρ_Λ), or $\Lambda = 8\pi G\rho_\Lambda$, where G is the gravitational constant [19]. Dark energy density: was uniformly distributed in our universe; was the sum of eight permanent Higgs force energy densities, or $\rho_\Lambda = H_{11d}, H_{10d}, H_{12d}, H_{31d}, H_{32d}, H_{9d}, H_{13d}, H_{14d}$; and decreased with time along with the cosmological constant as our universe expanded.

This integrated dark energy with particle creation, inflation, Higgs forces, spontaneous symmetry breaking, dark matter, universe expansions, Super Universe, stellar black holes, arrow of time, cosmological constant problem, baryogenesis, and quantum gravity theories, (see Table V).

12 Messenger particles

Messenger particles were amplified to contain embedded clocks/computers as their operational mechanisms.

Particles are insufficient to constitute matter, glues are also required. Strong force glue (gluon) is required for nuclei. Electromagnetic force glue (photon) is required for atoms/molecules. Gravitational force glue (graviton) is required for multi-mass systems [20].

12.1 Gravitational/electromagnetic

The graviton/photon clock/computer calculates Newton's gravitational or Coulomb's force and provides it to the receiving particle.

Figure 10 shows an up quark particle p_{11} surrounded by quantized Higgs force particles h_{11} in two instead of three dimensions. The up quark/Higgs force are one and inseparable and modeled as an undersized porcupine with overgrown spines. Both the undersized porcupine (up quark) and its associated Higgs force (overgrown spines) have been quantized into Planck cube closed superstrings. Radial Higgs force strength is diminished by the propagation factor $1/R^2$ where R is the distance between the up quark p_{11} in the center Planck cube and a quantized Higgs force h_{11} in another Planck cube.

Newton's gravitational force ($F = Gm_1m_2/r^2$) and Coulomb's force ($F = Cq_1q_2/r^2$) equations have the same form, where m_1 and m_2 are two masses, q_1 and q_2 are two charges, r is the range between masses/charges, G is the gravitational constant, and C is Coulomb's constant. For Newton's gravitational force, the graviton extracts mass m_1 from the attached Higgs force particle (see h_{11} contents of Fig. 10) associated with the transmitting particle (e.g., up quark p_{11}). The Higgs force particle contents includes mass, charges, and spin of both the particle p_{11} and its associated Higgs force h_{11} , and messenger particle p_1 , p_2 , p_{15} , p_{16} templates. For example, the p_1 template contains Newton's gravitational force equation parameter formats: G , m_1 , m_2 , t_r , t_t , and c . The graviton extracts G from the graviton p_1 template. The clock initiates at transmission time t_t and stops at reception time t_r . The computer calculates the range factor ($1/r^2$) as $1/[(t_r - t_t)(c)]^2$. Upon graviton reception the receiving mass m_2 is extracted from the Higgs force particle associated with the receiving particle (e.g. down quark p_{10}). The graviton clock/computer calculates Newton's gravitational force and provides it to the receiving particle. The gravitational force between transmitting and receiving particles consist of a continuous series of graviton messenger particles. For Coulomb's force, the two masses m_1 and m_2 are replaced by two charges q_1 and q_2 and the Gravitational constant G is replaced by Coulomb's constant C . These concepts must be amplified to include: multiple fundamental particles, protons, neutrons, atoms, molecules, stars, and galaxies.

Newton's gravitational force is calculated for Higgsinos in a similar manner except the Higgsino mass and p_1 template are embedded in the Higgsinos.

This integrated messenger particles with Higgs forces and quantum gravity theories, (see Table V).

12.2 Strong

The gluon clock/computer calculates the strong force and provides it to the receiving quark.

Quantum Chromodynamics (QCD) is strong force theory and has two major properties, confinement where the force between quarks does not diminish with separation and asymptotic freedom where the force approaches zero at short separations and quarks are free particles. Potential energy between two quarks is $V = -\alpha_s/r + kr$ and force is $F = -dV/dr = \alpha_s/r^2 - k$ where r is the range between quark masses, k is a constant, and α_s is the running or nonlinear coupling constant which decreases with separation. The

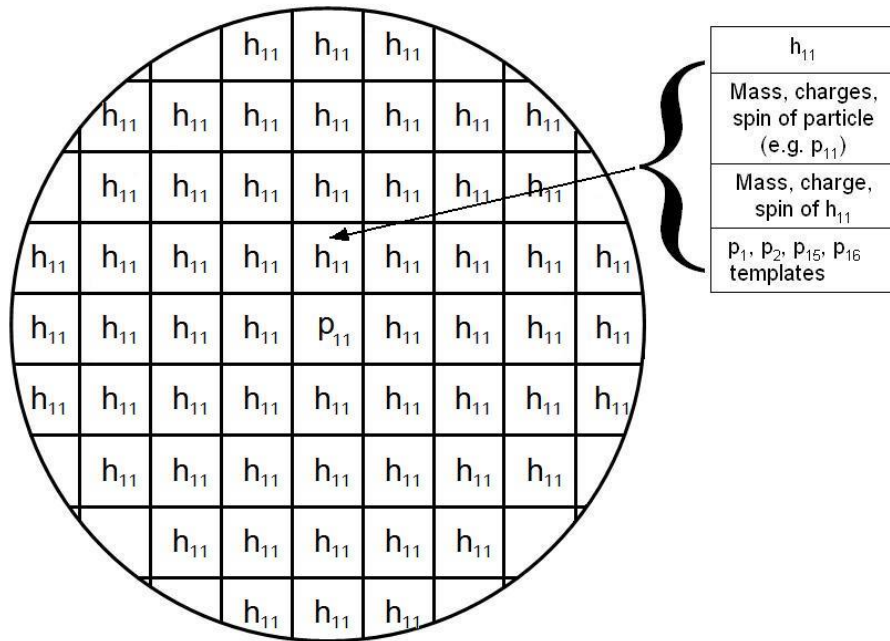

FIG. 10. Up quark with quantized Higgs force particles.

force equation has two components, a Coulomb like force (α_s/r^2) and a constant force (-k). As two confined quarks separate, the gluon fields form narrow tubes of color charge, which attract the quarks as if confined by an elastic bag. For quark separations comparable to the proton's radius (10^{-15} m), the gluon clock/computer provides the constant -k force to the receiving quark. For quark separations less than a proton radius, the gluon clock/computer calculates the strong force using either the Coulomb term or a force versus range table look up and provides it to the receiving quark [21].

13 Relative strengths of forces/Hierarchy problem

The relative strengths of gravitational and electromagnetic/weak forces are due to propagation factor dilution ($1/r^2$) between gravitational force activation and electromagnetic/weak force creation/activation.

There were two interpretations of the Hierarchy Problem. In the first interpretation, the Hierarchy Problem was the relative strengths of the gravitation force to the electromagnetic/weak force [22] whereas in the second interpretation it was the mass of the W/Z particles relative to the Planck mass [23]. Both interpretations were related but different. In the first interpretation the relative strengths of the gravitational force to the electromagnetic/weak force was 10^{-39} as shown in Table II. This corresponded to a propagation dilution factor ($1/r^2$) of approximately 10^{-19} . In the second interpretation as shown in Fig. 5, the mass of the W/Z particles (approximately 10^{15} K or 10^{11} eV) relative to the Planck mass of 10^{28} eV at the Planck time was 10^{-17} . The first interpretation was assumed correct because although the graviton was created at the Planck time, it was not activated until condensation of the heaviest matter particle, the gravitino. The first interpretation was described as follows.

TABLE II. Relative strengths of forces.

Force	Relative Strengths
Strong	1
Electromagnetic/weak	10^{-3}
Gravitational	10^{-42}

Column two of Table II shows computed relative strengths of gravitational and electromagnetic force between an electron and quark as 10^{-39} . From Fig. 6, the electromagnetic/weak force creation/activation time ($t_{w/z}$) was 10^{-12} s when our universe's radius was ($r_{w/z}$). All force strengths were equal at the Planck time 5.4×10^{-44} s. From Fig. 5, the gravitational force or graviton was created at 5.4×10^{-44} s but activated at t_g when our universe's radius was (r_g) in Fig. 6. This occurred during condensation of the heaviest supersymmetric matter particle assumed to be the gravitino. At electromagnetic/weak force creation/activation time ($t_{w/z}$) or 10^{-12} s, the gravitational force had already been diluted by 10^{-39} or equivalently a range dilution of approximately 10^{-19} . Since energy/masses of supersymmetric particles were estimated between 100 to 1500 GeV by Snowmass [2] and W/Z's were 80 to 90 GeV, their relative energy/masses and activation times were incompatible with the required range reduction factor. Thus, the Snowmass estimates of supersymmetric particle energy/masses were too low.

From Fig. 6, the electromagnetic/weak force creation/activation time ($t_{w/z}$) was 10^{-12} s which corresponded via the right and top dashed lines to our universe's radius ($r_{w/z}$) of 10^{11} m. The gravitational force activation time (t_g) was the time required to produce a 10^{-19} range reduction factor ($r_g/r_{w/z}$). From Fig. 6, the bottom and left dashed lines related our universe's radius (r_g) or 10^{-8} m to the gravitational force activation time (t_g) of approximately 10^{-33} s. From Fig. 5, t_g corresponded to a gravitino energy/mass of approximately 10^{25} K or 10^{21} eV.

This integrated relative strengths of forces with particle creation, inflation, universe expansions, and quantum gravity theories, (see Table V)

14 Conservation of energy/mass accountability

All 128 matter and force particle types complied with conservation of energy/mass accountability. Accountability of our universe's total 10^{54} kg of energy by the end of matter creation at $t = 100$ s follows.

Nine transient matter particles (top quark, bottom quark, charm quark, strange quark, tau, muon, gravitino, gluino, and W/Z's) and their nine associated Higgs forces for a total of 18 particles accounted for 0%. By 100 s, nine transient matter particles/Higgs forces evaporated and condensed (decayed) to eight permanent matter particles/Higgs forces.

X bosons or inflatons consisted of 12 transient superpartner forces and their 12 associated Higgsinos for a total of 24 particles. X bosons or inflatons accounted for 0% because all their energy expanded our universe during inflation.

By the end of matter creation at $t = 100$ s and at a temperature of 10^{10} K, all 64 anti-particles had been eliminated either by baryogenesis or inflation (12 anti-Higgsinos and their 12 associated superpartner forces) for a total of 64 particles.

Twenty two permanent matter and force particles remained. Three SM force particles (graviton, gluon, and photon) existed but accounted for 0%. Even though in transit photons contained radiation energies at

$t = 100$ s, these photons were assumed to contain zero energy. Transmitted radiation energies were allocated to transmitting particles until the radiation was received and then allocated to receiving particles.

Three types of matter and force particles with energy/masses remained at $t = 100$ s: atomic/subatomic matter, dark matter, and dark energy. Atomic/subatomic matter or six permanent matter particles (up quark, down quark, electron, electron-neutrino, muon-neutrino, and tau-neutrino) constituted 5% of our universe's energy/mass. Dark matter or the zino, photino, and three permanent Higgsino types constituted 26% of our universe's energy/mass. Dark energy or eight Higgs forces associated with eight permanent matter particles (up quark, down quark, electron, electron-neutrino, muon-neutrino, tau-neutrino, zino, and photino) constituted 69% of our universe's energy/mass [24].

15 Super Universe

The Super Universe or multiverse consisted of nested parallel precursor universes. Precursor universes consisted of nested parallel universes. Our universe was nested in our older precursor universe which was nested in the still older Super Universe as shown in Fig. 13. The Super Universe was modelled as a near infinitely large gumball machine. Our universe with a radius of 46.5 billion ly was one of the gumballs and parallel universes were other gumballs with different radii. A subset of the gumballs which included our universe was our precursor universe. The entire gumball machine was the Super Universe of parallel universes.

Universal laws of physics and structure were assumed across the Super Universe. The Super Universe: had a single vacuum; was homogeneous and isotropic on a large scale; contained 129 matter and force particle types; had eight permanent matter particles/Higgs forces; obeyed conservation of energy/mass; and had a constant dark energy to total energy/mass percentage (69%) just like our universe.

This integrated the Super Universe with superstring, dark energy, stellar black holes, arrow of time, cosmological constant problem, and quantum gravity theories, (see Table V).

16 Stellar black holes

Stellar black holes include quark stars (matter) and black holes (energy).

Currently a stellar black hole is defined as a spacetime region where gravity is so strong not even light can escape and having no support level below neutron degeneracy pressure. The black hole spacetime region is a three dimensional sphere which appears as a two dimensional hole just as our three dimensional sun appears as a two dimensional disk. An inconsistency in black hole definitions exists. A stellar black hole contains a singularity having minimum area and volume whereas the same stellar black hole has maximum entropy with maximum event horizon area as defined by Bekenstein or maximum volume as defined in section 17 Black hole entropy.

Stellar black hole theory was thus amplified to include a quark star (matter) and black hole (energy), both of which were "black." Their differences were a quark star (matter) had mass, volume, near zero temperature in accordance with the black hole temperature equation, permanence, and maximum entropy. In contrast, its associated black hole (energy) had super force energy, a minimum volume doughnut physical singularity at a Planck cube center, near infinite temperature, transientness, and minimal entropy.

Stellar gravitational collapse occurs when internal energy is insufficient to resist the star's own gravity and is stopped by Pauli's exclusion principle degeneracy pressure. If the star's mass is less than 8 solar masses, it gravitationally collapses to a white dwarf star supported by electron degeneracy pressure. The discrepancy between the initial 8 solar masses and approximately 1.39 solar masses or Chandrasekhar limit is due to solar winds. If the star is between 8 and 20 solar masses, it gravitationally collapses to a

neutron star supported by neutron degeneracy pressure with a supernova explosion. If the star is between 20 and 100 solar masses, it gravitationally collapses to a quark star (matter) supported by quark degeneracy pressure with a quark-nova explosion. According to Leahy and Ouyed, the quark star (matter) forms with a quark-nova's nuclear binding energy release. The delayed secondary quark-nova explosion follows a neutron star's primary supernova explosion (see section 24 Conclusions, independent analyses/validations).

Six types of Super Universe stellar black holes were: supermassive quark star (matter), quark star (matter), super supermassive quark star (matter), its associated super supermassive black hole (energy), super super supermassive quark star (matter), and its associated super super supermassive black hole (energy). The first two types, supermassive quark stars (matter) and quark stars (matter) existed in universes. The second two types, super supermassive quark stars (matter) and their associated super supermassive black holes (energy) existed in precursor universes and created universes. The third two types, super super supermassive quark stars (matter) and their associated super super supermassive black holes (energy) existed in the Super Universe and created precursor universes.

The first type or a supermassive quark star (matter) contains 10^6 to 10^{10} solar masses [25]. They may be "fossil quasars" with masses proportional to their host galaxies' masses. According to Carilli, galaxy to central black hole mass ratio was 30:1 in our early universe and 700:1 now [26]. Population III stars containing hydrogen, helium, and lithium first formed approximately 200 million years after the start of our universe. These first generation stars contained up to 100 times more gas than the sun, had short lives, and created over 100 billion neutron stars or quark stars (matter) and their supernova or quark-nova remnants [27]. Over the next 13.6 billion years, by accretion of stars/matter and merger with galaxies, approximately 100 billion supermassive quark stars (matter) and their 100 billion galaxies formed in our universe. That is, over the last 13.6 billion years, approximately 10^6 to 10^{10} solar masses were swallowed by these supermassive quark stars (matter).

The second type or quark star (matter) contains between several and 10^6 solar masses. Quark stars (matter) having several solar masses were initially created by first generation star collapses. Their sizes were augmented by accretion of stars/matter and merger with neutron stars or quark star (matter) galaxies during the next 13.6 billion years.

The third type or a super supermassive quark star (matter) contains 10^{10} to 10^{24} solar masses. In our precursor universe, a super supermassive quark star (matter) which consisted of a cold quark-gluon plasma [28], increased in size via accretion of stars/matter and merger with galaxies. At the 10^{24} solar mass threshold or our universe's energy/mass, quark degeneracy pressure was insufficient to stop further gravitational collapse. The super supermassive quark star (matter) instantaneously evaporated, deflated, and gravitationally collapsed to the fourth type or its associated super supermassive black hole (energy) which created our universe's "big bang" (white hole) and a bubble of zero-point energy. A zero-point energy bubble is completely empty (i.e., a perfect vacuum) whereas a true vacuum contains dark energy or Higgs forces.

In the Super Universe, the fifth type or a super super supermassive quark star (matter) contained $\gg 10^{24}$ solar masses and instantaneously evaporated, deflated, and gravitationally collapsed to the sixth type or its associated super super supermassive black hole (energy) and created a precursor universe. Table III summarized the relationships between stellar black hole types and precursor universes, universes, and galaxies.

This integrated stellar black holes with superstring, particle creation, dark energy, Super Universe, black hole entropy, arrow of time, cosmological constant problem, black hole information paradox, baryogenesis, and quantum gravity theories, (see Table V).

TABLE III. Relationships between stellar black hole types and precursor universes, universes, and galaxies.

Stellar black hole types	Stellar black hole sizes (solar energy/mass)	Creation of precursor universes, universes, galaxies
Super super supermassive quark stars (matter)/black holes (energy)	$\gg 10^{24}$	Precursor universes
Super supermassive quark stars (matter)/black holes (energy)	$\sim 10^{24}$	Universes
Supermassive quark stars (matter)	$10^6 - 10^{10}$	Galaxies
Quark stars (matter)	Several - 10^6	Small galaxies

16.1 Einstein's General Relativity/Dark energy expansion equations

The Friedmann, Lemaitre, Robertson, and Walker (FLRW) metric is the accepted solution to Einstein's General Relativity equations. The three terms in Friedmann's equation are [29]:

$$\ddot{a}/a = -4\pi G\rho/3 - 4\pi Gp + \Lambda/3 \quad (1)$$

where a is the scale factor, G is the gravitational constant, ρ is mass density, p is pressure, and Λ is the cosmological constant. Since the radiation pressure force ended at 380,000 years, the second term ($-4\pi Gp$) is ignored after that time and the remaining terms describe two opposing forces which shape universes. The first term ($-4\pi G\rho/3$) is the gravity/matter force and the third term ($+\Lambda/3$) is the anti-gravity/dark energy force.

The FLRW metric has three scenarios [30]. In the first scenario, matter and dark energy are in close balance. From a doughnut physical singularity, a universe expands at a decelerating rate until it reaches an inflection point and then expands at an accelerating rate. This is our universe's scenario where the inflection point is eight billion years after our universe's start. This scenario (big freeze) applies to most Super Universe parallel universes because it is balanced and stable.

In the second scenario, matter overwhelms dark energy. From a doughnut physical singularity, a universe expands at a decelerating rate until it reaches a maximum radius and then contracts to another doughnut physical singularity (big crunch). This is our precursor universe's scenario where the super supermassive quark star (matter) evaporated, deflated, and gravitationally collapsed to a super supermassive black hole (energy), creating our universe's "big bang" (white hole). See section 18 Arrow of time.

In the third scenario, dark energy overwhelms matter. From a nonzero radius, a universe expands at an ever increasing acceleration rate. This is the least understood scenario.

Two types of Planck cubes in our universe following galaxy formation were: Planck cubes containing matter particles (e.g., in stars, galaxies, and filaments); and Planck cubes containing force particles (e.g., superimposed Higgs forces) in Planck cubes between matter particles. There were eight permanent matter particle types (up quark, down quark, electron, electron-neutrino, muon-neutrino, tau-neutrino, zino, and photino) with associated three dimensional Higgs forces. Each particle in our universe of the eight

permanent matter particle types contributed a Higgs force to the second Planck cube type containing superimposed Higgs forces. The cosmological constant Λ was proportional to the vacuum or dark energy density (ρ_Λ), or $\Lambda = 8\pi G\rho_\Lambda$, where G is the gravitational constant and c is the speed of light. Dark energy density was the sum of superimposed Higgs force energies in a Planck cube divided by the Planck cube volume. The sum of these Planck cube dark energy densities over our universe's volume was dark energy. This energy density currently averages 2.72 K/Planck cube on a large scale (490 million light year cube). As our universe expands, this temperature approaches zero.

There is an intimate relationship between galaxy distance from the big bang location and the time required for the galaxy to reach that distance (see Amplified Hubble's law in section 19 Cosmological constant problem). Because of the time varying acceleration of our universe, the relationship between distance (d) and time (t) is a polynomial in time known as the dark energy expansion equations with currently undefined coefficients a, b, c, d , and e or,

$$\text{Distance} \quad d(t) = a + bt + ct^2 + dt^3 + et^4 \dots \quad (2)$$

$$\text{Velocity} \quad dd/dt = b + 2ct + 3dt^2 + 4et^3 \dots$$

$$\text{Acceleration} \quad d^2d/dt^2 = 2c + 6dt + 12et^2 \dots$$

Two techniques for defining the dark energy expansion equations' coefficients are summarized as follows and are suggested rather than definitive techniques. The first technique uses the Illustris N-body simulation's computed galaxy distances d and times t (or equivalently v) to fit the above dark energy expansion equations (2) and define the coefficients a, b, c, d , and e (see section 23 A Two-Step Integrated TOE: Second mathematics step). However, this is not a dark energy predictive technique.

The second technique is similar to the first except the galaxies' distances d and times t are calculated from a test volume's dark energy density ρ_Λ and mass density ρ instead of from the Illustris N-body simulation. A number of galaxies (e.g. 10) and their three dimension locations and times are initially defined by measured galaxy positions. Each particle of the eight permanent matter particle types in the test volume contributes a Higgs force to the second Planck cube type containing superimposed Higgs forces. Dark energy density is the sum of superimposed Higgs force energies in a Planck cube divided by its volume. The number of matter particles (e.g., up quarks) in a galaxy and the number of Planck cubes in the test volume are both near infinite. Since the calculation of Higgs forces in each of the second Planck cube types is computationally overwhelming, simplifications are required. For example, since Higgs force strength diminishes by $1/R^2$ where R is the distance from the associated matter particle, contributions of distant matter particles to superimposed Higgs forces are negligible and eliminated. Another simplification is for all matter particles in each galaxy to be concentrated to a galaxy center point having the entire galaxy's energy/mass. The following are then calculated: test volume ρ_Λ and ρ ; the first (gravity/matter force) and third (anti-gravity/dark energy) terms of equation (1); and \ddot{a}/a between two galaxies. From \ddot{a}/a , distance d and time t between the two galaxies are calculated and inserted in the distance equation (2) to obtain an equation with unknown coefficients a, b, c, d , and e . Distances d and times t are iteratively calculated for all 10 galaxy combinations to find the best coefficients match for the 10 galaxies. This proof of concept or a variation of it should provide a "ballpark" set of dark energy expansion equations coefficients a, b, c, d , and e . Once this proof of concept is demonstrated, the test volume is increased in size with inclusion of more galaxies, stars, and filaments. Iterations should improve the accuracy of the computed dark energy expansion equations coefficients.

16.2 Star factor products

Because of three star factor products only a small portion of our universe's volume (10^{-51}) contained stellar black holes. The three factor products were: stars were concentrated matter surrounded by large volumes of space (10^{-32}); only a small fraction of stars were stellar black holes (10^{-3}); and stellar black

holes were compressed stars (10^{-16}). Newton's equations of motion and Cartesian Coordinates were applicable for most of our universe's volume provided the dark energy expansion equations (2) were included. In those sub-volumes containing stellar black holes and on an exception basis, Einstein's equations of General Relativity must be substituted for Newton's equations and spacetime coordinates substituted for Cartesian Coordinates.

17 Black hole entropy

The proposed entropy formula for a quark star (matter) was proportional to the quark star's volume (r^3) and inversely proportional to a Planck cube's volume (l_p^3).

Entropy of a black hole is currently defined as $S_{BH} = \eta A / (l_p)^2$ where η is a constant, A is the event horizon area, and l_p is the Planck length [31]. BH stands for either "black hole" or "Bekenstein-Hawking."

A second proposed entropy formula uses Boltzmann's equation $S = k \log \Omega$, where k is Boltzmann's constant, and Ω is the total number of different ways matter particle closed superstrings can arrange themselves. A quark star (matter) contains N matter particle closed superstrings each in a Planck cube and a total of M Planck cubes containing matter particle or Higgs force closed superstrings. N and M are large and $N \ll M$. According to Dabholkar, the total number of ways of distributing N matter particle closed superstrings each with a volume $(l_p)^3$ within a quark star (matter) of volume $V = (4\pi r^3/3)$ is [32]:

$$S = k \log \Omega \text{ or} \tag{3}$$

$$\Omega = (1/N!)(V/(l_p)^3)^N \text{ where } l_p \text{ equals Planck length or}$$

$$\Omega = (1/N!)(4\pi r^3/3(l_p)^3)^N \text{ where } r \text{ is the quark star (matter) radius} \tag{4}$$

This integrated black hole entropy with particle creation, stellar black holes, arrow of time, cosmological constant problem, black hole information paradox, baryogenesis, and quantum gravity theories, (see Table V).

18 Arrow of time

In our precursor universe and at the 10^{24} solar mass threshold, a maximum entropy super supermassive quark star (matter) instantaneously evaporated, deflated, and gravitationally collapsed to its associated minimum entropy super supermassive black hole's (energy) doughnut physical singularity which created our universe.

In an isolated system such as our universe, the Second Law of Thermodynamics states entropy increases irreversibly with time and provides a thermodynamic arrow of time. In contrast, Einstein's Theory of General Relativity is time symmetric and apparently contradicts the Second Law of Thermodynamics. Schwarzschild's solution of Einstein's equations consists of a black hole, a white hole, and an Einstein-Rosen bridge (i.e. wormhole or doughnut physical singularity) connecting the two universes. Schwarzschild's solution is Friedmann's second scenario final stage gravitational collapse to a super supermassive black hole (energy).

During a specific time interval within a subset volume of our universe, entropy decreased without negating our universe's Second Law of Thermodynamics. A nebula's hydrogen/helium gas, dust, and plasma began ordering itself at our solar system's creation 4.6 billion years ago. Entropy decreased because life was created. Life is synonymous with low entropy or available energy and death with high entropy or unavailable energy. Since our solar system was one of approximately 100 billion Milky Way stars and our galaxy was one of approximately 100 billion galaxies in our universe, our solar system's entropy decrease did not negate our universe's entropy increase via the remaining 10^{22} stars. Similarly, entropy increased in our precursor universe whereas entropy decreased in a subset volume where a super

supermassive quark star (matter) evaporated, deflated, and gravitationally collapsed to a super supermassive black hole (energy).

At the 10^{24} solar mass threshold, a maximum entropy super supermassive quark star (matter) instantaneously evaporated, deflated, and gravitationally collapsed to its associated minimum entropy super supermassive black hole's (energy) doughnut physical singularity shown in Fig. 11. In Fig. 11a, a matter particle is shown as an m, a Higgs force as an h, and a force particle as an f in their Planck cubes. The m represents one of eight types of permanent matter particles or three permanent Higgsino types and h represents superimposed Higgs forces of each permanent matter particle (eight types). The f represents one of three permanent force particles graviton, gluon, or photon. Following matter creation in our universe (approximately 100 s and 10^{10} K) or in any other universe, only twenty two permanent matter and force particles remained. That is following matter creation, all universes, precursor universes, and the Super Universe had twenty two permanent matter and force particles. Two exceptions were: a universe with intelligent life developing a Large Hadron Collider type device which produced extremely high temperatures required for transient matter particles like a top quark; and radioactive decay where for example beta decay transformed carbon-14 into nitrogen-14 via creation of the high temperature W^- transient matter particle.

Fig. 11a shows only the super supermassive quark star (matter) core. Outside the core, are superimposed Higgs forces of each permanent matter particle (eight types) which are inside the core. These Higgs forces existed from the super supermassive quark star (matter) core's boundary to near infinity. Fig. 11a is shown in two instead of three dimensions and not to scale since Planck cubes are near infinitely small in comparison to the super supermassive quark star's (matter) radius. At approximately one second before $t = 0$, the super supermassive quark star (matter) swallowed an additional matter particle and quark degeneracy pressure threshold was exceeded. At the super supermassive quark star's (matter) center, a single electron-neutrino/Higgs force was subjected to extremely high pressure and temperature caused by matter particles above it. The electron-neutrino/Higgs force evaporated at 10^{10} K to the super force, incrementally increasing the super supermassive quark star (matter) center's temperature. A chain reaction began which instantaneously evaporated, deflated, and gravitationally collapsed the super supermassive quark star (matter) to a super supermassive black hole (energy) shown in Fig. 11b. The super supermassive black hole (energy) or super force doughnut physical singularity was a Kerr-Newman black hole.

In Fig. 11a, the super supermassive quark star (matter) existed until approximately one second before our universe's start. The Hawking temperature of the super supermassive quark star (matter) having our universe's mass $M = 10^{23} M_{\odot}$ was $T=10^{-7} (M_{\odot} / M)$ K or 10^{-30} K and its life time t was approximately $10^{66}(M/M_{\odot})^3$ years, where M_{\odot} was solar mass, and K was degrees Kelvin [33]. Since the super supermassive quark star's (matter) equation of state and cold quark-gluon plasma density were unknown, its radius was estimated as follows. Its upper radius was its Schwarzschild radius or $r_s = 2Gm/c^2 = (1.48 \times 10^{-27} \text{ m/kg}) (.32 \times 10^{54} \text{ kg}) \sim 5 \times 10^{26} \text{ m}$, where r_s is the Schwarzschild radius, G is the gravitational constant, c is the velocity of light, and m is our universe's mass [34]. The lower radius was approximated by assuming all matter particles were in contiguous Planck cubes. Since there were approximately 10^{81} matter particles in our universe, the minimum quark star volume was $V = (1.6 \times 10^{-35} \text{ m})^3 / (\text{matter particle}) (10^{81} \text{ matter particles}) = 4 \times 10^{-24} \text{ m}^3$, and its radius was approximately 10^{-8} m . The "rough" approximate radius was between the upper ($5 \times 10^{26} \text{ m}$) and lower (10^{-8} m) radius and shown in Fig. 11a as $\ll 10^{26} \text{ m}$. This $\ll 10^{26} \text{ m}$ radius was visualized as a radius of 50,000 ly or the radius of our Milky Way galaxy.

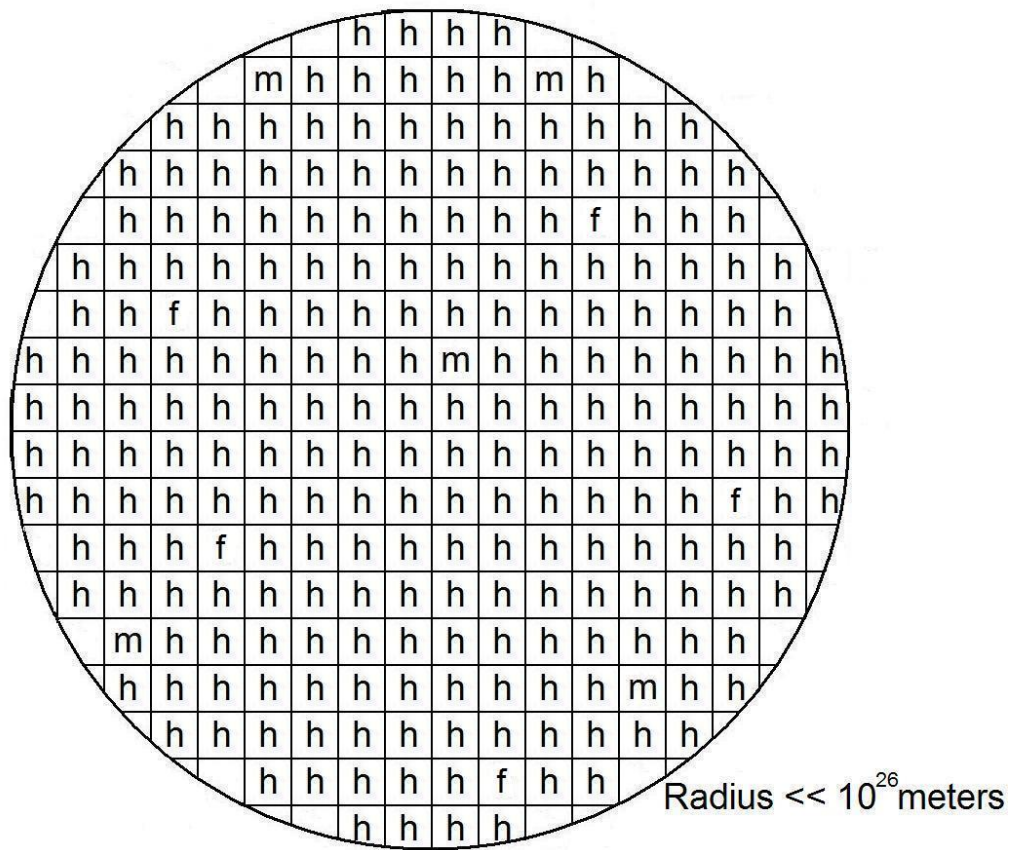

(a) Super supermassive quark star (matter) at $t=-1$ second

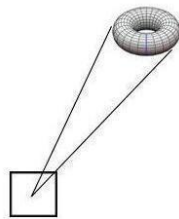

(b) Super supermassive black hole (energy) at $t=0$

Fig. 11. Super supermassive quark star (matter) collapse to a super supermassive black hole (energy).

Figure 12 shows our precursor universe's super supermassive quark star (matter)/black hole (energy) to our universe's big bang (white hole) transition. The X axis represents big bang time in seconds plus or minus from $t = 0$ and the Y axis represents number of super force particles. Fig. 12 shows time symmetry between -10^{-33} and 10^{-33} s in accordance with Einstein's theory of General Relativity. At $t = 0$, all our universe's energy consisted of super force particles stacked one atop another in a doughnut physical singularity at the center of a Planck cube. The number of super force particles was a maximum between $t = 0$ and the start of inflation at $t = 5 \times 10^{-36}$ s. The start of inflation was time synchronous with the one to seven Planck cubes energy to energy/matter expansion as described in section 4 Inflation. During inflation, the size of our universe expanded from a sphere smaller than a Planck cube to a sphere with a radius of 8 m. The latter was a hot quark-gluon plasma with a temperature of approximately 10^{25} K. During matter creation between 5×10^{-36} and 100 s and at extremely high temperatures between 10^{27} and 10^{10} K, heavy matter particles/Higgs forces evaporated to the super force and condensed to lighter matter particles/Higgs forces. By $t = 100$ s: only eight permanent matter particles (up quark, down quark, electron, electron-neutrino, muon-neutrino, tau-neutrino, zino, and photino); their eight associated super supersymmetric Higgs forces; three permanent Higgsino types; and their three associated SM forces existed.

On the left side of Fig. 12, matter evaporation occurred between $< -2 \times 10^{-33}$ and -5×10^{-36} s and was the counterpart of matter creation or condensation between 5×10^{-36} and 100 s. Deflation differed from inflation because its duration was longer and had two phases. During the first deflation phase between $< -2 \times 10^{-33}$ and -10^{-33} s, the super supermassive quark star (matter) or cold quark-gluon plasma at 10^{-30} K, gravitationally collapsed to a hot quark-gluon plasma with a radius of 8 m and a temperature of approximately 10^{25} K. During the second deflation phase between -10^{-33} and -5×10^{-36} s, the hot quark-gluon plasma gravitationally collapsed to a spherical physical singularity. The second deflation phase was the time reverse of inflation. That is, at -10^{-33} s, the super supermassive quark star (matter) consisted of a hot quark-gluon plasma with a radius of 8 m and a temperature of approximately 10^{25} K identical to our universe's hot quark-gluon plasma at 10^{-33} s. At -5×10^{-36} s, the super supermassive black hole (energy) or spherical physical singularity was identical to our universe's white hole (energy) spherical physical singularity at 5×10^{-36} s.

The start of matter evaporation coincided with the start of the first deflation phase at $t < -2 \times 10^{-33}$ s. Deflation of the 10^{-30} K super supermassive quark star (matter) began when its energy/mass reached the threshold of 10^{24} solar masses (10^{54} kg). A single electron-neutrino at the center of the super supermassive quark star (matter) was subjected to extremely high pressure and temperature (10^{10} K), even though the super supermassive quark star's (matter) average temperature was 10^{-30} K. This electron-neutrino/Higgs force evaporated to the super force, incrementally raising the temperature of the super supermassive quark star's (matter) center. A chain reaction began which instantaneously evaporated, deflated, and gravitationally collapsed the maximum entropy super supermassive quark star (matter) first to a hot quark-gluon plasma at -10^{-33} s and then to a minimum entropy super supermassive black hole (energy) spherical physical singularity at -5×10^{-36} s. The super supermassive black hole (energy) "resurrected" life via creation of super force particles in a subset volume of our precursor universe.

Jeans instability formula for interstellar gas cloud collapse and star formation was directly proportional to two parameters: the gas cloud's enclosed mass and gas density. This produced a variety of star sizes. Similarly, quark star (matter) collapse size was assumed to be a function of two parameters, energy/mass and energy/mass density. For our universe's creation, the energy/mass parameter was 10^{24} solar masses and the undefined energy/mass density was ρ_{qs} . If only one collapse parameter existed (e.g., energy/mass), each super supermassive quark star (matter) would collapse at 10^{24} solar masses to its associated super supermassive black hole (energy) and all created universes would be identically sized. There were combinations of energy/mass and energy/mass density parameters of super supermassive quark star (matter) collapses to associated super supermassive black holes (energy) for a variety of created universe sizes. There were also combinations of energy/mass and energy/mass density parameters of

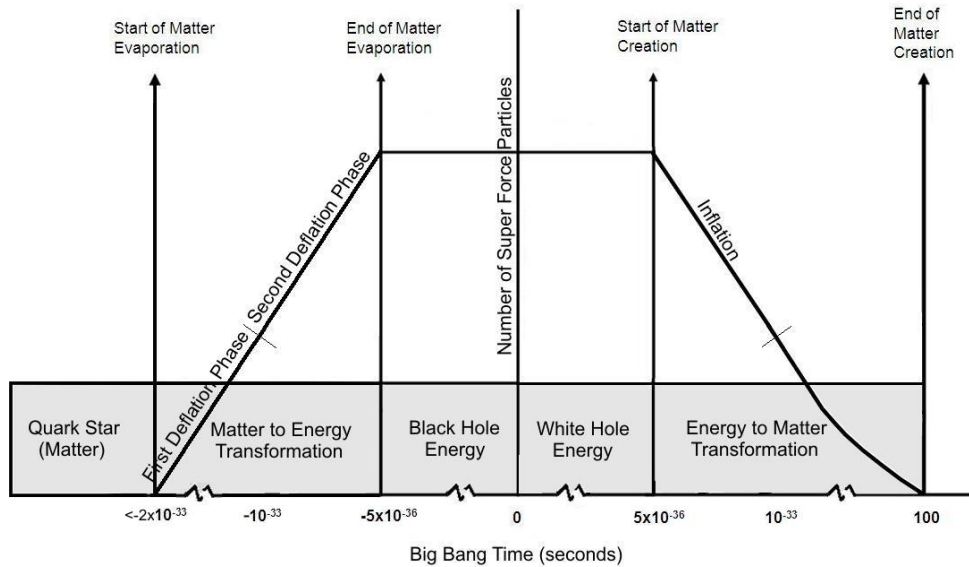

FIG. 12. Quark star/black hole to big bang (white hole) transition.

super super supermassive quark star (matter) collapses to associated super super supermassive black holes (energy) for a variety of created precursor universe sizes.

Following is a thought experiment on creation of a variety of quark star (matter) sizes. A neutron star consisted of eight permanent matter particles: up quark, down quark, electron, electron-neutrino, muon-neutrino, tau-neutrino, zino, and photino and three permanent Higgsino types. For analysis simplicity, the relatively low energy/mass electron and three neutrino matter particles were ignored. The seven remaining fundamental matter particles (up quark, down quark, zino, photino, and three permanent Higgsino types) were modeled as indivisible ball bearings in Planck cubes. Protons/neutrons were modeled as basketballs. Proton basketballs contained two up quarks and one down quark whereas neutron basketballs contained one up quark and two down quarks. In the first example, the neutron star consisted entirely of proton/neutron basketballs. As the number of basketballs in the neutron star increased, the basketballs compressed until neutron degeneracy pressure was inadequate to prevent further collapse to a quark star (matter) and its quark-nova explosion. In the second example, the neutron star consisted of proton/neutron basketballs with a percentage of zinos, photinos, and three permanent Higgsino types. The presence of zinos, photinos, and three permanent Higgsino types mitigated neutron star collapse until its mass was larger than the first example. The larger the percentage of zinos, photinos, and three permanent Higgsino types relative to proton/neutron basketballs in a neutron star, the larger was the neutron star, its resultant quark star (matter), and its quark-nova explosion. In the super supermassive quark star (matter) which created our universe, 26% of its energy/mass consisted of dark matter (zinos, photinos, and three permanent Higgsino types).

The larger the quark star's mass, the lower was its temperature and longer its life time. As our precursor universe's super supermassive quark star (matter) accumulated matter, its mass and life time approached near infinite whereas its temperature approached near zero. Entropy increased proportionally to the event horizon area in the Bekenstein-Hawking formula or to quark star volume in Boltzmann's equation. During the super supermassive quark star (matter) to black hole (energy) gravitational collapse; mass, life

time, temperature, and entropy values flipped. Mass, life time, and entropy approached near zero whereas temperature approached near infinite. However, total energy/mass was conserved. In the maximum entropy super supermassive quark star (matter), energy/mass was spread over a near infinite number of Planck cubes. In the minimum entropy super supermassive black hole (energy), energy was concentrated in a doughnut physical singularity in a Planck cube. During the deflationary period collapse, each matter particle, its associated Higgs force, and three permanent Higgsino types with three SM forces evaporated to super force energy leaving a zero-point energy bubble in its wake. Since the super supermassive black hole's (energy) near infinite temperature (10^{94} K) was much higher than the surrounding zero-point energy's temperature of 0 K, it transitioned to the white hole and initiated our universe's thermodynamic arrow of time. Our universe was created by a 10^{54} kg (10^{24} M_{\odot}) super force doughnut physical singularity surrounded by a spherical zero-point energy bubble. This complied with Einstein's time symmetric Theory of General Relativity. In essence, the super supermassive black hole (energy) "resurrected" life via creation of "mother" super force particles in a subset volume of our precursor universe. Thus, the super supermassive quark star (matter)/black hole (energy) had a dual nature: decomposition of matter structure (information) via evaporation of eight permanent matter particles, their eight associated super supersymmetric Higgs forces, and three permanent Higgsino types with three SM forces in the quark star (matter) state; and resurrection of life in the black hole (energy) state.

This integrated arrow of time with Higgs forces, dark energy, Super Universe, stellar black holes, black hole entropy, cosmological constant problem, black hole information paradox, baryogenesis, and quantum gravity theories, (see Table V).

18.1 A new cosmology theory justification

The prevailing cosmology theory "The Ultimate Free Lunch" satisfies only the third of three laws of physics and should be amplified to "A Two-Step Integrated TOE which satisfies all three [35].

Table IV compares the Ultimate Free Lunch theory versus a Two-Step Integrated TOE. Three laws of physics are listed in column one, the Ultimate Free Lunch theory in column two, and a Two-Step Integrated TOE in column three. The Ultimate Free Lunch theory stated the near infinite energy of our universe was created from nothing or more precisely from random energy fluctuations. Thus, the Ultimate Free Lunch theory violated Conservation of Energy/Mass at $t = 0$. A Two-Step Integrated TOE satisfied Conservation of Energy/Mass because the energy/mass in our precursor universe's super supermassive quark star (matter)/black hole (energy) was identical to our universe's energy.

Einstein's Theory of General Relativity is time symmetrical about $t = 0$ and consists of a black hole, a white hole, and an Einstein-Rosen bridge (i.e., a wormhole or doughnut physical singularity) connecting the two universes. The Ultimate Free Lunch theory violated Einstein's Theory of General Relativity because nothing preceded our universe. In contrast, a Two-Step Integrated TOE included a black hole, a white hole, and a wormhole or a super force doughnut physical singularity in a Planck cube.

The Ultimate Free Lunch satisfied the Second Law of Thermodynamics because of its assumed primacy over the laws of Conservation of Energy/Mass and Einstein's Theory of General Relativity. The logic was if our universe's entropy was minimum at time $t = 0$, nothing could have preceded our big bang because entropy increases irreversibly with time. A Two-Step Integrated TOE also satisfied the Second Law of Thermodynamics. In our precursor universe, the maximum entropy super supermassive quark star (matter) evaporated, deflated, and gravitationally collapsed to the minimum entropy super supermassive black hole (energy). The volume of our precursor universe was much larger relative to the volume of the super supermassive quark star (matter) so the entropy decrease in the latter did not negate the entropy increase in the former.

TABLE IV. The Ultimate Free Lunch theory versus a Two-Step Integrated TOE.

Law	The Ultimate Free Lunch theory	A Two-Step Integrated TOE
Conservation of Energy/Mass	violates	satisfies
Einstein's Theory of General Relativity	violates	satisfies
Second Law of Thermodynamics	satisfies	satisfies

19 Cosmological constant problem

Our universe was nested in our older precursor universe which was nested in the still older Super Universe. The cosmological constant problem existed because the Super Universe's volume was 10^{120} larger than our universe [36]. The Super Universe of parallel universes was created by time sequential and concurrent cycles of big bangs through stellar black holes. Hubble's law was not a constant but a variable in time between 200 million years and 13.8 billion years. Hubble's law existed for precursor universes within the Super Universe, universes within our precursor universe, and galaxies within universes including our universe. There were "n" time sequential precursor universes between the Super Universe and our universe. An estimate of sizes and number of precursor universe lineal descendants was provided. Proof of the Super Universe's parallel universes was via an existing multi-wavelength and advanced gravitational observatory techniques.

Our universe was nested in our older precursor universe which was nested in the still older Super Universe. Figure 13 shows three nested universes at $t = 0$ in two instead of three dimensions and not to scale. Our universe and a parallel universe were nested in our older precursor universe. At $t = 0$, our universe was a doughnut physical singularity at the center of a Planck cube. The parallel universe was of finite size because it was created before $t = 0$. Our precursor universe was nested in the still older Super Universe.

Our universe obeyed the cosmological principle, that is, the distribution of matter was homogeneous and isotropic on a large scale. In addition our universe had a center at its doughnut physical singularity location and a spherical boundary with a radius of 46.5 billion ly. Large scale was defined as a cube with a 490 million ly side according to Anderson's baryon acoustic oscillation spectroscopic survey [37]. Since dark energy (i.e., sum of eight Higgs force energies) and matter were created simultaneously and were intimately related, dark energy was also uniformly distributed on a large scale. Any 490 million ly cube in our universe had identical percentages of atomic/subatomic matter 5%, dark matter 26%, and dark energy 69%.

Since dark energy was a constant 69% of total Super Universe energy/mass, as the Super Universe expanded, dark energy density decreased with time. Dark energy was uniformly distributed on a large scale throughout the Super Universe, all precursor universes, and all universes including our universe. Matter and dark energy were uniformly distributed on a large but undefined scale in our precursor universe just prior to $t = 0$. However, matter and dark energy were not uniformly distributed on a small scale. A maximum entropy super supermassive quark star (matter) formed in one of our precursor universe's small scale volumes. At the 10^{24} solar mass threshold, it instantaneously evaporated, deflated, and gravitationally collapsed to its associated minimum entropy super supermassive black hole (energy) creating a zero-point energy bubble and our universe's "big bang" (white hole).

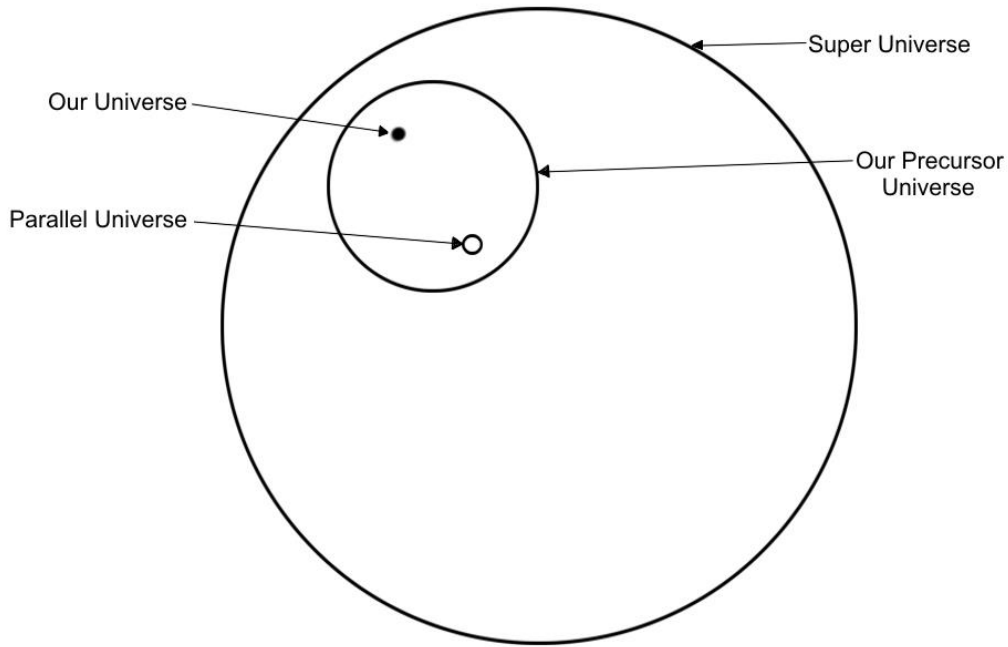

FIG. 13. Three nested universes at $t = 0$.

The cosmological constant problem existed because the Super Universe's volume was 10^{120} larger than our universe. The observed cosmological constant was 10^{-120} of the expected value ($2 \times 10^{110} \text{ erg/cm}^3$) and known as the cosmological constant problem [38]. According to Steinhardt, this problem existed because the Super Universe was older than expected because of precursor cyclical universes [39]. Cyclical universes were special cases of nested universes where the collapsed volume was the total precursor universe. Steinhardt's cyclical universes were amplified to nested universes to provide a dark energy reduction factor between our precursor universe and our universe. Because of uniform distribution of dark energy in our precursor universe, the dark energy reduction factor was the ratio of the super supermassive quark star's (matter) volume which created our universe divided by the total precursor universe's volume.

Figure 14 shows three nested universes: the Super Universe, our precursor universe, and our universe at four sequential big bang times in two instead of three dimensions and not to scale. Super force superstring doughnut physical singularities at the center of Planck cubes existed at the start of the Super Universe, all precursor universes, and all universes including our universe. The Super Universe's big bang occurred approximately at -10^{50} years. At an arbitrary $t = -10^{25}$ years, a super super supermassive black hole (energy) was created in the Super Universe preceded by its associated super super supermassive quark star (matter). By $t = 0$, that super super supermassive black hole (energy) expanded into our precursor universe. In our precursor universe, a super supermassive black hole (energy) was created preceded by its associated super supermassive quark star (matter). The super supermassive black hole (energy)

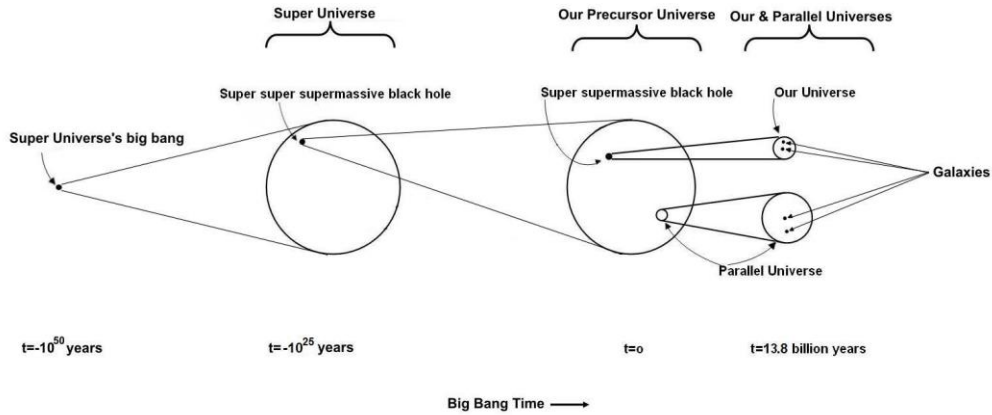

FIG. 14. Super Universe and nested universes.

transitioned to our big bang's white hole as described in section 16 Stellar black holes. After 13.8 billion years of expansion, our universe exists. Figure 14 also shows our precursor universe spawned a parallel universe at a time prior to $t = 0$. Within our universe and the parallel universe were galaxies. Eventually, the big bang time scale of Fig. 14 where our universe's big bang occurred at $t = 0$, should be replaced by the Super Universe's big bang time scale where $t = 0$ occurred approximately 10^{50} years ago.

Since the Super Universe's volume was 10^{120} larger than our universe and spherical volumes were proportional to their radii cubed, the ratio of the Super Universe's radius R_{su} to our universe's radius R_{ou} (46.5×10^9 ly) was $(10^{120})^{1/3}$ or 10^{40} . The Super Universe's radius was $R_{su} = (10^{40}) (46.5 \times 10^9$ ly) or approximately 10^{50} ly. Assuming equal expansion rates or our universe's radius/our universe's age = Super Universe's radius/Super Universe's age, the Super Universe's age was approximately 10^{50} years.

There were approximately 10^{120} parallel universes the size of our universe in the Super Universe. Galaxies of all parallel universes were uniformly distributed in the Super Universe on a large scale.

The Super Universe of parallel universes was created by time sequential and concurrent cycles of big bangs through stellar black holes. Three time sequential cycles are explicitly shown in Fig. 14. In the first cycle, the Super Universe's big bang created the Super Universe and at $t = -10^{25}$ years, a super super supermassive quark star (matter). Second, the latter's associated super super supermassive black hole (energy) created our precursor universe and at $t = 0$, a super supermassive quark star (matter). Third, the latter's associated super supermassive black hole (energy) created our universe and by $t = 13.8$ billion years, supermassive quark stars (matter) existed at the center of each of our universe's galaxies. The concurrent cycles of big bangs through stellar black holes are implicit in Fig. 14. For example, at approximately $t = -10^{25}$ years, a second super super supermassive black hole (energy) created a second parallel precursor universe and subsequently, a super supermassive quark star (matter). The latter's associated super supermassive black hole (energy) created a parallel universe in the second parallel precursor universe.

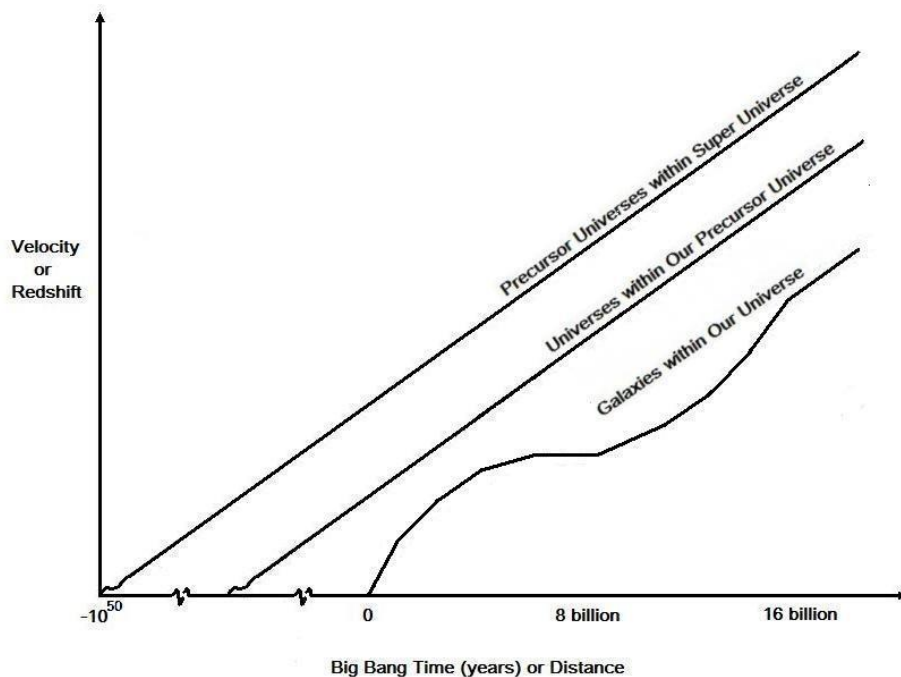

FIG. 15. Amplified Hubble’s law.

Hubble’s law was not a constant but a variable in time between 200 million years and 13.8 billion years. An amplified Hubble’s law existed for precursor universes within the Super Universe, universes within our precursor universe, and galaxies within our universe as explicitly shown in Fig. 15. Implicit in Fig. 15 is amplified Hubble’s laws existed for universes within all precursor universes and galaxies within all 10^{120} parallel universes. The X axis represents big bang time (years) or distance and the Y axis represents velocity or redshift. Traditional Hubble’s Law diagrams display Δ velocity/ Δ distance and are referenced from our Milky Way location with the X axis as distance. That is, velocities of galaxies measured from our Milky Way are proportional to their distances from our Milky Way. Since our universe’s expansion is homogeneous and isotropic and identical from any universe point, the reference point was shifted to the universal big bang doughnut physical singularity location. In addition, the X axis was represented by time to display the accelerating nature of our universe. Fig. 15 Amplified Hubble’s Law displays acceleration or Δ velocity/ Δ time. For example following $t = 0$ (actually 200 million years), galaxies formed and expanded from our universe’s doughnut physical singularity and their velocities were proportional to their transit times from the singularity. Similarly following our precursor universe’s undefined doughnut physical singularity time, universes formed and expanded from that singularity and their velocities were proportional to their transit times from that singularity. Following the Super Universe’s doughnut physical singularity time or approximately -10^{50} years, precursor universes formed and expanded from that singularity and their velocities were proportional to their transit times from that singularity.

Our universe was created 13.8 billion years ago by a super force doughnut physical singularity surrounded by a spherical zero-point energy bubble. As shown in Fig. 15 after $t = 0$, our universe expanded at a decelerating rate until it reached an inflection point at $t = 8$ billion years and then expanded at an accelerating rate to the present $t = 13.8$ billion years. This is shown by the inverted S curve straight line approximations. After $t = 0$, the first line’s slope or acceleration (Δ velocity/ Δ time) is a maximum. As time increases, the slope or acceleration of the straight line segments decrease until $t = 8$ billion years where the slope or acceleration is zero. Following $t = 8$ billion years, slope or acceleration steadily

increase. Galaxies within expanding parallel universes always accelerate with the exception of the inflection point where the acceleration is zero. The inverted S curve also occurred at the start of the precursor universes within the Super Universe and universes within our precursor universe as shown in Fig. 15. The amplified Hubble's law of Fig. 15 is not a constant but varies with time in our universe between $t = 0$ and 13.8 billion years. If the amplified Hubble's Law varies with time, the traditional Hubble's Law also varies with time. This is because according to equations (2) in section 16.1 Einstein's General Relativity/Dark energy expansion equations, velocity v on the Y axis and distance d on the X axis are polynomials in time t .

Currently, a zero-point energy spherical shell exists between the outer boundary of our spherical universe (46.5 billion ly radius) and the inner undefined spherical boundary of our precursor universe. As our universe accelerates, the spherical shell thickness will approach zero. Our universe's acceleration will stop increasing when our universe's outer boundary merges with our precursor universe's inner boundary. If our universe's deceleration/acceleration is assumed symmetrical, our universe will merge with our precursor universe in approximately 2.2 billion years (i.e., our universe decelerated during its first 8 billion years and accelerated during its last 5.8 billion years plus the future 2.2 billion years). Then, the acceleration of galaxies within our universe will become a constant and identical to the constant acceleration of universes within our precursor universe and precursor universes within the Super Universe. This is shown in Fig. 15 by three equal slopes or constant accelerations after $t = 16$ billion years.

Our universe, all universes, and all precursor universes obey the Second Law of Thermodynamics. Life exists in our solar system which is one of approximately 10^{22} stars in our universe. Our solar system has low entropy because life exists. Life is synonymous with low entropy or available energy and death with high entropy or unavailable energy. In our universe, the ratio of low entropy stars with life to high entropy stars with death is estimated as $\geq 10^{-22}$. Our universe's ratio of low entropy stars to high entropy stars is the counterpart of our precursor universe's dark energy reduction factor and the two are estimated to be equal, $\geq 10^{-22}$.

Figure 13 and Fig. 14 show a simplified Super Universe with only one nested child precursor universe between the Super Universe and our universe. If there was one precursor universe or two time intervals as shown in Fig. 14, the nested precursor universe formed at -10^{25} years. The assumption was there were two equal time intervals: creation to expansion of the Super Universe (10^{25} years); and creation to expansion of our precursor universe (10^{25} years). There were realistically "n" time sequential precursor universes between the Super Universe and our universe. The dark energy reduction factor was a function of the number of precursor universes. The "straw man" number of precursor universes was arbitrarily selected as 4.

Figure 16 shows four nested children precursor universes at $t = 0$. The Super Universe is the largest circle. Children precursor universes (PU) nested in the Super Universe are $PU_1, PU_2, PU_3, PU_4, PU_5,$ and PU_6 . Subscripts identify children, grandchildren, great-grandchildren, and great-great-grandchildren precursor universes. The first subscript identifies children, the second grandchildren, the third great-grandchildren, and the fourth great-great-grandchildren precursor universes. For example, in the first child precursor universe PU_1 are three grandchildren precursor universes $PU_{11}, PU_{12},$ and PU_{13} . In the first grandchild precursor universe PU_{11} are three great-grandchildren precursor universes $PU_{111}, PU_{112},$ and PU_{113} . In the first great-grandchild precursor universe PU_{111} are three great-great-grandchildren precursor universes $PU_{1111}, PU_{1112},$ and PU_{1113} . In the first great-great-grandchild precursor universe P_{1111} are our universe and a parallel universe. A variety of quark stars (matter)/black holes (energy) sizes created a variety of nested precursor universe sizes shown in Fig. 16.

Amplification of Fig. 16 is required as follows. First, the figure is shown in two instead of three dimensions and not to scale since the Super Universe's volume is 10^{120} larger than our universe. Second, empty spaces do not exist in the Super Universe. For example, between the six children precursor

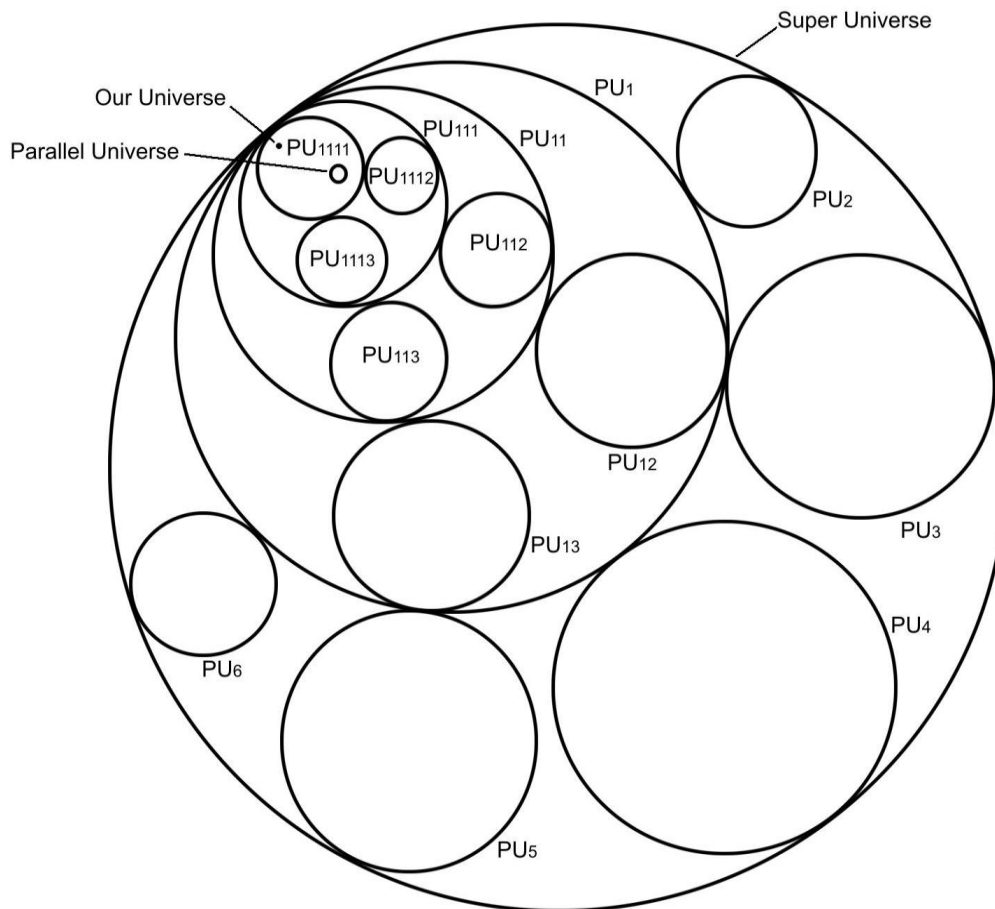

FIG. 16. Four nested children precursor universes at $t = 0$.

universes (PU_1 to PU_6) matter and dark energy must be uniformly distributed on a large scale. Empty spaces in Fig. 16 must be filled with smaller precursor universes or universes.

19.1 Proof of parallel universes

Proof of the Super Universe's parallel universes is via an existing multi-wavelength and an advanced gravitational observatory technique. First is the existing multi-wavelength data, for example, NED – NASA/IPAC Extragalactic Database. Galaxies within our universe are accelerating from our universe's doughnut physical singularity origin. Since parallel universes were formed similarly to our universe (e.g., doughnut physical singularity, inflation, particle creation, star formation, and galaxy formation), galaxies of all parallel universe are accelerating from their doughnut physical singularity origins. Parallel universes are uniformly distributed in the Super Universe between our universe's boundary (radius of 46.5 billion ly plus a zero-point energy spherical shell thickness) and the spherical Super Universe's boundary (radius of 10^{50} ly). Across the zero-point energy spherical shell is the closest galaxy of the closest parallel universe to our Milky Way galaxy. Our Milky Way galaxy is accelerating toward the closest galaxy and the latter is accelerating toward the Milky Way galaxy as described in the narrative associated with Fig. 15 Amplified Hubble's law. Since the two galaxies are accelerating towards each

other, a search of blue shift galaxies is required. The blue shift galaxy radiation strength is dependent on the galaxy's size and its distance from our Milky Way galaxy. That distance is dependent on the undefined location of our Milky Way galaxy in our universe and the undefined zero-point energy spherical shell thickness. The closer our Milky Way galaxy is to our universe's boundary and the smaller the zero-point energy spherical shell thickness, the greater is the signal from the closest galaxy. The direction of the closest galaxy of the closest parallel universe is opposite to the direction to our big bang location. Existing data (e.g., NED – NASA/IPAC Extragalactic Database) may already contain received galaxy blue shifts from parallel universes and should be re-analyzed.

Deceleration of our universe occurred during the first 8 billion years and acceleration during the last 5.8 billion years as shown in Fig. 15. If deceleration/acceleration of our universe is assumed symmetrical, our universe will merge with our precursor universe in approximately 2.2 billion years. If the Milky Way galaxy is at our universe's boundary, the closest galaxy of the closest parallel universe is only 2.2 billion ly away, well within the 13.2 billion year detection range of the Hubble Ultra Deep Field telescope.

The second advanced technique is a gravitational observatory. An estimated big bang gravitational energy waveform is shown in Fig. 17. The X axis represents big bang time in seconds plus or minus from $t = 0$ and the Y axis represents gravitational energy. This waveform was derived from Fig. 12 Quark star/black hole to big bang (white hole) transition.

The estimated big bang gravitational energy waveform consists of a pulse and decaying step function, both having identical maximum amplitudes. Figure 17 shows time symmetry between -10^{-33} and 10^{-33} s in accordance with Einstein's theory of General Relativity. Our precursor universe's super supermassive quark star (matter) composition at -10^{-33} s was identical to our universe's hot quark-gluon plasma at 10^{-33} s. Between $t = 0$ and $t = 5 \times 10^{-36}$ s, gravitational energy was zero because matter particles had not been created. Super force particles began condensing into matter particles/Higgs forces during inflation (5×10^{-36} to 10^{-33} s), or during the white hole (energy) to hot quark-gluon plasma (matter) transformation. At the start of the hot quark-gluon plasma (10^{-33} s), the heaviest matter particles were in the most compact 8 m radius sphere and gravitational energy was a maximum. As our universe expanded following 10^{-33} s, matter particles moved further apart from each other and gravitational energy decreased. Matter density and gravitational energy were a maximum at 10^{-33} s and at the time symmetrical hot quark-gluon plasma of the super supermassive quark star (matter) at time -10^{-33} s.

Prior to the first deflation phase at $< -2 \times 10^{-33}$ s, the super supermassive quark star (matter) added mass and its gravitational energy increased. At the first deflation phase start time, our universe's energy/mass was spread over an extremely large (radius $\sim 50,000$ ly) super supermassive quark star (matter) at 10^{-30} K (cold quark-gluon plasma). During the first deflation phase between $< -2 \times 10^{-33}$ and -10^{-33} s, the super supermassive quark star (matter) at 10^{-30} K evaporated, deflated, and gravitationally collapsed to a compact hot quark-gluon plasma with a corresponding increase in gravitational energy. Lighter matter particles/Higgs forces evaporated to the super force which then condensed to heavier matter particles/Higgs forces. Since matter particles were further apart at the start of the first deflation phase than at the end, its gravitational energy was less. Matter evaporation during the second deflation phase was the reverse of matter creation during inflation. That is, heavier matter particles/Higgs forces evaporated to super force particles between -10^{-33} and -5×10^{-36} s with a decrease in gravitational energy to zero at $t = -5 \times 10^{-36}$ s. Between -5×10^{-36} and 5×10^{-36} s, all our universe's energy (10^{54} kg) was in the form of super force particles and no matter particles or gravitational energy existed. That time period was also the transient life time (10^{-35} s) of the super supermassive black hole (energy)/white hole (energy).

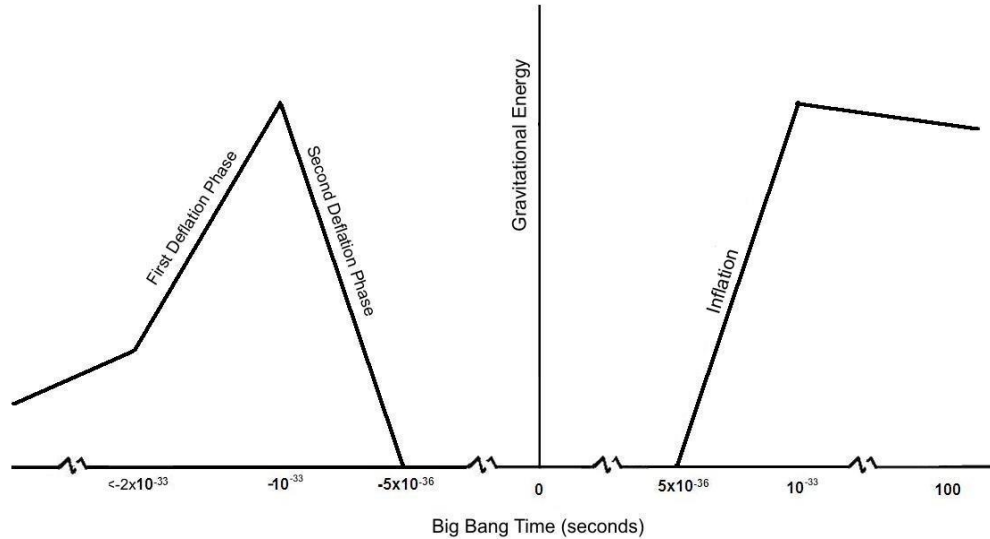

FIG. 17. Estimated big bang gravitational energy waveform.

The estimated big bang gravitational waveform's location was the origin of our universe's big bang. The estimated gravitational energy waveform occurred at the big bang time $t = 0$, or 13.8 billion years ago. If all our universe's galaxy positions are extrapolated backwards in three dimensional space, they intersect at the origin at $t = 0$. The estimated gravitational energy waveform should be detectable at the big bang's location and time by an advanced extraordinarily high frequency ($> 10^{33}$ Hertz) Laser Interferometer Gravitational Observatory (LIGO) or Laser Interferometer Space Antenna (LISA). The fundamental time period between peaks of the Fig. 17 waveform is 2×10^{-33} s. The Fourier series fundamental frequency is $f = 1/T = 1/(2 \times 10^{-33} \text{ s}) = .5 \times 10^{33} \text{ Hz}$.

However, there are two reasons why LIGO or LISA cannot detect our big bang gravitational waveform. The first reason is our early universe was an invisible white hole from which neither light nor gravitational waves could escape. Light and gravitational wave commonality is discussed by Aleksandra Piorkowska et. al., in their article, Strong gravitational lensing of gravitational waves in Einstein Telescope [40]. The white hole (matter) was the counterpart of the super supermassive quark star (matter) with an estimated 50,000 light year radius, described in section 18 Arrow of time. On the right side of Fig. 6, dotted lines defined the transition from white hole to non-white hole. The white hole had an estimated radius of 50,000 light years or 4.7×10^{20} m. This corresponded to a time of approximately 10^6 s or 1.7 weeks. After that time, our universe became visible. The curvature of spacetime around a stellar black/white hole is equivalent to a mass m_{cs} where the subscript cs is curvature of spacetime. A stellar black/white hole cannot emit either photons or gravitons. However, the curvature of spacetime around a stellar black/white hole transmits gravitons to other particles (e.g. electron) outside the black/white hole's event horizon. This is visualized by replacing the curvature of spacetime by a stellar black/white hole of mass m_{cs} which can transmit gravitons as described in section 12.1 Gravitational/electromagnetic.

The second reason why LIGO or LISA cannot detect our big bang gravitational waveform is inflation. The basis of detection of early galaxies is to look backward in time toward our big bang location, but one

cannot see through inflation because it expanded our universe faster than the speed of either light or gravitational waves. Therefore, our big bang gravitational waveform detection is speculative and undefined.

This integrated the cosmological constant problem with dark matter, dark energy, Super Universe, stellar black holes, black hole entropy, arrow of time, and quantum gravity theories, (see Table V).

20 Black hole information paradox

Intrinsic or structural information was lost in a super supermassive quark star (matter)/black hole (energy) formation and none was emitted as Hawking radiation. In 1975, Hawking correctly stated Hawking radiation contained no information swallowed by a black hole. In 2005, his position reversed and he incorrectly stated Hawking radiation contained information. This was the black hole information paradox caused by misunderstanding of an object's intrinsic and extrinsic information.

The "No Hair" theorem states a stellar black hole (energy) has three information parameters; mass, charge and spin, whereas our universe contains near infinite information. Any universe object's (e.g., an encyclopedia) intrinsic information at a time t consists of the contents and positions of all the object's contiguous Planck cubes. Intrinsic information consists primarily of the unique relative orientation of up quarks, down quarks, and electrons to each other or an object's molecular, atomic, nuclear, and fundamental matter (e.g., up quark) structure. In contrast, a universe object's (e.g. an encyclopedia) extrinsic information consists of its written words. For example, extrinsic information consists of English words, French words, or binary coded data. Stellar black holes are "dumb" and can neither read nor store extrinsic information.

Each up quark, down quark, and electron resides as a closed superstring within a specific Planck cube of the encyclopedia's ink, paper, binding, etc. molecules. Encyclopedia intrinsic information is lost in four star collapse stages during decomposition of its molecules to atoms, to protons/neutrons and electrons, to up and down quarks, and to super force particles. In a white dwarf star, molecules decompose to atoms and molecular intrinsic structural information is lost. In a neutron star, atoms decompose to neutrons, protons, and electrons and atomic intrinsic structural information is lost. In a super supermassive quark star (matter), protons and neutrons decompose to up and down quarks and nuclear intrinsic structural information is lost. In a super supermassive black hole (energy), up and down quarks decompose or evaporate to super force particles and fundamental matter intrinsic structural information is lost. Intrinsic or structural information is lost in a super supermassive quark star (matter)/black hole (energy) formation and none is emitted as Hawking radiation. Hawking's 1975 solution is correct, not his 2005 solution.

The above matter decomposition description was intimately related to and the reverse of our universe's matter creation as follows. During and immediately following inflation, particle creation was the condensation of super force particles into eight permanent matter particles/Higgs forces. During the hadron era, up quarks and down quarks combined to form protons and neutrons. At 380,000 years, protons and helium nuclei recombined with electrons to form hydrogen and helium atoms. Hydrogen atoms combined to form hydrogen molecules. Starting at 200 million years, molecular hydrogen clouds formed stars. Stellar core and supernova nucleosynthesis created all Periodic Table elements above hydrogen and helium. These atoms combined to form complex molecules.

Two opposing theories of black hole evaporation are described by Hawking and this author. Hawking stated giant black holes are stable and won't evaporate away, whereas small black holes are unstable [41]. We are in agreement for giant black holes in our universe but not those in precursor universes. Giant black holes or supermassive quark stars (matter) at the centers of each of our universe's over one hundred billion galaxies have energy/masses between 10^6 to $10^{10} M_{\odot}$ and are stable. However in our precursor universe and before our big bang, a maximum entropy super supermassive quark star (matter) with our universe's energy/mass ($10^{24} M_{\odot}$) instantaneously evaporated, deflated, and gravitationally collapsed to

its associated minimum entropy super supermassive black hole's (energy) doughnut physical singularity. Matter particle/Higgs force evaporation in the super supermassive quark star (matter) occurred as temperatures rose from 10^{10} to 10^{27} K and was the reverse of matter particle/Higgs force condensation in our early universe. There were approximately 10^{120} parallel universes in the Super Universe and each was created by a maximum entropy super supermassive quark star's (matter) instantaneous evaporation, deflation, and gravitational collapse to its associated minimum entropy super supermassive black hole (energy) doughnut physical singularity.

One interpretation of Hawking's small black hole evaporation is vacuum fluctuations cause a particle-antiparticle pair to appear at a small black hole's event horizon. One of the pair escapes whereas the second falls into the black hole. For conservation of energy/mass, the particle that fell into the black hole has negative energy and the black hole appears to emit or radiate a particle [42]. One objection to Hawking's small black hole theory is anti-particles exist only during baryogenesis in our early universe at temperatures greater than 10^{10} K. Anti-particles do not exist at Hawking undefined small black hole temperatures or at the vacuum temperature of 2.72 K. A second objection is high temperatures not vacuum fluctuations cause particle-antiparticle pairs.

This integrated black hole information paradox with particle creation, stellar black holes, black hole entropy, arrow of time, baryogenesis, and quantum gravity theories, (see Table V).

21 Baryogenesis

Charge, parity, and time (CPT) violation caused baryogenesis [43]. Baryogenesis is the asymmetric production of baryons and anti-baryons in our early universe expressed as the baryon to photon ratio $\eta = 6.1 \times 10^{-10}$. Asymmetric production of quarks and anti-quarks is more appropriate, however, since baryons and anti-baryons were defined before quarks and anti-quarks, the baryogenesis definition is retained. Big bang nucleosynthesis determined η and the Wilkinson Microwave Anisotropy Probe measured it accurately [44]. There are 44 identified baryogenesis theories [45] of which six are prominent: electroweak, GUT, quantum gravity, leptogenesis, Affleck-Dine, and CPT violation [46]. Electroweak occurs insufficiently in the SM and is considered unlikely without supersymmetry. Inflationary scenarios disfavor GUT and quantum gravity theories. Leptogenesis and Affleck-Dine are viable but not well understood. The sixth baryogenesis theory is CPT violation having three arguments which support each other and this article's conclusions.

The first argument according to T. D. Lee stated the CPT theorem was invalid at the Planck scale [47]. In this article, a Planck cube defined the quantum of matter particle, force particle, and space. Our universe originated as a super supermassive black hole (energy) or a super force doughnut physical singularity at the center of a Planck cube as described in section 2 Superstring theory. Quantum gravity theory was invalid between our universe's origin at $t = 0$ s and the start of inflation at $t = 5 \times 10^{-36}$ s because our universe was smaller than a Planck cube quantum, in agreement with Lee.

The second argument according to N. E. Mavromatos [48] is in the CPT theorem, laws of physics are unchanged by combined CPT operations provided locality, unitarity (sum of all possible outcomes of any event is one), and Lorentz invariance are respected. Highly curved spacetimes such as a super supermassive black hole (energy) singularity violate CPT because of apparent violations of unitarity caused by incoming matter information disappearance. From section 20 Black hole information paradox's conclusion, incoming matter information is lost in the gravitational collapse of a super supermassive quark star (matter) to a super supermassive black hole (energy) in agreement with Mavromatos.

The third argument according to F. Hulpke [49] was a quantum gravity theory axiom stated the transformation from one state to another respected unitarity and entropy preservation. According to section 18 Arrow of time, the maximum entropy super supermassive quark star (matter) evaporated, deflated, and gravitationally collapsed to the minimum entropy super supermassive black hole (energy). Entropy was reset to a minimum as the super supermassive black hole (energy) “resurrected” life via creation of super force particles. During the collapse, energy/mass quanta in Planck cubes gravitationally collapsed to a super force singularity in a volume smaller than a Planck cube quantum. During the collapse, quantum gravity theory was invalid and both unitarity and entropy preservation were not respected in agreement with Hulpke.

CPT, unitarity, and entropy preservation were violated in the highly curved spacetimes of both our precursor universe’s super supermassive black hole (energy) and its symmetric big bang white hole (energy) counterpart. The evaporation of each matter particle/Higgs force to a super force particle and the condensation of each super force particle to a matter particle/Higgs force violated CPT. This provided sufficient CPT violations to produce our universe’s baryon to photon ratio of 6.1×10^{-10} .

This integrated baryogenesis with particle creation, inflation, Higgs forces, spontaneous symmetry breaking, dark matter, dark energy, stellar black holes, black hole entropy, arrow of time, black hole information paradox, and quantum gravity theories, (see Table V).

22 Quantum Gravity Theory

Superstring theory and a Two-Step Integrated TOE as described in this article are identical to quantum gravity theory, or quantum mechanics with graviton inclusion. That is because they unify all known physical phenomena from the near infinitely small or Planck cube scale (quantum gravity theory) to the near infinitely large or Super Universe scale (Einstein’s General Relativity).

All matter and force particles exist as closed superstrings and reside within our universe’s fundamental building block, the Planck cube. Since the Planck cube is the quantum or unit of matter particles, force particles, and space, its actions are described by quantum gravity theory. In contrast, singularities of extremely massive collapsed stars are only described by Einstein’s law of General Relativity. These include: super supermassive black holes (energy), super super supermassive black holes (energy), and the super super super supermassive black hole (energy).

Superstring theory defined each of 129 fundamental matter and force particle types as a closed superstring in a Planck cube. Any object in the Super Universe was defined by a volume of contiguous Planck cubes containing these fundamental matter or force particle superstrings [e.g., super supermassive quark star (matter) shown in Fig. 11a]. Figure 11a exemplified A Two-Step Integrated TOE because it unified quantum gravity theory of the near infinitely small Planck cube scale (e.g., fundamental matter and force particles in Fig. 11a) with Einstein’s General Relativity at the near infinitely large super supermassive quark star (matter) of Fig. 11a.

This integrated quantum gravity with all other nineteen theories in an Integrated TOE, (see Table V).

22.1 Quantum gravity applicability/Singularities

General relativity was applicable for all times in our universe between $t = 0$ and $t = 13.8$ billion years, whereas quantum gravity theory was applicable for all times except between 0 and 5×10^{-36} s. Figure 5 illustrated general relativity and quantum gravity theory applicability. At $t = 0$, our universe was a doughnut physical singularity at a Planck cube center. At the beginning of matter creation and inflation or 5×10^{-36} s, our universe was a spherical physical singularity smaller than a Planck cube. Between 0 and 5

$\times 10^{-36}$ s, quantum gravity theory was not applicable because our universe was smaller than the Planck cube quantum.

A mathematical singularity is different than a physical singularity. If Schwarzschild's radius is inserted in Einstein's field equations, a mathematical singularity is produced. Both a super supermassive quark star (matter) and its associated black hole (energy) have identical mathematical singularities and event horizons. Mathematical singularities have no physical significance. In contrast, a super supermassive black hole's (energy) doughnut physical singularity of superimposed super force particles existed at the center of a Planck cube at the beginning of our universe. This is in contrast to Hawking's theory that no singularity existed at the beginning of our universe and that it can disappear because of quantum effects [50]. Only a super supermassive black hole (energy) not its associated quark star (matter) had a doughnut physical singularity. The "No Hair" theorem with three information parameters of mass, charge, and spin was applicable only to a super supermassive black hole (energy) not to its associated super supermassive quark star (matter).

22.2 Quantum gravity clarifications

Quantum gravity, the least understood of a Two-Step Integrated TOE's 20 theories, requires clarifications. Einstein was dissatisfied with quantum mechanics "God does not play dice with the universe" and Feynman said "Nobody understands quantum mechanics" [51]. These dissatisfactions were caused by misunderstandings of:

1. Double-slit experiments
2. Quantum fluctuations
3. Schrodinger's wave functions
4. Entanglement.

Each of 129 fundamental matter and force particle types exists as a unique closed superstring in a Planck cube. Currently, measurements are not available at the Planck scales (Planck length 1.6×10^{-35} m and Planck time 5.4×10^{-44} s). Thus, there is an inability to either produce or measure a single photon. A single photon directed towards a double slit will go through a single slit with no interference pattern. A stream of single photons directed towards a double slit will go through both slits and produce an interference pattern. Single photon sources do not function as described in the literature. These single photon sources are light pulses with picoseconds resolution which produce streams of photons, not a single photon in a Planck cube [52].

The 129 fundamental particle types are equivalently represented as dynamic point particles, unique closed superstrings, or Calabi-Yau membranes (clouds) in Planck cubes. Quantum fluctuations are jitter caused by the uncertainty principle of a dynamic point particle's position and momentum in a Planck cube. For example, electron dynamic point particle positions are periodic points (e.g., x_p , y_p , and z_p of Fig. 4) along the electron's closed superstring. That is, each point along the electron's closed superstring jitters in position and momentum according to the uncertainty principle $\Delta x \Delta p_x \geq h/4\pi$ [53].

Quantum fluctuations also apply to quantum field theory (e.g. an electron's electric field). The electron's electric field radiates outward from the electron and its strength is diminished by the propagation factor $1/R^2$ where R is the distance between the electron position in a Planck cube and a point in the electric field. There are two dynamic motions of this electric field. In the first dynamic motion, the electric field moves in an oscillatory pattern in space as the instantaneous electron position moves along the electron superstring, for example, from the right side of the Planck cube to the left side. The maximum deviation of this oscillatory electric field is a Planck length. The second dynamic motion is the instantaneous electron position which jitters in synchronism with the electric field jitters in space. The second dynamic motion modulates the first dynamic motion.

There were 22 permanent matter and force closed superstring particle types in our universe following the end of matter creation at $t = 100$ s. Two types of Planck cubes following galaxy formation were: Planck cubes containing matter particles (e.g., in stars, galaxies, and filaments); and Planck cubes containing force particles (e.g., superimposed Higgs forces) in Planck cubes between matter particles (see section 16.1). Dark energy density currently averages 2.72 K/Planck cube on a large scale (490 million light year cube). As our universe expands, this temperature will approach zero. At that time, the uncertainty principle energy and time $\Delta E \Delta t \geq h/2\pi$ will become the dominant energy in Planck cubes containing superimposed Higgs forces.

Schrodinger equations are applicable for each of the 129 fundamental matter and force particle types (e.g. “theoretical” particle, Higgs force, electron, etc.). Schrodinger equations are wave functions or particle probability magnitude (more precisely the square of the magnitude). The probability of finding a particle (e.g. electron) is greater where the wave function is large than where the wave function is small [54].

Fig. 18 shows the Schrodinger wave function for a “theoretical” zero mass, zero spin particle because none of the 129 fundamental matter and force particles have zero mass and zero spin. The “theoretical” particle is represented by a dynamic point particle with amplitude normalized to 1 along the Planck cube’s x_p axis. This is equivalent to a constant radius Calabi-Yau membrane or beach ball normalized to 1 and just touching the six Planck cube sides with no hills and valleys (zero mass) and no spin. The wave function is centered on the Planck cube’s x_p axis and its azimuth and elevation angles are both zero. Zero spin means the wave function does not spin in either azimuth (rotation around the z_p axis) or elevation angles (rotation around the y_p axis). The most likely theoretical particle position is at the distribution peak (radius = 1, azimuth = 0, elevation = 0). Quantum fluctuations modulate the instantaneous “theoretical” particle position in range, azimuth, and elevation producing the distribution function of Fig. 18.

For a spin-1 particle with 0 mass (e.g. photon), the wave function (Fig. 18) spins in azimuth angle around the z_p axis. For a spin-2 particle with zero mass (e.g. graviton), the wave function spins twice as fast as a spin-1 particle.

Figure 19 shows the Schrodinger wave function for a 125 GeV Higgs force, zero spin particle. A Higgs force is a superstring with periodic hills and valleys where the unknown amplitude of the hills and valleys was arbitrarily selected as plus or minus .1 from the zero energy normalized value of 1. Two wave functions are shown in the top and bottom portions of Fig. 19, which define the maximum and minimum wave function amplitudes. The instantaneous wave function is a sinusoidal variation in time at the superstring frequency between the maximum (1.1) and minimum (.9) wave function amplitudes. Since the Higgs force had zero spin, its wave function does not spin in either azimuth or elevation.

For a spin-1/2 particle with mass (e.g. electron), the wave function spins in both azimuth and elevation angles. One rotation in azimuth around the z_p axis and two rotations in elevation around the y_p axis brings the wave function back to its starting point (azimuth = 0, elevation = 0). As in Fig. 19, the instantaneous wave function is a sinusoidal variation in time at the superstring frequency between the maximum and minimum wave function amplitudes.

Each permanent macroscopic object in our universe consists of a volume of contiguous Planck cubes containing a maximum of 22 permanent matter and force particle types. Current interpretation of the Schrodinger wave function has no restrictions on object size. In contrast, there is a macroscopic object size where quantum gravity becomes invalid and classical physics becomes valid. Greenstein and Zajonc describe three examples: interference, uncertainty principle, and quantum tunneling where macroscopic objects the size of a baseball and a prisoner in a cell agree with classical mechanics and do not obey quantum gravity or the Schrodinger wave functions [55]. Thus, quantum gravity and Schrodinger’s wave functions are applicable for an object size smaller than a baseball. According to Samarin, a macroscopic object consists of quantum particles but the object’s center of mass obeys the laws of classical mechanics

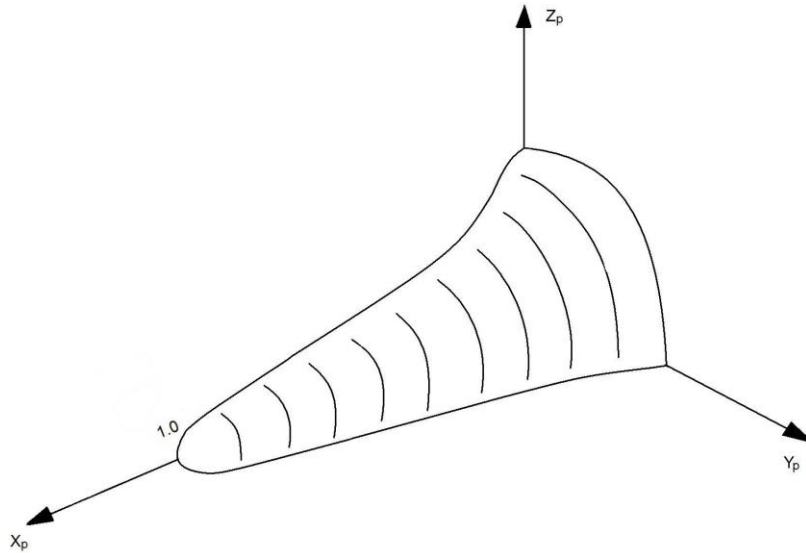

FIG. 18. Schrodinger wave function for a “theoretical” zero mass, zero spin particle.

[56]. A proton is the smallest macroscopic object that behaves as a unified object of contiguous Planck cube particles instead of individual Planck cube particles. From Greenstein/Zajonc and Samarin’s conclusions, the largest object size which obeys the Schrodinger wave function was arbitrarily selected as a Planck cube containing one of 22 permanent matter and force particle types.

An electron model is proposed to be a combination of the Bohr and Schrodinger electron cloud models. In the Bohr model, electrons are in discrete energy shells. In the Schrodinger electron cloud model for a hydrogen atom, electron position is distributed around an average distance of the electron from the proton. In the proposed model, the electron position is distributed only inside a Planck cube centered on an energy shell. This proposed model is also applicable for free electrons. For free electrons during our early universe, electron position is also distributed only inside a Planck cube. In contrast, the Schrodinger electron cloud model is not suitable for free electrons because neither a proton in a hydrogen atom nor an average distance of the electron from the proton exists.

Via conservation laws of energy/mass, charge, and angular momentum [57], the energy/mass, charge, and spin of our universe’s doughnut physical singularity was distributed to the energy/masses, charges, and spins of fundamental particles, atoms, stars, and galaxies in our universe. This was an entangled relationship. However, there was no entanglement between individual particles in our universe. When a down quark’s rest mass is converted to energy and radiation, they are absorbed by other particles in the first particle’s immediate vicinity (locality principle). Einstein’s theory of special relativity limits the

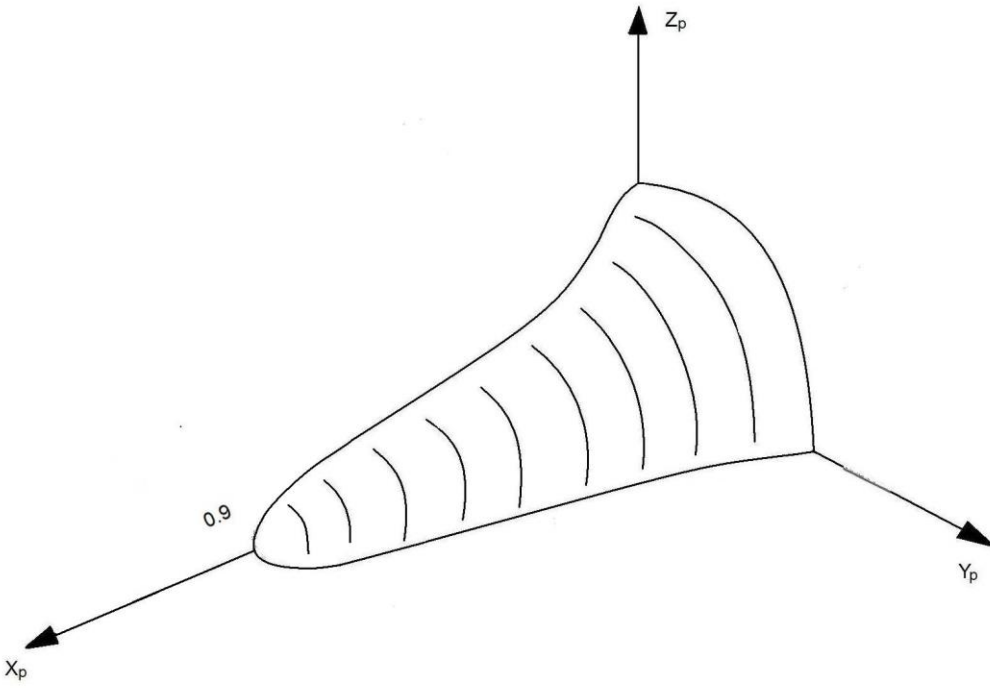
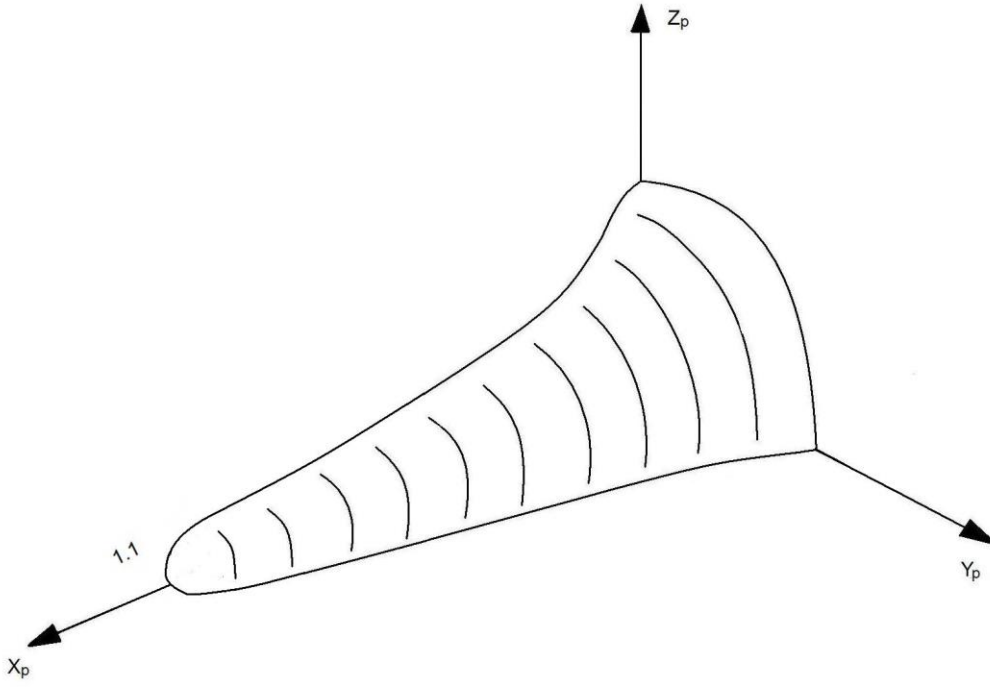

FIG. 19. Schrodinger wave function for a Higgs force 125 GeV, zero spin.

upper speed of information propagation at the speed of light. Current quantum entanglement measurements contradict the above definitions but incorrectly use single photon sources which produce streams of photons, not single photons.

In conclusion: a single photon does not produce an interference pattern in a double-slit experiment; quantum fluctuations are jitter caused by the uncertainty principle of a dynamic point particle's position and momentum in a Planck cube; Schrodinger's wave function is limited to an object size of a Planck cube containing one of 22 permanent matter and force particle types; and there is no entanglement between individual particles in our universe.

23 A Two-Step Integrated TOE: Second mathematics step

Two steps are required for a Two-Step Integrated TOE, a fundamental physics step and a two part mathematics step. The two parts of the mathematics step are, an amplified E8 Lie algebra for particles and an amplified N-body simulation for cosmology.

The TOE can be resolved via two opposing methodologies, one step or two-step. The prevailing Hawking's single mathematics step is intellectually overwhelming. After a century of attempts, this methodology had near zero results. In contrast, a Two-Step Integrated TOE is intellectually formidable but viable. In the first fundamental physics step and without sacrificing their integrities, twenty independent existing theories are replaced by twenty interrelated amplified theories as described in this article and summarized in Table V. This is followed by the second mathematics step. Two steps are essential because of unknown answers to physics questions upon which the mathematics step is dependent but cannot answer by itself. These questions include: what are Higgs forces, dark energy, dark matter, stellar black holes, the seven extra dimensions, etc.; and what caused the start of our universe, hierarchy problem, black hole information paradox, baryogenesis, cosmological constant problem, etc.?

The first part of the second mathematics step is an amplified E8 Lie algebra technique for particles and their interactions described by Lisi [58]. This article's amplified requirements must be added to Lisi's current E8 Lie algebra technique and include: 129 matter and force particle closed superstrings in Planck cubes; 32 super supersymmetric Higgs particles; spontaneous symmetry breaking caused by extremely high temperatures in our early universe; gauge mediated decays of both SM and supersymmetric particles (no graviweak coupling); mass given to a matter particle by its associated Higgs force, not by Higgs forces of W/Z's; a cosmological constant proportional to dark energy density or eight Higgs force energy densities; and an invalid quantum gravity theory prior to the start of matter creation at $t = 5 \times 10^{-36}$ s.

The second part of the second mathematics step is an amplified N-body numerical simulation for cosmology known as Illustris and described by Vogelsberger [59]. Illustris, or the calculation of our universe's structure formation, simulates 13 billion years of cosmic evolution using both baryonic and dark matter. This is accomplished on both a large scale (350 million light years) and small scale (individual galaxies) basis. However, dark energy is excluded as a simulation input.

A large scale, homogeneous, Λ CDM model is required. Since this article provides the dark energy theoretical roots for the universally accepted Λ CDM cosmological model [60], complex inhomogeneous models (e.g., modified gravity theories) are not required. This article's amplified requirements must be added to the Illustris N-body simulation and include: Dark energy was the sum of eight Higgs forces associated with eight permanent matter particles; Higgs forces were created during matter creation; dark energy was 69% of our universe's energy/mass at $t = 100$ s and remained constant for the next 13.8 billion years (no quintessence); atomic/subatomic matter, dark matter, and dark energy were uniformly distributed on a large scale (490 million light years); two opposing forces (gravity/matter and anti-gravity/dark energy) shaped our universe following the end of the radiation force at 380,000 years; and dark energy density and the cosmological constant decreased with time as our universe expanded. The amplified Illustris N-body simulation including dark energy should predict galaxy positions using

equations (2) as described in section 16.1 Einstein's General Relativity/Dark energy expansion equations. Illustris including dark energy should then predict galaxy positions which are compared with observed positions. In the current Illustris N-body simulation, computed and observed galaxy positions are used to define the dark energy model instead of vice versa. Eventually, the amplified Illustris N-body simulation should also include the Super Universe with nested precursor universes.

Because of its intellectual formidability, a Two-Step Integrated TOE solution consisting of: the fundamental physics step provided by this article, the proposed particle mathematics step, and the proposed cosmology mathematics step, remains a work in progress.

24 Conclusions

First as described in section 1 Introduction, each of twenty theories' requirements or equivalently each of twenty jigsaw puzzle pieces, was selectively amplified without sacrificing the theory's integrity to provide twenty snugly fitting interrelated amplified theories of Table V and Fig. 20.

Second, Hawking's single mathematics step TOE should be amplified to a Two-Step Integrated TOE. Two steps are essential because of unknown answers to key outstanding physics questions upon which the mathematics step is dependent but cannot answer by itself. Furthermore, Hawking's single mathematics step TOE had near zero results after a century of attempts.

Third, Fig. 8 SM matter and force particles should be amplified to Fig. 9 Fundamental SM/supersymmetric/super supersymmetric matter and force particles.

Fourth, the cosmological constant and Hubble's law were not constants. From section 11 Dark energy, the cosmological constant λ was proportional to the vacuum or dark energy density. Dark energy density decreased with time along with the cosmological constant as our universe expanded. From section 19 Cosmological constant, Hubble's law was not a constant but a variable in time between 200 million years and 13.8 billion years.

Fifth, the final Two-Step Integrated TOE should be initiated. This is the intellectually formidable integration of the fundamental physics step described by this article, with the proposed E8 Lie algebra for particles math step and proposed "Illustris" N-Body simulation for cosmology math step.

Sixth, Two-Step Integrated TOE validations should be initiated. There are seven advanced validation techniques which are state or beyond state-of-art techniques. They are presented in their viability order, that is, the first technique has the highest probability of success.

The first validation technique is independent analyses/validations by physicists and three currently exist. Leahy and Ouyed measured a quark nova in their article "Supernova SN2006gy as a first ever Quark Nova?" as described in section 16 Stellar black holes [61]. Morandi and Sun in their article "Probing dark energy via galaxy cluster outskirts" concluded there was no quintessence or dynamic dark energy in our universe as described in section 11 Dark energy [62]. Edmonds et. al. in their article "Testing Modified Dark Matter with Galaxy Clusters" concluded a relationship existed between the cosmological constant and dark matter [63]. That was described in section 11 Dark energy.

The six remaining validation techniques are in their viability order: Multi-wavelength observatory detection of parallel universes; Amplified "Illustris" N-body simulation for cosmology; Background Imaging of Cosmic Extragalactic Polarization (BICEP2)/Planck B-mode inflation polarization measurements; Large Hadron Collider (LHC) detection of 16 supersymmetric particles and 32 super supersymmetric Higgs particles; detection of the hierarchy problem estimate of gravitino energy/mass; and gravitational observatory detection of the estimated big bang gravitational energy waveform.

TABLE V. Primary interrelationships between 20 interrelated amplified theories.

	Superstring	Particle creation	Inflation	Higgs forces	Spontaneous symmetry breaking	Superpartner and SM decays	Neutrino oscillations	Dark matter	Universe expansions	Dark energy	Messenger particles	Relative strengths of forces	Super Universe	Stellar black holes	Black hole entropy	Arrow of time	Cosmological constant problem	Black hole information paradox	Baryogenesis	Quantum gravity	
Superstring	x	x							x				x	x							x
Particle creation	x	x	x	x	x	x	x	x	x	x		x		x	x			x	x	x	x
Inflation		x	x	x	x			x	x	x		x							x	x	x
Higgs forces		x	x	x	x	x		x	x	x	x					x			x	x	x
Spontaneous symmetry breaking		x	x	x	x	x	x	x	x	x									x	x	x
Superpartner and SM decays		x		x	x	x															x
Neutrino oscillations		x			x		x	x													x
Dark matter		x	x	x	x		x	x	x	x							x		x	x	x
Universe expansions	x	x	x	x	x			x	x	x		x									x
Dark energy		x	x	x	x			x	x	x			x	x		x	x		x	x	x
Messenger particles				x							x										x
Relative strengths of forces		x	x						x			x									x
Super Universe	x									x			x	x		x	x				x
Stellar black holes	x	x								x			x	x	x	x	x	x	x	x	x
Black hole entropy		x												x	x	x	x	x	x	x	x
Arrow of time				x						x			x	x	x	x	x	x	x	x	x
Cosmological constant problem								x		x			x	x	x	x	x				x
Black hole information paradox		x												x	x	x		x	x	x	x
Baryogenesis		x	x	x	x			x		x				x	x	x		x	x	x	x
Quantum gravity	x	x	x	x	x	x	x	x	x	x	x	x	x	x	x	x	x	x	x	x	x

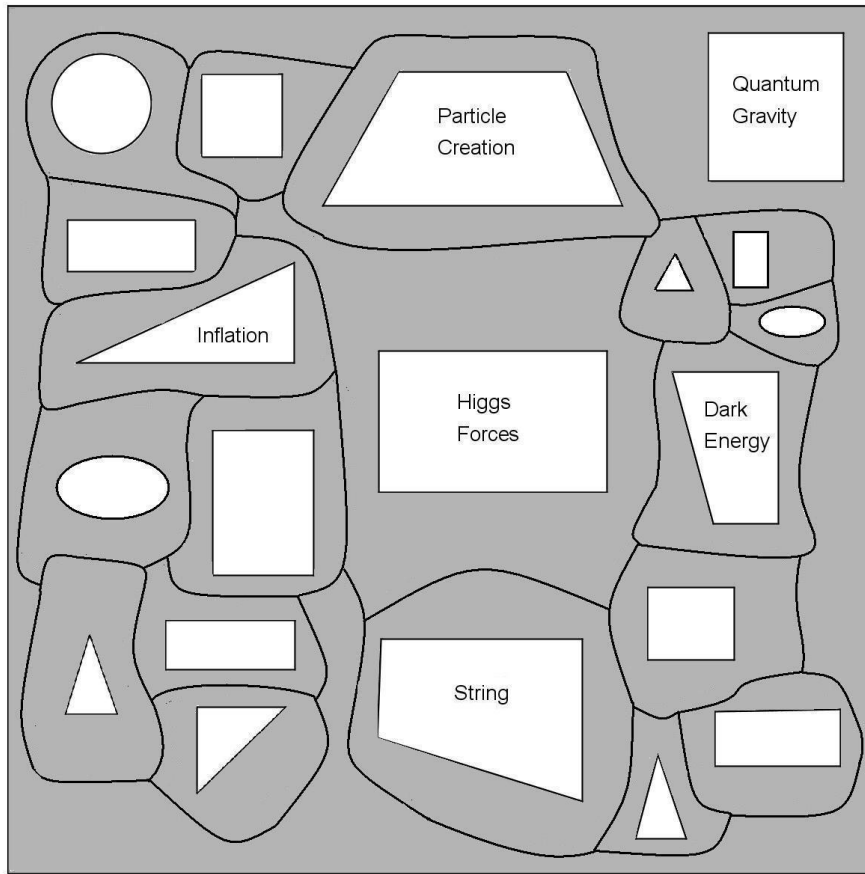

FIG. 20. A Two-Step Integrated TOE jigsaw puzzle.

The second validation technique is the multi-wavelength observatory (NED or NASA Extragalactic Database) detection of parallel universes. Detection of blue shift of the closest galaxy of the closest parallel universe to our Milky Way galaxy, is described in section 19.1 Proof of parallel universes.

Third, Two-Step Integrated TOE amplified requirements must be added to the “Illustris” N-body simulation for cosmology technique as described in section 23 A Two-Step Integrated TOE: Second mathematics step.

Fourth, in the BICEP2/Planck B-mode technique, a B-mode polarization type is generated during inflation. This B-mode polarization is being investigated by the BICEP2 experiment at the South Pole and the Planck satellite. According to Mortonson and Seljak, the BICEP2 results are not a definite proof of inflation because the measured B-mode polarization may have been caused by dust polarization contributions [64]. However, future B-mode polarization measurements and analyses should define inflation and the exponential inflation factor. One of three exponential inflation factors described in section 4 Inflation should be validated.

Fifth is the Large Hadron Collider (LHC) detection of 16 supersymmetric particles and 32 super supersymmetric Higgs particles. The 32 super supersymmetric Higgs particles consist of: Eight permanent and nine transient Higgs forces; and three permanent and twelve transient Higgsinos. LHC

detection of all 32 associated super supersymmetric Higgs particles requires the following amplified requirements from the section 5 Higgs forces be incorporated in the LHC.

1. Higgs particles were associate God particles because they constituted approximately 82% of our universe's total energy/mass
2. The sum of eight Higgs force energies associated with eight permanent matter particles was dark energy
3. Matter particles/Higgs forces were one and inseparable
4. Extremely high temperatures in our early universe caused spontaneous symmetry breaking
5. The Higgs force was a residual super force which contained the mass, charges, and spin of its associated matter particle
6. Mass was given to a matter particle by its associated Higgs force and gravitational force messenger particles
7. Spontaneous symmetry breaking was bidirectional.

Sixth, the gravitino estimated energy/mass of 10^{21} eV described in section 13 Relative strengths of forces/Hierarchy problem should be detected.

Seventh, is the gravitational observatory technique described in section 19.1 Proof of parallel universes. Two reasons why LIGO and LISA could not detect our big bang gravitational waveform were our early universe was a white hole and inflation. Therefore, detection of our big bang gravitational waveform is speculative and undefined.

This Two-Step Integrated TOE provides the framework for the final TOE. Open, frank, and cooperative discussions are required between physicists working in the 20 interrelated amplified theories. These physicists must provide the intellectually formidable details to this TOE framework. Only then will a Two-Step Integrated TOE, the final theory, the crowning achievement of science, the ultimate triumph of human reasoning, and knowledge of God's mind be resolved.

*AntonioAColella@gmail.com

- [1] B. Greene, *The Elegant Universe*, (Vintage Books, New York, 2000), pp. 143-144, p. 327.
- [2] C. Moskowitz, *Sci. Am.* **316**, 1 (2017).
- [3] B. C. Allanach *et al.*, <http://arxiv.org/pdf/hep-ph/0202233v1.pdf>
- [4] P. A. R. Ade *et al.*, [arXiv:1502.01589v2](https://arxiv.org/abs/1502.01589v2).
- [5] L. Susskind, *The Cosmic Landscape*, (Little, Brown & Company, New York, 2006), p. 21.
- [6] M. Rees, Ed., *Universe*, (DK Publishing, New York, 2005), pp. 46-49.
- [7] E. J. Chaisson, https://www.cfa.harvard.edu/~ejchaisson/cosmic_evolution/docs/text/text_part_5.html.
- [8] A. H. Guth, *The Inflationary Universe* (Perseus Publishing, New York, 1997), p. 185.
- [9] A. R. Liddle and D. H. Lyth, *Cosmological Inflation and Large-scale Structure* (Cambridge University Press, Cambridge, 2000), p. 46.
- [10] A. H. Guth, *The Inflationary Universe* (Perseus Publishing, New York, 1997), p. 209.
- [11] G. Kane, *Sci. Am.* **293**, 1 (2005).
- [12] D. B. Cline, *Sci. Am.* **288**, 3 (2003).
- [13] B. Povh, K. Rith, C. Scholz, and F. Zetsche, *Particles and Nuclei* (Springer-Verlag Berlin, Heidelberg, 2008), p. 2.
- [14] E. J. Chaisson, https://www.cfa.harvard.edu/~ejchaisson/cosmic_evolution/docs/text/text_part_5.html.
- [15] B. Kayser, http://www.pd.infn.it/~laveder/unbound/scuole/2009/DBD-09/B_Kayser-DBDmeeting-oct-2009.pdf.
- [16] M. Y. Khlopov, <http://www.roma1.infn.it/people/bini/seminars/khlopov.ppt>.
- [17] M. Turner's estimate (private communication).
- [18] G. W. Hinshaw, <http://arxiv.org/pdf/0803.0732v2.pdf>.
- [19] S. M. Carroll, <https://link.springer.com/article/10.12942/lrr-2001-1>
- [20] A. Zichichi, <http://cerncourier.com/cws/article/cern/38704>.
- [21] M. A. Thomson, http://www.hep.phy.cam.ac.uk/~thomson/lectures/partIIparticles/pp2004_qcd.pdf.
- [22] C. P. Poole, *The Physics Handbook*, (John Wiley, New York, 1998), p. 365.
- [23] S. P. Martin, <https://arxiv.org/pdf/hep-ph/9709356v7.pdf>
- [24] P. A. R. Ade *et al.*, [arxiv:1502.01589v2](https://arxiv.org/abs/1502.01589v2).
- [25] D. Savage, <http://hubblesite.org/newscenter/archive/releases/1997/01/text/>.
- [26] C. Carilli, *Science* **323**, 323 (16 January 2009).
- [27] R. Irion, *Science* **295**, 66 (4 January 2002).
- [28] A. Kurkela, P. Romatschke, A. Vuorinen, http://arxiv.org/PS_cache/arxiv/pdf/0912/0912.1856v2.pdf.
- [29] S. M. Carroll, <https://link.springer.com/article/10.12942/lrr-2001-1>
- [30] A. Belenkiy, *Physics Today* **65**, 40 (October 2012).
- [31] J. D. Bekenstein, http://arxiv.org/PS_cache/quant-ph/pdf/0311/0311049v1.pdf.
- [32] A. Dabholkar, *Current Science* **89**, 2058-9 (25 December 2005).
- [33] K. Griest, <http://physics.ucsd.edu/students/courses/winter2010/physics161/p161.3mar10.pdf>.
- [34] A. Hamilton, <http://casa.colorado.edu/~ajsh/schwp.html>.
- [35] A. A. Colella, <http://vixra.org/abs/1410.0150>.
- [36] A. A. Colella, <http://vixra.org/abs/1411.0584>.
- [37] L. Anderson, <http://arxiv.org/pdf/1312.4877v2.pdf>.
- [38] S. M. Carroll, <https://link.springer.com/article/10.12942/lrr-2001-1>
- [39] P. J. Steinhardt, N. Turok, *Endless Universe: Beyond the Big Bang*, (Doubleday, New York, 2007), p. 249.
- [40] A. Piorkowska *et al.*, <https://arxiv.org/pdf/1309.5731.pdf>
- [41] S. Hawking, <https://arxiv.org/pdf/hep-th/0507171.pdf>
- [42] K. N. Kumar *et al.*, *Advances in Natural Science* **5**, 2 (2012).
- [43] A. A. Colella, <http://vixra.org/abs/1411.0057>.

-
- [44] J. M. Cline, http://arxiv.org/PS_cache/hep-ph/pdf/0609/0609145v3.pdf.
- [45] M. Shaposhnikov, <http://m.iopscience.iop.org/1742-6596/171/1/012005>.
- [46] N. Bao, P. Saraswat,
<http://www.astro.caltech.edu/~golwala/ph135c/14SaraswatBaoBaryogenesis.pdf>.
- [47] T. D. Lee, *Selected Papers, 1985-1996* (Gordon and Breach, Amsterdam, 1998), p. 776, p. 787.
- [48] N. E. Mavromatos, http://arxiv.org/PS_cache/hep-ph/pdf/0504/0504143v1.pdf.
- [49] F. Hulpke *et al.*, *Foundations of Physics* **36**, 4 (April 2006).
- [50] S. Hawking, *A Brief History of Time*, (Bantam Books, New York, 1988), p. 50.
- [51] Greenstein and Zajonc, *The Quantum Challenge*, (Jones and Bartlett Publishers, Boston, 1997), pp xiii – xiv.
- [52] L. K. Shalm *et al.*, <https://arxiv.org/pdf/1511.03189v2.pdf>.
- [53] Greenstein and Zajonc, *The Quantum Challenge*, (Jones and Bartlett Publishers, Boston, 1997), p. 47.
- [54] B. Greene, *The Elegant Universe*, (Vintage Books, New York, 2000), p. 105.
- [55] Greenstein and Zajonc, *The Quantum Challenge*, (Jones and Bartlett Publishers, Boston, 1997), pp 162 – 163.
- [56] A. Yu Samarin, <https://arxiv.org/pdf/1408.0340.pdf>.
- [57] M. J. Longo, <http://arxiv.org/abs/1104.2815>.
- [58] A. G. Lisi, <http://arxiv.org/pdf/0711.0770v1.pdf>.
- [59] M. Vogelsberger *et al.*, <https://arxiv.org/pdf/1405.2921v2.pdf>.
- [60] P. A. R. Ade *et al.*, [arXiv:1502.01589v2](https://arxiv.org/abs/1502.01589v2).
- [61] D. Leahy, R. Ouyed, http://arxiv.org/PS_cache/arxiv/pdf/0708/0708.1787v4.pdf.
- [62] A. Morandi, M. Sun, <https://arxiv.org/abs/1601.03741>.
- [63] D. Edmonds *et al.*, <https://arxiv.org/pdf/1601.00662.pdf>
- [64] M. J. Mortonson, U. Seljak, <http://arxiv.org/abs/1405.5857>.