

# Three-Qubit Operators for E8 ToE Particles

---

**Sai Venkatesh Balasubramanian**

Sree Sai Vidhya Mandhir, Mallasandra, Bengaluru-560109, Karnataka, India  
saivenkateshbalasubramanian@gmail.com

## Abstract

Using the principles of CQI and E8 charge space-qubit entanglement mentioned above, it is possible to represent various particle creations and particle-particle interactions using creation, rotation and other qubit operators. Discussed here are formulations, procedures and examples of the same.

## Introduction:

It is seen that while equating uncertainty of quantum mechanics with the practical randomness of chaos theory, the interpretation of quantum mechanics using chaos theory can be used in conjunction with the computational universe model, which equates the action of computational ‘matter’ (defined by the angle of phase shift (scattering) that a qubit undergoes on passing through each quantum gate), and the action of gravitation of spacetime geometry, according to the Einstein Regge Equations  $\sum_h \frac{\delta A_h}{\delta g_{ab}} g_{ab}(l) = 16\pi G U \Delta V_l = 16\pi \hbar G \theta_l$  [57]. This concept, along with the principle of metahomeomorphism, which states that all n-dimensional informational fields are equivalent in information space, leads to an important result.

The E8 Theory of Everything unifies the fields of gravity and the standard model as an E8 principal bundle connection, illustrated, composed of a SU(3) for the strong nuclear force, SU(2)xU(1) for the electroweak, SO(3,1) for the gravitational force along with the frame Higgs and three generations of Fermions, with all the ensuing interactions and dynamics described by curvature and action over a 4D base manifold. The crux of this theory is the development of eight quantum numbers which together, identify each of the 240 roots of the E8 polytope as a fundamental particle, as shown in Fig. 1 and 2. Thus, in essence, the intricate interaction of the beautiful E8 with the fabric of spacetime crystallizes into 8 kinds of charges in the charge space. These 8 charges are defined for every point in spacetime, since the E8 is present in every point of spacetime. From basic definitions, it is known that any function (in this case, charge) varying with space and time is a “signal”. So, the 8 charges are seen as

8 signals - signals of information. Using the Chaotic Interpretation, the superposed state of a quantum system, such as a qubit, is nothing but a chaotic signal. The chaotic nature is destroyed once the qubit collapses to a 0 or 1. The initial conditions already determine which of the 2 options (0 or 1) the qubit will collapse into, once we ‘measure’ it. For a 2 qubit system, represented by 2 chaotic signals with entanglement, there are 4 main states (00,01,10,11) and any entangled state can be formed by combining the 4 states in suitable proportions. Similarly, 3 chaotic signals, representing 3 qubits can have 8 fundamental states (000,001,010,011,100,101,110,111) using which entangled states can be constructed. Thus, given 8 columns of data, according to metahomeomorphism, one can represent them as the combining factors of the 8 states, and represent these 8 states as entangled states of a 3-qubit system. According to the chaotic interpretation, the 3 Qubits are 3 chaotic signals representing information, as the 8 states.

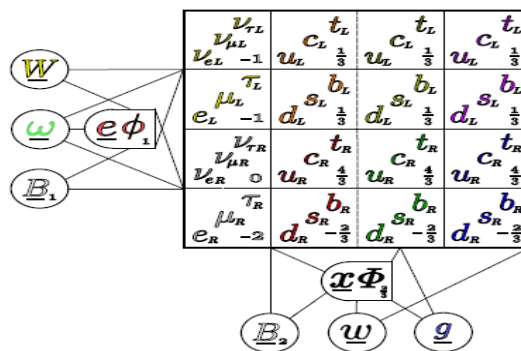

Figure 1 Periodic Table of the E8 ToE



















E8		$\frac{1}{2}\omega_T^3$	$\frac{1}{2}\omega_S^3$	$U^3$	$V^3$	$w$	$x$	$y$	$z$	F4	G2	#
	$\omega_L^{\wedge/\vee} \omega_R^{\wedge/\vee}$	$\pm 1$	$\pm 1$	0	0	0	0	0	0	$D2_G$	1	4
	$W^\pm B_1^\pm$	0		$\pm 1 \pm 1$	0	0	0	0	0	$D2_{ew}$	1	4
	$e\phi_+ e\phi_- e\phi_1 e\phi_0$	$\pm 1$		$\pm 1$	0	0	0	0	0	$4 \times 4$	1	16
	$\nu_{eL} e_L \nu_{eR} e_R$	$\pm 1/2 \dots$	$\text{even}\# > 0$			-1/2	-1/2	-1/2	-1/2	$8_{S+}$	$l$	8
	$\bar{\nu}_{eL} \bar{e}_L \bar{\nu}_{eR} \bar{e}_R$	$\pm 1/2 \dots$	$\text{even}\# > 0$			1/2	1/2	1/2	1/2	$8_{S+}$	$\bar{l}$	8
	$u_L d_L u_R d_R$	$\pm 1/2 \dots$	$\text{even}\# > 0$			-1/2	$\pm 1/2 \dots$	$\text{two} > 0$		$8_{S+}$	$q_I$	24
	$\bar{u}_L \bar{d}_L \bar{u}_R \bar{d}_R$	$\pm 1/2 \dots$	$\text{even}\# > 0$			1/2	$\pm 1/2 \dots$	$\text{one} > 0$		$8_{S+}$	$\bar{q}_I$	24
	$\nu_{\mu L} \mu_L \nu_{\mu R} \mu_R$	$\pm 1/2 \dots$	$\text{odd}\# > 0$			-1/2	1/2	1/2	1/2	$8_{S-}$	$l$	8
	$\bar{\nu}_{\mu L} \bar{\mu}_L \bar{\nu}_{\mu R} \bar{\mu}_R$	$\pm 1/2 \dots$	$\text{odd}\# > 0$			1/2	-1/2	-1/2	-1/2	$8_{S-}$	$\bar{l}$	8
	$c_L s_L c_R s_R$	$\pm 1/2 \dots$	$\text{odd}\# > 0$			1/2	$\pm 1/2 \dots$	$\text{two} > 0$		$8_{S-}$	$q_I$	24
	$\bar{c}_L \bar{s}_L \bar{c}_R \bar{s}_R$	$\pm 1/2 \dots$	$\text{odd}\# > 0$			-1/2	$\pm 1/2 \dots$	$\text{one} > 0$		$8_{S-}$	$\bar{q}_I$	24
	$\nu_{\tau L} \tau_L \nu_{\tau R} \tau_R$			$\pm 1$		1	0	0	0	$8_V$	1	8
	$\bar{\nu}_{\tau L} \bar{\tau}_L \bar{\nu}_{\tau R} \bar{\tau}_R$			$\pm 1$		-1	0	0	0	$8_V$	1	8
	$t_L b_L t_R b_R$			$\pm 1$		0	-1	0	0	$8_V$	$q_{II}$	24
	$\bar{t}_L \bar{b}_L \bar{t}_R \bar{b}_R$			$\pm 1$		0	1	0	0	$8_V$	$\bar{q}_{II}$	24
	$g$			0		0	1	-1	0	1	$A2$	6
	$x_1\Phi$			0		-1	$\pm 1$	0	0	1	$q_{III}$	6
	$x_2\Phi$			0		1	$\pm 1$	0	0	1	$q_{III}$	6
	$x_3\Phi$			0		0	$\pm(1 \ 1)$	0	0	1	$q_{III}$	6

Figure 2 Periodic Table of the E8 ToE

### Qubit operators for Particle Creation and Interactions:

Using the principles of CQI and E8 charge space-qubit entanglement mentioned above, it is possible to represent various particle creations and particle-particle interactions using creation, rotation and other qubit operators. Shown below are examples of gluon creation operators from vacuum state of  $|000\rangle$ .

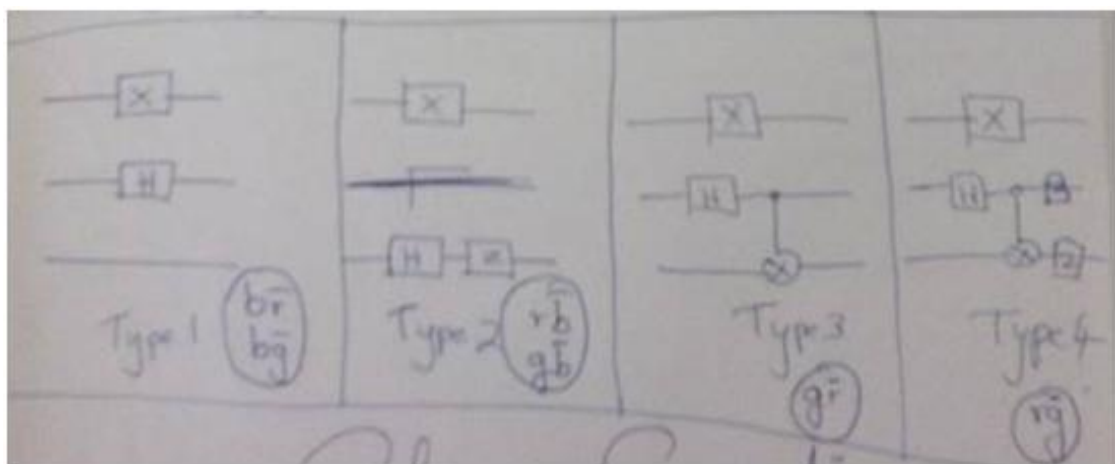

The gluon-gluon interaction can be represented as follows:

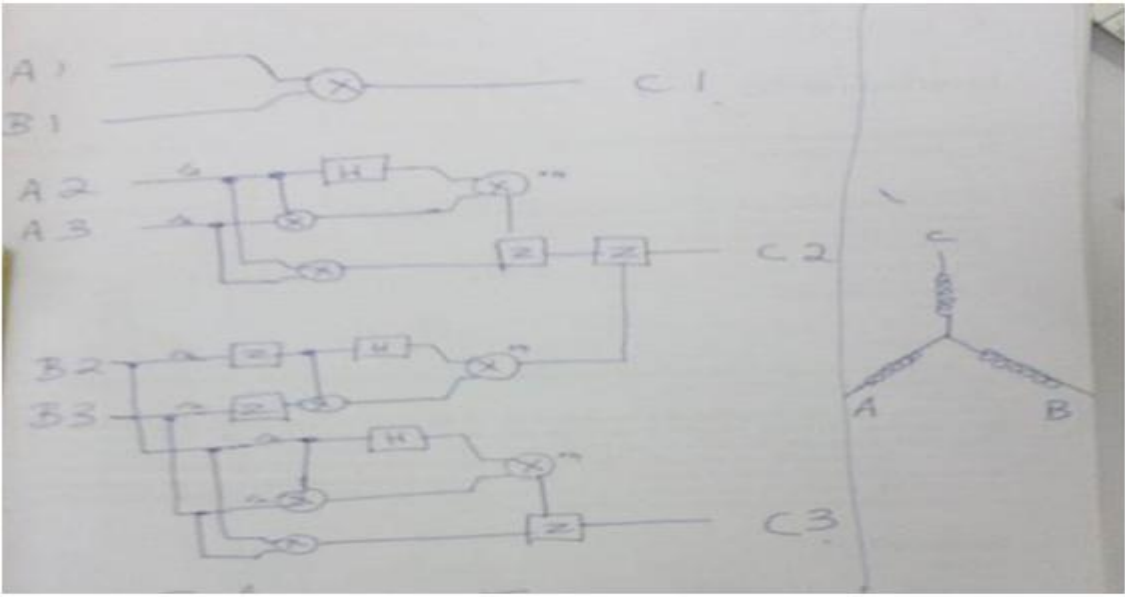

The top/bottom antiquarks are represented as follows:

