

# An Exceptionally Simple “Theory of Everything” using Chaotic Quantum Information

---

**Sai Venkatesh Balasubramanian**

Sree Sai Vidhya Mandhir, Mallasandra, Bengaluru-560109, Karnataka, India.  
saivenkateshbalasubramanian@gmail.com

## Abstract

The search for an all comprehensive Theory of Everything unifying the four fundamental forces described by Quantum Mechanics and General Relativity has always been an elusive one. Among the plethora of theories including Superstring Theory and Loop Quantum Gravity proposed in recent years, the present article focuses on the E8 Theory of Everything. After a brief overview on the underlying principles of this theory, the principles of “Metahomeomorphism” and Quantum Computation are explored to represent the 8D Charge space of the E8 Theory using a 3 Qubit system. A Chaos Theory based interpretation of Quantum Mechanics is then proposed, to represent the 3 qubits as three chaotic signals. The result is an extension of the E8 theory, termed the Chaotic Quantum Information based E8 Theory of Everything (CQIE8ToE). The physical interpretation of this theory is explored along with particle creation and particle interaction formulations. While the validation of the E8 Theory await experimental evidence, the principles of metahomeomorphism, quantum computation and subsequently the CQIE8ToE ensure that any representation of a unified theory in a Lie Group based on a charge space yields to the elegant merging of Relativity, Quantum Physics, Particle Physics and Chaos Theory, into a simple yet effective World-View.

**Keywords:** *ToE, E8, Computational Universe, Quantum Mechanics, Chaos Theory*

## 1. Introduction

The greatest advancements in physics during the 20<sup>th</sup> century are undoubtedly the trio of Quantum Mechanics, Relativity Theory and Chaos Theory, all three of them rigorously validated and proved right by numerous experiments [1-10]. Subsequent developments on Quantum Mechanics yielded Quantum Field Theory and by extension, the Standard Model of Particle physics, which is a collection of matter-based (fermions) and force-carrying (bosons) particles [11-16]. The Standard Model has been able to successfully unify three of the four fundamental forces of nature – the electromagnetic and the strong and weak nuclear forces [16]. However, uniting this model with the fourth fundamental force, gravity, has ever since been elusive, owing to basic disparities between the basic principles of General Relativity and Quantum Mechanics [17-20].

This conundrum has led to a plethora of theories developed, either suggesting towards or claiming to be the Theory of Everything, the most notable ones of which include Superstring Theory and Loop Quantum Gravity, both known for their extremely complicated mathematical constructs, with string theory variants positing as much as 25 dimensions for the universe [21-29]. However, off-mainstream, simpler theories have been developed, most notable of which is the E8 theory proposed by Lisi - a geometrical Theory of Everything (ToE) based on the most beautiful yet complex structure in all of mathematics – the E8, where the fields of gravity and the standard model are unified as an E8 principal bundle connection, composed of a SU(3) for the strong nuclear force, SU(2)xU(1) for the electroweak, SO(3,1) for the gravitational

force along with the frame Higgs and three generations of Fermions, with all the ensuing interactions and dynamics described by curvature and action over a 4D base manifold [30-32]. The crux of this theory is the development of eight quantum numbers which together, identify each of the 240 roots of the E8 polytope as a fundamental particle.

In this article, an overview of the most important principles of the E8 ToE is presented, with the end result being the 8 Dimensional Charge Space of the E8ToE uniquely identifying each of the 240 fundamental particles. The objective of the present work is to provide a quantum information approach to further unify/simplify the 8D charge space into the manifestations of a 2-Qubit system, using appropriate quantum operators. This idea comes from Lloyd's Computational Universe model, where quantum information is equated to 4D spacetime, and by introducing the postulate of "Meta-homeo-morphism", the E8ToE is expressed as an information based ToE. Following this, the essentials of a Chaotic Interpretation of Quantum Mechanics is presented, where a qubit is equated to a chaotic signals. Finally, using these constructs, a "Chaotic Quantum Information based E8 Theory of Everything" (CQIE8ToE) is proposed, which views the entire universe and all its constituents as the evolution and interplay between three chaotic signals.

## 2. An overview of the E8 ToE

From the Standard Model of Particle Physics, it is well known that the electroweak and strong gauge fields are described as Lie algebra based connection 1-forms,  $W \in SU(2)$ ,  $B \in U(1)$  and  $g \in SU(3)$  and the gravitational fields by a spin connection  $w \in SO(3,1) = Cl^2(3,1)$  and the frame  $e \in Cl^1(3,1)$  that interacts with the Higgs scalar field  $\phi$  to give masses to the particles. Fermions are represented as Grassmann valued spinor fields  $\{v_e, e, u, \dots\}$  with the electroweak  $W$ , strong  $g$  and electroweak  $B$  acting on left chiral, colored and hypercharge possessing fermions respectively [30-32].

By combining the Gauge fields as the connections of a larger Lie Group, viewing the spin, frame and Higgs as parts of a "graviweak" connection and including the fermions as Lie algebra elements, a principal bundle connection with everything is obtained as follows [30]:

$$A = \frac{1}{2}w + \frac{1}{4}e\phi + B + W + g + (v_e + e + u + d) + (v_\mu + \mu + c + s) + (v_\tau + \tau + t + b) \quad (1)$$

where examples of bosonic and fermionic fields are  $g = dx^i g_i^A T_A$  and  $u = u^A T_A$ .

In this light the strong force is seen as a  $SU(3)$  group with a 3 dimensional charge space given by  $(x, y, z)$  or  $(B_2, g_3, g_8)$ , including three series of quarks and anti-quarks.

By representing gravity as a  $Cl(3,1)$ , the gravitational frame  $e$  is obtained using the left and right chiral parts, and by defining the  $D2 = SO(3,1)$  of the gravitational spin using spatial rotation  $w_s$  and temporal boost  $w_T$ , the left and right chiral parts of the spin connection are viewed as  $w_{L/R} = w_s -/+ i w_T$ . Thus, in essence, the Gravitational D2 is viewed as a 2D charge space defined by  $(w_L/2, w_R/2)$  or  $(w_s/2, w_T/2i)$  [30].

By combining the electroweak gauge fields  $W$ , acting on left chiral doublets and  $B_1$ , acting on all right chiral doublets, the electroweak  $B$  is obtained as a  $U(1)$ . This allows the Higgs vector field  $\phi$  to be represented along with the electroweak as a  $Cl^2(4)$ , represented by 2D charge space  $(W, B_1)$  analogous to

$(w_L, w_R)$  or  $(U, V)$  analogous to  $(w_S, w_T/i)$ . Based on this, the weak hypercharge  $Y$  is defined as  $Y/2 = B_1^3 - \sqrt{0.67} B_2$ . Consequently, charge  $Q$  becomes  $Q = W^3 + Y/2$  [30].

The above mentioned gravitational and electroweak combine as a graviweak  $D4 = SO(7, 1)$ . This is represented as a 4D charge space  $(w_L, w_R, W, B_1)$ . This yields a set of symmetries, the triality, acting as  $TTT_{w_R} = TTB_1 = Tw_L = w_R$ . Thus, the triality partners generate the three generations of fermions, and this combined with the  $D4$  yields the 48 roots of  $F4$  [30].

The  $F4$  combined with the  $G2$  finally yield the 240 roots of the  $E8$ , whose roots are seen as vertices of the  $E8$  polytope, and is represented by an 8 dimensional charge space  $(w_T/2i, w_S/2, U, V, w, x, y, z)$ , as in Fig. 1.



















$E8$		$\frac{1}{2i}\omega_T^3$	$\frac{1}{2}\omega_S^3$	$U^3$	$V^3$	$w$	$x$	$y$	$z$	$F4$	$G2$	#
	$\omega_L^{\wedge/V} \omega_R^{\wedge/V}$	$\pm 1$	$\pm 1$	0	0	0	0	0	0	$D2_G$	1	4
	$W^\pm B_1^\pm$	0		$\pm 1 \pm 1$	0	0	0	0	0	$D2_{ew}$	1	4
	$e\phi_+ e\phi_- e\phi_1 e\phi_0$	$\pm 1$		$\pm 1$	0	0	0	0	0	$4 \times 4$	1	16
	$\nu_{eL} e_L \nu_{eR} e_R$	$\pm 1/2 \dots$	even#>0			-1/2	-1/2	-1/2	-1/2	$8_{S+}$	$l$	8
	$\bar{\nu}_{eL} \bar{e}_L \bar{\nu}_{eR} \bar{e}_R$	$\pm 1/2 \dots$	even#>0			1/2	1/2	1/2	1/2	$8_{S+}$	$\bar{l}$	8
	$u_L d_L u_R d_R$	$\pm 1/2 \dots$	even#>0			-1/2	$\pm 1/2 \dots$	two>0		$8_{S+}$	$q_I$	24
	$\bar{u}_L \bar{d}_L \bar{u}_R \bar{d}_R$	$\pm 1/2 \dots$	even#>0			1/2	$\pm 1/2 \dots$	one>0		$8_{S+}$	$\bar{q}_I$	24
	$\nu_{\mu L} \mu_L \nu_{\mu R} \mu_R$	$\pm 1/2 \dots$	odd#>0			-1/2	1/2	1/2	1/2	$8_{S-}$	$l$	8
	$\bar{\nu}_{\mu L} \bar{\mu}_L \bar{\nu}_{\mu R} \bar{\mu}_R$	$\pm 1/2 \dots$	odd#>0			1/2	-1/2	-1/2	-1/2	$8_{S-}$	$\bar{l}$	8
	$c_L s_L c_R s_R$	$\pm 1/2 \dots$	odd#>0			1/2	$\pm 1/2 \dots$	two>0		$8_{S-}$	$q_I$	24
	$\bar{c}_L \bar{s}_L \bar{c}_R \bar{s}_R$	$\pm 1/2 \dots$	odd#>0			-1/2	$\pm 1/2 \dots$	one>0		$8_{S-}$	$\bar{q}_I$	24
	$\nu_{\tau L} \tau_L \nu_{\tau R} \tau_R$		$\pm 1$			1	0	0	0	$8_V$	1	8
	$\bar{\nu}_{\tau L} \bar{\tau}_L \bar{\nu}_{\tau R} \bar{\tau}_R$		$\pm 1$			-1	0	0	0	$8_V$	1	8
	$t_L b_L t_R b_R$		$\pm 1$			0	-1	0	0	$8_V$	$q_{II}$	24
	$\bar{t}_L \bar{b}_L \bar{t}_R \bar{b}_R$		$\pm 1$			0	1	0	0	$8_V$	$\bar{q}_{II}$	24
	$g$		0			0	1	-1	0	1	$A2$	6
	$x_1 \Phi$		0			-1	$\pm 1$	0	0	1	$q_{III}$	6
	$x_2 \Phi$		0			1	$\pm 1$	0	0	1	$q_{III}$	6
	$x_3 \Phi$		0			0	$\pm(1 \ 1)$	0	0	1	$q_{III}$	6

Figure 1 The 240 roots of the  $E8$  as elementary particles

An interesting feature of the  $E8$  is the prediction of new Higgs like particles, which, if found experimentally confirms the validity of the  $E8$  ToE. The  $E8$  is represented as a periodic table as in Fig. 2, with the root system illustrated in Fig. 3.

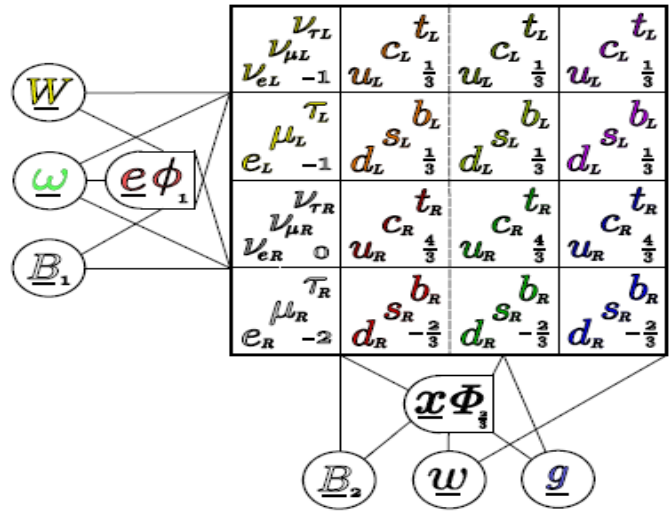

Figure 2 Periodic Table of the E8ToE

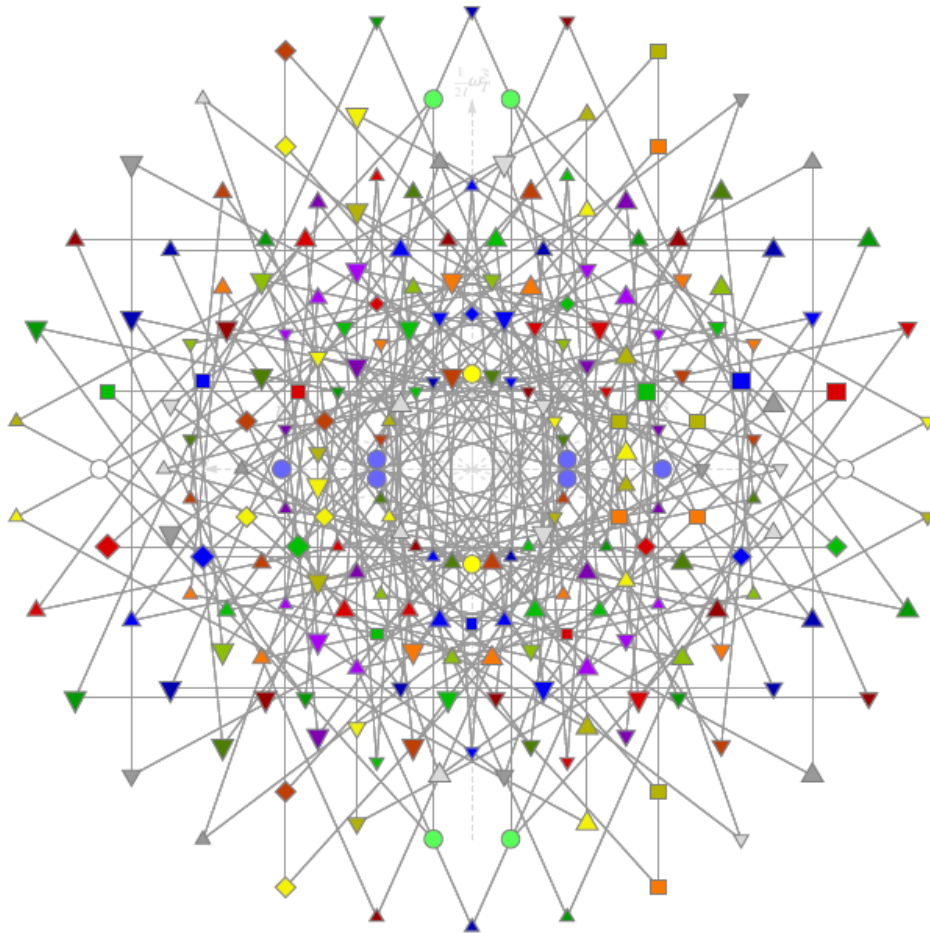

Figure 3 An illustration of the E8 root system

### 3. Computational Universe and MetaHomeoMorphism

The principal objective of the present article is to give a chaos theory/quantum information theory based underpinning to the E8 model. In order to achieve this, it is first important to visualize how fundamental forces representing matter and energy, and the spacetime can possibly be viewed as information. This is precisely the crux of the Computational Universe model, presented by Lloyd [33-39].

In this theory, each quantum computation is viewed as an acyclic graph, consisting of initial vertices representing input states, directed edges corresponding to quantum wires and internal vertices corresponding to quantum logic gates describing the interactions between the qubits. At each vertex of the graph, depending on the qubit state and logic operation, qubits are either transformed (viewed as scattered) or untransformed. The “scattering” is the angle  $\theta$  by which the phase of incoming qubit has been shifted by the logic gate  $U=e^{-i\theta P}$ ,  $P$  being the projection operator. By viewing the probabilistic nature of the qubit as an ensemble of separate “Causal Structures”, the total phase  $\theta_1$  accumulated by each causal structure  $C$  is found, and gives rise to the corresponding action  $I_c$ , termed the action of the “Computational Matter”. Thus in essence, a quantum computation is a superposition of “computational histories” [33-39].

This ensemble of causal structures and the quantum logic framework is seen as the spacetime of General Relativity, where vertices are events, wires are paths, information is matter, edges are null geodesics and the four dimensional metric has the signature  $(+++ -)$ . Thus, the entire graph with each computational history is embedded into a 4D manifold, and the computational framework is defined as a simplicial Geodesic dome, based on the Delaunay (dome edges) and Voronoi (volume associated with each vertex) lattices, an example of which is shown in Fig. 4 [33-39].

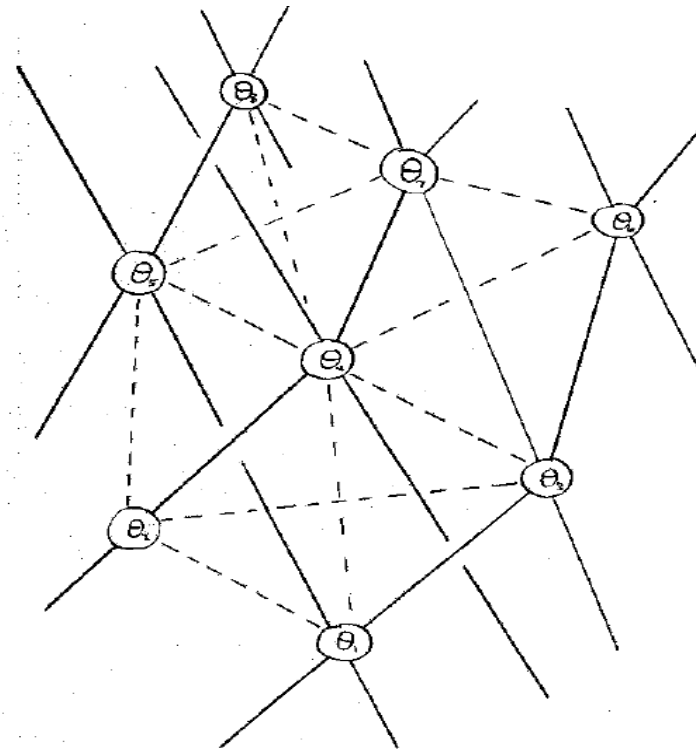

Figure 4 The Geodesic Dome Lattice

By equating the action of the computational matter with the action of gravitational degrees of freedom, one obtains the Einstein-Regge equations, with the following relation satisfying the equations [38]:

$$\sum_h \epsilon_h \frac{\delta A_h}{\delta g_{ab}} g_{ab}(l) = 16\pi G U \Delta V_l = 16\pi \hbar G \theta_l \quad (2)$$

This equation equates spacetime geometry to computational matter, thus proving the equivalence of information with matter and spacetime.

Two interesting applications of the ‘‘Computational Matter’’ concept are briefly presented as follows.

### A. Inflation, Dark Matter and Dark Energy

A significant amount of research effort into understanding the early stages of the universe is directed at investigating dark matter and dark energy, with dark matter viewed as matter that reflects minimal to no light, yet having a gravitational influence, and Dark Energy being referred to the unseen influence causing the universal expansion to accelerate. From the perspective of the Computational Universe paradigm, the following is the explanation of Dark Matter and Dark Energy.

In an approximately homogenous, isotropic universe, the Einstein Regge equations take on a Friedmann-Robertson-Walker (FRW) form, as follows [38]:

$$\rho' = -\frac{3(\rho + p)a'}{a}; \frac{4\pi G(\rho + 3p)}{3} = -\frac{a''}{a}; \frac{8\pi G\rho}{3} = \frac{a'^2}{a^2} - \frac{k}{a^2} \quad (3)$$

where  $\rho$  is energy density,  $p$  is pressure,  $k=-1,0,1$  for positive, zero and negative curvatures respectively. Also, in terms of Kinetic energy  $K$  and potential energy  $U$ ,  $\rho=K+U$  and  $p=K/3-U$ .

Defining the Hubble parameter  $H = a'/a$ , and for  $\theta$  as net phase acquired within volume  $\Delta V$ ,  $U=\hbar\theta/\Delta V$ . Rewriting Eq. 3 in terms of  $H$  and solving the first part yields  $K$  according to second part. Thus, the FRW equations can be rewritten as follows [38]:

$$-\frac{16\pi GK}{3} = H'; \frac{8\pi G(K + U)}{3} = H^2 - \frac{k}{a^2} \quad (4)$$

In the case of  $k=0$ ,  $H'=0$ ,  $H$  and  $U$  are constants, Universe undergoes inflation at a constant rate.

If  $U \gg K$ , universe expands exponentially, but if  $K > 0$ , from Eq. 4, rate of expansion decreases with time. But  $a''/a=8\pi G(U-K)/3$ , when  $K > U$ ,  $a'' < 0$ , and universe ceases to inflate.

$K \gg U$  corresponds to a radiation dominated universe and  $K=3U$  corresponds to matter dominated universe ( $p=0$ ).

These scenarios are possible at different stages of the same computation. For instance, at  $t=0$ , let  $a=1$  and  $K=0$ . This corresponds to inflation at the Planck rate with Gaussian curvature fluctuations also subsequently inflated. However, such an inflation is unstable, since for non-zero  $K$ , inflation decreases. In regions where  $K > U$ ,  $a''$  becomes 0 and inflation stops.  $K$  itself is seen as the breaking of homogeneity by quantum fluctuations, thanks to the phases  $\theta$  acquired in individual gates. This slowing down in inflation creates energetic matter giving rise to a radiation dominated universe [38].



As  $K \propto 1/a^4 \propto t^{-2}$  and  $U \propto 1/a^3 \propto t^{-3/2}$ , with  $U$  being proportional to the density of logic gates,  $K$  lowers to the level  $K=3U$  and the universe becomes matter dominated. At this stage, the universe exhibits significant clumping and is no longer homogenous. In addition to matter dominated regions, in certain regions,  $U < K < 3U$ . Here, pressure  $p$  is negative as  $p = K/3 - U$ , but  $a'' > 0$  and thus  $p$  is not sufficient for inflation. In some regions,  $K < U$ , and these regions start inflating again, though at a much lower rate.

In this scenario, the computational universe contains regions dominated by three different kinds of energy as follows [38]:

1. Ordinary matter and radiation,  $K > 3U$ .
2. Dark Matter, with non-inflating negative pressure at  $U < K < 3U$ , typically in halos of galaxies.
3. Dark Energy, undergoing inflation,  $K < U$ .

## B. Black Holes and Entanglement

Black holes are geometrically defined regions of spacetime, with a gravitational effect so strong that nothing escapes from it and the boundary from which no escape is possible is termed the Event Horizon [40-42]. The “no-hair” theorem states that once a black hole achieves stable condition after formation, it has only three independent properties – mass, charge and angular momentum (spin) [43-47].

The most general, static spherically symmetric black hole solution of Einstein Maxwell theory is given in spherical polar coordinates by the Reissner Nordstrom line element [48-53]. A popular model of the black hole is the STU Supergravity model, displaying a symmetry  $SL(2) \times SL(2) \times SL(2)$ , with a triality between  $S$ ,  $T$  and  $U$  [54-59]. This solution depends on 8 charges denoted as  $q_0, q_3, p^1, p^3$ , with the extremal black hole entropy written as a function of these charges.

By defining a hypermatrix  $ABC$  in 3 dimensions with the geometrical shape as a cube with 8 vertices, the 8 charges of the STU are identified with the 98 vertices representing the states (000-111) of a 3-qubit system and the entropy  $S$  of the black hole given as  $S = \pi \sqrt{|ABC|}$  [60,61].

Following this equivalence, it is seen that the various classes of entanglement in a 3 qubit system, such as Zero, Separable classes (A-B-C), Biseparable classes (A-BC, B-CA, C-AB), and the genuine tripartite entanglement class GHZ ( $|111\rangle - |100\rangle - |010\rangle - |001\rangle$ ) with the Number of charges/Kets  $N$  from 0 to 3 correspond respectively to 1 Susy,  $1/2$  Susy,  $1/4$  Susy and the  $1/8$  Susy states respectively, the last one being the STU black hole [62-64].

Thus, this relation establishes the equivalence between the STU Black hole and the GHZ entangled state of a 3-qubit system. It is indeed interesting to note that the maximally asymmetric GHZ entangled state provides the maximum phase shift from a vacuum state  $|000\rangle$  and is thus the causal structure with highest value of  $\theta$ . Thus, the equivalence between matter, mass, information and symmetry is established.

### C. Metahomeomorphism

Based on Computational Universe equivalence, the following, termed “Metahomeomorphism” is postulated, based on the topological concept of homeomorphism [65-67]:

**All n-dimensional informational fields are equivalent in information space.**

This principle enables a system-agnostic view of any system of information with a particular m-dimensional charge space, as an m-dimensional information space, and this leads to the representation of the system as the manifestations of simpler systems.

If m is a power of 2,  $m=2^n$ , it is seen that the m-dimensional system can be represented as a system of n qubits.

The simplest case of such a mapping is a 2D system, with a charge space given by (A,B). The various values of this charge space can be given by the states of a single qubit Q. For instance pure states such as (0,1) and (1,0) are represented as the qubit states  $|1\rangle$  and  $|0\rangle$  respectively. Mixed states such as (1/2,1/2) correspond to a superposed state which can be represented as a Hadamard operator acting on Q initially in a vacuum state  $|0\rangle$ . Other states can be obtained by using appropriate scaling factors. As will be seen later, this principle of metahomeomorphism is used to simplify the 8D E8 charge space into a system of 3 qubits.

### 4. Chaos based Interpretation of Quantum Mechanics

The final and most important building block of the proposed CQIE8ToE is an interpretation of Quantum Mechanics based on Chaos Theory.

In essence, the most prominent nature of a quantum system is the existence of superposed states, where a qubit for instance exhibits the values of  $|0\rangle$  and  $|1\rangle$  simultaneously, with an inherent probability. The operation of measurement causes the superposed state to collapse to one of the two values. This is succinctly represented by the Schrodinger equation, given as [68-71]

$$H|\psi\rangle = E|\psi\rangle \quad (5)$$

Chaos System, in its essence is defined as a system with a behavior highly fluctuating, depending on certain factors, called “initial conditions” [7,8]. This implies that, even if the initial condition changes very slightly, the system will show a drastic difference in the behavior and this property is aptly named “Sensitive Dependence on Initial Conditions”, also explained more popularly as the “Butterfly Effect” [7]. Chaos is essentially deterministic. This means that if one knows the initial conditions, one can easily find out the output of a chaotic system at any point in time. But since the behavior is so fluctuating and it is almost always impossible to know all initial conditions, it appears like as if the chaos looks random, which is a clearly misleading appearance.

Thus, the first step in a chaos theory based interpretation of quantum mechanics is the equivalence between the inherent probabilistic nature of a superposed state and the theoretically deterministic yet practically random nature of the chaotic signal. This gives rise to the following inferences and postulates:

1. The superposed state of a quantum system is a chaotic signal, and is seen as the wavefunction “ $\psi$ ”.
2. Collapse is a stage in the evolution of “ $\psi$ ” and is a reduction in its ‘chaoticity’ and asymmetry.



3. Given the exact initial conditions, one can predict the evolution of the chaotic system at any time. However the impracticality of knowing all the initial conditions make the system “practically random”.
4. Collapse is related to Measurement, and Collapse is an irreversible process.
5. Measurement and Initial Configurations together form the “initial conditions” of the system.
6. Measurement only determines “when System will collapse” and not “what System will collapse to”.
7. In the chaotic interpretation, ‘ $H|\psi(t)\rangle$ ’ is simply viewed as a function  $H[\psi(t)]$  of the chaotic signal  $\psi(t)$ , and  $E$  is the resultant output of this operation. The same concept holds for other operators and their corresponding Eigen Values as well. Thus, in the chaotic interpretation, the equations 1 and 4 are rewritten together as  $i\hbar \frac{d(\psi(t))}{dt} = H[\psi(t)] = E \cdot \psi(t)$ .

The above mentioned points are schematically illustrated in Fig. 5.

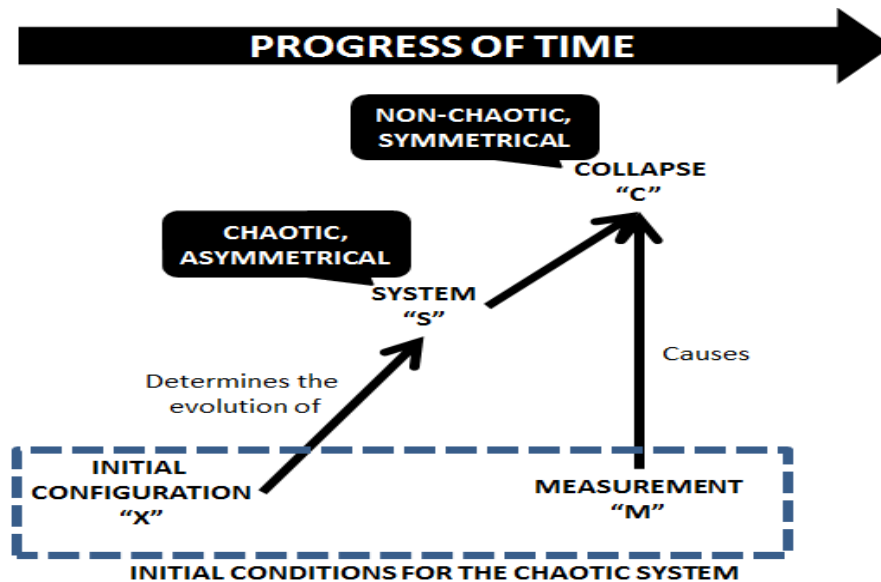

Figure 5 Illustration of the Chaotic Interpretation of Quantum Mechanics

## The postulates of Quantum Mechanics

In this section, the 4 fundamental postulates of Quantum Mechanics are explored in the chaotic perspective [43-45]:

### First Postulate:

*The state of a quantum mechanical particle is represented by  $|\psi\rangle$  in a Hilbert space, a linear vector space consisting of an inner product space.*

According to this postulate,  $|\psi\rangle$  is defined in a Hilbert space. This enables one to have a finite dimensional representation of  $|\psi\rangle$ , as a linear combination of unit vectors chosen as the basis vectors. This postulate is unchanged in the chaotic interpretation, and the Hilbert space basis yields the space and time coordinates of the chaotic signal  $\psi$ .

### Second Postulate:

*The classical variables depicting the position ‘x’ and momentum ‘p’ are represented by the corresponding Hermitian operators ‘X’ and ‘P’ with the matrix elements in X basis given by*

$$\langle x|X|x' \rangle = x \delta(x - x') \text{ and } \langle x|P|x' \rangle = -i\hbar \frac{d}{dx} (\delta(x - x')). \quad (2, 3)$$

This postulate concerns with the operators for various physical quantities such as position ‘x’, momentum ‘p’, and Hamiltonian ‘H’ leading to generation of basis vectors  $|x\rangle$ ,  $|p\rangle$  and  $|E\rangle$  respectively. In the chaotic interpretation, the various operators are viewed as functions acting on the chaotic signal, to give the output signals which become the corresponding basis vectors, or ‘observables’.

### Third Postulate:

*When a quantum mechanical measurement is made by the action of a quantum mechanical operator A on a particle in state  $|\psi\rangle$ , the state of the system changes from  $|\psi\rangle$  to  $|\lambda\rangle$ . The variable corresponding to the operator A will yield one of the Eigen values of  $\lambda$  of A with a probability  $P(\lambda)$  proportional to  $|\langle \lambda|\psi\rangle|^2$ .*

This postulate concisely explains the effect of measurement on the quantum state. Since the quantum state of a system is viewed as a chaotic signal, this postulate enunciates how a signal ‘ $\psi$ ’ changes to another signal ‘ $\lambda$ ’ upon effect of the measurement operator ‘ $\Lambda$ ’. The proportionality and probability must be seen as a purely ‘practically probable’ case, with the use of probability to compensate for the lack of information about initial configuration X.

### Fourth Postulate:

*The time dependent Schrödinger equation is given as follows, where ‘H’ is the quantum mechanical Hamiltonian, the energy operator.*

$$i\hbar \frac{d|\psi(t)\rangle}{dt} = H|\psi(t)\rangle \quad (4)$$

This postulate introduces the Energy basis with the operator H, and if  $|\psi\rangle$  is used as the Energy Basis, the Eigen Value denoting the observable energy E is obtained according to Eq. 1. In the chaotic interpretation, ‘ $H|\psi(t)\rangle$ ’ is simply viewed as a function  $H[\psi(t)]$  of the chaotic signal  $\psi(t)$ , and E is the resultant output of this operation. The same concept holds for other operators and their corresponding Eigen Values as well.

On a high-level perspective, the chaotic interpretation seems to have replaced the ‘completely random’ nature of conventional interpretations with the ‘practically random’ nature of chaos. This approach might open some new windows into understanding more about the elusive initial configuration ‘X’ by studying the patterns observed in the evolution of the system.

The Chaotic Interpretation of QM is compared with other existing well-established interpretations in terms of various properties such as determinism, realism, unique history, counterfactual definiteness and so on, and the differences are tabulated in Table 1 [72-91].

Table 1 Comparison of Properties of Various Quantum Interpretations (Agn: Agnostic)

Interpretation	Determinism	Real	Unique History	Hidden Variable	Collapse	Observer Role	Local	CFD	Universal $\psi$
Ensemble	Agn	No	Yes	Agn	No	No	Agn	No	No
Hydrodynamic	Yes	Yes	Yes	Yes	No	No	No	Yes	Yes
Copenhagen	No	No	Yes	No	Yes	Causal	Agn	No	No
Broglie-Bohm	Yes	Yes	Yes	Yes	No	No	No	Yes	Yes
Von Neuman	No	Yes	Yes	No	Yes	Causal	No	No	Yes
Q – Logic	Agn	Agn	Yes	No	No	Interpret	Agn	No	No
T Symmetric	Yes	Yes	Yes	Yes	No	No	Yes	No	Yes
Many Worlds	Yes	Yes	No	No	No	No	Yes	No	Yes
Popper	No	Yes	Yes	Yes	No	No	Yes	Yes	No
Stochastic	No	No	Yes	Yes	No	No	No	Pos	No
Many Minds	Yes	Yes	No	No	No	Interpret	Yes	No	No
Consistent H	Agn	Agn	No	No	No	Interpret	Yes	No	No
Obj Collapse	No	Yes	Yes	No	Ye	No	No	No	No
Transactional	No	Yes	Yes	No	Yes	No	No	Yes	No
Relational	Agn	No	Agn	No	Yes	Intrinsic	Yes	No	No
<b>Chaotic</b>	<b>Yes</b>	<b>Yes</b>	<b>Yes</b>	<b>No</b>	<b>Yes</b>	<b>Timing</b>	<b>No</b>	<b>Yes</b>	<b>Yes</b>

## 5. The Chaotic Quantum Information based E8 Theory of Everything (CQIE8ToE)

The above sections detailed the connection from the charge space of E8 to quantum information via quantum computation and metahomeomorphism as well as the connection from a qubit to chaotic signal through the chaotic interpretation of Quantum Mechanics.

Using these equivalences and interpretations, the E8 Theory is extended to a Chaotic Quantum Information based E8 Theory of Everything (CQIE8ToE), whose fundamental postulate is as follows:

**Each root of the 8D charge space in the E8 ToE is the state of a 3-qubit system |C1C2C3>.**

Specifically, the 8 tuple  $(w_T/2i, w_S/2, U, V, w, x, y, z)$  is seen as the equivalent of the eight states  $(000, 001, 010, 011, 100, 101, 110, 111)$  of  $|ABC\rangle$ , and by weighted combinations of the 8 states, any of the 240 particles in Fig. 1 can be constructed. For instance, six gluons can be prepared from the  $|000\rangle$  vacuum state, as in Fig. 6, with the Gluon Interaction viewed as Fig. 7. The fundamental gates required to construct the various elementary particles and their interactions from a vacuum state are as follows [92-100]:

- The Pauli X Gate or the “Bit-Flip”, given by  $X = \begin{bmatrix} 0 & 1 \\ 1 & 0 \end{bmatrix}$ .
- The Pauli Z Gate or the “Phase-Flip”, given by  $Z = \begin{bmatrix} 1 & 0 \\ 0 & -1 \end{bmatrix}$ .
- The Hadamard Gate given by  $H = \frac{1}{\sqrt{2}} \begin{bmatrix} 1 & 1 \\ 1 & -1 \end{bmatrix}$ , converting pure states into superposed states and vice versa.

- The Controlled NOT or CNOT Gate, given by  $\text{CNOT} = \begin{bmatrix} 1 & 0 & 0 & 0 \\ 0 & 1 & 0 & 0 \\ 0 & 0 & 0 & 1 \\ 0 & 0 & 1 & 0 \end{bmatrix}$ .

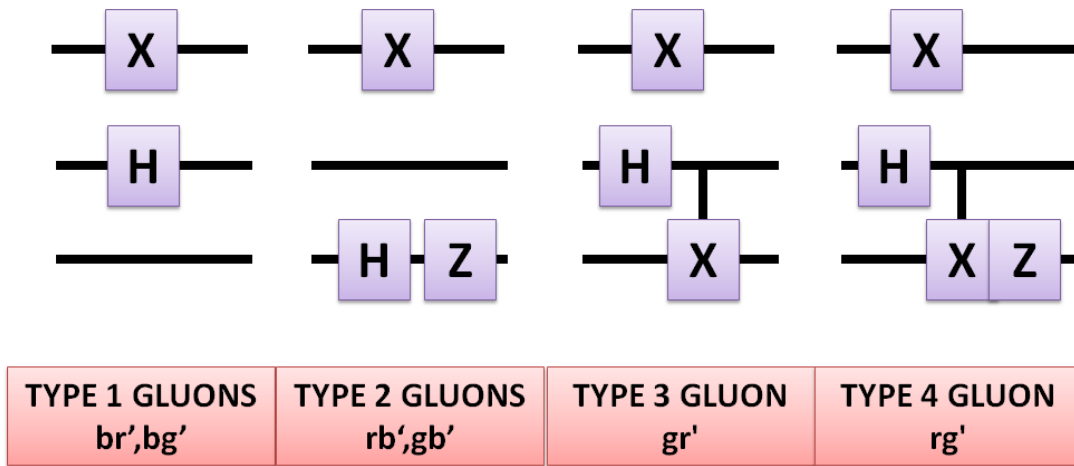

Figure 6 Generation of Gluons from the vacuum state  $|000\rangle$

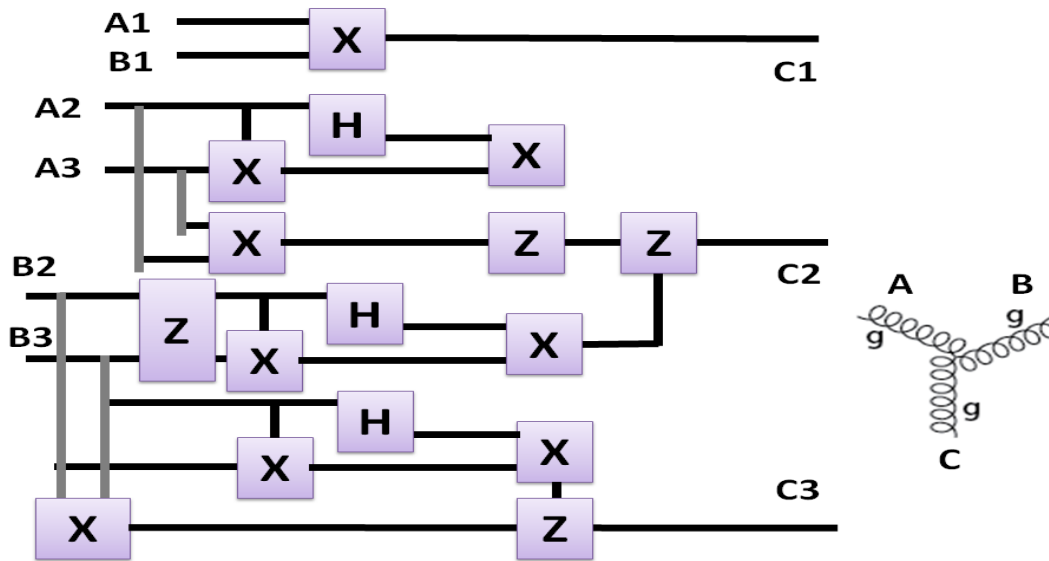
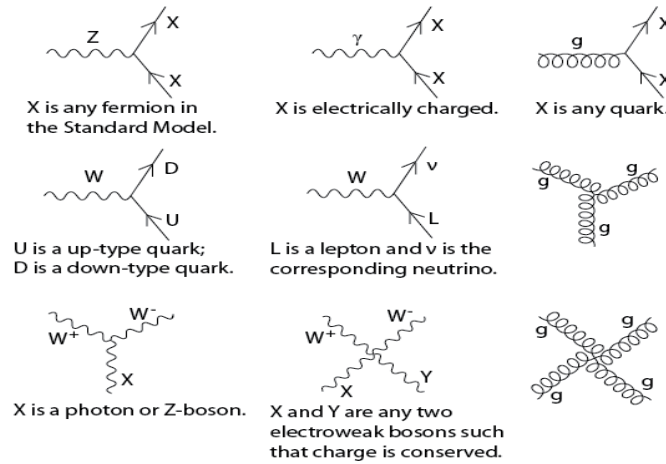

Figure 7 The Gluon Interaction

In a similar fashion, various other particles as listed in Fig. 1 and corresponding interactions, as illustrated in Fig. 8, can be implemented using appropriate quantum logic circuits [11-16].

**Standard Model Interactions  
(Forces Mediated by Gauge Bosons)**



**Figure 8 Assorted Interactions in the Standard Model**

The next step is to obtain a Physical Interpretation and Understanding of the CQIE8ToE.

As a simplified model, consider the spacetime as a 2D fabric, with the only fore acting as the electromagnetic force. The electric and magnetic parts of this force are interconnected. Mathematically, this connection is seen as a circle  $U(1)$ . This implies that, at every point in this fabric is a circle, a vector (marking) on its topmost point. As long as the mark stays on top, the value of electromagnetic force (EM) is zero. If the mark moves from the top, caused by rotation of the circle, the EM force acquires a value. The rotation represents a charge – the electric charge. Thus there are two representations of the EM force – a ‘geometric space’ (circle on a fabric) and a charge space (the value of electric charge at every point).

Now, along the same lines, consider a 248 dimensional structure moving along a 4 dimensional spacetime fabric. This is the E8 structure. This structure has not one, but 8 useful “markings”. Thus the geometric space of this is a 248 dimensional E8 on our 4 dimensional space time, whereas the charge space has 8 charges.

Thus, in essence, the intricate interaction of the beautiful E8 with the fabric of spacetime crystallize into 8 kinds of charges in the charge space. These 8 charges are defined for every point in spacetime, since the E8 is present in every point of spacetime.

From basic definitions, it is known that any function (in this case, charge) varying with space and time is a “signal”. So, the 8 charges are seen as 8 signals - signals of information.

Using the Chaotic Interpretation, the superposed state of a quantum system, such as a qubit, is nothing but a chaotic signal. The chaotic nature is destroyed once the qubit collapses to a 0 or 1. The initial conditions already determine which of the 2 options (0 or 1) the qubit will collapse into, once we ‘measure’ it. For a 2 qubit system, represented by 2 chaotic signals with entanglement, there are 4 main states (00,01,10,11) and any entangled state can be formed by combining the 4 states in suitable proportions. Similarly, 3 chaotic signals, representing 3 qubits can have 8 fundamental states (000,001,010,011,100,101,110,111) using which entangled states can be constructed.

Thus, given 8 columns of data, according to metahomeomorphism, one can represent them as the combining

factors of the 8 states, and represent these 8 states as entangled states of a 3-qubit system. According to the chaotic interpretation, the 3 Qubits are 3 chaotic signals representing – information, represented as the 8 states.

From a spiritual perspective, it is seen that the three Chaotic Signals forming the basis of all matter and force in this universe – giving properties like charge, color, mass, spin and at higher levels, smell, taste, emotions, feelings to the universe, without which, the universe would just be an empty directionless grid. In essence, three Chaotic signals giving life, form, properties and identity to the universe.

Thus, the three signals form the fundamental properties of Consciousness, known in Indian Philosophy as the three Gunas – Sattva, Rajas and Tamas. From the Kapilopadesha, 2:10, “Prakriti is constituted of the three Gunas of Sattva, Rajas and Tamas. It is imperceptible, not being apprehended by any organ of knowledge, but it exists eternally, as it provides the basis and substance for all objects in their causal and effectual conditions.”

## Conclusion

An overview of the key principles of the E8 ToE is presented along with the 8D charge space that describes all the 240 elementary particles. Following this, the principles of Computational Universe is explored in the context of matter-information-spacetime equivalence. Following this, the principles of metahomeomorphism are introduced which enables one to view the 8D charge space as the states of a 3 qubit system. A chaotic interpretation of quantum mechanics is presented which posits that superposed states of quantum systems are in fact chaotic signals, replacing the inherent probabilistic nature with a practically random one. Following this, the Chaotic Quantum Information based E8 Theory of Everything is explored in light of particle creation, particle interaction and physical interpretation.

Whether or not the E8 ToE accurately describes the working of the universe is a question to be answered by experiments pertaining to the detection of new elementary particles. However, the principles of Computational Matter and Metahomeomorphism ensure that even in the case of any other Lie Group mapping with a certain charge space, the Chaotic Quantum Information perspective will hold, with the only changes in the number of fundamental chaotic signals, and the structures of the operators.

However, the elegance in which General Relativity, Particle Physics, Quantum Mechanics and Chaos Theory merge into the proposed CQIE8ToE with the entire universe constructed using three chaotic signals might be a testimony to the unmatched simplicity and efficiency of nature.

## References

- [1] Weinberg, Steven, and R. H. Dicke. "Gravitation and cosmology: principles and applications of the general theory of relativity." *American Journal of Physics* 41.4 (1973): 598-599.
- [2] Penrose, Roger. *GRAVITATIONAL COLLAPSE: THE ROLE OF GENERAL RELATIVITY*. Birkbeck Coll., London, 1969.
- [3] Eddington, Arthur Stanley. "The mathematical theory of relativity." *The Mathematical Theory of Relativity*, by AS Eddington, Cambridge, UK: Cambridge University Press, 1920 1 (1920).
- [4] Bohm, David, Basil Hiley, and John D. Barrow. *The special theory of relativity*. New York: WA Benjamin, 1965.
- [5] Feynman, Richard Phillips, and Albert R. Hibbs. *Quantum mechanics and path integrals*. Vol. 2. New York: McGraw-Hill, 1965.



- [6] Bjorken, James D., and Sidney David Drell. "Relativistic quantum mechanics." (1964).
- [7] Strogatz, Steven H. *Nonlinear dynamics and chaos: with applications to physics, biology, chemistry, and engineering*. Westview press, 2014.
- [8] Thompson, John Michael Tutill, and H. Bruce Stewart. *Nonlinear dynamics and chaos*. John Wiley & Sons, 2002.
- [9] Stöckmann, Hans-Jürgen. *Quantum chaos: an introduction*. Cambridge university press, 2006.
- [10] Barrow, John D. "General relativistic chaos and nonlinear dynamics." *General Relativity and Gravitation* 14.6 (1982): 523-530.
- [11] Itzykson, Claude, and Jean-Bernard Zuber. *Quantum field theory*. Courier Corporation, 2006.
- [12] Kaku, Michio. *Quantum field theory*. Oxford Univ. Press, 1993.
- [13] Hagiwara, Kaoru, et al. "Review of particle physics." *Physical review D* 66.1 (2002).
- [14] Haber, Howard E., and Gordon L. Kane. "The search for supersymmetry: probing physics beyond the standard model." *Physics Reports* 117.2 (1985): 75-263.
- [15] Colladay, Don, and V. Alan Kostelecký. "CPT violation and the standard model." *Physical Review D* 55.11 (1997): 6760.
- [16] Donoghue, John F., Eugene Golowich, and Barry R. Holstein. *Dynamics of the standard model*. Vol. 35. Cambridge university press, 2014.
- [17] Staudenmann, J-L., et al. "Gravity and inertia in quantum mechanics." *Physical Review A* 21.5 (1980): 1419.
- [18] Hawking, Stephen W. "The path-integral approach to quantum gravity." *General relativity*. 1979.
- [19] Callender, Craig, and Nick Huggett. *Physics meets philosophy at the Planck scale: Contemporary theories in quantum gravity*. Cambridge University Press, 2001.
- [20] Isham, Chris J. "Canonical quantum gravity and the problem of time." *Integrable systems, quantum groups, and quantum field theories*. Springer Netherlands, 1993. 157-287.
- [21] Peat, David. "Superstrings and the Search for the Theory of Everything." (1988).
- [22] Davies, Paul Charles William, and Julian Brown. *Superstrings: a theory of everything?*. Cambridge University Press, 1992.
- [23] Lust, D., and Stefan Theisen. "Lectures on string theory." (1989).
- [24] Smolin, Lee, and John Harnad. "The trouble with physics: the rise of string theory, the fall of a science, and what comes next." *The Mathematical Intelligencer* 30.3 (2008): 66-69.
- [25] Polchinski, Joseph. *String theory: Volume 2, superstring theory and beyond*. Cambridge university press, 1998.
- [26] Skenderis, Kostas. "Black Holes in string theory." *Towards Quantum Gravity*. Springer Berlin Heidelberg, 2000. 325-364.
- [27] Rovelli, Carlo. "Loop quantum gravity." *Living Rev. Relativity* 11.5 (2008).
- [28] Sahlmann, Hanno. "Loop quantum gravity." *Foundations of Space and Time: Reflections on Quantum Gravity* (2012): 185.
- [29] Meissner, Krzysztof A. "Black-hole entropy in loop quantum gravity." *Classical and Quantum Gravity* 21.22 (2004): 5245.
- [30] Lisi, A. Garrett. "An exceptionally simple theory of everything." arXiv preprint arXiv:0711.0770 (2007).
- [31] Lisi, A. Garrett, and James Owen Weatherall. "A geometric theory of everything." *Scientific American* 303.6 (2010): 54-61.
- [32] Lisi, A. Garrett. "An explicit embedding of gravity and the Standard Model in E8." *Representation Theory and Mathematical Physics, Contemp. Math* 557 (2011): 231-244.
- [33] Lloyd, Seth. "Computational capacity of the universe." *Physical Review Letters* 88.23 (2002): 237901.
- [34] Lloyd, Seth. *Programming the universe: a quantum computer scientist takes on the cosmos*. Vintage, 2006.
- [35] Lloyd, Seth. "5 The computational universe." *Information and the nature of reality: From physics to metaphysics* (2010): 92.
- [36] Lloyd, Seth. "Universe as quantum computer." *Complexity* 3.1 (1997): 32-35.
- [37] Lloyd, Seth. *The Computational Universe: Quantum gravity from quantum computation*. No. quant-ph/0501135. 2005.

- [38] Lloyd, Seth. "A theory of quantum gravity based on quantum computation." arXiv preprint quant-ph/0501135 (2005).
- [39] Davies, Paul CW. "Emergent biological principles and the computational properties of the universe." arXiv preprint astro-ph/0408014 (2004).
- [40] Hawking, Stephen W. "Black hole explosions." *Nature* 248.5443 (1974): 30-31.
- [41] Bardeen, James M., Brandon Carter, and Stephen W. Hawking. "The four laws of black hole mechanics." *Communications in Mathematical Physics* 31.2 (1973): 161-170.
- [42] Wald, Robert M. "Black hole entropy is the Noether charge." *Physical Review D* 48.8 (1993): R3427.
- [43] Bekenstein, Jacob D. "Novel 'no-scalar-hair' theorem for black holes." *Physical Review D* 51.12 (1995): R6608.
- [44] Johannsen, Tim, and Dimitrios Psaltis. "Testing the no-hair theorem with observations in the electromagnetic spectrum. II. Black hole images." *The Astrophysical Journal* 718.1 (2010): 446.
- [45] Droz, Serge, Markus Heusler, and Norbert Straumann. "New black hole solutions with hair." *Physics Letters B* 268.3 (1991): 371-376.
- [46] Bekenstein, Jacob D. "Black hole hair: twenty--five years after." arXiv preprint gr-qc/9605059 (1996).
- [47] Sudarsky, Daniel. "A simple proof of a no-hair theorem in Einstein-Higgs theory." *Classical and Quantum Gravity* 12.2 (1995): 579.
- [48] Wiltshire, D. L. "Spherically symmetric solutions of Einstein-Maxwell theory with a Gauss-Bonnet term." *Physics Letters B* 169.1 (1986): 36-40.
- [49] Halliwell, Jonathan J. "The quantum cosmology of Einstein-Maxwell theory in six dimensions." *Nuclear Physics B* 266.1 (1986): 228-244.
- [50] Exton, Albert R., Ezra T. Newman, and Roger Penrose. "Conserved Quantities in the Einstein-Maxwell Theory." *Journal of Mathematical Physics* 10.9 (1969): 1566-1570.
- [51] Moncrief, Vincent. "Odd-parity stability of a Reissner-Nordström black hole." *Physical Review D* 9.10 (1974): 2707.
- [52] Chandrasekhar, Subrahmanyan, and James B. Hartle. "On crossing the Cauchy horizon of a Reissner-Nordstrom black-hole." *Proceedings of the Royal Society of London A: Mathematical, Physical and Engineering Sciences*. Vol. 384. No. 1787. The Royal Society, 1982.
- [53] Lee, Kimyeong, V. P. Nair, and Erick J. Weinberg. "A classical instability of Reissner-Nordström solutions and the fate of magnetically charged black holes." *Physical review letters* 68.8 (1992): 1100.
- [54] Cvetič, M., et al. "Electrodynamics of black holes in STU supergravity." *Journal of High Energy Physics* 2014.9 (2014): 1-27.
- [55] Katsimpouri, Despoina, Axel Kleinschmidt, and Amitabh Virmani. "An inverse scattering formalism for STU supergravity." *Journal of High Energy Physics* 2014.3 (2014): 1-27.
- [56] Borsten, Leron, et al. "Four-qubit entanglement classification from string theory." *Physical review letters* 105.10 (2010): 100507.
- [57] Chow, David DK, and Geoffrey Compère. "Black holes in  $N=8$  supergravity from  $SO(4,4)$  hidden symmetries." *Physical Review D* 90.2 (2014): 025029.
- [58] Kallosh, Renata, and Andrei Linde. "Strings, black holes, and quantum information." *Physical Review D* 73.10 (2006): 104033.
- [59] Duff, Michael J., James T. Liu, and J. Rahmfeld. "Four-dimensional string/string/string triality." *Nuclear Physics B* 459.1 (1996): 125-159.
- [60] Behrndt, Klaus, Dieter Lüst, and Wafic A. Sabra. "Stationary solutions of  $N=2$  supergravity." *Nuclear Physics B* 510.1 (1998): 264-288.
- [61] Duff, Michael J. "String triality, black hole entropy, and Cayley's hyperdeterminant." *Physical Review D* 76.2 (2007): 025017.
- [62] Dür, Wolfgang, Guifre Vidal, and J. Ignacio Cirac. "Three qubits can be entangled in two inequivalent ways." *Physical Review A* 62.6 (2000): 062314.
- [63] Borsten, Leron, et al. "Black holes, qubits and octonions." *Physics Reports* 471.3 (2009): 113-219.

- [64] Borsten, Leron, et al. "Four-qubit entanglement classification from string theory." *Physical review letters* 105.10 (2010): 100507.
- [65] Fortune, Steven, John Hopcroft, and James Wyllie. "The directed subgraph homeomorphism problem." *Theoretical Computer Science* 10.2 (1980): 111-121.
- [66] Arens, Richard. "Topologies for homeomorphism groups." *American Journal of Mathematics* (1946): 593-610.
- [67] de Groot, Johannes. "Groups represented by homeomorphism groups I." *Mathematische Annalen* 138.1 (1959): 80-102.
- [68] Cycon, Hans L., et al. *Schrödinger operators: With application to quantum mechanics and global geometry*. Springer, 2009.
- [69] Bohm, Arno, and Mark Loewe. *Quantum mechanics: foundations and applications*. Vol. 3. New York: Springer, 1986.
- [70] Baym, Gordon A. *Lectures on quantum mechanics*. Benjamin, 1969.
- [71] Nelson, Edward. "Derivation of the Schrödinger equation from Newtonian mechanics." *Physical review* 150.4 (1966): 1079.
- [72] Becker, L. (2001). The quantum mechanics of minds and worlds. *The Philosophical Review*, 110(3), 482-484.
- [73] Rubin, M. A. (2001). Locality in the Everett interpretation of Heisenberg-picture quantum mechanics. *Foundations of Physics Letters*, 14(4), 301-322.
- [74] Everett, H., Barrett, J. A., & Byrne, P. (2012). *The Everett interpretation of quantum mechanics: Collected works 1955-1980 with commentary*. Princeton University Press.
- [75] Dowker, F., & Kent, A. (1995). Properties of consistent histories. *Physical Review Letters*, 75(17), 3038.
- [76] Griffiths, R. B. (2003). *Consistent quantum theory*. Cambridge University Press.
- [77] Bohm, D., & Hiley, B. J. (2006). *The undivided universe: An ontological interpretation of quantum theory*. Routledge.
- [78] Caves, C. M., & Fuchs, C. A. (1996). Quantum information: How much information in a state vector?. arXiv preprint quant-ph/9601025.
- [79] Born, M. (1954). The statistical interpretation of quantum mechanics. Nobel Lecture, 11, 1942-1962.
- [80] Madelung, E. (1927). Quantentheorie in hydrodynamischer Form. *Zeitschrift für Physik A Hadrons and Nuclei*, 40(3), 322-326.
- [81] Bohm, D. (1952). A suggested interpretation of the quantum theory in terms of "hidden" variables. I. *Physical Review*, 85(2), 166.
- [82] Prziabram, K., Schrödinger, E., Einstein, A., Lorentz, H. A., & Planck, M. (1967). *Letters on wave mechanics*. Vision.
- [83] Heisenberg, W. (2013). *The physical principles of the quantum theory*. Courier Corporation.
- [84] John Von Neumann. (1955). *Mathematical foundations of quantum mechanics* (No. 2). Princeton university press.
- [85] Cohen, D. W. (2012). *An introduction to Hilbert space and quantum logic*. Springer Science & Business Media.
- [86] Popper, K. R. (1992). *Quantum theory and the schism in physics* (Vol. 3). Psychology Press.
- [87] Namsrai, K. (1986). *Nonlocal quantum field theory and stochastic quantum mechanics* (Vol. 13). Springer Science & Business Media.
- [88] Albert, D., & Loewer, B. (1988). Interpreting the many worlds interpretation. *Synthese*, 77(2), 195-213.
- [89] Greenberger, D., Hentschel, K., & Weinert, F. (Eds.). (2009). *Compendium of quantum physics: concepts, experiments, history and philosophy*. Springer Science & Business Media.
- [90] Cramer, J. G. (1986). The transactional interpretation of quantum mechanics. *Reviews of Modern Physics*, 58(3), 647.
- [91] Rovelli, C. (1996). Relational quantum mechanics. *International Journal of Theoretical Physics*, 35(8), 1637-1678.
- [92] Steane, Andrew. "Quantum computing." *Reports on Progress in Physics* 61.2 (1998): 117.
- [93] Gruska, Jozef, and Czech Republik. "QUANTUM COMPUTING 1." (2004).

- [94] Lanyon, B. P., et al. "Experimental quantum computing without entanglement." *Physical review letters* 101.20 (2008): 200501.
- [95] Ifrah, Georges, et al. *The universal history of computing: From the abacus to quantum computing*. John Wiley & Sons, Inc., 2000.
- [96] McMahon, David. *Quantum computing explained*. John Wiley & Sons, 2007.
- [97] Lloyd, Seth. "Almost any quantum logic gate is universal." *Physical Review Letters* 75.2 (1995): 346.
- [98] Muthukrishnan, Ashok, and C. R. Stroud Jr. "Multivalued logic gates for quantum computation." *Physical Review A* 62.5 (2000): 052309.
- [99] Pittman, T. B., B. C. Jacobs, and J. D. Franson. "Probabilistic quantum logic operations using polarizing beam splitters." *Physical Review A* 64.6 (2001): 062311.
- [100] Barenco, Adriano, et al. "Elementary gates for quantum computation." *Physical Review A* 52.5 (1995): 3457.