

Spacelike and Timelike Admissible Smarandache Curves in Pseudo-Galilean Space

M. Khalifa Saad*

Mathematics Dept., Faculty of Science, Sohag University, 82524 Sohag, Egypt

Abstract. In this paper, space and timelike admissible Smarandache curves in the pseudo-Galilean space G_3^1 are investigated. Also, Smarandache curves of the position vector of space and timelike arbitrary curve and some of its special curves in G_3^1 are obtained. To confirm our main results, some examples are given and illustrated.

M.S.C. 2010: 53A35, 53B30.

Key Words: Pseudo-Galilean space, Smarandache curves, admissible curve, Frenet frame.

1 Introduction

In recent years, researchers have begun to investigate curves and surfaces in the Galilean space and thereafter pseudo-Galilean space G_3 and G_3^1 . In the study of the fundamental theory and the characterizations of space curves, the corresponding relations between the curves are the very interesting and important problem.

It is known that a Smarandache geometry is a geometry which has at least one Smarandache denied axiom [1]. An axiom is said to be Smarandache denied, if it behaves in at least two different ways within the same space. Smarandache geometries are connected with the theory of relativity and the parallel universes. Smarandache curves are the objects of Smarandache geometry. By definition, if the position vector of a curve δ is composed by Frenet frame's vectors of another curve β , then the curve δ is called a Smarandache curve [2]. Smarandache curves have been investigated by some differential geometers (see for example, [2, 3]). M. Turgut and S. Yilmaz defined a special case of such curves and call it Smarandache TB_2 curves in the space E_1^4 [2]. They studied special Smarandache curves which are defined by the tangent and second binormal vector fields. In [3], the author introduced some special Smarandache curves in the Euclidean space. He studied Frenet-Serret invariants of a special case.

In the field of computer aided design and computer graphics, helices can be used for the tool path description, the simulation of kinematic motion or the design of highways, etc. [4]. The

* E-mail address: mohamed_khalifa77@science.sohag.edu.eg

main feature of general helix is that the tangent makes a constant angle with a fixed straight line which is called the axis of the general helix. A classical result stated by Lancret in 1802 and first proved by de Saint Venant in 1845 says that: A necessary and sufficient condition that a curve be a general helix is that the ratio (κ/τ) is constant along the curve, where κ and τ denote the curvature and the torsion, respectively. Also, the helix is also known as circular helix or W-curve which is a special case of the general helix [5].

Salkowski (resp. Anti-Salkowski) curves in Euclidean space are generally known as family of curves with constant curvature (resp. torsion) but nonconstant torsion (resp. curvature) with an explicit parametrization. They were defined in an earlier paper [6].

In this paper, we obtain Smarandache curves for a position vector of an arbitrary curve in G_3^1 and some of its special curves (helix, circular helix, Salkowski and Anti-Salkowski curves). In other words, according to Frenet frame $\mathbf{e}_1, \mathbf{e}_2, \mathbf{e}_3$ of the considered curves in the pseudo-Galilean space G_3^1 , the meant Smarandache curves $\mathbf{e}_1\mathbf{e}_2, \mathbf{e}_1\mathbf{e}_3$ and $\mathbf{e}_1\mathbf{e}_2\mathbf{e}_3$ are obtained. To the best of author's knowledge, Smarandache curves have not been presented in the pseudo-Galilean geometry in depth. Thus, the study is proposed to serve such a need.

2 Basic notions and properties

In this section, let us first recall basic notions from pseudo-Galilean geometry [7–11]. In the inhomogeneous affine coordinates for points and vectors (point pairs) the similarity group H_8 of G_3^1 has the following form

$$\begin{aligned}\bar{x} &= a + b.x, \\ \bar{y} &= c + d.x + r.\cosh\theta.y + r.\sinh\theta.z, \\ \bar{z} &= e + f.x + r.\sinh\theta.y + r.\cosh\theta.z,\end{aligned}\tag{2.1}$$

where a, b, c, d, e, f, r and θ are real numbers. Particularly, for $b = r = 1$, the group (2.1) becomes the group $B_6 \subset H_8$ of isometries (proper motions) of the pseudo-Galilean space G_3^1 . The motion group leaves invariant the absolute figure and defines the other invariants of this geometry. It has the following form

$$\begin{aligned}\bar{x} &= a + x, \\ \bar{y} &= c + d.x + \cosh\theta.y + \sinh\theta.z, \\ \bar{z} &= e + f.x + \sinh\theta.y + \cosh\theta.z.\end{aligned}\tag{2.2}$$

According to the motion group in the pseudo-Galilean space, there are non-isotropic vectors $A(A_1, A_2, A_3)$ (for which holds $A_1 \neq 0$) and four types of isotropic vectors: spacelike ($A_1 = 0, A_2^2 - A_3^2 > 0$), timelike ($A_1 = 0, A_2^2 - A_3^2 < 0$) and two types of lightlike vectors ($A_1 = 0, A_2 =$

$\pm A_3$). The scalar product of two vectors $u = (u_1, u_2, u_3)$ and $v = (v_1, v_2, v_3)$ in G_3^1 is defined by

$$\langle u, v \rangle_{G_3^1} = \left\{ \begin{array}{ll} u_1 v_1, & \text{if } u_1 \neq 0 \text{ or } v_1 \neq 0, \\ u_2 v_2 - u_3 v_3 & \text{if } u_1 = 0 \text{ and } v_1 = 0. \end{array} \right\}$$

We introduce a pseudo-Galilean cross product in the following way

$$u \times_{G_3^1} v = \begin{vmatrix} 0 & -j & k \\ u_1 & u_2 & u_3 \\ v_1 & v_2 & v_3 \end{vmatrix},$$

where $j = (0, 1, 0)$ and $k = (0, 0, 1)$ are unit spacelike and timelike vectors, respectively. Let us recall basic facts about curves in G_3^1 , that were introduced in [7–9].

A curve $\gamma(s) = (x(s), y(s), z(s))$ is called an admissible curve if it has no inflection points ($\dot{\gamma} \times \ddot{\gamma} \neq 0$) and no isotropic tangents ($\dot{x} \neq 0$) or normals whose projections on the absolute plane would be lightlike vectors ($\dot{y} \neq \pm \dot{z}$). An admissible curve in G_3^1 is an analogue of a regular curve in Euclidean space [8].

For an admissible curve $\gamma : I \subseteq \mathbb{R} \rightarrow G_3^1$, the curvature $\kappa(s)$ and torsion $\tau(s)$ are defined by

$$\kappa(s) = \frac{\sqrt{|\dot{y}(s)^2 - \dot{z}(s)^2|}}{(\dot{x}(s))^2}, \quad \tau(s) = \frac{\dot{y}(s)\ddot{z}(s) - \ddot{y}(s)\dot{z}(s)}{|\dot{x}(s)|^5 \cdot \kappa^2(s)}, \quad (2.3)$$

expressed in components. Hence, for an admissible curve $\gamma : I \subseteq \mathbb{R} \rightarrow G_3^1$ parameterized by the arc length s with differential form $ds = dx$, given by

$$\gamma(x) = (x, y(x), z(x)), \quad (2.4)$$

the formulas (2.3) have the following form

$$\kappa(x) = \sqrt{|y''(x)^2 - z''(x)^2|}, \quad \tau(x) = \frac{y''(x)z'''(x) - y'''(x)z''(x)}{\kappa^2(x)}. \quad (2.5)$$

The associated trihedron is given by

$$\begin{aligned} \mathbf{e}_1 &= \gamma'(x) = (1, y'(x), z'(x)), \\ \mathbf{e}_2 &= \frac{1}{\kappa(x)} \gamma''(x) = \frac{1}{\kappa(x)} (0, y''(x), z''(x)), \\ \mathbf{e}_3 &= \frac{1}{\kappa(x)} (0, \epsilon z''(x), \epsilon y''(x)), \end{aligned} \quad (2.6)$$

where $\epsilon = +1$ or $\epsilon = -1$, chosen by criterion $\text{Det}(e_1, e_2, e_3) = 1$, that means

$$|y''(x)^2 - z''(x)^2| = \epsilon(y''(x)^2 - z''(x)^2).$$

The curve γ given by (2.4) is timelike (resp. spacelike) if $\mathbf{e}_2(s)$ is a spacelike (resp. timelike) vector. The principal normal vector or simply normal is spacelike if $\epsilon = +1$ and timelike if

$\epsilon = -1$. For derivatives of the tangent \mathbf{e}_1 , normal \mathbf{e}_2 and binormal \mathbf{e}_3 vector fields, the following Frenet formulas in G_3^1 hold:

$$\begin{aligned}\mathbf{e}'_1(x) &= \kappa(x)\mathbf{e}_2(x), \\ \mathbf{e}'_2(x) &= \tau(x)\mathbf{e}_3(x), \\ \mathbf{e}'_3(x) &= \tau(x)\mathbf{e}_2(x).\end{aligned}\tag{2.7}$$

From (2.5) and (2.6), we have the following important relation that is true in Galilean and pseudo-Galilean spaces [11–13]

$$\eta'''(s) = \kappa'(s)\mathbf{N}(s) + \kappa(s)\tau(s)\mathbf{B}(s).$$

In [2] authors introduced:

Definition 2.1 *A regular curve in Minkowski space-time, whose position vector is composed by Frenet frame vectors on another regular curve, is called a Smarandache curve.*

In the light of the above definition, we adapt it to admissible curves in the pseudo-Galilean space as follows:

Definition 2.2 *let $\eta = \eta(s)$ be an admissible curve in G_3^1 and $\{\mathbf{e}_1, \mathbf{e}_2, \mathbf{e}_3\}$ be its moving Frenet frame. Smarandache $\mathbf{e}_1\mathbf{e}_2$, $\mathbf{e}_1\mathbf{e}_3$ and $\mathbf{e}_1\mathbf{e}_2\mathbf{e}_3$ curves are respectively, defined by*

$$\begin{aligned}\eta_{\mathbf{e}_1\mathbf{e}_2} &= \frac{\mathbf{e}_1 + \mathbf{e}_2}{\|\mathbf{e}_1 + \mathbf{e}_2\|}, \\ \eta_{\mathbf{e}_1\mathbf{e}_3} &= \frac{\mathbf{e}_1 + \mathbf{e}_3}{\|\mathbf{e}_1 + \mathbf{e}_3\|}, \\ \eta_{\mathbf{e}_1\mathbf{e}_2\mathbf{e}_3} &= \frac{\mathbf{e}_1 + \mathbf{e}_2 + \mathbf{e}_3}{\|\mathbf{e}_1 + \mathbf{e}_2 + \mathbf{e}_3\|}.\end{aligned}\tag{2.8}$$

3 Smarandache curves of an arbitrary curve in G_3^1

In the light of which introduced in the Galilean 3-space G_3 by [3], we introduce the position vectors of *spacelike* and *timelike* arbitrary curves with curvature $\kappa(s)$ and torsion $\tau(s)$ in the pseudo-Galilean space G_3^1 and then calculate their Smarandache curves.

Let us start with an arbitrary curve $\mathbf{r}(s)$ in G_3^1 , so we get

Case 3.1 $\mathbf{r}(s)$ is spacelike:

$$\mathbf{r}(s) = \left(s, - \int \left(\int \sinh \left(\int \tau(s) ds \right) \kappa(s) ds \right) ds, \int \left(\int \cosh \left(\int \tau(s) ds \right) \kappa(s) ds \right) ds \right).\tag{3.1}$$

The derivatives of this curve are respectively, given by

$$\begin{aligned}
\mathbf{r}'(s) &= \left(1, - \int \sinh \left(\int \tau(s) ds \right) \kappa(s) ds, \int \cosh \left(\int \tau(s) ds \right) \kappa(s) ds \right), \\
\mathbf{r}''(s) &= \left(0, - \sinh \left(\int \tau(s) ds \right) \kappa(s), \cosh \left(\int \tau(s) ds \right) \kappa(s) \right), \\
\mathbf{r}'''(s) &= \left(0, -\kappa' \sinh \left(\int \tau(s) ds \right) - \cosh \left(\int \tau(s) ds \right) \kappa(s) \tau(s), \right. \\
&\quad \left. \cosh \left(\int \tau(s) ds \right) \kappa' + \sinh \left(\int \tau(s) ds \right) \kappa(s) \tau(s) \right). \tag{3.2}
\end{aligned}$$

The frame vector fields of \mathbf{r} are as follows

$$\begin{aligned}
(\mathbf{e}_1)_r &= \left(1, - \int \sinh \left(\int \tau(s) ds \right) \kappa(s) ds, \int \cosh \left(\int \tau(s) ds \right) \kappa(s) ds \right), \\
(\mathbf{e}_2)_r &= \left(0, - \sinh \left(\int \tau(s) ds \right), \cosh \left(\int \tau(s) ds \right) \right), \\
(\mathbf{e}_3)_r &= \left(0, - \cosh \left(\int \tau(s) ds \right), \sinh \left(\int \tau(s) ds \right) \right). \tag{3.3}
\end{aligned}$$

By Definition (2.2), the $\mathbf{e}_1\mathbf{e}_2$, $\mathbf{e}_1\mathbf{e}_3$ and $\mathbf{e}_1\mathbf{e}_2\mathbf{e}_3$ Smarandache curves of r are respectively, written as

$$\begin{aligned}
\mathbf{r}_{\mathbf{e}_1\mathbf{e}_2} &= \left(1, - \int \sinh \left(\int \tau(s) ds \right) \kappa(s) ds - \sinh \left(\int \tau(s) ds \right), \right. \\
&\quad \left. \cosh \left(\int \tau(s) ds \right) + \int \cosh \left(\int \tau(s) ds \right) \kappa(s) ds \right), \\
\mathbf{r}_{\mathbf{e}_1\mathbf{e}_3} &= \left(1, - \cosh \left(\int \tau(s) ds \right) - \int \sinh \left(\int \tau(s) ds \right) \kappa(s) ds, \right. \\
&\quad \left. \int \cosh \left(\int \tau(s) ds \right) \kappa(s) ds + \sinh \left(\int \tau(s) ds \right) \right), \\
\mathbf{r}_{\mathbf{e}_1\mathbf{e}_2\mathbf{e}_3} &= \left(1, -e^{\int \tau[s] ds} - \int \sinh \left(\int \tau(s) ds \right) \kappa(s) ds, \right. \\
&\quad \left. e^{\int \tau[s] ds} + \int \cosh \left(\int \tau(s) ds \right) \kappa(s) ds \right). \tag{3.4}
\end{aligned}$$

Case 3.2 $\mathbf{r}(s)$ is timelike:

$$\mathbf{r}(s) = \left(s, \int \left(\int \cosh \left(\int \tau(s) ds \right) \kappa(s) ds \right) ds, \int \left(\int \sinh \left(\int \tau(s) ds \right) \kappa(s) ds \right) ds \right). \tag{3.5}$$

So, the derivatives of $\mathbf{r}(s)$ are

$$\begin{aligned}
\mathbf{r}'(s) &= \left(1, \int \cosh \left(\int \tau(s) ds \right) \kappa(s) ds, \int \sinh \left(\int \tau(s) ds \right) \kappa(s) ds \right), \\
\mathbf{r}''(s) &= \left(0, \cosh \left(\int \tau(s) ds \right) \kappa(s), \sinh \left(\int \tau(s) ds \right) \kappa(s) \right), \\
\mathbf{r}'''(s) &= \left(0, \cosh \left(\int \tau(s) ds \right) \kappa' + \sinh \left(\int \tau(s) ds \right) \kappa(s) \tau(s), \right. \\
&\quad \left. \kappa' \sinh \left(\int \tau(s) ds \right) + \cosh \left(\int \tau(s) ds \right) \kappa(s) \tau(s) \right). \tag{3.6}
\end{aligned}$$

And the frame vector fields are as follows

$$(\mathbf{e}_1)_r = \left(1, \int \cosh \left(\int \tau(s) ds \right) \kappa(s) ds, \int \sinh \left(\int \tau(s) ds \right) \kappa(s) ds \right),$$

$$\begin{aligned}
(\mathbf{e}_2)_r &= \left(0, \cosh \left(\int \tau(s) ds \right), \sinh \left(\int \tau(s) ds \right) \right), \\
(\mathbf{e}_3)_r &= \left(0, \sinh \left(\int \tau(s) ds \right), \cosh \left(\int \tau(s) ds \right) \right).
\end{aligned} \tag{3.7}$$

Hence, the Smarandache curves are

$$\begin{aligned}
\mathbf{r}_{\mathbf{e}_1\mathbf{e}_2} &= \left(1, \cosh \left(\int \tau(s) ds \right) + \int \cosh \left(\int \tau(s) ds \right) \kappa(s) ds, \right. \\
&\quad \left. \int \sinh \left(\int \tau(s) ds \right) \kappa(s) ds + \sinh \left(\int \tau(s) ds \right) \right), \\
\mathbf{r}_{\mathbf{e}_1\mathbf{e}_3} &= \left(1, \int \cosh \left(\int \tau(s) ds \right) \kappa(s) ds + \sinh \left(\int \tau(s) ds \right), \right. \\
&\quad \left. \cosh \left(\int \tau(s) ds \right) + \int \sinh \left(\int \tau(s) ds \right) \kappa(s) ds \right), \\
\mathbf{r}_{\mathbf{e}_1\mathbf{e}_2\mathbf{e}_3} &= \left(1, e^{\int \tau(s) ds} + \int \cosh \left(\int \tau(s) ds \right) \kappa(s) ds, \right. \\
&\quad \left. e^{\int \tau(s) ds} + \int \sinh \left(\int \tau(s) ds \right) \kappa(s) ds \right).
\end{aligned} \tag{3.8}$$

4 Smarandache curves of some special curves in G_3^1

4.1 Smarandache curves of a general helix

Let $\alpha(s)$ be an admissible general helix in G_3^1 with $(\tau/\kappa = m = \text{const.})$, we have

Case 4.1.1 $\alpha(s)$ is spacelike:

$$\alpha(s) = \left(s, -\frac{1}{m} \int \cosh \left(m \int \kappa(s) ds \right) ds, \frac{1}{m} \int \sinh \left(m \int \kappa(s) ds \right) ds \right). \tag{4.1}$$

Then $\alpha', \alpha'', \alpha'''$ for this curve are respectively, expressed as

$$\begin{aligned}
\alpha'(s) &= \left(1, -\frac{1}{m} \cosh \left(m \int \kappa(s) ds \right), \frac{1}{m} \sinh \left(m \int \kappa(s) ds \right) \right), \\
\alpha''(s) &= \left(0, -\sinh \left(m \int \kappa(s) ds \right) \kappa(s), \cosh \left(m \int \kappa(s) ds \right) \kappa(s) \right), \\
\alpha'''(s) &= \left(0, -\kappa' \sinh \left(m \int \kappa(s) ds \right) - m \cosh \left(m \int \kappa(s) ds \right) \kappa^2(s), \right. \\
&\quad \left. \cosh \left(m \int \kappa(s) ds \right) \kappa' + m \sinh \left(m \int \kappa(s) ds \right) \kappa^2(s) \right).
\end{aligned} \tag{4.2}$$

The moving Frenet vectors of $\alpha(s)$ are given by

$$\begin{aligned}
(\mathbf{e}_1)_\alpha &= \left(1, -\frac{1}{m} \cosh \left(m \int \kappa(s) ds \right), \frac{1}{m} \sinh \left(m \int \kappa(s) ds \right) \right), \\
(\mathbf{e}_2)_\alpha &= \left(0, -\sinh \left(m \int \kappa(s) ds \right), \cosh \left(m \int \kappa(s) ds \right) \right), \\
(\mathbf{e}_3)_\alpha &= \left(0, -\cosh \left(m \int \kappa(s) ds \right), \sinh \left(m \int \kappa(s) ds \right) \right).
\end{aligned} \tag{4.3}$$

From which, Smarandache curves are given by

$$\alpha_{\mathbf{e}_1\mathbf{e}_2} = \left(1, -\frac{1}{m} \cosh \left(m \int \kappa(s) ds \right) + m \sinh \left(m \int \kappa(s) ds \right), \right. \\
\quad \left. \cosh \left(m \int \kappa(s) ds \right) + \frac{1}{m} \sinh \left(m \int \kappa(s) ds \right) \right),$$

$$\begin{aligned}\alpha_{\mathbf{e}_1\mathbf{e}_3} &= \left(1, -\frac{1}{m}(1+m) \cosh \left(m \int \kappa(s) ds \right), \frac{1}{m}(1+m) \sinh \left(m \int \kappa(s) ds \right) \right), \\ \alpha_{\mathbf{e}_1\mathbf{e}_2\mathbf{e}_3} &= \left(1, -\frac{1}{m}(1+m) \cosh \left(m \int \kappa(s) ds \right) + m \sinh \left(m \int \kappa(s) ds \right), \right. \\ &\quad \left. e^{m \int \kappa(s) ds} + \frac{1}{m} \sinh \left(m \int \kappa(s) ds \right) \right). \end{aligned} \quad (4.4)$$

Case 4.1.2 $\alpha(s)$ is *timelike*:

$$\alpha(s) = \left(s, \frac{1}{m} \int \sinh \left(m \int \kappa(s) ds \right) ds, \frac{1}{m} \int \cosh \left(m \int \kappa(s) ds \right) ds \right). \quad (4.5)$$

So, $\alpha', \alpha'', \alpha'''$ are respectively,

$$\begin{aligned}\alpha'(s) &= \left(1, \frac{1}{m} \sinh \left(m \int \kappa(s) ds \right), \frac{1}{m} \cosh \left(m \int \kappa(s) ds \right) \right), \\ \alpha''(s) &= \left(0, \cosh \left(m \int \kappa(s) ds \right) \kappa(s), \sinh \left(m \int \kappa(s) ds \right) \kappa(s) \right), \\ \alpha'''(s) &= \left(0, \kappa' \cosh \left(m \int \kappa(s) ds \right) + m \sinh \left(m \int \kappa(s) ds \right) \kappa^2(s), \right. \\ &\quad \left. \sinh \left(m \int \kappa(s) ds \right) \kappa' + m \cosh \left(m \int \kappa(s) ds \right) \kappa^2(s) \right). \end{aligned} \quad (4.6)$$

The Frenet vectors of $\alpha(s)$ are given by

$$\begin{aligned}(\mathbf{e}_1)_\alpha &= \left(1, \frac{1}{m} \sinh \left(m \int \kappa(s) ds \right), \frac{1}{m} \cosh \left(m \int \kappa(s) ds \right) \right), \\ (\mathbf{e}_2)_\alpha &= \left(0, \cosh \left(m \int \kappa(s) ds \right), \sinh \left(m \int \kappa(s) ds \right) \right), \\ (\mathbf{e}_3)_\alpha &= \left(0, \sinh \left(m \int \kappa(s) ds \right), \cosh \left(m \int \kappa(s) ds \right) \right). \end{aligned} \quad (4.7)$$

So, Smarandache curves of α are as follows

$$\begin{aligned}\alpha_{\mathbf{e}_1\mathbf{e}_2} &= \left(1, \frac{1}{m} \sinh \left(m \int \kappa(s) ds \right) + \cosh \left(m \int \kappa(s) ds \right), \right. \\ &\quad \left. \frac{1}{m} \cosh \left(m \int \kappa(s) ds \right) + \sinh \left(m \int \kappa(s) ds \right) \right), \\ \alpha_{\mathbf{e}_1\mathbf{e}_3} &= \left(1, \frac{1}{m}(1+m) \sinh \left(m \int \kappa(s) ds \right), \frac{1}{m}(1+m) \cosh \left(m \int \kappa(s) ds \right) \right), \\ \alpha_{\mathbf{e}_1\mathbf{e}_2\mathbf{e}_3} &= \left(1, e^{m \int \kappa(s) ds} + \frac{1}{m} \sinh \left(m \int \kappa(s) ds \right), \right. \\ &\quad \left. \frac{1}{m}(1+m) \cosh \left(m \int \kappa(s) ds \right) + \sinh \left(m \int \kappa(s) ds \right) \right). \end{aligned} \quad (4.8)$$

4.2 Smarandache curves of a circular helix

Let $\beta(s)$ be an admissible circular helix in G_3^1 with $(\tau = a = \text{const.}, \kappa = b = \text{const.})$, we have

Case 4.2.1 $\beta(s)$ is *spacelike*:

$$\beta(s) = \left(s, a \int \left(\int \sinh(bs) ds \right) ds, a \int \left(\int \cosh(bs) ds \right) ds \right). \quad (4.9)$$

For this curve, we have

$$\begin{aligned}\beta'(s) &= \left(1, \frac{a}{b} \cosh(bs), \frac{a}{b} \sinh(bs)\right), \\ \beta''(s) &= \left(1, \frac{a}{b} \cosh(bs), \frac{a}{b} \sinh(bs)\right), \\ \beta'''(s) &= (0, a \sinh(bs), a \cosh(bs)).\end{aligned}\tag{4.10}$$

Making necessary calculations from above, we have

$$\begin{aligned}(\mathbf{e}_1)_\beta &= \left(1, \frac{a}{b} \cosh(bs), \frac{a}{b} \sinh(bs)\right), \\ (\mathbf{e}_2)_\beta &= (0, \sinh(bs), \cosh(bs)), \\ (\mathbf{e}_3)_\beta &= (0, -\cosh(bs), -\sinh(bs)).\end{aligned}\tag{4.11}$$

Considering the last Frenet vectors, the $\mathbf{e}_1\mathbf{e}_2$, $\mathbf{e}_1\mathbf{e}_3$ and $\mathbf{e}_1\mathbf{e}_2\mathbf{e}_3$ Smarandache curves of β are respectively, as follows

$$\begin{aligned}\beta_{\mathbf{e}_1\mathbf{e}_2} &= \left(1, \frac{a}{b} \cosh(bs) + \sinh(bs), \cosh(bs) + \frac{a}{b} \sinh(bs)\right), \\ \beta_{\mathbf{e}_1\mathbf{e}_3} &= \left(1, \frac{(a-b)}{b} \cosh(bs), \frac{(a-b)}{b} \sinh(bs)\right), \\ \beta_{\mathbf{e}_1\mathbf{e}_2\mathbf{e}_3} &= \left(1, \left(\frac{a}{b} - 1\right) \cosh(bs) + \sinh(bs), \cosh(bs) + \frac{(a-b)}{b} \sinh(bs)\right).\end{aligned}\tag{4.12}$$

Case 4.2.2 $\beta(s)$ is *timelike*:

$$\beta(s) = \left(s, -a \int \left(\int \cosh(bs) ds\right) ds, a \int \left(\int \sinh(bs) ds\right) ds\right).\tag{4.13}$$

For $\beta(s)$, we have

$$\begin{aligned}\beta'(s) &= \left(1, -\frac{a}{b} \sinh(bs), \frac{a}{b} \cosh(bs)\right), \\ \beta''(s) &= (0, -a \cosh(bs), a \sinh(bs)), \\ \beta'''(s) &= (0, -ab \sinh(bs), ab \cosh(bs)).\end{aligned}\tag{4.14}$$

The Frenet frame of β is

$$\begin{aligned}(\mathbf{e}_1)_\beta &= \left(1, -\frac{a}{b} \sinh(bs), \frac{a}{b} \cosh(bs)\right), \\ (\mathbf{e}_2)_\beta &= (0, -\cosh(bs), \sinh(bs)), \\ (\mathbf{e}_3)_\beta &= (0, \sinh(bs), -\cosh(bs)).\end{aligned}\tag{4.15}$$

Thus the Smarandache curves of β are respectively, given by

$$\begin{aligned}\beta_{\mathbf{e}_1\mathbf{e}_2} &= \left(1, -\frac{1}{b} (b \cosh(bs) + a \sinh(bs)), \frac{a}{b} \cosh(bs) + \sinh(bs)\right), \\ \beta_{\mathbf{e}_1\mathbf{e}_3} &= \left(1, -\frac{(a+b)}{b} \sinh(bs), \frac{(a+b)}{b} \cosh(bs)\right), \\ \beta_{\mathbf{e}_1\mathbf{e}_2\mathbf{e}_3} &= \left(1, -\frac{1}{b} (be^{bs} + a \sinh(bs)), \frac{(a+b)}{b} \cosh(bs) + \sinh(bs)\right).\end{aligned}\tag{4.16}$$

4.3 Smarandache curves of Salkowski curve

Let $\gamma(s)$ be a Salkowski curve in G_3^1 with $(\tau = \tau(s), \kappa = a = \text{const.})$

Case 4.3.1 $\gamma(s)$ is *spacelike*:

$$\gamma(s) = \left(s, -a \int \left(\int \sinh \left(\int \tau(s) ds \right) ds \right) ds, a \int \left(\int \cosh \left(\int \tau(s) ds \right) ds \right) ds \right). \quad (4.17)$$

If we differentiate this equation three times, one can obtain

$$\begin{aligned} \gamma'(s) &= \left(1, -a \int \sinh \left(\int \tau(s) ds \right) ds, a \int \cosh \left(\int \tau(s) ds \right) ds \right), \\ \gamma''(s) &= \left(0, -a \sinh \left(\int \tau(s) ds \right), a \cosh \left(\int \tau(s) ds \right) \right), \\ \gamma'''(s) &= \left(0, -a \cosh \left(\int \tau(s) ds \right) \tau(s), a \sinh \left(\int \tau(s) ds \right) \tau(s) \right). \end{aligned} \quad (4.18)$$

In addition to that, the tangent, principal normal and binormal vectors of γ are in the following forms

$$\begin{aligned} (\mathbf{e}_1)_\gamma &= \left(1, -a \int \sinh \left(\int \tau(s) ds \right) ds, a \int \cosh \left(\int \tau(s) ds \right) ds \right), \\ (\mathbf{e}_2)_\gamma &= \left(0, -\sinh \left(\int \tau(s) ds \right), \cosh \left(\int \tau(s) ds \right) \right), \\ (\mathbf{e}_3)_\gamma &= \left(0, -\cosh \left(\int \tau(s) ds \right), \sinh \left(\int \tau(s) ds \right) \right). \end{aligned} \quad (4.19)$$

Furthermore, Smarandache curves for γ are

$$\begin{aligned} \gamma_{\mathbf{e}_1 \mathbf{e}_2} &= \left(1, -a \int \sinh \left(\int \tau(s) ds \right) ds - \sinh \left(\int \tau(s) ds \right), \right. \\ &\quad \left. \cosh \left(\int \tau(s) ds \right) + a \int \cosh \left(\int \tau(s) ds \right) ds \right), \\ \gamma_{\mathbf{e}_1 \mathbf{e}_3} &= \left(1, -\cosh \left(\int \tau(s) ds \right) - a \int \sinh \left(\int \tau(s) ds \right) ds, \right. \\ &\quad \left. a \int \cosh \left(\int \tau(s) ds \right) ds + \sinh \left(\int \tau(s) ds \right) \right), \\ \gamma_{\mathbf{e}_1 \mathbf{e}_2 \mathbf{e}_3} &= \left(1, -e^{\int \tau(s) ds} - a \int \sinh \left(\int \tau(s) ds \right) ds, e^{\int \tau(s) ds} + a \int \cosh \left(\int \tau(s) ds \right) ds \right). \end{aligned} \quad (4.20)$$

Case 4.3.2 $\gamma(s)$ is *timelike*:

$$\gamma(s) = \left(s, a \int \left(\int \cosh \left(\int \tau(s) ds \right) ds \right) ds, a \int \left(\int \sinh \left(\int \tau(s) ds \right) ds \right) ds \right). \quad (4.21)$$

We differentiate this equation three times to get

$$\begin{aligned} \gamma'(s) &= \left(1, a \int \cosh \left(\int \tau(s) ds \right) ds, a \int \sinh \left(\int \tau(s) ds \right) ds \right), \\ \gamma''(s) &= \left(0, a \cosh \left(\int \tau(s) ds \right), a \sinh \left(\int \tau(s) ds \right) \right), \end{aligned}$$

$$\gamma'''(s) = \left(0, a \sinh \left(\int \tau(s) ds \right) \tau(s), a \cosh \left(\int \tau(s) ds \right) \tau(s) \right). \quad (4.22)$$

The tangent, principal normal and binormal vectors of γ are in the following forms

$$\begin{aligned} (\mathbf{e}_1)_\gamma &= \left(1, a \int \cosh \left(\int \tau(s) ds \right) ds, a \int \sinh \left(\int \tau(s) ds \right) ds \right), \\ (\mathbf{e}_2)_\gamma &= \left(0, \cosh \left(\int \tau(s) ds \right), \sinh \left(\int \tau(s) ds \right) \right), \\ (\mathbf{e}_3)_\gamma &= \left(0, \sinh \left(\int \tau(s) ds \right), \cosh \left(\int \tau(s) ds \right) \right). \end{aligned} \quad (4.23)$$

So, Smarandache curves for γ are as follows

$$\begin{aligned} \gamma_{\mathbf{e}_1 \mathbf{e}_2} &= \left(1, a \int \cosh \left(\int \tau(s) ds \right) ds + \cosh \left(\int \tau(s) ds \right), \right. \\ &\quad \left. \sinh \left(\int \tau(s) ds \right) + a \int \sinh \left(\int \tau(s) ds \right) ds \right), \\ \gamma_{\mathbf{e}_1 \mathbf{e}_3} &= \left(1, \sinh \left(\int \tau(s) ds \right) + a \int \cosh \left(\int \tau(s) ds \right) ds, \right. \\ &\quad \left. a \int \sinh \left(\int \tau(s) ds \right) ds + \cosh \left(\int \tau(s) ds \right) \right), \\ \gamma_{\mathbf{e}_1 \mathbf{e}_2 \mathbf{e}_3} &= \left(1, e^{\int \tau(s) ds} + a \int \cosh \left(\int \tau(s) ds \right) ds, e^{\int \tau(s) ds} + a \int \sinh \left(\int \tau(s) ds \right) ds \right). \end{aligned} \quad (4.24)$$

4.4 Smarandache curves of Anti-Salkowski curve

Let $\delta(s)$ be Anti-Salkowski curve in G_3^1 with $(\kappa = \kappa(s), \tau = a = \text{const.})$

Case 4.4.1 $\delta(s)$ is spacelike:

$$\delta(s) = \left(s, - \int \left(\int \sinh(bs)\kappa(s) ds \right) ds, \int \left(\int \cosh(bs)\kappa(s) ds \right) ds \right). \quad (4.25)$$

It gives us the following derivatives

$$\begin{aligned} \delta'(s) &= \left(1, - \int \sinh(bs)\kappa(s) ds, \int \cosh(bs)\kappa(s) ds \right), \\ \delta''(s) &= (0, - \sinh(bs)\kappa(s), \cosh(bs)\kappa(s)), \\ \delta'''(s) &= (0, -\kappa'(s) \sinh(bs) - b \cosh(bs)\kappa(s), \kappa'(s) \cosh(bs) + b \sinh(bs)\kappa(s)). \end{aligned} \quad (4.26)$$

Further, we obtain the following Frenet vectors $\mathbf{e}_1, \mathbf{e}_2, \mathbf{e}_3$ in the form

$$\begin{aligned} (\mathbf{e}_1)_\delta &= \left(1, - \int \sinh(bs)\kappa(s) ds, \int \cosh(bs)\kappa(s) ds \right), \\ (\mathbf{e}_2)_\delta &= (0, - \sinh(bs), \cosh(bs)), \\ (\mathbf{e}_3)_\delta &= (0, - \cosh(bs), \sinh(bs)). \end{aligned} \quad (4.27)$$

Thus, the above computations of Frenet vectors give Smarandache curves as follows

$$\begin{aligned}\delta_{\mathbf{e}_1\mathbf{e}_2} &= \left(1, -\int \sinh(bs)\kappa(s) ds - \sinh(bs), \cosh(bs) + \int \cosh(bs)\kappa(s)ds\right), \\ \delta_{\mathbf{e}_1\mathbf{e}_3} &= \left(1, -\cosh(bs) - \int \sinh(bs)\kappa(s)ds, \int \cosh(bs)\kappa(s) ds + \sinh(bs)\right), \\ \delta_{\mathbf{e}_1\mathbf{e}_2\mathbf{e}_3} &= \left(1, -e^{bs} - \int \sinh(bs)\kappa(s)ds, e^{bs} + \int \cosh(bs)\kappa(s) ds\right).\end{aligned}\quad (4.28)$$

Case 4.4.2 $\delta(s)$ is *timelike*:

$$\delta(s) = \left(s, \int \left(\int \cosh(bs)\kappa(s) ds\right) ds, \int \left(\int \sinh(bs)\kappa(s) ds\right) ds\right).\quad (4.29)$$

The derivatives of δ are

$$\begin{aligned}\delta'(s) &= \left(1, \int \cosh(bs)\kappa(s) ds, \int \sinh(bs)\kappa(s)ds\right), \\ \delta''(s) &= (0, \cosh(bs)\kappa(s), \sinh(bs)\kappa(s)), \\ \delta'''(s) &= (0, \kappa'(s) \cosh(bs) + b \sinh(bs)\kappa(s), \kappa'(s) \sinh(bs) + b \cosh(bs)\kappa(s)).\end{aligned}\quad (4.30)$$

Hence, we obtain the following Frenet vectors

$$\begin{aligned}(\mathbf{e}_1)_\delta &= \left(1, \int \cosh(bs)\kappa(s) ds, \int \sinh(bs)\kappa(s) ds\right), \\ (\mathbf{e}_2)_\delta &= (0, \cosh(bs), \sinh(bs)), \\ (\mathbf{e}_3)_\delta &= (0, \sinh(bs), \cosh(bs)).\end{aligned}\quad (4.31)$$

Thus the Smarandache curves by

$$\begin{aligned}\delta_{\mathbf{e}_1\mathbf{e}_2} &= \left(1, \cosh(bs) + \int \cosh(bs)\kappa(s)ds, \int \sinh(bs)\kappa(s) ds + \sinh(bs)\right), \\ \delta_{\mathbf{e}_1\mathbf{e}_3} &= \left(1, \int \cosh(bs)\kappa(s)ds + \sinh(bs), \cosh(bs) + \int \sinh(bs)\kappa(s) ds\right), \\ \delta_{\mathbf{e}_1\mathbf{e}_2\mathbf{e}_3} &= \left(1, e^{bs} + \int \cosh(bs)\kappa(s) ds, e^{bs} + \int \sinh(bs)\kappa(s)ds\right).\end{aligned}\quad (4.32)$$

Notation 4.1 *In the light of the above calculations, there are not $\mathbf{e}_2\mathbf{e}_3$ Smarandache curves in the Galilean or pseudo-Galilean spaces.*

5 Examples

Example 5.1 Consider $\alpha(u)$ is a spacelike general helix in G_3^1 parameterized by

$$\alpha(s) = \left(u, \frac{1}{6}u(-\cosh(2\ln(u)) + 2\sinh(2\ln(u))), \frac{1}{6}u(2\cosh(2\ln(u)) - \sinh(2\ln(u))) \right).$$

We use the derivatives of $\alpha; \alpha', \alpha'', \alpha'''$ to get the associated trihedron of α as follows

$$(\mathbf{e}_1)_\alpha = \left(1, \frac{1}{2}\cosh(2\ln(u)), \frac{1}{2}\sinh(2\ln(u)) \right),$$

$$(\mathbf{e}_2)_\alpha = (0, \sinh(2\ln(u)), \cosh(2\ln(u))),$$

$$(\mathbf{e}_3)_\alpha = (0, -\cosh(2\ln(u)), -\sinh(2\ln(u))).$$

Curvature $\kappa(s)$ and torsion $\tau(s)$ are obtained as follows

$$\kappa_\alpha = \frac{1}{u}, \tau_\alpha = \frac{-2}{u}.$$

According to the above calculations, Smarandache curves of α are

$$\alpha_{\mathbf{e}_1\mathbf{e}_2} = \left(1, \frac{1}{2}\cosh(2\ln(u)) + \sinh(2\ln(u)), \frac{1+3u^4}{4u^2} \right),$$

$$\alpha_{\mathbf{e}_1\mathbf{e}_3} = \left(1, -\frac{1}{2}\cosh(2\ln(u)), -\frac{1}{2}\sinh(2\ln(u)) \right),$$

$$\alpha_{\mathbf{e}_1\mathbf{e}_2\mathbf{e}_3} = \left(1, \frac{-3+u^4}{4u^2}, \frac{3+u^4}{4u^2} \right).$$

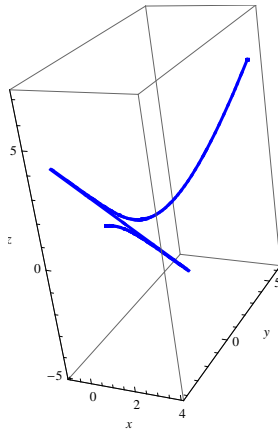

Figure 1: The spacelike general helix α in G_3^1 with $\kappa_\alpha = \frac{1}{u}$ and $\tau_\alpha = \frac{-2}{u}$.

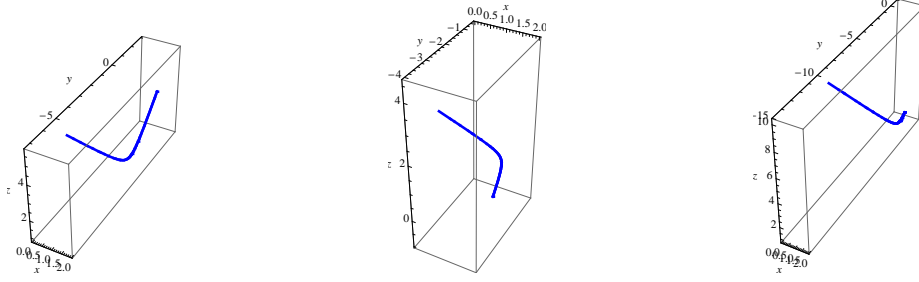

Figure 2: The $\mathbf{e}_1\mathbf{e}_2$, $\mathbf{e}_1\mathbf{e}_3$ and $\mathbf{e}_1\mathbf{e}_2\mathbf{e}_3$ Smarandache curves of α .

Example 5.2 Consider $\alpha^*(s)$ is a timelike general helix in G_3^1 given by

$$\alpha^*(s) = \left(u, \frac{1}{6}u(2 \cosh(2 \ln(u)) - \sinh(2 \ln(u))), \frac{1}{6}u(-\cosh(2 \ln(u)) + 2 \sinh(2 \ln(u))) \right).$$

Also, we use the derivatives of α^* ; $(\alpha^*)'$, $(\alpha^*)''$, $(\alpha^*)'''$ to get the associated trihedron of α^* as follows

$$(\mathbf{e}_1)_{\alpha^*} = \left(1, \frac{1}{2} \sinh(2 \ln(u)), \frac{1}{2} \cosh(2 \ln(u)) \right),$$

$$(\mathbf{e}_2)_{\alpha^*} = (0, \cosh(2 \ln(u)), \sinh(2 \ln(u))),$$

$$(\mathbf{e}_3)_{\alpha^*} = (0, \sinh(2 \ln(u)), \cosh(2 \ln(u))).$$

Curvature $\kappa(s)$ and torsion $\tau(s)$ are obtained as follows

$$\kappa_{\alpha^*} = \frac{1}{u}, \tau_{\alpha^*} = \frac{2}{u}.$$

According to the above calculations, Smarandache curves of α^* are

$$\alpha_{\mathbf{e}_1\mathbf{e}_2}^* = \left(1, \frac{1+3u^4}{4u^2}, \frac{1}{2} \cosh(2 \ln(u)) + \sinh(2 \ln(u)) \right),$$

$$\alpha_{\mathbf{e}_1\mathbf{e}_3}^* = \left(1, \frac{3}{2} \sinh(2 \ln(u)), \frac{3}{2} \cosh(2 \ln(u)) \right),$$

$$\alpha_{\mathbf{e}_1\mathbf{e}_2\mathbf{e}_3}^* = \left(1, \cosh(2 \ln(u)) + \frac{3}{2} \sinh(2 \ln(u)), \frac{1+5u^4}{4u^2} \right).$$

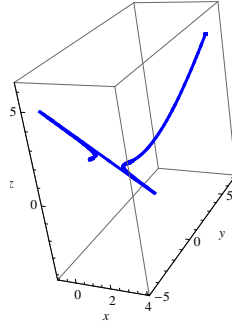

Figure 3: The timelike general helix α^* in G_3^1 with $\kappa_{\alpha^*} = \frac{1}{u}$ and $\tau_{\alpha^*} = \frac{2}{u}$.

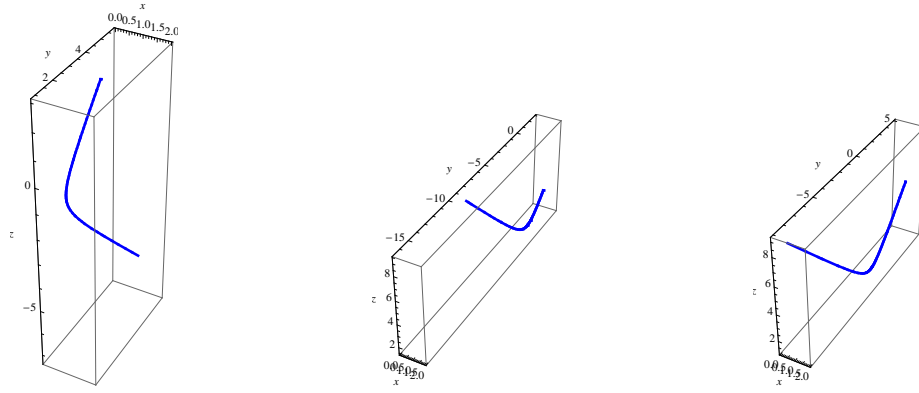

Figure 4: The $\mathbf{e}_1\mathbf{e}_2$, $\mathbf{e}_1\mathbf{e}_3$ and $\mathbf{e}_1\mathbf{e}_2\mathbf{e}_3$ Smarandache curves of α^* .

Example 5.3 Let $\delta : I \rightarrow G_3^1$ be a spacelike Anti-Salkowski curve parameterized by

$$\delta(s) = \left(u, \frac{1}{9}e^{-u} (4 \cosh(2u) + 5 \sinh(2u)), \frac{1}{9}e^{-u} (5 \cosh(2u) + 4 \sinh(2u)) \right).$$

By differentiation, we get

$$\begin{aligned} \delta'(s) &= \left(1, \frac{1}{6}(e^{-3u} + 3e^u), -\frac{1}{6}e^{-3u} + \frac{e^u}{2} \right), \\ \delta''(s) &= (0, e^{-u} \sinh(2u), e^{-u} \cosh(2u)), \\ \delta'''(s) &= \left(0, \frac{1}{2}(3e^{-3u} + e^u), \frac{1}{2}(-3e^{-3u} + e^u) \right). \end{aligned}$$

Using (2.5) to obtain

$$\begin{aligned} (\mathbf{e}_1)_\delta &= \left(1, \frac{1}{6}(e^{-3u} + 3e^u), -\frac{1}{6}e^{-3u} + \frac{e^u}{2} \right), \\ (\mathbf{e}_2)_\delta &= (0, \sinh(2u), \cosh(2u)), \\ (\mathbf{e}_3)_\delta &= (0, -\cosh(2u), -\sinh(2u)). \end{aligned}$$

The natural equations of this curve are given by

$$\kappa_\delta = e^{-u}, \tau_\delta = -2.$$

Thus, the Smarandache curves of δ are respectively, given by

$$\begin{aligned} \delta_{\mathbf{e}_1\mathbf{e}_2} &= \left(1, \frac{1}{6}(e^{-3u} + 3e^u) + \sinh(2u), -\frac{1}{6}e^{-3u} + \frac{e^u}{2} + \cosh(2u) \right), \\ \delta_{\mathbf{e}_1\mathbf{e}_3} &= \left(1, \frac{1}{6}(e^{-3u} + 3e^u - 6\cosh(2u)), -\frac{1}{6}e^{-3u} + \frac{e^u}{2} - \sinh(2u) \right), \\ \delta_{\mathbf{e}_1\mathbf{e}_2\mathbf{e}_3} &= \left(1, \frac{1}{6}e^{-3u}(1 - 6e^u + 3e^{4u}), \frac{1}{6}e^{-3u}(-1 + 6e^u + 3e^{4u}) \right). \end{aligned}$$

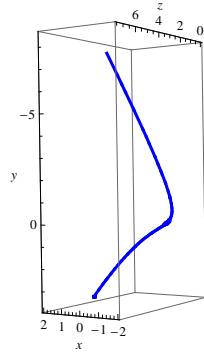

Figure 5: The spacelike Anti-Salkowski curve δ in G_3^1 with $\kappa_\delta = e^{-u}$ and $\tau_\delta = -2$.

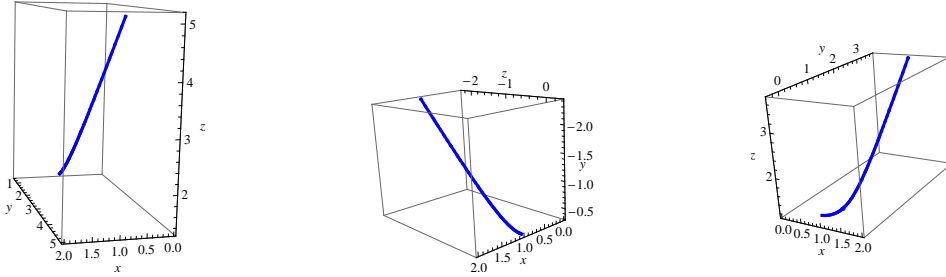

Figure 6: From left to right, the $\mathbf{e}_1\mathbf{e}_2$, $\mathbf{e}_1\mathbf{e}_3$ and $\mathbf{e}_1\mathbf{e}_2\mathbf{e}_3$ Smarandache curves of δ .

Example 5.4 Let δ^* be a timelike Anti-Salkowski curve in G_3^1 given by

$$\delta^*(s) = \left(u, \frac{1}{9}e^{-u}(5\cosh(2u) + 4\sinh(2u)), \frac{1}{9}e^{-u}(4\cosh(2u) + 5\sinh(2u)) \right).$$

By differentiation, we get

$$\begin{aligned}
(\delta^*)'(s) &= \left(1, -\frac{1}{6}e^{-3u} + \frac{e^u}{2}, \frac{1}{6}(e^{-3u} + 3e^u)\right), \\
(\delta^*)''(s) &= (0, e^{-u} \cosh(2u), e^{-u} \sinh(2u)), \\
(\delta^*)'''(s) &= \left(0, \frac{1}{2}(-3e^{-3u} + e^u), \frac{1}{2}(3e^{-3u} + e^u)\right).
\end{aligned}$$

Using (2.5) to obtain

$$\begin{aligned}
(\mathbf{e}_1)_{\delta^*} &= \left(1, -\frac{1}{6}e^{-3u} + \frac{e^u}{2}, \frac{1}{6}(e^{-3u} + 3e^u)\right), \\
(\mathbf{e}_2)_{\delta^*} &= (0, \cosh(2u), \sinh(2u)), \\
(\mathbf{e}_3)_{\delta^*} &= (0, \sinh(2u), \cosh(2u)).
\end{aligned}$$

The natural equations of this curve are given by

$$\kappa_{\delta^*} = e^{-u}, \tau_{\delta^*} = 2.$$

Thus, the Smarandache curves of δ^* are respectively, given by

$$\begin{aligned}
(\delta^*)_{\mathbf{e}_1\mathbf{e}_2} &= \left(1, -\frac{1}{6}e^{-3u} + \frac{e^u}{2} + \cosh(2u), \frac{1}{6}(e^{-3u} + 3e^u) + \sinh(2u)\right), \\
(\delta^*)_{\mathbf{e}_1\mathbf{e}_3} &= \left(1, -\frac{1}{6}e^{-3u} + \frac{e^u}{2} + \sinh(2u), \frac{1}{6}(e^{-3u} + 3e^u) + \cosh(2u)\right), \\
(\delta^*)_{\mathbf{e}_1\mathbf{e}_2\mathbf{e}_3} &= \left(1, -\frac{1}{6}e^{-3u} + \frac{e^u}{2} + e^{2u}, \frac{e^{-3u}}{6} + \frac{e^u}{2} + e^{2u}\right).
\end{aligned}$$

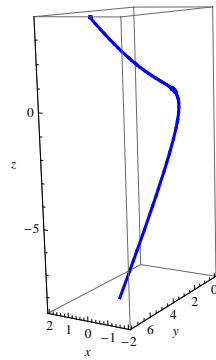

Figure 7: The timelike Anti-Salkowski curve δ^* in G_3^1 with $\kappa_{\delta^*} = e^{-u}$ and $\tau_{\delta^*} = 2$.

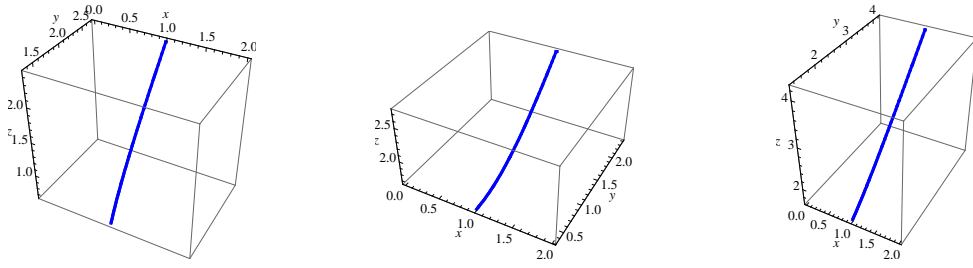

Figure 8: From left to right, the $\mathbf{e}_1\mathbf{e}_2$, $\mathbf{e}_1\mathbf{e}_3$ and $\mathbf{e}_1\mathbf{e}_2\mathbf{e}_3$ Smarandache curves of δ^* .

Example 5.5 Consider η is a timelike spiral in G_3^1 parameterized as follows

$$\eta(s) = (u, (2+u)(-1 + \ln(2+u)), 0).$$

So, we get

$$\eta'(s) = (1, \ln(2+u), 0),$$

$$\eta''(s) = \left(0, \frac{1}{2+u}, 0\right),$$

$$\eta'''(s) = \left(0, -\frac{1}{(2+u)^2}, 0\right).$$

The Frenet vectors of η are

$$(\mathbf{e}_1)_\eta = (1, \ln(2+u), 0),$$

$$(\mathbf{e}_2)_\eta = (0, 1, 0),$$

$$(\mathbf{e}_3)_\eta = (0, 0, 1).$$

The curvatures of this curve are given by

$$\kappa_\eta = \frac{1}{2+u}, \tau_\eta = 0.$$

Thus, the Smarandache curves of this spiral are given by

$$\eta_{\mathbf{e}_1\mathbf{e}_2} = (1, \ln(2+u), 1),$$

$$\eta_{\mathbf{e}_1\mathbf{e}_3} = (1, 1 + \ln(2+u), 1),$$

$$\eta_{\mathbf{e}_1\mathbf{e}_2\mathbf{e}_3} = (1, 1 + \ln(2+u), 1).$$

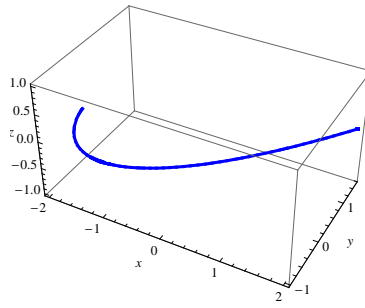

Figure 9: The timelike spiral curve η in G_3^1 with $\kappa_\eta = \frac{1}{2+u}$ and $\tau_\eta = 0$.

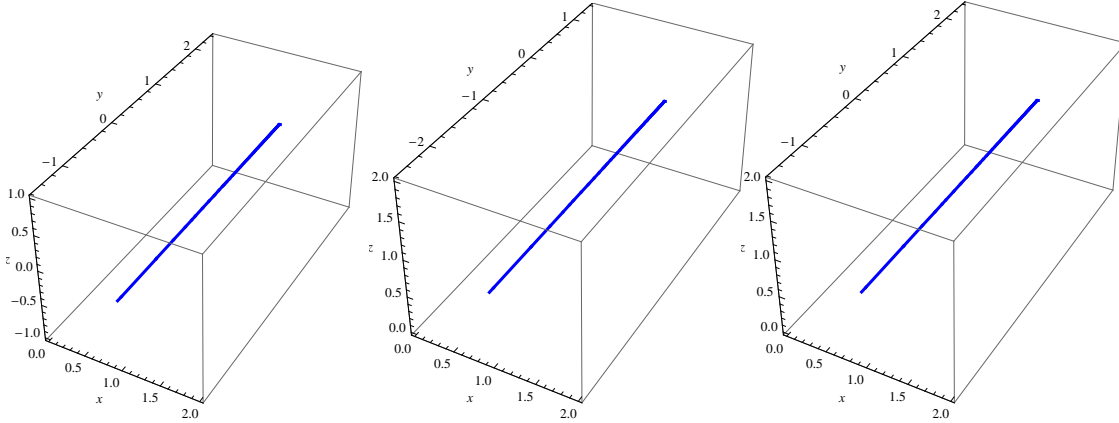

Figure 10: The $\mathbf{e}_1\mathbf{e}_2$, $\mathbf{e}_1\mathbf{e}_3$ and $\mathbf{e}_1\mathbf{e}_2\mathbf{e}_3$ Smarandache curves of η .

6 Conclusion

In the three-dimensional pseudo-Galilean space G_3^1 , Smarandache curves of space and timelike arbitrary curve and some of its special curves have been studied. Some examples of these curves such as general helix, Ant-Salkowski and spiral curves have been given and plotted.

References

- [1] C. Ashbacher, Smarandache geometries, Smarandache Notions Journal, **8**(1-3)(1997), 212-215.
- [2] M. Turgut and S. Yilmaz, Smarandache curves in Minkowski space-time, International Journal of Mathematical Combinatorics, **3**(2008), 51-55.
- [3] A. T. Ali, Position vectors of curves in the Galilean space G_3 , Matematicki Vesnik, **64**(3)(2012), 200-210.

- [4] X. Yang, High accuracy approximation of helices by quintic curve, *Comput. Aided Geomet. Design*, **20** (2003), 303-317.
- [5] D.J. Struik, *Lectures in Classical Differential Geometry*, Addison,-Wesley, Reading, MA, 1961.
- [6] E. Salkowski, Zur transformation von raumkurven, *Mathematische Annalen*, **66**(4)(1909), 517-557.
- [7] Z. Erjavec and B. Divjak, The equiform differential geometry of curves in the pseudo-Galilean space, *Math. Communications*, **13**(2008), 321-332.
- [8] Z. Erjavec, On Generalization of Helices in the Galilean and the Pseudo-Galilean Space, *Journal of Mathematics Research*, **6**(3)(2014), 39-50.
- [9] B. Divjak, The General Solution of the Frenet's System of Differential Equations for Curves in the Pseudo-Galilean Space G_3^1 , *Math. Communications*, **2**(1997), 143-147.
- [10] B. Divjak, *Geometrija pseudogalilejevih prostora*, Ph. D. thesis, University of Zagreb, 1997.
- [11] B. Divjak, Curves in pseudo-Galilean geometry, *Annales Univ. Sci. Budapest* 41(1998), 117-128.
- [12] I. Yaglom, *A simple non-Euclidean geometry and its physical basis*, Springer-Verlag, in New York, 1979.
- [13] B. J. Pavković, Equiform Geometry of Curves in the Isotropic Spaces I_3^1 and I_3^2 , *Rad JAZU*, (1986), 39-44.