

Signals for retarded Big Bang Black Hole Nucleus Splitting and Pairing into Dual Black Hole based Quasar- and Herbig Haro Systems.

Leo Vuyk,
Architect,
Rotterdam, the Netherlands.

Abstract,

According to Quantum Function Follows Form Theory, the Big Bang was the evaporation and splitting of a former Big Crunch black hole nucleus of compressed Axion Higgs particles into the oscillating Axion /Higgs field vacuum lattice respectively chunky nuclei of dark matter black holes.

The vacuum Lattice is supposed to represent a dynamic reference frame and the so called Dark Energy or Zero Point Energy acting as the motor for all Fermion spin and as the transfer medium for all photon information, leading to local lightspeed and local time.

The energetic vacuum lattice is also assumed to act as a Gravity Quantum Dipole Repeller because gravitons do not supposed to attract- but repel Fermions with less impulse than the vacuum particles.

As a consequence, Feynman diagrams become more complex than before..

Recent measurements by Yehuda Hoffman et al. did show the repelling effect of “empty space” in opposition of the “attracting gravity effect” of super clusters which he called “Dipole Repeller” effect.

Recently I found that the merging of galaxy clusters itself show dynamic observational signs of a contraction of the vacuum inside the merging galaxy clusters by the anomalous central clustering of the dark matter black hole content which seems to be stripped from the individual galaxy clusters located at the borders of the new super cluster.

(see Abell 520 and bullet cluster: “no inertia effect of dark matter black holes”.)

If there is vacuum absorption inside galaxy clusters, (Black Holes EAT the vacuum (Axion Higgs Field) then we also may assume that the universal vacuum between galaxy clusters should be also subjected to this absorption process, as a sign for universal contraction leading to a big crunch black hole.

Introduction,

In particle physics it is an interesting challenge to postulate that the FORM and structure of elementary particles is the origin of different FUNCTIONS of these particles.

The model which is the result is called “Quantum Function Follows Form” model.

As a consequence, the standard model should be extended with changes for an alternative electric dark matter black hole, quantum gravity, the mass related local lightspeed, and topological superconductive dark energy Axion/Higgs vacuum etc.

The massless Axion-Higgs particle itself is supposed to be the base for an discrete energetic oscillating space lattice with the Planck scale and the origin of Casimir pressure effect as one counteracting pressure half of all forces in nature such as a repulsive quantum gravity or magnetism.

The other half of all forces is supposed to be created by the opposing repulsive force on fermions of open rigid monopole photonic space oscillating vacuum lattice particles.

(see quantum gravity: figure 20.)

Occam’s razor seems to be not needed here to create an ontological sound mechanism.

As a consequence, a singularity (black hole) is depicted as a complex knot of different shaped rigid Axion Higgs particles and the Big Bang singularity black hole is supposed to contain all the particles which lived before in a former universe.

According to Quantum FFF Theory however, the LHC Higgs particle of 124-126 GeV is not supposed to be the single massless Axion Higgs in the form of a closed torus rigid string, but as the smallest rigid string knot to form the smallest black hole nucleus.

The dual mass between 124 and 126 GeV, is assumed to be originated by the dual mirror symmetrical shape of the Higgs knot in relation with the chirality of the vacuum lattice .

(For the Quantum Dipole Repeller effects, see figures 33, 34.)

Observed dual LHC signals of 124-126 GeV Higgs

The chirality of our material universal vacuum lattice formed by the massless Axion/Higgs oscillating dark energy field, is supposed to be the origin of these different masses. According to Quantum FFF Theory.



Figure 1 Rigid stringknots representing the dual semi massive Higgs black hole of 124 and 126 GeV.

Dark Matter Black holes EAT the dark energy Axion-Higgs vacuum lattice as the origin of the Hubble redshift. According to Quantum Function Follows Form Theory.

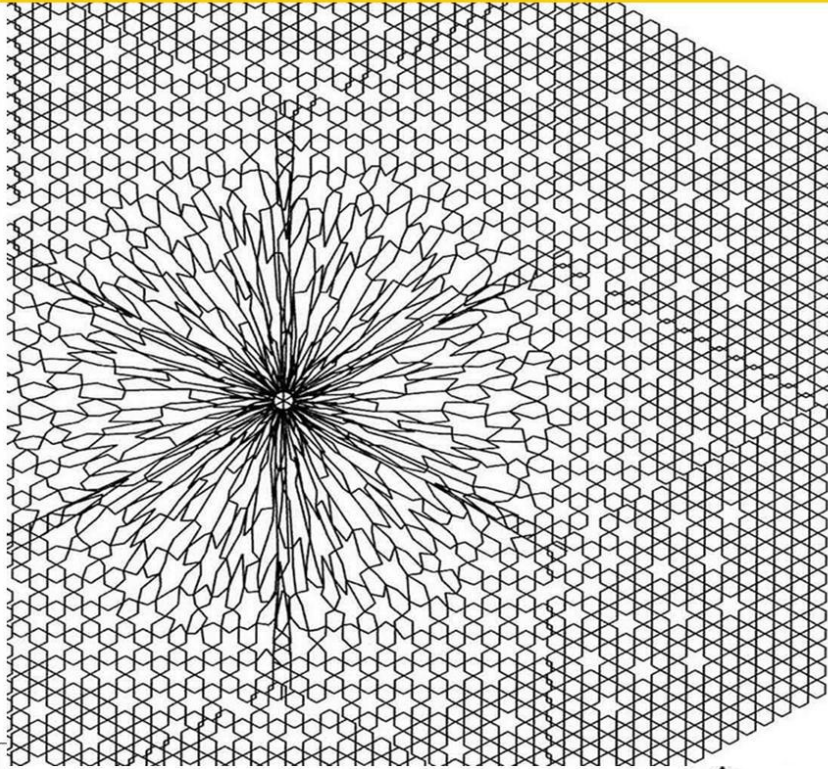

Black holes EAT the vacuum lattice with the oscillating Higgs particles, So, the vacuum lattice structure around a black hole could be represented like this. As a result, the near vacuum is thinner or diluted, it has holes, which could be the origin of the Universal HUBBLE redshift. By contrast, my new black hole paradigm says: the origin of universal redshift is Dark matter. Dark matter is the proliferation of vast numbers of Black holes around Galaxies. Conclusion, based on Hubble redshift, we don't know anything about expansion or contraction of the universe. (Author Leo Vuyk)

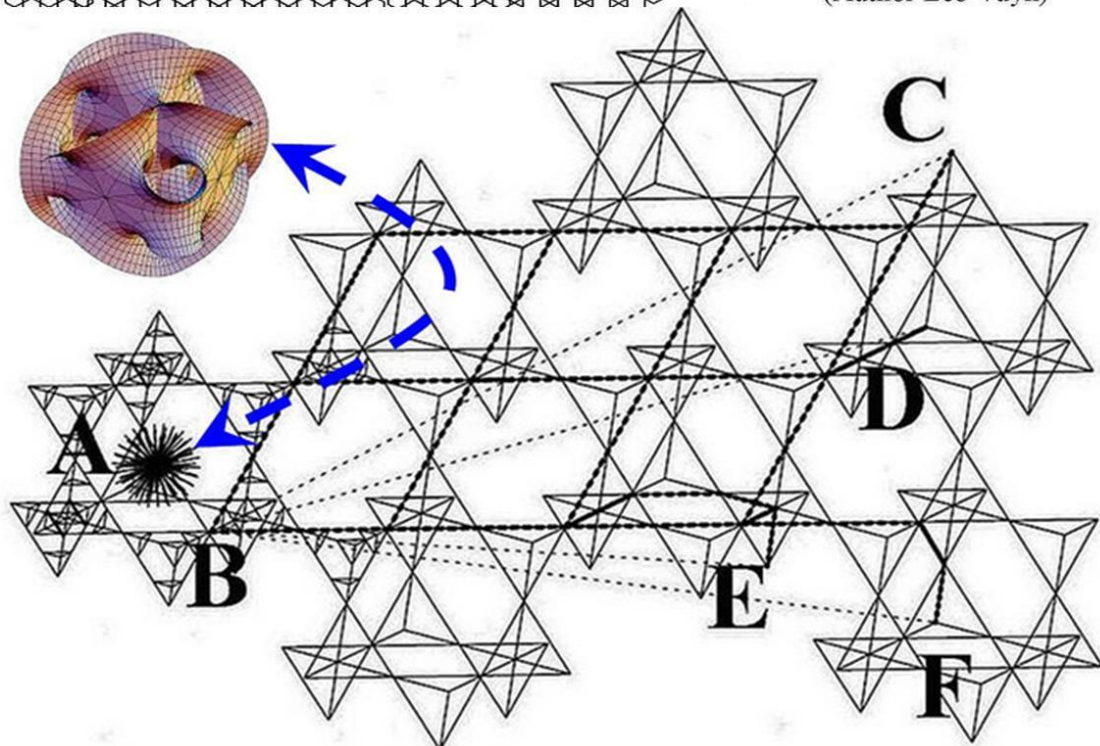
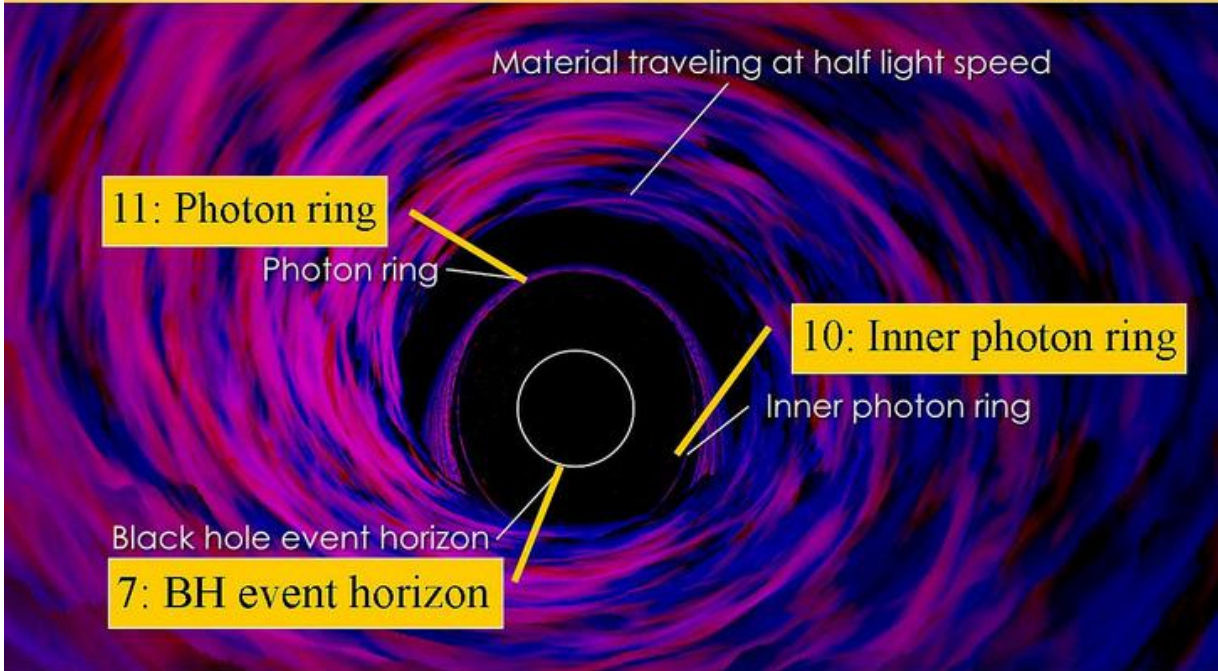
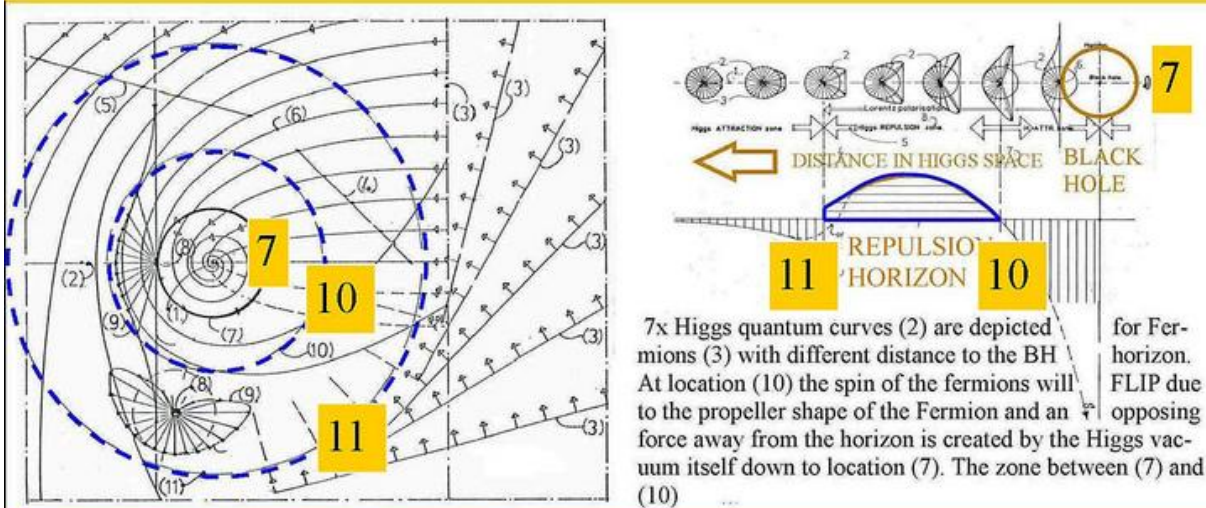

Figure 2, Dark Matter Black holes EAT the dark energy Axion-Higgs vacuum lattice as the origin of the Hubble redshift. According to Quantum Function Follows Form Theory.

Tripple Black Hole horizons found by NASA in accordance with Quantum FFF theory..



For tripple B-H horizons in Quantum FFF theory see (nrs: 7: Event horizon, 10: Inner photon ring, (10+11 =Fermion repulsion zone) 11: Photon ring)



- 1: Non rotating Black hole nucleus (in 2D cross section).
- 2: Reference axis for trajectories 4,5 and 6.
- 3: Other incoming photonic/Higgs fronts (without depicted trajectories)
- 7: High photon energy collider globular shell, with intense Quantum effects like pair production (e^-e^+). 8: test masses.
- 9: Butterfly shaped Higgs/photon Fermion pushing curves in 2D.
- 10 and 11: Fermion repulsion zone. Due to the propeller shape of the Fermions, they will experience a so called "Spin Flip" in this zone.

Figure 3. New physics Fermion repelling dark matter black hole horizon in contrast with Vacuum eating black hole.

No Inertia Effect in Dark Matter System of the Bullet Galaxy Cluster

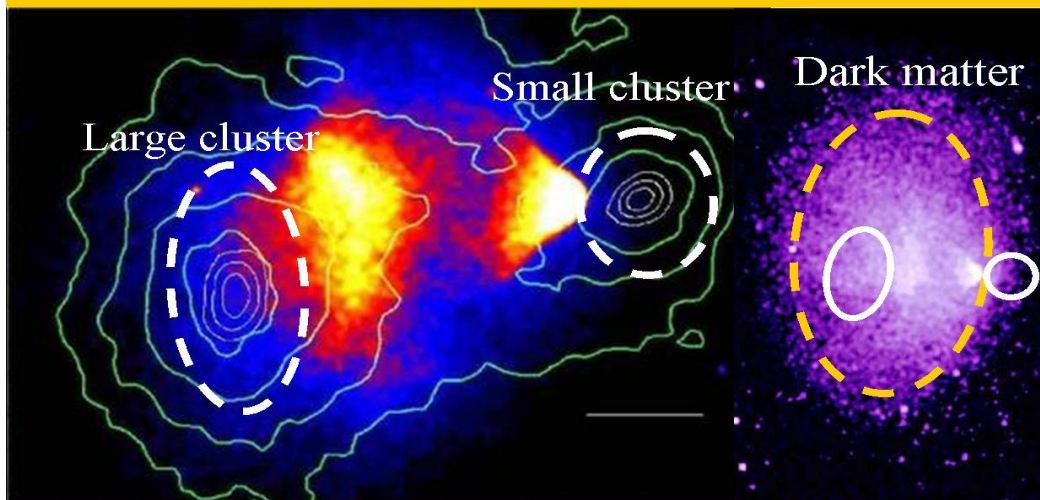

The smaller galaxy cluster is moving away (to the right) from the larger galaxy cluster (left) after collision. Hot gasses are left behind in between. However both dark matter systems seem to have merged and concentrate around the larger galaxy cluster. **The smaller cluster lost most dark matter content to the larger cluster.**

Conclusion:

- 1: Larger dark matter systems seem to be able to attract and merge smaller dark matter systems.
 - 2: dark matter has smaller or even NO inertia effect than baryonic matter.
 - 3: Dark matter systems tend to clumpiness and eventual decelerate smaller colliding clusters.
- In line with Quantum Function Follows form Theory.

Figure 4, No Inertia Effect in Dark Matter of the Bullet Galaxy Cluster

The smaller galaxy cluster is moving away (to the right) from the larger galaxy cluster (left) after collision. Hot gasses are left behind in between. However both dark matter systems seem to have merged and concentrate around the larger galaxy cluster. The smaller cluster lost its dark matter content (dark matter black holes) to the larger cluster.

Conclusion:

- 1: Larger dark matter systems seem to be able to attract and merge smaller dark matter systems.
- 2: dark matter has smaller or even NO inertia effect than baryonic matter, only Fermions have.
- 3: Dark matter systems tend to clump into growing black hole nuclei, they merge and decelerate smaller colliding clusters. In line with Quantum FFF Theory.

Dark matter merging dynamics of the Bullet Cluster before and after collision.

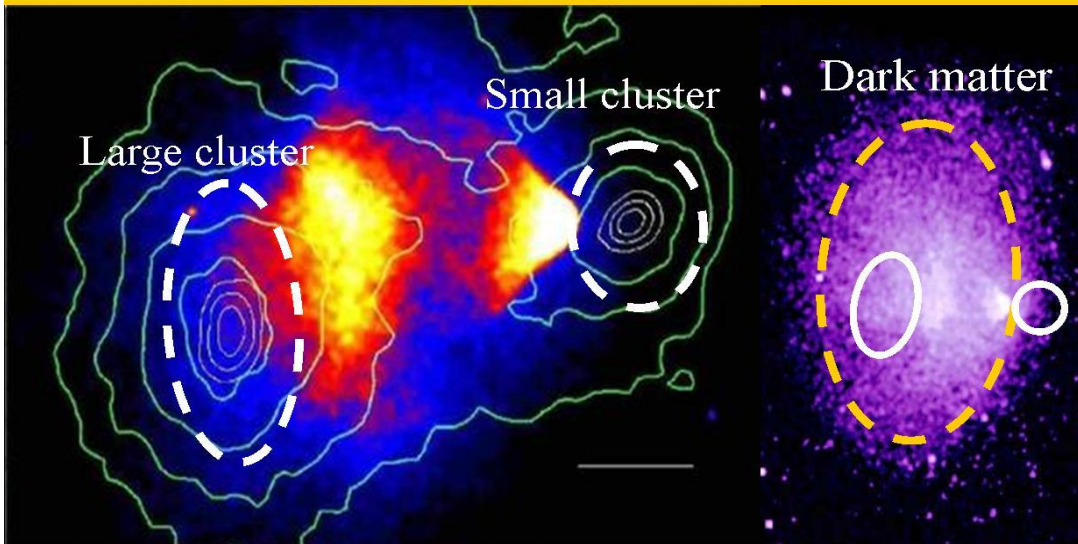

The smaller cluster (bullet) lost most dark matter content to the larger cluster. (A, B, C)

It is assumed that the smaller cluster will decelerate and return to merge and unite.

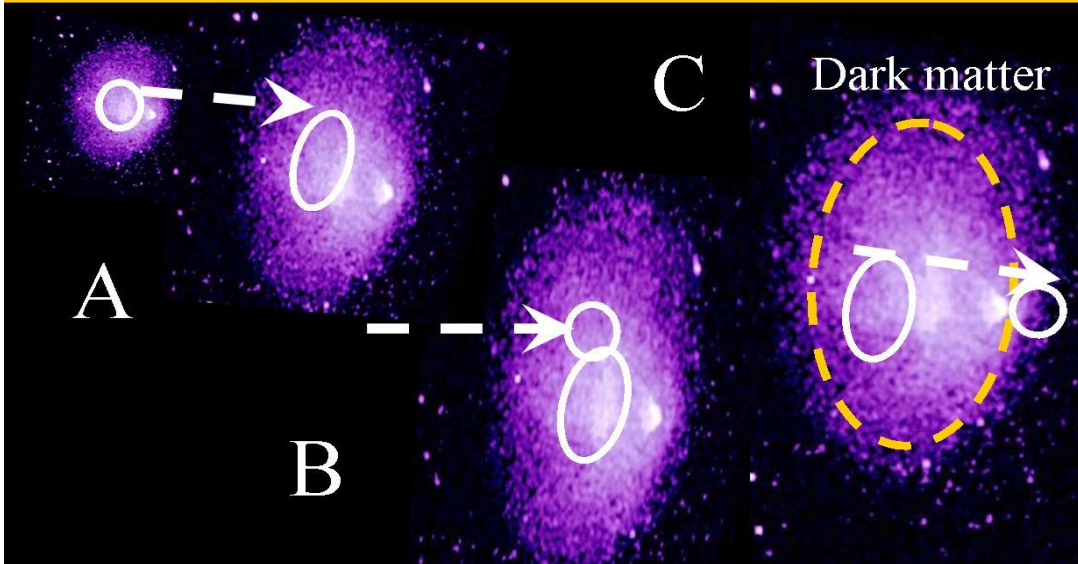

Figure 5, Dark matter merging dynamics of the Bullet Cluster before and after collision.

The smaller cluster (bullet) lost most dark matter content to the larger cluster. (A, B, C) It is assumed that the smaller cluster will decelerate and return to merge and unite.

see: Electric Dark Matter Black Holes Outside and Inside Galaxies possibly related to the creation and contraction of a Cyclic Universe.

see: <http://vixra.org/pdf/1503.0186v5.pdf>

Abell 520 Galaxy cluster collision, is a clear example of the clumping of dark matter (black holes) during galaxy passage through the center of the collision. Galaxies lost their Galaxy Anchor Black Holes, (GABHs)
In line with Quantum FFF model.

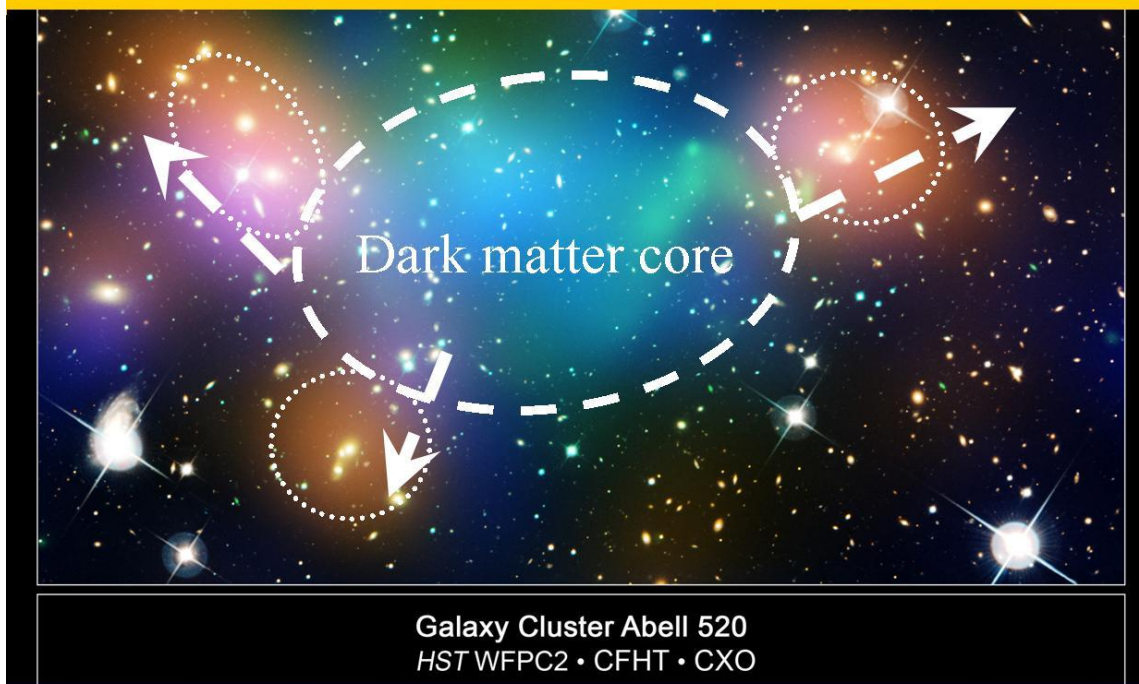

Quotation of Wikipedia: “The dark matter collected into a "dark core" containing far fewer galaxies than would be expected if the dark matter and galaxies hung together. Most of the galaxies apparently have sailed far away from the collision. This result could present a challenge to basic theories of dark matter, which predict that galaxies should be anchored to the invisible substance, even during the shock of a collision “ see also: Bullet cluster with central DM core.

Figure 6. Abell 520 and the mystery central dark matter core.

Abell 520 Galaxy cluster collision, is a clear example of the clumping of dark matter (black holes) during galaxy passage through the center of the collision. Galaxies lost their Galaxy Anchor Black Holes, (GABHs)

Then wave particle duality and the so called one particle double slit interference could be explained by accepting that real shaped 3D photon particles only exist in their function of Gluons. However Gluons should transfer form information to the oscillating luminiferous Axion-Higgs field ether, within about 1 cm distance from a fermion.(see: Babock and Bergman anomaly,1964)

18, Different elementary particles have different qualities by their different complex stringy shape. Leptons and Quarks have a propeller shape with left or right handed pitch creating charge difference. Gluons, Photons and Neutrino particles have no pitch.

20 All particles can be converted to one or more Higgs particles, Lepto Quarks are also compound particles with an exception for the electron and positron..

21 All particles are assumed to be present as Higgs particles already in the cyclic Big Bang Black Hole (BBBH) after the former multiverse has collapsed into a Big Crunch Black Hole.

22, We seem to live inside one material universal bubble of an instant entangled (Charge Parity Time) CPT symmetric raspberry bubble multiverse. Each quantum jump or wave function collapse or human choice is guided by this instant entanglement at long distant.

If our material universes has a chiral oscillating Higgs field, then our material Right Handed DNA helix molecule could be explained.

However it also suggests that in our opposing ANTI-MATERIAL multiverse neighbour universe the DNA helix should have a LEFT HANDED spiral.

According to Max Tegmark: in an entangled multiverse we may ask: is there COPY PERSON over there, who is reading the same lines as I do?

If this COPY person is indeed living over there, then even our consciousness should be shared in a sort of DEMOCRATIC form,

Then we are not alone with our thoughts and doubts, see:

Democratic Free Will in the instant Entangled Multiverse.

Conclusion, Quantum FFF Theory is based on Non-Local Realism. The CP(T)-symmetrical raspberry shaped multiverse (with 8-12 berries) is non local instant connected down to each quantum. Each quantum can be visualised as a deformed Axion-Higgs ring able to convert into other shapes and able to form compound structures like quarks, muons or even Tau leptons. So realism (cogwheels) connected by symmetric non-local instant entanglement.

vixra.org/pdf/1401.0071v2.pdf

It was **Abdus Salam** who proposed that quarks and leptons should have a sub-quantum level structure, and that they are compound hardrock particles with a specific non-zero sized form.

Jean Paul Vigiér postulated that quarks and leptons are "pushed around" by an energetic sea of vacuum particles.

David Bohm suggested in contrast with The "Copenhagen interpretation", that reality is not created by the eye of the human observer, and second: elementary particles should be "guided by a pilot wave".

John Bell argued that the motion of mass related to the surrounding vacuum reference frame, should originate real

"Lorentz-transformations", and also real relativistic measurable contraction.

Richard Feynman postulated the idea of an all pervading energetic quantum vacuum. He rejected it, because it should originate resistance for every mass in motion, relative to the reference frame of the quantum vacuum.

However, I postulate the strange and counter intuitive possibility, that this resistance for mass in motion, can be compensated, if we combine the ideas of Vigiér, Bell, Bohm and Salam, and a new dual universal Bohmian "pilot wave", which is interpreted as the EPR correlation (or

Big Bang entanglement) between individual elementary anti-mirror particles, living in dual universes.

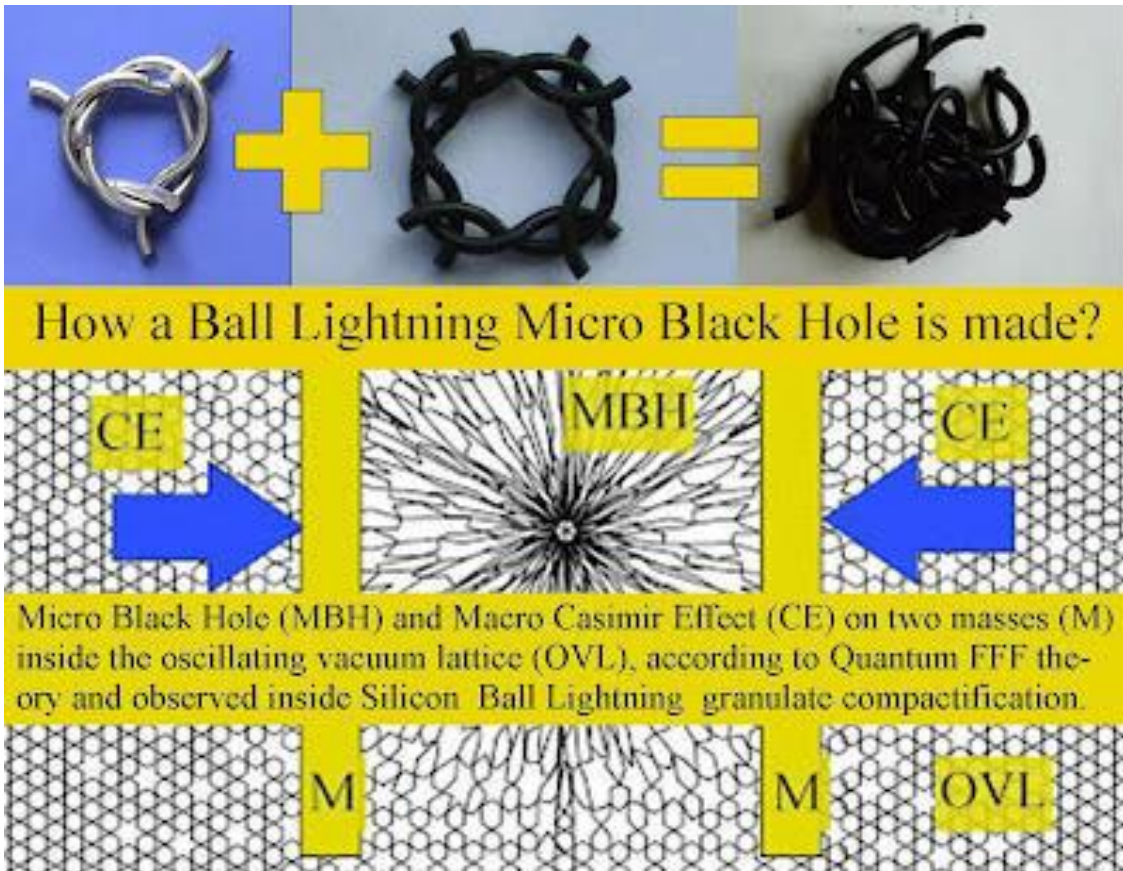
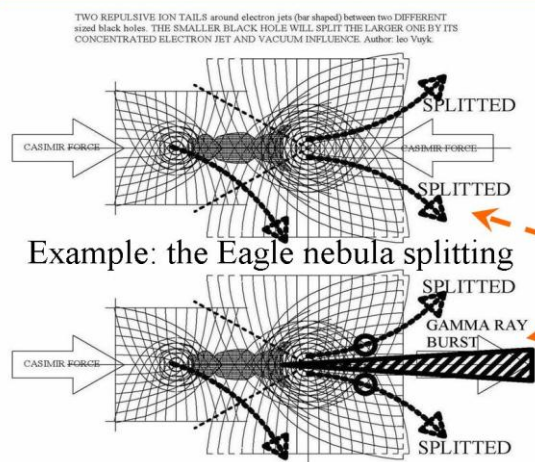

Figure 8, basic elements for black hole formation, with vacuum deformed structure around a black hole.

LIGO based Black Hole ratios and the ability to merge or split into two equal BH parts, able to create Herbig Haro systems and Gamma Ray Bursts. Such splitting systems are observed in the so called Spire part of the Eagle nebula.

The origin of Gamma Ray Bursts, by splitting black holes of different size, leaving three BHs behind. Two of them could form a Herbig Haro Object with a dumbbell structure. (Quantum FFF theory@Leo Vuyk).

Dual black hole merger nominal mass contents observed by LIGO in 2015 and 2016 resp. 29/36x and 7.5/14.2x sun masses. see: Quantum FFF Theory. The related ratios are: 1/1.24 resp. 1/1.9.



Small black holes should split larger BHs into two equal parts to create dual Herbig Haro hotspots also called bowshocks or accretion outburst sources.

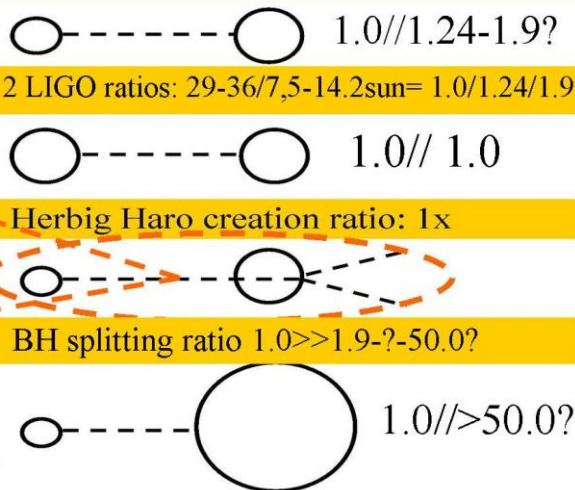

Galaxy central BH merger: 1.0 //>50.0?

Figure 9, suggestions for black hole nuclear splitting and merging by BH nuclear collision of different sizes.

The massless chiral Axion/Higgs oscillating dark energy vacuum field with a Topological superconductor function.

The massless transformable Axion /Higgs particle is supposed to act as the mother of all single and compound rigid string particles fermions/neutrinos, photons etc.

Topology of the Oscillating Chiral Higgs field vacuum structure, with Dark Matter Quantum Knots inside Black Hole Nuclei, as the second energetic element to make the Multiverse a cyclic self organising system.

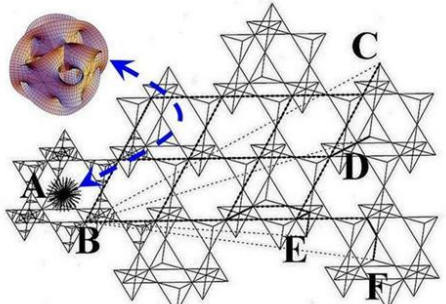

Photon trajectories through the tetrahedral oscillating Higgs vacuum lattice. (Acc. to Quantum FFF Theory)
 A: a real shaped Photon is created by Higgs collision with a dual axis spinning (Calabi Yau) Fermion propeller.
 B: that Photon transfers CODED form information (monopole photon info) and direction information into one Higgs particle which transfers this information by mutual Higgs collisionary oscillations through the vacuum in one specific direction.
 C, D, E, or F
 I: Only magnetic photonic information (2x : North and South) are subject to curvature by an undisturbed symmetric oscillating vacuum
 II: Local Anti-Symmetric Oscillating vacuum Frames are influenced by massive objects like the earth and responsible for semi relativistic effects.
 III The vacuum lattice has helix- or chiral quality being the origin of our material universe.



Dark Matter Quantum Knots inside BH Nuclei.



New Dark Matter Black Hole, "Eat" the chiral oscillating Higgs vacuum. (Quantum-FFF Theory)

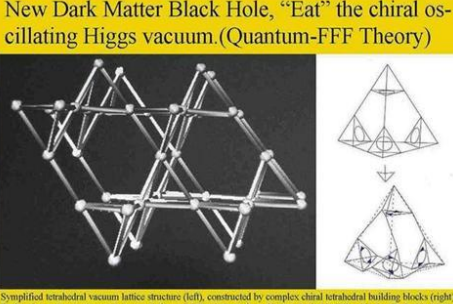

Simplified tetrahedral vacuum lattice structure (left), constructed by complex chiral tetrahedral building blocks (right) Each universe has to choose between a left- or righthanded rotation of its tetrahedral building blocks. Each chiral lattice

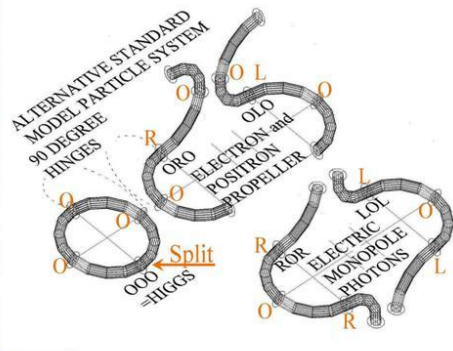

ALTERNATIVE STANDARD MODEL PARTICLE SYSTEM
 90 DEGREE HINGES
 ORO ELECTRON and POSITRON PROPPELLER
 OOO =HIGGS
 ROR ELECTRIC MONOPOLE PHOTONS
 LOL

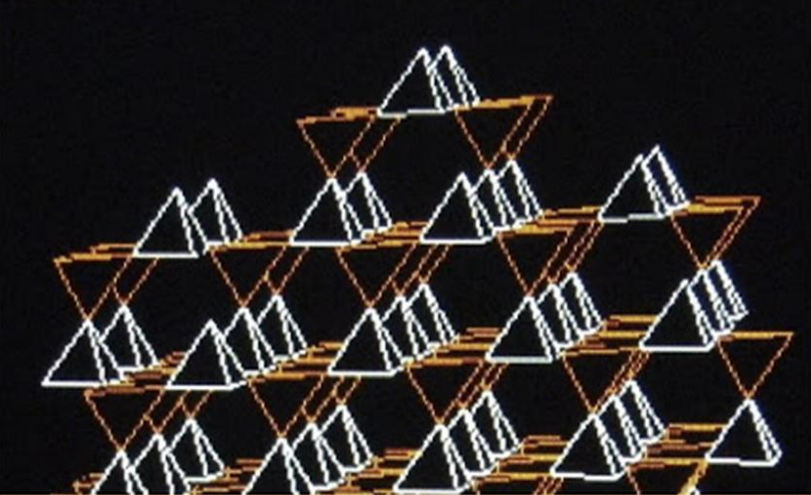

3-D image of TWO tetrahedron space fill units with chiral, left or right handed characteristics, the origin of our material universe and our opposite anti-matter universe.

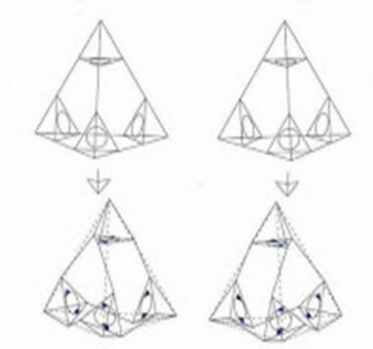

Space fill unit with RIGHT hand rotation. Space fill unit with LEFT hand rotation.

Truncated tetrahedron space according to the Quantum-FFF model. Each tetrahedron lattice has a spiral shape based on three linear units

Figure 10, Dark energy vacuum field with topological superconductor function for local and inter-universal entanglements as a base for a function collapse and democratic free will according to Quantum FFF Theory.

Our position in the 8 or 12 !!! fold raspberry multiverse. Elliptic shaped CMB peak radiations are tell tales. (left). At the rightside a 12 fold symmetric cube octahedron multiverse diagram is depicted with red: matter and green: anti matter entangled universes.

CONFIGURATION FOR 8 OR 12 UNIVERSES.

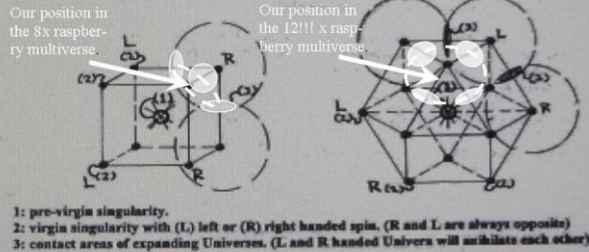

3, 4 or 5x elliptic Contact areas in the CMB?

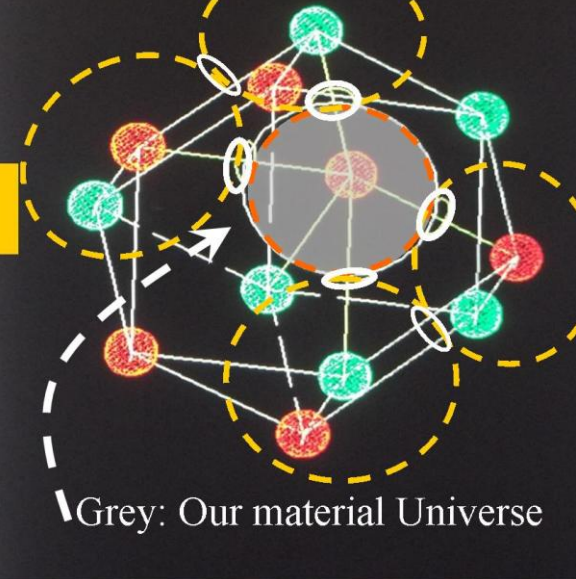

Three extreme fluctuations (elliptic shaped peaks) in the Cosmic Background radiation tell us about our position inside the 8-or-12 fold raspberry multiverse, according to Quantum FFF Theory.

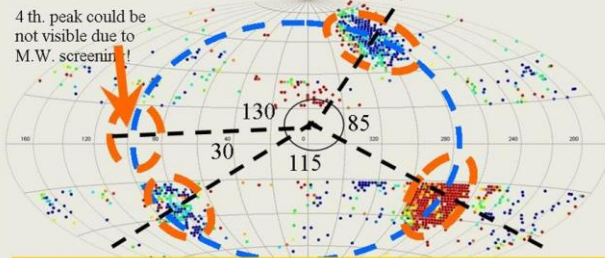

FLUCTUATION ANOMALIES IN THE COSMIC MICROWAVE BACKGROUND. CREDIT: V. G. GURZADYAN AND R. PENROSE.

Figure 11, the entangled 8- or 12 fold raspberry multiverse.

The great misconception in Astronomy:

Herbig Haro Bowshocks and Cometary Globules, are not interpreted as Dark Matter Black Holes. See below: Bok- and Cometary Globules with young Herbig Haro Bowshocks in the making in the Carina nebula.

Splitting and pairing electric dark matter black holes. Magic self propelling in space and even on earth according to Quantum FFF theory.

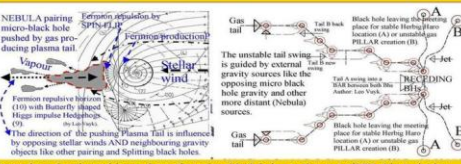

Several accelerating pairing and receding micro black holes, as the start of HH objects, in the Carina nebula, with temporary meeting place (A) and ionised plasma tail. (Quantum-FFF Theory)



The pairing and splitting of Electric Dark Matter Black Holes into dual Herbig Haro bowshocks, as the fast creation and proliferation of Stars and galaxies after the splitting bigbang.

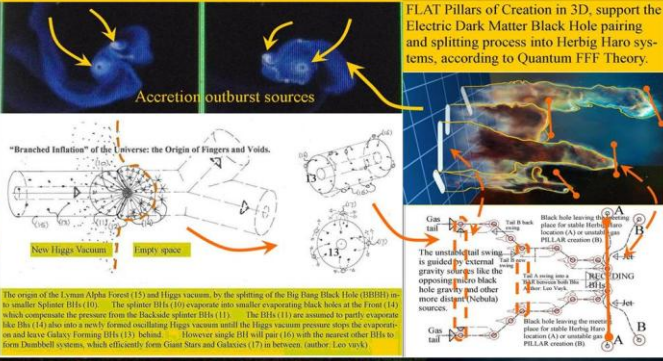
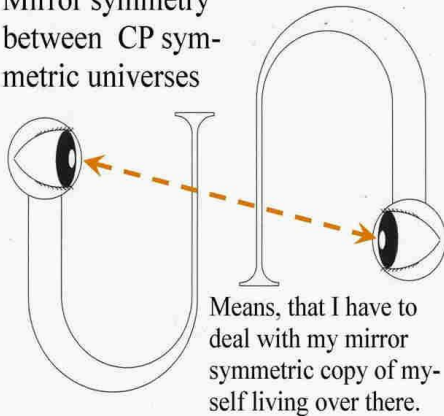

Figure 12, great misconceptions in astronomy and the solution with alternative electric dark matter black holes able to combine into Herbig haro objects with star formation in between.

The Wavefunction collapse in the (CP symmetric) raspberry multiverse by the entangled observation between (anti) copy particles

According to Quantum FFF Theory, the collapse of the wavefunction is assumed to be triggered by particle collisions with instant entanglement between (anti-) COPY universes. So there is Charge and Parity symmetry between the entangled particles living in opposing universes. Each particle is its own observer!! Each human has to deal with one or more opposing anti-COPY humans.

Mirror symmetry between CP symmetric universes



2-D Section through the raspberry multiverse, with huge void in the middle. The void in the middle is supposed to be originated by the start of the Fractal process, when the vacuum density of the former cyclic multiverse was still too high for a fine grained fractal process (see my book).

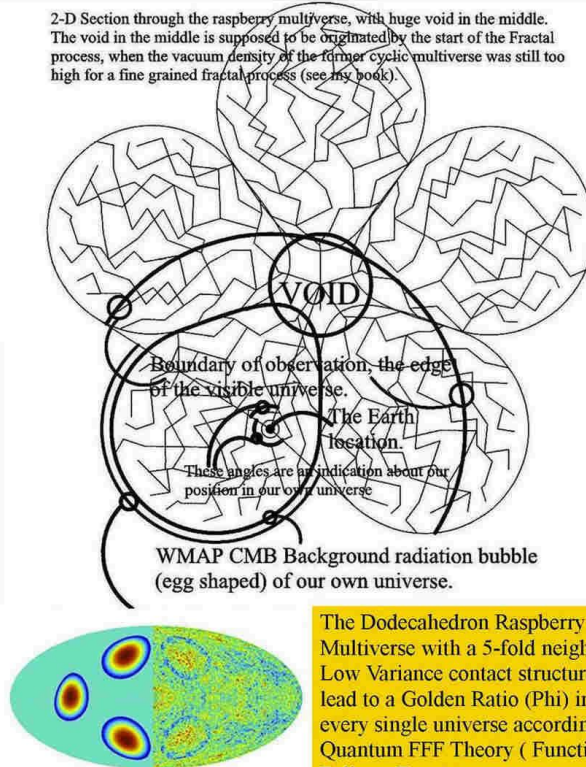

Figure 13, Wavefunction collapse in the multiverse.

The great Penrose High-Low Entropy misconception.

Big Bang and Big Crunch originated by the splitting pairing and recycling via merging of central galaxy S-nova black holes. According to Quantum FFF Theory..

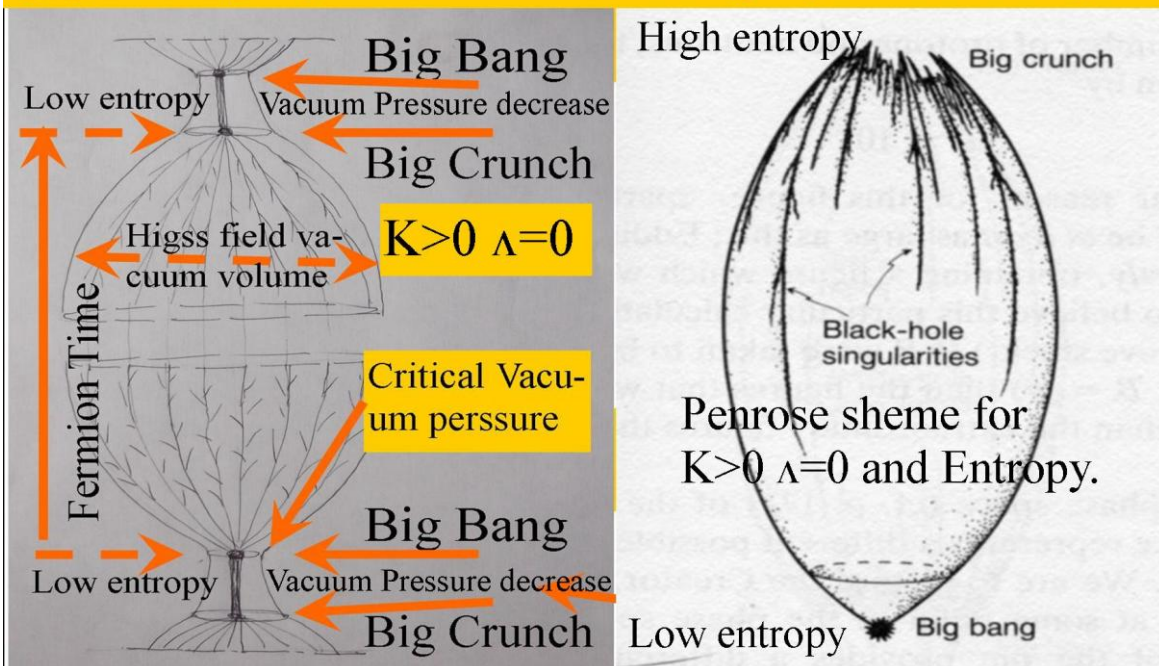

Figure 14, The consequence: a bouncing CP(T) symmetric multiverse.

Micro Comet march 2015. 4-8 plasma tails seem to indicate to be related to 4- 8x clustered sprite fireballs. Regio Perm in g.Kizel.

According to Quanium FFF Theory.



Below several other examples of micro comets and Ball Lightning.

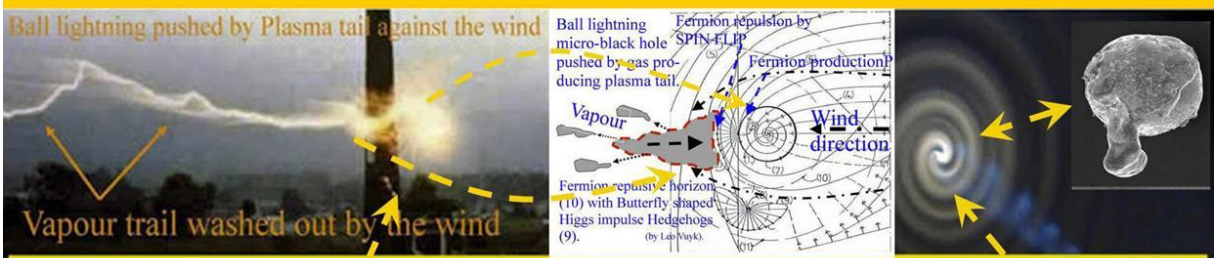

Ball Lightning and Micro Comets Based on New ZPE Black Hole Paradigm



Micro Comets (micro black holes) also pushed by plasma tail against the wind

Figure 15, examples of micro black hole based Ball Lightning and micro comets on earth.

This Ball Lightning photo is an important piece of the new physics of Quantum FFF theory. It shows a self produced vapor trail washed out by the opposing wind of the massless BL nucleus, which seem to be pushed against the wind. Just as observed in multiple single- and pairing Black Hole examples in nebula like the Carina.



Other examples of BLs with plasma tails

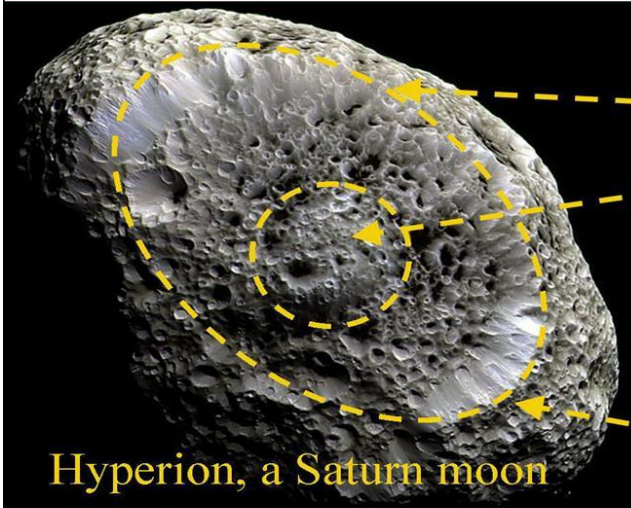

Figure 16, other examples of Ball Lightnings with plasma tails.

Black Holes of all sizes, (even the fast evaporating smallest ones, like ball lightning) are supposed to EAT the Vacuum and leave a super conducting channel behind, e.g. for fast lightning charge transmission. According to Quantum FFF Model.

see also: <http://bigbang-entanglement.blogspot.nl/2016/07/is-vacuum-super-conductor-for-instant.html>

Electric Dark Matter Black Hole Comets and Icy remnants (e.g. Hyperion)



Hyperion, a Saturn moon

Cross section through a Megacryometeor or Terrestrial micro Comet nucleus.

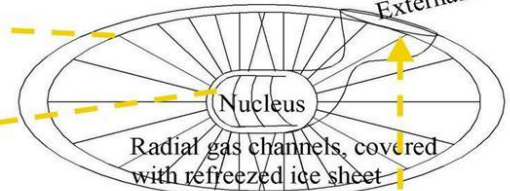

Expected ice structure of the ellipsoidal ice chunk (Megacryometeor) found by J.M.Frais (Madrid). According to Quantum FFF theory this chunk should be the Nucleus of a Terrestrial Micro Comet, produced by a new paradigm black hole, which left the nucleus through the external hole, in consonance with the ice structure of the Hyperion moon. (author Leo Vuyk)

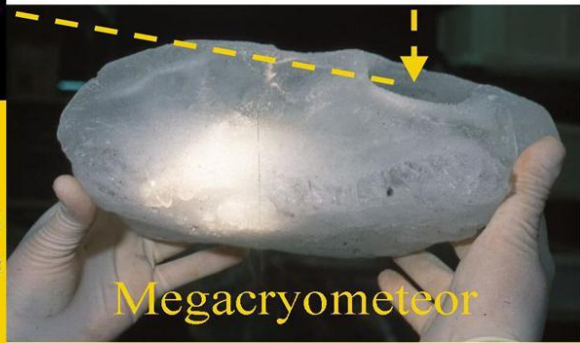

Megacryometeor

The relation between the Hyperion ice structure and the structure of a Megacryometeor as the result of Micro Black hole ice production inside both nuclei.

According to Quantum FFF Theory, even Nano interference Black Holes have a radial structured electric potential horizon layer (internal positive-protons and external negative electrons charged). They produce H₂ and water leading to the icy nuclei of Comets, Ball Lightning and Megacryometeors. The origin: a Fermion repulsion horizon of the black hole, see below.

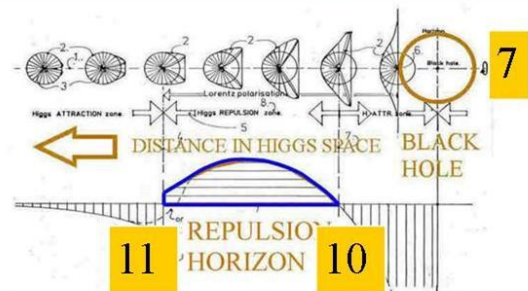
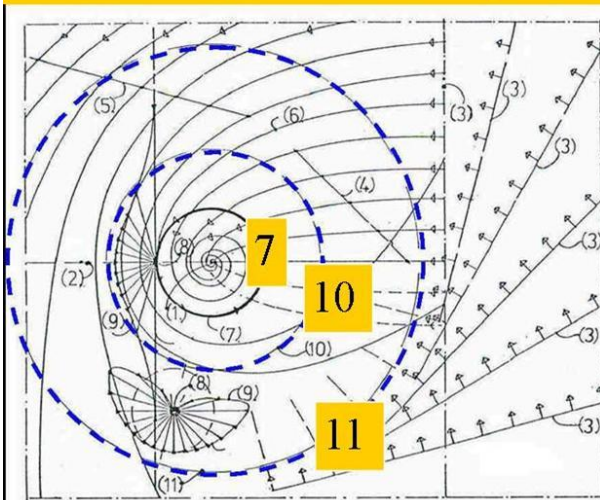

7x Higgs quantum curves (2) are depicted for Fermions (3) with different distance to the BH horizon. At location (10) the spin of the fermions will FLIP due to the propeller shape of the Fermion and an opposing force away from the horizon is created by the Higgs vacuum itself down to location (7). The zone between (7) and (10)

Figure 17, The principle of fermion production (also water) and repulsion around a new paradigm black hole.

Early NGC 3801, a cosmic Miracle?

Not so, in Quantum FFF Theory, if we accept to recognize two GABH's (Galaxy Anchor Black Holes) both in line with the central star forming region.



Secondary and tertiary Dual BH Herbig Haro systems, as the origin of different shaped dwarf galaxies and Star clusters.

Below: Simplification of different sized dual black hole (5) based Herbig Haro Systems with dwarf and star formation in between, in the halo of the MW.

Dual Galaxy- and Stellar Anchor Black Holes (G-SABHs) as former Herbig Haro bowshocks, observed in deep space or Planetary Nebula.

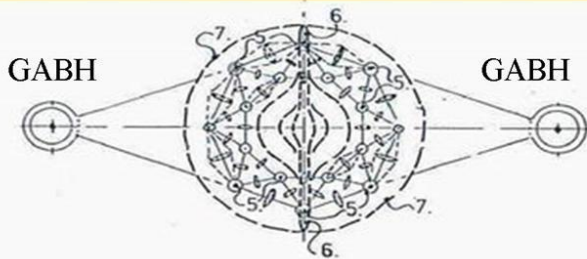

Dual black hole systems of all scales, Galaxy and Stars are supposed to be the origin of the self organising universe according to a new electric dark matter black hole model called Quantum FFF Theory. See: Image credit: Prathamesh Tamhane/Yogesh Wadadekar

According to Quantum FFF Theory, Black holes create Proton-Electron plasma at the Fermion repelling horizon. As a consequence dual black hole systems like Herbig Haro objects are equipped with dual EM jets, supported by cone shaped Casimir pressurized Higgs field vacuum polarization. Birkeland and Alfvén current circuits are supposed to be the result. Higgs-Casimir pressure vectors are depicted above and below.

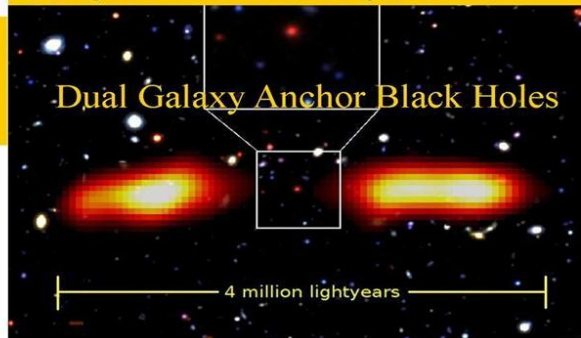
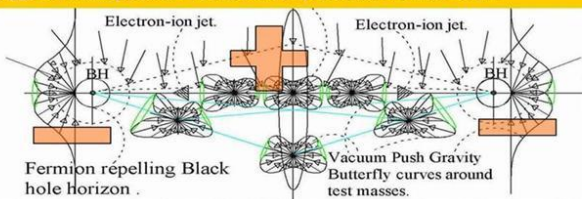

Figure 18, how stars and galaxies are formed by Herbig Haro systems between two equal sized new paradigm black holes.

Binary Star Production in LMC N55 in a System of Evolved Herbig Haro Black Holes alike Quasar 3C405.

Quasars are early HH systems with plasma creation at the hotspots and a growing fore-runner Big Crunch black hole at the center. According to Quantum FFF Theory, all Quasars are produced by the trillions of paired black holes spawn by the big bang and creating early Herbig Haro objects, with star and galaxies forming in between. According to Quantum FFF Theory.

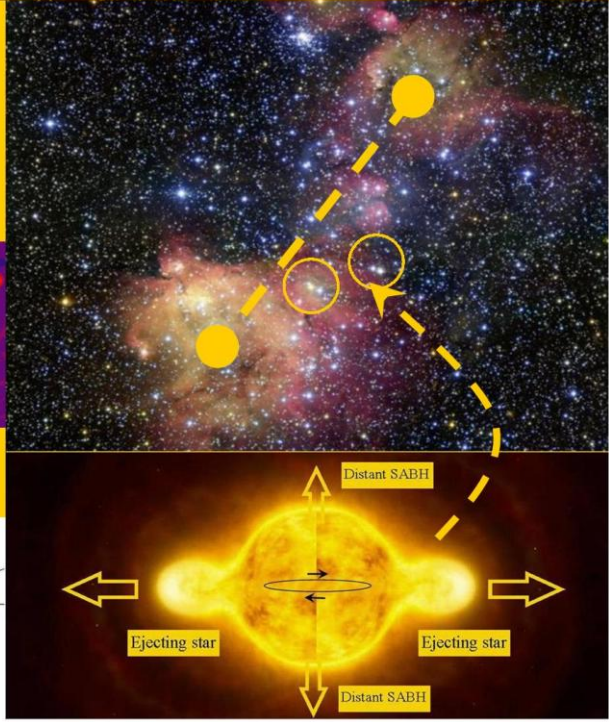
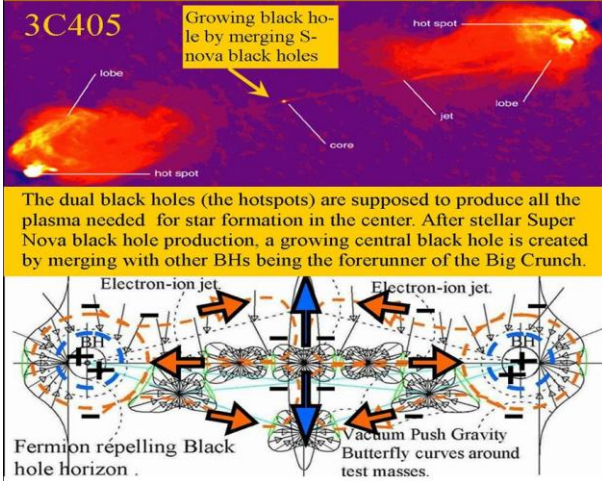

Figure 19, Binary star production .

Equivalence between gravity and acceleration does not hold in Quantum FFF Theory. Mass in motion needs a reference frame of ZPE oscillating Higgs field and Lorentz polarization of conscious propeller Fermions (s) to keep a non accelerated flight.

Quantum Gravity as pressure distribution of the oscillating dual Higgs/Graviton vector field.

Polarized Fermion Mass in motion through the resistive, but also pushing oscillating Higgs vacuum (according to Quantum FFF theory)

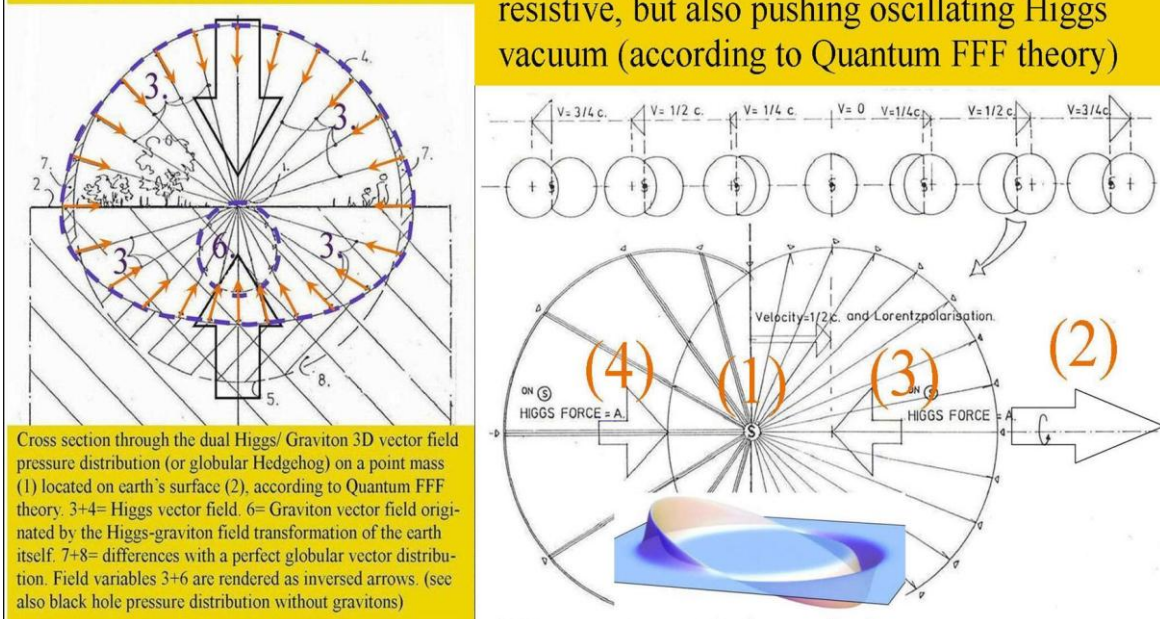
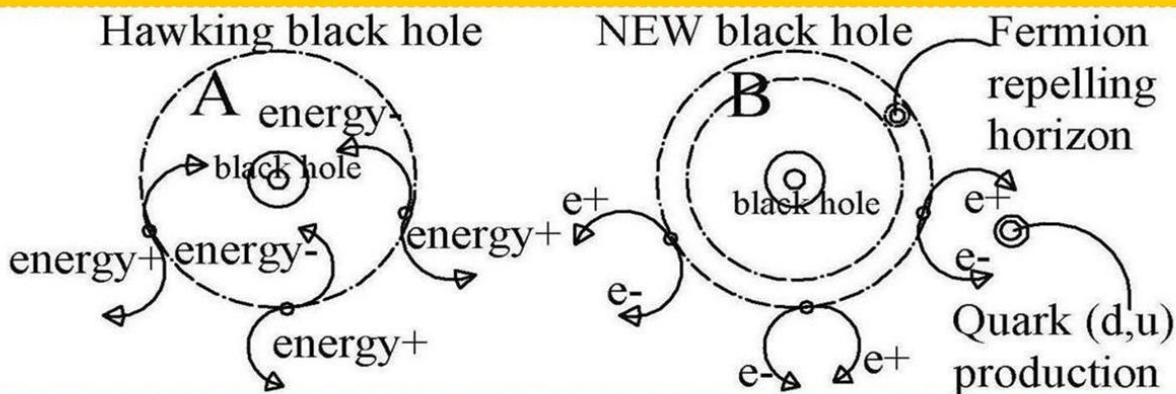

Figure 20, equivalence between gravity and acceleration does not hold in Q-FFF theory.

Fermion/ Dust production and repulsion at small (Herbig Haro) black hole horizons during and after fractal inflation.



According to Quantum FFF Theory, there is no fermion information loss, only photonic information loss in a black hole. Quantum fluctuations around the BH horizon produce pairs of leptons. e^- , e^+ and even compound quarks (d,u, etc, see Fermion 3D string propeller theory: Fermion repelling by spin flip). For tripple BH horizons see image nrs 7, 10 and 11. Event horizon=7, Inner photon ring = 10, Outer photon ring = 11. Conclusion The Big Bang did not produce instantly all the Fermions in the universes. Even now lots of Fermions are produced by all BHs even the largest primordial Big bang splinters located outside large galaxies. see also: <<http://vixra.org/abs/1410.0039>

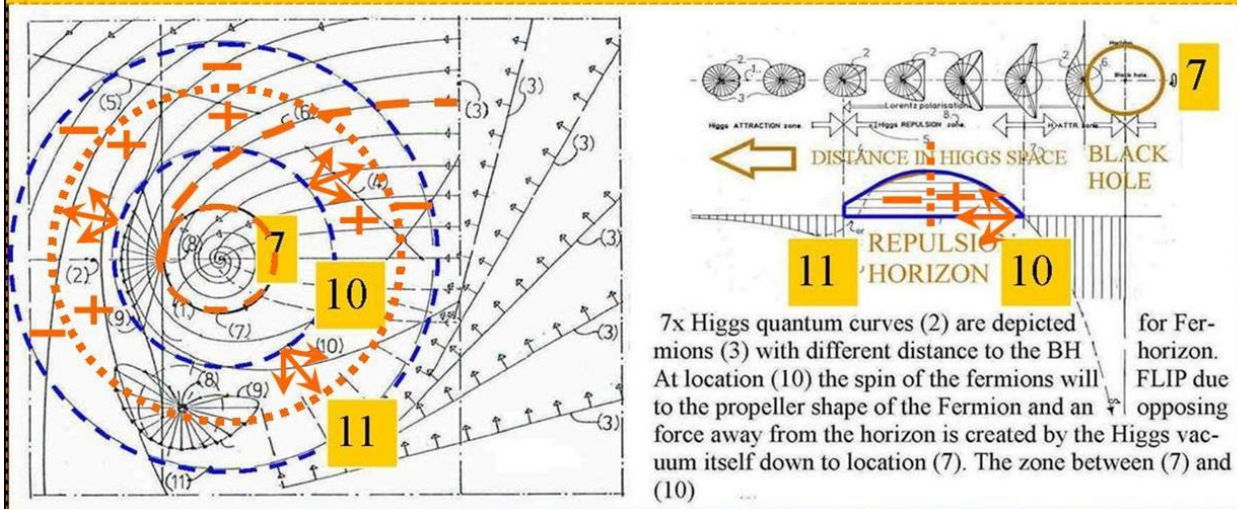
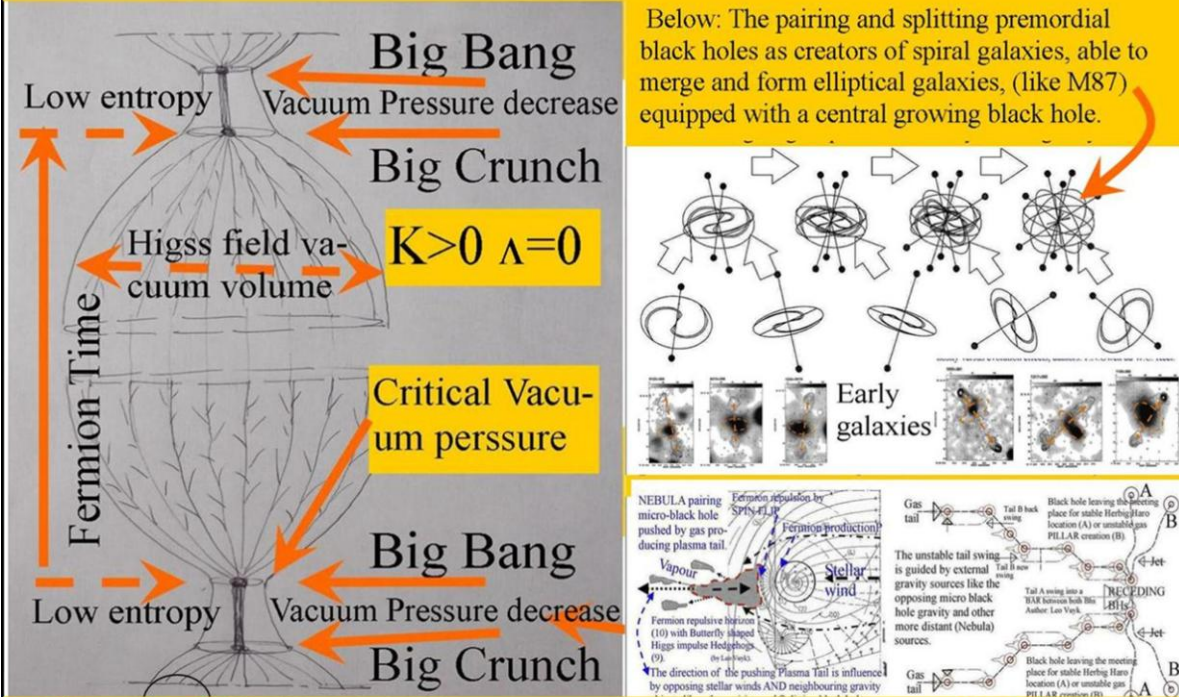

Figure 21, the new electric dark matter Black Hole paradigm.

New Cyclic Multiverse with Bang and Crunch

The Big Bang and Big Crunch originated by Black Hole splitting, pairing and recycling into massive growing central galaxy black holes, according to Quantum FFF Theory.



Below: The pairing and splitting primordial black holes as creators of spiral galaxies, able to merge and form elliptical galaxies, (like M87) equipped with a central growing black hole.

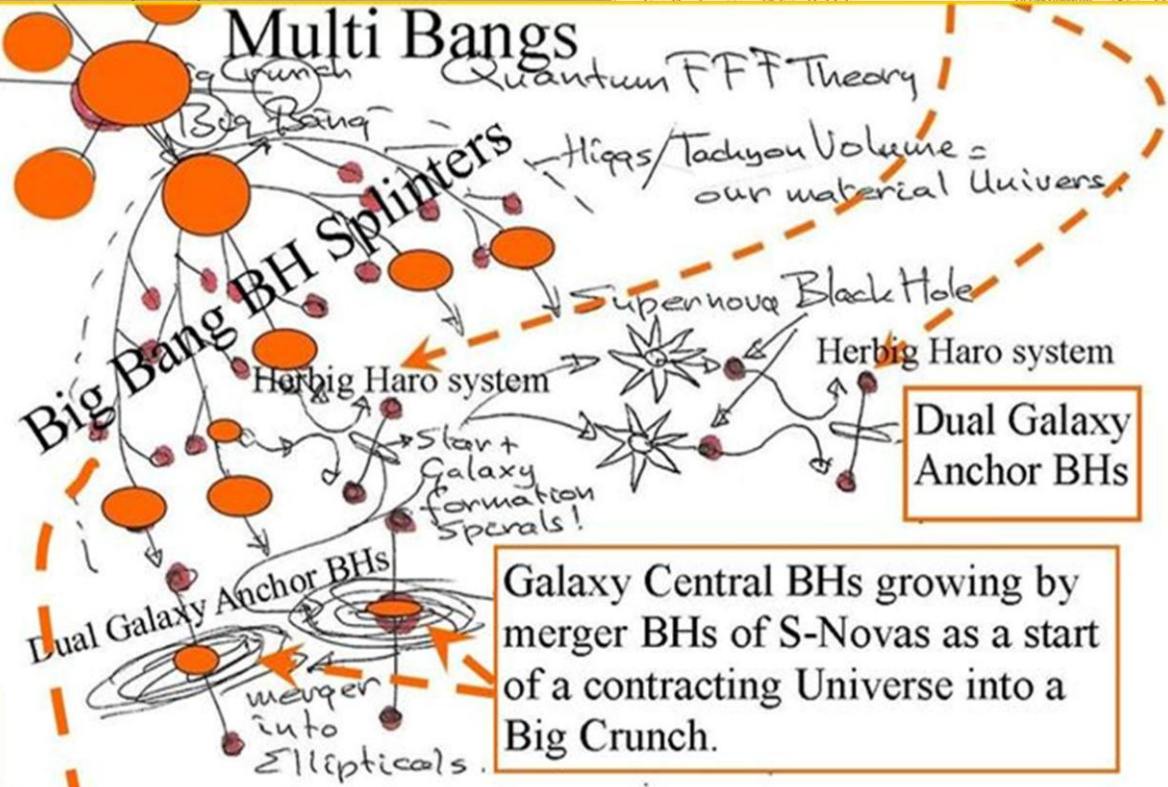
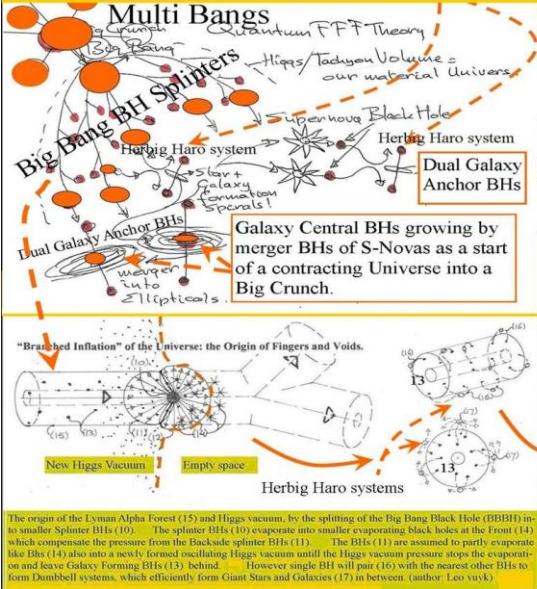

Figure 22, The new Cyclic Multiverse with CP(T) symmetric universes.

Big Bang Black Hole Nucleus Splitting and Pairing process after a Big Crunch created by central eating of smaller black holes.

The Origin of energy overdensities in the CMB
 The Cosmic Background (CMB) energy overdensities can be explained by a Big Bang Black Hole splitting and evaporation process, according to Quantum FFF Theory.



Alignment of Quasars in the L-A forest explained by Herbig Haro BH alignment.

Below: Central BH eating of smaller merger black holes (Andromeda: left) and sometimes star formation



Figure: 23, B Bang Black Hole Nucleus Splitting and Pairing Process after a Big Crunch of the Raspberry Multiverse .

Single CDF-S-XT1 and Dual MACS1423-z7p64 After the Initial B.Bang

Big Bang Black Hole Nucleus Splitting and Subsequent Pairing Process to form Herbig Haro Systems with galaxy formation in between Dual Electric Dark Matter Black Holes. Mind the difference between SINGLE and DUAL BLOBS !!
 Astronomical Mysteries solved by Quantum FFF Theory (Function Follows Form)

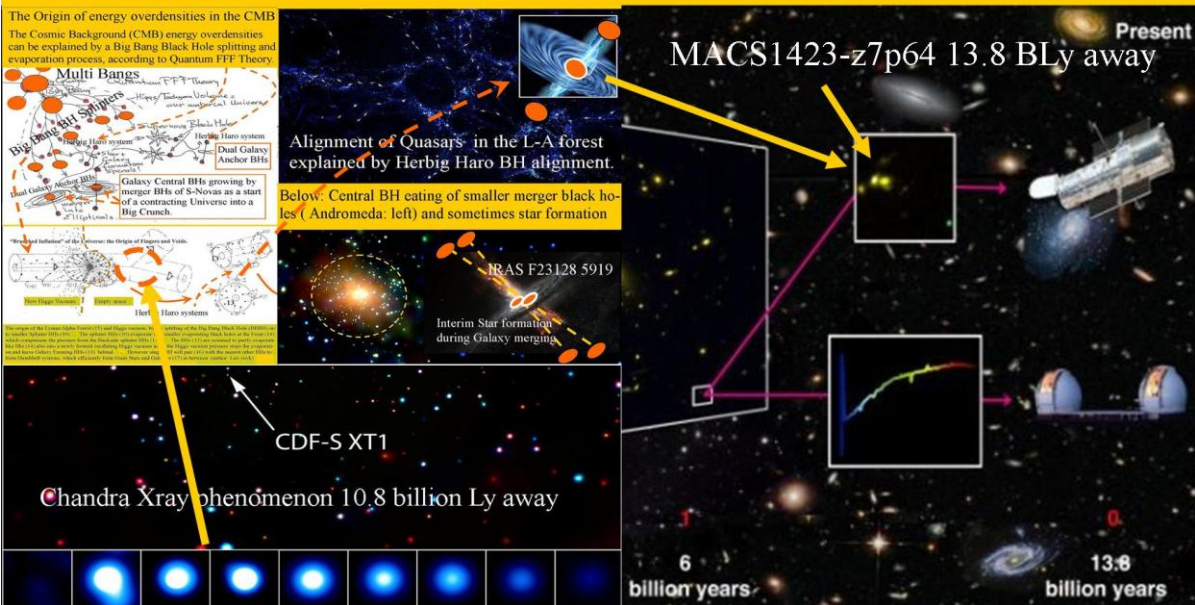

Figure: 24, Single and Double Black Hole signals in the early universe.

Supervoid alignment with the Cold Spot in the Cosmic Microwave Background. (l, b : 209/-57 degr.) a strong support for a Charge Parity entangled symmetric multiverse big bang theory.

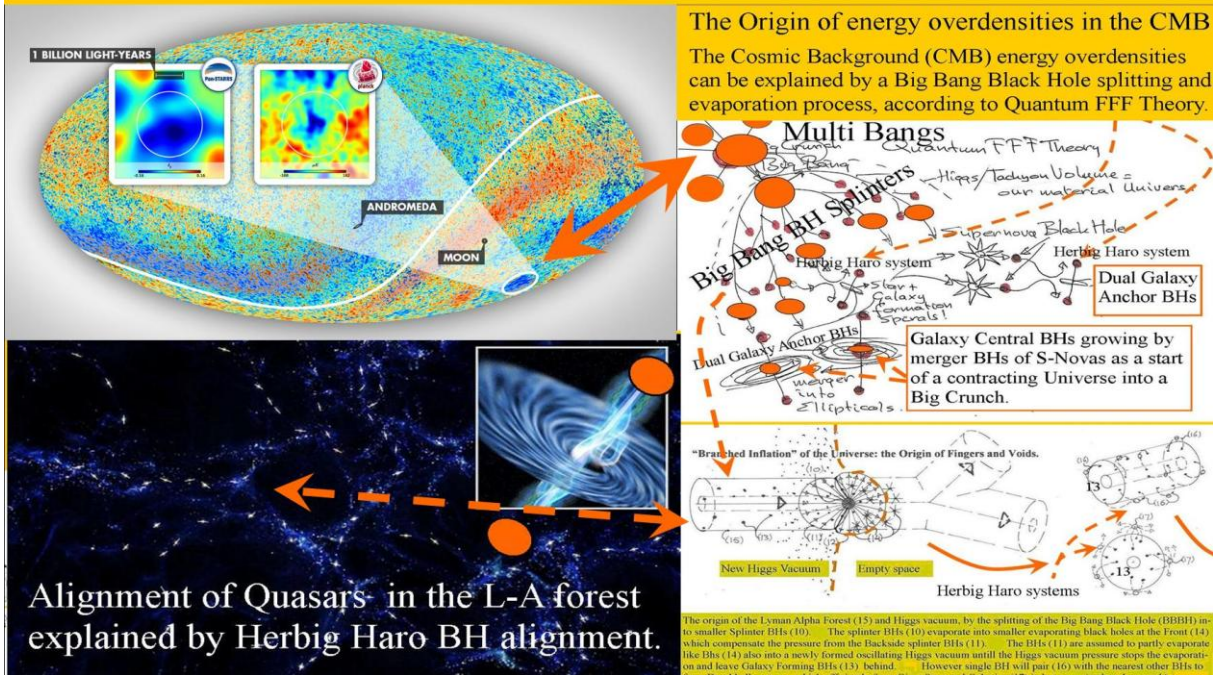

Figure: 25, Cold Spot alignment with the Supervoid. As location for the BigBang.

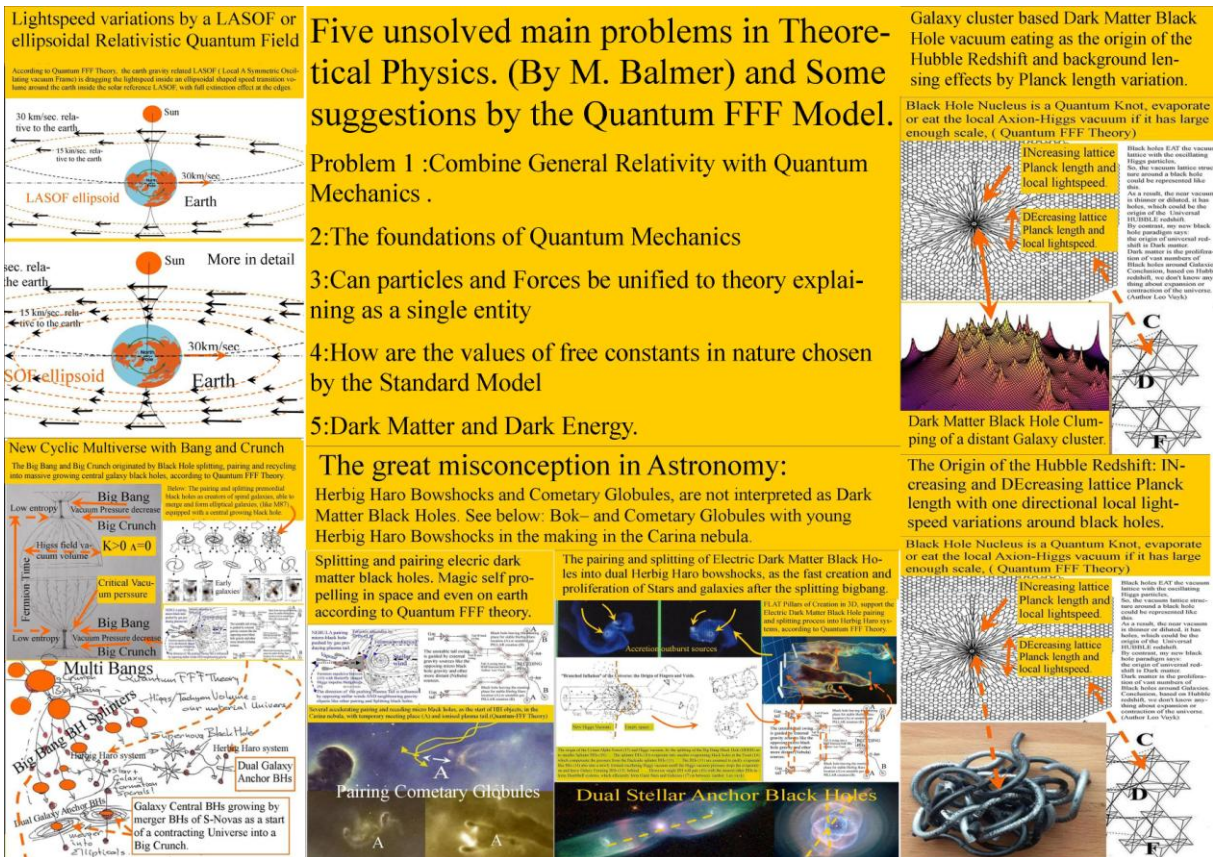
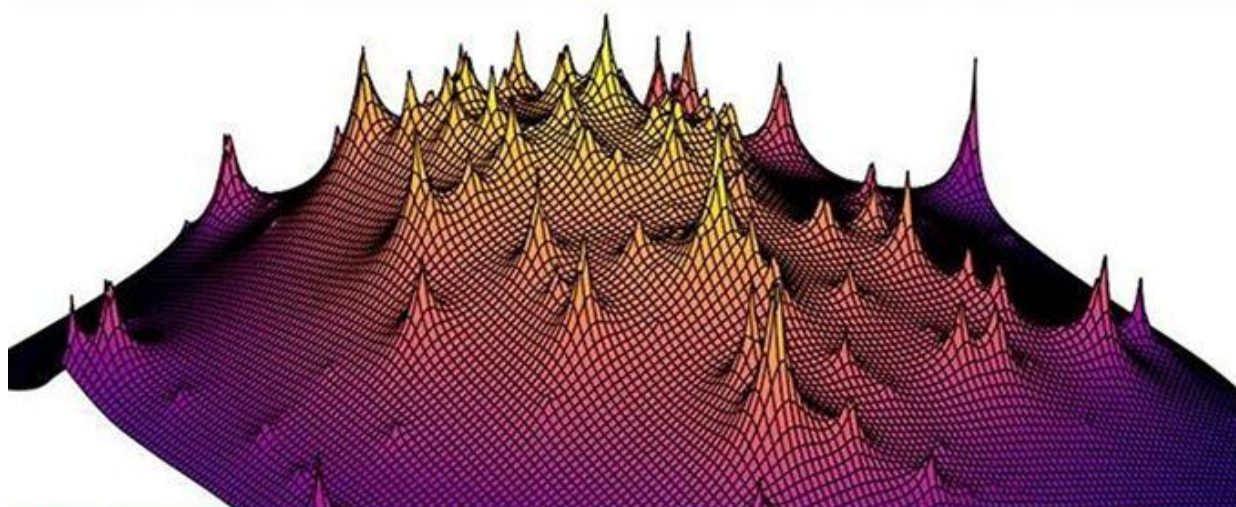

Figure: 26, Five unsolved problems in Physics.

Numerous Dark Matter peaks assumed to be Galaxy Anchor Dark Matter Black Holes.

(According to Quantum FFF Theory)

Dark matter clump 3D distributions in a distant galaxy cluster. According to Quantum FFF Theory, Galaxy Anchor Black Holes are dual grouped Big Bang Black Hole splinters mostly grouped into dual Herbig Haro systems, as a base for star and galaxy formation.



Below: Example of the clumping of dark matter black holes during temporary galaxy passage through the center of the collision area. Galaxies seem to lose their Galaxy Anchor Black Holes concentrating around the center.



Figure: 27, Dark Matter Black Hole Peakes in dark matter core of a Galaxy cluster.

High speed gas ejection (Hydra cluster, M82 and Mrk 231) as evidence for external Galaxy Anchor Black Holes (GABHs, according to Quantum FFF Theory).

Galaxy Anchor Black Hole (GABH)-
Effect on High speed gas ejection.

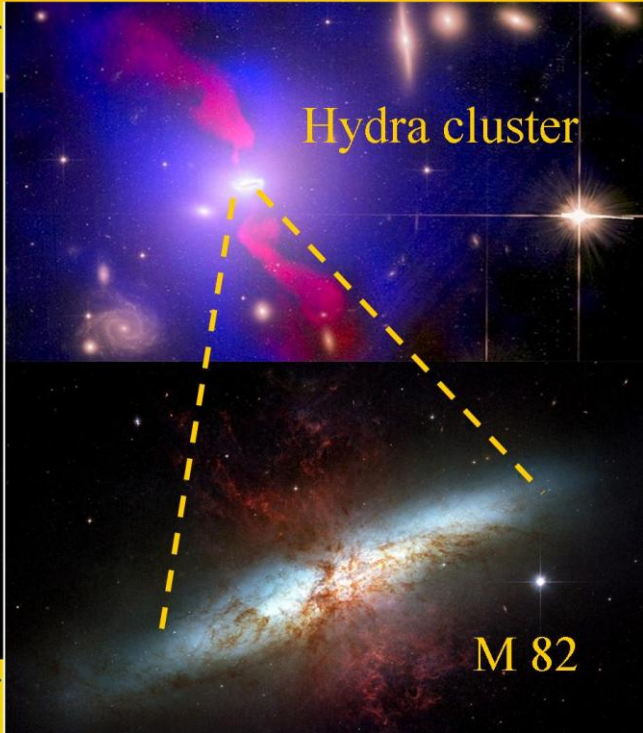
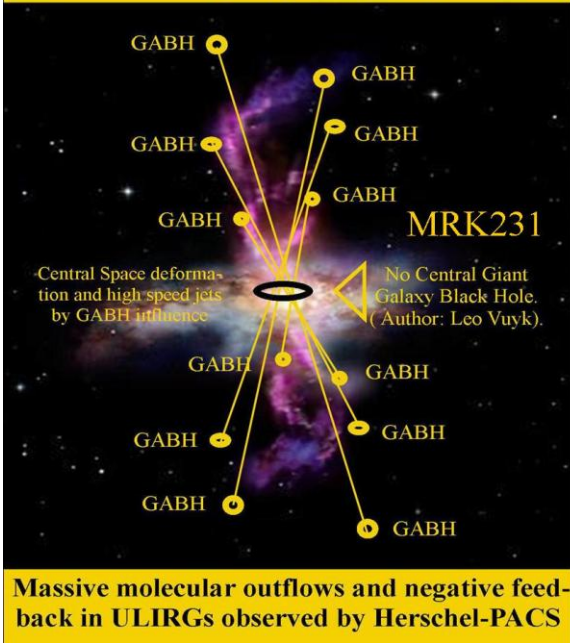

Massive molecular outflows and negative feedback in ULIRGs observed by Herschel-PACS

Figure 28, Primordial Galaxy Anchor black holes.

The NEW Plasma Creating Electric Black Hole versus the Hawking Black Hole, according to Quantum FFF Theory, the origin of Comet - Sunspot - BL mystery.

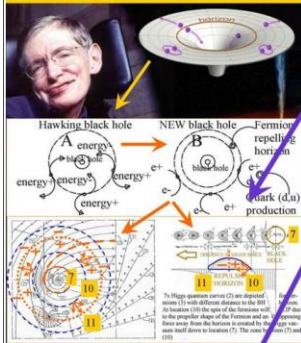

The new paradigm of star/
galaxy formation and dying.

Based on the new paradigm of Fermion repelling and creating black holes.

Electric dark matter black holes seem to have the intelligence to pair by self propulsion with other BHs of comparable size to form Herbig Haro systems with star formation in between. (according to Quantum FFF Theory)

Giant galaxies die from the inside out: Star formation shuts down in the centers of elliptical galaxies first. According to Quantum FFF Theory, Galaxy- and Cluster black hole hierarchy is the origin of dying galaxies where star formation in the center stops. X-ray point sources (Dark matter black holes) in Virgo and Perseus cluster centers present evidence for black hole hierarchy. The smallest BHs are located in the centers and are not any more able to create Supernova black holes large enough to form Herbig Haro systems with star formation in between. The result: Dying 'red and dead' galaxies as the start of Universal contraction and collapse (Big Crunch) in a cyclic multiverse.

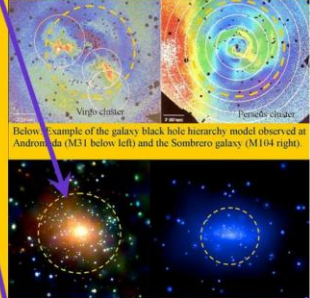

How massive galaxy clusters are formed in the early Universe. According to Quantum FFF Theory, the Big Bang process is the result of a fractal shaped splitting and evaporating BH dark matter black hole process creating the Loman Alpha structure of galaxy distribution. By the evaporation of BH 'splinters' (14) the resulting Higgs field vacuum is created by the so-called 'branched inflation'. Rotational Black hole anchors (13) do not evaporate by Higgs vacuum pressure, but create plasma 'wells' by being thrown away from the center of gravity in search for a partner to form a Herbig Haro system (16,17).

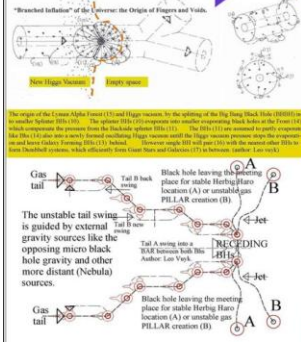

Dwarf Galaxy formation between Galaxy Anchor Black Holes (GABHs) as the Origin of stellar migration forming Polar Ring Galaxies. More GABHs means more Dwarfs means more sources for Stellar migration and bulge formation, according to Quantum FFF Theory.

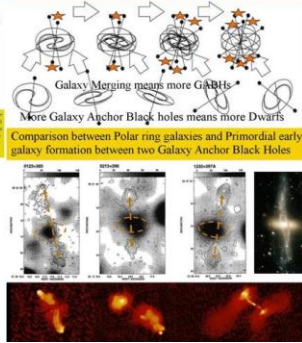

Herbig Haro and A10en current circuits are responsible for magnetic fields inside Herbig Haro star forming systems according to Quantum FFF Theory. Here, the Helix (Paw) Nebula, made by Spitzer Space Telescope. The magnetic fields influence star formation on a variety of scales, from hundreds of light-years down to a fraction of a light-year. The large gas globules are supposed to harbor young Electric Dark Matter Black Holes.

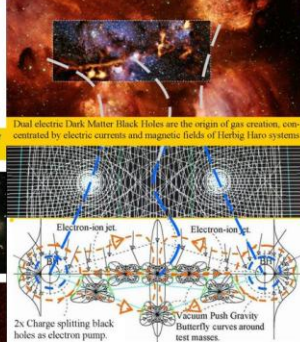

New class of 'dark' globular star clusters discovered around giant galaxy Centaurus A. Evidence for GABHs of Quantum-FFF Theory.

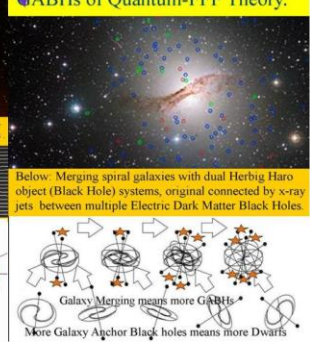
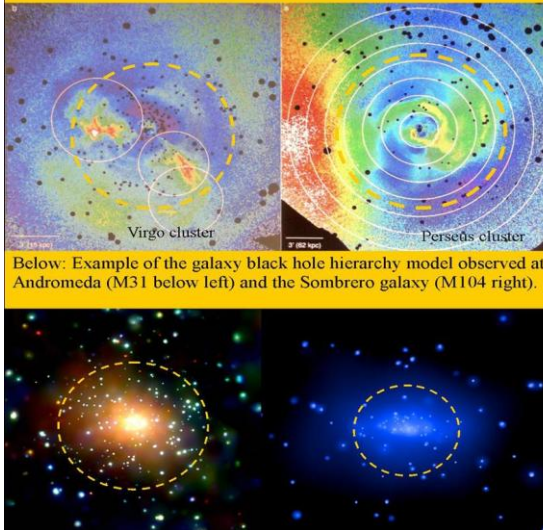

Figure 29, star formation and dying according to Quantum-FFF Theory.

The cool corus mystery of galaxy clusters: small black holes

The Virgo and Perseus cluster have cool corus and show unresolved 3.5 KeV radiation. The solution: In these centers only small black holes are pushed to be eaten by the central giant black hole.

X-ray point sources (Dark matter black holes) in Virgo and Perseus cluster centres present evidence for black hole hierarchy. According to Quantum FFF Theory (Function Follows Form), not the giants- but the smallest black holes reside in the centre of galaxies (see M104) and consequently in galaxy clusters. See also: <http://vixra.org/abs/1406.0076> Images: <http://arxiv.org/ftp/arxiv/papers/1410/1410.6485.pdf>



Below: Example of the galaxy black hole hierarchy model observed at Andromeda (M31 below left) and the Sombrero galaxy (M104 right).

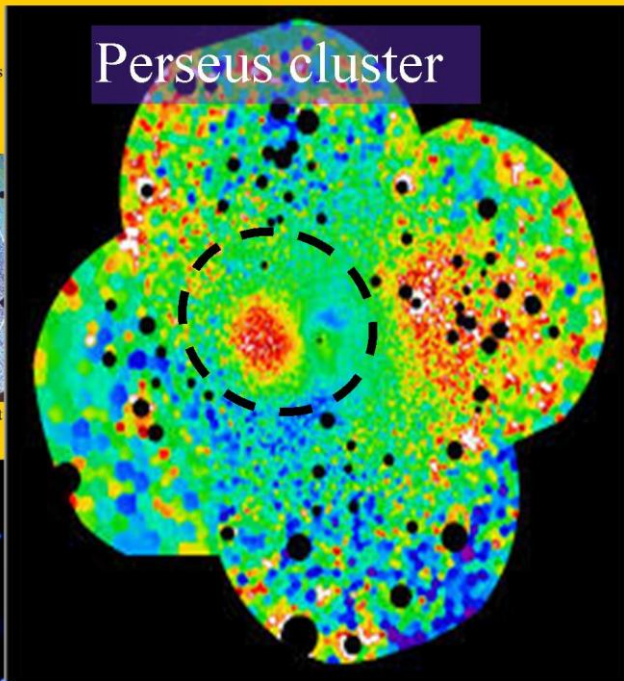

Figure 32, Cool Corus with small BHs.

Charge differences of $1/3$ and $2/3$ between d and u quarks should be originated by the chirality differences with the vacuum.

Left, the D and U Quarks of a neutron are depicted. Below the chiral oscillating Higgs field vacuum, according to Quantum FFF Theory.

Axions, Weyl Fermions

Simplified tetrahedral vacuum lattice structure (left), constructed by complex chiral tetrahedral building blocks (right). Each universe has to choose between a left- or righthanded rotation of its tetrahedral building blocks. Each chiral lattice has the Planck length and is supposed to be equipped with at least two oscillating massless new Higgs particles.

Figure 33, DDU Neutron- Quark configuration

Evidence of Galaxy Anchor Black Holes POLAR distribution: (dSph) escorting the Milky Way as a support for MW flat rotation curves and being a merger spiral galaxy with multiple dSph GABHs.

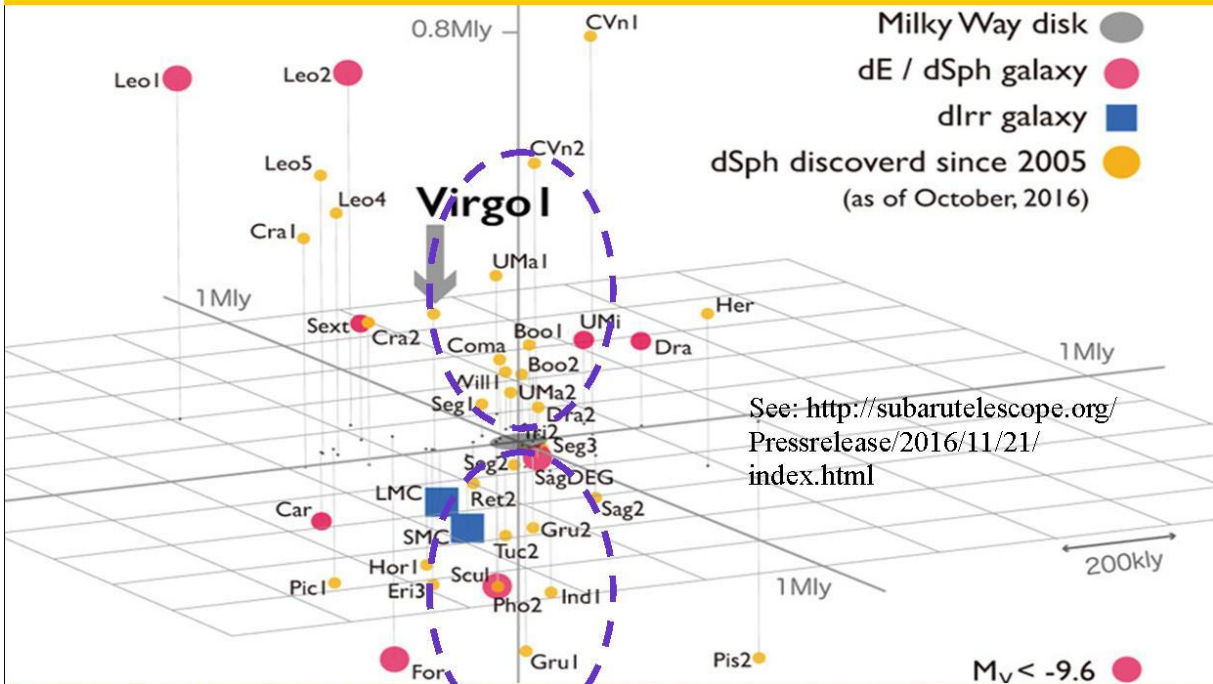

Clumpy Dark Matter around Dwarf Galaxies related to Dark Matter based Galaxy Anchor Black Holes (GABHs) according to Quantum FFF-Theory

DWARF Galaxy formation (15) in between (2+) Galaxy Anchor Black Holes (1) (GABHs= Clumpy Dark Matter) after Galaxy merging according to Quantum FFF- Theory.

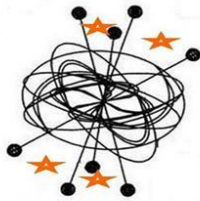
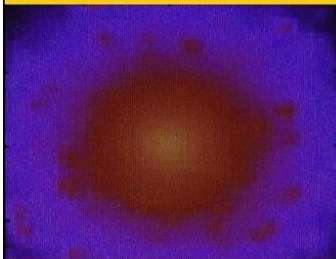

Clumpy Dark Matter also around main Galaxies such as The Sombrero galaxy. M104 is seeded with soft x-ray point sources, representing star formations like (Globular) Dwarfs (embedded in GABH-dark matter halos) and GCs (Globular Clusters with central GABHs). According to Quantum FFF-Theory, Halo Galaxy Anchor Black Holes have different sizes related to different ages.

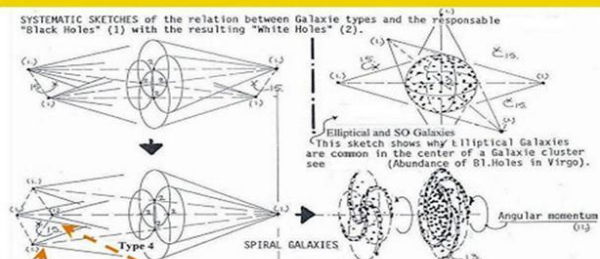

DWARFS between GABHs

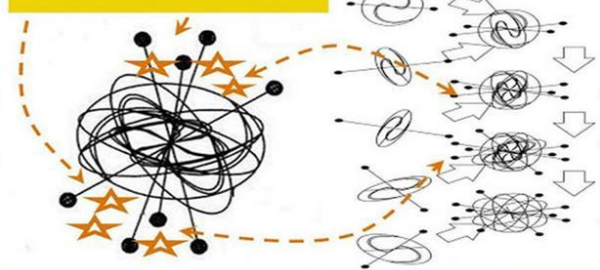

Galaxy merging

Figure 34, Polar distribution of Dark Matter BHs.

'Wasteful' galaxies launch heavy elements into surrounding halos and deep space,

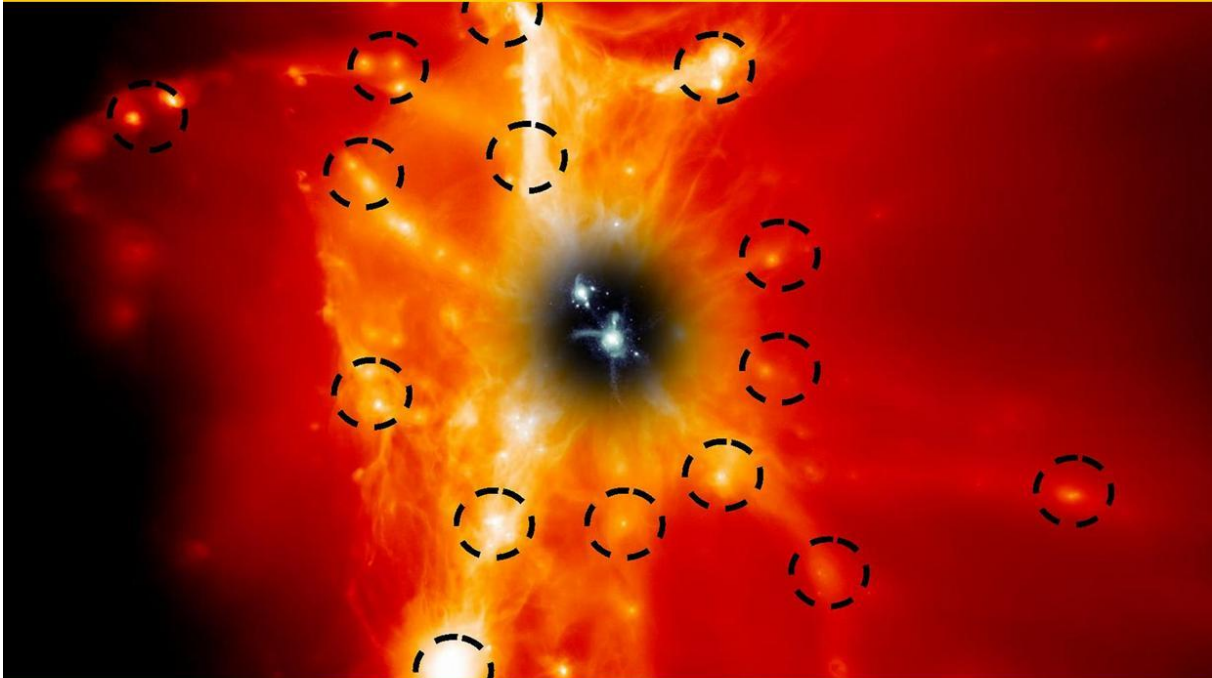

Quantum FFF Theory says: this galaxy is a young merger with multiple GABHs in the CGM. as remnants of former merger GABHs

Clumpy Dark Matter around Dwarf Galaxies related to Dark Matter based Galaxy Anchor Black Holes (GABHs) according to Quantum FFF-Theory

DWARF Galaxy formation (15) in between (2+) Galaxy Anchor Black Holes (1) (GABHs= Clumpy Dark Matter) after Galaxy merging according to Quantum FFF- Theory.

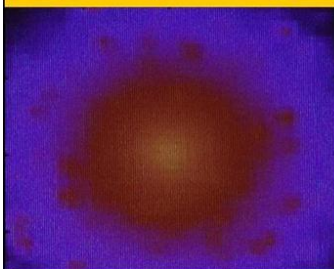

Clumpy Dark Matter also around main Galaxies such as The Sombrero galaxy. M104 is seeded with soft x-ray point sources, representing star formations like (Globular) Dwarfs (embedded in GABH-dark matter halos) and GCs (Globular Clusters with central GABHs). According to Quantum FFF-Theory, Halo Galaxy Anchor Black Holes have different sizes related to different ages.

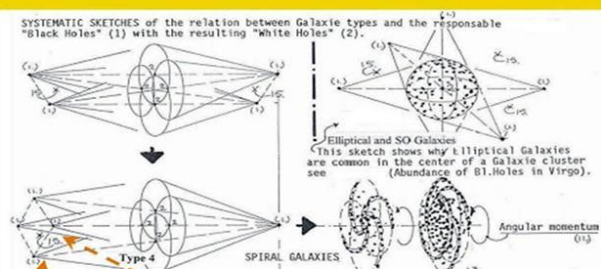

DWARFS between GABHs

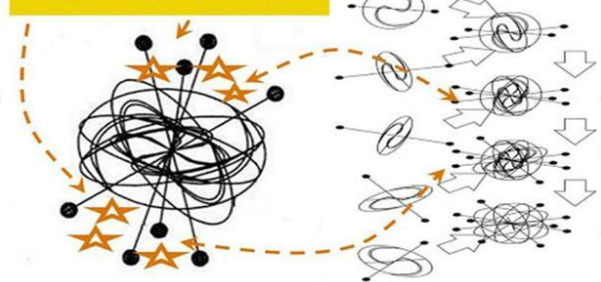

Galaxy merging

Figure 35, more evidence for BH distribution .

Einstein Cross Quadrupole effect originated by TWO or even One Quadrupole lensing Dark Matter galaxies. (Quantum FFF Theory)

2x perpendicular Galaxies form a Quadrupole (elliptic) system. Dark Matter Galaxy Anchor Black Hole (GABHs) Quadrupole of Mrk 231.

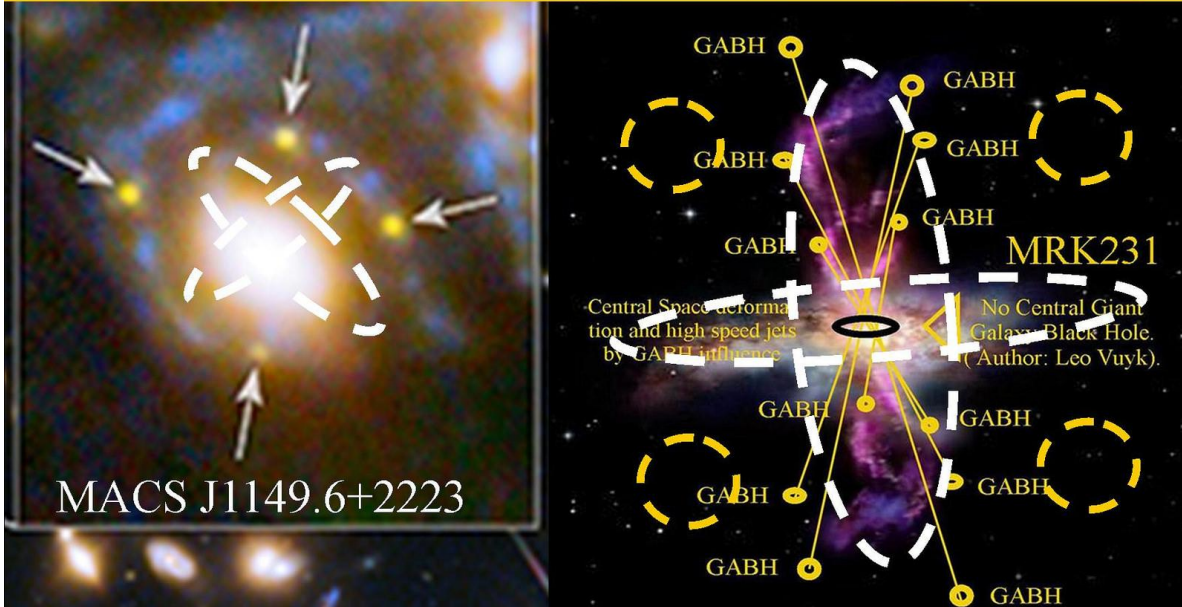
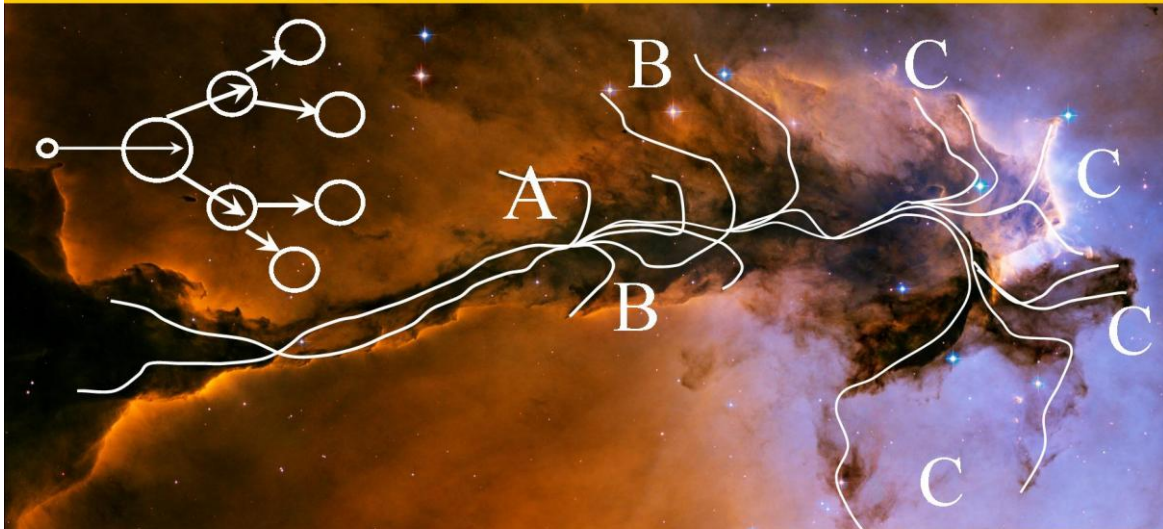

Figure 36. Einstein Cross effect explained by the quadrupole dark matter distribution of single and sometimes even dual edge-on galaxies . see also figure 29. for our single Milky Way galaxy edge on distribution of dark matter.

Black hole splitting in the Spire Eagle nebula

According to the Quantum Function Follows Form Model, small black holes split larger BHs in equal halves, (A) which are able to repel each other and form Dumbbell shaped Herbig Haro systems (B,C) with star formation in between.



At location (A) both unequal sized black holes seem to split into 4x dual sets of smaller BHs one dual set has even evolved into a second 4x dual sets of BHs.

Figure 37. Spire Eagle nebula black hole splitting

Quantum Dipole Repeller Gravity pushing our Galaxy.

According to Quantum FFF Theory, empty space is filled with a fast oscillating lattice of massless Axion-Higgs field particles as a half base for our opposing dipole pressure Higgs-graviton gravity on earth. Now prof. Yehuda Hoffman shows us a support for this hypothesis.

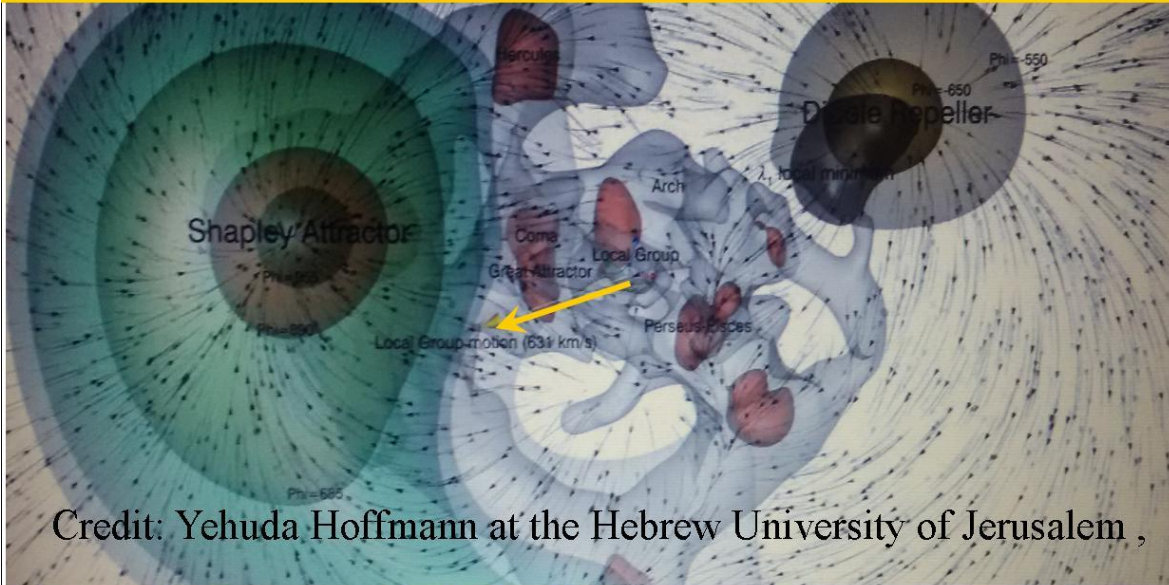

Credit: Yehuda Hoffmann at the Hebrew University of Jerusalem ,

Quantum Gravity as pressure distribution of the oscillating dual Higgs/Graviton vector field.

New Dark Matter Black Hole, "Eat" the chiral oscillating Higgs vacuum.(Quantum-FFF Theory)

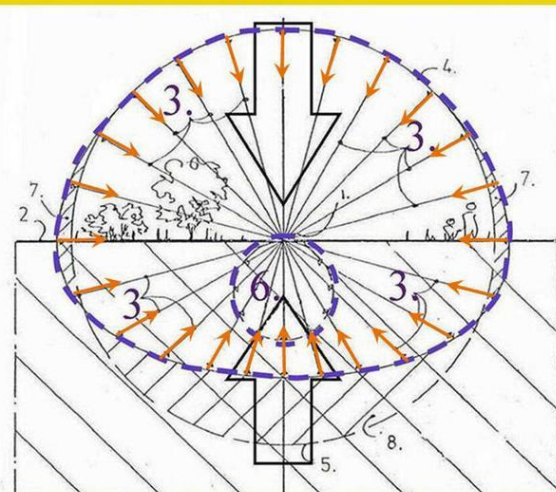

Cross section through the dual Higgs/ Graviton 3D vector field pressure distribution (or globular Hedgehog) on a point mass (1) located on earth's surface (2), according to Quantum FFF theory. 3+4= Higgs vector field. 6= Graviton vector field originated by the Higgs-graviton field transformation of the earth itself. 7+8= differences with a perfect globular vector distribution. Field variables 3+6 are rendered as inversed arrows. (see also black hole pressure distribution without gravitons)

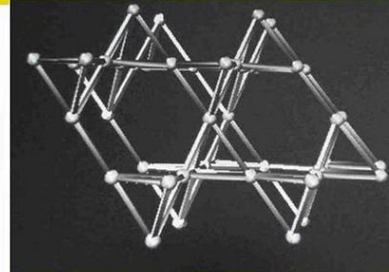

Simplified tetrahedral vacuum lattice structure (left), constructed by complex chiral tetrahedral building blocks (right). Each universe has to choose between a left- or righthanded rotation of its tetrahedral building blocks. Each chiral lattice has the Planck length and is supposed to be equipped with at least two oscillating massless new Higgs particles.

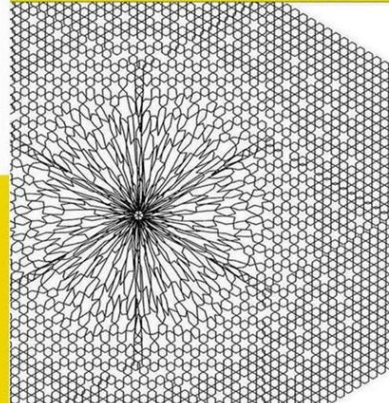
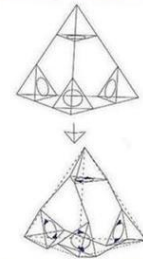

Black holes EAT the vacuum lattice with the oscillating Higgs particles. So, the vacuum lattice structure around a black hole could be represented like this. As a result, the near vacuum is thinner or diluted, it has holes, which could be the origin of the Universal HUBBLE redshift. By contrast, my new black hole paradigm says: the origin of universal redshift is Dark matter. Dark matter is the proliferation of vast numbers of Black holes around Galaxies. Conclusion, based on Hubble redshift, we don't know anything about expansion or contraction of the universe. (Author Leo Vuyk)

Figure 38, Quantum Dipole Repeller Gravity pushing our Galaxy. According to Quantum FFF Theory, empty space is filled with a fast oscillating lattice of massless Axion-Higgs field particles as a half base for our opposing dipole pressure Higgs-graviton gravity on earth. Now prof. Yehuda Hoffman shows us a support for this hypothesis.

Feynman Diagrams for Dipole Repeller Forces

Attraction and Repulsion forces created by Dipole Repeller effects between the Higgs Field vacuum (OOO) and 5x opposing Photons. (UOU, ROU, LOU, ROR, LOL)
According to Quantum FFF Theory.

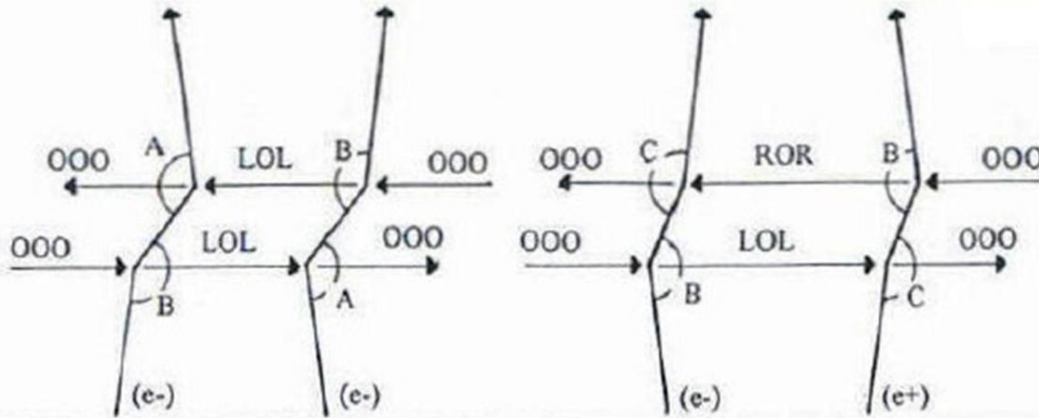

(Above) Alternative Feynman diagrams for electron-positron attraction and electron– electron repulsion by Dipole Repeller system.

Explanation of the codes:
 U= Up rotation (180 degrees)
 O= Unchanged circle.
 L= Left rotation (90 degrees)
 R= Right rotation (90 degrees)

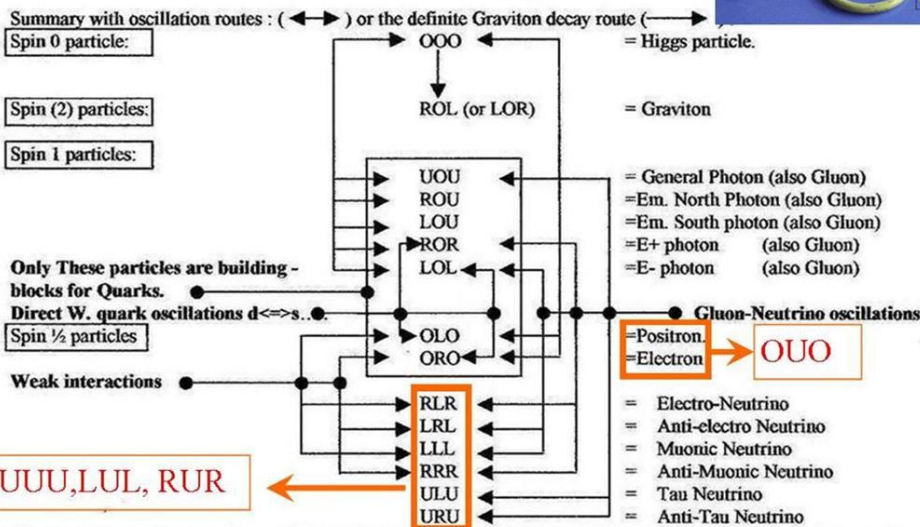
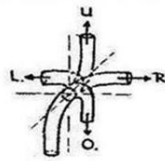

Higgs particles are supposed to oscillate in Tandem along so called linear Vacuum Lattices, two by two in opposite directions, as the symmetrical opposite pistons of a boxer engine, as the origin of all energy, spin and mass effects. This enables the Tandem Higgs particles to change the form of their own Torus into an Electron and Positron pair at

Figure 39, Feynman Diagrams for Dipole Repeller Forces. Attraction and Repulsion forces created by Dipole Repeller effects between the Higgs Field vacuum (OOO) and 5x opposing Photons. (UOU, ROU, LOU, ROR, LOL) According to Quantum FFF Theory.

References:

[71.] The New God Particle and Free Will. Author: Leo Vuyk, LuLu publishers, 2008. ISBN number 978-1-4092-1031-3 <http://www.lulu.com/spotlight/LeoVuyk>

[70.] Quantum FFF Theory is also published in the form of POSTERS at the Flickr site: <http://www.flickr.com/photos/93308747@N05/>

[69.] Numbered listing of Vixra essays by Leo Vuyk. http://vixra.org/author/leo_vuyk

[68] viXra:1611.0005 Electric Dark Matter Black Holes in the Moon (Orientale Basin)

[67] viXra:1609.0407 New Physics Elements in the Quantum Function Follows Form Model.

[66] viXra:1608.0329 God Seems to Play Dice with Dual Entangled Pinball Machines in a Supersymmetric (Susy) Multiverse

[65] viXra:1607.0376 Axion-Higgs 3-Dimensional Rigid Transformable Strings and the Compound 650 GeV Z-Z Decay into Quarks/Leptoquarks.

[64] viXra:1605.0257 Reaction Less Drive by Anti Maxwell Dead Zone Around a Wire.

[63] viXra:1604.0372 Herbig Haro Hotspots or Bowshocks Are the Origin of Star Formation, not the Result as the Mainstream Suggest.

[62] viXra:1604.0229 Er=epr in the Supersymmetric Cyclic Multiverse and in the Lab Without Strange Cats.

[61] viXra:1603.0253 Reaction Less Drive by Anti Maxwell Dropping Zone Around a Wire.

[60] viXra:1603.0240 Reaction Less Space Propulsion by the Magnetic Monopole Quantum Field Creation of an Anti Maxwellian Dropping Zone Around an Energized Electric Wire.

[59] viXra:1505.0101 The Origin of Bok Globules and Molecular Clouds, Splitting and Pairing Electric Dark Matter Black Holes.

[58] viXra:1503.0186 Primordial Dark Matter Black Holes Outside Galaxies Responsible for the Creation and Contraction of a Cyclic Universe? 22

[57] viXra:1503.0097 Quantum FFF Theory, Poster News 4.2

[56] viXra:1502.0086 Parity and Chirality as a Base for Quark-Gluon Plasma and Dust Creating Black Holes and the Beginning and End of Time..

[55] viXra:1411.0039 Quantum FFF Theory, Poster News 2

[54] viXra:1410.0039 Evidence for Dark Matter Black Hole Based Plasma, Dust and Ice Production Inside Comets Like 67P,C-G. and the Growing Earth.

[53] viXra:1409.0164 The O'Connell Effect in Eclipsing Binaries Explained by Mass Related

Light Speed Extinction Distances (Lasof) of Stars and Even Planets.

[52] viXra:1407.0001 Evidence for Evaporating Dark Matter Particles in Silicon Fireballs.

[51] viXra:1406.0076 Galaxy Formation and Evolution According to Quantum FFF Theory.

[50] viXra:1406.0019 Quantum FFF Theory Proposals for Some Unsolved Physics Problems.

[49] viXra:1405.0224 Dual Star Ejection in Open Star Clusters by the Central Star.

[48] viXra:1404.0151 Future Free Energy of New Physics Ball Lightning Black Holes, the Origin of a Super Social Society or the Opposite?

[47] viXra:1404.0002 Proposal for the Origin of Unexpected Large B-Modes Found in the Bicep2 Measurements.

[46] viXra:1402.0132 Reconciliation of GR and QM by a New Gravity-Black Hole and Lightspeed Model Called Quantum- FFF Theory.

[45] viXra:1402.0044 The Impossible Zero Point Electric Black Hole as the Origin of New Physics even for Comets like 67P,C-G.

[44] viXra:1401.0115 Calabi Yau Shaped Double Fermion Spin States.

[43] viXra:1401.0071 Democratic Free Will in the Instant Entangled Multiverse.

[42] viXra:1312.0143 The Navel Cord Multiverse with Raspberry Shape, a Super Symmetric Entangled 12 Fold Bubble Universe.

[41] viXra:1312.0076 Are Sunspots Made of Gravitating Dark Matter Black Holes?

[40] viXra:1310.0101 The New Nuclear Magic Number (34) Explained by the Polar Coaxial Ring System of Quantum FFF Theory.

[39] viXra:1310.0059 The Semi Relativistic Higgs Field Aether with Mass Related Lightspeed Adaptation.

[38] viXra:1309.0081 New Physics by Table Top Experiments.

[37] viXra:1308.0083 23 The Raspberry Shaped Super Symmetric Multiverse

[36] viXra:1307.0068 Quantum Function Follows Form Theory, the Small Scale, Posters part 1.

[35] viXra:1307.0067 Quantum Function Follows Form Theory, the Large Scale, Posters part 2.

[34] viXra:1306.0218) Dark Matter UFO Dust Particles or Quantum Knots in the LHC at CERN ?

33, viXra:1306.0065 The Splitting Dark Matter- Black Hole- Big Bang and the Cyclic Multiverse.

32, viXra:1305.0140 Quantum FFF Theory Experiments, a Summary.

31, viXra:1305.0041 The Shnoll Effect Explained by Quantum FFF Theory.

30, viXra:1304.0022 The Self Organizing Universe in the Carina Nebula.

29, viXra:1303.0211 Hubble Redshift Combined with Universal Contraction is Possible.

28, viXra:1303.0053 Micro Birkeland Currents Between Two RF Generated Plasma Balls in the Laboratory.

27, viXra:1302.0172 Silicon Based Ball Lightning Globule Structures and Signs for Accumulation and Retarded Decrease of Tunnelling Energy Bullets.

26, viXra:1301.0088 Two or Three Large Quasar Groups (LQGs) Located at the Start of Two or Three Lyman Alpha Systems and a Part of the Raspberry Multiverse?

25, viXra:1301.0050 Dwarf Galaxies and Their Relation with Dark Matter Based Galaxy Anchor Black Holes (Gabhs).

24, viXra:1210.0177 Instant Broglie Bohm Pilot Waves, the Origin of All Entanglement Effects in the Lab and Wavefunction Collapses in Our Universe as Related to Our Opposing Anti-Copy Universe(s) According to Quantum FFF Theory.

23, viXra:1209.0092 New Dark Matter Black Holes and a New Dark Energy Higgs Field, Lead to a Bouncing CP Symmetrical Multiverse, and New Experiments.

- 22, viXra:1209.0061 Birkeland Currents, Sunspots, Comets and Ball Lightning Originated by New Paradigm Dark Matter Black Holes.
- 21, viXra:1209.0030 Majorana and Sterile Neutrino Solutions in the Quantum-FFF Model.
- 20, viXra:1208.0031 Clumpy Dark Matter Around Dwarf Galaxies a Support for an Alternative Black Hole Theory According to the Quantum Function Follows Form Model.
- 19, viXra:1202.0091 Earth Magnetic Monopole Array Field Interaction with Cyclotron – Synchrotron Electrons and Muon Conversion Used for Levitation Systems.
- 18, viXra:1201.0092 Earth Magnetic Monopole Array Field Interaction with Cyclotron Electrons used for Levitation Systems.
- 17, viXra:1112.0065 24 LHC Signals Between 121-130 Gev Interpreted with Quantum-FFF Theory
- 16, viXra:1111.0096 Reconciliation of QM and GR and the Need for a Pulsating Entangled CPT Symmetric Raspberry Shaped Multiverse.
- 15, viXra:1111.0061 Black Hole Horizon Curvature Dependent Balance Between Plasma Creation and e-e+ Annihilation in Quantum FFF Theory.
- 14, viXra:1108.0036 Artificial Ball Lightning Production and Exploitation Device for Zero Point Electric Energy Usage.
- 13, viXra:1108.0006 Mass in Motion in Quantum FFF Theory
- 12, viXra:1104.0083 Quantum FFF Theory in Posters.
- 11, viXra:1104.0044 Ball Lightning, Micro Comets, Sprite-Fireballs and X-Ray/gamma Flashes According to Quantum FFF Theory.
- 10, viXra:1104.0002 Stellar Anchor Black Holes as the Remnants of Former Herbig Haro Objects
- 9, viXra:1103.0097 ZPE Zero Point Energy Examples Around Black Holes.
- 8, viXra:1103.0068 Funktion Follows Form, at the Quantum Scale and Beyond.
- 7, viXra:1103.0024 Quantum Gravity and Electro Magnetic Forces in FFF Theory
- 6, viXra:1103.0015 Wavefunction Collapse and Human Choice-Making Inside an Entangled Mirror Symmetrical Multiverse.
- 5, viXra:1103.0011 An Alternative Black Hole, Provided with Entropy Decrease and Plasma Creation
- 4, viXra:1103.0002 3- Dimensional String Based Alternative Particles Model
- 3, viXra:1102.0056 Experiments to Determine the Mass Related Lightspeed Extinction Volume around massive objects.
- 2, viXra:1102.0054 Atomic Nuclear Geometry Based on Magic Number Logic.
- 1, viXra:1102.0052 Construction Principles for Chiral “atoms of Spacetime Geometry.

=====