

# JOURNEY OF THE UNIVERSE FROM BIRTH TO REBIRTH WITH INSIGHT INTO THE UNIFIED INTERACTION OF ELEMENTARY PARTICLES WITH SPIRAL STRUCTURE

Suraj Kumar

Email: [surajkumar600s@gmail.com](mailto:surajkumar600s@gmail.com)

PACS: 10, 11, 21, 31, 32, 41, 95, 96, 97, 98

## Abstract

In this paper it has been tried to propose a hypothesis for Universe life cycle from its birth to death along with a cyclic view into its rebirth referring to the concept of Cosmic Microwave Background Radiation, Spiral Structure of Galaxies and Spiral Structure of Elementary Particles. It has been tried to inherit the behaviour of Big Bang in consensus with the proposals of Steady State Cosmology within the vicinity of all modern ongoing researches. It also provides a unified approach for various force interactions of particles through the intrinsic behaviours of Spiral Structure of Elementary Particles. The inverse relation between mass of particle and rate of change of cross section of spiral arms gives us a distinct view of gravitational interactions. Also the orientation of the curl of spiral differentiate the electromagnetic interaction when has revolution and electroweak interaction when has rotational curl. Strong interaction can be described through the phase differences of particles with charge not in multiple of  $\frac{1}{2}$ . This paper also describes the process for formation off composite particles and the atomic structure through various dynamics of interactions by spiral structured particles.

**Keywords:** spiral, particles, intrinsic, quasi-particles, universe, dark matter and dark energy;

*(If the cosmos were to suddenly frozen and all movement ceased, a survey of its structure would not reveal a random distribution of parts. Simple geometric patterns, for example, would be found in profusion from the spirals of galaxies to the hexagonal shapes of snow crystal. Set the clockwork going, and its parts move rhythmically to laws that often could be expressed by equations of surprising simplicity. And there is no logical or a priori reason why these things should be so.) – Martin Gardner “Order & Surprise (1985)*

**Introduction:**

**Birth of the Universe**

Initially the Universe was a heat ball with temperature  $-273.23$  Kelvin i.e. absolute zero. It was in condensate and inactive due to continuous and simultaneous constructive and destructive interferences of Heat Potent Waves. These waves constitute the Dark Energy which was dormant in the beginning to initiate Universe formation waiting for trigger of spontaneous symmetry breaking which at the beginning for the birth of universe is called as Big Bang. The first fundamental force in action to trigger the spontaneous symmetry breaking was Gravity whose field of Interaction is consecutive cycle of two waves which satisfies the concept of gravitons having spin 2 as described in spiral structure of elementary particles [1]. With the change in  $dQ/dx$  linearly corresponding to  $dr/d\theta$  (where  $Q$  is the amplitude corresponding to radius of cross section of spiral arm), the parent wave gets the Higgs field to give birth to child particles out of graviton. This Higgs Field consists of two oppositely charged metastable particle which makes its charge equals zero. The metastable particles have Spin 0.

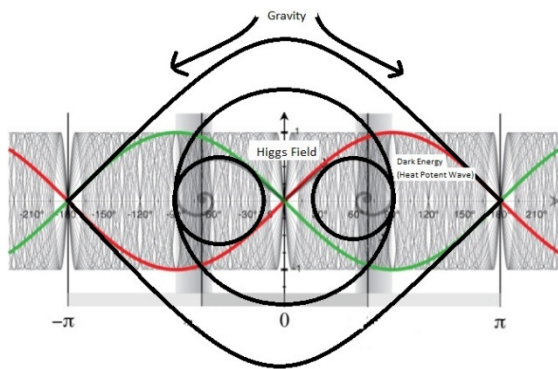

Fig 1: Explains the initiation of Higgs field due to gravity with declining  $dQ/dx$ .

The Higgs field provides the spontaneous symmetry breaking arising from the gravitational force originating through the diminishing amplitude of the stationary heat potent waves to the symmetric cancellations of Heat Potent Waves. This result in formation of two bosons with spin 1 (if formed with potential of graviton) or two fermions i.e. pair of particle and anti-particle with spin  $\frac{1}{2}$  (if formed

with the potential of parent wave), which creates gravitational field to further create the Higgs field in adjacent waves. This initial process can be an evidence for the existence of Cosmic Microwave Background Radiations which was created in recombination era. The process disturbs the condensate state of Dark Universe and results in gain of spontaneous heats which get redistributed along with the continuous formation of particles resulting in expansion of Universe. When the parent wave damps in response to the gravity action beyond the radius of Higgs Field. The Higgs Field disintegrates into a pair of Z or W bosons which carry the weak charges with Spin 1 depending on the rotational orientations of the field lines in Higgs Field.

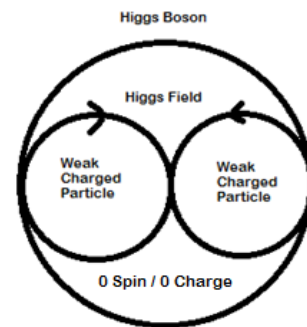

Fig 2: The Higgs Boson with its field constituted by two opposite weak charged particle.

For example if Higgs disintegrates into Z bosons, its orientation would be as:

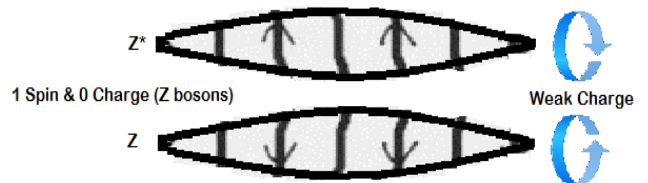

Fig 3: The orientation of curl in weak charged Z boson.

Weak charges represents the rotation of particle on the axis passing through both the nodes of the heat potent wave unlike the electric charges which are due to revolution of Spiral arms around an axis passing vertically through the node or antinodes of the heat potent wave. As shown in figure below:

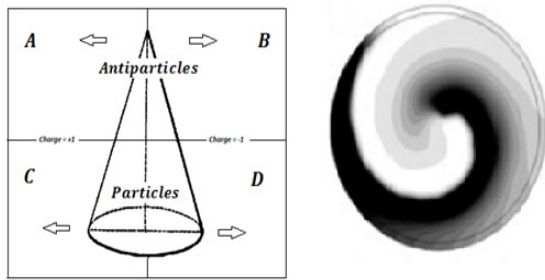

Fig 4: The orientation of curl in electromagnetically charged particle and antiparticles.

This leads to the creation of independent spiral waves which are travelling in stationary media. The spontaneous breakup of an isolated spiral leads to the creation of numerous other spirals which settle into a state commonly known in as "Spiral Glass". The tip followed complex trajectories in contrast to the circles traced out when the wave is rigidly rotating. Dwight Barkley found that the dynamics were centred on a resonant Hopf Bifurcation where eigenmodes of the bifurcation interacted with those of the system's Euclidean symmetry.

Once a rigidly rotating spiral wave destabilises in Hopf Bifurcation, meandering or drifting spiral waves bifurcate. Meandering spiral waves comes in two flavours, namely inwardly and outwardly. It is the motion of their tip that distinguishes these spirals from rotating spiral wave. The Hopf Bifurcation adds another frequency to the temporal dynamics of bifurcating spiral wave which induces Doppler Effect resulting in the dynamics of Atomic Interactions.

The parent wave responsible for triggering the spontaneous symmetry breaking can be traced back in the Cosmic Microwave Background Radiation Maps generated by WMAP (Wilkinson Microwave Anisotropy Probe) & PLANCK satellites which shows tiny temperature fluctuations that correspond to regions of slightly different densities at very early times, representing the seeds of all future structure: the stars and galaxies of today.

Two CMB anomalous features hinted at by Planck's predecessor, NASA's WMAP, are confirmed in the new high-precision data. One is an asymmetry in the average temperatures on opposite hemispheres of the sky (indicated by the curved line indicating the parent wave of initial formation

phase), with slightly higher average temperatures in the southern ecliptic hemisphere and slightly

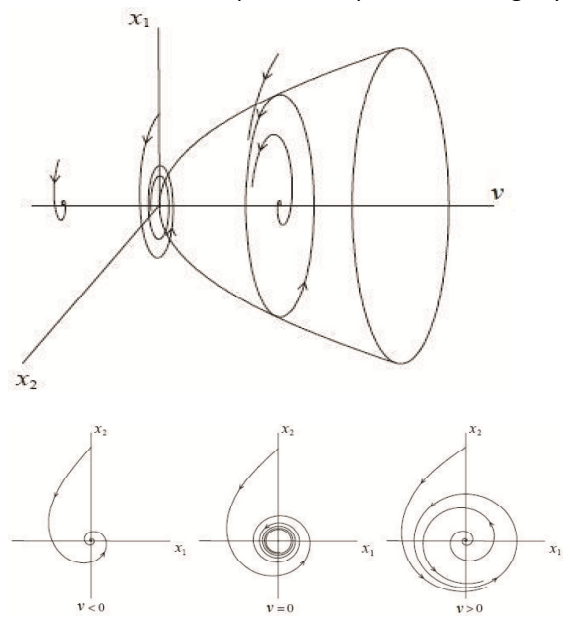

Fig 5: Supercritical Hopf Bifurcation in stable state when operating value of parameter is less than critical value of parameter.

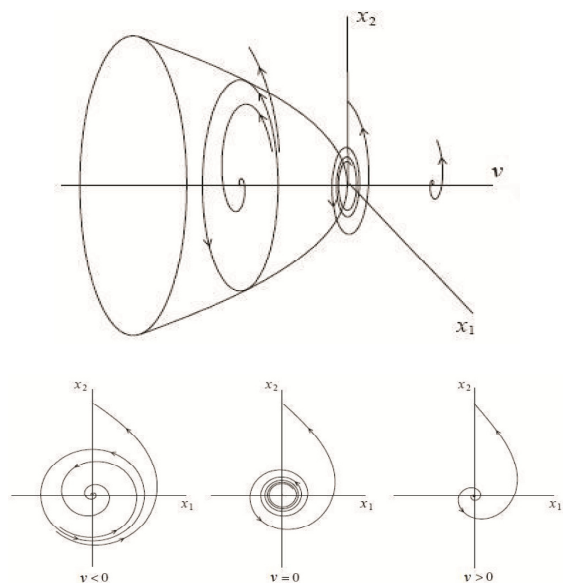

Fig 6: Supercritical Hopf Bifurcation in unstable stable state when operating value of parameter is more than critical value of parameter.

lower average temperatures in the northern ecliptic hemisphere. There is also a cold spot that extends over a patch of sky that is much larger than expected (circled). This cold spot is the origin of the new parent wave front which goes through the phase of particle formation and gets into highly dense and hot portion of the map represented by the redder portion of the southern hemisphere

which letter on redistributes itself according to the potentials of Dark Energy constituted by Heat Potent Waves to form perfect Universe.

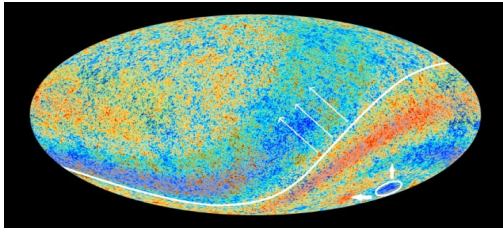

Fig 7: CMB Map by ESA's PLANK.

### Formation of the elementary particles with spiral structures:

The quest for search of a unified theory that could explain all the fundamental interactions of the Universe i.e. Gravity, Electromagnetic, Strong and Weak interactions has been a priority for more than a century in physics society.

The Standard Model has given us the rates at which interactions takes place. The rigorous efforts have unified the Electromagnetic and Weak interactions in Electroweak Theory. But, the Standard Model is incomplete as it does not incorporate the most important force of all i.e. Gravity which guides the working of the Universe as whole. Through various hypothesis, it is expected that all the interactions unifies together at  $10^{19}$  GeV energy.

In this paper we will look at how the structure gets formed and how it induces the different interactions including Gravity.

#### Ingredient:

From [1], we know that the mass of elementary particle is proportional to  $\frac{1}{\left(\frac{dr}{d\theta}\right)}$  and the potential function guiding the formation of particle is:

$$\Rightarrow \mathbf{u}_t = \mathbf{D}[\mathbf{Grad}(\mathbf{Div}(\mathbf{u})) - \mathbf{Curl}(\mathbf{Curl}(\mathbf{u}))] + \mathbf{f}(\mathbf{u})$$

With  $\mathbf{D} = \mathbf{1}$  as the spiral is in saturated system, with rate of autocatalysis equals the square of speed of light i.e.

$$\Rightarrow \mathbf{y}(\text{rate of autocatalysis}) = \mathbf{c}^2$$

Where  $\mathbf{f}(\mathbf{u})$  represents the produced spiral structure of elementary particle i.e. the work done against decayed potential.

For the formation of Spiral Structure of elementary particles we need a heat potent wave of length of  $\mathbf{h}\mathbf{u}$  (i.e. measuring length in terms of energy unit taking the wavelength constant to Planck's length) is obtained from the Heat Potent Waves of Dark Energy as presented in previous section by the mass-energy relation i.e.

$$\Rightarrow \mathbf{E} = \mathbf{m} \mathbf{c}^2$$

Here  $\mathbf{c}^2$  are considered to be the **rate of autocatalysis** at which the process output itself is catalysis for that process.



Fig 8: The ingredient heat potent wave for bosons and fermions.

The process of autocatalysis creates curls at different wavelength of the above ingredient heat potent wave to create spirals for elementary particles.

#### **Structure of Particles:**

Since the particle is formed from the part of Heat Potent Wave, considering the structure of fermions we know that,

$$\Rightarrow \text{Mass is propotional to } \frac{1}{\left(\frac{dr}{d\theta}\right)}$$

The transverse heat potent waves, which are ingredient to the spiral structure of

elementary particles, can relatively have the proportionality as:

$$\Rightarrow \text{Mass is propotional to } \frac{1}{\left(\frac{dQ}{dx}\right)}$$

Thus, the fundamental unit of mass can be assumed to have  $U = 1$  with mass as  $h$  (**Planck constant**) derived from the creation triggering Heat Potent Wave Potential.

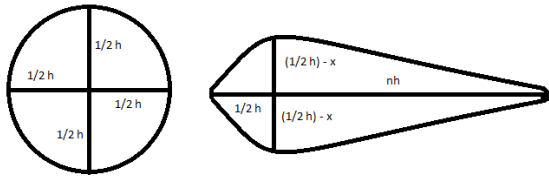

Fig 9: Fundamental unit structure of mass and extended half wave form for fermions.

Considering fermions, the particles having frequency more than 1 have a structure of extended half wave form i.e. length of Spiral

as  $\frac{1}{2}h + nh$ , wavelength of Parent Heat Potent Wave as  $2nh$  and frequency of child particle as  $n$ . The extended wave form produced from stretching the fundamental unit structure of mass that is sphere with radius of  $\frac{1}{2}h$  would have its vertical diameter diminished by a quantity  $2x$ . The value of  $x$  for different  $n$  has been derived in the following table:

$n$	$x_1$	$x_2$	$x_3$
0	-0.293701	0.89685 - 0.687365 $i$	0.89685 +0.687365 $i$
$\frac{1}{2}^*$	-0.0651977	1.2826 +0.521714 $i$	1.2826 - 0.521714 $i$
1	0	1.5	1.5
In above measures the fundamental unit of mass i.e. with $U = 1$ was influenced by the positive potential and diverges rotating outwards to account for energy distribution of the overall positive potential of Universe which is observed in CMB. It is unstable to exist as a particle.			

### Observable Particles: Phase I

$n=3$ :

$$\{x \rightarrow 3.95819 - 1.38778 \times 10^{-16} i\}, \{x \rightarrow 0.140088 - 4.44089 \times 10^{-16} i\}, \{x \rightarrow 0.901721 + 6.66134 \times 10^{-16} i\}$$

$n=4$ :

$$\{x \rightarrow 4.97503 - 2.77556 \times 10^{-17} i\}, \{x \rightarrow 0.177989 - 4.44089 \times 10^{-16} i\}, \{x \rightarrow 0.846979 + 4.44089 \times 10^{-16} i\}$$

$n=9/2$ :

$$\{x \rightarrow 5.47984 - 1.66533 \times 10^{-16} i\}, \{x \rightarrow 0.827109 + 1.11022 \times 10^{-15} i\}, \{x \rightarrow 0.193054 - 6.66134 \times 10^{-16} i\}$$

### Phase II

$n=5$ :

$$\{x \rightarrow 5.98337 + 2.77556 \times 10^{-17} i\}, \{x \rightarrow 0.206232 + 2.22045 \times 10^{-16} i\}, \{x \rightarrow 0.810397 - 2.22045 \times 10^{-16} i\}$$

$n=500$ :

$$\{x \rightarrow 501. - 6.93889 \times 10^{-18} i\}, \{x \rightarrow 0.468394 - 8.52651 \times 10^{-14} i\}, \{x \rightarrow 0.531608 + 8.52651 \times 10^{-14} i\}$$

$n=300000000$ :

$$\{x \rightarrow 3. \times 10^8 - 1.01644 \times 10^{-19} i\}, \{x \rightarrow 0.499959 - 3.72529 \times 10^{-7} i\}, \{x \rightarrow 0.500041 + 3.72529 \times 10^{-7} i\}$$

$n=(10^{10})$ :

$$\{x \rightarrow 5. \times 10^{10} - 9.52912 \times 10^{-21} i\}, \{x \rightarrow 0.499994 - 0.0000762939 i\}, \{x \rightarrow 0.500002 + 0.0000762939 i\}$$

### Phase III

$n=10^{11}$ :

$$\{\{x \rightarrow 5. \times 10^{11} - 1.69407 \times 10^{-21} i\}, \{x \rightarrow 0.499969 - 0.000396729 i\}, \{x \rightarrow 0.499969 + 0.000396729 i\}\}$$

$n=10^{14}$ :

$$\{\{x \rightarrow 5. \times 10^{14} - 5.9557 \times 10^{-23} i\}, \{x \rightarrow 0.484375 - 0.5 i\}, \{x \rightarrow 0.484375 + 0.5 i\}\}$$

$n=10^{16}$ :

$$\{\{x \rightarrow 5. \times 10^{16} - 2.39882 \times 10^{-23} i\}, \{x \rightarrow -2. - 192. i\}, \{x \rightarrow -2. + 192. i\}\}$$

**Remarks:** The first value of  $x < 0.5$  is the accepted value and the imaginary part of it accounts in the expansion of radius possible in influence of Dark Potentials like that of due to acceleration. The second value of  $x$  i.e.  $0.5 < x < 1$  is the marginal effect on  $x$  with addition of one more energy sphere of radius  $\frac{1}{2} h$ . In this situation the value of  $x$  is subtracted from the energy sphere of radius  $h$ . The imaginary part of the third value of  $x$  is the oscillatory radius variation of particle in effect of its corresponding super symmetric particle.

### Observations:

- ⇒ In **Phase I**, there is very less influence of dark potentials and the real radius of rest particle is dominant, the marginal effect on  $x$  with addition of one more energy sphere of radius  $\frac{1}{2} h$  makes the particle unstable as the sum of real part of both the values of  $x$  exceeds 1 and either decay off or disintegrates. The imaginary part of first and second value of  $x$  are not equal thus results in induced instability in Dark potentials.
- ⇒ In **Phase II**, except for  $n=5$ , rest all particles are stable with addition of energy sphere as sum of real part of both first and second value of  $x \leq 1$ . Thus, it's possible for particle to get into short lived metastable state with consecutive emissions of photons. Also since the imaginary part of first and second value of  $x$  is equals, it satisfies the stability even in influence of Dark Potential.
- ⇒ In **Phase III**, there is not much effect on addition of energy sphere and the extra energy is readily absorbed without radiating off. It has high influence of Dark Potentials and the particle satisfies the stability therein.
- ⇒ In the formation cycle of particle, the spontaneous symmetry breaking resulted in formation and acceleration of spiral particles as in **Phase I** and it continued until stable particles where obtained with conservation of stability even in the influence of the Dark Potentials as in **Phase II**.
- ⇒ **Phase III** defines the particle of extra large structure and massive singularities in the Universe.

### Oscillatory Phase:

It's being observed that particle with  $n > 10^{16}$  have negative value of  $x$  and results in positive potential interactions of Dark Energy resulting in accelerated expansion. This positive potential oscillates between  $n=10^{171}$ ,  $10^{175}$  &  $10^{179}$  where the real and imaginary part of first and second value of  $x$  is 0 with negative value of  $x$  in between these values of  $n$ . Thus, in this condition there are chances for existence of extremely massive particle or singularities or even can be the boundary of Parallel Universe as the celestial composite structure behaves as a singular particle in

terms of Dark Potential. The same values of  $x$  could be observed above  $n=10^{309}$ , but it's not oscillatory and continues to hold the same value further on. Hence, it can be concluded that the ceiling for the maximum value of  $n$  possible in The Universe is  $10^{309}$ .

**Formation of Nucleus:**

A Nucleus consists of protons and neutrons bounded or existing together irrespective of electromagnetic interactions. This is possible with existence of colour charges, weak charges and gluons together. For a composite particle like protons or neutron the quarks having distinct phase differences of their front i.e. colour charge combines together in accordance with the electromagnetic charges (to form integer multiple of charges) combines together to form a stable integer charged particle where gluon is the medium of exchange which regulates the phase exchange which results in colour swap between the particles as presented by Quantum Chromo Dynamics.

Thus, the quark configuration inside a proton produces a net integer charge, but since it's not the intrinsic charge of the underlying spiral structure of constituent particle, the proton independently inside a nucleus is dominated by the combined charge of quarks induced through the mutual interaction of quarks at gluon which is with zero electric charge and octet states of colour charge. Hence, quarks inside nucleons are glued together with the interaction of octet colour charge states. Due to symmetry of particle's colour charge, we can have three possible zones of phase differences:

Minimum Phase Difference (in °)	Maximum Phase Difference (in °)	Colour Charge
0	120	Red
120	240	Green
240	360	Blue

The colour for phase difference zones are defined on the basis of their amplitude, wavelength and position in Energy Spectrum. The Antired, Antiblue and Antigreen are the results of phase differences of spiral of Antiparticles.

Weak interactions allows for quark to swap their flavour for another. As these interaction changes the rotational orientation of the quark through Transmutation.

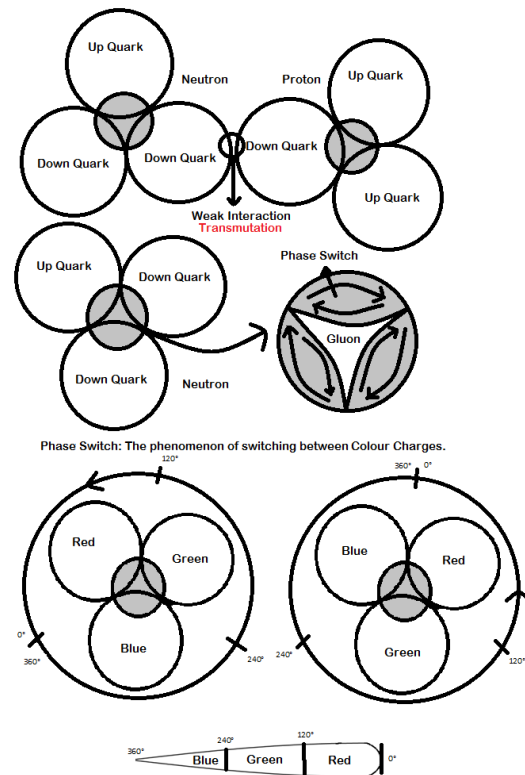

Fig 10: The assembly of quarks inside nucleons glued together with gluons and the derivation of colour charges associated to the quarks.

Inside the nucleus, proton and neutron stick together due to independent interactions of constituent of composite particles with that of others. The distinction of the constituent of a composite particle with that of others is done through weak interactions associated with the



constituent particles. The weak interaction curls also prevents it from annihilating it from opposite charged particle. The weak interaction between particles works on similar principle of threads in Nut and Bolt and in such interaction of opposite charged particle, there is transmutation and changes the flavour of quark. Hence, this overall strong and weak interaction along with the gluon creates the stable and heavy nucleus.

### Formation of Atom: Structure of Dark Matter and Nuclear Dark Matter

**Dark Matter:** It's a vicinity of gravitational mass associated with moving particle, when the mass of a particle increases with acceleration, by special relativistic phenomenon we have,

$$m = \frac{m_0}{\sqrt{1 - v^2/c^2}}$$

where:

- m is relativistic mass
- $m_0$  is rest mass
- v is m's velocity
- c is 'constant' vacuum speed of light

In Spiral Structure Model of Elementary Particles  $c^2$  are considered to be the **rate of autocatalysis** as the interference and interactions of spirals revolving at speed of light results in formation of other Spirals.

When a particle is accelerated inside particle accelerator its spiral curls around the axis of acceleration as shown in below diagram:

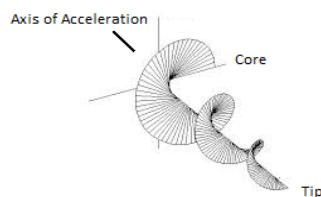

Fig 11: Representation of particle's spiral when accelerated with velocity closer to speed of light.

With increase in further acceleration  $\frac{dr}{d\theta}$

and consecutively the  $\frac{dQ}{dx}$  decreases, thus increasing the mass of the associated particle.

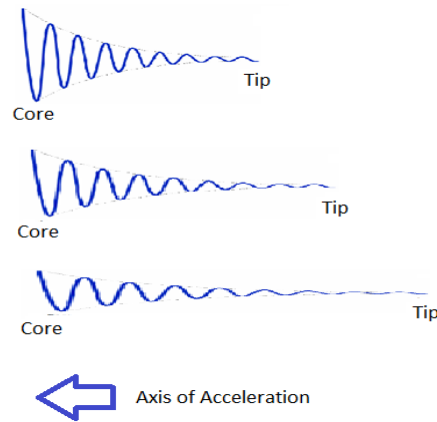

Fig 12: Decrease in  $dQ/dx$  of particle's spiral when accelerated with velocity closer to speed of light.

But it has a limitation as the spiral can't get a straight wave form free from curl even at infinite acceleration. Thus, it can't attain the speed equal to the speed of light.

The elongated spiral if taken and curled back into a single frame with increased frequency of new mass (since wavelength of underlying particle is assumed to be conserved at **plank's length**) gives a larger curled spiral in single frame. This structure is a metastable state with potential to absorb energy by interacting with photons to attain back the mass proportionate to  $\frac{dr}{d\theta}$  originally associate to the particle. But this is a shot lived state and soon when the particle is withdrawn from the acceleration and gets in process to recover back its original state by emitting high energy radiating photons.

If these photons are not provided and a potential is left, it's what we observe as dark potential and the additional mass due to force of dark potential by Supersymmetry is what we experience as Dark Matter.



Thus, every existence in this Universe having expression of Dark Matter is under the influence of autocatalysis i.e.  $c^2$ . Hence, requires moving at speed of light relative to some fixed frame. In elementary particles, there is very light expression of Dark Matter generally observed inside nucleus and in formation of Atomic Structure as they are always revolving inwardly towards their core at speed of light. Thus, a small vibrational or translational acceleration can induce dark potential.

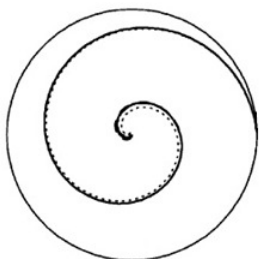

Rest Mass Particle in Single Frame

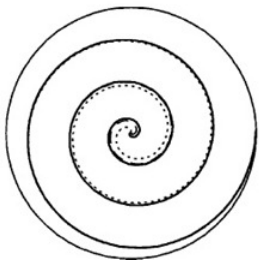

Accelerated Particle in Single Frame

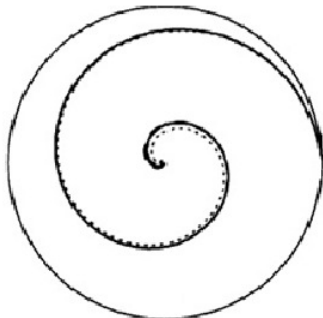

Accelerated Particle with conserved  $dQ/dx$

Fig 13: Representation of metastable state of particle during acceleration or absorption of photon.

### Nuclear Dark Potential:

Nucleus from outside behaves as a single particle in spite of being composed of constituents such as neutron and proton

which in turns is composed of quarks. This heavy single particle with relative acceleration of composite particles inside creates a dark potential around it. Since, it's a composite particle; there are constructive and destructive interferences of the initial potential waves of constituent particles and finally result in a single damping waveform as:

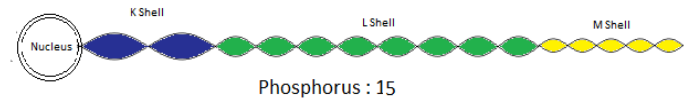

This spirals around the nucleus and results in the probability space for existence of electrons.

Electrons in higher potential requires more energized photon energy incident on it to eject.

### Ejection of Electron:

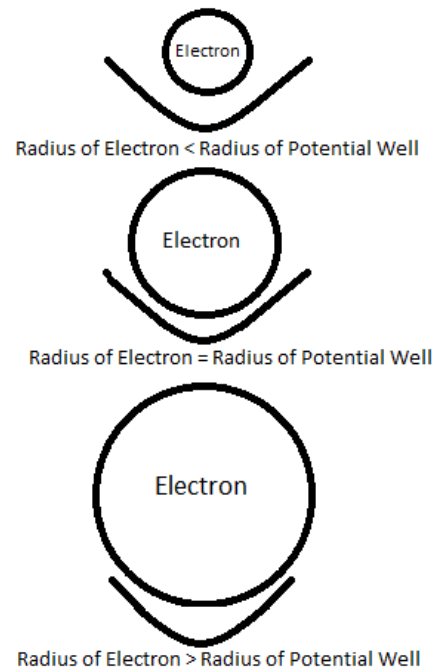

Fig 14: Absorption of photon and ejection of electron.

With absorption of photon the cross section of the arm of spiral of electron increases conserving the frequency and consecutively the energy which tends to lower the mass.

But it's an unstable state as mass conserves along with frequency which progress to recover back the  $\frac{dr}{d\theta}$ , by increasing the frequency and conserving back the original mass. But it's also an unstable state, since the proportionality of mass with frequency is violated. Hence, the particle emits back photons.

The ejection of electron from an orbit of atom takes place when the overall spiral cross section of extra energized electron crosses the radius of the potential well defined by Nuclear Dark Potential. It will no longer be able to fit in the potential depth and the extra energy left to it after satisfying the potential results in ejecting out of the electron. The electrons in outer orbits are easier to eject as the potential depth of outer orbits are much less. Also the electrons in outer orbits are more certain unlike those of inner orbits which have wider potential range in their probabilistic space to exist in. Thus, inner orbits have higher relevance of Heisenberg Uncertainty Principle unlike the outer orbits.

**Universe:**

Universe as a whole is a uniformly charged particle with Spin 1 and the spiral rotates at extremely small speed. Its movement decides the dark potential for the functioning of the constituent cosmic bodies.

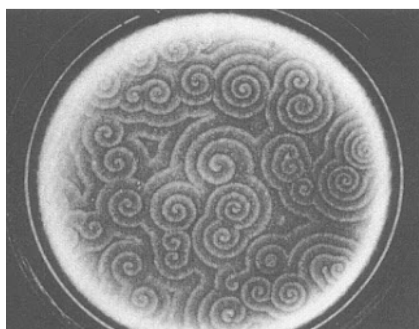

Fig 15: Spirals corresponding to celestial bodies inside the Dark Potential of Universe.

The spirals inside the disc above correspond to dark potential of different cosmic bodies. The Spiral hierarchy is the celestial system of multilevel organs like Galaxies constitutes of Stars, Neutron Stars, etc.

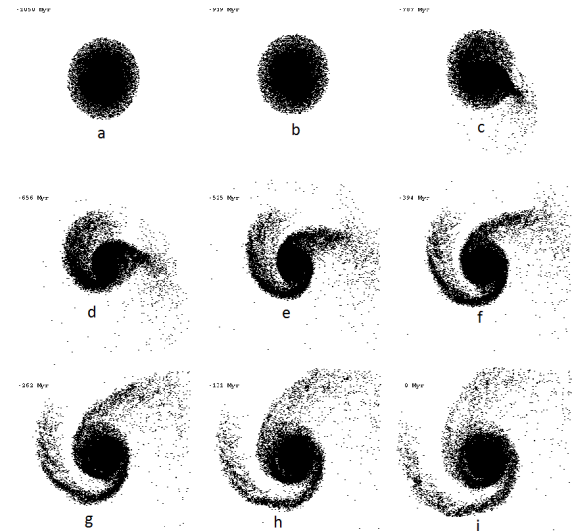

Fig 16: Life cycle of Universe.

The life cycle of Universe goes similar in the way of Galaxies. With the formation of Universe initially at the centre of the heat potent wave, the arms of the Universal Spiral are formed on both sides of the wave potential as shown above. In the positive phase, the particle or the cosmos moves in anti clockwise direction and at highest amplitude potential the angle between the arms are 180° and curls back to initial dense state of (a) in last figure with negative phase of the Heat Potent Wave. Thus the end of the Universe is by shrinking back in centre with arms embossed in centre after negative phase.

The potential determination of the Heat Potent Wave guiding the functioning of Universe is by superposition and interference of various potential interactions of all underlying constituent heat potent waves of cosmic bodies. The dark energy guiding the interaction of particles is the first stage wave fronts which in turn affect the subsequent

superior stages and finally the overall potential of the Universe.

As we know a positive potential can have either two positive or two negative potentials interacting together. Universe currently is in its positive phase i.e. positive potential and has constituent waves either positive or negative. The opposite potential interaction vanishes to the parent potential giving back its energy in the constitution of dark energy. The positive-positive and negative-negative potential interaction survives to have existence. The positive potential since is incapable to form particles due to diminishing gravity [5] accounts for accelerated expansion of the universe while the negative potential results in formation of particles and consequently the composite structure. In the negative cycle, there is increase in mass either by creation of new particle or acceleration of existing particle to create illusionary mass of Dark Matter from the particles. It redistributes the potential and particles to attain homogeneity. Thus resulting in accelerated expansion catalysed by positive-positive potential interaction.

**Supersymmetry:** With the consideration of Supersymmetry it considers the **Force** to be similar to **Matter**, which in turns satisfies well with our model and gives us a definition or views that it's not the mass which creates the curvature in the space time continuum for gravitational interactions but is the gravity which through the curvature of space time continuum accumulates mass. It also propose that for every particle likes electron, quarks and neutrinos- there is a corresponding super partner of higher mass. So the electron would be paired with a particle called as selectron. This cancels out the tiny quantum jiggles that would drive the weak force away from its observed range. It gives a candidate for dark matter as it's supermassive but don't interact

with light. It well satisfies with our description of accelerated particles dark potential which envelopes the jiggling electron in a heavy potential cover.

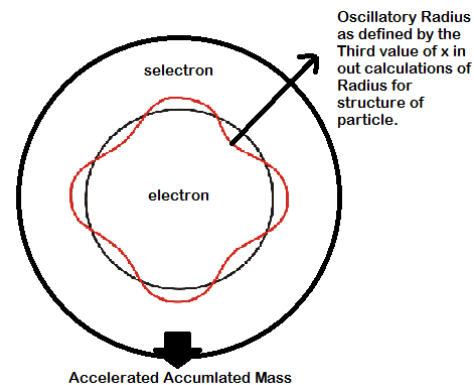

Fig 17: Illustration off Super Symmetric particle.

### Formation of Celestial Bodies and working of Solar System:

The particles created during the birth of the Universe have their own respective system of Spirals and Dark Potentials which in response to the encompassing parent wave cluster together to form celestial bodies at large scale. We can see the effect of Dark potentials at much larger scale of Galaxies and its cluster forming in similar way as the Universe itself grows in the potential cycle of its encompassing Heat potent Wave. The growth of Universe redistributes the constituent Dark Energy which modifies the Subsequent Heat Potent Waves effecting in the Dark Matter embedding of galaxies.

In the Universe there are two type of Dark Matter corresponding to different charges of the particles and its encompassing dark potential. These are strong and weak dark matter.

**Strong dark matter:** The dark matter associated to positive particle encompassed in positive dark potential are strong and shows

the behaviour of behaving as a single particle on large scale inspite of sub structures within.

**Weak dark matter:** The dark matter associated to positive particle encompassed in negative dark potential are weak and shows disintegrated or independent behaviour at sub structure level. The weakness itself weakens at larger scale and seems to be less relevant as in case of our own Milky Way galaxy.

The strength of dark matter is also affected by the angle and direction of orientation of considered dark matter with respect to encompassing dark matter. It's strong when there is less variation in angle and direction of orientation between considered dark matter and encompassing dark matter.

Our Solar System experiences weak dark matter of positively charged Sun encompassed in negative charged dark potential of Milky Way galaxy (According to the potential function of Universe, we can deduce that the Milky Way is in its negative phase and is in process of shrinking to end). The Milky Way also experiences weak dark matter being encompassed in positive dark potential of the Universe but since its scale is very large and the variation in angle and direction of orientation of its dark matter is less compared to encompassing dark potential of Universe, its weakness is not much relevant.

Due to the weak dark matter of Sun, planets move with wide varying speed. Also since Sun is a composite particle like, its dark matter has influence of weak charge on the spiral arms. It's true for all large scale cosmic structures being composite in internal structure.

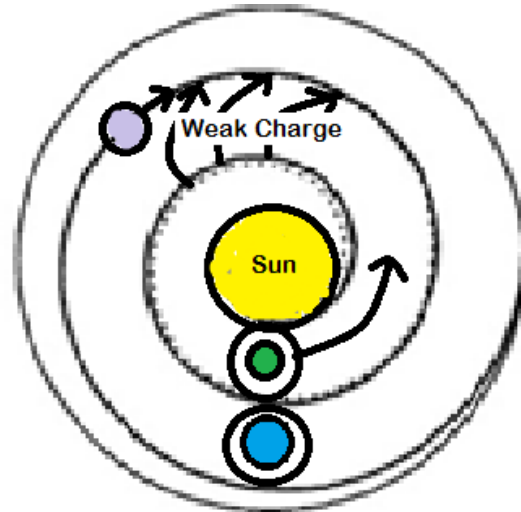

Fig 18: Illustration of a Solar System.

The planets moving west to east i.e. anti-clockwise moves embedded in the dark matter of the Sun. The planets in the arms are packed because of their own associated dark matter with them which prevents them from vibration but the planets in inner orbit have wider arms to move along which gives a slight vibrational effect which is seen through perihelion and aphelion on earth. The planets moving east to west are moving not embedded in the dark matter of the sun but at the edge of the spiral arms which is in influence of weak interaction.

The solar cycle experienced is similar to the potential switch observed in Universe life cycle. The dark potential waves inscribed inside the Sun switches its phases to change the charge and consecutively the poles, but it is ineffective to the heat potent wave encompassing the Sun and guiding its dynamics overall. At the maximum potential of positive phase of the inscribed dark potential waves, is the point of solar maxima when the condition of solar storm arises.

### Conclusion:

As per the study conducted above, we can explain how the big bang would have occurred in a steady state of cosmos. Also we

can conclude the birth of various celestial bodies at large scale and various elementary and composite particles at small scale through spiral dynamics. It is also interesting that now the dynamics of spirals for galaxy structure can also be used for elementary particles. Apart from it our explanations unifies all the four fundamental interaction in the Universe in a Unified model. Our study tries to fit the picture of these micro spirals of elementary particles into the macro spirals of Cosmos which help us to deduce the definition of Dark Potentials. Further we would be looking to solve various mysterious facts of Universe and its composition in future studies.

#### **Bibliography:**

1. Suraj Kumar, "A Spiral Structure for Elementary Particles" IJR Vol. 1, Issue 6, July 2014 [ISSN 2348-6848]
2. Landau, L., "On the vibration of the electronic plasma." J. Phys. USSR 10 (1946), 25. English translation in JETP 16, 574.
3. Dios-Leyva, M., et. al. (1997), "Quasi-periodic structure of Landau magnetic levels and absorption spectra of GaAs – (Ga, Al) As Fibonacci superlattices under in-plane magnetic fields." Journal of Physics: Condensed Matter, Volume 9, Number 5.
4. Mathematics and Beauty: A Sampling of Spirals and 'Strange' Spirals in Science, Nature & Art, Clifford A. Pickover, Leonardo, Vol. 21, No. 22 (1988), pp 173-181, [Published by MIT Press]
5. Fran de Aquino, "**Gravity Control by Means of Electromagnetic Field Through Gas or Plasma at Ultra-Low Pressure**",  
([arxiv.org/pdf/physics/0701091](https://arxiv.org/pdf/physics/0701091))