

Comparison of methods controlling slug pulling by using an indirect method in automotive industry

Viktor Tittel¹, Ľuboš Bernadič¹

¹Slovak University of Technology in Bratislava, Faculty of Materials Science and Technology in Trnava, Institute of Production Technologies, Department of Forming, Paulínska 16, 917 24 Trnava,, The Slovak Republic,
viktor.tittel@stuba.sk

Abstract. Slug pulling occurs if a slug is caught to the punch face and afterward the punch pulls the slug up from the die. Slug pulling is a cause of problems. The aim is to give an answer which of methods is more effective than the others. Researched holes were cut by using a press with various cutting tools. Slug pulling rate was observed by an indirect method of slug pulling rate measurement. The method is based on observation of indentations on workpieces caused by pulled slugs. It was found that a slug is most often pulled by common punch while on the other hand usage of ejector punches and special dies with grooves is more effective with no pulled slug. A surprise is that efficiency of the aeration punch has been higher than expectation. The shear ground punch and the stepped punch are placed in the middle of the chart.

Keywords: slug pulling, punching, blanking, a punch, a die.

1 Introduction

Many parts made in automobile industry contain holes. The holes are manufactured by various ways of hole making process. Drilling, laser cutting, ultrasonic cutting, water jet cutting, plasma cutting, magnetic field cutting and punching belong to hole making ways [1]. Punching is an operation of shearing. Shearing is the process of cutting (parting) material, which is subjected to shearing

stresses between the blades of shears of the edges of a punch and die of a shear tool. Various operations based on the shearing process are performed. Thus they may be explained as punching and blanking. Punching and blanking are the operations of cutting a flat shape from a strip of metal in a die. Perforating is actually punching a number of small holes in a sheet [2]. Punching is more productive and cheaper process than other processes. That is why sheet metal is perforated by punching. In sheet metal stamping operation in automotive and appliance industries the workpiece blanks are prepared mainly by mechanical shearing, at a high production speed [3].

The punches and dies manufactured by a company are mostly for the two basic sheet metal cutting operations: blanking and punching. Blanking is a cutting operation by which a part is cut from a sheet metal stock such that the cut touches no edge of the sheet metal stock. The cut-out part from the sheet metal stock is called a blank. Although the punching operation is quite similar to blanking, there is a small difference between the two operations. In the blanking operation, the part cut from the original sheet metal stock is the usable portion; in punching, the part that is cut out (called a slug) is scrapped [4].

In the world of high-volume sheet metal cutting and production, in automotive industry, challenges are often encountered. Cutting, although a simple and trouble-free operation at first glance, can blind-side us. Slug pulling, a concomitant effect of sheet cutting, is one such unpleasant surprise. The drive to produce more and more products on shorter timescales by punching or blanking sometimes leads to slug pulling [5].

The slug falls down through the die opening or the slug remains caught in the die opening in ordinary circumstances. Slug pulling occurs if a slug sticks on the punch face, holds and remains there. Then the punch pulls the slug from the die. For most companies involved in the punching or blanking of sheet metal, it can be a recurring, undesirable side-effect of punching or of blanking responsible for downtime, financial losses, press failure, punch breakage, poor geometry precision and low roughness quality etc. A fallen slug from a punch can cause indentation on formed parts or on the stamping die. It is needed to stop the press as soon as possible to avoid

indentations on the workpieces or on the dies. The slug can fall into the interior of a press and can cause an expensive press failure. Nowadays slug pulling problem trouble us more than in the past. It is caused by automation and robotization innovations, economization, faster production, greater productivity, price cutting, material costs savings, cost reduction etc.

Main factors responsible for slug pulling are magnetization of punches after grinding of the punch face, vacuum between the punch face and the slug and a suction which is created between the punch and the die during the punch withdrawal in high speed stamping. Another factor responsible for slug pulling is adhesion between the punch face and the slug. Extremely fast piercing operations lead to slug pulling too [6]. A larger than conventional clearance value generally results in the slug pulling problem [7]. Generally, tight clearances in the 3-5% per side range result in fewer tendencies for the slug to be pulled from the die opening [8]. It also can be caused by poor setup techniques, lack of operator training, faulty tooling components, lack of seal breakers of the punches, insufficient spring pressure on the seal breakers, improper draft on the die sections, excessive or lack of lubricant, improper die set up and dulling to name a few [9].

Fortunately, slug-pulling is a problem that can be prevented during design by using one of several applicable techniques [10]. The foremost operation to avoid slug pulling at ferromagnetic materials punching or blanking is demagnetization of the punch. Demagnetization also relates to other parts of cutting tool if possible [11]. According to [12] possible solutions for slug pulling prevention are decreasing of die clearance on small holes or increasing of die clearance on holes greater than 2" (51 mm), using of thinner lubricant and so on. A possible solution to avoid slug pulling is to increase punch penetration into the die [12].

Following techniques below help to reduce frequency of slug pulling and were tested in our research. The aeration punch allows air to aerate vacuum through a vent on the side of the punch and then air can leads through the hole in the body of the punch. An often solution is an ejector punch. Designed to combat troubles related to slug pulling, also exist elastic pins with a screw at the end made of special elastic

material – perfect for stamping soft materials such as aluminum, copper and Tbrass alloys [13]. Insertion of a small urethane pin into the punch tip has quite similar effect. This elastic urethane pin pushes the slug from the punch face. A punch with a small hemisphere or just with a metal piece on the punch face does not allow to create tight seal in the vicinity of possible vacuum. The effective solution can be a shear ground punch. There are a lot of types of shear ground punches [14]. Another method is a die with grooves. In a round die opening, the grooves are helical or straight. The inability of the small discontinuity on the slug to follow the groove locks the slug into the die section. This method may leave a slight burr on both the slug and opening that may be objectionable in some cases [15].

Among the other methods rank nicking of the punch face, an air blow punch, a slug-hugger die with barbs [16], a vacuum die [17] a die with reverse taper also called the bell mouthing die [18, 19], deposited hard metal on the die land and others. Besides the solutions previously described, there are other systems that control the whole cutting process based on an acoustic emission or similar principle. These systems involve sensors which output a signal to an operators monitor [5]. The monitor immediately recognizes out-of-ordinary acoustic pulses generated by cracks, slugs or unejected scrap and breaks in tooling, and immediately shuts down the press [20]. There are even special lubricants solving slug pulling in the market. One possible solution could be the flexible punching method using an elastic tool instead of a metal punch as it was tested in [21].

The questions are:

- 1, Do they actually work?
- 2, How much time is lost in the toolroom and the pressroom maintaining these dies? and
- 3, What are the added costs to the tool itself? [9]

The aim of the paper is to try an indirect method to find slug pulling rate of a few methods against slug pulling. Methods to find slug pulling rate divide into direct and indirect methods. Among direct methods ranks simple observation of a cutting process by a man directly at the press. This method is crude and time consuming.

Another method is using high speed camera. This method is used at high speed stamping. It is also possible to use systems containing acoustic or other sensors mount on each corner of the stripper plate and as the die runs in the press. The sensors automatically give an order to stop the press as soon as the slug is stuck on the punch face or if the slug has fallen onto the sheet metal. It is a reliable method. Indirect method consists in the fact on large workpieces the slug can not fall out of the workpiece area but the fallen slug remains there. When the workpiece is stamped again the slug causes a indentation on the workpiece. Because of marking workpiece it is clearly see that the slug was pulled and caused the indentation. This method can not be used at small workpieces because the slugs can not only fall onto the workpiece but also onto the ground. Moreover, mainly, when punches without striperes are used, double shearing can occurs and it can cause inaccuracy of results. Otherwise, this indirect method can be successfully used to find slug pulling rate causing marking workpieces by indentation of slugs.

2 Methods

As used workpiece, back doors of a car were selected. Tests were made both on the right and on the left door. The design o the car door can not be shown in a figure due to intellectual property of the car company. The observed hole is placed on this door. The shape and size of the hole is shown in Fig. 1. The hole is produced by punching.

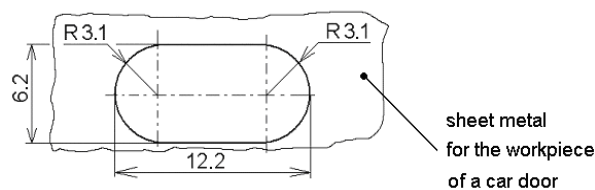

Fig. 1 The hole on the workpiece which slug pulling rate was measured of

The cutting clearance per side is 5% of sheet metal thickness and it is calculated below:

$$m_s = 0.05 \times s \quad (1)$$

$$m_s = 0.05 \times 0.69$$

$$m_s = 0.0345 \text{ mm, rounding: } \dots m_s = 0.035 \text{ mm.}$$

Where m_s is clearance per side in mm and s is thickness of sheet metal.

Total clearance:

$$v_s = 2m_s \quad (2)$$

$$v_s = 2 \times 0.035$$

$$v_s = 0.07 \text{ mm.}$$

Where v_s is total clearance in mm and m_s is clearance per side in mm. The holes were punched by various combinations of punches and dies, which differ in shape and size. Hardness of punches and dies is HRC 60-63. Used dies are shown in Fig. 2. Used punches are shown in Fig. 3. Tested combinations of the punch and die:

- Common die + common punch
- Common die + shear ground punch
- Common die + stepped punch
- Common die + ejector punch
- Common die + aeration punch
- Special die with grooves inside + Common punch

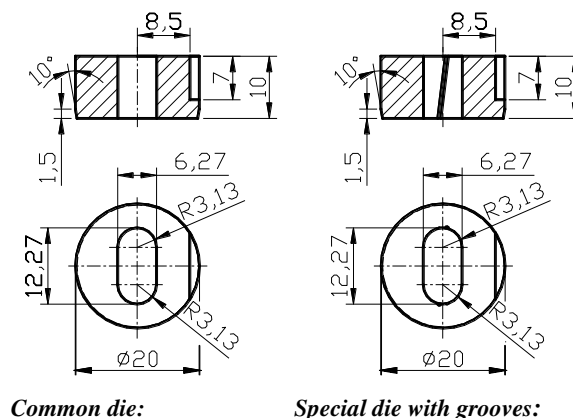
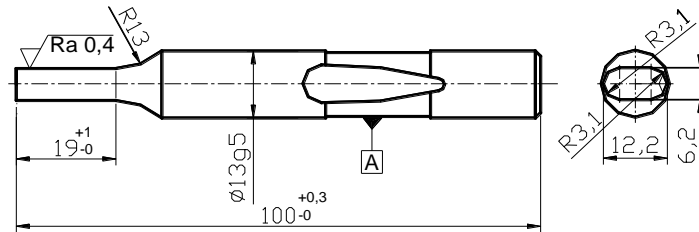
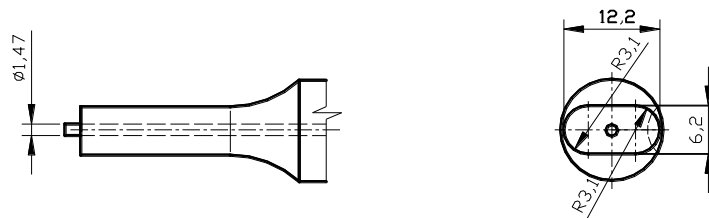

Fig. 2 Dies used in the experiment

Common punch:



Ejector punch:



Aeration punch:

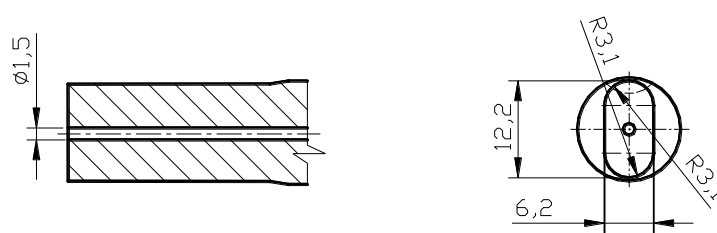

Stepped punch:

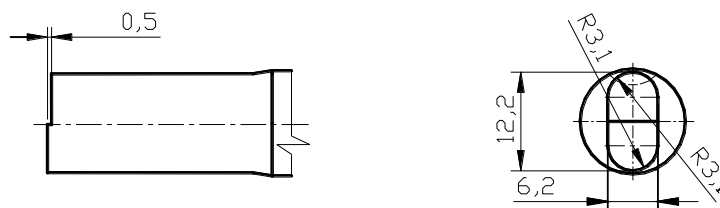

Shear ground punch:

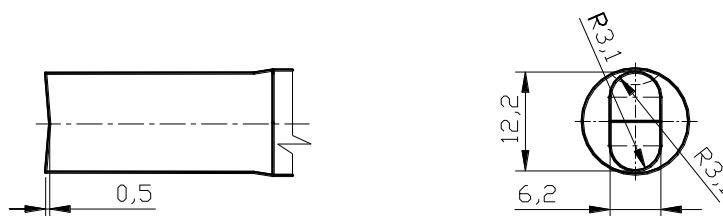

Fig. 3 Punches used in the experiment

Punching conditions are shown in Table 1.

Tab. 1 Punching conditions

	Hits per minute	Clearance per side	Sheet metal thickness	Lift of the press	Penetration	Magnetic induction of the punch
Unit	[-]	[%]	[mm]	[mm]	[mm]	[mT]
Value	22	5	0.69	1 100	2.69	<0.5

Physical and mechanical properties of metals are dependent on chemical composition, on a grain size, on a grain shape and on grain organization [22]. The chemical composition of zinc coated sheet metal used for the workpiece is shown in Table 2 and mechanical properties are in Table 3.

Tab. 2 Chemical composition

Element	Ceq	C	Mn	Si	P	S	Al
weight [%]	0.140	0.080	0.400	0.100	0.025	0.025	0.020

Tab. 3 Mechanical properties

Property	R _{p0.2}	R _m	A min	HRB max	G _{min}
Unit	[MPa]	[MPa]	[%]	[-]	[-]
Value	160 - 200	280 - 340	37	50	6

The process of experiments is such: the selected hole was punched by a combination of a die and punch. In ordinary circumstances the slug remains in the die or the slug falls down through the die. But sometimes slug pulling can occur. As soon as the punch pulled a slug from the die, the slug fell down on the workpiece due to the stripper around the punch and vibrations in the punch. The slug stays on the workpiece. The workpiece is made in several operations. When the workpiece is stamped in next operation again the slug causes an indentation on the workpiece. Every workpiece is checked under visual control. Always, the operator notices the

indentation he/she take a note that indentation on the workpiece was present. Since every indentation is caused by a pulled slug we can state that slug pulling had to occur. This is the principle of the indirect method for slug pulling rate by using an indentation on a workpiece. Thus we made tests of various combinations of punches and dies on thousands of holes. Then we evaluated and compared results.

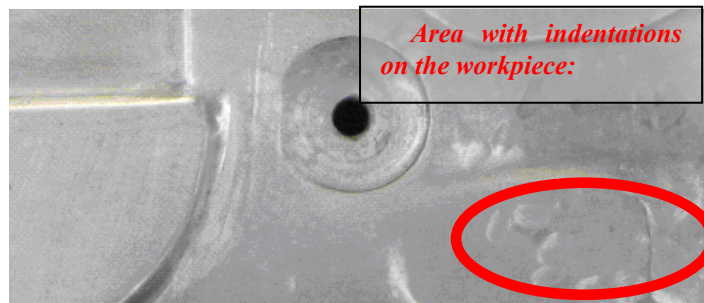

Fig. 4 Photo of indentations on the workpiece

3 Results

Tables with results are shown in the text below. Results of slug pulling rate on the right door are shown in Table 4. These results are shown in the bar chart in Fig. 5.

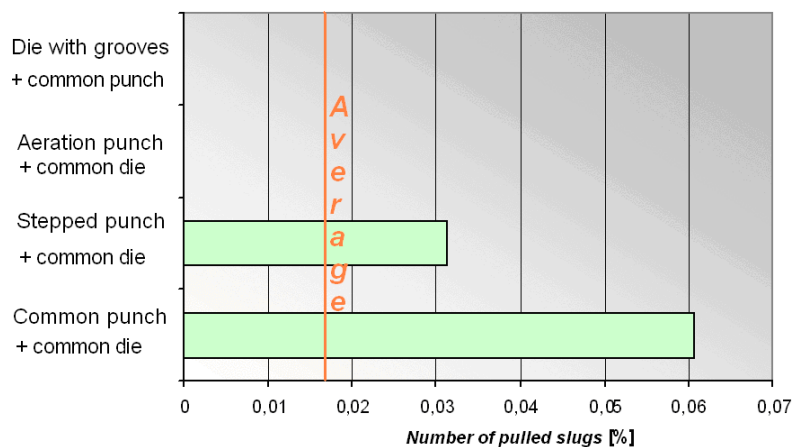

Fig. 5 Effectivity of methods controlling slug pulling for the researched hole at the right doors

Tab. 4 Effectivity of various methods controlling slug pulling for the researched hole at the right doors

	The number of holes punched by a combination of a punch and a die	The number of pulled slugs	The number of pulled slugs
	[pcs]	[pcs]	[%]
Common punch (+ common die)	3 300	2	0.0606
Stepped punch (+ common die)	3 200	1	0.0313
Aeration punch (+ common die)	5 600	0	0
Die with grooves (+ common punch)	5 400	0	0
Together	17 500	3	-
Average	4 375	0.75	0.0171

Results of slug pulling rate on the left door are shown in Table 5. The results are shown in Fig. 6.

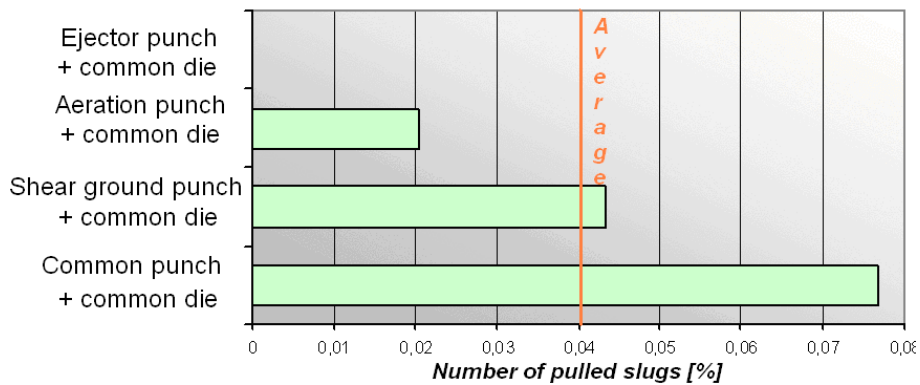

Fig. 6 Effectivity of various methods controlling slug pulling for the researched hole at the left doors

Tab. 5 Effectivity of various methods controlling slug pulling for the researched hole at the left doors

	The number of holes punched by a combination of a punch and a die	The number of pulled slugs	The number of pulled slugs
	[pcs]	[pcs]	[%]
Common punch (+ common die)	5 200	4	0.0769
Shear ground punch (+ common die)	4 600	2	0.0435
Aeration punch (+ common die)	4 900	1	0.0204
Ejector punch (+ common die)	2 800	0	0
Together	17 500	6	-
Average	4 375	1.5	0.04

In Table 6 are shown all results of the right doors and the left ones. The results are shown in the bar chart in Fig 7 and in the bubble chart in Fig. 8. The size of a bubble denotes the number of holes punched by a punch and die. On the y axis is slug pulling rate.

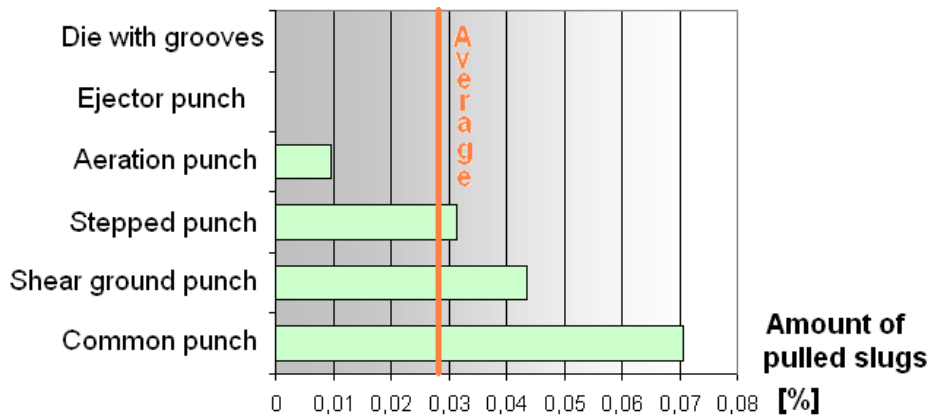

Fig. 7 Effectivity of methods controlling slug pulling both at the right and on the left doors

Tab. 6 Effectivity of various methods controlling slug pulling for searched both at the right and on the left doors

	The number of holes punched by a combination of a punch and a die	The number of pulled slugs	The number of pulled slugs
	[pcs]	[pcs]	[%]
Common punch(+ common die)	8 500	6	0.0705
Shear angle punch (+ common die)	4 600	2	0.0435
Stepped punch (+ common die)	3 200	1	0.0313
Aeration punch (+ common die)	10 500	1	0.0095
Ejector punch (+ common die)	2 800	0	0
Die with grooves (+ common punch)	5 400	0	0
Together	35 000	10	-
Average	5 833.333	1.6667	0.0286

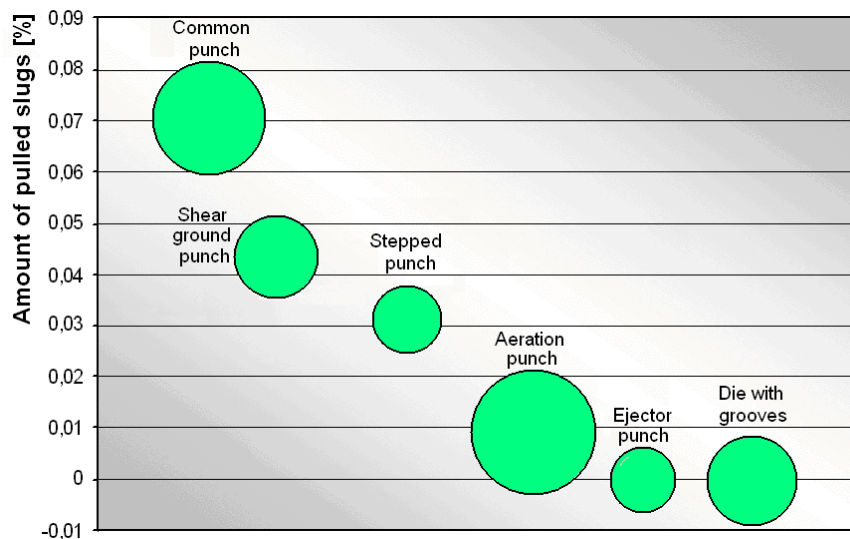

Fig. 8 Effectivity of methods controlling slug pulling in the bubble chart
The size of a bubble denotes the number of holes punched by a punch and die

The most often slug pulling occurred at punching by using a common punch and a common die. On the contrary, the ejector punch and the special die with grooves belong to the best methods controlling slug pulling. The aeration punch was also effective. The shear ground punch and the stepped punch removed slug pulling but they were not so effective as other methods except for the common punch.

4 Conclusion

We can state from the whole research that the slug pulling rate is possible to measure by using the indirect method based on observation of the indentations on workpieces. This method could be used in this research because of large workpieces and the slugs can not fall down from these large workpieces. The slugs could fall down to the ground from the workpiece if the workpieces would be too small and smooth and in this case this method could not be used.

The common punch is suitable for punching if slug pulling is one of problem at cutting operation. One disadvantage of the ejector punch, but mainly of the sheat ground punch and of the stepped punch is the need for time consuming grinding. Another disadvantage of special punches and dies for example aeration punches or dies with grooves is higher price of the punches and dies.

If you make holes in perforated material you should always pay attention to slug pulling. Especially if you cut too fast and you cut very costly parts, as it is usual in automobile industry, slug pulling happens very troublesome and permanent problem, namely at high volume production. Therefore you would use a solution to avoid this type of a problem. The consequence of slug pulling will be more expensive than the costs of any other used special punch and die. Some special punches and dies will bring benefit by means of time saving, costs saving, etc. It could be a way to defeat competition across the market and to have an advantage over competition in the field of stamped parts.

References

1. Novotný, J., Langer, Z. *Stříhaní a další způsoby dělení kovových materiálů*. Praha: SNTL, 1980.
2. Kostka, Peter., *Metal Forming*. Bratislava: STU, 2002. ISBN 80-227-1801-7
3. Wu, X., Bahmanpoura, H., Schmid, K., Characterization of mechanically sheared edges of dual phase steels, In *Journal of Materials Processing Technology*. Vol. 212, Issue 6, 2012, ISSN 0924-0136
4. American Society of Tool and Manufacturing Engineers, *Die Design Handbook*, McGraw Hill Company, New York, 1965.
5. Bernadič, L., Tittel, V., Bútorá, P. Keeping control of slug pulling. In: *International Sheet Metal Review*, 2012, Vol. 14, Issue 3, pp. 32-33, ISSN 1471-6542
6. Hedrick, Art. Die Basics 101: Part XI [online]. [cit. 2010-09-28]. Available on internet <<http://www.thefabricator.com/article/toolanddie/die-basics-101-part-xi>>
7. Jain, K., C., Chitale, A. K. *Textbook of production engineering*. New Delhi: PHI, 2010. ISBN-978-81-203-3526-4
8. Spitler, D., Lantrip, J., Nee, J. G., Smith, D. A. *Fundamentals of tool design*. Dearborn: SME, 2003. ISBN 0-87263-650-X
9. Szumera, J. *The metal stamping process: your product from concept to customer*. New York: Industrial Press Inc., 2003. ISBN 0-8311-3164-0
10. R. J. Rizzo, Slug retention ideas that have worked, *Modern Machine Shop*. Issue 3 (1991)
11. Moravec, Ján. *Magnetizmus v tvárnení*. Žilina: EDIS, 2005. ISBN 80 – 807 – 385 – X
12. Laroux, K. G., *Troubleshooting manufacturing processes: adapted from the Tool and Manufacturing Engineers*. Dearborn: SME, 1988, ISBN 0-87263-326-8
13. The shed-it company, For carefree slug pulling. In *Metalformingmagazine*, 2010, Vol. 44, Issue 11, pp. 26-27
14. Moravec, J., Stroka, R., Kopas, P., Vaško, M. *Tvárniace nástroje*. Žilina: EDIS, 2008. ISBN 978-80-8070-812-2
15. Smith, D., A. *Die maintenance handbook*. Dearborn: SME, 2001. ISBN 0-87263-525-2

International Journal of Mechanical Engineering

ISSN : 2277-7059

Volume 2 Issue 10 (October 2012)

<http://www.ijmejournal.com/>

<https://sites.google.com/site/journalijme/>

16. Hedrick, Art, Eliminating slug pulling during piercing operations. In *Stamping Journal*, 3/2004, ISSN 1091-2460, [online]. [cit. 2010-09-27]. available on internet <:<http://www.thefabricator.com/article/toolanddie/eliminating-slug-pulling-during-piercing-operations>.>
17. Hedrick, Art. Die Basics 101: Part XII [online], [cit. 2010-09-20]. Dostupné na internete <:<http://www.thefabricator.com/article/toolanddie/die-basics-101-part-xii>.>
18. Cubides, W., J. Controlling slug pulling with hole lapping . In *Stamping Journal*. 1/2008
19. Spence-Parsons, Andy. The formula for successful punching. In *The Fabricator* 8/2006 [online]. [cit. 2010-10-26]. available on internet <:<http://www.thefabricator.com/article/punching/the-formula-for-successful-punching>.>
20. Acoustic monitoring cures slug-pulling woes. In *Metalformingmagazine*, 2008, Vol. 42, Issue. 7, pp. 28-29
21. Watari, H., Ona, H., Yoshida, Y. Flexible punching method using an elastic tool instead of a metal punch. In *Journal of Materials Processing Technology*. 1-3/2003
22. Hrivnak, A., Evin, E. Lisovateľnosť plechov – predikcia lisovateľnosti oceľových plechov s vyššími pevnostnými vlastnosťami. Košice: Elfa, 2004, ISBN 80-89066-93-3