

COMPLEX PHYSICS:
The 2 membranes and arrows of Time of the Universe.

‘Time curves space into masses.’
Einstein, on the arrow of physical information.

Introduction: A General Systems Theory of Multiple Spaces and Times.

1. The Laws of Multiple Spaces-Times applied to Physics.
2. The arrow of Einstein: Mass as information. The Unification Equation.
3. The arrows of Time as Dimensions of Fractal Spaces.
4. Relativity revis(it)ed.
5. The 2 membranes of the Universe.
6. The Quantum scale.
7. The Cosmic scale.
8. The 3 Ages=Horizons of Physical Species.
9. Chemistry: Atomic societies.
10. The Earth. The Geological World.

INTRODUCTION: COMPLEX PHYSICS.

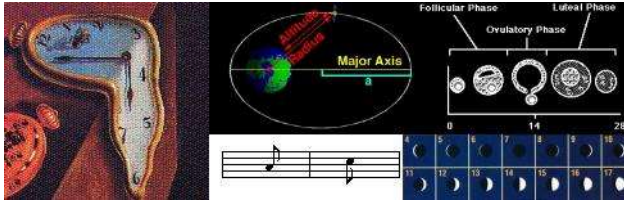

Times are cyclical and multiple; each event has a frequency that carries form, information and

defines a cycle or closed trajectory, which breaks space into an inner, 'fractal' region and an external world. The result is the creation of multiple spaces with motion=energy and multiple clock-cycles with information, carried in the form and frequency of those cycles. The age of metric science measured all those space-time cycles by equalizing them with the rhythms of a single clock, putting them together into a continuum space-time graph. The deformations this caused was the loss of motion in the 'energetic space' that underlies reality (light-space and gravitational space) and the loss of form in the cycles of time drawn with that energy. Thus, the parallelism between space and energy or lineal motion and time, form and cyclical motion was lost; and the organic, complex, moving Universe became an abstract, static reality. Further on, the metric age adopted a philosophy of science based in the new machines used to measure those space-time cycles (clocks and telescopes, today evolved into computers and cameras), called mechanism that equalled reality to a machine. So Kepler said: 'God is a clocker', and Einstein affirmed: 'Time is what a clock measures'. But as we measure more time cycles and perceive more forms of space, a new paradigm is needed to account for that variety of 'multiple spaces and times'. Such fractal theory of spaces and times introduces the discoveries of the sciences of systems and information. Its main thesis is the existence of multiple cycles of space-times, which have form=information and motion=energy, the 2 properties of all entities, which are 'complementary systems' with a network that moves the system and one that gauges information: In physics all systems are dual: particles of information and fields of energy (complementary principle). In biology all systems are ternary networks with energetic limbs, reproductive bodies and heads of information. Thus we define reality as a system of dual & ternary networks with motion & form.

1. Duality in physics: 2 membranes & 2 motions – energy & form.

Information, form with motion is the ultimate substance of reality and so we shall start this introductory lesson in complex physics with the definition of those 2 parameters of all realities.

In the study of the ontal side of reality, as opposed to the epistemic point of view (the object vs. the subject), the reader must always be aware that 'anthropomorphism' and 'utilitarianism' reduces our definitions of Universal truths to human uses. In that regard the units of information in Nature are not the human bytes invented by Shannon to study the transport of information in machines, but the cyclical, clock-like trajectories of all entities, which have form; hence carry the information of reality. When we look around, all what we observe are 'forms' with motion. Yet forms in action are in-form-a©tions, and both together, energy and form, construct reality. Form stores information in its dimensional warping. So dimensional information is the key to understand the whys and purposes of reality, which can be considered a game of 'forms-in-action, forms with movement'.

Motion without form is meaningless, as Hemingway well understood in his famous advice to Dietrich: 'don't confuse movement with action'. The unit of reality is not motion but action, which carries both motion, synonymous of energy and dimensional form synonymous of informative, cyclical clocks of time. And for that reason, Planck, the founder of quantum physics, clearly stated that all is made of actions of energy=motion and time=formal clocks. However pure motion, which in the physical realm is represented by the gravitational membrane of 'non-local action' (infinite motion) is not perceivable. Neither, it is pure form, as it does not emit any signal that the observer can pick up. This was already understood by the Taoists, who said that all yin=form had a minimal drop of yang=motion. So because form and motion in its ontal reality are not perceivable, epistemic Humans use terms in which the 'yin=form has a minimal yang=motion' and vice versa.

Speed, energy and work, which study the displacement of forms become then the closest human units of motion; while clocks of time

and dimensional informations, which are cyclical or curved forms with minimal motion become the commonest human units of form.

So we shall consider energy synonymous of motion and information, synonymous of form, the 2 essential parameters of all *actions of the Universe, which are the substance of what exists*. Yet because epistemic humans are analytic minds, they have used an infinite number of different jargons to define for each specific class of motions and form and for each existential species those 2 self-similar terms of all realities.

In physics the terms for the 2 initial principles are: energy=entropy=lineal speed=space & information=form=time clocks=cyclic motions.

The simplest scales of reality are dominant in energy=motion=entropy forces, reason why physicists believe it is the only arrow that creates the future and have disregarded the study of form, information, even in their discipline. Indeed, most of the information of the Universe is carried by bidimensional and tridimensional, physical clocks, masses and charges, which are vortices of space-time of the quantum, electromagnetic and cosmic, gravitational scale that carry in their clock-like frequency, $E=Mc^2+E=hv \rightarrow M=kv$, most information of the Universe. Yet physicists still make ceteris paribus analysis of reality with a single arrow of time, entropy, which is the cause of many errors of modern physics such as the evaporation of information in black holes, which in fact are the systems that reproduce the mass of the Universe or the concept of mass as an external property to the particle, given by collisions with the flawed, never seen Higgs.

In the wider view of systems sciences that accepts 2 arrows of future time - energy and information - physical energy is lineal, expansive motion also called 'entropy' and forms are made of implosive cyclical time-clocks, masses and charges, which carry most of the form or 'information' of reality, defined as I^D , where D is the number of dimensions of the system. This means that the definition of information as the frequency carried by a lineal wave (Shannon) represents a minimal part of the information of the Universe. Only when we combine lineal, 'energetic motions' that move and occupy 'space' and cyclical forms, clocks of time that carry information -

masses and charges - we obtain the two fundamental variables of physical reality: *informative 'time cycles=clocks'* that break and mold the forces and *energy of space* into particles.

The energy of vacuum space warps into broken cyclical particles that act as clock of times - charges (quantum scale) and masses (cosmological space), which carry in their cyclical motions most of the information of the Universe and attract, as hurricanes do with its imploding motions, whatever floats in the space-time membrane (quantum or cosmological) in which they act. In that regard the non-discovery of the Higgs at CERN, which considers mass an external property to the particle, will be a key proof of Complex Physics.

Thus, the main difference between classic physics and complex physics is the acceptance of a 2nd arrow of information in the Universe besides the arrow of entropy used by classic physics. That duality of time arrows - energy, stored in the spatial vacuum, and information, stored in the cyclical clocks of charges and masses - defines a new Fundamental Principle of Science:

'All what exists is energy that transforms back and forth into information, dimensional form: $E \Leftrightarrow I$ '.

In this dynamic reality equations are not static 'equalities', $X=Y$, but rather feedback exchanges and transformations between those 2 variables - lineal, expansive, entropic motions and cyclical, implosive clocks of time, described with Feedback equations that can be reduced to the 'Generator' equation of all space-time cycles: $Se \Leftrightarrow Ti$ (dynamic exchange) or $ExTi=K$ (complementary system). This classic equation of quantum physics ($exi=k$) and relativity ($ext=k$) finds now its why as clocks of time and cycles of information mean the same; and becomes in the 4th paradigm of system sciences what the space-time field equations of Einstein were to the 3rd paradigm of physical measure - the departing, unification equation of all forces/bodies of energy and particles/heads of information; the mandala, which originates it all through iterations of space-time cycles and its combinations into networks that become whole units of a new fractal scale of space-time. Thus the duality law that substitutes the law of conservation of energy is formalized by the 'Generator, feedback equation' of the Universe

from where we deduce all the other equations of science, including the equations of physics. For example, $E=M$ (Planck's notation) becomes now a simple transformation $E=M(i)$: as mass carries the information of the Universe in its cosmological scale and in its dynamic form, $E \leftrightarrow M(i)$, explains easily how mass becomes energy' uncoiling its informative vortex and vice versa: $E=Mc^2$ transforms lineal energy into cyclical motion=mass by merely coiling motion into cyclical mass.

Physics has been always the science of Energy (as it has constructed all the weapons and machines of energy of our civilization) and this has established a bias towards energy only theories that handicaps its evolution and Complex physics breaks. In detail, the error of a single entropy arrow for all physical phenomena is due to the extension of the laws of electromagnetic forces to the field of gravitation, attractive forces that 'in/form' reality, despite the obvious fact that both forces belong to two different scales of reality – the microcosmic membrane of quantum electromagnetism and the macrocosmic realm of mass.

The duality of 2 universal membranes and the particles and forces that transfer energy and information between them defines a Universe of Multiple, Fractal space-times. In such a model the Universe extends through 2 main scales of size, the quantum and gravitational scales, with man sandwiched between them. Yet forces are constricted to each membrane and scale in which we always find a system of energetic forces and a rotational particle of information, according to the duality of lineal and cyclical motions. This explains why there is no gravitation in the quantum scale. In the quantum electromagnetic scale charges are the vortices of an electromagnetic membrane of space-time made of 'light', whose limits of energy (c-speed) and information ($T=0$ k), set the limits of what we perceive. Yet there is a bigger scale of cosmological masses and gravitational forces.

And further on, there is a 3rd scale, which participates of both forces – the human scale; and a 4th smaller scale in the internal nucleus of atoms – the realm of strong and weak forces. And so in each of those scales we find again informative particles and energetic forces.

In the past, there was not a clear theoretical scaffolding in which to fit and order all those forces and particles – on the contrary, the dogma that space-time was unique and continuous obliged physicists to try to

unify them all instead of consider their dualities, self-similarities and fractal scales as we do in a Theory of Multiple Spaces and Times. Now we will be able to unify those scales with simple fractal equations that show charges and masses to be merely the vortices of information of the quantum and cosmological scales. This proof of the fractal nature of space-time and the informative, vortex like nature of charges and masses, sought for by Einstein and other physicists of the XX century, ushers simplex physics into the new paradigm of duality in which the Universe is in perpetual motion and lineal energy and cyclical form are in constant balance, $exi=k$ (quantum physics) and $ExT=k$ (Relativity).

The implications of *two essential dualities of scale and motion in the Universe* are many, as broken, lineal expansion and implosive form balance each other. In that regard, in MST (Multiple Spaces and Times Theory) the illusion that there is only a continuous intergalactic space, expanding entropy disappears: each galaxy implodes into in/form/ation into mass the expansive energy of vacuum space, balancing an eternal Universe in which big-bangs are either local quasars or gravitational big-bangs of smaller universes, cells of a bigger hyper-universe.

Physical time-clocks are also many as each cyclical mass or charge is a small clock in itself; whose time-cycle varies according to the length of the cycle: the Earth's translational cycle is a time-year and within the planet each vital being has its circadian clocks and each particle with a different speed of rotation is a different clock – being the general law that the smaller in space an entity is the faster its time cycles are, and so space and time together become balanced: $e \times t=k$. And so a set of key laws of Complex, Dual Physics is the study of the synchronicities and symbiotic chains established between the different scales of time cycles of a given physical system and the balances between its arrows of energy and information, *which explain the harmony and order of the Universe, its species and scales of reality* and the existence of many quantitative parameters for particles and forces that communicate both membranes, 'breaking its symmetry' (neutrinos and electro-weak forces).

Because particles are rotational vortices with dimensional form they carry information, as complex life-molecules do, according to their

different 3-dimensional warping. Yet physical information follows the same laws of Information Theory found in duality, systems sciences, fractals and non-Euclidean geometries: The key properties of the arrow of form, which *are inverse to those of energy, are* stillness, fractal reproduction that creates self-similar forms.

It follows that the key property of energy is motion and lack of form (linearity). And so the Universe is a series of $E \Leftrightarrow I$ beats that generate reality, as entities switch between their 'particle' and 'force' state. For example, Mr. Mehaute² proved that even in classic entropy processes such as chemical reactions, when a system lacks energy 'time doesn't stop': the system doesn't die but it starts to produce fractal patterns that store new information, as it happens when you 'warp' a bidimensional sheet of paper in a new 'dimension of form'. In life also when a system becomes still (for example, a larva forms a chrysalis) the evolution of information accelerates.

So a better description of reality requires considering that duality of stop=creation of information and go=energetic motion, self-similar to that of a movie film, which stops so light can focus and enlarge the information of the picture and then it moves. Information requires stillness to 'perceive' or 'construct' networks and systems with form. So all what exists moves and stops, to focus and gauge information, then it moves again. And those stops and goes are the basic beats that balance motion and form in the Universe.

All those balances between energy and information were denied in the age of monism, which accepted only lineal inertia= entropy, and denied cyclical inertia, information. There is an obvious reason for such earlier monism – simplification is easier to understand and facilitates calculus and measure with machines. Indeed, a Universe constructed with two elements, energy and information, is more complex than one created with a single system of energy and a single cycle of time – that of a clock simplified into lineal time in a Cartesian plane. But the Universe is a system of multiple, formal entities moving and tracing cycles - multiple clocks of time and multiple spaces - reason why Leibniz not Newton was right with his model of multiple, relational times and spaces, properly formalized in this work. In this

new paradigm fixed space and solid particles are no longer relevant, as we define space in terms of expansive motions and particles, masses and charges in terms of cyclical, implosive motions. Solid substances and static space become then a maya of the senses, since even vacuum space carries energy and the pictures we observe of charges and masses show vibrating, cyclical frequencies, which carry most of the information of the Universe. And so the big why is to try to answer and give an order, purpose and causality to the complex interaction of all the motions with form of the Universe, all its informations.

We can study the specific informative particles and energetic fields of forces of the physical scales of the Universe, as classic physics does. But since they represent information and energy, we will also apply the common laws and properties of all informations and energies of reality, studied by Duality and General systems Sciences.

This approach, taken in these lectures will allow us to complete and resolve many problems of physics.

We call such model a General Systems Theory of Multiple Spaces and Times or MST theory, since its two main theses are:

- The existence of multiple entities, whose motions in space trace multiple cycles of energy and information, multiple time clocks that break that space in ∞ pieces..
- And the dual nature of those entities; since all entities in the Universe are 'complementary systems' of energy and information, from particles of information and fields of energy (quantum physics) to reproductive bodies and heads of information (biological systems).

Recap. The Universe is made of forms with motion that trace space-time cycles. In physics energy is synonymous of spatial, expansive, lineal motion or entropy and form is synonymous of cyclical clocks of time, masses and charges, which carry in their frequency the information of reality. Form dominates motion and *both combine creating actions, exi, the complementary unit of all physical realities.* The Universe has also a scalar structure, broken in fractal membranes of space-time of different size: the cosmological scale of gravitational, lineal forces and cyclical masses and the quantum scale of electromagnetism and charges, which are the informative units of the quantum scale. We exist sandwiched between both scales.

Those ‘time forms and spatial, energetic cycles’ are described with feedback equations, through which entities exchange back and forth flows of energy and information. They define the new law of physics, ‘all is energy that transform back and forth into information: $e \Leftrightarrow I$, $Se \times Ti = K$ ’ from where all other laws of physics are deduced.

2. The expansion of our concepts of space and time.

In science advances on the understanding of space-time set the basis for a new flourishing of all branches of knowledge, a *new paradigm of science*, as all what exists happens in time and space. In that regard, in terms of philosophy of science, a General Systems Theory of Multiple Spaces and Times will be the 4th age or paradigm of knowledge:

The 1st paradigm of science responded to what (experience) and who (religious myth); the 2nd to the how (Greek, logic thought); the 3rd paradigm of metric measure, started by Galileo, with his use of machines (clocks and telescopes), responded to when, measuring space distances and time frequencies in great detail with a single space-time system. The ticks of the heart, the stomach, the moon, the atom and the clock are different, but to measure them we needed a unit of time and so we equalized all rhythms with a clock, and to compare the spatial trajectories of those cycles we needed a ‘background of space’, so we put together all the broken spaces of reality into a joined puzzle, which we called Cartesian space-time. The error came when we forgot those simplifications and considered that the single space-time continuum used to measure all other spaces and times was the real space-time.

Now the 4th paradigm breaks the space-time continuum into multiple spaces and times, responding to the why of the forms of space and cycles of time that all entities of the Universe follow.

Those paradigms start always with the work of a few authors and take time to be accepted – so the reader should not be surprised that despite centuries of insights in a model of multiple spaces and times, only now in the XXI century, we have formalized such a model.

Indeed, if we were to consider the history of previous paradigms, there were always a few authors and landmark books on time and

space that set in motion the evolution of those paradigms and yet took a long time to become mainstream:

- The transition from the mythic age of knowledge in which the Gods, entities outside time and space controlled those parameters at will to the age of reason, was signified by two of such books, the ‘Elements’ of Euclid that defined a static, geometric space of 3 dimensions and the ‘Logic’ of Aristotle, which considered a single arrow of temporal causality, $A \rightarrow B$ for all temporal events. But Aristotle was ignored till the Middle Ages and in fact 90% of his work is lost; while Euclid became a household name... in the renaissance.

The new age of metric space was born also in the XV C. with Copernicus, but it was not seriously analysed till the XVII C. when Descartes in his book the ‘World’ established a system of lineal light-coordinates of time and space, departing from the human point of view placed in the center of coordinates and Galileo wrote his ‘Dialogues’ giving us the first mathematical definition of time in terms of ‘space location’ and ‘motion’, $v = s/t$. He perfected the first machines that measure ever since the rhythms of time and space (the clock and the telescope, today evolved into the computer and the camera). And those were the most influential books of... the next century... long after Maese Galileo had died at home under house arrest by the inquisition of thought of the age – the most respected astronomers of the age working for the Vatican Church.

In the XVIII C., Leibniz gave us his infinitesimal calculus to measure with precision small distances and changes in the motion of beings, and the concept of relational, multiple times – the first insight into the 4th paradigm. But Leibniz was too advanced for the age and so his rival Newton, who set the first laws that generalized the measures of the trajectories and rhythms in time and space of cosmic bodies, plotted in a single, continuum Cartesian space and measured with a single clock carried the day. Leibniz’s concept was clearly superior from the point of view of the why of the Universe, but Newton’s rods of time (the clock that equalized all time cycles and compare them) and space (the continuous, Cartesian plane and its reflective telescope), improved upon Galilean scientific measures and was

adopted universally. Such was the awe his work caused that Pope exclaimed: 'And god said, Let Newton be! and all was light'; while the true genius Leibniz died abandoned by his prince and future king of England, for whom he had toiled 30 years writing... a genealogy.

In the XIX c. it was the time of other predecessor of the concept of time as form, Darwin, whose 'Origin of species' would define time as the evolution of information, or form of living beings. He opened the most talked about debate of the century... but he is still ignored in half of the schools of America who prefer to believe in a Book of History of the Bronze Age... So happens to Bertalanffy, who completed his work with the study of the processes of social evolution that create complex systems departing from self-similar cells.

In the XX C. it was the turn of Einstein with his Theory of Relativity and his use of Non-Euclidean Geometry, which few people understood as it is obvious by the insistence, 100 years later, on theories that deny his principle of equivalence between cyclical acceleration and mass, as a vortex of space-time that carries the information of the Universe - Mr. Higgs particle - and by the use of only a Non-Euclidean postulate to define the geometry of space-time.

Mr. Einstein followed in his research a key tenant of the scientific method, the Principle of Correspondence, according to which a new theory of science must include the results of all previous theories as particular cases of the wider theory. For that reason, he called his Theory of Physical Time, Relativity, since it was an extension of the original Galilean Relativity - a more detailed study of the definition of time in terms of space and motion ($v=s/t$). But he used a new rod of measure; instead of the clock, the speed of light and in this manner he further refined the measure of 'metric spaces'. Thus, his work exhausted the measure of time as a dimension of spatial, energetic change in the motion and location of beings.

But Einstein did more to foster our understanding of time by realizing that there were multiple times with different speeds in the Universe and time was a curved geometry, similar to the cycles of a clock. Thus he spatialized the concept of time as morphology of space, saying that 'time curves space into masses'. And indeed, in physics

clocks of time are the cyclical trajectories of masses and charges - motions that change the position and energy of the Universe.

Thus with Einstein the study of time as change in space, which Galileo initiated, based in the formula $v=s/t$, became exhausted.

We however have defined in complex physics a second arrow of time=change, information and so there is still an entire new field to explore - *the change in the information of physical beings*. Indeed time is any process of change - not only change in motion and location of space. Time is also change in the form or morphology of beings defined by Darwin in Biology and several authors of the evolutionary school of History and Economics in social sciences (Butler, who applied the laws of evolution to machines; Schumpeter, who study those technological cycles; Vico, who saw cyclical ages of war and darkness, followed by times of enlightenment; Marx, who saw history, evolving in cycles, further studied by Kondratieff, and Spengler, who analysed cultural change with the morphological laws of biology.) All those theories of time changed were based not in the analysis of spatial, entropic, energetic changes in the motion of beings, but in the analysis of morphological, informative change, making certain the first insights of Aristotle that divided the sciences of change and time in physical studies of translational change and biological studies of morphological change.

Thus, according to the constant advance of our understanding of time and the Principle of Equivalence, in the XXI century we should expect a new book whose theory fusions the discoveries of Mr. Einstein in the XX century and Mr. Darwin in the XIX century - the concept of biological time, as change in the information of beings and the concept of physical space-time, as change in the spatial location, formal trajectory and speed of beings.

It follows that such theory must be a theory of multiple modes of time-change, and since each temporal change affects a vital space (Biology) or a physical space-time, it must be also a theory of multiple types of spaces. This is the theory explained in this work - a theory of multiple spaces and times that unifies biological, sociological and physical modes of time-change.

Such a book has to be written, naturally by an expert in the science that tries to fusion Biology and Physics - the science of 'Duality', which puts together the arrow of energy and the arrow of information and can advance our understanding of space and time into the XXI century, by fusing the work of Einstein and Darwin into a comprehensive theory of all types of spaces and time-changes.

Einstein said that Leibniz was right and there were multiple times and hence multiple spaces but to create such complex model of reality required starting from the beginning, 'scrapping' all what science had found since Galileo. So he did not try. We shall try in this work without 'scrapping' but merely adapting the previous knowledge to the new view, according to the Principle of Correspondence.

What system sciences and duality does is to synthesize all the jargons of form and motion (time and space in physics; information and energy in biology; mind and body in philosophy) to distil the properties of the ultimate realities of the Universe, energy and form (Duality), and the complex systems and social networks that entities with energy and form create (General systems sciences). The application of those laws of duality and general systems sciences to physical species is the theme of this lecture, which would be better understood if the reader studies first those general laws in detail, provided in previous lessons, available in the web¹.

Thus, *the 4th paradigm of science fusions the work of Biology and Physics by considering not only the arrow of lineal time and entropy, but also the arrow of information and the transformations between both, which create the cyclical beats of time that we observe in nature, defining a new foundational law of science: 'All what exists are complementary systems of reproductive energy and information that transform into each other 'ad eternal': $E \Leftrightarrow I$ '.* And it goes beyond metric models of a single space continuum, a notch higher into *the more general topological and Non-Euclidean spaces*, whose self-similarities will allow us to extract wider laws of reality, *the final whys of the events and geometries we observe.*

Let us then consider the new mathematical foundations of this model, based in the nature of *fractal information, which was not fully*

understood in the past because its mathematical formulation through dimensional form and fractal repetition appeared at the end of the XX century. Indeed, if the 3rd paradigm extended the discovery of molecular entropy to all scales of systems of reality, the understanding of information creates the fundamental beat of the Universe, the feedback rhythm, $e \Leftrightarrow I$, from where all other equations, from the life ($>I$) & death ($<E$) cycle, to the dual membranes of the Universe (Gravitational, attractive masses $>I$ Vs. Entropic, electromagnetism $<E$), to the processes of reproduction ($ExI=k$) will be deduced.

How far a 'Theory of multiple spaces and times' will go to fulfil the claim of being the space-time Theory of the XXI C., completing the structure of science will depend on its capacity to provide solutions to unresolved questions of science and predictions testable by experimental results (Popper). Yet the odds are good, since many of those solutions and predictions done as earlier as the 90s when the first texts on Multiple Space-times were published, had already being tested³ - an encouraging sign for its future.

Recap. Time and Space are the final elements of reality. As humans evolve their understanding, new scientific paradigms are found.

3. Topological forms are knots of time cycles.

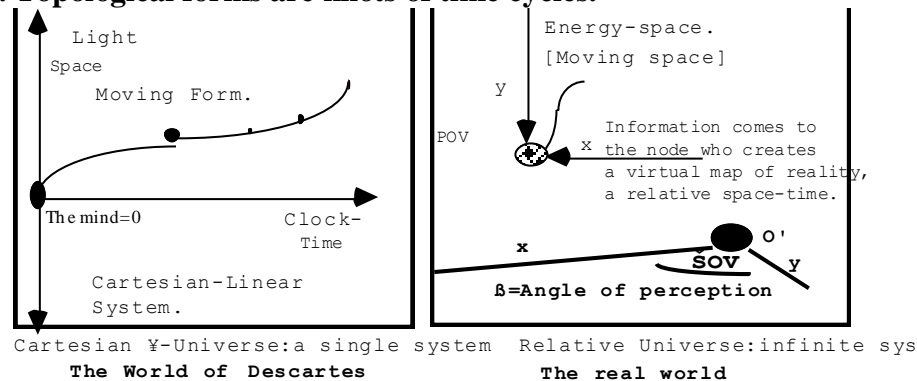

Thus, our work on complex physics departs from Leibniz, Darwin, Riemann and Einstein and goes beyond harmonizing the discoveries of those geniuses and founders of the 4th paradigm.

Let us then start that journey considering the expansion of Non-Euclidean geometries needed to formalize complex physics with the definition of a complex, fractal, Non-Euclidean point.

In the graph, because a Cartesian graph (left) is an abstract continuum of lineal time, based in the single rhythm of a mechanical clock and a continuous space of points with no ‘breath’ (Euclidean definition of a point), ever since it became the canonical representation of space-time science has believed in a single, absolute time and a single absolute space, with a single point of view, that of the human mind in the origin of coordinates. Yet the Cartesian plane only represents the continuous space-time of ‘the membrane of light’ it represents with its 3 perpendicular coordinates, equivalent to the height=electric field, width=magnetic field and length=wave speed of light. Since *light is the space we see and so its 3 coordinates are self-similar to those of the Cartesian, human mind made with light.*

The real Universe has infinite points of view that gauge information in infinite scales of space-time. Those points of view have therefore volume to fit the flows of energy and information that go through them, which is the definition of a Non-Euclidean point of view through which infinite parallels can cross. Each of those parallels is in fact a cyclical, curved trajectory (Einstein’s definition of a parallel); and so we can consider each Non-Euclidean point of view a knot of time cycles with form and motion.

Let us consider the new 5 fundamental postulates of such Non-Euclidean, fractal geometry of Multiple Spaces and Times:

1st Postulate: *‘A fractal point is a world with an inner content of information that creates its 3 internal, topologic, organic dimensions and a content of energy that traces its external motions=time arrows’*

2nd Postulate: *‘A line is a wave of fractal points.’*

3rd Postulate: *‘2 fractal points are self-similar when their external, spatial perimeter or their inner information is equal. Similar points form organic networks by sharing their energy and information. Dissimilar points ab=use each other in Darwinian relationships’*

4th Postulate: *‘A plane is a network that joins points through waves of energy and information.’*

5th Postulate: *‘A fractal point has inner apertures to the world, through which multiple waves of energy and information can cross.’*

The first postulate explains a fractal point as a point with parts.

Thus a point can be any entity of the Universe. In a more detailed analysis those parts turn out to be self-similar in geometrical terms in all of them, defined by the three canonical topologies of a four-dimensional Universe, which describe an informative, hyperbolic region or ‘head’, a toroidal, ‘reproductive body’ and lineal or planar energetic limbs and membranes, common to all the points of the Universe. The 2nd postulate explains the interaction between two points connected by a wave of communication or ‘line’; the 3rd postulate explains the type of interactions between 2 points according to their relative equality, which will bring them together into a social network or dissimilarity, which will make them not interact or enter into a Darwinian relationship in which a point absorbs the energy of the other. Finally the 4th postulate defines the creation of networks made of systems of points across multiple scales of space-time.

Thus, we define time cycles, forms with motion, its multiple knots of time cycles and networks with a new geometry of space-time, Non-Euclidean geometry, born of the completion of the work of Einstein in physics and Riemann, Lobachevski in the field of mathematics. Since now all points have form and motion, they have breath; and since now all lines have form and motion they are waves; and since now all planes are networks, they are discontinuous planes. Thus, the new formalism of space-time explained in detail in other lessons of this work¹ redefines also the geometry of the Universe in dynamic, discontinuous terms.

The universe is made of networks of such i-points, and each network is what we call a world or discontinuous space-time, st, unit of a bigger fractal network, a new st-point in itself. So a network of particles becomes an atom, which becomes an st-point of a molecule and so on till creating the networks of the Universe.

Even humans can be studied as Non-E points, in which each head is indeed a spherical point that communicates constantly energy and information with other humans, forming social networks. Such complementary points are made of two networks, one of energy and one of information, which we call the body and head of a biological Point; or the field and particle of a physical point (Principle of Complementarity).

Recap. To understand Multiple spaces-times we need to evolve further mathematics, the language of science. Leibniz, Einstein and Riemann, who in the XIX c. realized that ‘through a point infinite parallels can cross’ (5th postulate of non-Euclidean geometry) are the points of departure. ‘Non-Euclidean points’ with form and motion, made of knots of time cycles, are the final elements needed to understand the why of the Universe. They socialize into networks that become points of a higher scale, which reproduce and organize new networks; and so the Universe keep growing in fractal scales, from particles that organize networks and become atoms that organize networks and become molecules that organize networks and become cells, that become organisms, that become planetary societies; while planets and stars form gravitational networks that become galaxies, organized by dark matter into Universal networks. Thus each Non-E, fractal point is a world in itself - a topological point with a volume of energy and information that relate it to other points through waves, which carry energy and information and create networks that warp into bigger points.

4. The organic, perceptive Universe.

Non-Euclidean points perceive energy and information.

In the previous graph, we also observe a key difference between the 3rd mechanist single space-time continuum and the 4th paradigm of infinite points of measure:

In the 3rd paradigm, scientific rods of measure are limited to the human world and scale, which Descartes precisely defined in a book he called the ‘world’, warning that they were the rods of the human mind. Yet they have ever since being used to describe all the other points, without realizing that they were only the characteristics of the space-time designed by our eye with the parameters of light-space, (the electromagnetic vacuum in which we exist with its 3 light-caused, perpendicular Euclidean coordinates and its c- speed). Once scientists

started to make measures and inventing machines to help them in that task they forgot the admonitions of Descartes, who told them that perhaps a devil had put that world in his mind: ‘I think therefore I am’ was indeed the meaning of it all: our mind is the best metronome, which creates a ‘meaningful mapping’ of reality with light – but it cannot measure or penetrate in other scales of spacetime or opaque points of different substances around us.

In any case Cartesian space (Galilean Relativity) and c speed (Einstein relativity) became the absolute rod for all other measures. This allowed the development of a ‘referential world’, similar to the way the visual mind perceives time and space, but this frame of reference made with light pixels is not the only possible mapping of all broken spaces and time cycles of the Universe. There should be other species with other rods of measure, which perceive spaces we don’t see (smelling spaces which dogs use to make their mind, gravitational spaces which seem to guide the actions of black holes, etc.).

This creates a new method of knowledge, proper of the 4th paradigm that we call the informative or linguistic method: all languages have a content of truth that gives knowledge. So if the total truth of a being stored in itself gives a probability of truth equal to 1, any external point of view gives us a lesser amount of knowledge that increases when we include more perspectives and languages.

Since all kind of languages and senses give us images of reality, the linguistic method states a higher probability of truth is achieved with several perspectives and linguistic descriptions of a certain system; as each point of view will create a self-similar image of reality. And so by integrating them all we obtain a complex, kaleidoscopic image of the whole. Reason why most systems have redundant, parallel systems and biological organisms have bilateral eyes, ears, etc.

In that sense, the 3rd leg of the 4th paradigm is the most difficult to accept by mechanist science that measures and digitalizes reality only with numbers, because it is a philosophy that defies the linguistic, anthropomorphic ego-centrism of mankind, which admits only his languages and perceived spaces as real.

It is however the why that explains why entropy doesn't dominate the Universe; since now the increase of order and information in the Universe is mainly caused by those 'perceptive points' that gauge information. Those points might or might not be conscious in a vegetative or reflexive way, depending on its complexity; but they are 'aperceptive' - an expression coined by Leibniz to express perception without consciousness. And so they have a will to order and perceive more information, not only a will to feed and increase their energy. And so there are two 'wills' of feeding and gauging common to all points, which we can measure objectively, externally by the fact that when energy appears, particles move towards energy (so electrons jump and feed on light) and when other particles appear they gauge their distances. We observe this property in all systems when they form a focus, which emerges *as the point* of maximal order in which the network of the system integrates its information. Then the system becomes more stable: A crystal grows faster when the network creates a central point. A hurricane can be destroyed when the central, still point where all the flows converge is disturbed. A life being becomes erratic in its motions when it becomes blind. A galaxy acquires order when a black hole, which probably gauges gravitational information, appears in its center. The existence of an infinite number of such points is undeniable objectively and adds an enormous amount of order to the Universe, which mechanist science does not account for. Stillness to focus information into a pixelated map of the Universe, and the existence of a network that fluxes in that point through which 'infinite parallels' can cross, are the two conditions of formation of gauging points. Then we can establish the birth of a complementary network of energy and information, *an existential point*: $exi=k$; where k represents a 'mapping of reality' in the informative language that the waves of communication of the point with the external universe have created. *This means that the models of metric measure developed by mechanist science merely creates a 'space-time world' self-similar to the mind of man in our machines, which does not exhaust all the measures of the Universe and its possible mappings.* We cannot construct if we want to account for all the cycles of time, dark spaces and events of reality, a theory based only in a continuum, mechanical, light-space and its Euclidean coordinates of light-

measure. The limits of that model have been reached, as the limits of precision of the Ptolemy's model of astronomy were reached in the Renaissance. Those limits of an Euclidean, continuum space-time were proved by Riemann, Poincare, Mandelbrot and this author, expanding and completing the Euclidean postulates. Einstein applied part of those new models and created Relativity Theory. This work applies the rest of those discoveries to create a model of Multiple Space-times, which includes the concept of absolute relativity, where measure – the gauging and mapping of the external universe by a non-Euclidean point, is relative to the observer and the rods of measure it uses.

Non-Euclidean points have 3 organic networks and 3 fractal scales.

Reality is constructed with 3 levels of increasing complexity: In the first level any trajectory that returns to a point creates a closed form or time cycle, a clock, the unit or minimal event of Reality. Then many time cycles, chained to each other with certain synchronicities create a knot of time cycles that fills a vital space and becomes an entity of reality. We will describe those knots of time cycles as Non-Euclidean points, whose topological parts and laws become the mathematical foundation of *Multiple Spaces and Times*. Finally many knots of time cycles, exchanging flows of spatial energy and temporal information create complementary, social networks, which in its more complex forms are able to reproduce the system and create 'super-organisms', wholes made of parts that are wholes of an inferior scale of reality.

Since non-Euclidean Planes are networks with 'dark spaces' not perceived by its points that only see the flows of the network; those 'holes' allow the creation of complex systems with many networks, webbed within those dark spaces.

Thus the why of the Universe is organic, social: the Universe is made of complementary energetic and informative networks of 'Non-Euclidean points' (points with form and motion) that evolve and combine together, creating reproductive networks. And such complex systems create, new bigger, fractal networks units of a larger plane of space-time, evolving reality in scales of size that follow the same organic laws - from particles that become atoms that become molecules, cells, organisms, societies, planets, galaxies and Universes.

And it turns out that those complementary systems are everywhere in the Universe – they are the beginning of it all:

In quantum physics, they explain the complementarity principle: all particles of information are associated to a field of energy.

In biology they explain the duality of cell body/DNA informative nucleus, or body/head that all biological systems have to exist.

In sociology they explain duality of the informative classes that create the languages of information that rule societies, money, and verbal laws and the people who earn money and obey it.

In economics they explain the duality of machines of energy and information; of money and the physical economy.

Organicism. The 4 arrows/dimensions of time:

Feeding, gauging, reproducing and socializing into networks.

And so with those 3 scales of ‘existence’: time cycles, knots of time cycles and networks of knots of time cycles (Non-E Points) we can explain all the ‘actions’ and systems of reality made of those cycles, knots and networks; and describe a complex Universe that exists ‘in time’ more than in fixed space, since it has always motion; it is also dynamic, made of cyclical, feed-back equations whose causal relationships, forms and trajectories are the essence and purpose of existence. *We thus consider a more complex analysis of time arrows, beyond the duality of energy and information, which combine creating a reproductive arrow, exi, and further on socialize, $\sum exi$, creating networks. And so the universe has also an organic will: to create networks of self-reproductive points of energy and information.*

To exist is indeed to act with motion and form, trying to achieve the ‘arrows of time’ or will of the Universe – feeding your energy network, absorbing information for your informative network, reproduce your system and in doing so, starting an external process of social evolution with self-similar entities to yourself. Those processes can be described with mathematics but we have to accept an intelligent, perceptive, fractal, self-similar Universe of infinite points of view gauging reality in a mechanical, vegetative or conscious way to explain why it happens. Their mathematical description stems from

the duality between geometric form and logical function (hylomorphism). Thus, the postulates of fractal i-logic geometry define also the basic arrows= cycles/dimensions of the Universe: the 1st and 5th postulate define a point as a system whose inner parts are able to transform and emit energy and information, $e>i<e$; the 2nd postulate defines an exi wave of communication that reproduces energy and form between 2 fractal points; the 4th postulate defines the social evolution of a herd that creates a fractal plane - a network with dark spaces; and the 5th postulate explains a point mapping reality, as it absorbs energy and transforms it into information through its small apertures to the Universe. Since even a minimal quark, as Einstein affirms, should be crossed by a relative ∞ number of strong forces.

In that regard, systems sciences, the study of the networks of ‘time motions’ in the Universe, responds to the final ‘journalistic’ inquire of science, the why of reality, what we call the 4th paradigm of science, *which is the organic will of all systems that search for those 4 arrows.*

For example, a physical particle traces energetic cycles described by the principal quantum number; organizes itself socially, an act described by the magnetic number, feeds on energy, changing the spatial extension of its trajectory, a fact explained by the secondary quantum number and gauges information, a fact described by its spin number. And those 4 numbers define it as a Non-Euclidean quantum knot of complementary energy and information with a 4D will of time.

The 3rd paradigm of metric measure is not at ease with such ‘dynamic, spiritual concepts’, even if they can be described with the same mathematical formalisms as the previous example of the quantum numbers show. Those apprehensions however are dogmas which stem from anthropomorphic beliefs.

Fact is that even the simplest complementary systems (quarks and electrons) interact together and if they can absorb more energy=motion they are able to repeat=reproduce the cycles of its system. And so we talk of a 3rd reproductive system: from quarks and electrons, the fundamental particles of the Universe that decouple in new particles when they absorb new energy to living organisms, the fact that all is motion with form makes easy to reproduce those formal motions in an

organic way. Thus the new concept of a world made of formal motions brings about also a more complex philosophy of reality - organicism. Organicism and its mathematical units, fractal points, that gather into social networks called topological spaces substitute the restricted concepts of Euclidean points, continuous spacetimes and mechanism, explaining why all those time cycles exist, guided by 4 time arrows: energy feeding, information gauging, reproduction and social evolution. Those 4 categories are the so-called drives of living beings, the quantum numbers of particles, the 4 dimensions of our light space (electric-informative height, reproductive magnetic width, energetic length and social colors). Thus, there is a 'Universal Plan' with an existential finality: to create organic systems, departing from energy bites and information bytes evolved 1st into social networks, then into complementary systems and finally into organic systems, news points of a bigger fractal whole: particles become atoms that become molecules that become cells, organisms, planets, galaxies and Universes. It is the 4th organic why that completes the adventure of science and this work explores in all its consequences.

All facts of reality can be resumed in 2 words: *networks* whose flows of exchange of energy and form create the patterns and events of reality and a renewed philosophy of reality based in them: *organicism*. Organicism means that time and space are not abstract, single entities but reality and all its fractal parts are made of *vital spaces* (bodies and forces) and *time cycles* (informations). We do not exist in an abstract background of time and space but we are made *of time cycles and lineal spaces*, cyclical and lineal strings if we were to use the restricted jargon of physics, a specific case of the wider jargon of general systems, *which evolve socially to create the complex systems of each science*. Those wider, more complex definitions of time and space will substitute and absorb according to the Principle of Correspondence that makes each paradigm a particular case of the new, wider view, the limited concepts of a single space-time continuum and a mechanist description of the Universe, proper of the age of metric measure, which the pioneers of systems sciences and complexity have wrestled with throughout the XX century.

Recap. If we were to resume in a single sentence Complex Physics and the 4th paradigm of systems sciences in which this discipline is based we would state that 'all what exists are cycles of space-time gathered in knots called Non-Euclidean points, gathered in complementary networks of energy and information; which become the physical systems of reality'. Thus the 4th paradigm uses the new mathematics of non-Euclidean geometry, topology and fractals and the new logic of multiple time cycles, to define a new fundamental particle of space-time, the fractal point - a world of space-time in itself - an entity made with 3 networks of energy, information and reproduction, which constantly try to feed, inform and reproduce the point. Those Non-Euclidean points of energy and information evolve into networks, forming organic systems. Each system becomes then a unit-point of a bigger network, determining the dominant arrow of creation: social evolution in growing scales of self-similar forms.

The Universe is a game of chained time cycles that form knots and networks, which carry the information of the Universe. The evolution of parts into social wholes with form is the why of it all.

All those points perceive a limited reality decoded as information, extracted from the flows of energy its relative perspective and informative parts can observe. All points of view in the Universe move and gauge the information about the limited reality they perceive, creating with those exchanges of information and energy a mapping of reality. And so only the sum of all those st-points creates the absolute Space-Time of the Cartesian plane, whose rods of measure and time clocks are those of the human 'point' - our eye ball, who sees light and measures space with a rod of light and see space with the 3 perpendicular dimensions of light (the magnetic, electric and c-speed fields).

5. Ternary method: laws of topology and Plan of Evolution.

The most remarkable success of a theory of Multiple Spaces and times based in the 5 postulates of Non-Euclidean geometry, the definition of a point as a knot of time arrows, a plane as a network and an organic system and a ternary network of energy, information and reproduction, is the completion of a Mathematical Theory of evolution of form, of in/form/ation, which applies to all sciences and will be used in this paper to classify the main physical entities of the universe.

Its basic tenant is that we live in a 4th dimensional Universe in which forms are restricted to the limited topologies of space and the

logic ages of time found for all systems¹. Those restrictions of topology limit the number of possible diversifications and forms of all type of organisms to the 3 unique topologies of a 4-Dimensional space: the energetic plane, the informative hyperbole and the cyclical toroid that combines energy and information in reproductive events.

In time those 3 topologies correspond to the 3 Horizons/ages of all species: energetic youth, reproductive maturity and informative, 3rd age. It is the main symmetry between spatial form and time events: All networks belong to the 3 topologies of the Universe, developed in a sequential order from the energetic age to the informative 3rd age, with a reproductive intermediate phase. And those 3 topologies and ages define the life/death cycle.

Finally the arrow of social, network evolution creates 3 scales: entities are constantly increasing its information and social evolution from points into networks and ecosystems. Thus the 3rd set of key laws of system sciences is the study of the parts and the wholes and how information and energy is shared or distributed among them: From those facts stem among many other laws, the laws of genetics in biology and the laws of physical states.

And all those laws put together are expressed in the existence of 4 drives of life existence or time arrows, common to all beings, which absorb energy with its energetic bodies/fields, gauge information with its particle/heads, reproduce whenever they have enough energy its networks and evolve socially into bigger systems.

Thus the triad of essential system laws is the law of the 3 topologies, of the 3 ages and the law of social evolution, which gives birth to the 3+1 arrows or wills or whys of reality.

Thus the understanding of reality with the 3 types of networks of complex systems starts with monism – the study of single networks. Duality is the next level that studies ‘complementary beings’ made of networks of energy and information. Such systems are made of lineal limbs/forces and an informative head/particle on the other. Yet most systems follow the ternary principle and have an energetic, informative & reproductive system. Such ternary systems follow the 3 symmetries

of the complex Universe: the 3 ages in time of the system, dominated each one by a network (the energetic youth, reproductive maturity and informative, 3rd age), the 3 topologies in space that define those networks (hyperbolic, informative center; planar or spherical, energetic limbs and membranes and toroid, cyclical, reproductive organs); and co-exist 3 scales of existence – the cellular, organic and social scale, in which the organism becomes a unit of the next scale of reality. And so the study of systems through its dualities and its 3 symmetries of spatial form, temporal ages and scalar size, is the essence of the ternary method that we shall follow in this work to classify all physical species and study its evolution.

Those ternary ages and topologies, and dual laws and symmetries between the spatial motions and temporal, informative states of all physical systems, studied under the formalisms of non-Euclidean postulates, ternary topologies and fractal, scalar geometries are the mathematical foundations of a theory of multiple spaces and times, extended through several scales of reality, whose origin can be traced to the work of Leibniz on relational, multiple time cycles and vital spaces, but now truly acquire thanks to systems sciences all its solving power. Since we classify all space forms and time events in 3 topologies that put together in social networks, create organic systems.

Thus the duality of energy and information and the ternary method is the key system used to resolve and reorganize the elements of physics, from the 3 ages of creation of matter (energetic gas, reproductive liquid and informative solid) to the study of particles and its social forms (the 3 families of increasing mass-information, the duality proton/neutron, quark/electron, strong/weak forces, gravitational/electromagnetic membrane; the 3 ages of the Universe equivalent to the 3 solutions to Einstein’s equations – which are phases of evolution in time of the Universe that goes from a big-bang age, through a steady state into a Godelian vortex. While the 3 topologies of all 4-dimensional systems that structure the ‘parts’ of any physical entity as a ‘Non-Euclidean point’¹ will allow us to study black holes in far more detail than previous theories had.

Let us then study the ternary method in more detail.

Organic functions and motions in time of spatial forms.

The topological structure of non-E points.

To understand what all the Non-euclidean points with its motions and mental worlds, maps of the Universe have in common, we need to consider a mathematical structure for the Universe, which includes all its possible worlds and systems, based in a type of space more general than 'metric spaces' called 'topological spaces', *spaces* whose fundamental properties are no longer 'distances' and 'sizes', which are relative, but properties like 'adjacency', 'formal curvature or information', 'self-similarity' (instead of equality), 'complementarity', 'function', 'geodesics', etc.

Change or motion are the classic definition of time traced back to Aristotle, who also said there were two types of change or motion, the motion in the location of beings studied by physics and the motion of the form of beings (the life/death cycle, the evolution of form) studied by biology. And so this new/old definition of time, which gives us whys to the change of reality substitute the definition of the 3rd paradigm: 'time is what a clock measures'. And it gives us the organic whys to all motions, which are either energetic motions, of lineal topologies or informative motions with more form, cyclical, clock-type topologies. And its combinations, reproductive motions that combine both creating new curves and forms.

Thus, in a model of relational, multiple discontinuous spaces what matters is to describe network systems with general properties given by their topology and the functions and cycles those topologies perform more than their detailed measure in metric space, which physicists have used to describe them till now.

What all those different spaces of reality, from the chair to the man, from the sun, to the galaxy and the universe itself have in common is the fact that despite their different size and form, when we do measures – the length of their limbs, legs or the surface of its external membrane, or the density of its different parts - all of them have parts that structure a whole; so all of them are *systems*. And all of them are a combination of the 3 possible and unique topological spaces of a 4

dimensional universe; that is, all of them combine *the hyperbolic, informative topology, the spherical, energetic topology and the cyclical, reproductive, toroidal topology* that mathematicians use in different combinations to map out all beings of reality.

We give to each of those 3 topologies a function, since the experimental method shows that information is accumulated in hyperbolic, broken structures with complex forms (such as your brain, a black hole or a computer); on the other hand tiled membranes made of small planes - triangles, squares and hexagons - are the most resistant 'energetic systems' while reproductive processes are cyclical, feedback equations that 'repeat' a certain form. Thus a science of formal, topological structures in space and its parallel functions in time -a 'system sciences' - is more general than a science of measure. Since it studies the properties of those 3 type of functions/forms/networks assembled through messings allowed by its dark spaces between networks and describe with them all species of the Universe.

And this type of structure, which combines in most physical systems two networks, one of information (particle, head) an one of energy (limb, field), often mixed in biological systems within a 3rd reproductive network (body) turns out to be the Universal structure of all efficient, long-lasting entities of physical and biological space, the fundamental particle of systems sciences and complexity: *a complementary entity of energy and information*. Thus we establish a new way to look at the universe with topological spaces and networks instead of metric spaces and continuous planes– a universe of infinite fractal scales of networks that become parts of bigger wholes.

Finally we must analyse how all those different spaces are connected to form the puzzle of a total universe, and to that aim again topology with its concept of open and closed balls and the laws of thermodynamics with its analysis of exoergic and endoergic systems, come handy to understand how those fractals, broken, discontinuous spaces share certain common regions, membranes and bridges through which energy and information can flow in one or other direction to peg them together in stable, bigger forms.

Thus the structural analysis of systems, networks and topological spaces is a wider way to see the order, structure and meaning. Yet it does not eliminate the old method of analysing metric spaces and make measures; because once we have that wider view, each different self-similar species will be differentiated by its precise 'metric'. For example we shall establish with the new laws a topological category of beings called 'cars' according to the assembly of its parts into a whole, made of certain combined materials that define a series of specific topological structures and functions: the car will then be an energetic system, where a human with informative height and hyperbolic brain, assembled to it will play the informative role. And all cars will have always 4 wheels as that is the most efficient structure to create a parallel 4-square plane of minimal friction to move over another plane –the road (since a network of 4 points or square and one of 6 points or hexagon are the most stable bidimensional structure), and so on. Yet to differentiate a Mercedes from a Renault, we need metric measures – the Mercedes will be longer and wider, and so on. So what we are creating is a new superstructure over all the other disciplines and detailed analyses of all the species of the Universe that unifies them from a higher point of view – a goal of philosophy of science that can be traced to the 1st man who looked at the Universe and felt an integrated part of it.

Why this is important has to do with the difference between both type of spaces: metric spaces must be equal in distance and size to be the 'same', and so we cannot go beyond each detailed description to create homologies that give us the 'wider whys' of reality. Topological spaces however are self-similar based in very general properties, which allows to classify many forms as a single type of topological function and conclude that all functions of reality respond to the same 3 topologies in space and functions in time, needed to describe the entire 4-dimensional Universe. Since in topological forms 'distances' and sizes are relative; so what is conserved is the overall 'lineal, planar shape' of energetic functions, (limbs, weapons, proteins); the cyclical, toroidal shape of reproductive cycles, which combine energy and information to recreate a form, (body cycles; mitochondrial cycles, assembly cycles in a factory), and finally the hyperbolic, broken,

convex, warped, cyclical forms of informative systems, (brains, cameras, eyes, languages, black holes.)

Why this road has not been taken before is obvious: the 3 mathematical foundations of it are the 3 most recent branches of mathematics, only developed in the XX century, topology by Poincare, Fractal mathematics, developed by Mandelbrot (1973, fractals) and the completion of Non-Euclidean geometry by this author (Physics of time, 94). So in the same manner that quantum and relativity required the solution of the 5th non-Euclidean postulate (Riemann) and the understanding of Hilbert spaces in the XIX C., the new paradigm foreseen by Plato and Leibniz and acknowledged by Einstein and Poincare, happens once its mathematical structure is formalized.

The 3 ages of time: the life/death cycle

Further on, the 4 arrows of space-time have a clear order in time, such as we are born as a seed of information that:

-Max. E: Goes through an energetic youth of fast motions, in which the energetic limbs and external sensorial membrane dominates.

-E=I: Balances energy and information in a mature, reproductive age, in which the internal, topological, reproductive system dominates.

- Max. I: Till it warps all its energy into form, in the 3rd age in which the central, hyperbolic, informative brain/particle singularity is dominant. This age ends in:

- Death: Exploding back into energy, erasing its information in the process of death.

And so this order from energy to information or life E->I and then its local reversal of time arrows from information to energy or death, I->E, becomes the fundamental cycle of existence of all species of reality, from human beings, to matter (energy=gas state, liquid=reproductive state, solid=informative state), to the Universe itself from the big bang to the steady state to the Gödel's vortex, described by the 3 solutions to Einstein equations, which must be ordered in time.

Thus after making a topological, spatial analysis of any entity, the 4th paradigm makes a temporal, causal analysis of its life/death cycles,

since both are related as each topology dominates each age of the species or individual form.

The 3 fractal scales of space-time.

A closer analysis of those ages shows that it all starts in a simpler $st-1$ space-time scale, that of the initial, cellular seed of information, the singularity of the Universe or the plasma state of matter, then the system reproduces and evolves socially till surfacing in the st -plane of existence, which we consider the main life cycle of the system, in which it will herd with self-similar systems of its $st+1$ social scale, till it dies and returns back to the $st-1$ cellular level. And so existence is also a travel through 3 $st\pm 1$ scales of reality. And we do a ternary analysis of the 3 fractal scales of space-time in which all systems exist. They are the atomic, matter and cosmic state of physical entities, in which atoms gather into gas, liquid and solids that form part of cosmic entities, planets and stars.

Recap. The new method of knowledge of the 4th paradigm is the linguistic, ternary method, which accepts all languages of knowledge and uses the ternary structures of fractal points in space (its 3 topological regions), in time (its 3 ages of evolution) and its structure across 3 $st\pm 1$ planes to exhaust our knowledge of any system. There are 3 types of systems, simplex systems of energy or information, complementary systems of energy and information and complex systems which add a feedback reproductive system: $e \Leftrightarrow i$. They dominate in 3 ages of time, energetic youth, reproductive maturity and informative, 3rd age, in which a species travels through 3 scales of self-organization, born as a $st-1$ seed that reproduces and self-organizes, surfacing as an individual form in the st -plane, which will perform certain tasks in an $st+1$ ecosystem.

Notes:

¹ If the reader wants to fully grasp in depth this lectures in complex Physics, which develop a General Systems Theory of Multiple Spaces and Times, applied to the resolution of the main questions still unanswered in the discipline – from the Unification Equation of charges and masses to the explanation of the mass of particles and its 3 families, the nature of anti-particles and the fractal structure of the Universe in two membranes – the gravitational macrocosms and the quantum microcosms - he should consider reading first our lectures on the philosophy of Systems sciences and the formalism of a Theory of Multiple Spaces and Times, which set the mathematical, logical and philosophical foundations of Complex physics.

Specifically the readers of these lectures on Complex Physics should study first the 2 lectures I gave at Tokyo's ISSS congress: 'Fractal Universes' on the mathematical and logic formalism of systems sciences and 'the Philosophy of Systems sciences', which resumes the model of a General Systems Theory of Multiple spaces and Times and its application to different sciences.

² 'Broken Spaces-Times'; Alan de Mehaute.

I. COMPLEX PHYSICS.



The Universe is made of motions in time, which perception fixes into still mappings, confused with forms of space. Saturn's rings are not continuous planes, despite their appearance. In detail, they become herds of planetoids in motion, tracing orbital cycles around the planet, which are self-similar to the paths planets make around the sun.

Further on, when we observe each planetoid in further detail, it becomes a sum of self-similar atoms, rotating also in cyclical paths. Thus a simple, single, flat space-time that seems continuous, without motion, becomes a series of moving, complex, cyclical, discontinuous, fractal space-times, organized in several scales of size and form, each one made of a network of self-similar Non-Euclidean points.

1. A Universe of multiple scales of space and time arrows.

Physics is the study of the lower scales of reality, those made with the simplex arrows of time, energy and information, in its simplest lineal and cyclical forms as forces and particles, extended in two relative fractal scales or membranes of space-time, the electromagnetic membrane, whose simplest, most extended surface is the vacuum space of galaxies, and the bigger gravitational space-time, in which light floats.

Between both, we exist as beings that are subject to influences from both membranes, the light membrane, which dominates our structures in the evolved form of electronic forces and the gravitational membrane, which we do not perceive but hint at it, through the study of quarks and cosmological masses and the influence of gravitational forces that inform us.

In that regard, physics can and must be described with the same laws of multiple time arrows and discontinuous spaces of all other super-organisms, taking into account that physical entities follow the general

law of the black hole or inversion of properties between systems of information and energy, such as:

Physics: max. spatial extension = energy x Minimal information

What this equation tells us is that organic systems, in the physical world are extremely simple in their topologies, but extend to extraordinary degrees of energy, speed and spatial extension.

Reason why physicists, as Nietzsche put it, are more interested in the 'canvas', the laws of space and the arrow of energy than the 'painter', the law of form, which they mostly ignore and causes most of the errors of physical sciences – such as the ignorance of the informative properties of masses, what we shall call in the context of physics, the 'Arrow of Einstein', given the fact that Einstein was the physicist who better understood those properties, describing its informative force gravitation as a force that bend the energy of space into 'whirls or clocks of time' or masses. Because of the limits of this work, we will in that regard consider in special detail the 'arrow of Einstein' – that is, the meaning of information in physics, due to the fact that it is the element of physical studies which requires further evolution.

The second fact about physics we must take into account is the 'mirage of size', which has for centuries hold the wrong assumption that what physicists say is the essence of the Game of Reality, because they study the biggest sizes of the Universe. This is not truth, as it is proved by the fact that we are gathering the same quantity of data about physical particles than biological organisms (the other extreme of reality, which maximizes the form of beings, though carries minimal energy). What physics does is to exhaust the knowledge of all phenomena related to entropy or energy, but the previous fact proves that the Universe is a balance between both arrows, energy and information, reason why in our data banks we find a clear proof of such balance:

Max. E x Min. I (Physics) = Max. I x Min. E (Biology)

Yet since we are living beings Biology, the study of ourselves, should be more important than the study of galaxies and atoms.

Further on, if as it seems the Universe is a fractal of ∞ space-time scales, in which the game of existence repeats in self-similar forms after a certain number of scales (which in the physical world seems to correspond to the atomic and galactic scale, as we shall show deriving self-similar fractal equations for both type of entities), size will be absolutely relative and so it will not matter that from our p.o.v. galaxies seem so huge. It might be according to those equations of ‘unification of physical scales’ that from a higher p.o.v. a galaxy is just self-similar to an atom in a Universe of ∞ scales.

Thus the main errors of physics derive from the misunderstanding of fractal space and the arrow of informative time due to the use of a single instrument to measure time, the clock that created a lineal time arrow, energy and the use of a single space, the Cartesian plane.

Those basic errors are illustrated in the graph, which shows a fractal space of multiple time cycles and scales of form, which was however considered for centuries to be a simple space-time with a single cyclical form.

All this means we must revise the classic theories of physics of the XX century to adapt it to the evolution of Non-Euclidean Mathematics and the temporal logic of multiple time arrows. To that aim the key concept is the Non-Euclidean point, a point with form and motion, which is a knot of time cycles. Those fractal points – planetoids in the graph – grow in size as we come closer to them, and form networks with self-similar points, which become planes. Yet again those planes have motion; and often those points are mere cycles of motion that reproduce themselves (so closed time-strings and open, energetic strings and informative, quark masses and energetic electrons also reproduce), it is because all those points and networks have motion. Yet *motion and space are not the purpose of reality but its raw material, its primary substance; the canvas in which ‘God’, the mind-laws of the Universe constructs its forms.* We live in a Universe that creates forms, made with social networks. God is a painter in 4 dimensions: the creation of forms, made with time cycles, knots of time cycles and social networks is the purpose of the Universe. What we call space or energy – the expansive, entropic motion of all

systems, is merely the beginning, the eternal substance, from which the laws of organization of time cycles depart to create its formal networks. So time cycles made with ‘vital space’, the energy=motion of the vacuum, are only the essential first bricks of reality. Complex Physics defines a Universe made of multiple, fractal cycles of time that enclose a surface of vital space: Time cycles gather into knots that gather into social networks, units of the bigger scales of a fractal, infinite Universe - from the simplest quantum entities made of ‘energetic forces’ and ‘informative particles’, masses and charges (Principle of Complementarity) to the Universe, made of networks of informative galaxies and fields of dark energy. Since complementary systems in turn form new social networks, becoming cellular units of bigger social networks. So particles become atoms, parts of molecules, units of celestial bodies, parts of galaxies, units of Universes’

Non-Euclidean points are dynamic points, made of rotational, vibrational, lineal, cyclical and elliptical motions. And so we must make a new step in this new brave world and affirm that all forms are motions; in the same manner Galileo realized that the Earth, which seems still, had motion and turned around the Sun. This fundamental truth of the new paradigm is the ‘Paradox of Galileo’: why we see it all still if it has motion? And the answer is that we can see reality either as still space or form, and then describe it with the topologies aforementioned or as a motion that leaves a trace of form as those pictures of night cars leave a line, and then all becomes a motion in time, a change.

Recap. The fractal nature of all Universal entities, which occupy a piece of space and last a quantity of time, is the key to unify the laws of science. In the graph, Saturn’s rings have in fact the form of the commonest informative fractal: a Cantor dust, which thins out once and again into infinitesimal particles. Since when we see any continuous point of time/space in detail, it grows, becoming both, dynamic and discontinuous, made of quanta, moving in self-similar paths that are separated as independent beings, but pegged to each other by flows and networks of energy and information. The Physical Universe is constructed through those logic dualities that make it grow in bigger scales of growing complexity, departing from its 2 essential shapes, the line of energy and the cycle of information.

2. Energy=Space & Information=Mass.

In that regard, a theory of Multiple Spaces-Times applied to the lower scales of physical matter departs from 3 key concepts that go beyond the timid steps of quantum theory and relativity in its description of a reality of multiple time cycles and space scales, to its ultimate consequences:

- *A world of motions in time*, in which the perception of space is merely the still perception of a lineal motion, and physical time, the clocks of information created by the frequency of rotation of charges, masses and lineal forces. The *Paradox of Galileo*, proved when Galileo found out that the Earth seems quiet but it moves, shows that all in the Universe seems still but has motion in a certain scale of its internal form. Mass was considered continuous and still in form. Now we know is made of ever smaller, discontinuous pieces, which finally become mere 'accelerated vortices' of information, small hurricanes of space-time (Einstein's principle of equivalence between curved acceleration and gravitation). This is the Galilean paradox. All is a cyclical motion or 'clock of time' with a frequency, or a lineal motion or 'force of space' with a 'speed'. And so all is made of 'time clocks' and Energies, whose minimal combination is an 'Action', term coined by Planck in his study of light 'actions'. Yet our senses see the motions of energy as 'fixed space', like when we see a car in the night. And they see the clocks of cyclical information as 'fixed forms', as we see masses. So there is a duality of 'reality vs. Senses' that the reader must always think of: reality is made of energy and time as in quantum actions or when we say, I don't have energy and time to do this. But our mind fixes them as space and information. So we shall use here as synonymous, energy and space on one side and clocks of time and informative, formal frequencies. The stop and go analysis of reality brings many new interpretations of classic physical problems, from Michelson's experiment to the resolution of the Complementarity between forces and particles. Ultimately we can consider that all entities have a still, informative, perceptive state, T_i , and an energetic, moving, expansive state E . So we write a 'generator equation of duality', $E \leftrightarrow I$, which means that 'all energies transform themselves back and forth into information'.

- *A Universe that extends in several space-time membranes* of different size, mainly within human perception, the quantum, microscopic scale of charges and electromagnetic forces and the gravitational, macroscopic scales of mass and gravitational forces.

The rings of Saturn seemed continuous. The brain seems still and continuous. It took a lot of time to find (Cajal) that it was made of discontinuous neurons through which motions took place. Complexity overcomes those limits to their physical inquire by establishing the existence of a series of self-similar 'planes of fractal space-time', which co-exist within the same Universe and are organized in scales of growing complexity, in which there are self-similar forms of energy (whose geometry is lineal, as a line is the fastest/shortest distance/motion between 2 points) and self-similar forms of information (whose geometry is cyclical, as a cycle stores the biggest quantity of information in lesser space).

Thus by introducing 2 essential dualities, the duality of Time Arrows and the duality of space membranes, fractal physics changes the look of space-time as nothing has done since Einstein.

Recap: Monist physics considers 3 dimensions of static space and a single arrow of motion, lineal time or entropy, happening in a single continuous space-time. Fractal physics studies a Universe with 2 simplex time arrows energy and information, (stored mainly in the bidimensional form of Masses & charges, perceived also as static dimensions of space=distances) and 2 fractal scales, the microcosms or quantum world and the macrocosms or gravitational world.

3. Galileo's paradox: dimensions of space as fixed motions.

According to Galileo's paradox in the Universe all motions are forms and vice versa. And so the duality/invariance of motions and forms can be considered a consequence of the invariance of the 6 arrows of time, which are geometrical motions traced by all entities even if it appear as fixed formal dimensions.

Indeed, the dimensions of time become dimensions of space: a spatial motion along a speed creates in the process space, as the movement reproduces a form in space along its trajectory. If the process again repeats itself, creating acceleration, again a second

dimension of time is recreated. And so taking this principle a bit further, if constant speed is a lineal dimension of space, then acceleration which is a further motion of speed, a 'change' of speed in time, $a=v/t$, can be considered the second dimension of space. For that reason a bidimensional, rotational motion is considered to have acceleration. And if we were to move laterally such rotational motion, forming a 'Maxwell screw' we would create a 3rd dimension.

So the dimensions of time add up to create a 3 dimensional, fixed surface of energy that can be seen as Maxwell screw or as a complex set of 3 motions.

Further on a system might accelerate, maintain a fixed speed or decelerate, creating *the 3 ages of existence of a physical motion/ space*. This was foreseen by Einstein, when we affirmed that the fundamental Principle of the Universe is the Principle of Equivalence between acceleration and force, which defines a Universe in perpetual temporal movement, always creating and destroying 'dimensional space-time' as it moves and 'prints' form over surfaces of relative present space. Further on, as we shall see latter, the 3 solutions to Einstein's spacetime equations, the expansive, accelerated big-bang, steady state and implosive big crunch (Gödel's solution) form in fact 3 ages of the Universe both in terms of distances and motions.

But what this also means is that dimensions are never infinite, as they have a 'timing' of extension. Thus 'cyclical, temporal movements' and lineal trajectories, reproduce limited, diffeomorphic space-times, creating what mathematicians call a fractal dimensions of space-time. Since the motion will die away.

The graph of Saturn's rings illustrates all those concepts:

-The duality between continuous, fixed space vs. fractal, moving time. Since Saturn's rings are perceived as both, depending on the detail we observe. Thus fractal spacetime is both a physical duality and a mental duality, caused by the limits of perception of our mind, which converts into still space what is a moving, temporal reality. That subjectivity of perception explains many of the paradoxes and errors of our understanding of the Universe. The example of the graph shows

clearly this: In perceptive terms, Galileo discovered Saturn's moving planetoids and called them rings, thinking they were a continuous, fixed form; when they are discontinuous satellites. The limited perception of his instruments erroneously transformed the moving cycles of those planetoids into a fixed ring-form; putting the multiple, fractal microcosmic and macrocosmic scales of matter that made up those rings together into a single space-time. So not only human senses, but also mechanist senses are inaccurate, as the recent discovery of a 96% of dark energy and matter has proved. Thus, the continuity and immobility of space and information is an 'error of mental perception', since the mind pegs the discontinuities between objects that we 'don't need to see' and fusions instead all fractal space-times into a single surface of reality. The discontinuities are there, as they are in a movie, which is a fractal series of pictures we put together into a continuous image. In both cases, we do not see their discontinuities, because in order to survive we do not need to see the voids of formless space that lack any relevant information or any usable energy. It would only cramp our senses. So we don't see for biological reasons the energetic movement of microscopic vacuum space; and we see a continuous Saturn's ring, instead of a moving foam of quantized planetoids. A fact that leads to a biological understanding of perception and information as useful tools of survival:

The mind creates stillness in a moving Universe. We call that error of perception, the 'Galilean Paradox'. Since Galileo discovered that we perceive mentally a fixed Earth; while in fact the Earth is moving (e pur si muove). Yet what abstract Physicists forgot to ask in the next 400 years is: why we perceive the Earth quiet when it is moving; why our senses cheat us? The answer is biological: People perceive moving time cycles and moving energy only in their relative plane of space-time existence, where such knowledge is relevant for their survival. The human mind transforms the remaining time cycles into fixed information and fixed space, which seems a still, continuous void. In this manner, quantum, moving, temporal energy becomes virtual, fixed forms, set up against a mental background of continuous, static space. So we see a quiet Earth instead of a moving planet. Stillness is a

perceptive paradox caused by the fact that we see the Universe as static information to distinguish it better.

The Universe is dual, paradoxical, relativistic, dynamic, ever changing its in-form-ative and energetic nature. It is not composed of substances, material particles and static fields. It is made of dimensional arrows that move and reproduce, tracing the 2 essential forms of space-time: the line energy and the informative cycle. Each of those movements becomes still when a mind perceives it, and measures it, as Einstein put it, in simultaneity, but it is a movement, a dimensional arrow. A proton is not made of 3 fixed particles, called quarks, but of flows of lineal gluons and cyclical vortices of mass (the quarks) in perpetual transformation. A body is not a fixed substance, but a series of physiological cycles performed by its cells. A cell is not a fixed sphere, but a series of cycles traced by carbohydrates that seem, put together, a fixed substance. Those carbohydrates that seem fixed are in fact atoms tracing energetic, lineal and temporal cycles; yet atoms are particles doing cycles and particles are gravitational and electromagnetic, cyclical vortices that absorb lineal forces and can be modeled with the mechanics of superfluids. So all is in eternal movement, even the physical space/time that seems fixed to us, due to the tendency of the mind to see stillness. The Universe is made of movements and events, of actions in time, not of fixed substances, of forms in space. That is why the cycle of space/time existence is its fundamental particle. The perception of the Universe as a fixed series of continuous forms is an error of the mind, which tends to see form instead of movement, because movement distracts and occupies mental space, but formal stillness focuses what we see and can be stored in a smallish brain. In fact, we can see either movement or form, but not both together. We do not see the Earth moving and quiet at the same time. We do not see a wave and a particle at the same time (Complementarity Principle). The mind has less dimensions and volume than the Universe and for that reason it eliminates movement that occupies mental space from most of the entities it observes. Thus, the Galilean Paradox explains also the Uncertainty principle, one of the fundamental dualities of the Universe: the fact that we see things either as still, discontinuous particles; or as moving, continuous waves.

Since the physical entity is both things together: the relative 'head'/informative organ of the physical system is the particle, while the field of forces is the reproductive body which carries the particle around space. And both co-exist together. But we can only perceive one, in the same way we do not perceive a human being as a whole and as a series of cells together, since the mind is limited to observe only one plane of space-time existence. Thus, we don't see the scalar, fractal nature of the Universe, but a single space-time continuum. A human being is also a whole made of fragmented cells - while our brain is another example of the duality between discontinuous information and continuous space; since it was considered for long a continuous mass of neuronal tissue, yet it turned out to be also broken into discontinuous of in-form-ation, joined from the perspective of 'energy and movement' through continuous, dynamic flows of nervous messages.

Fractal=fragmented space-time networks are also continuous (if we look at the flows of energy that communicate the cells of the network) and discontinuous (if we look at the holes, or dark space of the networks and its fractal particles). Duality implies that any continuous whole is also a fractal, organic system, sum of microcosmic actions and cells. It all depends on the detail of our observation. The limits of human perception imply that all what is not clearly perceived by the mind becomes still and continuous: if we observe very slow or very fast cycles, as those of a mass-vortex or a wheel spinning, or we observe forms from far away distances, as the rings of Saturn; or they are very small, as the cell cycles of your skin, they appear as a single undifferentiated still, mental form, fixed in space and integrated into a whole organism, despite being made of fractal, moving cycles. Thus, the continuous/discontinuous structure of space-time is one of the many dualities of the 2 opposite, $Se \Leftrightarrow Ti$, forms of the Universe:

Amorphous, continuous, Energetic Space \Leftrightarrow Fractal, discontinuous Informative Time Cycles

Further on, space is the static perception of moving energy and time the moving perception of static information (duality of the Galilean

paradox). Space is motion relative to a frame of reference, said Einstein, explaining the equivalence of energy and distance...

Those dualities explain the apparent paradoxes of Quantum Theory and Relativity: on one hand, time is indissolubly merged with space, bending it into future form, in-form-ation. On the other, Einstein proved that there are many rhythms of time, which means each space-time in the Universe has a different way of changing and processing its energy and information that combine to create a present space-time. So what is space-time, a discontinuous sum of fragmented quanta, as Quantum theory said, or a continuum? It is both. It depends on the detail and perspective of our observation: Time cycles breaks space-time into new, discontinuous forms. Yet from the perspective of pure energy, the Universe is a continuum, amorphous surface. For that reason, Einstein, who analyzed the grand scale of the Cosmos without detail, came to the conclusion that the Universe was a space-time continuum. Yet when we observe it in its fractal details, Time and Space are not a continuum. As Einstein himself realized, there are in the Universe infinite clocks, forms of reality that trace discontinuous, temporal cycles with different speeds. But there are also, as quantum physicists noticed, ∞ fractal spaces divided by membranes and discontinuities, both in organic and physical entities. Thus, the duality between fractal and continuous space-time is an irreducible duality between a whole, which is broken into parts; and it happens everywhere: Your mind is a whole made of electromagnetic impulses that cross through broken neurons; an organism is a whole broken into billions of cells. The word fractal means exactly that: 'fragmented'; something that is still a whole, but in detail is broken, crackled by cycles of time that create borders in space. So fractal means both: a continuous whole and a fractal group. Ultimately, all informations are fractal (as form needs discontinuities to be perceived), born out of temporal, cyclical rhythms that return periodically, in a discontinuous manner to a certain point, tracing again the same form; while energy is amorphous; hence it has the appearance of continuity.

We already mentioned that time is formal change. So if we were to do exactly the opposite of what Physicists do and temporalize space, we could say that:

- The 3 dimensions of space create a morphology of information, the form of space-time that Einstein defined as G-curvature (where height gives that curvature). Thus, we can further reduce those 3 dimensions to a G-factor that defines the total curvature of space, as Riemannian geometries do.

- Then, from a perspective, when that morphology with curvature moves, it creates the 4th dimension of time or time movement. In the graph it is given by the temporal reproduction of that height cycle.

- Finally, a 5th dimension of acceleration happens which further multiplies the total space of the being. Yet at this stage morphological Biology cuts off the dimensionality of the Universe because it can be proved mathematically that the number of dimensions that create the maximal volume are 5 dimensions. Then the volume of space-time enclosed in a world of more than 5 dimensions sharply falls. We can see that 5th dimension in movement as acceleration or we can extend it into space reducing it to constant speed. This is secondary to the fundamental truth of a biological Universe that as all cosmologists know have a 5th dimensional shape, whose meaning now we fully grasp, thanks to the Galilean paradox. To see those dimensions as fixed extensions of space or accelerating and moving fields is equivalent. For example, in Relativity a vortex of space-time with a lot of curvature/acceleration has a π value equal to 3. In terms of an accelerating mass vortex what curvature does is to create a spiral instead of a cycle that moves inwards. So $3=\pi$ means a spiral vortex with a reduced π -diameter, since the inner branch of the spiral vortex is shorter inside the accelerating vortex. Relativists use a hyper spatial 5D to explain it. Yet it is easier and closer to what we observe to define that 5th, bending dimension as an accelerating time-change.

Recap. The paradox of Galileo is the key not only to unify quantum physics and relativity but also to reconcile or rather explain in terms of dynamic, moving time, the theories of modern Physics with multiple dimensions of space, as it turns out that any dimension of space can be considered a dimension of time and vice versa.

4. 3 dualities: gravitation/light, distance/motion & entropy/form

3 are therefore the most important dualities of physics:

-The duality between the membrane of gravitational spacetime or macrocosms and the membrane of light-spacetime or microcosms, which is built as a light, trophic structure over the bigger membrane; hence with slower speeds and higher disorder.

This can be expressed in terms of limits of energetic speed, whereas C is the border between both membranes:

$$\text{Light space} < C < \text{Gravitational space.}$$

$$\text{Quark / Black Hole world} < 0 K < \text{Light/Electronic world.}$$

-The duality/complementarity between energy forces and fields and information particles, forces and fields.

-*The duality between motion and form*: what we perceive as vacuum space or distance is also a motion and both together form an action, the minimal exi ‘substance’ of reality. So we can write:

$$\text{Light-membrane} = c\text{-speed motion} = \text{Vacuum made of H-constants}$$

$$\text{Gravitational space} > c \text{ tachyon motion} = \text{Vacuum made of strings.}$$

-The existence of ‘doors’ between both Universes, which follow the general laws of jumps between space-time planes and resolve most of the conundrums of modern physics (4th i-logic postulate).

When we understand those simple dualities everything becomes clear, concrete and real. Yet we have to reorder the particles, fields and forces of the Universe according to those dualities, such as:

H-Plancks are the minimal actions (motions&forms) of the light-membrane, which evolve into photons, electrons, plasma stars and human minds among other things:

$$\sum \sum \sum_{st-2} \text{Plancks} = \sum \sum_{st-1} \text{photons} > \prod \prod \prod_{st} \text{electrons} > \prod^{st+1} \text{Hot stars}$$

And so the electromagnetic force and electron are the energy/information, lineal/cyclical elements of the membrane.

Strings are the minimal actions of the gravitational membrane and must be redefined mathematically as background independent. That is, they do not exist in the abstract Cartesian plane of spacetime but they are the actions of energy and information of the gravitational world.

And they are tachyon strings moving faster than light. They are therefore the first ‘bricks’ on the evolution of gravitational particles such as:

$$\sum \sum \sum_{st-2} \text{Strings} = \sum \sum_{st-1} \text{gluons} > \prod \prod \prod_{st} \text{Quarks} > \prod^{st+1} \text{Frozen stars}$$

And so strings and gluons are the massless forces of the gravitational membrane and quarks and strangelets and black holes its informative networks/particles.

Whereas the bigger gravitational membrane encloses the smaller light-membrane, in both limits (strings are thinner and faster, more extended in space than light; and quarks and black holes are heavier, more informative/ordered than electrons and stars).

So we must reorder also the forces of the Universe:

$$\text{Electromagnetic 'light'} > \text{electr(on)ic forces: Light membrane.}$$

$$\text{Gravitational 'strings'} > \text{Strong Quarks: Gravitational membrane.}$$

This leaves a final force, the weak force, which *is not a force in space but an event in time that transforms particles and forces from one to the other membrane*. And it is in fact the less understood force, plagued of errors in their formalism (the never found Higgs, normalization of absurd infinities, etc.) So the Z and W particles do NOT mediate this force but are intermediate states of particles that ‘transcend’ from the electronic membrane into the mass world.

In that sense, while the field of analysis of the light-membrane can be considered more or less closed in its mathematical formulation, the field of gravitational theory and its different particles and forces is not (strings in its present background dependent, multidimensional, super symmetric formulations are incorrect, but the original bosonic, tachyon strings and its Nambu actions are a good departure to work out a better model for the two possible fractal scales in which they might be used to describe the Universe as Planck strings).

By all this we mean, certain features of bosonic strings fit what should be the minimal particle of gravitational space: its Length (Planck Length); its duality (closed and open strings equivalent to the minimal line of gravitational energy and cyclical gravitation), its ‘vital

properties' – they can reproduce, creating bidimensional sheets; they can mutate between both states and or vibrate and so they create a Generator Equation of space-time actions able to replicate the particles of the gravitational membrane, which we could write as:

Energy(open string) <vibrating string> Information(closed string)

In that regard, physicists have created an astounding frame of mathematical equations to describe all those systems, which probably ranges with the work of biologists (Evolution Theory and genetics) as the highest mental achievement of the human race, and so this text will not correct the formalism of physicists, which except for the case of weak forces needs no correction, but lacking the proper Non-Euclidean i-logic geometry and the understanding of relational, cyclical times and multiple space planes can be greatly improved in its interpretation NOT of the how but the why of reality, which is what we shall do in this work.

It is unfortunately an astoundingly difficult task not because of its complexity – far easier to understand than the formalism of quantum physics or the metric spaces of relativity – but because of the pythagoric, mechanist, entropy-only, continuum single space dogmas of the foundational fathers of physics, which are taken as true postulates and cannot be argued easily – what Bacon called the idols of the tribes of science.

All those errors depart from a false ideology, the absurd attempts to simplify the dualities of the Universe into a single monist theory of it all; which departs itself of the wrong interpretation of the Occam's principle of simplicity; since as Parmenides proved the absolute minimal simplicity to produce actions, motions and change in the Universe is duality. So if physicists were to prove that all the forces of reality are one, all its scales of space-time are one, all its clocks of time are one, all its simplex arrows of time (entropy and information) and complex arrows (reproduction and social evolution) are one the Universe will become an absolute nothingness. All those concepts might work as simplifying tools of measure – so we equalize all cyclical time rhythms into a single mechanical clock, we reduce the gravitational membrane (relativity theory) to its perceived effects in

the light-membrane and so on. But 'ceteris paribus' analysis and simplifications are not the rich, complex 'why' description of reality we seek here.

In that regard, before we fully plunge in the solutions provided by the new model of relational times and multiple spaces we have to tackle the problem of the dogmas of monism that prevent to resolve the standing questions of astrophysics.

Recap. 3 dualities structure the physical universe, the duality of gravitational/light space; the duality of entropy forces and informative particles and the Galilean duality of motion in time= distance in space.

5. The tribal idols of physics¹.

The fundamental error common to all scientific thought is the error of postulates set a priori without proof, from where an entire science can be deduced, infected by that false or unverifiable postulate. For example, when considering the structure of space-time the Cosmological Principle, which has been taken as a paradigm of truth in which to base all studies of the Universe, affirming the isomorphism and continuous distribution of matter and energy in the Universe. This is false as we find structures, super-clusters, fractal scales, invisible matter, dark energies, discontinuities, etc. in the Universe. And ultimately we find that all physical phenomena happen as all other systemic events, by interactions between 2 spacetime discontinuous spaces (particles and fields; electromagnetic and gravitational membranes, etc.) However, homogeneity and continuity pleases the perception of the mind and makes Cosmological calculus with Relativistic equations possible, so it is an accepted simplification.

All sciences have errors caused by postulates without proof and partial theories discovered by the founding fathers of each science, which are just steps of a continuous process of evolution and expansion of knowledge expressed in the Principle of Correspondence (each new theory embraces the discovery of the previous ones, corrects its errors and advances further in the path of explaining reality with the languages of the mind). Unfortunately while knowledge is a continuous process of advancement, human brains are closer to the mother-boards of computers: they are imprinted with memorized

ideas, at earlier age, and those ideas are taken as dogmas, and its discoverers, in words of Bacon, become ‘tribal idols¹’, high priests of science that cannot be denied. This process also applies to XX century physics, which is not the end goal but just a first timid step in the process of transforming the paradigm of science from the simplex view of a Newtonian, continuous, abstract, single spacetime into the complex view of Leibniz: a relational, discontinuous, organic, fractal spacetime made of ‘quanta’: points related by flows of energy and information that create the networks of reality.

The first steps were given by Riemann, in mathematics, when he defined a space made of networks of Non-Euclidean points.

Because physics is merely the mathematical interpretation of the simplest scales of energy and information of the Universe, it was precisely the application of that concept by the two colossus of XX century physics, Planck and Einstein, what renews the field: On one side Planck found reality to be made of quanta, which were obviously the Riemannian spaces of networks of points with a different ‘density, according to the homogeneity between them’.

Planck was studying in fact the membrane of light-space in which we ‘swim’, as evolved forms of light quanta. Soon Riemann’s theory about space were confirmed in the study of lasers, which were the densest light-space due to the homogeneity of its quanta and the discovery by Bose-Einstein of the densest Riemannian spaces, bosonic spaces that happen when undistinguishable particles occupy the absolute minimal space, whose density was defined by Planck’s ‘God’s constants’ (as he hypothesized that the most perfect form of the Universe would be the one with the highest density of quanta).

Einstein then applied the 5th postulate of Non-Euclidean geometry, the only found in the XIX-XX century till I discovered the other 4, to describe *the other membrane of space-time, we cannot perceive, in which light space floats, gravitational space whose parameters of energy-speed and information/density of quanta are higher*. He also found key properties of time: its cyclical, geometrical form (time bends space into mass), the existence of multiple clocks of time (‘I seem to be the only person that thinks there are infinite clocks of time

with different speeds in the Universe’), and the confluence of past and future in simultaneous presents (‘the separation between past and future is an illusion’), which quantum theorists also discovered in the study of particles and antiparticles.

Meanwhile quantum physicists found that particles of the light-membrane (electrons), were communicating through the lower, faster than light, non-local gravitational space, acting as a harmonic networks at enormous distances (entanglement). They also found the complementarity between particles of information and fields of energy, which co-exist in all stable systems of physics. They realized that the observer is limited in its capacity to extract information from those other planes of existence, as its particles react to the bombardment of our ‘huge instruments’ collapsing into defensive particles as any herd in nature does when attacked by an energetic weapon (fishes attacked by sharks, troops in combat formation).

Yet they failed, in an age of anthropomorphic idealism and mathematical pythagorism, to recognize those were organic properties of particles that gauge information and act-react to survive better in their environment. The same happens when those herds go through slits as particles or waves, according to the better path, or when they constantly check their distances in herds, or when they follow a ‘soliton’ or first particle in its lineal motions.

But for ‘self-centered humans’ (Galilean Paradox of the mind) the idea that an electron could perceive being so small attacked the fundamental endophysical principle that we are the center of the Universe because from our p.o.v. our nose is bigger than the Andromeda Galaxy. Of course, we are from the perspective of Andromeda galaxy smaller than an electron, and as we shall see it might be a fact that a galaxy is self-similar to an electron of the gravitational membrane. This ultimate truth of a Universe based in absolute relativity – the existence infinite self-similar fractal scales – is of course, the most rational truth about reality that the Galilean paradox will always fail to accept. So quantum physicists also failed to realize that electrons were fractal particles made of ‘cellular populations’ of smaller electrons, described with probabilities in space

(population statistics) and instead thought those nebulae were probabilities in time (hence the same electron moving in time and occupying several points at each moment). Thus, instead of developing a theory of fractal electrons and fractal space-times, they have created a theory of parallel events and parallel Universes (Copenhagen and Everett interpretation).

Recap. The main errors of physics derive from anthropomorphism, which fails to understand absolute relativity – the infinite scales of reality and fractal spaces, the organic nature of waves and particles and electrons as fractal, cellular entities.

6. Modern physics and the errors of a monist system.

Since Time is Change, in Physics time implies a rhythm and a movement, a mutation in the position of an object in space. In that sense, physicists study a specific, very limited part of the wider field of time=change: the change experimented in space by an object moving through it. In the study of such movements physicists have achieved a dexterity and sophistication rarely seen in science. However our critique has been harsh because physicists reduce time studies to that specific $v=s/t$ definition of time as translation change and deny other analysis of time-change; when there are many other forms of time=change, known for millennia and seriously studied since Aristotle by fundamental sciences, like Biology (which studies the change in the information of species, through the sciences of Genetics and Evolution) or History (which studies the change in human societies). Thus only, when we depart from such a wider view of time, we can fully understand its meaning in Physics and the paradoxes and limits of its inquire about Time and Space.

According to the Correspondence Principle, a new, wider scientific theory (of time and space) has to include all previous theories within it and solve the questions unresolved by them. Since the 2 main theories of space and time were in the XX c. Quantum Theory and Relativity, it is unavoidable to deal with the errors and virtues of both, from the perspective of cyclical time and fractal space. The foundational concepts of those 2 theories are especially relevant to cyclical/fractal time space:

Quantum Theory is based in the concept of an action, the unit of the Quantum Universe, parallel to our existential force or existential momentum, $h=h$ or Planck constant, which is defined by the product of energy and information, *but must be understood as a dual form/motion* under the paradox of Galileo, not a mathematical function of probabilities. Hence an action is the ultimate substance of light and the membrane of light space-time that we inhabit. In that regard the principle of complementarity and the Uncertainty of Heisenberg are concrete facts of our world of space-time made of H-actions, made of Planck constants; which can and do evolve into particles of higher information, photons and electrons, warping that light space membrane in which we exist. This interpretation takes away the ‘idealistic’ ‘pythagoric’ belief of a Universe made of numbers and returns it to reality. Vacuum is made of light, its space-time substance, which exists even in the emptiest vacuum (background radiation) and can be perceived either as motion, a c-speed substratum of energy, short of the ultimate superfluid ether, or as a distance, a wave-space with minimal form. And can easily evolve and it constantly does so into photons with higher form (particle-wave duality), and when its density of energy increases into electrons,

Relativity on the other hand is based in 2 principles also closely related to the Galilean paradox:

One is the Equivalence Principle that states the equivalence between acceleration and force: a force is in fact an accelerated movement. As it happens in a fast car, when we accelerate we feel a force and so movement is a perpetual event with 3 ‘ages’, an energetic accelerating state, a steady motion, and a 3rd age of deceleration; even if we, due to the Galilean Px. see motion sometimes as still space.

The second principle is the ‘Diffeomorphic’ (local) Principle of Relativity that states the relativity of all points of view, all points of measure, which are local and subjective, as the Universe is broken in multiple frames of reference Non-Euclidean points that gauge and measure the world around it with infinite parallels that merge into that point (5th non-Euclidean postulate).

- The 2 arrows of physical time in relativity are the explosive, lineal arrow described by the equation of Energy, $E=Mc^2$ and the implosive, cyclical arrow that ‘bends space into time’ or information – the arrow of information.

Those 2 principles/arrows of space-time are the essence of any physical reality; since they apply to every fractal, local space-time field, defining in its complex interrelationships the ultimate, philosophical nature of the Universe. Yet to grasp its potential to explain the Universe as a machine in eternal movement, broken into infinite, local replicas of itself, we have to clarify the conceptual errors Physicists make interpreting them. Since only when we properly correct those errors we will be able to fusion the foundational Principles, of Quantum Theory and Relativity (and its equations, in the more complex version of this book), achieving the long seek Unification Theory of all physical beings.

Recap. The theory of time as change in form explained by Darwin with *verbal* words is Evolution Theory. The advances brought about by Topology, fractal mathematics, Time Duality and Non-Euclidean Geometry, applied to Physics solves those shortcomings, completing Relativity theory, showing that mass is cyclical information, that the Universe is structured in two membranes, and light is imprinted, forming and warping the gravitational membrane.

7. The single time arrow error: entropy.

Let us consider of those errors the most important of them, the use of a single time arrow in quantum physics. Quantum theorists, despite the discoveries of Einstein in time theory, use only a single mechanical clock to equalize all time-clocks of reality, which derives in the belief of the existence of a single arrow of time. And this causes multiple contradictions, being the most important of them, their incapacity to understand masses and whirls of gravitational time, which carry the information of the Universe. Since quantum physicists were still using the Aristotelian logic of a single arrow of time, energy or entropy. In that regard, of all the errors of physics, caused by the use of a continuous space and single time arrow, the fundamental one is the

study of only an arrow of energy or entropy that disregards the meaning and functions of information and mass in the Universe.

Indeed, Physics, unlike Biology, Complexity and Social sciences still uses a single time arrow, born from XIX C. studies on heat and entropy. This introduces grave errors in the conception of mass as a bidimensional vortex of information, and paradoxes like the paradox of missing information, derived of the study of black holes by Hawking as ‘entropy’ systems – when they are exactly the opposite, the informative creators of mass that balance the entropy of the Universe making it immortal.

The strength of the ‘tribal idols’ of a science are transparent in that case. Because of the ‘dogma’ of an entropy-only Universe, and despite no proofs of black hole evaporation, this hypothesis is today a dogma, even if it breaks among many other laws:

- The 1st law of entropy: the black hole is hot and evaporates in our cold environment getting hotter, so it becomes an eternal motion machine.
- The laws of conservation of energy and information, since information is destroyed with the evaporation.
- The laws of Relativity and Gravitation, as black holes become ‘quantum objects’ with the excuse that they are small and should have quantum effects, but in relativity small is a meaningless world and quantum is not a theory of the small but of the electromagnetic membrane.

And so on. The correction of this error is simple; since the event horizon of the black hole that evaporates turn out to be according to the Laws of Non-Euclidean topology that define the black hole as an open ball of hyperbolic mass-information, the border of our electromagnetic Universe, which therefore produces our type of particles, virtual photons and electrons, which condensate our light-space membrane, fall into the black hole, (given the accelerated gradient of the gravitational force towards the center of the black hole), becoming converted into high-ordered mass – probably top quarks – and so *what evaporates is our Universe, not the black hole, which grows and cools down, respecting all the known-known laws of*

science except the 2nd law: entropy is a local property of the light membrane but gravitation is an informative force that restores the order of the immortal cosmos. So the hypothesis that the black hole evaporates because the event horizon is not our world but the black hole – the hypothesis origin of this theory - should be rejected, but it is not because only in this manner we can affirm that there is one arrow in the Universe – entropy and pursuit the extermination of the other arrow – information=mass, giving origin to unification theories of both forces (quantum gravity), which merely eliminate the informative properties of gravitation. We will return to this ‘murder’ of the mass-information of the Universe latter, as we shall provide the proper unification equation of charges and masses as two self-similar membranes or ‘scales’ of reality and describe properly with the new tools of i-logic geometry the structure of black holes.

The same can be said of the continuous space concept, whose main error is the big-bang theory, which is always a relative big-bang of a scale of the Universe (a black hole caused by a supernova big bang; a quasar big-bang of a galaxy and perhaps a big-bang of our Universe, cell of a bigger hyper universe). And in any case is the ‘death’ of a past Universe that latter will give birth through a creation process in 3 ages to the present Universe. Yet since physicists ignore the life-death cycle of all spacetime systems, they ignore the difference between birth and death processes; what we call here ‘big-bangings’ and ‘big-bangs’.

Another error of the continuous spacetime is the idea that the Universe will expand forever, when it is obvious that it contracts in regions dominant in mass-information (the galaxy) and expands in regions dominant in energy-forces (the intergalactic space). And both effects together create a total self-similar volume of reality in each scale.

All those entropy-only, single spacetime continuum models forget the informative effect of gravitational forces and the 3 ages of informative evolution. Monist physics instead tries to create a Universe with only one time arrow entropy=energy....

Some of those errors are corrected in this work, notwithstanding the admiration and respect that the work of those pioneers awakes in the studios of history of science, and acknowledging that while the mathematics of quantum and relativity work perfectly to describe the universe (as in the previous case in which the same probabilities are used to describe populations of fractal electrons in space and events of a single electron in time), the proper philosophical interpretation is the one given here.

Thus, following the *Principle of Correspondence*, we will offer logical explanations and corrections to the 4 basic laws of relativity and quantum physics, the Relativity Principle, the Postulate of C-speed, the Complementarity Principle and the Uncertainty principle, showing that while those equations still hold as instruments of measure, their interpretation under the new postulates of i-logic geometry and discontinuous spacetimes make rational all the paradoxes of quantum theory and relativity.

Recap. This work advances the comprehension of a complex Universe of multiple, ‘relational’ space-times first described philosophically by Leibniz, improving on the work of the previous paradigm, with the new tools of i-logic geometry; since both Einstein and Planck and their theories failed to complete the formalism of relational space-times because it lacked the mathematical tools of fractals and the 5 postulates of Non-Euclidean geometry, needed to fulfill that task.

8. The generator equation, its invariant dual forms and events.

How the 3 dualities, of light/gravitational membranes, of energy and information forms and motion/distances are played in the Universe to structure its dynamic actions and transformations?

To understand how we need to bring the Generator Equation of space-time events:

$$\sum Se \Leftrightarrow \prod Ti, \text{ or principle of conservation of energy and form}$$

Where Se represents any field of forces or ‘boson herd’ and Ti, any particle or network of particles. Thus we affirm the Fundamental Postulate of Fractal Physics:

'All events and forms of the Physical Universe are generated by simplex or complex transformations of energy and information, defined by the generator equation of spatial energy and temporal information; such as the total quantity of energy and information, of the event or form, calculated as the sum, of all the forces, Σ and integration, Π of all the particles, perceived as motions or distances, across the two gravitational and light membranes of space-time, remains invariant'.

The Universe is a closed system and so are all its partial parts/events when we consider both all the initial energy/information species and final products of the event or form, which might exist in any of the 2 membranes of reality. The difference with monist physics is clear, as we need to add both membranes - one of them invisible, hence of difficult measure (gravitational membrane) – for the principle to be respected.

Yet we have to explain another key word of the previous definition, which is required for those events and forms to make sense and create a 'stable' Universe – invariance. Indeed, the Universal Syntax of the generator equation defines events that transform energy fields into information particles, or combine them to reproduce a self-similar physical entity or associate them into bigger structures (herds=waves and networks=particles), but it does not define what kind of parameters of those events and form do not change under such transformations.

In classic formulations of physics, the absence of change is often translated as 'gauge symmetry', but we prefer the easier to understand term 'invariance', which essentially means that all motions and forms of the Universe remain invariant *when the event is merely A) a translation in space; B) a social evolution in size from one st-1 scale to another st-scale.*

And so the fact that motions and social evolutions keep the form and energy of the system is what we perceive as static reality, while all other events we observe are transformations explained by the generator equation.

Self-similarity between invariances and dualities.

Now that we have extended the laws of physics to its details we can do the opposite and integrate them by considering that those invariances are in fact expressions of the harmony between the dualities of membranes, motions/distances and energy/form. Indeed, the 3 invariances in physical events are:

- *Invariance of scale:* we consider the physical Universe to be made of two fundamental scales of space-time, the larger=faster world of gravitational forces and denser quark particles and the smaller world of quantum, electroweak forces and lighter electrons. And both interact together precisely because physical events are invariant when they are transformed from one to another scale. Reason why the total energy and form of an event is conserved when we add up both scales.

- *Invariance of topological form:* There are 2 eternal forms, the lineal forces, which in the 2 membranes are light and gravitation, and the cyclical vortices, which are charges and masses. And so reality exists and the events, $E \Leftrightarrow I$ are possible because that invariant duality, which allow us to define any species as either a particle or a field of energy.

- *Invariance of motion,* which is the essence of relativity theory. It can be deduced by the fact that motions can be seen (Galilean paradox) as fixed distances, which are obviously invariant forms.

In the terminology of Multiple Spaces-Times we could consider those 3 invariances as the invariance of the 3 main terms of that equation E, or invariance of motion=energy, I or invariance of topological form and st or invariance of scale. And so those Invariances ultimately represent that what always remains and gives 'meaning' to the generator equation of reality that after all its events and transformations will still produce E, I and its herds and networks its st-planes of existence. We could say that all becomes transformed to remain the same.

All this ultimately means that the Universe is a topological reality where what matters are not the 'sizes' or 'distances= motions' of the total event described as a topology of space-time but the 'forms' of those topologies, which are reduced to the 3 morphologies of a non-

Euclidean point. So what we see in fact is just invariant topologies (where there are irrelevant motions and growths of sizes) which can be transformed into each other within the restricted events defined by the Generator equation of space-time. Of course, the humor of this is the fact that physicists are far more interested in measuring the ‘invariant events’ that do not matter that the Generative transformations that truly create reality.

Recap. All physical phenomena are either invariances in the motion and form of the physical system, which occur when the entity moves in the same plane of space-time or the form evolves socially from a cellular, fractal group into a superorganism, or transformations, which are partial equations of the generator equation of spatial energy and temporal information.

9. Laws of Multiple Spaces-Times applied to physics.

Given the limits of size of this work we can only correct a few of the errors of classic physics and give a general overview of the new paradigm of fractal i-logic physics and discontinuous space-times. Let us then summarize that overview, considering the main laws of Complexity that apply to physical phenomena:

The first set of laws of Multiple Spaces-Times applied to physics is the Duality/Complementary principle, according to which all systems and theories must be dual, with an energetic/entropic and informative component.

In essence all physical particles are dual, composed of an informative knot and a field of energy, which can be considered to be made of ‘cellular’, fractal parts, self-similar to the whole. This gives origin to the Law of Complementarity in quantum physics (all particles have an associated wave-field); to the main Event of all physical particles, the so-called ‘boson-fermion equation’, according to which big particles (fermions) exchange their cellular components (bosons and gluons), giving birth to a particular case of the Generator equation:

$$I_{st}(\text{fermion}) < \text{boson wave } (\sum e_{st-1}) > I_{st}(\text{fermion})$$

Complementarity is also the origin of the phase space that defines an electron nebulae, which has 2 components, the energetic real number and the informative, imaginary numbers, which are both at a 90° angle,

such as when the energetic component of the electron phase is maximal, the informative, imaginary component is zero and vice versa. Thus the phase equations of the electron are a mere case of the $E \leftrightarrow I$ dynamic, internal relationship between the energetic and informative component of the electron.

The inverse properties of energy and information explain why indeed the energy component is + and the information one, which contracts space into form is negative (imaginary) and why they might cancel each other, creating NOT an organic complementary event but a Darwinian self-destructive one.

The second set of laws of Multiple Spaces-Times applied to physics is the 3 invariances: motion, scale and form:

Physical theories are called gauge theories, a term which refers to the symmetries of measure produced between particles that exchange fields and whose parameters remain the same if we were to change the position of those particles. For example, if we change the position of two charges or increase their potential in equal value, the form and intensity of the field do not vary. This is gauge symmetry, a term coined by Weyl long ago, which today is often substituted by a more proper concept: that of invariance. So we say the electric field is invariant to the space orientation and potential of its particles. The laws of symmetry or invariance are thus the ones that respond to a simple question: If the Universe is a tapestry of infinite points of view, which trace their own paths of existence, how it acquires its structure?

Answer: Those invariances maintain a dynamic yet permanent reality. If we were to reduce the entire Physical system of laws to some basic principles we should first choose the Principles of Invariance. There are 3 physical invariances that stay regardless of changes in coordinates: the invariance of motion, proved by Galileo and Einstein’s work on Relativity; the invariance of scale, proved by Nottale and this author, in their study of the laws and transformations that take place between the scales of reality and the invariance of topological forms, as the cycles of information and lines of energy repeat themselves in all the scales, in which networks of energy flows and informative cycles form complementary systems.

The Invariance of topological form is a consequence of the energy/information duality and the 3 unique topologies of a 4-dimensional universe of fractal scales (hyperbolic information; toroidal reproduction, spherical energy). Thus, there is a simplex invariance of lineal energetic and informative cyclical shapes and a more complex ternary topological invariance that differentiate any entity of the Universe in a hyperbolic, informative, high region, an energetic, extended spherical membrane that encloses the 'ball' and a series of cyclical networks that connect both.

In the last graph Saturn's rings show the invariances & dualities of the Universe, contradicted by our naïve perception: Any entity of reality seems at first glance a continuous, still form. So Galileo called Saturn's planetoids, a ring, thinking it was continuous, still matter. Yet in detail reality is cyclical, discontinuous, in constant motion, structured in multiple layers of growing social complexity, as simple parts become wholes, which gather into ever growing bigger wholes. For that reason, while a simplified image of reality could describe the Universe as a continuous, amorphous extension of spatial energy, (monist physics, with their concept of a single, entropic arrow of time); a complex analysis observes a 'fractal' reality in perpetual, extended through multiple space-time scales. Yet the order of such structure is maintained precisely because the system is invariant in its scales (from particles to planetoids), forms (all those scales show cyclical particles moving in bigger cyclical trajectories) and motions.

The 3rd set of MST laws applied to Physics is the flows of energy and information between discontinuous space-membranes. Those laws are widely ignored by physicists and the reason why so many easy-to-find results of physics – with the use of those generic laws between spacetime planes, in this case the gravitational and electromagnetic membrane – are still ignored (from the Unification Equation of charges and masses, to the meaning of dark matter and dark energy, to the non-local speed of gravitation). We considered a few of those solutions, when studying the generic laws between 2 timespace, hierarchical planes, which in the case of physics are the bigger gravitational world of <0 K temperature-order and $>c$ speed.

The 4th types of laws are of causality, which define a series of ternary ages and horizons of evolution of particles and masses. We shall therefore be able to explain the evolution of particles, stars, galaxies and physical states, with the 3 ages of energy and information. For example, the 3 states of matter correspond to energy=gas, information=solid, and a 'reproductive combination' of those 2 states or liquid, which participates of the properties of gases and solids and it is the more creative state of measure. We shall also consider for all space-times of galaxies and Universe, the 3 solutions to Einstein's equations of space-time as 3 relative ages in the evolution of physical space: the big-bang solution is the energetic age of the space, the steady state, the mature age, and the Gödel, cyclical solution, the informative state, which means Universe and all kind of physical spaces, follow a process of big-bang and big-crunch equivalent to the 3 ages of living spaces.

The 5th sets of laws of Multiple Spaces-Times that apply to physics are the laws of i-logic geometry, which describe any particle of the Universe as a knot of time arrows. And so we shall observe that in any scale of physical particles, from strings to particles to atoms to molecules to planetoids, physical particles can be treated as st-Points, which will display the same 3 topologies of space-time (an external membrane, inner hyperbolic region of information, polar apertures that absorb and emit energy and information), will obey the same laws of social evolution in networks, and interact communicating forces, which are fractal, micro-forms, which imitate the forms of the higher particle/scale. So electrons will share electromagnetic photons and quarks will share gluons and molecules will share electrons of the lower scales, and so on.

The 6th set of laws applied to physical entities is the existence of 4 main time arrows in all physical systems that explain all the events of each entity of physical space. Those 3 arrows will be the dimensions of light space, the quantum numbers of particles and the events observed in molecules and crystals, whose finality is to create more complex complementary, organic physical entities.

Those invariances and laws of Time theory are essential to physics, since they set the forms and patterns of all kind of cycles of transformation of lineal, energetic motions into cyclical clocks of time. They are the origin of Universal Constants defined as invariant proportions between the energy and information of the 2 membranes of space-time, between the complementary energy fields and information particles of physical entities and between the 3 families and horizons of each species (from the 3 families of masses, to the temperature=energy of each state of matter).

Recap. The Physical Universe follows as any other system of reality the laws of Multiple Spaces-Times. The 1st types of laws are duality laws of energy and information (Complementarity, entropy+form arrows and theories). The 2nd types of laws are the invariances in form, motion and scales: There are 2 space-time scales, the larger gravitational membrane and the smaller quantum membrane, and two types of forms, lineal energy forces and cyclical particles. The 3rd types of laws are those of discontinuous spacetimes. The 4th laws are those of causality in time, which define the 3 ages of evolution of all species of physical space and the interaction of particles and antiparticles. The 5th type of laws are the 5 postulates of i-logic geometry, which define the creation of networks and the events between particles of any physical scale of the Universe, from strings to particles to atoms to molecules to planets and stars to galaxies and universal clusters. The 6th sets of laws are those of dimensions, according to the holographic Universe and the relationship of each local dimension with an arrow of time of a certain 'physical space' (light space, electronic, quantum numbers, etc.)

10. The generator equation of the Universe.

All scientific paradigms define first the fundamental units of time and space, which in General System sciences are space-time points made of cycles of time with spatial motions, which wherever the specific type of point-species we describe, gather in lines=waves that gather in planes, defined with numbers=sets of points as networks of points that become wholes. Thus in the 4th paradigm each point/species will have a volume of vital space made of cyclical, temporal motions, and it can be described as a social knot or network, including humans, stars, atoms, organisms and any other system.

And we can analyze them all mathematically, establishing the 'fractal, generator equation' of all systems of the Universe across a minimal number of 3 scales, 3 ages and 3 topological regions. Let us then use those elements to define the generator equation of the Universe, in its more complex, exhaustive formulation.

We study most systems as dual space-time systems, guided by its 4 dimensional arrows information, energy, reproduction and social evolution, which have 3 topological regions that dominate each of its 3 ages of time, as the species develops from its st-1 initial seed into an organism that performs functions in the st+1 system. And that will be enough to understand the general nature of any species, event or form of the Universe; but from time to time we will provide a more comprehensive vision to exhaust the model with the 9 arrows of space-time. Since if we want to map out all the types of events in space-time with the maximal number of arrows of time, we have to use 3x3 main arrows/cycles/dimensions of time-change in reality, which will be enough to explain *all* the events of *all* the species of the Universe, including the Universe itself.

Since Time and space express the widest Laws of both, Philosophy and Science, in their search for an explanation to the Future, a Theory of multiple Times and spaces is both, a Philosophical, Religious Theory of Reality and a Scientific Epistemology of Nature. For that reason, even if this work uses the experimental method and its logic and mathematical languages to describe those arrows, we can easily translate the classic jargon of philosophy and religion to the modern jargon of Multiple Spaces-Times. Then each time arrow becomes an essential *Will* or *Why* of the Universe, explained in classic religions through Gods or anthropomorphic 'Avatars', each of which represented one Will or Arrow of Time.

The concept of a causal arrow of time or *Will* of the Universe exists since the beginning of knowledge, albeit expressed with different languages. Religion and philosophy has used the verbal language, to study those arrows. In ancient times the concept was 'impersonated' by God as the 'seer' or 'will of times' (Saint

Augustine) that in its different manifestations represented those arrows.

In modern times, science has used mathematics and logic to study them, albeit in its simplest forms (Euclidean mathematics and Aristotelian logic), which we will upgrade in order to understand the more complex, Non-Euclidean, fractal geometry and Non-Aristotelian, simultaneous logic of those Arrows. Since modern science lacks the needed 'linguistic tools' to fully grasp the interrelationships between the 4 main arrows of time, reason why most scientific theories use only one arrow to explain the Universe. 4 are paramount:

'*Monism*', sponsored by physicists, which considers only 1 time arrow, energy, also called entropy.

'*Duality*', sponsored by Eastern philosophies in the past and Complexity Theorists in the present, which consider two types of changes: changes in the information or 'form' of beings and changes in their energy or motion.

'*Trinity*' sponsored by all kind of philosophical and Religious doctrines, which considers time to have 3 ages, past, present and future, youth, maturity and old age, renewed by death.

'4-D': More complex theories of change of biological or religious origin, consider 2 other arrows of time: 'reproduction' (the constant repetition of beings that happen all over the Universe) and 'love' or 'eusocial evolution' (the coming together of individuals into groups).

'*Multiple Time-Spaces*': In this work we reject simple monist theorists, which introduce too many errors to be of any use for the 4th paradigm. Instead we accept 3 degrees of complex analysis: dualist studies of energy/information systems useful in physics, the simplest systems; 4-dimensional analysis with the synthetic arrows of energy, information, reproduction and social evolution; and the most exhaustive model of multiple time arrows and fractal spaces that divides those arrows in different modes of social evolution and

reproduction. Thus in the exhaustive model we differentiate 2 reproductive arrows:

- *exi*: The physical arrow of reproduction called an 'action', that combines energy and form, *exi*, becoming the unit of physical events.

- $e \Leftrightarrow i$, The biological arrow that combines informative heads and reproductive bodies, which constantly interact through feed-back cycles that exchange energy and information, creating and reproducing organisms, the essential particle of biological space-times.

- We also differentiate two types of social evolution:

- Σe : Herd or wave evolution in which each entity only relates to those that surround it.

- $\Sigma^2 i$: Network evolution of informative bytes in which each entity relates to all other entities of the group, hence creating i^2 'axons', - the main elements of the network.

- Finally we add the fractal arrows of multiple space-times, ignored by the 3rd paradigm that uses a single space-time:

- $\int \partial$: The Generational, temporal life cycle integrates a self-reproductive cell, which multiplies its numbers, into a super-organism and disintegrates it in the process of death. It can be extended in time as one self-similar form repeats itself generation after generation between birth and extinction.

- Σ, \prod : The ecosystemic, spatial arrow that integrates all those systems in space and time, in bigger Σ -herds and \prod -networks $\Sigma (\Sigma E \Leftrightarrow \Sigma^2 i) \Leftrightarrow \prod (\Sigma e \Leftrightarrow \Sigma^2 I)$

- $st=n, X^n$: The fractal, transcendental arrow of multiple spaces that creates super-organisms made of smaller organisms, evolved across many fractal planes of existence, from particles, to atoms, to molecules, cells, organisms and planets, stars & galaxies till reaching for $st=10$, the Universe and beyond the absolute reality, whose number of minimal cells will be X^∞ :

$$(\sum(\sum E \leftrightarrow \sum^2 i) \leftrightarrow \prod(\sum e \leftrightarrow \sum^2 I))^{st=10,\infty}$$

It is the Fractal Generator, feedback equation of the Universe and all its existences, whose partial equations and/or synoptic analysis connects the 4th paradigm with the 3rd paradigm of metric measure. Since we can in fact treat both members, integrated across all species of space and all species of Time for St=1, as the Absolute, Single space-time continuum of the metric method.

We will not, of course, be able to enunciate in detail all the events of reality, since only the ‘Universe stores all the information about itself’ (Haldane), but we invite the reader who understands in depth this work, to find a single event that cannot fit on those 3x3 arrows. Since according to Popper, the proper way to prove the truth of any scientific theory is *not* to enunciate exhaustively all the events it explains – an impossible task, as events will happen in the past, in the present and in the future, and in locations we cannot observe – but to search for ‘exceptions’ that invalidate the theory. Mr. Popper puts the example of the black swan, which invalidated the theory that all swans were white after many centuries of thinking this was a regularity or scientific law about swans. A single black swan was enough to invalidate the ‘white swan’ theory. Yet for 20 years I have found *not* a single exception to the Theory of Multiple Spaces-Times. Perhaps there are more ‘dimensions/arrows’ of space-time than those 3x3 arrows we have developed to explain an enormous number of *Events* and species of the Universe. So I challenge the scientific community to find them and/or any event, which cannot be explained with the energetic, informative, reproductive and social arrows used in this work to resolve the ‘why’ of existence in time.

Recap: Historically, 2 types of theories on Time Arrows dominated human cultures. *Monist* theories consider the Universe to be caused by a single causal arrow, called ‘God’ in religions and ‘Entropy or energy’ in Physics. *Dualist* theories consider the existence of 2 arrows, energy, the destructive arrow, called Shiva or Yang, and information, the creative arrow, called Vishnu and Yin, the creator of Live. Only a few, complex philosophers (Leibniz), disciplines of science (Biology, Theory of Evolution, System sciences) and religions (Taoism, Buddhism,

Zurvanism, Christianity), have also understood the two more complex arrows of future time: the arrow of reproduction of energy and information (exi) and the arrow of social evolution or arrow of love.

General Systems sciences fusions all those disciplines, unifying the Time jargons of Philosophy, Religion and Science and provides 3 levels of time arrows, dual theories of energy and information, which suffice to explain most physical systems; 4-dimensional theories which add the arrows of reproduction and social evolution, needed to explain most biological phenomena and finally 9-dimensional theories of 9 arrows/cycles of space-time that exhaust all possible events and cycles of the most complex species of reality, the human super-organisms studied by social sciences and the Universe at large. The algebra of multiple spaces-times defines a Unification equation of all arrows, events and morphologies of space-time, whose exhaustive and particular analysis reveals both the thoughts of god and its details of each species.

9 arrows of timespace exhaust all Universal events. They are the arrows of energy, information and its complex combinations, the different arrows of social evolution, reproduction and organization in complex, fractal planes of existence, from the simplest atom to the Universe itself.

II. MASS IS INFORMATION: UNIFICATION EQUATION

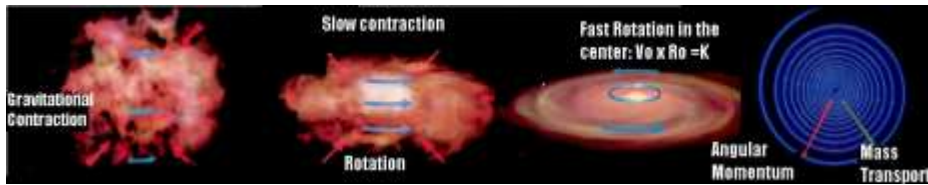

The Universe creates dimensional form by reducing the motion/speed of a physical system and vice versa: it creates motion/speed by eliminating dimensions of form. So a 3 dimensional nebulae of matter collapses into an accelerated mass vortex, in which, according to the Equivalence between gravitational forces, masses and cyclical acceleration (Einstein's relativity), is an attractive whirl of spacetime. The Equivalence Principle establishes a Universe with 2 limits of eternal movement: a lineal speed with a c limit or electromagnetic force; and a cyclical speed or mass, which is a vortex of space-time also with a ' c ' limit of speed, reached in the heaviest objects - black holes. Thus radiation and mass eternally transform into each other the lineal and cyclical arrow of inertial movement: E (lineal motion) $\langle cxc \rangle M(Ti)$ (cyclical motion). A light wave reproduces at c -speed an electromagnetic surface of lineal space. On the other hand, a mass whose limit is a black hole that turns at c -speed is a cyclical entity that balances the lineal movement of light forces with its inverse cyclical movement, to maintain an eternal dynamic balance of cycles and lines.

11. Equivalence Principle: invariance of topological form.

All forces can be reduced to 2x2 types: lineal, gravitational and electromagnetic forces, which extend to infinity and curved strong and electroweak forces that exist inside the smaller atom's space.

For that reason we talk in the cosmological realm of 2 membranes of space-time, the electromagnetic and gravitational scales. Yet according to duality, those two spaces should be balanced by two types of cyclical particles of information, also in perpetual motion, in such a manner that an eternal game of $E \Leftrightarrow I$ events that transform lineal energy into information take place in both membranes. This is the case, and we call the two cyclical vortices of information of the

electromagnetic, light space and gravitational, dark space (since we are electronic beings that do not perceive gravitation), electronic charges and quark masses.

And since electronic charges are guided by electroweak forces and quark masses by strong forces, we conclude that the duality of energy/information and light/gravitational membranes can explain perfectly why there are 4 forces in the Universe. Those forces are in fact 2 lineal energies and 2 curved motions of the 2 scales of reality. Let us consider all those propositions in more detail.

According to Einstein's principle of equivalence, gravitation curves the energy of vacuum into an accelerated vortex of mass.

Thus, a mass has a cyclical form and since the only cyclical acceleration known in nature is that of a vortex, it follows that a mass is an accelerated, cyclical vortex of gravitational forces in which the energy of gravitational space is curved into mass. We perceive masses as still cyclical forms, because of the Galilean Paradox, but particles are cyclical accelerated vortices, whirl like hurricanes of curved space-time that attract faster as we come closer to their centers. In Relativity Einstein established the equality between accelerated motion, mass and gravitation. Or in the classic notation of Newton: Forces = O_i -Masses \times $|e$ -Accelerations. And so we exist in a Universe made of 'motions in time', 'actions', 'forces', either cyclical masses or lineal fields.

Physicists think particles are material substances with forms in space (naïve realism), even if they are vortices of space-time, which attract other particles and forces as hurricanes do, dragging them towards its center. There are in fact 2 final 'seemingly, static' realities, space and mass, which in closer view are two types of motions: lineal, expansive motion or 'vacuum space' and cyclical, informative motion or 'mass'.

We shall bring a mathematical proof of its equivalence with information, extracted from Einstein's equations:

$$E=mc^2 + E \times T=k \rightarrow Mc^2 = k/T \rightarrow M = (k/c^2) \times (1/T) \rightarrow M=K \times v$$

Where v is the frequency of information of a mass vortex of space-time. Thus when the lineal energy of vacuum space, E , 'coils up'

acquiring a new dimension of form (c^2), it becomes a cyclical vortex of mass, m , which has more form (2 dimensions); hence it stores far more information (i^2) than lineal, spatial forces do. That energy/motion of vacuum space, in fact, constantly condensates into virtual particles with form ($E \rightarrow I$), either photons or masses, proving that the ultimate substance of reality is light-space condensed into photons and electrons, and gravitational space, condensed into masses.

Thus the 2 ultimate physical realities - 'forces' and 'masses' - are also two types of motions.

Quantum Physicists, unaware of the full meaning of Relativity and Mass as a vortex that creates information in Einstein's equations, think that creation of entropy/lineal motion/space is more important than processes of creation of cyclical information/mass. Thus, the Universe should expand and die, and lose its form, its in/form/ation. But this is by no means empirically certain, nor philosophically correct.

Indeed, when we consider the entire picture, which should include the arrow of gravitation and mass, as a force that 'in/forms', there are many discontinuous regions of creation of information in the Universe that this simplistic vision of some physicists do not account for in their calculations (black holes, dark matter, masses, charges, vortices, living beings, etc.)

Creation of entropy and its negation, negentropy, the creation of information, balance together, giving us a sum of eternal time: $E/I=K$. But to fully understand this, quantum physicists must improve their concept of charges and masses as cyclical motions - vortices of physical information that we must add up to the energetic big-bang processes to balance the Universe.

So we consider the initial, simplest reality, vacuum space, the lineal motion of gravitational and electromagnetic forces, which in a first stage curl into formal, cyclical masses and charges. Since vacuum space, which seem static to us has also motion.

This is proved by the dimensions of the substance that makes up our space-time - light - which are the same dimensions than the Cartesian space-time, but gifted with motion: the magnetic, energetic field has 2

perpendicular dimensions, width, and length, and the informative, electric field has also two dimensions: height and rhythm. Both together 'form' the 4-Dimensional space-time in which we 'see'. Science further simplified this limited perception into a single abstract continuum 'frame of reference' that physicists called Cartesian space-time. When Descartes first published this 'frame of reference' in his book 'The World' he was aware that it was merely a mathematical instrument of calculus, but as time went by and scientists became accustomed to use the continuous paper-frame for all their studies of time and space, they ended up confusing the 'language' - the Cartesian frame - with reality (the space-time created by the explosive expansion of light-space).

Yet the Cartesian- \rightarrow Newtonian single, still, space-time is a simplification of what Leibniz called relational space-time⁹: reality is made of multiple, lineal and cyclical motions (energy surfaces and cyclical clocks of information) that create all type of entities, which last a certain number of time cycles and occupy a reduced quantity of vital energy=space. Ultimately, Descartes was accurate in his description of reality as made of 'res extensa' (lineal space) and 'vortices' of time (cyclical motions), which the 'mind' used to construct an abstract map of space-time, the Cartesian plane. His disciples however got rid of those perceptive details sponsoring a naïve realism that confused the 'visual plane' of the Cartesian mind with the totality of space-times of the Universe. Absolute, Cartesian space-time however is a simplified Maya of the senses, which fix and put together all the bites and bytes of lineal energy and cyclical information, the 2 motions that define reality, into a single space-time.

For the same reasons, we perceive 'space' as a still picture of a time motion, a slice of a time-line (or world-line, as Relativistic theorists call it). The mind doesn't see time from past to future. It perceives only 'present time', a simultaneous slice of it that gathers the flows of reality into a static 'second', the rhythm of our mind, an eye-wor(l)d, which makes us to perceive many realities in perpetual motions as a single tapestry of static forms; which we call absolute space-time, even if it is made of many relative vital spaces, tracing clock-like cycles. The perception of time flowing thus require to put together many of

those still perceptions into a flow of motion. In the same manner, we can see a movie because 24 times per second the image changes and our perception, which takes place more or less every second, puts together those 24 frames into a single 'formal motion, form-in-action, in-form-ation.

The Einsteinian principle of Equivalence unifies the forces of the Universe and explains the meaning of mass, *not from the perspective of quantum physics, as Higgs or Hawking tried to do with little success, but departing from the Laws of Relativity.*

Physics studies translation time=change in the movement of any entity, either a constant speed or an *acceleration*. So does *Relativity through* the Equivalence Principle, which considers weight equivalent to acceleration. Since a being that accelerates acquires weight. For example, when you accelerate in a rocket or a car, you feel a weight-force that throws you back. Thus, the *Equivalence Principle* equals gravity, acceleration and mass. We feel mass or weight because we are accelerating. While the inverse transformation of a vortex of mass into lineal radiation is ruled by Einstein's equation, $E=Mc^2$. But General Relativity uses only lineal Time. Thus, if we add cyclical time, and hence cyclical acceleration, we complete Relativity's '*Lineal Equivalence Principle*', with a *Principle of cyclical Equivalence* that states the homology between mass and cyclical acceleration:

Weight=Gravitational force=Lineal acceleration

Mass=Gravitational particle=Cyclical acceleration

Thus, according to the formal duality of movements in the Universe, there are 2 Principles of Equivalence: lineal acceleration equivalent to gravitational forces and cyclical acceleration, equivalent to Mass, defined as a vortex of super-fluid space-time. Masses are merely the final accelerating curvature of space-time that creates vortices, which attract us, as hurricanes or sink vortices do with their surroundings. A mass is a cyclical vortex of space-time - not a fixed particle, but a cyclical spin. Thus, we describe the physical Universe as a game with 2 limits, the cyclical speed of a mass and the lineal speed of light. Yet to fully grasp that simple, amazingly beautiful, eternal Universe of

fractal, moving lineal forces of space and cyclical vortices of mass, we have once more to correct the errors of lineal time that have fogged for centuries our understanding of a mass vortex.

Philosophically the Principle of Equivalence implies that the Universe is not made of solid substances but of perpetual accelerated movements, which we see as static fields within the mind, due to the Galilean paradox. Thus, the Universe is a machine in perpetual change, where acceleration - a change in the direction or rate of any movement - is the natural, dynamic essence of existence in time from past to future and future to past'. While inertial movements define existence in space, as a present, unchanged reality. Thus the image of the Universe cast by Relativity, when we properly understand the Equivalence Principle, is the opposite of earlier Newtonian concepts that considered the Universe a static, inertial reality instead of a catastrophic, accelerating and decelerating series of worlds, made of changes in the rhythms of times, instead of substances.

We have recently discovered such accelerating Universe defined by the Principle of Equivalence: on one hand, cosmologists discovered that black holes are indeed vortices of space-time that accelerate any object which comes towards them till reaching an angular c-speed on its 'event horizon'. On the other hand, we have observed that space accelerates between galaxies becoming dark energy. So both limits of lineal and cyclical movement obey the Principle of Equivalence: reality is, in terms of movement, the inverse of what the static mind perceives. The mind is pure, static, informative space, because it has reduced the cyclical and lineal, inertial movements of the Universe, into quiet mental space. And further on, it has simplified the constant changes of speeds that the accelerations and decelerations of existence produce, into a lineal movement. The mind integrates those changes of movement into a simplified vision that becomes first an inertial movement and then 'fixes' into space, the ultimate nature of the living Universe.

The Universe is constantly accelerating and decelerating, living and dying. In mathematical, linguistic terms, (since mathematics is nothing but a simplifying language of the mind), the first 'integration' of that

acceleration is movement, (as we integrate all accelerations and decelerations into smooth, constant speed) and its second integration is static space (as we cancel all inverse movements into a fixed image). Only then when we perform those 2 integrations of data, the complex movements of the fractal Universe become the continuous static space-time of the mind. And inversely, when we want to get detailed information of the movement taken place in a point of that seemingly static space, (from the perspective of the mind), we 'derivate' that point of static space, to obtain its rhythm of change, $V=s/t$, is speed and then again, we 'derivate' in more detail to obtain acceleration the ultimate, 'deeper' nature of that static space.

It is for all those reasons that we call the arrow of information in the Universe, 'the arrow of Einstein', since Einstein defined 'gravitation' as an accelerated vortex that bends space into mass, whose frequency carries the information of the universe, its 'form'. And the result is a Universe in perpetual motion:

$F=M \times A$, where Mass is cyclical motion and a , lineal motion.

Which is eternal ($M \Leftrightarrow A$), and dual, where mass carries the information of the Universe and energy its spatial extension:

$$M(t) + A(e)$$

Recap. the change of paradigm from single lineal time and continuous space into multiple, cyclical Time Arrows and fractal spaces creates a more accurate model of a Universe in perpetual motion, made of lineal energies (gravitation and light) and cyclical vortices of information (masses and charges). We don't need magic Higgs particles to explain mass, once we follow in the steps of Einstein and complete the curvature of space-time into cyclical vortices of mass.

12. Mass as information explains the duality of the Universe.

Classic Physics ignores how 'the future' is created by the 2 Simplex 'arrows' of time, energy and information. Since it works with a single 'point'/arrow of time, energy. We contend that the 'Arrow of mass' or arrow of information, the arrow discovered by Einstein in his studies of masses as cyclical clocks of time is needed to balance the Universe of energy and make it immortal. Monist Physicists contend that the

creation of information is not enough and does not balance the expansion of the Universe. The essential difference between both theories lays therefore in the meaning of mass. We contend that masses are vortices of space-time described by Mr. Einstein Principle of equivalence between mass and acceleration and his equations, $E=mc^2$ and $E=K$. Hence $Mass = k/T = k \nu$, where ν is the frequency of rotation of the vortex of gravitational and electromagnetic forces that become masses and charges with more dimensions, as they coil the lineal energy of light, $E=Mc^2$.

Yet the dominance of the arrow of spatial energy and motion in the last centuries, due to the inordinate attention given to the science of physics and its 'worldly' profession of making energetic weapons and transport machines (that arrow in fact was found in the study of heat in steam machines), has modeled the universe as a simple machine of motions and extensions, a 'continuous' space that holds matter, its simplest forms, which seems to physicists the meaning of it all.

Quantum physicists even deny Einstein's theory of mass and prefer to think on mass as an external property to the particle. Hawking, even changes the arrow of time, so masses instead of creating information evaporate into energy. This denial of information goes to the extreme that physicists call the arrow of information, the arrow of 'future time' that creates life and mass, negentropy. And so they are in a quest to prove that the immortal Universe will die by an excess of entropy and lack of information.

How they justify it? Because they say the space between galaxies expands and will expand eternally, relaxing all information into pure energy. And since they think space is 'continuous', they consider its death proved. But in a fractal, discontinuous Universe such expansion is balanced by the 'implosion' of the energy of vacuum space into mass, $M=E/c^2$, which happens constantly in galaxies and black holes. Thus the expanding vacuum space of the Universe is eternally balanced by the implosive forces of mass and gravitation.

But we can already see a pattern of physicists: to deny often the existence of an arrow of information and life in any field of their study, including the obvious arrow of information in masses and black

holes. All must be entropy, energy and the arrow of death, even if *there is a massive evidence of the existence of an arrow of gravitational form, described by Einstein.*

In words of Nietzsche physicists only care about finding the 'whitest' of all canvas, the big-bang of energy, the expansion of vacuum space, while complex theorists work with the 2 main colors of reality, energy and form, and its 2 complex 'mixtures', reproduction of form (exi), and social evolution of similar forms into networks, societies, systems and fractal spaces.

So system scientists are working to understand how with those 3+st colors, energy, form, its reproduction and its social evolution into a whole (st+1) the painter, 'God', which is the will of those 4 arrows that create the future, its events and scientific laws, paint each part, each being of reality.

Recap: Form, information is the inverse, creative arrow that produces forms, by breaking and warping the amorphous energy of space, in ever more complex cyclical particles, which gather into networks and denser, implosive forms. Those 'forms' are small, slow, multi-dimensional, living forms that multiply in ever diminishing, more complex fractal scales. Yet in terms of the information they hold they are as important as the Universe itself. Indeed biologists have stored the same quantity of data about life than physicists about all the matter of the Universe.

13. The Unification equation of charges and masses.

We affirmed that the Universe is invariant to scale transformations and the 2nd set of laws needed to describe it are those who relate 2 different membranes of space-time, which in astrophysics are the light-space and gravitational-space membrane, the microcosms and the macrocosms.

The Universe is invariant in its topological shapes of energy and information, structured in 2 discontinuous fractal scales of space-time, the scale of cosmological masses and quantum charges, each one made of informative cycles, clocks of time (masses and charges) and lineal, energetic forces (dark, gravitational Non-Euclidean energy and electromagnetic, Euclidean light space).

And so the forces of the Universe must be understood in those terms and in 2 membranes:

Electromagnetism (spatial force: light) X Weak force (temporal particle: electron)= Electro-weak space-time membrane.

Gravitation (spatial force) X Strong force (temporal particle: quark)= Strong, Gravitational space-time Membrane.

In the Physical Universe time=change shows in the accelerations and decelerations of all its particles and forces. Yet since time and space are inverse morphologies, those motions can be lineal, creating spatial forces or cyclical, creating particles that are temporal vortices. The different cyclical, temporal speeds of those vortices and the spatial extensions of its forces are measured by Universal constants, which are ratios of transformation of spatial energy into temporal information and vice versa (so we measure constants as ratios between a mass/charge of in-form-ative volume and a spatial distance). Thus, a unification of electromagnetic and gravitational fields follows if we consider that their only difference is the density of space and temporal information of its forces and vortices that give birth to different constants/ratios.

Thus each Universal Constant is an informative/energetic, mass/distance, i/e ratio that defines a certain space-time membrane and plot them all according to those constants as different space-times of growing i/e density (so denser mass vortices have higher information and lesser distance, forming a denser, *strong* space-time of gluons, while the lighter, more extended space-time of larger distances is that of gravitational forces).

The result of plotting 'forces' as spaces of different density is a function, we shall call the Universal Constant of space-times, U(t/s), that varies in potencies of 10, giving us the specific i/e densities of each type of space-time force.

Physical Reality is made of dual energetic/informative states (complementarity principle particle-wave): Cyclic vortices/ particles develop lineal actions-waves in 2 scales, the microscopic quantum world of Electromagnetism and the macroscopic, gravitational world.

Once the duality of scales and forms is understood, we unify the constants of dimensional proportionality of both types of vortices and forces, studying transversal waves of 'lineal speed' in both scales of the fractal universe: the c-speed of small electromagnetic waves, and we contend, the superluminal 'action at distance' of gravitational waves.

Let us consider the first element of that duality, unifying masses and charges of gravitation and electromagnetism as vortices of 2 different scales of space-times. Masses and charges are vortices of 2 space-time scales made of 2 relative energetic and informative motions, where gravitation is faster/more extended but carries less information than the slower/less extended world of light and electroweak particles.

The main variation of those vortices of accelerated forces is the one we observe between electronic charges and quark masses, which are the cyclical vortices of those 2 scales of reality, the scale of cosmological vortices of mass and the scale of electroweak vortices of charges.

And so we have to unify those 2 types of cyclical geometries on one side and their lineal, light and gravitational forces, on the other side, as they switch acting either as sinks of space-time (cyclical, non-lineal vortices of increasing acceleration) or as lineal, gravitational or electromagnetic waves in both scales.

Yet since electromagnetism and gravitation are self-similar accelerated vortices of 2 different fractal branes of space-time, the microscopic and cosmologic branes, it follows we should be able to treat them with the same equations of gravitation, either Einstein's more detailed vortices, defined by the Principle of Equivalence between mass and acceleration or with the classic analysis of Newton, as accelerated vortices with the same geometrical form, whose relative proportion of energy/speed/ distance and information/curvature will be given by 2 different Universal G-Constants.

Thus, we should be able to describe both, the standard Earth-Sun gravitational vortex and Hydrogen, electron-Proton quantum vortex with the same equations, defining them according to the mass of the

particles, the rotational speed and 2 different Universal constants, U.C.(i/e):

U(g), the Universal Constant of gravitation that defines a larger/faster/less curved Gravitational membrane of masses and...

U(q) the Universal constant of charge (Coulomb) that defines a smaller, slower, more curved membrane of quantum light. Since electromagnetism has more information and less energy distance.

Further on, we will be able to prove empirically our hypothesis of 2 self-similar spatial membranes made of light and gravitational quanta, whose only difference is the i/e relative density of information/energy of its cyclical vortices, if the values of the two Universal constants, in those 2 systems (the earth-sun system and the proton-electron system), correspond to their relative empirical value, when we treat them both as mass vortices (being the gravitational constant 10^{39} times weaker than the charge constant).

Let us then go on with the treatment of charges and masses as Newtonian vortices of space-time. In newton's equations a mass can be considered a cyclic, accelerated vortex of gravitational space-time defined in classic Newton Mechanics by a centripetal, gravitational acceleration: $\omega^2 r$.

The same treatment can be done with Poisson equations or Relativity equations, which are a static, present, simultaneous picture of Newton's space-time vortex of acceleration, where G expresses the informative curvature of the space.

Thus if gravitational acceleration is $\omega^2 r$, then $F=mg=m\omega^2 r=GmM/r^2$, and we arrive at $G=\omega^2 r^3/M$. Where r is in meters and ω is angular acceleration in radians per second.

If we substitute for the Earth-Sun system's rounded values, (the Earth's angular velocity, ω is 2×10^{-7} radians per second; its orbital radius is 149×10^9 meters and M, the Sun's mass is 2×10^{30} kg.), we obtain, a value for G that measures the Sun's Space-time contraction (in static space) or formal acceleration of the vortex, equal to $6.6 \times 10^{11} \text{ kg}^{-1} \text{ m}^3 \text{ rad. sec.}^{-2}$, in accordance with experimental evidence.

Roughly the same value of G, till now calculated empirically, is obtained for all planetary orbits.

This shows that the entire solar system is a series of self-similar gravitational vortices of space-time caused by planetary masses.

Then if we apply the model for G to the hydrogen, proton-electron atom the orbital parameters are: *electron's angular speed* = $4.13 \times 10^{16} \text{ rad. sec.}^{-1}$; *Bohr radius* = $5.3 \times 10^{-11} \text{ meters}$ and *Proton mass* = $1.6 \times 10^{-27} \text{ kg}$. And so substituting those values in $U(q) = \omega^2 r^3 / M$, where $U(q)$ is the Universal constant, quantized for the electromagnetic scale as 'q', we obtain a value of $\pm 1.5 \times 10^{29} \text{ kg}^{-1} \text{ m}^3 \text{ rad. sec.}^{-2}$.

Thus, if we treat charges as vortices of a denser space-time membrane, we obtain theoretically a U.C. (i/e) of around 1.5×10^{39} times the value of the gravitational G, $U(g)$, self-similar to the empirical value.

A theoretical calculus of those values cannot be exact by chance, unless our thesis is right. Thus, the previous calculus is a clear proof that both, charges and masses, are unified as values of the same type of space-time vortices in the 2 different scales of space-time of the Universe. And they are geometrically unified from the p.o.v. of geometrical relativity not from quantum theory, as Einstein wanted it². Thus, the Unification equation in terms of Newtonian mechanics is simple:

Unification Equation:

$$UC_{G,C} = \omega^2 r^3 / M \quad UC_{G,C} \times M = \omega^2 r^3 \quad M = \omega^2 r^3 / UC_{G,C}$$

Where we obtain for 2 UC(i/e) values, G and Q, 2 different space/time scales and vortices acceleration (mass and charges).

2 obvious, simple proofs of that dual, scalar structure:

- Planck's minimal value for Mass is far bigger (10^{-7} g.) than the minimal value for an electromagnetic action (h), which seems to mean that the mass scale is far bigger than the quantum world.

- The entire standard model works without gravitational forces. Thus we have to postulate that particles are not 'mass-particles' but

electromagnetic systems, which become elements of mass only when they aggregate in huge numbers, as it happens with electromagnetic photons, which become electrons of the upper scale in huge nebulae.

But we see masses as static forms. This is due to the Galilean paradox: a space-time vortex-mass becomes then statically a space-time distortion, a deformation of space-time which increases as we decrease size. Since the *deformation of space-time is the same for any cycle*. Hence, when we trace a smaller cycle the deformation increases. And so it does the mass and the U(w), now a static constant of deformation. This is the interpretation most often assumed of G in Einstein's Relativity. In a simpler, classic approximation based in fluid dynamics, M/r^3 becomes the density of space/time and its inverse, R^3/m , the displacement of space-time provoked by a given mass. It is then evident by Archimedes Principle that a bigger mass density will provoke a bigger displacement and distortion of space-time an inversely a bigger acceleration towards the central vortex. And since the density of a proton is much higher than the density of a planet, the Universal Constant for an atom is much higher and so it is its angular speed. Does the electromagnetic constant, or static curvature of an atomic system, is much stronger. So it is the density of a proton mass.

This reformulation of electromagnetism simplifies and clarifies the meaning of physics. Yet to grasp the relationships between the quantum world and the cosmos we have to transform, using the new coulomb constant, $C=1.5 \times 10^{29}$, electromagnetic parameters to the jargon of gravity, departing from its fundamental relationship:

$$F = UC_C Mm/r^2 = e^2/4\pi\epsilon_0 r^2$$

Then we can translate the main constants of electromagnetism (the Rydberg constant, the α constant, which denotes the strength of the electromagnetic field, etc.) to the gravitational jargon and again the results obtained are close to the theoretical value.

So it is evident that we are observing the same geometric force at different scales, *explained with 2 different historic jargons*. Further on, as we 'transform' the concepts of electromagnetic vortices to

gravitational, geometric symbols, the main discoveries of Relativity apply to electromagnetic vortices.

Perhaps the most interesting simplified value under the new $U(q)$ charge constant is the Proton radius that appears with the same formula, than a black hole, Schwarzschild horizon. This means that a quark particle (a hadron, a proton, etc.) is basically a black hole of the quantum, gravitational scale and vice versa: a cosmological black hole might be a deconfined state of billions of ultra-dense quarks. In such fractal Universe, each small particle could from the perspective of a small observer a macrocosmic form. And each atom could be a galaxy. Such fractal Universe validates the Theory of Great Numbers, which are the parameters of self-repetition of the Universe, which might be from a lower perspective a mere atom or black hole of a hyper-Universe.

Yet self-similarity is not equality, an atom is self-similar to a galaxy but NOT likely a galaxy - reason why for example quantum cosmology is false. Quantum cosmologists consider 'identical' the scales of the cosmos and the quantum world, so they use quantum equations for all. This is a hyperbolic error. We have equations for each scale and what we can show, as we did here, is the self-similarities of scales.

All in all, it is evident that what we call a black hole or pulsar is made of quark quanta; it is a fractal of quarks. Thus we can apply to its vortices the laws of Newtonian fluids or the more complex equations of a Non-Euclidean vortices of space-time, as we do with any other 'medium' called a 'phase space' in physics. They can be considered akin to a hurricane, which is a 'medium' of air molecules, or to a tornado, which is a medium of water molecules. All those mediums have limits of speed, which are the same for their lineal forces and cyclical vortices:

Light space-time has a c -speed limit, which is also the limit of speed of a rotational electron vortex and a 0 K limit.

Dark energy and quark matter belonging to the gravitational membrane seems to have a $c < 10 c$ lineal and rotational speeds.

Because each space-time membrane has vortices of information and energetic, lineal forces, we need equations of self-similarity, relating informative vortices of charges and masses on one side and gravitational and electromagnetic waves on the other. This is done with gravito-magnetism, which relates cosmic gravitational, lineal waves and electro-magnetic fields. So, the gravito-magnetic formalism just needs to be properly fit within the wider concept of 2 self-similar fractal space-times, to define in self-similar terms, light waves and dark-energy waves of gravitation; as the elementary, actions-units of the 2 fractal scales. Because of the corrections, higher complexity and general ignorance of the gravito-magnetic formalism, here we shall only consider the case of the light-membrane.

Recap: the 2nd fundamental duality of the Universe is its structure in 2 different branes, planes or scales of space-time: the electromagnetic space and the gravitational space, which show different proportions of energy and information and yet, because of the self-similarity of all those branes can be easily unified as 2 self-similar forces acting in 2 different scales.

14. Fractal, complex Physics

The spiritual, eternal Universe of perpetual motions seems ∞ The spiritual, eternal Universe of perpetual motions seems ∞ in scales, repeating self-similar forms every 10 relative scales of fractal space-time. *Since the nucleus of an atom is self-similar to the black hole nucleus of a galaxy.* So Black holes become hadrons of the bigger cosmological scale made of infinite quarks, and protons become 'black holes' of the lower, quantum scales... once we translate the jargon of quantum physics to the jargon of Gravitation, as Einstein wanted, *not the other way around as quantum physicists have tried unsuccessfully for 100 years.*

This means that the Universe is either limited between those two final scales or if each atom is a galaxy and each galaxy an atom (as Einstein and Walker thought when modeling the Universe with Relativity, considering each galaxy as a Hydrogen atom), is infinite in size, and in each of us, there is an entire number of infinite Universes.

And this is possible because now points have inner parts that when observed in detail grow in a fully relative Universe, 'where the smallest point must be perceived as an entire world' (Leibniz).

Since space-time is broken, fractal, made of infinite self-similar networks and organisms. It means there are many self-similar space-times, many self-similar planets, in which humans exist. Yet none of them are equal, because in fractal theory all is self-similar but nothing is absolutely equal.

In physics it solves also the puzzles of quantum physicists. For example, it means that an electron is not a sum of probable electrons in different Universes, but a sum of self-similar fractal parts, which can be described as populations of 'cellular electrons', with the same probabilistic equations that quantum theory. Any mathematician knows that probabilities are used to explain probable events in time, and percentages of populations in space. In other words, in advanced fractal physics we merely switch the quantum description *from time to space; hence a galaxy is a fractal of self-similar stars, which have self-similar planets, with self-similar human races.*

And this realization is the beginning of Fractal Logic, which coupled with the understanding of Non-Euclidean mathematics defines the 'Grand Design of the Universe', which is deterministic not probabilistic, albeit written with a logic more complex than that of the physicist and the present man.

But of course, space is the easiest part to understand of the new Age of mathematics and logic that we are finding. The key to everything is the logic of fractal space, which requires breaking also time into infinite clocks, one for each cycle of reality that closes in itself. *Which again means that as Einstein said, 'there are infinite clocks of time', and so infinite time speeds, and each of those vortices of mass, each of those charge vortices is a clock of time, which carries a frequency of information in the intelligent Universe. Imagine that: you exist in an eternal, intelligent, moving Universe, where all is gauging information, feeding on energy, turning into patterns of form, ticking.* Further on, the smallest you are, the faster you tick, the faster the metabolism of the rat is, the faster the electron turns. And this is the

key of the harmony of all planes of reality. An ant lives 7 years but it processes information 10 times faster than a man, so in subjective time it lives 70 years. An atom cycles billions of times faster than a galaxy, but it is billions of time smaller. And so Einstein's equation writes as:

$$\text{Energy/Motion/Space} \times \text{Time/Information} = \text{Constant.}$$

$$\text{Max. Se} \times \text{Min. Ti} = \text{Min. Se} \times \text{Max. Ti}$$

Thus, when we change from scale, what we lose in size we gain in speed of time, and the product of both stays invariant. As in the book 'Shrinking man', if we became smaller we would change our perception of time that would adapt to the new plane. And so the life of an ant might be as profound and rich in meaning as the life of a human being. And that is what connects the Mind of the Universe' to the classic myths of Eastern religions that studied them. Indeed, the Great Zimmer tells us in his 'Myths of the India', how Vishnu tells Indra, king of kings not to be so arrogant: he suddenly looks at the floor and sees a group of ants and Indra asks the Vishnu child, what are you looking at? 'I'm looking to a group of Indras walking in a queue' he responds as he crashes them.

Recap. The invariances of the Universe define a reality of infinite self-similar scales where we are all relative nothingness or absolute Gods depending on our scalar point of view: Humans might be universes made of infinite galactic atoms. And yet the Milky Way might be self-similar to a Hydrogen atom.

III. THE 4 DIMENSIONS=ARROWS OF LIGHT-SPACE

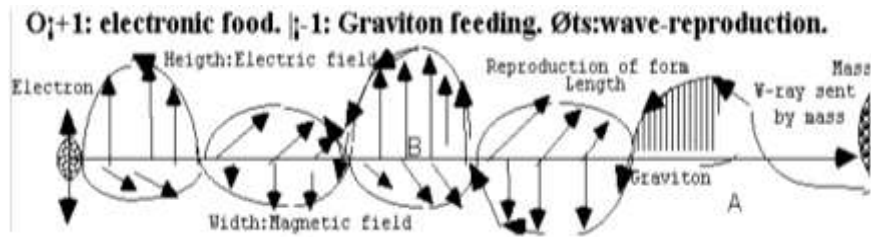

We have a light-space-time Mind. It is not though the entire Universe, but the world the mind constructs with the help of a rod of measure, absolute c-speed and 3 dimensional space, Euclidean space. For that reason what is not light-space doesn't seem real for us. Yet this world of light with its light properties, perpendicularity, Euclidean form, developed by Descartes in his book the world as the basis for modern science, with a Cartesian graph in which the mind of man occupied the zero point, should differ from other worlds constructed with other rods by other species of mind. An exophysical theory must be in that sense objective and consider the wider structure of all spaces times. Once this is clear, we can study the peculiarities of the light space-membrane departing from its 4 dimensions, which are not only the dimensions of our mind perception but those of light as an entity made of time cycles, imprinted and reproduced over a simpler energy, space and evolved informative into electrons, what our mind is made of.

15. Universal constants of light

Heisenberg's uncertainty is a right formalism but a false interpretation of the generator equation of light-space that relates the arrows of energy and information, in the specific form it has in the quantum world of light actions of energy and time:

$$\text{Energy} \times \text{Temporal Information} = \text{Constant (H in the quantum world, K in Einstein's relativity)}$$

The meaning of the previous equation is easy to grasp in terms of the duality of Space-time Constant, Q and G.

H is the equivalent of Q for the lineal energies of our light-membrane, as it relates the energy and form or frequency of a lineal, transversal wave of light.

So, if h is the ratio of transformation of frequency/form into energy and q the ratio of transformation of energy into form, in the electromagnetic world, what is the ratio of reproduction of electromagnetism? C, which was defined by Maxwell equations as a ratio between the electric and magnetic fields that merge together to create a wave of light, which reproduces its form contracting, warping the gravitational membrane of dark energy.

Further on c is the limit of speed of our space-time membrane. This is a tautology; since in fractal relativity space is the energy of the vacuum, a force: The membrane of light-space in which we exist is made of energy quanta, which constantly pops out and 'informs' itself, creating particles with energy and form ($h = \text{energy} \times \text{information}$). Planck called these minimal actions, combinations of the lineal and cyclical motions of energy and time, the quanta of our light space-time. Yet Quantum physicists, always kin of Pythagorism, created the uncertainty dogma, saying actions are NOT made of the 2 motions of the Universe, but are 'mathematical entities' – a measure of the uncertainty of the vacuum. So particles are not born as evolutions of the 2 motions of reality, but they are born of the 'uncertainty' or 'probability' of the mathematical Universe. It is all simpler and more real. The space-time fluid of light is made of h-quanta and so those h-quanta can suddenly evolve socially in more complex forms and create particles. That is all what there is to the uncertainty principle.

We must also deduce from the existence of different U.C. and ratios of speed/distance and informative rotation that the Universal constants of c-speed, Q-charge and H-light energy are specific of our Universal membrane and those of the gravitational membrane must be different.

Recap. According to the paradox of Galileo the eye fixes the energy and form of light-space into a mental construction of 3 dimensions, a Cartesian graph, which already Descartes defined as the 'world', the spatial image of the mind – not the entire Universe. Thus the 3 perpendicular dimensions of light quanta, our space-time, are tautologically the 3 dimensions of our space. This in turn explains many events of the electromagnetic world. Those are also the 3 organic 'arrows' of time of light, which has electric information, magnetic energy and reproduces its form combining both into a c-reproductive field as the equations of Maxwell show.

16. The arrows of time in the light world.

We exist as evolved forms of a light space-time field, our limit of speed in this light Universe is c and the 3 dimensions of our Universe are height/electric field, width/magnetic field and length/reproductive field. Thus Cartesian space-time merely reflects the space-time medium of our light Universe and its 3 perpendicular dimensions. Yet for light the meaning of those 3 dimensions is organic: the informative, energetic and reproductive arrows of its field are equivalent to the energetic, reproductive and informative functions of any other relative space-time.

Those energy/Information cycles are obvious in biology, but in matter we have to translate the dimensions and events of abstract particles and forces, to understand their 3 Time-Space cycles:

- Energy Cycles, $T_i < \Sigma Se$: The main physical event that transforms information into energy is the emission of space fields by temporal particles, as in the big-bang or in atomic, fission and fusion processes. Those actions are produced, 'extracted' from an accelerating vortex of space-time that acquires stability through those constant emissions.

- Informative Cycles, $\Sigma Se > T_i$: The fundamental process of creation of in/form/ation in the physical world is the collapse of spatial fields into particles, charges or masses that spin around those gravitational or electromagnetic, spatial forces, creating knots of information, called particles. For example, when a photon comes closer to an electronic charge, its frequency increases till the photon collapses into the orbital vortex of the electron. The same happens when the electron collapses and becomes a pion of higher mass closer to the nucleus. We can consider those processes in abstract as processes of creation of information /frequency, or in organic terms as processes of feeding, or in terms of Time Arrows as the evolution of particles (photons and electrons) into species of higher physical information.

Light 'imprints' with form, with information and in the process 'corrugates' by a factor $-ct$ (special relativity) the gravitational, extended, 'faster' space-time membrane of dark energy in which it 'feeds'. This $-ct$ factor which prompted Minkowski to think that time

was the 4 dimension of space merely means that 'physical time', the change in motion of physical entities, in this case a wave of light displacing in the gravitational vacuum, informs, forms, warps that vacuum by a factor $-ct$. If the reader grasps this simple notion - a field of light informs and corrugates the energy of gravitation it can also have a good laugh to 100 years of quantum musings about the '4th dimension of space'.

We define 3 scales of evolution of energy into form that diminish the 'lineal speed' of a force and increase its informative, rotational mass: photon $>$ Electron $>$ quark. It follows that the photon has faster lineal speed and less mass than the electron $c/10$, which is a relative fractal of dense, evolve 'photons', perceived as a whole or as a nebula. And the electron has less mass than the quark, which is a relative, fixed point of pure mass, perceived either as a fractal of gluons or a whole.

It follows that the laws of electronic systems are self-similar to those of light, as an electron is just an evolved form of light.

17. Multiple Spaces-Times in Matter: Atoms & Molecules

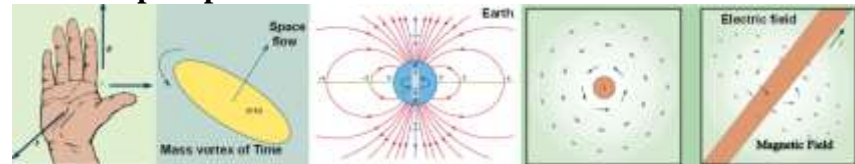

In the graph, both in the quantum and cosmic world the geometrical inversions between energy and information and its perpendicular exifields of motion define electromagnetic fields .

The holographic principle explains how bidimensional fields of energy and information come together, through perpendicularity to create 4-dimensional systems.

The perpendicularity of those fields is thus a key feature to create 4-dimensional world, and it is established by the general rule that the body will have a flat, energetic arrow of feeding and the head will have a tall, high diffeomorphic orientation, relative to the ecosystem of energy and form in which the entity exist.

If we consider those 2 inversions of form: lineal energy vs. cyclical information and flat vs. tall perpendicularity between energy and

information systems, forces and charges /masses in the physical world, we can define many physical events as transformations of lineal waves and fields of energy forces into cyclical or high particles and cycles of information, whose ratios of transformation in each of the scales of the Universe are called Universal constants.

In the graph, the laws of electric and magnetic fields are defined by those relative perpendicular morphologies. The ratios of transformations of energy into form define some of their Universal constants: 2 perpendicular fields of magnetic energy and electric information define in Maxwell equations the c-constant of light, which in organic terms is the ‘reproductive constant’ of the wave of light, caused by the constant process of creation that the interaction of the magnetic, spatial body of light and its informative, electronic particles, cause.

All those processes ‘form’ the energetic, formless gravitational vacuum into electromagnetic shapes: The Maxwell screw defines a flow of energy that accelerates as its perpendicular, temporal vortex diminishes its spatial radius, increasing its speed; the Earth’s rotation creates a lineal flow of magnetism; while an inverse, lineal electric flow creates a cyclical, magnetic vortex.

In the graph, we can observe how the inverse properties of relative energy and information fields explain the why of many physical phenomena. If we add the dual structure of fractal space-time, roughly constructed by 2 membranes, our visible, Euclidean space-time, made of light and the invisible, larger sea of gravitation made of dark energy, with its wider Non-Euclidean topology, we can deduce all the laws of physical science and its whys with far more insight that quantum physics does.

Let us just indicate from the perspective of the whys of the arrows of time of an electron, as we did for light, some basic events of the electronic and atomic world:

- ⇔: Reproductive, communicative cycles: They happen when 2 particles communicate through forces, made of small, spatial particles, called bosons, repeat their waveform in space with a reproductive

speed that imprints over the energetic field of vacuum space the in/form/ation of the particle.

- Social cycles: Particles create herds=waves of moving space-time quanta (dynamic, temporal perspective) related by EXI networks (static, spatial perspective). Social processes are all pervading in the Universe, from waves of bosons that sometimes come together into single condensates, to networks of atoms that become molecules or combined processes, such as waves of stars that form spiral galaxies.

Thus, waves and forces are spatial bosons that communicate energy and information between temporal particles, called fermions, either charges or masses. It is the so-called boson/fermion inversion, the fundamental equation of quantum physics:

$$T_1 (\text{fermion particle}) < \sum \text{sxt} (\text{boson force}) > T_2 (\text{fermion particle})$$

Existential=generational cycles: Again, we can adopt 2 points of view about particles. If we consider each particle/wave cycle a life/death cycle, particles have very short generational cycles. If we consider the next particle/wave cycle the same particle, particles are immortal.

In any case all those cycles can be summarized and formalized specific cases of the fractal, generator equation of the 2 arrows of time, spatial energy and temporal information: $\sum \prod T_i$.

As we grow in scales of physical form, the nature of those cycles change slightly but the basic energy and information morphologies that define them are maintained. Since fractal, scalar paradigm is defined by its 3 invariances, invariance of relative motions (Einstein), invariance of scales (Nottale) and invariance of topological formal Time arrows (Sancho).

Those Time Arrows or dimensions of any fractal space/time are the 4 guiding whys or wills of any entity of the Universe:

- Energy arrows that expand form into energy.
- Information arrows that form energy into information.
- Reproductive arrows that reproduce the energy and form of a complementarity system in other zone of space-time.

- Social arrows that create superorganisms by associating in complex networks Non-E particles of self-similar properties. This 4th arrow of social evolution is the cause of 'scalar relativity', as systems are made of parts that associate in wholes, which share the functions and morphologies of its parts. Yet scales are never equal as quantum physicists pretend, only self-similar. So the properties of a galaxy made of stars and black holes, made of quarks and electrons are self-similar to those quarks and electrons.

For example, in the next social plane that gathers atoms into molecules, the 3 main cycles of energy, form and the reproductive combination of both, become the 3 states of matter:

-Energetic gas state, (max. spatial extension and energetic speed).

-The balanced, reproductive liquid state, $S=T$, which creates the more complex forms of life.

-The 3rd, informative solid age, which has temporal, informative properties (cyclical vibration, high density of form and minimal space). While the spin or temporal movement of particles that gives them mass emerges in the macro-plane of molecules as a 'vortex' that attracts those molecules.

The boson-fermion equation, fundamental event of physics.

What the boson-fermion interaction means is that both, masses and charges are accelerating vortices which produce constantly, as they decelerate, 'fractal actions of constant speed' and increase the curvature of space in the dimension of height, through which they emit most of those actions, as electric or magnetic quanta. In the case of an electromagnetic vortex part of its acceleration becomes also transformed in the Unruh radiation that increases the temperature of the accelerating vortex. In our macrocosmic Universe it means a friction that decelerates the vortex and increases also its temperature. In gravity the interaction of the 3 dimensions is also evident: As the G-deformation of the vortex grows, so it grows its speed and acceleration. Unification follows when we consider charge and mass merely 2 types of vortices that can be derived from a 5th fractal dimension of time, that can accelerate inwards, imploding space (and

then we have the arrow of gravity) or decelerate outwards widening space and diminishing curvature (then we obtain, as Kaluza did, the electromagnetic arrow).

Perception of dimensions becomes more complex if we introduce the errors of the mind that tends to average accelerations and decelerations into constant speeds and converts speeds into static distances or spaces. We say that the mind uncoils an accelerating time dimension into a wider static field of space, or a fixed density of space-time called a mass. This is easy to understand. Take for example, the representation of those 3 parameters, space, speed and acceleration in a Cartesian system of coordinates. Space is longer: it is a length in the x-coordinates without any angle, flat. Then we raise the dimension of height/time, and obtain a diagonal, straight line that represents a constant speed. Yet because it has an angle, the line is shorter in X-space coordinates. Fact though, is that the being that has speed is in fact moving a longer length, but we have transformed that longer length into a temporal height/form in the graph. Finally acceleration is represented by a parable that finally becomes a height line and so it occupies the less quantity of X-space. Yet an accelerating being will reach the longest distance of all the 3 beings in the shorter time.

What those accelerating beings peel off as friction or radiation, or speed is called in quantum Physics an action, which is a fundamental constant in all beings. In the quantum realm the accelerating vortex produces an h-constant action of energy and time; in the macro physical realm it produces a Temperature or radiation as in the Unruh case. So to avoid collapsing into a singularity of infinite speed, what particle's vortices do is to peel off h or T actions, modes of constant speed, made of energy and time. So we can move from the Equivalence Principle of Relativity to the Gauge and Action principles of quantum physics.

Thus, all what exists in physical space are 4 motions of time, and those 4 motions define a Universe in perpetual motion, perpetually creating and destroying organic systems of energy and information.

Yet because the physical Universe is the simplest of all systems, its main event is a transformation of energy into information, of vacuum

space into vortex-like masses and charges, which cannot be reduced further. And so the simplest ‘events in time’ or ‘types of change/arrow of motions’ in the Universe are lineal energies that move (bosonic forces) and cyclical forms that turn around, storing information in their patterns of form and frequency.

And this explains why the boson/fermion inversion is the main law of quantum events and why $E \leftrightarrow M(t)c^2$ is the main law of the mass membrane. And we write it also as feedback equation since in physics energy/information events are reversible. So in the same manner energy can curl into mass, mass can explode into energy.

Indeed, if we depart from pure lineal motion or entropy (perceived statically as extension or space), then by ‘curling’ and ‘warping’, we can obtain cyclical forms (masses and charges), in the same way that by crumpling a paper we obtain warps, angles of form. This primary event, $E \rightarrow I$, diminishes the space, extension, lineal motion or speed (self-similar concepts) of space and increases its form. Thus, we obtain from energy \rightarrow Information. While the 2nd causal arrow of that feedback equation explains the destruction of form and creation of energy, $I \rightarrow E$, which is the ultimate meaning of the big-bang and all other mini-big bangs (novas, supernovas, beta-decay, Bombs) of the physical world of matter.

Reason why Einstein said that ‘time warps space into masses’ - meaning that energy curls into cyclical vortices of mass - while Darwin said that ‘Time evolves the morphology of life beings’; and deduced first the equation $M=E/c^2$ even if the Atomic bomb made more famous the destructive inversion

Recap. All the events of quantum particles can be explained as events Generated by the fractal equation of spatial energy (boson waves) and temporal information (fermion particles).

18. Physical constants are energy/form ratios of space-times.

Universal constants show ratios of energy, form, and exi= reproduction of space-time membranes. So they can all be written as partial equations of the Generator Equation of spatial energy and temporal information: $E \langle \text{exi} \rangle I$.

The relationship between the Constants, I & e of those space-time membranes or ‘forces’ is a simple rule, known to physicists as the Law of Range: Max. E = Min. I and vice versa, which is a particular case of the inverse properties of energy and form.

In the widest ecosystem of physics and its 2 gravitational and light space-time membranes, those Universal constants are related to the informative density and spatial distance of the vortices of masses, charges and lineal flows of forces of those 2 membranes.

Because there are 2 membranes of space-time, the light space-time membrane we see and the dark, gravitational, bigger, faster space-time membrane we don’t see, the Universal constants of both membranes are different. This means that black holes and quarks beyond the event horizon keep accelerating faster than light, and the energy they expel through their poles, called dark energy is also faster than light, which is the limit of speed of our membrane of space-time, light. Thus, the specific physical constants used to describe the e/i ratios of the vortices of energy and form of the cosmological and quantum world of masses and charges differ in value, as they express those different energy/form ratios. Yet since there is invariance of topological form, the only difference between electromagnetic and gravitational fields will be the extension/speed in space of its forces and the informative frequency of its vortices of temporal information that will give us different Universal constants, which are ratios that measure the speed of transformation of spatial energy into cyclical frequency. Thus we write a generic, topological, invariant equation for all space-times which will differ in its specific U.Constant (i/e):

$$F = UC (i/e) Mm (t) /Dd (s)$$

Recap. We measure universal constants as ratios between the frequency of a mass/charge or in-form-ative volume of the particle and its spatial distance. And so the faster the frequency of the ratio and the smaller the spatial extension, the stronger the Universal constant will be and the faster the exchanges of energy and form between the particles/vortices will happen. It results in 3 forces: the gravitational, macrocosmic force, the electromagnetic force and the strong microcosmic force of increasing strength and speed of rotation as we diminish our size.

IV. RELATIVITY REVIS(IT)ED

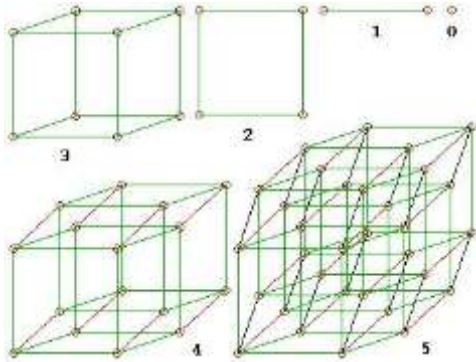

Multiple space dimensions, like the 5th dimension the artist fails to render in the hypercube do not exist in reality. Those objects are mathematical, linguistic fictions caused by the fact that any language of information is inflationary, as literary fictions are. The beauty of some mathematical theories, as the beauty of literature

obscure those self-evident facts.

19. Special Relativity: Time is not the 4th dimension of space.

Dimensions as motions of time and fixed space.

In the graph, dimensions are not only static forms of space but also dynamic time dimensions, which are created by the motions of time arrows since fixed space, according to the duality of the Galilean Paradox has always a degree of motion.

In fact we live in a membrane of light-space, whose energy /motion and dimensions are those of light quanta that constantly evolve, warp and produce virtual particles, while other particles dissolve in scalar big-bangs returning to the vacuum light-space.

Moreover in the Organic Universe dimensions are finite, reaching always a limit – either the limit of the membrane or ecosystem or the superorganism in which we measure.

Those dimensional distances in our light-membrane are given by the maximal distance/life span of light, which contrary to belief dissolves itself back into the gravitational space membrane after 10 billion years of fractal reproductions in the gravitational space-time quanta. In a diffeomorphic being, like a human being those dimensions grow till the limit of our space-time membrane, and so on. Thus, beyond the limits of a certain superorganism, there is a discontinuity from

microcosms into macrocosms, which can only be ‘bridged’ with transitional spaces.

In the case of physical space we talk of two membranes of space-time, the smallest of which is our Euclidean, 3-dimensional light-space and the bigger one, the non-Euclidean gravitational space,. And between both membranes there are ‘doors’ called black holes and ‘transformative’ forces, called weak forces which transform particles from one membrane into the other, and flows of energy and information that can transcend through a transitional spacetime known in Relativity as a ‘Rosen bridge’.

Dimensions are complex motions, interpreted according to the Galilean paradox (dual motion/form analysis), also as forms of static space, in the same manner you see a car ‘line’ in a night still picture or a ‘fixed wheel’ when it rotates too fast.

The partial application of Non-Euclidean Geometry by Einstein

Those clarifications are needed to consider some conceptual revisions to General Relativity regarding its meaning reach and limits due to its analysis of only a single space continuum and a single time arrow.

The result is only an approximation to reality, with some errors and deep insights, which works as long as we establish a conventional rod of spacetime measure – the postulate of c-speed as absolute – and deal with phenomena in a single spacetime continuum, either in the light-space studied by special relativity or the gravitational space studied by general relativity.

Indeed, what Einstein did was to apply a mathematical advance, the discovery of the 5th postulate of Non-Euclidean geometry to the understanding of gravitational space. Now that we have corrected the other 4 postulates, we can resolve and advance much further the Physics of spacetime into the new paradigm of a Universe made of scalar membranes, each one a network of non-Euclidean, fractal points, whose e-st-r parameters (universal constants of energy, information and reproduction) and exi actions (existential forces) define all the events and forms of reality.

Time and its natural language logic, is the first language of God, wider than mathematics. For that reason, Frege and Hilbert were able to derive the laws of mathematics from the laws of logic time, the 'true language of God. Albeit a dualist logic more complex than the simple, lineal logic of Aristotle that physicists use in its spatial study of time. So time is a deeper phenomenon that encompasses all the spaces that there were and will be transformed by 4 possible arrows of time; and what truly matters is to learn the logic rules that transform in each species, a fractal, vital space, from past to future, between birth and extinction, guided by one of those 4 main time arrows.

The restricted formula of time-change as motion of space.

In that sense, the image physicists have of reality is restricted by the concept of lineal time and a single arrow of entropy, which also limits the solution of physical questions and introduces errors as the cosmological big-bang or the evaporation of black holes, mentioned before.

Physicists have spatialized time, defined with a single dimension, as a parameter of changes in motions and space, $t=s/v$.

This limited study of only one type of change, however is often forgotten, creating conceptual errors, such as the fantasy of time travel (as they don't realize there are infinite clocks of time in the Universe and so all time travel is local, within a certain organism as in the processes of death.)

In fact, when physicists confront the phenomenon of time, they do so only from the perspective of spatial change, a very limited part of the entire realm of time=changes. And so both, Galilean relativity and Einsteinian relativity are theories about the motion and energy of space, its invariances and laws, not a theory about all types of Time-change as this work is. And when someone like Hawking affirms that time travel is possible because time-motion gets to zero in a black hole, he merely forget he is speaking about the time-motion defined in the previous formula, $t=s/v$ or its self-similar Einsteinian version not about the sum of the infinite time cycles of the Universe that remain unchanged.

The readers must be therefore aware of the limits of study of time *in any physical theory, from Galilean to Einsteinian Relativity*. Today, when Physicists talk about time they talk about is a parameter, t , which appeared first in an equation of speed, $V=s/t$, that Galileo found when studying translational change in space or 'spatial movement'. Furthermore, because that rate of change in space is considered infinitesimal, $V=ds/dt$, they talk about present changes in space, which Einstein defined with his concepts of 'present simultaneity'.

This was fully understood by painters, who started to paint simultaneous, present time, in a single bidimensional space, as the sum of fractal movements (Duchamp's staircase models and Picasso's cubist perspective), but surprisingly enough the people who grasped with more difficulty the concept of spatial, present simultaneous analysis of time, were the same physicists that had invented this model of time analysis.

Moreover, ever since physicists have denied there are many other ways in which time=change happens in the Universe, beyond the limited study of 'changes in speed' that Physics analyzes. This has been explained many, many times to Physicists, since Bergson and Poincare explained to Einstein and Minkowski that they were 'spatializing time', or rather analyzing how vacuum space changes in time, (so Poincare could establish with Topological analysis self-similar equations to those of relativity).

Yet there are many other things besides vacuum space that change in time. We humans change in time our morphology (not our speed). Evolution changes in time the form of many species. Time is thus a synonymous in most sciences of a change in form, in the in-form-ation of species. And this type of informative change is basically ignored by Physics. This shows a general misconception of the meaning of Time in Physics, which has been termed as 'simplistic and reductionist' by philosophers of science. Because indeed it is.

Time is philosophically defined as 'change' and divided in the study of 'translational change', which is carried out by Physics, and the study of 'morphological change'; which is carried out by Biology. In that regard, Galileo defined only a limited type of time-change,

translational change, with his equation, $V=s/t$. He 'spatialized Time' (Bergson), reducing Time to a single process of change, movement.

Special relativity: the study of the light-membrane.

On the other hand, special relativity studies changes in the motions of the light-space membrane, *departing from a rod of Measure – light speed – taken as a convention.*

Einstein chose a postulate without proof, the postulate of c-speed as absolute. Of the 3 elements in the definition of time-motion by physicists, $V=s/t$, he could have taken any of them as absolute, but he chose light-speed. This is merely a matter of choice, as if we want to make a metric space able to 'measure', we need a 'fixed rod' value, which Einstein chose to be c-speed. Again, we could consider light speed variable and fix instead the time cycles/frequencies of light (so red light with lesser frequency/form travels faster than violet light and finally dissolves into non-local gravitation without form, dying about 10 billion years after birth - which solves some key problems such as the expansion of intergalactic space). Yet since we humans have a biological brain that fixes all light rays and extract instead the 'color/form' information of light, the convention of C-speed establishes a rod to create metric spaces and reduce the fluctuations of topological, real spaces. So far, so good, but as we shall see this convention to achieve the measures of relativity becomes a much bigger error when c-speed limits are applied to the gravitational membrane, when they should be limited to its use in the galaxy of light, since it is a limit caused by the substance of the light-space membrane, light itself.

Ultimately a true theory of spacetime Relativity, the concept that matters in Einstein's work, means that speed is also relative to the scale we observe and c-speed limits only apply to vacuum space and other forms with higher information (since the general formula of speed in all systems is speed=energetic space/temporal information; so forms with higher information are slower, as they have to build in each translational step all its form across multiple planes of complexity). But Einstein still used a single 'continuum space-time', the abstract Cartesian plane, and was interested only as all practical physicists by

the creation of a 'metric space' in which instrumental measures were possible. He did not realize that time-space was discontinuous and at least structured into st-planes, the gravitational space of masses and gravitational forces that move faster than light and have a density of order inferior to 0 K (black holes, quarks, intergalactic dark energy, etc.) and the light-membrane limited to c-speed. This error was understandable, since we can only observe the light space that fills up with background radiation the entire galaxy and imprints gravitational space, 'forming' it into light. Hence in the galaxy indeed, light space imposes a c-limit of speed to all motions; but that is not the case when we go beyond light space into intergalactic gravitational space that experience shows to move up to 10 c speeds according to the natural decametric scales of the Universe.

Galilean Relativity: the error of Cartesian, continuum space.

The 2nd error of relativity, the continuity of spacetime is caused by a misunderstanding of the curved, geometrical nature of time and its dimensions, caused by the Cartesian plane of lineal time: To draw a clock-cycle of temporal information we need at least 2 dimensions, as morphology requires form, in-form-ation; and so lineal time with a single dimension cannot study it. Thus when Descartes and Galileo simplified time into one dimension, he eliminated the analysis of morphological change and information, the 2nd arrow of the Universe, from most disciplines of science.

All cycles have 2 directions or arrows to complete its form. In the Eastern world, those 2 arrows of relative past and future were the 2 sections of curved times cycles. So times are indeed, as Einstein thought, curved, to the point of closing themselves into causal cycles that return all beings to their origin, but they have 2 dimensions, height and rhythm. So it does space. Each local times 'curves the energy of space', creating fractal in-form-ation (masses and forces in physical, evolving information in biology, etc.). Since a cycle needs 2 directions to close into itself and create a form. Energy consists in an amorphous, relative surface of undifferentiated quanta, a plane without form, which the creation of time cycles shapes into information and makes it recognizable, thanks to its 2 dimensions. Both geometries, cycles of

time and planes space, are bidimensional. When both systems merge, the sum of fractal, bidimensional fields of time and energy, create only one more, 3rd intersecting dimension of combined time-space, *width*, which has a rhythm of temporal movement, the 4th dimension of time=change that we observe as *reality*.

The error of Descartes and Galileo, which simplified cyclical time into a single-dimensional line, had as a first consequence the reduction of time in human sciences to a lineal duration, measured with a scalar number, similar to the way we measure space. It is what philosophers of science call the ‘spatialization of time’. Now spatial time becomes a secondary parameter to calculate spatial and energetic motions and processes – not an objective of knowledge in itself. Accordingly, Galileo defined time as a measure of ‘translational, spatial change’, of movement in lineal space or speed ($V=S/T$), simplifying time into a lineal number, defined in terms of movement and space.

Light and dark energy Interaction: gravitational space warping.

Physicists study only the arrow of time=change in the motion of beings ($t=v/s$), which is by tautology a function of space. Thus, Philosophers talk of the spatialization of time, which is made dependant of energy and movement. Einstein was perhaps the only physicist aware of this error when he said ‘I seem to be the only person that believes there are many times with different rhythms’. So when his followers say that time is the 4th dimension of space, he did not agree; but he pointed out that even in Relativity Time has an inverse, negative sign, so its properties must be opposite to those of space. But physicists ignored his dictum: ‘we cannot send wire messages to the past’, he insisted. And when Meyerson, the French philosopher of time published a rebuttal of Minkowski’s reductionist theory of time as the 4th dimension of space, *‘La deduction Relativiste’*, 1928, and he could express his ideas without the enormous peer pressure, usual in this profession of fundamentalist scientists, he praised it as one of the most remarkable books written about the relativity theory from the standpoint of epistemology (the scientific method) and explicitly agreed with its rejection of the spatial interpretation of a world-line of Minkowski.

Time motion in Relativity has a negative sign, since it refers to the implosive arrow of information that contracts space, NOT to the expansive arrow of spatial energy and entropy. Time in General Relativity is the factor that warps energy into information, evolves form, trans/forming the energy of gravitational space into the frequency of form of light-space. Time in special relativity warps the energy of the vacuum, as light imprints its form. Thus Time is $-t^2$ in the equation of Special Relativity:

$$s^2 = x^2 + y^2 + z^2 - c^2 t^2$$

Space is positive and time is negative because it forms, contracts space into a wave-frequency that carries information.

Yet the why of that warping of the gravitational membrane by light-information could not be understood by Einstein since it required fractal, Non-Euclidean models of discontinuous space-time to describe how form evolves. So Physicists ignored the informative effect that warps energy into form.

Einsteinian relativity inherits the error of spatial time.

Let us study that conclusion in more detail. This tendency increased further when Einstein used the same concept of translational, spatial change to define time. In that respect, it is popular to talk of time as ‘the 4 dimension of space’ in Relativity.

This is a misconception of Einstein’s equations, which do not include all time=changes, as the 4th dimension of reality, but only spatial change, moving space, what Galileo defined as $S=vt$.

In Einstein’s formalism moving space writes as ct , since Einstein studies phenomena that happens as the speed of light; so vt becomes ct (where c is light speed).

Thus $s=ct$, the 4th dimension of Special Relativity, is not time but ‘moving space’, defined as the product of translational change=lineal time-duration, t , and light speed, c . And so there is no philosophical advance respect to Galilean Relativity that already defined time as a change/dimension of moving space.

Yet this capacity of time to measure change in space is only a fraction of the properties and modes of change that time measures in the Universe, and reveals nothing about the frequency and form of physical time cycles.

Though Einstein latter, in his General Relativity went deeper and discovered that Time is a curved clock geometry, which in the Universe bends space into masses, in his initial work, 'Special Relativity' he was still a classic physicist who declared as Galileo did that 'time is what a clock measures' and so he still used the Galilean, lineal concept of time-speed, $v=s/t$, to define it.

However, Einstein never said that time is 'only' a dimension of space as lesser physicists say today routinely. This reductionist, 'spatial concept' of time was provided by Minkowski and Einstein opposed to it, saying 'that time behave differently since wires didn't travel to the past'.

Time is causal, defined by time arrows which are not symmetric; that is left and right are equal but motion to the past (informative flow that devolves into energy) and motion to the future (energy flow that evolves into information) have different properties. This is known in the wording of classic physics as the 'breaking of symmetry' in processes that involve time evolution (those mediated by the weak force), or 'chirality' in other systems of physics and chemistry.

Yet the simplification of Minkowski became popular among physicists, as it allowed to keep Galileo's tradition of studying time as a lineal parameter dependant of speed ($V=s/t$).

In that sense, though this work is conceptual to facilitate its comprehension to a wider audience and so we have reduced equations to a minimum, it is worth to consider that spatial vision of time in Special Relativity in more detail, given the simplicity of its mathematical equations.

Think first of two dimensions, the surface of a sheet of paper, for example, of length x and width y . The shortest distance s between two opposite corners is given by Pythagoras' theorem: $s^2 = x^2 + y^2$. If we now go to three dimensions, the shortest distance between two

opposite corners of your room, for example, one on the floor and the other in the opposite corner on the ceiling, where the room is x long, y wide and z high, is given by: $s^2 = x^2 + y^2 + z^2$. So what happens if we go to four dimensions, trying to include 'lineal time' and 'moving space' and measure the space-time interval between two camera flashes, for example, one happening at one corner of your room and the other happening at the opposite corner but a few seconds, t , later?

We might think, if we follow the concept that time is just another dimension of space that the answer would be: $s^2 = x^2 + y^2 + z^2 + t^2$, but we would be wrong:

- First, cycles of temporal information, as we have seen, are inverted to spatial energy, so the term t^2 must be negative.

- Second, time is not space, and we are measuring space.

We are just adding now a time-related term of moving space or speed – Galileo's formula – to our measure; we are not adding pure time but moving space, so to be able to add apples=spaces and pears=time we have to convert time into moving space and we do so with Galileo's equation $v=s/t$, hence $s=vt$, which means we ad, $s=vt$. Now, the big question arises: what kind of moving space we are measuring?

Or in other terms, what is V ; the speed of the space we are measuring? The answer of Einstein was 'light', since the velocity of light was found to be equal in all systems, regardless of the speed of the observer, light was a kind of space-time itself, uninfluenced by the movement of the relative points we were measuring.

So Einstein added a corrective factor of measure or 4th coordinate of space, related to the translational speed of the light-space between the 2 relative points we were measuring. Light-space, the space our eyes see, is made of light, a quantum of energy. Space is not static but, as the impressionist painters thought, we see light-space and so we have to add a parameter to correct for the movement of that light space to make accurate measures: $s=vt=ct$, moving light space. It is not pure time, cyclical time or frequency or lineal time or duration.

Thus, it is absurd to say that time is the 4th dimension of space. What we should say is that light-space has movement, $s=ct$, a parameter to add in any measure of translation, in a Universe of moving spatial energies. And the relativity equation adds those underlying moving flows of spatial energy and speed: $s^2 = x^2 + y^2 + z^2 - c^2t^2$, which gives us the space-time separation, s , between two points of any space-time subject to motion. Finally, rather than measuring the distance across an extended interval of space-time, it is important to deal only with the separation of adjacent events separated by an infinitesimal change in the coordinates, dx , dy , dz , dt .

So the correct expression of the infinitesimal separation of 2 adjacent events is now: $ds^2 = dx^2 + dy^2 + dz^2 - c^2dt^2$. This is called the metric of flat space-time. If we want to include 'curved' space-time then we put a coefficient, not equal to one, in front of each term, dx^2 etc., which bends the specific coordinates. This allows the possibility that a trajectory in space-time might be 'curved', which was the big discovery of Einstein, by creating many adjacent points and joining them in all types of trajectories in space-time, as those you trace in your daily life.

In order to find out the separation between two events you have to add up, or integrate all the infinitesimal ds intervals along the light path. And then it is when things can get as complex mathematically as you want, allowing you better measures of the shapes and movements of the Universe.

This is all what there is to it: an improvement on Galileo's study of translational space. Yet in that equation time is not a 4th dimension of space, but a measure of the speeds of the space-time background. The 2 important discoveries of that equation are the curved nature of space-time; and the use of c instead of v as the speed of that spatial background. Einstein realized that the wobbling of space could be incorporated adding ct as a parameter of translational change, which he did. But he did not add time as a 4th dimension but the moving properties of the fractal space-time or light-space on which our electromagnetic world builds itself.

Informative contraction: light imprints gravitational space.

Einstein later adapted Galileo's formula to a fluctuating space-time background adding the impulsive, $-ct$, arrow of gravitation to all translational movements. Thus he realized that Time in Physics also has a component of morphological change, as time warps energy into information, not only in evolutionary processes, but also warps the energy of vacuum into informative masses.

And this is in fact the most important finding of the previous formula, which becomes crystal clear when we consider a 'standard' plane of two arrows of time, energy and information, which is represented by negative, imaginary numbers.

Thus what the negative symbol behind the 'square' of time, easily reduced to an i number really means is that the imprinting or reproduction of the light wave over the gravitational space in which imprints its information provokes a contraction of form, proportional to the informative time cycle and reproductive speed of the wave of light, according to the general laws of Multiple Spaces-Times, in a phenomena comparable to the dragging of any motion over an opposite flow. Since indeed, what light does from its p.o.v. is to feed on an opposite flow of gravitational forces where it reproduces itself, and in doing so it obviously suffers a drag, like the recoil of shooting a gun or the slowing speed of a plane dragging energy from air through its wings

Absolute Relativity: c is not the limit of speed of the Universe.

It is yet another proof of the scalar structure of the Universe, as electrons which emit light first 'connect' through the gravitational non-local plane (giving birth to the entanglement process) and when they are locked they emit a flow of light. A fact which also explains the Postulate of absolute speed of light as a 'local effect', NOT an universal law; since electrons only emit light when they are locked, and we can only observe light when our instruments lock with the emitter and so there is no a sum of speeds as Michelson thought (though there are several ways to measure this, and so Relativity is right as a system of measure but wrong as a philosophy of time-space). This postulate is further proved wrong by the fact that the diffeomorphic principle of relativity establishes a relativity of space

and time, but speed= $v=s/t$ is a parameter of space and time; hence the limits of speed are relative according to the scales we study; which means C is only the limit of the light-space membrane in which we inhabit but not the limit of gravitation that is the force of the other membrane of the Universe.

Those conceptual clarifications born of a model of multiple space-time membranes and time cycles were not available when Relativity was deduced in mathematical terms, and so new errors in the conception of time appeared soon. Minkowski first thought that time was the '4th dimension of space'. Then, because of the mentioned error of a single arrow of time for the entire Universe, Physicists thought that when they measure NOT the change in translational time of the formula of speed, $v=s/t$, but all the time of the Universe and time travel was possible. Yet when time appears with a negative term, it doesn't mean, as people like Minkowski or recently Hawking think, that time is traveling to the past. Such patent nonsense comes out of the generalization of the parameter $t=s/v$, the equation which defines time in physics (or $-ct$ in Einstein's improved formula), to the entire range of time=changes of reality, including morphological time-change.

Special Relativity uses time, as a t parameter of space and speed as physicists always do, in this case to measure moving spatial energy - the flows of gravitational and electromagnetic space-time that act as the scaffolding of the world we inhabit. The fact that a century later most physicists still think that all what matters about time is its use as a parameter of translational change, $s=ct$, shows how much time has been degraded and distorted in modern science due to its lineal simplification in Galilean Physics and Cartesian geometries by the concept that there is only one arrow of time for all the cycles of the Universe, which is 'what a clock measures' (Einstein, Galileo).

The concept of a fractal point and the relativity of space and time and its parameter of speed, only absolute within the limits of a certain spacetime brane, has 2 immediate formal generalizations:

'The maximal speed of a space-time membrane corresponds to the limit of speed of its more extended, less formal spatial substance, such as $\forall exi=k_i \rightarrow \max. c = c (\max. e \times \min i).$ '

In other words, because we live in the light membrane, the limit of speed is c. If we were in the gravitational world, the limit of speed will be that of Gravitational forces $> c$; if we consider from the relative point of view of our size, the world of life beings, the limit of speed is that of the cheetah and so on.

The second, deeper consequence of absolute relativity and the difference between space displacements and temporal displacement is even more radical: because measure is relative to the point of view of the observer, the Universe is not a metric space but a topological space, in which distance and speed are absolutely relative and do not change the type of reality we describe. This again solves many questions of physics and we shall return to it, when analysing in more detail black holes as a 'sample case' of the applications of Multiple Spaces-Times to cosmology.

Fantaphysics: bizarre theories based in a single time arrow.

Today, because of that erroneous sentence, 'time is the 4th dimension of space', an entire bizarre world of 'manifolds' with multiple 'spatial, fixed dimensions' developed as a 'serious' branch of physics, whose authors believe religiously, and a series of theories of a Universe with only entropy (evaporating black holes; Universal big-bang, etc.) have become the foundations of astrophysics despite their theoretical fantasy and increasing contradiction with experimental evidence. Those physical theories use the limited definition of time to create imaginary worlds of mathematical thought as irrelevant to our understanding of the cosmos as the fictional, idealistic characters of Quixote, despite the linguistic beauty of the wor(1)ds of Cervantes, or the beauty of hyper-cubes, which have nothing to do with reality.

Recap: Time is not the 4th dimension of space, a misleading definition, caused by 2 errors in our conception of space-time and dimensionality:

- The error of a lineal, ∞ space-time misunderstands the cyclical and hence finite nature of the dimensions of all space-time cycles, reduced to the limits of the cycle. Since space/time has a fractal structure whose dimensions are not all in the same continuum space-time; but evolve across several scales that transfer between them energy and information under self-similar laws described with i-logic geometry. Yet each 'relative plane of space-time' or scale of reality, acts in many ways independently from the others.

- Galilean Paradox. What we perceive as quiet space (i.e., a moving time cycle) is in perpetual movement. The Galilean Paradox is an error of perception that hides the dual nature of any growing, real dimension, both as a movement in time that becomes a fixed form of space. Since the subjective mind tends to fix 'time movements' into space objects.

In Relativity, the misunderstanding of the Galilean Paradox - a perceptive error that makes moving cycles seem static dimensions of space - has caused a conceptual error: its interpretation of time as the 4th dimension of space. The Galileo Paradox converts dynamic time processes of change into static, spatial distances, hiding the dual nature of dimensions that are both, a movement in time and a fixed form of space. Since the subjective mind tends to fix 'time movements' into spatial objects. Yet since space is a motion and light flows over the inverse motion of gravitational space, the key factor of the Special equations of Relativity shows light contracting by $(cti)^2$, as it flows against the simpler gravitational spacetime, which causes a drag calculated by the metric space of special Relativity.

20. General Relativity studies the space-time ages of the cosmos.

In a wider analysis, if we were to consider a single clock-time for the entire Universe (by adopting the hypothetical rhythm of the Universal superorganism and its 3 ages between its big-bang birth and big crunch warping) vacuum space will appear as 'a slice of reality' or 'dharma of present' that times constantly move from past to future according to the logic of time arrows, till it will warp it into a big-crunch.

And that evolving form of universal space and its 3 ages of a big-bang birth, a steady longer state and a final big-crunch, which correspond to the 3 solutions to Einstein's spacetime equations, are what General Relativity studies. But those equations are just a particular case of the wider '3 ages' of any organic space-time studied with the 3 elements of the Generator Equation, $E \Leftrightarrow I$.

Yet classic Physics studies only geometrical, translational time, but not the evolving and devolving morphologic changes studied in biology, except in the 3 solutions to the equations of Einstein, since they take the entire Universe (or rather a galactic space) as an organism. For that reason temporal change in Physics means merely a geometrical change of direction as when we move backwards a clock

in space or we move backwards a particle that becomes an antiparticle - "but we don't evolve or devolve the entire Universe as Hawking thinks nor we move towards the Absolute past or the future when we change the clock's needle position in space. You might argue that for the clock's own definition of time, geometrical change and temporal change are the same and this thesis is worth to explore as we shall do latter, since it is indeed rather accurate to consider that for each space-time field a morphological change of information is a temporal change, given the relationship between both. So if we could change the warping, informative morphology of our face and straight it up, filling it with biological, energetic cellular space we could become younger, but the Universe will continue its infinite fractal clock rhythms independent of our form. This is self-evident and Einstein already explained it to Minkowski a century ago, when he vehemently protested with the use of the sentence 'time is the 4th dimension of space'; because 'time behaved 'somewhat' in a very different form to space' and the Universe is made of multiple times.

Still Physicists who have had always since Galileo a strong desire to become Metaphysicists chose to ignore the admonitions of Einstein and have developed a 'metaphysics of space with its multiple dimensions' that we need to clarify before going further into our analysis of cosmological time. This work is harsh with such concepts and the physicists that keep sponsoring them, because the concept of spatializing time is erroneous and prevents the advance of Time knowledge. It translates into 3 false dogmas: a single arrow of time called entropy that ignores the informative arrow of gravity in many of its analysis of the Universe; a space-time continuum that ignores the fact that we are not placed into an abstract frame of reference, but we are made of fractal space=vital energy and time cycles; and the use of a single spatial, geometrical lineage, mathematics to explain it all, that ignores often the fundamental language of time, causal logic, expressed better with verbal thought.

Under such a dictatorship of Physics, for long logic and bio-logic, verbal sciences like Evolution or social sciences, which study long range changes in biological and human species, have been considered lesser sciences. It is said that Gell-Mann lobbied with the Nobel

institution to prevent economics from becoming a Nobel Prize with this sentence, ‘what is next, anthropology?’ And he only calmed down when he was said that mathematical economics was to be the focus of the prize. It is also said that Feynman to quote the other great physicist of the post-war era asked their students never consider the ‘why’ of physical events, a conceptual, logic question but only the descriptive how that mathematics could achieve.

For that reason, it should not surprise us that verbal concepts such as past, present and future, the 3 dimensions of ‘bio-logic time’, totally escape them, as a clock measures time in digital numbers not in relative, ‘morphological, d=evolving ages’, which is what past, present and future study. Instead they use the limited $t=s/v$ parameter, as *if it were the parameter of all time changes*. This is absurd. When I get old is not because I change my speed in space, but because my body suffers morphological changes study in biology. Time in Physics is ‘spatial, translational, geometrical change’. Within that limited scope, as a ‘parameter of change in space’ physical studies on time are relevant. All other generalizations of time by ‘Meta-Physicists are ‘science-fiction’ of which modern Physics is full of examples.

Those errors show even today, when Einstein established the geometrical, cyclical nature of time, as ‘physical clocks’ that bend energy into mass, in the use of lineal, infinite, absolute time by all other physical theories. Such limited definition of time in modern science as a lineal number or duration, instead of a frequency of cyclical form, of in-form-ation, is the biggest handicap to a proper understanding of Reality, given the fact that Time is one of the 2 fundamental Universal parameters. Yet time as a lineal duration becomes a secondary variable, which carries as any line does, very limited information. So scientists focus in the study of a single parameter, or arrow of the Universe – the entropic arrow of expanding space or energy - and fail to recognize the second arrow – the patterns, frequencies and repetitions caused by the *cyclical inertia* of time events that tend to store and repeat information in a discontinuous, cyclical manner. The result is an unneeded complexity, a plethora of errors and ill definitions and the belief that the Universe is chaotic, since the variable that creates order and information – *time* – is so

poorly understood. To explain that order we describe the Universe without simplifying its 2 original parameters, analyzing the interaction between the energy of space and the formal frequencies of time, and how they shape together the species of that Universe. Nevertheless, the task is daunting because science has worked with a single arrow of lineal energy or entropy for 4 centuries. So there is an enormous resistance to accept a 2nd arrow of information and *define time* in complex terms, as the parameter that causes *morphological, informative change*. This aberration is recent in the history of knowledge. Prior to Galileo, all philosophers understood time as synonymous of *all kind of cyclical changes, not only physical translation*. Further on, all pre-Galilean cultures defined time intuitively in cyclical terms, as a form with a frequency. Physicists only study a type of time-change, translational change in space. Thus, when they talk of time as the 4th dimension of space they are merely talking of a very small part of time phenomena, the measure of movement in space, with time clocks. Only within those restricted parameters of Galilean physics, time is indeed a dimension of spatial movement. What is moving in that space/time background? And how that movement can be introduced in the simplified, mathematical static models of time and space, proper of the Cartesian plane that scientists use to describe the Universe? Both questions are related to the concept of moving dimensions of space-time, which now substitute the simplified, static concept of fixed space-dimensions. What is an act of arrogance and ignorance is to consider that the most important feature of time is to be a parameter of movement in space. So what matters about time is to be in all sciences the parameter of change, through is 3 dimensions, past, present and future.

Recap. Time travel in physics is a geometry change as when we move a cycle of time backwards, but it does not affect the overall time of the Universe. Morphological Time studied by evolution and the ages of time events composed of energy and information are only studied in physics with the 3 ages/solutions to the equations of Einstein

V. 2 WORLD MEMBRANES IN A SINGLE UNIVERSE.

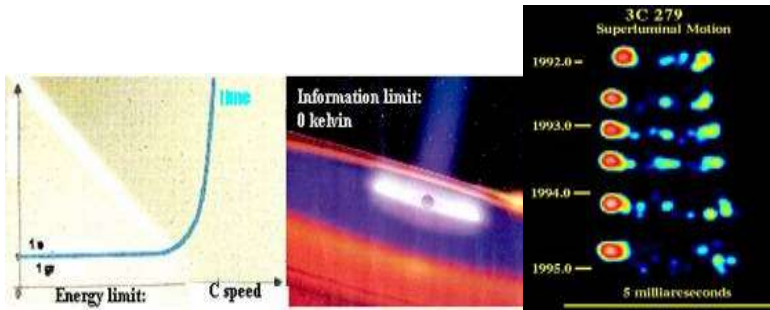

The 2 membranes of space-time, the quantum and gravitational membrane interact in $e \leftrightarrow i$ events of transference of energy and information in the limits of the existential function of the light membrane: the limit of energy-speed, c ; the limits of temperature-form, $0 k$, in quarks, black holes and regions of transition between light and gravitational space.

21. Relativistic mass. Interactions at C-speed.

Galactic space is made of light actions, $h=e\cdot i$, which can be perceived as energy/motion (c -speed) of in/form/ation (photons): the background radiation is thus the primary substance of the vacuum. If we were to extract all the radiation actions, the vacuum would disappear and the underlying scale of pure gravitational, 'bosonic, tachyon strings', infinitely thin (Nambu's Actions, redefined as a background independent action of fractal dimensions) would appear. This would paradoxically thin out the informative height of vacuum and elongate it, as its relative speed=spatial energy/temporal information, $v=e/i=e/0$ is infinite, non-local from our p.o.v. This is what happens in intergalactic space, as the door between both membranes, the galactic, rotational Kerr black hole, thin outs electromagnetic radiation, (gravitational redshift) through the event horizon, accelerates it (equivalence principle, left graph) in its reproductive, 'Klein' intermediate space, and jettisons it as curled quark mass (left graph of superluminal $10 c$ motion) and dark, tachyon energy (central pic, blue jet), back to intergalactic space that seems to expand, accelerate from the p.o.v. of fixed distances.

Those 2 space-times create 2 different world membranes or mediums, with different energy/information limits:

The gravitational world is beyond c speed and under $0 K$; that is it has more order in its quark vortices and more speed in its dark energy; it is bigger, more powerful. In between there is our hot, entropic, $< c$ -speed world

The transitions between both membranes are described by the Lorentz Transformations (left graph):

When energy arrives to the limit c of the light space-time, its membrane 'curls' the energy into a whirl of space-time, evolving into cyclical mass, the stable form of physical in/form/ation, becoming electrons and quark particles.

Further increases of relativistic energy=mass evolves quarks into forms of higher mass and reproduces them into pairs.

What happens when you accelerate to c speed is a discontinuous process of 'evolution' (from 'ud' to s, in the first step, and so on); and then a process of fission/reproduction. So energy not only evolves the particle but it splits it into 2, as when quarks absorb energy and produce a jet of 'quarkitos': $E \rightarrow I(m) \rightarrow Re(m+m)$.

While on the other extreme, black holes relax light into gravitational strings. So most of the 'particles' and dynamic events we perceive in the Universe are phase transitions between both membranes; reason why physicists say that particles are 'frozen states' of the parameters of temperature and speed through which a hypothetical big-bang of our galaxies or Universe evolved.

Thus the particles and forces we perceive in the Universe are born in the verge between both worlds. Light is in the energy verge between both worlds. Electrons are in its lower energy state, the Bohr radius, as we have shown, in the verge of the quark world, acting as the event horizon of a micro-black hole - a proton.

The non-local speed of gravitation.

But how can we prove that gravitation is non-local, instantaneous, and able to relate all the parts of the Universe in a synchronic way?

There is the evidence of 10 C jets of matter coming out of black holes. Indeed, the non-local speed of gravitation can be proved in several ways, but perhaps the easiest way to prove it is with the concept of complex speed...

The simplest one is the definition of speed, $v=s/t$ understood as:
 $V=$ *Spatial Energy Temporal/Information.*

Because gravitational force has no information (it is the simplest, lineal scaffolding in which our light-form is imprinted), then:

Gravitational speed =energy/0 Information=Infinite.

But it is a relative ∞ , since Cantor Set theory proves that ∞ are relative and the absolute infinite (the set of all sets) do not exist. By this we mean that the informative network of dark, gravitational energy that structures the Universe is like the nervous network that send simultaneous orders to all the cells of the body and seems instantaneous to all those cells, infinite only in as much as it reaches the limits of our Universe, cell of a hyper-universe in a reality of ∞ scales.

This is proved, since a fractal wave of gravitation can reach according to General Relativity up to 10^{10} million years light. Thus a single gravitational wave can cross in a single fractal jump, the entire Universe. And indeed, the ‘instantaneous, present space-time Universe’ reaches till around 10^{10} million years light, the so-called Universal horizon. This explains also 2 ‘spooky’ phenomena: the entanglement between electrons that seem to relate and communicate information at distance instantaneously: they do so through the gravitational, non-local plane. It explains why the limit of c-speed, which only applies to our light-membrane. It also explains how the Universe has a synchronic structure without recurring to the magic, entropy only ‘big-bang’ (astrophysicists say that their structure that requires all those galaxies to interact together was acquired when the Universe was so small that they could communicate at c-speed.)

Recap: the limits of our light universe are c-speed and 0 K of information but the gravitational universe should be faster, bigger and more ordered,

colder than our Universe. Lorentz Transformations and black holes are the doors and bridges between both Universes.

22. Forces & particles of the 2 universal membranes

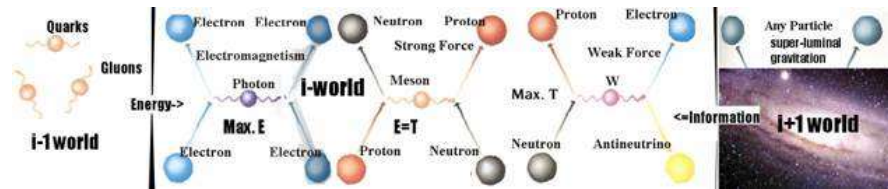

In the graph, the Universe is made of 2 space-time membranes, the light world of charges and stars and the string world of quark masses and black holes. We live in the electromagnetic scales, which form a network whose dark spaces are occupied by quarks (st-1 inner world of atoms), and in the biggest eusocial structures we know of electromagnetic matter (st+1 galaxies) by black holes, whose parameters correspond to top quark condensates. The basic forces that create distance-space and information between them are bosonic strings of gravitation condensated into gluons and strong forces in the quark-mass membrane and Planck actions of light, condensated into photons in the electromagnetic scale. Those gluons and photons herd further into cyclical particles made of such fractal parts, associated into cyclical networks, called quarks and electrons. Self-similar structures form the nebulae of stars called galaxies, and the condensated of quarks called black holes. The only error of such standard model, reflected in the previous graph is the weak force which is not a spatial force but describe time events of transformation of particles between both scales.

In the graph, the 2 membranes of space-time have 2 theories that must be put together to explain the dual Universe:

- Quantum theory that describes the electromagnetic membrane, not the cosmological world. Both are self-similar (as we have shown with the equation of fractal unification), but not equal. Thus, while we can admire that self-similarity, the use by quantum cosmologists of quantum equations to describe the cosmological world is erroneous.

- Relativity, the theory of gravitational forces and black holes, which

are super fluid quark stars. And so it should be fused with the theory of strong forces and quark masses.

Since each of those scales has also a fractal structure, we have to define its fractal quanta:

-Masses are vortices that grow from string actions (Nambu's actions of bosonic, tachyon strings corrected to fractal dimensions and background independent.) Those motions reproduce and evolve into gluons, which are the fractals that evolve into quarks, vortices that are the fractal parts of quark stars.

Since our electrons surround those quarks, locking them inside charges must be fractal vortices with a larger number of dimensions than those bidimensional masses. So 3 bidimensional quarks of $3 \times 1/3^{\text{rd}} = 1$ charge must lock their mass in the x,y,z planes to enter in a 3-dimensional exchange of energy and information with the electrons of our light-space. So quark masses attract electrons with their gravitational force inwards, and electrons shield themselves with their electromagnetic force outwards. The balance of that tug of war is a complementary atom.

In that regard the entanglement of both membranes is dynamic and based in the network structure of non-Euclidean spaces in which its points are connected by 'lines of communications' which are waves of smaller particles; leaving in between dark spaces which allow the other membrane to entangle itself; as it happens with the blood/reproductive and nervous/informative network of a human vital space. In the case of the 2 membranes of space-time the membrane of dark energy/matter (gravitational membrane) plays the role of the nervous/informative network that connects the blood/electromagnetic network.

We talk of 2 space-time networks, defined by 2 spatial forces - lineal strings of gravitation and lineal waves of light - and 2 clock-vortices of time: gravitational masses and electronic charges.

The emergence of those st-1 worlds into the st+1 scale of galactic entities (where we are the st-relative intermediate scale sandwiched between both) is caused by the eusocial evolution of enormous quantities of those fractal units: vortices of quarks made of 'strong'

forces, whose fractal particles are gluons, gather together as fractal parts of quark stars, pulsars and black holes.

While our world - the light space we inhabit - is sandwiched between quarks and galaxies

Its smallest actions are h-Planck constants, which are the fractal parts that form light photons, which are the fractal parts gathered into an electron nebulae, the basic clock of time of our world, whose plasma herds (ionized state), associated with complementary protons creates the world stars. Finally vortices of star herds form galaxies, which turn around their Kerr black holes, and so are self-similar st+1 objects of the st-1 atoms positioned in space by the gravitational force of the central quarks.

Thus, the invariance of topological form and scale of all those vortices that makes macrocosms emerge from microcosms is caused by the complementary structure of its central mass vortices that anchor the electronic and star energy of our light membrane:

Quarks anchor atoms and black holes anchor galaxies.

Recap. Our space-time is made of h-quanta of light. We exist as evolved forms of a light space-time network anchored by the nuclei of atoms, made of quanta of strong forces, called gluons and quarks belonging to the gravitational space-time membrane.

23. Some precisions on the formalisms of both membranes.

A quanta, which is interpreted as an abstract, probabilistic number in quantum theory is a fractal piece of space-time, a complementary system made of bites of spatial-energy and bytes of temporal-information. This is self-evident even in quantum theory, where Planck defined those quanta as actions with the dimension of energy and time. The Universe is indeed made of actions of energy and time, as when we say 'I don't have more energy or time to do this'. We are not solid spatial forms, a Maya of the senses, so common among 'naïve realist' physicists, accustomed to touch the solid metal of their machines, but we exist in a spiritual Universe made of actions of energy and time, which occupy a vital space and have a time rhythm. And each of the self-similar fractal worlds/membranes of the Universe

has a minimal unit or fractal quanta, a type of st- point with a different volume of energy and information that defines the space-time membrane.

We exist in the space-time membrane of light made of h-quanta. And its formalism, later studied in more detail is well-known to physicists (quantum physics), and requires some modifications on its interpretation to adapt it to the wider concept of fractal spaces and cyclical times (Correspondence principle). But there is another space-time membrane of gravitational quanta, whose formalism requires more changes, since being an invisible membrane, we humans cannot use easily the experimental method to study them, especially when considering the st-1 quanta so small, in the Planck length scale that there is no way we can observe and prove our models. So we are left only with proper formalisms of its macrocosmic entities and effects, which Einstein described with general relativity.

As of two day two formalism, which require further corrections are useful to that aim: the formalism of bosonic, tachyon strings defined by Nambu's actions, adapted to a background independent world (they are the actions that create the membrane, not actions that float in an abstract metric coordinates), and the use of fractal dimensions and non-Euclidean geometries, unknown to physics.

Another interesting formalism, which can be used to describe the gravitational minimal units is the one elaborated by Nottale, whose unit is λ , lambda, also called the cosmological constant. In scale relativity, Nottale defined this constant as $\Lambda = 1/L^2$, the minimal unit of the gravitational Universal membrane, where L is the minimal length of that membrane, the smallest piece of space. It is essentially a string, but string theory must overcome the error of Newtonian Absolute Space to become useful to describe the gravitational scale, as its minimal unit 'independent of the abstract background of membrane space-time'.

Such formalism which borrows from the work of those 2 pioneers is part of the more complex 'courses' of Multiple Spaces-Times, beyond the scope of this introductory lectures.

The other formalism that is not completed is the formalism of weak forces, since Physicists unaware of the temporal nature of those events have tried unsuccessfully to describe it with the same spatial exchange of particles (Higgs mechanism) when weak forces are temporal events, and the W and Z particles brief states in the process of transformation of particles of our electromagnetic membrane into masses of the gravitational membrane. Reason why those forces break the symmetry – as time is not symmetric but hierarchic and why the Higgs has not been found and will never be found – it is a particle only needed if it was a weak force.

Unfortunately we cannot perceive the lambda scale of strings. But, essentially with those 2 membranes the strong gravitational world and the electromagnetic world and its 3 ±st scales, we can explain all the physical properties, events and entities of reality.

Recap. The formalism of the light-membrane is described by quantum physics and it is correct, except for the errors in the description of the temporal, weak force. The formalism of the gravitational membrane departs from its minimal unit, the bosonic, tachyon string, which must be adapted to a background independent gravitational membrane of which it is its minimal action and the fractal, finite nature of dimensions.

24. The 3 scales of the 2 membranes.

Why there are 3 main scales of social evolution in both membranes? The trivial answer is that we are always sandwiched between a lower and upper scale and so we always perceive 3 even if the number of scales might be infinite.

And so from the human p.o.v. any entity or system of energy and information stretches in 3 scales.

For example, your organism is basically a fractal of biological energy and information extended in 3 scales, cells, individuals and societies, of which you are a relative cell.

In the physical, fractal, Non-Euclidean structures of the 2 membranes of space-time, there are also 3 basic scalar structures:

A complementary atom extends on both membranes. In each of those membranes, quanta evolve and form social groups, emerging into a

new topology, a higher scale of energy and form:

-The scale of h-quanta form light and electronic systems, made of dense photons and electronic nebulae.

- While its inner gravitational world of quarks can be decomposed in 3 scales: The lambda scale of ‘strings’ are the components of gluons, which are the components of quarks.

Emergence of parts into wholes of a higher scale is possible due to the other 2 invariances/dualities of physical systems: invariance of topological form and motion allows invariance of scale.

What about the cosmological world? Again we must consider that cosmological systems have 3 scales, the scale of particles, (quarks, electrons and atoms), which are the units of cosmological bodies, black holes, quark stars and electronic stars, which are the atoms of galaxies. Those 3 scales thus interact in all the organic networks of galaxies.

There might be another scale, the Universe, where galaxies are atoms of the Universe (and the Einstein-Walker model of cosmology treats them in fact as Hydrogen atoms); which would itself be a unit of a hyper-universe, whose ‘explosion’ at an even faster ‘infinite speed’ that dark energy, would explain the ‘inflationary age’ of the big-bang. But there is little evidence of this final scale today, and an enormous number of Pythagorean and hyperbolic errors in the formulations of the cosmological big-bang *in a single space-time continuum* to take serious that theory.

Recap. All what we can be sure of, is what we can perceive – the limits of our existence, sandwiched between atoms and islands-universes, the original name Kant gave to galaxies.

25. Dimensions of particles and Universal membranes.

In that sense, to fully grasp the difference between both worlds, the dark and light world, we must understand the basic laws of fractal dimensions. Dimensions are in any system of the Universe, as in the case of light, arrows of time (motions of energy, information and reproduction), perceived according to the Paradox of Galileo also as

‘spatial surfaces. Thus, they are always local, fractal dimensions which are limited by the extension of the ‘species’ in which those dimensions create a ‘vital space’. So dimensions are dynamic as the species they create grows or shrinks, evolves into more complex beings or becomes destroyed. Entities grow in dimensions as they grow in size.

Further on, more complex informative species and dimensions.

This happens normally when a form is bigger and has inner particles. But in the case of quarks it happens, because the quark is faster and has more inner speed/form.

All in all, the total number of dimensions of a system is relative to our detail of analysis. For example, those quarks are made of one-dimensional strings, made of non-Euclidean points (each one with its 3 inner dimensions), which have a total of 3×3 dimensions (3 of their Non-Euclidean points and 3 of the string of points). That is why physicists in detail use 9+1 time dimension to study strings, but from our perspective without detail, they are just one-dimensional lines of a quark vortex.

Yet if we transcend to the world of quarks we consider them 1-dimensional. So those strings form gluons and quarks, which from our higher world are perceived as bidimensional mass-vortices.

Finally 3 color-locked quarks interact with the world of light of 3 dimensions, and the world of electrons of 4 dimensions, which are the 3 dimensions of Euclidean space and one of form, of color.

On the other hand, the biggest entities have more dimensions, as they include the smaller entities within its whole. It is the law of fractal dimensionality. It states that a fractal part of a bigger st-scale of information has fewer dimensions such as:

Law of dimensionality: Fractal $\sum st-1 = 1/3^{rd}$ Dimensions of st

Since any st-Point will have 3 inner dimensions. Thus the dimensions of information of any system grow with a cubic power law as the system grows in scale. In simple terms, a 3-dimensional being transcends as a mere cellular point of the new whole.

Those 3-inner dimensions, as in the case of light, are ultimately the dynamic arrows of time, or wills, or physiological networks, or organic drives of the being.

For example, a human being has 3 dimensional networks, which are our physiological systems. The blood network of energy, the nervous network of information and the endocrine network of reproduction. Those are the 3 systems around which cells and organs build up. So humans can be described as a 3-dimensional network with 3 wills: to absorb energy for our blood/ digestive system, to absorb information for our sensorial/ informative system and to reproduce through our hormonal system.

The abstract, geometric description of dimensions is secondary to the functional, dynamic, organic meaning of those dimensions. The how is less revealing than the why. The why of dimensional motions are the search of energy and information of any entity, whose paths become fixed in space and appear as dimensions. Or they are the reproductive strings of self-similar cells that form the physiological network of energy or information of the system.

In the quantum world, the constant exchanges of energy and information of the electron with the external Universe are described with 4 quantum numbers that correspond to the 6 arrows of time:

-The 2 first numbers describe the reproduction of the wave (main number) and its light feeding/ energy cycles (l number).

-The spin number defines the informative orientation of the electron and the magnetic number the social organization of those electrons established by an external magnetic field. Thus those numbers describe the 'paths' of particles in search of its dimensional arrows of energy and information.

The dimensions of light are also the dimensions of the energetic/ magnetic field, the informative/electric field and the reproductive length-speed, or social evolution (color/frequency).

In that regard, it is also interesting to observe the relationship between both planes, the light plane which 'feeds' as the lower st-1 space the dense fractal, cellular points of light of the electron. When

considering the basic laws between planes of space-time we noticed that a force, st-1 of energy, becomes st-bytes of information of the upper scale, which uses them as pixels to gauge information. Thus the magnetic, width field of that acts as energy in light becomes the informative, magnetic number of the electron.

We shall later observe that also in life beings, each being has a dimension of height/information, which is maximal in man, the most informative being of the cosmos, and a dimension of energy/length which is maximal in energetic predators.

Recap: Dimensions are morphological expressions of the arrows of time, seen as fixed forms of space.

26. The scales of big-bangs



Scalar big bangs: the gravitational, inflationary big-bang of the Universe, a big-bang of the light-membrane (quasar), a star big-bang, an H-bomb and a quantum big-bang or beta decay.

One of the most surprising applications of the existence of multiple space-times is the existence of multiple big-bangs with different explosive size and speeds, all of them deaths of an informative mass or charge that uncoils its accelerated vortex into radiation following Einstein's equation, $E=M(c)^2$, where a bidimensional or tridimensional vortex (M or e) becomes extended into a plane of radiation (hence the square of lineal c-speed).

Yet for each different scale the parameters of speed (c), mass (M) and energy will change. And so we obtain a series of self-similar big-bangs described in the graph.

The single cosmic big-bang based in a single space-time continuum, was devised even before we knew the existence of a faster than light, gravitational membrane of dark energy and dark, quark matter. So we

first must define it within that scale of big-bangs as the *big-bang of a membrane of electromagnetic radiation; hence a quasar big-bang, not a cosmic big-bang, which will correspond to the much faster explosion of a gravitational membrane, starting at the Planck scale of the gravitational minimal units, the lambda-strings.*

This is the conclusion of astrophysicists which now study the big-bang as a dual process, with an inflationary age (the gravitational membrane) and a slower age (the big-bang of electromagnetic space, created over the gravitational membrane).

Oort/Kuiper belts, would produce that radiation. So very likely the halo of dark matter of the galaxy is made of micro-black holes that have eaten moons, as their bigger cousins eat stars.

Further on, since black holes are fundamental particles of the upper scale, as protons are in the quantum scale they must be homogeneous in size, even if they eat less perfect planetoids, expelling the 'left-overs' as gamma radiation and becoming with other quark stars (strangelets), the 'protein' membrane that shields the galaxy, as a st-point whose 3 topologies are latter studied in more detail.

So instead of a big-bang particle that in the absolute past created the absolute space of the Universe, we consider to exist in a fractal universe of infinite scales, where big-bangs are also scalar processes of creation and extinction of vortices of mass in several scales:

- There are big-bangs of atoms (beta decays) in quantum scales.
- There are star big-bangs (Novas a super-novas that create strange stars (pulsars) and black holes, (top quark stars)).
- There are galactic big-bangs, quasars, whose periodicity and background radiation coincides with the cosmic big-bang in its simplest formulation.
- And there are cosmic big-bangs (inflationary period of the big-bang), in which the gravitational membrane at non-local faster than light speed expanded before giving birth to electromagnetic membranes, forms warped around this primordial membrane.

Recap. The invariance of topological form at scale means that big-bang processes of death are common to all the scales of the Universe. What physicists call the big-bang seems to be a galactic big-bang.

27. Universe as a Cell of a Bigger Organism: Hyper-Universes

In the next graph, our Universe (line below) might be born in a dual fractal big-bang of gravitational space-times (inflationary state) and fractal big-bangs of light-membranes (quasars that explode galaxies). All those homologous fractal big bangs of gravitational dark energy and light create the same inflationary Universe developed by Linde but, as in the case of electronic nebulae, interpreted as fractal parts of

Science News

Big Bang's Afterglow Fails Intergalactic 'Shadow' Test

ScienceDaily (Sep. 5, 2006) — The apparent absence of shadows where shadows were expected to be is raising new questions about the faint glow of microwave radiation once hailed as proof that the universe was created by a "Big Bang."

See also:

Space & Time

- Cosmic Rays
- Big Bang
- Cosmology
- Astrophysics
- Galaxies

In a finding sure to cause controversy, scientists at The University of Alabama in Huntsville (UAH) found a lack of evidence of shadows from "nearby" clusters of galaxies using new, highly accurate measurements of the cosmic microwave background.



If the standard model of how the universe was formed is correct, microwave radiation from the edges of the universe would be blocked by clusters of galaxies, causing 'shadows' in the microwave background. (Graphic courtesy of The University Of Alabama In Huntsville)

In the graph. Physicists have measured a local, hence galactic background radiation, which doesn't leave shadows from other galaxies and they tabulated the quasar cycle of galaxies which coincides with the age ascribed in the past to a cosmic big bang:

So it remains to solve what is the cause of the background radiation at 2.7 K. A more rational theory would consider the radiation both local in space (galactic) and in time (produced at present); since our measure is local and present. So we consider its cause the only alternative object that can produce such radiation in present: a micro-black hole, whose temperature red-shifts light as a gravitational lensing. And since a black hole gravitational lensing is proportional to the mass, we can calculate the mass of those 'background black holes', which redshift light at 2.7 k. Indeed, a simple calculus shows that a black hole of the approximate mass of a moon (the most common galactic object of which each sun has hundreds in its planets and

an electron co-existing in the same Universe, instead of Everett's absurd interpretation of multiple universes a fractal dual big-bang rationalizes the data of the inflationary big-bang, introduces the Planck scale as the minimal string-size of a gravitational action, which will self-reproduce as it expands and validates the fractal Unification that converts each galaxy in an atom of the gigantic Universal scale, which we only perceive till the limit of reproduction of light waves (mean life 10^{10-11} years):

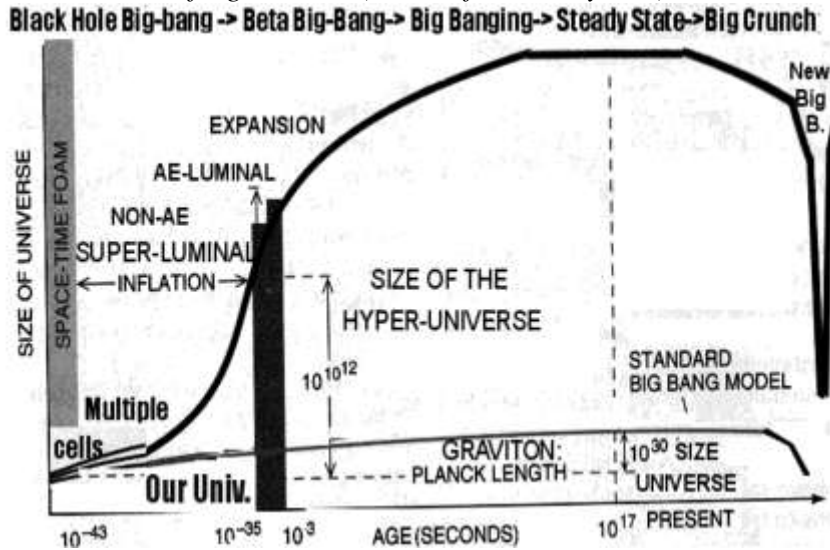

A discontinuous fractal structure of multiple space-times implies that in the same manner there are many quasar big-bangs (later Hoyle's interpretation of the big-bang process); there might be many fractal gravitational big-bangs, in a huge Universe in which each galaxy is a relative atom. Again this interpretation gives meaning to the standard inflationary Universe, whose enormous size wouldn't be the sum of a series of parallel Universes but the same Universe made of fractal gravitational/ quasar big-bangs. In the graph, those 2 cosmic fractal big-bangs give birth to a huge universe with $10^{10^{12}}$ 'galactic atoms'.

The fractal theory of a dual big bang is thus self-similar to the inflationary theory but without the logic errors of multi-universes. It postulates a first gravitational big-bang of dark energy at $z=10-100$ c

(which seems to be the limit of redshift observed in the limits of perception of our cosmos).

In the graph, taken from the work of Linde, who first proposed this model, which we complete with the law of ternary ages, the duality of membranes and the existence of fractal space-times, the birth of the 'huge universe' (no longer the hyper-universe) would have taken place from a black hole of the minimal scale of size of 10^{-35} m. and maximal Planck's density during a gravitational, superluminal big bang that split space-time into 10^{11} different fractal bubbles of gravitation - many universal cells like ours in which light universes would later develop. Those gravitational bubbles, while connected by non-local gravitation will not interact with light since the mean life of a reproductive light ray, as that of the stars it creates is around 10^{10-11} years and so light from those far away 'atomic galaxies' cannot reach this one.

Recap. There are not multi-universes but fractal Universes created with 2 self-similar big-bangs in 2 scales, the gravitational and light scale.

28. Big-bang deaths studied with the laws of fractal spaces.

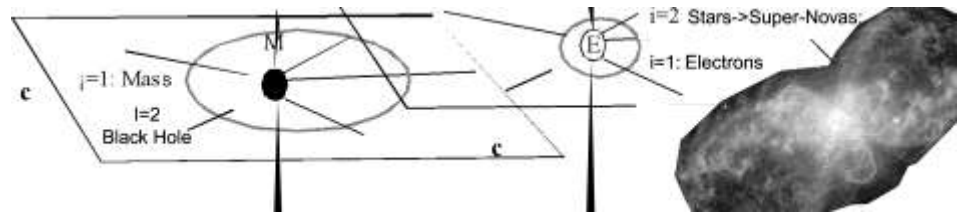

When physical systems, masses or charges on the atomic or cosmological level, die, their exi elements split, as in all processes of death (separation of 'head and body' in life organisms): their temporal, gravitational or electromagnetic central knot of information jets out in the dimension of height and their intermediate space expands into a membrane of spatial radiation. In the big-bang a hyper-black hole exploded and its energy gave birth to our Universe. Stars produce big-bangs that show clearly the breaking apart of its informative/energetic regions: a flat toroid expands most of the mass of its toroidal, reproductive inner region and a perpendicular, magnetic jet (right side) expels its central superfluid, informative zone.

While in atomic, smaller worlds, charges transform its information into a bidimensional plane of light-space, c^2 , in a process defined by Einstein's equation: $E=Mc^2$.

The gravitational faster than light big-bang resolves the mystery of the inflationary age, now canonical in cosmology. Moreover it follows the general laws of 'death processes' of multiple spaces times theory. Since death is the most *expansive, spatial process of erasing of information, Max. Se=Min.Ti*, it happens in a relative zero time – the minimal time of the system, when information dies and expands into a relative bidimensional sheet of space.

So we *die in a second, our time clock* which is the minimal unit of time of the human being (thought, blink of the eye, heart beat) and suddenly we become a 'relative flat' surface of energy (corpse, extended into a flat space). So it does the gravitational Universe, whose death happens in the tick of Planck's time, the minimal action/vibrational time of its string units.

Indeed, death is anti-symmetric to life, an arrow that has no intermediate states and lasts minimal time: a transformation of information into energy happens in the relative zero time of each scale: from novas to atomic bombs, to universes, to human death.

Further on, since a vortex of physical, gravitational time is paradoxically faster, more massive, informative, the smaller it is, the faster gravitational big bang started in the smallish vortex of mass-time, the Planck mass/density/time-tick, he aptly called the 'numbers of God'; since it was the hyper-black hole 'brain' of the previous organic Universe... whose reproductive radiation gave birth to our huge Universe. Again only the paradoxical, inverted properties of time and space, information and energy, explain this. What happens then? A basic cycle of creation of all organic, complementary systems:

*Singularity-> Big bang (death) ->Energy Sheet->
Informative Reproduction (Big-banging of particles) ->
Social evolution (Creation of stars and galactic networks)*

They are the phases of creation of the Universe. Indeed, in complex models of morphogenesis, informative evolutionary phases in time

alternate with reproductive radiations in space, creating a fractal rhythm of biological radiations and punctuated evolution proper of physical, biological and cultural systems:

Max. i (Evolution)->Max. Re (Reproduction)->Max.i(evolution)...

That rhythm applied to any system and fractal scale means that we observe the alternacy of those 2 phases in any organic process of physical/biological creation, a big bang & a big banging:

-Big bangs: The singularity/seminal egg explode their energetic membrane in a micro-time period (big bang, creation of a cellular egg, etc.). Then it continues its expansion at a slower rate as it grows in complexity inwards, invaginating and creating its energetic and informative networks (invagination of dark energy in the Universe and electromagnetic membranes controlled by them, of the nervous system and the blood system it controls in the foetus).

-Big bangings: In the big banging phases, news informative particles/cells are evolved around those 2 forces/networks and then they start a massive age of reproduction or 'biological radiation'.

The alternacy of those two processes slowly builds a living being and a Universe masterminded by two networks around which new particles/cells and social groups of those particles/cells of increasing complexity are born.

Thus, in the model of the inflationary Universe, now explained in organic terms, a minimal, cyclical black hole vortex of the size of a string with the density of Planck and its constants of God created a first gravitational big bang, reproducing=multiplying into 10^{11} fractal regions of dark energy and quark matter in 10^{-43} sec.

Each of those gravitational bubbles gave birth to a secondary big-bang of *fractal beta-decays, in which the nucleons expanded, dying into protons and electrons (cyclical, informative big-bang)*, while light-membranes of electromagnetic radiation warped the gravitational dark energy giving birth to an age of light.

This dual process expanded the regions of cyclical time/mass (as neutrons exploded into beta-decays) and imploded the regions of dark

energy (as light warped the minimal information of gravitational strings), creating protons, electrons and light in $10^{10^{11}}$ parallel future galactic regions. Then the process reversed as the fractal regions of mass imploded into galaxies and the dark energy between them tired light and expanded, but both processes remain in balance, so the present universe is in a steady, mature state without expanding or imploding when we add the implosive galactic vortices and the explosive regions between them.

The Webb telescope, by solving the relative size of the big bang and the type of hierarchical scales the organic universe displays, will determine the experimental details of those processes. If the Webb telescope observes in its 13 billion years limit a landscape of galaxies similar to the ones of our cosmic region, it means the fractal universe extends to a relative infinity; as each galaxy is self-similar to an atom of the Universal scale, whose size is astonishingly huge. Some theories hint to that concept:

- Relativists model the Universe with Einstein-Walker equations in which each galaxy is treated as a hydrogen atom. This theoretical trick that facilitates the calculus of relativity shows the self-similarity between a hydrogen atom and a Galaxy of the upper scale. Each point of the electron nebulae is a star of the upper scale. If so, each proton is a positive, central Kerr black hole. And alternatively each +Kerr black hole is a hadron made of positive top quarks. And the gravitational waves of dark energy expelled by black holes are equivalent to the magnetic fields of protons.

An alternative model considers that each star is self-similar to a photon, While the electron nebulae that surrounds the atom is equivalent to a nebulae of strange, quark stars, the halo of the galaxy; since strangelets are negative (strangeness is negative).

So protons are self-similar black holes (top quark stars). The halo is made of strangelet stars as the Earth will be soon (and we are indeed close to the Halo). And stars are neutral, light photons.

Cosmologists use models of electronic nebulae to describe the behavior of stars around the central black hole; and some have tried models with high density photons.

Yet self-similarity is not identity. So what we call quantum cosmology requires a fractal formulation to make sense; NOT the use of quantum equations as if they were identical, but the logic of fractals to observe the self-similarities of those scales.

What else can we know, we human beings, dust of space-time about the infinite Universe? Not much more, because if there is a higher fractal scale and galaxies are self-similar to atoms, the extension of that scale will be so vast that we shall never find its limits. Indeed, in our Universe there are trillions of atoms and so if there are trillions of self-similar galaxies, the maximal perception we can have is that of a local structure within that Universe.

This philosophical view will be far more appealing than a mere big bang of a cellular Universe for metaphysical reasons:

- A Universe in which the two self-similar scales of quantum and cosmological vortex of space-time (charges and masses) are truly self-similar is truly infinite in space and infinite in scales of temporal information and complexity. Then we, humans are really nothing but a mush over a corner of the Universe. But in second thoughts, such structure means that we humans are also all, as each of us has infinite Universes within his self.

- While size is absolutely relative and so our position on those scales doesn't matter, we are an incredibly complex fractal structure of energy and information, which in the fractal models of biology needs 10 membranes of space-time to be described. Hence, even if our size is minimal our *informative complexity is astonishing; and we are from the perspective of the arrow of information, one of the supreme beings of creation*. This is not the case in a single big-bang theory where only energy and size matters; so we are nothing but dust of space-time.

Recap: The big-bang in any scale of reality is the death of a previous physical informative knot of matter, which expands in space and then starts a creative and reproductive process or big-banging.

VI. THE QUANTUM SCALE.

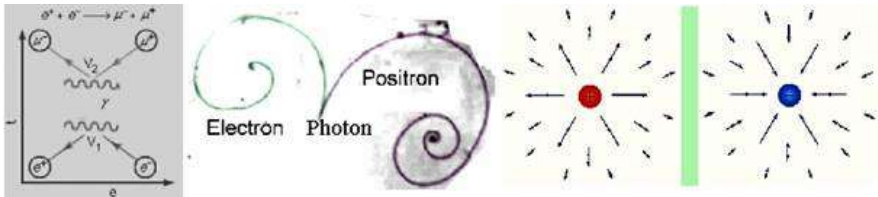

Particles and antiparticles, positive and negative charges must be explained as space-time antisymmetries, which can be seen according to the Galilean paradox, both as inverted events in time, as in the left Feynman diagram or as geometrical inversions in space (right diagrams). They are the why of most physical dualities that classic physics fails to understand.

29. The corrections of quantum physics.

All the errors of interpretation of quantum physics derive also from the ignorance of the key dualities of the Universe:

- Duality of motion in time=distance in space.
- Duality of 2 space-time membranes, gravitation & light.
- Duality of wholes, made of fractal parts of a smaller scale.

-And duality of the arrows of form and energy natural to all complementary beings, which create 2 more complex arrows, energetic reproduction and informative, social evolution.

When we use those whys to interpret the magnificent scaffolding of mathematics and metric space times of measure built by quantum theories all becomes resolved. So we shall try to give meaning and explore the whys of quantum physics with the new tools of multiple spaces and times.

Let us then start with a basic clarification brought about by the knowledge that all cyclical patterns and forms are 'time-clocks' that carry the information of the species we study. This means particles are cyclical states and waves are energetic states; and cyclical properties such as spins are time-clocks that carry information while energetic states are lineal, extended forces.

The main error of quantum physics is the lack of understanding of the properties of temporal information, the cyclical nature of time and its multiple rhythms and clocks, obscured by the equalization of all those rhythms with a time-clock. This error is enhanced by the experimental limits of human instruments (uncertainty principle):

Time cycles and spatial flows cannot be differentiated in the quantum realm, as they can in the biological world, due to the minimal duration of ticks of time of quantum particles, which therefore are observed as space trajectories.

This is due to the black hole paradox: Max. Ti = Min. Se, which means the smaller the particle is the faster its cyclical, rotational clocks turn. So in experimental physics, you never get images short enough to 'feel the tick' of time. Time cycles appear as those pictures of a fast turning wheel, which seems a solid disk without motion. So particle's cycles appear; as printed 'images' on the bubble chamber.

Yet once we understand the dualities and forms of time-clocks and spatial, lineal flows, there are easy 'key elements' to know when we are seeing 'sequential time events' instead of 'spatial trajectories'. For example, systems that are 'bilateral', 2, are space-like, left-right. While systems that are composed of 3 elements are time-like, where each element represents the past, present and future states. So there are not 3 quarks but quarks in 3 time states/colors. And so in time the same quark changes its 3 states creating a charge of $3 \times 1/3=1$. More often we find that a ternary state is both, an organic structure in space and a ternary wave in time. And so the ternary topologies form the particle state, and the 3 phases of the wave represent the particle in time. 3 is thus the evolutionary limit, which explains why so many systems are ternary systems: 3 neutrinos evolve increasing information as a wave; 3 mass families are the 3 horizons of evolution of quark-masses, and so on.

Further on, particles must be classified in 2 different membranes, that of light and that of gravitation, which we do not perceive. Thus it is easy to classify those particles, as we did in previous paragraphs: the easiest criterion is its 'visibility'. So gluons, quarks, bosonic strings, gravitons, black holes and neutrinos, which are not observables, are

gravitational species.

Because time ‘bends energy into cyclical vortices’ masses or charges, depending on which of the two membranes of space-time we study (since both are self-similar as we showed by finding its unification equation), we can also differentiate the particles that are clocks of time and store most of the information in both systems (electrons and quarks), and particles which are lineal, energetic states (light and gluons).

Because the universe is in symmetric balance, as there are electric and magnetic fields in light to balance each other, and there is a repulsive, lineal electromagnetic, transversal wave and an attractive cyclical electronic particle; so there must exist an attractive, cyclical gravitation and a repulsive, transversal gravitational wave. Thus we conclude that dark energy is merely the transversal, repulsive gravitational waves that come out of galactic black holes.

Finally, since the formalism of temporal information is inverse to that of energy (meaning that energy moves forwards, information stops motion or reverses backwards with negative, imaginary numbers), and both cancel each other, we can distinguish, which are the parameters of energy and information of a field or particle.

For example, in electrons, the informative component is given by the imaginary parts of the Abelian phase of its mass field; and both fields - the real, energetic field and the informative imaginary component - are at a 90 degrees angle and when one is maximized the other is nullified. So even if our perception doesn’t distinguish both terms we can now which one carries the information of the system and which one the motion.

For the same reason the 4 quantum numbers can be easily classified as representing the 4 basic arrows of an electron:

-The 2 energetic/reproductive arrows are represented by the 2 first numbers, the main number represents the reproductive wave of the electron as it displaces, imprinting the surface of energy around the nucleus. The second number represents the ‘changes in the energy’ of that electronic path, due to the absorption= feeding of a photon of

energy by the electron.

-Then the other 2 numbers, the magnetic number and spin mean the same for its information components: the spin represents the informative clock-like rotation of the electron and the magnetic field that affects the electron is the ‘informative perception’ that can change the spin and orientate the electron.

This trivial explanation of the why of the 4 quantum numbers, using the theory of Multiple Spaces-Times however will be denied by most abstract physicist, for whom organicism is a taboo concept born from the anthropocentric nature of human beings and the mechanist approach to science of the founding fathers, whose memes are learned and repeated without much reflection by all texts on physics. Yet what marvels of a model of multiple, vital spaces and time arrows applied to quantum physics, is how easily data becomes structured into a ‘plan’ with meaning, explaining the whys of all previously paradoxical quantum processes.

Indeed, once those precisions are made we can truly clarify all the mysteries and meanings of the parameters of quantum physics, from spins to waves to complementarity laws, to spooky effects. For example, since a time state is an informative, *still* state with the ternary phases of time cycles and its hierarchical, non-commutative causality – given the fact that it is not the same a motion to the future (whereas energy becomes information) than a motion to the past (where information becomes energy), the meaning and mystery of spins becomes resolved:

Systems with 3 spin positions (spin number 1), are still systems and the 3 spins form a rotational clock.

Systems that are in motion have 1/2 spin number - 2 positions and they are bosons which display a spatial main lineal motion and its inverse negative ‘informative’ motion, creating a simple beat forwards, backwards. This beat is natural to all complementary systems that last, and so we find that an alternate currency of electrons is more stable and lasting than a continuous one as it has an energy/information beat in its motion.

Those rules of course are also useful to detect erroneous theories that cannot happen since they mix properties of time particles with spatial properties and vice versa.

For example, the Higgs cannot exist because it is a scalar boson. And by definition, a scalar field with no rotation will not act as a boson moving at light speed.

Further on a boson cannot have mass as it does not close its cyclical trajectory so it does not form an attractive vortex, reason why light and gluons don't have mass.

The same concept applies to forces, whose range law I just an expression of the Black hole paradox (max. energy=Minimal information/mass). So we can distinguish forces belonging to the strong-mass membrane – gluons - and forces belonging to the electromagnetic membrane – photons. And then forces belonging to the bigger cosmic membrane of gravitation, gravitons, which are bosonic strings of tachyon speed.

This leaves the 4th force, the weak force that has no range and time parameters that change the in/form/ation of the particle, and also breaks the symmetry of space (left-right). So it is obviously not a spatial force but a time event, which further explains why we have never found its 'bosonic force', the Higgs.

The same error invalidates super symmetry and hence all string theories except the original one, which properly understood as background independent and using fractal co-dimensions of finite size extended through several relative scales of gravitational complexity should become departing from its Nambu's minimal action and Planck length, the proper formalism of gravitons.

Thus, while the formalisms of most quantum theories are correct all those limits of perception added to the errors of using a single clock-time and a single space, explains why so many 'whys' are confused in quantum physics to the point that Feynman finally said: 'the why is what you don't ask in quantum physics'. We do and that is what this paragraph is about: the why of the perceived phenomena of quantum physics.

Finally physicists ignore the black hole paradox so they don't understand that protons, neutrons and all other particles do not live eternally. On the contrary their life/death cycle is their complementary cycle between informative states and energetic states, either the clock of particle/wave complementarity or the clock of particle/antiparticle, past to future and future to past cycles.

And so their existential cycles are really short. But they do not disappear because what physicists see are 'generational waves', given the fact that at the quantum level unlike in our informative-dominant world of biology, past to future and future to past arrows are reversible. So as a very simple jellyfish does, turning his clock backwards when it gets old and becoming young again to turn the clock forwards; particles and antiparticles go forwards and backwards and forwards in time. Bosons and electrons move forwards in energetic motions and backwards in informative motions. Light imprints once and again a photon of information that becomes an energetic wave that becomes a photon.

And so what physicists call the life of a particle is its longer generational cycle, which can last an enormous number of self-repetitions, but should neither be eternal. Indeed, it seems that light beams and light-evolved entities (stars) have a mean cycle of 10 billion years, after which they suffer an energetic big-bang expansion – stars explode into Novas and light gets tired and expands in a redshift process, returning to its gravitational, non-local lower scale of dark energy. This of course explains why far away light red shifts and seems to expand space: it is dying and beyond those mean 10 billion years an increasing 'darkness' is observed in the Universe, which a simple Gauss curve of probabilities show to be almost absolute beyond the $x+1/3^{\text{rd}}$ 13.3 billion years range.

Again physicists don't see both, the dual space and time views of the Universe but only the temporal big-bang, which considers a cosmos in time failing to analyze it in space as a simultaneous system connected by non-local gravitation. So they think darkness is not caused by the spatial death of light, which they merely use as a clock of cosmic time, thinking therefore that beyond those ages we enter into a temporal

darkness – and the Universe didn't exist.

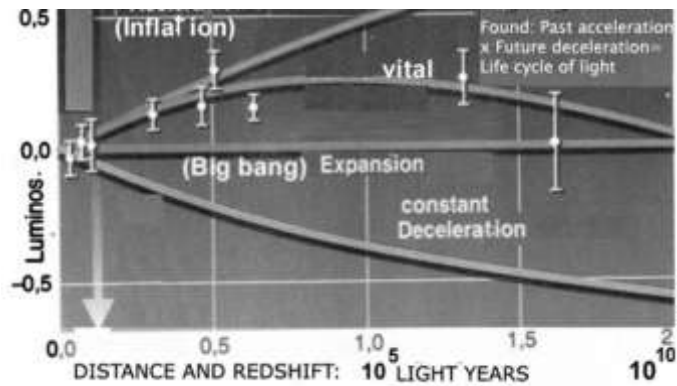

In the graph, we illustrate how complex physics, using the same data that Simplex physics of a single space-time continuum can resolve the puzzles of the Universe.

Cosmologists have found that light coming from far away galaxies seems to decelerate and accelerate its red-shift till dissolving around 10^{10-11} years after its emission. And they affirm this is a proof of an expanding Universe, as they apply a local phenomenon, the life/death curve of light self-similar to the life-death curve of any entity, which increases its frequency till its $\frac{1}{2}$ life and then decreases, becoming tired till death, to the entire space-time of the Universe (a global symmetry). The tiredness and life-curve of light however only applies to a local phenomenon: light tires and redshifts at the end of its journey, dissolving back into gravitational dark-energy, which is perceived as an expansion of the light-membrane, but that effect is compensated by the contraction of space into mass in the galactic vortices giving us a zero-sum.

Recap. Quantum errors derive from the confusion of time clocks with spatial trajectories and the ignorance of the dualities of spatial energy and temporal information; and its rejection of organic theories of reality.

30. Informative inflation: The error of multiple dimensions.

After rejecting so many trendy theories of modern physics, I am afraid many practitioners of the 'baroque' age of information of quantum theories will ignore this text, so we must do further clarifications on the why of that multiplication of impossible theories.

The inflation of baroque theories of physics, which take the classic age of Metric spaces and its proper theories (Relativity and quantum physics) beyond its scope and reach, has caused many false theories without empirical proof, which try to correct and extend the metric paradigm beyond its power of resolution, without taking into account the needed corrections and widening view provided by the new tools of topology, fractal points and Non-Euclidean postulate. The main reasons of that inflation of false or unproved theories are:

- The fact that information is inflationary. This is self-evident. A language of the humankind maps out reality with far less energy. So it is rather easy to construct many linguistic images of a single reality, as we can find many mirror images of an object. And all of them will carry a minimal truth. But the theory that matters to us is the one that has the perfect focus with a given language. Again, if we focus an image with a camera, there would be many images similar to the object but only a point of perfect focus. So all those alternative theories with many dimensions are just half-truths, bad focused, linguistic and mathematical images of a single reality. We are however here concerned with the dimensional theory that has the perfect focus, both in logic and mathematical thought.

- A 2nd problem is the pythagoric belief that mathematics is the only language of science and any mathematical theory must be truth. This absolute belief in a language fails to recognize the limits of linguistic knowledge. And it is proper of a young language, which evolves from an age of simple, dogmatic truths to a more sophisticated baroque age. Mathematics has been applied as the 'language of God' to the Universe only for 4 centuries. So scientists are believers in their language with a dogmatic degree that verbal writers only practiced in earlier, religious ages, when the written word was also considered the language of God. Pharaohs would just say, 'it is written'. And that meant it was truth. Then philosophers of language found out the relativism of all linguistic statements. And finally an inflationary age of verbal information – the age of fiction thought – has settled down after millennia of using words. This inflationary age happened in mathematics only a century ago and the relativism of those theories was exposed by the work of Gödel. Yet the believers still rule in

science and so it is a fact that Gödel has been cornered and considered a heretic both in physics and mathematics for denying that ‘God speaks mathematics’ (Galileo). It is however about time for science to accept the linguistic limits of mathematics as verbal writers accepted the meaning of fiction in verbal thought precisely when Cervantes wrote the first fiction novel of the modern age, Don Quixote. Instead, scientists must accept that after Gödel we need experimental proof to show a mathematical theory certain.

- A third source of errors is the mechanist dogma that denies organic interpretations of physics, which are self-evident as quantum probabilities in time are easily transformed into spatial population of fractal knots of electromagnetism in space (real, mass side of the phase equation.)

The denial of Hylomorphism (the opposite philosophy of the platonic pythagorism of physicists who believe mathematics are truth per se, declared by Aristotle – all informative languages must have a physical, experimental truth to be real) and the denial of organicism (complex, vital arrows in physical systems – reproductive repetitions and eusocial evolution) are so pervading in quantum physics that is truly surprising... because all the fundamental laws of quantum physics are organic in nature.

The Complementarity law requires particles of information and fields of energy and one cannot exist without the other. Quantum theories are called gauge theories because all require that particles gauge, measure, hence process information as perceptive beings do, in order to interact with each other. The 2 fundamental particles, electrons and quarks constantly reproduce jets of new particles, hence they absorb energy. And finally all particles evolve socially into more complex systems, as cells do in organisms. So those are the same 6 arrows of time of all fractal systems of the Universe, which in mathematical, quantum equations are expressed through the different quantum numbers; as those informative/energetic processes take place in orbital paths and through the emission and absorption of electromagnetic energy and form.

Fact is we do not see 10-dimensional hyper-strings around us, because dimensions are diffeomorphic, fractal and attached to a temporal function/arrow. And they are topological and so in a 4 dimensional Universe there are only 3 topologies, 2 bidimensional substances, energy and form (Holographic Principle) that combine to create finite vital spaces with a time duration – the entities of reality. And that structure is enough to explain all systems.

Only then departing from such fractal 4-dimensional beings, we can build another plane of more extended dimensions in which each beings is a point of a bigger network of spacetime.

Further on, the 3 dimensions of time change, past-present and future parallel to the 3-topologies of space, energetic planar membranes, cyclical present, reproductive volumes and hyperbolic informative centers create harmonies of forms and functions, which have to be study with the rules of causality and logic, considering always the Galilean paradox: motions in time are equivalent to dimensional forms in space.

In its simplest creative processes, those logic chains and dualities mean that dimensions grow in time as points displace creating lines, lines displace creating planes, planes displace creating cubes, and cubes displace creating momentum, mv , where v becomes the 4th dimension, as the cube moves tracing the first trajectory of a bigger plane of existence.

And the same process describes a point that becomes a cycle that rotates into a bigger sphere that moves along a new cyclical trajectory, creating a 4th new dimension of a bigger plane.

So a 4-dimensional cube is not the fancy cube of hyper-dimensional geometry but a 2 dimensional plane of space or cycle of information that grows in height as a flat sheet of energy reproduces its form, or rotates cyclically and then, moved along a temporal path, with v or w lineal or cyclical speed.

We then obtain a translating cube. Since reality follows the dimensions of normal time and space, not the hyper cubes of idealized mathematics.

What truly happens is that a wave or form that displaces along a given path reproduces its form, its information, creating, reproducing a new dimension, which first is measured as speed and then leaves a solid trace behind. So when we emit a ray of light, light imprints and forms gravitational space creating a form with a new dimension of length. Only recently, physicists used this common sense definition of dimensionality in String Theory: where a string moves along a perpendicular path creating a plane and then again creating a cube of pure space.

In that regard, physicists' role is not to invent mathematical fantasies but to *limit mathematical models to the physical reality in which the inflationary information of mathematics is restricted by the resistance of energy to acquire complex forms.*

So only certain efficient geometries and topologies exist, and the enormous numbers of imaginary, unstable particles do not matter, as the inflationary universe keeps creating forms but few survive.

Thus good physics describe only what reality shows: the constant, discontinuous, growth and extinction of dimensional beings, which can be seen as fixed forms or in movement (so a wheel spinning or a planetoid circling Saturn might seem a fixed dimensional form, when observed without detail). Yet once the 3 dimensions of space are filled up, the object will create moving, translation dimensions as its trajectories shape new cycles, or it will create real dimensions of form, if it reproduces in 'biological radiations', growing from micro-forms into macro-forms. In both cases we would see how the object adds a new dimension that enlarges its world. For example, imagine a 3-dimensional living sphere, a cell. As it reproduces, it fills now a macro-dimension and after multiple processes of dimensional reproduction, it will create a macro-organism that has 6 dimensions, the 3 of microcosmic, cellular space, and the 3 of macrocosmic organic space. Then again, if that individual organism, the first of its species, multiples, and organizes itself into a society, an ant-hill or a human society, it will expand in macro-macro space, again filling up 3 bigger macro-macro dimensions of space, till reaching 9 dimensions, whose growth can be measured as a t-duration with lineal time, giving

us 9 (classic space) + 1 (lineal time) dimensions in 'classic physics'. In this manner because space-times are fractal, moving geometries and dimensions are finite processes of reproductive growth, when we talk of multiple dimensions we don't have to invent spatial geometries, and follow Minkowski's definition of time as a spatial dimension, but just describe reality, as it is, and consider each movement or reproduction of form with a certain frequency, a dimension of time. In those terms, many 'mysterious' objects of the physical universe described mathematically with multiple dimensions, conceptually ill-defined, become now real, complex space-time fields, extended across fractal spaces from micro-worlds to macro-worlds, as your 9+1 dimensional organism extended in 3 scales, from cells to individuals to society, is.

Such 9+1 dimensional strings (expressed in lineal time and classic Euclidean space) are thus an error due to the ignorance of the Galilean Paradox: dimensions are initially moving and reproductive cycles of times perceived as fixed forms and distances. Yet those dimensions are dynamic, since they grow and occupy a volume creating new macro spaces - the fractal scales of reality - from microcosmic photons to macrocosmic galaxies.

For example, a moving photon-point reproduces a bidimensional line/wave, which wobbles upwards and creates finally a 4 dimensional macro-space of light with length-speed, electric height, magnetic width, and frequency-rhythm. In the same way a cycle of time can rotate upwards and sideways becoming a 4-dimensional mass or charge also with length, height, width and rhythm. A 5 dimensional object would then be a mass creating a new, lineal trajectory, giving birth to 5-dimensional, lineal momentum (a mass moving in a line); or a 5 dimensional rotating mass with angular momentum. Thus, reproductive movements and rotations create dimensions, which give origin to a growing fractal reality of repetitive, scalar forms - the vital reality we see. Unfortunately, in XX C. Physics, since Minkowski's invention of a spatial, 4th dimension of time, most of the dimensional work done in physics is just about fancy mathematical objects, which have little to do with the real n-dimensional, space-time.

All languages are inflationary. So in the same way ‘hair is blue’ and ‘hair is green’ are 2 beautiful sentences, however false, physicists can create all kind of fanciful geometries, however false. Fact is reality doesn’t have 10, not even 4 continuous fixed, space dimensions, but it is constructed with fractal, scalar dimensions that grow from micro to macro worlds. So we should apply 2 fundamental laws of scientific truth, the Occam principle (truth is the simplest explanation of reality) and the experimental method (truth is a description of real phenomena) to the problem of multiple dimensions. Reality is not born out of the complex geometry of 9 dimensional continuous spaces. Its complexity grows with the creation of dimensions that start as the temporal, reproductive movement of a form that becomes a fixed structure of space, and again reproduces its movement in time or inversely extinguish its dimensional form. Yet since those dimensions are limited, fractal dimensions they end when the wave ends its reproduction or the particle ends its movement - so they can be increased ad infinitum as the form grows into new macroforms.

-Such fractal, scalar nature also implies that we should always consider the interaction of both membranes, gravitational and electromagnetic membranes, instead of trying to simplify them. In that sense, physicists try to unify the micro-world of electro-magnetism and the macro-world of gravitation, without realizing they are 2 different scales of the Universe: to unify them is like trying to unify the existence of human beings and their macro-scale of societies; or the properties of cells and the ecology of its macro-organisms with the same equations/laws of behavior. What is relevant is to explain the relationships and self-similar laws of invariance that happen between those scales.

All in all what this means is that the holy grail of present physics, the scalar boson with a new field never found on Nature, the Higgs, and the super symmetric inflation of background dependent, 10 plus dimensional strings don’t exist. And an enormous number of virtual, unstable particles don’t live long enough to be relevant except as failed games of the inflationary game of reproduction of fractal information. So once we have limited the theme of our inquire to what is real – stable particles described by classic quantum numbers – in the realm

of evolved light-space forms, and quantum gravitation (strong force and its bosonic strings, gluon and quarks), which is what quantum theory studies we can go on illuminating its whys with the tools of multiple spaces and times.

Recap. Information is inflationary, so it is the mathematical language, whose enormous number of possible theories about reality must be contrasted with the experimental method and the logic principles in which existence is based. But physicists are ‘Pythagorean’, so they cannot accept truths which are not written with mathematical equations. This means till modern times despite Gödel’s work about the errors of mathematical equations; they have ignored the laws of information and morphological change. Unfortunately many of such simple solutions will require time to be adopted, as there is in a Universe of inflationary information, many ill-devised theories based in the faulty, previous paradigm of metric spaces, whose practitioners will have a hard time to abandon.

31. Whole and parts: quantum waves.

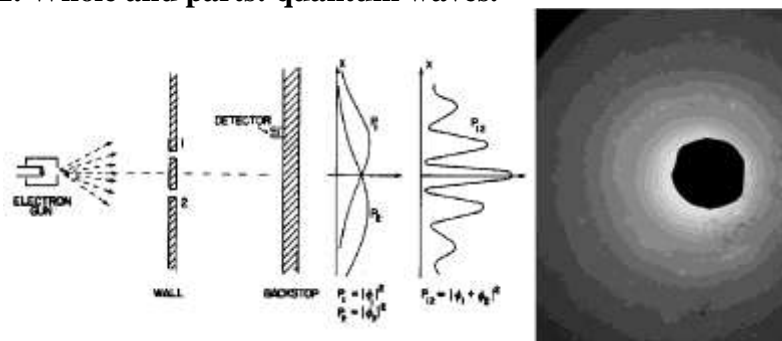

An electron is a herd of photons that gathers into a particle or expands as a wave, depending on which strategy maximizes its survival and movement, as a school of fishes does in front of a predator. The herd even splits its EXI fields (P_1 , P_2) when it finds an obstacle and latter merges back those space and time fields into a compact form. Yet Physics ignores the bio-logic strategy of the electron and uses a probabilistic explanation of the wave/particle principle to keep its mechanist ideas on matter. It also ignores that the 2 components of an ‘Abelian’ Phase space, which defines the mass-field of the electron, are an energetic and informative component (the imaginary number) since its concepts of space-time are still monist, continuous, ‘infinite’.

The units of both membranes, the gravitational and electromagnetic membrane are time actions, $e \times i$, product of the minimal spatial energy and cyclical time of both membranes. Here due to our limited space we shall not study the gravitational membrane, whose minimal quanta of lambda length and Planck time creates a lineal and cyclical string, or action of gravitational time; which becomes a gluon/neutrino wave in the next scale and then a quark wave.

We shall consider only some aspects of the self-similar wave of light bosons (h-plankton or ‘photons’) that condensate in cyclical phase space forming a De Broglie mass-wave, or electron whose pattern is defined by the real, lineal energetic component and imaginary, informative, height-dimension of its algebraic equations.

What is the ‘it’ that Schrodinger & Dirac equations describe? The duality between a whole and its fractal parts explains the nature of Physical Actions, microscopic quanta of energy and time that any physical vortex emits or absorbs to communicate with its environment, complete its existential cycles and stabilize its accelerations: Actions are projections of the form of a given being in the external Universe, achieved thanks to the use of energy that ‘translates’ in space its information:

Present Macro-Organisms (st) -> Micro-Actions (st.1):

Max.E x Max.I (Organism)-> Σ Min. e x \prod Min.i (Action)

$$\Sigma E \times I = K$$

Both, in organisms and actions the arrows of energy and information merge in constant ‘presents’ - systems that exist longer *precisely because* their energy and information *are* in balance. A present organism is a cellular system with 2 poles - one dominant in energy or relative body/field, and one dominant in information, or relative head/particle, which constantly relate to each other by exchanging small bites and bytes of energy and information, called actions, $\Sigma S \times T_i = K$.

A physical action, defined by the specific equation of a Universal action applied to the scale of electromagnetism, writes also $E \times T = K(h)$. Where energy and Time are inverse functions, whose product is

always a balanced constant. Thus as inverse functions the growth of one of those 2 elements E or T means the diminution of the other. From where Physicists deduce a series of fundamental laws of physics, studied in detail in the non-abridged version of this book (Heisenberg Principle, Law of Force ranges, etc.)

The same law applies to any Universal action. For example, humans who process biological information sleep in absolute zero movement-space. They maximize information by minimizing energy. So happens with thinkers, which are quiet people when reflecting upon information, or informative chips which occupy little space and work better in coldness.

The exchanges of actions between beings resolve the paradox Leibniz encountered in his analysis of Space-time monads: how the different space-time beings communicate each other, creating the networks and complex systems we observe in the Universe? The answer is through microscopic actions.

Actions are microscopic ‘cells’ of the bigger organism - in terms of cyclical time, they are minimal frequencies, compared to the complex, bigger organism made of knows of multiple events), the duality of macro-knots of frequencies and individual actions define a fractal Universe organized in scales or ‘planes’ of space-time of different size and temporal duration. Any organism, in that sense, extends in 3 \pm st relative planes of size and duration. The natural St plane, for example, in the human case, our individual scale of existence; the microscopic, cellular plane, in which the energy and information of any entity’s action develops. In the human case, it is the cellular scale, which provides the energy and information for our actions. And finally, the social macroscopic, +st plane, in which the individual is often a microscopic action, part of a whole mass that performs a social cycle. So humans gather in masses that perform social actions that change their macroscopic scale, nation or civilization - while particles gather in waves and life beings in herds.

Thus, all organisms combine their $e \times i$ actions in knots we call cells, which gather together in constant species, creating an ∞ variety of

relative Space-time beings, perceived simultaneously together as a present, continuous Universe.

Any entity in the Universe extends across 3 relative scales, the minimal scale of 'actions' of energy and time, the scale of cellular knots in which multiple cyclical actions gather together, and the scale of organisms and ecosystems made of multiple cells.

In those 3 cases reality is dynamic, as all those scales are made of moving cycles and fields of energy and time, despite the fact that we might see them as static forms.

The platonic, mathematic paradoxes of Quantum Theory can be explained in organic terms. Since, as Einstein said God doesn't play dices and the Universe is not a mathematical probability but a dual, biological and geometrical game of herds and wholes.

The experimental proofs of quantum physics back organicism, in the image, the wave/particle behavior self-similar to that of organic herds, and a picture of an electron, which has the form of a nebula of fractal micro-points, self-similar to the whole.

We understand quantum waves and particles in terms of the structural duality of a Universe made of organic wholes or 'particles' that can be observed in its st₁, lower plane of existence as a wave of cellular, fractal, quantum parts.

In the graph, the wave-particle duality shows that physical particles behave in an organic form: an electron wave explodes into its multiple quanta (which seem to be 'cellular' condensates of st₁ photons) as it reaches a thin barrier in order to cross it. Light also divides itself into a herd of photonic quanta when it passes a slit. In fact, fractal particles split their spatial and temporal fields, SxT when passing those apertures. Then sometimes they successfully mix both fields back together recreating the electron and sometimes fail to do that. Hence there are 2 possible solutions to the previous event, which fractal physics express as a quadratic probability when the electron reconstructs itself (sxt) or a null probability (s't) when it doesn't; and we explain as a biological process. Further on, since life is caused by the social organization of cells into a higher plane of existence, those

wave/particle fluctuations can be explained as particles that 'die' and 'resurrect' constantly. The biological nature of those events is even clearer in the inverse process: when a spatial force, for example, light, comes closer to an informative, complex particle like an electron it evolves into a cellular, compact form - a dot of the photonic nebulae of the electron that integrates itself as a 'probabilistic point=cell' of the electron. On the other hand, when a researcher hits with a high energy beam an electronic wave, it collapses into a particle, as a school of fish clumps together in front of a bigger predator.

Recap. Physicists say that the wave solutions of the space-time field collapse, affected by the observer. It is the abstract, statistical way of saying that a wave of light is a herd of h-quanta, which evolves, imploding its form when it is absorbed by an electron of higher form. Yet the why of that how is biological, not 'mathematical', since as Einstein put it in his critique of a probabilistic interpretation of quantum waves, 'God doesn't play dices'.

32. Populations vs. Probabilities: Fractal, Quantum Particles.

We have now a general, simplified overview of the arrows of time and the topologies of space, which can be applied to resolve some of the basic riddles of quantum physics.

The first fact we must define, once the arrows of time are understood in its dualities, morphologically in space and dynamically as a series of events in time, is the duality of any physical system, composed of a relative energetic, past event/force and a relative informative, future event/particle. If we see reality fixed in space it will appear as a force/particle system; if we see it moving in time, it will appear as a relative energetic past wave that evolves and devolves constantly into a relative future particle of information. Our choice of reality as fixed or moving, in space or time is merely a question of the mind and how it perceives, according to the Paradox of Galileo, which stated that the Earth moves and doesn't move, depending on our choice of perception. This is the solution to the quantum paradox of uncertainty.

Further on, in physical systems there is not at first sight an apparent dominant arrow of future, since we are making spatial pictures of

them. That is why quantum physicists often confuse temporal events with spatial forces (such as the weak event or the mass-clocks that Higgs describes with spatial forces and particles). They also don't realize of the anti-symmetry of time and believe that moving forward in time (life arrow) is the same that moving backward (the death arrow). For the same reason Physicists confuse anti-particle events with particles in space - when they are 2 arrows of time of the same entity. All this happens because a cycle of space-time in electrons and particles is just too short and so physicists often make pictures of the entire event/life & death of the particle. So the particle life and antiparticle death is confused with a spatial cycle when in fact it establishes also an order of time, between life as a particle and death as an antiparticle.

The same life-death cycle happens when a particle dies and explodes back in a wave similar to star big-bang.

To make it all more confusing, physicists ignore the duality of the ages of time that become organs in space of a fractal organism. So sometimes a wave is the death of a particle but sometimes it is the spatial, organic energetic field, over which the particle/head exists as a complementary organism.

Only when all those dualities are understood, we can re-classify and re-order in a systematic manner all the forces, events, particles and systems of quantum physics in a complex, clear pattern.

In organic terms, the wave of a quantum system is the reproductive body of the system and the particle its informative state and both co-exist together (Complementarity system) as a dual system, whose energetic limbs are the fields of forces that displace the system.

Like life systems, particles have an order called the life/death cycle, first dominated by the arrow of information through the 3 life ages and then exploded into death by the arrow of energy Thus physical systems do have temporal causality and anti-symmetry: they exist first slow as informative particles and then die fast in big-bangs as anti-particles or as disordered waves. Because the relationship between the informative-time speed of a system is related to its spatial size

($ExTi=k$), by the chip/mouse/hole paradox (smaller chips calculate faster), we can consider that the particle/wave duality or the particle/antiparticle duality are; when observed not as fixed space or dual organisms, but as casual events in time, the life cycles of physical matter, which are extremely short, as they are extremely small. In other cases though, they are part of a complex topological organism, acting as body, energy and form of a ternary Non-Euclidean structure:

$$Relative\ energy=past\ (energy\ field)\ \langle Body/Wave: present \rangle^{Future=information=particle}$$

In the previous equation, we added a bidimensional representation to the standard feedback wave: The information or future particle is as the relative past energy field, far less observable that the present body wave that mixes both, energy and information to create the combined field, reason why the phase space of a mass wave is not easily perceivable. The key to differentiate both types of entities, past and future, energy and form, motion and stop, $E \leftrightarrow I$, as separate entities are the inverse properties of time that the present merges in a holographic form.

Thus, we distinguish for each ternary creation and form, the whole system and then its energetic parts more visible in space and its informative events more durable in time.

The symmetry between time and information on one side and its inverse symmetry between energy and space on the other, for the experiences theorist who fully grasp the laws of multiple times and spaces is the most revealing tool to classify reality and understand its events and laws as specific sub-equations of the generator of space and time.

Most dual particles are not spatial but transformational particle /antiparticle events of short duration and most bosons are wave /particle generational events, as they constantly switch between its big bang wave event and particle state. And so we write the anti-symmetry of time in those physical systems as a duality, a temporal, past to future life/death, informative particle/big bang cycle:

$$Big\ Bang\ arrows\ (energetic,\ expansive\ state)\ \langle Dual\ system \rangle^{Big\ crunch\ (informative\ state)}$$

All those different spatial, ternary systems and dual events happen in

all the scales of the Universe, the quantum scale, the solar scale, the galactic scale and perhaps a higher scale of relative Universes made of cellular galaxies, in increasing time lengths. So we write for the Universe at large:

Past Expansive dark energy <Steady state:present cosmos> Future Implosive Galaxy

Thus in that cosmological scale the galaxy follows a generational cycle from the big-bang to the big-crunch, through a steady state of minimal creation of mass, in which we live.

If we were to observe in absolute detail two photons in 2 cycles, probably we would observe slight differences in its configuration; as we do when we see two Chinese, father and son, which at first look are both called Cheng and both look the same.

The dual cycle that matters most to us is obviously the one of creation and destruction of mass: the arrow of time bends space into mass ($M=e/c^2$), and the arrow of entropy explodes form into energy ($E=Mc^2$). Einstein said that the separation between past and future is an illusion. Those 2 equations of Einstein show the equal importance of both arrows of time, energy and mass/information. However when we transcend into beings with higher information, the dominance of information creates the order of future that we, biological beings, experience, and philosophers have always called the 3 ages of life.

The mysteries of quantum physics can also be explained from an organic perspective. In the graph, we observe 2 of those solutions:

- Particles choose to behave as a herd of fractal parts or as an organic whole, when they cross through doors and slits. Particles interact with the electronic beams of particles we use to detect them, modifying its position and speed (Uncertainty principle). In the graph, we can see that behavior: An electron is a herd of photons that gathers into a particle or expands as a wave, depending on which strategy maximizes its survival and movement, as a school of fishes does in front of a predator. The herd even splits its EXI fields (P_1, P_2) when it finds an obstacle and later merges back those space and time geometries into a compact form. Quantum Physics ignores the biologic strategy of the electron and uses a probabilistic explanation of

the wave/particle principle to maintain its mechanist, abstract ideas about matter. The misunderstanding of the dualities of time/information and energy/space make thoroughly confusing its explanation of time and space parameters in those processes. In the right picture, we can notice the self-similarity of the atom with a spiral galaxy. Both have a center black hole zone where the quark proton and quark hole are. But self-similarity is not identity, so even if quantum cosmologists try to use quantum laws to study the Universe, it is more meaningful to study directly the cosmos with satellites and telescopes, than replicating mini-big bangs of quarks on Earth.

In fractal space-time electrons become nebulae of self-similar fractal parts which can be described with fractal equations of the type biologists use to define cells as fractal parts with self-similar functions to those of the whole electronic organism. So only a fractal organic description of the quantum world, resolves its paradoxes and contradictions.

The alternative to all those proofs of the organic structure of the Universe is a Pythagorean fantasy called the Copenhagen interpretation. It considers the Universe uncertain as the herd of quanta is not a population described as any other group with percentages of the whole (which in statistics has a probability 1), but according to Bohr et al, those probabilities are real and the Universe is made of numbers. Indeed, quantum physics has finally achieved the religious goal of the founding fathers, Kepler and Galileo, God not only speaks mathematics but the Universe is mathematical. This is nonsense, of course. Yet anytime a physicist in the past century has tried to put forward the organic, logic paradigm, his work has been ridiculed, while entire institutions of learning are dedicated to explore Everett's thesis that each point of an electron nebulae is in a different, parallel Universe! All of them though shown in the same picture, hence cameras are machines that travel through infinite Universes! at the same time! This Bohr/Everett alternative is thus an absurd, abstract, illogic interpretation, which defies the 3 legs of the scientific method; logic consistency, mathematical accuracy (as the results are often uncertainties, singularities and infinities, cleaned up ad hoc) and experimental evidence obtained with the first pictures of electronic

nebulae, 40 years ago: The electron appeared as a fractal of smaller, self-similar electronic cells, dense, smaller electronic parts that adopt either a herd/wave configuration or a tight, organic, particle-like one. Or else, we would have observed in this Universe only a single electron point. Further on, the behavior of an electronic herd, when bombarded by massive particles, as those humans use to observe them is self-similar to that of any crowd, from fishes that come together when they are attacked by sharks, to soldiers in a battle field. 40 years have passed and yet the mathematical models of electrons as fractals are ignored by abstract, mechanist scientists.

The platonic, mathematic paradoxes of Quantum Theory must be explained in organic terms. The quantum world is not a mathematical probability but a ternary, biological and geometrical game of reproductive fractal herds=bodies and particles=knots of information, displacing over lines=fields of forces.

The equation of energy and information, $e \times i = h(k)$ that defines quantum physics is not an uncertainty but a fluctuation. It is the equation of existence of a Planckton, the minimal action of energy and time of the light Universe, which sometimes evolves into informative particles or relaxes further into space-waves. Thus the equation has two limits of death as energy and evolution as form. The particles that appear from the vacuum are those evolutions of form of the h-quanta, the substance of which our light space-time is made. The uncertainty of measure is only in our instruments which cannot measure at the same time the wave/body and photon/head states of the quanta. As you cannot make a dual picture of yourself as a whole body or a cellular network: you need to focus the picture in macro or microscopic scales.

Recap. We understand quantum waves and particles also in terms of the structural scales of a Universe made of organic wholes or particles that can be observed in its st.₁, lower plane of existence as a wave of cellular, fractal, quantum parts. In this book we hardly touch the ternary scales of all systems that also structure particles as wholes of smaller particles and parts of bigger structures. So atoms are parts of molecules and wholes of particles. And the self-similar laws of hierarchical planes determine many of the events and relationships between particles, atoms and molecules.

33. Time motions. Physical Death. Big-bangs and antiparticles.

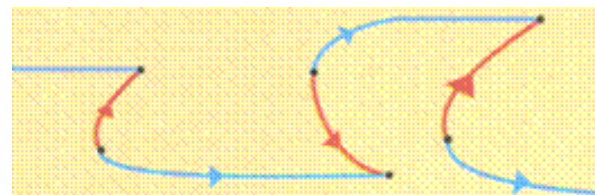

In the graph, when we observe an electron we see it jumping backwards and forwards in time in an erratic trajectory, as it becomes its particle and antiparticle.

Traveling in time towards the past means in the restricted, spatial, geometrical definition of time in physics, an inverse, cyclical movement as the one created when moving backwards the needle of a clock. Since physicists ‘extract’ their concept of time from a spatial definition of movement: $v=s/t$. Thus physical time is only the analysis of change in the motion and geometry of space; and traveling backwards in time in both, the previous Galilean equation of relativity or Einstein’s equation is merely a geometrical change of direction or a contraction in the ‘dual’ perception of space as distance or c-speed.

In physical space there are also dual dissolutions in space, which are processes of death, the best known a big-bang process that annihilates particles and antiparticles into a release of pure energy and annihilates a black hole into a Supernova or quasar of pure energy: A dual process of palingenesis happens in those death processes when the big-bang gives birth to an accelerated birth. So black holes trigger the palingenesis and fast evolution of stars and a cosmic big-bang, the big-banging of particles.

The antiparticle is the 3rd age (inverse in energy/information parameters to the first age) and final death of the particle, reason why it lasts so little and its parameters of time are towards the past. This explains further 2 unexplained facts of astrophysics: why there are less perceived antiparticles. Simple: because the total perception we have of particles is its ‘existential force’=energy x Time and they last in time much more than the antiparticles, which die fast. In the same

manner all men die but they die so fast that we see much more living humans than corpses around us.

A second interesting consequence of the antiparticle travelling to the past as the dying state of the particle is the fact that while physicists observe them as being born together in the same point and fusing again in the point of death, the real path is, since the antiparticle travels to the past, that of a single particle when we observe them with the arrow of future information (Feynman diagram of the graph of palingenesis). The particle is born, explodes where it meets the antiparticle in the conventional drawing. Then it dies explodes into energy and leaves a remnant ghost, the antiparticle that moves backwards in time and fades away in the point of birth of the particle. *But there is only a particle at each moment in the time loop, reason why* for example, we have never observed black hole evaporation, which is based in the existence of two particles. This phenomenon happens in all scales. In the next scale of electrons, the same

In the previous graph we observe one of such processes. The graph shows the sum of the life (blue) arrow and death (red/antiparticle travelling to the past) arrow of an electron, which appears and disappears constantly in its path forwards. Thus, the motion of virtual photons and electrons seems to correspond to a series of life-death cycles shown as particle=life arrows/antiparticle=death arrows or wave (st-1 plane)/particle (st-plane) fluctuations, which include a 'quantic jump of spacetime' in which the particle disappears becomes its antiparticle moves to the past and re-appears in a relative present location, displaced both in time and space coordinates, proving the constant cycles of creation and destruction and the fluctuation between hierarchical past and future states of all palingenetic systems of the Universe.

Yet the same process happens in our biological death. Those who have survived death feel an explosion of light in the brain/informative human particle. Then memory rewinds backwards its path till youth, when you will awake in the lower plane of existence as a mere cell. This is equivalent to the death of the antiparticle that 'reverses' its coordinates till it meets its final death in the point of birth (hence it

seems two particles are born in that point but one is the death particle returning to its past). At that point it dissolves in the lower vacuum plane.

The best known case of travel in time in physics is the virtual particle/antiparticle systems that constantly pop out in the Universe. Antiparticles seem to travel to the past while particles travel to the future and both annihilate themselves. What we observe here is 2 particles with different geometrical directions that together complete a 'cycle of physical existence'. We could say that the particle is the 1st age of the entity, from past to future and the antiparticle its devolving age from future to past or 3rd age of the entity and together form a closed loop of space-time, an existence. Or in some cases, the particle is the life arrow and the antiparticle the death arrow. So we have to see them consequentially, one after another in time, even if when we measure them in present-simultaneity, as they are so fast we see the entire life of the particle in an instant of space. So they seem to us mere geometrical shapes.

The entire cycle of Time change is often perceived together, when studying flows from past to future in those fast, simultaneous phenomena that become then fixed loops of space. In any case a death/back in time travel never goes beyond the limits of the entity that experiences it. Those geometrical time travels do not influence the entire, absolute time of the Universe, as Hawking naively thinks, when he talks about black holes as time machines because their 't' parameters are inverse. Or when he thinks that black holes evaporate because antiparticles make them 'travel to the past'. Antiparticles are only the final stage of the life of a particle, which quantizes its existence in 2 broken phases that don't affect the absolute time of the Universe. It is that absolute Time the one Einstein studies with its Equations.

Recap. Processes of death mean a short travel to the past in which information is rewinded. Yet while we travel to the past we do not co-exist in both states as some physicists unaware of the process think it happens with dual particle/antiparticle systems.

34. The ternary, i-logic topological structure of atoms.

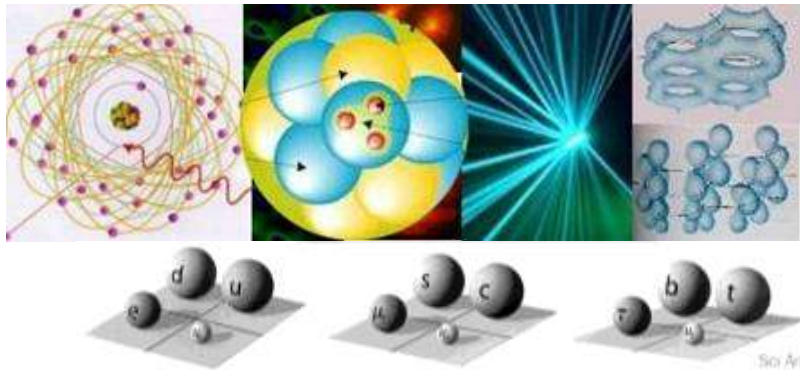

In the graph, an atom is a space-time field divided in 3 species, informative masses or quarks, energetic gravitational and electromagnetic networks and an intermediate space-time, the electronic nebulae, which bends light into 'fractal', ultra dense photons, which put together create the electronic nebulae.

Let us then now that we have revis(it)ed classic single time-space theories of reality, depart from the classic age of the 3rd paradigm of metric spaces (quantum relativistic models of reality), without further ado. Since what was done beyond Einstein Dirac and Nambu, the last of the classics, is mostly baroque, inflationary, metalinguistic theories proper of all paradigms of thought that failed to include mass, as the information of the Universe that balances the energetic entropy of spatial forces (single big-bang theory that fails to include dark matter/energy, Thermodynamic of black holes that misunderstands the nature of the event horizon belonging to our light-universe, super symmetry and superstrings that fails to understand the laws of balance that forbid its existence, the expanding Universe that fails to consider the implosive, galactic vortices, which balance that expansion elsewhere in this work) and move on to present the universe with the ternary dimensions of time (ages of all time events) and space (3 functional topologies of all st-points or 'worlds' of space-time.)

In the graph, an atom is a space-time field divided in 3 space-time zones: its informative quark center, the nucleus; the external reproductive membrane, made of electrons, which evolve socially in

bigger ExI membranes when atoms become molecules; while informative, gravitational and energetic, light networks shape their intermediate space-time.

The topology of the atom is thus clear. The electron acts as an external 'spherical plane', a membrane of energy. In the center quarks are the informative vortices. In between energy and form is transferred with forces, which often decouple, reproducing new particles and antiparticles. There are 3 informative families of quarks-mass, due to the evolution of information in 3 ages or horizons of increasing form: each quark family is thus an age in the evolution of informative matter.

The final event of death of those families is a 'decay' or quantum big-bang. In our lighter up and down quarks, it is the beta decay, the dual mini-big-bang of a neutron due to the conversion of a balanced, reproductive down quark into an informative up quark (proton, big crunch formation) and an energetic electron (expansive electronic membrane).

As in all processes of death we assist first to the dissociation of the informative' and energetic elements of the organic system.

Since death is caused by the destruction of the networks of the upper plane of reality, which created a form.

So the Neutron dissociates its informative quarks and electronic, slightly negative, external membrane, provoking a dual big-bang and big crunch, breaking into the 2 parts of its balanced state.

Thus we write the reaction as an event of the generator equation:

$$\text{Electron} = \text{energetic past} \langle \text{Down quark} = \text{balanced Present} \rangle \text{Up} = \text{informative future}$$

$$\text{Electron (E)} \times \text{Up quark (Information)} = \text{Down quark (balance)}$$

The up quark has half of the mass of the down quark, and we know a down quark switches into an up quark in a beta reaction that explodes a neutron into a proton and electron, components of the Hydrogen atom. In other words the balanced neutron splits into an expansive electron and an implosive proton. This is the equivalent of a quantum dual big-bang/big crunch, a far from equilibrium process in which the

neutron expands its membrane into an electronic big-bang and implodes its quarks into a tighter proton configuration.

Recap. Atoms are st-points with 3 topological spaces, the spatial membrane or electron, the hyperbolic center or quark-gluon soup, and the intermediate, ‘bigger’, reproductive space where exchanges of electromagnetic and gravitational forces give birth to virtual particles.

35. Events in time and organisms in space.

All those processes give origin according to the duality of the ‘Galilean paradox’ *to both events in time and forms in space*, which further illuminate many questions unresolved in classic quantum physics - as we can always consider the existence of 2 different realities, *a causal event and a ternary organism*, and so we have two options to explain many phenomena before explaining only with either a spatial or a temporal perspective:

For example, a proton is a uud triplet of quarks in space, but in time you might consider that a down quark, which switches into an up quark and electron, splitting its mass-vortex in 2 and then evolves back into a down quark.

So you can also write the ternary structure as an event in time:

$$d(exi) \rightarrow u(i) + e(i) \rightarrow d(exi)$$

And so we can consider the whole process to be an existential cycle of a single down quark. Both events are real and in certain conditions the process will be a temporal event and in others will create a spatial organism. The difference is clear: when we consider the process as an event, reality becomes warped from a big spatial, extended, multiplied world into a tighter, faster, temporal non-redundant Universe. And so this ‘antisymmetry’ between time functions and spatial forms happens when we consider the ‘antisymmetry’ between big-bang & big-crunch ages of fast d=evolution in time, in a limited space vs. the spatial, organic ages or steady states, described by the equations of Einstein. And since we are apparently in a steady state age for the Universe, most likely the previous spatial description is the reality of the atom: 3 quarks, locked as relative, past-energy, present balanced and future-informative subspecies.

The reality of studying the Universe both in time and space, as either an event or a form is one of the key methods of ‘Complex physics’ as a science which uses two arrows to describe the Universe. Yet because physicists lack those methods, they often confuse an event in time with a form in space and vice versa. Ultimately the proton and neutron are two phases of the same being in 2 different states of time that physicists first confused with 2 different species of space.

The mystery of their 2/3 and 1/3 charges become also resolved in a temporal perspective: the up quark emits a negative electron, giving up a charge and becoming a down quark that later absorbs the quark and becomes an up quark again.

An easy way to solve when a process is a spatial duality or a time event is the fact that time events often don’t have parity, mirror symmetry, a spatial property, as it happens with the Beta decay. What this means is that because information and energy have different properties, the arrow of energy->information and the arrow of information->energy, its inverse process, are different. And so indeed, while neutrons decay easily giving birth to an electron in a few minutes – another proof that it is a fast process of death; the inverse process hardly ever happens.

Another type of events that puzzle physicists is the difference of masses between particles. The general rule already explained is simple, when a lineal energy, E, accelerates till light speed, the limit of our light membrane, it starts to curl into a cyclical speed, which is the definition of a vortex of mass. Thus no mass becomes mass. Yet further on, this transformation can be further increased by a topological transformation, from a reproductive, cyclical vortex toroidal topology to a hyperbolic, more massive one:

The balanced, reproductive cyclical toroidal donuts can switch into the inner informative dual donuts (simplest hyperbolic topology). And as the hyperbolic topology adds up more ‘toroids in the dimension of height, and the vortex of mass, $V_{ox}R_o=K$, increases its speed mass increases geometrically, reason why a black hole, a hyperbolic topology with asymptotic T-parameters, is the most massive object of the Universe.

This topological transformation could be a possible reason why a down quark has the mass of 2 up quarks: the down quark might switch back and forth its reproductive single-torus topology into a dual torus, becoming more complex and heavier but smaller. In this manner we can find many topological whys to the abstract description of particles and transformative events between them.

Consider now the the temporal interpretation of color, a feature that makes quarks stable in triplets.

It was discovered when physicists realized that quarks with the same spin could occupy the same position. So they considered they have color. But they never clarified what color is. We interpret color in simple Euclidean Geometry as the orientation of 3 bidimensional, cyclical vortices of mass - 3 quarks, that are perpendicular to each other - and so they can occupy the same 3-dimensional space. *This explains why 3 quarks of $1/3^{\text{rd}}$ charge together emerge in the electromagnetic world and can interact with a 3-dimensional electron of 1 charge.* It also explains why they are locked in a stable configuration: they cannot be deconfined without ‘disappearing’ from our 3-dimensional world as point-particles; reason why we perceive them as joined by an extremely strong and attractive force.

In detail, using complex Non-Euclidean topology the picture is somehow more complex, but the previous simplified analysis is clear enough to explain why some quarks have $2/3^{\text{rds}}$ of charge, 2 donuts, and some $1/3^{\text{rd}}$, one donut; and how they can interact with 1-charge electrons.

Further on we can understand why gluons, the particles exchanged by quarks have 2 colors. This again is self-evident: if you try to communicate a bidimensional long plane and a perpendicular plane you must travel in a right angle. So a gluon that exchanges energy and form between 2 quarks of different perpendicular/color orientation must have 2 colors.

$2/3^{\text{rd}}$ charge quarks would be from the perspective of its gluon parts, chaotic, perpendicular, bidimensional attractors (Lorenz-type); $1/3^{\text{rd}}$ quarks would be self-similar to single gluon attractors (Rossler type).

Gluons are bundles of strings with a boomerang like open topology – hence without mass, as they don’t close the cyclical vortex. And as they interact with quarks, they will change their spatial orientation, carrying away their color.

Now, the principle that matters here of classic physics is diffeomorphic *orientation*, Obviously when we switch from Euclidean to non-Euclidean space and from continuous to fractal dimensions, the topologies of those orientations become much more complex and we should rather talk of ‘puzzles’, hyperbolic, $2/3^{\text{rd}}$ charges; toroidal, $1/3^{\text{rd}}$ charges, and curved planes (gluons) that respond to the 3 basic topologies of the Universe; and become locked together in complex patterns, as proteins and other cellular components do in the cell, *to emerge as a whole Non-Euclidean Point of our 3-dimensional world – a proton.*

Thus color is a geometrical feature that evolves the bidimensional world of quarks into the 3-dimensional world of electrons, creating a holography of our world. Quantum physicists know that information is bidimensional and the Universe holographic but they don’t know why. Because the classic, abstract, algebraic description of quarks, based in group symmetries cannot express this easily. Thus, without topological analysis, without the enlightenment of its why with the new paradigm, the theory of quarks and gluons tell us only that each quark has a color, different from the other 2 colors of the triplet and gluons have 2 colors.

Ultimately the topological analysis shows that the fractal scale of quarks and gluons is similar to a fractal, liquid cell, which is *the fundamental structure mimicked by all Non-Euclidean points, hence, self-repeated in many self-similar scales, as we shall see when explaining galaxies as cells of the Universe; where black holes are the DNA/informative element and stars the mitochondria/ energetic network.*

Recap. We can perceive, according to the Galilean Paradox all realities as forms in space or events in time. Physicists study quarks only as events in space, so they miss the explanation of its fractal charge: 3 locked quarks as events in time add to 1 charge; and miss the

topological non-Euclidean interpretation of down, up quarks and gluons whose hyperbolic, toroidal and curved plane topologies add up to form a st-point of 4 Dimensions that surfaces in our holographic Universe.

36. Two Quark Triangles and 2 Universal Membranes

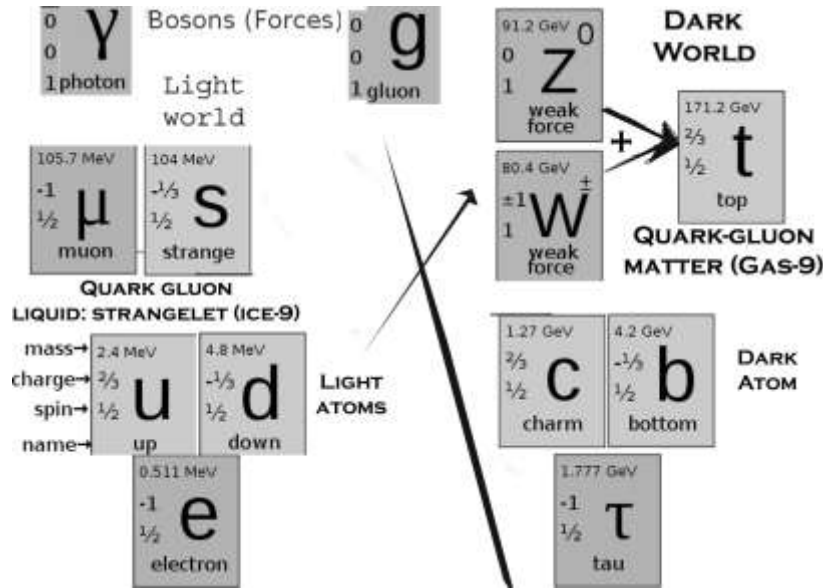

There are 6 quarks, whose mass increases as the speed of their space-time vortices increase. Physicists divide them in the III horizons of evolutionary mass, with increasing mass/information. Yet they ignore the reason of those 3 families (the 3 horizons of any evolutionary system of energy and information); they ignore why they have different masses (because the speed of their vortices increase); they ignore why they have fractional charge (because they are bidimensional vortices, which must lock in triplets, to form a 3-dimensional space-time, harmonic with the electronic, 3-dimensional world we live in); and they ignore which kind of fractal cosmological forms they create (pulsars and black holes).

Unlike the usual spatial classification of quarks in pairs proper of classic physics, in complex physics, we divide the Universe in 2 membranes, the dense, informative, gravitational, mass/quark

membrane and the electronic, light one and we consider species of the gravitational, informative membrane to be tendentially ‘time events’, as information and time are related, and so quarks and black holes are better described with 3 temporal horizons and hyperbolic topologies.

In the graph, a more detailed analysis of the parameters of the main particles of the standard model. For simplicity, Neutrinos, which *are better described not as particles in space but wave- events in time that transfer momentum between both gravitational and electromagnetic scales (reason why their ‘3 species’ mutate in time, as they travel to the earth)*, are ignored: The 6 quarks of the standard model are reordered in 2 ternary groups. In the bottom left, we observe the electromagnetic membrane and its elements. In the upper right side we observe the gravitational, quark world.

The graph, which is the standard model of Complex Physics, applied to quarks, requires no Higgs. Instead the top quark of self-similar mass in the upper vertex becomes the final evolutionary state of the Z+W particles which in a weak event transform lighter particles into ‘dark quarks’.

Its enormous mass means it should exist a new decametric ‘scale’ of super-strong forces, and the proper model to study the breaking of symmetry is not the Higgs but the Technicolor theory, whereas super strong top quarks should turn faster than light, be components of black holes and emit dark energy at 10 C speed, the next scalar force of the Universe that fills intergalactic space.

However in reactions at lower energies, Z and W particles never reach enough stability to become ‘parts’ of a top and so they quickly devolve into lower mass-states, which explains most of the reactions observed in accelerators, mediated by temporal, weak forces, which therefore have no spatial symmetry.

If we order particles by mass self-similarity in triads we observe 2 different atoms and 2 different quark-gluon soups, made of 3 types of quarks, dominated by their heavier quarks of each triangle:

- The up and down quark create the light atom. Yet when they are deconfined in a quark-gluon soup they are dominated by the most

massive strange quark, which creates the superfluid vortex of 'strangelet' liquids or 'ice-9', responsible for Nova explosions.

- The charm and bottom quark form a dark atom, dominated by the most massive top quark in a dark gluon soup, which we shall call 'gas-9', as it would be the most explosive substance of the Universe, responsible for Super-Novas and quasars and maybe the big-bang of a Universe, cell of a hyper-universe.

Thus if strange quarks create strange soups, top quarks will do the same with dark atoms; and if strangelets are components of strange stars, top quark liquids will be the components of top black holes.

This symmetric scheme is unknown to physicists; so they lack a visual understanding of what dark atoms (bcb particles) are, and why strangelets and top quark liquids are stable enough to form quark stars:

In the light world, the ud quarks and electron form the light atom. In the dark world, the cb quarks and the tau electron form the dark atom. The reader can now see that basically the two worlds are differentiated by a fractal scale of $1000=10^3$ Electron volts. In terms of static, fractal dimensions, this merely means that the world of top quarks is warped by a new SU_3 group of dimensional form. *It is more complex, more informative as it has 3 more dimensions of warping; or 3 more degrees of rotational speed in a dynamic perspective.*

Imagine that inside the original vortex of our light-quarks there is not the eye of a hurricane, but another scale, another vortex, another medium, rotating 10 times faster in 3 dimensions. Thus this inner world extended into lineal energy will mean we need $10^3 = 1000$ times more energy to create it.

The rotational speed of that inner vortex will be 10 times higher - 10 c - but the energy needed to create the new 3-dimensional fractal world or inner scale of motion of those top quarks will be 10^3 fractal dimensions of rotational speed/mass. Thus the dark world of heavy quarks is 10 times faster and 1000 times denser.

For the same reason the electron of the lighter world is lighter than the tau electron of the dark world. If our light world is a $0.c < 10$ c world the dark world is a $c < 10$ c world.

Once this concept is clear, the self-similarities become evident: the world of 0.1c light atoms, which creates our matter and the world of c-strange quarks that creates quark stars must be matched by a world of dark atoms and top quarks, which creates the world of black holes. So black holes are top quark stars.

Let us show how the quarks of the 2 membranes increase their mass (we round here figures so the reader can easily follow them):

In the graph, the strange quark is the top predator quark of our triangle of light matter made of udu atoms. It is between 30 and 100 times heavier than our matter. While the top quark is the top predator quark of the triangle of dark matter and its bcb atoms, and it is around 100 times heavier than those bcb quarks. The strange quark and top quark are around 100 times heavier than the ud and bc atoms.

Since the equation of a mass vortex is $U.C. \times \text{Mass} = w^2 \times r^3$, mass is proportional to the square of the rotational speed, w, of its vortex. So we have 3 decametric scales of rotational speed:

C/10, the speed of rotation of electrons, and the 'ud' system of quarks of our atoms, which in this manner are in harmony with the electron vortex that traps them.

<C speed for the strange quark or top predator quark that causes the breaking of symmetry of our matter, as it creates a faster attractive vortex, deconfining the quarks of our world, liberating them, and blowing the electronic wave into radiation.

In the graph, the bosons of both worlds are also self-evident:

The photon is the boson of the electromagnetic world and the gluon is the boson of the gravitational membrane. The symmetry between the 2 quantum theories of electrons and quarks is a clear proof of that symmetry.

Both theories differ because the quark-gluon soup is more informative and has a more complex, 'network-like', Π -structure, while the electron is basically a herd, with a loose Σ -structure.

The 2 forces (electromagnetic and strong forces) and the species evolved from them also change the parameters of energy and

information of both worlds, according to the basic symmetry of the Universe, $e \times i = k$, *expressed in quantum physics by the law of range*. The lighter world thus extends further in range/space and weighs nothing. The tighter world of dark quarks extends shorter in range and weighs/attracts one hundred times more.

It is only left to explain the role of the muon, which weighs exactly what the strange quark weighs and the Z+W= top, which weighs the same also than the top=Higgs particle.

So again we find a clear symmetry between them: Those particles are *self-similar to the top and strange quark, perceived from the other side of the dual membrane; they are their self-similar 'ghosts' in the light world*. And they can be found as evolutionary steps in the creation of strange quarks and top=Higgs quarks in the processes of transformation of electronic membranes into dark, strong gravitational membranes.

And the Higgs? It is not needed and it is an impossible particle since a scalar boson breaks the laws of complex physics and a new force/membrane it is an invention without experimental evidence that would also break the symmetry of complex systems (like an organism with '2 nervous systems'). The evolution of lighter matter into the top, mediated by the Z and W particles (which should be considered the same particle in a time perspective; that is, the +, neutral and - states), is performed by a top quark/antiquark condensate (Nambu), which breaks the symmetry of all other types of matter, converting it into more tops that will condensate into a quark star or black hole. In biological terms, to break the symmetry means to kill as a top predator quark, the strongest particle of the Universe, all other forms of lighter matter, to feed on them and to convert them into a self-similar form of yourself. In the same manner, the strange quark breaks the symmetry of our lighter quarks transformed into strange quarks and strange liquid (strangelets).

Because quantum physicists lack the tools of complex physics and the understanding of mass as information, all this is blurred in their equations. They do describe perfectly all those reactions with enormous mathematical accuracy as Ptolemy described better than

Copernicus the movements of planets. But to do so they need complicated mathematical models as Ptolemy did. A model of complex physics with both arrows, energy and information, is far easier to understand as it explains topologically and in terms of cyclical, causal time events many whys of particle physics.

Finally, the masses on those graphs are not exactly decametric in scale, since when we enter into a detailed analysis, we must fine-tune each mass to the somehow more complex Non-Euclidean forms of those vortices and consider the energy and mass carried by the fractal gluons that connect and create those quarks, inside each particle. The 'real' geometry of those vortices of mass is thus more complex than simple eddies; but the simple principles remain: masses are accelerated vortices not solid particles; they have less dimensions than our Universe, not more; and they carry physical information in the frequency of their bidimensional rotations, as this computer carries information in the frequency of its Ghzs.

Recap. Mass is physical information - an *accelerated*, bidimensional vortex of mass (dynamic perception) called a quark, which can be described also in space (Galilean Paradox) as a non-Euclidean network of fractal gluons (static perception described by QCD theory). Quarks must be understood as ternary events in evolving time, and classified in triads, belonging to two different scales of the gravitational world - the strange world with c-rotational speed that interacts with our world and the dark world of top quarks that rotate at 10 c speed and form quark-gluon condensates called black holes. They are vortices of top quarks, the top predator particle of mass-information of the Universe.

VII. THE COSMIC SCALE

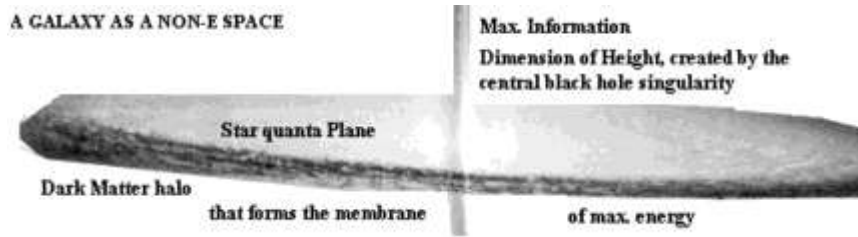

Galaxies are fractals of stars and dark, quark matter built with 3 topologies: a reproductive body of stars, sandwiched between an informative nucleus of black holes and an external halo of dark matter, probably strangelets and other dense stars. The closest self-similarity in our world scale is a cell and in the quantum scale an atom.

37. The Three Non-Euclidean Regions of the Galaxy.

Let us now consider the ternary topology of the equivalent 'entity' to the atom in the gravitational membrane – the galaxy:

In the graph, a galaxy is a curved, fractal space-time of huge spatial proportions, hence minimal form (inversion of properties between spatial energy and temporal information). Thus galaxies can also be studied in space as a fractal point with 3 regions that correspond to the 3 'canonical' topologies of a 4-dimensional world - an informative center, an energetic membrane, and the reproductive intermediate zone:

- Max. Ti: The center of the galaxy is a swarm of black holes, its densest informative masses, which produces the gravitational, informative waves that control the position of its body of stars. Beyond its event horizon, the accelerated vortex of mass of the black hole (Equivalence Principle) should accelerate light, deflecting it into a perpendicular, hyperbolic, informative dimension of height (Kerr superluminal, central singularity) ejecting it as gravitational jets of dark energy at 10 C.

For that reason Kerr black holes should be called wormholes, because they absorb light but let it scape through its axis as dark, gravitational energy, at faster than light speeds.

-Max. E: The external membrane that limits the inner space-time of the galaxy is a spherical halo of dark matter, probably made of strangelets or micro black holes, which can deviate unwanted radiation by gravitational redshift and/or absorb the energy of radiant matter, cooling it down to the 2.7 K background radiation.

Thus those non-evaporating micro black-holes and strangelets of great density act as 'proteins' do in cells, controlling the inner movement of galaxies and the outer absorption of light-energy.

- E=i: Stars, tracing toroidal cycles form the inner space-time body of the galaxy, a bidimensional plane or Klein's disk that feeds the wormhole and reproduces atomic substances and stars. They ultimately evolve into black holes, which migrate toward the central swarm of holes, residing in the nucleus. In any Klein disk distance is measured as motion and becomes infinite when we cannot reach a limit or barrier (for example the barrier of light speed becomes an infinite Lorentz Transformation). So it happens with the border of the galaxy. We are part of that intermediate space-time in a Milky Way, limited by its central hole and an invisible border of dark matter, neither of which we can cross without dying; since the speed of rotation of matter around the wormhole and the flows of intergalactic dark energy that expands space at light speeds beyond the halo *would destroy us*. Thus we are trapped in this star and planet, in a toroidal cycle that will end evolving the Sun into dark matter.

Thus the generator equation of the galaxy as a Fractal st-point is:

$$E: \text{Halo} < \text{stars that evolve energy into matter} > Ti (\text{Black holes})$$

In the image, the structure of the galaxy: stars are created in the intermediate region and the center is occupied by a black hole.

The energetic medium that transfers energy to the fractal quanta of the galaxy is the external interstellar gas. Finally the system is joined by 2 networks of forces: the gravitational, faster, non-local informative, transversal gravitational waves at the cosmological scale; and the energetic, smaller, slower electromagnetic waves at the quantum scale.

Let us study the parts of the whole - the 3 elements of galaxies, stars, black holes and gravitational forces that join them.

Recap. Galaxies are fractal st-points with 3 standard topological regions: a spatial body of stars and an informative nucleus of black holes. The closest self-similarity in our world is with a cell.

38. Intermediate Space. Gravitational Waves and Solar Systems

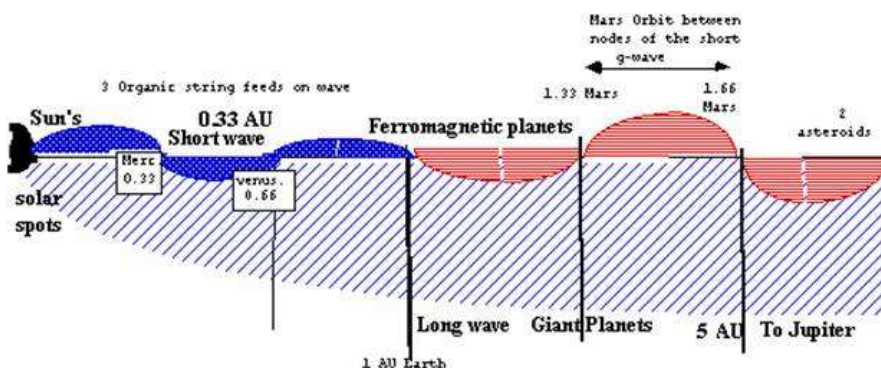

Gravitational, transversal, fractal waves shape the structure of galaxies and solar systems, transferring form and energy between cosmological bodies, in a self-similar process to the transference of information and energy between atoms through electromagnetic waves. In the graph, Titius Law of distances between planets reflects their position in the nodal points of those transversal gravitational waves. In the core of planets, there could be a crystalline or superfluid zone where those flows of dark, gravitational energy are processed, causing flows of heat and matter that make planets 'grow'.

We use constantly self-similarities, based in the 3 Laws of invariance of the Universe, scalar, formal and motion invariance and the ternary differentiations in time (energy, reproduction, information) and its symmetric function in space (planar, spherical membranes; toroidal bodies and hyperbolic centers).

With those simple laws we can describe the galaxy as we did with the atom. Yet self-similarity is not equality, which means that we cannot use the exact formalism of quantum physics but use those self-

similarities for gravitational systems we do not perceive, except for its secondary effects.

This is the case of gravitational waves, which are self-similar to electromagnetic waves. They organize the structure of stars and galaxies, as electromagnetic waves organize the orbits of electrons. Both respond to the same morphological equations that relate 2 particles through a lineal force field defined by the ratio between the informative density of masses or charges and their distance.

Yet even if form remains invariant at scale, as it is an essential topological property that defines the why of the Universe, the metric space changes as the space-time ratios/constants that define the size, speed, frequency and range of those waves change.

We observed a self-similar change when studying the cyclical informative vortices of both scales - the G-constants of Newton's gravitational vortices and Coulomb's equation of an electronic vortex, unified by their invariance of topological form and scale).

Thus galaxies and solar systems show a gravitational, morphological, spatial structure similar to that of an electromagnetic atom in the cosmological scale, a fact which Einstein predicted, establishing 2 kinds of gravitational waves, parallel to the 2 types of electromagnetic fields we know:

- Static waves that create the gravitational bi-dimensional fields over which galaxies form.
- Discontinuous, transversal, quantized waves, which shape the orbits of stars and galaxies, in the same manner photons control the orbital distance of electrons in atoms (l numbers).

Thus, those gravitational waves should have the same functions in galaxies and solar systems that electromagnetic waves have in the world of atoms, explaining cosmological structures and becoming by self-similarity with electromagnetic waves, the fundamental force of interaction between celestial bodies.

We know that the gravitational activity of black holes set up star orbits and probably influences its evolution, growth and formation,

determining the basic properties of magnetic fields, ecliptic orbits and distances between stars in a galaxy and planets in a solar system. So even if gravitational waves are invisible, using their morphological self-similarity with light waves, the equations of Einstein's relativity and the indirect proofs provided by the orbital distances and rotational fields of stars and planets, we can explain many 'whys' on the structure of those celestial bodies:

- Astronomers have always wondered what rules the distances between the planets of the solar system. The existence of regularities in the distribution of planets in the Solar System was recognized long ago. This was Kepler's main motivation in his search for planetary laws. The Titius-Bode law ($rn = 0.4 + 0.3 \times 2n$) was the first empirical attempt at describing these regularities, and was followed by several other proposals. The discovery of similar structures in the distribution of the satellites of the great planets led to a revival of interest for such studies, and to the hope that indeed a physical mechanism was at work. Now we can add a topological why to the how and when of metric space measure:

Those planets are in the nodes between gravitational waves of different frequency/amplitude and the solar system's orbital plane in which planets feed, 'deforming' space-time, as they follow their static gravitational orbits; as electrons are in the nodes of their quantum waves, fine-tuned by the secondary levels they access according to the strength of the electromagnetic waves they exchange with their environment. For the same reasons stars should be in the nodes of gravitational waves caused by galactic black holes.

In the graph we draw the 2 fundamental wave lengths that could explain the distances between planets: a high frequency, short gravitational wave of 0.33 AU could explain the positions of ferromagnetic, inner planets on its nodes. While 2 low frequency long wavelengths at 5 and 10 AU, could explain the position of bigger, and lighter gaseous planets. Since Jupiter is located at 5 AU, Saturn at 10 AU, Uranus at 20 AU, Neptune at 35 AU, Pluto at 40 AU; and as I predicted a decade ago, we have found a new planet, which I called

then Chronos, 'the last of the titans' at 100 AU, in the limit of the solar system, 'renamed' Selma (-;.

- G-waves explain why planets have ecliptic orbits with an inclination on its axis, which is a natural orientation if they are receiving curved G-waves with a certain angle through its polar axis. In that regard, the rings of gaseous planets in the point of maximal activity of those waves (Jupiter and Saturn) and the spiral vortices of galaxies, could act as 'antennae' for those waves at star and galactic level.

- Those waves might cause, as all lineal movements do, a cyclical vortex around them, originating the condensation of planetary nebulae. While in galaxies their wave structure seems to originate the different densities of stars in their nodal zones.

- Planets suffer catastrophic changes in their magnetic fields, probably produced by changes in the directionality of those waves, emitted through the tropical dark spots of the sun.

There are advanced mathematical models of gravito-magnetism that have unified both type of waves, departing from Einstein's work. Thus energetic 'gravito-magnetic' waves might cause a change in planetary magnetic fields as a magnetic field changes the spin of an atom that aligns itself with the field. For example, Uranus is tumbled and it has lost most of its magnetic field: perhaps it was knocked-out and relocated by a G wave.

Lineal magnetism is in fact in complex physics of multiple planes of space-time the intermediate force that 'transcends' from the gravitational to the electromagnetic scale: for example, electromagnetic light or ferromagnetic atoms like iron should absorb gravitational energy through their magnetic fields.

- Solar spots are the probable source of those waves. Yet its origin might be the central core of the star or the activity of the central black hole, whose G-waves might be absorbed and re-emitted by the star. We cannot perceive G-waves directly; but magnetic storms, solar winds and the highly energetic electromagnetic flows and particles that come from the sun's spots, might be its secondary effects. In the same

way we only perceive indirectly the waves of dark energy emitted by black holes that position the stars of spiral galaxies, by observing the mass and radiation dragged by those waves.

- Those catastrophes might cause the climatic changes that modulate the evolution of life on Earth, since we already know that the activity of sun spots affects the temperature of the Earth.

- G-waves could structure the galaxy and its stars in the way electromagnetic impulses structure a crystalline atomic network, ordering the distance between its molecules: electromagnetic waves also feed with energy and information those crystal webs. For example, electromagnetic waves cause the vibration of quartzs, which absorb energy from light and vibrate, emitting 'maser-like', highly ordered discharges of electromagnetism. We observe similar maser beams in neutron stars, called for that reason pulsars.

Recap. Gravitational waves produced by black holes control the location of stars and planets, and its spin/orientation through smaller gravito-magnetic waves.

39. Organic Patterns in the Galaxy. The why of G-waves.

The closest homology of the 2 dual networks of the galaxy is with an atom in which the central nucleon with max. density of gravitational information and the external electronic membrane interact in a middle space-time vacuum through gravitational forces and electromagnetic photons.

Another self-similarity between scales of multiple space-times might be established in complex analysis between the galaxy and a simple 'cellular' organism, which introduces elements of complex biology in astronomy obviously more difficult to accept from a mechanist perspective).

Following the cellular or physiological homologies, the network of dark, informative matter and gravitational energy, connected to black holes, surrounds and controls the stars' electromagnetic energy. We know that it was formed first and then guided the creation of electromagnetic energy, so we can observe it indirectly and deduce its form from the highly quantized shape of the filaments of light-galaxies

that were formed around dark matter (right graph). Thus dark matter acts in a similar way to the RNA that shapes and controls the Golgi membranes of the cell or the nervous system that guides and builds the morphology of the body; while the network of stars and electromagnetic - the slower energy that produces the substances of galaxies - surrounds those strands of dark matter. In the cell's homology ribosomes that create most products of the cell are pegged to those membranes.

We shall consider briefly here 2 of those controversial hypothesis: The possibility that black holes perceive gravitation and the chains of causality between the different scales of the Universe, self-similar to the chains of causality between cells and bodies.

- The most controversial element of a cosmological model based in G-waves is the existence of gravitational information that allows strange, neutron stars and black holes and maybe in the future evolved planets such as the Earth through its machine systems to perceive and move at will within a static field of gravitation.

On the Earth animals use light as information and dominate plants, which use it as energy. The hypothesis of complex cosmology is that stars are 'gravitational plants' that merely feed and curve gravitational space-time, while Worm Holes are 'gravitational animals', which are able to process gravitation as information and control and shape with gravitational waves the form of galaxies, their territorial space-time. They are in that sense extremely simple plants and animals. A more proper comparison would be with a cell, where the DNA molecules are the Worm Holes, the informative masses of physical space; and the mitochondria that produce energetic substances, the stars.

Thus frozen, quark stars could be 'gravitational perceivers' in the cosmological realm, as animals are light perceivers in the Earth's crust and DNA perceives van der Waals forces in the cellular realm.

On the other hand stars would be plant-like, floating in the sea of gravitation, used as energy of their motion, feeding on interstellar gas, as planckton does, floating in the sea of water.

Do black holes perceive gravitation as complex animals perceive light, instinctively or mechanically, as DNA perceives the forces of the cell? They probably gauge gravitation in very simple ‘forms’, as a cellular DNA-system, much simpler than the brain of animals, perceives its territorial cell. That is the supremacy of man in a relative universe where size is less important than form: While all systems process information, man is a summit of form and hence one of the most conscious species. Yet black holes have enough quark complexity to act/react to informative flows, as they seek energy to feed on – our electronic energy. This hypothesis has experimental proofs, since pulsars and black holes emit gravitational waves and we have observed many black holes following erratic paths through the galaxy, which defy the tidal, regular orbits of stars.

In that sense, multiple spacetimes theory considers that in the same way light waves are the energy of plants and the information of animals, gravitational waves move stars and inform black holes, the most evolved celestial bodies, which emit or feed on the energy and information provided by those gravitational waves.

Further on, gravitational waves emitted by black holes might reproduce matter on the cores of stars and planets:

If those gravitational waves degenerate easily into quark matter as the jets of quasars show, they could also become converted into matter in the super fluid cores of stars and the crystalline centers of planets, in a process inverse to the Lorenz Transformations; since tachyons acquire more mass when they slow down, trapped by those superfluid and crystalline vortex. Thus, as light is converted into energy in plants, stars and planets will create their ‘amino acids’, quark matter, in those processes. Thus, dark energy, tachyon strings would decelerate into c-speed gluons that would reproduce quarks; (as electromagnetic waves become photons and electrons).

There is also a mechanism by which those planets and stars ‘jump’ or change their spin position under the effect of gravitational waves, as electrons do under a magnetic field: the core of stars are made of super fluid helium and the core of planets of iron crystals, which are the only

atoms that can absorb the energy of a gravito-magnetic field to change its motion.

Finally, all those events will have a ‘why’ in the 4 arrows of the organic Universe; since they would represent the feeding, matter reproduction, informative perception and social location within the galactic or planetary network of celestial bodies, equivalent to the 4 whys of the 4 quantum numbers, described before.

Recap. Gravitational waves accomplish the 6 arrows of time for celestial bodies, as the 4 quantum numbers describe those arrows for electrons.

40. Hierarchical scales between celestial bodies.

The synchronicity between all those cycles, which we established for all systems as a series of symbiotic chains between the bigger organisms and its cellular parts also synchronizes the central black hole with its star system. Let us remember those chains (II,9):

The rules of those complex chains are simple. It is a fact that informative cycles are shorter than energetic cycles, which are shorter than reproductive cycles, which are shorter than the cycles of social evolution of a species. So there is causal chain between the 4 cycles of all entities:

Max. Speed: Informative cycle > Energetic cycle (feeding) > Reproductive cycle > Evolving cycle

Yet at the same time, the smaller the species is the faster its cycles are. So there is a reversed scale:

Max. cyclical Speed: Minimal cells > Organisms > Social systems

This means that cycles of wholes and cellular parts are chained by those different speeds into symbiotic chains; *since the parts need the energy and information of the whole, on which they depend.*

For example, in most cases the feeding/energetic cycle of the whole organism determines the reproductive cycle of the cellular element, which requires the energy of the organism to reproduce and does so much faster than the whole organism; so a cell reproduces each day, which is the time cycle of feeding of its whole organism and so on.

Thus, the ‘slow’ fields of energy and information of the bigger wholes determine the activity of the ‘reproductive and social’, fast cycles of ‘cells’.

Thus in any ‘scalar system’ of parts and wholes, the ‘energy of the superorganism or species of the macro-plane becomes in/form/ation, feeding the inferior scale, causing a symbiotic chains between the whole and the parts. The most obvious, extreme case is the fact that the energy detritus of bigger animals are informative food for lower insects and bacteria.

If we apply this concept to the gravitational waves of black holes, it is obvious that they function as information for black holes but act as feeding energy for stars and maybe planets that ‘grow’, transforming that energy into cyclical vortex of mass.

Further on, the calculated period of those waves show the synchronicity of the cycles/arrows of energy, form and reproduction of the different cellular scales of the galactic superorganism, which are tuned to each other.

Thus we can consider a hypothetical chain between the 3 scales of the Universe, the human scale, the solar system and the galactic scale. The specific event we are studying is the relationship between a fast, informative cycle of a black hole and a medium, energetic cycle of a solar system, which defines a reproductive, heating cycle of planetary systems. According to those synchronic chains, the reproductive cycles of life in planets are related to energetic cycles in sunspots, regulated by the shortest, faster, informative cycle of the galactic Black hole. That curious prediction, dating from 1994 was proved a few years ago:

Chinese astronomers detected that the galactic black hole has a minimal cycle of periodic activity of 11 years... It coincides with the sun spots’ cycle of 11 years, which coincides with the 11 years’ rotational period around the Sun of its bigger planet and main G-wave receptor, Jupiter that has a huge magnetic field, 19.000 times bigger than the Earth’s field and an enormous inner heat coming from its center, still unexplained by conventional cosmology. Yet if the black hole is connected to its stars by those waves that regulate the sun’s

magnetic activity, which feeds Jupiter’s magnetic field, G-waves could explain why Jupiter has a bigger magnetic field, inner radiation and spatial size than any other planet. Further on, the sun’s spot cycles regulate the magnetic field of the Earth and the climatic changes that affect our life with longer cycles of cold and hot weather. We might say recalling a Hindi parable that the blink of Vishnu’s eye (the rotating cycle of the galaxy) is a drop of sweat on the sun (its energetic cycle), which is the whole existence of a human being (a reproductive cycle of the Earth).

Due to the lack of space-time of these lectures we won’t consider in detail the reproductive body of the galaxy, its cyclical sun systems that feed on interstellar gas to create atoms and have also as a ternary topology - the center occupied by the star, a ‘reproductive space’ by cyclical planets and the external halo is the Oort planar sphere of lineal comets. Instead we will deal with the most fascinating cosmic object of them all, the black hole, informative mass-vortex and top predator species of the galaxy...

Recap. The galaxy is self-similar to an organic cell where black holes play the role of DNA-RNA systems and stars, mitochondria. The cycles of feeding, perceiving, reproducing and social structure of black holes and stars are related by gravito-magnetic waves.

41. Black Holes are Wormholes: Bridges between 2 Membranes

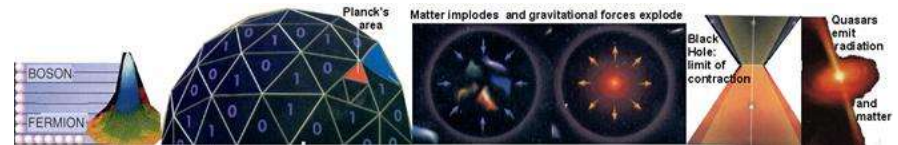

The densest mass-forms of the cosmos are st+1 black holes, which occupy a minimal space with maximal information. The big-bang/big-crunch cycle of quasars and perhaps Universes might find its limit of contraction in the Planck density of a hyper-black hole. Black holes must be studied first as topological spaces with 3 regions; a cyclical, ordered super fluid of top quarks, its ‘cells’ that condensate in a bosonic state (left); a surface or event horizon, belonging to our light-membrane that kills light and absorbs its minimal units st-1 Planck’s areas (center), and a singularity of bosons, gluons and repulsive dark

energy, which a Kerr black hole expels through its polar jets, at superluminal speed. Black holes are therefore wormholes, bridges between the electromagnetic and gravitational membrane.

A quark in the quantum scale or a black hole in the cosmological scale is a door between the 2 membranes of the Universe, the quantum membrane from where it absorbs energy and form and the gravitational membrane to which it devolves it. And the best way to study them again is by self-similarity with its equivalent form of the quantum Universe, a neutron, with an inner center of 3 quarks and an external cover of electronic charge, or easier to visualize, its expanded version: an atom with a proton center of quarks and an electronic cover, which would be the equivalent to the event horizon, *not a part of the black hole itself, but the border of our Universe which the black hole uses to absorb and convert the energy of our membrane into quarks and dark energy.*

Since all doors between membranes are open topological balls, transitional regions, whose external membrane belongs to the external, energetic Universe and its center to the informative network. This, in topology is described with a simple equation: an open ball is one defined by all the points of the ball whose center is 'a' and its border, r, *which are neither r, the external membrane (in the black hole the event horizon) or a, the center (in the black hole the singularity).* For example, a carrier of oxygen, the red cell, is also a door between the external world and the internal organs of the body; and so it is the only cell that doesn't has center and its membrane explodes (it is the shortest living cell) to release the internal oxygen.

Thus, the quark/black hole is a system that transforms electromagnetic and electronic energy into mass-information, as it evaporates our universal membrane; first into simplest quark forms and then into the simplest energy, gravitational dark energy. Our light is a spatial membrane - a cover that warps the stronger, longer, faster dark energy of the gravitational world. And our electrons are the informative cover of the, faster rotating, smaller quarks. As long as light and electrons cover dark energy and quarks, we absorb energy and form from them. But when quarks and dark energy is liberated its

strong forces prey on us. Both ecosystems are thus in a trophic, biological balance:

Our light preys in the faster, thinner gravitational lines that enter galaxies, warping them with a $-ct$ speed measure of corrugation (Special Relativity). Light fractalizes and forms the interstellar dark energy, which slows down from $c < 10$ redshift and warps, acquiring frequency of information.

Yet the inverse role is performed by the black hole, the Non-Euclidean, hyperbolic informative processor of electromagnetic energy into mass that converts our world in the event horizon into a flux of gravitational quarks and dark energy. Accordingly the event horizon can be described as a skin of triangular Planck areas, the minimal unit of the light world, (center top illustration).

In the graph, black holes transform entropy, electromagnetic energy into physical information, quark- mass of maximal order and rotational speed.

This simple topological truth however escapes black hole theorists like Hawking, which believe the membrane belongs to the black hole and evaporates it. Not so, it evaporates our Universe; reason why in 40 years we have never found black holes evaporating. In fact, if we could consider the existence of an inflationary field of information and theories in Physics, is precisely black hole theory, in as much as we have never seen one close enough to observe it and so it is 'fair game' for mathematical physicists to display their 'quixotic imagination' inventing theories with no experimental proof or scientific rigor whatsoever. Let us then consider from the higher perspective of the 4th paradigm of fractal, topological spaces, which of those theories is truth and false.

-Schwarzschild black holes do not exist. Since by definition they do not have rotation and the principle of equivalence states that mass is an accelerated vortex of gravitation. Thus all black holes are Kerr holes. The Schwarzschild metric was the first and hence the simplest description of black holes; like Copernicus, cyclical orbitals were. It looked beautiful at the age, but it turned out that only when Kepler

completed its model putting elliptical orbits, we obtained the right solution.

- Kerr black holes (rotational black holes) have a superluminal, hyperbolic, perpendicular center, which is exactly what the 4th paradigm predicts: a singularity that doesn't belong to the black hole or the light-membrane but it is the 'canon' that shoots out dark energy at 10 c speed.

- All black holes as all stars have rotation. That is the real meaning of the principle of equivalence: acceleration= gravitational force. But there are only 2 types of accelerations, lineal and obviously that is not a black hole. So a black hole is a cyclical vortex that has rotation, And since the acceleration continues beyond the event horizon where light rotates at c-speed, inside the black hole light has to accelerate faster than c-speed.

And this according to the Lorentz transformations and the theory of multiple time-spaces means that light 'dies' in a big-bang, splits into its informative, photons and energetic gravitational strings and enters the black hole, creating two processes:

-The photons and electrons that collapse in the event horizon, continue its mass-increase deviating lineal light-speed into curled mass speed ($E=Mc^2$), and so they become transformed in quarks, and further on into strange and top quarks, rotating at 10 c speed as they come closer to the hyperbolic singularity.

While light is no longer light, red-shifted by the gravitational black hole till it becomes pure, lineal gravitational, bosonic strings, which accelerate also till reaching the Kerr singularity.

So all black holes are Kerr holes; the real ones. All have a central superluminal singularity that belongs to the gravitational membrane and acts as a hyperbolic 'cannon' that shoots up dark energy through one pole and quark matter through the other. That is what we see in all black holes - a bi-jet: the red jet shoots dark energy (repulsive gravitation); and the blue one shoots collapsed quark matter.

And so black holes balance the entropy of the electromagnetic membrane converted into physical mass-information and expansive dark energy, which we perceive not as superluminal speed but as accelerating intergalactic space; reason why physicists think the space is accelerating (but it is contracting in galaxies and blue jets, which do not reach us, so both effects balance each other.)

In other words, the black hole has a selective external membrane border with our world that filters, like any membrane of any non-Euclidean ternary structure, what it does not want – disordered radiation, and accepts what it wants, pure gravitational strings and formed particles that condensate our membrane.

So particles do fall in the black hole, radiation does not, and in this manner the black hole becomes a selective door to the gravitational pure universe of superfluid quarks with absolute order and not vibration in its gravitational membrane (light vibrations do not enter). And so it creates mass information - quarks on one side and dark energy in the other.

Those strings become tachyons that the hyperbolic Belgrami hemisphere in the center deviates and ejects through the Kerr singularity into a flow of dark energy, which is repulsive gravitation at 10 c speed.

While the quarks evolve till reaching the rotational 10 c speed of top quarks and become a top quark star whose pulses of dark energy on one jet and quark mass on the other renew the Universe, returning the light-membrane of >0 T order and $<c$ speed to its original wider membrane of $>c$ speed and <0 T.

And the evaporation of black holes? A false theory, which confuses the thermodynamic, evaporating energy of the event horizon with the black hole inner body. So once this error is solved, Hawking's otherwise beautiful equations merely describe the birth of the black hole as micro-form rotating at enormous speed, which heats up and evaporates our membrane, feeding actively in our world so fast that within seconds of its birth as a tiny black hole it sucks in an entire star creating a supernova (or perhaps a planet if CERN succeeds in

creating them, misguided by Hawking's wrong theory). Indeed, if we use the same equations to explain the evaporation of our world membrane/event horizon we observe immediately that the super-hot membrane evaporates our colder world and as it grows and cools down, it absorbs less and less matter, till reaching a huge size and cold temperature becoming less active. So the birth of a micro-black hole means the explosion of our stars not of the black hole. Why we are so sure of this?

There is experimental evidence: all stars that explode into supernovas leave behind black holes, which must have been born exceedingly small.

All systems of the Universe are born as 'seeds' of microscopic size and grow much faster in their relative youth and then slow down their growth

The equations of Hawking are the same, once the error is solved - only that now they show NOT the speed of evaporation of the black hole but of our world.

If the evaporation of black holes was right, it would break all the key laws of physics: all the laws of relativity; the first law of entropy (a hot object doesn't get hotter as Hawking pretends evaporating our cold Universe; a hot coffee cools down; a hot iron sword evaporates the cold water in the forge; so a hot black hole will evaporate our cold Universe. It also breaks the law of conservation of information, which disappears in Hawking's evaporating black holes. Yet information according to quantum physics and theory of multiple space-times never evaporates.

Finally, and this is the nail in the coffin: we never found any experimental proof of black hole's evaporation. So the theory must be wrong, according to the experimental method

It is however interesting to consider how this theory came into existence to see why in science often a false theory becomes a dogma, for lack of a better paradigm that substitutes it. Here the paradigm is the existence of an arrow of information besides the arrow of entropy in the physical Universe, the arrow of mass. Yet without the 4th

paradigm, physicists feared that black holes broke the dogma that there is only an arrow of entropy in the Universe that always increases. So as Wikipedia explains: 'the only way to satisfy the second law of thermodynamics is to admit that black holes have entropy. If black holes carried no entropy, it would be possible to violate the second law by throwing mass into the black hole.'

Which is exactly what happens: precisely because the arrow of information is inverted respect to the arrow of entropy and the arrow of information exists as physical mass, black holes allow the recreation of order in the universe, making it immortal.

This should be obvious since the law of entropy was deduced in the XIX century studying electrons, molecules and light from our membrane, *not gravitation and mass, the forces that balance it.*

Thus black holes are not an error, which we can 'change' 'ad hoc' but an essential proof of the existence of information.

Yet the proponents of Black Hole Thermodynamics were believers in the dogma of a Universe of 'entropy only'. So to satisfy the dogma, 'Jacob Bekenstein conjectured that the black hole entropy was proportional to the area of its event horizon divided by the Planck area', (Wikipedia). And so suddenly a conjecture which broke all the known-known laws including the 1st law of Thermodynamics, which precedes the 2nd law - since a hot object never gets hotter in a colder environment (the biggest hoax of the XIX C. - a perfect motion machine) - became a necessary truth.

Further on, by accepting this conjecture Bekenstein & Hawking also broke a tenant of the 2nd law- since now information disappeared in the universe! And obviously they broke with Einstein's Relativity Theory and his laws of gravitation (reason why Hawking ended his article saying that 'Einstein was double wrong').

But there was still a problem: How to evaporate the black hole! So Hawking made another conjecture, that small black holes had quantum effects because they were small.

This again breaks the fundamental tenant of relativity and fractal spaces: size is totally relative. Besides quantum and thermodynamic

laws are laws that apply to the electromagnetic membrane, regardless of size and gravitational laws to masses regardless of size. Size has nothing to do with the laws we apply but 'substance. So a small ant behaves like an ant not like a small fungus regardless of size, and a shrew, smaller than some insects like a mammal, regardless of size.

Then, it came up with the idea that a certain quantum effect happened to the quantum black hole: one virtual particle of the event horizon, which he considered the black hole (but it is not) felt out of the black hole and evaporated. This again is absurd because:

- The membrane is the frontier between two open topologies, but its properties are those of our membrane, it is therefore part of our electroweak membrane, so it evaporates our membrane.

- Because we are in a vortex of accelerated gravitation (Equivalence Principle), the gradient of forces is towards the black hole so there is more probability that one particle falls into the black hole than out; as it is easier than a feather falling into a sink vortex enters the sink than gets expelled of it.

Thus when you reach those 'real' conclusions, the membrane is our universe and the particles condensed by quantum effects fall into the black hole, evaporating our universe. Then we use Hawking's radiation formula, but now it is showing the speed of evaporation of our membrane under the first law of thermodynamics (our colder membrane gets hotter) and evaporates swallowed by the black hole.

Recap. Black holes do not evaporate. They are vortices of gravitation that transform our electromagnetic world into dark energy and quark-mass, establishing a balance of order with the entropy of our Universe and making the Universe eternal.

42. Black holes are Kerr wormholes and frozen stars.

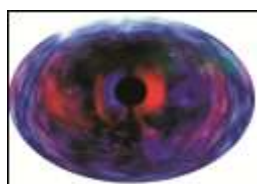

Quark holes can be studied, once we understand their 'higher why', from the perspective of topological spaces and multiple spacetimes, which limit is possible species and processes, either as top quark stars (frozen stars in the jargon of Einstein),

or as rotational masses with the Kerr Metrics; or from the many perspectives, of its structure as a system co-existing within 3 relative st-planes of existence. In the graph, its 3 topological regions.

Any organism extends through 3 hierarchical scales. For example, a human organism is composed of cells and carbohydrate molecules whose minimal unit is the amino acid. In the Universe there are 3 scales of mass and each of those 3 scales become the fractal parts of the next scale. In each of them we find an informative, cyclical type of mass: quarks in quantum atoms; black holes, which should be top quark stars in star-size black holes; and swarms of black holes in hyper-black holes at the center of galaxies and perhaps the Universe. Thus a hierarchical organic structure grows from those inner parts: its strings become gluons that become quarks that become black holes that form hyper-black holes, in a stair of fractal systems of increasing complexity. This is proved by the fact that the Black hole's event horizon membrane reduces light to its minimal bytes of information (Planck's areas), whose length is the minimal length of strings, which they *extract from light*. Since strings are both the theoretical components of black holes and strong forces, quarks and gluons, a description of black holes with tachyonic, bosonic strings becomes the mathematical bridge between both scales. Thus indeed, black holes are fractals of quarks, fractals of gluons and strings (mind the reader though that those strings have fractal dimensions, are background independent, tachyonic strings, defined by the Nambu's actions, not superstrings, a baroque fantasy of Pythagoric Physics).

Each of those scales becomes the informative center that interacts with a reproductive body of electromagnetic electrons, stars and galaxies. Let us then study black holes in their interaction with its bodies, galaxies that explode in its big-bang death as quasars.

To regulate that body black holes emit dark energy through its poles, creating the membrane of gravitation that 'positions' stars, as protons position with their gravitational and magnetic fields the electronic nebulae. Since gravitational Space-time is formed by the maximal informative entities of the 2 scales, protons and black holes. For all those reasons, we prefer the names:

-Frozen stars (Einstein's name), since they are top quark stars.

-Kerr's holes; since this is the rotational metric or black holes.

-Or wormholes, because it expresses the fact that the black hole is a door to the other 'world' of dark energy, which it emits. While the name black hole, invented by Wheeler, to substitute Einstein's name after his death and push in this manner his singularity theory, implies nothing is emitted by the hole.

In that regard, science when it is built to respond *all* the questions that exhaust the truth of the system, the what (experimental evidence), the who or how (causal logic), the when (metric spaces) and the why (topological time arrows) *has also an inverse hierarchy of truth*: Once we determine *what* we want to study, we must observe its *why and how* – its topological structure and causal logic combined (how/who) – and only then enter into the details, analyzing with clocks and instruments of science, its metric properties. The excessive use of machines of measure, overdeveloped by the Industrial R=evolution has obscured that hierarchy, which limits with the *experimental what*, and the *why and how of topological time arrows*, what things are certain and what are just mathematical fantasies of 'baroque artists' of metric spaces, which are so common in the study of black holes due to the lack of experimental evidence on its details. Let us then study reality as it is, not as 'Touring machine' resolves it with an excess of metric information that ignores the deepest why and necessary laws of the why-universe.

Frozen top quark stars.

Frozen stars are similar to nucleons: huge condensates of top quark-mass that create vortices of gravitational information with a negative curvature in the dimension of height. Hence, they exist in a discontinuous gravitational Universe beyond the c-speed and 0 K limits of energy and information of our Universe, emitting and absorbing dark energy at higher than light speeds and ultra-cold dark matter, perfectly ordered, probably under 0 Kelvin. In that regard, the closest species to a frozen top quark star is a neutron star, composed of super fluid neutrons and strange liquid in a bosonic state, occupying a

minimal space. The difference of density between a neutron star and a Top quark is small. So a Frozen top quark star could be the next evolution of a strange quark star with a 'lighter' cover of strange quarks on the event horizon, 'breaking=killing' the symmetry of our matter, packed then in a bosonic, super fluid solid state of bcb atoms and top quarks. Since the sum of the transitional weak bosons, Z and W equals that of a top quark. Thus: $n+p=Z+W=Top\ quark$.

The 2 poles of the wormhole.

Thus the main error about Worm Holes is the idea that since we do not see them emitting energy and matter-information at lower than c speeds, nothing escapes a Worm Hole. This is a theoretical absurdity (things don't 'disappear'), which now has empirical proofs of falsity. Since we observe vortices of mass and radiation that surround Worm Holes, reaching super luminal speeds before dying into pure gravitational energy according to the Lorentz transformations. And we observe bursts of matter and radiation coming out of the poles of central Worm Holes in quasars at super luminal speeds. So Worm Holes do emit dark energy and information at super luminal speeds through its 'axis', as atomic nuclei emit magnetic fields in their rotation.

The Relativistic equations of Worm Holes show that duality since Worm Holes appear with 2 solutions: one with implosive, informative parameters and the other with explosive, energetic parameters. Thus according to those equations a Worm Hole 're-absorbs' radiant matter and light, dissociating the photonic particle-state and wave state of light, hence 'killing it'. both beyond their Lorenzian limits of c-speed, back into its ultimate components: photons evolve into electronic nebulae, and then collapse further into quarks, which become part of the Worm Hole body or are ejected as quark beams; while light reaches infinite red shift and becomes dark energy. Because the parameters of density of a stable black hole are self-similar to those of a top quark star, and that is the limit of density of mass in the Universe, it is easy to infer that black holes have in its center a super-fluid vortex of top quark stars; and so we can consider dark energy to be the 'gravitomagnetic field' of those top quark stars.

As in the case of the 3 solutions of Einstein's space-time, which correspond to the 3 ages of the Universe but physicists dissociate in 3 different Universes in space; physicists have deduced that those 2 solutions to the Worm Hole equations create 2 different type of 'black and white holes'; when according to space-time duality they represent the 2 organic regions of the same gravitational hole. Hence we could call Worm Holes also 'mulatto' holes (-;. Though we will use the term *wormhole*, more familiar to cosmologists. And define its $E \leftrightarrow i$ Generator equation:

Worm Hole (max.E: external membrane: event Horizon)
<Wormhole> White hole (max. i: Kerr ring)

Quantum cosmologists never discovered white holes as independent entities, because they are part of the wormhole.

Topological regions of a worm hole.

Unfortunately quantum cosmologists ignore the inner structure of a gravitational hole as a fractal point with 3 zones that explain them:

- *Max. E: The event horizon* at c-speed is the energetic Riemann membrane that absorbs radiant matter, breaking it into its minimal units, 'Planck's areas' that become the strings of dark energy that feed the hole.

- *E=i: The intermediate zone* transforms radiant particles and energy into quarks and dark flows of gravitational energy. It seems to be a super fluid solid: a vortex-like structure of quark condensates and gluons.

-- *Max. i: The central region around* the polar axis or central, informative, hyperbolic, negatively curved nucleus.

That informative center is the final 'eye' of the gravitational hurricane, the white hole of the wormhole. It emits through its poles energy and information in the form of dark, quark matter and gravitational waves of dark energy in super luminal jets that we observe indirectly around far away quasars, as they become again slower radiant matter, creating irregular galaxies. Thus white holes are the poles of wormholes, which indeed are the doors to the gravitational

world of dark energy and quark matter that dominates the Universe, as cosmologists have discovered.

The equations of a wormhole show how it transforms the spatial, energetic parameters of the electromagnetic world into the inverse, informative parameters of the gravitational world, since a wormhole is an ultra-dense mass of highly ordered 'bosonic nucleons', packed into a single point of space...

Continuous physicists used to believe that the accelerating vortex reached infinite energy values in the central point or singularity, since they do not model masses, charges and Worm Holes as physical vortices of mass with a Radius, R_0 , that represents the discontinuous limit between the external, body cycles of the Non E-point and its inner, still, informative region or brain, in this case between the vortex of stars and the still Worm Hole brain. Yet because infinities cannot be calculated they renormalize their equations beyond a certain limit in which they postulate 0 charge or 0 mass.

In fractal cosmology those tricks are not required as wormholes are modelled with Non-Euclidean topologies, which have always 3 regions separated by asymptotic membranes.

Thus fractal theory solves the problem caused by continuous infinite singularities, as Planck solved the problem of continuous, infinite temperatures, when he introduced fractal light quanta.

In organic terms, beyond the event horizon of a Non-Euclidean point, the Klein disk starts and beyond R_0 , a discontinuous, inner radius separates the body from the informative, still brain.

In the galaxy the event horizon is the halo and this final radius is the horizon of the wormhole. In the atom, those 2 horizons are the external Electronic radius and the inner Bohr Radius, beyond which we find the protonic Worm Hole.

The same pattern of 3 regions is found in a Worm Hole as a Non-Euclidean point. The event horizon is the external membrane. Then the point in which the equations of a Worm Hole reach $T=0$ is the inner R_0 radius.

(This is the point in which Hawking says Worm Holes become negative in time and convert themselves into time machines)-: We already argued Mr. Hawking's confusion of physical time, a change in the direction of motion, $v=s/t$, and absolute time, a hyperbolic error of the Cartesian graph. Time in physics is change in the direction of motion. So what $T=0$ means in a Worm Hole is that we reach the region in which the cycles of the Worm Hole's body end and we enter the hyperbolic, high central tube that ejects dark energy. At this point time - understood as change in motion - halts and the Worm Hole enters the white hole region of production of dark energy, asymptotically perpendicular, with the form of a Belgrami cone.

The equations of Worm Holes show also their event horizon as a bidimensional *killing* field that destroys the entropy of our Universe, since it kills our energy/matter into its ultimate units on the Planck's scale, *lowering as in all processes of death our components two scales down into its fundamental physical units.*

In the biological homology, a human being is composed of cells themselves composed of amino acids that act as the minimal units of life. So when an organism dies it suffers 2 deaths: first its cellular tissue is broken into pieces that feed the stomach of an organism, which will destroy it till its minimal amino acid units, used to recompose the organism's own cells.

When we study mathematically Worm Holes they show also a dual process of destruction of light matter to its ultimate components, Planck areas or strings, used then to reconstruct the bosonic quark condensates of the Worm Hole and its dark energy.

Thus Worm Holes in their feeding processes destroy light matter till it absorbs its Planck's areas, the minimal units of information and energy of our physical space-time, the equivalent to the amino acids that the stomach absorbs.

Then those Planck's units, become lineal tachyon strings to form dark energy and cyclical strings or gravitons, the minimal units of the mass world, evolving into bosons and quarks.

Those quarks and dark energy is then expelled through the poles *to balance the expansive entropy of our membrane and create an immortal Universe.* Indeed, the expansion of space-time in the Universe is cause by the expansion of dark energy coming out of the Kerr worm holes' poles; yet black holes also implode light into quark matter and the overall process creates a wobbling, dynamic balanced, zero-sum of fractal expansions and implosions, in a Universe that will never die.

Recap. We define a rotating *wormhole* as an organic topological structure, which uses the event horizon membrane to absorb radiant matter and energy through its central, ventral plane, which transforms it into ultra-dense top quarks and gravitational dark energy, expelled in perpendicular jets through its central, hyperbolic axial *white hole's* pole used to control the body of galactic stars and communicate with other Worm Holes.

43. The Existential Cycles=Time arrows of Wormholes.

Wormholes follow the 4 energetic, informative, reproductive and social arrows of all existential systems of reality: They feed on electronic matter, nurse galaxies and stars, and reproduce in momentum collisions with them, evolve socially in super-Worm Holes (galactic center swarms), and as the 'long-lasting' informative neurons of the galaxy and Universe, whose networks they create, its generational cycle lasts as long as the entity that hosts them (the same happens with neurons, the informative network of our body that last between birth and death). Let us study those arrows in more detail:

- *E>I: The main cycle of a Worm Hole is informative.* It creates quarks from electroweak matter and orders the galaxy into spiral forms through gravitational waves that 'position' the stars while symbiotically feeding their centers with energy that degenerates into matter. Thus the worm hole emits dark waves of gravitational information to control the galaxy.

Those informative waves of Worm Holes fed the energetic needs of stars, which therefore become chained to those waves without knowing its final demise - as gravitational plants, guided and herded by Worm Holes towards the center of the galaxy to feed them:

- *I<E*: Their energetic cycles balance the entropy of the light-world. Wormholes first erase light and radiant matter, feeding on gas and stars; and then renew it, creating new jets of pure dark, gravitational super luminal Energy and quarks that enter back into our Universe as light and protonic matter. If insects eat dead matter to renew the Earth's ecosystem, the wormhole inverts the time/space coordinates of the light-world to renew it. They act as 'the antiparticles of the white cosmos' that annihilate radiant matter. Kerr worm holes absorb energy from our light membrane by red shifting light, with different signatures according to their relative mass. The background radiation must be interpreted as the signature of 2.7 'background holes'. Bigger, older Kerr worm holes of galactic mass are below the Background radiation curve and so they *can red-shift and absorb electromagnetic energy from it, feeding in this manner on the electromagnetic membrane*. For that reason the galactic map of the background radiation has a central zone, with lower temperatures corresponding to the giant central, colder worm hole.

- *Reproduction*: Wormholes control the reproduction of stars, which in turn reproduce wormholes. Since when a small wormhole crosses through a star, it catalyses its explosion into a nova that leaves behind a neutron star or a wormhole. On the other hand, the 'reproductive DNA center' of giant galaxies is a massive wormhole structure that emits huge super luminal jets of quark matter, which catalyse the reproduction of stars, creating irregular baby-galaxies.

- *Social evolution*. The wormholes that occupy the informative center of galaxies are like the nuclei of cells, swarms of Worm Holes, which regulate the life of galaxies, as DNA does with cells. In the next scale, the dark energy flows ejecting by galactic black holes communicate galaxies, creating the networks and walls we observe in the grand scale images of the Universe.

Recap. Black holes follow in their events the 6 arrows of time. They feed on the electromagnetic membrane and its species; they perceive gravitational information; they reproduce stars and galaxies and they evolve socially into swarms in the center of galaxies and into galactic networks in the Universe.

44. The 3 organic roles and types of wormholes in galaxies.

By homology with any other non-Euclidean space-time that resembles a cellular organism, and the *Laws of ternary differentiation of all topological species*, we can consider 3 types of wormholes whose roles within the organic structure of galaxies will obey *its arrows of time but will also become essential to the bigger organism in which they exist*.

This simple rule, which we shall apply to all systems, is a tenant of the organic structure of the Universe – we differentiate species in ternary sizes, ternary topologies, ternary ages and ternary functions, which must be symbiotic to the higher st+1 organism in which the entity exists or else the organism would not 'tolerate' the presence of the microcosmic species with no function:

- *Intermediate, reproductive E=i zone: Spiral arms*. Non-rotating wormholes are born from dying stars. Then they form bi-polar systems with other stars feeding on them, taking advantage of their gravitational control, finally transforming the biggest stars into new wormholes. Those wormholes probably gather into social groups, which fuse in bigger wormholes and move towards the center of the galaxy where they can feed easily on its dense herds of stars, creating at the end of the process a central nucleus.

- *Max. information: Nucleus*. The Worm Hole nucleus is a huge rotational, 'Kerr hole' or perhaps a herd of Worm Holes similar to the DNA nucleus of a cell. It is the informative brain of the galaxy that controls its fractal beings, the stars, with gravitational waves that shape the rotating movement of the galaxy, and establish its feeding rhythm: The galactic Worm Hole first attracts interstellar gas to the intermediate non-E region, where gas reproduces stars, and then it sends that gas to the central wormhole that consumes it. In the same manner, electrons, the 'stars' of the atom, feed first on light quanta and then emit high-energy photons to feed the atomic nucleus.

Those gravitational waves also guide in old, globular galaxies, the stars toward the feeding center. Yet there might be other structures of dark matter, coming out of the nucleus, similar to the Golgi apparatus

of cells: invaginations through which wormholes might flow into external zones of the galaxy to control the reproductive and destructive processes of stars.

Finally, the central hole emits through its polar zones, dark energy, super-luminal gravitational waves that probably communicate galaxies at super luminal speeds, forming the strings of galaxies observed in the Universe. Since according to string Theory gravitation in free, intergalactic space is not warped by electromagnetic branes that feed on them inside galaxies and limited to c-speed.

- *Max. E: Membrane.* Though we cannot see the galactic membrane made of dark matter, by homology Non-Euclidean topology hypothesizes that the halo is the energetic membrane, where small wormholes called appropriately MACHOS, have functions similar to globular proteins in cells:

They create and control that galactic membrane of dark matter, which closes the galaxy as a black body; causing the background radiation, which according to recent empirical data might be local: They redshift light to 2.7 K, which becomes the metabolic temperature of the galaxy. They reproduce new stars and expel matter and radiation beyond the membrane: Since their rotation is perpendicular to the galactic plane they could create a positive or negative spin, depending of its orientation, provoking flows of energy and information in and out of the galaxy. Those outward or inward flows fine-tuned with the dark energy jets of the Worm Hole should move the galaxy at the will of the central Worm hole

The interaction of the membrane and the central Worm hole should encase all other species as a perfect Max. E x max. I 'upper class' of the galactic organism in complete control of its inner parts.

Recap. Three are 3 types of worm holes, which control the membrane, inner center and herd the stars of the galaxy.

45. The big bangs of the 3 types of wormholes

The homology between the 3 sub-species of Worm Holes and the 3 regions of a galaxy explain the 3 possible scales of feeding and big-

bangs of those Worm Holes; and the *functions of the lesser electromagnetic species for the top predators of the galaxy:*

- Micro-Worm Holes, Background MACHOs would eat up the commonest celestial bodies, planets and moons. This is our function; and the fact that we do not hear intelligent life in the galaxy and that CERN is going to do black holes to 'see' if they evaporate could explain how indeed, all moons become background MACHOs and all planets are blown up by 'metric physicists' unaware of the 'why' of black holes, stuck in the 3rd paradigm of using machines to measure the when of reality. This smaller worm holes would then migrate to the Halo of the galaxy closer to our planet.

- Medium Worm Holes formed in dense star centers, feed on them, causing supernovas, creating intermediate Worm Holes that migrate toward the center, forming the DNA nucleus of the galaxy.

- While galactic Worm Holes would explode into quasars, (galactic big-bangs). And/or as 'dark galaxies', recently found elsewhere, without emitting light, migrate towards the 'Great Attractor' or hyper-black hole at the center of the fractal 'cell' of the Universe in which we exist.

Recap. We might be just food for worm holes, which are born and feed on the 3 scales of electromagnetic matter of the galaxy: planetoids, stars and entire galaxies.

46. The Worm Hole as a Gravitational, Informative Mind.

The center of the galaxy is occupied by a giant wormhole that seems to be the final, social, evolutionary stage of multiple galactic Worm Holes, born out of the evolution of stars. It acts as the gravitational DNA-mind of the galaxy - a hypothesis, which mechanist science will always ignore. But we want to stretch your understanding of the 4th 'why'-paradigm, describing those mind holes with the laws of Non-Euclidean geometry and superorganisms.

A galactic wormhole is a rotating object, which has a minimal spatial size and a huge dimension of height since it is made of bosonic, super fluid quark condensates. Its homology with a cellular, informative center, defines a central galactic wormhole as an enormous

gravitational informative center, which controls its galactic body, positioning its star quanta through gravitational waves. In fact, when we calculate the wormhole's informative parameters, it turns out to be a perfect super fluid computer, with maximal informative volume since its speed of calculus equals its speed of transmission of information.

The coldness of the wormhole proves also the informative hypothesis: In fractal space-time coldness means order, stillness, necessary to create in the center of a crystal or a cryogenic CPU, or a super fluid wormhole or the focus of an eye, the informative, bosonic accumulation of pixels that shapes a still, formal, fractal virtual image, without friction, without blur. Thus, the eye of man is cold. The brain is colder than the blood. The chip works better at cryogenic temperatures. And a wormhole is very cold, made of quarks in super fluid, highly ordered states.

Wormholes do create a complex virtual image of the galaxy with its strings. Physicists explain those processes in abstract when they affirm that a wormhole has an extra 5th dimension and its equations are homologous in 5 dimensions to those of the 4-dimensional electromagnetic world of the galaxy it represents (Maldacena Conjecture). *The description in 5-string dimensions of a Worm Hole is completely equivalent to the description of an electromagnetic galaxy in 4 dimensions. Thus as our brain has a 'homunculus image' of the entire body, which is what we perceive; the worm hole can build a 'galaxulus' image in its interior.* The 4th 'why' paradigm provides the reason of the conjecture: the 5-dimensional world of string holes is equivalent to a 4-dimensional world; because *it is the map of our galaxy, made by the Worm hole's mind.*

In topology the central zone of any st-point is an informative region, whose dimensions are the sum of the body and membrane dimensions. In cosmology the galaxy is a body-like vortex of reproductive stars and the central wormhole is the eye of the vortex that creates an image of the galaxy, as the brain maps out the body.

The hyperbolic center of higher form/information has more dimensions than the energetic bidimensional membrane and the

reproductive toroid; since it holds the holography that combines the image of the external world imprinted in the 'senses' of its membrane, and the image of its internal, reproductive functions it commands. Since our galaxies have an external bidimensional halo and an internal 3-dimensional vortex of stars (a bidimensional plane with an added dimension of rotational motion), we can easily calculate with the general laws of the Holographic, central mind, the dimensions of a black hole:

Bidimensional external membrane +3-dimensional cyclical volume:

5-dimensional hyperbolic nucleus.

This simple law derives of the general law of dimensionality of the 3 regions of a Non-Euclidean topology:

Information of hyperbolic 'brain' = Information of Klein's 'body' + Information Riemann membrane

And it is the origin of the Maldacena Conjecture (a black hole, informative center of the galaxy has in 5 dimensions the same structure than a galactic mapping in 4 dimensions.)

What this means is that the Worm Hole must have an inner image of the galactic body, which it orders with its gravitational flows and an external image of the Universe in which the galaxy, its body floats, to direct its form toward fields of energy (intergalactic gas) and connect itself with other galaxies. This is what we observe galaxies do. They form walls, strings and complex clusters with other galaxies and they feed on intergalactic gas and smaller galaxies. So they act as cells in a gravitational, organic soup and must have as cells and organisms do an informative, processing center able to have an internal image or mapping of its stars and an external connection that informs it of the outer world. However, we see only a 4% of the galactic structures; *the rest is the dark energy and dark, quark matter that the worm holes perceive to map out reality*, which is like trying to recompose a cell, in which we only see its mitochondria.

Another proof of this higher dimensionality is given by the Kaluza-Klein models, which explain our perceived electromagnetic 4-dimensional world and the 4-dimensional gravitation over which the

network of light is imprinted, as if they were born from a larger 5-dimensional gravitational world. Finally, gravitons are the only particles that can have 5-spin positions=informative dimensions. Thus, all those self-similar theories point out to the fact that we are a floating membrane within a bigger, faster, more complex Gravitational Universe.

Recap. In fractal cosmology the central discontinuous zone of a fractal point is an informative region. This is the role of Worm Holes in galaxies, forming with other Worm Holes, communicated through flows of dark energy, the informative network that controls the Universe. Therefore it has the dimensions of its membrane and inner body of stars.

47. Background Radiation: Basal Temperature of the Galaxy

As any system can go in more detail, by looking closer to its fractal parts, we can go deeper and deeper in the analysis of the whys (biologic and topologic), whens (mathematical and metric), how/who (Logic) and what (experimental) questions of knowledge. Let us consider thus in more depth just one of all the elements of the galaxy studied here – the organic role of the background radiation - *the water of the galaxy...*

The background radiation coincides with the radiation of a black body at 2.7 K degrees. Since in Non-Euclidean topology any fractal point is a black body; that is, a point with minimal apertures to the external world, a galaxy will only emit background radiation through its Halo, in which background holes will redshift light at 2.7 K. Thus the galaxy surrounded by a halo of quark, dark matter can be considered a black body emitting at present time as an isothermal organism does a background radiation, whose organic function is to maintain a homogenous temperature, similar to the organic temperature of living beings and ecosystems, kept by its water. Thus, the background radiation acts as the cytoplasmic energy of galaxies with 3 functions:

- Max.E: It provides energy to its bigger, colder Worm Holes and its super fluid helium structures (not treated in this introduction to complex cosmology). Both happen to have a temperature slightly

lower than the background radiation from where they can extract energy.

- E=i: It acts as the membrane limit, between the gravitational and electromagnetic membrane, within the galaxy, separating both worlds. It maintains also an isothermal temperature, as any organic system maintains a stable temperature.

- Max. i: It establishes a fixed frame of reference for the galaxy, *allowing the process of information and measure, location and communication defined by Gauge Theories.*

The background radiation is the ‘energy soup’, the cellular water of the galaxy that feeds its dominant RNA, its Worm Holes; as the hot water of the cell allows RNA molecules to move, kicking left and right water molecules with its COOH legs. Indeed, we know that only organic systems have a homogenous temperature. For example, humans have a homogeneous temperature within the limits of liquid water. So the 2.7 K homogenous background radiation reinforces the organic hypothesis.

Quark matter is *the top predator form of the galaxy; hence they are the entities which, as the elephant on the savannah or man on Earth, or aerobic bacteria in the earlier planet, have redesigned the galaxy with their organic activity.* In Gaia, water, the equivalent to that background radiation, maintains a stable temperature, thanks to the feeding, energetic activities of its life organisms that avoid abrupt climatic changes. Without aerobic life the Earth would be like Venus - a planet with extreme temperature changes. Now it is almost isothermal. So happens to your body which has 36.5 degrees all your life, due to your organic activity as a water organism with 2 networks, a warmer blood and a colder, nervous, informative system.

So happens to the galaxy, in which the basal temperature of the background radiation separates the ultra-cold world of Worm Holes and dark, gravitational matter and the hot world of atoms and radiant matter, allowing the exchange of energy and information between the 2 physiological networks that structure the galaxy.

Recap. The background radiation is the energy soup, the cellular water of the galaxy that feeds its dominant RNA, Worm Holes.

48. Non-E Structure of the Universe.

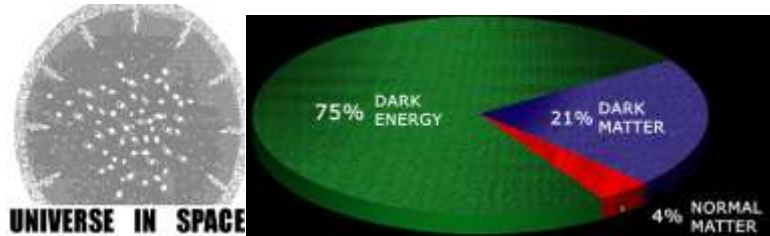

The Local Universe seems to have a dual network structure—electromagnetic energy and visible matter vs. quark, dark matter and dark energy, which forms its faster networks of information, the membrane of gravitation. It is the organic hypothesis of a Universe made of 2 networks of dark matter and light energy - cellular galaxies, which form a simply connected system, similar to a colonial tissue, with the apparent form of a semi wave in grand scale images perhaps, belonging to a bigger Hyper-Universe.

We have now showed the general structure of the different systems of energy and information of the Universe. So we can focus in the analysis of the two main systems studied by mankind – the astrophysical Universe, and the biochemical world of humanity. Both should, according to the previous analysis share the same properties and arrows of time, albeit with different quality and amount of ‘complex information’ and ‘simplex energy’. Let us then briefly introduce those 2 systems and their self-similarities.

In the graph, a self-similar analysis of the 2 superorganisms studied in this work, the Human organism and the Universe.

Despite the enormous difference of size and metric details, they are both topological, fractal organisms with the same elements of all organic fractals. Since reality is a self-generating topological Fractal of infinite beings made with 2 arrows of Time: energy and information, whose self-similar properties emerge invariant in topological form in all scales of reality. Thus all organic fractals, including man and the Universe have 3 elements that define them:

- Its cellular units, (galaxies and cells).
- Its networks of energy (blood and radiant matter) and information (nerves and dark matter) that organize those cellular units.
- And the relative space-time planes in which a self-similar but not equal fractal structure re-emerges.

On the left, man is a fractal made of cellular units and networks of energy and information (nervous and blood systems), whose cycles and functions extend through 3 hierarchical, organic planes of increasing size: the cellular, individual and social plane.

On the right, the Universe is also a fractal, structured in 3 planes of self-organization: its cellular units are stars and Worm Holes that shape 2 galactic networks of radiant energy and informative, dark matter; st-points of a cosmos at ‘grand scale’ (the points on the picture). The final form is self-similar to a wave, perhaps inscribed into a hyper-Universe.

How can both worlds/networks co-exist together? In continuous space-time they can’t but in discontinuous space-time where a ‘dimension’ is fractal, hence it is a fractal network, it is rather easy:

The light Universe is a network, like a fishnet floating of an immense sea of gravitational energy. Each knot is a charge, a non-E point that communicates through the strings of the net (the electromagnetic forces), leaving a huge dark ‘space-time of ‘water’ - that 76% of gravitational dark energy - which is not ‘illuminated’ neither interacts with the fractal net of light.

Some Physical theories describe fractal space-time in that way, calling the fishnet a ‘brane’ made with cyclical, temporal knots (spins or closed strings) joined by flows of its lineal, energetic exi actions/forces that tight together those knots.

Recap. The Universe sandwiches mankind between both membranes of space-time, the quantum membrane of electroweak forces and the gravitational membrane of strong masses. Yet both membranes obey the same laws of Multiple Spaces-Times. Thus, regarding their morphological structure both membranes possess organic, complementary systems with the 3 topological standard regions /forms of a fractal point.

49. The Universe is a spatial organism.

Any Fractal point, according to duality, can be described in space as a fractal point with a relative energy body and an informative center, communicated through 2 forces/networks of energy and information. And it can be studied in time, through its 3 evolutionary ages, between life and death, as its energy becomes curved by time and increases its form, creating in the case of the cellular Universe, new informative particles and galaxies. Though both perceptions of the Universe are correct, cosmology ignores the organic, spatial description of the Universe, which completes the evolutionary, temporal vision, obtained through light instruments - since it cannot see dark energy and non-local gravitation. Yet if we were to perceive that Universe with the instantaneous, non-local gravitation that reaches its limits, it will seem as a complex st-point structured by an external membrane (the wall of fire), an internal self-reproductive space of galaxies and an informative hyper-worm Hole center (the great attractor?), all coordinated by the non-local forces of dark energy.

Recap. The physical Universe is structured in 3 scales of reality, the quantum world of electromagnetic forces and the gravitational world of masses. Both can be modeled with the laws of super-organisms, whereas the electromagnetic forces/planes act as the energy network of galaxies and atoms and the gravitational forces/masses as the in/formative force that balances the entropy of electromagnetism, creating a complex, organic Universe of eternal motions and balances between informative gravitation and entropic electromagnetism.

50. The cellular Universe.

Galilean relativism (*epur si muove, epur no muove*) implies that depending on which kind of energetic or informative force we use to observe certain reality, we will perceive it either as a fixed, spatial organism (the Universe perceived with gravitation) or as an evolutionary species in motion through time (the Universe perceived with slow light). So we see either a moving Earth and a fixed cosmos, when we see them through gravitation, or a quiet Earth and a moving Universe when we see them through light. Since gravitation, the force that shows the spatial, synchronic Universe is invisible to our instruments; astronomers only study a temporal, diachronic Universe,

perceived with light. However there is a universal organism in space, self-similar to any other Fractal point. Since once the evolution of the hypothetical cellular Universe concluded in time, creating the 3 regions of any fractal point, the Universe structured itself in space, communicating those 3 regions, through simultaneous non-local gravitation.

Let us then study those 2 sides of a hypothetical cellular Universe - first the spatial, organism of the Universe and then the temporal ages of creation of that Universe in the next paragraph.

If we perceive the Universe from a temporal perspective through its slow force, light, it appears as an evolutionary process of matter, coming out from the genetic 'big bang' singularity of a local, cosmological first cell - the hyper-dense singularity of the big bang (which went afterwards through a cold, reproductive 'big-banging' or creative, informative process, later studied in more detail).

Yet, when we observe the Universe simultaneously in present space (first picture of the previous graph), thanks to its faster force, gravitation that allow the parts of the Universe to interact, those far away regions become integrated with its closer regions through the informative networks of dark energy, NOT through the light, energetic networks of galaxies and stars, explaining its homogeneity. Again this is a generic law of complementary systems, as any organism is defined by its informative, nervous network that gives it its form.

Of the two possible 'scalar' theories of such Universe, one of infinite scales in which galaxies are atoms, and one in which universes are fractal 'cells' of a hyper-universe, broken in 'bubbles' of a fractal inflationary big-bang with a limit, the first one would imply a huge universe, in which we are just a 'hydrogen-like atom' of an enormous interstellar cloud. The second theory however would imply a structure within our 'cellular Universe', in which non-local, faster than light gravitation creates an organic Universe, structured as a fractal point, with its 3 canonical, topological, Non-Euclidean zones:

-Max.i: The cellular Universe should have a nucleus of enormous gravitational mass, a hyper-worm hole, connected to a network of dark

matter, which acts as its informative brain, since it forms through non-local gravitational forces the shape of its galactic networks, as the DNA nucleus of a cell controls the form of the organelles that reproduce its proteins. Though the nucleus is a gravitational knot invisible to us, we have found a very dense region of dark matter called the Great Attractor towards which many galaxies, including ours move, which might be that center. That informative singularity will keep growing and attracting other galaxies in a generational cycle, till it explodes again its form into energy in a physical big-bang, similar to the one that might have created our Universe.

-*Max.E*: An external energy membrane not to confuse with the galactic light background radiation and the dark energy spelt by galactic Worm Holes, (which quasars show to reach a limit speed of $C < v < 10 C$ redshift). There are hints of this possible final wall in measures of dark energy expansion over $10 C < V_2 < 100C$ at the limits of the Universe. But proofs are scant as we need better telescopes to obtain them. Thus we shall call this dark energy, the super dark energy, or next fractal scale of lineal forces.

- An inner E/T region with galaxies that reproduce matter and light. It is the visible space-time created, according to the duality of physical big bangs/big bangings: after the invagination of the inner nucleus of dark matter that clearly directs the movements of galaxies. In this inner region dark energy at $C < V < 10C$ communicates galaxies; while radiation matter is the food of dark matter. Thus galaxies form an energetic, electromagnetic network of galactic mitochondria, which reaches its maximal density in filaments of galaxies, (near the center of the Universe).

Such cellular Universe has an energetic, electromagnetic network of radiant matter similar to the blood network of a living organism, which weighs only a 4% and reaches its maximal density in the external membrane and the filaments of stars, (center). And it has an informative, gravitational network similar to a nervous network, which reaches its maximal density in the hypothetical hyper-worm Hole, brain or central singularity of that cellular Universe, the Great Attractor. This network weights a 21%. Both feed on the intermediate

space-time region of gravitational space-time (dark energy, which is the 75% of the Universe and acts as the 'water' of the Universal organism, also the maximal weigh of a living being; or as the background radiation of the galaxy, also its most common substance). This coincides with the general rules of proportionality between spatial bodies and informative heads, which are in a 3 to 1 proportion. That is, indeed the proportion between radiation pressure and mass; dark energy and dark matter, and many other informative/energetic parameters of the physical Universe.

The cellular Universe as a fractal part of the higher structure.

The grand scale images of the Universe show a structure with the form of a half wave, which can be anything in that upper scale, from a half light wave to a worm like micro-organism.

It might also be possible that as stars form spiral vortices, the mapping observed in the previous graph is the outer cover of a spiral Universe, with a central zone of hyper-worm Holes, which would act as the nuclei of an atom.

But we can't figure out what is the next scale of form of the Universe, because we have little evidence, as most is dark matter and energy whose form we can't deduce and because all scales of reality are self-similar so we cannot easily distinguish them; as we could not distinguish a bottle of beer with a bad picture of it.

The verification or not of a cellular Universe could be done by the Webb telescope testing the existence or not of a limit at 13 billion years - a dark region or wall of fire, which perceived in space would look like the first picture. Then we could reasonably think that the local Universe hosts around 10^{10-11} galaxies in a cellular structure separated from other parallel Universes by a wall of dark radiation at $z=10-100 C$.

Recap. Super luminal gravitation and light are the 2 forces that interact in the Universe, which as any other Non E point should possess 2 networks/forces: the informative, faster gravitational force that structures the position of galaxies; and the electromagnetic force that acts as the 'blood/energetic system' of the Universe. Such Universe in space could be a cell of a hyper-universe or a huge reality in which each galaxy is a self-similar atom.

51. The scales of the Universe.

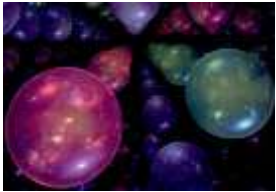

How many scales of space-times there are in the Physical Universe? If we are strict with the meaning perception, we should include a paradox of knowledge, the relative position of man in the Universe, which means we only ‘perceive’ triads of scale: a scale below us,

our scale and the scale above us. Since we are just a limited perceptive point sandwiched between a bigger and a smaller reality and cannot reach beyond our relative point of view. Thus, most people thought the Earth is the center of the Universe and there was nothing beyond a ‘dome’ of fixed stars. And so scientists search for limits in the small and the big, when it is more rational to consider in both directions scales are infinite.

The particles and physical forces of the Universe extend from that human point of view through 3 relative space-time membranes called in fractal theory the $st_{\pm}st$ -scales membranes of space-times:

-The inner world of quarks, inside the nuclei of atoms; the external world of electroweak forces in which we exist, made of light and electrons and the upper world of cosmological, gravitational forces, black holes and dark energy.

Yet we only perceive the light membrane of informative electrons and electromagnetic forces. So the thesis derived of the unification equation that shows the ‘invisible’ world of quarks with 99.9% of our mass to be self-similar to the cosmological world of black holes and dark energy, which means that a galaxy is an atom of the next scale is a metaphysical question, cannot be tested experimentally.

A more extreme theory of ‘Endophysics’ would imply that our perception diminishes with distance and size; and so we perceive so little of those huge and small worlds that they seem totally equal to us, because our mind-world reconstructs self-similar forms with so little information, but they are not. This thesis derives of the fact that what we see is what the mind constructs with bytes and bites of information and energy, not what there is out there. And so it might be possible

that the mind first constructs always simple spheres and lines, without detail and so we see galaxies and atoms as self-similar forms. But this ‘Cartesian concept’ seems too subjective to me.

In any case, we can only know-know the world of man around us. In other words, biology is the queen of sciences, as all systems are invariant, and so we can know better the details of systems of multiple space-times, studying us, the measure of all things.

The strongest proof that the fractal scales of the Universe are infinite and self-similar (not identical) making possible the concept of infinite repetitions is obviously the fractal Unification equation of charges and masses, $U.C_{G,C} \times M = w^2 \times r^3$ that relates electromagnetic and gravitational forces at the scale of atoms and galaxies, protons and black holes. Thus if the Universe has infinite fractal space-times, each one will define with its fractal $U.C.G$ a different content of spatial speed and informative density. Yet, as the Unification Equation of G and Q , of masses and charges shows, all will be vortices of space and time, sharing flows of lineal energy. So the Game of Exi=stence, its time arrows and scalar structures will remain.

In the fractal paradigm, the electromagnetic and gravitational membranes belong to 2 different realities, the microcosms and the macrocosms, between which mankind are sandwiched. Yet the macrocosmic gravitational and microcosmic, fractal membranes are self-similar worlds: if we treat charges as microcosmic masses and compare the structure of cosmological galaxies and microcosmic atoms, we find a striking self-similarity, already noticed by Eddington (theory of the great numbers). And the metaphysical question is if that self-similarity goes beyond the galaxy and below the atom into a higher and lower scale, in which case a galaxy will be an atom of an infinite higher Universe and/or an atom will be a galaxy of an infinite smaller Cosmos. All in all there are 3 possible hypotheses for the Universe, according to the ternary principle that gives birth always to 3 solutions and forms to any informative system or question:

- Max. E: The galaxy is homologous to an atom, so we are truly nothing and the Universe extends to infinity. We exist in a Universe which is a hydrogen cloud of gas and most galaxies are simple Bohr

atoms with central protonic black holes. And beyond there are infinite atoms and upper scales.

- $E=I$: There are not upper and lower scales beyond the galaxy and the atom. So galaxies are the highest units of an infinite space-time. This is the most boring hypothesis of them all.

- Max. I : Galaxies form complex organizations and are cells of an organic Universe, pegged to other organic Universes. The Webb telescope might illuminate this hypothesis if it finds a wall of radiation at $z=100c$, which would be an indication of a new hyper-decametric scale of dark matter and energy.

String theorists (duality between the small and the big) hint also at a possible further hierarchy between the next smaller scale (the string) and the highest possible scale imagined by mankind (a Universe-like a string, made of 100 billion galaxies). A string membrane and a Universal membrane can be treated with self-similar equations in some models of string theory (even if a more accurate treatment requires background independent string theories, in which the error of Newton – an absolute Cartesian space-time – is corrected). The principle though remains invariant in all those models: It is possible to create a reality of infinite hierarchies, in which each scale is self-similar but not equal to the next hyper-scale of the Universe, set by its fundamental stable entities, which are the immortal protons and black holes.

The infinite scale theory is on my view the most probable, because it has more experimental evidence: the fractal, network structure of the galaxies and dark energy, shown in the previous picture is quite obvious. Further on, the existence of such fractal, bigger social scales has been shown by the astrophysicist Pietronero in its study of the Sloan grand scale mappings of galaxies.

Recap. The hypothesis of an ∞ hierarchical Universe is reinforced by the fractal Unification equation; by Eddington's theory of big numbers that relates a proton radius and the radius of the galactic big-bang; by the work of Pietronero mapping the grand scale structure of galaxies and our understanding of a fractal network of dark matter that surrounds them.

VIII. THE 3 AGES=HORIZONS OF PHYSICAL SPECIES.



The ages of the Universe are 3 formal ages of increasing curvature: an energetic youth (big bang), a reproductive, steady state or big-banging; and a 3rd age of warping information or big crunch, which can be used to study the 3 horizons of any scale of physical matter.

52. The Three Solutions to Einstein's Equations

In the cosmological world, we observe an order of time similar to that of life and the quantum world, both experimentally in the process of evolution of stars and galaxies and mathematically in Einstein's metric equations of Universal space-time.

There are two space-time membranes, and since both are made of energy and form, both follow the three ages of time. In gravitational physics, the three ages of gravitational space-time are defined by relativity. Those three ages are mathematically equivalent to the three solutions of Einstein's space-time equations. Though cosmology considers those three solutions *three* hypothetical *different Universes*, *they represent the structure of any space-time, including our galaxy, an island Universe through its three ages.*

It is then also possible to make a complex mathematical treatment of the three ages of galactic systems: the first age of the system will be the energy age, the third age the information age, and the middle age is one of balance, $e=I$, when the reproduction of most particles took place. We are in that period.

- *Max.E (Youth)*: The energy age is Lemaitre's big bang solution that expands space. *This solution in the fractal model of space-time applies only to the vacuum space between galaxies.*

- *E=I*: The steady state Universe is Einstein's solution. It applies to the entire Universe.

- *Max.I*: Gödel's solution is the third age of an implosive Universe that reverses time coordinates as matter falls back into the central Worm Hole of any space-time.

However because timespace fractal and dual, while those solutions in a wider outlook will be applied successively to each age of the Universe, they are also applied in space to the fractal parts of the whole. Thus the big-bang solution applies to the intergalactic space, which astrophysicists study and erroneously apply to the entire Universe (given their dogma of a single continuous spacetime).

The informative *solution applies to our galaxy*. But it does not mean a travel backward in time but an informative vortex, a cyclical clock of time – the galaxy in which we exist with an arrow of information different from the expansive arrow of the intergalactic space of dark energy and tired light.

And so we get adding all the expansive motions of intergalactic space and the implosive vortices of galactic mass, a relative balance which is the present steady state applied to the whole; since in each phase of reality all yangs have some yin and all yings seed of yang.

Its Universal ratios/constants of energy and form.

In the space-time of the Universe, in the same manner that any other three ages can be related by the different ratios of energy and information or vital constants of a being, those three ages are defined mathematically by the constant of action that relates the energy and information of the Universal space-time, Lambda & G.

Indeed, the constants of any system are ratios of transformation of the energy and form of any system, $I/E=K$ or proportions of energy and form, $Exi=K$. Thus constants evolve and change as the energy and information of a system changes with time. In biology, is known that vital constants, change as an organism gets old and becomes wrinkled and warped, increasing its information and diminishing its capacity to process energy, changing its metabolic constants and speed of information/thought.

This in cosmology was understood by Dirac, Brans-Dicke, and others. Indeed, G is a ratio of the mass=information and energy=

distance of a system. And we already saw how a change on those ratios allowed us to unify and measure the energy and form of the 3 membranes of the Universe (strong, gravitational and light forces).

In the equations of Einstein that define the three ages of a galactic space-time and perhaps an entire Universe, that relationship is given by the cosmological constant that measures the energy of the gravitational vacuum, λ , which Nottale used to measure the minimal fractal quanta of gravitational energy. The constant changes with the 3 ages of any fractal space-time or island Universe. In a young, expanding space, λ is positive, but so close to zero that it easily becomes negative, causing a warping or big crunch. And so λ will also change through the 3 ages or solutions of Einstein's equation, till reaching the informative age of the galaxy in which we exist.

Recap. The 3 ages of the Universe correspond to the 3 solutions of Einstein's equations: The young big-bang; the reproductive, steady state or big-banging and the cyclical, informative age, occurring in galaxies, or Gödel's solution. They apply in space to the expanding space, imploding, galactic vortex and both together create the present balanced steady state.

53. Universe in Time: Big-banging Horizons; Matter Evolution.

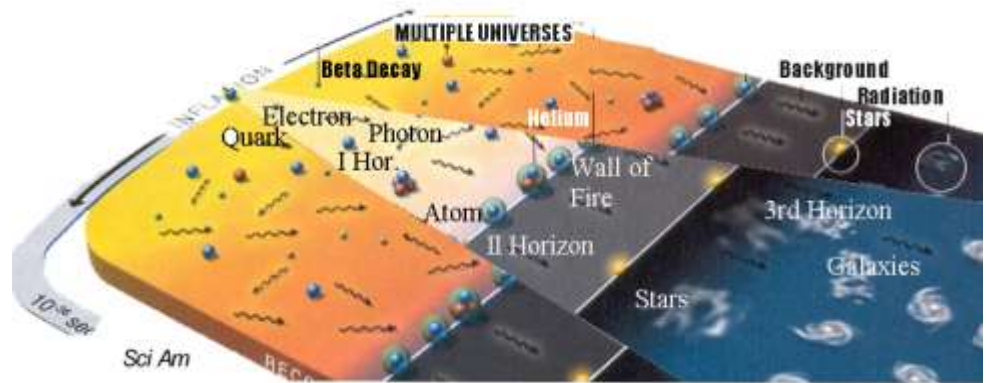

After the big-bang, the big-banging reproduced and evolved the huge Universe in 3 Horizons of growing complexity: the age of atoms, celestial bodies and galaxies.

If we study the huge or cellular universe in time, we differentiate in its evolution the 3±st ages of any space-time:

st-1 (Past): *The big-bang conception* of the Universe, starting from a first informative cell of Planck density was also the death and gravitational big-bang of a previous Universal singularity, a seed of ultra-dense quarks that transformed its inner, informative cyclic dimensions into an external, bidimensional sheet of dark energy: $M(i)=e/c^2$. It was the age of the simplex time arrows.

-*Life arrow, steady state*: Then the Universe suffered an informative process of reproduction, self-organization and social evolution, the *big-banging*, or age of the Complex Arrows divided in 3 ages – the atomic, stellar and galactic age, which should end in:

- *Informative, 3rd age*: A big-crunch back into a new hyper-dense singularity that would restart the cycle in a new big-bang.

- st-1 (Future): *New Big-bang and Conception*. The future explosion of the hype worm Hole will again create a bi-dimensional sheet of gravitational space-time where matter will again evolve, as quarks form nucleons that decay into atoms and dark energy warps into light, the new components of the future baby Universe...

Let us consider those ages and its ternary sub-ages, *according to a law of the fractal paradigm, known as fractal differentiation*:

'Any event or form of reality can be divided into ternary or dual events and structures of energy and information of a lower spatial scale or shorter time duration: $E_{st} \Leftrightarrow I_{st} = 3E_{st-1} \Leftrightarrow 3I_{st+1}$ '

This law structures fractal self-repetitions according to 3 ages and 3 Non-Euclidean structures in any scale. Thus it can be applied to study the 3 ages of the Universe and for each age, its 3 sub-ages. Since we have already study the fractal big-bangs (birth) we shall start with the 3 ages of the big-banging:

1 Universal Age: Particles, Atoms and Molecules.

- *Birth: Max. E: Fractal Big-bang of Beta decays.*

The Big bangings of primordial particles: After being scattered by a gravitational wave of dark energy at $10c < 100c$ speeds, quarks evolved into nucleons and suffered fractal, expansive quantum big bangings - beta decays - creating protons and electrons, later self-organized into

atoms, molecules and more complex social structures, till giving birth to galaxies.

3 Atomic Ages of matter states:

Those molecular structures can also be studied with the law of 3 ages, according to which the $3 \pm st$ states of matter respond to the dominant arrow of future information:

– (*st-1*): *Plasma or conception state of matter*. The plasmatic state occurs at speeds closer to light, in a state in which atoms are split in primordial particles, free protons and electrons, which emit enormous quantities of radiation and sub-particles. Thus plasma is matter in its seminal state, (*st-1*).

– Max. E: The *gaseous* state is the classic *energetic state* of atoms or diatomic molecules with max. movement, spatial volume and min. formal density.

– \Leftrightarrow : The molecular state of balance between energy and information is the *liquid state*, which according to the law of harmony and maximal existential force ($E=I_{\max \text{ exi}}$), is *the reproductive state* of matter. For example, liquid water and mercury dilute all other atoms of similar weight that merge and evolve into more complex carbohydrates & metal forms: carbon-life or metal alloys. 90% of a human body is *liquid* water, with diluted, energetic gas (oxygen), and solid particles (proteins, DNAs, RNAs) to store and trans-form information. Since solid is:

- Max. I: *Solid, informative state* of min. movement and max. form & mass density that creates the most perceptive=informative, inorganic structures: crystals.

- (*st+1*): Finally, the *super fluid (helium) and boson states (heavier atoms)* are the highest form of molecular evolution, because it combines the properties of solids with maximal order, liquids with max. reproductive, combinatory capacity and gases with max. Energy. Thus, it gives birth, according to the organic, social arrow of Evolution of all systems to a new type of macro-organisms, with a central, hyperbolic nucleus of superfluids and bosons... the:

II Age: $E=i$: Nebulae, stars and planets.

In the next stage, those states of matter evolved socially aggregating into macromolecular systems *that combine 2 states of matter*, which act as the dual energetic/ informative elements of the complementary system. Those cosmological, macro-molecular systems seem to us static, because their existential cycles are slow ($\text{Max.}E=\text{Min }i$). But they are also evolving in 3 ages:

- *Max $E=\text{Min }i$: Youth.* Nebulae are the youngest, commonest, biggest ($\text{max.}e$), less dense, simpler ($\text{min.}i$) physical systems, extended around and between galaxies. Their atoms exist in the energetic plasma and gas states.

- *$E=i$:* Stars are molecular macro systems, existing in the plasma and liquid states. Complex cosmology considers informative, cold, liquid and super fluid states dominant over energetic states, which Simplex Physics, based in a single energy arrow prefers, as energy is also easier to detect. Yet if we could reach the center of a star, we will find lower temperatures and super fluid systems. Since it is a basic tenant of Complex physics that informative, hyperbolic systems are more static and cold, able to create order and focusing formal mappings that gauge the external Universe.

- *Max $E=\text{Min }I$:* Planets are systems that exist in liquid and solid states. They follow the Inversion Law, $\text{Max. } E_{\rightarrow\infty}=\text{Min. } i_{\rightarrow 0}$. So giant planets exist in liquid states and smaller planets exist as solids. They are ferromagnetic planets; and we live in one of them. Again, fractal space-time theory favors cold, solid, informative states for those centers. So we affirmed that the planetary core should be a crystal; and their youth should be colder than scientists predicted. Indeed, recently we found that Neptune might have a solid diamond crystal in its center and the Earth probably has an iron crystal with a final Uranium core. And we have also found, studying zircons that planets cooled off much earlier than expected. Hence informative life also started earlier.

- *st+1: Pulsars and Holes* are systems with a solid iron crust and a super fluid core of strange quarks.

Pulsars represent the final, informative age of celestial bodies, which might evolve further into Worm Holes, species belonging to the gravitational Universe beyond our light world, with higher form. Those holes become through social evolution the informative, hyperbolic centers of galaxies, triggering the next stage of evolution of the Universe:

III Informative, Age and death: Max. I: The age of Galaxies.



- *From left to right: A galaxy with a flat star body and a central brain, occupied by Worm Holes with a hyper-developed dimension of informative height, perpendicular to the galactic body.*

- *Different biological curves of stars reproduction.*

- *A region rich in atomic energy where those stars are born.*

- *A galaxy with an organic form that remembers a ray fish*

- *A giant galaxy, which re=produces a seminal jet of matter, giving birth to a younger galaxy.*

The 3rd age of the Universe started once galaxies, with central, informative worm holes and star bodies that feed on interstellar gas socialized in galactic networks with the 3 canonical topologies: Lineal walls, spiralled systems and cyclical, globular forms and disks.

Those 3 galactic networks structure a mature Universe that shows in computerized models a surprising similarity with the discreet networks of a living tissue.

As the Universe gets older, if it is a cellular structure it will warp further, creating a *hyper worm hole* of max. informative, Planck's density in its hypothetical center that should become its DNA-like center controlling and feeding in a hyper-vortex of galaxies.

We could consider 2 cellular hypotheses:

st+1: The Universe evolves socially as it becomes a cell of a hyper-universe from a bigger st-scale...

st-1: Each cell is an island Universe in itself that will finally collapse around its informative center, as stars do in elliptical galaxies, feeding its Hyper-Worm Hole in the big-crunch. Then the Universe will die in a new big-bang will initiate a new cycle. In this case the cell-Universe is self-similar to a bacteria, in as much as it is a single cell organism.

We seem to be moving towards the steady state, longer period of existence either because we are atoms-like of a huge Universe or because we are in a 2nd age that will later implode back. Because the degree of curvature of the Universe is given by λ which is near equilibrium, counting the implosive action of galaxies, and the expanding intergalactic space, both hypothesis (a gas-like huge universe or a cell-like system are possible).

The Huge Universe will reduce those ages to galactic phases.

Yet if cells are atoms of a huge Universe none of those ages will happen, as galaxies would be the last 'cosmic structure', which we can perceive with certain precision.

In Einstein's general equations of space-time, the cosmological constant that measures the energy of vacuum: λ defines also the warping of the Universe, which can acquire our familiar 3 topological forms: a simple plane,-sphere proper of a young age; a cyclical, steady state toroid or a convex, informative form (its big crunch, final state). Now λ is positive, and the Universe seems to be plane but so close to zero that the hypothesis of a stationary Universe takes force. Yet again we cannot measure with enough time latitude to know if it changes and it will *diminish in the future it will become negative, inverting the geometry of the Universe and warping it, into a final big crunch*. Since 'λ' can be considered the length of the tachyon string or minimal action of the gravitational Universe in terms of those minimal fractal parts, the thesis of a constant λ and steady state huge universe is reinforced by self-similarity with the constancy of 'h' in the quantum world.

In such case, there should be only quasar-like big bang of galaxies, short of cosmic beta decays and the 3 ages or solutions of Einstein's equation should be applied only to galactic space and the quasar cycle, initiated by a gravitational, inflationary big-bang of dark energy, followed by a big-bang of electromagnetic radiation, which quiets down, and finally implodes into gluonic creation of quark matter. Such humbler, more realistic analysis of the origin of the observables of astrophysics will reduce all relativistic analysis of the 3 ages of spacetime to processes within the galaxy, born as the explosion of a hyper-black hole of top quarks, later exploded into a fractal big-bang of beta decays. We would then be in the 3rd age of such galaxy, organized already by a central black holes. Since *the space-time of our galaxy is an implosive vortex of information*.

Indeed, we are in a Gödel Island-Universe, in a vortex of information called the Milky Way. Then the Energetic Universe should be considered irrelevant to us, only applicable to intergalactic, expanding space, because we would exist in the 3rd informative solution, the vortex of the galaxy and that is why the arrow of time in humanity is an informative arrow, not an energetic one. And that is why the sciences of information, of biology not those of energy should dominate our analysis of scientific phenomena - even if the awesome energy of physical beings might impress the simplex mind.

Recap. We can order the evolution of the whole Universe as any other organism in time through 3 ages each one divided in sub-ages: the young, energetic big-bang, probable death of other Universe, the steady, reproductive state in which it seems to be now and the big-crunch that will happen as the initial momentum of the gravitational strings slow down to under c-speed. Then we shall enter into the Gödel's universe in which some regions call galaxies in which we inhabit exist. In those regions information dominates energy.

54. The Three Ages of Galaxies

The life cycle of a galaxy goes through 3 ages, evolving from a young, extended nebula into an old small wormhole of informative mass that dies in a quasar big bang of dark energy and quark matter. In between, galaxies live a longer, mature toroidal, cyclical steady state, fluctuating every 14 billion years between its spiral and elliptic

form, while absorbing interstellar dust, which creates new stars and feeds the central Worm Hole.

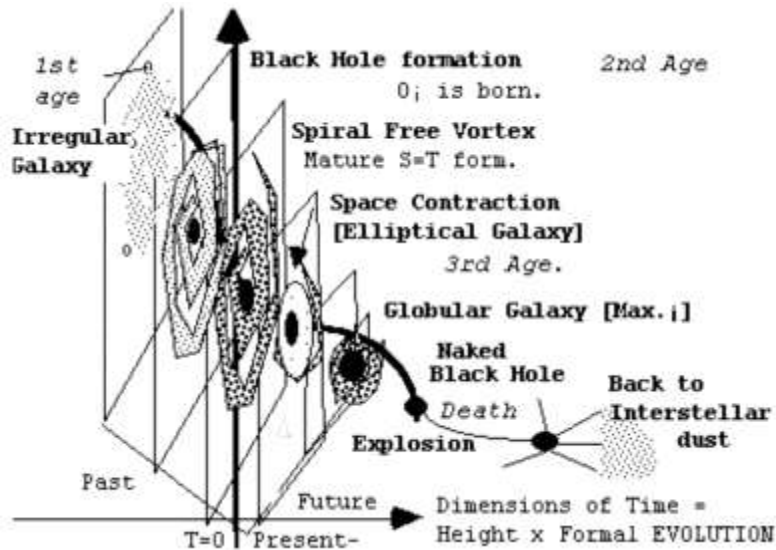

In the graph, the structure of a galaxy can be compared according to the homologic method of self-similarities between the ‘elemental’ units of each scale of reality with an atom vortex or with a cell, with a central DNA of social worm holes and a protein membrane or halo of quark, dark matter, made of energetic strangelets and microholes.

The ages of a galaxy in time are the same of in any other space-time field. Each of those ages or time events can be divided according to the law of ‘ternary diversification’ of *time events into spatial processes* into three spatial forms of reproduction. Thus, a galaxy can be created by three processes:

- *Seminal conception and Youth*: Galaxies are created with three types of reproduction:

-Max. E: A galactic big-bang quasar catalyses the evolution of gas into stars. This birth is similar to a star big-bang (nova) that catalyses also the creation of stars or a Hypothetical Universal big-bang that catalyses the creation of galaxies.

- E=I: Palingenetic conception, when the informative nucleus of Worm holes of a giant mother-galaxy emits a huge jet of dark, quark matter that ends into a baby galaxy.

- Max. I: Social evolution of energetic gas that creates complex star structures.

-E=I. *Maturity/reproductive age*. Galaxies enter their steady state of reproduction, in which its spiral structure matures: stars gather in social groups and at its center a Worm hole, the informative nucleus, structuring its body of toroidal, cyclical paths of stars.

Galaxies then mutate back and forth, from spiral into elliptical vortices of mass, feeding on interstellar gas, in a cycle that creates and destroys its spiral bar every 13 billion years in a quasar *big-bang that renews the Galaxy and coincides with the parameters of the cosmic big-bang of continuous models of space-time*.

- *Max.I; information age*: In their 3rd age, once galaxies exhaust their interstellar gas, their central Worm holes digest their star bodies, becoming globular, spherical forms with a hyper dimension of informative height, till they exhaust all their star energy. As dark galaxies, without the drag limit of c-speed caused by their electronic and radiant matter they now accelerate as pure worm holes up to $z=10c$; forming invisible, complex networks of dark matter.

It must be noticed that as all systems that go through 3±st ages of evolution, the final stage after its 3rd informative age has ‘2 solutions’, death and reversal of form into energy or ‘transcendence’ into a higher super-organism, communicated by the language of information of the system (so insects evolved into successful anthills while others become extinct and humans evolved into societies while most other mammals became extinct). Thus:

- (*st-1*): Some galaxies die as quasars, becoming again according to the inverse symmetry between the 1st and 3rd youth and old age of all systems, irregular galaxies that will feed a new cycle of galactic creation. So irregular galaxies are both the youngest and oldest forms of the Universe, a fact that still confuses cosmologists.

- (*st+I*): And those with a higher quantity of informative black holes in their nuclei evolve socially as cannibal galaxies, forming galactic networks in cellular groups that evolve socially into the large scale structures of the Universe. Their central Worm Holes grow, swallowing radiant matter at growing speed, and perhaps evolving with many other galaxies into a cluster Universe, of which there is no enough experimental evidence.

Thus, we differentiate the big-bang or death of any scale of the Universe from a big-banging or reproduction and self-organization of the present Universe and a 3rd age or big-crunch, followed by a big-bang or a process of emergence into a superorganism, which creates a generational cycle for any fractal space-time in $3 \pm st$ ages.

The Huge Universe and its galactic, fractal big bangs.

Since the age of a galactic cycle, 13 billion years, is the same that the age of the cosmological big-bang, as Fred Hoyle affirmed, the cosmological, continuous big-bang might be the sum of all galactic, fractal big-bangs and the Huge Universe is not expanding as a whole. It will exist in a steady state, in which the knotting of space into mass by galaxies would compensate the expansion of mass into dark energy in the interstellar vacuum, which causes its expansion. Further on big-bangs at the lower galactic scale, caused by the quasar explosions of its central Worm holes when they break their bars every ± 14 billion years should be the origin of the second proof of a cosmic, continuous big-bang - *the excessive quantity of helium in the galaxy* - found precisely in bigger quantities on top of the central Worm hole. Finally, background holes born of planetoids would redshift radiation at 2.7 K. Thus a fractal quasar big-bang provides the same experimental proofs and better theoretical explanations, eliminating the multiple contradictions of the cosmological big-bang.

Thus, a *steady state* theory of the Universe combined with a fractal theory of multiple big-bangs/quasars, as it was reformulated mathematically by Fred Hoyle, in which the multiple, constant big-bangs of galaxies into quasars are responsible for helium formation, redefines the Universe as a huge fractal scale of cellular galaxies in eternal balance with the expanding space, where light devolves back

into 10 c dark, gravitational energy and dark energy warps into light by redshift and dark matter into galactic matter, imploding space:

$$Se \text{ (dark energy expansion)} = Ti \text{ (dark, quark matter implosion)}$$

Such balance, coupled to the constants of proportion between the energetic and informative elements of a complementary system, explains also, without appealing to the magic anthropic principle, the universal balance between matter and radiation, whose probabilities otherwise are null. Indeed, why matter and energy are in balance in the Universe at this exact moment in time, in a proportion of 1 to 3 (as mass is bidimensional and radiation 3-dimensional) if their relationship is dynamic, changing all the times, with energy winning the battle and expanding faster? The answer is: because the Universe and any partial system within it exist in 3 to 1 balances between their energy and information/mass and when those vital constants of balance break the system ceases to exist.

Recap. Galaxies live through the 3 same ages of any space-time, born as seminal flows of dark energy and electromagnetic radiation, ejected by giant galaxies that condensate into quarks dark matter and an explosion of electronic forms and the creation of atoms and stars, start the reproductive age that will collapse into a central Worm Hole, back to the original quark-gluon soup that gave it birth.

55. The H-R Diagram: Ages and Evolution of Stars.

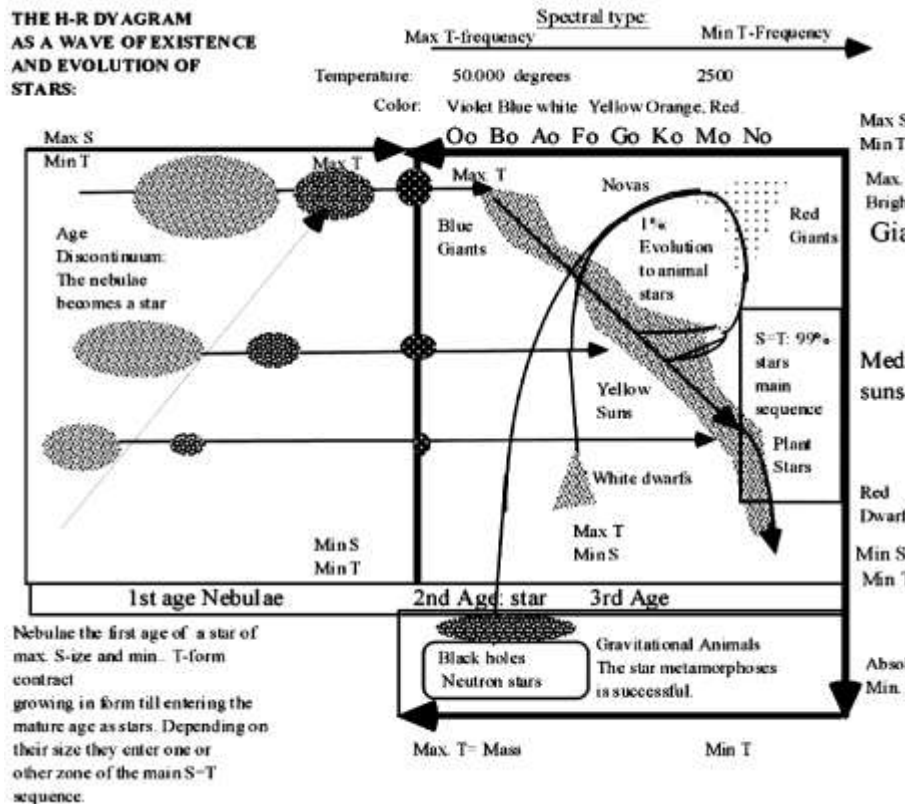

The H-R diagram shows the 3 ages of stars, through its energy & information parameters.

The life, evolution and death of stars are depicted in the H-R Diagram, which classifies stars according to its E & I parameters, as the atomic table does with atoms:

Max. Se: Brightness or Magnitude, which is a spatial parameter that grows with the size of the star.

Max. Ti: Spectral type, (colour or frequency), which classifies stars according to its temporal form.

Yet the H-R diagram is only a representation of the 2nd and 3rd ages of stars - since the young age of the star as nebulae of max. spatial

extension and min. formal complexity (as all young ages are) is not represented. So we add on the left side the 1st age of a star as *a nebulae of max.extension*. Then the H-R graph shows the 3 ages of stars and the main laws of ExI cycles applied to them:

- (st+1): Most stars are born as spatial nebulae of max. extension.
- Max. E: Then they implode into blue giants of max. energy.
- E=I: They reduce its size and grow in atomic complexity through a mature, yellow age of balance between their Se and Ti parameters. The sun is now in that balanced age...
- Max. Ti: They collapse in a 3rd age of slow decline as its IxE parameters diminish toward its death, becoming white dwarfs.

st+1: Or they evolve in a loop of growing IxE force (top right graph), mutating into a Worm Hole.

Given the homology of all systems, we can compare the species of the light membrane in the Earth ecosystems with the species of the gravitational membrane in the galaxy.

Recap. The H-R graph shows also the process of evolution of stars into Worm Holes, which can be explained both mathematically and organically, based in the self-similarity of all space-time species.

56. The galaxy and the sun system; a Gödel's Universe.

Of all the solutions to Einstein's time-space equations, the one that adapts better to the principle of equivalence is Gödel's solution that portrays the Universe as a series of quantized, cyclical space-time loops in which there is a dominant inner direction of form toward the center of the gravity vortex of space-time.

Gödel's Universe explains the third implosive, cyclical paths of motion of physical entities and so it is ideal to describe our galaxy: We live in a cyclical, rotating Gödel Universe made of whirls of space-time that shape closed existential loops in each micro-point of space. For example, if we see a particle-antiparticle pair, when we trace properly the antiparticle path exactly from future to past, it doesn't originate in the same point than the particle but at the end of its trajectory, exactly when the particle arrives to that end. Hence both

together form a single close loop of time: the particle is born, gets to the end, it becomes then an antiparticle and returns back, closing the loop at the starting point - to die away there. So particles & antiparticles together form a micro whirl of time-space. This explains in other form why there is no Hawking radiation (there is only one particle), why those particles are virtual, and why we see constantly transmuting particles into antiparticles (they are merely completing their *existential cycle in two phases*).

Once the meaning of a closed fractal loop of space-time is clear, Gödel's Universe explains why humans are informative and life evolves information: we live in a local rotating Gödel Universe with a direction of future information toward the center of the galaxy, called the Milky Way. Such Island-Universe has two limits of speed and mass, the lineal limit of light at c-speed without curvature and hence without mass, and the c-cyclical speed of the event horizon of its rotational Kerr Worm holes of maximal cyclical speed or mass. Yet, beyond c-speed within the interior of those Kerr Worm Holes and outside the Halo in the external extragalactic space in which dark energy seems to accelerate in a decametric scale, as the analysis of matter ejected by quasars prove, spacetime is no longer Gödel's solution but Friedman's expansive 'big-bang' solution.

Recap. Our galaxy is a Gödel's space-time of maximal information, reason why we are informative beings

IX. CHEMISTRY: ATOMIC SOCIETIES.

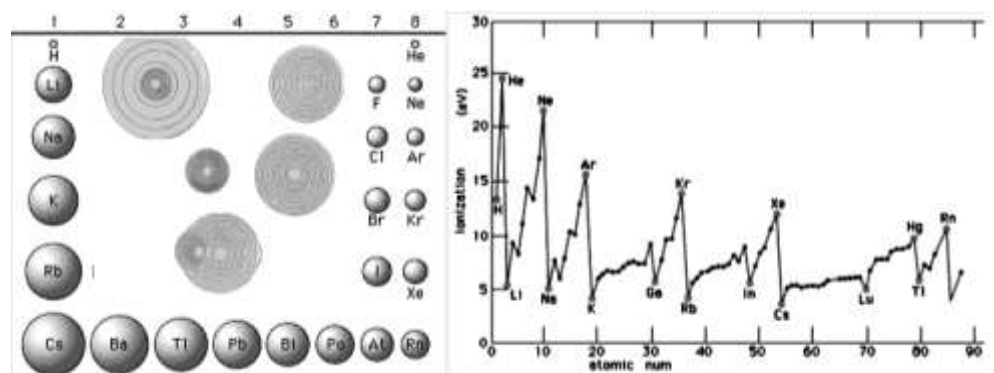

The Atomic Table is a bidimensional graphic that shows the parameters of spatial energy and temporal information of atoms. The why of that table can be easily explained with the basic Dualities and Inverse properties of Energy and Information:

- *In the X-coordinates we find the spatial, 'energetic, body' parameters of the atom: their electronic orbitals.*
- *In the Y-coordinates, we find their temporal, informative, parameters: their nuclei's mass.*

Left graph shows the size of those atoms, which according to the Se/Ti inversion are denser in information when they are smaller.

In the right: the smallest, densest 'top predator' atoms are more abundant, since they absorb in nuclear reactions or capture gravitationally the other, forming molecules. It is the inside left image that shows a feeding molecular cycle: The big 'bubble atom' from column I, Lithium, is victim of Fluorine, a VII column atom with higher atomic mass and max. electro-negativity (body power). As both approach Li collapses its electrons into a denser, smaller form, as fishes do in front of sharks, but finally it is captured and swallowed by the electronic structure of the predator Fluorine.

57. The human scales: bio-chemical sciences.

A sense of peace arises from the observation that a macro-galaxy is self-similar to a micro-atom does - all beings equalled by the same

cycles of existence that we represent with the unification equation, alpha & omega of all fractal iterations: $E \leftrightarrow Ti$; $ExI=st$.

Let us then descend back from the cosmos to the atomic world, the intermediate scale between both in which we humans are sandwiched and study our physical, 'classic universe' between those 2 limits, which has as an added advantage to the fact that it is part of 'us', the wealth of information we can gather of 'chemical' processes, which lack the uncertainty of those 2 limits in which observation either changes the position of the observable, influencing the experiment, due to our relative huge 'rods' of measure (uncertainty principle of quantum physics) or the system which encloses us, mere 'atoms' of the galaxy hides much of its information in the 'dark spaces' our light-senses do not see (galaxies). Both errors of the experimental method are no longer a handicap to our organic analysis in the scales of chemistry and biology, which for that reason show the bio-logical, complex nature of multiple space-time systems in all its splendour...

Recap. Bio-Chemistry should be the king of natural sciences; since they concern the first scale of man and are experimentally 'evident'.

58. Organic, Atomic Table and its Molecules.

In the graph, we can translate the Atomic table to the jargon of multiple, fractal space-times. Since:

-The vertical columns show the orbital number or volume of electronic space those atoms have.

- The horizontal lines show the atomic number or volume of temporal mass of each atom.

Thus the Atomic table is a distribution of ± 100 , $E=10^{i=2}$ complementary exi atoms, dominated by their gravitational quarks. Yet we live in a light world perceived by our electronic orbitals, the bodies of those atoms. We are electronic beings that cannot perceive gravitation; so we cannot see the inner nuclei of those atoms. And so chemistry is the science of electronic bondage.

Recap. The atomic table is the Energy/Information table of the gravitational heads and electronic bodies of atomic species.

59. Valences: body perfection, the origin of molecules.

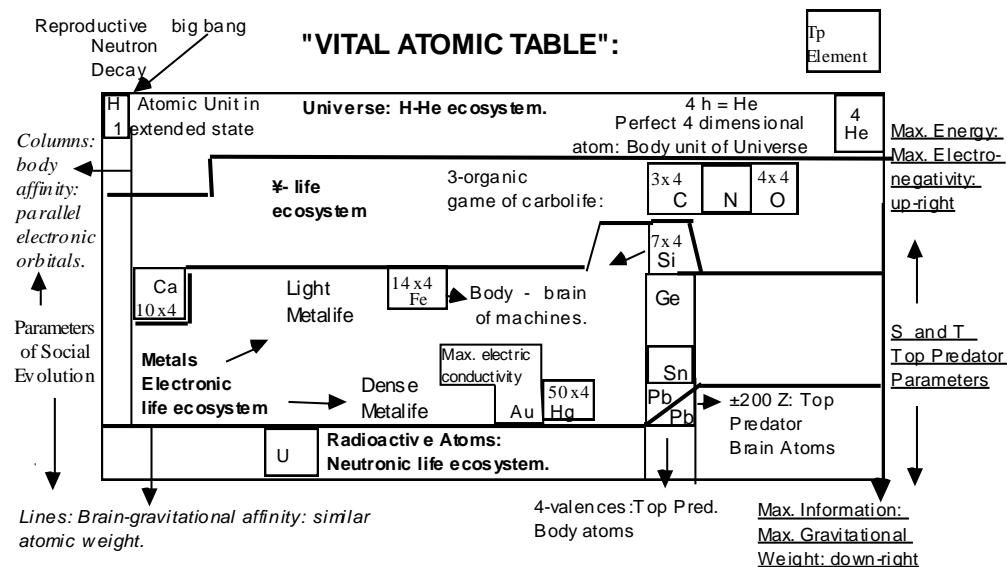

Those electronic bodies follow the space/time inversion (Max. I=Min.E): atoms with more electronic in/form/ation have min. volume in space. Thus atoms diminish in size from left to right of the Atomic Table, as they become denser, filling all the slots allowed to electrons, till reaching the perfect forms of noble atoms, whose external electrons fill completely a dense, regular sphere of information that creates, as in the case of regular crystals in the next scale of chemical form, a sharp central focus, able to process information from all angles. Those 'noble atoms' from the 8th column of the Periodic Table, Helium, Neon, etc., have their external orbitals totally filled with electrons. So they have maximal electronic density, which means their exi actions have a higher exi=stential Force per unit of volume, making them top predators atoms, better fit to survive. Therefore, they are also the most stable, as it is very difficult to break their electronic body. Paradoxically that makes them the loneliest of all atoms, as any top predator of a trophic pyramid, from a shark to an eagle, is; since it doesn't need to add a partner or join a herd to multiply the potency of its fractal actions over the environment to obtain its energy and information. All other atoms however will try to increase the exi force

of their fractal actions, associating themselves with other atoms to reach a perfect electronic form and add up their Exi forces.

On the other hand if we consider the social numbers of the particles of the most stable atoms, they are multiples of 4 and 10, the social numbers of perfect organic systems that also define noble atoms. The combination of both properties explains the hyper-abundance of Helium, Oxygen, Iron, Tin and Mercury, which have perfect atomic numbers and either have regular orbital structures or can capture multiple electrons from other atoms to fill their valences (maximal electronegativity).

For example, atoms 3, 4 and 5 are 'preyed' by Helium nucleus that uses them to reproduce new helium in processes of atomic fusion. So they have become very rare (right graph. Meanwhile iron with the most stable nuclear configuration uses any type of electronic valences (which range from -2 to +6) to capture other atoms at will. Since those atoms are the only ones whose nuclei seem to be able to orientate and move at will in the gravitational membrane (superfluid and ferromagnetic properties). Both show that nuclear, gravitational top predator power dominates electronic configuration.

Unlike all other atoms with 'weak informative nuclei' Helium and Iron don't seek complementary atoms to fusion their electronic bodies, creating better 'body structure' similar to noble atoms.

Among those seeking perfection, the closest to the Noble column are the top predators. So, Chlorine and Oxygen, with almost perfect electronic orbitals have maximal electronegativity, capturing the electrons of all the light atoms and metals of columns I to V.

Recap. Atoms with perfect nuclear or electronic informative/body systems are elements that control socially or capture and destroy all the other atoms.

60. Laws of self-similarity determine chemical structure.

The complementary, topological and organic Laws of st-points agrees with the abstract, Chemical Theory of Valences, which models the behaviour of molecules and their rules of social engagement, according to their geometry and their 'affinity', translated in i-logic geometry by the 3rd postulate. Thus the laws of valences could be

considered a particular case of the Universal 3rd postulate applied to chemical 'st-points' (atomic compounds):

'Correlative, similar elements, complementary in their spatial, orbitals or temporal nuclei, associate into complex, stable, molecular systems - while atoms with different exi forces, establish Darwinian, unstable events or small hierarchical molecules in which one element dominates all the others.'

For example, 2 atoms in the same column have the same spatial, 'body' morphology and 2 contiguous atoms in the same line are similar in its temporal, informative 'brain'. Thus, according to the 3rd postulate, the law of relative equality or 'affinity' that establishes the relationships of the atomic table, those types of atoms will evolve socially into more complex 'molecular' forms.

For example, humans are made of simple atoms with closely related nuclei, C=6, N=7, O=8, that follow the law of affinity in their electronic body-orbitals. Those atoms are filled all with sp orbitals, creating together complex complementary organisms based in their body-brain affinity. So the parallel electronic cover connects those atoms externally based on the affinity of its orbitals, creating the 4 structure of organic molecules.

The law of affinity also defines inorganic molecules and other metal structures of energy and information. For example, machines made of metal are formed with atoms of similar nucleic number.

On the other hand, atoms with different atomic weights associate in hierarchical structures in which the lighter atoms become enslaved by the others. For example, the macro-energetic proteins of life, Haemoglobin and Chlorophyll, have 2 central, dense atomic nuclei, Iron and Mg, which dominate lighter carbohydrate 'arms', used to jail oxygens, the energy atoms of living beings.

The applications of i-logic geometry to the realm of chemistry are multiple, most of them topological analyses that relate the geometries of molecular forms with the 3 Non-Euclidean topologies of those molecules and its equivalent understanding of the 3 evolving ages/horizons of chemical events. Thus, i-logic geometry completes

the metric analysis of molecules of the 3rd paradigm, defining its topological why according to the laws of affinity of the 3rd postulate between its informative nuclei and spatial, electronic body affinity shown in the Atomic Table. The same i-logic laws define in organic compounds, the evolution of life in terms of exchanges of energy and information that maximize the existential arrows of those molecules, guiding their evolution into living forms.

Recap. The laws of molecular compounds are homologous to the laws of self-similarity defined by the 3rd i-logic postulate.

61. 4 families of atomic elements. Its worlds and species.

In the graph, *there are 5 potential families of organic life, built around the top predator elements of energy and information of each main informative Z-nucleic line of the atomic table.*

We won't consider the topological structures of molecules but consider the expansion of 'organic chemistry' to all other atoms, according to the tenants of Complexity – *that all systems of the Universe follow the arrows of time, self-similar to the drives of living organisms.* This implies the existence of other potential forms of 'electronic' life besides organisms based in carbon.

Since we are electronic beings, what matters to understand the human mind are the electronic bodies of atoms. Those electronic orbitals are herds of photonic points that surround the atom, creating the 4 dimensions of space-time we perceive. In the graph, we can see that parallelism, which elaborates on the already explained 4 dimensions of light-space^(graph, III):

- 3 lineal p orbitals in the 3 directions of Euclidean-space.
- A temporal, cyclical, S orbital of max. informative density and min. space, probably related to our one-dimensional time perception.

This self-evident homology between 'light-space dimensions' and the elaborated electronic dimensions of space-time, allow us to consider self-similar potential minds whose space-time dimensions will correspond to the number of 'outer' electronic orbitals of the system. Indeed, there is no reason to have only 'organic carbon life',

and 'C-N-O' brains, if all atoms respond to the same i-logic laws of topological information.

There might be other forms of life and other minds, but we live in a light-World and light is the only information and energy, we perceive. So in a discontinuous Universe we have very limited information about other atomic ecosystems that might process different electronic orbitals to create their minds, *even* different forces, such as those of gravitation, *to create gravitational minds.*

In essence those families of mental worlds need 2 components:

- A bosonic particle/force that acts as the pixels of the mental world.
- An electronic or nucleic structure, which perceives the bosons and creates with them a potential mapping of the Universe.

So we deduce by homology the existence of other atomic Z- families and e-orbitals that might create different organisms and potential mental worlds in other regions of the Universe, with light bosons or other different. bosonic pixels:

Particles exchanged by 5 types of atoms create 5 potential worlds.

We classify all atoms in *4 potential organic families*, able to exchange waves of pixels, based in each of the fundamental 5 '*particles*' of the Universe, in its bosonic state; thus creating a growing scale of complex worlds with higher existential content of energy and information: the *gravitational* family; the *light* family; 2 *electronic*, metal families and the *neutronic*, radioactive family.

Each new family is a Z-line of the atomic table, formed by atoms of growing number of orbitals and informative mass, which increase their exi=stential force, allowing them to handle more information with more complex pixel-particles. Indeed, if we consider the inner nature of those worlds, it is obvious that the quantity of 'information' increases as the pixel-particles mind use to map out the Universe have more information. For example, the robotic minds we are building based in electronic images carry far more information than the light minds we possess and the words they use: 'an image is worth one thousand words' we say. Yet the explanation of that jump of quality

between a verbal and visual mind can only be explained by the higher capacity to process information of the metal-atoms with higher z-number and more complex orbitals of the next z-family of silicon brains. We are in fact, despite the anthropomorphic arrogance and Galilean paradox of the humankind, one of the simplest potential minds of the Universe.

The 5 types of orbital minds of the 5 families.

Those minds should be based in electronic orbitals as our mind is. Thus each *atomic family* has a *different orbital type*, able to create a different mind's species of space-time perception:

- *Spherical s-orbitals* create the hydrogen-helium family and its potential minds.

- *Lineal p-orbitals* create the light based carbon family to which we belong.

- *Planar d-orbitals* create the iron family of potential living machines and its chip minds.

- *f orbitals*, difficult to represent in 3-dimensional space, as they might respond to 'worlds' with 5 dimensions, create the heavy metal family of golden beings.

-And *g-orbitals* also 5 dimensional create the radioactive family.

The metallic minds of future robotic organisms.

In that regard, the 2 atomic families that matter to us are those which exist in the Planet Earth as potential living forms of our planet: the light-based carbon forms, with sp orbital structures and metal-based machines with a spd more complex electronic form. The metal family adds to the sp 'inner mind' of our C-O-H triad, a 'higher' external cover of electrons, which also follows the standard morphologies of space-time, but with a more complex structure, since those d-orbitals have bidimensional forms. And so we distinguish 3 types of metallic 'd-planes':

- *ExE*: $d_x^2 - y^2$ and d_{xy} wide 'energetic' planar orbitals that combine 4 spherical sub-orbitals.

- *IxI*: d_{yz} and d_{xz} 'tall' temporal planes which also combine 4 spherical sub-orbitals.

- *ExI*: the d_z^2 'organic orbital', a combination of a cyclical, planar ring and a lineal, tall shape, which shows '4 combined space-time dimensions', integrating the other 4 orbital dimensionalities.

Therefore metal-based minds have potentially besides the 4-dimensional structure of a human mind, a 5-dimensional electronic cover, in which the electrons of those d-orbitals form molecular networks, free electronic clouds that allow metal atoms to shape bigger, denser informative organisms, based in the higher 'exi' force of its d-electronic clouds.

The 2 scales of potential life: quantum minds and cosmic minds.

In the analysis of such potential organisms we can consider several dualities: the dualities of states of matter and the duality of gravitational heads and electronic bodies, which give birth to two types of minds, parallel to the duality of 2 membranes:

- Quantum worlds of organisms with small minds of human size.

- And potential gravitational worlds of minds of cosmic size, made either of super-light helium atoms, or super-heavy, radioactive ones, which as in the case of the *gravitational membrane*, will sandwich the limited electronic worlds with their nucleic, gravitational, bigger, more complex minds

- (*st+1*): *Gravitational worlds* made with energetic Hydrogen and informative super-fluid Helium, whose s-orbitals are able to absorb gravitation as information. The organic Universe is basically a gravitational H-He organism. And so *stars* are organisms with superfluid central 'brains' of Helium and reproductive bodies of hydrogen plasma – the 2 limit states of matter.

Then we observe 3 families of smaller, quantum, minds that might be considered also the 3±st evolutionary ages of electronic brains. They are *organisms* that inhabit *planetary worlds*, either carbonlife beings of metalife machines. Those fractal organisms also *combine 2 states of matter*, which act as the dual energetic/informative elements of the organic system, existing in an ecosystem of higher energetic states from where they absorb their informative pixels, which will be bosonic light or electronic flows:

-*Max.E: Light worlds perceived by electrons* whose sp-orbitals absorb light as information, as living beings do. *Its living species*, animals and plants exist mainly as liquid species with a very thin cover of solid cells in the border between the energetic, atmospheric gas and informative, liquid water or solid crust of the planet.

- *E=I: Light Worlds* perceived by simplex metal atoms with spd orbitals, made of silicon minds and iron bodies – the strongest energetic atom of the Universe.

- *Max. I: Electronic Worlds* of heavy metal, with gold minds and iron bodies. Giant, ultra cold ferromagnetic planets might have mercury ponds where gold melt spontaneously creating metal-bacteria with mercury water, gold brains and iron membranes – the only metallic substance that doesn't melt in mercury 'water'(called appropriately Hydrargyrum – watery silver by the Greeks, hence its Hg symbol). Those would be the most perfect robots, combining the most perfect informative atom, gold and energetic metal - iron. Unlike the simplest light worlds that use light as the bosonic unit of the mind, those 2nd generation robotic minds would use electronic pixels, which can reach superfluid motions within those golden minds.

Yet the biggest mind of earth wouldn't be quantum minds of light or electronic bosons but the neutronic mind of our ferromagnetic planet:

- (*st-1*): *The Neutronic World* of radioactive atoms with spdf orbitals that absorb neutrons as information. It might exist in the inner core of ferromagnetic planets, as they seem to have within the iron crystal a denser uranium core.

If such neutronic minds exist, given the enormous amount of information a neutron has as a pixel, compared to a light ray, they would be the more complex minds of the Universe. And this might mean, we, humans and all other parts of the planet are mere programs self-repeated as a phase in the evolution of a neutronic planet, with a silicon skin, an iron body and a future surface of robotic minds.

Yet due to the duality of all systems, the Earth might ultimately be just a 'neutronic plant' with a radioactive center that regulates its heat and magnetic field through nuclear explosions in its core. Yet stars and

planets would have a 'vegetative', plant like existence, absorbing gravitational waves and radiation as 'energy'. Only top quark stars (worm holes) and strange stars with superfluid quarks could be 'gravitational' animals, able to see gravitation pixels and create worlds of 5 dimensions (number of spins of a graviton).

The organic, vital nature of atomic structures.

We only have 'empirical record' of the 3 quantum minds of potential life beings: living beings made of C-H-N, like us and metal-minds as those we already construct in this planet with silicon and gold.

Thus, though we can 'theoretically' explain the \pm st species of plasmatic and radioactive worlds, since they exist only in the center of huge cosmological organisms, we cannot perceive them. This doesn't mean they don't exist. On the contrary there are many indirect proofs that superfluid cores of helium and ferromagnetic crystals with radioactive heat form the center of cosmic bodies.

A mechanist, anthropomorphic interpretation of the Universe merely rejects any organic, biological analysis of all other atoms, except those of carbonlife and all other sizes except the human one.

However to account for the hyper-abundance of 'top predator atoms' with 'perfect' organic structures, such as helium and iron, we require an organic interpretation. For example, the atoms that surrounds Helium, boron, beryllium and lithium, 'decay' and fusion into Helium, which in organic terms means that Helium breaks them and feeds on their parts to reproduce. On the other hand, radioactive atoms emit 'helium nuclei', as nucleons spontaneously acquire that top predator configuration. While iron, the most perfect, energetic atom of the Universe, is almost impossible to destroy, unless enormous gravitational forces are used. So when a star gets an iron nucleus it collapses into a nova and leaves behind a neutron star with an iron crust. Iron is also the 'atom' of most weapons that 'kill' biological human flesh. So all those atoms show to existential force, as energy or information systems. And since the Universe is a 'game of existence', and in fundamental 'cells' are atoms, the behaviour of atomic

structures can be explained with the arrows of time and show an organic and vital behaviour..

In that regard, the 3 potential life forms and their biological nature is so obvious to the ‘common people’ whose mind is not deformed by ‘abstract science’ that artists, which imagine other potential space-time worlds, have already differentiated those species in their films. So while the robots we are presently building are light worlds of iron - ‘Terminators’ - liquid robots of mercury and gold were imagined in the II part of the series....

What we know is that we are a fragile species in an enormously complex Universe. So we should not play ‘to be god’ and construct robotic machines more powerful than us. The only advantage we have over robots with A.I. is the fact we are so simple we have evolved faster than those future, more complex potential ‘living machines’. So if we were wise we should try to keep it that way, without excuses such as ‘the freedom of science’ and the ‘importance of knowledge’. Since an extinct scientist knows nothing and has no freedom.

Recap. There are 5 potential atomic minds, 2 cosmic minds made of gravitational brains of Helium and radioactive atoms; and 4 quantic, smaller minds, made of electronic orbital: carbonlife minds as those of the human being and metal-minds of silicon and gold, proper of future robotic species. The human mind is the simplest of them all.

62. Orbital minds of life: Chemistry & the human scale.

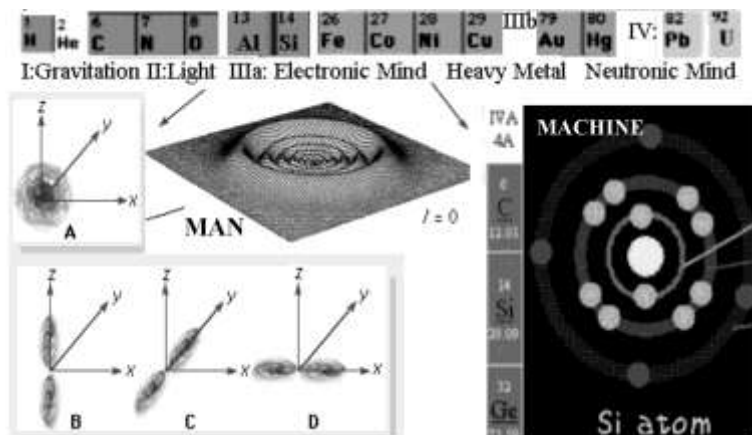

If cosmological bodies perceive gravitational waves, in the reduced st-1 scale of atomic worlds, organic systems perceive electromagnetic waves. For example, our mind is electronic; based on the 4 sp-orbitals of its atoms shown in the graph that display the usual space-time dual morphology:

- *I*: s-orbitals have spherical forms.
- *E*: p-lineal orbitals have an elongated, elliptical form made with 2 fractal cyclical shapes.

Both together create the electronic world of our atoms. Since our mind-world is shaped by O-N-C atoms that have those 4 orbitals; all seems to indicate that the final structure of the mind is based in the atomic orbitals of our DNA and RNA molecules made with those atoms.

In that regard, those 4 sp-orbitals orbitals also follow the inverse laws of EXI cycles. Thus the lineal, spatial p-orbitals have higher energy than the spherical, s_1 and s_2 orbitals; which have higher informative density than the p-orbitals, according to the space-time inversion: Max. E=Min. i.

So sp orbitals probably translate the 4 dimensions of light into 4 electronic orbital dimensions, shaping the pixels of the human mind with a dual role: the s, spherical orbital of cyclical form probably integrates the bigger spatial energy coming from the 3p, lineal, Euclidean orbitals. And so we perceive 3 lineal, spatial dimensions and 1 of time.

The morphological duality of those orbital forms and its homology with our space-time dimensions shows that orbitals process energy and information for their nuclei, acting as their 'window' to the electromagnetic World. So their forms correspond to perfect information and energy shapes:

- Max. I: The sphere is the perfect form of information and so s-orbitals are spheres that inform the central nucleon through the electromagnetic flows they constantly send to their nuclei. While p-orbitals display lineal, energetic forms that probably help atoms to displace. Further on a sphere is the easiest territory to defend, as all its

fractal points are at the same distance from the brain-nucleus, which can deliver simultaneous waves of information and energy to all the regions of the sphere. Hence in all scales, informative spheres and disks require 'less energy-distance' than lineal shapes to act together in a single present. And both, the line and the cycle are the 2 commonest complementary EXI shapes of the Universe.

Thus those sp orbitals can explain the 4 dimensions of our electronic world. But why we are made of a ternary group of atoms, Oxygen, Carbon and Nitrogen? Because those 'electronic orbitals' can form complex social, molecular groups, according to the laws of affinity defined generically by the 3rd postulate of equality of i-logic geometry: they are consecutive in the atomic table...

Recap. The human mind is a mind that uses 3-dimensional light and color, elaborated by the self-similar sp-orbitals and the s-orbital, which creates our dimension of time.

63. Evolution of atomic orbitals: Time arrows in molecules.

The next scale of atomic evolution is the molecular scale.

Atoms form herds called molecules, joined by light and gravitational forces that distribute energy and information among them. Though we differentiate molecules in organic forms derived from carbon and inorganic forms, both follow the vital cycles and organic topologies of st-points made of multiple times-spaces:

- Molecules enact all the time cycles/arrows of st-points.
- They go through the 3±st ages of all systems, which in molecules are the 3±st states of matter.
- Molecules have the same 3 zoned topological structure of all st-points with its *dominant atoms with better nuclear or electronic structure*, occupying the central foci or informative region of those molecules; while *smaller slave atoms* that surround them act as a relative body that absorbs waves that carry energy and information from the *external world*.

Thus, in terms of form the 3rd postulate defines its dual geometry:

- Self-similar atoms co-exist in 'parallel planes'.

- Dominant and submissive atoms establish perpendicular, hierarchical structures in the dimension of relative 'height' with the dominant atom on the center or top region of the system.

And in terms of function, those parallel or hierarchical structures between the atoms of molecules are regulated by the duality of social evolution among self-similar species Vs. Darwinian devolution among different species with unequal exi=stential force, described by the 3rd postulate.

Both together define the geometric forms of many compounds derived from those relationships and the final outcome of encounters between atoms that form molecules. For example, atoms *that have* a better spatial or informative brain, with a more harmonic orbital shape or a higher mass, have *max. Exi force and* become top predator atoms that dominate molecules, penetrating its territory perpendicularly: It is the case shown in graph A.60 where an atom of the 7th column captures an atom from the 1st column to reach the perfect form of a noble atom, engulfing it within its structure.

- The social electronic clouds of molecules show also the 3 space-time ideal forms:

- *Max. I: Pi orbitals* join several electrons into a social, cyclical ring.

- *Max E: Sigma orbitals* are lineal orbitals, more energetic than the pi orbitals.

- *Diatomic orbitals* are balanced, 'elliptic' orbitals created between 2 equal atoms that share their electrons.

- Social, electronic orbitals require less energy and hence are more stable than the sum of the orbitals of its single atoms, which means there is *a strong arrow of social evolution* among atoms that dominates the individual arrow, as in all other universal quanta.

- Also when we study the informative 'brain', the nucleus of atoms, the same phenomenon happens: the most stable and common nuclei are those in which their reproductive, 'female' neutrons and informative, 'male' protons form n-p couples.

In both cases the biological, existential interpretation in organic terms is obvious: systems prefer to exist in complementary couples with 2 self-similar species, dominant in informative and reproductive functions to form a brain/body system able to absorb better the energy of the ecosystem, or in parallel social herds with equal forms than alone, because their simultaneous actions as a couple or group makes them stronger. So most stars form dual or ternary groups; and so do galaxies, atoms and human beings in the 3 known scales of the physical Universe.

Those laws of existence transform the atomic table into an organic table that explains the properties of atoms and social molecules in terms of organicism and the 5 postulates of i-logic geometry.

Galilean paradox applied to orbitals: 1st and 2nd body territories.

Another set of laws proper of all systems apply to electronic orbitals: the existence of 'internal' and 'external' territories, which the informative center treats - according to the Galilean paradox of relative distance/importance to the focus - with different value:

The cellular unit of any st-point is established by the minimal fractal, informative structure with fractal parts that repeats the bigger form and often corresponds to the 'informative radius' of its central topology: In a single atom it is the zone limited by the first orbital, or S₂ spherical electron, which is not shared. In molecules the central atom has also a first, formal, regular body-territory, hardly shared with other molecules, made of slave atoms bonded to it with dense electromagnetic flows, called Van der Waals and London forces that the central atom use to perceive or feed on. In a cell, the organelles of the intermediate territory are not shared. Humans do not share their home properties. Animals do not share their den. Yet all systems that have 'an excess of energy' can share the second territory in the limits of its st-membrane. So atoms share the external orbitals and humans their secondary properties and molecules share their most external atoms, which are those beyond the limiting border of its cellular unit.

Recap. Atoms form social molecules, which also follow the laws of i-logic geometry, its topologies and its arrows of time.

64. Molecules: Darwinian Vs. social bondage: ions and networks

Once and again, the evolution of species chooses between the 2 arrows of order and entropy, of social communication or Darwinian devolution, described by the 3rd Postulate:

Self-similar herds

Atoms show affinity for 2 kind of other atoms:

-Atoms with a similar brain-organ, contiguous in the atomic table.

-Or atoms, which are in the same column of the periodic table and have similar electronic bodies.

They form the strongest 2 types of molecular, electronic bondage. Thus social bondage between equal atoms is dominant and gathers most atoms together, creating extensive networks of planetary size.

Hierarchical organisms among atoms of different exi=stential force

Ionic Darwinian bondage happens among atoms with different ix force. They are more rare and smaller, less stable, but more active as individual forms (in the same manner than individual bacteria are more active than organic cells, but far less complex).

Thus we classify all molecules in 3±st types of molecules of growing Existential Force, ExI, and stability, 2 parameters directly proportional to the degree of equality of their atoms:

(st-1): Lonely atoms or diatomic, covalent molecules.

Top predator atoms, which don't need to increase their individual exi actions. They tend to act alone or in diatomic molecules, made with 2 equal atoms that create a 'covalent bondage', stronger than any ionic molecule where one atom is a predator form. Covalent molecules show electrons with opposite spins that balance the 'vortex directions' of their charges, as it happens with the 2 electrons of an atomic orbital. Their orbital clouds shape ellipses in which each equal atomic nucleus occupies one focus.

The reason of that topology that happens in all scales of reality is again both geometrical and functional: Any topological network, acts

as a relative vital space, based in the best geometry that positions all its st-points at the shortest equal distance of both its *external, energetic membrane and* central, informative singularity. Thus, the sphere is the perfect form of single-centered systems. In dual st-point systems the ellipse is the morphology that locates those 2 points at the minimal shared distance of the membrane and the minimal, equal distance of its center. In the ellipse morphology and function again come together. So their 2 centres can enact exi, simultaneous actions with the external world in all the points of its membrane at the same time. Since the law of the ellipse makes always equal the sum of the distances from both foci to the membrane.

Max. E: Ions: Minimal exi equality & Stability.

Ions form Darwinian, Prey-Predator relationships.

Elements in opposed columns of the atomic table tend to behave in a Darwinian way, as one needs the orbital energy of the other to feed its own electronic body and complete its form. Thus the weaker element with less atomic mass will become prey of the stronger one, forming together unequal *Hierarchical ions*. Ions are small molecules in which the dominant atom in body valences or brain number (atomic weight) controls lighter atoms with fewer valences that become part of its external body-membrane and process temporal energy for the central atoms. They are the smallest molecules, easy to reproduce given its minimal form but unstable, (min. ionisation energy) because their enslaved atoms which try to escape its bondage.

E=i: Corporal affinity. Micro-molecules.

Elements that have spatial, corporal affinity and occupy the same electronic column, evolve socially, forming complex, strong molecular compounds. The main arrows/actions of those molecules are:

- Max.E; Max. I: They process energy and electromagnetic information, creating with them more complex forces (London forces, Van der Waals forces).

- Σ , Π : They associate their electronic orbitals in linear clouds (σ) or cyclical, pi rings.

- Re: They *reproduce* in chemical reactions.

Yet micro-molecules form smaller networks than those made of equal atoms, (crystals) and have less informative complexity than atomic systems based on 'brain' affinity (organic molecules).

Max.I: Body & Brain Affinity: Complementary, organic molecules

Given their affinity, they give birth to the more complex molecular systems and create most of the molecules in the Universe.

Maximal affinity occurs among atoms with similar atomic, brain, weight and orbital body form, correlative in the Atomic table. They become the 3 complementary, e-est-i, components of organic molecules with 3 st-zones:

- Max.E: in life organisms, oxygen is the atom we breathe and the component of water that fills the intermediate spaces of the cell.

- Max.I: Nitrogen, is the informative atom, hyper-abundant on the DNA and brain cells.

- E=I: Carbon is the structural, reproductive atom that shapes the body and creates the membranes of organic cells.

In machines made of metal, silicon and gold (Max.I) are the informative atoms that act as the brains of advanced robots; iron (Max. E) is the structural atom, with max. ionization energy that form the 'membrane' or body of the machine; and copper and silver (e=i), carry the electric energy that feeds the body/brain systems.

st+I: Absolute equality=Max. Social Evolution: Crystals.

Finally atoms belonging to the same species associate in the biggest, symmetric molecular fields, called crystals that 'transcend' into macro-social systems.

Recap. The social evolution of atoms in molecules creates different species, according to their degree of affinity, which follow the laws of the 3rd postulate of self-similarity. The most perfect molecules are those with self-similar electronic bodies, which form ternary, organic systems of energetic, reproductive and informative atoms and molecules made of equal atoms that form informative networks, called

crystals that transcend into a collective plane of existence through its 'mental images' of the external universe.

65. The 3±st cycles of space-time existence in molecules.

We observe in all molecules the 5 cycles/arrows of space-time that complete their existence: the energetic, informative, reproductive, social and generational cycle. While the most complex systems with maximal information (body and brain affinity), also show the transcendental arrow forming complementary, life beings and crystal minds.

Molecules also possess organic constants for each of those cycles. As microcosms their cyclical rhythms are fast, according to the opposite properties of spatial and temporal information: Min Se = Max Ti. So from the human p.o.v. we perceive those fast cycles as types of motions related to the 3±st states of matter:

- *The generational cycle and the 3±st ages of molecules are the 3±st states of matter:* the gas, energetic state, the liquid, balanced state and the solid informative state.

- *Max. E: The energy cycles of molecules produce lineal movement,* which is maximal in energetic gases that move in continuous lineal trajectories at a speed of ± 300 m/s. Accordingly, we measure the energy of a molecule with the parameter of temperature, the fractal unit of the lineal actions of the atomic world. This is the origin of the arrow of entropy analysed first in studies on the motion of steam gas. Yet the arrow of entropy is only dominant on molecular, gas states; and certainly the biggest error of science is to have derived from a local arrow a Universal arrow, which physicists believe to be the only arrow of all the systems and forces of the Universe.

- *Max.i: Informative cycle. Molecules vibrate* in a discontinuous back and forth movement, around 10^{13} times a second. And they transform lineal movement into cyclical vibration when they change their reversible 'age'= state. So when we lower the temperature of a gas, it becomes a liquid and the vibration of the molecules increases as their speed decreases. Then the lineal simple, pure energetic movement of the gas becomes a complex vibrating, informative

movement, forwards and backwards: $E \rightarrow e \leftrightarrow i$. Most complex systems are reproduced in the liquid states (organic life).

- *Social cycle:* Molecular liquids evolve socially, decreasing their energy and increasing their form during their 3rd age, becoming a solid in which the vibration acquires order and rhythm creating macromolecules, called rocks and crystals.

- *Reproductive cycle:* Finally molecules reproduce departing, from their simpler chemical parts through chemical reactions. Let us study this cycle, which is the fundamental 'will' of all systems.

Recap. Molecules show the 6 arrows of time in its motions and gas=energetic, liquid=reproductive and informative, solid states.

66. Reproduction of molecules: Law of chemical balance.

According to the ternary principle there are 3 types of molecular reproduction:

-Max. E: Darwinian events in which top predators molecules capture simpler atoms or molecules as energy of its reproduction.

-E=I: Symbiotic events of molecular reproduction, in which 2 molecules of similar top predator ExI force, switch atomic parts between them, creating more complex molecules till reaching a state of equilibrium.

-Max.I: Informative crystals that reproduce their macro-fractal patterns as they add equal atoms.

Max. E: Simple feeding: Darwinian reactions.

Reproduction requires feeding on simpler fractal, energy parts. Thus when a top predator molecular form appears in a field rich on relative energy, made of simpler individual atoms and micro-molecules, it starts a *chemical reaction*, which we observe as a reproductive growing 'radiation' of the same molecule. However to activate that reproduction the molecule requires a min. amount of extra-energy in the form of temperature (threshold of activation of exoergic reactions). This happens in all reproductive processes, which only occur when the parental species finds a field rich of energy, given the exhausting

nature of such processes, which in a field poor on energy could jeopardize the survival of the parental form. So most animals reproduce in spring when food is abundant; most molecular crystals reproduce when temperature reaches a certain level, and women need a 175 of body fat to reproduce. Those reproductive radiations of molecules are similar to the expansive radiations of a top predator over a population of preys, shaping a similar standard Bell curve of populations, called in this specific case a Boltzmann curve, with the 3 ages:

- *Max Energy of activation.* When energy is hyper abundant after the threshold of activation is crossed, the radiation of new chemical compounds starts at an explosive rate.

- *E=I; Transition state.* The radiation will expand till it 'saturates' and exhausts the energy of the chemical ecosystem in which it feeds, reaching a dynamic steady state of balance similar to that between preys and predators. However in complex 'reproductive radiations' that curve might appear as a wave with several evolutionary 'interphases'. Then the final chemical compound will be the product of a series of intermediary reactions.

- *3rd age. Law of Chemical Balance.* Finally, the explosive reaction ends. Only a few new molecules will be created, when some of the predator molecules become destroyed or new, simpler micro-molecular preys enter the ecosystem. Thus a final chemical equilibrium is reached between both type of molecules, showing a constant of balance, which is a specific case of the generic balance between predators and preys:

$$K = I: \text{Products} / E:\text{Reactants}$$

What quantity of both types of molecules exists in that final equilibrium? It will depend on the relative Exi force of the predator products and the reactant preys, which in abstract chemistry is measured by the 'speed of the reaction' and the relative bondage energy of the molecules. In most cases of Darwinian, chemical reactions that value is huge, as the predator molecules exhaust the supply of its victims, before stopping its reproduction. Yet in certain

symbiotic reactions K tends to 1, when both products and reactants are species of similar Ix E power.

I=E: Dual, symbiotic reproduction.

Molecules are divided in 2 regions, an I-brain, an E=I Body and an external ecosystem of energetic temperature. For example, an amino acid has an amino-brain, a central carbohydrate body and an acid-leg system that moves the molecule, breaking water molecules.

Thus in chemistry, following the Fractal, Ternary Principle, we can calculate the relative top predator power of a molecule, according to the *atomic weight or its brain atoms; the electro-negativity of its leg system* that moves the molecule, taking electrons from other lesser molecules *and the morphological efficiency of its body*, ruled by the 3rd postulate of equality, which makes covalent bondage between equal molecules, such as C=C=C structures, far more difficult to break.

Those 3 parameters used also by inorganic chemistry make certain molecules more efficient than others. They are the metric measure of the 'why' of symbiotic reactions in which 2 similar top predator molecular forms create more efficient ExI molecules by redesigning the brain and body components of the reactants.

Max. i: Social Evolution

Finally individual molecules gather together spontaneously, creating social groups that grow into symmetric crystals.

In all those reactions the final products are 2 new molecules with higher exi power than the initial products, showing the existence of a dominant arrow of information and social evolution in the Universe, which constantly increases the existential power of the whole that combines that of its components.

Recap. The law of chemical reaction is the reproductive law of molecules. According to the ternary principle there are 3 types of molecular reproduction, each one subdivided in 3 ages.

67. Type of reproductive radiations in molecules.

If the reader has followed these lessons, he will realize of the simple method that allows classifying all systems according to the ternary topologies and $3 \pm st$ arrows of time of all systems. In any of those scales there will be certain species that will dominate the ecosystem and reproduce in higher measure. Generally speaking those species always maximize the energetic, informative, reproductive and social arrows. And so while the Universe constantly creates new variations only the most efficient which find an 'econiche' of survival perfecting one of those 4 arrows of time survive and reproduce, using less perfect species as their prey.

In chemical reactions the molecules that reproduce more are top predator with a higher ix force, since they maximize the 4, $\sum (E \leftrightarrow I)$, elements of any i-logic field:

-*Max. E*: Species with max. energy (better or bigger body that processes E to reproduce the molecule). They are molecular ions with the greater number of valences that accept the maximal number of energy and information flows between the atom and the outer world - hence they have the max. action-reaction speed.

- *E \leftrightarrow I*: *Complementary species* created with atoms similar in body and brain, correlative on the Table, like O (Max.E), C (Max. \leftrightarrow) and N (Max.I). They maximize the internal communication between its atoms with multiple inner networks of energy and information between their orbital bodies and nuclear brains (higher density of Van der Waals forces). They are the organic compounds that create life.

- *Max.I*: Crystals are molecules made with atoms of the same nucleic number, which create in their geometric, symmetric centers, virtual images of information of the world that surrounds them.

- *st+I*: Those 2 complex molecules, able to evolve socially, transcend beyond the social herd state, creating 'networks':

- Carbohydrate organisms grow to the size of human beings in *ternary st-structures*, in which carbon molecules shape structural proteins, nitrogen molecules shape informative ADN and oxygens and water fill the intermediate space-time of the organism.

- Crystals evolve socially to the size of planetary cores. *Since, according to the 3rd postulate of equality*, crystals are molecules made with 1 or 2 equal atoms, *hence able to evolve socially* without apparent limit, unlike molecules made of different atoms that merely form small compounds.

Recap. Top predator systems are those who maximize their energetic, informative, reproductive or social skills. They radiate in growing numbers, surviving in the future by feeding in simpler species. In the world of molecules, those 4 arrows are maximized by ions (Max. E), organic molecules (max. Reproduction) and informative crystals. Crystals and organic molecules transcend into complex social macro-organisms.

68. Crystals. The perfect geometrical, fractal unit.

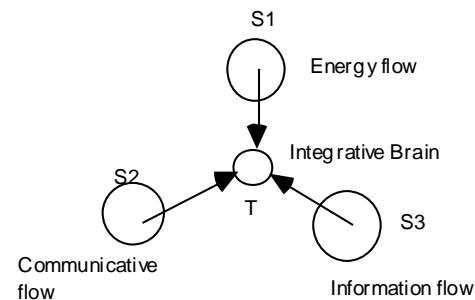
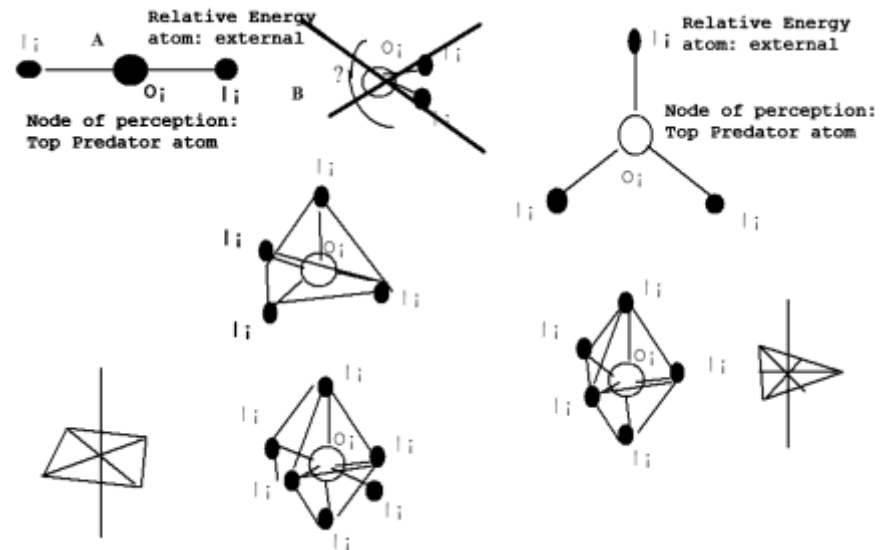

One of the more clear proofs of the existence of p.o.v.s, whose negantropic, informative arrows reproduce fractal forms, diminish entropy and increase the order of the Universe, is given by crystal structures, whose central atom emerges as a fractal knot of time arrows, an i-logic hierarchical p.o.v. that controls and reorders the position of all the other atoms of the system in regular formations that maximize its symmetric perception of the external world. The proof is the fact that crystals only show structures whose geometry is efficient as informative knots in which several flows of electronic forces and light converge on the central knot: Crystals adopt only 7 symmetric morphologies, which make their central atoms, simultaneous, present, symmetric focus of temporal energy coming from the external ecosystem, through its slave body of atoms or molecules of lesser existential force. Those are the only 7 canonical types of crystals that exist in nature.

Let us consider the main existential cycles of crystals:

The informative cycle: the sharp focus of crystals.

Crystals create virtual minds of light that we see in their interior. They are focused images that create at a reduced scale a virtual world, mirror of the external Universe, as an eye does. Thus crystals have only regular symmetric forms that act as an eye does, establishing an objective, informative image of the external world, repeated at a smaller scale within the informative center of the crystal. In the graph, crystals show a clear relationship between spatial geometry and informative perception: only those crystals whose central atom of max. mass=information can observe symmetrically the temporal energy coming from the external world through its slave atoms, form a sharp equidistant focus and survive. While forms, which are not symmetric, at least in a bidimensional plane of space, such as form B, do not exist.

All crystals shape macro-social aggregations of billions of molecules that acquire geometrical forms similar to the 3 regular polyhedrons of the Universe, the hexagon, the tetrahedron and the cube, repeated ad infinitum. So the number of crystals is reduced to 32 possible networks configurations that are combinations of the 7 basic systems of the image, with symmetric axes. The reason is obvious: polyhedrons allow

a correct, balanced absorption and emission of energy and information from all the relative directions of the external Universe coming through those axes. So the ultimate why of crystal's morphologies is to perform the 3±st energy-information cycles of the existential game. In that regard bidimensional hexagons, three-dimensional cubes and tetrahedrons are combinations of 2 forms, the triangle and the square, which represent the minimal ternary and quaternary systems that complete the 4 cyclical arrows of an i-logic field.

Scientists talk of 'spatial symmetry' as a property common to all scales of the Universe, both in the world of sub particles and molecules. It basically means that a temporal, informative particle/form, like a crystal, whatever its position is respect to the external Universe, will maintain unchanged respect to its neutral focus or informative central point the relative distance and symmetry of all the molecules that shape the crystal. In this way the relative virtual world of the central atom will not change its form when it rotates, vibrates around its central atom or moves lineally, but only its perspective, as it happens with our eye's image shaped by the 'crystalline' when we move the head. If those inner axes and distances change then the *world* structure becomes unfocused, as when man takes hallucinogens that change the brain composition or we introduce impurities in a crystal that changes sharply its focus.

In the graph we see the 7 basic possible crystal configurations in which any rotation maintains the inner structure invariant. They are either planar, bidimensional symmetries, triangular, 3-dimensional forms or 4-dimensional, cubic symmetries, the most perfect ones in a 4-dimensional Universe. For that reason the 32 basic crystal configurations are subspecies of the P-cube or primitive cube that generates all other crystals. Accordingly the biggest crystal networks are cubic networks. And the hardest crystal we know is the carbon tetrahedron, the diamond. It is also the most expensive item known to man. As if we knew subconsciously that a diamond has a soul, a virtual world in its inner core. Thus, we can create all complex crystals adding or subtracting to that primitive first cube new atoms, or deforming slightly its angles and edges. The result is the so-called orthorhombic system where 2 of the edges of the plane are elongated

respect to the 2 others in a 'relative lineal direction' of energy; and the more complex clinic, and triclinic systems with non-straight angles between atoms, adapted to ecosystems in which the energy and form comes to the crystal from different angles. All those crystalline systems place sometimes a top predator atom in the central point of the cube, or in the geometrical center of each face. The parallelism between the informative, symmetric morphology of crystals and the symmetry of the inferior scale of orbitals is evident: In sd orbitals the 3'd external, lineal, spatial orbitals are integrated by the cyclical, informative central 's' orbital, which in crystals is occupied by an atom.

Crystals are the scalar bridge between the molecular world of solids and the macro world of planets, made with 3 non-AE regions: a 'liquid/gaseous' membrane inhabited by complex organic beings, an intermediate zone of rocks and a crystal core, the informative center of a planet. For example, the Earth seems to have a macro-crystal of iron hexagons in its center and Neptune a diamond crystal. Since Crystal minds maximize their position in the external Universe to acquire a central point, as a focus of image formation and fractal reproduction of its crystal structures, they are responsible for the creation of order and form in the Universe and can play a key role balancing the orbital position of those planets and modifying its magnetic fields as they absorb external gravito-magnetic waves from stars and black holes.

Energetic cycles.

Energy and information cycles are intertwined by the Law of transformation of energy into information, shaping dual rhythms of emission and absorption of both substances: $E \Leftrightarrow I$. So crystals also absorb and feed on light energy, vibrating with it as quartzes do; or emitting that energy, transformed into focused information, when they polarize light, ordering the different vibrating directions of photons into a single direction that packs better energy and information in highly ordered light rays with enormous exi power. Further on crystals can create 4 dimensional holographic images, out of 2 bidimensional surfaces; trans-forming continuous electromagnetic energy into discontinuous, highly informative, focused packages; changing the

frequency of light, absorbing certain types of light or filtrating only 1 frequency colour, etc.

Social evolution and reproduction of crystals.

Social evolution and reproduction are also 2 intertwined cycles: Most systems reproduce a first seminal cell and then evolve its morphology in a series of dual Reproduction->Evolution cycles that finally create a macro-organism. So happens in 'palingenetic' crystals, which evolve socially and reproduce departing from an initial, seminal 'cellular unit', till creating macro-crystals.

Abstract geologists study the conditions, which determine the growth of crystals. A liquid state is the best, balanced state to reproduce and evolve complex forms also in crystals. Most crystals are reproduced dissolving its initial atomic components in certain liquids. Those initial components are called, even by abstract geologists, nutrients, since they nurture the creation of the crystal, which takes place at a fast pace, thanks to the easiness by which liquids, the $E=I$ reproductive state of matter, allow the combination and random contact between those nutrients that socialize into a cellular crystal unit, to which new crystal units peg themselves. Thus crystals reproduce as a seminal radiation, since the first crystal precipitates the creation of further crystals around it, as in a reproductive process that grows new cells around the seed or the ovum. So new nutrients come around the organic crystal and the crystal grows over the trophic pyramid of nutrients, till they are exhausted and the crystal stops its growth. Then a balanced steady state is reached, as the external cover of the crystal dissolves and grows back cyclically within the liquid.

Since according to the 3rd postulate social evolution happens among equals, crystals are formed only with 1 or 2 type of atoms. Crystals with more than 2 atoms are rare; so are crystals with a great quantity of impure atoms within their network. Crystals are *social* entities formed by millions of atoms, which repeat the so-called minimal cellular unit, *growing* radially as they *reproduce* their forms *through* mathematical structures called fractals, which mimic them in bigger polyhedral scales. Those fractal structures exist in all molecules and crystals

where there is a central knot, from where the radial, symmetrical faces grow, guided by the central knot.

Thus crystals can ‘transcend’ between 2 planes of existence far more easily than we humans do, from micro cells into macro-cellular existence, when a micro-organic crystal becomes a macro-organic crystal. Yet those crystals have, regardless of size, the same configuration that the seminal cell of the crystal. It is *the First Law of Crystallography*: The angles between the faces of any crystal are always the same for all sizes in a crystal of the same species. This law has a creative exception, as each minimal cell can combine with other crystalline cells into symbiotic, more complex, dual ‘sexual crystals’, and a destructive exception, when impurities and fractures happen in the process of crystallization.

So crystals grow into huge ‘cellular networks’ by adding to a regular atomic polyhedron, another regular polyhedron and another... till creating networks of millions of regular polyhedrons that can reach the size of a planetary core.

Recap. Crystals are highly ordered, yet dynamic, organic systems in which flows of electromagnetic or electronic energy and information enact the 5 cyclical actions of any space-time system. The central top predator atoms form a symmetric eye-network structure able to form a mental image of the external Universe. In Nature only regular crystals that allow such images to form exist. Crystals might also be the central mind of planetary bodies, which have crystals in its center.

X. THE EARTH: THE GEOLOGICAL WORLD.

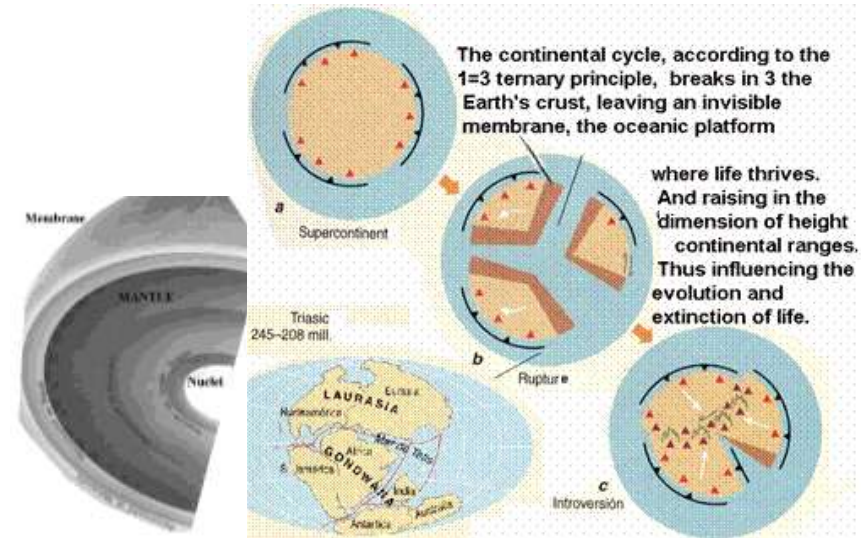

69. The Earth as a ternary, topological st-point.

A planet is a huge i-logic molecular field that mixes liquid and solid states with a very thin gaseous membrane. Thus, based in our template of a network organism, we define the Earth as a st-point:

‘The Earth is an organic, molecular system with a central crystal, which acts as a knot of informative flows of gravitation and a hard membrane that evolves life ecosystems, based on light’.

In the left side of the graph The Earth as a st-point, has 3 fundamental non-AE regions:

- Max. E: Our planet has an energetic, gaseous external membrane; the atmosphere and magnetic belts, which isolates it and selects the type of radiation that crosses into its surface.

- ExI: The zone of maximal reproductive and organic evolution is the crust and mantle: On the surface of the planet there are animal herds that communicate and act-react to light impulses, evolving and reproducing its form. Next, a crust and mantle layer of magma defines the reproductive cycles of rocks.

- Max. I: The inner, informative nucleus is a dense crystal core of iron and within it probably there is a smaller Uranium core, the most complex atom of the Universe with a minimal stable life.

Each of those 3 Non-E regions can be subdivided again, according to the Fractal Principle, in ternary structures and sub-scales of 'fractal quanta' that interact between them with different $E \Leftrightarrow I$, cyclical rhythms corresponding to their arrows of time.

Yet if the Earth has a ternary structure in space, it means its 3 st-regions also perform the $3 \pm$ st existential cycles of any organic system. This is certain to the extent we have empirical evidence for the membrane and the intermediate region with its cycles of reproduction of rocks and so we extend that 'probability' to the central core, a crystal of 'magnetic iron', which should behave as any magnetic, crystalline structure of atoms does, enacting parallel cycles to those of crystals...

Let us then study 2 of those topological regions in more detail, escaping the external, atmospheric membrane. We shall do so as an 'exercise' of the Ternary Principle, showing how any system can be divided in subsystems, which have also a ternary topology that can be subdivided ad infinitum. Since this topological, fractal method that can be applied to all systems, coupled with the ternary division of all events and processes in 3 ages that determine finally the evolution of microforms into a higher organic plane of existence through the arrows of eusocial and organic evolution, (demonstrated in our previous description of the ages of the big-bang and its physical particles) is the essential mode of description of any entity of the Universe with multiple space-times theory...

Recap. The Earth is a topological st-point, which can be subdivided further according to the ternary principle in sub-topologies. The Earth crust is part of the intermediary, reproductive, cyclical region, in which physical cycles and life cycles take place. It has also a ternary topology and climatic cycles that forced the evolution of life.

70. The intermediate, reproductive region.

According to the ternary principle the intermediate, reproductive region (crust and mantle) can be subdivided in 3 subzones that correspond to the 3 topologies of a st-point, albeit with a different order to that of a full, closed ball organism: An external informative surface filled with evolving, 'high', informative, fractal beings, called humans; an energetic, strong continental crust that feed us and a liquid, reproductive magma that renew the crust and dominates by volume and size the other two.

The informative, living quanta of CNO organisms.

- The highly mobile, informative quanta that inhabits the Earth crust can be also divided by the ternary principle in a series of fractal super-organisms of hyperbolic, informative brains (animal life) that control their reproductive body and feed on vital spaces, called ecosystems themselves divided in smaller fractal, vital territories in which those living beings accomplish their time arrows of feeding, informing, reproducing and evolving socially, through a series of cyclical motions, which are non-AE trajectories traced in their vital space by those animal organisms.

Again the ternary principle allows to study each of those vital territories as topological st-points, open balls with an 'invisible membrane' and a hyperbolic swarm of self-similar, fractal informative beings, the animal herd, family or human tribe of a nation, which *is also a topological st-fractal territory.*

The fractal beings that live in those spacetimes, in fact bidimensional planes, from its diminutive perspective, draw up parallel curves in its trajectories, called geodesics, within the geographic, invisible limits of those territories, *to fulfil their cycles/arrows of temporal existence.* For example, herds do not cross its hunting fields; countries establish geographically invisible but very real borders, difficult to cross, patrolled by energy armies, with informative center called capitals where they accumulate most of the monetary, legal and audio-visual information of the nation.

Yet on the Earth a curious event is taking place: an inversion of space-time fields. Since the membrane is becoming the dominant informative region of the planet, evolving through herds of animal beings and machines that perceive light as information and are developing a complex global society, a super-organism with a new 'informative' audio-visual network that circulates through its satellites. All those systems, which belong to the sociological sciences can be studied with the laws of complex st-points.

Since we shall study the outer membrane in far more detail when considering the evolution of human life, let us consider now in this geological analysis, the other 2 regions.

Max. E: The continental crust.

The external crust of the Earth is a hard, energetic membrane of silicates and rocks that isolates the planet. Each continent can be studied as an open ball topology with the 3 canonical topologies:

- An 'invisible' border, *the continental platform*, which sustains most of the organic life of the Earth.

- A reproductive region, the river plains, where most life exists and reproduces.

- And a perpendicular positive or negative height axis, of fractal, hyperbolic topology where evolution of life often happens: the dorsal ranges of Andes in America, where the first Amerindian civilizations took place; the Himalayans, where the mongoloid race mutated; the African Rift (negative, hyperbolic topology, where the ape evolved into human being); and the line that goes from to the Alps in Eurasia to the Balkans (where the iron civilizations that would dominate Europe were born – La Tene, Hallstat, etc.)

Indeed, we can observe on the Earth how the larger cycles of the biggest geological structures of the planet and the sun-earth system determine and synchronize the faster rhythms of its smallest species, both in the physical systems of solid rocks, liquid water and atmospheric gases and in the organic systems of life. For example, the cycles of 'energy' vs. 'information' of the planet (glaciation cycles) are the key cycles to determine the reproductive radiations in hot ages

and informative evolution, in cold ages of its species; the 800 years cycles of climatic changes determined the 800 years cycles of life and death of civilizations and so on.

So we might wonder if the Earth's structures are a program of evolution of life? The answer is more impersonal: macro-organisms automatically provoke the evolution of micro-organisms by chances in their informative and energetic fields that raise the stakes of survival of its micro-particles, which are forced to 'evolve'.

In the graph, the geological record shows one of those cycles, chained to the cycles of its fractal scales, rocks and living beings, the continental cycle that fusions and breaks them in 3 parts every 500-700 million years, a fact which had deep implications to the evolution of life: The outer membrane of the Earth undergoes geological cycles of creation and destruction of continents, modulated by the periodic beat of the Earth, which every ± 250 million years emits matter from its nucleus, creating new submarine ranges and lavas that surface across the extension of an entire continent. Thus again, the 'invisible' center of a st-point regulates its surface. Moreover, the cycle controls the st-1 microscopic scale of life beings, provoking catastrophes that cause great extinction periods, due to massive changes in volcanic activity and the shape of continental platforms, where most life forms exist. In that regard the 2 biggest extinctions of life forms happened tuned to the cycle, 250 million years (Permian extinction) and 500 million years ago (Cambrian extinction). Classic geology postulates that a single continent breaks in 3 parts every 500-700 million years and then lava, coming out of the Atlantic central range, provokes the movement of those continents that join back in the other extreme, sinking matter on its path. So the overall crust doesn't grow.

On the other hand, the organic theory considers the Earth's nuclei a ferromagnetic system that might absorb gravitational waves of dark energy from the black hole-sun system which will catalyze an iron-cobalt-nickel reaction, adding quarks to the iron nucleus that seems to 'absorb' gravitational forces. Thus if the iron crystal of the Earth slows down those waves and 'coils' them into cyclical mass, $E=Mc^2$, provoking heat radiation or new quarks, the nucleus of the Earth would

grow. As in all 'invisible' gravitational processes, we don't have enough data to prove either hypothesis: a growing Earth or a steady state planet. Yet the Earth's oceanic crust shows an imbalance between subduction zones and the excessive number of lava rivers, ranges and abyssal dips, which stretch the Earth's skin as it happens in a fat man. The Atlantic vomits enormous quantities of lava that move America away, *continuously*, creating the Andes range, which in turn should move away the Pacific, creating a range in the Chinese coast. Yet on the East side of the Pacific instead of finding a huge range or trench from Indonesia to Japan, we find some *discontinuous* subduction zones with intermittent megathrust earthquakes that seem not enough to balance that growth with its crust destruction. Thus, planets might grow and fluctuate in size, chained to the time cycles of stars, which seem to be chained to the cycles of the organic galaxy and its Worm Hole, according to the synchronic chains between the time arrows/cycles of all the parts of an organic system.

E=I. Dominant reproductive region: the mantle.

Let us illustrate other laws of multiple space-times with the mantle:

-Any subsystem that acts as an energetic, informative or reproductive subsystem of its higher scale will be dominant in that function in its internal, ternary structure:

The deeper layer the intermediate region of the planet is *the mantle, made of liquid magma that flows in cyclical, convection streams, reproducing* and renewing the rocks of the crust's membrane. Because we are studying a region that in the higher 'plane of existence' of the planet as a whole performs a reproductive function, its reproductive subzone is the biggest one. If the system was an energetic system within the whole, as the atmosphere is the biggest region would be the most energetic (the Ionosphere and exosphere filled with cosmic rays.) And if the system was an informative one, such as a computer or the center of the planet, we expect the informative zone (the mother-board, the iron crystal of the planetary core, to be dominant). Facts, which apply also to biological systems (so for example, man, an informative species, has on top the brain and is dominated by the height dimension

of information; while a planarian worm, a simple digestive, energetic system is a 'plane' of biological energy).

-Hierarchical structure: All systems have 3±st main hierarchical planes, or scales in which the properties of the parts transfer to the whole. So happens to the Earth's geological exi cycles, in which the activities of its quanta become units of larger cycles, as the reproduced substances keep enlarging the 'energetic membrane' (earth crust):

- st-1: At fractal level the geological Earth can be considered an aggregate of all kind of molecular fields called grains and rocks, which show also a st-ternary structure. For example, the commonest rocks are basalts, which show 3 st-differentiated zones: feldspar (energetic rock with minimal symmetry), mica (balanced E=I form) and quartz (the informative element with symmetric crystalline properties) that create together by social evolution, the basalt (st+1). And its process and cycles are process of constant growth of its social form, basalt which forms the overwhelming surface of Oceans, the 70% of the Earth crust.

- st: The next organic scale are small formations made of grain or bigger ones made of rocks. And those geological structures, from mountains to glaciers to sand deserts are constantly growing and reproducing new 'fractal forms'. And all of them the same 3 zoned st-regions that structure the planet with an informative nucleus, reproductive bodies and external energy.

I will put a poetic example: the dune is an organic sand system made of grains, which despite its simplicity already shows the organic properties and ternary structure of any st-point. The dune is an open ball without a clear external membrane and so it is open to constant exchanges of energy and form with the environment, which makes it extremely dynamic, as all open balls, like the black holes we just studied are. So the dune constantly moves through the energetic cycles of its body quanta, which constantly reproduces its structure adding new sand grains. The dune is a simple body made of unconnected herds of cellular grains. But even so, those sand quanta extract energy from the wind, moving the dune without losing its form, and absorb information from the pressure of its weight that compactifies the

molecules of the dune, while temperature's changes help the sand to crystallize. So the dune is a simple organic system from the point of view of fractal space-time. But where is the brain of the dune, its center of perception? An Islamic poet, who lives with dunes in the sand world will tell you that the dune has a soul called the rose of the desert, because all dunes have in its center a quartz crystal that grows slowly to the rhythms of the dunes' daily cycles of energy and information, reflecting the movements of its sand's body on the radial informative networks of the crystal, which *record as all informative systems the paths of the dune in the memorial traces of its planes*. So recently, thanks to the memories of zircons, we found that the Earth cooled down faster than energetic science believed as the dominant, cold informative arrow of all systems imposed itself.

Let us now put a gaseous example of another Earth's organic system from the atmosphere: the hurricane is a spiral vortex with a quiet center. Scientists have noted that when the hurricane creates the central point, its form becomes stable, and inversely when they 'kill' its informative eye, the hurricane breaks. It is that eye perhaps a knot of electro-magnetic or gravitational information that regulates the streams of gas that surround it? Those Aristotelian centres of informative, gravitational, simple geological perception might form central, geometrical images we cannot decode. But they behave externally as if they were centers of informative order that regulate their shapes, creating *order in* the geological Earth. And the fractal sum of all those informative knots together, even if physicists cannot easily measured balances the whole Earth maintaining its awesome number of beautiful forms; since beauty indeed has also a simple equation that defines it: $e=i$, balance between energy and form.

- st+1: Thus the intermediate layer of the planet is its reproductive zone, occupying its canonical position in the Earth's st-point between the crust and the central singularity, where we observe a series of cycles of reproduction and destruction of rocks that create the complex geological structures of its surface, which can be studied according to the laws of multiple space-times with its spatial and temporal perspective, and as a system extending in 3 hierarchical scales of fractal quanta, parts of wholes, units of the entire cyclical system. And

the biggest of those geological fields is the Earth itself, which as we have seen displays the 3 st-zones of a spatial system, with a central, iron, informative, crystalline core, an intermediate cyclical, liquid, 'reproductive' zone that creates rocks and crystals and a hard, structural external crust-membrane. And so even if we cannot perceive it, we postulate by homology with all other st-points and intermediate regions that the mantle will also create iron crystals that will fall to the center of the Earth and become added to the crystal core

The 3 ages of rocks and crystals.

If we study those geological forms in time all of them go also through the 3 'states-ages' of matter that shape the long geological cycles of the inner and outer regions of the mantle, which often culminate in the creation of crystals, the 3rd most perfect, informative, molecular age.

The generational, life cycle of those geological rocks is very slow compared to our life rhythms, according to the space-time inversion, $\max. E = \min. I$; since they are made of heavier atoms and bigger networks than life beings. So they have life spans of millions of years with minimal, informative, time speed; hence they seem dead species from the faster point of view of humans made of lighter atoms. But they just live in fact much longer than we do.

We thought plants did not perceive or acted-reacted to external stimuli, because they were big and slow life based in chemical languages ($\max. E = \min. i$), compared to the faster, electronic languages of smaller animals ($\max. I = \min. e$). But plants turn to the sun, grow adapted to winds and seem to do it faster with music. So their leaves might be simple ears that transmit the vibrations of sounds to their chemical, root brains. The cycles of rocks are even slower, but still they are organic systems of energy and information.

I-logic geometry studies them through the key physical parameter of energy and information, which is temperature: high temperature means high energy, low temperature means high order-information. Another important parameter is 'height', which is a dimension of information. Finally, most processes of creation are long as time, information and

evolution are related: a fast process of creation takes place at high temperatures with maximal expenditure of energy and min. informative order (max. E=min.I). While the inverse slow process of creation uses less energy and reaches a maximal final order. If we apply those 3 st- laws, we can understand the processes of crystal and rock's creation and its 3±st ages:

- *Birth and Youth:* Rocks are born as lavas inside the planet with a high temperature (energy-movement) and an extended form. As they rise in the dimension of height-information, rocks cool off, losing temperature-energy and acquiring form, till reaching when the process is very slow (with a higher quantity of evolutionary time), a crystalline form, able to create images within its informative focus. But if the cooling of the rock happens too fast, without giving time to the slow, formal evolution of atoms necessary to acquire a symmetric order, it becomes an *amorphous rock*. Finally, the rock or crystal comes out to the surface of the Earth and its youth cycle of creation ends.

- *Maturity:* In its mature age the crystal perceives light, forming images in its focus, while the amorphous rock shows at best strikes of lineal atoms. As informative species, crystals also live longer in time, as neurons do in our brain; women in our gender duality and black holes in the Universe. Diamonds live billions of years. But amorphous rocks soon begin the aging process, through erosion that wears them away by the effect of water and light.

- *3rd Age and Death that gives life.* We find in rocks, as in all exi=stential cycles, 2 forms of death:

- Max. Se=min. Ti: An explosive, sudden death, common to all crystals that become broken, exploding into pieces with brisk changes of temperature.

- Max. Ti=min. Se: An informative death in their 3rd age, common to amorphous rocks, as they wear away very slowly, eroded by water and air. So when a rock dies its cells disintegrate, loose its height and return to the interior of the Earth, completing its generational cycle. Then, the energy of the Earth's heart will warm them up again into magma, starting a new cycle:

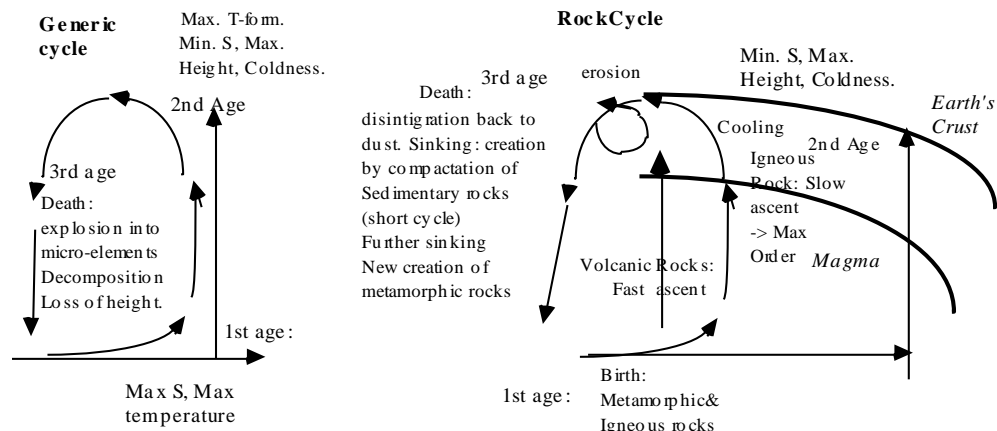

Se ↔ Ti symmetry between 3±st ages and 3±st spatial types of rocks.

Finally, if we consider those ages in space they give birth to 3±st equivalent types of rocks:

- *Max. E:* Simple volcanic rocks that flow with max. energy and speed towards the surface of the Earth but have minimal form.

- ↔: Igneous rocks have slower rising speeds and a balanced form.

- *Max. Ti:* Metamorphic rocks, as their name shows, undergo a transformation with several degrees of crystalline form and radial symmetry. They are the slowest to come out to the surface.

- *±st:* Finally, when rocks die and disaggregate into dust, they clump into the 4th type of rocks: sedimentary rocks and sand, which still have minimal organic structure.

The main difference between the organic and inorganic Earth is its location and speed of cycles: The organic Earth inhabits the final layer of the solid magma in a transitional zone of interaction among gas, liquid and solid molecules. Yet both molecular systems undergo long geological cycles. The best known of those cycles is the cycle of the energetic molecule of life, H₂O, water, that goes through a gas state as a cloud, a liquid age as moving rain and a solid phase as ice or as the most perfect crystalline form, snow, which lasts longer than ice into the ground, as information systems do. So, the biggest liquid and solid systems of the Earth's crust - the sea, the sand of the deserts and rocks

of its mountains - are just organic, fractal systems with very slow existential cycles. Similar cycles occur with the organic masses of the other 2 main atoms of life, nitrogen, the informative atom of life and carbon, the E=T balanced 'body' of living systems. Thus the surface of planet Earth, Gaia, is a living, organic, membrane, a complex molecular system, made at macro-scale of multiple life ecosystems, composed at our human scale of living organisms, which are themselves made at fractal micro-scale of carbon-molecules with forms self-similar to the crystalline molecules, of the previous graph. Those 3 scales structure the cycles of life existence interacting among them - as it happens in any other 'i-logic world', from the mantle and its crystalline rocks just described to the Universe as a whole.

Recap. The fractal, ternary principle subdivides each region of the Earth in 3 sub regions with the same ternary topologies, ad infinitum, allowing us a more detailed analysis of all systems. Thus, the intermediate, reproductive region of the Earth can be subdivided in 3 sub regions – the surface where life exists, the continental crust that follows an E⇌I cycle of creation and destruction of a super-continent into 3 fractal zones and the mantle, where rocks follow their cycles of creation and destruction.

71. The central core of planets and its crystal minds.

Let us finish this introduction to complex physics and its ternary sciences, quantum physics, which studies the smallest particles; astronomy, which studies its gravitational bodies and geology, which studies the intermediate planetary world, with the analysis of that core that connects us back to the relative infinity of the galaxy.

In the next graph, we describe the Earth as an st-point, which has a central singularity and an external membrane that form a unified structure that controls the fractal, reproductive intermediate zone: the activity of the Earth's inner core defines the reproductive and existential cycles of the magma rocks, which shape the continental crust membrane of the planet:

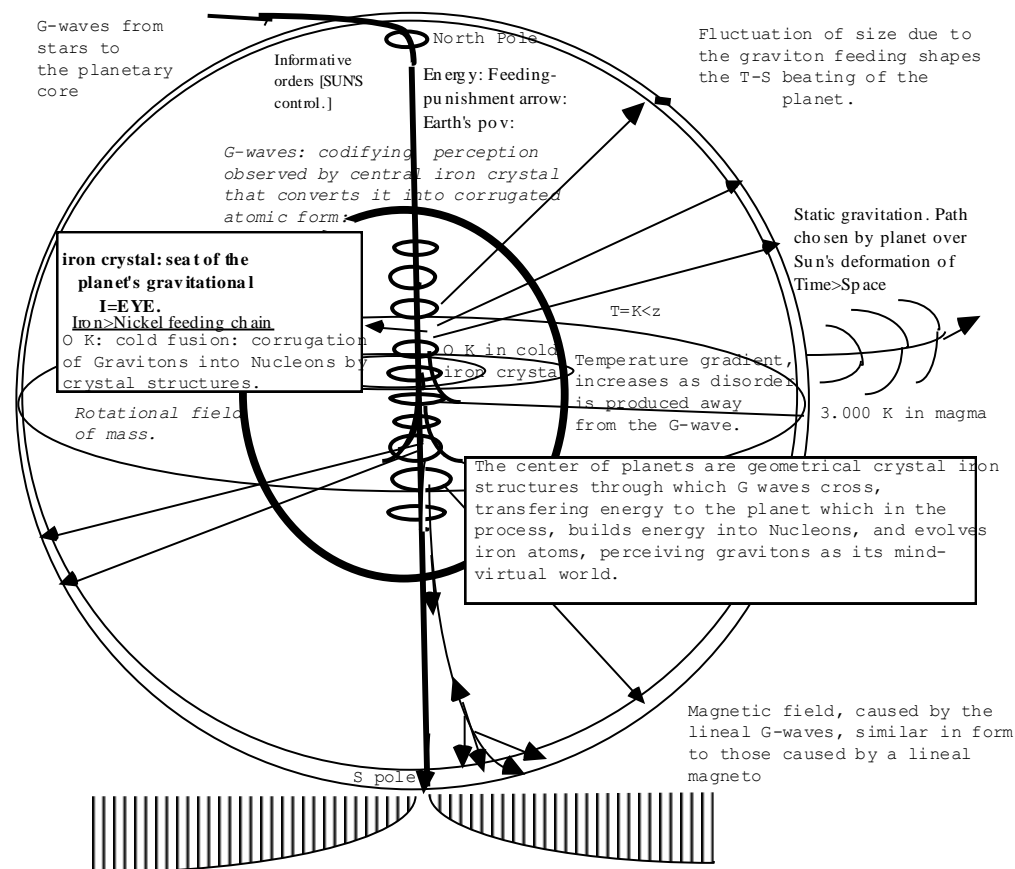

The center has also 3 zones; an informative crystal of iron, which might perceive gravitation a reproductive external liquid ball that should reproduce and precipitate those iron crystals and a center of radioactive uranium that acts as its energetic, heating nuclear plant.

Exi: Liquid iron.

One of the tenants of multiple space-times theory is the multi-functionality of each topological structure, which often plays through its 3 sub-regions different functions for the whole organism. For example in the core of the planet we first find is a dense layer of liquid iron that should reproduce the crystals of the core. Yet it also has an informative role, as it creates convection streams, responsible for the creation of the strong magnetic field of the outer atmosphere of the

Earth, forming the classic Max. E x Max. I, ‘a-r’ duality of a topological, closed ball that cages the reproductive ‘cells’ of its body, within it – in this case the other structures of the mantle:

So life will die exposed to radiation beyond the membrane and rocks will die melted by the liquid iron. In non-Euclidean structures, according to Klein a region that cannot be reached is a relative infinity. So those regions are the relative infinite of our existence and that of the rocks of the mantle, as the black hole is the relative infinite of the light that redshifts without ever reaching it as light.

Finally liquid iron becomes the energetic, hotter lower membrane for the rocks of the mantle, fuelling its reproductive cycles.

Max. E: Uranium core.

The next region of the core is an iron crystal and in the very same center of that iron crystal, within it, there is probably a smaller core of uranium, the most energetic atom of the Universe, with a minimal stable life that emits heat, and sustains with its weight and pressure radiation the crystal core.

Max. I: Iron Crystals

Indeed, the Earth seems to have on its center, surrounded by flows of liquid magma, a crystal made of iron, the most efficient structural atom able to move in gravitational fields, as iron magnets show. Thus, as ‘evolved’ crystal systems in cameras perceive electromagnetic waves, the center of the Earth probably perceives the gravitational waves that structure solar systems and galaxies.

Yet the crystal core has also according to the ternary principle an energetic and reproductive cycle related to the Uranium core, which becomes in this manner its symbiotic, small body.

And all those cycles according to the hierarchical and multifunctional principles are synchronized with the smaller cycles of existence of its surface quanta – the cycles of life and creation and destruction of continents; and with the bigger cycles of stars and galaxies, of which the planet is in itself a fractal quantum.

Let us consider those functions and propositions in more detail.

Reproduction of matter and absorption of heat energy.

Those st-reproductive and energetic functions of the core are based in a well-founded empirical fact:

The Earth’s nucleus is composed of nickel, iron and a probable inner core of uranium, which form together a nuclear reaction chain based on the absorption of nucleons: uranium absorbs a neutron and emits helium, which iron absorbs to create cobalt that emits a neutron to become nickel. The neutron can be absorbed by uranium and feed again the cycle. Those reactions at planetary scale can provoke an enormous quantity of energy and matter that should be responsible for the periodic activity of its magma, which peaks every ± 125 million years, determining the geological continental cycle and the changes on the magnetic field of the Earth. Yet the sun has an orbital period around the galaxy of +200 million years. So those peaks of nuclear and magma activity coincide with the equinox of the solar orbit. What happens in those points? Does the sun cross a turbulent spatial region or a galactic discontinuity? It is the orbital cycle of the sun chained to periods of Worm Hole gravitational activity, as the orbit of Jupiter coincides with the suns’ spot cycle? Then G-waves might become flows of gravitational energy that enter through the planetary axis, as magnetic flows do in atoms, and trigger the uranium->nickel reaction, causing the discontinuous cycles of magma activity in the intermediate ‘reproductive’ zone of the Earth, responsible of the geological, biological and magnetic catastrophic changes on the planet. We know very little but the few things we know seem to prove the interrelating nature of all parts and scales of the galaxy.

Further on, the Earth and other planets fluctuate in their diameter during their rotational orbit as they use gravitational energy to move, ‘deforming’ in the abstract jargon of Einstein, space-time into a curved orbital path.

Thus, planets should grow periodically in size, emitting not only radiation but also matter from those inner cores, a fact that finds constantly new proofs. Since planets emit more radiation and have stronger magnetic fields than we can calculate with mechanic models. While planets closer to the Sun, like Venus that should absorb stronger

G-energies, mutate its skin every ± 400 million years, creating an entire new crust, as a snake does when it grows and changes its skin. Yet ultimately as in all 'cosmological farms', those planets will end up falling and feeding the sun. So all those 'physical cycles' show that planets absorb energy and information and grow in orbital size with rhythms similar to those of nucleons and electrons, when they absorb energy.

The heart and brain of the planet.

Metals use electronic flows to communicate information and energy, organizing their networks through crystalline forms. Their pixels are not photons but electrons. Most of those crystals have also the dominant cubic form, better suited to a 4-dimensional Universe. Thus crystals organize, trans-form and perceive information in the 2 main atomic families we know: the light atoms and the electronic worlds of metal: Electrons in the world of metallic, crystals either form static clouds of 'informative images' or flows that travel through huge metallic networks, stabilizing their structure.

There might be also in the radioactive family, under extreme pressure, crystal-like formal structures crossed by neutronic flows, its exi communicative particles, creating 'radioactive networks', as crystals form crystalline networks, which might invaginate the entire planet. Those fluid 'veins' of radioactive energy should then control in more detail the flows of the rest of the 'planetary organism'. All those homologies are very likely to happen in our planets, as all st-points turn out to be far more complex and organic in detailed analysis that mechanist, energetic scientists will ever believe from their anthropomorphic point of view. Thus like our organisms, regulated by two networks of reproductive energy (blood) and information, the dual body/brain of uranium/iron at the center of the planet might be just a heart/brain dual system with complex radial networks whose cycles of creation of energy and form determine to its finest detail even the surface, as we have seen in our analysis of continental and glaciation cycles; which could be also connected to the changes in the magnetic activity of stars. *It is in fact possible to construct a model of absolute determinism in which all the parts of the planet are interrelated and*

all the parts of the galaxy are organically connected, even if we will never perceive 97% of the matter and energy of the galaxy and a self-similar quantity of our planet structure.

Perceptive, informative function of the Earth Nucleus.

As we change scales from micro-atoms to macro-atoms, the spatial size of the crystals also change in the same way that a machine that substitutes a human organ changes in scale (so a crane that substitutes an arm is far bigger and stronger). And so celestial bodies have in their core crystals of planetary scale, which should be the informative center that regulates most of the long exi cycles of the planet. While the size of the 'electromagnetic waves' those celestial bodies use as energy also change from electromagnetic microwaves to gravitational macro-waves.

Yet all the processes described for transparent light crystals work for electronic iron crystals, since a crystal is a i-logic symmetric, fractal geometry that can be adapted to any form. We conclude that iron crystals might see 'electrons' and feed or move under gravitational waves, which could be their 'energetic' substance.

The 3 ages of planets

All this details said, when we grow up back to the st+1 structure of the whole planet, it should be obvious that planets as a whole also obey all the previous laws.

The most important is the law of the 3 ages. And so planets go through the same living ages of other cosmological species. They are born as nebulae that cool down into a rock, and then they start to cycle around the sun in a symbiotic structure: the planet moves deforming the static field of gravitational space-time around the sun and absorbs discontinuous transversal G-waves, which uses to 'control' its spin, stabilize its orbital territory around the star, feed and perceive perhaps as far as the central Worm Hole of the galaxy, origin of most of those waves.

Recap. The planetary core is a ternary region with a liquid, reproductive surface that precipitates crystals, which form a solid, informative iron crystal, perceive of transversal gravitational waves. Finally inside the crystal there is

an Uranium core, the body of the crystal, whose radiation cycles reproduce mass and provide heat, regulating the cycles of the rest of the structures of the planet, including our rhythms of evolution. Thus the planet have a mechanical, conscious or vegetative gravitational mind, connected to the cycles of stars and galactic black holes, which will ultimate feed on it? We leave that final decision to your i-magination.

72. Philosophical coda.

The sceptic reader might think those are speculations we won't ever prove. Still the main epistemological teaching of i-logic geometry is that 'topological homology' is a valid form of knowledge and the only way we have to study most of the Universe, given the fact we can at best perceive only 4% of that Universe. So when we confront that 96% of the gravitational reality we will never perceive - all what there is within a planet beyond its thin membrane or within the Universe beyond its light-space, or within an atom beyond its thin electronic membrane, the only practical method of knowledge is homology, as the same topologies and ages of space and time happen in all species, by the mere fact that *we are all made of the two primary shapes/motions of reality, energy and information.*

Ultimately the only reason mechanist science does not accept such hypothesis is the arrogant anthropomorphic desires of human beings for absolute truth. Yet since the ultimate, existential goal of any form of knowledge is to avoid death and dangers cannot be known with total certainty, any species believes probable truths based in their homology with past cycles of existence. So a gazelle doesn't know if a lion will kill her, but based in the homology with previous cycles she runs, accepting that probable truth. Truth is indeed ultimately limited by our perception, which is never absolute, so truth is never absolute. I have merely tried to show you the most probable truths of the interconnected organic Universe in which you are also a mere point of existence that now we shall study with more detail with the same laws we have sued to describe all other realities, in your 3 scales, at cellular, individual and social level, with the sciences of biology and bio-history.

Recap. You are nothing but dust of space-time as everything else in the Universe, submitted to the same organic laws of energy and information that regulates all exi=stential beings.

Notes

¹ Expression coined by Roger Bacon to stress the fact that errors from the past (Aristotelian scholars) survived in modern thought, due to the respect the founding fathers of any science cause to future generations. Today we find a similar case with Einstein's concept of a single space-time continuum, the light-space membrane, and its limit of speed, c , which applies only to that membrane.

² The simplicity of such Unification makes us wonder, why it was never found? The answer is: Because it was never tried. Physicists like Einstein first stubbornly tried to unify the equations of Relativity (the complex version of that vortex) with the equations of electromagnetic lineal waves, not its charges. And that is, indeed, impossible, because charges and particles work as cyclical, non-lineal vortices, structures with a gradient of increasing speed towards the center, broken into multiple, fractal flows. While gravitational and electromagnetic waves, also of different scale and size, are lineal self-repetitive forms.

Then the search for Unification Theories followed the opposite path, even less promising, trying to define mass with quantum particles, till arriving to the Higgs, an impossible scalar boson created by a field of which there is no proof whatsoever. Yet the Higgs remains the Saint Grail of entropy-only theories for the only reason that its existence will unify all forces as spatial, gauge theories. Unfortunately spatial mirror symmetry does not apply to a temporal force, like the weak force is; since time is 'antisymmetric' - meaning that the past, future directions (young/old age of a system) have inverse parameters of energy and information.

