



**SUBSET NON
ASSOCIATIVE
TOPOLOGICAL
SPACES**

**W.B.VASANTHA KANDASAMY
FLORENTIN SMARANDACHE**

Subset Non Associative Topological Spaces

**W. B. Vasantha Kandasamy
Florentin Smarandache**

**Educational Publisher Inc.
Ohio
2013**

This book can be ordered from:

Education Publisher Inc.
1313 Chesapeake Ave.
Columbus, Ohio 43212,
USA
Toll Free: 1-866-880-5373

Copyright 2013 by *Educational Publisher Inc.* and the *Authors*

Peer reviewers:

Dr. Stefan Vladutescu, University of Craiova, Romania.
Dr. Valeri Kroumov, Okayama University of Science, Japan.
Professor Paul P. Wang, Ph D, Department of Electrical & Computer
Engineering, Pratt School of Engineering, Duke University, Durham, NC
27708, USA.
Dr. Arsham Borumand Saeid, University of Kerman, Iran

Many books can be downloaded from the following
Digital Library of Science:
<http://www.gallup.unm.edu/eBooks-otherformats.htm>

ISBN-13: 978-1-59973-244-2
EAN: 9781599732442

Printed in the United States of America

CONTENTS

Preface	5
Chapter One BASIC CONCEPTS	7
Chapter Two NON ASSOCIATIVE SPECIAL SUBSET TOPOLOGICAL SPACES USING GROUPOIDS AND LOOPS	31
Chapter Three NON ASSOCIATIVE SUBSET TOPOLOGICAL SPACES ASSOCIATED WITH NON ASSOCIATIVE RINGS AND SEMRINGS	109

FURTHER READING	201
INDEX	207
ABOUT THE AUTHORS	211

PREFACE

The concept of non associative topological space is new and innovative. In general topological spaces are defined as union and intersection of subsets of a set X . In this book authors for the first time define non associative topological spaces using subsets of groupoids or subsets of loops or subsets of groupoid rings or subsets of loop rings. This study leads to several interesting results in this direction. Over hundred problems on non associative topological spaces using of subsets of loops or groupoids is suggested at the end of chapter two. Also conditions for these non associative subset topological spaces to satisfy special identities is also discussed and determined.

Chapter three develops subset non associative topological spaces by using non associative ring or semirings. Over 90 problems are suggested for this chapter. These non associative subset topological spaces can be got by using matrices. We also find non associative topological spaces which satisfies special

identities. Certainly this study can lead to a lot of applications as this notion is very new.

We thank Dr. K.Kandasamy for proof reading and being extremely supportive.

W.B.VASANTHA KANDASAMY
FLORENTIN SMARANDACHE

Chapter One

BASIC CONCEPTS

In this chapter we introduce those concepts which are very essential to make this book a self contained one. However we have given references at each stage so that in time of need one can refer them.

We first introduce from [53, 56, 59] the new class of groupoids based on which the non associative structures are built.

Throughout this book by a groupoid G we mean a semigroup in which the operation is non associative.

Example 1.1: Let $G = \{Z_{15}, *, (3, 6)\}$ be the groupoid of order 15. It is easily verified $*$ is a closed non associative operation on G .

Example 1.2: Let $G = \{Z_{19}, *, (3, 0)\}$ be the groupoid of order 19 which is non commutative.

Example 1.3: Let $S = \{Z_{45}, *, (6, 6)\}$ be a groupoid of order 45. G is a commutative groupoid.

Thus we can construct using Z_n the modulo integers several groupoids.

$G = \{Z_n, *, (t, s) \mid t, s \in Z_n\}$; ($t = s = 0$ and $t = s = 1$ alone is not allowed) gives a class of groupoids of order n .

For instance take $n = 5$ the groupoids using Z_5 are

$$\begin{aligned} G_1 &= \{Z_5, *, (2, 2)\}, G_2 = \{Z_5, *, (3, 3)\}, \\ G_3 &= \{Z_5, *, (4, 4)\}, G_4 = \{Z_5, *, (2, 0)\}, \\ G_5 &= \{Z_5, *, (0, 2)\}, G_6 = \{Z_5, *, (0, 3)\}, \\ G_7 &= \{Z_5, *, (3, 0)\}, G_8 = \{Z_5, *, (4, 0)\}, \\ G_9 &= \{Z_5, *, (0, 4)\}, G_{10} = \{Z_5, *, (2, 3)\}, \\ G_{11} &= \{Z_5, *, (3, 2)\}, G_{12} = \{Z_5, *, (3, 4)\}, \\ G_{13} &= \{Z_5, *, (4, 3)\}, G_{14} = \{Z_5, *, (2, 4)\}, \\ G_{15} &= \{Z_5, *, (4, 2)\}, G_{16} = \{Z_5, *, (1, 2)\}, \\ G_{17} &= \{Z_5, *, (1, 3)\}, G_{18} = \{Z_5, *, (3, 1)\}, \\ G_{19} &= \{Z_5, *, (2, 1)\}, G_{20} = \{Z_5, *, (1, 4)\} \\ &\text{and } G_{21} = \{Z_5, *, (4, 1)\}. \end{aligned}$$

Thus using Z_5 we can get atleast 20 different groupoids.

This is the advantage of using non associative binary operation on Z_5 for we can have '+' or \times leading to a group or a semigroup and nothing more.

Thus it remains an open problem to find the number of groupoids for a given Z_n which are not semigroups.

For more about groupoids of this type refer [53, 56, 59].

In groupoids we can define ideals.

Let G be a groupoid. A non empty proper subset P of G is said to be a left ideal of the groupoid G if

- (i) P is a subgroupoid of G .
- (ii) For all $x \in G$ and $a \in P$, $xa \in P$.

If for $x \in G$ and $a \in P$, $ax \in P$ we call P to be a right ideal. If P is simultaneously a left ideal and a right ideal we call P to be an ideal of G .

Example 1.4: Let G be a groupoid given by the following table;

*	a_0	a_1	a_2	a_3	a_4	a_5
a_0	a_0	a_4	a_2	a_0	a_4	a_2
a_1	a_2	a_0	a_4	a_2	a_0	a_4
a_2	a_4	a_2	a_0	a_4	a_2	a_0
a_3	a_0	a_4	a_2	a_0	a_4	a_2
a_4	a_2	a_0	a_4	a_2	a_0	a_4
a_5	a_4	a_2	a_0	a_4	a_2	a_6

$P = \{a_0, a_2, a_4\}$ is both a left ideal and right ideal of G .

Example 1.5: Let G be a groupoid given by the following table:

*	a_0	a_1	a_2	a_3
a_0	a_0	a_3	a_2	a_1
a_1	a_2	a_1	a_0	a_3
a_2	a_0	a_3	a_2	a_1
a_3	a_2	a_1	a_0	a_3

$P_1 = \{a_0, a_2\}$ and $P_2 = \{a_1, a_3\}$ are only left ideals of G and G has no right ideals.

Next we proceed onto just define the notion of Smarandache groupoid.

A groupoid $(G, *)$ is said to be a Smarandache groupoid if G has a proper subset $P \subseteq G$ such that $(P, *)$ is a semigroup.

Example 1.6: Let G be a groupoid given by the following table:

*	0	1	2	3	4	5
0	0	3	0	3	0	3
1	1	4	1	4	1	4
2	2	5	2	5	2	5
3	3	0	3	0	3	0
4	4	1	4	1	4	1
5	5	2	5	2	5	2

$S_1 = \{0, 3\}$, $S_2 = \{1, 4\}$ and $S_3 = \{2, 5\}$ are all proper subsets of G which are semigroups in G . So G is a Smarandache groupoid.

A Smarandache groupoid G is said to be a Smarandache Moufang groupoid (S-Moufang groupoid) if there exist $H \subseteq G$ such that H is a S-subgroupoid satisfying the Moufang identity.

$$(xy)(zx) = (x(yz))x \dots \text{ (M)}$$

for all $x, y, z \in H$.

Example 1.7: Let $G = \{Z_{10}, *, (5, 6)\}$ be the groupoid.

G is a S-groupoid infact G is a S-Moufang groupoid.

We call a S-Moufang groupoid G to be a Smarandache strong Moufang groupoid if every Smarandache subgroupoid H of G satisfies the Moufang identity (M).

Clearly the groupoid given in Example 1.7 is a S-strong Moufang groupoid.

Example 1.8: Let $G = \{Z_{12}, *, (3, 9)\}$ be a groupoid. G is only a S-Moufang groupoid and not a S-strong Moufang groupoid as

the $A_2 = \{0, 3, 6, 9\} \subseteq G$ does not satisfy the Moufang identity (M).

We call a groupoid G to be a Smarandache Bol groupoid if G has a subgroupoid H such that H is a Smarandache groupoid and if for all $x, y, z \in H$ we have

$$((x * y) * z) * y = x * ((y * z) * y) \quad \dots \quad (B)$$

We call G to be a Smarandache Bol groupoid.

If every S-subgroupoid H of G satisfies the Bol identity (B) then we define G to be a Smarandache strong Bol groupoid.

Example 1.9: Let $G = \{Z_{12}, (3, 4), *\}$ be a groupoid. G is a Smarandache strong Bol groupoid as every $x, y, z \in G$ satisfies the Bol identity (B); hence every S-subgroupoid will satisfy the Bol identity B.

Example 1.10: Let $G = \{Z_4, *, (2, 3)\}$ be a groupoid. G is a S-Bol groupoid and not a S-strong Bol groupoid as we have S - subgroupoids in G which does not satisfy the Bol identity B.

We call a groupoid G to be a Smarandache P-groupoid if G contains a proper Smarandache subgroupoid H and the identity

$$(x * y) * x = x * (y * x) \quad \dots \quad (P)$$

is true for all $x, y \in H$.

If for every S-subgroupoid H in G satisfies the identity P then we call G to be a Smarandache strong P-groupoid.

Example 1.11: Let $G = \{Z_6, *, (4, 3)\}$ be the groupoid. G is a Smarandache strong P-groupoid.

Example 1.12: Let $G = \{Z_6, *, (3, 5)\}$ be a groupoid. G is only a Smarandache P-groupoid and not a S-strong P-groupoid.

Let us now define S-alternative groupoid and S-strong alternative groupoid.

Let G be a S-groupoid, G is said to be a Smarandache right alternative groupoid if a proper subset H of G where H is a S-subgroupoid of G and satisfies the right alternative identity;

$$(x * y) * y = x * (y * y) \quad \dots \text{(r.a)}$$

for all $x, y \in H$.

We say G is a left alternative groupoid if the proper S-subgroupoid H of G satisfies the left alternative identity;

$$(x * y) * y = x * (x * y) \quad \dots \text{(l.a)}$$

for all $x, y \in H$.

G is a S-alternative groupoid if a S-subgroupoid H of G satisfies both the identities (r.a) and (l.a) that is right alternative identity and left alternative identity respectively.

We say G is a S-strong left alternative (right alternative) if every S-subgroupoid H of G satisfies (l.a) ((r.a)) for every $x, y \in H$.

Similarly G is a S-strong alternative if every S-subgroupoid H of G satisfies both the identities (r.a) and (l.a).

We will give a few example of this.

Example 1.13: Let $G = \{Z_{12}, (5, 10), *\}$ be a groupoid G is only a Smarandache P-groupoid and not a S-strong P-groupoid.

Example 1.14: Let $G = \{Z_{14}, *, (7, 8)\}$ be a S-groupoid. G is a S-strong alternative groupoid.

Example 1.15: Let $G = \{Z_{12}, *, (4, 0)\}$ be a groupoid. G is a S-strong alternative groupoid.

Example 1.16: Let G be the groupoid given in the following table:

*	e	g_1	g_2	g_3	g_4	g_5	g_6	g_7
e	e	g_1	g_2	g_3	g_4	g_5	g_6	g_7
g_1	g_1	e	g_4	g_7	g_3	g_6	g_2	g_5
g_2	g_2	g_6	e	g_5	g_1	g_4	g_7	g_3
g_3	g_3	g_4	g_7	e	g_6	g_2	g_5	g_1
g_4	g_4	g_2	g_5	g_3	e	g_7	g_3	g_6
g_5	g_5	g_7	g_3	g_6	g_2	e	g_1	g_4
g_6	g_6	g_5	g_1	g_4	g_7	g_3	e	g_2
g_7	g_7	g_3	g_6	g_2	g_5	g_1	g_4	e

G is a non commutative groupoid but is a S -commutative groupoid for every subgroupoid is commutative.

Example 1.17: Let G be a groupoid given by the following table:

*	e	g_1	g_2	g_3	g_4	g_5
e	e	g_1	g_2	g_3	g_4	g_5
g_1	g_1	e	g_3	g_5	g_2	g_4
g_2	g_2	g_5	e	g_4	g_1	g_3
g_3	g_3	g_4	g_1	e	g_5	g_2
g_4	g_4	g_3	g_5	g_2	e	g_1
g_5	g_5	g_2	g_4	g_1	g_3	e

G is a S -strong right alternative groupoid.

Example 1.18: Let G be a groupoid given by the following table:

*	e	g ₁	g ₂	g ₃	g ₄	g ₅
e	e	g ₁	g ₂	g ₃	g ₄	g ₅
g ₁	g ₁	e	g ₅	g ₄	g ₃	g ₂
g ₂	g ₂	g ₃	e	g ₁	g ₅	g ₄
g ₃	g ₃	g ₅	g ₄	e	g ₂	g ₁
g ₄	g ₄	g ₂	g ₁	g ₅	e	g ₃
g ₅	g ₅	g ₄	g ₃	g ₂	g ₁	e

G is a S-strong left alternative groupoid.

Now we just recall the definition of S-strong idempotent groupoid.

Let G be a groupoid. G is said to be an idempotent groupoid if $x^2 = x$ for all $x \in G$.

Example 1.19: Let $G = \{Z_{11}, *, (6, 6)\}$ be the groupoid. G is an idempotent groupoid.

Example 1.20: Let $G = \{Z_{19}, *, (10, 10)\}$ be the groupoid. G is an idempotent groupoid.

Both the examples 1.19 and 1.20 are S-idempotent groupoids.

Now we proceed onto introduce the notion of finite loops from [7, 35, 61].

Let $L_n(m) = \{e, 1, 2, \dots, n\}$ be a set where $n > 3$; n is odd and m is a positive integer such that $(m, n) = 1$ and $(m - 1, n) = 1$ with $m < n$ and e is the identity of $L_n(m)$.

Define on $L_n(m)$ a binary operation * as follows:

- (i) $e * i = i * e = i$ for all $i \in L_n(m)$
- (ii) $i^2 = i * i = e$ for all $i \in L_n(m)$
- (iii) $i * j = t$ where $t = (m_j - (m - 1)i) \pmod n$

for all $i, j \in L_n(m)$ $i \neq j$, $i \neq e$, $j \neq e$; then $L_n(m)$ is a loop under the operation $*$.

We will give some examples of them.

Example 1.21: Let $L_5(3) = \{e, 1, 2, 3, 4, 5\}$ be the loop of order 6 given by the following table:

*	e	1	2	3	4	5
e	e	1	2	3	4	5
1	1	e	3	5	2	4
2	2	5	e	4	1	3
3	3	4	1	e	5	2
4	4	3	5	2	e	1
5	5	2	4	1	3	e

Example 1.22: Let $L_{15}(8)$ be a loop of order 16. $L_{15}(8)$ is a commutative loop.

Example 1.23: Let $L_{19}(7)$ be a loop of order 20.

We call a loop L to be a Smarandache loop if L contains a proper subset P such that, P under the operation of L is a group.

Example 1.24: Let $L_{25}(8)$ be a loop of order 26.

$P_i = \{e, g_i\}$; $g_i \in L_{25}(8) \setminus \{e\}$, $i = 1, 2, \dots, 25$ are subgroups of $L_{25}(8)$ of order two. So $L_{25}(8)$ is a S-loop.

We say a loop L is a Moufang loop if the Moufang identity (M) is satisfied for every $x, y, z \in L$.

A loop L is said to be an right alternative loop if every $x, y \in L$ satisfies the identity (r.a).

Example 1.25: Let $L_{19}(2)$ be a loop. L is a right alternative loop of order 20.

Example 1.26: Let $L_{29}(2)$ is a right alternative loop of order 30.

We see in L_n the loop $L_n(2)$ is always a right alternative loop of order $n + 1$.

A loop L is said to be a left alternative loop if every pair of elements x, y in L satisfies the (l.a) identity.

Example 1.27: Let $L_{27}(26)$ be a loop of order 28. $L_{27}(26)$ is a left alternative loop.

Example 1.28: Let $L_{49}(48)$ be a left alternative loop of order 50.

Example 1.29: Let $L_{47}(46)$ be a left alternative loop of order 48.

There exists one and only one loop in L_n namely the loop $L_n(n - 1)$ which is a left alternative loop [55, 60-1].

A loop L is said to be alternative if both the (l.a) and (r.a) identity is satisfied by every pair $x, y \in L$.

We see no loop in L_n is alternative.

For more about the special type of loops please refer [55, 60-1].

Next we proceed onto define the notion of non associative semiring and non associative ring.

To get a non associative ring we can make use of both the groupoid or a loop over a ring or a field.

Let G be a groupoid. R a ring or a field. RG the groupoid ring consists of all finite formal sums of the form $\sum_{i=1}^n a_i g_i$; $a_i \in$

R and $g_i \in G$, $n = |G|$; that is number of elements if G . n will be finite if $|G| = n < \infty$ and n will be infinite if $|G| = n = \infty$.

We can have infinite groupoids; we will illustrate them in the following examples.

Example 1.30: Let $G = \{Z, *, (10, -3)\}$ be a groupoid which is of infinite cardinality.

Example 1.31: Let $G = \{Q, *, (3/5, 17/2)\}$ be a groupoid of infinite cardinality.

Example 1.32: Let $G = \{\langle R \cup I \rangle, *, (\sqrt{3} I, -4I)\}$ be a groupoid of infinite order. Infact G is a real neutrosophic groupoid.

Example 1.33: Let $G = \{(a_1, a_2, \dots, a_9), *, (3, 0), a_i \in Z, 1 \leq i \leq 9\}$ be an infinite matrix groupoid.

Let $x = (3, 0, 1, 0, 2, 5, 7, 9 -1)$ and $y = (4, 2, -1, -5, 0, 0, -2, 7, 0) \in G$.

We see

$$x * y = (3, 0, 1, 0, 2, 5, 7, 9 -1) * (4, 2, -1, -5, 0, 0, -2, 7, 0)$$

$$= \{(3 * 4, 0 * 2, 1 * -1, 0 * -5, 2 * 0, 5 * 0, 7 * -2, 9 * 7, -1 * 0)\}$$

$= (9, 0, 3, 0, 6, 15, 21, 27, -3) \in G$. This is the way $*$ operation on G is performed.

Example 1.34: Let

$$G = \left\{ \begin{bmatrix} a_1 \\ a_2 \\ a_3 \\ a_4 \\ a_5 \end{bmatrix} \mid a_i \in Q; *, (1, -1/2); 1 \leq i \leq 5 \right\}$$

be the column matrix groupoid of infinite order.

$$\text{Let } x = \begin{bmatrix} 3 \\ 1 \\ 0 \\ 5 \\ -4 \end{bmatrix} \text{ and } y = \begin{bmatrix} 2 \\ -4 \\ -6 \\ 0 \\ 7 \end{bmatrix} \in G.$$

$$x * y = \begin{bmatrix} 3 \\ 1 \\ 0 \\ 5 \\ -4 \end{bmatrix} * \begin{bmatrix} 2 \\ -4 \\ -6 \\ 0 \\ 7 \end{bmatrix}$$

$$= \begin{bmatrix} 3 * 2 \\ 1 * -4 \\ 0 * -6 \\ 5 * 0 \\ -4 * 7 \end{bmatrix} = \begin{bmatrix} 2 \\ 3 \\ 3 \\ 5 \\ 7(1/2) \end{bmatrix} \in G.$$

This is the way the operation $*$ is performed on G .

Example 1.35: Let

$$G = \left\{ \left[\begin{array}{cccc} a_1 & a_2 & a_3 & a_4 \\ a_5 & a_6 & a_7 & a_8 \\ a_9 & a_{10} & a_{11} & a_{12} \end{array} \right] \mid a_i \in \mathbf{R}; *, (\sqrt{3}, 0); 1 \leq i \leq 12 \right\}$$

be the matrix groupoid of infinite order.

$$\text{Let } A = \begin{bmatrix} 3 & \sqrt{3} & 0 & 1 \\ 4 & 1/\sqrt{3} & 3 & 0 \\ 0 & 0 & 1 & -2 \end{bmatrix}$$

$$\text{and } B = \begin{bmatrix} 8 & 9 & \sqrt{3} & \sqrt{7} \\ -\sqrt{11} & 2+\sqrt{3} & 0 & \sqrt{15} \\ 0 & 0 & \sqrt{19}+1 & -\sqrt{29}+5 \end{bmatrix} \in G.$$

$$= \begin{bmatrix} 3 & \sqrt{3} & 0 & 1 \\ 4 & 1/\sqrt{3} & 3 & 0 \\ 0 & 0 & 1 & -2 \end{bmatrix} *$$

$$\begin{bmatrix} 8 & 9 & \sqrt{3} & \sqrt{7} \\ -\sqrt{11} & 2+\sqrt{3} & 0 & \sqrt{15} \\ 0 & 0 & \sqrt{19}+1 & -\sqrt{29}+5 \end{bmatrix}$$

$$= \begin{bmatrix} 3*8 & \sqrt{3}*9 & 0*\sqrt{3} & 1*\sqrt{7} \\ 4*-\sqrt{11} & 1/\sqrt{3}*(2+\sqrt{3}) & 3*0 & 0*\sqrt{15} \\ 0*0 & 0*0 & 1*\sqrt{19}+1 & -2*-\sqrt{29}+5 \end{bmatrix}$$

$$= \begin{bmatrix} 3\sqrt{3} & 3 & 0 & \sqrt{3} \\ 4\sqrt{3} & 1 & 3\sqrt{3} & 0 \\ 0 & 0 & \sqrt{3} & -2\sqrt{3} \end{bmatrix} \in G.$$

This is the way * operation is performed.

That is the matrix multiplication is the natural product \times_n of matrices.

Example 1.36: Let

$$G = \left\{ \begin{bmatrix} a_1 & a_2 & a_3 \\ a_4 & a_5 & a_6 \\ a_7 & a_8 & a_9 \end{bmatrix} \mid a_i \in \langle \mathbb{R} \cup \mathbb{I} \rangle, *, (\mathbb{I}, -2\mathbb{I} + 1); 1 \leq i \leq 9 \right\}$$

be an infinite matrix groupoid.

$$\text{Let } A = \begin{bmatrix} 0 & 3 & 2 \\ \mathbb{I} & 0 & -4 \\ \sqrt{2} & 5\mathbb{I} & 0 \end{bmatrix} \text{ and } B = \begin{bmatrix} 0 & 3 & 2 \\ \mathbb{I} & 0 & -4 \\ \sqrt{2} & 5\mathbb{I} & 0 \end{bmatrix} \in G.$$

We now find

$$\begin{aligned} A * B &= \begin{bmatrix} 0 & 3 & 2 \\ \mathbb{I} & 0 & -4 \\ \sqrt{2} & 5\mathbb{I} & 0 \end{bmatrix} * \begin{bmatrix} 0 & 3 & 2 \\ \mathbb{I} & 0 & -4 \\ \sqrt{2} & 5\mathbb{I} & 0 \end{bmatrix} \\ &= \begin{bmatrix} 0*1 & 3*0 & 2*4 \\ \mathbb{I}*0 & 0*1+\mathbb{I} & -4*-2 \\ \sqrt{2}*1 & 5\mathbb{I}*0 & 0*0 \end{bmatrix} \\ &= \begin{bmatrix} 1-2\mathbb{I} & 3\mathbb{I} & -6\mathbb{I}+4 \\ \mathbb{I} & 1-3\mathbb{I} & -2 \\ \sqrt{2}\mathbb{I}-\mathbb{I} & 5\mathbb{I} & 0 \end{bmatrix} \text{ is in } G. \end{aligned}$$

Now all the groupoids are of infinite order.

We can have finite order matrix groupoids also.

Example 1.37: Let

$$G = \left\{ \begin{bmatrix} a_1 & a_2 \\ a_3 & a_4 \\ a_5 & a_6 \\ a_7 & a_8 \end{bmatrix} \mid a_i \in V = \{C(\mathbb{Z}_{12}), *, (3, 4i_F); 1 \leq i \leq 8\} \right\}$$

be the matrix groupoid of finite order.

Example 1.38: Let

$G = \{(a_1, a_2, \dots, a_9) \mid a_i \in B = \{\langle \mathbb{Z}_7 \cup I \rangle, *, (3I, 4 + 2I)\}; 1 \leq i \leq 9\}$ be a matrix groupoid of finite order.

Example 1.39: Let

$$G = \left\{ \begin{bmatrix} a_1 \\ a_2 \\ \vdots \\ a_{15} \end{bmatrix} \mid a_i \in B = \{C(\mathbb{Z}_{15} \cup I), *, (5I, 10)\}; 1 \leq i \leq 15\right\}$$

be a matrix groupoid of finite order.

Example 1.40: Let

$$G = \left\{ \begin{bmatrix} a_1 & a_2 & a_3 & a_4 \\ a_5 & a_6 & a_7 & a_8 \\ a_9 & a_{10} & a_{11} & a_{12} \\ a_{13} & a_{14} & a_{15} & a_{16} \end{bmatrix} \mid a_i \in B = \{C(\mathbb{Z}_{20}), *, (10i_F, 0)\}; \right.$$

$$\left. 1 \leq i \leq 16\right\}$$

be a matrix groupoid of finite order.

Finally we can also have polynomial groupoids.

Example 1.41: Let

$$G = \left\{ \sum_{i=0}^{\infty} a_i x^i \mid a_i \in \{ \langle \mathbb{R} \cup I \rangle, *, I(-3I + 4\sqrt{3}) \} \right\}$$

be a polynomial groupoid.

Now we proceed onto give a few examples of interval groupoids of both finite and infinite order.

Example 1.42: Let $G = \{ [a, b] \mid a, b \in B = \{ \mathbb{Z}_{45}, *, (3, 10) \} \}$ be an interval groupoid of finite order.

Example 1.43: Let

$G = \{ [a, b] \mid a, b \in B = \{ \langle \mathbb{R} \cup I \rangle, *, (3I, 0) \} \}$ be the interval groupoid of infinite order.

Example 1.44: Let $G = \{ ([a_1, b_1], [a_2, b_2], \dots, [a_7, b_7]) \mid a_i, b_i \in B = \{ \langle \mathbb{Z}_{10} \cup I \rangle, *, (5I, 0) \}, 1 \leq i \leq 7 \}$ be the interval row matrix groupoid of finite order.

Example 1.45: Let

$$G = \left\{ \left[\begin{array}{c} [a_1 b_1] \\ [a_2 b_2] \\ \vdots \\ [a_{15} b_{15}] \end{array} \right] \mid a_i, b_i \in B = \{ \langle \mathbb{R} \cup I \rangle, *, (3I, 2 - \sqrt{7}I) \}, \right. \\ \left. 1 \leq i \leq 15 \right\}$$

be the interval matrix groupoid of infinite order.

Example 1.46: Let

$$G = \left\{ \begin{bmatrix} [a_1, b_1] \\ [a_2, b_2] \\ [a_3, b_3] \end{bmatrix} \mid a_i, b_i \in B = \{Z_6, *, (0, 2)\} \ 1 \leq i \leq 3 \right\}$$

be the interval matrix groupoid.

$$\text{Let } A = \begin{bmatrix} [3, 1] \\ [0, 2] \\ [4, 5] \end{bmatrix} \text{ and } B = \begin{bmatrix} [0, 3] \\ [4, 3] \\ [2, 1] \end{bmatrix} \in G.$$

$$A * B = \begin{bmatrix} [3, 1] \\ [0, 2] \\ [4, 5] \end{bmatrix} * \begin{bmatrix} [0, 3] \\ [4, 3] \\ [2, 1] \end{bmatrix}$$

$$= \begin{bmatrix} [3, 1] * [0, 3] \\ [0, 2] * [4, 3] \\ [4, 5] * [2, 1] \end{bmatrix}$$

$$= \begin{bmatrix} [3 * 0, 1 * 3] \\ [0 * 4, 2 * 3] \\ [4 * 3, 5 * 1] \end{bmatrix}$$

$$= \begin{bmatrix} [0, 0] \\ [0, 3] \\ [0, 3] \end{bmatrix} \in G.$$

This is the way operation is performed on G.

Example 1.47: Let

$$G = \left\{ \left[\begin{array}{c} a_1 \\ a_2 \\ a_3 \\ \hline a_4 \\ a_5 \\ a_6 \\ \hline a_7 \\ a_8 \\ \hline a_9 \\ a_{10} \end{array} \right] \mid a_i \in B = \{Z_{16}, *, (4, 0)\}, 1 \leq i \leq 10\} \right.$$

be the super matrix groupoid of finite order.

Example 1.48: Let

$$G = \left\{ \left[\begin{array}{c|c|c|c} a_1 & a_2 & a_3 & a_4 \\ \hline a_5 & \dots & \dots & a_8 \\ \hline a_9 & \dots & \dots & a_{12} \\ \hline a_{13} & \dots & \dots & a_{16} \\ a_{17} & \dots & \dots & a_{20} \\ \hline a_{21} & \dots & \dots & a_{24} \end{array} \right] \mid a_i \in B = \{ \langle Z_{10} \cup I \rangle, *, (5I, 0) \}, \right.$$

$$1 \leq i \leq 24 \} \}$$

be the finite super matrix groupoid.

All properties of groupoids can also be derived for interval matrix groupoids and super matrix groupoids.

Apart from these groupoids we can also construct groupoids using loops which we will illustrate by some examples.

Example 1.49: Let

$$G = \left\{ \begin{bmatrix} a_1 \\ a_2 \\ a_3 \\ a_4 \\ a_5 \\ a_6 \end{bmatrix} \mid a_i \in L_{23}(8); 1 \leq i \leq 6 \right\}$$

be a groupoid of finite order.

Example 1.50: Let

$$G = \left\{ \begin{bmatrix} a_1 & a_2 & a_3 \\ a_4 & a_5 & a_6 \\ a_7 & a_8 & a_9 \\ a_{10} & a_{11} & a_{12} \end{bmatrix} \mid a_i \in L_{15}(8); 1 \leq i \leq 12 \right\}$$

be a finite matrix groupoid.

Example 1.51: Let

$G = \{(a_1, a_2, a_3, \dots, a_{16}) \mid a_i \in L_9(8) \times L_{27}(26); 1 \leq i \leq 16\}$ be a finite matrix groupoid.

Example 1.52: Let

$$G = \left\{ \begin{bmatrix} a_1 & a_2 & a_3 \\ a_4 & a_5 & a_6 \\ a_7 & a_8 & a_9 \\ \vdots & \vdots & \vdots \\ a_{28} & a_{29} & a_{30} \end{bmatrix} \mid a_i \in L_{25}(8); 1 \leq i \leq 30 \right\}$$

be a finite matrix groupoid.

Example 1.53: Let $G = \{[a, b] \mid a, b \in L_{49}(10)\}$ be a finite interval groupoid.

Example 1.54: Let

$$G = \left\{ \left[\begin{array}{cc} [a_1, b_1] & [a_2, b_2] \\ \vdots & \vdots \\ [a_{19}, b_{19}] & [a_{20}, b_{20}] \end{array} \right] \mid a_i, b_i \in L_{29}(3); 1 \leq i \leq 30 \right\}$$

be a finite interval matrix groupoid.

Example 1.55: Let $G = \left\{ \sum_{i=0}^{\infty} [a_i, b_i] x^i \mid a_i, b_i \in L_{45}(44) \right\}$ be an infinite polynomial interval groupoid.

We have, using these groupoids (or loops) constructed subset groupoids and interval subset groupoids [59, 75]

Let G be any groupoid, $S = \{\text{Collection of all subsets of } G\}$. S under the operations of G is a groupoid known as the subset groupoid.

Clearly $G \subseteq S$ as a proper subset.

Example 1.56: Let $G = \{\text{Collection of all subsets from the groupoid } G = \{Z_7, *, (4, 0)\}\}$ be the subset groupoid of G .

S is also non associative and of finite order.

Example 1.57: Let $S = \{\text{Collection of all subsets from the groupoid } G = \{Z, *, (10, -3)\}\}$ be the subset groupoid of infinite order.

Even if we use subsets from loops still we get the subset collection to be only a groupoid and not a loop.

Example 1.58: Let

$S = \{\text{Collection of all subsets from the loop } L_{25}(24)\}$ be the subset groupoid of the loop. S is S -left alternative subset groupoid.

Example 1.59: Let

$S = \{\text{Collection of all subsets from the loop } L_9(8) \times L_{21}(11)\}$ be the subset groupoid.

Example 1.60: Let $S = \{\text{Collection of all subsets from the groupoid}$

$$G = \left\{ \begin{array}{c} [a_1] \\ [a_2] \\ [a_3] \\ [a_4] \\ [a_5] \end{array} \right\} \mid a_i \in L_{27}(26); 1 \leq i \leq 5 \}$$

be the subset matrix groupoid.

Example 1.61: Let $S = \{\text{Collection of all subsets from } G = \{([a_1, b_1], [a_2, b_2], \dots, [a_9, b_9]) \mid a_i, b_i \in B = \{\mathbb{Z}_{40}, *, (20, 15)\}, 1 \leq i \leq 9\}\}$ be the subset interval matrix groupoid.

We can define substructure etc [75, 78].

Now we proceed onto recall the concept of non associative rings and semirings.

Let R be any ring. L a loop; RL will be a non associative ring known as the loop ring of the loop L over the ring R [45-55, 60-1].

If L is replaced by G a groupoid; RG will be a non associative ring known as the groupoid ring of the groupoid G over the ring R .

If R is replaced by a semiring P then PL will be a non associative semiring or loop semiring.

Similarly PG will be non associative semiring known as the groupoid semiring.

We will describe these by some examples.

Example 1.62: Let RG be the groupoid ring (R - reals) and $G = \{Z_{20}, *, (10, 0)\}$ be the groupoid.

RG is a non associative ring of infinite order.

Example 1.63: Let

$$\langle Z \cup I \rangle G = \left\{ \sum_{i=1}^n a_i g_i \mid a_i \in \langle Z \cup I \rangle \text{ and } g_i \in G; |G| = n \right\}$$

be the groupoid ring of infinite order $\langle Z \cup I \rangle G$ is a non associative ring.

Example 1.64: Let $T = (Z^+ \cup \{0\}) L_{25}(2)$ be the loop semiring. T is a non associative semiring of infinite order.

Example 1.65: Let $T = Z_5 L_{11}(7)$ be a finite non associative ring.

Example 1.66: Let $P = Z_7 G$ where $G = \{Z_{15}, *, (10, 2)\}$ be the groupoid ring. P is a finite non associative ring.

Example 1.67: Let $T = C(Z_{17}) L_{23}(2)$ be a non associative ring of finite order which is Smarandache right alternative.

Example 1.68: Let $B = \langle C \cup I \rangle L_{23}(22)$ be a non associative infinite ring which is left alternative.

Example 1.69: Let $B = LL_{19}(3)$ where $L =$

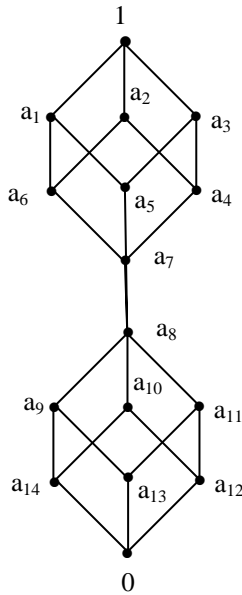

be the non associative semiring of finite order.

Example 1.70: Let $B = LG$ where $G = \{Z_{24}, *, (10, 4)\}$ and L is the lattice as in example 1.69, B is again a non associative semiring of finite order.

Example 1.71: Let $B = Z_{24} G$ where $G = \{C(Z_5), *, (4i_F, 0)\}$ be the non associative ring of finite order.

For more about these structures please refer [45-55].

The notion of subsemirings, subrings, ideals etc. are a matter of routine and hence is left for the reader to refer [62, 64, 77].

Finally the notion of quasi set ideal topological spaces and set ideal subset topological spaces can be had from [72-3].

Chapter Two

NON ASSOCIATIVE SPECIAL SUBSET TOPOLOGICAL SPACES USING GROUPOIDS AND LOOPS

In this chapter we just introduce the notion of subset groupoids and the topological spaces associated with them. Further using subset groupoid; semivector spaces which are non associative. We built topological spaces associated with these non associative spaces.

Thus we see these newly constructed topological spaces enjoy the non associative operation. It is important to keep on record that this is the first time such non associative topological spaces are built.

We will first describe this situation by some examples so that the material in this book is self contained.

Example 2.1: Let $S = \{\text{Collection of all subsets from the groupoid } G = \{Z_{40}, *, (2, 7)\}\}$ be the subset groupoid of finite

order. Clearly S under the operations of $*$ is non associative and $o(S) < \infty$.

Example 2.2: Let $S = \{\text{Collection of all subsets from the groupoid } G = \{Z_{17}, *, (10, 0)\}\}$ be the subset groupoid of finite order.

Let $x = \{3, 2\}$ and $y = \{5, 1\} \in S$

$$\begin{aligned} x * y &= \{3, 2\} * \{5, 1\} \\ &= \{3 * 5, 2 * 5, 3 * 1, 2 * 1\} \\ &= \{13, 3\} \end{aligned} \quad \dots \text{(I)}$$

Take $z = \{5, 2\} \in S$

$$\begin{aligned} (x * y) * z &= \{13, 10\} * \{5, 2\} \text{ (using I)} \\ &= \{13 * 5, 10 * 5, 13 * 2, 10 * 2\} \\ &= \{130 \pmod{17}, 100 \pmod{17}\} \\ &= \{11, 15\} \end{aligned} \quad \dots \text{(i)}$$

$$\begin{aligned} \text{Consider } x * (y * z) &= x * [(5, 1) * (5, 2)] \\ &= x * [5 * 5, 1 * 5, 1 * 2, 5 * 2] \\ &= x * \{50 \pmod{17}, 10 \pmod{17}\} \\ &= x * (16, 10) \\ &= \{3, 2\} \times \{16, 10\} \\ &= \{3 * 16, 2 * 16, 3 * 10, 2 * 10\} \\ &= \{13, 3\} \end{aligned} \quad \dots \text{(ii)}$$

Clearly (i) and (ii) are distinct so $(x * y) * z \neq x * (y * z)$ in general for $x, y, z \in S$.

We see S cannot be given a topological structure using only $*$ for we need atleast two operations on S .

So $T_o = \{S \cup \{\phi\}, \cup, \cap\}$, $T_\cup^* = \{S, \cup, *\}$ and $T_\cap^* = \{S \cup \{\phi\}, \cap, *\}$ can be given topologies and these will be known as special subset groupoid topological spaces.

All the three spaces are different and T_{\cup}^* and T_{\cap}^* are in general non associative. So based on these observations, we make the following definition.

DEFINITION 2.1: *Let*

*$S = \{\text{Collection of all subsets from the groupoid } (G, *)\}$ be the subset groupoid. Let $T_o = \{S \cup \{\phi\}, \cup, \cap\}$, $T_{\cup}^* = \{S, *, \cup\}$ and $T_{\cap}^* = \{S' = S \cup \{\phi\}, \cap, *\}$ be three sets with the binary operations mentioned.*

All the three sets can be made into topological spaces with the respective operations.

T_o is defined as the usual subset groupoid topological space as on T_o only usual union ' \cup ' and intersection ' \cap ' operations are defined.

T_{\cup}^ is a special subset groupoid topological space and it is non associative with respect to $*$.*

T_{\cap}^ is also a non associative subset special groupoid topological space and it is different from T_o and T_{\cup}^* .*

We will illustrate all these situations by some examples.

Example 2.3: Let $S = \{\text{Collection of all subsets from the groupoid } G = \{Z_{10}, *, (5, 1)\}\}$ be the subset groupoid.

$T_o = \{S \cup \{\phi\}, \cup, \cap\}$, $T_{\cup}^* = \{S, \cup, *\}$ and $T_{\cap}^* = \{S' = S \cup \{\phi\}, *, \cap\}$ are three subset groupoid topological spaces which are different.

For take $A = \{5, 2, 7, 1\}$ and $B = \{3, 4, 9, 0\} \in S$.

Suppose $A, B \in T_o = \{S', \cup, \cap\}$ then

$$\begin{aligned} A \cup B &= \{5, 2, 7, 1\} \cup \{3, 4, 9, 0\} \\ &= \{1, 2, 5, 7, 3, 4, 9, 0\} \end{aligned}$$

and

$$\begin{aligned} A \cap B &= \{5, 2, 7, 1\} \cap \{3, 4, 9, 0\} \\ &= \emptyset \text{ are in } T_o. \end{aligned}$$

For $A, B \in T_{\cup}^*$ we get

$$\begin{aligned} A \cup B &= \{5, 2, 7, 1\} \cup \{3, 4, 9, 0\} \\ &= \{1, 2, 3, 5, 7, 4, 9, 0\} \end{aligned}$$

and

$$\begin{aligned} A * B &= \{5, 2, 7, 1\} * \{3, 4, 9, 0\} \\ &= \{8, 9, 4, 5, 3, 0\} \text{ are in } T_{\cup}^*. \end{aligned}$$

T_{\cup}^* is different from T_o

Let $A, B \in T_{\cap}^*$

$$\begin{aligned} A \cap B &= \{5, 2, 7, 1\} \cap \{3, 4, 9, 0\} \\ &= \emptyset \text{ and} \end{aligned}$$

$$\begin{aligned} A * B &= \{5, 2, 7, 1\} * \{3, 4, 9, 0\} \\ &= \{0, 3, 4, 5, 8, 9\} \text{ are in } T_{\cap}^*. \end{aligned}$$

T_{\cap}^* is different from T_{\cup}^* and T_o . Thus we get three distinct subset special topological spaces of S .

It is pertinent to observe these topological spaces T_{\cap}^* and T_{\cup}^* are both non associative and non commutative.

Let $A = \{7\}$ and $B = \{3\} \in T_{\cup}^*$ (or T_{\cap}^*)

$$\begin{aligned} A * B &= \{7\} * \{3\} \\ &= \{7 * 3\} \\ &= \{35 + 3\} \\ &= \{8\} \end{aligned} \quad \dots \text{ I}$$

$$\begin{aligned} B * A &= \{3\} * \{7\} \\ &= \{3 * 7\} \\ &= \{15 + 7\} \\ &= \{2\} \end{aligned} \quad \dots \text{ II}$$

I and II are distinct. So T_{\cup}^* and T_{\cap}^* are non commutative.

Example 2.4: Let $S = \{\text{Collection of all subsets from the groupoid } G = \{Z_{12}, *, (3, 6)\}\}$ be the subset groupoid.

Let T_{\cup}^* , T_{\cap}^* and T_o be the three distinct topological spaces associated with S .

We see if $A = \{6\}$, $B = \{5\}$ and $C = \{7\} \in T_{\cup}^*$ (or T_{\cap}^*)

$$\begin{aligned} (A * B) * C &= (\{6\} * \{5\}) * \{7\} \\ &= \{6 * 5\} * \{7\} \\ &= \{6 \times 3 + 5 \times 6\} * \{7\} \\ &= \{0\} * \{7\} \\ &= \{0 * 7\} \\ &= \{6\} \qquad \dots \text{I} \end{aligned}$$

Consider $A * (B * C)$

$$\begin{aligned} &= \{6\} * (\{5\} * \{7\}) \\ &= \{6\} * \{5 * 7\} \\ &= \{6\} * \{15 * 42\} \\ &= \{6\} * \{9\} \\ &= \{6 * 9\} \\ &= \{18 + 54\} \\ &= \{0\} \qquad \dots \text{II} \end{aligned}$$

We see I and II are distinct so $A * (B * C) \neq (A * B) * C$ in general for $A, B, C \in S$.

So the subset topological groupoid spaces are non associative in general.

Example 2.5: Let $S = \{\text{Collection of all subsets from the groupoid } G = \{Z_{19}, *, (3, 4)\}\}$ be the subset groupoid.

T_o , T_{\cup}^* and T_{\cap}^* are subset special groupoid topological spaces of S .

Clearly both the spaces T_{\cup}^* and T_{\cap}^* are non associative and non commutative but of finite order.

Example 2.6: Let $S = \{\text{Collection of all subsets from the groupoid } G = \{Z_{24}, *, (6, 7)\}\}$ be the subset groupoid.

T_{\cup}^* , T_{\cap}^* and T_{\cap}^* are three distinct topological spaces. T_{\cup}^* and T_{\cap}^* are non associative and non commutative and of finite order.

Example 2.7: Let $S = \{\text{Collection of all subsets from the groupoid } G = \{C(Z_{16}), *, (8, 8i_F)\}\}$ be the subset groupoid. T_{\cup}^* , T_{\cap}^* and T_{\cap}^* are distinct topological groupoid complex modulo integer spaces of finite order; both of them are non commutative and non associative.

Example 2.8: Let $S = \{\text{Collection of all subsets from the groupoid } G = \{(Z_7 \times Z_{25}), *, ((2,0), (5,8))\}\}$ be a subset groupoid. T_{\cup}^* , T_{\cap}^* and T_{\cap}^* are subset special groupoid topological spaces where T_{\cup}^* and T_{\cap}^* are non commutative and non associative.

Take $A = \{(5, 3), (3, 4)\}$ and
 $B = \{(1, 10)\} \in T_{\cup}^*$ (or T_{\cap}^*).

We now find $A * B$ and $B * A$

$$\begin{aligned} A * B &= \{(5, 3), (3, 4)\} * \{(1, 10)\} \\ &= \{(5, 3), (1, 10), (3, 4), (1, 10)\} \\ &= \{(5, 3) * (1, 10), (3, 4) * (1, 10)\} \\ &= \{5 * 1, 3 * 10\} \{3 * 1, 4 * 10\} \\ &= \{(3, 20), (6, 20)\} \quad \dots \text{I} \end{aligned}$$

Consider

$$\begin{aligned} B * A &= \{(1, 10)\} * \{(5, 3), (3, 4)\} \\ &= \{(1, 10) * (5, 3), (1, 10) * (3, 4)\} \\ &= \{(4 * 5, 10 * 3)\} \{(1 * 3, 10 * 4)\} \\ &= \{(2, 24), (2, 7)\} \quad \dots \text{II} \end{aligned}$$

Clearly I and II are different so the groupoid subset topological spaces T_{\cup}^* and T_{\cap}^* are non commutative.

Consider $C = \{(4, 21)\} \in T_{\cup}^*$ (or T_{\cap}^*)

We find both $(A * B) * C$ and $A * (B * C)$

$$(A * B) * C = (\{(5, 3), 8, 4\} * \{(1, 10)\}) * \{(4, 21)\}$$

(using I we get)

$$\begin{aligned} &= \{(3, 20), (6, 20)\} * \{(4, 21)\} \\ &= \{(3,20) * (4,21), (6,20) * (4,21)\} \\ &= \{(6, 18), (5, 18)\} \end{aligned} \quad \dots \text{ I}$$

$$A * (B * C) = A * (\{(1, 10)\} * \{(4, 21)\})$$

$$\begin{aligned} &= \{(5, 3), (3, 4)\} * \{(1, 10) * (4, 21)\} \\ &= \{(5, 3), (3, 4)\} * \{(1 * 4, 10 * 21)\} \\ &= \{(5, 3), (3, 4)\} * \{(2, 18)\} \\ &= \{(5, 3) * (2, 18), (3, 4) * (2, 18)\} \\ &= \{(5 * 2, 3 * 18), (3 * 2, 4 * 18)\} \\ &= \{(3, 9), (6, 18)\} \end{aligned} \quad \dots \text{ II}$$

I and II are distinct so $(A * B) * C \neq A * (B * C)$ in general for $A, B, C \in T_{\cup}^*$ (or T_{\cap}^*).

Thus both the spaces T_{\cup}^* and T_{\cap}^* are non associative topological subset groupoid spaces of S .

Example 2.9: Let $S = \{\text{Collection of all subsets from the groupoid } G = \{(C(\mathbb{Z}_7) \times C(\mathbb{Z}_4), * = (*_1, *_2), ((3, 0), (0, 2))\}\}$ be the subset groupoid.

T_{\cup}^* and T_{\cap}^* are both non associative and non commutative subset groupoid topological spaces of S .

$$\text{Let } A = \{(5i_F, 3)\} \text{ and } B = \{(6, 2i_F)\} \in T_{\cup}^* \text{ (or } T_{\cap}^*)$$

$$A * B = \{(5i_F, 3)\} * \{(6, 2i_F)\}$$

$$\begin{aligned}
 &= \{(5i_F, 3) * (6, 2i_F)\} \\
 &= \{(5i_F *_1 6)\} * \{(3 *_2 2i_F)\} \\
 &= \{(i_F, 0)\} \qquad \dots \text{ I}
 \end{aligned}$$

Consider

$$\begin{aligned}
 B * A &= \{(6, 2i_F)\} * \{(5i_F, 3)\} \\
 &= \{(6, 2i_F) * (5i_F, 3)\} \\
 &= \{(6 *_1 5i_F, 2i_F *_2 3)\} \\
 &= \{(4, 2)\} \qquad \dots \text{ II}
 \end{aligned}$$

I and II are distinct, so $A * B \neq B * A$ in general for $A, B \in T_{\cup}^*$ (or T_{\cap}^*). Thus the subset groupoid topological spaces are non commutative.

Let $C = \{(i_F, 1)\} \in T_{\cup}^*$ (or T_{\cap}^*).

$$\begin{aligned}
 \text{Consider } (A * B) * C &= \{ \{(5i_F, 3)\} * \{(6, 2i_F)\} \} * \{(i_F, 1)\}
 \end{aligned}$$

$$\begin{aligned}
 &\text{(using equation (I))} \\
 &= \{(i_F, 0)\} * \{(i_F, 1)\} \\
 &= \{(i_F, 0) * (i_F, 1)\} \\
 &= \{(i_F *_1 i_F, 0 *_2 1)\} \\
 &= \{(3i_F, 2)\} \qquad \dots \text{ I}
 \end{aligned}$$

$$\begin{aligned}
 \text{Consider } A * (B * C) &= \{(5i_F, 3)\} * \{ \{(6, 2i_F)\} * \{(i_F, 1)\} \} \\
 &= \{(5i_F, 3)\} * \{(6, 2i_F) * (i_F, 1)\} \\
 &= \{(5i_F, 3)\} * \{(6 *_1 i_F, 2i_F *_2 1)\} \\
 &= \{(5i_F, 3)\} * \{(4, 2)\} \\
 &= \{(5i_F, 3) * (4, 2)\} \\
 &= \{(5i_F *_1 4, 3 *_2 2)\} \\
 &= \{(i_F, 0)\} \qquad \dots \text{ II}
 \end{aligned}$$

I and II are distinct so $(A * B) * C \neq A * (B * C)$ in general for A, B, C in T_{\cup}^* (or T_{\cap}^*).

Thus T_{\cup}^* and T_{\cap}^* are subset groupoid topological spaces which are non associative.

Example 2.10: Let $S = \{\text{Collection of all subsets from the groupoid } G = \{\mathbb{Z}_{10}(g_1, g_2), *, (3g_1, 5g_2) \text{ where } g_1^2 = 0, g_2^2 = g_2, g_1g_2 = g_2g_1 = 0\}\}$ be the subset groupoid of G .

T_{\cup}^* and T_{\cap}^* are subset groupoid topological spaces of finite order and both of them are non associative and non commutative.

Example 2.11: Let $G = \{\text{Collection of all subsets from the groupoid } G = \{\langle \mathbb{Z}_6 \cup I \rangle, *, (2, 0)\}\}$ be the subset groupoid. T_{\cup}^* and T_{\cap}^* are known as neutrosophic subset groupoid topological spaces of S and are both non associative and non commutative and is of finite order.

Example 2.12: Let $S = \{\text{Collection of all subsets from the finite complex modulo integer neutrosophic groupoid } G = \{\langle \mathbb{Z}_{12} \cup I \rangle, *, (5I, 7)\}\}$ be the subset groupoid.

T_{\cup}^* , T_{\cap}^* and T_{\cap}^* are known as the subset finite complex modulo integer neutrosophic groupoid topological spaces of finite order, the latter two are non associative and non commutative.

Example 2.13: Let $S = \{\text{Collection of all the subsets from the groupoid } G = \{\langle \langle \mathbb{Z}_{19} \cup I \rangle, *, (3i_F, 4 + 3I) \rangle\}\}$ be the subset groupoid. T_{\cup}^* and T_{\cap}^* are non commutative and non associative subset topological groupoid spaces of S and they are of finite order.

Example 2.14: Let $S = \{\text{Collection of all the subsets from the groupoid } G = \{\langle \langle \mathbb{Z}_{18} \rangle S_3, *, (10, 0) \rangle\}\}$ be the subset groupoid. T_{\cup}^* and T_{\cap}^* are doubly non commutative as the subset topological spaces groupoid S of G and are non commutative.

For if $A = \{(3i_F + 2)p_1\}$ and $B = \{5i_F p_2 + (3i_F + 5)\}$ are in T_{\cup}^* (or T_{\cap}^*) where

$$p_1 = \begin{pmatrix} 1 & 2 & 3 \\ 1 & 3 & 2 \end{pmatrix} \text{ and } p_2 = \begin{pmatrix} 1 & 2 & 3 \\ 3 & 2 & 1 \end{pmatrix} \text{ then}$$

$$\begin{aligned} A * B &= \{(3i_F + 2)p_1\} * \{5i_F p_2 + (3i_F + 5)\} \\ &= \{(3i_F + 2)p_1 * (5i_F p_2 + 3i_F + 5)\} \\ &= \{(3i_F + 2)p_1 * 5i_F p_2 + (3i_F + 2)p_1 * (3i_F + 5)\} \\ &= \{(12i_F + 2)p_1 + (12i_F + 2)p_1\} \\ &= \{(6i_F + 4)p_1\} \qquad \dots \text{ I} \end{aligned}$$

$$\begin{aligned} \text{Consider } B * A &= \{5i_F p_2 + (3i_F + 5)\} * (3i_F + 2)p_1 \\ &= \{5i_F p_2 * (3i_F + 2)p_1 + (3i_F + 5) * (3i_F + 2)p_1\} \\ &= \{14i_F p_2 + (12i_F + 14)\} \qquad \dots \text{ II} \end{aligned}$$

Since I and II distinct we see T_{\cup}^* and T_{\cap}^* are non commutative.

Example 2.15: Let $S = \{\text{Collection of all subsets from the groupoid } G = \{\langle Z_{37} \cup I \rangle S(7), *, (3I + 7, 31I)\}\}$ be the subset groupoid. T_{\cup}^* and T_{\cap}^* are non associative and non commutative subset topological spaces of finite order.

Example 2.16: Let $S = \{\text{Collection of all subsets from the groupoid } G = \{Z_{124}S(5), *, (3g_2, 0) \text{ where } g_2 = \begin{pmatrix} 1 & 2 & 3 & 4 & 5 \\ 3 & 2 & 4 & 5 & 1 \end{pmatrix}\}\}$ be the subset groupoid. T_{\cup}^* and T_{\cap}^* are non commutative and non associative topological spaces.

Example 2.17: Let $S = \{\text{Collection of all subsets from the groupoid } G = \{Z_9 \times Z_8 \times Z_{15}, * = (*_1, *_2, *_3), \{(3, 6), (2, 6), (10, 5)\}\}\}$ be the subset groupoid.

$$\begin{aligned} \text{Let } A &= \{(3, 2, 1), (5, 1, 8)\} \text{ and} \\ B &= \{(0, 3, 10)\} \in T_{\cup}^* \text{ (or } T_{\cap}^* \text{)}. \end{aligned}$$

$$\begin{aligned} \text{Now } A * B &= \{(3, 2, 1), (5, 1, 8)\} * \{(0, 3, 10)\} \\ &= \{(3, 2, 1) * (0, 3, 10), (5, 1, 8) * (0, 3, 10)\} \\ &= \{(3 *_1 0, 2 *_2 3, 1 *_3 10), (5 *_1 0, 1 *_2 3, 8 *_3 10)\} \end{aligned}$$

$$= \{(0, 6, 0), (6, 4, 5)\} \quad \dots \text{I}$$

Consider

$$\begin{aligned} B * A &= \{(0, 3, 10)\} * \{(3, 2, 1), (5, 1, 8)\} \\ &= \{(0, 3, 10) * (3, 2, 1), (0, 3, 10) * (5, 1, 8)\} \\ &= \{(0 *_1 3, 3 *_2 2, 10 *_3 1), (0 *_1 5, 3 *_2 1, 10 *_3 8)\} \\ &= \{(0, 2, 0), (3, 4, 0)\} \quad \dots \text{II} \end{aligned}$$

I and II are distinct so T_{\cup}^* and T_{\cap}^* are non commutative finite topological subset groupoid spaces which are also non associative.

THEOREM 2.1: *Let*

S = {Collection of all subsets from a groupoid G} be the subset groupoid of G. T_{\cup} , T_{\cup}^ and T_{\cap}^* be the three subset groupoid topological spaces of S.*

(i) *T_{\cup}^* and T_{\cap}^* are always non associative topological subset groupoid spaces.*

(ii) *T_{\cup} and T_{\cap} are non commutative if and only if G is a non commutative groupoid.*

The proof follows from the fact that T_{\cup}^* and T_{\cap}^* enjoy basically the algebraic structure enjoyed by the groupoid G.

Example 2.18: Let $S = \{\text{Collection of all subsets from the matrix groupoid } M = \{(a_1, a_2, \dots, a_9) \mid a_i \in G = \{Z_{10}, *, (5, 2)\}, 1 \leq i \leq 9\}\}$ be the subset matrix groupoid.

T_{\cup} , T_{\cup}^* and T_{\cap}^* are the three subset matrix groupoid topological spaces of S and the later two spaces are both non associative and non commutative.

Example 2.19: Let $S = \{\text{Collection of all subsets from the matrix groupoid}$

$$P = \left\{ \begin{matrix} a_1 \\ a_2 \\ a_3 \\ a_4 \\ a_5 \end{matrix} \right\} \quad a_i \in G = \{Z_6, *, (4, 2)\}; 1 \leq i \leq 5\}$$

be the subset matrix groupoid of P.

$$\text{Let } A = \left\{ \begin{matrix} 2 \\ 1 \\ 0 \\ 4 \\ 3 \end{matrix} \begin{matrix} 0 \\ 1 \\ 2 \\ 3 \\ 4 \end{matrix} \right\} \text{ and } B = \left\{ \begin{matrix} 4 \\ 5 \\ 2 \\ 3 \\ 0 \end{matrix} \begin{matrix} 1 \\ 0 \\ 4 \\ 2 \\ 0 \end{matrix} \right\} \text{ be in } T_{\cup}^* \text{ (or } T_{\cap}^* \text{)}.$$

$$\text{We find } A * B = \left\{ \begin{matrix} 2 \\ 1 \\ 0 \\ 4 \\ 3 \end{matrix} \begin{matrix} 0 \\ 1 \\ 2 \\ 3 \\ 4 \end{matrix} \right\} * \left\{ \begin{matrix} 4 \\ 5 \\ 2 \\ 3 \\ 0 \end{matrix} \begin{matrix} 1 \\ 0 \\ 4 \\ 2 \\ 0 \end{matrix} \right\}$$

$$= \left\{ \begin{matrix} 2 \\ 1 \\ 0 \\ 4 \\ 3 \end{matrix} \begin{matrix} 4 \\ 5 \\ 2 \\ 3 \\ 0 \end{matrix} \begin{matrix} 2 \\ 1 \\ 0 \\ 4 \\ 3 \end{matrix} \begin{matrix} 1 \\ 0 \\ 2 \\ 2 \\ 0 \end{matrix} \begin{matrix} 0 \\ 1 \\ 2 \\ 3 \\ 4 \end{matrix} \begin{matrix} 4 \\ 5 \\ 2 \\ 3 \\ 0 \end{matrix} \begin{matrix} 0 \\ 1 \\ 2 \\ 3 \\ 4 \end{matrix} \begin{matrix} 1 \\ 0 \\ 4 \\ 2 \\ 0 \end{matrix} \right\}$$

$$= \left\{ \begin{matrix} 2*4 \\ 1*5 \\ 0*2 \\ 4*3 \\ 3*0 \end{matrix} \begin{matrix} 2*1 \\ 1*0 \\ 0*4 \\ 4*2 \\ 3*0 \end{matrix} \begin{matrix} 0*4 \\ 1*5 \\ 2*2 \\ 3*3 \\ 4*0 \end{matrix} \begin{matrix} 0*1 \\ 1*0 \\ 2*4 \\ 3*2 \\ 4*0 \end{matrix} \right\}$$

$$= \left\{ \begin{bmatrix} 4 \\ 2 \\ 4 \\ 4 \\ 0 \end{bmatrix}, \begin{bmatrix} 2 \\ 2 \\ 0 \\ 4 \end{bmatrix}, \begin{bmatrix} 4 \\ 4 \\ 2 \\ 2 \\ 0 \end{bmatrix}, \begin{bmatrix} 2 \\ 4 \\ 4 \\ 4 \\ 4 \end{bmatrix} \right\} \quad \dots \text{I}$$

Consider $B * A = \left\{ \begin{bmatrix} 4 \\ 5 \\ 2 \\ 3 \\ 0 \end{bmatrix}, \begin{bmatrix} 1 \\ 0 \\ 4 \\ 2 \\ 0 \end{bmatrix} \right\} * \left\{ \begin{bmatrix} 2 \\ 1 \\ 0 \\ 4 \\ 3 \end{bmatrix}, \begin{bmatrix} 0 \\ 1 \\ 2 \\ 3 \\ 4 \end{bmatrix} \right\}$

$$= \left\{ \begin{bmatrix} 4 \\ 5 \\ 2 \\ 3 \\ 0 \end{bmatrix} * \begin{bmatrix} 2 \\ 1 \\ 0 \\ 4 \\ 3 \end{bmatrix}, \begin{bmatrix} 1 \\ 0 \\ 4 \\ 2 \\ 0 \end{bmatrix} * \begin{bmatrix} 2 \\ 1 \\ 0 \\ 4 \\ 3 \end{bmatrix}, \begin{bmatrix} 2 \\ 4 \\ 4 \\ 3 \\ 0 \end{bmatrix} * \begin{bmatrix} 0 \\ 1 \\ 2 \\ 3 \\ 4 \end{bmatrix}, \begin{bmatrix} 4 \\ 5 \\ 2 \\ 3 \\ 0 \end{bmatrix} * \begin{bmatrix} 0 \\ 1 \\ 2 \\ 3 \\ 4 \end{bmatrix} \right\}$$

$$= \left\{ \begin{bmatrix} 4*2 \\ 5*1 \\ 2*0 \\ 3*4 \\ 0*3 \end{bmatrix}, \begin{bmatrix} 1*2 \\ 0*1 \\ 4*0 \\ 2*4 \\ 0*3 \end{bmatrix}, \begin{bmatrix} 4*0 \\ 5*1 \\ 2*2 \\ 3*3 \\ 0*4 \end{bmatrix}, \begin{bmatrix} 1*0 \\ 0*1 \\ 4*2 \\ 2*3 \\ 0*4 \end{bmatrix} \right\}$$

$$= \left\{ \begin{bmatrix} 2 \\ 4 \\ 2 \\ 2 \\ 0 \end{bmatrix}, \begin{bmatrix} 2 \\ 2 \\ 2 \\ 4 \\ 0 \end{bmatrix}, \begin{bmatrix} 4 \\ 4 \\ 0 \\ 0 \\ 2 \end{bmatrix}, \begin{bmatrix} 4 \\ 2 \\ 2 \\ 2 \\ 2 \end{bmatrix} \right\} \quad \dots \text{II}$$

I and II are not equal so T_{\cup}^* and T_{\cap}^* are non commutative subset column matrix groupoid topological spaces of finite order.

$$\text{Let } A = \left\{ \begin{matrix} [3] \\ 0 \\ 0 \\ 0 \\ 0 \end{matrix} \right\} \text{ and } B = \left\{ \begin{matrix} [1] \\ 0 \\ 0 \\ 0 \\ 0 \end{matrix} \right\} \text{ and } C = \left\{ \begin{matrix} [5] \\ 0 \\ 0 \\ 0 \\ 0 \end{matrix} \right\} \in T_{\cup}^*$$

(or T_{\cap}^*).

We first find

$$(A * B) * C = \left\{ \left(\begin{matrix} [3] \\ 0 \\ 0 \\ 0 \\ 0 \end{matrix} \right) * \left(\begin{matrix} [1] \\ 0 \\ 0 \\ 0 \\ 0 \end{matrix} \right) \right\} * \left\{ \begin{matrix} [5] \\ 0 \\ 0 \\ 0 \\ 0 \end{matrix} \right\}$$

$$= \left\{ \begin{matrix} [3] \\ 0 \\ 0 \\ 0 \\ 0 \end{matrix} * \begin{matrix} [1] \\ 0 \\ 0 \\ 0 \\ 0 \end{matrix} \right\} * \left\{ \begin{matrix} [5] \\ 0 \\ 0 \\ 0 \\ 0 \end{matrix} \right\}$$

$$= \left\{ \begin{matrix} [3*1] \\ 0 \\ 0 \\ 0 \\ 0 \end{matrix} \right\} * \left\{ \begin{matrix} [5] \\ 0 \\ 0 \\ 0 \\ 0 \end{matrix} \right\}$$

$$= \left\{ \begin{matrix} [2] \\ 0 \\ 0 \\ 0 \\ 0 \end{matrix} \right\} * \left\{ \begin{matrix} [5] \\ 0 \\ 0 \\ 0 \\ 0 \end{matrix} \right\}$$

$$= \left\{ \begin{matrix} [2] & [5] \\ 0 & 0 \\ 0 & * 0 \\ 0 & 0 \\ 0 & 0 \end{matrix} \right\}$$

$$= \left\{ \begin{matrix} [2*5] \\ 0 \\ 0 \\ 0 \\ 0 \end{matrix} \right\} = \left\{ \begin{matrix} [0] \\ 0 \\ 0 \\ 0 \\ 0 \end{matrix} \right\} \quad \dots I$$

We now consider $A * (B * C) =$

$$= \left\{ \begin{matrix} [3] \\ 0 \\ 0 \\ 0 \\ 0 \end{matrix} \right\} * \left(\left\{ \begin{matrix} [1] \\ 0 \\ 0 \\ 0 \\ 0 \end{matrix} \right\} * \left\{ \begin{matrix} [5] \\ 0 \\ 0 \\ 0 \\ 0 \end{matrix} \right\} \right)$$

$$\begin{aligned}
 &= \left\{ \begin{matrix} [3] \\ 0 \\ 0 \\ 0 \\ 0 \end{matrix} \right\} * \left\{ \begin{matrix} [1] & [5] \\ 0 & 0 \\ 0 & 0 \\ 0 & 0 \\ 0 & 0 \end{matrix} \right\} \\
 &= \left\{ \begin{matrix} [3] \\ 0 \\ 0 \\ 0 \\ 0 \end{matrix} \right\} * \left\{ \begin{matrix} [1*5] \\ 0 \\ 0 \\ 0 \\ 0 \end{matrix} \right\} \\
 &= \left\{ \begin{matrix} [3] \\ 0 \\ 0 \\ 0 \\ 0 \end{matrix} \right\} * \left\{ \begin{matrix} [2] \\ 0 \\ 0 \\ 0 \\ 0 \end{matrix} \right\} \\
 &= \left\{ \begin{matrix} [3*2] \\ 0 \\ 0 \\ 0 \\ 0 \end{matrix} \right\} = \left\{ \begin{matrix} [4] \\ 0 \\ 0 \\ 0 \\ 0 \end{matrix} \right\} \quad \dots \text{II}
 \end{aligned}$$

I and II are distinct so $A * (B * C) \neq (A * B) * C$ in general for $A, B, C \in T_{\cup}^*$ (or T_{\cap}^*).

Hence the subset column matrix groupoid topological space are non associative.

Example 2.20: Let $S = \{\text{Collection of all subsets from the matrix groupoid}\}$

$$M = \left\{ \left[\begin{array}{cccc} a_1 & a_2 & \dots & a_{10} \\ a_{11} & a_{12} & \dots & a_{20} \\ a_{21} & a_{22} & \dots & a_{30} \\ a_{31} & a_{32} & \dots & a_{40} \\ a_{41} & a_{42} & \dots & a_{50} \end{array} \right] \mid a_i \in G = \{C(Z_{18}), *, (6, 0)\}; \right. \\ \left. 1 \leq i \leq 50 \right\}$$

be the subset matrix groupoid.

T_o , T_{\cup}^* and T_{\cap}^* are all subset matrix groupoid topological spaces of S and they are of finite order.

Further T_{\cup}^* and T_{\cap}^* are spaces which are non associative and non commutative.

Example 2.21: Let S = {Collection of all subsets from the groupoid matrix

$$M = \left\{ \left[\begin{array}{cccc} a_1 & a_2 & a_3 & a_4 \\ a_5 & a_6 & a_7 & a_8 \\ \vdots & \vdots & \vdots & \vdots \\ a_{31} & a_{32} & \dots & a_{40} \end{array} \right] \mid a_i \in G = \{ \langle Z_7 \cup I \rangle, *, (3, 4) \}, \right. \\ \left. 1 \leq i \leq 40 \right\}$$

be the subset matrix groupoid.

T_o , T_{\cup}^* and T_{\cap}^* are the three subset groupoid matrix topological spaces of finite order and T_{\cup}^* and T_{\cap}^* are non associative and non commutative.

Example 2.22: Let S = {Collection of all subsets from the square matrix groupoid

$$M = \left\{ \begin{bmatrix} a_1 & a_2 & \dots & a_6 \\ a_7 & a_8 & \dots & a_{12} \\ a_{13} & a_{14} & \dots & a_{18} \\ a_{19} & a_{20} & \dots & a_{24} \\ a_{28} & a_{29} & \dots & a_{30} \\ a_{31} & a_{32} & \dots & a_{36} \end{bmatrix} \mid a_i \in G = \{C(\langle Z_{16} \cup I \rangle), *, (8, 8)\}; \right. \\ \left. 1 \leq i \leq 36 \right\}$$

be the subset matrix groupoid.

T_o , T_{\cup}^* and T_{\cap}^* be the subset matrix groupoid topological spaces of S .

T_{\cup}^* and T_{\cap}^* are non associative topological spaces but both of them are commutative.

This follows from the simple fact that the basic structure on which S is built is a groupoid which is now associative.

Example 2.23: Let $S = \{\text{Collection of all subset super matrix groupoid } M = \{(a_1 \mid a_2 \ a_3 \mid a_4 \ a_5 \ a_6 \mid a_7 \ a_8) \mid a_i \in G = \{Z_{15}, *, (3, 5)\}, 1 \leq i \leq 8\}\}$ be the subset super matrix groupoid.

We see T_o , T_{\cup}^* and T_{\cap}^* are all subset topological spaces of which the later two are non associative and non commutative.

Example 2.24: Let $S = \{\text{Collection of all subsets from the super matrix groupoid}$

$$M = \left\{ \left[\begin{array}{c} a_1 \\ a_2 \\ a_3 \\ a_4 \\ a_5 \\ a_6 \\ a_7 \\ a_8 \\ a_9 \end{array} \right] \mid a_i \in G = \{C(Z_7), *, (3, 4)\}; 1 \leq i \leq 9\} \right.$$

be the subset super matrix groupoid.

T_{\cup}^* and T_{\cap}^* are subset super matrix topological spaces which are both non associative and non commutative.

Example 2.25: Let $S = \{\text{Collection of all subsets from the groupoid}\}$

$$M = \left\{ \left[\begin{array}{c|ccccc|cc|c} a_1 & a_2 & a_3 & a_4 & a_5 & a_6 & a_7 & a_8 \\ a_9 & a_{10} & \dots & \dots & \dots & \dots & \dots & a_{16} \\ a_{17} & a_{18} & \dots & \dots & \dots & \dots & \dots & a_{24} \\ a_{25} & a_{26} & \dots & \dots & \dots & \dots & \dots & a_{32} \end{array} \right] \mid a_i \in$$

$$G = \{\langle Z_9 \cup I \rangle, *, (8, 4)\}; 1 \leq i \leq 32\}$$

be the subset groupoid.

This T_{\cup} , T_{\cup}^* and T_{\cap}^* are subset groupoid topological spaces of S of which T_{\cup}^* and T_{\cap}^* are non associative and non commutative.

Example 2.26: Let $S = \{\text{Collection of all subsets from the super matrix groupoid}\}$

We see this G is non commutative and non associative and so the related topological spaces are T_{\cup}^* and T_{\cap}^* are also non commutative and non associative.

Example 2.28: Let $S = \{\text{Collection of all subsets from the matrix groupoid } M = \{(a_1 a_2 a_3 a_4 | a_5 a_6 a_7 | a_8 a_9 | a_{10}) | a_i \in G = Z_9S_4, *, (4g, 3h); \text{ where } g = \begin{pmatrix} 1 & 2 & 3 & 4 \\ 2 & 1 & 4 & 3 \end{pmatrix}, h = \begin{pmatrix} 1 & 2 & 3 & 4 \\ 2 & 4 & 3 & 1 \end{pmatrix}\}, 1 \leq i \leq 10\}$ be the subset matrix groupoid. S is non commutative and non associative.

Example 2.29: Let $S = \{\text{Collection of all subsets from the super matrix groupoid}$

$$M = \left\{ \begin{bmatrix} a_1 \\ a_2 \\ a_3 \\ a_4 \\ a_5 \\ a_6 \\ a_7 \\ a_8 \\ a_9 \end{bmatrix} \mid a_i \in G = \{Z_{36}D_{2,7}, *, (3a + ab_2, 5ab_3)\}, 1 \leq i \leq 9\} \right\}$$

be the subset matrix groupoid.

We see S is not commutative and non associative. Thus the subset topological spaces T_{\cup}^* and T_{\cap}^* are both non associative and non commutative and is of finite order.

Example 2.30: Let $S = \{\text{Collection of all subsets from the interval matrix groupoid } M = \{([a_1, b_1], [a_2, b_2], [a_3, b_3], [a_4, b_4],$

$[a_5, b_5] \mid a_i, b_i \in G = \{C \langle(Z_6 \cup I)\rangle, *, (3i_F, 4I)\}; 1 \leq i \leq 5\}$ be the subset groupoid.

T_{\cup}^* and T_{\cap}^* are both non associative and non commutative subset groupoid interval topological spaces.

Example 2.31: Let $S = \{\text{Collection of all subsets from the interval matrix groupoid}\}$

$$M = \left\{ \begin{array}{l} [a_1 b_1] \\ [a_2 b_2] \\ [a_3 b_3] \\ [a_4 b_4] \\ [a_5 b_5] \\ [a_6 b_6] \end{array} \right\} \quad a_i, b_i \in G = \{Z_{12}, *, (4, 0)\}, 1 \leq i \leq 6\}$$

be the subset interval matrix groupoid. T_{\cup}^* and T_{\cap}^* are both non associative and non commutative topological spaces of finite order.

Example 2.32: Let $S = \{\text{Collection of all subsets from the interval matrix groupoid}\}$

$$M = \left\{ \begin{array}{c|cccc} [a_1 b_1] & [a_2 b_2] & [a_3 b_3] & [a_4 b_4] & [a_5 b_5] \\ [a_6 b_6] & \dots & \dots & \dots & [a_{10} b_{10}] \\ \hline [a_{11} b_{11}] & \dots & \dots & \dots & [a_{15} b_{15}] \\ [a_{16} b_{16}] & \dots & \dots & \dots & [a_{20} b_{20}] \\ \hline [a_{21} b_{21}] & \dots & \dots & \dots & [a_{25} b_{25}] \end{array} \right\} \quad a_i, b_i \in$$

$$G = \{C \langle(Z_{13} \cup I)\rangle (S_4 \times D_{2,10}), *, (3I(g, ab^3), (5 + 2I) (1, b^7))$$

$$\text{where } g = \begin{pmatrix} 1 & 2 & 3 & 4 \\ 2 & 3 & 4 & 1 \end{pmatrix}, 1 \leq i \leq 25\}$$

be the subset groupoid of finite order. We see T_{\cup}^* and T_{\cap}^* are non associative subset topological spaces of S.

Example 2.33: Let S = {Collection of all subsets from the groupoid

$$P = \left\{ \sum_{i=0}^{\infty} a_i x^i \mid a_i \in G = \{Z_{15}, *, (3, 9)\} \right\}$$

be the subset groupoid. T_{\cup}^* , T_{\cap}^* and T_o are subset topological groupoid spaces of infinite order. T_{\cup}^* and T_{\cap}^* are both non associative and non commutative.

Let $A = \{3x^2 + 4\}$, $B = \{7x\}$ and $C = \{2x^4\} \in T_{\cap}^*$ (or T_{\cup}^*).

$$\begin{aligned} \text{Now } A * B &= \{3x^2 + 4\} * \{7x\} \\ &= \{(3x^2 + 4) * 7x\} \\ &= \{9x^2 + 12 + 63x\} \\ &= \{9x^2 + 3x + 12\} \end{aligned} \quad \dots \text{ I}$$

$$\begin{aligned} B * A &= \{7x\} * \{3x^2 + 4\} \\ &= \{21x + 27x^2 + 36\} \\ &= \{6 + 6x + 12x^2\} \end{aligned} \quad \dots \text{ II}$$

I and II are distinct so the topological spaces T_{\cup}^* and T_{\cap}^* are non commutative.

$$\begin{aligned} \text{Consider } (A * B) * C &= (\{3x^2 + 4\} * \{7x\}) * \{2x^4\} \\ &= \{9x^2 + 3x + 12\} * \{2x^4\} \quad (\text{Using equation I}) \\ &= \{27x^2 + 9x + 36 + 18x^4\} \\ &= \{12x^2 + 9x + 6 + 3x^4\} \quad \dots \text{ (a)} \end{aligned}$$

$$\begin{aligned} \text{Consider } A * (B * C) &= \{3x^2 + 4\} * (\{7x\} * \{2x^4\}) \\ &= \{3x^2 + 4\} * \{21x + 18x^4\} \\ &= \{3x^2 + 4\} * \{6x + 3x^4\} \\ &= \{(3x^2 + 4) * \{3x^4 + 6x\}\} \\ &= \{18x^2 + 12 + 27x^4 + 54x\} \end{aligned}$$

$$= \{3x^2 + 12 + 12x^4 + 6x\} \quad \dots (b)$$

(a) and (b) are distinct so $A * (B * C) \neq (A * B) * C$ in general for $A, B, C \in T_{\cup}^*$ (or T_{\cap}^*). Hence T_{\cup}^* and T_{\cap}^* are non associative and non commutative and of infinite order.

Example 2.34: Let $S = \{\text{Collection of all subsets from the groupoid polynomial } M = \left\{ \sum_{i=0}^{\infty} a_i x^i \mid a_i \in \langle \mathbb{Z}_6 \cup I \rangle, *, (5, 1) \right\}\}$ be the subset groupoid. T_{\cup}^* , T_{\cap}^* and T_o are of infinite order and T_{\cup}^* and T_{\cap}^* are subset groupoid topological spaces of infinite order.

T_{\cup}^* and T_{\cap}^* are both non commutative and non associative.

Example 2.35: Let $S = \{\text{Collection of all subsets from the groupoid polynomial } M = \left\{ \sum_{i=0}^{\infty} a_i x^i \mid a_i \in G = \{\mathbb{Z}_{10} (S_7 \times D_{2,11}); *, (5, 4)\}\}\}$ be the subset groupoid which is non associative and non commutative. T_{\cup}^* and T_{\cap}^* are both non associative and non commutative as topological spaces and are of infinite order.

Example 2.36: Let $S = \{\text{Collection of all subsets from the groupoid } M = \left\{ \sum_{i=0}^{\infty} a_i x^i \mid a_i \in G = \{(\mathbb{Z}_{15} \times \mathbb{Z}_9)S_7, * = (*_1, *_2); ((2, 7), (3, 6))\}\}\}$ be the subset groupoid.

T_{\cup}^* and T_{\cap}^* are non associative and non commutative subset groupoid topological spaces of S of infinite order.

Now we proceed onto build subset groupoid topological spaces using infinite groupoids.

Example 2.37: Let $S = \{\text{Collection of all subsets from the groupoid } G = \{\mathbb{R}^+ \cup \{0\}, *, (3, 2)\}\}$ be the subset groupoid.

Clearly T_o , T_{\cup}^* and T_{\cap}^* are subset groupoid topological spaces and T_{\cup}^* and T_{\cap}^* are non commutative and non associative and are of infinite order.

$$\begin{aligned} \text{If } A &= \{5, \sqrt{2}, 10\} \text{ and } B = \{1, 7\} \in T_{\cup}^* \text{ (or } T_{\cap}^*) \text{ then} \\ A * B &= \{5, \sqrt{2}, 10\} * \{1, 7\} \\ &= \{5 * 1, \sqrt{2} * 1, 10 * 1, \sqrt{2} * 7, 5 * 7, 10 * 7\} \\ &= \{17, 3\sqrt{2} + 2, 32, 3\sqrt{7} + 14, 29, 51\} \in T_{\cup}^* \text{ (or } T_{\cap}^*). \end{aligned}$$

$$\begin{aligned} \text{Now } B * A &= \{1, 7\} * \{5, \sqrt{2}, 10\} \\ &= \{1 * 5, 1 * \sqrt{2}, 1 * 10, 7 * 5, 7 * \sqrt{2}, 7 * 10\} \\ &= \{13, 3 + 2\sqrt{2}, 23, 31, 2\sqrt{2} + 21 + 41\} \in T_{\cup}^* \text{ (or } T_{\cap}^*). \end{aligned}$$

Clearly $A * B \neq B * A$.

It is easily verified T_{\cup}^* and T_{\cap}^* are non associative as the groupoid is non associative.

Example 2.38: Let $S = \{\text{Collection of all subsets from the groupoid } G = \{\langle \mathbb{Z}^+ \cup I \cup \{0\} \rangle, *, (7I, 12)\}\}$ be the subset groupoid.

Clearly T_o , T_{\cup}^* and T_{\cap}^* are infinite groupoid topological spaces and the later two are non associative and non commutative. These topological spaces are known as neutrosophic subset groupoid topological spaces.

Example 2.39: Let $S = \{\text{Collection of all subsets from the groupoid } G = (\mathbb{Z}^+ \cup \{0\})S_7, *, (7g_1 + 6g_2, 10g_3 + 4) \text{ where}$

$$g_1 = \begin{pmatrix} 1 & 2 & 3 & 4 & 5 & 6 & 7 \\ 2 & 1 & 3 & 4 & 6 & 7 & 5 \end{pmatrix}, g_2 = \begin{pmatrix} 1 & 2 & 3 & 4 & 5 & 6 & 7 \\ 1 & 3 & 2 & 4 & 5 & 6 & 7 \end{pmatrix}$$

$$\text{and } g_3 = \left\{ \begin{pmatrix} 1 & 2 & 3 & 4 & 5 & 6 & 7 \\ 1 & 4 & 3 & 6 & 5 & 2 & 7 \end{pmatrix} \in S_7 \right\}$$

be the subset groupoid. T_{\cup}^* and T_{\cap}^* non associative and non commutative subset groupoids of infinite order.

Example 2.40: Let $S = \{\text{Collection of all subsets from the groupoid } G = (\langle Z^+ \cup I \rangle) (D_{2,7} \times S(5)), *, (3, 0)\}$ be the subset groupoid. T_{\cup}^* and T_{\cap}^* are both non commutative and non associative.

Example 2.41: Let $S = \{\text{Collection of all subsets from the matrix groupoid of infinite order}$

$$M = \left\{ \left[\begin{array}{c} a_1 \\ a_2 \\ \vdots \\ a_{15} \end{array} \right] \mid a_i \in G = \langle Z^+ \cup I \cup \{0\}, *, (I, 3) \rangle; 1 \leq i \leq 15 \right\}$$

be the subset matrix groupoid.

Both the spaces T_{\cup}^* and T_{\cap}^* are non commutative and non associative and of infinite order.

Example 2.42: Let $S = \{\text{Collection of all subsets from super column matrix groupoid}$

$$M = \left\{ \left[\begin{array}{c} a_1 \\ a_2 \\ a_3 \\ a_4 \\ a_5 \\ a_6 \\ a_7 \end{array} \right] \mid a_i \in \langle Z^+ \cup I \cup \{0\} \rangle S_4, *, (3, 6I), 1 \leq i \leq 7 \right\}$$

be the subset matrix groupoid of infinite order.

Both T_{\cup}^* and T_{\cap}^* are non commutative and non associative of infinite order.

Example 2.43: Let $S = \{\text{Collection of all subsets from the super matrix groupoid } M = \{(a_1 a_2 a_3 a_4 | a_5 a_6 a_7 | a_8 a_9 | a_{10}) | a_i \in G = \{(Z^+ \cup \{0\}) (S_5 \times D_{2,8}), *, (3, 4)\}, 1 \leq i \leq 10\}\}$ be the subset groupoid of infinite order.

All the three topological spaces T_o , T_{\cup}^* and T_{\cap}^* of the subset groupoids is of infinite order and T_{\cup}^* and T_{\cap}^* are both non commutative and non associative.

Example 2.44: Let $S = \{\text{Collection of all subsets from the super matrix groupoid}$

$$M = \left\{ \left[\begin{array}{ccc|ccc|ccc} a_1 & a_2 & a_3 & & & & & & & \\ \hline a_4 & a_5 & a_6 & & & & & & & \\ \hline a_7 & a_8 & a_9 & & & & & & & \\ \hline a_{10} & a_{11} & a_{12} & & & & & & & \\ a_{13} & a_{14} & a_{15} & & & & & & & \\ \hline a_{16} & a_{17} & a_{18} & & & & & & & \\ a_{19} & a_{20} & a_{21} & & & & & & & \\ \hline a_{22} & a_{23} & a_{24} & & & & & & & \end{array} \right] \mid a_i \in G = \{C\langle Q \cup I \rangle \cup \{0\}\} (g_1, g_2), \right.$$

$$g_1^2 = 0, g_2^2 = g_2, g_1g_2 = g_2g_1 = 0, *, (3g_1, 4/7g_2); 1 \leq i \leq 24 \}$$

be the subset groupoid of infinite order. So are the subset topological groupoid spaces.

Example 2.45: Let $S = \{\text{Collection of all subsets from the super matrix groupoid}$

$$M = \left\{ \left[\begin{array}{c|c|c|c} a_1 & a_2 & a_3 & a_4 \\ \hline a_5 & a_6 & a_7 & a_8 \\ \hline a_9 & \dots & \dots & a_{12} \\ \hline a_{13} & \dots & \dots & a_{16} \\ \hline a_{17} & \dots & \dots & a_{20} \end{array} \right] \mid a_i \in G = \{ \langle \mathbb{R}^+ \cup I \cup \{0\} \rangle S_{10}, *, (0, 3I), 1 \leq i \leq 20 \} \right\}$$

be the subset groupoid.

T_o , T_{\cup}^* and T_{\cap}^* are subset groupoid topological spaces of infinite order of which T_{\cup}^* and T_{\cap}^* are non commutative and non associative.

Now we describe subset loop groupoid topological spaces and then proceed onto describe their subspaces.

Example 2.46: Let

$S = \{ \text{Collection of all subsets from the loop } L_9(8) \}$ be the subset loop groupoid of finite order. The topological loop groupoid subset spaces of finite order associated with S are T_o , T_{\cup}^* and T_{\cap}^* .

Clearly T_{\cup}^* and T_{\cap}^* are both non associative and non commutative.

Example 2.47: Let $S = \{ \text{Collection of all subsets from the loop } L_{13}(6) \}$ be the subset loop groupoid.

We have two subset loop groupoid topological spaces T_{\cup}^* and T_{\cap}^* to be non commutative and non associative. However T_o is just the usual topological space.

Now it is important to note that for a given n ; n an odd number greater than three we can build several loops using $L_n(m)$ where $m < n$ with $(n, m) = (n, m-1) = 1$.

For more refer [35, 60]. Thus for $L_n(m) \in L_n$.

We can build many subset loop groupoids and related with each of these subset loop groupoids we have three subset loop groupoid topological spaces of same order.

Example 2.48: Let

$S = \{\text{Collection of all subsets from the loop } L_{19}(9)\}$ be the subset loop groupoid of finite order.

T_{\cup}^* and T_{\cap}^* are loop groupoid subset topological spaces of finite order which are non associative and non commutative.

Example 2.49: Let

$S = \{\text{Collection of all subsets from the loop } L_{19}(18)\}$ be the subset loop groupoid.

We see T_o , T_{\cup}^* and T_{\cap}^* are subset loop groupoid topological spaces of finite order but different from the spaces given in example 2.48.

Example 2.50: Let

$S = \{\text{Collection of all subsets from the loop } L_{23}(7)\}$ be the subset loop groupoid of finite order. T_o , T_{\cup}^* and T_{\cap}^* are subset loop groupoid topological spaces of S .

Now we enumerate some properties related with subset groupoid topological spaces and loop subset groupoid topological spaces.

In a similar way for a given Z_n , n fixed we can construct several groupoids G depending on the (t, s) which are used and $G = \{Z_n, *, (t, s), t, s \in Z_n\}$, if we take $t = s = 1$ then in that case G will be a semigroup.

Thus we can in case the loop $L_5(m) \in L_5$ have only 3 loops $L_5(4)$, $L_5(3)$ and $L_5(2)$.

These 3 loops pave way for 9 topological subset loop groupoid spaces of which T_o of all the three spaces would be the same only T_{\cup}^* and T_{\cap}^* are different for all the three spaces.

Example 2.51: Let $S = \{\text{Collection of all subsets from the groupoid } G = \{Z_{10}, *, (2, 4)\}\}$ be the subset groupoid.

T_o, T_{\cup}^* and T_{\cap}^* are three subset groupoid topological spaces of S .

We see if $G = \{Z_{10}, *, (2, 4)\}$ is replaced by $G = \{Z_{10}, *, (5, 1)\}$ we see T_o of both G and G_1 will be the same T_{\cup}^* and T_{\cap}^* of G and G_1 will be different.

In view of this we have the following theorem.

THEOREM 2.2: *Let $S = \{\text{Collection of all subsets from the groupoid } G_{(t,s)}^n = \{Z_n, *, (t, s); t = 1 = s \text{ alone is not possible}\}\}$ be subset groupoids for varying $(t, s) \in Z_n$.*

- (i) T_o of all subset groupoids topological spaces for varying (t, s) are one and the same.
- (ii) T_{\cup}^* and T_{\cap}^* of subset groupoid topological spaces of $G_{(t,s)}^n$ are distinct.

The proof is direct and hence left as an exercise to the reader.

Example 2.52: Let $S = \{\text{Collection of all subsets from the groupoid } G_i = \{Z_4, *, (i, 0)\}\}$ be the subset groupoids; $i = 1, 2, 3$. T_{\cup}^* and T_{\cap}^* for each G_i is distinct.

Let $A = \{3\}$ and $B = \{2\} \in T_{\cup}^*$ (or T_{\cap}^*); $A * B$ in case G_1 is used is given by

$$A * B = \{3\} * \{2\} = \{3 * 2\} = \{3\} \qquad \dots 1$$

Suppose G_2 is used then

$$\begin{aligned} A * B &= \{3\} * \{2\} \\ &= \{3 * 2\} \\ &= \{6 \pmod{4}\} \\ &= \{2\} \end{aligned} \quad \dots 2$$

Suppose G_3 is used then

$$\begin{aligned} A * B &= \{3\} * \{2\} \\ &= \{3 * 2\} = \{1\} \end{aligned} \quad \dots 3$$

We see (1), (2) and (3) are distinct. So the topological subset groupoid spaces are also different. Hence the claim.

Example 2.53: Let $S = \{\text{Collection of all subsets from the groupoids } G_1 = \{Z_5, (2, 0), *\} \text{ (or } G_2 = \{Z_5, (0, 2), *\} \text{ or } G_3 = \{Z_5, (3, 0), *\} \text{ or } G_4 = \{Z_5, (0, 3), *\} \text{ or } G_5 = \{Z_5, (4, 0), *\} \text{ or } G_6 = \{Z_5, (0, 4), *\} \text{ or } G_7 = \{Z_5, (3, 2), *\}\}$ be the subset groupoid.

Let T_o , T_{\cup}^* and T_{\cap}^* be the subset groupoid topological spaces of S .

We see T_o for all the seven subset groupoid topological spaces are the same.

However we see the seven subset groupoid topological spaces T_{\cup}^* (or T_{\cap}^*) are different for each of the seven groupoids.

Let $A = \{3\}$ and $B = \{2\} \in T_{\cup}^*$ (or T_{\cap}^*).

Take $A = \{3\}$ and $B = \{2\}$ from the groupoid G_1 of T_{\cup}^* .

$$\begin{aligned} A * B &= \{3\} * \{2\} \\ &= \{3 * 2\} = \{1\} \end{aligned} \quad \dots (1)$$

Suppose A, B be associated with T_{\cup}^* (or T_{\cap}^*) of G_2 .

$$\begin{aligned}
 A * B &= \{3\} * \{2\} \\
 &= \{3 * 2\} \\
 &= \{4\} \qquad \dots \quad (2)
 \end{aligned}$$

Let A, B be associated with the groupoid G_5

$$\begin{aligned}
 A * B &= \{3\} * \{2\} \\
 &= \{3 * 2\} \\
 &= \{2\} \qquad \dots \quad (3)
 \end{aligned}$$

Now if A, B be associated with G_7

$$\begin{aligned}
 A * B &= \{3\} * \{2\} \\
 &= \{3 * 2\} \\
 &= \{3\} \qquad \dots \quad (4)
 \end{aligned}$$

The four topological spaces for this subset A, B are distinct. Similarly by taking different subsets C, D on T_{\cup}^* or T_{\cap}^* we can show these seven spaces are distinct.

That is it is always possible to find subsets A, B such that $A * B$ is not the same in all the seven spaces. Hence the claim.

Example 2.54: Let S_1 or S_2 or $S_3 = \{\text{Collection of all subsets from the loop } L_5(4) \text{ (or } L_5(3) \text{ or } L_5(2))\}$ respectively be the subset loop groupoid of S_1 (or S_2 or S_3).

T_{\circ} for all the three subset groupoids S_1 , S_2 and S_3 are identical.

Now we show T_{\cup}^* and T_{\cap}^* for S_1 , S_2 and S_3 are distinct.

Let $A = \{3\}$ and $B = \{5\} \in T_{\cup}^*$ (or T_{\cap}^*).

Suppose A, B are associated with the loop $L_5(4)$.

$$\begin{aligned}
 A * B &= \{3 * 5\} \\
 &= \{1\} \qquad \dots \quad (1)
 \end{aligned}$$

For if A, B are subsets associated with the loop $L_5(2)$ then

$$\begin{aligned}
 A * B &= \{3\} * \{5\} \\
 &= \{3 * 5\} \\
 &= \{2\} \qquad \dots (2)
 \end{aligned}$$

If A, B are subsets associated with the loop $L_5(3)$ then

$$\begin{aligned}
 A * B &= \{3\} * \{5\} \\
 &= \{3 * 5\} \\
 &= \{4\} \qquad \dots (3)
 \end{aligned}$$

We see the equations (1) (2) and (3) are distinct so the six topological spaces are different.

Thus associated with the loops in L_5 we have six different non associative subset loop groupoid topological spaces associated with loops in L_5 .

THEOREM 2.3: *Let*

$S = \{Collection\ of\ all\ subsets\ from\ the\ loops\ } L_p(m) \in L_p\} ; 2 \leq m \leq p-1; p\ a\ prime. Associated\ with\ loops\ } L_p\ we\ have\ } 2(p-2)\ number\ of\ distinct\ subset\ loop\ groupoid\ topological\ spaces.$

Proof is direct hence left as an exercise to the reader.

THEOREM 2.4: *Let $S = \{Collection\ of\ all\ subsets\ from\ the\ loop\ } L_n(m) \in L_n(n\ an\ odd\ composite\ number)\}$ be the subset loop groupoid.*

If $n = p_1^{\alpha_1} p_2^{\alpha_2} \dots p_k^{\alpha_k}$ then associated with S we have exactly $2 \prod_{i=1}^k (p_i - 2) p_i^{\alpha_i - 1}$ number of distinct subset loop groupoid topological spaces of which only two of them are commutative and all other spaces are both non commutative and non associative.

Proof follows from the fact, L_n , the class of loops has only one commutative loop and $|L_n| = \prod_{i=1}^k (p_i - 2)p_i^{\alpha_i - 1}$.

We say a subset loop groupoid topological spaces T_{\cup}^* and T_{\cap}^* are said to satisfy a special identity if a subset of T_{\cup}^* and T_{\cap}^* satisfies that special identity.

Thus we say if the basic loop $L_n(m)$ over which this subset loop groupoid topological space is defined satisfies the special identity then we define the topological subset groupoid spaces T_{\cup}^* and T_{\cap}^* satisfies the Smarandache special identity.

We first illustrate this by the following example.

Example 2.55: Let

$S = \{\text{Collection of all subsets from the loop } L_7(4) \in L_n\}$ be the subset loop groupoid.

The topological subset loop groupoid spaces T_{\cup}^* and T_{\cap}^* are both commutative.

Follows from the simple fact $L_7(4)$ is a commutative loop given by the following table:

*	e	1	2	3	4	5	6	7
e	e	1	2	3	4	5	6	7
1	1	e	5	2	6	3	7	4
2	2	5	e	6	3	7	4	1
3	3	2	6	e	7	4	1	5
4	4	6	3	7	e	1	5	2
5	5	3	7	4	1	e	2	6
6	6	7	4	1	5	2	e	3
7	7	4	1	5	2	6	3	e

Thus if we define by $C_n(T_{\cup}^*)$ (and $C_n(T_{\cap}^*)$) the class of all loop groupoid subset topological spaces T_{\cup}^* and T_{\cap}^* respectively built over the loop in $L_n = \{(L_n(m) \mid (m, n) = (m - 1, n) = 1, 2 \leq m \leq n)\}$.

Example 2.56: Let $S = \{\text{Collection of all subsets from the loop } L_{29}(7)\}$ be the subset groupoid. The subset groupoid topological spaces T_{\cup}^* and T_{\cap}^* are Smarandache strictly non commutative.

We see $L_{29}(7)$ is a strictly non commutative loop so the subset loop groupoid S contains a proper subset. $P = \{\{e\}, \{g_1\}, \{g_2\}, \dots, \{g_{29}\}\} \subseteq S$ is such that P is a strictly non commutative subset loop.

Hence S is a Smarandache subset strictly non commutative loop groupoid hence the subset loop groupoid topological spaces T_{\cup}^* and T_{\cap}^* are also Smarandache strictly non commutative loop groupoid topological spaces.

Example 2.57: Let $S = \{\text{Collection of all subsets from the loop } L_{25}(2)\}$ be the subset loop groupoid of the loop $L_{25}(2)$. S is a Smarandache right alternative subset loop groupoid.

So the subset loop groupoid topological spaces T_{\cup}^* and T_{\cap}^* are Smarandache right alternative subset loop groupoid topological spaces of S .

Example 2.58: Let $S = \{\text{Collection of all subsets from the loop } L_{127}(2)\}$ be the subset loop groupoid of the loop $L_{127}(2)$.

Clearly S is a Smarandache right alternative loop groupoid so both T_{\cup}^* and T_{\cap}^* are Smarandache right alternative subset loop groupoid topological spaces of S .

Example 2.59: Let

$S = \{\text{Collection of all subsets from the loop } L_{337}(2)\}$ be the subset loop groupoid.

S is a Smarandache subset right alternative loop groupoid. So that both T_{\cup}^* and T_{\cap}^* are Smarandache subset right alternative topological loop groupoid spaces of S .

Inview of all these we have the following theorem the proof of which is direct.

THEOREM 2.5: Let

$S = \{\text{Collection of all subsets from the loop } L_n(m) \in L_n\}$ be the subset loop groupoid of the loop $L_n(m) \in L_n$.

There exists one and only one subset loop groupoid in $C(S)$ which is S -right alternative; associated with it we have T_{\cup}^ and T_{\cap}^* to be S -right alternative subset loop groupoid topological spaces.*

Proof follows from the fact that there exists one and only one loop $L_n(m)$ in L_n which is right alternative; that is when $m = 2$; T_{\cup}^* and T_{\cap}^* are the S -subset right alternative loop groupoid topological spaces.

Now we proceed onto give examples of S -left alternative subset loop groupoid topological spaces.

Example 2.60: Let

$S = \{\text{Collection of all subsets from the loop } L_{25}(24)\}$ be the subset loop groupoid of the loop $L_{25}(24)$. S is a Smarandache subset left alternative loop groupoid as $L_{25}(24)$ is a left alternative loop.

Hence the subset loop groupoid topological spaces T_{\cup}^* and T_{\cap}^* are both Smarandache left alternative subset loop groupoid topological spaces of S .

Example 2.61: Let

$S = \{\text{Collection of all subsets from the loop } L_{43}(42)\}$ be the subset loop groupoid of the loop $L_{43}(42)$.

S is a Smarandache left alternative subset loop groupoid. T_{\cup}^* and T_{\cap}^* are Smarandache left alternative subset loop groupoid topological spaces of S .

Example 2.62: Let

$S = \{\text{Collection of all subsets from the loop } L_{13}(12)\}$ be the subset loop groupoid of the loop $L_{13}(12)$.

Clearly S is a Smarandache left alternative subset loop groupoid as the loop $L_{13}(2)$ is a left alternative loop.

Based on this; T_{\cup}^* and T_{\cap}^* are both Smarandache subset left alternative loop groupoid topological spaces of S .

Example 2.63: Let

$S = \{\text{Collection of all subsets from the loop } L_{33}(32)\}$ the left alternative loop $L_{33}(32)$. S is a Smarandache left alternative subset loop groupoid, hence both L_{\cup}^* and L_{\cap}^* are Smarandache left alternative subset loop groupoid topological spaces of S .

In view of all these we have the following theorem.

THEOREM 2.6: Let

$S = \{\text{Collection of all subsets from the loop } L_n(n-1) \in L_n\}$ be the subset loop groupoid of the loop $L_n(n-1)$.

- (1) S is a S -left alternative subset loop groupoid.
- (2) Both T_{\cup}^* and T_{\cap}^* are S -left alternative subset loop groupoid topological spaces of S .
- (3) There exist one and only one loop in L_n viz. $L_n(n-1)$ which contributes for the S -left alternative subset loop groupoid topological spaces.

Follows from the simple fact that the class of loops L_n has one and only one left alternative loop.

We see both T_{\cup}^* and T_{\cap}^* contains $P = \{\{e\}, \{1\}, \{2\}, \dots, \{n\}\} \subseteq S$ as a subset loop subgroupoid of S and P is a subset loop groupoid which satisfies the left alternative identity when $m = n - 1$. Hence the claim.

Next we proceed onto describe Smarandache weak inverse property subset loop groupoids by examples.

Example 2.64: Let $S = \{\text{Collection of all subsets from the loop } L_7(3)\}$ given by the following table.

*	e	1	2	3	4	5	6	7
e	e	1	2	3	4	5	6	7
1	1	e	4	7	3	6	2	5
2	2	6	e	5	1	4	7	3
3	3	4	7	e	6	2	5	1
4	4	2	5	1	e	7	3	6
5	5	7	3	6	2	e	1	4
6	6	5	1	4	7	3	e	2
7	7	3	6	2	5	1	4	e

be the subset loop groupoid S is a Smarandache weak inverse property (WIP) loop groupoid.

Clearly $P = \{\{e\}, \{1\}, \{2\}, \{3\}, \{4\}, \{5\}, \{6\}, \{7\}\} \subseteq S$ is a subset collection which is a subset WIP loop. Hence both the topological spaces T_{\cup}^* and T_{\cap}^* are S -subset weak inverse property loop groupoid topological spaces of S .

Example 2.65: Let

$S = \{\text{Collection of all subsets from the loop } L_{13}(4)\}$ be the subset loop groupoid S is a S -WIP subset loop groupoid of the

WIP loop $L_{13}(4)$ and T_{\cup}^* and T_{\cap}^* are S-WIP subset loop groupoid topological spaces of S.

Example 2.66: Let

$S = \{\text{Collection of all subsets from the loop } L_{21}(5)\}$ be the subset loop groupoid of the WIP loop $L_{21}(5)$. S is a S-WIP subset loop groupoid. So T_{\cup}^* and T_{\cap}^* are S-subset WIP loop groupoid topological spaces of $L_{21}(5)$.

Example 2.67: Let

$S = \{\text{Collection of all subsets from the loop } L_{31}(6)\}$ be the subset loop groupoid of the WIP loop $L_{31}(6)$. T_{\cup}^* and T_{\cap}^* are S-subset WIP loop groupoid topological spaces of S.

Example 2.68: Let

$S = \{\text{Collection of all subsets from the loop } L_{43}(7)\}$ be the subset loop groupoid of WIP loop $L_{43}(7)$.

Both T_{\cup}^* and T_{\cap}^* are S-subset WIP loop groupoid topological spaces of S.

Example 2.69: Let

$S = \{\text{Collection of all subsets from the WIP loop } L_{57}(8)\}$ be the S-WIP subset loop groupoid. T_{\cup}^* and T_{\cap}^* are both S-WIP subset loop groupoid topological spaces of S.

We see all numbers $m^2 - m + 1 = t$ is always odd and those m 's give $L_t(m)$ to be a WIP loop.

Now having seen S-WIP subset loop groupoid topological spaces we proceed onto study S-strictly non commutative subset loop groupoid topological spaces.

Example 2.70: Let

$S = \{\text{Collection of all subsets from the loop } L_{29}(7)\}$ be the subset loop groupoid of the loop $L_{29}(7)$. $L_{29}(7)$ is a strictly non commutative loop so S is a S-strictly non commutative subset loop groupoid of $L_{29}(7)$.

Hence T_{\cup}^* and T_{\cap}^* are both S-strictly non commutative subset loop groupoid topological spaces of S.

Example 2.71: Let

$S = \{\text{Collection of all subsets from the loops } L_{21}\}$ be the subset loop groupoid.

None of the loops in L_{21} is a strictly non commutative loop so none of the subset loop groupoid topological spaces associated with them as S-strictly non commutative subset loop groupoid topological spaces.

Example 2.72: Let

$S = \{\text{Collection of all subsets from the loop } L_{79}(8)\}$ be the subset loop groupoid. S is a S-strictly non commutative subset loop groupoid.

Both T_{\cup}^* and T_{\cap}^* are S-subset strictly non commutative loop groupoid topological spaces of finite order.

In view of these examples we have the following theorem.

THEOREM 2.7: Let $C(S) = \{\text{Collection of all collections of subsets from the loop in } L_n \text{ where } n = p_1^{\alpha_1} p_2^{\alpha_2} \dots p_k^{\alpha_k}\}$ be the collection of all subset loop groupoids of the loops in L_n .

(i) $C(S)$ contains exactly $N = \prod_{i=1}^k (p_i - 3) p_i^{\alpha_i - 1}$ number of S-subset strictly non commutative loop groupoids.

(ii) Associated with the collection $C(S)$, there exists exactly $2N$; number of S-subset strictly non commutative loop groupoid topological spaces.

Proof follows from the fact L_n when n is as said in theorem has N number of strictly non commutative loops.

Corollary 2.1: Let $n = 3t$, $N = 0$, that is number of S-subset strictly non commutative loop groupoids is zero.

Corollary 2.2: Let $n = a$ prime $p, p \geq 5$ we have $p-3$ number of strictly non commutative loops.

Now we proceed onto study substructures using subset groupoids and subset loop groupoids of the subset groupoids (loop) topological spaces.

Example 2.73: Let $S = \{\text{Collection of all subsets from the groupoid } G = \{Z_{24}, *, (2, 0)\}\}$ be the subset groupoid of the groupoid. T_{\cup}^* , T_{\cap}^* and T_o are the subset groupoid topological spaces of S .

Now let $M = \{\text{Collection of all subsets from the subgroupoid } P = \{2Z_{24}, *, (2, 0)\} \subseteq G\} \subseteq S$ be the subset subgroupoid of S .

Associated with M are the M_o, M_{\cup}^* and M_{\cap}^* the subset groupoid topological subspaces of T_o, T_{\cup}^* and T_{\cap}^* respectively.

Example 2.74: Let $S = \{\text{Collection of all subsets from the groupoid } G = \{Z_{36}, *, (4, 2)\}\}$ be the subset groupoid of the groupoid G .

T_o, T_{\cup}^* and T_{\cap}^* the subset groupoid topological spaces contain subset groupoid topological subspaces.

It is an interesting and an open problem to characterize those subset groupoids which has no subset groupoid topological subspaces associated with T_o, T_{\cup}^* and T_{\cap}^* . The very existence of such topological spaces may not be possible.

Example 2.75: Let $S = \{\text{Collection of all subsets from the matrix groupoid}$

$$M = \left\{ \left[\begin{array}{cccc} a_1 & a_2 & \dots & a_{10} \\ a_{11} & a_{12} & \dots & a_{20} \\ a_{21} & a_{22} & \dots & a_{30} \end{array} \right] \mid a_i \in G = \{\langle Z_{12} \cup I \rangle S_5, *, (2, I)\}; \right.$$

$$1 \leq i \leq 30 \}$$

be the subset groupoid.

All the three subset groupoid topological spaces T_{\cup}^* , T_{\cap}^* and T_o contain atleast 30 subspaces each of which are distinct.

Example 2.76: Let $S = \{\text{Collection of all subsets from the matrix groupoid } M = \{(a_1, a_2, \dots, a_{20}) \mid a_i \in L_{295}(2), 1 \leq i \leq 20\}\}$ be the subset groupoid. T_o , T_{\cup}^* and T_{\cap}^* has atleast several subset groupoid topological subspaces.

$W = \{\text{Collection of all subsets from } P = \{(a_1, a_2, a_3, a_4, a_5, 0, 0, \dots, 0) \mid a_i \in L_{295}(2); 1 \leq i \leq 5\}\} \subseteq S$ give way to subset groupoid topological subspaces.

Example 2.77: Let $S = \{\text{Collection of all subsets from the loop } L_5(2)\}$ be the subset groupoid. T_o , T_{\cup}^* and T_{\cap}^* are subset topological spaces and they have 5 subspaces each which are associative.

Let $W_i = \{\text{Collection of all subsets from the subgroup } \{e, g_i\} \subseteq L_5(2)\}$ be the subset subgroupoid. Associated with W_i , $1 \leq i \leq 5$ we have topological subspaces of T_o , T_{\cup}^* and T_{\cap}^* all of which are associative and W_i 's are infact subset semigroups.

So these subset groupoid topological spaces T_{\cup}^* and T_{\cap}^* have subspaces which are associative so will be known as Smarandache subset groupoid topological spaces.

Example 2.78: Let $S = \{\text{Collection of all subsets from the loop } L_{15}(8)\}$ be the subset groupoid. T_o , T_{\cup}^* and T_{\cap}^* be the subset topological groupoid spaces.

They have subset topological subspaces which are associative and commutative. For instance $W_i = \{\{e\}, \{e, g_i\},$

$\{g_i\}, \phi \subseteq S$ paves way to topological subspaces of T_{\cup}^* and T_{\cap}^* which are commutative and associative.

Infact we have 15 such subspaces and the trees associated with them being

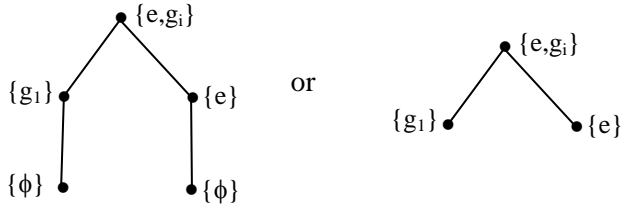

So T_{\cup}^* and T_{\cap}^* are S-subset groupoid topological spaces. Apart from this we have collection of all subsets from the subloop $H_1(5) = \{e, 1, 6, 11\} \subseteq L_{15}(8)$.

$W = \{\{e\}, \{1\}, \{6\}, \{11\}, \{e, 1\}, \{e, 11\}, \{e, 6\}, \{1, 6\}, \{1, 11\}, \{6, 11\}, \{e, 1, 6\}, \{e, 1, 11\}, \{e, 6, 11\}, \{1, 11, 6\}, \{e, 1, 6, 11\}\} \cup \{\phi\}$.

This collection from a topological subspace of T_{\cup}^* and T_{\cap}^* . The trees associated with this subspace is

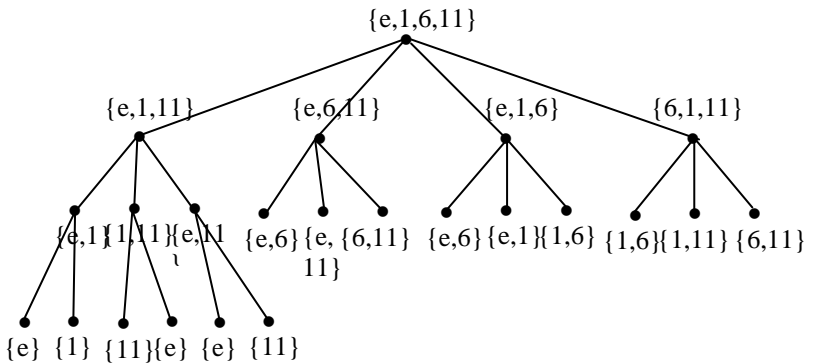

This subspace given by W is also a S -subset groupoid topological subspace of T_{\cup}^* (or T_{\cap}^*).

Example 2.79: Let $S = \{\text{Collection of all subsets from the matrix groupoid } M = \{(a_1, a_2, \dots, a_{11}) \mid a_i \in L_{15}(8); 1 \leq i \leq 11\}\}$ be the subset groupoid.

T_{\cup}^* , T_{\cap}^* and T_{\cap}^* has several subset groupoid topological spaces of finite order as $o(S) < \infty$.

THEOREM 2.8: *Let $S = \{\text{Collection of all subsets from a loop } L_n(m) \text{ (or matrices with entries from } L_n(m)\}$ be the subset groupoid.*

(i) T_{\cup}^* and T_{\cap}^* has atleast n number of subset groupoid topological subspaces which are associative and commutative and of same order.

(ii) In case of matrix groupoids; T_{\cup}^* and T_{\cap}^* has atleast $n+$ (order of matrix) + several other subset topological subspaces which are associative and commutative.

Proof is direct and hence left as an exercise to the reader.

Finally we wish to keep on record that subset groupoids have subset groupoid ideals as groupoids contain ideals.

Now using these subset groupoid ideals we can build the notion of set subset subgroupoids of a subset groupoid G .

We will first describe how this is constructed.

Let $S = \{\text{Collection of all subsets from the groupoid } G\}$ be the subset groupoid. Related with each of the subgroupoids of G we can build a collection of set subset groupoid ideals over these subgroupoids.

These collection can be given the topological structure as T_{\cup}^* and T_{\cap}^* both will be well defined naturally. This method of defining subset groupoid set ideal topological spaces over subgroupoids give more such spaces depending on the number of subgroupoids of G .

We shall denote the subset set ideal groupoid topological spaces of S over the subgroupoid H by ${}_H T_o$, ${}_H T_{\cup}^*$ and ${}_H T_{\cap}^*$.

Thus with each subgroupoid H we have a subset set ideal groupoid topological space over H . In case of subset set ideal loop groupoids we say over subloops.

Example 2.80: Let $S = \{\text{Collection of all subsets from the groupoid } G = \{Z_6, *, (3, 0)\}\}$ be the subset groupoid. $H_1 = \{\{0, 2, 4\} \subseteq Z_6, *, (3, 0)\} \subseteq G$ is a subgroupoid of G .

Let $M_1 = \{\text{Collection of all subset set ideals of } S \text{ over the subgroupoid } H_1 \text{ of } G\}$

$= \{\{0\}, \{0, 2\}, \{0, 4\}, \{0, 3\}, \{3\}, \{0, 2, 4\}, \{0, 2, 3\} \text{ and so on}\} \subseteq S$.

We have ${}_{H_1} T_o$, ${}_{H_1} T_{\cup}^*$ and ${}_{H_1} T_{\cap}^*$ to be the subset set ideal groupoid topological spaces of S over the subgroupoid H_1 of G .

Similarly consider $H_2 = \{0, 3, 1\} \subseteq G$, the subgroupoid of G . Collection of all subset set groupoid ideals of S over the subgroupoid H_2 is $M_2 = \{\{0\}, \{0, 1, 3\}, \{0, 2\}, \{0, 4\}, \{0, 2, 4\}, \{0, 1, 3, 2, 4\} \text{ and so on}\}$.

Thus we have using M_2 the subset set ideal groupoid topological spaces ${}_{H_2} T_o$, ${}_{H_2} T_{\cup}^*$ and ${}_{H_2} T_{\cap}^*$ over the subgroupoid H_2 of G .

Example 2.81: Let $S = \{\text{Collection of all subsets from the groupoid } G = \{\langle Z_{15} \cup I \rangle, *, (0, 5)\}\}$ be the subset groupoid of G .

Clearly $H_1 = \{Z_{15}\}$, $H_2 = \{0, 5, 10\}$ and $H_3 = \{0, 3, 6, 9, 12\}$ are some of the subgroupoids of G .

We see related with these subgroupoids we can have ${}_{H_i}T_o$, ${}_{H_i}T_\cup^*$ and ${}_{H_i}T_\cap^*$ to be subset set ideal groupoid topological spaces over the subset subgroupoids H_i , $1 \leq i \leq 3$.

Example 2.82: Let

$S = \{\text{Collection of all subsets from the loop; } L_{45}(8)\}$ be the subset loop groupoid. We see $H_i = \{e, g_i\}$; $1 \leq i \leq 45$, are 45 subloops and using each of them we have an associated subset set ideal groupoid topological spaces over these subloops. Further $L_{45}(8)$ has other subloops like $H_i(9)$, $H_i(3)$, $H_i(5)$ and $H_i(15)$ with appropriate i . Related to each of these subloops we have three topological subset set ideal groupoid spaces of different orders.

Example 2.83: Let

$S = \{\text{Collection of all subsets from the loop } L_{43}(9)\}$ be the subset groupoids. $H_i = \{e, g_i\}$; $g_i \in L_{43}(9) \setminus \{e\}$; $1 \leq i \leq 43$ are subloops and each ${}_{H_i}T_o$, ${}_{H_i}T_\cup^*$ and ${}_{H_i}T_\cap^*$; subset set ideal topological groupoid spaces over H_i all of them are not in general commutative and associative spaces. They are non commutative and non associative.

Example 2.84: Let $S = \{\text{Collection of all subsets from the matrix groupoid } M = \{(a_1, a_2, a_3, a_4, a_5) \mid a_i \in L_{19}(8); 1 \leq i \leq 5\}\}$ be the subset groupoid.

Clearly M has more than 19 subgroupoids. Thus we have several subset set ideal groupoid topological spaces over subgroupoids of M .

Example 2.85: Let $S = \{\text{Collection of all subsets from the matrix groupoid}$

$$M = \left\{ \begin{bmatrix} a_1 & a_2 \\ a_3 & a_4 \\ a_5 & a_6 \\ a_7 & a_8 \\ a_9 & a_{10} \\ a_{11} & a_{12} \\ a_{13} & a_{14} \end{bmatrix} \mid a_i \in L_{25}(4); 1 \leq i \leq 14 \right\}$$

be the subset groupoid.

M has several subgroupoids so, has several subset set ideal groupoid topological spaces associated with each of the subgroupoids of M.

Example 2.86: Let $S = \{ \text{Collection of all subsets from the matrix groupoid} \}$

$$M = \left\{ \begin{bmatrix} a_1 & a_2 & \dots & a_{10} \\ a_{11} & a_{12} & \dots & a_{20} \\ a_{21} & a_{22} & \dots & a_{30} \\ a_{31} & a_{32} & \dots & a_{40} \\ a_{41} & a_{42} & \dots & a_{50} \end{bmatrix} \mid a_i \in L_{129}(8); 1 \leq i \leq 50 \right\}$$

be the subset groupoid of M.

Since M has several subgroupoids associated with each of the subgroupoids H_i of M we have subset set ideal topological groupoid spaces over H_i , viz., ${}_{H_i}T_o$, ${}_{H_i}T_{\cup}^*$ and ${}_{H_i}T_{\cap}^*$.

Example 2.87: Let $S = \{ \text{Collection of all subset from the matrix groupoid} \}$

$$M = \left\{ \begin{bmatrix} a_1 & a_2 & \dots & a_{15} \\ a_{16} & a_{17} & \dots & a_{30} \\ a_{31} & a_{32} & \dots & a_{45} \end{bmatrix} \middle| a_i \in G = \{C\langle Z_{48} \cup I \rangle, *, (4i_F, 28I)\}; 1 \leq i \leq 45\} \right.$$

be the subset groupoid.

M has several subgroupoids associated with them we have subset set ideal groupoid topological spaces over those subgroupoids.

Example 2.88: Let $S = \{\text{Collection of all subsets from the matrix groupoid}\}$

$$M = \left\{ \begin{bmatrix} a_1 & a_2 & \dots & a_9 \\ a_{10} & a_{11} & \dots & a_{18} \\ \vdots & \vdots & \dots & \vdots \\ a_{73} & a_{74} & \dots & a_{81} \end{bmatrix} \middle| a_i \in G = \{C\langle Z_{40} \rangle, *, (10, 30i_F)\}; 1 \leq i \leq 81\} \right.$$

be the subset groupoid of M.

Since M has several subgroupoids we see S has several subset set ideal groupoid topological spaces over these subgroupoids.

Only if the groupoid G over which S is build has no subgroupoids then only we see associated with S we will not have any subset set ideal topological groupoid spaces.

Such subset groupoids will be known as set ideal quasi simple subset groupoids.

Example 2.89: Let $S = \{\text{Collection of all subsets from the interval groupoid } M = \{\{[a, b] \mid a, b \in L_{27}(8)\}\}$ be the subset groupoid. M has subgroupoids H_i , so associated with H_i we have subset set ideal topological groupoid spaces.

Example 2.90: Let $S = \{\text{Collection of all subsets from the groupoid } M = \{([a_1, b_1], [a_2, b_2], \dots, [a_9, b_9]) \mid a_i, b_i \in L_{149}(2), 1 \leq i \leq 9\}\}$ be the subset groupoid.

M has several subgroupoids so associated with them; S has subset set ideal groupoid topological spaces.

Example 2.91: Let $S = \{\text{Collection of all subsets from the interval matrix groupoid}$

$$M = \left\{ \left[\begin{array}{cc} [a_1, b_1] & [a_2, b_2] \\ [a_3, b_3] & [a_4, b_4] \\ \vdots & \vdots \\ [a_{15}, b_{15}] & [a_{16}, b_{16}] \end{array} \right] \mid a_i \in G = \{Z_{486}, *, (400, 0)\}; \right. \\ \left. 1 \leq i \leq 16 \right\}$$

be the subset groupoid.

As M has several subgroupoids H_i , we have several subset set ideal groupoid topological spaces over H_i 's.

Example 2.92: Let $S = \{\text{Collection of all subsets from the polynomial groupoid}$

$$M = \left\{ \sum_{i=0}^{\infty} a_i x^i \mid a_i \in G = \{\langle Z_{43} \cup I \rangle, *, (40, 3)\} \right\}$$

be the subset groupoid.

M has infinite number of subgroupoids so associated with S we have infinite number of subset set ideal groupoid topological spaces over the subgroupoids of M.

Example 2.93: Let $S = \{\text{Collection of all subsets from the polynomial groupoid } M = \left\{ \sum_{i=0}^{\infty} a_i x^i \mid a_i \in L_{47}(3) \right\}\}$ be the subset groupoid.

M has infinite number of subgroupoids so associated with them we have infinite number of subset set ideal groupoid topological spaces over the subgroupoids of M.

Example 2.94: Let $S = \{\text{Collection of all subsets from the polynomial interval groupoid } M = \left\{ \sum_{i=0}^{\infty} [a_i, b_i] x^i \mid a_i, b_i \in L_{473}(8) \right\}\}$ be the subset groupoid.

M has infinite number of subgroupoids so associated with these subgroupoids, S has infinite number of subset set ideal groupoid topological spaces defined over the subgroupoids of M.

Example 2.95: Let $S = \{\text{Collection of all subsets from the interval polynomial groupoid } M = \left\{ \sum_{i=0}^{\infty} [a_i, b_i] x^i \mid a_i, b_i \in G = \{C \langle \langle \mathbb{Z}_{48} \cup I \rangle \rangle S_4; *, (4, 40) \}\}\}$ be the subset groupoid.

As M has infinite number of subgroupoids, S has infinite number of subset set ideal groupoid topological spaces.

Finally one can prove the following theorem.

THEOREM 2.9: *Let S be the collection of subsets of a groupoid G. S is a set ideal quasi simple subset groupoid if and only if G has no proper subgroupoids.*

Proof is direct hence left as an exercise to the reader.

We now suggest the following problem for this chapter.

Problems

1. Find some special features enjoyed by non associative subset groupoid topological spaces T_{\cup}^* and T_{\cap}^* .
2. Let $S = \{\text{Collection of all subsets from the groupoid } G = \{\mathbb{Z}_{10}, *, (9, 3)\}\}$ be the subset groupoid of G .
 - (i) Find $o(G)$.
 - (ii) Find T_{\cup}^* and T_{\cap}^* .
 - (iii) Show both T_{\cup}^* and T_{\cap}^* are non associative.
 - (iv) Show T_{\cup}^* and T_{\cap}^* are non commutative.
 - (v) Can T_{\cup}^* and T_{\cap}^* have subset topological groupoid zero divisors?

3. Let $S = \{\text{Collection of all subsets from the groupoid } G = \{\mathbb{Z}_{19}, *, (2, 8)\}\}$ be the subset groupoid.

Study questions (i) to (v) of problem 2 for this S .

4. Let $S = \{\text{Collection of all subsets from the groupoid } G = \{\mathbb{Z}_{18}, *, (6, 7)\}\}$ be the subset groupoid.

Study questions (i) to (v) of problem 2 for this S .

5. Let $S = \{\text{Collection of all subsets from the groupoid } G = \{\mathbb{C}(\mathbb{Z}_{12}), *, (3, 2i_F)\}\}$ be the subset groupoid.

Study questions (i) to (v) of problem 2 for this S .

6. Let $S = \{\text{Collection of all subsets from the groupoid } G = \{\langle \mathbb{Z}_{13} \cup I \rangle, *, (5, 6I)\}\}$ be the subset groupoid.

Study questions (i) to (v) of problem 2 for this S .

7. Let $S = \{\text{Collection of all subsets from the groupoid } G = \{\langle Z_{13} \cup I \rangle, *, (7I, 8I)\}\}$ be the subset groupoid.

Study questions (i) to (v) of problem 2 for this S .

8. Let $S = \text{Collection of all subsets from the groupoid } G = \{\langle Z_{13} \cup I \rangle, (8, 9), *\}$ be the subset groupoid.

Study questions (i) to (v) of problem 2 for this S .

9. How many subset groupoid topological spaces (distinct) can be obtained from $G = \{Z_{16}, *, (t, s); t, s \in Z_6 \text{ only } t = s = 1 \text{ makes } G \text{ to be a semigroup}\}$?

10. Study question (9) when Z_{19} is used.

11. Let $S = \{\text{Collection of all subsets from the groupoid } G = \{\langle Z_{12} \cup I \rangle, *, (5I, 2)\}\}$ be the subset groupoid.

Study questions (i) to (v) of problem 2 for this S .

12. If G in problem (11) S is replaced by $G_1 = \{\langle Z_{12} \cup I \rangle, *, (7I, 5I+2)\}$, study questions (i) to (v) of problem 2 for this S .

Also compare the spaces in (11) and (12).

13. Let $S = \{\text{Collection of all subsets from the groupoid } G = \{C(Z_{45}), *, (10, 20i_F)\}\}$ be the subset groupoid.

- (i) Study questions (i) to (v) of problem 2 for this S .
- (ii) If in G ; $(10, 20i_F)$ is replaced by $(10 + 20i_F, 10i_F + 20)$, study questions (i) to (v) of problem 2 for this S .
- (iii) Compare both the sets of topological spaces.

14. Let $S = \{\text{Collection of all subsets from the groupoid } G = \{C\langle Z_{14} \cup I \rangle, *, (10, 2I)\}\}$ be the subset groupoid of the groupoid G .

Study questions (i) to (v) of problem 2 for this S .

15. Let $S_1 = \{\text{Collection of all subsets from the groupoid } G = \{C\langle Z_{14} \cup I \rangle, *, (10, 2i_F)\}\}$ be the subset groupoid of the groupoid G .

- (i) Study questions (i) to (v) of problem 2 for this S .
- (ii) Compare S in problem 14 with S_1 in this problem 15.

16. Let $S = \{\text{Collection of all subsets from the groupoid } G = \{Z_{12} \times Z_{10}, * = (*_1, *_2); ((5, 6), (2, 5))\}\}$ be the subset groupoid.

Study questions (i) to (v) of problem 2 for this S .

17. Let $S = \{\text{Collection of all subsets from the groupoid } G = \{Z_5 S_7, *, (1+g_1, 4 + 3g_2); \text{ where}$

$$g_1 = \begin{pmatrix} 1 & 2 & 3 & 4 & 5 & 6 & 7 \\ 2 & 1 & 4 & 3 & 6 & 7 & 5 \end{pmatrix} \text{ and}$$

$$g_2 = \begin{pmatrix} 1 & 2 & 3 & 4 & 5 & 6 & 7 \\ 2 & 3 & 4 & 5 & 6 & 7 & 1 \end{pmatrix} \} \}$$
 be the subset groupoid.

Study questions (i) to (v) of problem 2 for this S .

18. Let $S = \{\text{Collection of all subsets from the groupoid } G = \{C\langle Z_{20} \rangle D_{2,7}, *, (3i_F a + 2b^2, 5ab^3 + 8i_F)\}\}$ be the subset groupoid.

Study questions (i) to (v) of problem 2 for this S .

19. Let $S = \{\text{Collection of all subsets from the groupoid } G = \{Z_{15} (S(3) \times D_{2,7}), *, (5, 10)\}\}$ be the subset groupoid.

Study questions (i) to (v) of problem 2 for this S .

20. Let $S = \{\text{Collection of all subsets from the groupoid } G = \{C(Z_9) (S(5) \times D_{2,8}), *, (8i_F, 3i_F)\}\}$ be the subset groupoid.

- (i) Study questions (i) to (v) of problem 2 for this S .
 (ii) How many different groupoids can be built using $C(Z_9) (S(5) \times D_{2,8})$?

21. Characterize those subset groupoid topological spaces of infinite order which contain subset groupoid topological subspaces of finite order.

22. Let $S = \{\text{Collection of all subsets from the polynomial groupoid } P = \left\{ \sum_{i=0}^{\infty} a_i x^i \mid a_i \in G = \{Z_{12}, *, (7, 0)\} \right\}\}$ be the subset polynomial groupoid.

- (i) Show S is non commutative and of infinite order.
 (ii) Find T_{\cup}^* and T_{\cap}^* and show they are non associative and non commutative groupoid subset topological spaces.

23. Let $S = \{\text{Collection of all subsets from the matrix groupoid } M = \{(a_1, a_2, a_3, a_4, a_5) \mid a_i \in G = \{ZZ_{40}, *, (10, 30)\}, 1 \leq i \leq 5\}\}$ be the subset row matrix groupoid.

- (i) Study questions (i) to (v) of problem 2 for this S .
 (ii) Show S has subset zero divisors.
 (iii) Show T_{\cup}^* and T_{\cap}^* have subset topological zero divisors.

24. Let $S = \{\text{Collection of all subsets from the matrix groupoid}\}$

$$M = \left\{ \left[\begin{array}{c} a_1 \\ a_2 \\ \vdots \\ a_{12} \end{array} \right] \middle| a_i \in G = \{C(Z_{15})^*, (8, 7i_F)\} \ 1 \leq i \leq 12 \right\}$$

be the subset groupoid.

Study questions (i) to (iii) of problem 23 for this S .

25. Let $S = \{\text{Collection of all subsets from the matrix groupoid}\}$

$$M = \left\{ \left[\begin{array}{cccc} a_1 & a_2 & \dots & a_{15} \\ a_{16} & a_{17} & \dots & a_{30} \\ a_{31} & a_{32} & \dots & a_{45} \end{array} \right] \middle| a_i \in G = \{Z_{10} S_4, *\}, \right.$$

$$\left. (3 + 2g_1 + 5g_2, 7g_4 + 6g_3 + 1) \text{ where } g_1 = \begin{pmatrix} 1 & 2 & 3 & 4 \\ 2 & 3 & 4 & 1 \end{pmatrix}, \right.$$

$$g_2 = \begin{pmatrix} 1 & 2 & 3 & 4 \\ 4 & 3 & 2 & 1 \end{pmatrix}, g_3 = \begin{pmatrix} 1 & 2 & 3 & 4 \\ 2 & 3 & 1 & 4 \end{pmatrix},$$

$$g_4 = \left. \begin{pmatrix} 1 & 2 & 3 & 4 \\ 2 & 4 & 3 & 1 \end{pmatrix} \right\} \ 1 \leq i \leq 45 \} \text{ be the subset groupoid.}$$

Study questions (i) to (iii) of problem 23 for this S .

26. Let $S = \{\text{Collection of all subsets from the groupoid matrix}\}$

$$M = \left\{ \begin{bmatrix} a_1 & a_2 & \dots & a_6 \\ a_7 & a_8 & \dots & a_{12} \\ a_{13} & a_{14} & \dots & a_{18} \\ a_{19} & a_{20} & \dots & a_{24} \\ a_{25} & a_{26} & \dots & a_{30} \\ a_{31} & a_{32} & \dots & a_{36} \end{bmatrix} \right\} \quad a_i \in G = \{C(Z_{12}) D_{2,7}, *, (3i_F$$

+ 2ab + 5b³, 10i_F + 5ab² + ab³); a, b ∈ D_{2,7}}, 1 ≤ i ≤ 36} be the subset groupoid.

Study questions (i) to (iii) of problem 23 for this S.

27. Let S = {Collection of all subsets from the super matrix

$$\text{groupoid } M = \left\{ \begin{bmatrix} a_1 \\ a_2 \\ a_3 \\ a_4 \\ a_5 \\ a_6 \\ a_7 \end{bmatrix} \right\} \quad a_i \in G = \{C(\langle Z_{15} \cup I \rangle); *, (5I, 10 +$$

5I), 1 ≤ i ≤ 7} be the subset super matrix groupoid.

Study questions (i) to (iii) of problem 23 for this S.

28. Let S = {Collection of all subsets from the super matrix groupoid M = {(a₁ | a₂ a₃ a₄ a₅ | a₆ a₇ a₈ | a₉ a₁₀ | a₁₁) | a_i ∈ G = {C(⟨Z₄ ∪ I⟩); *, (3 + 4i_F + 10I, 15I_F + 14i_F + 1)) 1 ≤ i ≤ 11} be the subset super matrix finite complex neutrosophic modulo integer groupoid.

Study questions (i) to (iii) of problem 23 for this S.

29. Let $S = \{\text{Collection of all subsets from the super matrix groupoid}\}$

$$M = \left\{ \left[\begin{array}{c|ccc|ccc|cc} a_1 & a_2 & a_3 & a_4 & a_5 & a_6 & a_7 & a_8 & a_9 \\ a_{10} & \dots & \dots & \dots & \dots & \dots & \dots & \dots & a_{18} \\ a_{19} & \dots & \dots & \dots & \dots & \dots & \dots & \dots & a_{27} \\ \hline a_{28} & \dots & \dots & \dots & \dots & \dots & \dots & \dots & a_{36} \\ \hline a_{37} & \dots & \dots & \dots & \dots & \dots & \dots & \dots & a_{45} \\ a_{46} & \dots & \dots & \dots & \dots & \dots & \dots & \dots & a_{54} \end{array} \right] \mid a_i \in G \right\}$$

$= \{C(\langle Z_5 \cup I \rangle D_{2,11}, *, (3Ia + 2 + 5I + 3i_F + 2i_F I ab^3, 0); 1 \leq i \leq 54)\}$ be the finite complex neutrosophic modulo integer super matrix subset groupoid.

Study questions (i) to (iii) of problem 23 for this S .

30. Let $S = \{\text{Collection of all subsets from the super matrix groupoid}\}$

$$\text{groupoid } M = \left\{ \left[\begin{array}{c|ccc|c} a_1 & a_2 & a_3 & a_4 & a_5 \\ a_6 & \dots & \dots & \dots & a_{10} \\ a_{11} & \dots & \dots & \dots & a_{15} \\ \hline a_{16} & \dots & \dots & \dots & a_{20} \\ a_{21} & \dots & \dots & \dots & a_{25} \end{array} \right] \mid a_i \in G = \right\}$$

$\{C(\langle Z_{12} \cup I \rangle), *, (5I + 3 + 4i_F + 6i_F I, 6); 1 \leq i \leq 25)\}$ be the subset super matrix groupoid.

Study questions (i) to (iii) of problem 23 for this S .

31. Let $S = \{\text{Collection of all subsets from the polynomial groupoid}\}$
 $M = \left\{ \sum_{i=0}^{\infty} a_i x^i \mid a_i \in G = C(Z_{10} \cup I), *, (3 + 2i_F + 4, 6i_F I + 7I + 2i_F)\} \right\}$ be the subset matrix groupoid.

Study questions (i) to (iii) of problem 23 for this S.

32. Study S in problem 31 if G is replaced by $G' = \{Z_{10}, *, (5, 4)\}$ and compare both.
33. Let $S = \{\text{Collection of all subsets from the loop } L_{21}(11)\}$ be the subset loop groupoid.
- (i) Find $o(S)$.
 - (ii) Find the subset topological groupoid spaces T_{\cup}^* and T_{\cap}^* .
 - (iii) Prove both T_{\cup}^* and T_{\cap}^* are non commutative and non associative.
 - (iv) Does T_{\cup}^* and T_{\cap}^* satisfy any of the S-special identities?
34. Let $S = \{\text{Collection of all subsets from the loop } L_{29}(15)\}$ be the subset loop groupoid.

Study questions (i) to (iv) of problem 33 for this S.

35. Let $S = \{\text{Collection of all subsets from the loop } L_{15}(8)\}$ be the subset loop groupoid.

Study questions (i) to (iv) of problem 33 for this S.

36. Let $S = \{\text{Collection of all subsets from the loop } L_{19}(7)\}$ be the subset loop groupoid.

Study questions (i) to (iv) of problem 33 for this S.

37. Can there be a finite subset loop groupoid which is a Smarandache Bol subset groupoid?
38. Can there be a finite subset loop groupoid S such that the subset groupoid topological spaces T_{\cup}^* and T_{\cap}^* are S-Bruck subset topological spaces?

39. Study the problem 37 in case of infinite subset groupoid.
40. Let $S = \{\text{Collection of all subsets from the loop } L_{27}(8)\}$ be the subset loop groupoid.

Study questions (i) to (iv) of problem 33 for this S .

41. Let $S = \{\text{Collection of all subsets from the loop } L_{123}(8)\}$ be the subset loop groupoid.

Study questions (i) to (iv) of problem 33 for this S .

42. Let $S = \{\text{Collection of all subsets from the loop } L_5(2) \times L_{23}(9)\}$ be the subset loop groupoid.

Study questions (i) to (iv) of problem 33 for this S .

43. Does there exists a finite / infinite subset loop groupoid which is S -Moufang?

44. Give an example of a S -finite Moufang subset loop groupoid.

45. Let $C(S) = \{\text{Collection of all subsets of the loops } L_n(m) \in L_n\}$ be the collection of all subsets loop groupoid.

- (i) How many of them have S -subset WIP topological spaces associated with them?
- (ii) How many of them have S -subset commutative topological spaces associated with them?
- (iii) How many of them have S -subset strictly commutative topological spaces associated with them?
- (iv) How many of them have S -subset right alternative topological spaces associated with them?
- (v) How many of them have S -subset left alternative topological spaces associated with them?

46. Let $C(S) = \{\text{Collection of all subsets from the loops } L_{219}\}$
 $= \{\text{Collection of all subset loop groupoids of the loops } L_{219}(m) \in L_{219}\}$.

Study questions (i) to (v) of problem 45 for this $C(S)$.

47. Let $C(S) = \{\text{Collection of all subset loop groupoids from the loop in } L_{43}\}$.

Study questions (i) to (v) of problem 45 for this $C(S)$.

48. Let $C(S) = \{\text{Collection of all subset loop groupoids from the class of loops } L_{279}\}$;

- (i) Study questions (i) to (v) of problem 45 for this S .
- (ii) Prove $C(S)$ has non S -subset topological spaces which are strictly non commutative.

49. Let $S = \{\text{Collection of all subset loop groupoids from the class of loops in } L_{73}\}$

- (i) Study questions (i) to (v) of problem 45 for this $C(S)$.
- (ii) Show only one $S \in C(S)$ is such that the subset loop groupoid topological spaces T_{\cup}^* and T_{\cap}^* are S -strictly non commutative.

50. Let $C(S) = \{\text{Collection of all subset loop groupoids from the class of loop } L_{451}\}$.

Study questions (i) to (v) of problem 45 for this $C(S)$.

51. Let $S = \{\text{Collection of all subsets from the loop } L_{151}(7)\}$ be the subset loop groupoid.

Study questions (i) to (iv) of problem 33 for this S .

52. Let $S = \{\text{Collection of all subsets from the loop } L_{43}(8)\}$ be the subset loop groupoid.

Study questions (i) to (iv) of problem 33 for this S .

53. Let $S = \{\text{Collection of all subsets from the loop } L_{125}(9)\}$ be the subset loop groupoid.

Study questions (i) to (iv) of problem 33 for this S .

54. Let $S = \{\text{Collection of all subsets from the matrix$

$$\text{groupoid } M = \left\{ \left[\begin{array}{c} a_1 \\ a_2 \\ a_3 \\ \vdots \\ a_{18} \end{array} \right] \mid a_i \in L_{15}(8), 1 \leq i \leq 18 \right\} \text{ be the}$$

subset groupoid.

Study questions (i) to (iv) of problem 33 for this S .

55. Let $S = \{\text{Collection of all subsets form the matrix$

$$\text{groupoid } M = \left\{ \left[\begin{array}{cccc} a_1 & a_2 & \dots & a_{10} \\ a_{11} & a_{12} & \dots & a_{20} \\ a_{21} & a_{22} & \dots & a_{30} \\ a_{31} & a_{32} & \dots & a_{40} \\ a_{41} & a_{42} & \dots & a_{50} \end{array} \right] \mid a_i \in L_{43}(9), \right.$$

$1 \leq i \leq 50\} \}$ be the subset loop groupoid.

Study questions (i) to (iv) of problem 33 for this S .

56. Let $S = \{\text{Collection of all subsets from the matrix$

$$\text{groupoid } M = \left\{ \begin{bmatrix} a_1 & a_2 & a_3 & a_4 \\ a_5 & a_6 & a_7 & a_8 \\ a_9 & a_{10} & a_{11} & a_{12} \\ a_{13} & a_{14} & a_{15} & a_{16} \end{bmatrix} \mid a_i \in L_{219}(38), \right.$$

$1 \leq i \leq 16\} \}$ be the subset groupoid.

Study questions (i) to (iv) of problem 33 for this S.

57. Let $S = \{\text{Collection of all subsets from the polynomial groupoid } M = \left\{ \sum_{i=0}^{\infty} a_i x^i \mid a_i \in L_{49}(9) \right\} \}$ be the subset groupoid.

Study questions (i) to (iv) of problem 33 for this S.

58. Let $S = \{\text{Collection of all subsets from the polynomial groupoid } M = \left\{ \sum_{i=0}^{\infty} a_i x^i \mid a_i \in L_{47}(9) \right\} \}$ be the subset groupoid.

Study questions (i) to (iv) of problem 33 for this S.

59. Let $S = \{\text{Collection of all subsets from the polynomial groupoid } M = \left\{ \sum_{i=0}^{\infty} a_i x^i \mid a_i \in L_7(3) \times L_{13}(7) \right\} \}$ be the subset groupoid.

Study questions (i) to (iv) of problem 33 for this S.

60. Let $S = \{\text{Collection of all subsets from the polynomial groupoid } G = \{[a, b] \mid a, b \in L_{254}(7)\} \}$ be the subset interval groupoid.

Study questions (i) to (iv) of problem 33 for this S.

61. Let $S = \{\text{Collection of all subsets from the interval}$

$$\text{groupoid } G = \left\{ \begin{bmatrix} [a_1 b_1] \\ [a_2 b_2] \\ \vdots \\ [a_9 b_9] \end{bmatrix} \middle| a_i, b_i \in L_{89}(9); 1 \leq i \leq 9 \right\} \text{ be}$$

the subset groupoid.

Study questions (i) to (iv) of problem 33 for this S .

62. Let $S = \{\text{Collection of all subsets from the interval}$
 groupoid $G = \{(a_1, b_1), (a_2, b_2), \dots, (a_{10}, b_{10}) \mid a_i, b_i \in L_{29}(8); 1 \leq i \leq 10\}$ be the subset groupoid.

Study questions (i) to (iv) of problem 33 for this S

63. Let $S = \{\text{Collection of all subsets from the interval}$
 groupoid

$$G = \left\{ \begin{bmatrix} [a_1 b_1] & [a_2 b_2] & [a_3 b_3] & \dots & [a_{10} b_{10}] \\ [a_{11} b_{11}] & [a_{12} b_{12}] & [a_{13} b_{13}] & \dots & [a_{20} b_{20}] \\ [a_{21} b_{21}] & [a_{22} b_{22}] & [a_{23} b_{23}] & \dots & [a_{30} b_{30}] \end{bmatrix} \middle| a_i, b_i \in$$

$L_{143}(8); 1 \leq i \leq 30\}$ be the subset groupoid.

Study questions (i) to (iv) of problem 33 for this S .

64. Let $S = \{\text{Collection of all subsets from the interval}$

$$\text{groupoid } G = \left\{ \begin{bmatrix} [a_1 b_1] & \dots & [a_6 b_6] \\ [a_7 b_7] & \dots & [a_{12} b_{12}] \\ [a_{13} b_{13}] & \dots & [a_{18} b_{18}] \\ [a_{19} b_{19}] & \dots & [a_{24} b_{24}] \\ [a_{25} b_{25}] & \dots & [a_{30} b_{30}] \\ [a_{31} b_{31}] & \dots & [a_{36} b_{36}] \end{bmatrix} \middle| a_i, b_i \in L_{29}(19);$$

$1 \leq i \leq 36\}$ be the subset groupoid.

Study questions (i) to (iv) of problem 33 for this S.

65. Let $S = \{\text{Collection of all subsets from the interval}$

$$\text{groupoid } G = \left\{ \left[\begin{array}{c} [a_1 b_1] \\ [a_2 b_2] \\ \vdots \\ [a_{19} b_{19}] \end{array} \right] \mid a_i, b_i \in G = \{\mathbb{Z}_9 S_3, *, (7g_1 + g_2 \right.$$

$$+ 3g_3, 4g_2 + 5g_4); 1 \leq i \leq 19\}; g_1 = \begin{pmatrix} 1 & 2 & 3 \\ 1 & 3 & 2 \end{pmatrix},$$

$$g_2 = \begin{pmatrix} 1 & 2 & 3 \\ 3 & 2 & 1 \end{pmatrix}, g_3 = \begin{pmatrix} 1 & 2 & 3 \\ 2 & 1 & 3 \end{pmatrix} \text{ and } g_4 = \begin{pmatrix} 1 & 2 & 3 \\ 2 & 3 & 1 \end{pmatrix} \} \}$$

be the subset groupoid.

Study questions (i) to (iv) of problem 33 for this S.

66. Let $S = \{\text{Collection of all subsets from the interval matrix groupoid } M = \{([a_1, b_1], [a_2, b_2], \dots, [a_{19}, b_{19}]) \mid a_i, b_i \in G = \{C(\langle \mathbb{Z}_{11} \cup I \rangle) D_{2,7}, *, (3a + 5i_F b + 7Iab^3 + 8Ii_F, 10i_F + 3Ii_F ab^5 + 3b^3); 1 \leq i \leq 19\}\}$ be the subset groupoid.

Study questions (i) to (iv) of problem 33 for this S.

67. Let $S = \{\text{Collection of all subsets from the matrix}$

$$\text{groupoid } M = \left\{ \left[\begin{array}{ccc} [a_1 b_1] & \dots & [a_{12} b_{12}] \\ [a_{13} b_{13}] & \dots & [a_{24} b_{24}] \\ [a_{25} b_{25}] & \dots & [a_{36} b_{36}] \end{array} \right] \mid a_i, b_i \in C = \right.$$

$\{C(Z_{15}); *, (i_F, 8 + 7i_F) \mid 1 \leq i \leq 36\}$ be the subset groupoid.

Study questions (i) to (iv) of problem 33 for this S.

- 68. Obtain some special features enjoyed by subset groupoids of infinite order.
- 69. Will the trees in general of T_{\cup}^* and T_{\cap}^* be different?
- 70. Let $S = \{\text{Collection of all subsets from the groupoid}$

$$\text{interval matrix } M = \left\{ \begin{array}{cccc} [a_1 b_1] & [a_2 b_2] & \dots & [a_7 b_7] \\ [a_8 b_8] & [a_9 b_9] & \dots & [a_{14} b_{14}] \\ \vdots & \vdots & & \vdots \\ [a_{43} b_{43}] & [a_{44} b_{44}] & \dots & [a_{49} b_{49}] \end{array} \right\}$$

$a_i, b_i \in G = \{C(Z_{18} \cup I) D_{2,11}, *, (10I, 2i_F) \mid 1 \leq i \leq 49\}$ be the subset groupoid.

- (i) Study questions (i) to (iv) of problem 33 for this S.
- (ii) Can S have subset zero divisors?

- 71. Let $S = \{\text{Collection of all subsets from the super interval matrix groupoid } G =$

$$\left\{ \begin{array}{c|cc|cc|c} [a_1 b_1] & [a_2 b_2] & [a_3 b_3] & [a_4 b_4] & [a_5 b_5] & [a_6 b_6] & [a_7 b_7] \\ [a_8 b_8] & & & \dots & \dots & \dots & [a_{14} b_{14}] \\ [a_{15} b_{15}] & & & \dots & \dots & \dots & [a_{21} b_{21}] \\ [a_{22} b_{22}] & & & \dots & \dots & \dots & [a_{28} b_{28}] \end{array} \right\}$$

$a_i \in \{C(Z_{19} \cup I) (S(5) \times D_{2,19}) \mid 1 \leq i \leq 28\}$ be the subset interval matrix groupoid.

Study questions (i) to (iv) of problem 33 for this S.

72. Let $S = \{\text{Collection of all subsets from the interval}$

$$\text{groupoid } G = \left\{ \left[\begin{array}{c} [a_1 b_1] \\ [a_2 b_2] \\ \vdots \\ [a_{15} b_{15}] \end{array} \right] \mid a_i, b_i \in L_{23}(7); 1 \leq i \leq 15 \right\} \text{ be}$$

the subset interval matrix groupoid.

Study questions (i) to (iv) of problem 33 for this S .

73. Let $S = \{\text{Collection of all subsets from the interval matrix}$

$$\text{groupoid } M = \left\{ \left[\begin{array}{cccc} [a_1 b_1] & [a_2 b_2] & \dots & [a_{10} b_{10}] \\ [a_{11} b_{11}] & [a_{12} b_{12}] & \dots & [a_{20} b_{20}] \\ [a_{21} b_{21}] & [a_{22} b_{22}] & \dots & [a_{30} b_{30}] \end{array} \right] \mid a_i, b_i \in$$

$L_{298}(18); 1 \leq i \leq 30 \}$ be the subset groupoid.

Study questions (i) to (iv) of problem 33 for this S .

74. Let $S = \{\text{Collection of all subsets from the groupoid } G = \{Z_{45}, *, (3, 10)\}\}$ be the subset groupoid.

- (i) Find all subspaces of the subset groupoid topological spaces T_o , T_{\cup}^* and T_{\cap}^* .
- (ii) Can one say both T_{\cup}^* and T_{\cap}^* have the same number of topological subspaces?
- (iii) Find the trees of T_o , T_{\cup}^* and T_{\cap}^* .
- (iv) Find all subsets subgroupoid of S .
- (v) Is the number of subset subgroupoids of S be the same as the number of subgroupoids of the groupoid G ?

- (vi) Can one say the number of topological subspaces of T_{\cup}^* and T_{\cap}^* is the same as that of the number of subset groupoids of S.
- (vii) Find the total numbers in (iv), (v) and (vi).

75. Let $S = \{\text{Collection of all subsets from the groupoid } G = \{(C(Z_{10}), *, (i_F, 9))\}\}$ be the subset groupoid .

Study questions (i) to (vii) of problem 74 for this S.

76. Let $S = \{\text{Collection of all subsets from the groupoid } G = \{(Z_{19} \cup I), *, (9I, I+10)\}\}$ be the subset groupoid.

Study questions (i) to (vii) of problem 74 for this S.

77. Let $S = \{\text{Collection of all subsets from the groupoid } G = \{(Z_7 \times Z_{12}, * = (*_1, *_2); ((3, 4), (6,0))\}\}$ be the subset groupoid.

Study questions (i) to (vii) of problem 74 for this S.

78. Let $S = \{\text{Collection of all subsets from the groupoid } G = \{(Z_{16} \cup I)S_4, *, (8I, 4 + 7i_F + 2I)\}\}$ be the subset groupoid.

Study questions (i) to (vii) of problem 74 for this S.

79. Let $S = \{\text{Collection of all subsets from the groupoid } G = \{(Z_7 \cup I), (S_5 \times D_{2,8}), *, (4I, 2+3I)\}\}$ be the subset groupoid .

Study questions (i) to (vii) of problem 74 for this S.

80. Let $S = \{\text{Collection of all subsets from the matrix}$

$$\text{groupoid } M = \left\{ \left[\begin{array}{c} a_1 \\ a_2 \\ a_3 \\ \vdots \\ a_9 \end{array} \right] \mid a_i \in C(\langle \mathbb{Z}_{17} \cup I \rangle S(3)), 1 \leq i \leq 9 \right\}$$

be the subset groupoid.

Study questions (i) to (vii) of problem 74 for this S .

81. Let $S = \{\text{Collection of all subsets from the matrix groupoid } M = \{(a_1, a_2, \dots, a_{16}) \mid a_i \in G = \{\mathbb{Z}_{43} (D_{2,7}), *, (7ab^4 + 8, 4a + 4b^3)\}, 1 \leq i \leq 16\}\}$ be the subset groupoid.

Study questions (i) to (vii) of problem 74 for this S .

82. Let $S = \{\text{Collection of all subsets from the matrix groupoid}$

$$M = \left\{ \left[\begin{array}{cccc} a_1 & a_2 & a_3 & a_4 \\ a_5 & a_6 & a_7 & a_8 \\ \vdots & \vdots & \vdots & \vdots \\ a_{37} & a_{38} & a_{39} & a_{40} \end{array} \right] \mid a_i \in G = \{C(\mathbb{Z}_{15}) D_{2,11}, *, (3i_F + 4 + 8b + 7ab^5, 9ab^7 + i_F a)\}, 1 \leq i \leq 40\}$$

be the subset groupoid.

Study questions (i) to (vii) of problem 74 for this S .

83. Let $S = \{\text{Collection of all subsets from the super matrix groupoid}$

$$M = \left\{ \left[\begin{array}{c} \overline{a_1} \\ \overline{a_2} \\ \overline{a_3} \\ \overline{a_4} \\ a_5 \\ \overline{a_6} \\ \overline{a_7} \\ \overline{a_8} \\ \overline{a_9} \end{array} \right] \mid a_i \in G = \{C(\langle Z_{19} \cup I \rangle), *, (30I + 40i_F + 70Ii_F, \right.$$

$0)\}, 1 \leq i \leq 9\}$ be the subset groupoid.

Study questions (i) to (vii) of problem 74 for this S.

84. Let $S = \{\text{Collection of all subsets from the loop } L_7(4)\}$ be the subset groupoid.

Study questions (i) to (vii) of problem 74 for this S.

85. Let $S = \{\text{Collection of all subsets from the loop } L_{45}(8)\}$ be the subset groupoid.

- (i) Study questions (i) to (vii) of problem 74 for this S.
- (ii) Find all subloops of $L_{45}(8)$.
- (iii) Show T_{\cup}^* and T_{\cap}^* has atleast 45 subset loop groupoid topological subspaces which are associative.

86. Let $S = \{\text{Collection of all subsets from the loop } L_{129}(11)\}$ be the subset groupoid.

Study questions (i) to (iii) of problem 85 for this S.

87. Let $S = \{\text{Collection of all subsets from the loop } L_{27}(8) \times L_{19}(7)\}$ be the subset loop groupoid.

Study questions (i) to (iii) of problem 85 for this S.

88. Let $S = \{\text{Collection of all subsets from the matrix}$

$$\text{groupoid } M = \left\{ \left[\begin{array}{c} a_1 \\ a_2 \\ a_3 \\ a_4 \\ a_5 \\ a_6 \\ a_7 \\ a_8 \end{array} \right] \mid a_i \in L_{43}(7), 1 \leq i \leq 8 \right\} \text{ be the}$$

subset groupoid.

- (i) Study questions (i) to (vii) of problem 74 for this S.
- (ii) How many subset groupoid topological subspaces in T_{\cup}^* and T_{\cap}^* are associative?
- (iii) Is the number in (ii) greater than 44 (order of the loop over which M is built)?

89. Let $S = \{\text{Collection of all subsets from the matrix groupoid } M = \{(a_1, a_2, \dots, a_9) \mid a_i \in L_{49}(9); 1 \leq i \leq 9\}\}$ be the subset groupoid.

Study questions (i) to (iii) of problem 88 for this S.

90. Let $S = \{\text{Collection of all subsets from the matrix}$

$$\text{groupoid } M = \left\{ \left[\begin{array}{ccc} a_1 & a_2 & a_3 \\ a_4 & a_5 & a_6 \\ \vdots & \vdots & \vdots \\ a_{28} & a_{29} & a_{30} \end{array} \right] \mid a_i \in L_{123}(11), 1 \leq i \leq \right.$$

$30\}$ be the subset groupoid.

Study questions (i) to (iii) of problem 88 for this S.

91. Let $S = \{\text{Collection of all subsets from the matrix}$

$$\text{groupoid } M = \left\{ \left[\begin{array}{c|cc|c} a_1 & a_2 & a_3 & a_4 \\ \hline a_5 & a_6 & a_7 & a_8 \\ \hline a_9 & a_{10} & a_{11} & a_{12} \\ \hline a_{13} & a_{14} & a_{15} & a_{16} \\ \hline a_{17} & a_{18} & a_{19} & a_{20} \end{array} \right] \mid a_i \in L_{31}(7) \times$$

$L_{13}(7), 1 \leq i \leq 20\} \}$ be the subset groupoid.

Study questions (i) to (iii) of problem 88 for this S.

92. Let $S = \{\text{Collection of all subsets from the matrix groupoid } M = \{([a_1, b_1], [a_2, b_2], \dots, [a_{10}, b_{10}]) \mid a_i, b_i \in L_{27}(11), 1 \leq i \leq 10\} \}$ be the subset groupoid.

Study questions (i) to (iii) of problem 88 for this S.

93. Let $S = \{\text{Collection of all subsets from the matrix}$

$$\text{groupoid } M = \left\{ \left[\begin{array}{cc} [a_1 b_1] & [a_2 b_2] \\ [a_3 b_3] & [a_4 b_4] \\ \vdots & \vdots \\ [a_{11} b_{11}] & [a_{12} b_{12}] \end{array} \right] \mid a_i, b_i \in L_{147}(9), 1 \leq i$$

$\leq 12\} \}$ be the subset groupoid.

Study questions (i) to (iii) of problem 88 for this S.

94. Let $S = \{\text{Collection of all subsets from the matrix groupoid}$

$$M = \left\{ \left[\begin{array}{ccc} [a_1, b_1] & \dots & [a_6, b_6] \\ [a_3, b_3] & \dots & [a_{12}, b_{12}] \\ \vdots & & \vdots \\ [a_{11}, b_{11}] & \dots & [a_{36}, b_{36}] \end{array} \right] \mid a_i, b_i \in L_{147}(9), \right.$$

$1 \leq i \leq 36 \}$ be the subset groupoid.

Study questions (i) to (iii) of problem 88 for this S.

95. Let $S = \{\text{Collection of all subsets from the groupoid polynomial } P = \left\{ \sum_{i=0}^{\infty} a_i x^i \mid a_i \in G = \{Z_{42}, *, (6,7)\} \}\}$ be the subset groupoid.

Study questions (i) to (iii) of problem 88 for this S.

96. Let $S = \{\text{Collection of all subsets from the groupoid polynomial } P = \left\{ \sum_{i=0}^{\infty} a_i x^i \mid a_i \in L_{29}(8)\} \}\}$ be the subset groupoid.

Study questions (i) to (iii) of problem 88 for this S.

97. Let $S = \{\text{Collection of all subsets from the groupoid polynomial } P = \left\{ \sum_{i=0}^{\infty} a_i x^i \mid a_i \in L_{31}(7) \times L_7(3)\} \}\}$ be the subset groupoid.

Study questions (i) to (iii) of problem 88 for this S.

98. Let $S = \{\text{Collection of all subsets from the groupoid polynomial } P = \left\{ \sum_{i=0}^{\infty} a_i x^i \mid a_i \in G = \{\langle Z_{14} \cup I \rangle S_5, *, (10, D)\} \}\}$ be the subset groupoid.

Study questions (i) to (iii) of problem 88 for this S.

99. Let $S = \{ \text{Collection of all subsets from the groupoid polynomial } P = \left\{ \sum_{i=0}^{\infty} a_i x^i \mid a_i \in L_{15}(8) \right\} \}$ be the subset groupoid.

Study questions (i) to (iii) of problem 88 for this S.

100. Let $S = \{ \text{Collection of all subsets from the groupoid polynomial } P = \left\{ \sum_{i=0}^{\infty} a_i x^i \mid a_i \in L_{19}(7) \right\} \}$ be the subset groupoid.

Study questions (i) to (iii) of problem 88 for this S.

101. Let $S = \{ \text{Collection of all subsets from the loop } L_{43}(7) \}$ be the subset loop groupoid.

- (i) How many subset loop groupoids of $L_{43}(m)$ exist?
- (ii) Are these subset loop groupoids isomorphic?
- (iii) Show T_{\cup}^* and T_{\cap}^* are different for each loop in L_{43} .
- (iv) Show T_{\circ} for all of these loop groupoids is the same.

102. Study problem (101) for any loop $L_n(m)$.

103. Let $S = \{ \text{Collection of all subsets from the interval polynomial groupoid } M = \left\{ \sum_{i=0}^{\infty} [a_i, b_i] x^i \mid a_i, b_i \in L_{55}(13) \right\} \}$ be the subset groupoid.

Study questions (i) to (iii) of problem 88 for this S.

104. Let $S = \{\text{Collection of all subsets from the interval polynomial groupoid } M = \left\{ \sum_{i=0}^{\infty} [a_i, b_i]x^i \mid a_i, b_i \in G = \{\langle \mathbb{Z}_{45} \cup I \rangle, *, (10I, 0)\} \right\}$ be the subset groupoid.

Study questions (i) to (iii) of problem 88 for this S.

105. Let $S = \{\text{Collection of all subsets from the interval polynomial groupoid } G = \{\langle \mathbb{Z} \cup I \rangle, *, (6 + 4I, 6 - 4I)\} \}$ be the subset groupoid.

Study questions (i) to (iii) of problem 88 for this S.

Study S if $\langle \mathbb{Z} \cup I \rangle$ is replaced by $\langle \mathbb{C} \cup I \rangle$.

106. Let $S = \{\text{Collection of all subsets from the groupoid } G = \{(a_1, \dots, a_7) \mid a_i \in \langle \mathbb{Q} \cup I \rangle, 1 \leq i \leq 7\} \}$ be the subset groupoid.

Study questions (i) to (iii) of problem 88 for this S.

107. Let $S = \{\text{Collection of all subsets from the groupoid}$

$$M = \left\{ \left[\begin{array}{c} a_1 \\ a_2 \\ a_3 \\ \vdots \\ a_9 \end{array} \right] \mid a_i \in \langle \mathbb{Q}^+ \cup I \cup \{0\} \rangle S_{10}, 1 \leq i \leq 9 \right\} \text{ be the}$$

subset groupoid.

Study questions (i) to (iii) of problem 88 for this S.

108. Let $S = \{\text{Collection of all subsets from the groupoid } M = \{\langle \mathbb{Q} \cup I \rangle \times \mathbb{R}, * = (*_1, *_2), ((10, I), (\sqrt{43}, 0))\} \}$ be the subset groupoid.

Study questions (i) to (iii) of problem 88 for this S.

109. Let $S = \{\text{Collection of all subsets from the groupoid}$

$$M = \left\{ \sum_{i=0}^{\infty} a_i x^i \mid a_i \in G = \{\langle C \cup I \rangle *, 4 - 7i, 8 + I - 4i + \right.$$

$9iI)\} be the subset groupoid.$

Study questions (i) to (iii) of problem 88 for this S.

110. Let $S = \{\text{Collection of all subsets from the interval groupoid}$

$$M = \left\{ \begin{bmatrix} [a_1 b_1] & [a_2 b_2] & [a_3 b_3] \\ [a_4 b_4] & [a_5 b_5] & [a_6 b_6] \\ \vdots & \vdots & \vdots \\ [a_{28} b_{28}] & [a_{29} b_{29}] & [a_{30} b_{30}] \end{bmatrix} \mid a_i b_i \in G = \{\langle \mathbb{R}^+ \cup I \rangle$$

$*, (\sqrt{3}I, \sqrt{3}I)\} be the subset groupoid.$

Study questions (i) to (iii) of problem 88 for this S.

111. Let $S = \{\text{Collection of all subsets from the interval groupoid } G = \{\mathbb{Z}_{48}, *, (12, 0)\}\}$ be the subset groupoid.

- (i) Find all subgroupoids of $H_i G$.
- (ii) How many subset set ideal groupoid topological spaces of S over H_i exist?

112. Let $S = \{\text{Collection of all subsets from the interval groupoid } M = \{(a_1, a_2, \dots, a_{12}) \mid a_i \in G = \{\langle \mathbb{Z}_9 \cup I \rangle *, *, (3I, 3)\}, 1 \leq i \leq 12\}\}$ be the subset groupoid of M .

- (i) How many subgroupoid H_i of M are there?
- (ii) Find all the related subset set ideal groupoid topological spaces of S over $H_i \subseteq M$.

113. Characterize those quasi simple subset set ideal subset groupoids.

114. Let $S = \{\text{Collection of all subsets from the groupoid}$

$$M = \left\{ \left[\begin{array}{c} a_1 \\ a_2 \\ a_3 \\ a_4 \\ a_5 \end{array} \right] \mid a_i \in L_{425}(4); 1 \leq i \leq 5 \right\} \text{ be the subset}$$

groupoid.

Study questions (i) to (ii) of problem 112 for this S.

115. Let $S = \{\text{Collection of all subsets from the groupoid } P = \{[a_1, a_2, \dots, a_{14}] \mid a_i \in L_5(3) \times L_{29}(7); 1 \leq i \leq 14\}\}$ be the subset groupoid.

Study questions (i) to (ii) of problem 112 for this S.

116. Let $S = \{\text{Collection of all subsets from the groupoid } G = \{C(\mathbb{Z}_{15}), *, (10, i_F)\}\}$ be the subset groupoid.

Study questions (i) to (ii) of problem 112 for this S.

117. Let $S = \{\text{Collection of all subsets from the groupoid } M = \{L_7(3) \times L_{17}(4) \times G\}$ where $G = \{\mathbb{Z}_{17}, *, (10, 7)\}\}$ be the subset groupoid.

Study questions (i) to (ii) of problem 112 for this S.

118. Let $S = \{\text{Collection of all subsets from the polynomial groupoid } P = \{\sum a_i x^i \mid a_i \in M \text{ in problem 117}\}\}$ be the subset groupoid.

Study questions (i) to (ii) of problem 112 for this S.

119. Let $S = \{\text{Collection of all subsets from the groupoid } M = \left\{ \sum_{i=0}^{\infty} [a_i, b_i] x^i \mid a_i, b_i \in L_{13}(7) \times G \text{ where } G = \{C(Z_{13}), *, (12i_F, 0)\} \right\}\}$ be the subset groupoid.

Study questions (i) to (ii) of problem 112 for this S.

120. Let $S = \{\text{Collection of all subsets from the groupoid } M = \{L_{17}(4) \times L_{17}(3) \times L_{17}(5) \times L_{17}(2)\}\}$ be the subset groupoid.

Study questions (i) to (ii) of problem 112 for this S.

121. Let $S = \{\text{Collection of all subsets from the groupoid}$

$$M = \left\{ \left[\begin{array}{c} a_1 \\ a_2 \\ a_3 \\ \vdots \\ a_{18} \end{array} \right] \mid a_i \in L_7(3) \times L_5(2) \times L_{25}(4), 1 \leq i \leq 18 \right\} \text{ be}$$

the subset groupoid.

Study questions (i) to (ii) of problem 112 for this S.

122. Let $S = \{\text{Collection of all subsets from the groupoid}$

$$M = \left\{ \left[\begin{array}{cccc} [a_1 b_1] & [a_2 b_2] & [a_3 b_3] & [a_4 b_4] \\ [a_5 b_5] & [a_6 b_6] & [a_7 b_7] & [a_8 b_8] \\ \vdots & \vdots & \vdots & \vdots \\ [a_{37} b_{37}] & [a_{38} b_{38}] & [a_{39} b_{39}] & [a_{40} b_{40}] \end{array} \right] \mid a_i \in L_9(5)$$

$\times L_{19}(7) \times L_{63}(11), 1 \leq i \leq 40 \}$ be the subset groupoid.

Study questions (i) to (ii) of problem 112 for this S.

123. Let $S = \{\text{Collection of all subsets from the groupoid } G_1 \times G_2 \times G_3 \times G_4 \text{ where } G_1 = \{Z_5, *, (3, 2)\}, G_2 = \{C(Z_7), *, (6i_F, 0)\}, G_3 = \{C(Z_{12} \cup I), *, (10I, 8)\} \text{ and } G_4 = \{C(Z_{17} \cup I), *, (12I, 10i_F + 3)\}\}$ be the subset groupoid.

Study questions (i) to (ii) of problem 112 for this S.

124. Give an example of a subset groupoid which has infinite number of subset set ideal groupoid topological spaces over subgroupoids.
125. Give an example of a subset groupoid which has no subset set ideal groupoid topological spaces.
126. Let $S = \{\text{Collection of all subsets from the groupoid}$

$$M = \left\{ \left[\begin{array}{cccc} a_1 & a_2 & \dots & a_{10} \\ a_{11} & a_{12} & \dots & a_{20} \\ \vdots & \vdots & & \vdots \\ a_{91} & a_{92} & \dots & a_{100} \end{array} \right] \right\} \quad a_i \in L_{13}(7) \times L_{19}(8) \times L_{23}(7),$$

$1 \leq i \leq 100\}$ be the subset groupoid. Study questions (i) to (ii) of problem 112 for this S.

Chapter Three

NON ASSOCIATIVE SUBSET TOPOLOGICAL SPACES ASSOCIATED WITH NON ASSOCIATIVE RINGS AND SEMIRINGS

In this chapter we for the first time introduce the new notion of non associative subset topological spaces of non associative (NA) semirings and rings. Here we study their basic properties and develop some results depending on the structure of the ring or semiring.

Let $S = \{\text{Collection of all subsets from the non associative semiring or a ring}\}$ be the subset non associative ring.

$T_o = \{S' = S \cup \{\phi\}, \cup, \cap\}$ will be the usual (or ordinary) subset non associative (NA) semiring topological space. $T_{\cup}^{\times} = \{S', \cup, \times\}$ is the special subset NA semiring topological space.

T_{\cup}^{+} is the special subset NA semiring topological spaces where $T_{\cup}^{+} = \{S, \cup, +\}$. $T_{\cap}^{\times} = \{S', \cap, \times\}$ and $T_{\cap}^{+} = \{S', \cap, +\}$ are special subset non associative (NA) semiring topological spaces.

Finally $T_s = \{S, \times, +\}$ is the special strong NA semiring topological space.

Only the NA subset semiring topological spaces T_s, T_{\cup}^{\times} and T_{\cap}^{\times} are non associative and T_o, T_{\cap}^+ and T_{\cup}^+ are associative. Thus with every S we have in general six different topological spaces, which we call in general as NA semiring topological space as they are basically built using non associative rings or semirings.

We will illustrate this by some examples.

Example 3.1: Let $S = \{\text{Collection of all subsets from the groupoid semiring } (Z^+ \cup \{0\})G \text{ where } G = \{Z_{15}, *, (2, 0)\}\}$ be the subset non associative semiring (NA semiring).

$T_o, T_s, T_{\cup}^+, T_{\cap}^+, T_{\cup}^{\times}$ and T_{\cap}^{\times} be the subset NA semiring topological spaces.

$$\text{Let } \{g_o, g_1, \dots, g_{14}\} = \{0, 1, \dots, 14\} = Z_{15}$$

$$\text{Let } A = \{5g_3, 2g_4, 10g_7, g_9\} \text{ and } B = \{g_{12}\} \in T_o$$

$$\begin{aligned} A \cup B &= \{5g_3, 2g_4, 10g_7, g_9\} \cup \{g_{12}\} \\ &= \{5g_3, 2g_4, 10g_7, g_9, g_{12}\} \text{ and} \end{aligned}$$

$$\begin{aligned} A \cap B &= \{5g_3, 2g_4, 10g_7, g_9\} \cap \{g_{12}\} \\ &= \phi \text{ are in } T_o. \end{aligned}$$

Let $A, B \in T_{\cup}^+$, clearly

$$\begin{aligned} A \cup B &= \{5g_3, 2g_4, 10g_7, g_9\} \cup \{g_{12}\} \\ &= \{5g_3, 2g_4, 10g_7, g_9, g_{12}\} \text{ and} \end{aligned}$$

$$\begin{aligned} A + B &= \{5g_3, 2g_4, 10g_7, g_9\} + \{g_{12}\} \\ &= \{5g_3 + g_{12}, 2g_4 + g_{12}, 10g_7 + g_{12}, g_9 + g_{12}\} \\ &\text{are in } T_{\cup}^+. \end{aligned}$$

Now consider $A, B \in T_{\cup}^{\times}$;

$$\begin{aligned} A \cup B &= \{5g_3, 2g_4, 10g_7, g_9\} \cup \{g_{12}\} \\ &= \{5g_3, 2g_4, 10g_7, g_9, g_{12}\} \text{ and} \end{aligned}$$

$$\begin{aligned} A \times B &= \{5g_3, 2g_4, 10g_7, g_9\} \times \{g_{12}\} \\ &= \{5g_3 * g_{12}, 2g_4 * g_{12}, 10g_7 * g_{12}, g_9 * g_{12}\} \\ &= \{5g_6, 2g_8, 10g_{14}, g_3\} \text{ are in } T_{\cup}^* . \end{aligned}$$

Suppose $A, B \in T_{\cap}^*$

$$\begin{aligned} A \cap B &= \{5g_3, 2g_4, 10g_7, g_9\} \cap \{g_{12}\} \\ &= \phi \text{ and} \end{aligned}$$

$$\begin{aligned} A * B &= A \times B = \{5g_3, 2g_4, 10g_7, g_9\} \times \{g_{12}\} \\ &= \{5g_3 * g_{12}, 2g_4 * g_{12}, 10g_7 * g_{12}, g_9 * g_{12}\} \\ &= \{5g_6, 2g_8, 10g_{14}, g_3\} \text{ and in } T_{\cap}^* . \end{aligned}$$

Finally $A, B \in T_{\cap}^+$;

$$\begin{aligned} A + B &= \{5g_3, 2g_4, 10g_7, g_9\} + \{g_{12}\} \\ &= \{5g_3 + g_{12}, 2g_4 + g_{12}, 10g_7 + g_{12}, g_9 + g_{12}\} \text{ and} \end{aligned}$$

$$\begin{aligned} A \cap B &= \{5g_3, 2g_4, 10g_7, g_9\} \cap \{g_{12}\} \\ &= \phi \text{ are in } T_{\cap}^+ . \end{aligned}$$

Suppose $A, B \in T_s$.

$$\begin{aligned} A + B &= \{5g_3, 2g_4, 10g_7, g_9\} + \{g_{12}\} \\ &= \{5g_3 + g_{12}, 2g_4 + g_{12}, 10g_7 + g_{12}, g_9 + g_{12}\} \text{ and} \end{aligned}$$

$$\begin{aligned} A * B &= \{5g_3, 2g_4, 10g_7, g_9\} * \{g_{12}\} \\ &= \{5g_6, 2g_8, 10g_{14}, g_3\} \text{ are in } T_s . \end{aligned}$$

We see all the six spaces are different from each other. However only the spaces $T_{\cup}^* = T_{\cup}^{\times}$, $T_{\cap}^* = T_{\cap}^{\times}$ and T_s are non commutative and non associative.

For take $A = \{3g_5\}$, $B = \{2g_4\}$ and $C = \{g_7\}$ in T_s or T_{\cup}^* or T_{\cap}^* .

$$\begin{aligned}(A * B) &= \{3g_5\} * \{2g_4\} \\ &= \{3g_5 * 2g_4\} \\ &= \{6g_5 * g_4\} \\ &= \{6g_{10}\} \quad \dots (1)\end{aligned}$$

$$\begin{aligned}(B * A) &= \{2g_4\} * \{3g_5\} \\ &= \{2g_4 * 3g_5\} \\ &= \{6g_8\} \quad \dots (2)\end{aligned}$$

(1) and (2) are different so the three spaces T_s , $T_{\cup}^* = T_{\cup}^{\times}$ and $T_{\cap}^* = T_{\cap}^{\times}$ are non commutative.

Consider

$$\begin{aligned}(A * B) * C &= (\{3g_5\} * \{2g_4\}) * \{g_7\} \\ &= \{6g_{10}\} * \{g_7\} \quad (\text{using (1) for } A * B) \\ &= \{6g_{10} * g_7\} \\ &= \{6g_5\} \quad \dots (1)\end{aligned}$$

Now

$$\begin{aligned}A * (B * C) &= \{3g_5\} * (\{2g_4\} * \{g_7\}) \\ &= \{3g_5\} * (\{2g_4 * g_7\}) \\ &= \{3g_5\} * \{2g_8\} \\ &= \{3g_5 * 2g_8\} \\ &= \{6g_{10}\} \quad \dots (2)\end{aligned}$$

(1) and (2) are different hence the operations on T_s , T_{\cup}^* and T_{\cap}^* are non associative.

Thus these three subset special NA semiring topological spaces T_s , T_{\cup}^{\times} and T_{\cap}^{\times} are both non associative and non commutative.

Example 3.2: Let $S = \{\text{Collection of all subsets from the NA loop semiring } (R^+ \cup \{0\})L_{19}(3)\}$ be the NA subset semiring. Clearly the six NA topological semiring spaces $T_o, T_{\cup}^+, T_{\cap}^+, T_{\cup}^*, T_{\cap}^*$ and T_s are such that the first three spaces are both commutative and associative and the later three spaces are both non commutative and non associative.

Example 3.3: Let $S = \{\text{Collection of all subsets from the groupoid semiring } (Z^+ \cup \{0\})G \text{ where } G = \{\langle Z_4 \cup I \rangle, *, (2I, 2I)\}\}$ be the subset semiring.

We see all the six NA topological semiring spaces are commutative but certainly T_s, T_{\cup}^* and T_{\cap}^* are non associative.

Example 3.4: Let $S = \{\text{Collection of all subsets from the NA groupoid semiring } (R^+ \cup I \cup \{0\})G \text{ where } G = \{Z_{20}, *, (2, 10)\}\}$ be the NA semiring of infinite order.

Clearly the three subset special NA topological spaces T_s, T_{\cup}^* and T_{\cap}^* are all both non associative and non commutative.

Example 3.5: Let $S = \{\text{Collection of all subsets from the NA loop semiring } R = \{\langle Z^+ \cup I \cup \{0\} \rangle L_{43}(9)\}\}$ be the subset NA semiring of infinite order.

T_s, T_{\cup}^* and T_{\cap}^* are all non associative and non commutative semiring NA special topological spaces of infinite order.

Example 3.6: Let $S = \{\text{Collection of all subsets from the NA loop semiring } R = \{\langle Z^+ \cup \{0\} \rangle \times \langle Q^+ \cup I \cup \{0\} \rangle L_{13}(7)\}$ be the NA subset semiring of infinite order.

T_s, T_{\cup}^* and T_{\cap}^* are special NA subset semiring topological spaces which are non associative but are commutative.

Example 3.7: Let $S = \{\text{Collection of all subsets from the NA loop semiring } (Z^+ \cup \{0\})(L_7(3) \times L_{35}(9))\}$ be the NA subset semiring.

Clearly the three NA topological semiring spaces T_s, T_{\cup}^* and T_{\cap}^* are all non commutative and non associative and are of infinite order.

Example 3.8: Let $S = \{\text{Collection of all subsets from the NA semiring } (Z^+ \cup \{0\})(L_{15}(8) \times G) \text{ where } G = \{Z_{16}, * (2,5)\}\}$ be the subset NA semiring.

T_s, T_{\cup}^* and T_{\cap}^* are all non associative and non commutative subset NA semiring topological spaces of infinite order.

Example 3.9: Let $S = \{\text{Collection of all subsets from the NA row matrix semiring } M = \{(a_1, a_2, \dots, a_9) \mid a_i \in R = (Z^+ \cup \{0\} \cup I) L_{27}(8); 1 \leq i \leq 9\}\}$ be the NA subset semiring.

T_s, T_{\cup}^* and T_{\cap}^* (* is the \times operation on R) are special subset NA semiring topological spaces which are non commutative and non associative.

All these three spaces contain subset topological zero divisors which are infinite in number.

Example 3.10: Let $S = \{\text{Collection of all subsets from the NA semiring}$

$$R = \left\{ \left[\begin{array}{ccc} a_1 & a_2 & a_3 \\ a_4 & a_5 & a_6 \\ \vdots & \vdots & \vdots \\ a_{28} & a_{29} & a_{30} \end{array} \right] \mid a_i \in (R^+ \cup \{0\}) L_{27}(14), 1 \leq i \leq 30 \right\}$$

be the subset NA matrix semiring.

T_s , T_{\cup}^* and T_{\cap}^* are all NA subset special topological semiring spaces which are commutative.

Example 3.11: Let $S = \{\text{Collection of all subsets from the NA semiring } R = (Q^+ \cup \{0\}) (L_7(5) \times L_9(8) \times L_{13}(2) \times L_{43}(2))\}$ be the subset NA semiring.

T_s , T_{\cup}^* and T_{\cap}^* are both NA subset special semiring topological spaces of infinite order which are non commutative and non associative and has subset topological zero divisors.

Example 3.12: Let $S = \{\text{Collection of all subsets from the NA semiring matrix}$

$$M = \left\{ \begin{bmatrix} a_1 \\ a_2 \\ a_3 \\ \vdots \\ a_9 \end{bmatrix} \mid a_i \in \langle Q^+ \cup I \cup \{0\} \rangle G \text{ where} \right.$$

$$G = \{C(Z_{45}), *, (7i_F, 0), 1 \leq i \leq 9\}$$

be the NA subset column matrix semiring of infinite order.

All the three special NA semiring subset topological spaces T_s , T_{\cup}^* and T_{\cap}^* are of infinite order, non associative and non commutative having subset topological zero divisors.

Example 3.13: Let $S = \{\text{Collection of all subsets from the NA semiring super matrix } M = \{(a_1 \ a_2 \ a_3 \mid a_4 \mid a_5 \ a_6) \text{ where } a_i \in P = \langle Q^+ \cup I \cup \{0\} \rangle L_{49}(9); 1 \leq i \leq 6\}\}$ be the subset NA semiring of infinite order.

The three topological special NA subset semiring spaces T_s , T_{\cup}^* and T_{\cap}^* are non associative and non commutative and has non trivial subset topological zero divisors given by

$$A = \{(a_1 \ a_2 \ a_3 \ | \ 0 \ | \ 0 \ 0), (a_1 \ 0 \ a_3 \ | \ 0 \ | \ 0 \ 0), (0 \ a_1 \ a_2 \ | \ 0 \ | \ 0 \ 0), (0 \ 0 \ a_1 \ | \ 0 \ | \ 0 \ 0), (a_1 \ 0 \ 0 \ | \ 0 \ | \ 0 \ 0)\} \text{ and}$$

$$B = \{(0 \ 0 \ 0 \ | \ a_1 \ | \ 0 \ 0), (0 \ 0 \ 0 \ | \ a_1 \ | \ a_2 \ a_3), (0 \ 0 \ 0 \ | \ 0 \ | \ a_1 \ a_2), (0 \ 0 \ 0 \ | \ 0 \ | \ a_1), (0 \ 0 \ 0 \ | \ a_1 \ | \ 0 \ a_2)\} \text{ where } a_i \in P; 1 \leq i \leq 3 \text{ in } T_s \text{ (or } T_{\cup}^* \text{ and } T_{\cap}^*) \text{ are such that}$$

$$A * B = A \times B = \{(0 \ 0 \ 0 \ | \ 0 \ | \ 0 \ 0)\}.$$

Thus T_s , T_{\cup}^* and T_{\cap}^* has infinite number of topological subset zero divisors.

Example 3.14: Let $S = \{\text{Collection of all subsets from the NA semiring super matrix}$

$$M = \left\{ \left(\begin{array}{c|c|c|c|c|c|c|c|c} a_1 & a_2 & a_3 & a_4 & a_5 & a_6 & a_7 & a_8 & a_9 \\ \hline a_{10} & \dots & \dots & \dots & \dots & \dots & \dots & \dots & a_{18} \\ \hline a_{19} & \dots & \dots & \dots & \dots & \dots & \dots & \dots & a_{27} \\ \hline a_{28} & \dots & \dots & \dots & \dots & \dots & \dots & \dots & a_{36} \\ \hline a_{37} & \dots & \dots & \dots & \dots & \dots & \dots & \dots & a_{45} \\ \hline a_{46} & \dots & \dots & \dots & \dots & \dots & \dots & \dots & a_{54} \end{array} \right) \right\} \quad a_i \in P$$

$$= \{(\mathbb{R}^+ \cup I \cup \{0\}) (L_7(3) \times 3) \text{ where } G = \{C(\mathbb{Z}_{27}), *, (9, 9i_F + 8)\}, 1 \leq i \leq 54\}$$

T_s , T_{\cup}^* and T_{\cap}^* are subset special NA topological semiring spaces of infinite order both non associative and non commutative and has infinite number of subset topological zero divisors.

Example 3.15: Let $S = \{\text{Collection of all subsets from the NA super matrix semiring}$

$$M = \left\{ \left[\begin{array}{c|c|c} \mathbf{a}_1 & \mathbf{a}_2 & \mathbf{a}_3 \\ \hline \mathbf{a}_4 & \mathbf{a}_5 & \mathbf{a}_6 \\ \hline \mathbf{a}_7 & \mathbf{a}_8 & \mathbf{a}_9 \\ \hline \mathbf{a}_{10} & \mathbf{a}_{11} & \mathbf{a}_{12} \\ \mathbf{a}_{13} & \mathbf{a}_{14} & \mathbf{a}_{15} \\ \hline \mathbf{a}_{16} & \mathbf{a}_{17} & \mathbf{a}_{18} \\ \mathbf{a}_{19} & \mathbf{a}_{20} & \mathbf{a}_{21} \\ \hline \mathbf{a}_{22} & \mathbf{a}_{23} & \mathbf{a}_{24} \\ \mathbf{a}_{25} & \mathbf{a}_{26} & \mathbf{a}_{27} \\ \hline \mathbf{a}_{28} & \mathbf{a}_{29} & \mathbf{a}_{30} \\ \hline \mathbf{a}_{31} & \mathbf{a}_{32} & \mathbf{a}_{33} \\ \hline \mathbf{a}_{34} & \mathbf{a}_{35} & \mathbf{a}_{36} \end{array} \right] \mid \mathbf{a}_i \in \langle \mathbb{Z}^+ \cup \{0\} \cup \mathbb{I} \rangle (\mathbb{G}_1 \times \mathbb{G}_2 \times \mathbb{G}_3) \right.$$

where $G_1 = \{Z_{10}, *, (4, 5)\}$, $G_2 = \{(Z_{10} \cup \mathbb{I}), *, (4I, 5)\}$ and $G_3 = \{C(Z_{10}), *, (4, 5i_F) \mid 1 \leq i \leq 36\}$ be the NA semiring of infinite order.

T_s , T_{\cup}^* and T_{\cap}^* are all subset NA special semiring topological spaces of infinite order which is non commutative and non associative but has infinite number of subset topological zero divisors.

Example 3.16: Let $S = \{\text{Collection of all subsets from the NA super matrix semiring}\}$

$$M = \left\{ \left(\begin{array}{c|ccc|cc|c} \mathbf{a}_1 & \mathbf{a}_2 & \mathbf{a}_3 & \mathbf{a}_4 & \mathbf{a}_5 & \mathbf{a}_6 & \mathbf{a}_7 & \mathbf{a}_8 \\ \hline \mathbf{a}_9 & \mathbf{a}_{10} & \dots & \dots & \dots & \dots & \dots & \mathbf{a}_{16} \\ \hline \mathbf{a}_{17} & \mathbf{a}_{18} & \dots & \dots & \dots & \dots & \dots & \mathbf{a}_{24} \end{array} \right) \mid \mathbf{a}_i \in (\mathbb{Q}^+ \cup \{0\}) \right.$$

$$(\mathbb{L}_{43}(8) \times \mathbb{L}_{18}(8)), 1 \leq i \leq 24 \}$$

be the NA subset super matrix semiring of infinite order.

Clearly T_s , T_{\cup}^* and T_{\cap}^* are all non associative non commutative special NA semiring topological spaces of infinite order. All the three spaces contain subset topological zero divisors in infinite number.

Example 3.17: Let $S = \{\text{Collection of all subsets from the interval semiring } M = \{[a, b] \mid a, b \in (\mathbb{Z}^+ \cup \{0\})_{L_7(3)}\}\}$ be the subset semiring of infinite order.

T_s , T_{\cup}^* and T_{\cap}^* are all subset NA special topological semiring spaces of infinite order which are non associative and non commutative. This has subset topological zero divisors. However T_o , T_{\cup}^+ and T_{\cap}^+ are all subset NA semiring special topological spaces which are associative and commutative.

Example 3.18: Let $S = \{\text{Collection of all subsets from the NA semiring interval matrix } M = \{([a_1, b_1], [a_2, b_2], [a_3, b_3], [a_4, b_4], [a_5, b_5], [a_6, b_6], [a_7, b_7], [a_8, b_8]) \mid a_i, b_i \in (\mathbb{R}^+ \cup \{I\} \cup \{0\}) (G_1 \times L_9(8) \times G_2) \text{ where } G_1 = \{\mathbb{Z}_9, *, (3, 2)\} \text{ and } G_2 = \{\mathbb{Z}_{45}, *, (9, 2)\}\}\}$ be the subset NA interval matrix semiring.

T_o , T_{\cup}^+ , T_{\cap}^+ , T_{\cup}^{\times} , T_{\cap}^{\times} and T_s be the subset NA special semiring topological spaces of infinite order. The later three spaces are non associative and non commutative and has subset topological zero divisors which are infact infinite in number.

Example 3.19: Let $S = \{\text{Collection of all subsets from the interval matrix semiring}$

$$M = \left\{ \left[\begin{array}{c} [a_1, b_1] \\ [a_2, b_2] \\ [a_3, b_3] \\ \vdots \\ [a_{15}, b_{15}] \end{array} \right] \mid a_i, b_i \in (\mathbb{Z}^+ \cup I) \right.$$

$$\left. (\mathbb{L}_{19}(6) \times \mathbb{L}_{19}(3) \times \mathbb{L}_{19}(7) \times \mathbb{L}_{19}(10)); 1 \leq i \leq 15 \right\}$$

be the subset NA matrix interval semiring of infinite order.

Clearly of the six subset NA special semiring topological spaces only T_s , T_{\cup}^* and T_{\cap}^* are both non associative and non commutative and of infinite order. Further all the three spaces contain subset topological zero divisors which are infinite in number.

Example 3.20: Let $S = \{\text{Collection of all subsets from the interval matrix NA semiring}\}$

$$M = \left\{ \begin{bmatrix} [a_1, b_1] & [a_2, b_2] & [a_3, b_3] & [a_4, b_4] \\ [a_5, b_5] & \dots & \dots & [a_8, b_8] \\ [a_9, b_9] & \dots & \dots & [a_{12}, b_{12}] \\ [a_{13}, b_{13}] & \dots & \dots & [a_{16}, b_{16}] \\ [a_{17}, b_{17}] & \dots & \dots & [a_{20}, b_{20}] \\ [a_{21}, b_{21}] & \dots & \dots & [a_{28}, b_{28}] \end{bmatrix} \right\}$$

be the subset NA interval matrix semiring of M . T_{\cup} , T_{\cup}^+ , T_{\cap}^+ , T_{\cup}^{\times} , T_{\cap}^{\times} and T_s be the subset NA interval matrix semiring special topological spaces of infinite order. The later three spaces are non associative and non commutative and have infinite number of subset topological zero divisors.

Example 3.21: Let $S = \{\text{Collection of all subsets from the NA polynomial semiring}\}$

$$M = \left\{ \sum_{i=0}^{\infty} a_i x^i \mid a_i \in (\mathbb{Z}^+ \cup \{0\})(L_9(5) \times L_{19}(8)) \right\}$$

be the NA subset semiring of infinite order.

The three spaces T_s , T_{\cup}^* and T_{\cap}^* are non associative and non commutative and are of infinite order. S has no subset topological zero divisors.

Example 3.22: Let $S = \{\text{Collection of all subsets from the NA polynomial semiring}\}$

$$M = \left\{ \sum_{i=0}^{\infty} a_i x^i \mid a_i \in (\mathbb{Z}^+ \cup \{0\})(G_1 \times G_2 \times G_3) \right\}$$

where $G_1 = \{\mathbb{Z}_{45}, *, (10, 3)\}$, $G_2 = \{\mathbb{Z}_{12}, *, (6, 0)\}$ and

$$G_3 = \{\mathbb{C}(\mathbb{Z}_3), *, (i_F, 2)\}$$

be the subset NA semiring. Of the six NA subset special semiring topological spaces $T_o, T_{\cup}^+, T_{\cap}^+, T_{\cup}^{\times}, T_{\cap}^{\times}$ and T_s the later three are non associative and non commutative and of infinite order.

Example 3.23: Let $S = \{\text{Collection of all subsets from the NA interval polynomial semiring}\}$

$$M = \left\{ \sum_{i=0}^{\infty} [a_i, b_i] x^i \mid a_i, b_i \in (\mathbb{Z}^+ \cup I \cup \{0\})G \times L_7(6) \right\}$$

where $G = \{(\mathbb{Z}_7, *, (2, 5))\}$

be the NA subset interval polynomial semiring. T_{\cup}^*, T_{\cap}^* and T_s are NA subset special topological spaces which are non associative and non commutative and are of infinite order.

Example 3.24: Let $S = \{\text{Collection of all subsets from the interval polynomial NA semiring}\}$

$$P = \left\{ \sum_{i=0}^{\infty} [a_i, b_i] x^i \mid a_i, b_i \in (\mathbb{Q}^+ \cup I \cup \{0\})G; \right.$$

$$\left. G = \{\mathbb{Z}_{148}, *, (2, 0)\} \right\}$$

be the NA subset semiring. T_s , T_{\cup}^* and T_{\cap}^* are NA subset special topological semiring space of infinite order which is non commutative and non associative.

So far we have given only subset semiring NA special topological spaces of infinite order built using only NA semirings.

Example 3.25: Let $S = \{\text{Collection of all subsets from the groupoid lattice LG where } G = \{\mathbb{Z}_{40}, *, 20, 0\}\}$ and L is the semiring (distributive lattice) which is as follows:

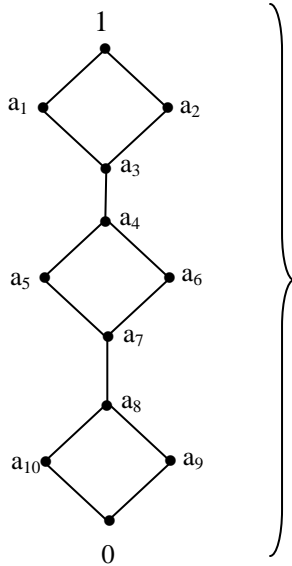

be the subset NA semiring of finite order.

T_s , T_o , T_{\cup}^+ , T_{\cap}^+ , T_{\cup}^{\times} and T_{\cap}^{\times} are all subset NA special semiring topological spaces of finite order.

We show how operations on these six topological spaces are performed.

Let $A = \{a_110 + a_215, a_85\}$ and
 $B = \{a_{10}1 + a_64, a_47\} \in T_o = \{S' = S \cup \{\phi\}, \cup, \cap\}$.

Now $A \cup B = \{a_110 + a_215, a_85\} \cup \{a_{10}1 + a_64, a_47\}$
 $= \{a_110 + a_215, a_85, a_{10}1 + a_64, a_47\}$

and $A \cap B = \{a_110 + a_215, a_85\} \cap \{a_{10}1 + a_64, a_47\}$
 $= \phi$ are in T_o .

T_o is a finite usual topological space of subsets of LG including the empty set.

Let $A, B \in T_{\cup}^+ = \{S, +, \cup\}$
 $A \cup B = \{a_110 + a_215, a_85\} \cup \{a_{10}1 + a_64, a_47\}$
 $= \{a_110 + a_215, a_85, a_47, a_{10}1 + a_64\}$ and

$A + B = \{a_110 + a_215, a_85\} + \{a_{10}1 + a_64, a_47\}$
 $= \{a_110 + a_215 + a_{10}1 + a_64, a_85 + a_{10}1 + a_64,$
 $a_110 + a_215 + a_47, a_85 + a_47\}$

are in T_{\cup}^+ .

Clearly T_o and T_{\cup}^+ are NA semiring subset topological spaces which are different.

Consider $A, B \in T_{\cap}^+ = \{S' = S \cup \{\phi\}, \cap, +\}$.

$A \cap B = \{a_110 + a_215, a_85\} \cap \{a_{10}1 + a_64, a_47\}$
 $= \{\phi\}$ and

$A + B = \{a_110 + a_215, a_85\} + \{a_{10}1 + a_64, a_47\}$
 $= \{a_110 + a_215, a_{10}1 + a_64, a_85 + a_{10}1 + a_64, a_85 +$
 $a_47, a_110 + a_215 + a_47\}$ are in T_{\cap}^+ .

We see T_{\cap}^+ is different from both the spaces T_{\cup}^+ and T_o .
 Let $A, B \in T_{\cap}^{\times}$.

$$\begin{aligned} A \cup B &= \{a_110 + a_215, a_85\} \cup \{a_{10}1 + a_64, a_47\} \\ &= \{a_110 + a_215, a_85, a_47, a_{10}1 + a_64\} \text{ and} \end{aligned}$$

$$\begin{aligned} A \times B &= \{a_110 + a_215, a_85\} \times \{a_{10}1 + a_64, a_47\} \\ &= \{(a_110 + a_215) \times a_{47}, a_{85} \times a_{47}, (a_110 + a_215) \times \\ &\quad (a_{10}1 + a_64)\} \\ &= \{(a_1 \cap a_4) (10 * 7) + (a_2 \cap a_4) (15 * 7), \\ &\quad a_8 \cap a_4 (5 * 7), (a_1 \cap a_{10}) (10 * 1) + \\ &\quad (a_2 \cap a_{10}) (15 * 1) + (a_1 \cap a_6) (10 * 4) + \\ &\quad (a_2 \cap a_6) (15 * 4), (a_8 \cap a_{10}) (5 * 1) + \\ &\quad (a_8 \cap a_6) (5 * 4)\} \\ &= a_{40} + a_{420} + a_{820} + a_{100}, a_{1020} + a_{60} + a_{620}, \\ &\quad a_{1020} + a_{820} \\ &= (a_4 \cup a_8) 20, 0, (a_{10} \cup a_6) 20, (a_{10} \cup a_8) 20\} \\ &= \{a_{420}, 0, a_{620}, a_{820}\} \text{ are in } T_{\cup}^{\times} \end{aligned}$$

and T_{\cup}^{\times} is different from T_{\cup}^+ , T_{\cap}^+ and T_o as special subset topological spaces.

Now let $A, B \in T_{\cap}^{\times} = \{S' = S \cup \{\phi\}, \times, \cap\}$.

$$\begin{aligned} A \cap B &= \{a_110 + a_215, a_85\} \cap \{a_{10}1 + a_64, a_47\} \\ &= \{\phi\} \text{ and} \end{aligned}$$

$$\begin{aligned} A \times B &= \{a_110 + a_215, a_85\} \times \{a_{10}1 + a_64, a_47\} \\ &= \{0, a_{420}, a_{620}, a_{820}\} \text{ (calculated earlier)} \end{aligned}$$

are in T_{\cap}^{\times} and T_{\cap}^{\times} is different from subset special NA semiring topological spaces T_{\cup}^{\times} , T_o , T_{\cup}^+ and T_{\cap}^+ .

Finally let $A, B \in T_s = \{S, +, \times\}$

$$\begin{aligned}
 A + B &= \{a_110 + a_215, a_85\} + \{a_{10}1 + a_64, a_47\} \\
 &= \{a_110 + a_215 + a_{10}1 + a_64, a_85 + a_{10}1 + a_64, a_85 + a_47, a_110 + a_215 + a_47\}
 \end{aligned}$$

and

$$\begin{aligned}
 A \times B &= \{a_110 + a_215, a_85\} \times \{a_{10}1 + a_64, a_47\} \\
 &= \{0, a_420, a_620, a_820\} \text{ are in } T_s.
 \end{aligned}$$

T_s is different from the five subset topological NA semiring spaces; $T_o, T_{\cup}^+, T_{\cap}^+, T_{\cup}^{\times}$ and T_{\cap}^{\times} .

Thus all the six spaces are different from each other and are of finite order. It can be easily verified T_s, T_{\cup}^{\times} and T_{\cap}^{\times} are all NA subset semiring topological spaces which are non commutative and non associative.

Example 3.26: Let $S = \{\text{Collection of all subsets from the groupoid lattice } LG \text{ where } G = \{L(\mathbb{Z}_{12}), *, (3, 9)_{\mathbb{F}}\} \text{ and } L =$

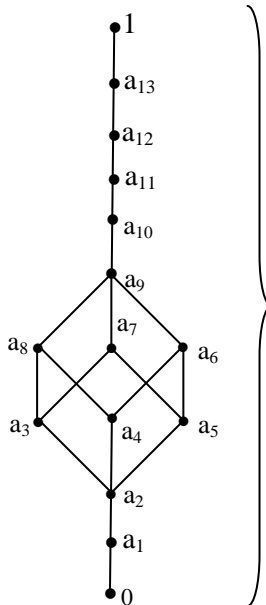

be the subset NA semiring.

It is easily verified that all the six NA subset semiring topological spaces of S are distinct.

Example 3.27: Let $S = \{\text{Collection of all subsets from the groupoid lattice } LG \text{ where } L \text{ is a Boolean algebra of order } 2^8 \text{ and } G = \{C(\langle Z_6 \cup I \rangle), *, (I, 2i_F); \text{ the groupoid}\}$ be the subset special NA semiring of finite order. All the six spaces are finite and are distinct.

T_s, T_{\cup}^{\times} and T_{\cap}^{\times} contain subset topological zero divisors.

Example 3.28: Let $S = \{\text{Collection of all subsets from the loop lattice } LL_7(3) \text{ where } L \text{ is the following lattice}\}$

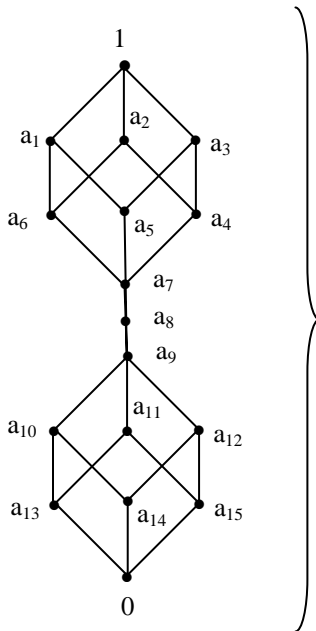

be the NA subset semiring of finite order.

All the six topological spaces associated with S is of finite order and T_s, T_{\cup}^{\times} and T_{\cap}^{\times} are non associative and non commutative and has subset topological zero divisors.

Example 3.29: Let $S = \{\text{Collection of all subsets from the groupoid lattice } LG \text{ where } G = \{\mathbb{Z}_{60}, *, (30, 0)\} \text{ and } L =$

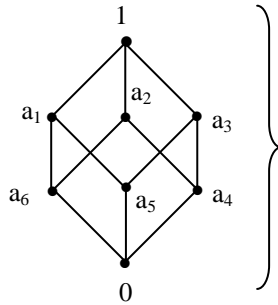

be the NA subset semiring of finite order.

All the six topological spaces associated with S is of finite order.

T_s , T_{\cup}^{\times} and T_{\cap}^{\times} are non associative and non commutative and has subset topological zero divisors.

Example 3.30: Let $S = \{\text{Collection of all subsets from the loop lattice } LL_{25}(8) \text{ where } L =$

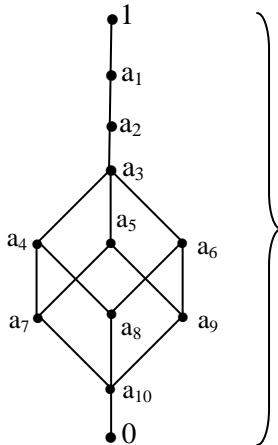

be the NA subset semiring of finite order.

All the six special NA topological spaces associated with them are finite order and T_s , T_{\cup}^{\times} and T_{\cap}^{\times} are both non associative and non commutative and has no subset topological zero divisors.

In view of these we just state the following theorem the proof of which is left as an exercise to the reader.

THEOREM 3.1: *Let*

$S = \{ \text{Collection of all subsets of a NA semiring } P \}$ be the NA subset semiring.

If P has no zero divisors then S has no subset zero divisors. Further T_s , T_{\cup}^{\times} and T_{\cap}^{\times} have no subset topological zero divisors.

Example 3.31: Let $S = \{ \text{Collection of all subsets from the groupoid lattice } L(G_1 \times G_2) \text{ where } G_1 = \{Z_{24}, *1, (10, 20)\} \text{ and } G_2 = \{C(Z_{16}), *_2, (10i_F, 0)\} \}$ and L is a Boolean algebra with 64 elements} be the NA subset semiring of finite order.

All the six special NA subset topological spaces of S are of finite order.

T_s , T_{\cup}^* and T_{\cap}^* are both non commutative and non associative and has subset topological zero divisors.

Example 3.32: Let $S = \{ \text{Collection of all subsets from the loop lattice } L(L_{17}(9) \times L_{15}(8)) \text{ where } L \text{ is a distributive lattice given below;} \}$

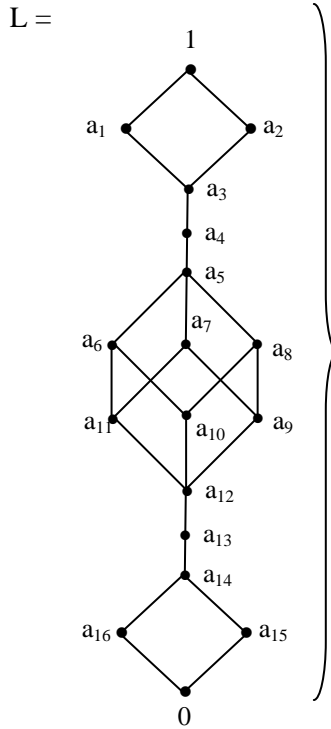

be the NA - subset semiring of finite order.

T_s , T_{\cup}^{\times} and T_{\cap}^{\times} are non associative but commutative and of finite order and has finite number of subset topological zero divisors.

Example 3.33: Let $S = \{ \text{Collection of all subsets from the loop lattice matrix } M = \{ (a_1, a_2, a_3, a_4) \mid a_i \in LL_{15}(2); 1 \leq i \leq 24 \} \}$ where

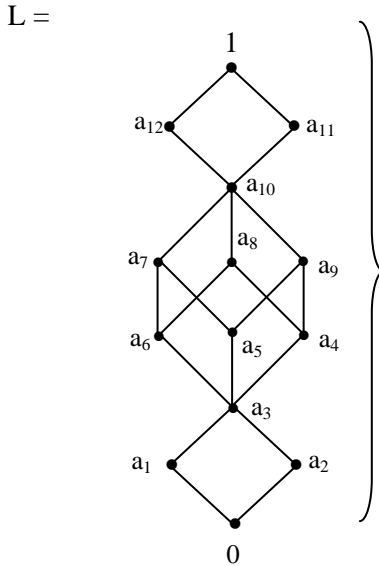

be the NA subset semiring of finite order.

All the six topological spaces are of finite order.

T_{\cup}^* , T_{\cap}^* and T_s are both non associative and non commutative and has finite number of subset topological zero divisors and the three spaces are the S-subset NA special right alternative topological semiring spaces.

Example 3.34: Let $S = \{\text{Collection of all subsets from the loop lattice matrix}\}$

$$M = \left\{ \begin{matrix} \left[\begin{matrix} a_1 \\ a_2 \\ a_3 \\ \vdots \\ a_9 \end{matrix} \right] \mid a_i \in LL_9(2), 1 \leq i \leq 9 \text{ and } L = \end{matrix} \right.$$

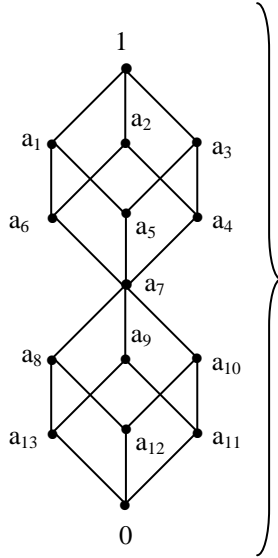

be the NA subset semiring of finite order S has several subset zero divisors.

So the NA topological semiring spaces T_s , T_{\cup}^* and T_{\cap}^* has several subset topological zero divisors.

Example 3.35: Let $S = \{\text{Collection of all subsets from the NA semiring } (L \times L \times L \times L) \text{ } G \text{ where } G = \{Z_{15}, *, (10, 9)\} \text{ and } L =$

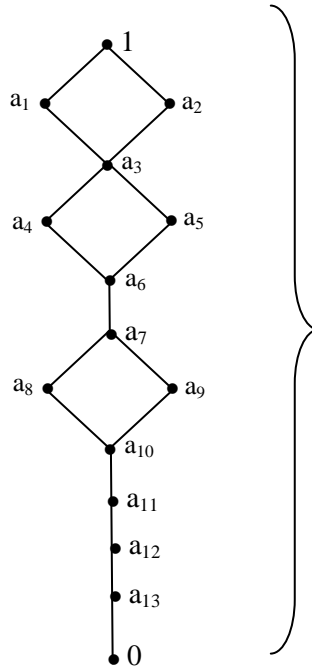

be the NA subset semiring of finite order.

Example 3.36: Let $S = \{\text{Collection of all subsets from the NA matrix semiring}\}$

$$M = \left\{ \left[\begin{array}{ccc} a_1 & a_2 & a_3 \\ a_4 & a_5 & a_6 \\ \vdots & \vdots & \vdots \\ a_{43} & a_{44} & a_{45} \end{array} \right] \mid a_i \in LL_{11}(2); 1 \leq i \leq 45 \right\}$$

be the NA subset semiring of finite order.

S has several subset NA subsemirings.

Further related to all these subset NA subsemiring we have topological subset semiring subspaces of $T_o, T_s, T_{\cup}^+, T_{\cap}^+, T_{\cup}^{\times}$ and T_{\cap}^{\times} .

$B = \{ \text{Collection of all subsets from the NA semiring} \}$

$$P = \left\{ \left[\begin{array}{ccc} a_1 & a_2 & a_3 \\ 0 & 0 & 0 \\ \vdots & \vdots & \vdots \\ 0 & 0 & 0 \end{array} \right] \mid a_i \in LL_{11}(2); 1 \leq i \leq 3 \right\} \subseteq M \subseteq S.$$

Now associated with B we have all the six subset NA semiring topological subspaces $B_o, B_s, B_{\cup}^+, B_{\cap}^+, B_{\cup}^{\times}$ and B_{\cap}^{\times} contained in $T_o, T_s, T_{\cup}^+, T_{\cap}^+, T_{\cup}^{\times}$ and T_{\cap}^{\times} respectively.

Example 3.37: Let $S = \{ \text{Collection of all subsets from the NA semiring} \}$

$$M = \left\{ \left(\begin{array}{c|c|c|c|c} a_1 & a_2 & a_3 & a_4 & a_5 & a_6 & a_7 & a_8 & a_9 \\ \hline a_{10} & a_{11} & \dots & \dots & \dots & \dots & \dots & \dots & a_{19} \end{array} \right) \mid a_i \in L(L_9(8) \times L_{13}(12)); 1 \leq i \leq 18 \right\}$$

be the subset NA semiring of finite order. S has finite number of subset NA subsemirings.

Now having seen examples of NA subset semirings of finite order and their properties; we now give a few examples of their substructures before we proceed to define subset set ideal special NA semiring topological spaces of all the six types.

Example 3.38: Let $S = \{ \text{Collection of all subsets from the NA semiring} \}$

$$M = \left\{ \begin{bmatrix} a_1 & a_2 & a_3 & a_4 \\ a_5 & a_6 & a_7 & a_8 \\ a_9 & a_{10} & a_{11} & a_{12} \\ a_{13} & a_{14} & a_{15} & a_{16} \end{bmatrix} \mid a_i \in LL_{11}(2); 1 \leq i \leq 16 \right\}$$

be the subset NA semiring of finite order. $L = C_{10}$, a chain lattice. $T_o, T_s, T_{\cup}^+, T_{\cap}^+, T_{\cup}^{\times}$ and T_{\cap}^{\times} be the NA special subset semiring topological spaces of S .

Let $B_1 = \{\text{Collection of all subsets from the NA subsemiring}$

$$P_1 = \left\{ \begin{bmatrix} a_1 & 0 & 0 & 0 \\ 0 & 0 & 0 & 0 \\ 0 & 0 & 0 & 0 \\ 0 & 0 & 0 & 0 \end{bmatrix} \mid a_i \in LL_{11}(2) \subseteq M \subseteq S, \right.$$

$B_2 = \{\text{Collection of all subsets from the NA subsemiring}$

$$P_2 = \left\{ \begin{bmatrix} 0 & a_2 & 0 & 0 \\ 0 & 0 & 0 & 0 \\ 0 & 0 & 0 & 0 \\ 0 & 0 & 0 & 0 \end{bmatrix} \mid a_i \in LL_{11}(2) \subseteq M \subseteq S, \right.$$

$B_3 = \{\text{Collection of all subsets from the NA subsemiring}$

$$P_3 = \left\{ \begin{bmatrix} 0 & 0 & a_3 & 0 \\ 0 & 0 & 0 & 0 \\ 0 & 0 & 0 & 0 \\ 0 & 0 & 0 & 0 \end{bmatrix} \mid a_i \in LL_{11}(2) \subseteq M \subseteq S, \right.$$

and so on and

$$B_{16} = \left\{ \left[\begin{array}{cccc} 0 & 0 & 0 & 0 \\ 0 & 0 & 0 & 0 \\ 0 & 0 & 0 & 0 \\ 0 & 0 & 0 & a_{16} \end{array} \right] \mid a_i \in LL_{11}(2) \subseteq M \subseteq S \right.$$

be the sixteen subset NA subsemirings of S.

Associated with each these NA subset subsemirings we have the six types of subset NA subsemiring special topological spaces T_o , T_s , T_{\cup}^+ , T_{\cap}^+ , T_{\cup}^{\times} and T_{\cap}^{\times} .

All of them are proper subspaces and the subspaces of T_{\cup}^{\times} , T_{\cap}^{\times} and T_s are non associative and non commutative.

Infact these 3 spaces satisfy S-special identity.

Now only we have 16 such subspaces we can have several other NA subset subsemirings like say $M_1 = \{ \text{Collection of all subsets from the NA subsets semiring} \}$

$$V_1 = \left\{ \left[\begin{array}{cccc} a_1 & a_2 & 0 & 0 \\ 0 & 0 & 0 & 0 \\ 0 & 0 & 0 & 0 \\ 0 & 0 & 0 & 0 \end{array} \right] \mid a_i \in LL_{11}(2) \subseteq M \subseteq S, \right.$$

$M_2 = \{ \text{Collection of all subsets from the NA subset semiring} \}$

$$V_2 = \left\{ \left[\begin{array}{cccc} a_1 & 0 & a_2 & 0 \\ 0 & 0 & 0 & 0 \\ 0 & 0 & 0 & 0 \\ 0 & 0 & 0 & 0 \end{array} \right] \mid a_i \in LL_{11}(2) \subseteq M \subseteq S, \right.$$

$M_3 = \{ \text{Collection of all subsets from the NA subset semiring} \}$

$$V_3 = \left\{ \begin{bmatrix} a_1 & 0 & 0 & a_2 \\ 0 & 0 & 0 & 0 \\ 0 & 0 & 0 & 0 \\ 0 & 0 & 0 & 0 \end{bmatrix} \middle| a_i \in LL_{11}(2) \subseteq M \subseteq S \right.$$

and so on and

$M_{15} = \{ \text{Collection of all subsets from the NA subset semiring} \}$

$$V_{15} = \left\{ \begin{bmatrix} a_1 & 0 & 0 & 0 \\ 0 & 0 & 0 & 0 \\ 0 & 0 & 0 & 0 \\ 0 & 0 & 0 & a_2 \end{bmatrix} \middle| a_i \in LL_{11}(2) \subseteq M \subseteq S \right.$$

and so on.

We see all the fifteen subset NA subsemirings are of finite order and associated with each of them we have subtopological NA special semiring spaces.

Not only these 15 NA subset subsemiring topological spaces we can have more and all them satisfy a S-special identity.

Example 3.39: Let $S = \{ \text{Collection of all subsets from the NA semiring} \}$

$$M = \left\{ \begin{pmatrix} a_1 & a_2 & \dots & a_{12} \\ a_{13} & a_{14} & \dots & a_{24} \\ a_{25} & a_{26} & \dots & a_{36} \end{pmatrix} \middle| a_i \in LG \text{ where } L = \right.$$

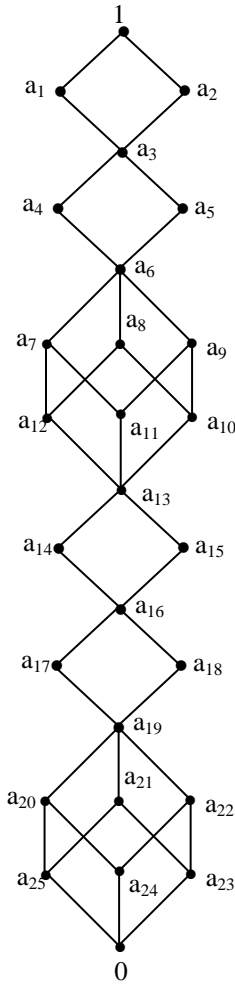

and $G = \{Z_7 \times Z_{15}, * = (*_1, *_2); (3, 0), (0, 5)\}$ be the NA subset semiring. This has several subset special NA semiring topological subspaces.

Example 3.40: Let $S = \{\text{Collection of all subsets from the NA semiring}\}$

$$P = \left\{ \sum_{i=0}^{\infty} a_i x^i \mid a_i \in LL_{29}(2) \right\}$$

be the subset NA semiring. S has several NA subset semiring topological subspaces viz. $T_0, T_s, T_{\cup}^{\times}, T_{\cap}^{\times}, T_{\cup}^+$ and T_{\cap}^+ .

Infact each of these subset NA semiring topological spaces has infinite number of subspaces.

Example 3.41: Let $S = \{ \text{Collection of all subsets from the NA semiring}$

$$M = \left\{ \left[\begin{array}{c} [a_1, b_1] \\ [a_2, b_2] \\ \vdots \\ [a_{10}, b_{10}] \end{array} \right] \mid a_i, b_i \in LL_{15}(8); L \text{ is from example 3.40,} \right.$$

$$\left. 1 \leq i \leq 10 \right\}$$

be the subset NA semiring. All the NA subset semiring topological spaces have subspaces.

Further $T_{\cup}^{\times}, T_{\cap}^{\times}$ and T_s have pairs of subspaces A, B such

that $A \times B = \left\{ \left[\begin{array}{c} [0,0] \\ [0,0] \\ \vdots \\ [0,0] \end{array} \right] \right\}$.

Example 3.42: Let $S = \{ \text{Collection of all subsets from the NA semiring}$

$$M = \left\{ \sum_{i=0}^{\infty} [a_i, b_i] x^i \mid a_i, b_i \in LG \text{ where } L = \right.$$

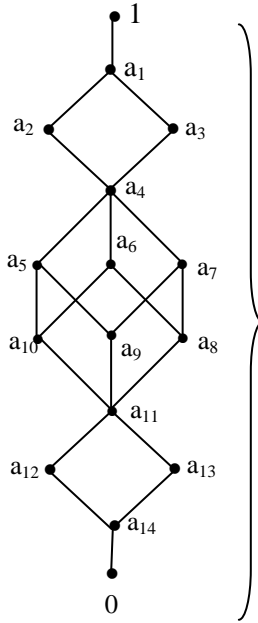

and $G = \{C\langle Z_{10} \cup I \rangle, *, (6I, 4)\}$ be the NA subset semiring. All the six subset special NA semiring topological spaces have subspaces infact of infinite order.

Example 3.43: Let $S = \{\text{Collection of all subsets from the NA semiring}\}$

$$P = \left\{ \sum_{i=0}^{\infty} [a_i, b_i] x^i \mid a_i, b_i \in LL_{19}(8) \right\}$$

be the NA subset semiring. Associated with these NA special subset topological spaces T_o, T_s, T_{\cup}^+ and $T_{\cap}^+, T_{\cup}^{\times}$ and T_{\cap}^{\times} we have infinite number of subspaces.

We now proceed onto just briefly describe that the NA topological subset semiring space and if the basic structure which is used to build the NA subset semiring satisfies any of

the special identities like Moufang, Bruck, Bol or right alternative or left alternative or alternative or so on. We define the NA subset special semiring topological space to be a S-NA subset alternative (right alternative or Moufang or Bol) semiring topological space.

We will illustrate this situation by an example or two.

Example 3.44: Let $S = \{\text{Collection of all subsets from the NA semiring } M = \{[a_i, b_i] x^i \mid a_i, b_i \in LG \text{ where } L \text{ is a distributive lattice which is as follows:}\}$

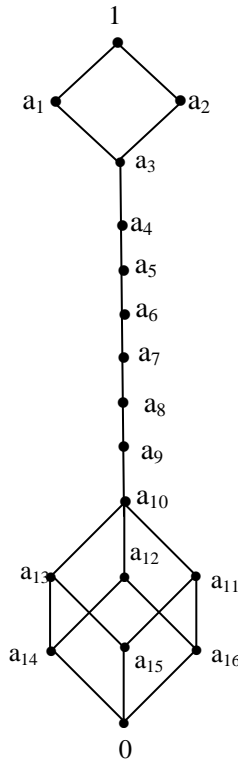

and $G = \{C(\langle Z_{10} \cup I \rangle, *, (6I, 4))\}$ be the subset NA semiring of finite order.

All the six subset NA semiring topological spaces have subspaces infact of finite order.

Example 3.45: Let $S = \{\text{Collection of all subsets from the NA semiring } (\mathbb{Z}^+ \cup \{0\})L_7(3)\}$ be the subset NA semiring.

Since $L_7(3)$ is a **WIP** (weak inverse property) loop so all the six topological spaces are Smarandache subset NA semiring Weak Inverse Property (**WIP**) topological spaces.

Example 3.46: Let $S = \{\text{Collection of all subsets from the NA semiring } \langle \mathbb{R}^+ \cup I \cup \{0\} \rangle L_{45}(2)\}$ be the subset NA semiring.

Since $L_{45}(2)$ is a right alternative loop S is a **S-NA** right alternative subset semiring. T_{\cup}^{\times} , T_{\cap}^{\times} and T_s are all **S-NA** subset semiring right alternative topological spaces of infinite order.

Example 3.47: Let $S = \{\text{Collection of all subsets from the NA semiring } M = LL_{65}(2) \text{ where } K \text{ is a distributive lattice which is as follows:}\}$

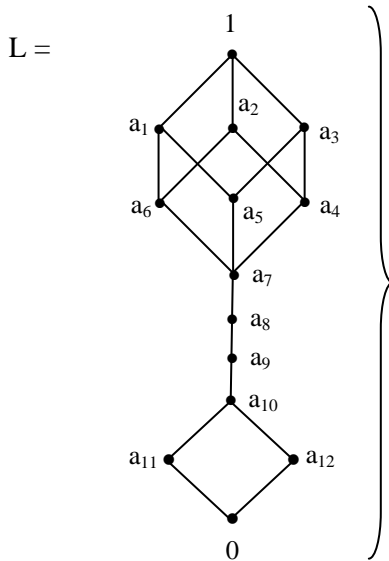

be the NA semiring of finite order; $L_{65}(2)$ is a right alternative loop so S is a S -subset NA right alternative semiring and T_s , T_{\cup}^{\times} , T_{\cap}^{\times} are all S -subset NA semiring right alternative topological spaces of finite order.

Example 3.48: Let $S = \{\text{Collection of all subsets from the NA semiring } LL_{27}(26)\}$ be the subset NA semiring where $L =$

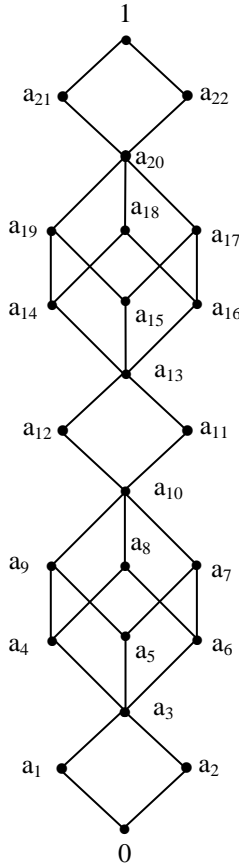

$L_{27}(26)$ is a left alternative loop}. Hence S is a S -left alternative subset NA semiring. Infact T_{\cup}^{\times} , T_{\cap}^{\times} and T_s are all S -NA subset left alternative semiring topological spaces of finite order.

Example 3.49: Let $S = \{\text{Collection of all subsets from the NA semiring } (Q^+ \cup I \cup \{0\})L_{43}(42)\}$ be the NA subset semiring. Since $L_{43}(42)$ is a left alternative loop S is a S-left alternative NA subset semiring.

Hence T_{\cup}^{\times} , T_{\cap}^{\times} and T_s are S-left alternative semiring topological spaces of finite order.

Example 3.50: Let $S = \{\text{Collection of all subsets from the NA semiring } (Z^+ \cup \{0\})G \text{ where } G = \{Z_6, *, (4, 5)\}\}$ be the subset NA semiring.

Since $(Z^+ \cup \{0\})G$ is a S-subset NA semiring we see all the topological space are S-NA subset semiring topological spaces.

Example 3.51: Let $S = \{\text{Collection of all subsets from the NA semiring } LG \text{ where } G = \{Z_8, *, (2, 6)\} \text{ and } L =$

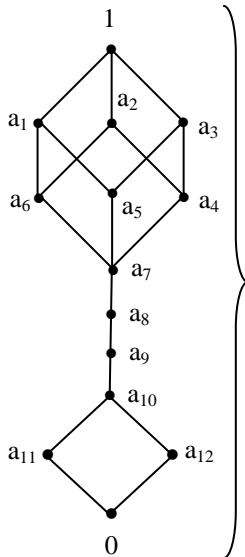

be the NA subset semiring. S is a S-NA subset semiring as the groupoid is a Smarandache groupoid.

Hence the topological spaces T_s , T_{\cup}^{\times} and T_{\cap}^{\times} of S are Smarandache NA subset semiring topological spaces of S .

Example 3.52: Let $S = \{\text{Collection of all subsets from the NA semiring } (Z^+ \cup \{0\})G \text{ where } G = \{Z_{12}, *, (4, 0)\}\}$ be the NA subset semiring.

We see G is a P-groupoid as
 $(x * y) * x = x * (y * x)$ for all $x, y \in G$.

We call S the NA subset semiring to be a S-P-subset semiring as the basic algebraic structure which is used is a P-groupoid.

We see the S is a S-subset NA P-semiring.

Further T_s , T_{\cup}^{\times} and T_{\cap}^{\times} are all S-subset NA semiring P-topological spaces of S .

Here it is pertinent to keep on record that only in case of subset topological spaces which are non associative we can study special types of topological spaces.

Infact we have these topological spaces satisfy some special identities.

This is a striking feature of these new special type of topological structures constructed by us.

Example 3.53: Let $S = \{\text{Collection of all subsets from the NA semiring } LG \text{ where } L =$

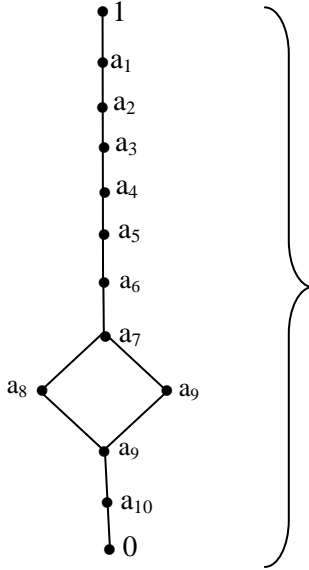

and $G = \{Z_{19}, *, (10, 10)\}$ be the NA subset semiring. Clearly G is a P-groupoid.

So S is a S-NA subset semiring and T_{\cup}^{\times} , T_{\cap}^{\times} and T_s are all S-NA subset NA subset semiring P-topological spaces of finite order.

In view of this we have the following theorems.

THEOREM 3.2: *Let $S = \{\text{Collection of all subsets from the NA semiring } RG \text{ (where } R = Z^+ \cup \{0\} \text{ or } Q^+ \cup \{0\} \text{ or } R^+ \cup \{0\} \text{ or } \langle Z^+ \cup I \cup \{0\} \rangle \text{ or } \langle Q^+ \cup I \cup \{0\} \rangle \text{ or } \langle R^+ \cup I \cup \{0\} \rangle)\}$ and $G = \{Z_n, *, (t, t); 1 < t < n-1\}$ be the NA subset semiring of infinite order.*

- (i) S is a S-P-NA subset semiring.
- (ii) T_{\cup}^{\times} , T_{\cap}^{\times} and T_s are S-NA subset semiring P-topological spaces of S of infinite order.

The proof follows from the fact $G = \{Z_n, *, (t, t); 1 < t < n\}$ is a P-groupoid.

THEOREM 3.3: *Let $S = \{\text{Collection of all subsets from the groupoid semiring } LG \text{ where } L \text{ is a finite distributive lattice and } G = \{Z_n, *, (t, t), 1 < t < n\}\}$ be the NA finite subset semiring.*

- (i) S is a S-NA subset P-semiring of finite order.
- (ii) T_{\cup}^{\times} , T_{\cap}^{\times} and T_s are all S-NA subset semiring P-topological spaces of finite order.

Proof follows from the fact the groupoid $G = \{Z_n, *, (t, t), 1 < t < n\}$ is a P-groupoid.

THEOREM 3.4: *Let $S = \{\text{Collection of all subsets from the NA semiring } (Q^+ \cup \{0\})G \text{ where } G = \{Z_n, *, (t, 0)\}\}$ be the NA subset semiring.*

T_s , T_{\cup}^{\times} and T_{\cap}^{\times} are all S-NA subset semiring P-topological spaces if and only if in the groupoid G , $t^2 = t \pmod n$.

Proof follows from the fact the groupoid $G = \{Z_n, *, (0, t)\}$ is a P-groupoid if and only if $t^2 = t \pmod n$.

Example 3.54: Let $S = \{\text{Collection of all subsets of the NA groupoid semiring } Q^+ \cup \{0\}G \text{ with } G = \{Z_{12}, *, (9, 0)\}\}$ be the NA subset semiring. S is a S NA subset alternative semiring.

The topological spaces T_s , T_{\cup}^* and T_{\cap}^* are all S-subset NA semiring alternative topological spaces of S .

Example 3.55: Let $S = \{\text{Collection of all subsets from the NA semiring } LG \text{ with } G = \{Z_{10}, *, (5, 0)\}$ and $L =$

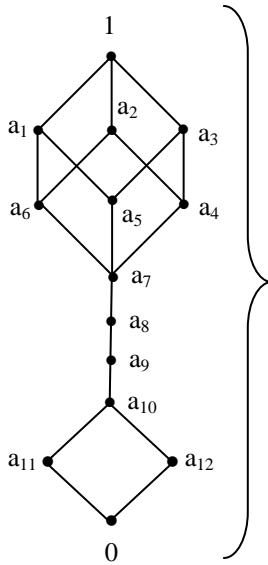

be the NA subset semiring.

S is a S-subset NA alternative semiring as the groupoid G is an alternative groupoid.

The topological spaces T_s , T_{\cup}^{\times} and T_{\cap}^{\times} are all S-subset NA alternative semiring topological spaces of finite order.

In view of this we have the following theorem.

THEOREM 3.5: *Let $S = \{ \text{Collection of all subsets from the NA semiring } LG \text{ with } G = \{Z_n, *, (t, 0)\} \text{ } n, \text{ not a prime and } L \text{ any distributive lattice} \}$ be a NA subset semiring.*

The topological spaces T_s , T_{\cup}^{\times} and T_{\cap}^{\times} are S-NA subset semiring alternative topological spaces if and only if in G;
 $t^2 = t \pmod n$.

We see the groupoid $G = \{Z_n, *, (t, 0)\}$ with $t^2 = t \pmod n$ makes S both a NA subset semiring which is S-alternative as well as S-P-subset semiring.

But it is important to say that all S-subset semirings need not be always a S-subset NA alternative semiring. To this end we first give an example or two.

Example 3.56: Let $S = \{\text{Collection of all subsets from the NA semiring } (Q^+ \cup \{0\})G \text{ with } G = \{Z_{19}, *, (10, 10)\}\}$ be the NA subset semiring. Clearly S is not a S-NA subset alternative semiring as G is not an alternative groupoid.

Infact when in Z_n , n is a prime the groupoids fail to be alternative.

Example 3.57: Let $S = \{\text{Collection of all subsets from the NA semiring } (Z^+ \cup \{0\})G \text{ with } G = \{Z_{12}, *, (3, 9)\}\}$ be the NA subset semiring. S is S-NA subset Moufang semiring.

Thus, T_s , T_{\cup}^{\times} and T_{\cap}^{\times} are all S-NA subset semiring Moufang topological spaces as G is a S-Moufang groupoid.

Example 3.58: Let $S = \{\text{Collection of all subsets from the NA semiring } LG \text{ where } G = \{Z_{10}, *, (5, 6)\} \text{ and } L =$

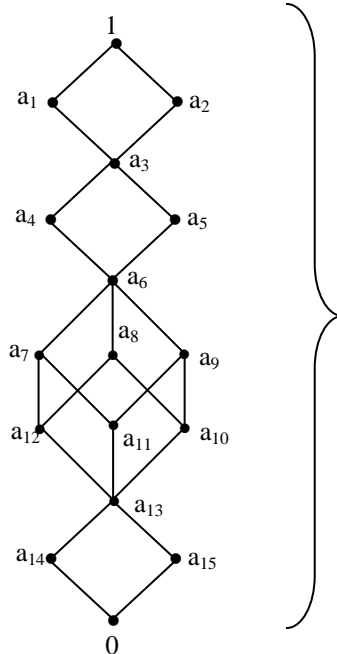

be the NA subset semiring.

As G is a S -strong Moufang groupoid. S is a S -NA subset strong Moufang semiring. Further T_s , T_{\cup}^{\times} and T_{\cap}^{\times} are all S -NA subset strong Moufang topological semiring spaces of S .

Example 3.59: Let $S = \{\text{Collection of all subsets from the NA semiring } (Q^+ \cup \{0\})G \text{ where } G = \{Z_{14}, *, (7, 8)\}\}$ be a NA subset semiring.

As G is a S -strong Moufang groupoid S is a S -strong Moufang NA subset semiring.

Further T_s , T_{\cup}^{\times} and T_{\cap}^{\times} are all S -NA strong Moufang topological semiring spaces of S of infinite order.

Example 3.60: Let $S = \{\text{Collection of all subsets of the NA semiring } LG \text{ where } G = \{Z_{26}, *, (13, 14)\} \text{ and } L =$

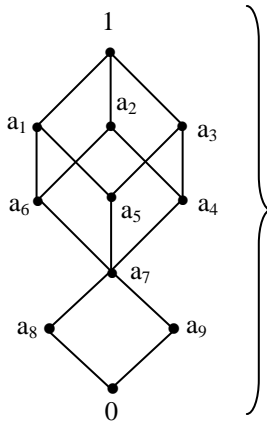

be the NA subset semiring of finite order.

Since G is a S -strong Moufang groupoid so S is a S -strong Moufang NA subset semiring. The topological spaces T_s , T_{\cup}^{\times}

and T_{\cap}^{\times} are S NA semiring strong Moufang topological spaces of finite order.

In view of all this we have the following theorem.

THEOREM 3.6: *Let $S = \{\text{Collection of all subsets from the NA semiring } RG \text{ where } R \text{ is } R^+ \cup \{0\} \text{ or } Z^+ \cup \{0\} \text{ or } Q^+ \cup \{0\} \text{ or } \langle R^+ \cup I \cup \{0\} \rangle \text{ or } \langle Q^+ \cup I \cup \{0\} \rangle \text{ or } \langle Z^+ \cup I \cup \{0\} \rangle \text{ or } R \text{ is a distributive lattice and } G = \{Z_{2p}, *, (p, p+1)\} \text{ be a groupoid and } p \text{ a prime}\}$ be the NA subset semiring. Then*

- (i) G is a S-strong Moufang groupoid.
- (ii) S is a S-strong Moufang NA subset semiring.
- (iii) T_s, T_{\cup}^{\times} and T_{\cap}^{\times} are S-strong Moufang subset special semiring topological spaces of S .

The proof is left as an exercise to the reader.

The result follows from the fact that if

$G = \{Z_{2p}, *, (p, p+1); p \text{ a prime}\}$ is always a S-strong Moufang groupoid.

Example 3.61: Let $S = \{\text{Collection of all subsets from the NA semiring } (Z^+ \cup \{0\})G \text{ where } G = \{Z_4, *, (2, 3)\}\}$ be the subset NA semiring.

Since G is a Smarandache Bol groupoid we see S is a S-subset Bol semiring.

Further T_s, T_{\cup}^{\times} and T_{\cap}^{\times} are all S-subset NA semiring Bol topological spaces of S .

However these spaces are not S-subset NA strong Bol semiring topological spaces.

Example 3.62: Let $S = \{\text{Collection of all subsets from the NA semiring } LG \text{ where } G = \{Z_{12}, *, (3, 4)\} \text{ and } L \text{ is the lattice given in the following};$

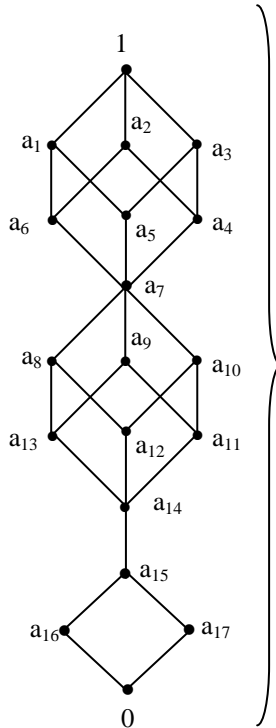

be the NA subset semiring of finite order. Since G is a S -strong Bol groupoid, we see S is a S -strong Bol NA semiring. T_s , T_{\cup}^{\times} and T_{\cap}^{\times} are S -strong Bol subset semiring topological spaces of S .

Example 3.63: Let $S = \{\text{Collection of all subsets from the NA semiring } (Z^+ \cup \{0\})G \text{ where } G = \{Z_p, *, ((p+1)/2, (p+1)/2)\}; p \text{ a prime}\}$ be the subset NA semiring.

G is a Smarandache idempotent groupoid so S is a S -NA idempotent semiring of infinite order. Further the topological spaces T_s , T_{\cup}^{\times} and T_{\cap}^{\times} are all S -strong idempotent NA semiring topological spaces.

Thus we have seen NA semiring topological spaces which satisfy S -strong special identities.

Now we proceed on to use rings instead of semirings and just indicate how these structures behave.

Example 3.64: Let $S = \{\text{Collection of all subsets from the NA ring } Z_5G \text{ where } G = \{Z_{20}, *, (5, 0)\}\}$ be the NA subset semiring. S is a S -strong NA P -semiring and T_s, T_{\cup}^{\times} and T_{\cap}^{\times} are all S -strong P -topological spaces.

Example 3.65: Let $S = \{\text{Collection of all subsets from the groupoid ring } RG \text{ where } G = \{Z_{12}, *, (3, 4)\}\}$ be the subset semiring. S is S -strong Bol NA subset semiring of infinite order.

Example 3.66: Let $S = \{\text{Collection of all subsets from the groupoid ring } Z_{28}G \text{ where } G = \{Z_4, *, (2, 3)\}\}$ be the subset NA semiring. S is a S -Bol NA subset semiring of finite order.

The topological spaces T_s, T_{\cup}^{\times} and T_{\cap}^{\times} are all S -subset NA Bol semiring topological spaces of finite order.

So using NA rings or NA semirings we see the NA subset semiring topological spaces which satisfy special identities which is an innovative and a new concept pertaining to NA topological spaces.

Next we proceed onto define the notion of subset set ideal topological semiring spaces of S over subrings or subsemirings over which S is defined.

Let $S = \{\text{Collection of all subsets from the NA ring } R \text{ (or NA semiring } P)\}$ be the subset semiring. Let M be a subring of R (or N a subsemiring of P).

Let $B = \{\text{Collection of all subset set ideals of the semiring over the subring } M \text{ (or over the subsemiring } N)\}$.

Now B can be given six topologies viz., ${}_M B_o = \{B, \cup, \cap\}$ ordinary or usual topology. ${}_M B_{\cup}^+ = \{B, +, \cup\}$, ${}_M B_{\cap}^+ = \{B' = B \cap \{\phi\} = \{B', +, \cap\}$, ${}_M B_{\cup}^{\times} = \{B, \times, \cup\}$, ${}_M B_{\cap}^{\times} = \{B', \times, \cap\}$ and

${}_M B_s = \{B, +, \cup\}$ are six topological spaces over subrings (or subsemirings).

The advantage of defining set ideal subset NA semiring topological spaces over subrings (or subsemirings) is that we see in general we can get as many number of spaces as the number of subrings of a ring R (or subsemirings of a semiring P).

We will illustrate this situation by some examples.

Example 3.67: Let $S = \{\text{Collection of all subsets from the NA ring } Z_5G \text{ with } G = \{Z_{10}, *, (5, 0)\}\}$ be the subset NA semiring. Take $V = Z_5P$ where $P = \{0, 5\} \subseteq G$ be a NA subsemiring of S. Let $B = \{\text{Collection of all set subset ideals of } S \text{ over the subsemiring } V = Z_5P\} \subseteq S$. On B we have all the six topologies given by ${}_v B_o, {}_v B_\cup^+, {}_v B_\cap^+, {}_v B_\cup^\times, {}_v B_\cap^\times$ and ${}_v B_s$.

We see associated with each NA subring P_i of Z_5G we have these six topologies associated with them.

Example 3.68: Let $S = \{\text{Collection of all subsets from the NA semiring } RG \text{ where } G = \{Z_{16}, *, (3, 13)\}\}$ be the NA subset semiring. Let $P = \{\text{Collection of all set ideals of the subsets over the NA subring } W_1 = QG \subseteq RG\}$. ${}_{w_1} P_o, {}_{w_1} P_\cup^+, {}_{w_1} P_\cap^+, {}_{w_1} P_\cup^\times, {}_{w_1} P_\cap^\times$ and ${}_{w_1} P_s$ are the six set ideal NA subset semiring topological spaces over the NA subring W_1 of S.

Example 3.69: Let $S = \{\text{Collection of all subsets from the NA ring } R = ZL_{19}(3)\}$ be the NA subset semiring. $P = \{3ZL_{19}(3)\} \subseteq L_{19}(3)$ be the NA subring of the ring R.

Let $V = \{\text{Collection of all set subset NA semiring ideals of } S \text{ over the NA subring } P \text{ of } R\}$.

V can be associated with all the six topological spaces ${}_P V_o$, ${}_P V_{\cup}^+$, ${}_P V_{\cap}^+$, ${}_P V_{\cup}^{\times}$, ${}_P V_{\cap}^{\times}$ and ${}_P V_s$.

Example 3.70: Let

$S = \{\text{Collection of all subsets of the NA ring } Z_{12}L_{15}(8)\}$ be the NA subset semiring. Let $M = Z_{12}P$ where $P = \{e, g_1\}$, $g_1 \in L_{15}(8)$ be a subring of $Z_{12}L_{15}(8)$. Suppose $W = \{\text{Collection of all subset set semiring ideals of } S \text{ over the subring } M\}$.

W can be given all the six topologies and W is a set NA subset ideal semiring topological spaces over the subring M of $Z_{12}L_{15}(8)$. Since S is a commutative NA semiring all topological spaces are also commutative.

Example 3.71: Let $S = \{\text{Collection of all subsets from the NA semiring } R = Z_{16}L_{19}(3)\}$ be the NA subset semiring. Let $B = PL_{19}(3)$ be a subring of R where $P = \{0, 2, 4, 6, 8, 10, 12, 14\} \subseteq Z_{16}$ is a subring of Z_{16} .

$M = \{\text{Collection of all set ideal subsets from } S \text{ over the subring } B\}$. Using B we can have all the six set ideal subset semiring topological spaces over the subring B of R .

The spaces ${}_B M_s$, ${}_B M_{\cup}^{\times}$ and ${}_B M_{\cap}^{\times}$ are all non associative and non commutative over B . However all of them are of finite order as S is a of finite order.

One can study the trees associated with them.

Example 3.72: Let $S = \{\text{Collection of all subsets from the NA groupoid ring } R = ZG \text{ with } G = \{Z_7, *, (3, 0)\}\}$ be the subset NA semiring; R has infinite number of subrings. Hence associated with each of these subrings we have infinite number of subset set ideal topological Non Associative (NA) semiring spaces.

Example 3.73: Let $S = \{\text{Collection of all subsets from the NA groupoid ring } R = Z_{12}G \text{ where } G = \{Z_{24}, *, (12, 0)\}\}$ be the NA subset semiring.

R has only finite number of subrings; so associated with them we have only a finite number of NA subset ideal semiring topological spaces over the subring P_i of R , $i < \infty$.

Example 3.74: Let $S = \{\text{Collection of all subsets from the NA groupoid ring } R = Z_pG \text{ where } G = \{Z_{15}, *, (3, 5)\}\}$ be the NA subset semiring. R has only finite number of subrings.

Thus S has only finite number of NA subset set ideal semiring topological spaces.

We see the associated trees of these topological spaces are finite as S is finite.

Example 3.75: Let $S = \{\text{Collection of all subsets from the NA loop ring } R = Z_{18}L_7(3)\}$ be the NA subset semiring.

Associated with R we have only finite number of subrings some of them are associative and commutative.

So these set ideal subset semiring topological spaces are still non associative and non commutative even if the subrings are commutative and associative.

Example 3.76: Let $S = \{\text{Collection of all subsets from the loop ring } R = Z_{19}L_{19}(8)\}$ be the NA subset semiring. R has only 19 subrings so associated with them we have 19×6 special subset set ideal topological semiring spaces.

Example 3.77: Let $S = \{\text{Collection of all subsets from the NA ring } R = CL_{25}(7)\}$ be the NA subset semiring.

R has infinite number of subrings so associated with these subrings we have infinite number of set ideal subset NA semiring topological spaces defined over these subrings of R .

Now we proceed onto discuss about set ideal S special subset NA semiring topological spaces over subsemirings of a NA semiring.

Example 3.78: Let $S = \{\text{Collection of all subsets from the NA semiring } P = LG \text{ where}$

$$L =$$

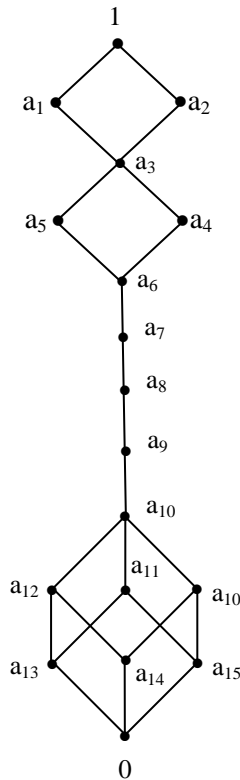

and $G = \{Z_{15}, *, (5, 10)\}$ be the NA subset semiring.

P has only finite number of NA subsemirings; so associated with them we have finite number of set special subset ideal NA semiring topological spaces over the subsemirings of P.

Example 3.79: Let $S = \{\text{Collection of all subsets from the NA semiring } P = (Z^+ \cup \{0\})G \text{ where } G = \{Z_{27}, *, (3, 0)\}\}$ be the NA subset semiring.

P has infinite number of NA subset subsemiring; so associated with each subsemiring of P we have an infinite number of subset set ideal non associative semiring topological spaces over the subsemirings.

Example 3.80: Let $S = \{\text{Collection of all subsets from the subset NA semiring } P = \{(Q^+ \cup I \cup \{0\})G \text{ where } G = \{C(Z_{15}), *, (5, 10i_F)\}\}\}$ be the NA subset semiring.

P has infinite number of subset NA subsemirings.

Hence associated with each of the subsemirings we have infinite number of set subset NA semiring topological spaces over the subsemirings of P.

Example 3.81: Let $S = \{\text{Collection of all subsets from the subset NA semiring } P = LG \text{ where } G = \{(Z_{26} \cup I), *, (3I, 10I)\}\}$ and L is the lattice which is as follows:

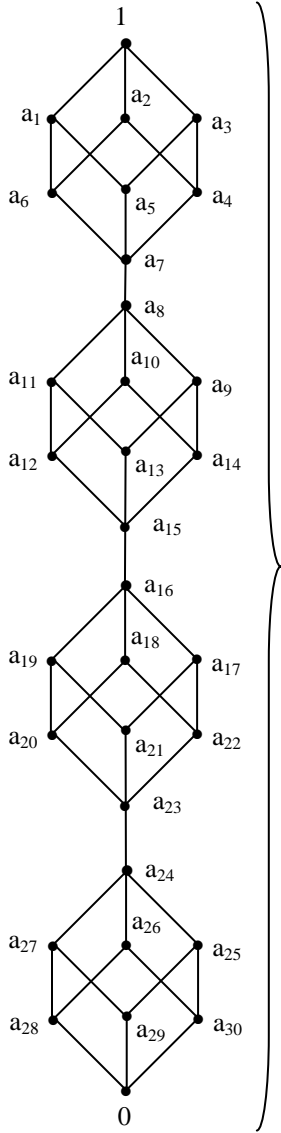

be the NA subset semiring of finite order.

P has only finite number of NA subsemirings. Associated with each one of them we get a finite number of set ideal subset non associative semiring topological spaces over the subsemirings of P.

Example 3.82: Let $S = \{\text{Collection of all subsets from the subset NA semiring } P = LL_{27}(11) \text{ where } L =$

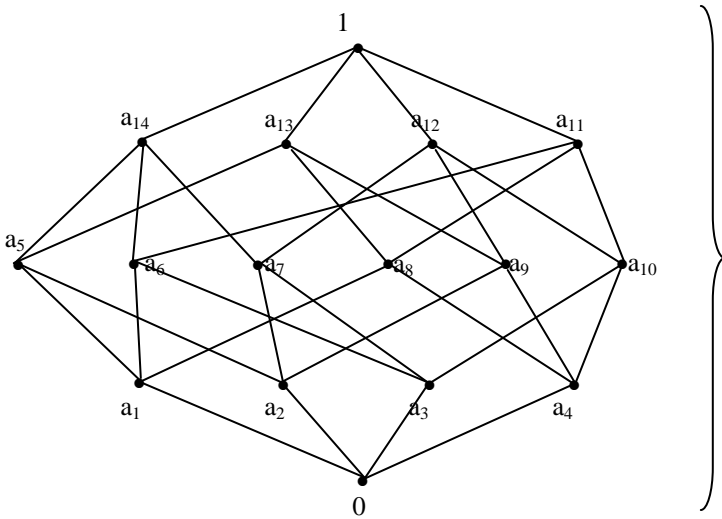

be the NA subset semiring.

P has only finite number of subsemirings so associated with them we have a finite number of special subset set ideal NA semiring topological spaces over the subsemirings of P.

Example 3.83: Let $S = \{\text{Collection of all subsets from the subset NA semiring } P = \{\langle\langle R^+ \cup I \cup \{0\} \rangle L_{49}(9)\rangle\}$ be the NA subset semiring of infinite order.

P has infinite number of subsemirings.

Associated with each of the subsemirings of P we can have a collection of set ideal subset semiring topological spaces of S.

Example 3.84: Let $S = \{\text{Collection of all subsets from the subset NA semiring } P = \{\langle(Q^+ \cup I \cup \{0\})G, \text{ where } G = \langle(Z_{12} \cup I), *, (6I, 10I)\rangle\}$ be the NA subset semiring.

P has infinite number of subset set ideal NA semiring topological spaces over the subsemirings of P .

Example 3.85: Let $S = \{\text{Collection of all subsets from the subset NA semiring } P = \{L(G_1 \times G_2) \text{ where } G_1 = \{C(Z_{10}), *, (5, 5i_F)\} \text{ and } G_2 = \{Z_{15}, *, (5, 10)\}\}$. L is a lattice which is as follows:

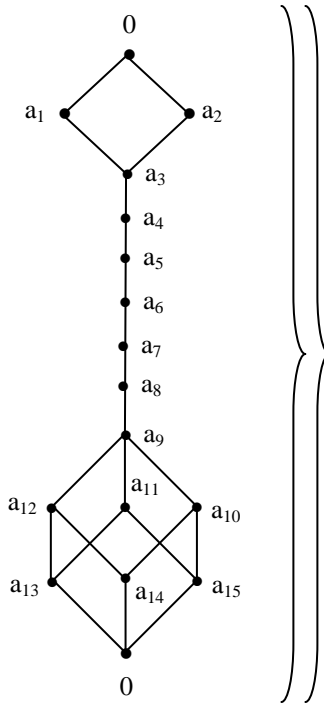

be the NA subset semiring of finite order.

P has only finite number of subsemirings. Thus S has only a finite number of subset set ideal NA semiring topological spaces defined over subsemirings of P .

If the groupoid or the loop using which the NA semirings are constructed happens to satisfy any special identity like Bol or Moufang or alternative or so on then the NA subset semiring will be a S-Bol subset NA semiring (S-Moufang subset NA semiring and so on).

Thus the subset set ideal semiring topological spaces would be S-set ideal subset Moufang (Bol or alternative) semiring topological spaces over the subsemiring.

Example 3.86: Let $S = \{\text{Collection of all subsets from the NA semiring } P = ((Z^+ \cup \{0\}) L_{29}(2))\}$ be the NA subset semiring. This P has infinite number of subsemirings.

P is a right alternative loop so S is a S-NA right alternative subset semiring. All the spaces ${}_{P_i}T_s$, ${}_{P_i}T_{\cup}^{\times}$ and ${}_{P_i}T_{\cap}^{\times}$, P_i subsemirings of P are S-NA right alternative subset set ideal topological spaces of S over P_i .

Example 3.87: Let $S = \{\text{Collection of all subsets from the NA semiring } LL_{45}(44) \text{ where } L \text{ is as follows:}\}$

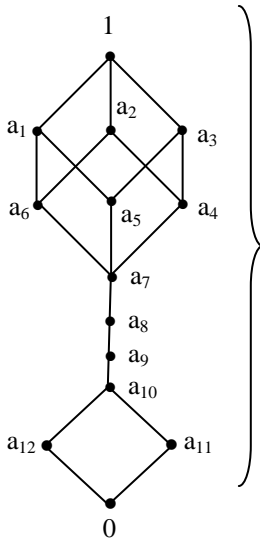

be the NA subset semiring and $L_{45}(44)$ is a left alternative loop so S is a S-NA subset left alternative semiring.

All set ideal subset NA semiring topological spaces over subsemirings of $LL_{45}(44)$ are S-left alternative topological spaces.

Example 3.88: Let $S = \{\text{Collection of all subsets from the NA semiring } P = \langle \mathbb{Z}^+ \cup I \cup \{0\} \rangle G \text{ where } G = \{\mathbb{Z}_{12}, (3, 4), *\}\}$ be the NA subset semiring.

G is a Smarandache strong Bol groupoid so S is a Smarandache strong Bol NA subset semiring, hence all subset set ideal NA semiring topological spaces over subset subsemiring of P are Smarandache strong Bol topological spaces.

Example 3.89: Let $S = \{\text{Collection of all subsets from the NA semiring } LG \text{ where } G = \{\mathbb{Z}_4, *, (2, 3)\} \text{ and } L =$

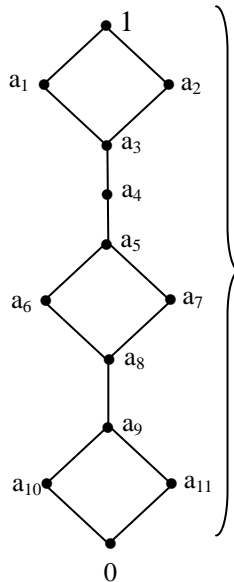

be the NA subset semiring. G is a Smarandache Bol groupoid and is not a Smarandache strong Bol groupoid. Hence S is just a S-NA subset Bol groupoid semiring so all the set ideal subset semiring topological spaces of S over the subsemirings of LG are S-Bol set ideal subset semiring topological spaces over subsemirings of LG .

In view of this we have the following theorem.

THEOREM 3.7: *Let $S = \{ \text{Collection of all subsets from a NA semiring } P \}$ be the NA subset semiring. If ${}_P T_s, {}_P T_\cup^\times$ and ${}_P T_\cap^\times$ are all S-strong set ideal subset semiring Bol topological spaces over $P_i \subseteq P$ then all the three spaces are S-set ideal subset semiring Bol topological spaces over $P_i \subseteq P$. However the converse is not true.*

The proof follows from definition and examples 3.88 and 3.89.

Example 3.90: Let $S = \{ \text{Collection of all subsets form the NA semiring } (\mathbb{Q}^+ \cup I \cup \{0\})G = P \text{ where } G = \{Z_{12}, *, (3, 9)\} \}$ be the NA subset semiring.

G is a S-Moufang groupoid so S is a S-Moufang NA semiring. The topological spaces ${}_P T_s, {}_P T_\cup^\times$ and ${}_P T_\cap^\times$ are all S-set ideal subset NA semiring Moufang topological spaces of S over the subsemiring P_i of P .

Example 3.91: Let $S = \{ \text{Collection of all subsets from the NA semiring } (\mathbb{Q}^+ \cup \{0\})G \text{ where } G = \{Z_{10}, *, (5, 6)\} \}$ be the NA subset semiring. G is a S-strong Moufang groupoid so S is a S-strong Moufang NA subset semiring.

Thus ${}_P T_s, {}_P T_\cup^\times$ and ${}_P T_\cap^\times$ are all S-subset set ideal NA semiring strong Moufang topological spaces of S over the subsemiring P_i of P .

Here also the theorem holds good if the Bol groupoid is replaced by Moufang groupoid.

Example 3.92: Let $S = \{\text{Collection of all subsets of the NA semiring } P = LG \text{ where } G = \{Z_{24}, *, (11, 11)\}\}$ be the NA subset semiring.

Since G is a P -groupoid. S is a S -subset NA P -semiring.

Further ${}_{P_i}T_s, {}_{P_i}T_{\cup}^{\times}$ and ${}_{P_i}T_{\cap}^{\times}$ are all S -subset set ideal P -topological semiring spaces of S over P_i, P_i the subsemiring of P . Here L is the C_{20} ; chain lattice.

Example 3.93: Let $S = \{\text{Collection of all subsets from the NA semiring } P = LG \text{ where } G = \{Z_{20}, *, (5, 0)\}\}$ and $L =$

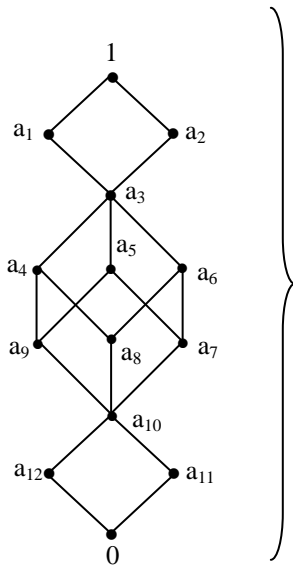

be the NA subset semiring. G is a P -groupoid.

So S is a NA P -subset semiring. ${}_{P_i}T_s, {}_{P_i}T_{\cup}^{\times}$ and ${}_{P_i}T_{\cap}^{\times}$ are all S - NA subset set ideal P -topological semiring spaces of S over the subsemiring P_i of P .

Example 3.94: Let $S = \{\text{Collection of all subsets from the NA semiring } P = LG \text{ where } G = \{Z_{12}, *, (9, 0)\} \text{ and } L =$

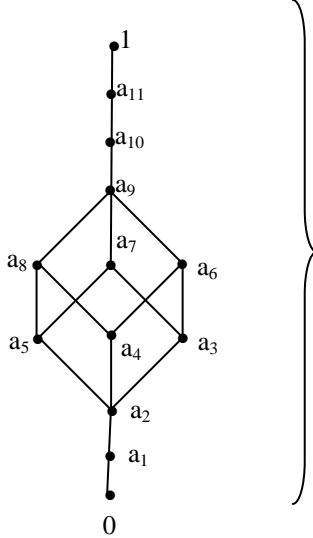

be the NA subset semiring.

G is an alternative groupoid, so S is a S -subset Non associative alternative semiring. ${}_P T_s, {}_P T_\cup^\times$ and ${}_P T_\cap^\times$ are all S -subset set ideal NA alternative semiring topological spaces of S over the subsemiring P_1 of P .

Thus we have seen only in case of set ideal subset NA topological semiring spaces; we can define the notion of a special identity being satisfied by some elements of those spaces which form the algebraic structure using which the NA subset semiring was built.

Now we proceed onto describe strong set ideal subset NA semiring topological spaces over subset subsemirings of S .

Let $S = \{\text{Collection of all subsets of a NA ring (or a NA semiring)}\}$ be the subset semiring. P be a subset subsemiring of S . $M = \{\text{Collection of all subset set ideals of } S \text{ over the subset subsemiring } P \text{ of } S\}$.

We call such subset set ideals over subset subsemirings as strong subset set ideals over a subset subsemiring P_i .

The subset set strong ideal NA semiring topological spaces over the subset subsemiring will be denoted by ${}_i T_o$, ${}_i T_\cup^+$, ${}_i T_\cap^+$, ${}_i T_\cup^\times$, ${}_i T_\cap^\times$ and ${}_i T_s$.

Clearly the three topological subset strong ideal spaces ${}_i T_s$, ${}_i T_\cup^\times$ and ${}_i T_\cap^\times$ are non associative and non commutative at times when S is non commutative.

The advantage of defining these systems of topological spaces is we can have several such spaces which solely depends on the subset subsemirings over which they are defined.

We will illustrate this situation by some examples.

Example 3.95: Let

$S = \{\text{Collection of all subsets from the NA loop ring } Z_5L_7(3)\}$ be the NA subset semiring.

We have $P_1 = \{\text{Collection of all subsets of the subloopring } Z_5B_1 \text{ where } B_1 = \{e, 1\} \subseteq L_7(3) = \{e, 1, 2, 3, 4, 5, 6, 7\} \subseteq S \text{ is a subset subsemiring of } S\}$.

Now we take $M = \{\text{Collection of all subset strong set ideals of } S \text{ over the subset subsemirings } P_1 \text{ of } S\}$.

${}_i M_o$, ${}_i M_\cup^+$, ${}_i M_\cap^+$, ${}_i M_\cup^\times$, ${}_i M_\cap^\times$ and ${}_i M_s$ are the six special subset set strong ideal topological NA semiring spaces of S over the subset subsemiring P_1 of S .

We have atleast seven such spaces by varying P_i and B_i where $P_i = \{\text{Collection of all subsets of the subring } Z_5B_i \text{ where } B_i = \{e, i\}, i \in \{1, 2, 3, 4, 5, 6, 7\}\}$.

Hence the claim.

Example 3.96: Let $S = \{\text{Collection of all subsets from the groupoid ring } Z_6G \text{ where } G = \{Z_{12}, *, (2, 0)\}\}$ be the non associative subset semiring.

Now S has several subset subsemirings $P_i \subseteq S$. Using them we can have subset strong set ideal NA semiring topological spaces of S over the subset subsemirings P_i of S .

Example 3.97: Let $S = \{\text{Collection of all subsets from the groupoid ring } ZG \text{ where } G = \{Z_{25}, *, (20, 5)\}\}$ be the NA subset semiring.

S has infinite number of subset semirings hence associated with S we have infinite number of subset special strong set ideal NA semiring topological spaces defined over the subset subsemirings of S .

Example 3.98: Let $S = \{\text{Collection of all subsets from the loop ring } QL_{25}(4)\}$ be the subset NA semiring. S has infinite number of subset NA subsemirings.

So associated with each of these subset NA subsemirings we have infinite number of subset strong special set ideal NA semiring topological spaces defined over the subset subsemirings of S .

Example 3.99: Let $S = \{\text{Collection of all subsets from the NA groupoid semiring } \langle Z^+ \cup I \cup \{0 \} \rangle G \text{ where } G = \{Z_{21}, *, (7, 0)\}\}$ be the NA subset semiring.

S has infinite number of subset subsemirings.

Thus associated with the subset subsemirings we have an infinite number of subset set ideal strong NA semiring topological spaces of S .

Example 3.100: Let $S = \{\text{Collection of all subsets from the NA semiring } (Q^+ \cup \{0\})G \text{ where } G = \{Z_{28}, *, (14, 0)\}\}$ be the subset NA semiring.

S has infinite number of subset subsemirings associated with these subset subsemirings we have infinite number of subset strong set ideal NA semiring topological spaces of S .

Example 3.101: Let $S = \{\text{Collection of all subsets from the NA semiring } LG \text{ where } L =$

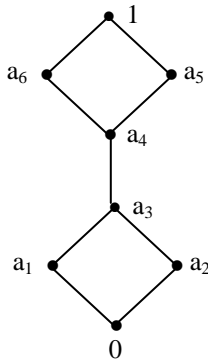

and $G = \{Z_{16}, *, (8, 0)\}$ be the NA subset semiring.

S has only finite number of subset subsemirings hence associated with them we have only a finite number of strong set ideal subset NA semiring topological spaces.

Example 3.102: Let $S = \{\text{Collection of all subsets from the matrix non associative semiring}$

$$M = \left\{ \begin{bmatrix} a_1 & a_2 & a_3 & a_4 & a_5 \\ a_6 & \dots & \dots & \dots & a_{10} \\ a_{11} & \dots & \dots & \dots & a_{15} \\ a_{16} & \dots & \dots & \dots & a_{20} \\ a_{21} & \dots & \dots & \dots & a_{25} \end{bmatrix} \right\} \quad a_i \in (R^+ \cup \{0\})G \text{ where}$$

$$G = \{Z_{17}, *, (3, 14) \mid 1 \leq i \leq 25\}$$

be the NA subset semiring of infinite order.

S has infinite number of subset strong set ideal NA semiring topological spaces of infinite order associated with the infinite number of subset subsemirings.

Example 3.103: Let $S = \{\text{Collection of all subsets form the NA matrix ring} = \{(a_1, a_2, a_3 \ a_4 \dots \ a_{10}) \mid a_i \in Z_{25} \ L_7(3); 1 \leq i \leq 10\}\}$ be the NA subset semiring of finite order.

So S has only finite number of subset subsemirings.

Hence associated with these subset subsemirings we have only finite number of strong set ideal NA subset semiring topological space all of them are of finite cardinality.

Example 3.104: Let $S = \{\text{Collection of all subsets from the NA matrix semiring}$

$$M = \left\{ \left(\begin{array}{cccc} a_1 & a_2 & \dots & a_{10} \\ a_{11} & a_{12} & \dots & a_{20} \\ a_{21} & a_{22} & \dots & a_{30} \\ a_{31} & a_{32} & \dots & a_{40} \end{array} \right) \mid a_i \in LG \text{ where } L = \right.$$

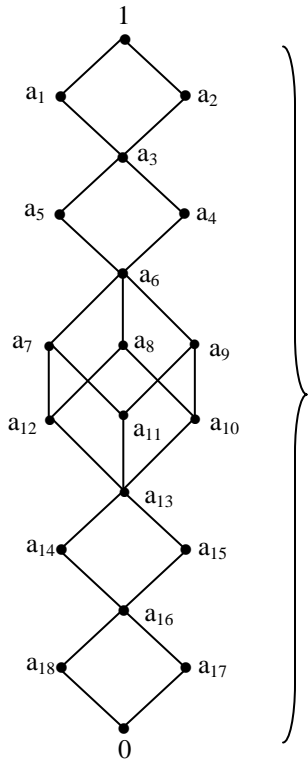

$G = \{C(\mathbb{Z}_{18}), *, (6, 9)\}$ be the NA subset semiring of finite order.

S has only finite number of subset subsemirings.

Hence associated with them S has only finite number of subset set ideal strong NA semiring topological spaces.

Example 3.105: Let $S = \{\text{Collection of all subsets from the NA matrix semiring}\}$

$$M = \left\{ \begin{bmatrix} a_1 \\ a_2 \\ a_3 \\ \vdots \\ a_9 \end{bmatrix} \mid a_i \in (\mathbb{Z}^+ \cup \{0\}) \times L_7(3), 1 \leq i \leq 9 \right\}$$

be the subset NA matrix semiring.

S has infinite number of NA matrix subsemirings.

Thus associated with these subset subsemirings we have infinite collection of strong subset set ideal NA semiring topological spaces of S.

The following are left as open problems.

- (i) Does there exist a subset set ideal strong NA topological semiring space over a subset semiring which has no topological subspaces?
- (ii) Can an infinite topological set ideal strong NA semiring space over a subset subsemiring have a finite basis?
- (iii) Does there exist set ideal subset strong NA semiring topological space which has infinite basis; for all topological spaces of S?
- (iv) Can the trees associated with them be always identical?
- (v) In case of finite topological spaces find trees such that none of them are identical?
- (vi) Can there be an associative topological space in case of ${}_P T_s$, ${}_P T_U^\times$ and ${}_P T_\cap^\times$ for P_i a subset subsemiring of S?

Thus we can build trees for these new non associative topological spaces which will certainly in due course of time find applications in data mining and other related fields.

We suggest the following problems for this chapter.

Problems

1. Obtain some special features enjoyed by NA subset special topological semiring spaces of infinite semirings.
2. Show the subset NA semiring topological spaces T_s , T_{\cup}^* and T_{\cap}^* of infinite order and are free from subset topological zero divisors.
3. Let $S = \{\text{Collection of all subsets from the NA semiring } (Z^+ \cup \{0\})L_7(3)\}$ be the NA subset semiring.
 - (i) Find all the six NA special subset semiring topological spaces.
 - (ii) Prove T_s , T_{\cup}^* and T_{\cap}^* are non associative and non commutative.
 - (iii) Find atleast 3 subspaces of each of these spaces.
4. Let $S = \{\text{Collection of all subsets from the NA semiring } (R^+ \cup \{0\})G \text{ where } G = \{Z_{43}, *, (20, 23)\}\}$ be the NA subset semiring.

Study questions (i) and (iii) of problem 3 for this S.

5. Let $S = \{\text{Collection of all subsets from the NA semiring } (Q^+ \cup I \cup \{0\})G \text{ where } G = \{C(Z_9), *, (6, 3i_F)\}\}$ be the NA subset semiring.

Study questions (i) and (iii) of problem 3 for this S.

6. Let $S = \{\text{Collection of all subsets from the NA semiring } ((Q^+ \cup I)) (L_{13}(3) \times L_{15}(8))\}$ be the subset NA semiring.

Study questions (i) and (iii) of problem 3 for this S.

7. Let $S = \{\text{Collection of all subsets from the NA semiring } \langle \mathbb{R}^+ \cup \{0\} \cup I \rangle L_{29}(15)\}$ be the NA subset semiring.

- (i) Prove S is commutative.
- (ii) Study questions (i) and (iii) of problem 3 for this S.

8. Let $S = \{\text{Collection of all subsets from the NA semiring } M = \{(a_1, a_2, a_3, a_4, a_5, a_6) \mid a_i \in \langle \mathbb{Q}^+ \cup \{0\} \cup I \rangle L_{29}(8), 1 \leq i \leq 6\}\}$ be the NA subset semiring.

Study questions (i) and (iii) of problem 3 for this S.

9. Let $S = \{\text{Collection of all subsets from the matrix NA}$

$$\text{semiring } M = \left\{ \left[\begin{array}{ccc} a_1 & a_2 & a_3 \\ a_4 & a_5 & a_6 \\ \vdots & \vdots & \vdots \\ a_{28} & a_{29} & a_{30} \end{array} \right] \mid a_i \in (\mathbb{Z}^+ \cup \{0\}) L_{19}(8) \right\},$$

$1 \leq i \leq 30\}$ be the NA subset semiring.

Study questions (i) and (iii) of problem 3 for this S.

10. Let $S = \{\text{Collection of all subsets from the NA matrix semiring}$

$$M = \left\{ \left[\begin{array}{cccc} a_1 & a_2 & \dots & a_7 \\ a_8 & a_9 & \dots & a_{14} \\ a_{15} & a_{16} & \dots & a_{21} \\ a_{22} & a_{23} & \dots & a_{28} \\ a_{29} & a_{30} & \dots & a_{35} \\ a_{36} & a_{37} & \dots & a_{42} \end{array} \right] \mid a_i \in (\mathbb{Z}^+ \times \mathbb{Q}^+ \cup \{0\}) \times \right.$$

$$(G_1 \times G_2 \times G_3); \text{ where } G_1 = \{Z_{14}, *, (10, 4)\},$$

$$G_2 = \{C(Z_{10}), *, (5i_F, 5)\}$$

$$\text{and } G_3 = \{C(Z_5 \cup I), *, (4i_F, 2)\}; 1 \leq i \leq 42\}$$

be the NA subset semiring.

Study questions (i) and (iii) of problem 3 for this S.

11. Let $S = \{\text{Collection of all subsets from the matrix NA semiring}$

$$M = \left\{ \left(\begin{array}{cccc} a_1 & a_2 & \dots & a_{10} \\ a_{11} & a_{12} & \dots & a_{20} \\ a_{21} & a_{22} & \dots & a_{30} \end{array} \right) \middle| a_i \in (Z^+ \cup \{0\}) (L_{17}(8) \times$$

$L_5(2) \times L_{27}(11))\}, 1 \leq i \leq 30\}$ be the NA subset semiring.

Study questions (i) and (iii) of problem 3 for this S.

12. Let $S = \{\text{Collection of all subsets from the NA super matrix semiring}$

$$M = \left\{ \left[\begin{array}{cc|cc|c} a_1 & a_2 & a_3 & a_4 & a_5 \\ a_6 & \dots & \dots & \dots & \dots \\ a_{11} & \dots & \dots & \dots & \dots \\ a_{16} & \dots & \dots & \dots & \dots \\ \hline a_{21} & \dots & \dots & \dots & \dots \\ a_{26} & \dots & \dots & \dots & \dots \\ \hline a_{31} & \dots & \dots & \dots & \dots \\ a_{36} & \dots & \dots & \dots & \dots \\ \hline a_{41} & \dots & \dots & \dots & \dots \end{array} \right] \middle| a_i \in (Z^+ \cup \{0\}) (L_7(3) \times$$

$G_1 \times G_2 \times L_{21}(11))\}, 1 \leq i \leq 45\}$ be the subset NA semiring.

Study questions (i) and (iii) of problem 3 for this S.

13. Let $S = \{\text{Collection of all subsets from the NA matrix semiring}$

$$P = \left\{ \begin{array}{c|c|c|c|c|c|c|c} a_1 & a_2 & a_3 & a_4 & a_5 & a_6 & a_7 & a_8 \\ \hline a_9 & \dots & \dots & \dots & \dots & \dots & \dots & a_{16} \\ \hline a_{17} & \dots & \dots & \dots & \dots & \dots & \dots & a_{24} \\ \hline a_{25} & \dots & \dots & \dots & \dots & \dots & \dots & a_{32} \\ \hline a_{33} & \dots & \dots & \dots & \dots & \dots & \dots & a_{40} \\ \hline a_{41} & \dots & \dots & \dots & \dots & \dots & \dots & a_{48} \\ \hline a_{49} & \dots & \dots & \dots & \dots & \dots & \dots & a_{56} \\ \hline a_{57} & \dots & \dots & \dots & \dots & \dots & \dots & a_{64} \end{array} \right\} \quad a_i \in$$

$(Z^+ \cup \{0\}) (L_9(8) \times L_{13}(12) \times L_{17}(16)), 1 \leq i \leq 64\}$ be the NA subset semiring.

- (i) Prove S satisfies a S-special identity.
 - (ii) Study questions (i) and (iii) of problem 3 for this S.
14. Characterize those NA subset semirings that satisfy S left alternative identity.
15. Characterize those NA subset semirings that satisfy the S-right alternative identity.
16. Does there exist an infinite NA subset semiring that satisfies S-Bruck identity?
17. Does there exist an infinite NA subset semiring that satisfies S-Bol identity?
18. Does there exist an infinite NA subset semiring that satisfies S-Moufang identity?

19. Let $S = \{\text{Collection of all subsets from the NA semiring } M = \left\{ \sum_{i=0}^{\infty} a_i x^i \mid a_i \in (\mathbb{Z}^+ \cup \{0\}) L_{93}(8) \right\} \}$ be the NA subset semiring.

Study questions (i) and (iii) of problem 3 for this S .

20. Let $S = \{\text{Collection of all subsets from the NA semiring } M = \left\{ \sum_{i=0}^{\infty} a_i x^i \mid a_i \in \langle \mathbb{Q}^+ \cup \{0\} \cup \mathbb{I} \rangle G_1 \times G_2; G_1 = \{\mathbb{Z}_9, *, (3, 0)\} \text{ and } G_2 = \{\mathbb{C}(\mathbb{Z}_{12}), *, (10, 2)\} \right\} \}$ be the NA subset semiring.

Study questions (i) and (iii) of problem 3 for this S .

21. Does there exist a S -subset NA strongly non commutative semiring?
22. Let $S = \{\text{Collection of all subsets from the NA semiring } B = LG \text{ where } G = \{\mathbb{Z}_{20}, *, (10, 0)\} \text{ and } L =$

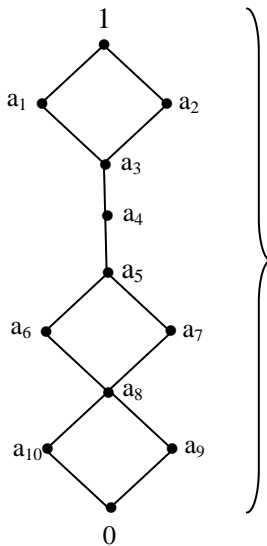

be the subset NA semiring.

- (i) Find $o(S)$.
 - (ii) Find $T_s, T_o, T_{\cup}^+, T_{\cap}^+, T_{\cup}^{\times}$ and T_{\cap}^{\times} .
 - (iii) Prove T_s, T_{\cup}^{\times} and T_{\cap}^{\times} are both non associative and non commutative.
 - (iv) Prove T_s, T_{\cup}^{\times} and T_{\cap}^{\times} contain subset topological zero divisors.
 - (v) Prove all the six spaces contain topological subset idempotents.
 - (vi) Find atleast three subset NA topological subspaces for all the 6 topological spaces.
23. Let $S = \{\text{Collection of all subsets from the NA loop semiring } LL_{15}(8)\}$ be the NA subset semiring where L is a Boolean algebra of order 2^8 .
- (i) Study questions (i) to (vi) of problem 22 for this S .
 - (ii) Prove all the six topological spaces are commutative.
24. Let $S = \{\text{Collection of all subsets from the NA loop semiring } LL_{25}(8)\}$ be the NA subset semiring.
- Study questions (i) to (vi) of problem 22 for this S .
25. Let $S = \{\text{Collection of all subsets from the NA semiring } L(G_1 \times G_2) \text{ with } L =$

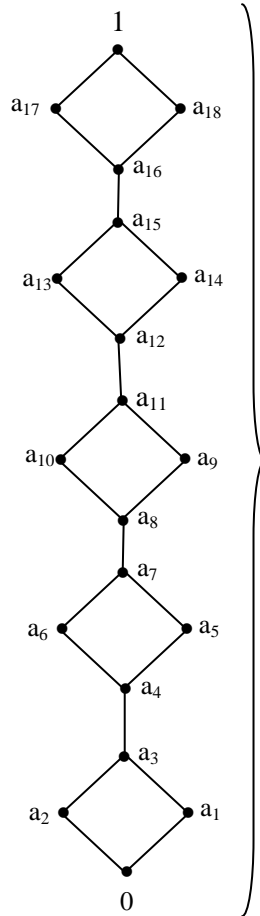

and $G_1 = \{\langle \mathbb{Z}_{40} \cup I \rangle, *, (20, 20I)\}$ and $G = \{C(\mathbb{Z}_{12}), *, (6, 3)\}$ be the NA subset semiring.

Study questions (i) to (vi) of problem 22 for this S.

26. Let $S = \{\text{Collection of all subsets from the NA subset semiring } (L_1 \times L_2) L_{231}(2)\}$ be the NA subset semiring; with

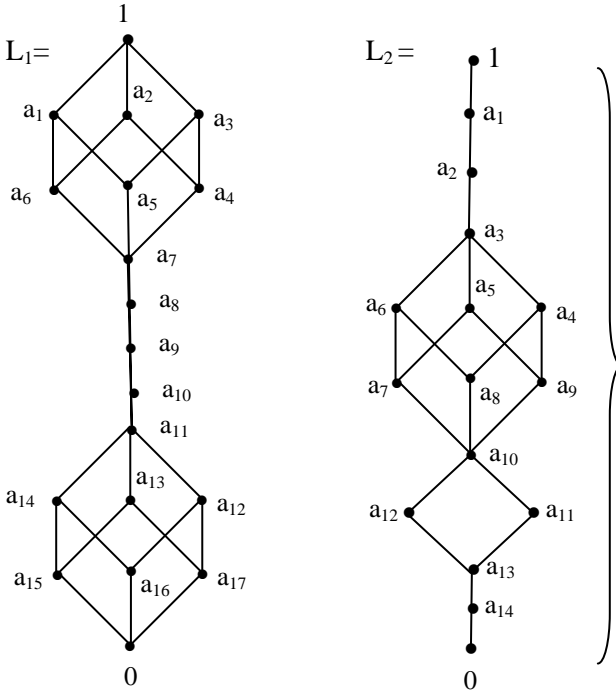

Study questions (i) to (vi) of problem 22 for this S .

27. Let $S = \{\text{Collection of all subsets from the NA semiring } M = \{(a_1 a_2 a_3) \mid a_i \in LG \text{ with } L = \}$

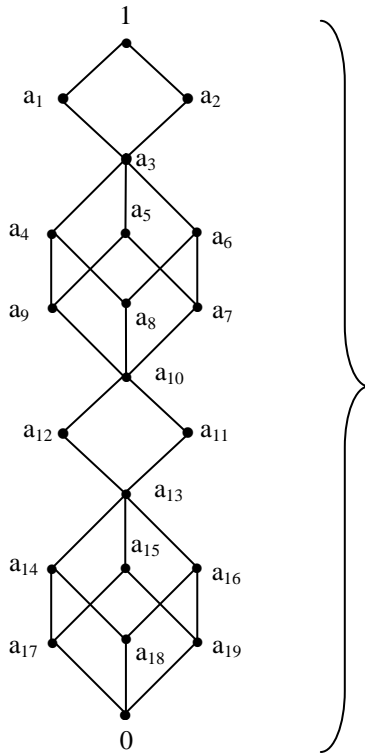

and $G = \{C(\mathbb{Z}_{24}), *, (12, 12i_F)\}$ be the subset NA semiring.

Study questions (i) to (vi) of problem 22 for this S.

28. Let $S = \{\text{Collection of all subsets from matrix groupoid lattice}\}$

$$M = \left\{ \left[\begin{array}{c} a_1 \\ a_2 \\ a_3 \\ \vdots \\ a_{15} \end{array} \right] \mid a_i \in (L_7(3) \times C) \text{ with } L = \right.$$

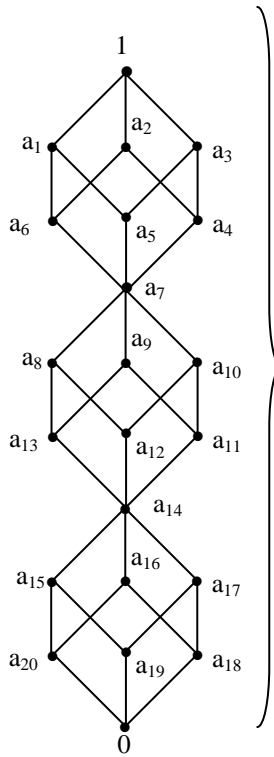

and $G = \{C(\mathbb{Z}_7), *, ((0, 4i_F))\}$ be the NA subset semiring.

Study questions (i) to (vi) of problem 22 for this S.

Can S have subset zero divisors?

29. Let $S = \{\text{Collection of all subsets from the NA matrix semiring}\}$

$$M = \left\{ \begin{bmatrix} a_1 & a_2 & a_3 & a_4 \\ a_5 & a_6 & a_7 & a_8 \\ a_9 & a_{10} & a_{11} & a_{12} \\ a_{13} & a_{14} & a_{15} & a_{16} \end{bmatrix} \mid a_i \in LL_{29}(2); 1 \leq i \leq 16 \right\}$$

be the NA subset semiring.

- (i) Study questions (i) to (vi) of problem 22 for this S.
- (ii) Prove S has subset zero divisors.
- (iii) Prove all the subset topological spaces satisfy a S-special identity.

30. Let $S = \{ \text{Collection of all subsets from the non associative semiring } L (G_1 \times G_2) \text{ with } L =$

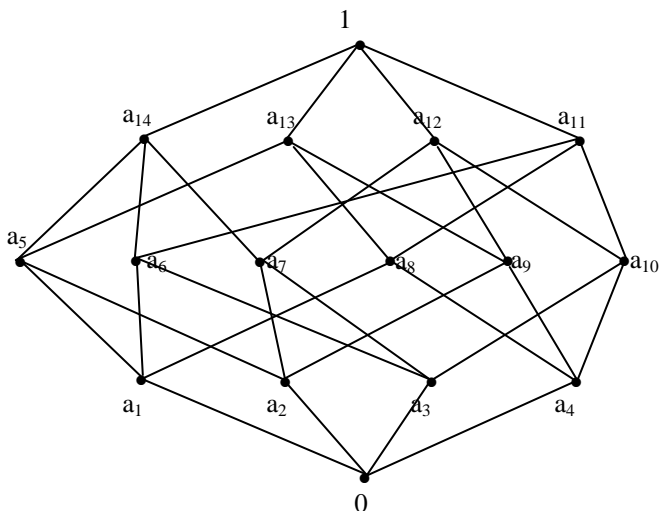

and $G_1 = \{ (C(Z_{12}), *, (4, 4i_F)) \}$ and $G_2 = \{ (Z_{12} \cup I, *, (4I, 4)) \}$ be the NA subset semiring.

Study questions (i) to (vi) of problem 22 for this S.

31. Let $S = \{ \text{Collection of all subsets from the NA semiring}$

$$M = \left\{ \begin{bmatrix} a_1 & a_2 & a_3 & a_4 \\ a_5 & a_6 & a_7 & a_8 \\ \vdots & \vdots & \vdots & \vdots \\ a_{61} & a_{62} & a_{63} & a_{64} \end{bmatrix} \mid a_i \in LL_9(2), 1 \leq i \leq 64 \right\}$$

be the NA-subset semiring.

- (i) Study questions (i) to (vi) of problem 22 for this S.

- (ii) Prove the topological spaces T_s , T_{\cup}^{\times} and T_{\cap}^{\times} are S-NA subsemiring right alternative topological spaces.
- (iii) Find the trees associated with these topological spaces.

32. Let $S = \{\text{Collection of all subsets from the NA semiring LG where } G = \{\mathbb{Z}_{12}, *, (4, 0)\} \text{ and } L \text{ is a lattice}\}$

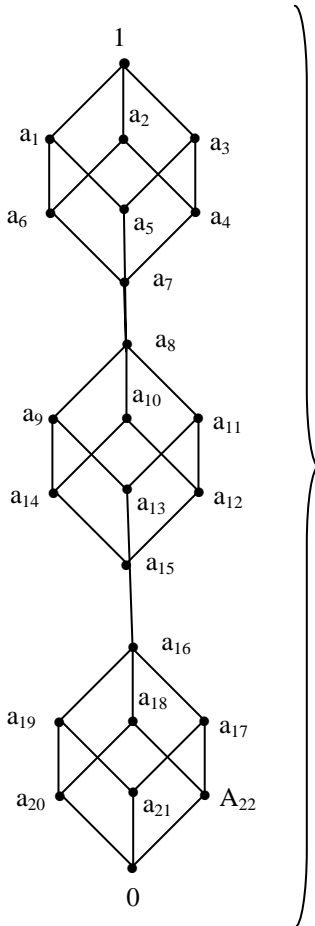

be the NA subset semiring.

- (i) Study questions (i) to (vi) of problem 22 for this S .

(ii) Prove the topological spaces T_s , T_{\cup}^{\times} and T_{\cap}^{\times} are all S-alternative subset NA semiring topological spaces of S.

33. Let $S = \{\text{Collection of all subsets from the NA semiring}$

$$M = \left\{ \begin{bmatrix} a_1 \\ a_2 \\ a_3 \\ \vdots \\ a_{19} \end{bmatrix} \mid a_i \in LL_{29}(28); 1 \leq i \leq 19 \right\} \text{ be the NA subset}$$

semiring where $L =$

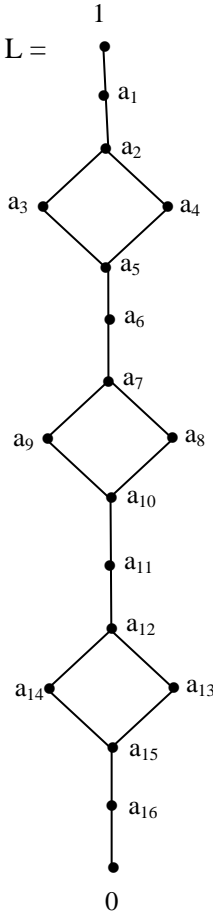

- (i) Study questions (i) to (vi) of problem 22 for this S.
 - (ii) Does the topological spaces T_{\cup}^{\times} , T_{\cap}^{\times} and T_s satisfy any of the special identities?
34. Let $S_1 = \{\text{Collection of all subsets from the NA semiring LG where } G = \{\mathbb{Z}_{29}, *, (11, 11)\} \text{ and L is as in problem 33}\}$ be the subset NA semiring.
- (i) Study questions (i) to (vi) of problem 22 for this S.
 - (ii) Compare S in 33 with S_1 in 34.
35. Obtain some special features associated with set ideal subset NA semiring topological spaces defined over subrings of a ring.
36. Study problem 35 when the subrings are replaced by subsemirings of a semiring ${}_P T_{\cup}^{\times}$, ${}_P T_{\cap}^{\times}$ and ${}_P T_s$.
37. Can these spaces satisfy Bruck identity? (P_i a subring of a ring or a subsemiring of a semiring over which S is built).
38. Can these set ideal subset NA semiring topological spaces T_{\cap}^+ , T_{\cup}^{\times} and T_s satisfy left alternative identity and not right alternative identity?
39. Give an example of a NA subset semiring S of infinite order which satisfies Smarandache strong Bruck identity.
40. Give an example of a NA subset semiring S of infinite order which satisfies S-strong Moufang identity.
41. Give an example of a subset NA semiring S of finite order which satisfies the Bol identity.
42. Is it ever possible to have a subset NA semiring which satisfies more than one special identity?

43. Prove there exists subset NA semirings which satisfies alternative identity and is also a P-subset NA semiring.
44. Let $S = \{\text{Collection of all subsets from the NA ring } R = \mathbb{Z}_{25}L_{11}(3)\}$ be the NA subset semiring.
- (i) Find all the subrings of R.
 - (ii) Find how many subset set ideal NA semiring topological spaces of S over the subrings of R be constructed?
 - (iii) Find the order of the smallest space and the order of the largest space in question (ii).
 - (iv) Does these spaces satisfy any special identity?
 - (v) Compare the subspaces of T_s , T_{\cap}^+ and T_{\cup}^{\times} with these space in (ii).

45. Let $S = \{\text{Collection of all subsets from the NA ring } R = \mathbb{Z}_{48}G \text{ where } G = \{\mathbb{Z}_{30}, *, (6, 0)\}\}$ be the subset NA semiring.

Study questions (i) to (v) of problem 44 for this S.

46. Let $S = \{\text{Collection of all subsets from the NA ring } R = \mathbb{Z}_{47}(G_1 \times G_2) \text{ where } G_1 = \{\mathbb{Z}_{10}, *, (0, 5)\} \text{ and } G_2 = \{\mathbb{Z}_6, (0, 3), *\}\}$ be the NA subset semiring.

Study questions (i) to (v) of problem 44 for this S.

47. Let $S = \{\text{Collection of all subsets from the NA ring } (\mathbb{Z}_{29} \times \mathbb{Z}_{31})G \text{ where } G = \{\mathbb{Z}_{42}, *, (10, 10)\}\}$ be the subset NA semiring.

Study questions (i) to (v) of problem 44 for this S.

48. Let $S = \{\text{Collection of all subsets from the NA ring } RG \text{ where } G = \{\mathbb{Z}_{50}, *, (25, 0)\}\}$ be the NA subset semiring.
- (i) Study questions (i) to (v) of problem 44 for this S.
 - (ii) Show RG has infinite number of subrings.

49. Let $S = \{\text{Collection of all subsets from the NA ring } R = \mathbb{Z}_{45} L_{45}(44)\}$ be the subset NA semiring.

- (i) Study questions (i) to (v) of problem 44 for this S.
- (ii) Is S a S-left alternative subset NA semiring?

50. Let $S = \{\text{Collection of all subsets from the NA ring } \mathbb{Z}_{13} L_{13}(12)\}$ be the subset NA semiring.

Study questions (i) to (v) of problem 44 for this S.

51. Let $S = \{\text{Collection of all subsets from the NA ring } R = \mathbb{Z}_{15} (G \times L_{15}(8)) \text{ where } G = \{\mathbb{Z}_{15}, *, (10, 0)\}\}$ be the NA subset semiring.

Study questions (i) to (v) of problem 44 for this S.

52. Let $S = \{\text{Collection of all subsets from the NA semiring } P = (\mathbb{Z}^+ \cup \{0\})L_{27}(8)\}$ be the subset NA semiring.

- (i) Show P has infinite number of subsemirings.
- (ii) Find set ideal subset NA topological semiring spaces over these subsemirings of P.
- (iii) Does S satisfy any special identity?
- (iv) Find subspaces of the spaces in (ii).

53. Let $S = \{\text{Collection of all subsets from the NA semiring } P = (\mathbb{Q}^+ \cup \mathbb{I} \cup \{0\})L_{29}(28)\}$ be the NA subset semiring.

Study questions (i) to (iv) of problem 52 for this S.

54. Let $S = \{\text{Collection of all subsets from the NA semiring } P = (\mathbb{R}^+ \cup \{0\})G \text{ where } G = \{\mathbb{Z}_{20}, *, (5, 0)\}\}$ be the NA subset semiring.

Study questions (i) to (iv) of problem 52 for this S.

55. Let $S = \{\text{Collection of all subsets from the NA semiring } P = (Q^+ \cup \{0\}) (G_1 \times G_2) \text{ where } G_1 = \{Z_{40}, *, (10, 10)\} \text{ and } G_2 = \{Z_{55}, *, (11, 0)\}\}$ be the NA subset semiring.

Study questions (i) to (iv) of problem 52 for this S.

56. Let $S = \{\text{Collection of all subsets from the NA semiring } P = (R^+ \cup \{0\}) (L_{23}(22) \times L_{35}(34))\}$ be the NA subset semiring.

Study questions (i) to (iv) of problem 52 for this S.

57. Let $S_1 = \{\text{Collection of all subsets from the NA semiring } P = (R^+ \cup \{0\}) (L_{23}(2) \times L_{35}(2))\}$ be the NA subset semiring.

Study questions (i) to (iv) of problem 52 for this S.

Compare S of problem 56 with S_1 of problem 57.

58. Let $S = \{\text{Collection of all subsets from the NA semiring } P = (Q^+ \cup \{0\}) (G_1 \times G_2) \text{ where } G_1 = \{Z_{16}, *, (4, 0)\} \text{ and } G_2 = \{Z_{16}, *, (0, 4)\}\}$ be the NA subset semiring of P.

Study questions (i) to (iv) of problem 52 for this S.

59. Let $S = \{\text{Collection of all subsets from the NA semiring } P = (Z^+ \cup I \cup \{0\}) (G_1 \times G_2 \times G_3) \text{ where } G_1 = \{Z_{24}, *, (12, 0)\}, G_2 = \{Z_{24}, *, (0, 24)\}, \text{ and } G_3 = \{Z_{24}, *, (12, 12)\}\}$ be the NA subset semiring.

Study questions (i) to (iv) of problem 52 for this S.

60. Let $S = \{\text{Collection of all subsets from the NA semiring } P = (Z^+ \cup I \cup \{0\}) (R^+ \cup \{0\}) (G_1 \times L_{27}(8))\}$ be the NA subset semiring.

Study questions (i) to (iv) of problem 52 for this S.

61. Let $S = \{\text{Collection of all subsets from the NA semiring LG where } L =$

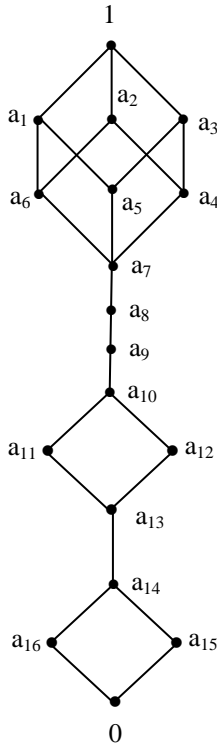

$G = \{C(Z_{21}), *, (7, 14)\}$ be the subset NA semiring.

- (i) Study questions (i) to (iv) of problem 52 for this S .
 - (ii) Find $o(S)$.
62. Let $S = \{\text{Collection of all subsets from the NA semiring } (\langle R^+ \cup I \rangle \cup \{0\}) (G_1 \times_{L_{27}}(26)) \text{ where } G_1 = \{Z_{27}, *, (26, 1)\}\}$ be the subset NA semiring.

Study questions (i) to (iv) of problem 52 for this S .

63. Let $S = \{\text{Collection of all subsets from the NA semiring LG where } L \text{ is a Boolean algebra of order } 256 \text{ and } G = \{Z_{10}, *, (5, 0)\}$ be the groupoid} be the NA subset semiring.

Study questions (i) to (iv) of problem 52 for this S.

64. Let $S = \{\text{Collection of all subsets from the NA ring } ZG \text{ where } G = \{Z_{16}, *, (4, 12)\}\}$ be the subset NA semiring.

Study questions (i) to (iv) of problem 52 for this S.

65. Let $S = \{\text{Collection of all subsets from the NA matrix}$

$$\text{semiring } M = \left\{ \left[\begin{array}{cc} [a_1, b_1] & [a_2, b_2] \\ [a_3, b_3] & [a_4, b_4] \\ \vdots & \vdots \\ [a_{13}, b_{13}] & [a_{14}, b_{14}] \end{array} \right] \mid a_i, b_i \in \langle Q \cup \{I\} \rangle \right\}$$

$L_{27}(2), 1 \leq i \leq 14\}$ be the subset NA semiring.

Study questions (i) to (iv) of problem 52 for this S.

66. Let $S = \{\text{Collection of all subsets from the NA matrix semiring } M = \{([a_1, b_1], [a_2, b_2], [a_3, b_3], \dots, [a_{10}, b_{10}]) \mid a_i, b_i \in Z_5L_{17}(3); 1 \leq i \leq 10\}\}$ be the NA subset semiring.

- (i) Study questions (i) to (iv) of problem 52 for this S.
- (ii) Find $o(S)$.
- (iii) Find the order of all special subset set ideal strong NA semiring topological spaces over subset subsemirings of S.

67. Let $S = \{\text{Collection of all subsets from the matrix NA semiring } M = \{(a_1 a_2 a_3 \mid a_4 \mid a_5 a_6 a_7 \mid a_8 a_9 \mid a_{10}) \mid a_i \in G \text{ where } G = \{Z_{10}, *, (3, 7)\}, 1 \leq i \leq 10\}\}$ be the subset NA semiring.

S has infinite number of subset subsemiring; so associated with each of the subset subsemiring we have an infinite number of strong special subset set ideal NA semiring topological subspaces over subset subsemirings; prove.

68. Obtain some special features enjoyed by the subset strong set ideal topological semiring spaces of S .
69. Let $S = \{\text{Collection of all subsets from the groupoid ring } Z_{10}G \text{ where } G = \{Z_{11}, *, (5, 2)\}\}$ be the subset NA semiring.
- (i) Find $o(S)$.
 - (ii) How many subset subsemiring does S contain?
 - (iii) Find the total number of subset set ideal strong NA topological spaces of S over the subset subsemirings of S .
 - (iv) Find the order of these spaces.

70. Let $S = \{\text{Collection of all subsets from the loop ring } Z_6L_9(2)\}$ be the subset NA semiring.

Study questions (i) to (iv) of problem 69 for this S .

71. Let $S = \{\text{Collection of all subsets from the loop ring } Z_{11}L_{11}(3)\}$ be the NA subset semiring.

Study questions (i) to (iv) of problem 69 for this S .

72. Let $S = \{\text{Collection of all subsets from the groupoid ring } Z_{12}G \text{ where } G = \{Z_{10}, *, (6, 4)\}\}$ be the NA subset semiring.

Study questions (i) to (iv) of problem 69 for this S .

73. Let $S = \{\text{Collection of all subsets from the NA groupoid ring } Z_{10}G \text{ where } G = \{C(Z_5), *, (i_F, 0)\}\}$ be the subset NA semiring.

Study questions (i) to (iv) of problem 69 for this S .

74. Let $S = \{\text{Collection of all subsets from the loop semiring } LL_{27}(11)\}$ be the NA subset semiring where $L =$

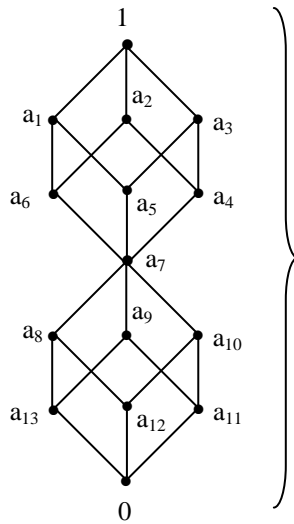

Study questions (i) to (iv) of problem 69 for this S.

75. Let $S = \{\text{Collection of all subsets from the loop semiring } LL_{19}(18) \text{ where } L =$

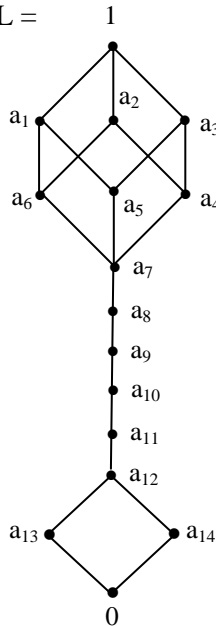

be the NA subset semiring.

Study questions (i) to (iv) of problem 69 for this S.

76. Let $S = \{\text{Collection of all subsets from the groupoid semiring LG where } G = \{\mathbb{Z}_{12}, *, (6, 0)\} \text{ and } L =$

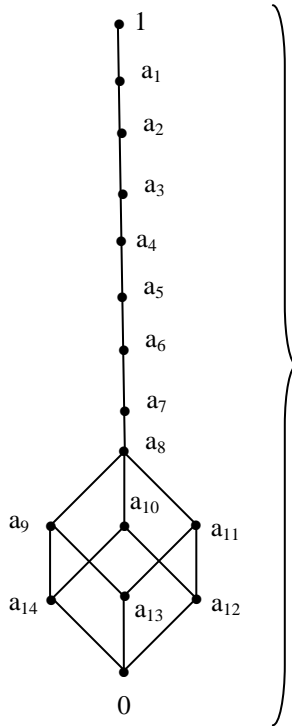

Be the subset NA semiring.

Study questions (i) to (iv) of problem 69 for this S.

77. Let $S = \{\text{Collection of all subsets from the matrix NA}$

$$\text{ring } M = \left\{ \begin{bmatrix} a_1 \\ a_2 \\ a_3 \\ a_4 \end{bmatrix} \mid a_i \in \mathbb{Z}_5 L_7(3); 1 \leq i \leq 4 \right\} \text{ be the subset}$$

NA semiring.

Study questions (i) to (iv) of problem 69 for this S.

78. Let $S = \{\text{Collection of all subsets from the matrix NA}$

$$\text{semiring } M = \left\{ \left[\begin{array}{c} a_1 \\ a_2 \\ \vdots \\ a_{15} \end{array} \right] \mid a_i \in \mathbb{Z}_{43}L_{43}(42); 1 \leq i \leq 15 \right\} \text{ be}$$

the NA subset semiring.

Study questions (i) to (iv) of problem 69 for this S.

79. Let $S = \{\text{Collection of all subsets from the matrix NA}$

$$\text{ring } M = \left\{ \left[\begin{array}{cccc} a_1 & a_2 & a_3 & a_4 \\ a_5 & a_6 & a_7 & a_8 \\ a_9 & a_{10} & a_{11} & a_{12} \\ a_{13} & a_{14} & a_{15} & a_{16} \end{array} \right] \mid a_i \in \mathbb{Z}_7L_{25}(8); \right.$$

$1 \leq i \leq 16\} \}$ be the subset NA semiring.

Study questions (i) to (iv) of problem 69 for this S.

80. Let $S = \{\text{Collection of all subsets from the matrix NA semiring}$

$$M = \left\{ \left[\begin{array}{cccc} a_1 & a_2 & \dots & a_{15} \\ a_{16} & a_{17} & \dots & a_{30} \\ a_{31} & a_{32} & \dots & a_{45} \\ a_{46} & a_{47} & \dots & a_{60} \end{array} \right] \mid a_i \in LL_{29}(8); 1 \leq i \leq 60 \right\}$$

where $L =$

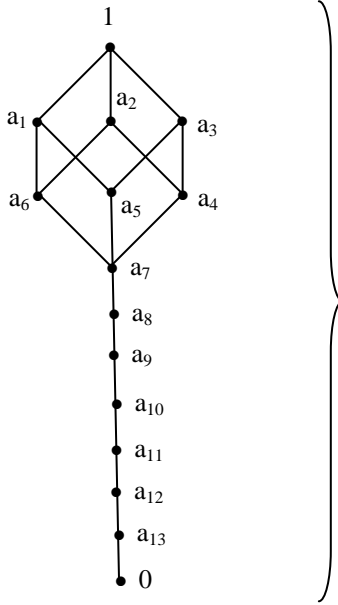

be the NA subset semiring.

Study questions (i) to (iv) of problem 69 for this S.

81. Let $S = \{\text{Collection of all subsets from the matrix NA}\}$

$$\text{semiring } M = \left\{ \left[\begin{array}{c|c|c|c} a_1 & a_2 & a_3 & a_4 \\ \hline a_5 & \dots & \dots & a_8 \\ a_9 & \dots & \dots & a_{12} \\ \hline a_{13} & \dots & \dots & a_{16} \\ \hline a_{17} & \dots & \dots & a_{20} \\ a_{21} & \dots & \dots & a_{24} \\ \hline a_{25} & \dots & \dots & a_{28} \end{array} \right] \mid a_i \in LL_7(3) \right\}$$

$1 \leq i \leq 28$; and $L =$

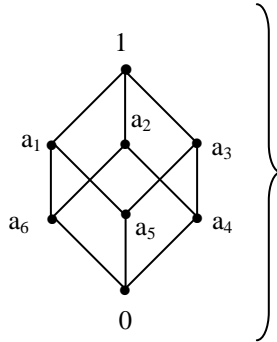

be the NA subset semiring.

Study questions (i) to (iv) of problem 69 for this S.

82. Let $S = \{\text{Collection of all subsets of the NA interval matrix ring}\}$

$$M = \left\{ \begin{bmatrix} [a_1, b_1] \\ [a_2, b_2] \\ \vdots \\ [a_{10}, b_{10}] \end{bmatrix} \mid a_i \in \mathbb{Z}_{15}L_{29}(15); 1 \leq i \leq 10 \right\}$$

subset NA semiring.

Study questions (i) to (iv) of problem 69 for this S.

83. Let $S = \{\text{Collection of all subsets from the interval matrix NA semiring } M = \{([a_1, b_1], [a_2, b_2], \dots, [a_{12}, b_{12}]) \mid a_i, b_i \in LL_{91}(2); 1 \leq i \leq 12\}\}$ be the subset NA semiring where L is a chain lattice C_{21} .

- (i) Find $o(S)$.
- (ii) Find the number of subset subsemirings of S.
- (iii) Find all subset set ideal strong NA semiring topological spaces associated with subset subsemiring of S in (ii).
- (iv) Do these topological spaces have subspaces?

(v) Find atleast 3 subspaces of each of the topological spaces.

84. Let $S = \{\text{Collection of all subsets from the interval matrix of the NA interval matrix semiring}\}$

$$M = \left\{ \begin{bmatrix} [a_1, b_1] \\ [a_2, b_2] \\ \vdots \\ [a_{15}, b_{15}] \end{bmatrix} \mid a_i, b_i \in LG \text{ where} \right.$$

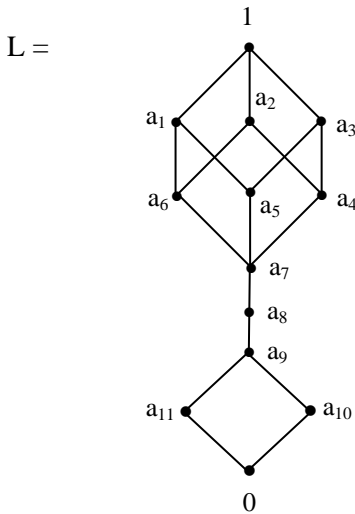

and $G = \{C(\mathbb{Z}_{12}), *, (3i_F, 0)\}, 1 \leq i \leq 15\}$ be the NA subset semiring.

Study questions (i) to (v) of problem 83 for this S .

85. Let $S = \{\text{Collection of all subsets from the interval matrix NA semiring}\}$

$$M = \left\{ \begin{bmatrix} [a_1, b_1] & [a_2, b_2] & [a_3, b_3] \\ \vdots & \vdots & \vdots \\ [a_{28}, b_{28}] & [a_{29}, b_{29}] & [a_{30}, b_{30}] \end{bmatrix} \mid \text{where } a_i, b_i \in \right.$$

LG where L =

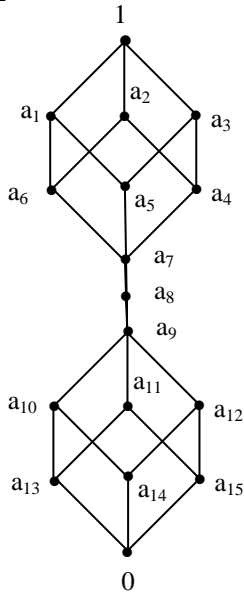

and $G = \{Z_{15}, *, (5, 10)\}$ the subset interval matrix NA semiring.

Study questions (i) to (v) of problem 83 for this S.

86. Let $S = \{\text{Collection of all subsets from the NA matrix interval semiring}\}$

$$M = \left\{ \left[\begin{array}{ccc} [a_1, b_1] & [a_2, b_2] & [a_3, b_3] \\ [a_4, b_4] & [a_5, b_5] & [a_6, b_6] \\ [a_7, b_7] & [a_8, b_8] & [a_9, b_9] \end{array} \right] \middle| a_i, b_i \in \right.$$

$L(G \times L_9(5))$ where $L =$

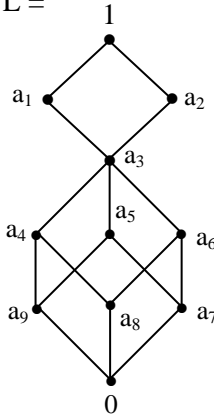

and $G = \{C(Z_6), *, (3, 0), 1 \leq i \leq 9\}$ be the subset interval NA semiring of finite order.

Study questions (i) to (v) of problem 83 for this S.

87. Let $S = \{\text{Collection of all subsets from the NA matrix ring } M =$

$$\left\{ \left[\begin{array}{c|c|c|c|c|c|c} [a_1, b_1] & [a_2, b_2] & [a_3, b_3] & [a_4, b_4] & [a_5, b_5] & [a_6, b_6] & [a_7, b_7] \\ \hline [a_8, b_8] & \dots & \dots & \dots & \dots & \dots & [a_{14}, b_{14}] \end{array} \right] \right\}$$

$a_i, b_i \in C(Z_{20}), L_{19}(8); 1 \leq i \leq 14\}$ be the subset interval NA semiring of finite order.

Study questions (i) to (v) of problem 83 for this S.

88. Does there exists a NA subset semiring such that none of its set ideal strong subset topological spaces over subsemirings have subtopological spaces?

89. Does there exist any subset NA semiring which has no subset subsemiring?
90. Let $M = \{\text{Collection of all subsets from the NA semiring } (L \times L \times L) (L_9(8) \times L_9(2) \times L_9(5) \text{ where } L \text{ is a Boolean algebra of order } 64)\}$ be the NA subset semiring.
- (i) Find $o(S)$.
 - (ii) Find every subset NA subsemirings.
 - (iii) Find all subset subsemirings which are non associative.
 - (iv) Prove associated with S all subset strong set ideal NA topological semiring spaces are non associative.
 - (v) Prove S has subset zero divisors.
 - (vi) Prove S has subset idempotents.
 - (vii) Prove the topological spaces have subspaces A, B such that $A \times B = \{(0)\}$.

91. Let $S = \{\text{Collection of all subsets from the NA semiring } (L_1 \times L_2) (L_{11}(3) \times G \times L_9(5))\}$

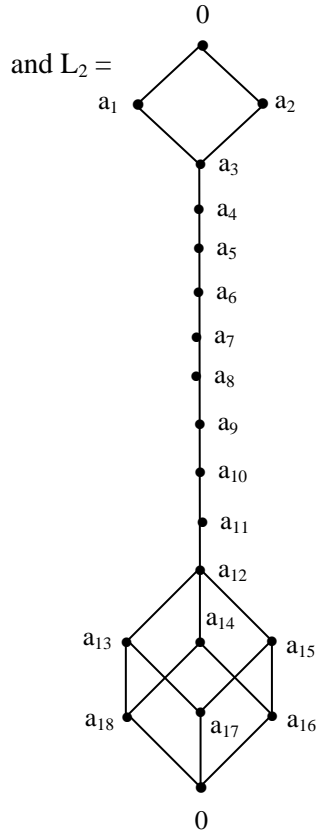
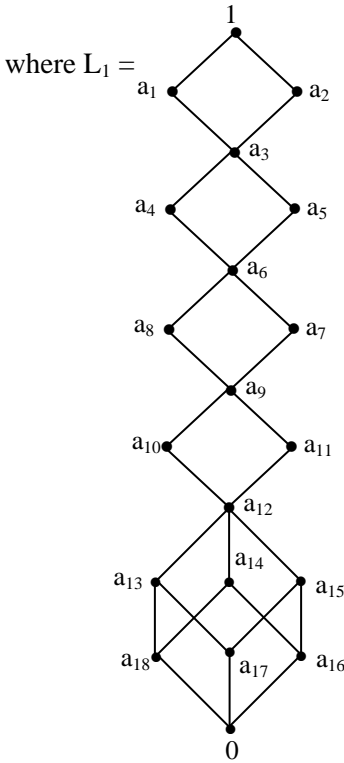

and $G = \{C(\langle Z_8 \cup I \rangle), *, (7i_F, 4I)\}$ be the NA subset semiring.

Study questions (i) to (vii) of problem 90 for this S .

FURTHER READING

1. Albert, A.A., *A structure theory for Jordan algebras*, Ann. Math(2), **48**, 546-567 (1947).
2. Albert, A.A., *Non-associative algebra I, II*, Ann. Math.(2), **43**, 685-707, (1942).
3. Baum J.D, *Elements of point set topology*, Prentice-Hall, N.J, 1964.
4. Bernavides, R., Burgueno and Costa, Mallol R., *Some algebras of order four*, Int. J. Math. Game Theory and Algebra, **9**, 159-172 (1999).
5. Birkhoff. G, *Lattice theory*, 2nd Edition, Amer-Math Soc. Providence RI (1948).
6. Birkhoff. G., and Maclane, S.S., *A Brief Survey of Modern Algebra*, New York, The Macmillan and Co. (1965).
7. Bruck, R.H., *A Survey of binary systems*, Berlin Springer Verlag, (1958).
8. Bruck.R.H., *Some results in the theory of linear non-associative algebra*, Trans. Amer. Math. Soc., **56**, 141-199 (1944).
9. Castillo, J., *The Smarandache Semigroup*, International Conference on Combinatorial Methods in Mathematics, II Meeting of the project 'Algebra, Geometria e Combinatoria', Faculdade de Ciencias da Universidade do Porto, Portugal, 9-11 July 1998.
10. Chein, Orin and Goodaire, Edgar G., *Code loops are RA2-loops*, J. Algebra, **130**, 385-387 (1990).
11. Chein, Orin and Goodaire, Edgar G., *Is a right alternative loop ring alternative?*, Algebras, Groups and Geometries, **5**, 297-304 (1988).

12. Chein, Orin and Goodaire, Edgar G., *Loops whose Loop rings are alternative*, Comm. Algebra, **14**, 293-310 (1986).
13. Chein, Orin and Goodaire, Edgar G., *Loops whose loop rings in characteristic two are alternative*, Comm. Algebra, **18**, 659-688 (1990).
14. Chein, Orin and Goodaire, Edgar G., *Minimally non-associative Moufang loops with a unique non-identity commutator are ring alternative*, Comment Math. Univ. Carolinae, **43**, 1-8 (2002).
15. Chein, Orin and Goodaire, Edgar G., *Moufang loops with a unique non-identity commutators*, J. Algebra, **130**, 369-384 (1990).
16. Connell, I.G., *On the group ring*, Canadian J. Math., **15**, 650-667 (1936).
17. Costa, Roberto, Grishkov, Alexander, Guzzo Jr., Henrique and Peresi, A. Luiz, *Non-associative algebras and its applications*, Lecture notes in Pure and Applied Mathematics, **211**, Marcel Dekker, (2000).
18. De Graaf, Willem A., *Lie Algebras :Theory and Algorithms*, North-Holland Pub. Co., Amsterdam, (2000).
19. Elduque, Alberto and Hyo, C. Myung, *Mutations of alternative algebras*, Kluwer Acad. Pub., Boston, (1994).
20. Goodaire, Edgar G. and Parmenter, M.M., *Semi-simplicity of alternative loop rings*, Acta. Math. Hung, **50**, 241-247 (1987).
21. Goodaire, Edgar G. and Parmenter, M.M., *Units in Alternative loop rings*, Israel J. Math., **53**, 209-216 (1986).
22. Goodaire, Edgar G., *Alternative loop rings*, Publications Mathematical Tomus, **30**, 31-38 (1983).
23. Gray, Mary W., *A radical approach to algebra*, Addison-Wesley, (1970).
24. Hentzel, Irvin Roy, Jacobs, D.P., and Muddana, Sekhar V., *Experimenting with the identity $(xy)z = y(zx)$* , (1993)
25. Higman, G., *The units of group rings*, Proc. London Math. Soc., **46**, 231-248 (1940).

26. Iqbal Unnisa and Vasantha Kandasamy, W. B., *Supermodular lattices*, J. Madras Univ., **44**, 58-80 (1981).
27. Jacobson, F.D., and Jacobson, Nathan, *Classification and representation of semi simple Jordan Algebras*, Trans. Amer. Math. Soc., **65**, 141-169 (1949).
28. Jacobson, Nathan, *General representation theory of Jordan algebras*, Trans. Amer. Math. Soc., **70**, 509-530 (1951).
29. Johnson, P.L., *The modular group ring of a finite p-group*, Proc. Amer. Math. Soc., **68**, 19-22 (1978).
30. Padilla, R., *Smarandache Algebraic Structures*, Smarandache Notions Journal, USA, Vol.9, No. 1-2, 36-38, (1998).
31. Padilla, Raul, *Smarandache algebraic structures*, Bull. Pure Appl. Sci., **17E**, 199-121 (1998).
32. Passman D.S., *The algebraic structure of group rings*, Wiley Interscience, (1977).
33. R.Lidl and G. Pilz, *Applied Abstract Algebra*, Springer Verlag, (1984).
34. Simmons, G.F., *Introduction to topology and Modern Analysis*, McGraw-Hill Book 60 N.Y. (1963).
35. Singh.S.V., *On a new class of loops and loop rings*, PhD thesis (under the guidance of W.B.Vasantha) Indian Institute of Technology, Aug. 1994.
36. Smarandache, Florentin, *Neutrosophic Logic, A Generalization of the Fuzzy Logic*, <http://gallup.unm.edu/~smarandache/NeutLog.txt>
37. Smarandache, Florentin, *Special Algebraic Structures, in Collected Papers III*, Abaddaba, Oradea, 78-81, 2000.
38. Smarandache. F. (editor), *Proceedings of the First International Conference on Neutrosophy*, Neutrosophic Probability and Statistics, Univ. of New Mexico-Gallup, 2001.
39. Solarin, A.R.T, *A short note on Bol algebras*, Riv. Mat. Pure. Appl., **8**, 7-11 (1988).

40. Springer, T.A., *Jordan algebras and algebraic groups*, Springer-Verlag, (1973).
41. Strojnowski, A., *A note on unique product groups*, Comm. Algebra, **8**, 235-260 (1980).
42. Sze Tsen Hu, *Elements of General Topology*, Holden Day Inc, (1970).
43. Vasantha Kandasamy, W. B., *On zero divisors in reduced group rings over ordered rings*, Proc. Japan Acad., **60**, No.9, 333-334 (1984).
44. Vasantha Kandasamy, W. B., *A note on the modular group ring of a finite p -group*, Kyungpook Math. J., **26**, 163-166 (1986).
45. Vasantha Kandasamy, W. B., *Zero divisors in loop algebras of power associative and di associative loops*, Acta Politechnica Prace, CVUT, Praze, **16**, 21-26 (1991).
46. Vasantha Kandasamy, W. B., *Idempotents in rational loop algebras*, Ganit, **12**, 53-56 (1992).
47. Vasantha Kandasamy, W. B., *On normal elements in loop rings*, U. Sci. Phys. Sci., **4**, 210-212 (1992).
48. Vasantha Kandasamy, W. B., *Units in loop rings*, U. Sci. Phys. Sci., **5**, 86-88 (1993).
49. Vasantha Kandasamy, W. B., *On strictly right loop rings*, J. Harbin Inst. Sci. Tech., **18**, 116-118 (1994).
50. Vasantha Kandasamy, W. B., *Semi idempotents in loop algebra*, J. Inst. Math. Comp. Sci., **7**, 241-244 (1994).
51. Vasantha Kandasamy, W. B., *A note on the modular loop ring of a finite loop*, Opuscula Math., **15**, 109-112 (1995).
52. Vasantha Kandasamy, W. B., *On loop rings which are Marot loop rings*, U. Sci Phys. Sci., **7**, 224-226 (1995).
53. Vasantha Kandasamy, W. B., *On ordered groupoids and groupoid rings*, J. Math. and Comp. Sci., **9**, 145-147, (1996).
54. Vasantha Kandasamy, W. B., *Loop algebras of Moufang loops*, Math Forum, **11**, 21-25 (1997).

55. Vasantha Kandasamy, W. B., *On a new class of Jordan loops and their loop rings*, J. Bihar Math. Soc., **19**, 71-75 (1999).
56. Vasantha Kandasamy, W. B., *New classes of finite groupoids using Z_n* , Varahmihir J. Math. Sci., **1**, 135-143 (2001).
57. Vasantha Kandasamy, W. B., *Smarandache non associative rings*, American Research Press, (2001)
58. Vasantha Kandasamy, W. B., *On Smarandache Non-Associative rings*, (2002).
59. Vasantha Kandasamy, W. B., *Smarandache groupoids*, American Research Press, Rehoboth, (2002).
60. Vasantha Kandasamy, W. B., *Smarandache Loops*, American Research Press, Rehoboth, (2002).
61. Vasantha Kandasamy, W. B., *Smarandache Loops*, Smarandache Notions Journal, **13**, 252-258 (2002).
62. Vasantha Kandasamy, W.B., *Smarandache Rings*, American Research Press, Rehoboth, (2002).
63. Vasantha Kandasamy, W.B., *Smarandache Semigroups*, American Research Press, Rehoboth, (2002).
64. Vasantha Kandasamy, W.B., *Smarandache Semirings, Semifields and Semivector spaces*, American Research Press, Rehoboth, (2002).
65. Vasantha Kandasamy, W.B., *Linear Algebra and Smarandache Linear Algebra*, Bookman Publishing, US, (2003).
66. Vasantha Kandasamy, W.B. and Florentin Smarandache, *Neutrosophic Rings*, Hexis, Arizona, (2006).
67. Vasantha Kandasamy, W.B., and Smarandache, Florentin, *Fuzzy Interval Matrices, Neutrosophic Interval Matrices and their Applications*, Hexis, Phoenix, (2006).
68. Vasantha Kandasamy, W.B. and Florentin Smarandache, *Set Linear Algebra and Set Fuzzy Linear Algebra*, InfoLearnQuest, Phoenix, (2008).
69. Vasantha Kandasamy, W.B. and Florentin Smarandache, *Finite Neutrosophic Complex Numbers*, Zip Publishing, Ohio, (2011).

70. Vasantha Kandasamy, W.B. and Florentin Smarandache, *Dual Numbers*, Zip Publishing, Ohio, (2012).
71. Vasantha Kandasamy, W.B. and Florentin Smarandache, *Natural Product \times_n on matrices*, Zip Publishing, Ohio, (2012).
72. Vasantha Kandasamy, W.B. and Florentin Smarandache, *Quasi Set Topological Vector Subspaces*, Educational Publisher Inc, Ohio, (2012).
73. Vasantha Kandasamy, W.B. and Florentin Smarandache, *Set Ideal Topological Spaces*, Zip Publishing, Ohio, (2012).
74. Vasantha Kandasamy, W.B. and Florentin Smarandache, *Special dual like numbers and lattices*, Zip Publishing, Ohio, (2012).
75. Vasantha Kandasamy, W.B. and Florentin Smarandache, *Special quasi dual numbers and groupoids*, Zip Publishing, Ohio, (2012).
76. Vasantha Kandasamy, W.B. and Florentin Smarandache, *Algebraic Structures using Subsets*, Educational Publisher Inc, Ohio, (2013).
77. Vasantha Kandasamy, W.B. and Florentin Smarandache, *Subset Polynomial Semirings and Subset Matrix Semirings*, Educational Publisher Inc, Ohio, (2013).
78. Vasantha Kandasamy, W.B. and Florentin Smarandache, *Subset Non Associative Semirings*, Educational Publisher Inc, Ohio, (2013).
79. Wan, Zhe-xian, *Lie algebras* (translated by Che Young Lee), Pergamon press, (1975).

INDEX

B

Bol identity, 11

C

Commutative groupoid, 7-12

Commutative loop, 15-6

F

Finite loop, 15-6

G

Groupoid ring, 27-8

Groupoid, 7-12

I

Ideal of a groupoid, 8-10

Interval matrix groupoid, 22-4

Interval subset groupoids, 26

L

- Left alternative identity, 12
- Left alternative loop, 15-6
- Left ideal of a groupoid, 8-10

M

- Moufang identity, 10
- Moufang loop, 15-6

N

- NA subset semiring P topological spaces of finite order, 143-8
- NA subset set ideal semiring topological spaces, 153-9
- Neutrosophic subset groupoids topological spaces, 38-42

R

- Real neutrosophic groupoid, 17-8
- Right alternative identity, 12
- Right alternative loop, 15-6
- Right ideal of a groupoid, 8-10

S

- S- alternative groupoid, 12-9
- S-Bol NA semiring topological spaces, 148-152
- S-commutative groupoid, 13-4
- S-idempotent groupoid, 14
- Smarandache alternative subset topological spaces, 65-9
- Smarandache Bol groupoid, 11-9
- Smarandache groupoid, 9-12
- Smarandache left alternative loop groupoid topological spaces, 65-9
- Smarandache P-groupoid, 11-9

- Smarandache right alternative loop groupoid topological spaces, 65-9
- Smarandache strictly non commutative loop groupoid topological spaces, 65-9
- Smarandache strong Bol groupoid, 11-9
- Smarandache strong P-groupoid, 11-9
- Smarandache subgroupoid, 10-15
- Smarandache WIP loop groupoid topological spaces, 68-72
- S-Moufang groupoid, 10-15
- S-NA subset semiring alternative topological spaces, 140-9
- S-NA subset semiring left alternative topological spaces, 140-9
- S-NA subset semiring right alternative topological spaces, 140-9
- S-NA subset semiring WIP topological spaces, 140-5
- Special subset groupoid non associative topological spaces, 33-8
- Special subset groupoid non commutative topological spaces, 33-9
- S-strong alternative groupoid, 12-9
- S-strong Bol NA semiring topological spaces, 148-152
- S-strong idempotent groupoid, 14
- S-strong idempotent NA semiring topological spaces, 150-9
- S-strong left alternative groupoid, 13-4
- S-strong Moufang groupoid, 10-8
- S-strong right alternative groupoid, 13-4
- S-subset NA Moufang semiring topological spaces, 146-9
- Subset groupoids, 26-35
- Subset loop groupoid topological spaces stratifying special Smarandache identity, 63-9
- Subset loop groupoid topological spaces, 58-65
- Subset loop groupoid, 58-65
- Subset non associative semiring topological spaces, 109-115
- Subset ring semiring topological spaces, 66-9
- Subset set ideal strong semiring topological spaces, 169-72
- Subset set ideal topological groupoid spaces, 77-9
- Subset topological zero divisors, 115-9
- Super matrix groupoid, 23-5

T

Trees associated with topological spaces, 73-5

U

Usual subset groupoid topological spaces, 33-8

ABOUT THE AUTHORS

Dr. W. B. Vasantha Kandasamy is a Professor in the Department of Mathematics, Indian Institute of Technology Madras, Chennai. In the past decade she has guided 13 Ph.D. scholars in the different fields of non-associative algebras, algebraic coding theory, transportation theory, fuzzy groups, and applications of fuzzy theory of the problems faced in chemical industries and cement industries. She has to her credit 646 research papers. She has guided over 100 M.Sc. and M.Tech. projects. She has worked in collaboration projects with the Indian Space Research Organization and with the Tamil Nadu State AIDS Control Society. She is presently working on a research project funded by the Board of Research in Nuclear Sciences, Government of India. This is her 89th book.

On India's 60th Independence Day, Dr. Vasantha was conferred the Kalpana Chawla Award for Courage and Daring Enterprise by the State Government of Tamil Nadu in recognition of her sustained fight for social justice in the Indian Institute of Technology (IIT) Madras and for her contribution to mathematics. The award, instituted in the memory of Indian-American astronaut Kalpana Chawla who died aboard Space Shuttle Columbia, carried a cash prize of five lakh rupees (the highest prize-money for any Indian award) and a gold medal.

She can be contacted at vasanthakandasamy@gmail.com

Web Site: http://mat.iitm.ac.in/home/wbv/public_html/

or <http://www.vasantha.in>

Dr. Florentin Smarandache is a Professor of Mathematics at the University of New Mexico in USA. He published over 75 books and 200 articles and notes in mathematics, physics, philosophy, psychology, rebus, literature. In mathematics his research is in number theory, non-Euclidean geometry, synthetic geometry, algebraic structures, statistics, neutrosophic logic and set (generalizations of fuzzy logic and set respectively), neutrosophic probability (generalization of classical and imprecise probability). Also, small contributions to nuclear and particle physics, information fusion, neutrosophy (a generalization of dialectics), law of sensations and stimuli, etc. He got the 2010 Telesio-Galilei Academy of Science Gold Medal, Adjunct Professor (equivalent to Doctor Honoris Causa) of Beijing Jiaotong University in 2011, and 2011 Romanian Academy Award for Technical Science (the highest in the country). Dr. W. B. Vasantha Kandasamy and Dr. Florentin Smarandache got the 2012 New Mexico-Arizona and 2011 New Mexico Book Award for Algebraic Structures. He can be contacted at smarand@unm.edu

The concept of non associative topological spaces is very new and interesting. In this book we have built non associative topological spaces using subsets of non associative algebraic structures like loops, groupoids, non associative rings and non associative semirings. We also find conditions on these non associative subset topological spaces to satisfy special identities like Bol, Moufang, right alternative etc. This new notion will find several applications.

US \$35.00

**Educational
Publisher Inc.**

ISBN 9781599732442

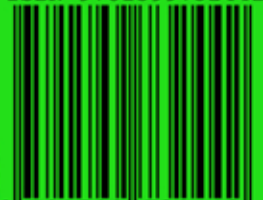

9 781599 732442