

The Semi Relativistic Higgs Field Aether with mass related lightspeed adaptation.

**Leo Vuyk,
Architect,
the Netherlands.**

Abstract,

Quantum FFF Theory states, that Black holes don't emit gravitons (as Fermions do) but suffer under the "Casimir push" of the oscillating Higgs (pushing gravity) Aether field lattice. That the Black hole is a real multiple string alike Higgs Knot inside this energetic oscillating Higgs vacuum lattice, which is origin of a Semi-Relativistic Aether!. This Semi-relativistic Higgs aether is supposed to be the origin of Lightning-channelling, Ball Lightning and Micro-Comet phenomena on earth and the origin of Comets, Sunspots, Herbig Haro Objects evolving into Stellar- or Galaxy Anchor Black Holes in space.

Photons are propagating through the Higgs vacuum lattice as "ripples" able to collapse (by Higgs transformation) as real string shaped photons connected to a string propeller shaped electron on a screen or as interference with two or more photons into Quantum Knots of a Sprite or ball Lightning. http://vixra.org/author/leo_vuyk . I expect that the new generation of telescopes will show the evidence of dual Dark Matter Black Holes found as Herbig Haro hotspots and in pairs outside Galaxies as Galaxy Anchor Black Holes (GABHs).

Introduction.

According to Quantum FFF (Function Follows Form) Theory, the FORM and Microstructure of elementary particles, is supposed to be the origin of FUNCTIONAL differences between Higgs- Graviton- Photon-Gluon and Fermion particles. At the same time, The Higgs particle as the base for the Higgs field aether, is assumed to be able to transform by symmetric fluctuation and merge into all other particles, which is reason to postulate that every Higgs particle existed already inside a splitting Big Bang Black Hole.

As a result, a NEW paradigm of splitting-, accelerating- and pairing Black Hole seems to be able to accelerate itself (by a new Quantum Fluctuation process), to form dumbbell systems, of two or even more black holes.

Inside Nebula these dumbbell systems are called Herbig Haro systems.

Inside the early universe however these systems are observed as dumbbell shaped radio lobes at both sides of early galaxies (Faint B3 radio galaxies).

Recent cosmic observations of the infra red and x-ray background radiation of the universe by Chandra and Spitzer space telescopes (CIB and CXB), suggest that even direct after the big bang ABUNDANT black holes already existed.

This can be interpreted as a support for a Black Hole splitting Big Bang and a Black Hole pairing Big Crunch before, thus there is reason to propose a cyclic Universe.

In Quantum FFF theory, the chirality of the universal Higgs vacuum lattice aether is proposed to be the origin of negative- or positive charged black holes and the origin of the formation of matter over anti-matter around negative charged black holes as in our universe seems to be the case.

The chirality of the oscillating Higgs vacuum lattice aether is supposed to be the origin of preferred Positron attachment with three different shaped monopole Gluon/photons for easy Quark formation without a lot of particle annihilation back into the Higgs vacuum.

At the same time, the possibility of a chiral universal vacuum is reason to support the idea of a super symmetric raspberry shaped multiverse, with multiversal copy universes, instant entangled down to all quantum systems as the base for all wavefunction collapses and emergence at the quantum level and above..

Quantum FFF (Function Follows Form) theory states, that the vacuum aether is seeded with fast oscillating massless Higgs particles (dark energy) , oscillating along a complex chiral tetrahedral vacuum lattice, which has the ability to transfer Photon and Graviton FORM information in bunches of oscillations (in wave form) , through the vacuum lattice with the local speed of light.

As a consequence there are no attraction forces on propeller shaped Fermions. Gravity seems to be the result of two different impulse arrays: the massless Higgs impulse array and the (less effective) massless Graviton impulse array.

As a consequence, new paradigm Dark Matter Black holes suffer only from the gravitational influence of Higgs vacuum impulses also coined Casimir push-gravity, because no gravitons can escape from the Black hole. The Black hole is supposed to be a super dense knot of Higgs particles floating inside (and compressed by) the oscillating Higgs vacuum frame. (Fig. 1) No photons like gravitons can escape from inside the Black hole. However, in Q-FFF theory, the vacuum is constantly “eaten” by these NEW Black hole nucleus and the origin of the Casimir gravity effect of Black holes..(fig 19)

In the Q-FFF model, Fermions are assumed to have a propeller shape equipped with a left- or right hand “pitch” Quarks and some leptons are compound particles (with photonic gluons) however, electrons and positrons are singular.

Only the statistical sum of the different kinds of vacuum impulses (in the form of butterfly shaped vector arrays) by real collisions from all directions on Fermions are responsible for all (energetic) phenomena in the universe. (Fig 2,3)

The polarisation and so called spin flip of Fermions around Black holes is the origin that Black holes are equipped with a narrow Fermion repelling globular horizon. As a result, Black holes are Zero Point Energy driven electric generators with negative charge at the outside and positive charge at the inside. The Fermion repelling horizon of Black holes (fig.7,8,9) is supposed to be the origin of vacuum polarisation between pairing Black holes leading to the fast creation of Stars by Stellar Anchor Black Holes (SABHs), Galaxies, (Cygnus A: fig 5) Herbig Haro objects, the pairing of Sunspots Alfvén circuits and Birkeland currents.

The accelerating plasma tail of NEW paradigm Black holes (fig 10), and the splitting Black holes into smaller pairing Black holes is supposed to be the origin of a smooth proliferation of Black holes and downsizing after the big bang of star magnitudes.

The Eagle Spire Nebula, (fig. 4) in the Carina and other nebulas, are examples of a smooth proliferation of down sizing by splitting Black holes through Galaxies and Nebula. We observe in these nebulas the pairing and splitting of Black holes ending up into multiple Herbig Haro objects (double stellar anchor Black hole systems) generating Hydrogen gas around the two black holes in addition with Birkeland Current systems as accelerating origin of fast new star formation and the start of open star clusters.

Consequently the electric energy production of Stellar Anchor Black Holes (SABHs), seem to be able to explain quick Star- and Galaxy formation, by Birkeland Currents, Alfvén Circuits. However, smaller (new paradigm) Black holes (created by magnetic interference and Radio Frequency currents) are supposed to be responsible for Sunspots, micro-Comets, Ball Lightning and even as multiple so called Quantum Knots inside Plasma Balls in the laboratory.

The Dark Matter Black Holes are supposed to EAT the Dark Energy Higgs Vacuum lattice, which is supposed to have an unstable influence on the Universal vacuum bubble and as a result, the Universe is supposed to be cyclic, super symmetric in the form of a raspberry shaped pulsating symmetric Multiverse with finite cycle time. (fig. 13-14)

The vacuum consumption of Dark matter black holes is also supposed to be the origin of the Hubble redshift in the universe, pointing into the direction of an accelerating expansion of the universe.

However the opposite is supposed to be the case in Quantum FFF theory, the universe is supposed to contract direct after the inflation epoch (fig 13).



A ball of Stringy particles compressed by the oscillation energy of the NEW Higgs vacuum Lattice= DARK ENERGY. The BH Nucleus itself is DARK MATTER.

Figure 1, Impression of a Quantum Knot based nucleus of the new Black Hole.

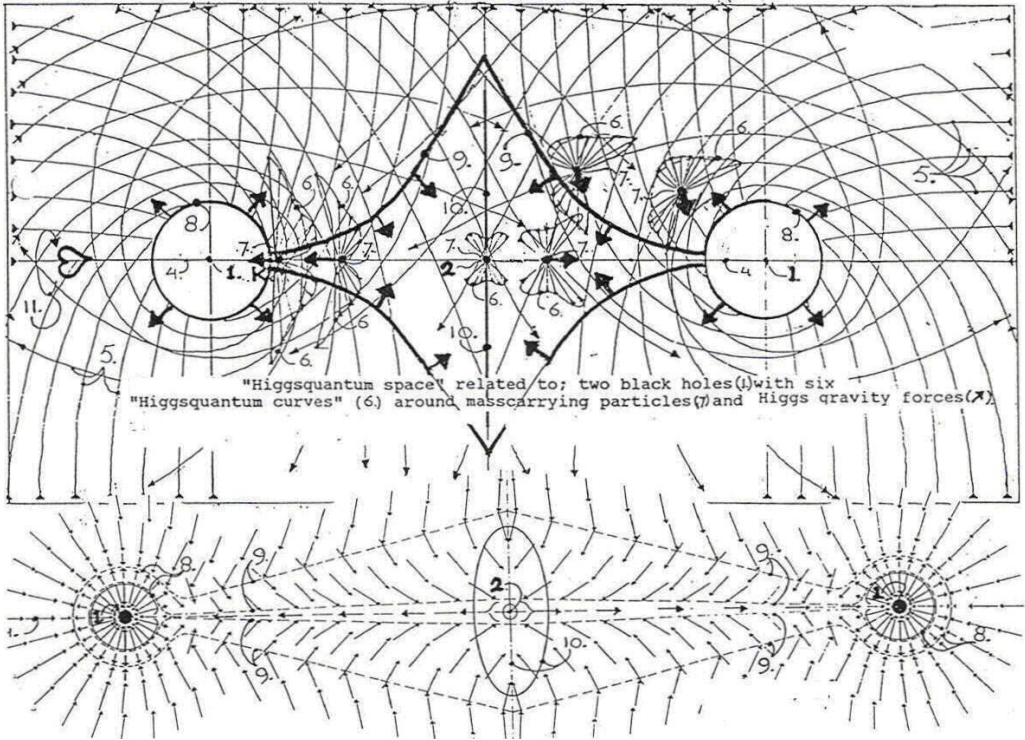

Figure 2, impression of the Higgs Vacuum structure around a set of two Black holes, as is found to be present around some Planetary nebula, early Galaxies and Herbig Haro objects. The negative charged particle jets is the result of the Black hole based electric potential combined with the vacuum polarisation

(acceleration) effect on light Fermions like electrons and the origin of Birkeland currents and Alfvén circuits.

Dumbbell systems of new paradigm Black holes kept apart by two Herbig Haro electron-ion particle jets. Zero Point energy pressure effects around test masses are depicted as butterfly shaped vacuum pressure vector array curves. In Q-FFF theory, the vacuum gravity pressure is interpreted as Dark energy and Black holes as Dark matter. The central “White-Grey hole” is always the place for gas concentration by electric Birkeland current pressure of all open star clusters and Spiral Galaxies. Only Globular star clusters and some Dwarf elliptical Galaxies will show central massive Black holes

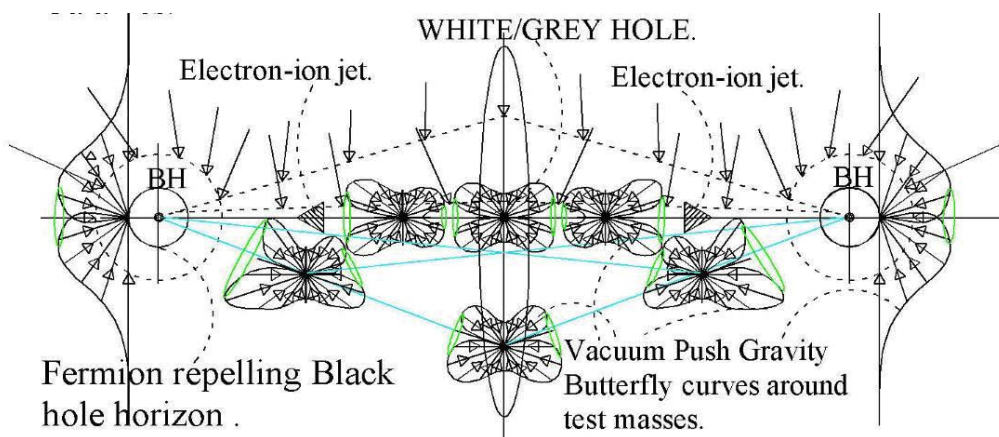

Figure 3, The same Birkeland current system as figure 2 with butterfly vector arrays at different locations around the Black holes. In the middle the vacuum has less density (larger Planck lengths) by the absorption of the dual Black holes.

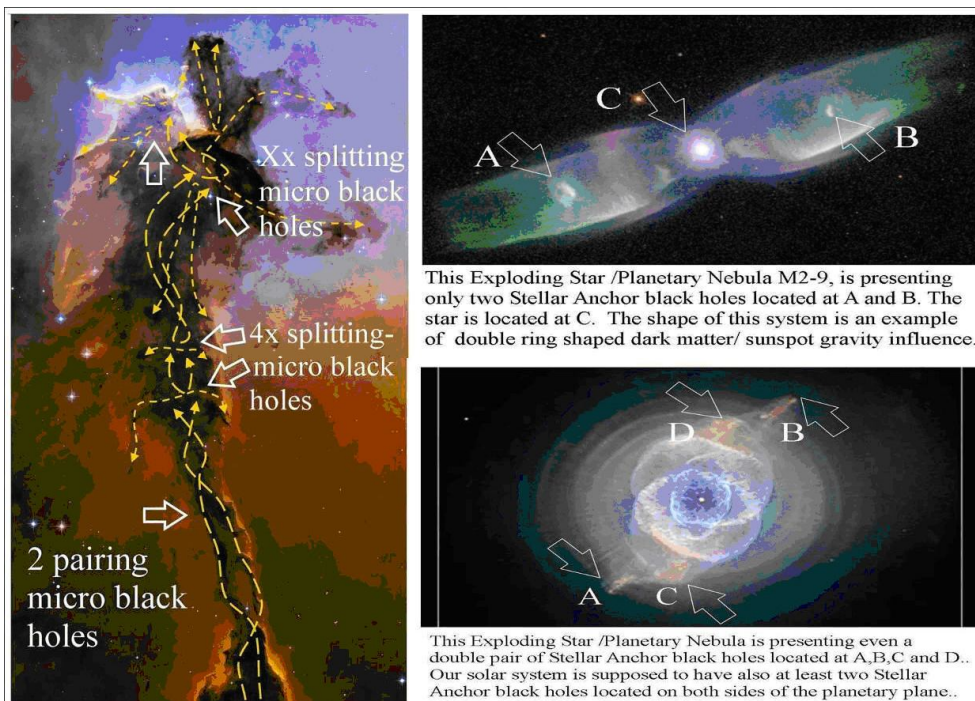

Figure 4, Examples of stellar anchor black holes and the formation of Herbig Haro systems inside the Spire nebula (left) by migrating and pairing black hole systems.

The origine of Double MWC922 interference rings

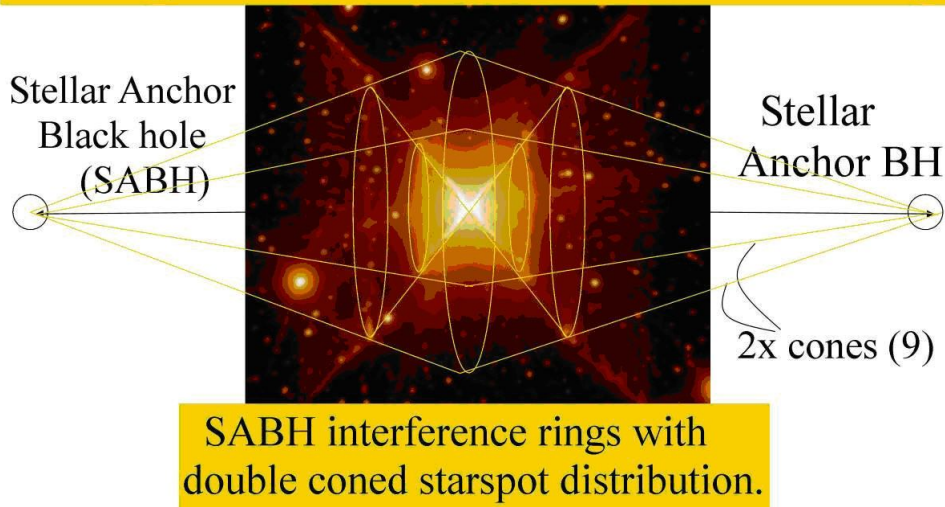

Figure 5, Star spots are supposed to be micro black holes and able to form interferenced double cone patterns after stellar explosion. The Red Square Planetary nebula MWC922, equipped with double cone structure of expelled material including trailing starspots (Micro Black Holes). There are FOUR cones of interferences observed, originated by the two Stellar Anchor Black holes (SABHs). These four cones seem to interfere with the TWO cones of expelled material of the star, leading to FOUR rings of interference.

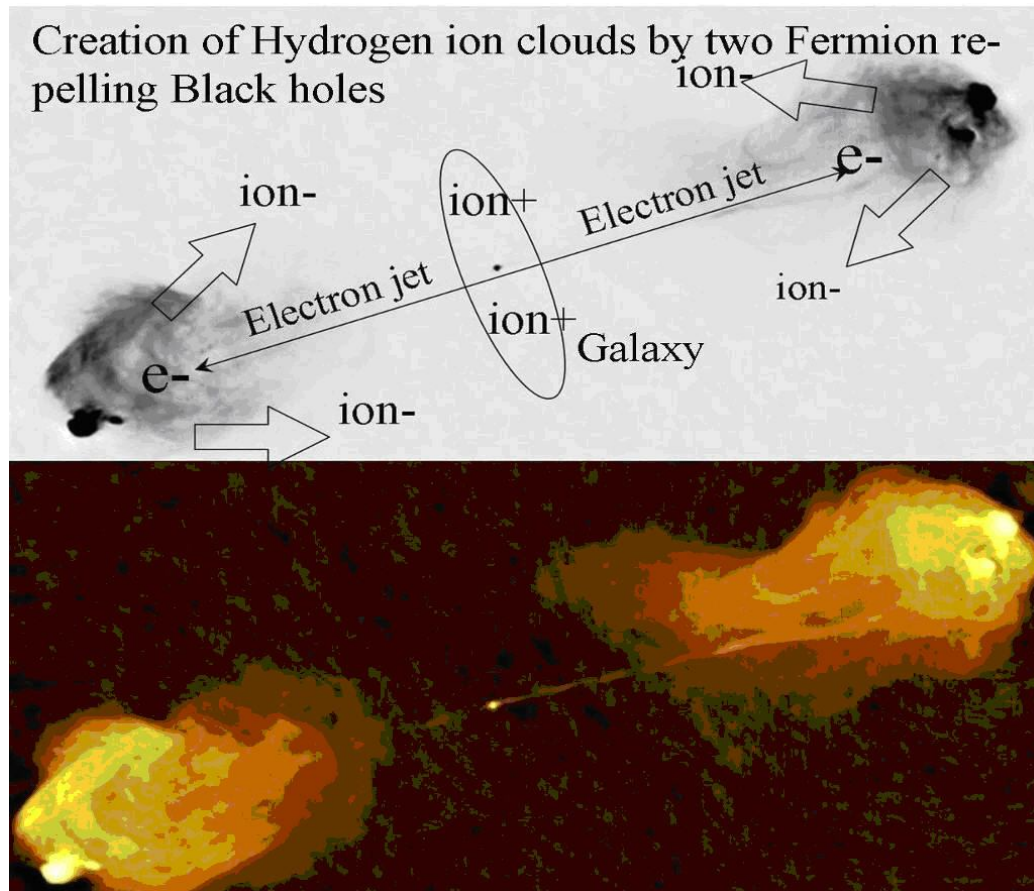

Figure 6 Cygnus A equipped with dual hotspots with gas production and electron jet including Birkeland currents and gas transportation by Alfvén circuits.

The OLD and NEW Black Hole differences.

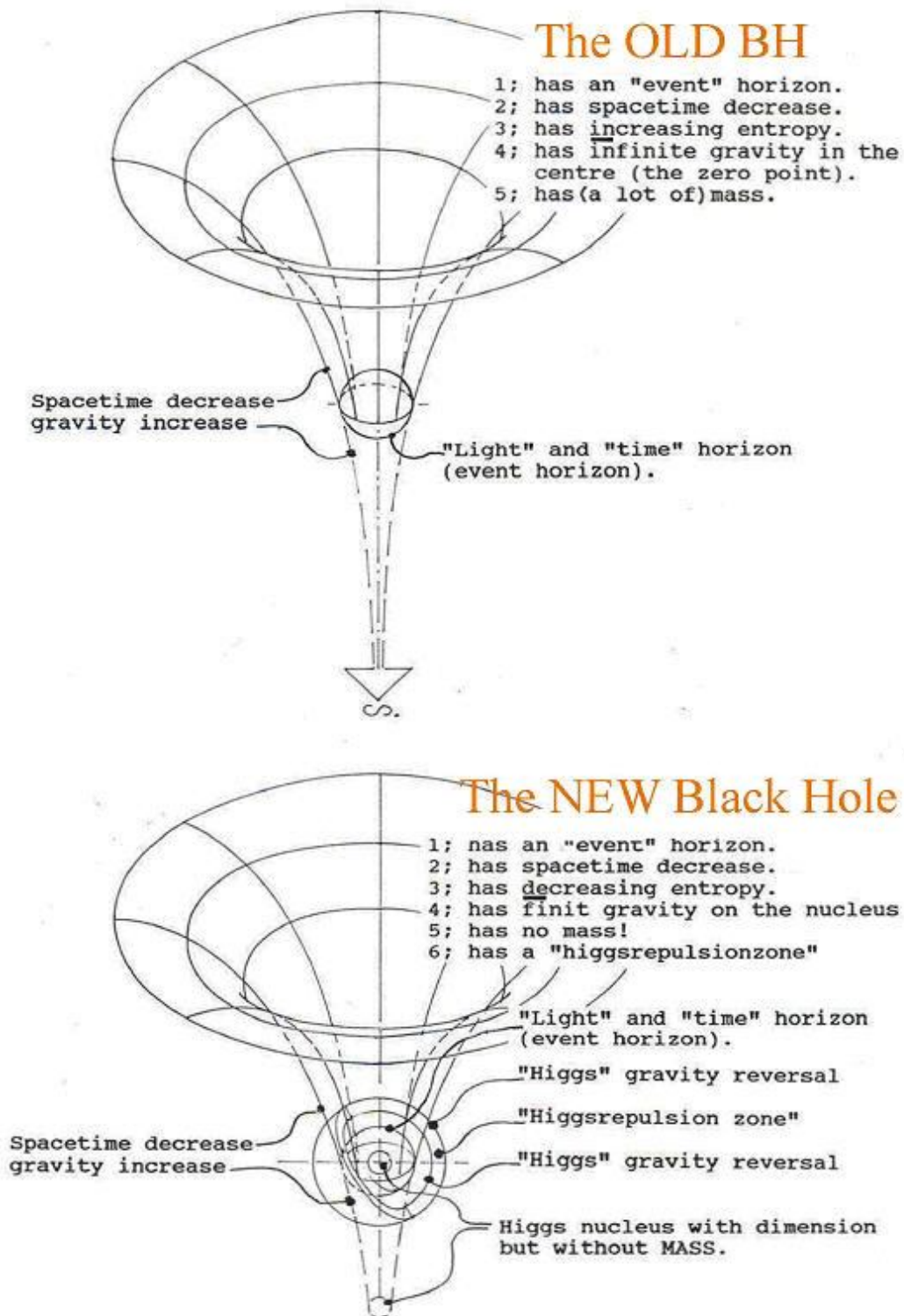
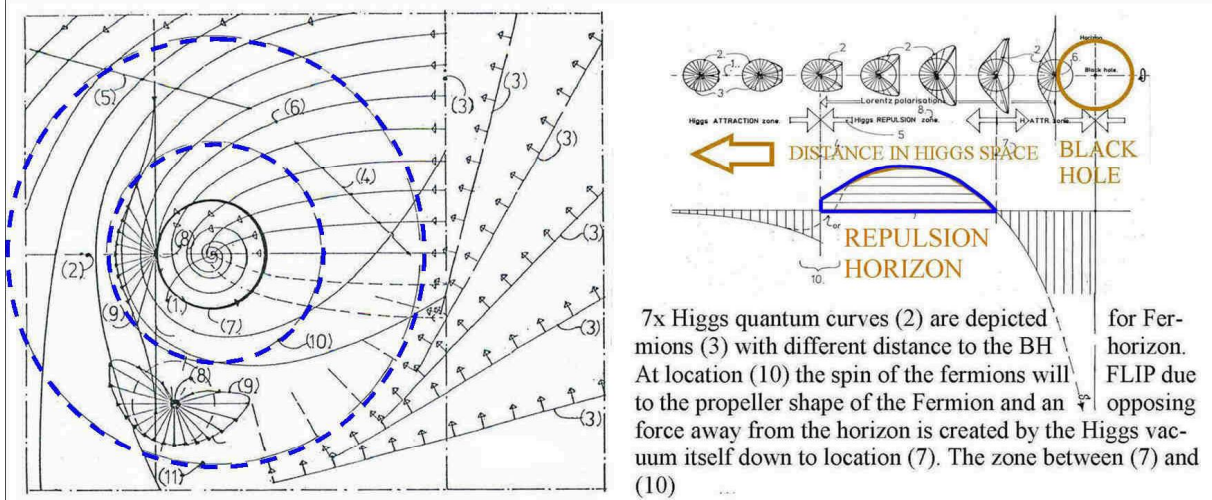

Figure 7, The difference between the old and new paradigm Black hole according to Quantum FFF Theory .

Fermion repulsion zone 10-11 around a Black hole, with Photon and Higgs trajectories around a NEW paradigm Black Holes.(Quantum-FFF Theory)



- 1: Non rotating Black hole nucleus (in 2D cross section).
- 2: Reference axis for trajectories 4,5 and 6.
- 3: Other incoming photonic/Higgs fronts (without depicted trajectories)
- 7: High photon energy collider globular shell, with intense Quantum effects like pair production (e^-e^+). 8: test masses.
- 9: Butterfly shaped Higgs/photon Fermion pushing curves in 2D.
- 10 and 11: Fermion repulsion zone. Due to the propeller shape of the Fermions, they will experience a so called "Spin Flip" in this zone.

Figure 8, Principle of Fermion repulsion around a Black hole according to Quantum FFF theory..

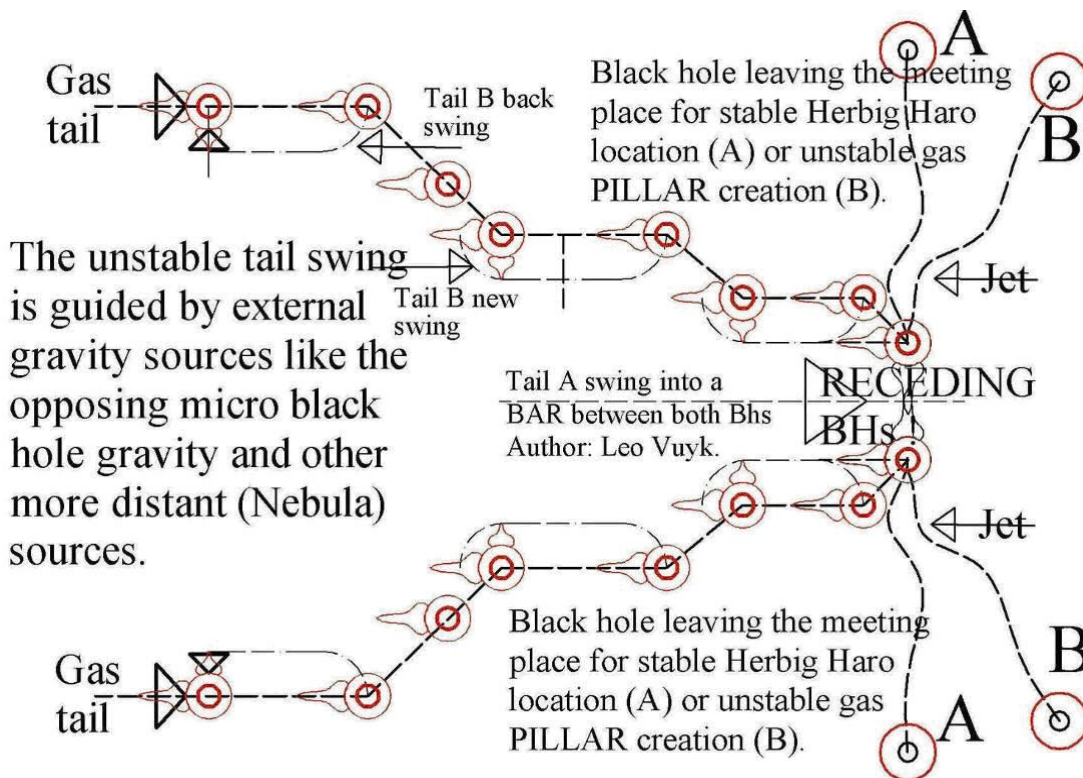
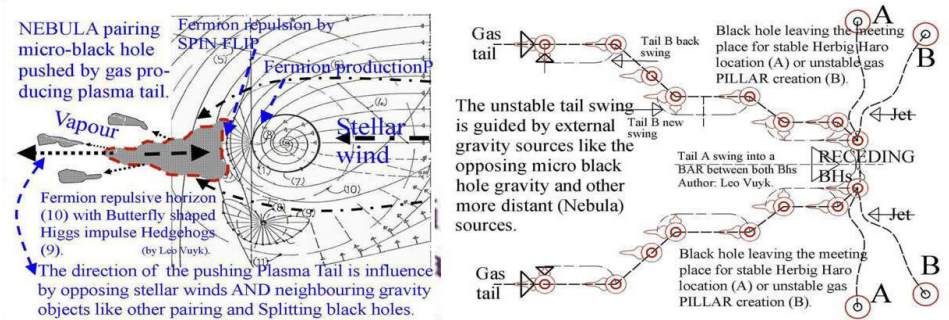

Figure 9, New Black hole propulsion principle by a self produced plasma-dust tail, also responsible for dust Pillar creation and the pairing and spitting effect as observed in nebula like the Eagle and Carina nebula.



Several accelerating pairing and receding micro black holes, as the start of HH objects, in the Carina nebula, with temporary meeting place (A) and ionised plasma tail.(Quantum-FFF Theory)

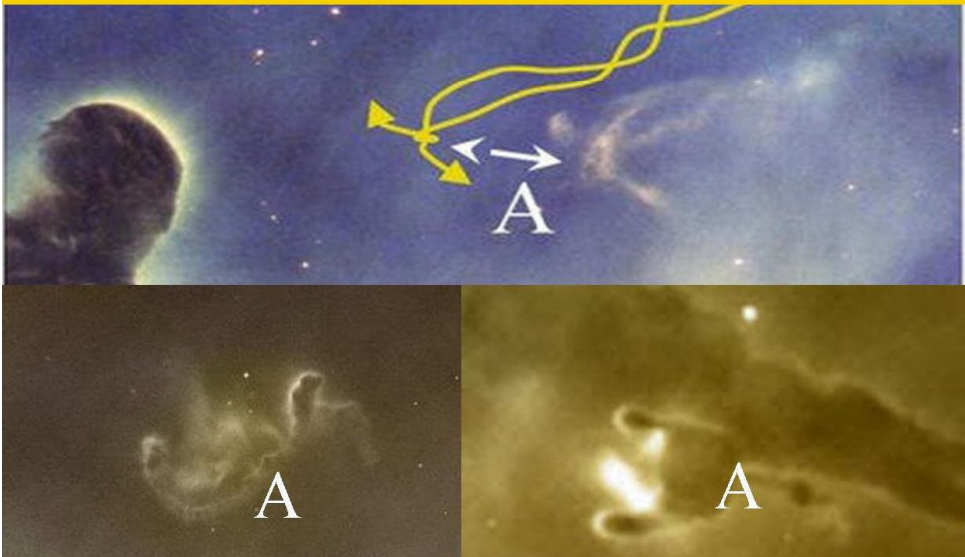
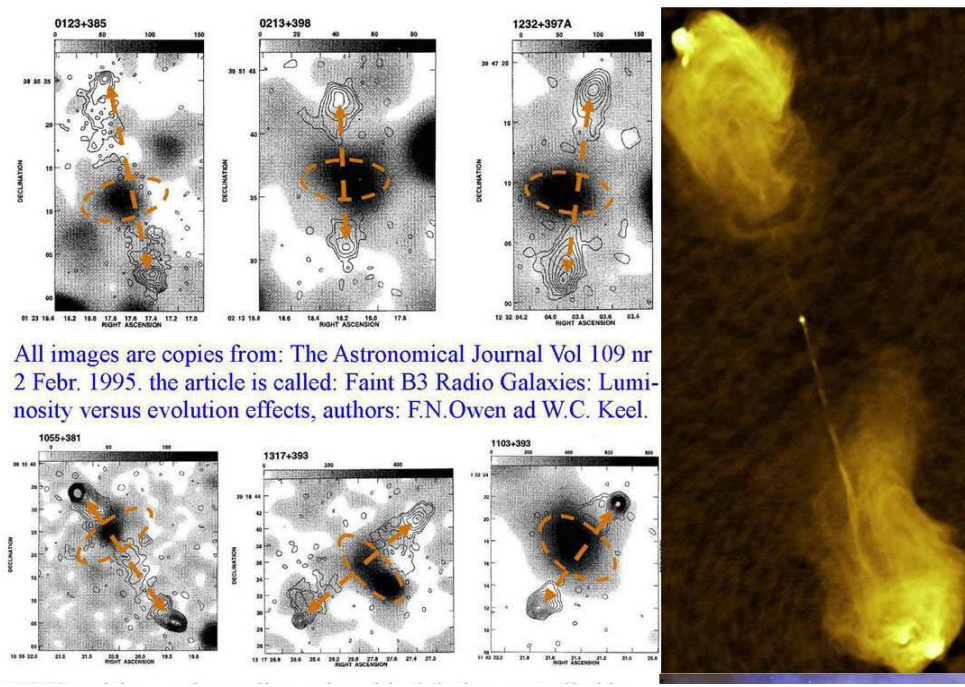

Figure 10, Three examples of ZPE accelerated Black Holes, plasma producing, pairing and splitting inside the Carina nebula.



All images are copies from: The Astronomical Journal Vol 109 nr 2 Febr. 1995. the article is called: Faint B3 Radio Galaxies: Luminosity versus evolution effects, authors: F.N.Owen ad W.C. Keel.

Figure 11, Cygnus A (right) is one of the best examples of Birkeland current driven gas concentration between dark matter Galaxy Anchor Black Holes (GaBHs) . Even in the early universe these dumbbell structures have been found like the “Faint B3 Radio Galaxies” (Owen and Keel)

Recent observed Black Hole abundance (left) in the CIB Cosmic Infra Red Background (right) and X-ray: CXB, is a strong support for Quantum-FFF theory Black Hole splitting Big Bang- and Contracting Big Crunch cycle,

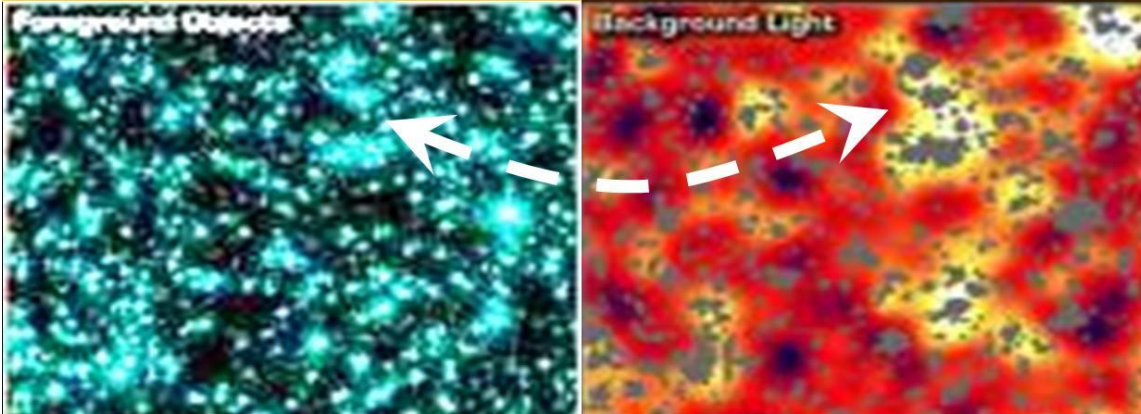

The CPT SYMMETRIC MULTIVERSE CYCLE.

The Inflation epoch starts if the decreasing vacuum pressure equals the increasing Higgs tension of the Big Crunch black hole nucleus. Inflation epoch ends if all splintered black hole nuclei are evaporated, or left behind as Galaxy Anchor Black Holes.

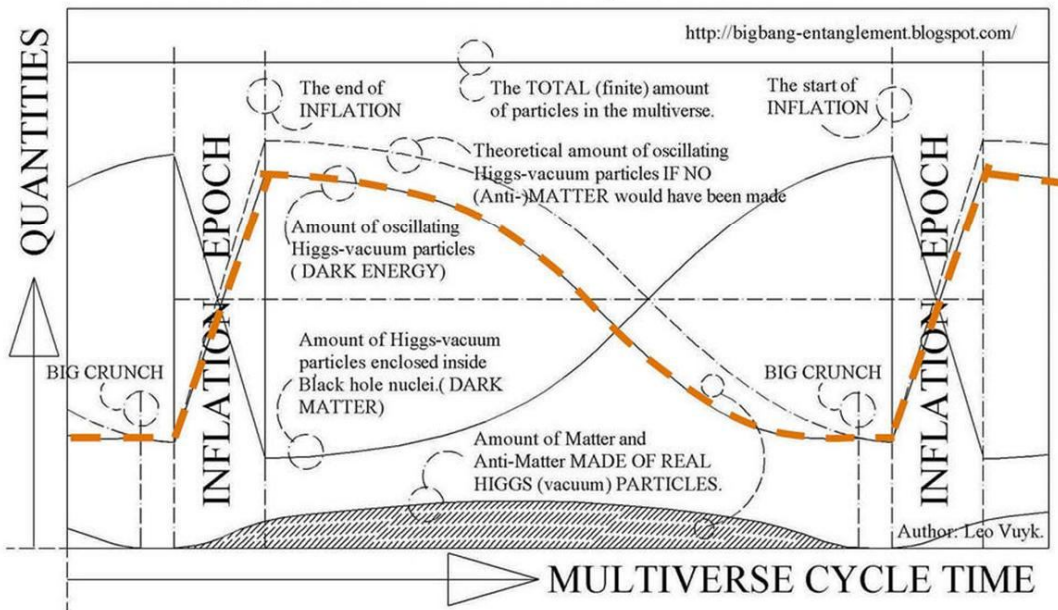

The Pulsating Multiverse depicted as a continuous flow of increasing and decreasing numbers free oscillating- and Black hole condensed Higgs particles and the amount of Quarks and leptons. The size of the pulsating multiverse vacuum is given in orange.

Figure 13, Abundant Black Holes observed in the early universe by the CIB and CXB of Chandra and Spitzer space telescopes (2013). A strong support for the Quantum FFF theory based Black Hole splitting Big Bang and contracting Big Crunch Cycle of the Multiverse.

Comparison of the Final ESA CMB Planck map with a cross section through the Raspberry Multiverse according to Quantum Function Follows Form theory. Compare the Cold Spot with the Void and the Warmer and Colder Hemisphere of the Plack CMB (left) with observation boundaries (right)

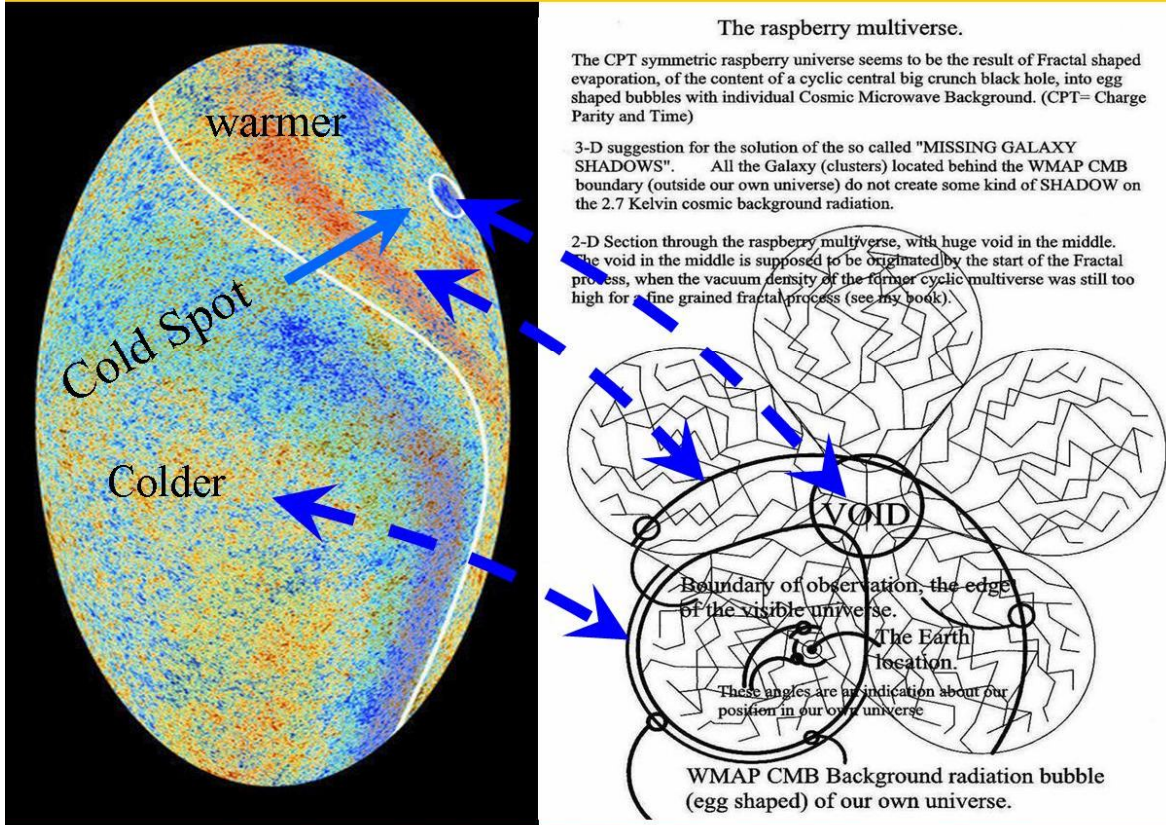

Quantum FFF theory is a combination of a holistic and a reductionist approach of nature. Holistic by the introduction of complexity into the sub quantum geometry or microstructure of elementary particles and fields and reductionist, by reducing that complexity into single elements and monopole forces.

However all these particles and fields are supposed to be connected by continuous active information fields called instant entanglement, between one or even more symmetrical anti matter universes at a long distant.

If particles combine together into simple knots they form quarks and some leptons.

If these knots become more complex (more than 6 particles) they are supposed to form ball lightning alike Casimir energy producing systems called micro black holes..

If stars explode into supernovas they for also quantum knots based on the remaining particles left over from the star's interior and form black holes.

All black hole nuclei are supposed to be based on such quantum knots.

The big bang is supposed to be the evaporation and explosion of the one and only big crunch black hole.

As a consequence we live inside a cyclic symmetric multiverse interconnected by instant entanglement between these anti-copy universe at the quantum scale.

Consciousness should also be subject of this active information system, and my thoughts are continuous competing with my brothers over there.... (Leo Vuyk)

Figure 14, The Pulsating Raspberry shaped Multiverse also to be observed from the Planck Cosmic Background Radiation image.

Addendum of some Quantum FFF theoretical principles

The NEW Black Hole Paradigm

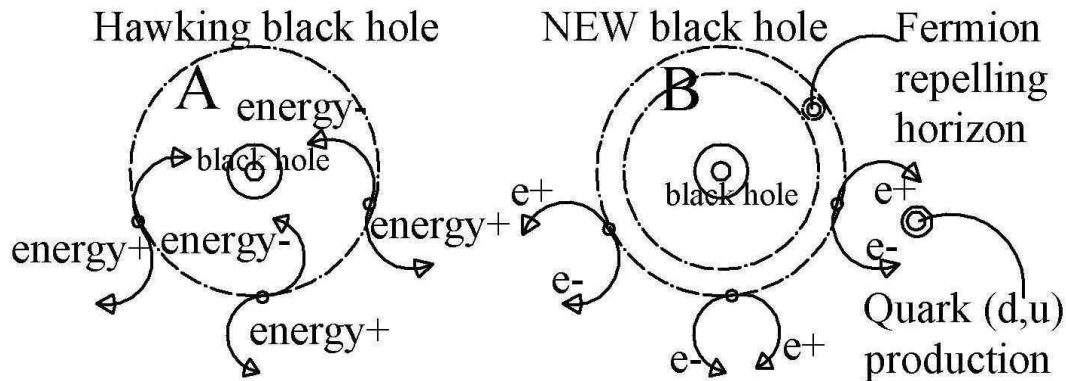

The standard Hawking Radiation postulate is: that all matter (NOT all energy) is drawn into the Black hole.

My NEW postulate is that matter is created (and pushed outside) at the Black hole horizon by QUANTUM FLUTUATIONS producing electrons and positrons.

Some electrons and positrons will annihilate, but the rest will form Quarks and plasma, because the Higgs vacuum lattice is CHIRAL and prefer to link gluons to positrons. Thus more electrons will stay single and form atom shells!

Due to the propeller shape of the particles all the plasma is repelled away from the black hole!! The black hole will not evaporate !

This is the base for NEW Physics and a support for a new explanation of Cometary X-rays, Hydrogen and AMINO ACID production. Even Gas Pillar and Herbig Haro formations inside Nebula become a logic base. Author Leo Vuyk.

Figure 15, Quantum Fluctuations as the origin of Plasma creation around Dark Matter Black Holes.

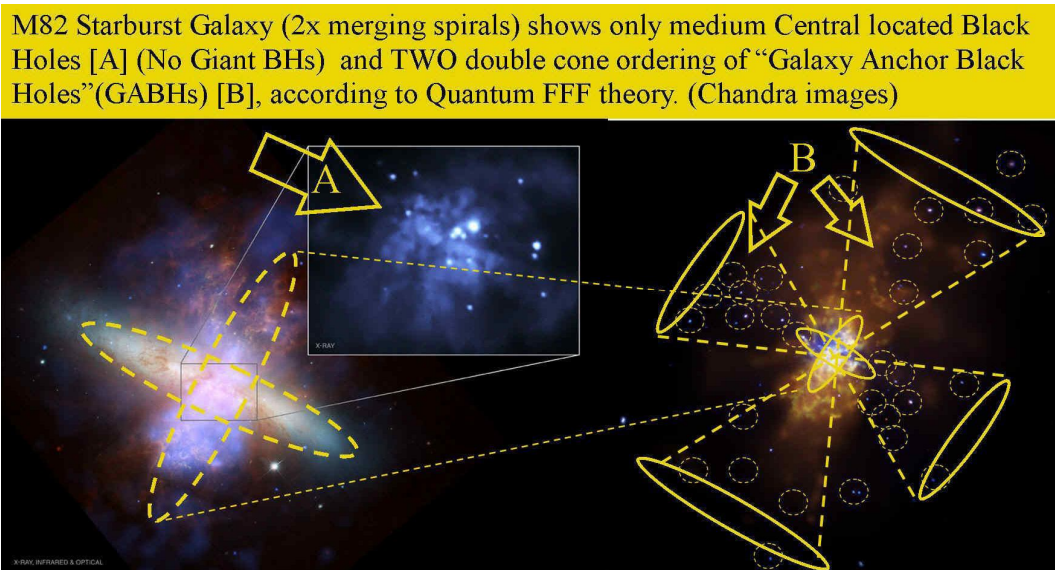

Figure 16, M82 Starburst Galaxy with a complex galaxy anchor black hole system

Electric Current processing between dual Dark Matter Black Hole systems around the Sun and Spiral Galaxies, according to Quantum FFF Theory

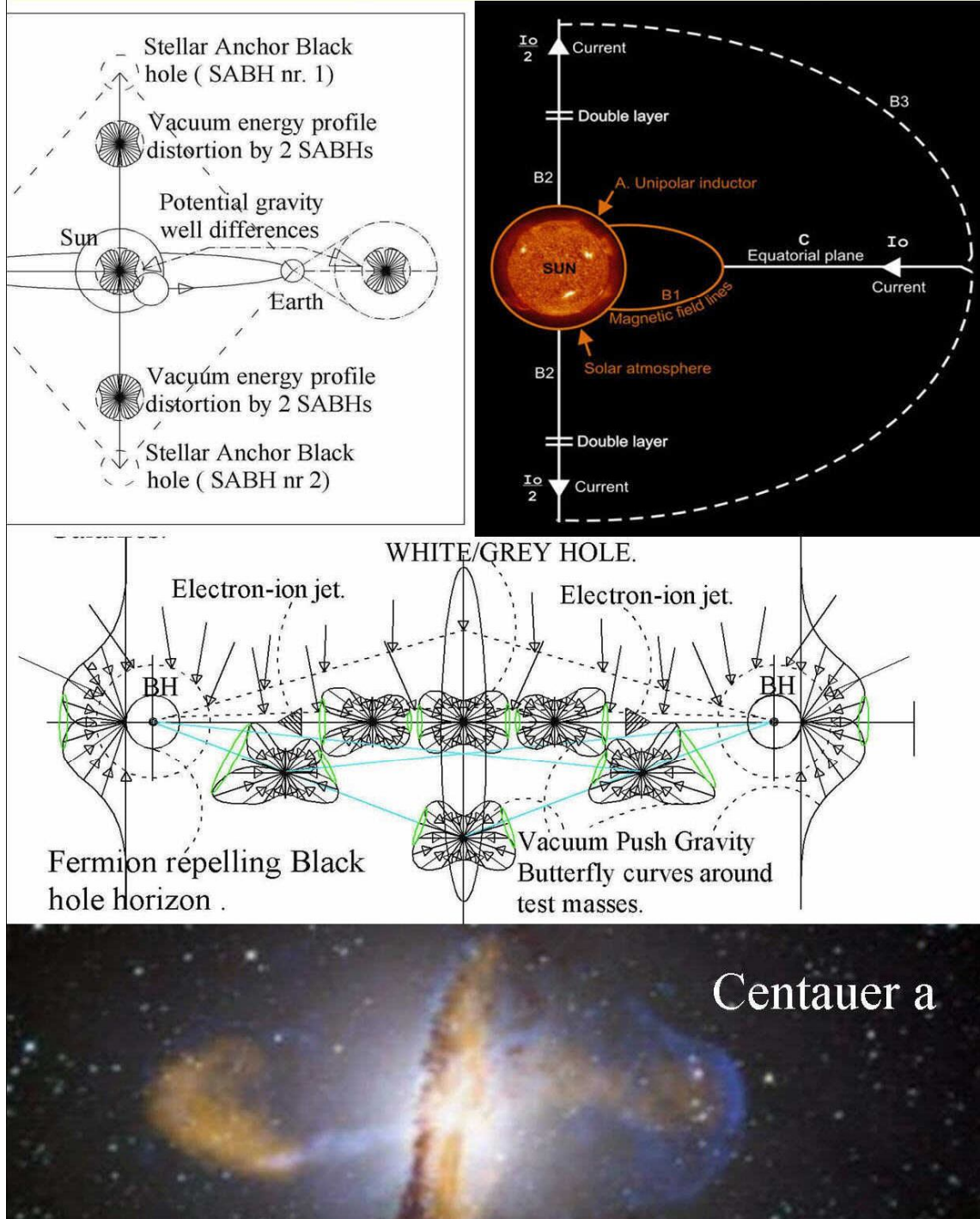

Figure 17, Birkeland current systems around stars and galaxies.

DWARF Galaxy formation (15) in between (2 +) Galaxy Anchor Black Holes (1) (GABHs= Clumpy Dark Matter) after Galaxy merging according to Quantum FFF- Theory.

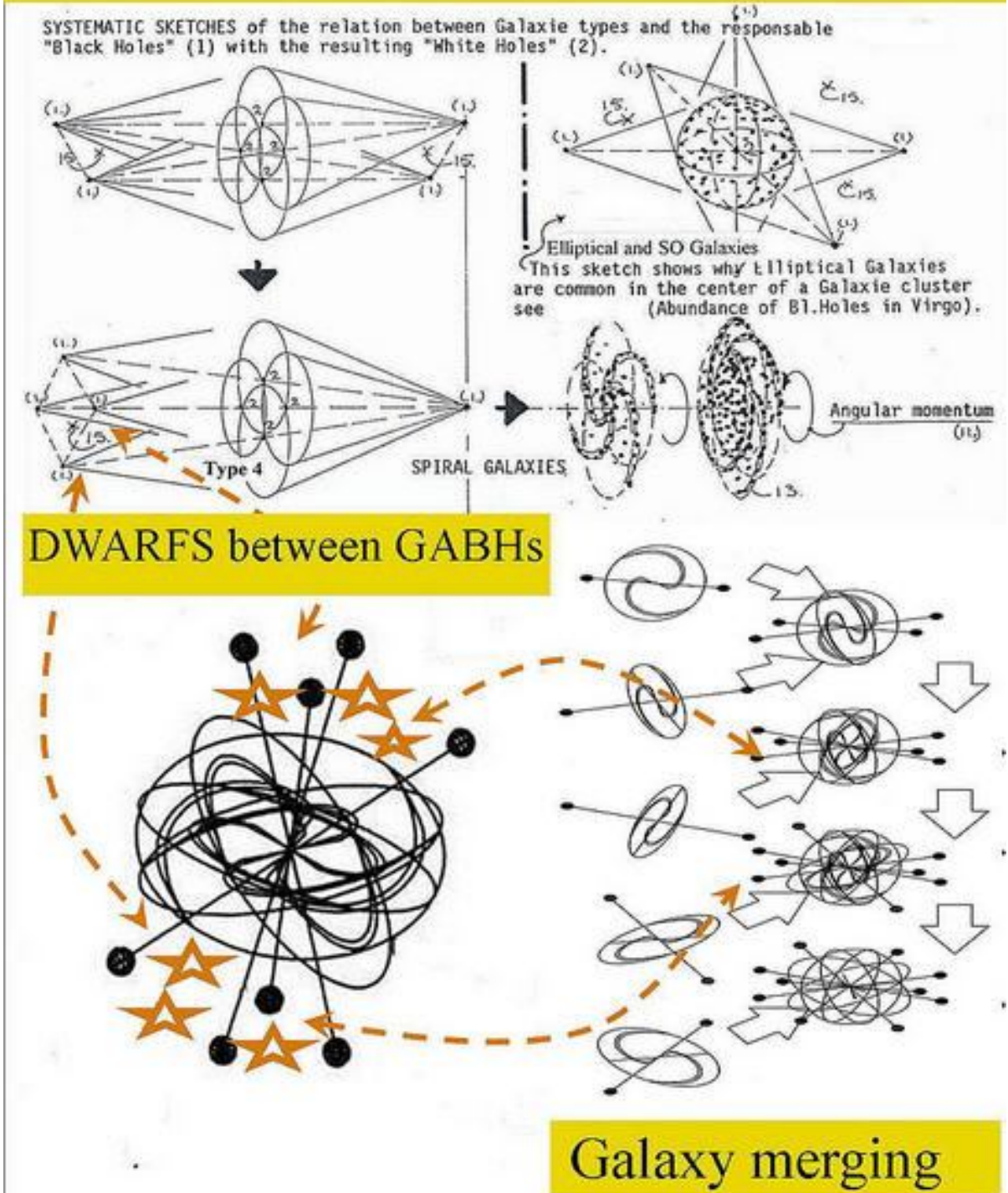
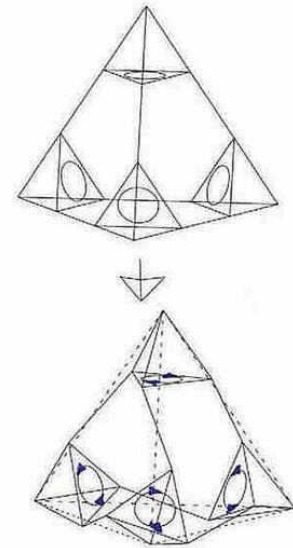
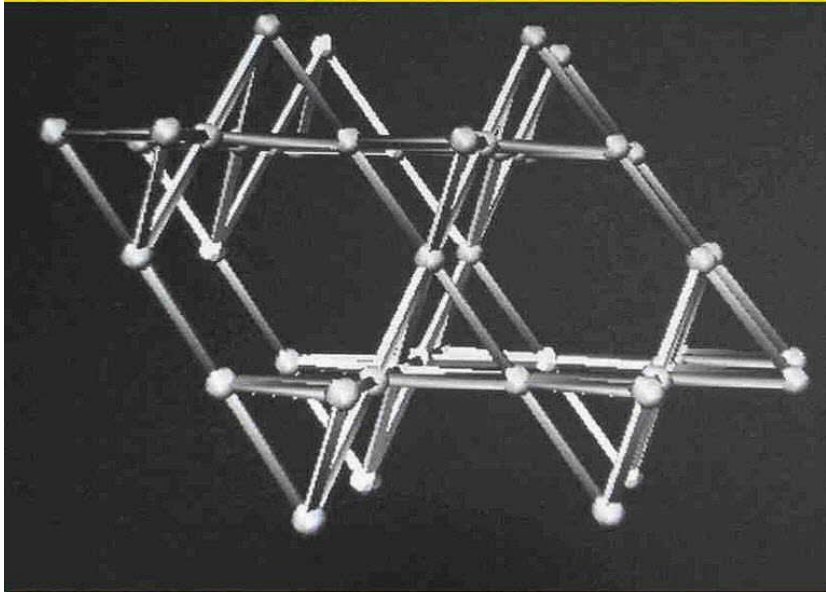
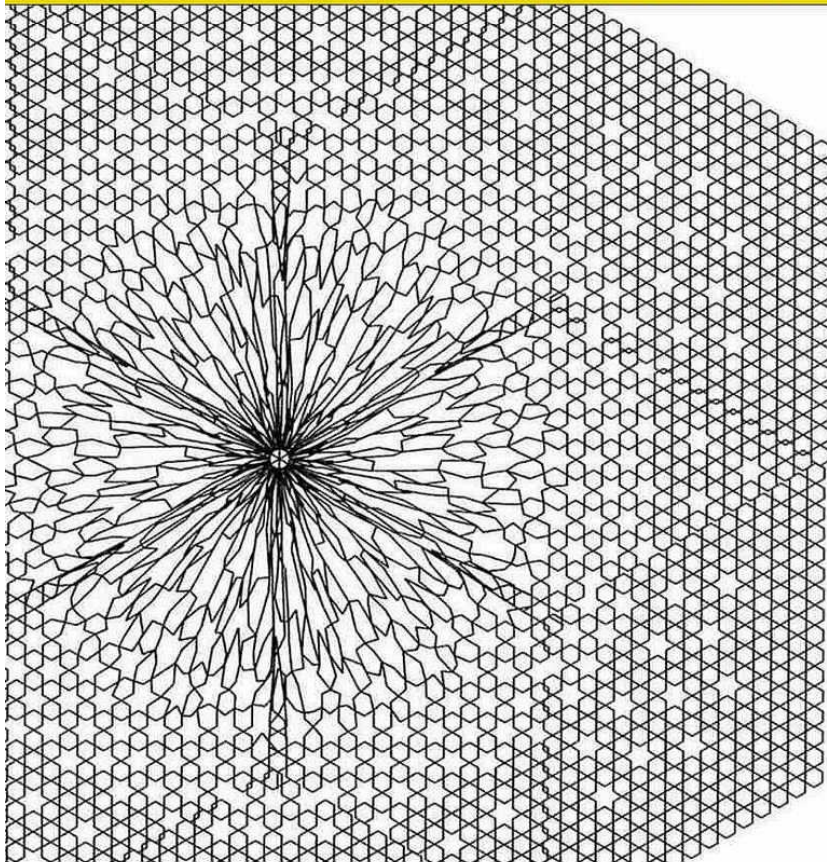

Figure 18, Dwarf galaxy formation between GABHs (Galaxy Anchor black Holes). TWO GABHs are able to form spiral galaxies in between. After merging with other spirals they can form more complex galaxies (even elliptical galaxies) , surrounded by more complex systems of GABHs. In between these GABHs there will automatically form DWARF GALAXIES.

New Dark Matter Black Hole, “Eat” the chiral oscillating Higgs vacuum.(Quantum-FFF Theory)



Simplified tetrahedral vacuum lattice structure (left), constructed by complex chiral tetrahedral building blocks (right). Each universe has to choose between a left- or righthanded rotation of its tetrahedral building blocks. Each chiral lattice has the Planck length and is supposed to be equipped with at least two oscillating massless new Higgs particles.



Black holes EAT the vacuum lattice with the oscillating Higgs particles.

So, the vacuum lattice structure around a black hole could be represented like this.

As a result, the near vacuum is thinner or diluted, it has holes, which could be the origin of the Universal HUBBLE redshift.

By contrast, my new black hole paradigm says: the origin of universal redshift is Dark matter.

Dark matter is the proliferation of vast numbers of Black holes around Galaxies. Conclusion, based on Hubble redshift, we don't know anything about expansion or contraction of the universe. (Author Leo Vuyk)

Figure 19, The Chirality and structure of the oscillating Dark Energy Higgs vacuum lattice

Quantum Function Follows Form Model

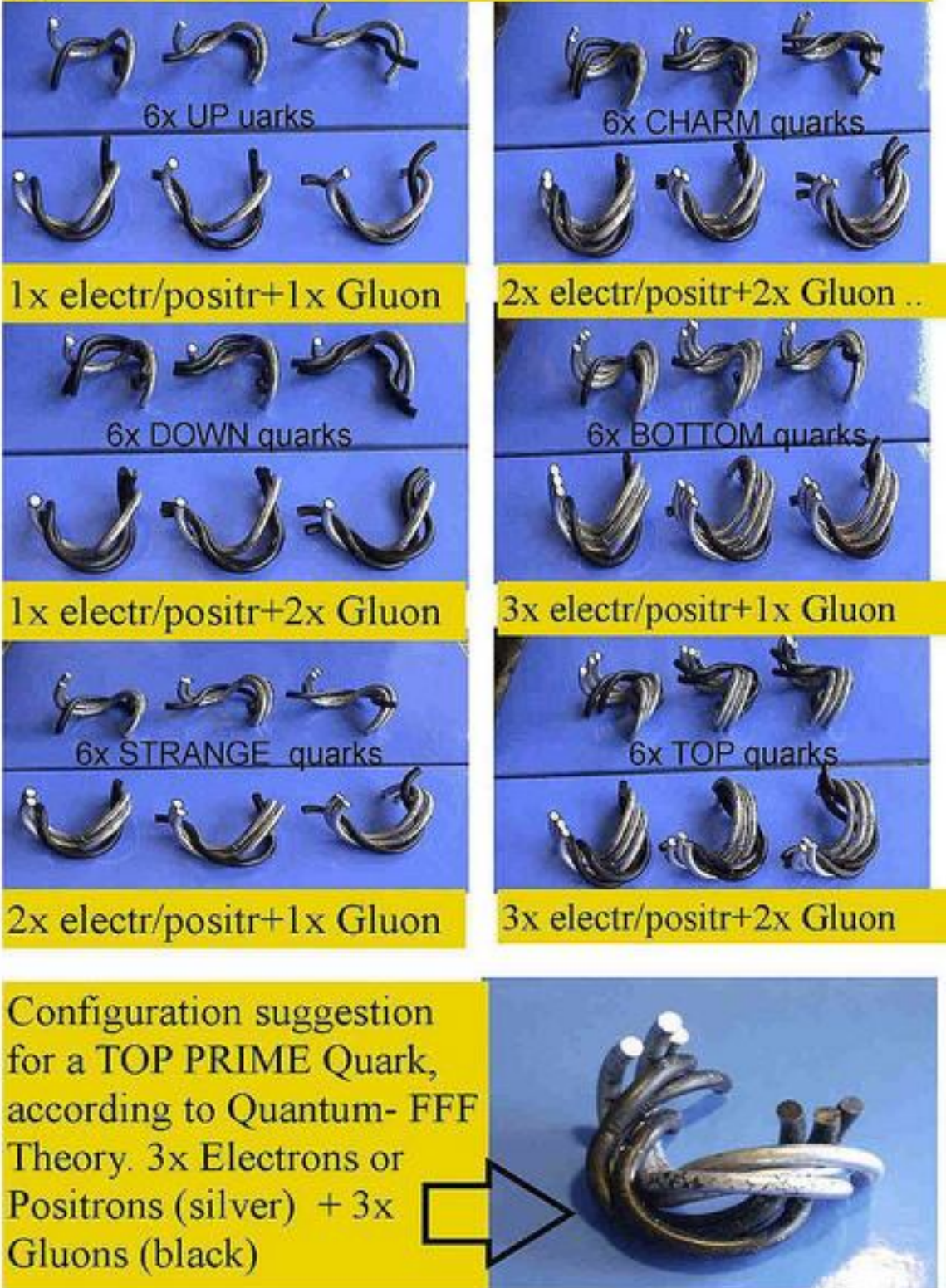

Figure 20, 5x different shaped Photon/Gluons can combine with the two propeller shapes of the electron and Positron to form all coloured (QCD) Quarks and even more!!

Synchrotron radiation by Polarized Fermion spin combined with high speed motion through the resistive oscillating Higgs vacuum (according to Quantum FFF theory)

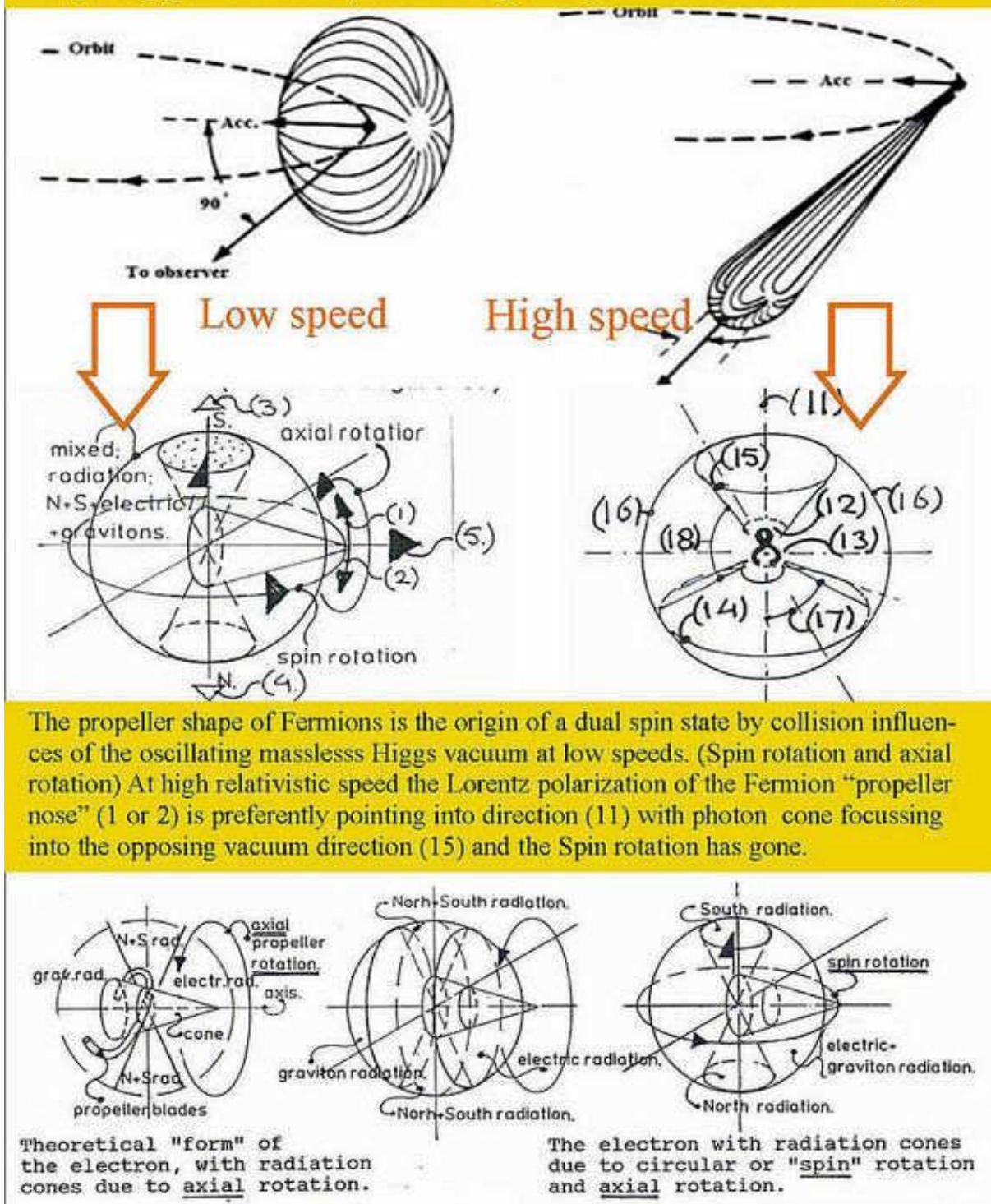
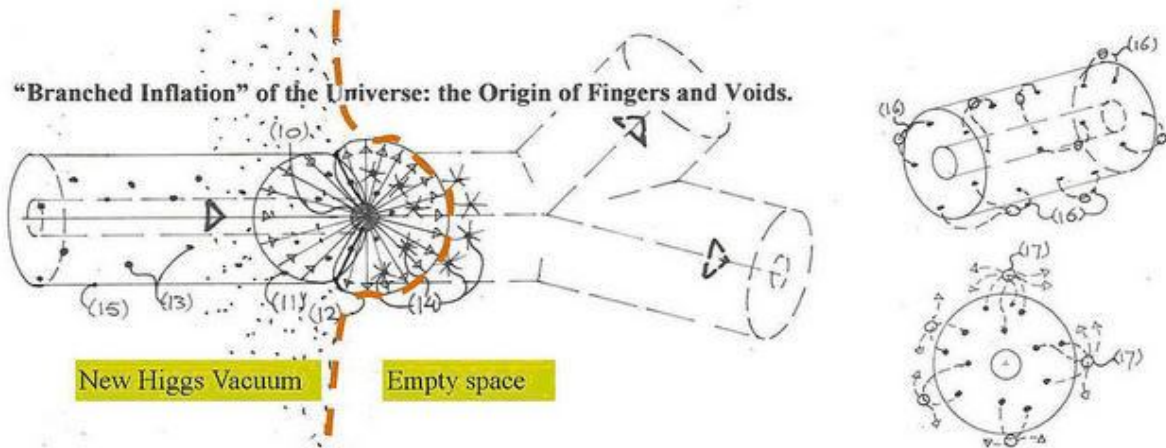

Figure 21, The polarisation of the double spinning propeller shape of fermions is the origin of all radiation differences.



The origin of the Lyman Alpha Forest (15) and Higgs vacuum, by the splitting of the Big Bang Black Hole (BBBH) into smaller Splinter BHs (10). The splinter BHs (10) evaporate into smaller evaporating black holes at the Front (14) which compensate the pressure from the Backside splinter BHs (11). The BHs (11) are assumed to partly evaporate like BHs (14) also into a newly formed oscillating Higgs vacuum until the Higgs vacuum pressure stops the evaporation and leave Galaxy Forming BHs (13) behind. However single BH will pair (16) with the nearest other BHs to form Dumbbell systems, which efficiently form Giant Stars and Galaxies (17) in between. (author: Leo vuyk)

Figure 22, How the Lyman Alpha structure of the universe and the Higgs ed, by the splitting and evaporation of the Big Bang Black hole.

Magnetic field variations by the “Curl” of Magnetic Monopole (N and South) Radiation around a wire and the earth.

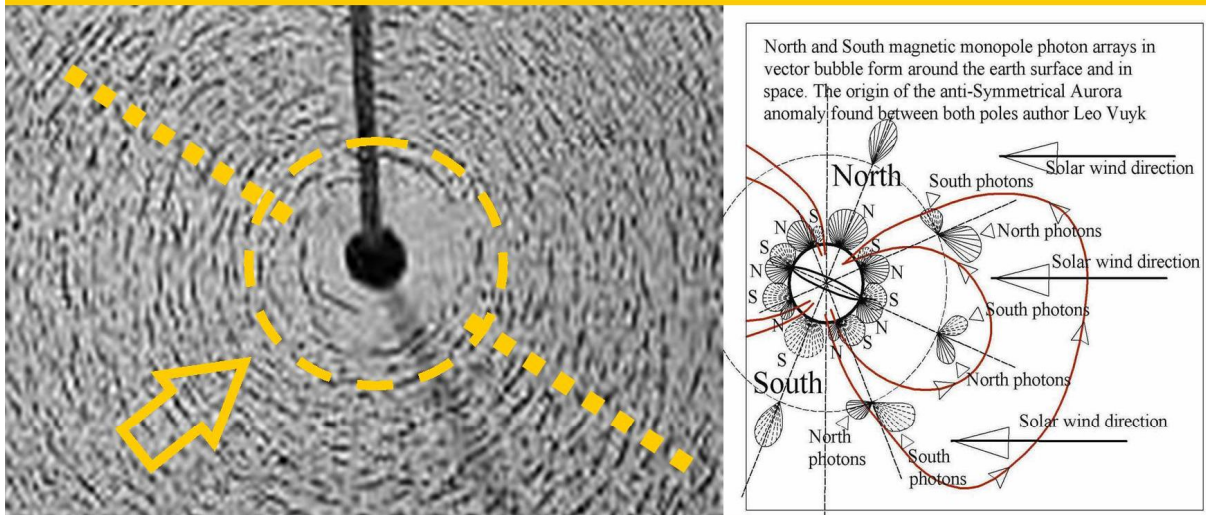

According to Quantum FFF theory, all magnetic fields can be presented as CURLED Magnetic Monopole Photon Vector Arrays. As a result, the magnetic field intensity is (away from polar positions) NOT dropping as the inverse cube of the distance from the source!! (See images). Also: direct around the current in a wire- equipped with iron powder on paper- the magnetic field strength seem to be even less than at some distance.

Figure 23, Monopole magnetic radiation explained.

Alternative standard particle model

All SINGLE (non-compound) elementary particles suggested by Quantum FFF Theory. OLO, ORO have "click-on potential" to form compound quark particles with only 5 different shaped Gluons/Photons. In yellow colour: Quantum-FFF suggestions for NEW PHYSICS particles. The Majoranas: (OUO+ mirroring Majoranas RUR+ LUL) and 4x extra neutrinos (RLU+ RRU+ LLU and LRU) (author:Leo Vuyk)

Explanation of the codes:
 U= Up rotation (180 degrees)
 O= Unchanged circle.
 L= Left rotation (90 degrees)
 R= Right rotation (90 degrees)

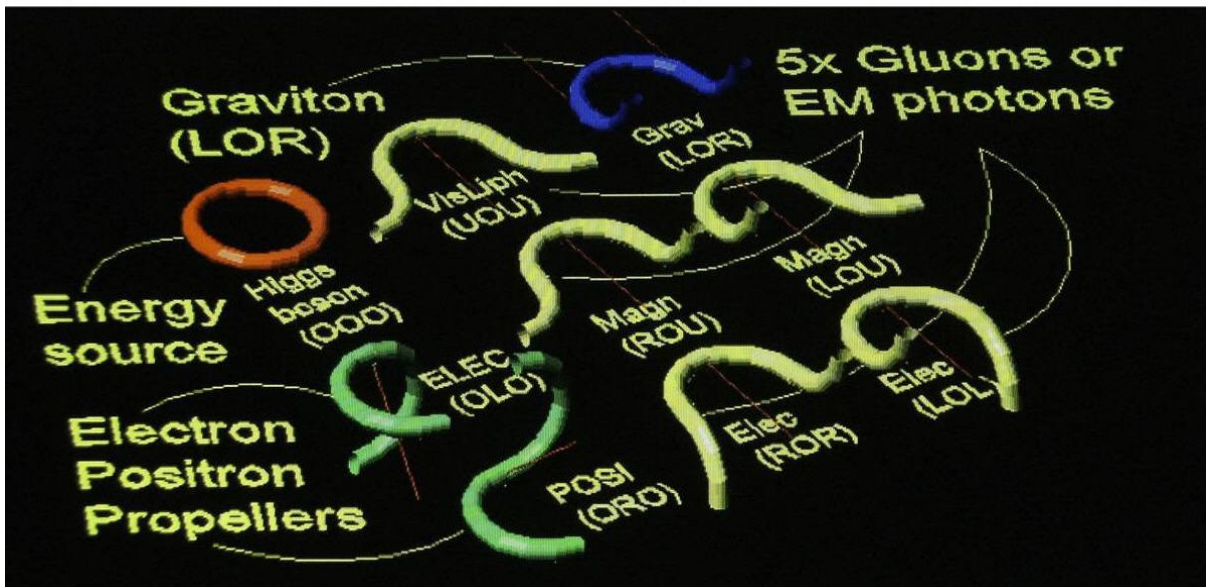
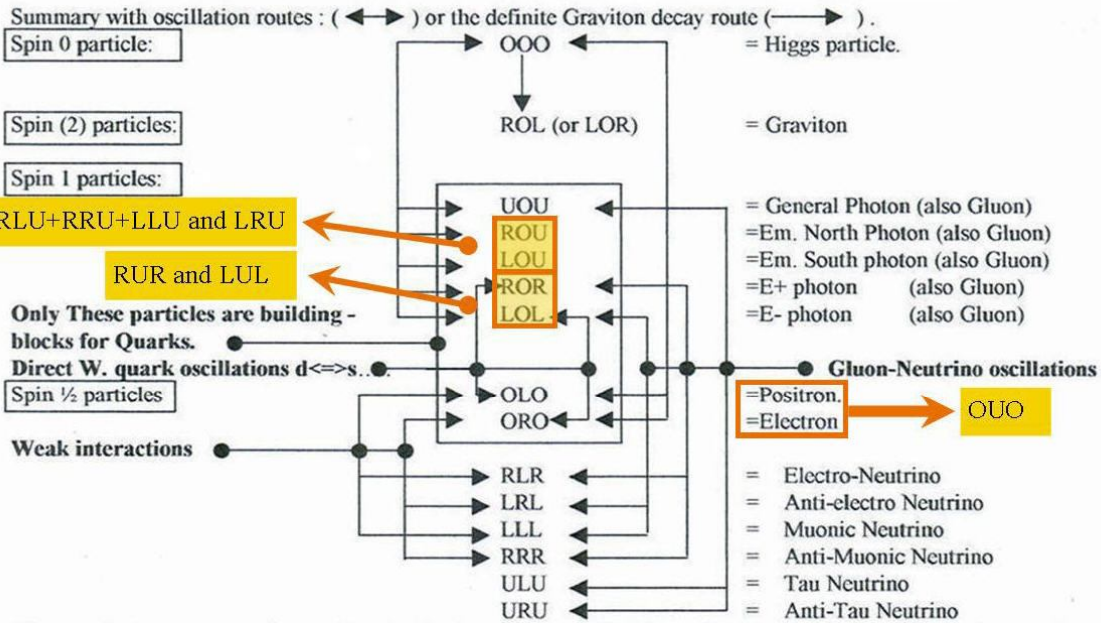
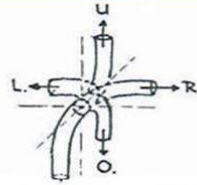
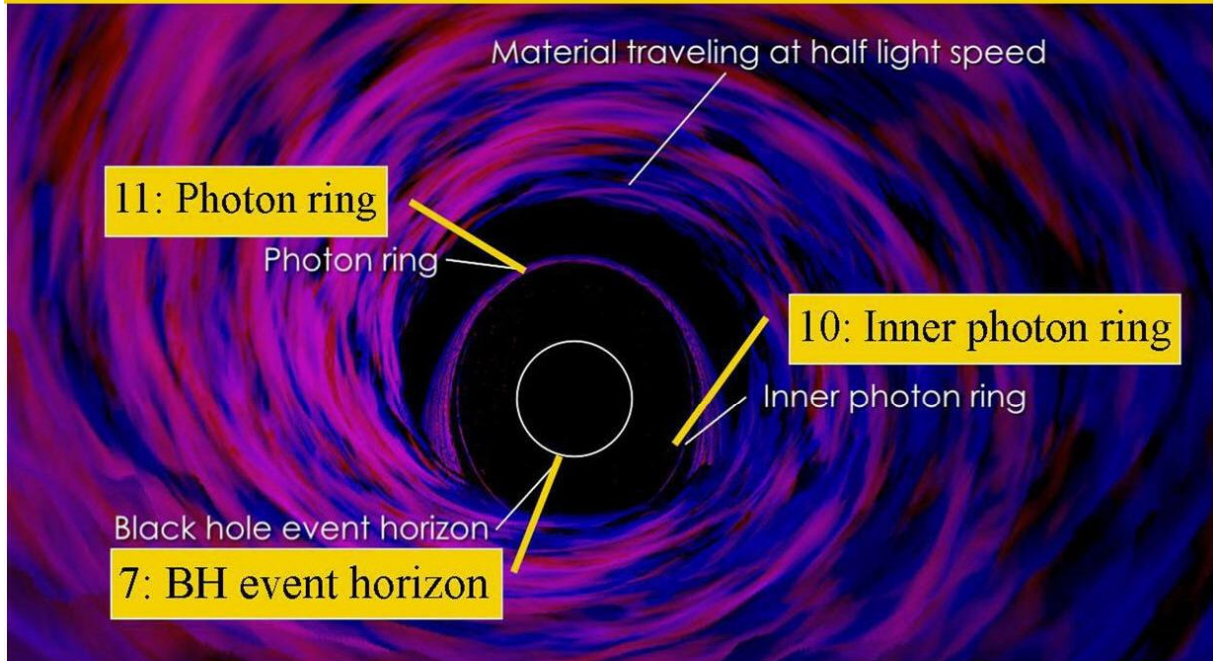
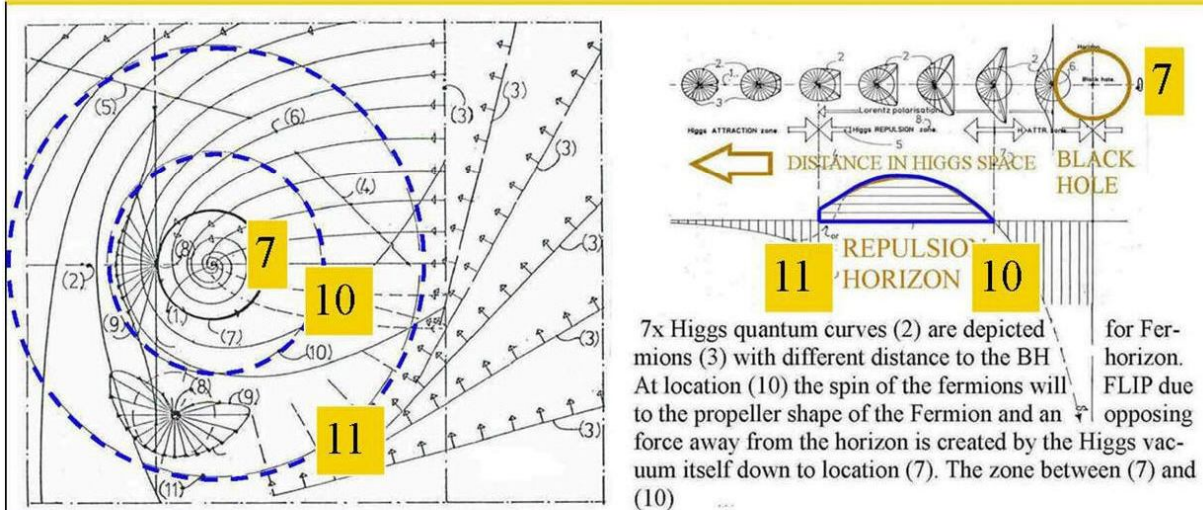

Figure 24, The particle zoo of single ELEMENTARY particles.

Triple Black Hole horizons found by NASA in accordance with Quantum FFF Theory.



For tripple B-H horizons in Quantum FFF theory see (nrs: 7: Event horizon, 10: Inner photon ring, (10+11 =Fermion repulsion zone) 11: Photon ring)



- 1: Non rotating Black hole nucleus (in 2D cross section).
- 2: Reference axis for trajectories 4,5 and 6.
- 3: Other incoming photonic/Higgs fronts (without depicted trajectories)
- 7: High photon energy collider globular shell, with intense Quantum effects like pair production (e-,e+). 8: test masses.
- 9: Butterfly shaped Higgs/photon Fermion pushing curves in 2D.
- 10 and 11: Fermion repulsion zone. Due to the propeller shape of the Fermions, they will experience a so called "Spin Flip" in this zone.

Figure 25, Triple Black hole horizons found by NASA, in accordance with Quantum FFF theory lots of emergence processes like H2 production by pair producing Quantum Fluctuations and the chiral vacuum.

Production hypothesis for Quantum Knot
 Ball Lightning by Interference, Micro Co-
 mets, “Dark gamma Lightning” and Sprites,
 based on Photos and Langmuir fireball vi-
 deos and Quantum FFF Theory 01-09-2013.

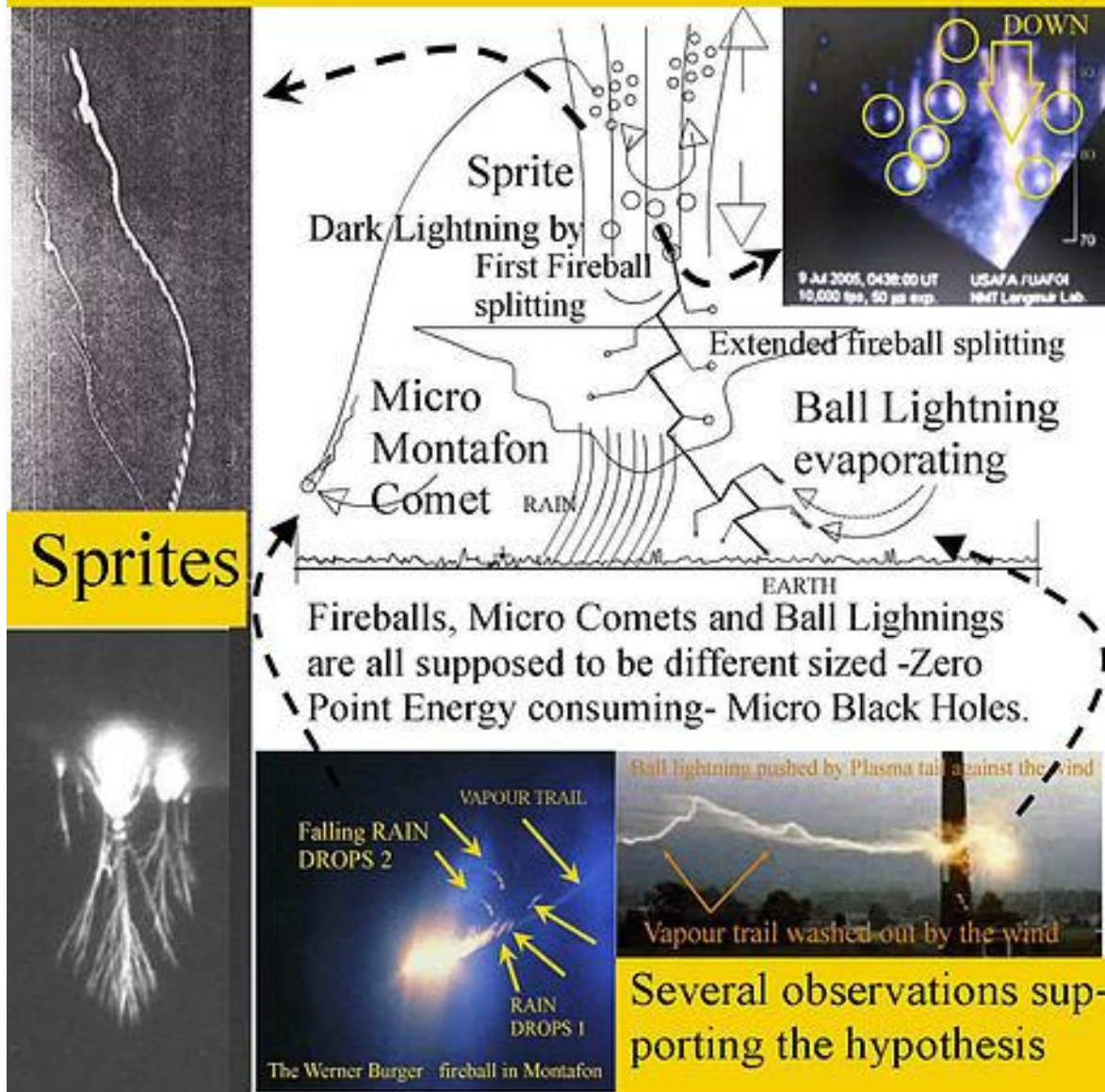

Figure: 26, Production by electro magnetic interference of the Higgs Aether into micro Black Holes or Quantum Knots as the base for Ball Lightning, Micro Comets or Sprites and Elve phenomena.

Characteristics of Quantum FFF Theory.

I postulate that Black holes don't emit gravitons (as Fermions do) but suffer under the "Casimir push" of the oscillating Higgs (pushing gravity) Aether field. That the Black hole is a real Quantum Knot inside an oscillating Higgs string vacuum lattice building a Relativistic Aether!. This relativistic Higgs aether is the origin of all Lightning-channeling, Ball Lightning and Micro-Comet phenomena on earth and the origin of Comets, Sunspots, Herbig Haro Objects evolving into stellar- and Galaxy Anchor Black Holes in space.

Photons are propagating through the Higgs vacuum lattice as "ripples" able to collapse (by Higgs transformation) as real string shaped photons connected to a string propeller shaped electron on a screen or as interference with two or more photons into Quantum Knots of a Sprite or ball Lightning. http://vixra.org/author/leo_vuyk . I expect that the new generation of telescopes will show the evidence of dual Dark Matter Black Holes located inside Herbig Haro lobes and in pairs outside Galaxies.

[Quantum-FFF \(Function Follows Form\) Theory by Leo Vuyk](#) THE START OF NEW PHYSICS ??

A Supersymmetric Multiverse interpretation of Quantum Mechanics with entanglement at universal distance.

Keywords: Massless Dark Energy Higgs Aether field, --Massless Dark Matter Black Holes, --Dual Higgs-Graviton PUSH Gravity, -- Dual Universal Wavefunction Collapse and Consciousness,--3D Geometrical Convertible Higgs particle as Mother particle of all other particles.

This many worlds or Supersymmetric Multiverse interpretation of quantum mechanics is the idea that NOT ALL POSSIBLE ALTERNATE HISTORIES of the universe NEED to exist IF THERE IS INSTANT mirror symmetrical wavefunction collapse in at least two distant (Charge and Parity) mirror symmetric universes. IF SO, then ALL ALTERNATE HISTORIES EXIST but have the same anti-copy result.

Dual entangled Cats and anti-Cats in both universes, die or live instantly (superposed) without looking at them: they (the nuclear decay trigger) look to each other by long distant instant Quantum entanglement.

Schrödinger was not aware of that of course so he described the paradox, which became known as Schrödinger's cat paradox. However deep down the Planck scale at the Higgs level there seem to be TWO entangled pinball machines active between dual anti-copy universes. The oscillating Higgs energy is compared with the pinball springs and the pinballs compared with the Fermions and photons

As a result:

QUANTUM-FFF THEORY elements are deviating from the Standard Model by a:

A: NEW DARK MATTER BLACK HOLE, (Non oscillating Higgs particle Knot as NUCLEUS of the Black Hole)

B: NEW DARK ENERGY HIGGS AETHER (with 126 GeV OSCILLATING energy and Spacetime universal- and Local Time),

C: NEW BIG BANG PARADIGM (with symmetrical entangled raspberry shaped cyclic multiverse).

D: NEW SYMMETRIC WAVEFUNCTION COLLAPSE (only by symmetric entanglement between NEIGHBOURING supersymmetric anti copy universes down to the quantum level. The so called "cosmological Multiverse SEPARATED by space(time)" in contrast with the Quantum Multiverse not separated by spacetime.

E: NEW HUMAN CONSCIOUSNESS (is based on the a comparable but retarded (B.Libet: 400 m.sec) collapse principle).

F: NEW STANDARD MODEL (has to be extended with propeller shaped Fermions).

G: The VARIABLE LIGHTSPEED is dragged around massive objects. So a bouncing radar pulse from Venus onto Earth will show anomalies.

H: NEW HUBBLE REDSHIFT is originated by transformation (lattice dilution) of the vacuum by Dark Matter black hole proliferation through the universe.

J: NEW QUANTUM GRAVITY and EM forces, based on opposing/combined Casimir, Higgs/Graviton/monopole photons and new Feynman diagrams)

DESCRIPTION MORE IN DETAIL:

A: That a "black hole" create and repel propeller shaped Fermions and photons at its horizon, it has a Higgs knotty nucleus but no mass -because it does not emit gravitons-, and is the origin of all "dark matter" in the universe. The BH is supposed to exist at all scales from Quantum Knots (or Ball lightning) up to Comets, Sunspots, external Stellar- and Galaxy Anchor Black Holes, up to the Big Crunch- or Big Bang Black Hole.

B: That "dark energy" is based on microscopic massless vacuum (non SM) Higgs particles, energetic oscillating in opposing pairs along a chiral but tetrahedron shaped vacuum lattice and able to convert (NOT DECAY) into pairs of electrons and positrons, e.g. at the horizon of black holes. The Higgs is supposed to be singular 3D-stringy particle able to convert by mutual collision into a different shape of an electron, positron photon or neutrinos. A Muon Tau or Quark, are supposed to be compound particles, based on composition of electron or positron propellers with photons/gluons.

That the 126 GeV mass of the Higgs particle (found by the LHC in Geneva) could be translated into 126 GeV energy of the paired vacuum particles and is supposed to be the origin of spacetime and so called Dark Energy. Conclusion, the LHC found a first sign of Dark Energy!!

C: That as a result, the Universe is cyclic, super symmetric and has the form of a raspberry shaped pulsating symmetric Multiverse with finite cycle time.

D: That all matter and humans have their instant entangled copy symmetric counterpart living inside the opposing super symmetric lobes of the raspberry multiverse. which is supposed to be the base for ALL WAVEFUNCTION COLLAPSES HERE on earth AND CONSCIOUSNESS.

E: That Humans and higher animals have the ability to influence conscious acts by a small retardation or lagging effect (300 m.sec) in decision making. This lagging effect phenomenon is already found and described for humans by Benjamin Libet, called RPI and RPII

(Readiness Potential 1 and 2) see: <http://vixra.org/abs/1103.0015> called "Wavefunction Collapse and Human Choice-Making Inside an Entangled Mirror Symmetrical Multiverse."

F: That the STANDARD MODEL has to be extended with electric and magnetic monopole photons/gluons and Elementary particles are interpreted as real 3-Dimensional entities with complex convertible shapes, able to form compound quarks and two Leptons (the Muon and Tau).

G: The LIGHTSPEED is dragged around massive objects. So a bouncing radar pulse from Venus onto Earth will show anomalies. The orbital speed of Venus and the Earth will originate this anomaly. (By a ellipsoidal shaped LASOF around the earth: LOCAL ANTI-SYMMETRIC OSCILLATING vacuum FRAME)

PUBLICATIONS:

As a result 2:

1: The clear MICROSTRUCTURE or the 3D FORM of elementary particles, (also called 3D-Preons) made out of convertible Higgs particles, is responsible for “Bound states of Fermions” and composite Quarks.

2: The Higgs is supposed to be energetic oscillating, it is the origin all particle motion and spin states and Dark energy (126 GeV) inside a truncated tetrahedron shaped chiral Higgs vacuum lattice. The lattice chirality (left or right handed) is the origin of our material universe. Higgs particles are zero point “Planck Oscillators” the origin of the Casimir force, waiting to be harnessed as free energy.

3: NOTHING SUCKS IN PHYSICS, Gravitons act with less pressure on Fermions than the Higgs vacuum (dark energy) and everything is ENTANGLED by INSTANT communication between at least two anti-copy UNIVERSES or MULTIVERSE, being entangled since the big bang.

4: Black holes of all sizes (down to ball lightning) do not emit gravitons, they feel only Casimir Gravity of the vacuum oscillations so they are massless but counter intuitively the origin of dark matter and producers of all Hydrogen by Electron and Positron pairs as horizon fluctuations and repel all Fermions even positrons at the double BH horizon.

5: Black Holes are supposed to have a negative surface charge in a material based universe and positive charged inside an ANTI-material universe, due to the chirality (left or right handed vacuum lattice spiralling) of the oscillating dark energy Higgs vacuum..

6: The Multiverse is Pulsating by two phenomena, A; vacuum (Higgs) eating new paradigm dark matter black holes (causing the Hubble redshift) and B: by universal expansion caused by the oscillation force (Dark energy) of the Higgs vacuum lattice.

FUNCTION FOLLOWS FORM in Quantum FFF-Theory. The Microstructure of elementary particles, is supposed to be the origin of FUNCTIONAL differences between Higgs- Photon- and propeller shaped Fermion particles. Something SMALL is missing in mainstream physics: a NEW splitting and pairing MASSLESS BLACK HOLE, the origin of all dark matter, Ball Lightning Micro Comets , Comets, Sunspots up to Galaxy external Anchor Black Holes and the Big Crunch of the CP symmetric pulsating raspberry shaped multiverse.

The multiverse is a collection of huge entangled pinball machines, with dark energy in the form of linear oscillating double Higgs pins as the origin of photonic collision products with the propeller shaped Fermions running and spinning as balls.

All forces are the result of this entangled Pin-Ball interaction. The 126GeV Boson recently found in the LHC is not a single but a double massless 3rd generation Higgs boson linear oscillating in tandem as opposing boxer engine pistons in a chiral truncated tetrahedron lattice.

The 126GeV energy is the base for universal dark energy, the frequency is the base for local time and the length a base for the Planck scale. (Twin Higgs, Dual Higgs, Duplex Higgs, or Tandem Higgs).

AS A RESULT, Free energy devices and electron-muon decay levitation is proposed. An unstable Higgs vacuum seems to be present around all black hole horizons by observed H₂ production and annihilation radiation created by pair production of positrons and electrons. (Instability of the Higgs Field Aether)

The main difference with mainstream physics is in short as follows:

A: That a "black hole" has no mass- it does not emit gravitons-, but is the origin of all "dark matter" in the universe and can exist at all scales from Quantum Knots (or Ball lightning) up to Comets, Sunspots, external Galaxy Anchor Black Holes, up to the Big Crunch- or Big Bang Black Hole.

B: That "dark energy" is based on microcopic massless vacuum (non SM) Higgs particles, energetic oscillating in opposing pairs and able to convert into pairs of electrons and positrons, e.g. at the horizon of black holes.

C: That the 126 GeV mass of the Higgs particle (found by the LHC in Geneva) could be translated into 126 GeV energy of the paired vacuum particles. (alternative non SM Higgs) (And is consequently THE FIRST SIGN OF "DARK ENERGY") The LHC found a first sign of Dark Energy!!

D: That as a result, the Universe is cyclic, super symmetric and has the form of a raspberry shaped pulsating symmetric Multiverse with finite cycle time.

E: That all matter and humans have their instant entangled copy symmetric counterpart living inside the opposing super symmetric lobes of the raspberry multiverse. which is supposed to be the base for consciousness.

F: That Humans and higher animals have the ability to influence conscious acts by a small retardation or lagging effect (300 msec) in decision making. This lagging effect phenomenon is already found and described for humans by Benjamin Libet, called RPI and RPII (Readiness Potential 1 and 2) see: "Wavefunction Collapse and Human Choice-Making Inside an Entangled Mirror Symmetrical Multiverse." On Vixra.

Experiments to determine the mass related Lightspeed extinction volume around the Earth and around spinning objects in the Lab.

According to Einstein's relativity theory, is the speed of light for every observer the same in all reference frames.

However, there seem to be incidental differences in the lightspeed if we observe the outliers of GPS satellite to CHAMP satellite distance measurements of 180m.

At the same time in the literature I found tiny structural but characteristic unexplained irregularities in Planetary radar-pulse reflection measurements, made by I.I. Shapiro in 1964, between the Earth and Venus.

Both observations support the idea of the existence of ellipsoidal lightspeed extinction (or vacuum adaptation) volumes around massive objects like the earth. Such a volume I will call LASOF or Local Asymmetric Oscillating Vacuum Frame or Higgs field Aether.

Other historic lightspeed experiments support the idea that all objects with mass are equipped with some extinction volume.

As a consequence I propose new triangular trajectory lightspeed comparison experiments between the earth and dual satellites or dual balloons and even in the laboratory to support these lightspeed extinction and adaptation ideas.

According to the famous Michelson and Morley (M&M) lightspeed experiment, the null result could be explained by the Lorentz contraction of the apparatus in the direction of the Motion of the Earth through the light medium reference frame. However, due to the perfect one-way GPS signal speed measurements we make today at elevations of more than 5 degrees above the horizon, we know now with certainty, that the one-way lightspeed around the Earth is really constant related to the GPS system..

However, there seem to be incidental differences in the lightspeed if we observe the outliers of GPS satellite to CHAMP satellite distance measurements of 180m.

At the same time in the literature I found tiny structural but characteristic unexplained irregularities in Planetary radar-pulse reflection measurements, made by I.I. Shapiro in 1964, between the Earth and Venus.

Both observations support the idea of the existence of ellipsoidal lightspeed extinction (or Higgs field vacuum adaptation) volumes around massive objects like the earth.

This introduces the possibilities of a tiny diurnal lightspeed effect at higher altitudes like mountain summits like Dayton Miller made around 1926 at mount Wilson. (ref 1,2.)

Dayton Miller made the same M&M measurements (1926, within a horizontal plane, thus also less than 5 degrees elevation) but in contrast with M&M on a high mountain summit of Mount Wilson. His results are pointing into a direction of some (anti-Einstein) diurnal Reference Frame effect (lightspeed or contraction effect).

As a consequence it should be still an scientific obligation, to search for subtle flaws in lightspeed measurements, such as low elevation GPS measurements (with elevations less than 5 degrees) , Satellite to Satellite measurements (the Champ or Grace satellites should be capable), Improved Babcock and Bergman Light Carrousel experiments, or signal interference of two signals between two mountain (or two Tower/High Riser) Summits as dr. Yu. M. Galaev did (Ref 3) see also : "6 experiments by Leo Vuyk; (ref 4)

If we postulate that each fast moving mass carrying particle "drags" the lightspeed over only a very small "mass dependent distance of extinction" about 1 cm , in radial direction of the particle, then the Massive Earth could "drag" the lightspeed in radial directions to the Earth, with a much longer distance of extinction related to the Solar reference frame.

This Distance of extinction is coined: **LASOF** (Local Anti-Symmetric Oscillating vacuum Frame). As a consequence, the LASOF is the origin of this new "scale and mass dependent drag effect of the lightspeed" which can be supposed to be the base for the so called isotropy of the lightspeed Postulated by Einstein. Consequently also the Sun is supposed to have its own LASOF inside the Galaxy LASOF.

Thus with the LASOF postulate we seem to have realistic base for new lightspeed experiments falsifying Einstein's lightspeed Postulate as described below.

For the experiments mentioned above see:

Experiments to determine the mass related Lightspeed extinction volume around the Earth and around spinning objects in the Lab.

<http://vixra.org/pdf/1102.0056v2.pdf>

References:

[1]: ABSOLUTE MOTION AND GRAVITATIONAL EFFECTS

Reginald T. Cahill 2003.

School of Chemistry, Physics and Earth Sciences

Flinders University. <http://arxiv.org/pdf/physics/0306196.pdf>

[2]: D.C. Miller, The Ether-Drift Experiment and the Determination of the Absolute Motion of the Earth, Rev. Mod. Phys. 5, 203-242(1933),

[3]: ETHERAL WIND IN EXPERIENCE OF MILLIMETRIC RADIOWAVES PROPAGATION Yu.M. Galaev.

The Institute of Radiophysics and Electronics of NSA in Ukraine,
12 Ac. Proskury St., Kharkov, 61085 Ukraine

Received August 26, 2001 in : Spacetime & Substance
International Physical Journal.

<http://www.spacetime.narod.ru/0010-pdf>

[4]: Quantum FFF Theory in Posters.

Authors: Leo Vuyk : viXra:1104.0083 submitted on 28 Apr 2011,

Category: High Energy Particle Physics

<http://rxiv.org/pdf/1103.0068v1.pdf>