

Neutrosophic Logic Approaches Applied to "RABOT" Real Time Control

Alexandru Gal
Institute of Solid Mechanics of the Romanian Academy
Romania, galexandru2003@yahoo.com

Luige Vladareanu
Institute of Solid Mechanics of the Romanian Academy
Romania, luigiv@imsar.bu.edu.ro, luigiv@arexim.ro

Florentin Smarandache
University of New Mexico
USA, fsmarandache@gmail.com

Hongnian Yu
University of Bournemouth
United Kingdom, <yuh@bournemouth.ac.uk>

Mincong Deng
Tokyo University of Agriculture and Technology
Japan, deng@cc.tuat.ac.jp

Abstract— In this paper we present a way of deciding which control law should operate at a time for a mobile walking robot. The proposed deciding method is based on the new research field, called Neutrosophic Logic. The results are presented as a simulated system for which the output is related to the inputs according to the Neutrosophic Logic.

Keywords— Neutrosophic Logic, Hybrid Control, Walking Robots

I. Introduction

The mobile robot control represents a real interest due to its industry applications, but also due to its ideas of using robots in households. Because of its complexity, one can say there are three major types of robot control[9]. The first one is formed out of the PID (proportional – integrative – derivative) control or PD (proportional – derivative) control[10 - 13], in which the tracking errors along with their integrative and derivative part are amplified with certain gain values and then given as input values to the actuation system. The second type of robot control laws is formed by the adaptive control [14-20], in which the control law modifies its parameters according to the robot and environment dynamics and also to compensate the outside perturbations. The third control law type is represented by the iterative control laws in which the motors torque is computed by summing in a certain way the previous torques [21 - 23]. Other methods of control include

Sliding Motion Control, Switching Control, Robust Control, etc.

All these types of control mentioned, are very good for certain applications. This is why, if we can't fit an application to a certain category for which, there are efficient control laws already made, then we need to design another control law for the robot. Another way is to use several control laws, each specialized for a certain task. But this is not possible unless you use a switching mechanism between the robot control laws. This is why, we need that the switching law used in selecting a different control law specialized for a certain task, and according to the wish of the designer/engineer and also according to different environmental factors given by sensors and transducers.

In this paper, we presented a new method for deciding how to switch between several control laws, and in particular between a kinematic control law (a PID controller) and a dynamic control law (a Sliding Motion Control Law). These control laws that were used, were thought to be used for controlling a mobile walking robot, laws that have the objective of following as good as possible a given trajectory for the robot foot.

This new switching method, is based on the new scientific area called Neutrosophy[7] and more precise on its derivative Neutrosophic logic. The neutrosophic logic was applied by using the classic Dezert-Smarandache[8] theory, but also the research of Smarandache and Vladareanu[6]. By making a

simulation of the conditions encountered by a walking robot foot, in Matlab Simulink, we could observe how the switching technique behaves, compared to a classic fuzzy switching method.

II. Neutrosophic logic and DSMT

The neutrosophic logic is a generalization of fuzzy logic. In neutrosophic logic a statement is $t\%$ true, $f\%$ false and $i\%$ indeterminate, and t, f, i are real values taken from the sets T, F, I . These three sets can be of any form and the sum = $t+f+i$ has no restrictions. Neutrosophic logic is related to other logics through the true and false parameters but it introduces the percentage of indeterminacy which expresses the percentage of unknown parameters or states [7].

If we choose U to be a universe of discourse, and M a set included in U , then an element x from U is noted with respect to the set M as $x(T,I,F)$ and belongs to M in the following way:

- x is $t\%$ true that it is in the set M
 - x is $i\%$ indeterminate that it is in the set M (the value of unknown)
 - x is $f\%$ false that it is in the set M
- where the value of t varies in T , the value of i varies in I and the value of f varies in F [8].

A distinctive part of DSMT (Dezert Smarandache Theory) is the notion of hyper-power set. Let $\Theta = \{\theta_1, \dots, \theta_n\}$ be a finite set of "n" exhaustive elements. Then the DSMT hyper-power set D^Θ is defined as the set of all composite propositions built from elements of Θ with the operators \cup and \cap such that [8]:

1. $\phi, \theta_1, \dots, \theta_n \in D^\Theta$
2. If $A, B \in D^\Theta$, then $A \cap B \in D^\Theta$ and $A \cup B \in D^\Theta$

Within the same set Θ and with $m(\cdot): D^\Theta \rightarrow [0,1]$ we have:

$$m(\emptyset): 0 \text{ and } \sum_{A \in D^\Theta} m(A) = 1 \quad (1)$$

where $m(A)$ is called the generalized basic belief assignment or mass (gbba) of A [8].

By using the belief function

$$Bel(A) = \sum_{\substack{B \subseteq A \\ B \in D^\Theta}} m(B) \quad (2)$$

associated with two sources (observers) $m_1(\cdot)$ and $m_2(\cdot)$ we can define the classic DS m rule of combination:

$$\forall C \in D^\Theta, m_{M^f(\Theta)}(C) \equiv m(C) = \sum_{\substack{A, B \in D^\Theta \\ A \cap B = C}} m_1(A) \cdot m_2(B) \quad (3)$$

Since D^Θ is closed under the set operators \cup and \cap this Dezert-Smarandache rule of combination guarantees that $m(\cdot)$ is a proper belief mass. Meaning that $m(\cdot): D^\Theta \rightarrow [0,1]$. The rule of combination described is commutative and associative. Also one can extend the rule for as many sources as required.

III. Applying the neutrosophic logic to a walking robot leg control

For the walking robot kinematic structure, one can imagine any kind of biped or hexapod structure, for it doesn't affect the neutrosophic decision making. Bearing this in mind, we have simulated the approach of the robot foot to the support surface through a well thought sine signal. By knowing where the support surface is at, we could say if the robot foot is near the surface, or is in contact with it. According to this distance we could compute the contact force between the robot foot and the contact surface / ground.

Having simulated these two sensors, we have chosen these two as our two observers for the Neutrosophic computations. Knowing this, we defined in figure 1, the basic diagram of how the neutrosophic logic is applied. Also we need to specify that the decision will be made between two control techniques for the walking robot leg control. These two control laws were chosen to be based on motion control for the foot trajectory. One will be based on a dynamic control law and the other will be based on a kinematic control law. Also, the two control laws were not implemented, but were only used in presenting the neutrosophic decision.

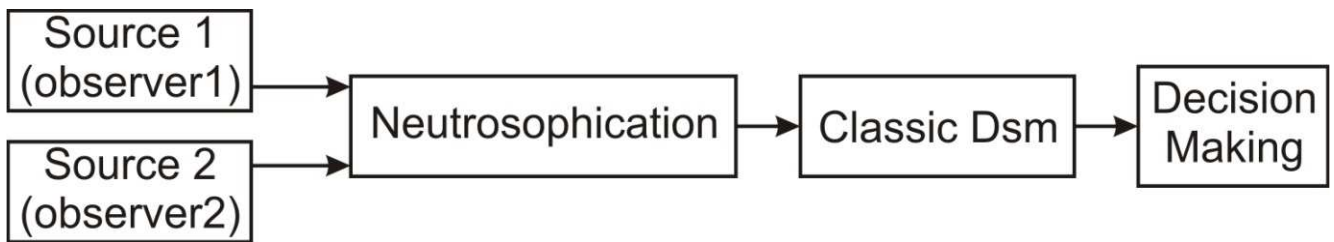

Fig. 1 Neutrosophic logic applied for two observers

As one can see, the first part of the neutrosophic diagram is formed from the two observers which we have chosen as the Proximity and Force sensors. After that, there is a stage of

Neutrosophication in which the sensors values are converted as in fuzzy logic, into values from the interval $[0,1]$.

For the neutrosophication stage, we have to bear in mind that the neutrosophic logic has functions that work with values

of Truth, Indeterminacy and Falsity. Because of this, we'll have similar to a fuzzification graph, three signals of Low, Medium and High areas, which are attributed to the percentages of Truth, Indeterminacy and Falsity according to a specific statement for each sensor.

For the proximity sensor, we have the member function in figure 2, in which one can see the three Low, Medium and High values. These three values correspond to the percentage values of truth, indeterminacy/unknown and falsity for the dynamic and kinematic control in the following manner (table 1).

TABLE I. NEUTROSOPHICATION CORRESPONDENCE OF FUZZY VALUES FOR THE PROXIMITY SENSOR

Control type	Low	Medium	High
Dynamic Control	Truth percentage	Indeterminacy/unknown percentage	Falsity percentage
Kinematic Control	Falsity percentage	Indeterminacy/unknown percentage	Truth percentage

For the force sensor diagram, we'll have a slightly different correspondence (table 2):

TABLE II. NEUTROSOPHICATION CORRESPONDENCE OF FUZZY VALUES FOR THE FORCE SENSOR

Control type	Low	Medium	High
Dynamic Control	Falsity percentage	Indeterminacy/unknown percentage	Truth percentage
Kinematic Control	Truth percentage	Indeterminacy/unknown percentage	Falsity percentage

For these two member functions, one can see that in figures 2 and 3 we have a threshold for the sensor values according to which, the values of the neutrosophication are directly influenced. This threshold is chosen according to the application in which the neutrosophication logic is used and is also adjusted by trial and error after seeing the experimental data.

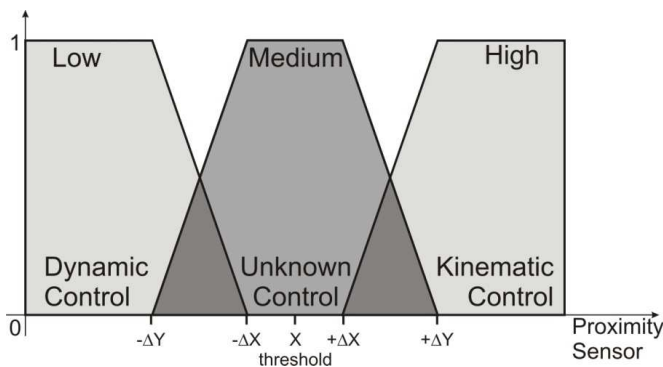

Fig.2 Neutrosophication for the Proximity sensor data

Therefore, when the robot foot is in contact with a support surface, it means that the proximity sensor will provide a 0 value or one very close to it, and it also means that the force

transducer should provide a value higher than the set threshold.

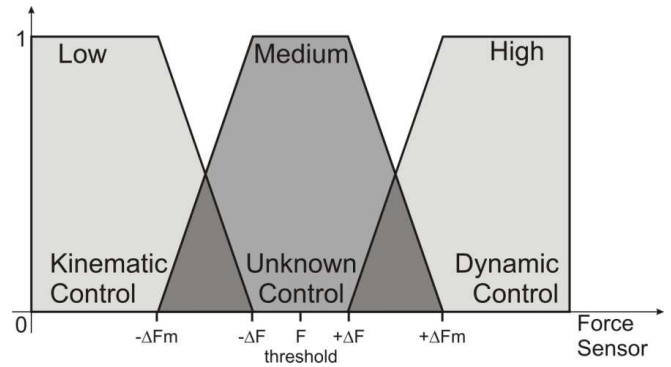

Fig. 3 Neutrosophication for the Force sensor data

Knowing these facts we developed the neutrosophic switching block control based on the theory presented in this paper, and its results are discussed in the next chapter. Also, we used a classic fuzzy control so we can compare the results obtained to a very common and known switching design.

IV. Results and Conclusion

To prove the validity of our proposed switching technique we developed a simulated system in Matlab Simulink, in which we built two loops one for the Neutrosophic logic and one for the Fuzzy logic so we can compare the results. Thus, figure 4 presents the switching system.

In the presented diagram of figure 4, one can identify the block that defines the reference values, made out of the robot vertical position, its foot position according to the distance between the robot platform and foot, and the third reference signal is the one that defines the ground position. The second diagram bloc, named Sensors computes the reference data and provides to the decision making block the values of force and proximity which in a real system would be provided by two real sensors.

By using the sensor data, we have defined two switching blocks. The first one is called Neutrosophic Decision Control and was made using the data presented in this paper, and the second one, is called Fuzzy Decision Control and was made using a simple fuzzy rule which was not presented because is not this paper objective, but was used to compare the final results. The output data was plotted to observe how the switching system behaves.

Figure 5, presents two of the reference signals. The first one defines the sine signal for the foot vertical position and the second the ground position which was made to look like a descending stair. The third signal that defines the robot position was not presented due to the fact that it was taken of value 0. Thus, one can observe that the foot reference position does not stop at the ground level, so that we can compute the force parameter due to the negative value of the proximity computed sensor. This was done only for the reason to present different cases that the robot can encounter.

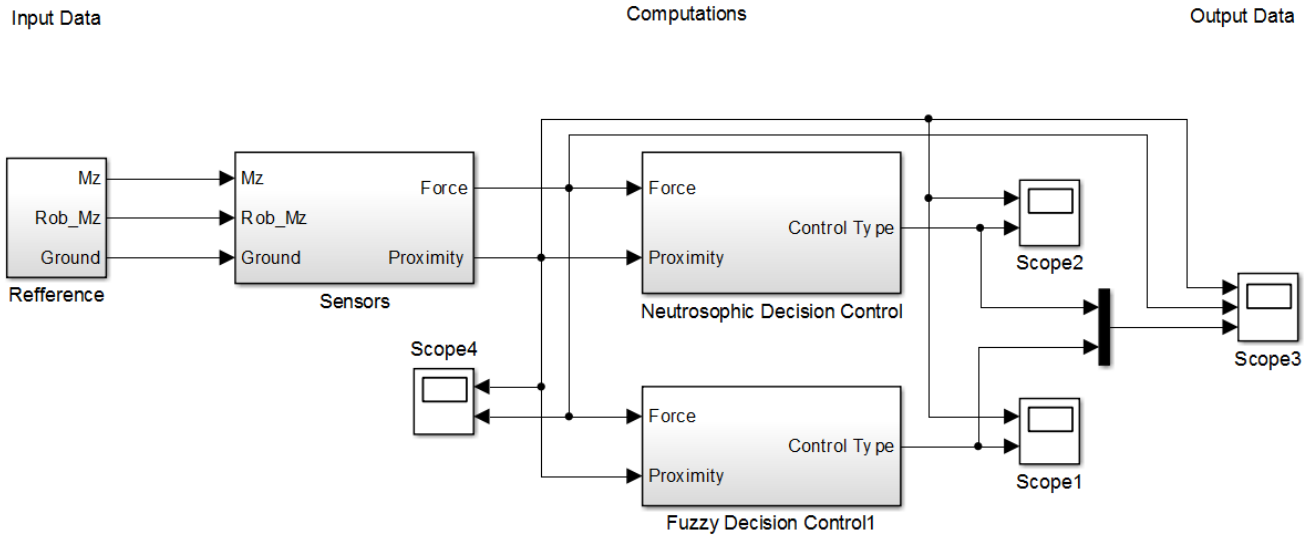

Fig. 4 The simulated switching system

After the simulation was done, the output data provided by the simulated sensors is shown in figure 6, the top two diagrams. These signals are for proximity data and the computed force. The third diagram of figure 6 presents the switching data provided by the neutrosophic and fuzzy decision blocks. The full line represents the neutrosophic decision and the dashed line the fuzzy decision. Also, the decision to choose the kinematic control law is when the output value of the switching law is equal to 10 and for the dynamic control law we have chosen the 0 value. Before the neutrosophic decision is made, we had to compute the four parameters on which the neutrosophic switching is based. These parameters are presented in figure 7.

One can observe that the value of the indeterminacy parameter is always 0 because the values provided by the sensors do not make our system to be in an unknown state.

One can see how the value of truthiness, indeterminacy, falsity and contradiction varies according to the values of proximity and force sensors. Also, we have to point out that these values correspond to the level of truthiness, indeterminacy and falsity for choosing the dynamic control law, and the kinematic control law is chosen when the dynamic one fails to be selected.

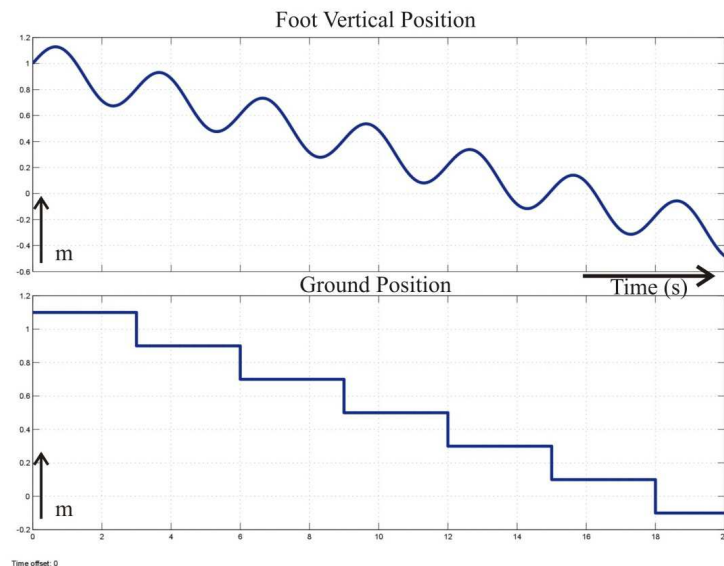

Fig. 5 The reference signals for the robot foot and ground

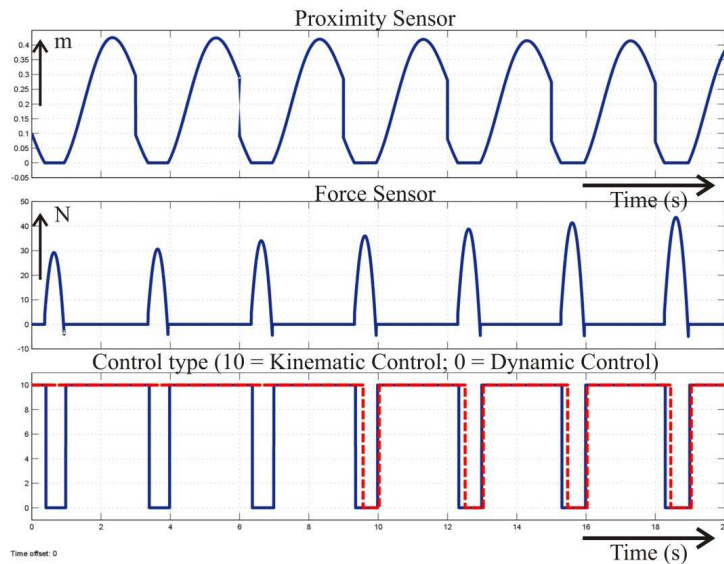

Fig. 6 The output data from sensors and the switching decisions

After the neutrosophication phase, in which we computed the truthiness, indeterminacy, falsity and contradiction parameters, we have applied the classic Neutrosophic decision, described in this paper. After that, we have chosen the control law, by simply comparing the results of the truthiness, indeterminacy, falsity and contradiction parameters to each other, and obtained the first diagram from figure 8.

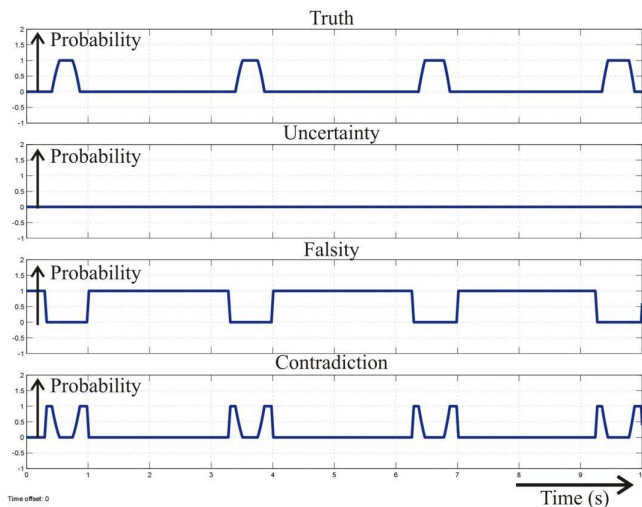

Fig. 7 Parameters after neutrosophication (Truthiness, Indeterminacy, Falsity and Contradiction)

The second diagram of figure 8, shows the output of the fuzzy switching block in which the decision was made with the help of a threshold value of 0,5 for the fuzzification values.

As one can see from figure 8, the neutrosophic based switching law has commuted from the kinematic control law to the dynamic control law when the robot foot was near and then in contact with the support surface.

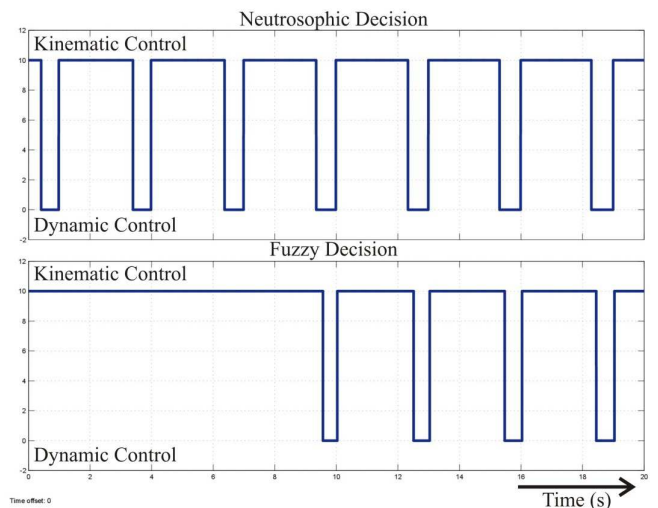

Fig. 8 Output data of the two switching techniques

After the contact has ended, the control law has been switched back from the dynamic control law to the kinematic control law. This was done at every step of the stairs. But, in comparison, the fuzzy based switching law did not behave like we wanted because it failed to switch to a dynamic control law for the first 3 steps, and after that, at the last 4 steps the robot has taken, it commuted the control laws too late to be efficient.

The main conclusion that can be drawn is that the neutrosophic technique behaves really well in different conditions of uncertainties, that can occur during the robot motion, due to the errors from the sensors or uneven ground surface in the case of the force sensor.

Further work will focus on implementing this switching technique on a simulation of a walking robot in which one will be able to see how the switching is influencing the motion of the walking robot. And after that, the second step will be to implement it on a real robot.

Acknowledgment

This work was supported in part by the Romanian Academ and the FP7 IRSES RABOT project no. 318902/2012-2016 (sponsor and financial support acknowledgment goes here).

References

- [1] Luige Vladareanu, Alexandru Gal, „A Multi-Functionl Approach of the HFPC Walking Robots”, Proceedings of the 15th WSEAS International Conference on Systems (part of the 15th WSEAS CSCC multiconference), Recent Researches in System Science, Corfu Island, Greece, July 14-16, 2011, pag: 339-345, ISBN: 978-1-61804-023-7, ISSN: 1792-4235.
- [2] Y. Liu, H. Handroos, O. Alkkioimäki, V. Kyrki, H. Kälviäinen, “Development of a Hybrid Position/Force Controlled Hydraulic parallel Robot for Impact Treatment”, Springer London 2010, ISBN: 978-1-84882-693-9.
- [3] Luige Vladareanu, G. Tont, Ion Ion, L. M. Velea, Alexandru Gal, O. Melinte, „Fuzzy Dynamic Modeling for Walking Modular Robot Control”, Proceedings of the 9th WSEAS International Conference on Applications of Electrical Engineering (AEE '10), Penang, Malaysia, March 23-25, 2010, pag:163-170, ISBN: 978-960-474-171-7, ISSN: 1790-2769.
- [4] Dr. William D. Fisher, Dr. M. ShahidMujtaba, „Hybrid Position/Force Control: A Correct Formulation”, Measurement & Manufacturing Systems Laboratory HPL-91-140, October, 1991.
- [5] H. Zhang and R. P. Paul, "Hybrid Control of Robot Manipulators," in International Conference on Robotics and Automation, IEEE Computer Society, March 1985. St. Louis, Missouri, pp.602-607.
- [6] F. Smarandache, Victor Vladareanu, "Applications of neutrosophic logic to robotics: An introduction", in Proc. GrC, 2011, pp.607-612.
- [7] FlorentinSmarandache, “Neutrosophy a new branch of Philosophy”, Multi. Val. Logic – Special Issue: Neutrosophy and Neutrosophic Logic, 2002, Vol. 8(3), pp.297-384, ISSN:1023-6627.
- [8] Florentin Smrandache, Jean Dezert, “Advances and Applications of Information Fusion”, American Research Press, Rehoboth, 2004.
- [9] P.R. Ouyang, W.J. Zhang, Madan M. Gupta, “An adaptive switching learning control method for trajectory tracking of robot manipulators”, *Mechatronics* 16 (2006) 51–61, Elsevier, 2005.
- [10] Craig JJ, “Introduction to robotics: mechanics and control”, MA: Addison-Wesley; 1986.
- [11] Qu ZH, “Global stability of trajectory tracking of robot under PD control”, *Dyn. Contr.* 1995; 5(1):59–71.
- [12] Kerry R, “PD control with desired gravity compensation of robotic manipulators: a review”, *Int J Robot Res* 1997;16(5):660–72.
- [13] Chen QJ, Chen HT, Wang YJ, Woo PY, “Global stability analysis for some trajectory tracking control schemes of robotic manipulators”, *J Robot Syst* 2001;18(2):69–75.
- [14] Craig JJ, “Adaptive control of mechanical manipulators”, Addison-Wesley; 1988.
- [15] Choi JY, Lee JS, “Adaptive iterative learning control of uncertain robotic systems”, *IEE ProcContr Theory Appl* 2000;147(2):217–23.
- [16] Slotine JJ, Li W, “On the adaptive control of robot manipulators”, *Int J Robot Res* 1987;6(3):49–59.
- [17] Li Q, Poo AN, Teo CL, Lim CM, “Developing a neuro-compensator for the adaptive control of robots”, *IEE ProcCont Theory Appl* 1996;142(6):562–8.
- [18] Li Q, Poo AN, Teo CL, “A multi-rate sampling structure for adaptive robot control using a neuro-compensator”, *Artificial IntellEng* 1996;10(1):85–94.
- [19] Tomei P, “Adaptive PD controller for robot manipulators”, *IEEE Trans Robot Automation* 1991;7(4):565–70.
- [20] Li Q, Tso SK, Zhang WJ, “Trajectory tracking control of robot manipulators using a neural-network-based torque-compensator”, *Proc I Mech E, Part I, J SystContr* 1998;212(5):361–72.
- [21] Tayebi A, “Adaptive iterative learning control for robot manipulators”, In: Proceedings of the American control conference, Denver, CO,USA, June 2003. p. 4518–23.
- [22] Chen YQ, Moore KL, “PI-type iterative learning control revisited”, In: Proceedings of the American control conference, Anchorage, AK,USA, May 2002. p. 2138–43.
- [23] Yan XG, Chen IM, Lam J, “D-type learning control for nonlinear time-varying systems with unknown initial states and inputs”, *TransInst Measure Contr* 2001;23(2):69–82.