

# The Trickle Up Effect:

A collection of economic and scientific papers

By Prof. Florentin Smarandache, Dept. of Mathematics  
and Science, University of New Mexico, Gallup, USA  
and V. Christianto, <http://www.sciprint.org>

2013

LAP LAMBERT Academic Publishing - Germany

The readers can contact the authors via email at: fsmarandache@gmail.com or victorchristianto@gmail.com

Copyright © Authors for their papers, 2013.

Copyright © Publication by LAP LAMBERT Academic Publishing, 2013.

LAP LAMBERT Academic Publishing is a trademark of OmniScriptum GmbH & Co. KG  
Heinrich-Böcking-Str. 6-8, 66121, Saarbrücken, Germany. URL: [www.lap-publishing.com](http://www.lap-publishing.com)

Copyright note: Electronic copying, print copying and distribution of this book for noncommercial, academic or individual use can be made by any user without permission or charge. Any part of this book being cited or used howsoever in other publications must acknowledge this publication. No part of this book may be reproduced in any form whatsoever (including storage in any media) for commercial use without the prior permission of the copyright holder. Requests for permission to reproduce any part of this book for commercial use must be addressed to the Author. The Author retains his rights to use this book as a whole or any part of it in any other publications and in any way he sees fit. This Copyright Agreement shall remain valid even if the Author transfers copyright of the book to another party.

Many books can be downloaded from the following Digital Library of Science:  
<http://www.gallup.unm.edu/~smarandache/eBooks-otherformats.htm>

ISBN: XXXXXXXXXXXXX

# The Trickle Up Effect: a collection of economic and scientific papers

## Preface

This book consists of a number of economic, mathematic, and scientific papers, covering different subjects, from global corporate control to cosmology issues. Hopefully the readers will find some interesting discussions in this collection.

The trickle-up effect is defined here as a reverse process from the ‘expected’ trickle-down effect, a well known effect which is supposed to happen during development process. According to an article in the Center of Progressive Economics: “*Libertarians contend that the prosperity generated at the top of the economic latter will trickle down to everyone else.*”<sup>1</sup> But the problem with pure laissez-faire economics is that the wealth generated at the top does not trickle down to the rest of society to a sufficient extent. The creative redistribution theory of Keynes and its implementation by FDR and World War II started to solve this problem, and made recirculation of wealth from the bottom to the top, which can be called as “*the trickle up.*” One can argue therefore that trickle up effect is more realistic, that is by helping the poor then the effect will be spiraling up to the wealthy and the affluent people.

The same situation apparently also happens in development economics. For example it is common to assume that the development of a country will need foreign loan to trigger effects, and then the good effects of economic development will trickle down from the affluent to the less affluent people. But as shown by a number of economists, it is often the reverse that occurs: the money flowing from the poor to the affluent is much more than the money flowing from the affluent to the poor.

And for the debt caused by foreign loan, it can create a massive poor society which becomes more dependent to other countries. See for instance a book by John Perkins, with title *Confessions of an Economic Hit Man*:<sup>2</sup>

“Like our counterparts in the Mafia, we provide favors. These take the form of loans to develop infrastructure—electric generating plants, highways, ports, airports, or industrial

---

<sup>1</sup> <http://cpe.us.com/22/trickle-up-vs-trickle-down-economics>; see also <http://iea.org.uk/blog/in-praise-of-trickle-economics>

<sup>2</sup> Perkins, J. (2004) *Confessions of an Economic Hit Man*, Berrett-Koehler Publishers, Inc, San Fransisco, p.5, 7

parks. One condition of such loans is that engineering and construction companies from our own country must build all these projects. In essence, most of the money never leaves the United States; it is simply transferred from banking offices in Washington to engineering offices in New York, Houston, or San Francisco...Indeed, one of the reasons the EHMs set their sights on Ecuador in the first place was because the sea of oil beneath its Amazon region is believed to rival the oil fields of the Middle East. The global empire demands its pound of flesh in the form of oil concessions.”

At first sight the trickle up effect term may sound a bit delusional, but you can read the veracity memo written by the publisher of John Perkins’s books, which suggest that all that he wrote in his book is telling the truth.<sup>3</sup>

Therefore we begin this book with a paper discussing Global corporate control and its relation with the Federal Reserve Bank’s fraud of around 16 trillion of dollars between 2007-2010. Now you can find that the world is dominated by a handful of financial companies who have the privilege to get secret loan while they were in trouble.

We hope that this book will trigger further thinking and discussions concerning how the reality of economic development process - governed by World Bank and its allies - makes developing countries become even poorer. And how some countries which don’t follow the so-called Washington Consensus have become countries with strong economy, for example BRIC (Brazil, Russia, India, and China). Therefore, apparently now is the right time to questioning the basic idea concerning trickle down economy, and returning to the trickle up economy.

We would like to express our sincere thanks to Ecaterina Tomsa from LAP LAMBERT Academic Publishing who has read and supported this book.

If you have any thought and comment on this book, especially on the idea of the trickling up effect, please take your time to send us email, either to [victorchristianto@gmail.com](mailto:victorchristianto@gmail.com) or to [fsmarandache@gmail.com](mailto:fsmarandache@gmail.com).

Version 1.0: August 28<sup>th</sup>, 2013. Version 1.1: November 5<sup>th</sup>, 2013

FS & VC

<http://www.sciprint.org>

<http://independent.academia.edu/VChristianto>

---

<sup>3</sup> The veracity memo of “Confessions of an Economic Hit Man” was written by Mr. Steven Piersanti, available from: <http://www.economichitman.com/pix/veracitymemo.pdf>

## Contents

1. On Global corporate control, Federal Reserve, and the Great Theft 2007-2010: V. Christianto & Florentin Smarandache (2013) Unpublished
2. A dialogue on the Fed's bailout during 2007-2010 and possibility of hyperinflation: Victor Christianto (2013) Unpublished
3. A Christian ethics consideration on Nuclear energy: Victor Christianto (2013) Unpublished
4. Applications of Neutrosophic Logic to Robotics: An Introduction: Florentin Smarandache & Luige Vladareanu (2011)
5. The Navigation Mobile Robot Systems using Bayesian Approach through the Virtual Projection Method: Luige Vladareanu, Gabriela Tont, Victor Vladareanu, Florentin Smarandache, Lucian Capitanu (2012)
6. Neutrosophic Masses & Indeterminate Models, Applications to Information Fusion: Florentin Smarandache (2012)
7. Eccentricity, Space Bending, Dimension: Marian Nitu, Florentin Smarandache, Mircea Eugen Selariu (2013)
8. Extension communication for solving the Ontological Contradiction between Communication and Information: Florentin Smarandache & Stefan Vladutescu (2012)
9. The Duality and the Euler's Line: Ion Patrascu & Florentin Smarandache (2012)
10. Parameterized Special Theory of Relativity (PSTR): Florentin Smarandache (Progress in Physics, April 2012, <http://ptep-online.com>)
11. Oblique-Length Contraction Factor in the Special Theory of Relativity: Florentin Smarandache (Progress in Physics, January 2013, <http://ptep-online.com>)
12. Relations between Distorted and Original Angles in STR: Florentin Smarandache (Progress in Physics, July 2013, <http://ptep-online.com>)
13. On Godel's Incompleteness Theorem(s), Artificial Intelligent/Life, and Human Mind: V. Christianto & Florentin Smarandache
14. Grand Design, Intelligent Designer or simply God: Stephen Hawking and his hoax: Victor Christianto (Scientific God Journal, 2010, <http://www.sciGod.com>)

# On Global corporate control, Federal Reserve, and the Great Theft 2007-2010

By Victor Christiano<sup>1</sup> & Florentin Smarandache<sup>2</sup>

## Abstract

A common intuition among scholars and in the media sees the global economy as being dominated by a handful of powerful transnational corporations (TNCs). However, such an assumption has not been confirmed by numerical data until recently, in a report by Vitali, Glattfelder, and Battiston [1]. They gave a list of 50 most elite TNCs, which were called “super-entity”, along with other 97 TNCs which were not mentioned in their list. This super-entity is supposed to be more powerful than the core, consisting of 1,318 corporations. In this paper we expose for the first time that Vitali et al.’s finding on these super-entity TNCs apparently does not match exactly with recipients of secret funds given by the Federal Reserve Bank of USA (the Fed) during 2007-2010. Therefore, it seems that more investigations are needed on the nature of the financial corporate which received secret funds from the Fed, because those recipients of fund from Fed appear to be more powerful than the 147 super-entity TNCs. Although we give references on several papers which outlined the implications of this finding to global economy, in this paper we give no prescription on how to improve the global economy architecture. We reserve this issue for a future paper.

## Introduction

In a series of papers based on network analysis, Vitali, Glattfelder and Battiston [1][2] described their findings of the network of global corporate that controls about 80% of the world profits. Vitali, Glattfelder, and Battiston gave a list of 50 most elite TNCs, which were called ‘super-entity’, along with other 97 TNCs which were not mentioned in their list. This super-entity is supposed to be more powerful than the ‘core’, consisting of 1,318 corporations.

In this paper we expose for the first time that Vitali et al.’s finding on these super-entity TNCs apparently does not match exactly with recipients of secret fund which was given by the Federal Reserve Bank (Fed) during 2007-2010. Therefore, it seems that more investigations are needed on the nature of the financial corporate which received secret fund from the Fed, because those recipients of funds from the Fed appear to be more powerful than the 147 super-entity TNCs discovered by Vitali et al. [1].

Although we give references on several papers which outlined the implications of such a finding from network analysis to global economy [5][6], in this paper we give no

---

<sup>1</sup> URL: <http://www.sciprint.org>, email: [victorchristianto@gmail.com](mailto:victorchristianto@gmail.com).

<sup>2</sup> Department of Mathematics and Sciences, University of New Mexico, Gallup, NM 87301, USA. Email: [smarand@unm.edu](mailto:smarand@unm.edu) or [fsmarandache@gmail.com](mailto:fsmarandache@gmail.com).

prescription concerning how to improve the global economy architecture. We reserve that issue for a future paper.

## **The Network of Global Corporate control**

Vitali et al. begin their paper with a remark as follows: [1]

“We present the first investigation of the architecture of the international ownership network, along with the computation of the control held by each global player. We find that transnational corporations form a giant bow-tie structure and that a large portion of control flows to a small tightly-knit core of financial institutions. This core can be seen as an economic “super-entity” that raises new important issues both for researchers and policy makers.”

Then they conclude their paper as follows: [1, p.6]

“In contrast, we find that only 737 top holders accumulate 80% of the control over the value of all TNCs (see also the list of the top 50 holders in Tbl. S1 of SI Appendix, Sec. 8.3). This means that network control is much more unequally distributed than wealth. In particular, the top ranked actors hold a control ten times bigger than what could be expected based on their wealth.”

Previously, Glattfelder and Battiston remarked in a separate paper [2, p.20], as follows:

“However, in contrast to such intuition, our main finding is that a local dispersion of control is associated with a global concentration of control and value. This means that only a small elite of shareholders controls a large fraction of the stock market, without ever having been previously systematically reported on. Some authors have suggested such a result by observing that a few big US mutual funds managing personal pension plans have become the biggest owners of corporate America since the 1990s.”

David Wilcock [3] summarizes Vitali et al’s finding about the network of Global Corporate control as follows:

“To review, 80 percent of the world’s profits are being earned by a ‘core’ group of 1,318 corporations. As we look even deeper, we find this ‘core’ is mostly run by a “super-entity” of 147 companies that are totally interlocked. 75 percent of them are financial institutions. The top 20 companies in the “super-entity” include Barclays Bank, JP Morgan Chase & Co., Merrill Lynch, UBS, Bank of New York, Deutsche Bank and Goldman Sachs. The 147-part “super-entity” has controlling interest in the 1318-part “core”, which in turn has controlling interest in 80 percent of the world’s wealth.”

Therefore it appears that 80% of the world's profit are being earned by a core group of 1,318 TNCs, which in turn these core TNCs are run by a super-entity of 147 companies. The Table S1 of S1 Appendix Sec. 8.3. in Vitali et al's paper consists of 50 top TNCs which are mostly financial corporate, as follows [1, p.33]:

- 1 BARCLAYS PLC GB 6512 SCC 4.05
- 2 CAPITAL GROUP COMPANIES INC, THE US 6713 IN 6.66
- 3 FMR CORP US 6713 IN 8.94
- 4 AXA FR 6712 SCC 11.21
- 5 STATE STREET CORPORATION US 6713 SCC 13.02
- 6 JPMORGAN CHASE & CO. US 6512 SCC 14.55
- 7 LEGAL & GENERAL GROUP PLC GB 6603 SCC 16.02
- 8 VANGUARD GROUP, INC., THE US 7415 IN 17.25
- 9 UBS AG CH 6512 SCC 18.46
- 10 MERRILL LYNCH & CO., INC. US 6712 SCC 19.45
- 11 WELLINGTON MANAGEMENT CO. L.L.P. US 6713 IN 20.33
- 12 DEUTSCHE BANK AG DE 6512 SCC 21.17
- 13 FRANKLIN RESOURCES, INC. US 6512 SCC 21.99
- 14 CREDIT SUISSE GROUP CH 6512 SCC 22.81
- 15 WALTON ENTERPRISES LLC US 2923 T&T 23.56
- 16 BANK OF NEW YORK MELLON CORP. US 6512 IN 24.28
- 17 NATIXIS FR 6512 SCC 24.98
- 18 GOLDMAN SACHS GROUP, INC., THE US 6712 SCC 25.64
- 19 T. ROWE PRICE GROUP, INC. US 6713 SCC 26.29
- 20 LEGG MASON, INC. US 6712 SCC 26.92
- 21 MORGAN STANLEY US 6712 SCC 27.56
- 22 MITSUBISHI UFJ FINANCIAL GROUP, INC. JP 6512 SCC 28.16
- 23 NORTHERN TRUST CORPORATION US 6512 SCC 28.72
- 24 SOCIÉTÉ GÉNÉRALE FR 6512 SCC 29.26
- 25 BANK OF AMERICA CORPORATION US 6512 SCC 29.79
- 26 LLOYDS TSB GROUP PLC GB 6512 SCC 30.30
- 27 INVESCO PLC GB 6523 SCC 30.82
- 28 ALLIANZ SE DE 7415 SCC 31.32
- 29 TIAA US 6601 IN 32.24
- 30 OLD MUTUAL PUBLIC LIMITED COMPANY GB 6601 SCC 32.69
- 31 AVIVA PLC GB 6601 SCC 33.14
- 32 SCHRODERS PLC GB 6712 SCC 33.57
- 33 DODGE & COX US 7415 IN 34.00
- 34 LEHMAN BROTHERS HOLDINGS, INC. US 6712 SCC 34.43
- 35 SUN LIFE FINANCIAL, INC. CA 6601 SCC 34.82
- 36 STANDARD LIFE PLC GB 6601 SCC 35.2
- 37 CNCE FR 6512 SCC 35.57
- 38 NOMURA HOLDINGS, INC. JP 6512 SCC 35.92
- 39 THE DEPOSITORY TRUST COMPANY US 6512 IN 36.28
- 40 MASSACHUSETTS MUTUAL LIFE INSUR. US 6601 IN 36.63
- 41 ING GROEP N.V. NL 6603 SCC 36.96



42 BRANDES INVESTMENT PARTNERS, L.P. US 6713 IN 37.29  
43 UNICREDITO ITALIANO SPA IT 6512 SCC 37.61  
44 DEPOSIT INSURANCE CORPORATION OF JP JP 6511 IN 37.93  
45 VERENIGING AEGON NL 6512 IN 38.25  
46 BNP PARIBAS FR 6512 SCC 38.56  
47 AFFILIATED MANAGERS GROUP, INC. US 6713 SCC 38.88  
48 RESONA HOLDINGS, INC. JP 6512 SCC 39.18  
49 CAPITAL GROUP INTERNATIONAL, INC. US 7414 IN 39.48  
50 CHINA PETROCHEMICAL GROUP CO. CN 6511 T&T 39.78

Next we will see whether there is connection between the above 50 top TNCs and the recipients of the Fed's secret funds during 2007-2010.

### **The Great Theft by the Fed between 2007-2010**

It is discovered after being audited by GAO, that the Fed secretly gave fund to a very short list of financial corporate both inside USA and from foreign countries, in a spectacular amount, i.e. about \$16,000,000,000,000 (sixteen trillions of US dollar). We propose to call that event as the Great Theft, because it is basically a massive theft of US tax payers' wealth during the financial crisis, when many middle-income families suffered.

According to O'Leary [4, p.13]:

"A partial audit of a limited period of time - the first audit of any kind in its near 100 year history - took place in July 2011 when, as part of the Dodd-Frank reform legislation, the Fed was forced to reveal whom it had lent money to during the financial debacle beginning in late 2007. The audit was carried out by the General Accounting Office (GAO) and is available on-line. To say that its shocking findings have been under-reported by the media is a gross understatement."

"During the period December 1, 2007 through July 21, 2010 the Fed created sixteen trillion (\$16,000,000,000,000) dollars worth of credit (loans) to US banks and corporations and (notwithstanding its supposed jurisdiction as an agency of the United States) to foreign banks. These were secret bailouts engineered to prevent the borrowers from insolvency or bankruptcy; the money was loaned at nearly zero percent (.01%) interest."

The recipients of the Fed's secret loan during 2007-2010 are as follows [4, p.14]:

Citigroup, Inc (Citibank): \$2.5 trillion  
\*Morgan Stanley: \$2.04 trillion  
\*Merrill Lynch & Co.: \$1.949 trillion  
\*Bank of America Corporation: \$1.344 trillion  
\*Barclays PLC (United Kingdom): \$868 billion  
Bear Sterns Companies, Inc.: \$853 billion  
\*Goldman Sachs Group, Inc.: \$814 billion

Royal Bank of Scotland PLC (UK): 541 billion  
\*JPMorgan Chase: \$391 billion  
\*Deutsche Bank AG (Germany): \$354 billion  
United Bank of Switzerland AG: \$287 billion  
\*Credit Suisse Group AG (Switzerland): \$262 billion  
\*Lehman Brothers Holdings, Inc. - NYC: \$183 billion  
Bank of Scotland PLC (UK): \$181 billion  
\*BNP Paribas SA (France): \$175 billion  
Dexia SA (Belgium): \$105 billion  
Wachovia Corporation: \$142 billion  
Dresdner Bank AG (Germany): \$123 billion  
\*Societe Generale SA (France): \$124 billion

The asterisks (\*) are intended to mark companies which also appear in the list of top 50 TNCs of Vitali et al. [1, p.33].

From the two lists above, we can conclude that there are 11 (eleven) out of 19 (nineteen) recipients of the Fed's money between 2007-2010, which also appear in the Vitali et al.'s list of top 50 TNCs. Therefore we can also conclude that apparently the Fed is behind almost all of the top 50 TNCs. That is why some people think that the Fed is one of the most powerful private entities all over the world.

## Discussion

The owners of the Fed remains mystery, although from history it is known that the Fed was formed after a Jekyll Island meeting .

“The Federal Reserve System was allegedly conceived at a secretive, confidential “duck hunting” Jekyll Island meeting of people related to J. P. Morgan, Kuhn, Loeb & Company, the Rothschilds, the Rockefellers, and the Warburgs.” [7, p.22]

However in recent years, there have been enough leaks to confirm the identities of the key banking families who founded the Federal Reserve [3, p.37]. J. W. McCallister, an oil industry insider with House of Saud connections, wrote in The Grim Reaper that information he acquired from Saudi bankers cited 80% ownership of the New York Federal Reserve Bank- by far the most powerful Fed branch- by just eight families, four of which reside in the US.

- They are the Goldman Sachs, Rockefellers, Lehmans and Kuhn Loeb's of New York; the Rothschilds of Paris and London; the Warburgs of Hamburg; the Lazards of Paris; and the Israel Moses Seifs of Rome.

CPA Thomas D. Schauf corroborates McCallister's claims, adding that ten banks control all twelve Federal Reserve Bank branches.

- He names N.M. Rothschild of London, Rothschild Bank of Berlin, Warburg Bank of Hamburg, Warburg Bank of Amsterdam, Lehman Brothers of New York, Lazard

Brothers of Paris, Kuhn Loeb Bank of New York, Israel Moses Seif Bank of Italy, Goldman Sachs of New York and JP Morgan Chase Bank of New York. Schauf lists William Rockefeller, Paul Warburg, Jacob Schiff and James Stillman as individuals who own large shares of the Fed. The Schiffs are insiders at Kuhn Loeb. The Stillmans are Citigroup insiders, who married into the Rockefeller clan at the turn of the century.

According to O'Leary [4, p.5]:

“To begin with, the Federal Reserve system is neither Federal nor does hold its own capital as bank “reserves”. The Federal Reserve is a private institution owned by private bankers which has no reserves other than what it creates for itself . . . *out of nothing.*”

O'Leary continues [4, p.6]:

“The Federal Reserve Act, passed by Congress just prior to its annual Christmas recess on December 22, 1913, was signed into law the very next day by President Woodrow Wilson. It transferred the right to print currency from the United States sovereign government to a bank which is quasi-federal in form but private in operation. The Fed was created by the powers of international capital, known in the 19th century as The Money Trust, and given a clever but deceptive name which disguises the fact that it is a private money monopoly owned by its member banks but controlled by a handful of super-banks which are conveniently described as “too big to fail”.”

Furthermore he writes [4, p.7]:

“The larger the member bank, the more Federal Reserve corporate stock it owns, the greater degree of control it exercises over the Fed's policies. The major New York banks own a majority share of the Fed. Since Federal Reserve Banks are not governmental agencies, their employees do not fall under Federal Civil Service.”

Now we know that it is possible that the Fed is owned by a handful of very powerful international banks, which also may form the ‘super-entity’ group, as reported by Vitali et al. [1].

O'Leary also explains why the Fed was never audited.

“The secrecy surrounding the operations of the Federal Reserve is phenomenal. Its actions are even more secret than the CIA's. The Federal Reserve System has never been audited. This bears repetition: the Federal Reserve has never been subject to a full and complete independent audit. No government official has the power to require the Fed to open up its books to public scrutiny. The only power the government has is to modify the Fed's charter by an act of Congress. Attempts to

legislate a full and complete audit have always been vehemently opposed by the “powers that be.” [4, p.13]

Since money created by the Fed is not backed up by anything except by the US Government and all US citizens, they are called ‘fiat money’. According to Hoppe [8, p.64]:

“Since abolishing the last remnants of the gold commodity money standard, he realizes, inflationary tendencies have dramatically increased on a world-wide scale; the predictability of future price movements has sharply decreased; the market for long-term bonds (such as consols) has been largely wiped out; the number of investment and “hard money” advisors and the resources bound up in such businesses have drastically increased; money market funds and currency futures markets have developed and absorbed significant amounts of real resources which otherwise-without the increased inflation and unpredictability-would not have come into existence at all or at least would never have assumed the same importance that they now have; and finally, it appears that even the direct resource costs devoted to the production of gold accumulated in private hoards as a hedge against inflation have increased.”

In the last analysis, if money is created by the Fed without permission of US Congress, then it can be called as an act of theft.

“In history, sovereigns and states have stolen the wealth of their subordinates and citizens a zillion of times, and they will do so again and again if they consider it necessary. Often monetary policy and instruments effectively amount to more or less obvious ways to plunder the public.”[7]

Now we can conclude that not only 11 out of 19 TNCs are recipients of the Fed’s secret loans between 2007-2010, but they also belong to the top 50 ‘super-entity’ list of Vitali et al’[1]. Therefore we can conclude that they participate in the Great Theft act of the Fed, and the Fed is at the center of this massive fraud of US economy. Now it seems that this discovery demands thorough investigations on the Fed’s part and also on the nineteen recipients of secret loans from the Fed between 2007-2010.

One thing should be kept in mind, that the Fed has become the center of the problem, that is why it will lead to financial crises in the future, especially if the financial integration will be implemented. As concluded by Stiglitz [12], a full financial integration may be not desirable. Stiglitz also writes that the “centralized” lending architecture may be more vulnerable to shocks to the “centers” (illustrated by the global impact of the US credit crisis) [12]. The apparent concentration of massive power in a handful of private financial corporate could mean that the risks are increasing, for instance read a Testimony of Wallace C. Turbeville at May 9, 2012: “A recent research piece by the Dallas Fed provides a window on this process. The study observes that in 1970 the top 5 banks in terms of assets held 17% of aggregate bank assets. By 2010, the top 5 banks held 52% of aggregate assets.”[14] This testimony seems to support the conclusion of Vitali et al. that there is

concentration of massive wealth in the hand of super-entity.[1] Therefore it could mean that the global economy is increasingly exposed to risks of financial crises.

## Concluding remarks

In accordance with David Wilcock [3] and O'Leary [4], there was the Great Theft event, when the Fed secretly gave funds to US and foreign financial companies, at breathtaking amount of trillions of US dollar.

The fiat money created by the Fed is deeply flawed [7][8][10][11]. Another flaw is the fractional reserve banking (FRB) practice all over the world, which only leads to great business cycles and crises. The fractional reserve banking system is defined as one in which only a fraction of the demand deposits are held in reserve; the remainder is in the form of long term loans, or illiquid assets [10, p.46]. There is a singular group of economists who concede that all FRB systems that have ever existed may have been equivalent to theft [10, [p.47].

This problem of FRB has been discussed by many economists especially from Austrian school; see for instance [9], [10] and [11]. The crises in Cyprus can be tracked to this FRB practice (see [13] or the Appendix). If this tendency of FRB practice continues, it only leads to hyperinflation. According to Hoppe [8, p.59]:

“The result would be hyperinflation. No one would accept paper money anymore, and a flight into real values would set in. The monetary economy would break down completely and society would revert back to a primitive, highly inefficient barter economy. Out of barter then, once again a new (most likely a gold) commodity money would emerge (and the note producers once again, so as to gain acceptability for their notes, would begin backing them by this money).”

A number of solutions have been offered by economists in order to find a way out of the many crises and business cycles; to mention a few of them:

- Applying theories of complex systems into economics, especially in order to assist decision makers[6].
- Going back to gold-backed currency, which is perhaps not so realistic; see [7][11]. According to Hoppe [8,p.74]: “*Only a system of universal commodity money (gold), competitive banks, and 100 percent reserve deposit banking with a strict functional separation of loan and deposit banking is in accordance with justice, can assure economic stability and represents a genuine answer to the current monetarist fiasco.*”
- Going to full-reserve banking, this appears to be quite realistic. For an argument supporting the idea of full-reserve banking, read as follows: “*Most recently, in late 2010, two British MP's, Douglas Carswell and Steven Baker, sought to introduce legislation into the British Parliament that would allow depositors to decide if their money should be lent out and for what period. If this legislative reform were to pass, British depositors would have the option to elect to save their money in full reserve bank accounts. In early 2013, the idea of full reserve banking began to reappear in*

*mainstream circles, after other "remedies" appeared to fail or only defer the next crisis, but not solve the banking "problem". Full reserve banking would require banks to retain in reserve all deposits that are legally available for immediate withdrawal, and permit lending only from longer-term deposits." [11]*

- Accepting the nature of business cycles and repeated financial crises, as promoted by Svozil [7]. This means that someday there will be a Great Crash as a consequence: *"Given these repeated financial crises arising from the fiat monetary system, many monetary reformers predict that there will inevitably be widespread default or hyperinflation or depression - or most likely all three simultaneously in what Ludwig von Mises predicted would be a "final and total catastrophe" of our unsustainable, Ponzi-like, fiat monetary system."*[11].
- According to some analysts, there is no solution to the present problems of the world economy; see [11]. This seems to support Svozil's argument that there is no alternative to present situation of the fiat money and fractional reserve banking: *"Thus, for pragmatic reasons, the only remaining alternative appears to be fiat money not directly backed by any commodity... The liquidity supplied to an economy by such a money volume expansion may result in a positive feedback loop of ever increasing production and prosperity. However, by the same negative feedback, it may also result in (hyper-)inflation by the restless production of additional money. For instance, it is a mathematical fact that the compound interest requires excessive (actually exponential) money quantities. In the long run, no such excessive growth of liquidity can be counterbalanced by the traded assets, goods and services."* [7, p.4]

However, this paper is not intended to give a prescription on how to improve the global economy architecture. We leave this issue to a future paper.

VC & FS, Version 1.0: July 20<sup>th</sup>, 2013. Version 1.1: July 25<sup>th</sup>, 2013.

## References

- [1] Vitali, S., Glattfelder, J.B., & Battiston, S. (2011) The network of global corporate control, arXiv:1107.5728 [q-fin.GN] 36p., URL: <http://arxiv.org/pdf/1107.5728.pdf>; [1a] J.B. Glattfelder, <http://www.newscientist.com/article/mg21228354.500-revealed--the-capitalist-network-that-runs-the-world.html>
- [2] Glattfelder, J.B., & Battiston, S. (2009) Backbone of complex network of corporations: The flow of control, Physical Review E 80, 2009, also available at arXiv:0902.0878 [q-fin.GN] 24p., URL: <http://arxiv.org/pdf/0902.0878.pdf>
- [3] Wilcock, D. (2012) *Financial Tyranny: Defeating the Greatest Cover-up of all time*, February 13, 2012, URL: [http://www.vigli.org/FINANCIAL\\_TYRANNY\\_Defeating\\_the-Greatest\\_Cover-Up\\_of\\_All\\_Time\\_David-Wilcock\\_Feb-13-2012.pdf](http://www.vigli.org/FINANCIAL_TYRANNY_Defeating_the-Greatest_Cover-Up_of_All_Time_David-Wilcock_Feb-13-2012.pdf), [3a] see also: <http://divinecosmos.com/start-here/davids-blog/1023-financial-tyranny>
- [4] O'Leary, P.V. (2012) The Federal Reserve System, Fiat Money and Fractional Reserve Banking, URL: [http://www.perseus.ch/wp-content/uploads/2012/03/The\\_Federal\\_Reserve\\_System.pdf](http://www.perseus.ch/wp-content/uploads/2012/03/The_Federal_Reserve_System.pdf)

- [5] Krause, S.M., Peixoto, T.P., & Bornholdt, S. (2013) Spontaneous centralization of control in a network of company ownerships, URL: <http://arxiv.org/pdf/1306.3422.pdf>
- [6] Doyne Farmer, J. et al. (2012) A complex systems approach to constructing better models for managing financial markets and the economy, *Eur. Phys. J. Special Topics* 214, 295–324, 2012, URL: [allariz.uc3m.es/~anxosanchez/ep/EconFinancialFuturITC16.pdf](http://allariz.uc3m.es/~anxosanchez/ep/EconFinancialFuturITC16.pdf)
- [7] Svozil, K. (2008) An apology for money. arXiv: 0811.3130 [q-fin.GN]. URL: <http://arxiv.org/pdf/0811.3130v6.pdf>
- [8] Hoppe, H-H. (1994) How is fiat money possible? – or, the Devolution of Money and Credit, *The Review of Austrian Economics* Vol.7, No.2, 1994:49-74, URL: [http://mises.org/journals/rae/pdf/rae7\\_2\\_3.pdf](http://mises.org/journals/rae/pdf/rae7_2_3.pdf)
- [9] Rothbard, M. (2008) *The Mystery of Banking*. 2<sup>nd</sup> ed. Auburn, Ala.: Ludwig von Mises Institute, 2008. URL: <http://mises.org/books/mysteryofbanking.pdf>
- [10] Block, M. (1988) "Fractional Reserve Banking: An Interdisciplinary Perspective," in *Man, Economy, and Liberty: Essays in Honor of Murray N. Rothbard*, Walter Block and Llewellyn H. Rockwell, Jr., eds., Auburn, Ala.: Ludwig von Mises Institute, 1988
- [11] URL: [http://wiki.mises.org/wiki/Criticism\\_of\\_fractional\\_reserve\\_banking](http://wiki.mises.org/wiki/Criticism_of_fractional_reserve_banking)
- [12] Stiglitz, J.E. (2010) Risk and Global Economic Architecture: Why Full Financial Integration May Be Undesirable, *American Economic Review: Papers & Proceedings* 100 (May 2010): 388–392, URL: [www.aeaweb.org/articles.php?doi=10.1257/aer.100.2.388](http://www.aeaweb.org/articles.php?doi=10.1257/aer.100.2.388)
- [13] Durden, T. (2013) "How Cyprus Exposed The Fundamental Flaw Of Fractional Reserve Banking", URL: <http://www.zerohedge.com/news/2013-03-31/visualization-modern-fractional-reserve-banking-and-how-cyprus-fits>
- [14] Turbeville, W.C. (2012) Testimony of Wallace C. Turbeville, Senate Committee on Banking, Housing and Urban Affairs, May 9<sup>th</sup>, 2012, URL: <http://www.demos.org/publication/testimony-wallace-c-turbeville-senate-committee-banking-housing-and-urban-affairs>

## Appendix:

Source: <http://www.zerohedge.com/news/2013-03-31/visualization-modern-fractional-reserve-banking-and-how-cyprus-fits>

### How Cyprus Exposed The Fundamental Flaw Of Fractional Reserve Banking

Submitted by Tyler Durden on 03/31/2013 18:03 -0400

In the past week much has been written about the emerging distinction between the Cypriot Euro and the currency of the Eurozone proper, even though the two are (or were) identical. The argument goes that all €'s are equal, but those that are found elsewhere than on the doomed island in the eastern Mediterranean are more equal than the Cypriot euros, or something along those lines. This of course, while superficially right, is woefully inaccurate as it misses the core of the problem, which is a distinction between electronic currency and hard, tangible banknotes. Which is why the capital controls imposed in Cyprus do little to limit the distribution and dissemination of electronic payments within the confines of the island (when it comes to payments leaving the island to other jurisdictions it is a different matter entirely), and are focused exclusively at limiting the procurement and allowance of paper banknotes in the hands of Cypriots (hence the limits on ATM and bank branch withdrawals, as well as the hard limit on currency exiting the island).

In other words, what the Cyprus fiasco should have taught those lucky enough to be in a net equity position vis-a-vis wealth (i.e., have cash savings greater than debts) is that suddenly a €100 banknote is worth far more than €100 in the bank, especially if the €100 is over the insured €100,000 limit, and especially in a time of ZIRP when said €100 collects no interest but is certainly an impairable liability if and when the bank goes tits up.

Said otherwise, there is now a very distinct premium to the value of hard cash over electronic cash.

And while this is true for Euros, it is just as true for US Dollars, Mexican Pesos, Iranian Rials and all other currencies in a fiat regime.

Which brings us to the crux of the issue, namely fractional reserve banking, or a system in which one currency unit in hard fiat currency can be redeposited with the bank that created it (as a reminder in a fiat system currency is created at the commercial bank level: as the Fed itself has made quite clear, "The actual process of money creation takes place primarily in banks") to be lent out and re-re-deposited an (un)limited number of times, until there is a literal pyramid of liabilities and obligations lying on top of every dollar, euro, or whatever other currency, is in circulation. The issue is that the bulk of such



obligations are electronic, and in its purest form, a bank run such as that seen in Cyprus, and preempted with the imposition of the first capital controls in the history of the Eurozone, seeks to convert electronic deposits into hard currency.

Alas, as the very name "fractional reserve banking" implies, there is a very big problem with this, and is why every bank run ultimately would end in absolute disaster and the collapse of a fiat regime, hyperinflation, and systemic bank and sovereign defaults, war, and other unpleasantries, if not halted while in process.

Why?

One look at the chart below should be sufficient to explain this rather problematic issue of a broken banking system in which trust is evaporating faster than Ice Cubes in the circle of hell reserved for economist PhD's.

# A dialogue on the Fed's bailout during 2007-2010 and possibility of hyperinflation

by Victor Christianto\*

\*<http://www.sciprint.org>, <http://independent.academia.edu/VChristianto>, email: [victorchristianto@gmail.com](mailto:victorchristianto@gmail.com)

## Abstract

The present paper consists of a dialogue with Jacky Mallett about the Fed's bailout during 2007-2010 and possibility of hyperinflation in the near future. According to the news (10/14/2013), a number of large investors have sold their stocks massively. See

[http://www.moneynews.com/MKTNews/billionaires-dump-economist-stock/2012/08/29/id/450265?PROMO\\_CODE=1393F-1](http://www.moneynews.com/MKTNews/billionaires-dump-economist-stock/2012/08/29/id/450265?PROMO_CODE=1393F-1). Perhaps we can agree with one thing from this news, that perhaps the Fed has printed too much money in recent years, so its full effect will take place in the form of massive hyperinflation. In other paper, we have reported that the Fed has issued no less than sixteen trillion of us dollars to several banks.

## Introduction

The present paper consists of a dialogue with Jacky Mallett about the Fed's bailout during 2007-2010 and possibility of hyperinflation in the near future, which can be viewed at [https://www.researchgate.net/post/Will\\_there\\_be\\_a\\_massive\\_hyperinflation\\_soon\\_in\\_the\\_USA\\_because\\_the\\_FRB\\_has\\_already\\_printed\\_too\\_much\\_money\\_out\\_of\\_thin\\_air](https://www.researchgate.net/post/Will_there_be_a_massive_hyperinflation_soon_in_the_USA_because_the_FRB_has_already_printed_too_much_money_out_of_thin_air). According to the news(10/14/2013), a number of large investors have sold their stocks massively. See [http://www.moneynews.com/MKTNews/billionaires-dump-economist-stock/2012/08/29/id/450265?PROMO\\_CODE=1393F-1](http://www.moneynews.com/MKTNews/billionaires-dump-economist-stock/2012/08/29/id/450265?PROMO_CODE=1393F-1). I agree with one thing from this news, that perhaps the Fed has printed too much money in recent years, so its full effect will take place in the form of massive hyperinflation. In other paper, we have reported that the Fed has issued no less than sixteen trillion of us dollars to several banks. See our paper in <http://vixra.org/abs/1307.0097>. What do you think? Is that hyperinflation possible to happen?

## Dialogue

### 1. Jacky Mallett

No.

And with reference to the Federal Reserve's statistics here,

<http://www.federalreserve.gov/econresdata/statisticsdata.htm>

would you mind pointing out the statistical series that shows a \$15 trillion increase in any money supply measure? That's actually more money than is in the entire US Banking system at this present time.

### 2. Victor Christianto

Thank you Jacky for your answer. According to a report there was a partial audit to the Fed in 2011 as part of Dodd-Frank reform, the result of that audit is that the Fed has given soft loans to

several banks at the amount of around sixteen trillions usd during 2007-2010. See my paper <http://vixra.org/pdf/1307.0097v2.pdf>.

3. **Victor Christianto**

Jacky, you can find a document in the Fed site itself telling about the audit of the board, see [http://www.federalreserve.gov/oig/files/Dodd\\_Frank\\_09.28.2011.pdf](http://www.federalreserve.gov/oig/files/Dodd_Frank_09.28.2011.pdf). But the revealing result about emergency loans during 2007-2010 is not exposed there.

4. **Victor Christianto**

In other site you can find more details info that the U.S. Federal Reserve gave out emergency loans to US and foreign financial institutions during dec. 1 2007 to july 21 2010 at amount of \$16.1 trillion. [http://www.teamliquid.net/forum/viewmessage.php?topic\\_id=246411](http://www.teamliquid.net/forum/viewmessage.php?topic_id=246411)

5. **Jacky Mallett**

If I lend you \$1 trillion for a week, and then rollover the loan every week for 52 weeks, how much have I lent you? \$52 trillion, or \$1 trillion?

You specifically claimed the **\*\*money supply\*\*** had increased by \$15 trillion - would you care to provide actual data to support your claim?

6. **Victor Christianto**

I think we have different opinions. What i say in the introduction of the question is that the Fed has issued no less than fifteen trillion of us dollars to several banks. I have given the link where you can read the report about the Gao audit to the Fed. I dont say that it implies increase in money supply.

7. **Victor Christianto**

Jacky, you may have a point here, although we have different opinion on this issue. According to simple math fifty dollars loan times ten times roll over is five hundreds dollars. But even if we breakdown the sixteen trillion dollars of emergency loans given by Fed during 2007-2010 by components, the result is still revealing. For example, using your logic, if we assume the PDCF component is rolledover loan, which is 8.951 trillions. Then this number is divided by 16.115 trillions, the result is 55.545% of the emergency loans is not a rolledover loans. See the breakdown data of the emergency loans in [http://www.teamliquid.net/forum/viewmessage.php?topic\\_id=246411](http://www.teamliquid.net/forum/viewmessage.php?topic_id=246411).

I use this assumption to simplify the argument. The assumption that pdcf loan is rolledover loan can be found in the following url: <http://www.dailypaul.com/252915/1600000000000000-in-secret-bailouts>.

Perhaps you should better take a look at teamliquid.net link that i give, before insisting on time series data. Best wishes

8. **Victor Christianto**

Errata. I mean that 55.545% is pdcf loan, then 44.5% of those emergency loans are perhaps not rolledover.

9. **Jacky Mallett**

I think you need to look at the Federal Statistical data, and confront the very simple fact, that \$15 trillion is more money than currently exists in the entire US monetary system - and that simple data point is really all that's needed to answer your original hypotheses firmly in the negative.

After that it gets quite technical I'm afraid, since the Federal Reserve was actually lending asset money/base money, rather than liability deposit money, and total asset money in the system iirc is somewhere in the \$2-3 trillion range (i.e. considerably less than \$15 trillion). I'm happy to guide you through those issues, if you have a genuine desire to understand how all this works, but I would strongly recommend you start by getting down and dirty with the H.6 and H.8 statistical series.

When the facts contradict a theory - why that's when science just starts getting exciting!

10. **Victor Christianto**

Dear Jacky, sorry I don't have time to dig statistical series (it is also beyond my scope of interest). Perhaps you're right that there is discrepancy here with the available money. But that is what makes this issue interesting.

Btw there is another 2011 report by James Felkerson (included here), available from [http://www.levyinstitute.org/pubs/wp\\_698.pdf](http://www.levyinstitute.org/pubs/wp_698.pdf). In his report it is found that the Fed bailout during 2007-2010 is not 16.1 trillions but more than 29 trillions. That number is even more breathtaking.

see also comments by Prof. L. Randall Wray on this issue:

<http://www.economonitor.com/lrwrap/2011/12/09/bernanke%E2%80%99s-obfuscation-continues-the-fed%E2%80%99s-29-trillion-bail-out-of-wall-street/>

11. **Jacky Mallett**

It takes an entire 5 minutes to look at the data - let me merely observe that if you're afraid of time series, you've really picked the wrong field.

Wray - if you read him - is quoting Bernanke making exactly the same point I did about summing up the total of rolled over debt (\$1.2 trillion total money in case you were curious). He then decides to ignore that point for what can only be judged to be political reasons. After all "breathtaking" and entirely false figures are a far easier way to attract attention, than actually trying to understand what really happened.

This kind of argument is the economic equivalent of summing up the total planetary rainfall for the last 100 years and then predicting that everybody is going to drown from the resulting flood.

12. **Victor Christianto**

Jacky, i got your point, perhaps that amount is aggregate sum of emergency loans which was rolled over several times. Btw i am not against time series, i just dont know how to find data from 2007-2010 from Fed database. I only find that Felkerson already shows some weekly data of Fed loan progress during that time, mostly around 2008.

### 13. **Jacky Mallett**

So essentially this is one of the traps, current economic theory has for the unwary, since it doesn't provide us with an adequate explanation for the monetary system. From the main Federal Reserve site above, the two series of interest are the H.6 Money Stock, and the H.8 Assets and Liabilities of the US Banking system:

<http://www.federalreserve.gov/releases/h6/current/h6.htm>

<http://www.federalreserve.gov/releases/h8/current/>

The nice people at the Federal Bank of St Louis also provide a separate site where you can get charts of all the different series. Then it gets interesting.

There are essentially two types of money in the system, all our bank deposits (a liability), and physical cash and the banks' deposits with other banks including reserves at the central bank (which for banks are an asset.) It helps at this point to know that if you deposit physical cash (asset) at a bank, a matching bank deposit (liability) is simultaneously created, so if you simply add physical cash to bank deposits (as many economists do), then the physical cash is being double counted.

So if we look at the Q.E. money which was created by the Fed, that is asset money:

<http://research.stlouisfed.org/fred2/series/AMBNS>

and you can see clearly from that graph when it's being injected. According to the current textbook explanation of the banking system (which turns out to not only be incorrect, but in fact falsifiable), what should happen if asset money increases like that is a multiplier increase in bank deposits, triggering hyper-inflation. Except of course, that that hasn't happened, viz:

<http://research.stlouisfed.org/fred2/series/M2>

This is M2, which is approximately total bank deposits in the system - and as you can see it just basically increases over time, independently of whatever the Fed is doing.

There are several reasons for that. The main one being that central bank reserves are no longer really used to control the expansion of the system, so although the TARP intervention did remove any limit there might have been, in actuality the expansion is being simultaneously throttled by the Basel Capital limits, and those are dominating. It can be anticipated that there will be an increase in monetary expansion, once the banks have finished increasing their basel capital holdings to meet new regulations, and that is I suspect when we'll have another credit bubble.

So that's an abbreviated overview of what's going on. If you want to know more, I can send you some papers I've just finished.

### 14. **Victor Christianto**

Jacky, thank you very much for your explanation. Sorry i cannot get into details as much as you

Victor Christianto, <http://www.sciprint.org>, <http://independent.academia.edu/VChristianto>

do. But i think i want to find statistical series of pdcf given by the Fed during period 2007-2010, because from Felkerson,s report it seems that pdcf which is discount window for primary dealers is the significant component of emergency loans, about 30% of total emergency loans.

Yes i read somewhere about M1 and M2 concept of monetary policy, but not sure if it has anything to do with emergency loans given by the Fed to certain financial institutions. I tried to read GAO audit report but they only say that the peak lending from the Fed is about 1.1 trillion. So there are different opinions of what the Fed did in the past: 1.1 trillion (Gao), 16.1 trillion (senator), 29 trillion (Felkerson). I think the assumptions made during calculation and summing up raw data affect the conclusions.

I read that you published paper about fractional reserve bank, you can upload your files here or just give the url. I also read some articles and books saying that the frb concept allows banks to create money out of thin air, just like The Fed did. What is your opinion?

#### 15. **Victor Christianto**

Ps: i just visit one url that you gave about st louis monetary base data. It says that there is rapid increasing qe from 2009 until now. At last month the number became 3.5 trillion (2013-09). Do you think that it will not trigger hyperinflation because of quantitative easing? Let alone the emergency loans since 2007. <http://research.stlouisfed.org/fred2/series/AMBNS>

#### 16. **Jacky Mallett**

When the federal reserve makes a loan, it transfers money to the recipient which has to be a qualified financial institution, and receives something - typically a financial instrument like a treasury or a securitized loan in return. Both of these are forms of debt of course. That money is asset money, and there is currently about \$3.5 trillion in the system.

The best way to visualise this is to think of a loan as a network flow of money. So the bank received asset money, and the Fed received a financial instrument that represents a loan in return. Loans have to be repaid, and so over time, the Fed gets the money it lent back with interest. That's the network flow back.

If the Federal reserve did nothing else, it would eventually drain the money back out of the banking system, to prevent that it pays interest on bank reserves back to the banks. It's a two-way flow, and it effectively doesn't touch the rest of the economy.

One final comment on hyper-inflation. Hyper-inflation is a consequence of a customer bank deposit (liability) expansion - and that's not what you're seeing in that graph. If you look at the other chart, you'll see there is no correlation between the rate of expansion between the total money in the banking system (M2 approximately) and the asset money being created by Q.E. There used to be, but there isn't any more.

#### **Concluding remarks**

The present paper consists of a dialogue with Jacky Mallett about the Fed's bailout during 2007-2010 and possibility of hyperinflation in the near future. According to the news (10/14/2013), a number of large investors have sold their stocks massively. See

Victor Christianto, <http://www.sciprint.org>, <http://independent.academia.edu/VChristianto>

[http://www.moneynews.com/MKTNews/billionaires-dump-economist-stock/2012/08/29/id/450265?PROMO\\_CODE=1393F-1](http://www.moneynews.com/MKTNews/billionaires-dump-economist-stock/2012/08/29/id/450265?PROMO_CODE=1393F-1). Perhaps we can agree with one thing from this news, that perhaps the Fed has printed too much money in recent years, so its full effect will take place in the form of massive hyperinflation. In other paper, we have reported that the Fed has issued no less than sixteen trillion of us dollars to several banks.

Version 1.0: 29th October, 2013.  
VC, [victorchristianto@gmail.com](mailto:victorchristianto@gmail.com)

### **References:**

1. Felkerson, J. (2011) \$29,000,000,000,000: A detailed look at the Fed's bailout by funding facility and recipient. Working Paper no. 698, Levy Economics Institute of Bard College. URL: [http://www.levyinstitute.org/pubs/wp\\_698.pdf](http://www.levyinstitute.org/pubs/wp_698.pdf)
2. Minsky, Hyman P., Ph.D. (1986) "Stabilizing an Unstable Economy," Hyman P. Minsky Archive. Paper 144. URL: [http://digitalcommons.bard.edu/hm\\_archive/144/](http://digitalcommons.bard.edu/hm_archive/144/)

# A Christian Ethics consideration on Nuclear Energy

Victor Christiano<sup>1</sup>

## Abstract

Based on ethical, ecological, and economics considerations, the writers conclude that it is not acceptable to consider nuclear energy as part of national's energy mix, especially for developing countries, because of many reasons, including: radiation risks of radioactive waste, the capital-intensive development cost of a NPP which may cause heavy foreign loan to that nation, and also the risks of contamination of water and environment during uranium mining and spent fuel storage.

Because of the above mentioned reasons, Christian people and common people should suggest to their governments to push forward the use of renewable energies especially WWS. For the short term, coal and natural gas can be considered as a temporary alternative.

## 1. Introduction

As we all know, the world oil reserve is depleting rapidly, and it is predicted to reach an end of oil reserve within few decades, that is why many countries started to think about how to anticipate this coming energy crisis before it takes place, in order to secure the energy supply for those countries.

For many countries, their oil supply largely depends on the oil delivered from foreign countries, especially from Middle East region. If something happens to this region that will stop the oil supply, then the dependant countries will face a severe crisis. That is why many countries begin to contemplate on how to find a way to get out from this kind of oil dependence, and to achieve energy independence.

One of the recent trends in many countries including developing countries in order to achieve energy independence is by introducing nuclear energy into their energy mix for the future. That is why many countries begin to consider nuclear energy seriously for their future energy, and this trend is pioneered by many nuclear experts who promote nuclear as a safe, cheap and clean energy option. See for instance a book by Eerkens, which emphasizes that nuclear option is imperative for USA and other countries.<sup>2</sup>

---

<sup>1</sup> <http://www.sciprint.org>, email: victorchristianto@gmail.com

<sup>2</sup> Eerkens, J.W., *The Nuclear Imperative: A Critical Look at the Approaching Energy Crisis (More Physics for Presidents)*, Second Edition. Dordrecht: Springer Science+Business Media B.V., 2010.



Nevertheless, one should also remember that nuclear energy is not without its own dangers and risks, for example:

- There is dependence to uranium fuel supply from other (developed countries), because those developed countries own the enrichment facilities.
- Nuclear power plant is capital-intensive, and often it requires foreign loan to finance it. And for developing countries the use of foreign loan will mean that development of nuclear power plant will make a large burden for a developing country's economy.
- There is risk of radiation leak at the nuclear power plant itself which may cause cancer to many people in the nearby area and also there are other harmful effects.<sup>3</sup>
- There is a necessity to take care of radioactive waste for hundreds of thousand years. Up to this time, there is no clear solution on how to reprocess this radioactive waste in order to reduce their very long time of decay period, other than to keep this radioactive waste in underground storage.
- The mining process of uranium requires plenty of water in order to separate uranium from dirt, and it also can induce radiation. This is potentially to intoxicate the environment.
- There is growing protest from many people who don't agree with nuclear power plant (NPP), especially those people who live in the areas nearby of a NPP.<sup>4</sup>

The above mentioned points are some objections against the use of nuclear power, for other reasons the reader is advised to read a report elsewhere.<sup>5</sup> We can also point out that several developed countries including Germany have decided to phase out from nuclear energy in 2011, especially after its government consider the aftermath of nuclear power plant disaster in Fukushima, Japan, in March 2011.<sup>6,7</sup>

In other words, nuclear energy is a dilemmatic option for energy mix in the future. At one side, it seems that nuclear energy is a promising choice to bring energy independence from oil. But at the other side nuclear energy imposes many risks and dangerous problems that need to be considered seriously. That is why this issue needs an ethical consideration. In this paper, we will discuss this nuclear energy issue from a Christian ethics' perspective.

---

<sup>3</sup> Elektrizitätswerke Schönau, 100 Good Reasons Against Nuclear Power.

<sup>4</sup> Ramana, M.V., Nuclear Power and the Public, Bulletin of the Atomic Scientists 2011 67:43.

<sup>5</sup> Elektrizitätswerke Schönau, 100 Good Reasons Against Nuclear Power.

<sup>6</sup> Ethics Commission for a Safe Energy Supply, Germany's Energy Transition: A Collective Endeavor for the Future, Berlin, May 2011

<sup>7</sup> Taebi, B., Ethics of Nuclear Power: How to Understand Sustainability in the Nuclear Debate, Nuclear Power - Deployment, Operation and Sustainability, Dr. Pavel Tsvetkov (Ed.), ISBN: 978-953-307-474-0, InTech, 2011, p. 129

## 2. A summary of different opinions

- a. IAEA as the international body that controls the use of nuclear energy all over the world expresses its opinion that the nuclear industry cannot rely only to its safety record to justify its present action and future plans: *“The nuclear industry cannot afford merely to point to a very creditable safety record in justification of its present action and future plans.”*<sup>8</sup> Besides, IAEA also emphasizes about the principal perceived technological risks which include several aspects including:<sup>9</sup>
  - i. of improper storage of high-level radioactive nuclear wastes;
  - ii. of catastrophic accidents, principally to nuclear reactors;
  - iii. of the effect of a multiplicity of low-level releases of radioactivity during normal operation, from various parts of the nuclear cycle;
  - iv. of possible accidents in fuel reprocessing plants.
- b. According to Damveld and Jan van den Berg, the storage of radioactive waste can cause damage in the future. This makes the application of justice principle is difficult: *“Storage of nuclear waste can cause damage in the future. This makes the application of the principles of justice difficult: future generations will carry the burden, but did not benefit from the advantages. Justice means that we are willing to have a responsibility for the consequences of our actions. For nuclear waste, it is a long-term responsibility.”*<sup>10</sup> They also state that nuclear energy cannot help to solve the greenhouse effect, and economically nuclear energy is not efficient because the proven amounts of uranium are limited: *“We do not think that nuclear energy can contribute seriously to prevent the greenhouse effect and give some arguments: nuclear power is not totally CO<sub>2</sub>-free; from the viewpoint of economics it is not an efficient means; the proven amounts of uranium are limited.”*<sup>11</sup>
- c. According to Taebi, there are two possibilities to use fission nuclear energy, i.e. by using the closed-cycle and the open-cycle. In the closed-cycle, the uranium fuel which has been used is reprocessed in order to produce radioactive waste with shorter decay time, but this reprocessing is relatively expensive. In the open-cycle, the uranium is used only once and then it is put into radioactive waste storage with decay time up to hundreds of thousand years. *“In the open fuel cycle, spent fuel is considered as waste. After irradiation the fuel in the reactor, the spent fuel, will be kept in interim storage on the*

---

<sup>8</sup> IAEA, Public Acceptance of Nuclear Power - Some Ethical Issues, IAEA BULLETIN-VOL.19, NO.6, p. 49

<sup>9</sup> IAEA, Public Acceptance of Nuclear Power - Some Ethical Issues, IAEA BULLETIN-VOL.19, NO.6, p. 50

<sup>10</sup> Damveld, H., & Jan van den Berg, R., (2000) Nuclear Waste and Nuclear Ethics, p. 6

<sup>11</sup> Damveld, H., & Jan van den Berg, R., (2000) Nuclear Waste and Nuclear Ethics, p. 7

surface for a couple of decades basically to let it cool down) and it will then be disposed of in deep underground repositories. Since the fuel will be irradiated only once, this cycle is referred to as a once-through or an open fuel cycle. The disposed of waste should be isolated from the biosphere for the period that it constitutes a radiation risk; for an open-fuel cycle this is about 200,000 years".<sup>12</sup> These two options are shown in the following diagram:<sup>13</sup>

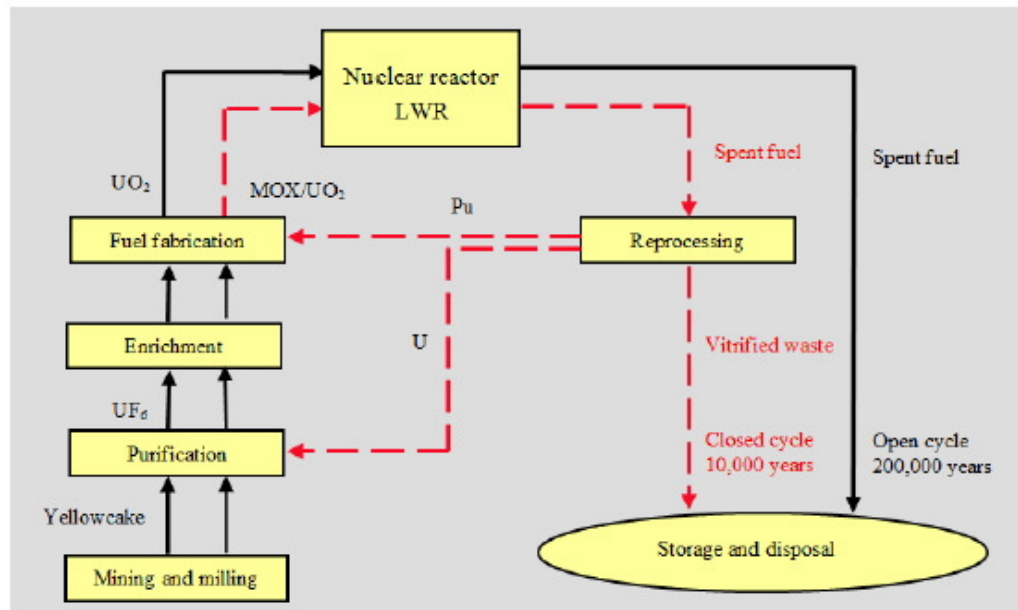

Fig. 1. Schematic representation of open and closed fuel cycles, together with the forecast waste life-times. The black solid lines represent the open fuel cycle and the red dotted lines illustrate the additional steps taken in the closed fuel cycle.

- d. According to M.V. Ramana, many opinion polls in several countries show tendency of decreasing public support for the use of nuclear energy. This decreasing public support is stimulated by public perception on the disaster risks, for instance by looking at what happens in Fukushima, Japan. *“Opinion polls show that public support for nuclear power has declined since the Fukushima crisis began, not only in Japan but also in other nations around the world. People oppose nuclear power for a variety of reasons, but the predominant concern is the perception that it is a risky technology.”*<sup>14</sup> *“Even in France, which relies on nuclear power for about three-quarters of its electricity,*

<sup>12</sup> Taebi, B., Ethics of Nuclear Power: How to Understand Sustainability in the Nuclear Debate, Nuclear Power - Deployment, Operation and Sustainability, Dr. Pavel Tsvetkov (Ed.), ISBN: 978-953-307-474-0, InTech, 2011, p. 138.

<sup>13</sup> Taebi, B., Ethics of Nuclear Power: How to Understand Sustainability in the Nuclear Debate, Nuclear Power - Deployment, Operation and Sustainability, Dr. Pavel Tsvetkov (Ed.), ISBN: 978-953-307-474-0, InTech, 2011, p. 138.

<sup>14</sup> Ramana, M.V., Nuclear Power and the Public, Bulletin of the Atomic Scientists 2011 67:43, p.1

*one poll found that a majority (57 percent) were in favor of abandoning nuclear energy.”<sup>15</sup>*

- e. An ethical commission in Germany gives recommendation to government to phase-out the nuclear energy within 1 decade: *“The Ethics Commission is of the firm conviction that phasing out the use of nuclear energy is possible within a decade with the measures for an energy transition presented here. ... Phase out is necessary and advisable to eliminate in the future the risks associated with nuclear energy in Germany. Phase out is possible because there are less risky alternatives.”<sup>16</sup>*
- f. Alvin Weinberg wrote a paper in 1971, calling the nuclear energy as a Faustian Bargain: *“The two elements of the Faustian Bargain were both present in the early nuclear enterprise: the temptation of the easy, carefree life it offered (electricity too cheap to be metered), and the bargain it struck (continuous striving was promised). The service electricity provides could be used to pursue progress in all kinds of ways, as long as the obligation was kept to look after the nuclear waste (and, for that matter, other fissionable material as well). If the obligation were shirked, it could, in an extreme scenario, mean the end of humankind.”<sup>17</sup>*
- g. According to Benjamin Hale: *“The Fukushima Daiichi disaster raises numerous questions about the future of nuclear power.”<sup>18</sup>*
- h. Another article reports that: *“Nuclear energy often subjects minority and low income groups to disproportionate environmental and health risks when it comes to uranium mining, enrichment, and waste disposal.”<sup>19</sup> “In the life cycle of the nuclear power process- from extraction of the fuel to the disposal of waste- it is often the most marginalized individuals that are forced to carry the majority of the burdens that this energy source generates.”<sup>20</sup>*

### **3. Biblical and ethical principles**

- a. Bridger develops a Christian ecology ethics which is based on eschatology. The treatment of ecology has centered almost exclusively on refining and developing a stewardship ethic based on the concept of dominion found in the creation narratives and worked out in Old Testament social legislation.<sup>21</sup>

---

<sup>15</sup> Ramana, M.V., Nuclear Power and the Public, Bulletin of the Atomic Scientists 2011 67:43, p.3

<sup>16</sup> Ethics Commission for a Safe Energy Supply, Germany’s Energy Transition: A Collective Endeavor for the Future, Berlin, May 2011, p. 2-3

<sup>17</sup> Spreng, D., Marland, G., & Weinberg, A.M., CO2 capture and storage: Another Faustian Bargain?, *Energy Policy* 35 (2007) 850-854

<sup>18</sup> Hale, B., *Ethics, Policy and Environment* Vol. 14, No. 3, October 2011

<sup>19</sup> NC State University, Nuclear Energy

<sup>20</sup> NC State University, Nuclear Energy

<sup>21</sup> Bridger, F., Ecology and Eschatology: A Neglected Dimension, *TYNBUL* 41:2 (NA 1990), p.1

However, there is another approach that is the eschatological approach, which looks into the future that there will be continuation between the new creation and the old creation. The old creation is a prototype of the new creation. *“We are faced, then, with two significantly different approaches. One would ground ecological ethics in the preservation of the created order commanded in the creation narratives and required by the role of vicegerent given to human beings through the bestowal of the imago dei. The other would accept this but interpret it from an eschatological perspective so that the original creation is seen as a prototype of the new creation. Ecological ethics on this account is rooted in the kingdom which is to come: it is anticipatory.”*<sup>22</sup>

Two passages which embody this line of theological reasoning are Romans 8:18–30 and Colossians 1:15–20. *“The primary argument for ecological responsibility lies in the connection between old and new creation outlined in the previous section. We are called to be stewards of the earth by virtue not simply of our orientation to the Edenic command of the Creator but also because of our orientation to the future. In acting to preserve and enhance the created order we are pointing to the coming rule of God in Christ. What we do ecologically, therefore, acts as a sign: the preservation of creation is no longer an action that has a significance of its own. . . it is rather itself an action pointing towards a goal which has its direction, its meaning and its value in its indication of the hope for the world which God will realize.”*<sup>23</sup>

- b. Butler develops a Christian ethics viewpoint for nuclear energy. He writes that Christian ethics has a great deal to say about nuclear power: *“From this perspective, Christian ethics has a great deal to say about nuclear power -- its potential to destroy life and to poison the earth. Christians often use the word “stewardship,” but most often in a narrow sense, in connection with the practice of tithing one’s worldly goods. True Christian stewardship embraces the larger meaning found in the ancient creeds: all of life, “the world and they that dwell therein.”*”<sup>24</sup> Besides, it is generally agreed that high-level waste poses risks. *“What of the danger to life and to the earth from high-level radioactive waste? It is generally agreed that high-level waste poses risks. Industry spokespersons say, however, that it can be safely dealt with. Other scientists, including Linus Pauling, predict genetic damage to millions yet unborn. Even a 1 per cent addition to the natural background radiation of the earth, says Dr. Pauling, means thousands of additional defective children born, and thousands more cases of cancer.”*<sup>25</sup> Moreover, according to Miller who is

---

<sup>22</sup> Bridger, F., Ecology and Eschatology: A Neglected Dimension, TYNBUL 41:2 (NA 1990), p.1

<sup>23</sup> Bridger, F., Ecology and Eschatology: A Neglected Dimension, TYNBUL 41:2 (NA 1990), p. 6

<sup>24</sup> Butler, J.G., Christian Ethics and Nuclear Power

<sup>25</sup> Butler, J.G., Christian Ethics and Nuclear Power

an economist, to rely on nuclear fission as primary energy source constitutes economic lunacy: *“The most thoroughgoing and trenchant economic analysis of nuclear power available is to be found in Saunders Miller’s book The Economics of Nuclear and Coal Power (Praeger, 1976). An investment banker, Miller is also an economist whose field is economic risk analysis. After examining nuclear power solely from the perspective of profit and loss, he concludes that “from an economic standpoint alone, to rely upon nuclear fission as the primary source of our stationary energy supplies will constitute economic lunacy on a scale unparalleled in recorded history, and may lead to the economic Waterloo of the United States.”*”<sup>26</sup>

- c. According to Parkins & Haluza-DeLay, a clear problem with the production of nuclear energy is the intergenerational equity that is equity between generations. One of the biggest unsolved problems related to nuclear energy is its radioactive waste. Intergenerational equity makes us questioning whether it is ethical to spread responsibility to take care radioactive waste over hundreds of thousand years, especially if only generations who will come in the next few decades who will benefit from the nuclear energy.<sup>27</sup>

#### **4. The writer’s viewpoint**

There are several aspects which need to be considered in relation to the use of nuclear energy to generate electricity/energy, for example:

- a. From the viewpoint of stewardship ethics, it is not acceptable to contaminate the environment with the radioactive sludge/mud while doing uranium mining or to store radioactive waste in the ground for 200 thousand years. The radioactive waste someday can leak and then it may contaminate the surrounding environment of a large area including water supply and river.
- b. Ecology ethics based on eschatology also instructs us to preserve the environment/nature with as small harm as possible, because the old creation will continue to become the new creation. Therefore the use of massive nuclear power is not acceptable, because of the risks of reactor disaster which may be caused by natural accidents like earthquakes or by core melting.
- c. From the economic viewpoint, it is also not acceptable to build one or two nuclear power plants (NPP) which require billion of US dollars, which may cause heavy loan to a nation’s account. For example, a few years ago the Philippines built a NPP in Bataan, but after presidential change it has never been used until now. In the meantime, that NPP project creates a huge

---

<sup>26</sup> Butler, J.G., Christian Ethics and Nuclear Power

<sup>27</sup> Parkins, J.R., & Haluza-DeLay, R., Social and Ethical Considerations of Nuclear Power Development, 2011, p.25

amount of foreign debt to Philippines which approaches about 20% of its GDP until now.

## 5. Some practical applications

There are several things that public in general and many Christian people can do in order to avoid the negative effects of using fission nuclear energy, for example:

- a. To suggest to national government to not to take into consideration nuclear energy in their future's energy mix.
- b. To suggest to national government to push forward the use of renewable energies in the national energy mix, for example by promoting WWS (wind, water and sun). If many governments and common people push forward to use of renewable energies, then it is possible that within a few decades WWS can be a solution to replace the depleting oil.<sup>28</sup> A summary of wind energy cost estimate can be found elsewhere.<sup>29</sup> However, there is also a recent report by Adam Smith Institute which suggests that wind energy has limit;<sup>30</sup> this problem needs to be addressed properly.
- c. To suggest to national government to give fiscal stimulus like tax cut and other incentives to corporate who pioneer the use of renewable energies and/or do research on renewable energies.
- d. To motivate all people in each nation to save oil, and to begin transition to renewable energies (sustainable energy).<sup>31</sup>
- e. For a review of some problems with nuclear energy development in Asia, the reader is referred to another report.<sup>32</sup>

## 6. Concluding remarks

Based on ethical, ecological, and economics considerations, the writers conclude that it is not acceptable to consider nuclear energy as part of national's energy mix, especially for developing countries, because of many reasons, including: radiation risks of radioactive waste, the capital-intensive development cost of a NPP which may cause heavy foreign loan to that nation, and also the risks of contamination of water and environment during uranium mining and spent fuel storage.

Because of the above mentioned reasons, Christian people and common people should suggest to government to push forward the use of renewable energies

---

<sup>28</sup> Jacobson, M.Z., & Delucchi, M.A., Providing all global energy with wind, water, and solar power, Part I, *Energy Policy* 39 (2011) 1154-1169

<sup>29</sup> Lantz, E., Hand, M., & Wiser, R., The past and future cost of wind energy, Conference paper NREL/CP-6A20-54526, August 2012

<sup>30</sup> Korchinski, W., The limits of wind power, Adam Smith Institute, Policy Study 403, February 2013

<sup>31</sup> [http://en.wikipedia.org/wiki/Sustainable\\_energy](http://en.wikipedia.org/wiki/Sustainable_energy)

<sup>32</sup> Christiano, V., Some problems of nuclear energy development in Asia, February 2013

especially WWS. For the short term, coal and natural gas can be considered as a temporary alternative.

## 7. References

- a. Bridger, F., Ecology and Eschatology: A Neglected Dimension, TYNBUL 41:2 (NA 1990). URL: <http://www.galaxie.com/journals>
- b. Butler, J.G., Christian Ethics and Nuclear Power, URL: <http://www.religion-online.org/showarticle.asp?title=1225>
- c. Christianto, V., Some problems of nuclear energy development in Asia, February 2013, available at amazon.com: <http://www.amazon.com/dp/B00B4LW5ZW>
- d. Damveld, H., & Jan van den Berg, R., (2000) Nuclear Waste and Nuclear Ethics
- e. Eerkens, J.W., The Nuclear Imperative: A Critical Look at the Approaching Energy Crisis (More Physics for Presidents), Second Edition. Dordrecht: Springer Science+Business Media B.V., 2010. URL: <http://myfreeapps.org/wp-includes/download-ebook-The-Nuclear-Imperative-A-Critical-Look-at-the-Approaching-Energy-Crisis-pdf-library-free-179762.html>
- f. Elektrizitätswerke Schönau, 100 Good Reasons Against Nuclear Power, URL: [http://www.ausgestrahlt.de/fileadmin/user\\_upload/Broschueren/g100rs\\_en.pdf](http://www.ausgestrahlt.de/fileadmin/user_upload/Broschueren/g100rs_en.pdf)
- g. [http://en.wikipedia.org/wiki/Sustainable\\_energy](http://en.wikipedia.org/wiki/Sustainable_energy)
- h. Ethics Commission for a Safe Energy Supply, Germany's Energy Transition: A Collective Endeavor for the Future, Berlin, May 2011.
- i. Ethics Commission for a Safe Energy Supply, Germany's Energy Turnaround – A Collective Effort for the Future, Berlin: Greenpeace Germany, 2011. URL: <http://stophinkley.org/EngRevu/ENERGY%20TURNAROUND.pdf>
- j. Hale, B., *Ethics, Policy and Environment* Vol. 14, No. 3, October 2011, 263–265
- k. IAEA, Public Acceptance of Nuclear Power - Some Ethical Issues, *IAEA BULLETIN-VOL.19, NO.6*, URL: <http://www.iaea.org/Publications/Magazines/Bulletin/Bull196/19604794857.pdf>
- l. Jacobson, M.Z., & Delucchi, M.A., Providing all global energy with wind, water, and solar power, Part I, *Energy Policy* 39 (2011) 1154-1169, URL: [www.elsevier.com/locate/enpol](http://www.elsevier.com/locate/enpol)
- m. Korchinski, W., The limits of wind power, Adam Smith Institute, Policy Study 403, February 2013, URL: <http://www.adamsmith.org/sites/default/files/research/files/thelimitsofwindpowerstudy-adamsmithinstitute.pdf>
- n. Lantz, E., Hand, M., & Wiser, R., The past and future cost of wind energy, Conference paper NREL/CP-6A20-54526, August 2012, URL: <http://www.nrel.gov/docs/fy12osti/54526.pdf>
- o. NC State University, Nuclear Energy, URL: <https://sites.google.com/a/ncsu.edu/nuclear-energy/ethics>



- p. Parkins, J.R., & Haluza-DeLay, R., Social and Ethical Considerations of Nuclear Power Development, 2011.
- q. Ramana, M.V., Nuclear Power and the Public, *Bulletin of the Atomic Scientists* 2011 67:43, URL: <http://bos.sagepub.com>
- r. Spreng, D., Marland, G., & Weinberg, A.M., CO2 capture and storage: Another Faustian Bargain?, *Energy Policy* 35 (2007) 850-854, URL: [http://www.ornl.net/info/ornlreview/v40\\_3\\_07/documents/article17web\\_jepo2184.pdf](http://www.ornl.net/info/ornlreview/v40_3_07/documents/article17web_jepo2184.pdf)
- s. Taebi, B., Ethics of Nuclear Power: How to Understand Sustainability in the Nuclear Debate, Nuclear Power - Deployment, Operation and Sustainability, Dr. Pavel Tsvetkov (Ed.), ISBN: 978-953-307-474-0, InTech, 2011. Available from: <http://www.intechopen.com/books/nuclear-power-deployment-operation-and-sustainability/ethics-of-nuclear-power-how-to-understand-sustainability-in-the-nuclear-debate>

VC & FS, 1<sup>st</sup> version: 24 june 2013. 1<sup>st</sup> revision: 1<sup>st</sup> july, 2013. 2<sup>nd</sup> revision: 2<sup>nd</sup> july 2013.

# Applications of Neutrosophic Logic to Robotics

## An Introduction

Florentin Smarandache  
University of New Mexico  
Gallup, NM 87301, USA  
E-mail: [smarand@unm.edu](mailto:smarand@unm.edu)

Luige Vlădăreanu  
Romanian Academy, Institute of Solid Mechanics  
15 C-tin Mille, 010141 Bucharest 1, Romania  
E-mail: [luigiv@arexim.ro](mailto:luigiv@arexim.ro)

**Abstract**— In this paper we present the N-norms/N-conorms in neutrosophic logic and set as extensions of T-norms/T-conorms in fuzzy logic and set. Then we show some applications of the neutrosophic logic to robotics.

**Keywords:** *N-norm, N-conorm, N-pseudonorm, N-pseudoconorm, Neutrosophic set, Neutrosophic logic, Robotics*

### I. DEFINITION OF NEUTROSOPHIC SET

Let  $T, I, F$  be real standard or non-standard subsets of  $]0, 1^+[$ ,  
with  $\sup T = t_{\sup}, \inf T = t_{\inf}$ ,  
 $\sup I = i_{\sup}, \inf I = i_{\inf}$ ,  
 $\sup F = f_{\sup}, \inf F = f_{\inf}$ ,  
and  $n_{\sup} = t_{\sup} + i_{\sup} + f_{\sup}$ ,  
 $n_{\inf} = t_{\inf} + i_{\inf} + f_{\inf}$ .

Let  $U$  be a universe of discourse, and  $M$  a set included in  $U$ . An element  $x$  from  $U$  is noted with respect to the set  $M$  as  $x(T, I, F)$  and belongs to  $M$  in the following way: it is  $t\%$  true in the set,  $i\%$  indeterminate (unknown if it is or not) in the set, and  $f\%$  false, where  $t$  varies in  $T$ ,  $i$  varies in  $I$ ,  $f$  varies in  $F$  ([1], [3]).

Statically  $T, I, F$  are subsets, but dynamically  $T, I, F$  are functions/operators depending on many known or unknown parameters.

### II. DEFINITION OF NEUTROSOPHIC LOGIC

In a similar way we define the Neutrosophic Logic: A logic in which each proposition  $x$  is  $T\%$  true,  $I\%$  indeterminate, and  $F\%$  false, and we write it  $x(T, I, F)$ , where  $T, I, F$  are defined above.

### III. PARTIAL ORDER

We define a *partial order relationship* on the neutrosophic set/logic in the following way:

$x(T_1, I_1, F_1) \leq y(T_2, I_2, F_2)$  iff (if and only if)  
 $T_1 \leq T_2, I_1 \geq I_2, F_1 \geq F_2$  for crisp components.

And, in general, for subunitary set components:

$x(T_1, I_1, F_1) \leq y(T_2, I_2, F_2)$  iff  
 $\inf T_1 \leq \inf T_2, \sup T_1 \leq \sup T_2,$   
 $\inf I_1 \geq \inf I_2, \sup I_1 \geq \sup I_2,$   
 $\inf F_1 \geq \inf F_2, \sup F_1 \geq \sup F_2.$

If we have mixed - crisp and subunitary - components, or only crisp components, we can transform any crisp component, say “a” with  $a \in [0, 1]$  or  $a \in ]0, 1^+[$ , into a subunitary set  $[a, a]$ . So, the definitions for subunitary set components should work in any case.

### IV. N-NORM AND N-CONORM

As a generalization of T-norm and T-conorm from the Fuzzy Logic and Set, we now introduce the N-norms and N-conorms for the Neutrosophic Logic and Set.

#### A. N-norm

$N_n: (]0, 1^+[ \times ]0, 1^+[ \times ]0, 1^+[ )^2 \rightarrow ]0, 1^+[ \times ]0, 1^+[ \times ]0, 1^+[$   
 $N_n(x(T_1, I_1, F_1), y(T_2, I_2, F_2)) = (N_nT(x, y), N_nI(x, y), N_nF(x, y))$ ,  
where  $N_nT(.,.), N_nI(.,.), N_nF(.,.)$  are the truth/membership, indeterminacy, and respectively falsehood/nonmembership components.

$N_n$  have to satisfy, for any  $x, y, z$  in the neutrosophic logic/set  $M$  of the universe of discourse  $U$ , the following axioms:

- a) Boundary Conditions:  $N_n(x, \mathbf{0}) = \mathbf{0}, N_n(x, \mathbf{1}) = x$ .
- b) Commutativity:  $N_n(x, y) = N_n(y, x)$ .
- c) Monotonicity: If  $x \leq y$ , then  $N_n(x, z) \leq N_n(y, z)$ .
- d) Associativity:  $N_n(N_n(x, y), z) = N_n(x, N_n(y, z))$ .

There are cases when not all these axioms are satisfied, for example the associativity when dealing with the neutrosophic normalization after each neutrosophic operation. But, since we work with approximations, we can call these N-pseudo-norms, which still give good results in practice.

$N_n$  represent the *and* operator in neutrosophic logic, and respectively the *intersection* operator in neutrosophic set theory.

Let  $J \in \{T, I, F\}$  be a component.

Most known N-norms, as in fuzzy logic and set the T-norms, are:

- The Algebraic Product N-norm:  $N_{n\text{-algebraic}}J(x, y) = x \cdot y$
- The Bounded N-Norm:  $N_{n\text{-bounded}}J(x, y) = \max\{0, x + y - 1\}$
- The Default (min) N-norm:  $N_{n\text{-min}}J(x, y) = \min\{x, y\}$ .

A general example of N-norm would be this.

Let  $x(T_1, I_1, F_1)$  and  $y(T_2, I_2, F_2)$  be in the neutrosophic set/logic M. Then:

$$N_n(x, y) = (T_1 \wedge T_2, I_1 \vee I_2, F_1 \vee F_2)$$

where the “ $\wedge$ ” operator, acting on two (standard or non-standard) subunitary sets, is a N-norm (verifying the above N-norms axioms); while the “ $\vee$ ” operator, also acting on two (standard or non-standard) subunitary sets, is a N-conorm (verifying the below N-conorms axioms).

For example,  $\wedge$  can be the Algebraic Product T-norm/N-norm, so  $T_1 \wedge T_2 = T_1 \cdot T_2$  (herein we have a product of two subunitary sets – using simplified notation); and  $\vee$  can be the Algebraic Product T-conorm/N-conorm, so  $T_1 \vee T_2 = T_1 + T_2 - T_1 \cdot T_2$  (herein we have a sum, then a product, and afterwards a subtraction of two subunitary sets).

Or  $\wedge$  can be any T-norm/N-norm, and  $\vee$  any T-conorm/N-conorm from the above and below; for example the easiest way would be to consider the *min* for crisp components (or *inf* for subset components) and respectively *max* for crisp components (or *sup* for subset components).

If we have crisp numbers, we can at the end neutrosophically normalize.

### B. N-conorm

$N_c: (]0,1^+[ \times ]0,1^+[ \times ]0,1^+[ \rightarrow ]0,1^+[ \times ]0,1^+[ \times ]0,1^+[$   
 $N_c(x(T_1, I_1, F_1), y(T_2, I_2, F_2)) = (N_c T(x, y), N_c I(x, y), N_c F(x, y))$ ,  
 where  $N_n T(\dots)$ ,  $N_n I(\dots)$ ,  $N_n F(\dots)$  are the truth/membership, indeterminacy, and respectively falsehood/nonmembership components.

$N_c$  have to satisfy, for any  $x, y, z$  in the neutrosophic logic/set M of universe of discourse U, the following axioms:

- Boundary Conditions:  $N_c(x, 1) = 1$ ,  $N_c(x, 0) = x$ .
- Commutativity:  $N_c(x, y) = N_c(y, x)$ .
- Monotonicity: if  $x \leq y$ , then  $N_c(x, z) \leq N_c(y, z)$ .
- Associativity:  $N_c(N_c(x, y), z) = N_c(x, N_c(y, z))$ .

There are cases when not all these axioms are satisfied, for example the associativity when dealing with the neutrosophic normalization after each neutrosophic operation. But, since we work with approximations, we can call these N-pseudo-conorms, which still give good results in practice.

$N_c$  represent the *or* operator in neutrosophic logic, and respectively the *union* operator in neutrosophic set theory.

Let  $J \in \{T, I, F\}$  be a component.

Most known N-conorms, as in fuzzy logic and set the T-conorms, are:

- The Algebraic Product N-conorm:  $N_{c\text{-algebraic}} J(x, y) = x + y - x \cdot y$
- The Bounded N-conorm:  $N_{c\text{-bounded}} J(x, y) = \min\{1, x + y\}$
- The Default (max) N-conorm:  $N_{c\text{-max}} J(x, y) = \max\{x, y\}$ .

A general example of N-conorm would be this.

Let  $x(T_1, I_1, F_1)$  and  $y(T_2, I_2, F_2)$  be in the neutrosophic set/logic M. Then:

$$N_n(x, y) = (T_1 \vee T_2, I_1 \wedge I_2, F_1 \wedge F_2)$$

Where – as above - the “ $\wedge$ ” operator, acting on two (standard or non-standard) subunitary sets, is a N-norm (verifying the above N-norms axioms); while the “ $\vee$ ” operator, also acting on two (standard or non-standard) subunitary sets, is a N-conorm (verifying the above N-conorms axioms).

For example,  $\wedge$  can be the Algebraic Product T-norm/N-norm, so  $T_1 \wedge T_2 = T_1 \cdot T_2$  (herein we have a product of two subunitary sets); and  $\vee$  can be the Algebraic Product T-conorm/N-conorm, so  $T_1 \vee T_2 = T_1 + T_2 - T_1 \cdot T_2$  (herein we have a sum, then a product, and afterwards a subtraction of two subunitary sets).

Or  $\wedge$  can be any T-norm/N-norm, and  $\vee$  any T-conorm/N-conorm from the above; for example the easiest way would be to consider the *min* for crisp components (or *inf* for subset components) and respectively *max* for crisp components (or *sup* for subset components).

If we have crisp numbers, we can at the end neutrosophically normalize.

Since the min/max (or inf/sup) operators work the best for subunitary set components, let’s present their definitions below. They are extensions from subunitary intervals {defined in [3]} to any subunitary sets. Analogously we can do for all neutrosophic operators defined in [3].

Let  $x(T_1, I_1, F_1)$  and  $y(T_2, I_2, F_2)$  be in the neutrosophic set/logic M.

### C. More Neutrosophic Operators

Neutrosophic Conjunction/Intersection:

$$x \wedge y = (T_\wedge, I_\wedge, F_\wedge),$$

where  $\inf T_\wedge = \min\{\inf T_1, \inf T_2\}$   
 $\sup T_\wedge = \min\{\sup T_1, \sup T_2\}$   
 $\inf I_\wedge = \max\{\inf I_1, \inf I_2\}$   
 $\sup I_\wedge = \max\{\sup I_1, \sup I_2\}$   
 $\inf F_\wedge = \max\{\inf F_1, \inf F_2\}$   
 $\sup F_\wedge = \max\{\sup F_1, \sup F_2\}$

Neutrosophic Disjunction/Union:

$$x \vee y = (T_\vee, I_\vee, F_\vee),$$

where  $\inf T_\vee = \max\{\inf T_1, \inf T_2\}$   
 $\sup T_\vee = \max\{\sup T_1, \sup T_2\}$   
 $\inf I_\vee = \min\{\inf I_1, \inf I_2\}$   
 $\sup I_\vee = \min\{\sup I_1, \sup I_2\}$   
 $\inf F_\vee = \min\{\inf F_1, \inf F_2\}$   
 $\sup F_\vee = \min\{\sup F_1, \sup F_2\}$

Neutrosophic Negation/Complement:

$$C(x) = (T_c, I_c, F_c),$$

where  $T_c = F_1$   
 $\inf I_c = 1 - \sup I_1$

$$\begin{aligned} \sup I_C &= 1 - \inf I_1 \\ F_C &= T_1 \end{aligned}$$

Upon the above Neutrosophic Conjunction/Intersection, we can define the

Neutrosophic Containment:

We say that the neutrosophic set A is included in the neutrosophic set B of the universe of discourse U, iff for any  $x(T_A, I_A, F_A) \in A$  with  $x(T_B, I_B, F_B) \in B$  we have:

$$\begin{aligned} \inf T_A &\leq \inf T_B; \sup T_A \leq \sup T_B; \\ \inf I_A &\geq \inf I_B; \sup I_A \geq \sup I_B; \\ \inf F_A &\geq \inf F_B; \sup F_A \geq \sup F_B. \end{aligned}$$

#### D. Remarks

- a) The non-standard unit interval  $]0, 1^+[$  is merely used for philosophical applications, especially when we want to make a distinction between relative truth (truth in at least one world) and absolute truth (truth in all possible worlds), and similarly for distinction between relative or absolute falsehood, and between relative or absolute indeterminacy.

But, for technical applications of neutrosophic logic and set, the domain of definition and range of the N-norm and N-conorm can be restrained to the normal standard real unit interval  $[0, 1]$ , which is easier to use, therefore:

$$\begin{aligned} N_n: ([0,1] \times [0,1] \times [0,1])^2 &\rightarrow [0,1] \times [0,1] \times [0,1] \\ &\text{and} \\ N_c: ([0,1] \times [0,1] \times [0,1])^2 &\rightarrow [0,1] \times [0,1] \times [0,1]. \end{aligned}$$

- b) Since in NL and NS the sum of the components (in the case when T, I, F are crisp numbers, not sets) is not necessary equal to 1 (so the normalization is not required), we can keep the final result un-normalized.

But, if the normalization is needed for special applications, we can normalize at the end by dividing each component by the sum all components.

If we work with intuitionistic logic/set (when the information is incomplete, i.e. the sum of the crisp components is less than 1, i.e. *sub-normalized*), or with paraconsistent logic/set (when the information overlaps and it is contradictory, i.e. the sum of crisp components is greater than 1, i.e. *over-normalized*), we need to define the neutrosophic measure of a proposition/set.

If  $x(T,I,F)$  is a NL/NS, and T,I,F are crisp numbers in  $[0,1]$ , then the neutrosophic vector norm of variable/set x is the sum of its components:

$$N_{\text{vector-norm}}(x) = T+I+F.$$

Now, if we apply the  $N_n$  and  $N_c$  to two propositions/sets which maybe intuitionistic or paraconsistent or normalized (i.e. the sum of components less than 1, bigger than 1, or equal to 1), x and y, what should be the neutrosophic measure of the results  $N_n(x,y)$  and  $N_c(x,y)$ ?

Herein again we have more possibilities:

- either the product of neutrosophic measures of x and y:  

$$N_{\text{vector-norm}}(N_n(x,y)) = N_{\text{vector-norm}}(x) \cdot N_{\text{vector-norm}}(y),$$
- or their average:  

$$N_{\text{vector-norm}}(N_n(x,y)) = (N_{\text{vector-norm}}(x) + N_{\text{vector-norm}}(y))/2,$$
- or other function of the initial neutrosophic measures:

$$N_{\text{vector-norm}}(N_n(x,y)) = f(N_{\text{vector-norm}}(x), N_{\text{vector-norm}}(y)), \text{ where } f(.,.) \text{ is a function to be determined according to each application.}$$

Similarly for  $N_{\text{vector-norm}}(N_c(x,y))$ .

Depending on the adopted neutrosophic vector norm, after applying each neutrosophic operator the result is neutrosophically normalized. We'd like to mention that "neutrosophically normalizing" doesn't mean that the sum of the resulting crisp components should be 1 as in fuzzy logic/set or intuitionistic fuzzy logic/set, but the sum of the components should be as above: either equal to the product of neutrosophic vector norms of the initial propositions/sets, or equal to the neutrosophic average of the initial propositions/sets vector norms, etc.

In conclusion, we neutrosophically normalize the resulting crisp components  $T', I', F'$  by multiplying each neutrosophic component  $T', I', F'$  with  $S/(T'+I'+F')$ , where

$$S = N_{\text{vector-norm}}(N_n(x,y)) \text{ for a N-norm or } S = N_{\text{vector-norm}}(N_c(x,y)) \text{ for a N-conorm - as defined above.}$$

- c) If T, I, F are subsets of  $[0, 1]$  the problem of neutrosophic normalization is more difficult.
  - i) If  $\sup(T)+\sup(I)+\sup(F) < 1$ , we have an *intuitionistic proposition/set*.
  - ii) If  $\inf(T)+\inf(I)+\inf(F) > 1$ , we have a *paraconsistent proposition/set*.
  - iii) If there exist the crisp numbers  $t \in T$ ,  $i \in I$ , and  $f \in F$  such that  $t+i+f=1$ , then we can say that we have a *plausible normalized proposition/set*.

But in many such cases, besides the normalized particular case showed herein, we also have crisp numbers, say  $t_1 \in T$ ,  $i_1 \in I$ , and  $f_1 \in F$  such that  $t_1+i_1+f_1 < 1$  (incomplete

information) and  $t_2 \in T$ ,  $i_2 \in I$ , and  $f_2 \in F$  such that  $t_2 + i_2 + f_2 > 1$  (paraconsistent information).

*E. Examples of Neutrosophic Operators which are N-norms or N-pseudonorms or, respectively N-conorms or N-pseudoconorms*

We define a binary neutrosophic conjunction (intersection) operator, which is a particular case of a N-norm (neutrosophic norm, a generalization of the fuzzy T-norm):

$$c_N^{NF} : ([0,1] \times [0,1] \times [0,1])^2 \rightarrow [0,1] \times [0,1] \times [0,1]$$

$$c_N^{NF}(x, y) = (T_1 T_2, I_1 I_2 + I_1 T_2 + T_1 I_2, F_1 F_2 + F_1 I_2 + F_1 T_2 + F_2 T_1 + F_2 I_1)$$

The neutrosophic conjunction (intersection) operator  $x \wedge_N y$  component truth, indeterminacy, and falsehood values result from the multiplication

$$(T_1 + I_1 + F_1) \cdot (T_2 + I_2 + F_2)$$

since we consider in a prudent way  $T \prec I \prec F$ , where “ $\prec$ ” is a neutrosophic relationship and means “weaker”, i.e. the products  $T_i I_j$  will go to  $I$ ,  $T_i F_j$  will go to  $F$ , and  $I_i F_j$  will go to  $F$  for all  $i, j \in \{1, 2\}$ ,  $i \neq j$ , while of course the product  $T_1 T_2$  will go to  $T$ ,  $I_1 I_2$  will go to  $I$ , and  $F_1 F_2$  will go to  $F$  (or reciprocally we can say that  $F$  prevails in front of  $I$  which prevails in front of  $T$ , and this neutrosophic relationship is transitive):

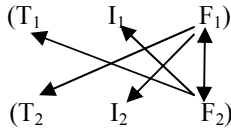
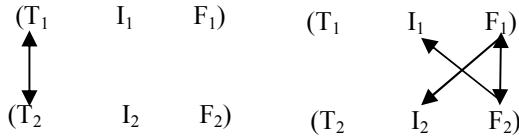

So, the truth value is  $T_1 T_2$ , the indeterminacy value is  $I_1 I_2 + I_1 T_2 + T_1 I_2$  and the false value is  $F_1 F_2 + F_1 I_2 + F_1 T_2 + F_2 T_1 + F_2 I_1$ . The norm of  $x \wedge_N y$  is  $(T_1 + I_1 + F_1) \cdot (T_2 + I_2 + F_2)$ . Thus, if  $x$  and  $y$  are normalized, then  $x \wedge_N y$  is also normalized. Of course, the

reader can redefine the neutrosophic conjunction operator, depending on application, in a different way, for example in a more optimistic way, i.e.  $I \prec T \prec F$  or  $T$  prevails with respect to  $I$ , then we get:

$$c_N^{IF}(x, y) = (T_1 T_2 + T_1 I_2 + T_2 I_1, I_1 I_2, F_1 F_2 + F_1 I_2 + F_1 T_2 + F_2 T_1 + F_2 I_1)$$

Or, the reader can consider the order  $T \prec F \prec I$ , etc.

## V. ROBOT POSITION CONTROL BASED ON KINEMATICS EQUATIONS

A robot can be considered as a mathematical relation of actuated joints which ensures coordinate transformation from one axis to the other connected as a serial link manipulator where the links sequence exists. Considering the case of revolute-geometry robot all joints are rotational around the freedom ax [4, 5]. In general having a six degrees of freedom the manipulator mathematical analysis becomes very complicated. There are two dominant coordinate systems: Cartesian coordinates and joints coordinates. Joint coordinates represent angles between links and link extensions. They form the coordinates where the robot links are moving with direct control by the actuators.

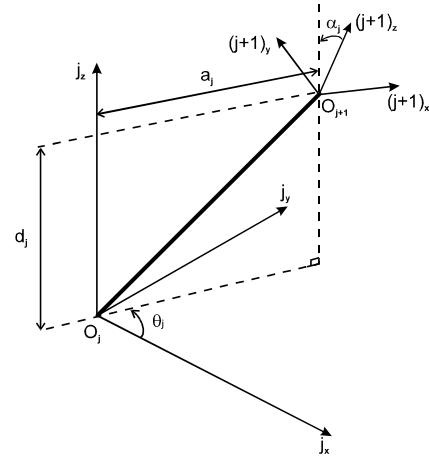

Fig.1. The robot control through DH transformation.

The position and orientation of each segment of the linkage structure can be described using Denavit-Hartenberg [DH] transformation [6]. To determine the D-H transformation matrix (Fig. 1) it is assumed that the Z-axis (which is the system's axis in relation to the motion surface) is the axis of rotation in each frame, with the following notations:  $\theta_j$  - joint angled is the joint angle positive in the right hand sense about  $j_z$ ;  $a_j$  - link length is the length of the common normal, positive in the direction of  $(j+1)_x$ ;  $\alpha_j$  - twist angled is the angle between  $j_z$  and  $(j+1)_z$  positive in the right hand sense about the common normal;  $d_j$  - offset distance is the value of  $j_z$  at which the common normal intersects  $j_z$ ; as well if  $j_x$  and  $(j+1)_x$  are parallel and in the

same direction, then  $\theta_j = 0$ ;  $(j+1)_X$  - is chosen to be collinear with the common normal between  $j_Z$  and  $(j+1)_Z$  [7, 8]. Figure 1 illustrates a robot position control based on the Denavit-Hartenberg transformation. The robot joint angles,  $\theta_c$ , are transformed in  $X_c$  - Cartesian coordinates with D-H transformation. Considering that a point in  $j$ , respectively  $j+1$  is given by:

$$\begin{bmatrix} X \\ Y \\ Z \\ 1 \end{bmatrix}_j = {}^jP \quad \text{and} \quad \begin{bmatrix} X \\ Y \\ Z \\ 1 \end{bmatrix}_{j+1} = {}^{j+1}P' \quad (1)$$

then  ${}^jP$  can be determined in relation to  ${}^{j+1}P$  through the equation :

$${}^jP = {}^jA_{j+1} \cdot {}^{j+1}P, \quad (2)$$

where the transformation matrix  ${}^jA_{j+1}$  is:

$${}^jA_{j+1} = \begin{bmatrix} \cos\theta_j - \sin\theta_j \cdot \cos\alpha_j + \sin\theta_j \cdot \sin\alpha_j \cdot a_j \cdot \cos\alpha_j & & & \\ \sin\theta_j - \cos\theta_j \cdot \cos\alpha_j - \cos\theta_j \cdot \sin\alpha_j \cdot a_j \cdot \sin\alpha_j & & & \\ 0 & \sin\theta_j & \cos\theta_j & d_j \\ 0 & 0 & 0 & 1 \end{bmatrix}$$

Control through forward kinematics consists of the transformation of robot coordinates at any given moment, resulting directly from the measurement transducers of each axis, to Cartesian coordinates and comparing to the desired target's Cartesian coordinates (reference point). The resulting error is the difference of position, represented in Cartesian coordinates, which requires changing. Using the inverted Jacobean matrix ensures the transformation into robot coordinates of the position error from Cartesian coordinates, which allows the generating of angle errors for the direct control of the actuator on each axis.

The control using forward kinematics consists of transforming the actual joint coordinates, resulting from transducers, to Cartesian coordinates and comparing them with the desired Cartesian coordinates. The resulted error is a required position change, which must be obtained on every axis. Using the Jacobean matrix inverting it will manage to transform the change in joint coordinates that will generate angle errors for the motor axis control.

Figure 2 illustrates a robot position control system based on the Denavit-Hartenberg transformation. The robot joint angles,  $\theta_c$ , are transformed in  $X_c$  - Cartesian coordinates with D-H transformation, where a matrix results from (1) and (2) with  $\theta_j$  -joint angle,  $d_j$  -offset distance,  $a_j$  - link length,  $\alpha_j$  - twist.

Position and orientation of the end effector with respect to the base coordinate frame is given by  $X_C$  :

$$X_C = A_1 \cdot A_2 \cdot A_3 \cdot \dots \cdot A_6 \quad (3)$$

Position error  $\Delta X$  is obtained as a difference between desired and current position. There is difficulty in controlling robot trajectory, if the desired conditions are

specified using position difference  $\Delta X$  with continuously measurement of current position  $\theta_{1,2,\dots,6}$ .

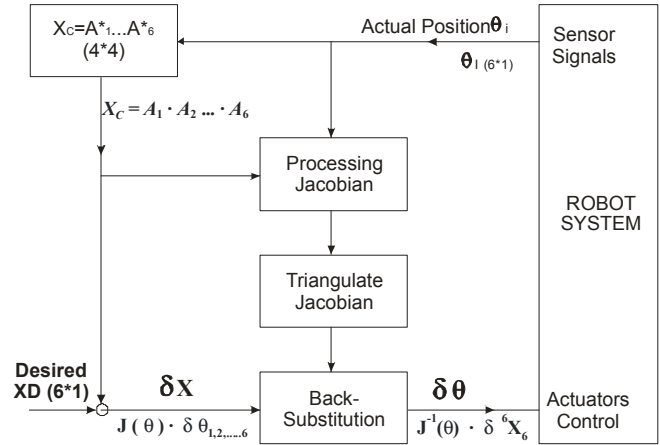

Fig. 2. Robot position control system based on the Denavit-Hartenberg transformation

The relation, between given by end-effector's position and orientation considered in Cartesian coordinates and the robot joint angles  $\theta_{1,2,\dots,6}$ , it is :

$$x_i = f_i(\theta) \quad (4)$$

where  $\theta$  is vector representing the degrees of freedom of robot. By differentiating we will have:  $\delta {}^6X_6 = J(\theta) \cdot \delta \theta_{1,2,\dots,6}$ , where  $\delta {}^6X_6$  represents differential linear and angular changes in the end effector at the currently values of  $X_6$  and  $\delta \theta_{1,2,\dots,6}$  represents the differential change of the set of joint angles.  $J(\theta)$  is the Jacobean matrix in which the elements  $a_{ij}$  satisfy the relation:  $a_{ij} = \delta f_{i-1} / \delta \theta_{j-1}$ , (x.6) where  $i, j$  are corresponding to the dimensions of  $x$  respectively  $\theta$ . The inverse Jacobean transforms the Cartesian position  $\delta {}^6X_6$  respectively  $\Delta X$  in joint angle error ( $\Delta \theta$ ):  $\delta \theta_{1,2,\dots,6} = J^{-1}(\theta) \cdot \delta {}^6X_6$ .

## VI. HYBRID POSITION AND FORCE CONTROL OF ROBOTS

Hybrid position and force control of industrial robots equipped with compliant joints must take into consideration the passive compliance of the system. The generalized area where a robot works can be defined in a constraint space with six degrees of freedom (DOF), with position constrains along the normal force of this area and force constrains along the tangents. On the basis of these two constrains there is described the general scheme of hybrid position and force control in figure 3. Variables  $X_C$  and  $F_C$  represent the Cartesian position and the Cartesian force exerted onto the environment. Considering  $X_C$  and  $F_C$  expressed in specific frame of coordinates, its can be determinate selection matrices  $S_x$  and  $S_f$ , which are diagonal matrices with 0 and 1

diagonal elements, and which satisfy relation:  $S_x + S_f = I_d$ , where  $S_x$  and  $S_f$  are methodically deduced from kinematics constrains imposed by the working environment [9, 10].

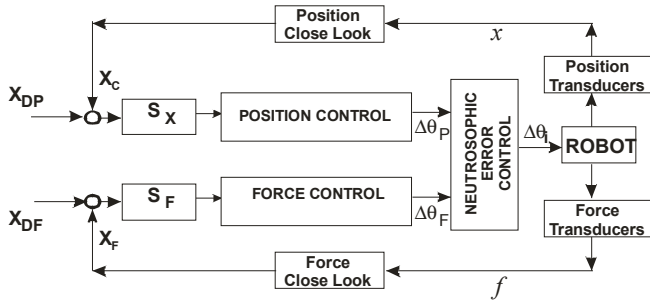

Fig. 3. General structure of hybrid control.

Mathematical equations for the hybrid position-force control. A system of hybrid position–force control normally achieves the simultaneous position–force control. In order to determine the control relations in this situation,  $\Delta X^p$  – the measured deviation of Cartesian coordinate command system is split in two sets:  $\Delta X^f$  corresponds to force controlled component and  $\Delta X^p$  corresponds to position control with axis actuating in accordance with the selected matrixes  $S_f$  and  $S_x$ . If there is considered only positional control on the directions established by the selection matrix  $S_x$  there can be determined the desired end - effector differential motions that correspond to position control in the relation:  $\Delta X_p = K_p \Delta X^p$ , where  $K_p$  is the gain matrix, respectively desired motion joint on position controlled axis:  $\Delta \theta_p = J^{-1}(\theta) \cdot \Delta X_p$  [11, 12].

Now taking into consideration the force control on the other directions left, the relation between the desired joint motion of end-effector and the force error  $\Delta X_f$  is given by the relation:  $\Delta \theta_f = J^{-1}(\theta) \cdot \Delta X_f$ , where the position error due to force  $\Delta X_f$  is the motion difference between  $\Delta X^f$  – current position deviation measured by the control system that generates position deviation for force controlled axis and  $\Delta X_D$  – position deviation because of desired residual force. Noting the given desired residual force as  $F_D$  and the physical rigidity  $K_w$  there is obtained the relation:  $\Delta X_D = K_w^{-1} \cdot F_D$ .

Thus,  $\Delta X_f$  can be calculated from the relation:  $\Delta X_f = K_f (\Delta X^f - \Delta X_D)$ , where  $K_f$  is the dimensionless ratio of the stiffness matrix. Finally, the motion variation on the robot axis matched to the motion variation of the end-effectors is obtained through the relation:  $\Delta \theta = J^{-1}(\theta) \Delta X_f + J^{-1}(\theta) \Delta X_p$ . Starting from this representation the architecture of the hybrid position – force control system was developed with the corresponding coordinate transformations applicable to systems with open architecture and a distributed and decentralized structure.

For the fusion of information received from various sensors, information that can be conflicting in a certain degree, the robot uses the fuzzy and neutrosophic logic or set [3]. In a real time it is used a neutrosophic dynamic fusion, so an autonomous robot can take a decision at any moment.

## CONCLUSION

In this paper we have provided in the first part an introduction to the neutrosophic logic and set operators and in the second part a short description of mathematical dynamics of a robot and then a way of applying neutrosophic science to robotics. Further study would be done in this direction in order to develop a robot neutrosophic control.

## REFERENCES

- [1] Florentin Smarandache, *A Unifying Field in Logics: Neutrosophic Field, Multiple-Valued Logic / An International Journal*, Vol. 8, No. 3, 385-438, June 2002
- [2] Andrew Schumann, *Neutrosophic logics on Non-Archimedean Structures*, Critical Review, Creighton University, USA, Vol. III, 36-58, 2009.
- [3] Xinde Li, Xianzhong Dai, Jean Dezert, Florentin Smarandache, *Fusion of Imprecise Qualitative Information*, Applied Intelligence, Springer, Vol. 33 (3), 340-351, 2010.
- [4] Vladareanu L, *Real Time Control of Robots and Mechanisms by Open Architecture Systems*, cap.14, Advanced Engineering in Applied Mechanics, Eds- T.Sireteanu,L.Vladareanu, Ed. Academiei 2006, pp.38, pg. 183-196, ISBN 978-973-27-1370-9
- [5] Vladareanu L, Ion I, Velea LM, Mitroi D, Gal A, "The Real Time Control of Modular Walking Robot Stability", Proceedings of the 8th International Conference on Applications of Electrical Engineering (AEE '09), Houston, USA, 2009,pg.179-186, ISSN: 1790-5117 , ISBN: 978-960-474-072-7
- [6] Denavit J., Hartenberg RB - *A kinematics notation for lower-pair mechanism based on matrices*. ASMEJ. Appl. Mechanics, vol.23June 1955, pg.215-221
- [7] Sidhu G.S. - *Scheduling algorithm for multiprocessor robot arm control*, Proc. 19th Southeastern Symp., March,1997
- [8] Vladareanu L; Tont G; Ion I; Vladareanu V; Mitroi D; *Modeling and Hybrid Position-Force Control of Walking Modular Robots*; American Conference on Applied Mathematics, pg:510-518; Harvard Univ, Cambridge, Boston, USA, 2010; ISBN: 978-960-474-150-2.
- [9] L.D.Joly, C.Andriot, V.Hayward, *Mechanical Analogic in Hybrid Position/Force Control*, IEEE Albuquerque, New Mexico, pg. 835-840, April 1997
- [10] Vladareanu L, *The robots' real time control through open architecture systems*, cap.11, Topics in Applied Mechanics, vol.3, Ed.Academiei 2006, pp.460-497, ISBN 973-27-1004-7
- [11] Vladareanu L, Sandru OI, Velea LM, YU Hongnian, *The Actuators Control in Continuous Flux using the Winer Filters*, Proceedings of Romanian Academy, Series A, Volume: 10 Issue: 1 Pg.: 81-90, 2009, ISSN 1454-9069
- [12] Yoshikawa T., Zheng X.Z. - *Coordinated Dynamic Hybrid Position/Force Control for Multiple Robot Manipulators Handling One Constrained Object*, The International Journal of Robotics Research, Vol. 12, No. 3, June 1993, pp. 219-230



# The Navigation Mobile Robot Systems Using Bayesian Approach through the Virtual Projection Method

Luige Vladareanu, Gabriela Tont, Victor Vladareanu, Florentin Smarandache, Lucian Capitanu

**Abstract.** The paper presents the navigation mobile walking robot systems for movement in non-stationary and non-structured environments, using a Bayesian approach of Simultaneous Localization and Mapping (SLAM) for avoiding obstacles and dynamical stability control for motion on rough terrain. By processing inertial information of force, torque, tilting and wireless sensor networks (WSN) an intelligent high level algorithm is implementing using the virtual projection method. The control system architecture for the dynamic robot walking is presented in correlation with a stochastic model of assessing system probability of unidirectional or bidirectional transition states, applying the non-homogeneous/non-stationary Markov chains. The rationality and validity of the proposed model are demonstrated via an example of quantitative assessment of states probabilities of an autonomous robot. The results show that the proposed new navigation strategy of the mobile robot using Bayesian approach walking robot control systems for going around obstacles has increased the robot's mobility and stability in workspace.

## I. INTRODUCTION

Walking robots, unlike other types of robots such as those with wheels or tracks, use similar devices for moving on the field like human or animal feet. A desirable characteristic a mobile robot must have the skills needed to recognize the landmarks and objects that surround it, and to be able to localize itself relative to its workspace. This knowledge is crucial for the successful completion of intelligent navigation tasks. But, for such interaction to take place, a model or description of the environment needs to be specified beforehand. If a global description or measurement of the elements present in the environment is available, the problem consists on the interpretation and matching of sensor readings to such previously stored object models. Moreover, if we know that the recognized objects are fixed and persist in the scene, they can be regarded as landmarks, and can be used as reference points for self localization. If

on the other hand, a global description or measurement of the elements in the environment is not available, at least the descriptors and methods that will be used for the autonomous building of one are required [1].

The approach of the localization and navigation problems of a mobile robot which uses a WSN which comprises of a large number of distributed nodes with low-cost cameras as main sensor, have the main advantage of require no collaboration from the object being tracked. The main advantages of using WSN multi-camera localization and tracking are:

- 1) the exploit of the distributed sensing capabilities of the WSN;
- 2) the benefit from the parallel computing capabilities of the distributed nodes. Even though each node have finite battery lifetime by cooperating with each other, they can perform tasks that are difficult to handle by traditional centralized sensing system.;
- 3) the employ of the communication infrastructure of the WSN to overcome multi-camera network issues. Also, camera-based WSN have easier deployment and higher re-configurability than traditional camera networks making them particularly interesting in applications such as security and search and rescue, where pre-existing infrastructure might be damaged [2].

Robots have to know where in the map they are in order to perform any task involving navigation. Probabilistic algorithms have proved very successful in many robotic environments. They calculate the probability of each possible position given some sensor readings and movement data provided by the robot [5]. The localization of a mobile robot is made using a particle filter that updates the belief of localization which, and estimates the maximal posterior probability density for localization. The causal and contextual relations of the sensing results and global localization in a Bayesian network, and a sensor planning approach based on Bayesian network inference to solve the dynamic environment is presented. In the study is proposed a mobile robot sensor planning approach based on a top-down decision tree algorithm. Since the system has to compute the utility values of all possible sensor selections in every planning step, the planning process is very complex.

The paper first presents the position force control and dynamic control using ZMP and inertial information with the aim of improving robot stability for movement in non-structured environments. The next chapter presents the mobile walking robot control system architecture for movement in non-stationary environments by applying

Manuscript received April 9, 2012. This work was supported in part by the Romanian Academy and the Romanian Scientific Research National Authority under Grant 005/2007-2010 (sponsor and financial support acknowledgment goes here).

L.Vladareanu, Institute of Solid Mechanics of the Romanian Academy, Head of Robotics and Mechatronics Department, Bucharest 1, C-tin Mille 15, 010141, [luigiv@imsar.bu.edu.ro](mailto:luigiv@imsar.bu.edu.ro), [luigiv@arexim.ro](mailto:luigiv@arexim.ro) (contact person)

G.Tont, University of Oradea, Faculty of Electrical Engineering and Information Technology, Oradea, Universitatii 1, 410087, ROMANIA, [gtont@uoradea.ro](mailto:gtont@uoradea.ro).

V.Vladareanu, "Politehnica" University of Bucharest, Faculty of Electronics, II, 313 Splaiul Independenței, 060042 Bucharest, ROMANIA

F.Smarandache, Mathematics Department, The University of New Mexico 705 Gurley, Gallup, NM87301,USA, E-mail: [smarand@unm.edu](mailto:smarand@unm.edu)

L.Capitanu, Institute of Solid Mechanics of the Romanian Academy, Scientific Director, Bucharest 1, C-tin Mille 15, [luiciancapitanu@yahoo.com](mailto:luiciancapitanu@yahoo.com)



Wireless Sensor Networks (WSN) methods. Finally, there are presented the results obtained in implementing the interface for sensor networks used to avoid obstacles and in improving the performance of dynamic stability control for motion on rough terrain, through a Bayesian approach of Simultaneous Localization and Mapping (SLAM).

## II. DYNAMICAL STABILITY CONTROL

The research evidences that stable gaits can be achieved by employing simple control approaches which take advantage of the dynamics of compliant systems. This allows a decentralization of the control system, through which a central command establishes the general movement trajectory and local control laws presented in the paper solve the motion stability problems, such as: damping control, ZMP compensation control, landing orientation control, gait timing control, walking pattern control, predictable motion control (see ICAMechS 2011, Zhengzhou [3]).

In order to carry out new capabilities for walking robots, such as walking down the slope, going by overcoming or avoiding obstacles, it is necessary to develop high-level intelligent algorithms, because the mechanism of walking robots stepping on a road with bumps is a complicated process to understand, being a repetitive process of tilting or unstable movements that can lead to the overthrow of the robot. The chosen method that adapts well to walking robots is the ZMP (Zero Moment Point) method. A new strategy is developed for the dynamic control for walking robot stepping using ZMP and inertial information. This, includes pattern generation of compliant walking, real-time ZMP compensation in one phase - support phase, the leg joint damping control, stable stepping control and stepping position control based on angular velocity of the platform. In this way, the walking robot is able to adapt on uneven ground, through real time control, without losing its stability during walking [13].

Based on studies and analysis, the compliant control system architecture was completed with tracking functions for HFPC walking robots, which through the implementation of many control loops in different phase of the walking robot, led to the development of new technological capabilities, to adapt the robot walking on sloping land, with obstacles and bumps. In this sense, a new control algorithm has been studied and analyzed for dynamic walking of robots based on sensory tools such as force / torque and inertial sensors [3,13]. Distributed control system architecture was integrated into the HFPC architecture so that it can be controlled with high efficiency and high performance.

## III. SIMULTANEOUS LOCALIZATION AND MAPING

A precise position error compensation and low-cost relative localization method is studied in [5] for structured environments using magnetic landmarks and hall sensors [6]. The proposed methodology can solve the problem of fine localization as well as global localization by tacking landmarks or by utilizing various patterns of magnetic landmark arrangement. The research in localization and

tracking methods using Wireless Sensor Networks (WSN) have been developed based on Radio Signal Strength Intensity (RSSI) [7] and ultrasound time of flight (TOF) [8]. Localization based on Radio Frequency Identification (RFID) systems have been used in fields such as logistics and transportation [9] but the constraints in terms of range between transmitter and reader limits its potential applications. Many efforts have been devoted to the development of cooperative perception strategies exploiting the complementarities among distributed static cameras at ground locations [10], among cameras mounted on mobile robotic platforms [11], and among static cameras and cameras onboard mobile robots [12]. Computation-based closed-loop controllers put most of the decision burden on the planning task. In hazardous and populated environments mobile robots utilize motion planning which relies on accurate, static models of the environments, and therefore they often fail their mission if humans or other unpredictable obstacles block their path. Autonomous mobile robots systems that can perceive their environments, react to unforeseen circumstances, and plan dynamically in order to achieve their mission have the objective of the motion planning and control problem [4, 9].

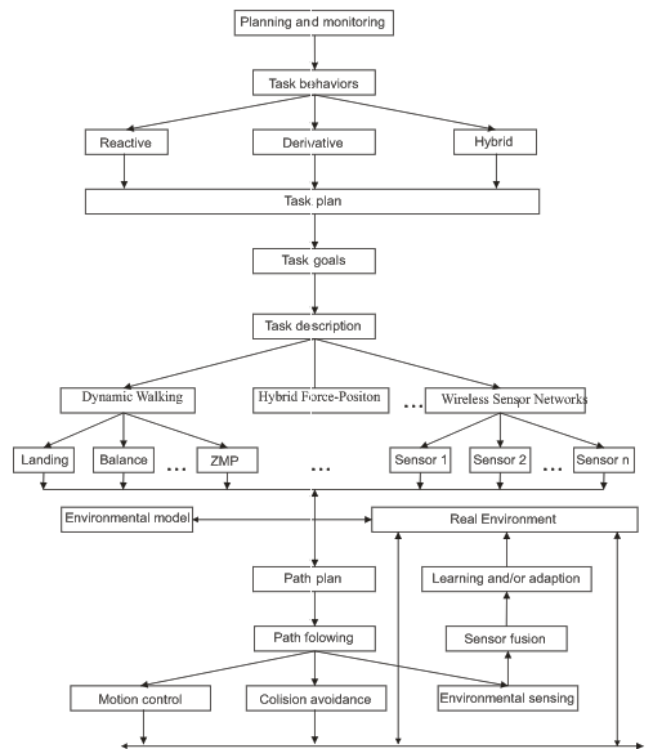

Figure 1 Mobile robot control system architecture

To find collision-free trajectories, in static or dynamic environments containing some obstacles, between a start and a goal configuration, the navigation of a mobile robot comprises localization, motion control, motion planning and collision avoidance. Its task is also the online real-time re-planning of trajectories in the case of obstacles blocking the pre-planned path or another unexpected event occurring. Inherent in any navigation scheme is the desire to reach a

destination without getting lost or crashing into anything. The responsibility for making this decision is shared by the process that creates the knowledge representation and the process that constructs a plan of action based on this knowledge representation. The choice of which representation is used and what knowledge is stored helps to decide the division of this responsibility. Very complex reasoning may be required to condense all of the available information into this single measure [4, 14]. The techniques include computation-based closed-loop control, cost-based search strategies, finite state machines, and rule-based systems [17].

Computation-based closed-loop controllers put most of the decision burden on the planning task. In hazardous and populated environments mobile robots utilize motion planning which relies on accurate, static models of the environments, and therefore they often fail their mission if humans or other unpredictable obstacles block their path. Autonomous mobile robots systems that can perceive their environments, react to unforeseen circumstances, and plan dynamically in order to achieve their mission have the objective of the motion planning and control problem. To find collision-free trajectories, in static or dynamic environments containing some obstacles, between a start and a goal configuration, the navigation of a mobile robot comprises localization, motion control, motion planning and collision avoidance [15, 16]. A higher-level process, a task planner, specifies the destination and any constraints on the course, such as time. Most mobile robot algorithms abort, when they encounter situations that make the navigation difficult. Set simply, the navigation problem is to find a path from start (S) to goal (G) and traverse it without collision. The relationship between the subtasks mapping and modeling of the environment; path planning and selection; path traversal and collision avoidance into which the navigation problem is decomposed, is shown in Figure 1.

Motion planning of mobile walking robots in uncertain dynamic environments based on the behavior dynamics of collision-avoidance is transformed into an optimization problem. Applying constraints based on control of the behavior dynamics, the decision-making space of this optimization.

#### IV. VIRTUAL PROJECTION METHOD

A virtual projection architecture system was designed which allows improvement and verification of the performance of dynamic force-position control of walking robots by integrating the multi-stage fuzzy method with acceleration solved in position-force control and dynamic control loops through the ZMP method for movement in non-structured environments and a bayesian approach of simultaneous localization and mapping (SLAM) for avoiding obstacles in non-stationary environments. By processing inertial information of force, torque, tilting and wireless sensor networks (WSN) an intelligent high level algorithm is implementing using the virtual projection method.

The virtual projection method, presented in Figure 2, patented by the research team, tests the performance of

dynamic position-force control by integrating dynamic control loops and a bayesian interface for the sensor network. The CMC classical mechatronic control directly actions the MS1, MSm servomotors, where m is the number of the robot's degrees of freedom. These signals are sent to a virtual control interface (VCI), which processes them and generates the necessary signals for graphical representation in 3D on a graphical terminal CGD. A number of n control interface functions ICF1-ICFn ensure the development of an open architecture control system by intergrating n control functions in addition to those supplied by the CMC mechatronic control system. With the help of these, new control methods can be implemented, such as: contour tracking functions, control schemes for tripod walking, centre of gravity control, orientation control through image processing and Bayesian interface for sensor networks. Priority control real time control and information exchange management between the n interfaces is ensured by the multifunctional control interface MCI, interconnected through a high speed data bus.

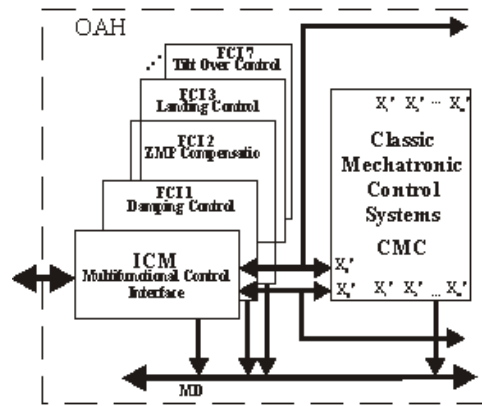

Fig. 2. The virtual projection method

#### Bayesian Interface for sensor networks.

To determine the priors for the model parameters and to calculate likelihood function (joint probability) we define a given random variable  $x$  whose probability distribution depends on a set of parameters  $P = (P_1, P_2, \dots, P_p)$ . Exact values of the parameters are not known with certainty, Bayesian reasoning assigns a probability distribution of the various possible values of these parameters that are considered as random variables. Bayes' theory is generally expressed through probabilistic statements as following:

$$P(A | B) = P(A) \times \frac{P(B | A)}{P(B)} \quad (1)$$

$P(A | B)$  is the probability of A given the event B occurs or the posteriori probability. Using Bayes' theory may be recurring, that if exist an a priori distribution  $P(A)$  and a series of tests with experimental results  $B_1, B_2, \dots, B_n, \dots$ , expressed according to successive equations:

$$P(A | B_1) = P(A) \frac{P(B_1 | A)}{P(B_1)} \quad (2)$$

$$P(A | B_1, B_2) = P(A) \frac{P(B_1 | A)}{P(B_1)} \frac{P(B_2 | A)}{P(B_2)}$$

$$P(A | B_1, B_2, \dots, B_n) = P(A | B_1, B_2, \dots, B_{n-1}) - \frac{P(B_n | A)}{P(B_n)}$$

A posteriori distribution called also belief, is used when the test results are known, being obtained as a new function a priori. The start of operations sequences in the Bayesian method regards the transformation  $\gamma$ . Recursive Bayesian updating is made under the Markov assumption:  $z_n$  is independent of  $z_1, \dots, z_{n-1}$  if we know  $x$ .

$$\begin{aligned} P(x | z_1, \dots, z_n) &= \frac{P(z_n | x) P(x | z_1, \dots, z_{n-1})}{P(z_n | z_1, \dots, z_{n-1})} \\ &= \eta P(z_n | x) P(x | z_1, \dots, z_{n-1}) \quad (3) \\ &= \eta_{1..n} \prod_{i=1..n} P(z_i | x) P(x) \end{aligned}$$

When there are no missing data or hidden variables the method for calculating  $P(B_{Si}, D)$  for some belief-network structure  $B_{Si}$  and database  $D$  is presented in [12]. Let  $Q$  be the set of all those belief-network structures that have a non-zero prior probability. We can derive the posterior probability of  $B_{Si}$  given  $D$  as:

$$P(B_{Si} | D) = P(B_{Si}, D) / \sum_{B_{Si} \in Q} P(B_{Si}, D) \quad (4)$$

The ratio of the posterior probabilities of two belief-network structures can be calculated as a ratio for belief-network structures  $B_{Si}$  and  $B_{Sj}$ , using the equivalence:

$$P(B_{Si} | D) / P(B_{Sj} | D) = P(B_{Si}, D) / P(B_{Sj}, D) \quad (5)$$

which we can derive that:

$$P(B_{Si}, D) = P(D | B_{Si}) P(B_{Si}) \quad (6)$$

Term  $P(B_{Si})$  represents prior probability that a process with belief-network structure  $B_{Si}$ . To designate the possible values of  $h$ , ca be used the Markov blanket method,  $MB(h)$  [12, 13]. Suppose that among the  $m$  cases in  $D$  there are  $u$  unique instantiations of the variables in  $MB(h)$ . Given these conditions it follows that:

$$P(D | B_S) = \sum_{G_1} \dots \sum_{G_u} f(G_1, \dots, G_u) \prod_{B_p} \int_{t=1}^m P(C_t h_t | B_S, B_p) f(B_S | B_p) dB_p \quad (7)$$

where  $G_i$  is a given group contains  $c_i$  case-specific hidden variables. Recall that  $u$  denotes only the number of unique instantiations *actually realized* in database  $D$  of the variables in the Markov blanket of hidden variable  $h$ . The number of such unique instantiations significantly influences the efficiency with which we can compute Equation 7.

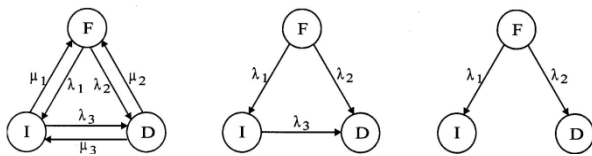

Fig.3 The model with three states for the robotic system

For any finite belief network, the number of such unique instantiations reaches a maximum regardless of how many cases there are in the database. That  $r$  denotes the maximum number of possible values for any variable in the database. If  $u$  and  $r$  are bounded from above, then the time to solve Equation 7 is bounded from above by a function that is polynomial in the number of variables  $n$  and the number of cases  $m$ . If  $u$  or  $r$  is large, however, the polynomial will be of high degree [12].

To model a robotic system requires considering in-between the two states of operating and faulting one or more intermediate states of partial success. In figure 3 is considered a robotic system characterized by three states: operating at full capacity (F), defect (D) and intermediate (I).

A generalized diagram of states is shown in figure 4, which included three intermediate states.

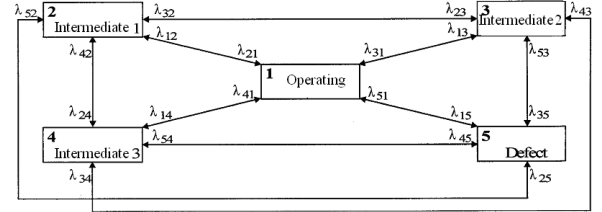

Fig. 4. Generalized diagram of states with three intermediate states

The Markov modeling technique requires to identify each intermediate state (in practice, more neighboring levels can be grouped together), to know the occupancy status of each component ( $T_i$ ) and the number of transitions between states ( $N_{ij}$ ), which can calculate as follows:

- occupancy probability of "i" state:  $P_i = \frac{T_i}{T_A}$

- transition intensity from state "i" in "j":  $\lambda_{ij} = \frac{N_{ij}}{T_i}$ ,

where:  $T_A = \sum_i T_i$  is analyzed time interval.

The number of intermediate states to be modeled in order to obtain a more accurate assessment of the reliability group is necessary to consider more than one intermediate state. Figure 5 presents a model with six states to assess the predictable transitions in a robotic system. The six states of the system are:

- 1 - operational state of robot;
- 2 - landing control
- 3 - balance control
- 4 - advance control
- 5 - wireless sensor networks (WSN) control
- 6 - unpredict event

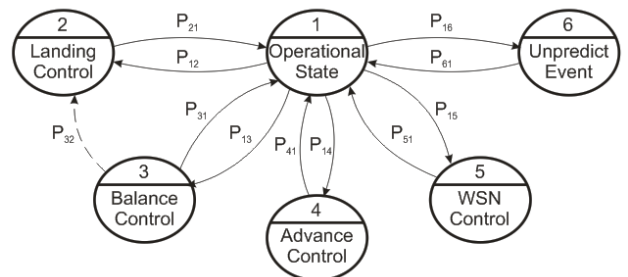

Fig.5. Modeling the states with possible transitions for robot

Based on the surveillance data in operation regime of robot were determined transition probabilities using of the relationship:  $\hat{p}_{ij} = \frac{n_{ij}}{n_i}$ , where  $n_{ij}$  is the transition from state

"i" in "j" in the analysis time interval;  $n_i$  is the number of all transitions from state "i" in any other states.

Values of these transition probabilities are:  $\hat{p}_{12} = 0,247$ ;  $\hat{p}_{13} = 0,32$ ;  $\hat{p}_{14} = 0,125$ ;  $\hat{p}_{15} = 0,205$ ;  $\hat{p}_{16} = 0,103$ ; By applying the method Markov chains are obtain the occupancy probability of the sates for the robot:  $P_1=0,31$ ;  $P_2=0,208$ ;  $P_3=0,115$ ;  $P_4=0,205$ ;  $P_5=0,102$ ;  $P_6=0,06$ .

The working diagram of the Petri network is presented in figure 6 (<http://www-dssz.informatik.tu-cottbus.de>). A token is assigned to  $P_3$ , and is assumed that the localizer initially knows its position. The Warning event  $t_5$  fires when the localizer fails in estimating robot's accurate position for several steps. Two navigation primitives can be modeled as  $P_1, P_2$ , respectively. Initially, the robot selects its motion by a random switch comprising the transitions  $t_1$  and  $t_2$  with corresponds to probabilities  $P_1'$  and  $P_2'$ , respectively. The transition between them takes place according to the change of localizer states. The immediate transition  $t_3$  means that the robot takes Contour tracking as soon as the localizer Warning event fires.

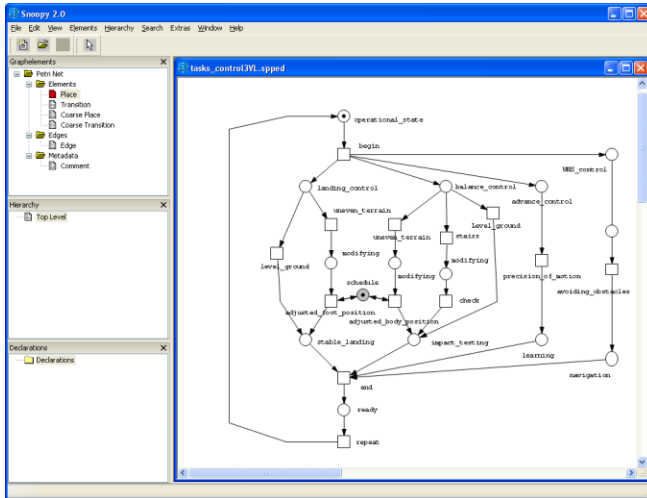

Fig.6. The Petri network diagram

The other transition between two primitives,  $t_2$  and  $t_4$ , are modeled as timed transitions in order to express that the robot can change its current navigation primitive during the localizer Success state, if necessary.

## V. RESULTS AND CONCLUSION

The control for walking robots is achieved by a control system with three levels. The first level is to produce control signals for motor drive mounted on leg joints, ensuring the robot moving in the direction required with a given speed. The language for this level is that of differential equations. The second level controls the walking, respectively it coordinates the movements, provides the data necessary to achieve progress. At this level, work is described in the language of algorithms types of walking. The third level of command defines the type of walking, speed and orientation.

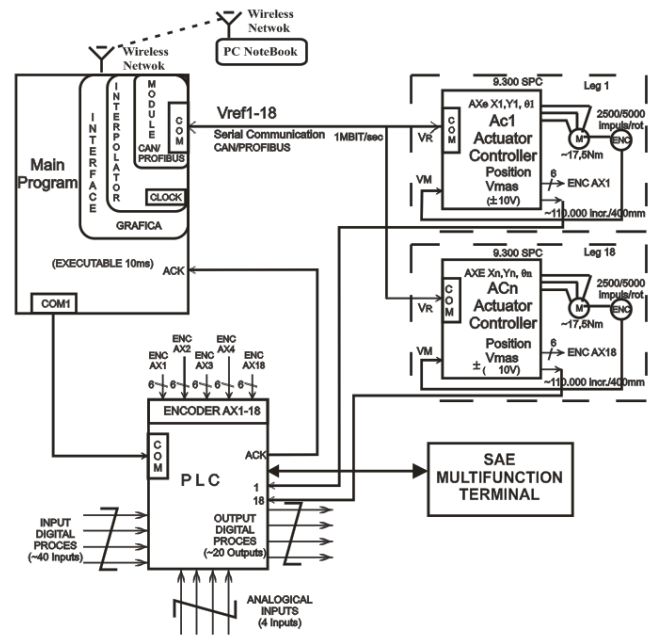

Fig.7. Open architecture system of the walking robot

At this level, the command may be provided by an operator who can use the control panel, in pursuit of its link with the robot, to specify the type of running and passing special orders (for the definition of the vector speed of movement).

To maintain the platform in a horizontal position, the information provided by the horizontality transducers (or verticality) is used, that sense walking robots deviation platform to the horizontal position. Restoring the horizontal position of the platform is achieved at the expense of vertical movement of different legs of support, as decided by the block to maintain balance. Returning to the fixed height of the platform is achieved by using information provided by the height transducer of the platform and by simultaneous control of vertical movement of all legs in support phase. From the analysis performed results the effectiveness of the proposed control strategy for a walking robot. The position of each actuator is controlled by a PD feedback loop, using encoder like transducers.

In HFPC control system, the PC system sends the reference positions to all actuators controllers simultaneously at an interval of 10 ms (100 Hz). Reference positions for the control of 18 actuators and actual positions on each axis robot obtained through interpolation are processed at an interval of 1 ms (1 kHz). Figure 1 shows the general configuration of the HFPC system for ZMP control method. The control system is distributive with multi-processor devices for joint control, data reception from transducers mounted on the robot, peripheral devices connected through a wireless LAN for off-line communications and CAN fast communication network for real time control. The HFPC system was designed in a distributed and decentralized structure to enable development of new applications easily and to add new modules for new hardware or software control functions. Moreover, the short time execution will ensure a faster feedback, allowing other programs to be performed in real



time as well, like the apprehension force control, objects recognition, making it possible that the control system have a human flexible and friendly interface.

#### ACKNOWLEDGMENT

This work was supported in part by the Romanian Academy and the Romanian Scientific Research National Authority under Grant 005/2007-2010 (sponsor and financial support acknowledgment goes here).

#### REFERENCES

- [1] Raibert M.H., Craig J.J. - *Hybrid Position / Force Control of Manipulators*, Trans. ASME, J. Dyn. Sys., Meas., Contr., 102, June 1981, pp. 126-133.
- [2] H. Zhang and R. P. Paul, *Hybrid Control of Robot Manipulators*, in *International Conference on Robotics and Automation*, IEEE Computer Society, March 1985. St. Louis, Missouri, pp.602-607.
- [3] Luige Vladareanu, Gabriela Tont, Hongnian Yu and Danut A. Bucur, *The Petri Nets and Markov Chains Approach for the Walking Robots Dynamical Stability Control*, *Proceedings of the 2011 International Conference on Advanced Mechatronic Systems*, IEEE Sponsor, Zhengzhou, China, August 11-13, 2011.
- [4] Vladareanu L., Ovidiu I. Sandru, Lucian M. Velea, Hongnian YU, *The Actuators Control in Continuous Flux using the Winer Filters*, *Proceedings of Romanian Academy, Series A: Mathematics, Physics, Technical Sciences, Informantion Science*, Volume: 10 Issue: 1 Pg.: 81-90, 2009.
- [5] Jung-Yup Kim, Ill-Woo Park, Jun-Ho Oh, *Walking Control Algorithm of Biped Humanoid Robot on Uneven and Inclined Floor*, *Springer Science, J. Intell Robot Syst* (2007) 48:457-484, DOI 10.1007/s10846-006-9107-8.
- [6] Luige Vladareanu, Gabriela Tont, Ion Ion, Victor Vladareanu, Daniel Mitroi, *Modeling and Hybrid Position-Force Control of Walking Modular Robots*, *ISI Proceedings, Recent Advances in Applied Mathematics*, Harvard University, Cambridge, USA, 2010, pg. 510-518, ISBN 978-960-474-150-2, ISSN 1790-2769.
- [7] Yoshikawa T., Zheng X.Z. - *Coordinated Dynamic Hybrid Position/Force Control for Multiple Robot Manipulators Handling One Constrained Object*, *The International Journal of Robotics Research*, Vol. 12, No. 3, June 1993, pp. 219-230.
- [8] Vladareanu, L., Tont, G., Ion, I., Munteanu, M. S., Mitroi, D., "Walking Robots Dynamic Control Systems on an Uneven Terrain", *Advances in Electrical and Computer Engineering*, ISSN 1582-7445, e-ISSN 1844-7600, vol. 10, no. 2, pp. 146-153, 2010, doi: 10.4316/AECE.2010.02026.
- [9] M.J. Stankovski, M.K. Vukobratovic, T.D. Kolemisevska-Gugulovska, A.T. Dinibutun, *Automation System Redesign Using Manipulator for Steel-pipe Production Line*, *Proceedings of the 10th Mediterranean Conference on Control and Automation - MED2002 Lisbon, Portugal*, July 9-12, 2002.
- [10] Gabriela Tont, Luige Vladareanu, Mihai Stelian Munteanu, Dan George Tont *Hierarchical Bayesian Reliability Analysis of Complex Dynamical Systems* *Proceedings of the International Conference on Applications of Electrical Engineering (AEE '10)*, pp 181-186, 6 pg., ISSN: 1790-2769, ISBN: 978-960-474-171-7, Malaysia, March 23-25, 2010.
- [11] Abolfazl Jalilvand, Sohrab Khanmohammadi, Fereidoon Shabaninia *Hybrid Modeling and Simulation of a Robotic Manufacturing System Using Timed Petri Nets*, *WSEAS Transactions on Systems*, Issue 5, Volume 4, May 2005.
- [12] C.G. Looney, *Fuzzy Petri nets and applications*, *Fuzzy Reasoning in Information, Decision and Control Systems*, Kluwer Academic Publisher, pp. 511-527, 1994
- [13] Vladareanu Luige, Lucian M. Velea, Radu Ioan Munteanu, Adrian Curaj, Sergiu Cononovici, Tudor Sireteanu, Lucian Capitanu, Mihai Stelian Munteanu, *Real time control method and device for robot in virtual projection*, patent no. EPO-09464001, 18.05.2009.

- [14] Khalil Shihab, *Simulating ATM Switches Using Petri Nets*, pp.1495-1502, *WSEAS Transactions on Computers*, Issue 11, Volume 4, 2005.
- [15] Luige Vladareanu, Ion Ion, Marius Velea, Daniel Mitroi, *The Robot Hybrid Position and Force Control in Multi-Microprocessor Systems*, *WSEAS Transation on Systems*, Issue 1, Vol.8, 2009, pg.148-157, ISSN 1109-2777.
- [16] J. Rummel, A. Seyfarth, *Stable Running with Segmented Legs*, *The International Journal of Robotics Research* 2008; 27; 919, DOI: 10.1177/027836490895136.
- [17] Luige Vladareanu, Gabriela Tont, Radu A. Munteanu, et.all., *Modular Structures in the Distributed and Decentralized Architecture*, *Proceedings of the International Conference On Parallel And Distributed Processing Techniques And Applications*, ISBN: 1-60132-121-X, 1-60132-122-8 (1-60132-123-6) Nevada, USA, Published by CSREA Press, pp. 42-47, 6 pg., Las Vegas, Nevada, SUA, July 13-16, 2009

# Neutrosophic Masses & Indeterminate Models.

## Applications to Information Fusion

Florentin Smarandache  
Mathematics Department  
The University of New Mexico  
705 Gurley Ave., Gallup, NM 87301, USA  
E-mail: smarand@unm.edu

**Abstract**—In this paper we introduce the *indeterminate models in information fusion*, which are due either to the existence of some *indeterminate elements in the fusion space* or to some *indeterminate masses*. The best approach for dealing with such models is the *neutrosophic logic*.

**Keywords:** *neutrosophic logic; indeterminacy; indeterminate model; indeterminate element; indeterminate mass; indeterminate fusion rules; DSmT; DST; TBM;*

### I. INTRODUCTION

In this paper we introduce for the first time the notions of indeterminate mass (bba), indeterminate element, indeterminate intersection, and so on. We give an example of neutrosophic dynamic fusion using two classical masses, defined on a determinate frame of discernment, but having indeterminate intersections in the super-power set  $S^\Theta$  (the fusion space). We also adjust several classical fusion rules (*PCR5* and *DSmH*) to work for indeterminate intersections instead of empty intersections.

References [3]-[13] show a wide variety of applications of the neutrosophic logic and set, based on indeterminacy, in information technology.

Let  $\Theta$  be a frame of discernment, defined as:

$$\Theta = \{\phi_1, \phi_2, \dots, \phi_n\}, n \geq 2, \quad (1)$$

and its Super-Power Set (or fusion space):

$$S^\Theta = (\Theta, \cup, \cap, \bar{\cdot}) \quad (2)$$

which means the set  $\Theta$  closed under union, intersection, and respectively complement.

This paper is organized as follows: we present the neutrosophic logic, the indeterminate masses, elements and models, and give an example of indeterminate intersection.

### II. INDETERMINATE MASS

#### A. Neutrosophic Logic

Neutrosophic Logic (NL) [1] started in 1995 as a generalization of the fuzzy logic, especially of the intuitionistic fuzzy logic. A logical proposition  $P$  is characterized by three neutrosophic components:

$$NL(P) = (T, I, F) \quad (3)$$

where  $T$  is the degree of truth,  $F$  the degree of falsehood, and  $I$  the degree of indeterminacy (or neutral, where the name “neutro-sophic” comes from, i.e. neither truth nor falsehood but in between – or included-middle principle), and with:

$$T, I, F \subseteq ]0, I^+[ \quad (4)$$

where  $]0, I^+[$  is a non-standard interval.

In this paper, for technical proposal, we can reduce this interval to the standard interval  $[0, I]$ .

The main distinction between neutrosophic logic and intuitionistic fuzzy logic (IFL) is that in NL the sum  $T+I+F$  of the components, when  $T, I,$  and  $F$  are crisp numbers, does not need to necessarily be  $I$  as in IFL, but it can also be less than  $I$  (for incomplete/missing information), equal to  $I$  (for complete information), or greater than  $I$  (for paraconsistent/contradictory information).

The combination of neutrosophic propositions is done using the neutrosophic operators (especially  $\wedge, \vee$ ).

#### B. Neutrosophic Mass

We recall that a classical mass  $m(\cdot)$  is defined as:

$$m : S^\Theta \rightarrow [0, 1] \quad (5)$$

such that

$$\sum_{X \in S^\Theta} m(X) = 1 \quad (6)$$

### III. INDETERMINATE ELEMENT

We extend this classical basic belief assignment (mass)  $m(\cdot)$  to a neutrosophic basic belief assignment (nbba) (or neutrosophic mass)  $m_n(\cdot)$  in the following way.

$$m_n : S^\ominus \rightarrow [0,1]^3 \quad (7)$$

with

$$m_n(A) = (T(A), I(A), F(A)) \quad (8)$$

where  $T(A)$  means the (local) chance that hypothesis  $A$  occurs,  $F(A)$  means the (local) chance that hypothesis  $A$  does not occur (nonchance), while  $I(A)$  means the (local) indeterminate chance of  $A$  (i.e. knowing neither if  $A$  occurs nor if  $A$  doesn't occur),

such that:

$$\sum_{X \in S^\ominus} [T(X) + I(X) + F(X)] = 1. \quad (9)$$

In a more general way, the summation (9) can be less than 1 (for incomplete neutrosophic information), equal to 1 (for complete neutrosophic information), or greater than 1 (for paraconsistent/conflicting neutrosophic information). But in this paper we only present the case when summation (9) is equal to 1.

Of course,

$$0 \leq T(A), I(A), F(A) \leq 1. \quad (10)$$

A *basic belief assignment* (or *mass*) is considered *indeterminate* if there exist at least an element  $A \in S^\ominus$  such that  $I(A) > 0$ , i.e. there exists some indeterminacy in the chance of at least an element  $A$  for occurring or for not occurring. Therefore, a neutrosophic mass which has at least one element  $A$  with  $I(A) > 0$  is an indeterminate mass.

A classical mass  $m(\cdot)$  as defined in equations (5) and (6) can be extended under the form of a neutrosophic mass  $m_n'(\cdot)$  in the following way:

$$m_n' : S^\ominus \rightarrow [0,1]^3 \quad (11)$$

with

$$m_n'(A) = (m(A), 0, 0) \quad (12)$$

but reciprocally it does not work since  $I(A)$  has no correspondence in the definition of the classical mass.

We just have  $T(A) = m(A)$  and  $F(A) = m(C(A))$ , where  $C(A)$  is the complement of  $A$ . The non-null  $I(A)$  can, for example, be roughly approximated by the total ignorance mass  $m(\Theta)$ , or better by the partial ignorance mass  $m(\Theta_I)$  where  $\Theta_I$  is the union of all singletons that have some non-zero indeterminacy, but these mean less accuracy and less refinement in the fusion.

If  $I(X) = 0$  for all  $X \in S^\ominus$ , then the neutrosophic mass is simply reduced to a classical mass.

We have two types of elements in the fusion space  $S^\ominus$ , *determinate elements* (which are well-defined), and *indeterminate elements* (which are not well-defined; for example: a geographical area whose frontiers are vague; or let's say in a murder case there are two suspects, *John* – who is known/determinate element – but he acted together with another man  $X$  (since the information source saw *John* together with an unknown/unidentified person) – therefore  $X$  is an indeterminate element).

Herein we gave examples of singletons as indeterminate elements just in the frame of discernment  $\Theta$ , but indeterminate elements can also result from the combinations (unions, intersections, and/or complements) of determinate elements that form the super-power set  $S^\ominus$ . For example,  $A$  and  $B$  can be determinate singletons (we call the elements in  $\Theta$  as singletons), but their intersection  $A \cap B$  can be an indeterminate (unknown) element, in the sense that we might not know if  $A \cap B = \emptyset$  or  $A \cap B \neq \emptyset$ .

Or  $A$  can be a determinate element, but its complement  $C(A)$  can be indeterminate element (not well-known), and similarly for determinate elements  $A$  and  $B$ , but their  $A \cup B$  might be indeterminate.

Indeterminate elements in  $S^\ominus$  can, of course, result from the combination of indeterminate singletons too. All depends on the problem that is studied.

A frame of discernment which has at least an indeterminate element is called *indeterminate frame of discernment*. Otherwise, it is called *determinate frame of discernment*. Similarly we call an *indeterminate fusion space* ( $S^\ominus$ ) that fusion space which has at least one indeterminate element. Of course an indeterminate frame of discernment spans an indeterminate fusion space.

An *indeterminate source of information* is a source which provides an indeterminate mass or an indeterminate fusion space. Otherwise it is called a *determinate source of information*.

### IV. INDETERMINATE MODEL

An *indeterminate model* is a model whose fusion space is indeterminate, or a mass that characterizes it is indeterminate.

Such case has not been studied in the information fusion literature so far. In the next sections we'll present some examples of indeterminate models.

### V. CLASSIFICATION OF MODELS

In the classical fusion theories all elements are considered determinate in the Closed World, except in Smets' Open World where there is some room (i.e. mass assigned to the empty set) for a possible unknown missing singleton in the frame of discernment. So, the Open World has a probable indeterminate element, and thus its frame of discernment is indeterminate. While the Closed World frame of discernment is determinate.

In the Closed World in Dezert-Smarandache Theory there are three models classified upon the types of singleton intersections: Shafer's Model (where all intersections are empty), Hybrid Model (where some intersections are empty, while others are non-empty), and Free Model (where all intersections are non-empty).

We now introduce a fourth category, called *Indeterminate Model* (where at least one intersection is indeterminate/unknown, and in general at least one element of the fusion space is indeterminate). We do this because in practical problems we don't always know if an intersection is empty or nonempty. As we still have to solve the problem in the real time, we have to work with what we have, i.e. with indeterminate models.

The *indeterminate intersection* cannot be refined (because not knowing if  $A \cap B$  is empty or nonempty, we'd get two different refinements:  $\{A, B\}$  when intersection is empty, and  $\{A \setminus B, B \setminus A, A \cap B\}$  when intersection is nonempty).

The *percentage of indeterminacy* of a model depends on the number of indeterminate elements and indeterminate masses.

By default: the sources, the masses, the elements, the frames of discernment, the fusion spaces, and the models are supposed determinate.

#### VI. AN EXAMPLE OF INFORMATION FUSION WITH AN INDETERMINATE MODEL

We present the below example.

Suppose we have two sources,  $m_1(.)$  and  $m_2(.)$ , such that:

	A	B	C	$A \cup B \cup C$	$A \cap B$ = <i>Ind.</i>	$A \cap C$ = $\phi$	$B \cap C$ = <i>Ind.</i>
$m_1$	0.4	0.2	0.3	0.1			
$m_2$	0.1	0.3	0.2	0.4			
$m_{12}$	.21	.17	.20	.04	.14	.11	.13

Table 1

Applying the conjunction rule to  $m_1$  and  $m_2$  we get  $m_{12}(.)$  as shown in Table 1.

The frame of discernment is  $\Theta = \{A, B, C\}$ . We know that  $A \cap C$  is empty, but we don't know the other two intersections: we note them as  $A \cap B = ind.$  and  $B \cap C = ind.$ , where *ind.* means indeterminate.

Using the Conjunctive Rule to fusion  $m_1$  and  $m_2$ , we get  $m_{12}(.)$ :

$$\forall A \in S^\Theta \setminus \phi, m_{12}(A) = \sum_{\substack{X, Y \in S^\Theta \\ A = X \cap Y}} m_1(X) m_2(Y). \quad (13)$$

Whence:  $m_{12}(A)=0.21$ ,  $m_{12}(B)=0.17$ ,  $m_{12}(C)=0.20$ ,  $m_{12}(A \cup B \cup C)=0.04$ , and for the intersections:

$$m_{12}(A \cap B)=0.14, m_{12}(A \cap C)=0.11, m_{12}(B \cap C)=0.13.$$

We then use the *PCR5* fusion rule style to redistribute the masses of these three intersections. We recall *PCR5* for two sources:

$$(14)$$

$$\forall A \in S^\Theta \setminus \phi,$$

$$m_{12_{PCR5}}(A) = m_{12}(A) + \sum_{\substack{X \in S^\Theta \setminus \{\phi\} \\ X \cap A = \phi}} \left[ \frac{m_1(A)^2 m_2(X)}{m_1(A) + m_2(X)} + \frac{m_2(A)^2 m_1(X)}{m_2(A) + m_1(X)} \right]$$

a)  $m_{12}(A \cap C)=0.11$  is redistributed back to  $A$  and  $C$  because  $A \cap C = \phi$ , according to the *PCR5* style.

Let  $\alpha 1$  and  $\alpha 2$  be the parts of mass  $0.11$  redistributed back to  $A$ , and  $\gamma 1$  and  $\gamma 2$  be the parts of mass  $0.11$  redistributed back to  $C$ .

We have the following proportionalizations:

$$\frac{\alpha 1}{0.4} = \frac{\gamma 1}{0.2} = \frac{0.4 \cdot 0.2}{0.4 + 0.2} = 0.133333,$$

$$\text{whence } \alpha 1 = 0.4(0.133333) \approx 0.053333$$

$$\text{and } \gamma 1 = 0.2(0.133333) \approx 0.026667.$$

Similarly:

$$\frac{\alpha 2}{0.1} = \frac{\gamma 2}{0.3} = \frac{0.1 \cdot 0.3}{0.1 + 0.3} = 0.075,$$

$$\text{whence } \alpha 2 = 0.1(0.075) = 0.0075$$

$$\text{and } \gamma 2 = 0.3(0.075) = 0.0225.$$

Therefore the mass of  $A$ , which can also be noted as  $T(A)$  in a neutrosophic mass form, receives from  $0.11$  back:

$$\alpha 1 + \alpha 2 = 0.053333 + 0.0075 = 0.060833,$$

while the mass of  $C$ , or  $T(C)$  in a neutrosophic form, receives from  $0.11$  back:

$$\gamma 1 + \gamma 2 = 0.026667 + 0.0225 = 0.049167.$$

We verify our calculations:  $0.060833 + 0.049167 = 0.11$ .

b)  $m_{12}(A \cap B)=0.14$  is redistributed back to the indeterminate parts of the masses of  $A$  and  $B$  respectively, namely  $I(A)$  and  $I(B)$  as noted in the neutrosophic mass form, because  $A \cap B = ind.$  We follow the same *PCR5* style as done in classical *PCR5* for empty intersections (as above).

Let  $\alpha 3$  and  $\alpha 4$  be the parts of mass  $0.14$  redistributed back to  $I(A)$ , and  $\beta 1$  and  $\beta 2$  be the parts of mass  $0.14$  redistributed back to  $I(B)$ .

We have the following proportionalizations:

$$\frac{\alpha 3}{0.4} = \frac{\beta 1}{0.3} = \frac{0.4 \cdot 0.3}{0.4 + 0.3} = 0.171429,$$

$$\text{whence } \alpha 3 = 0.4(0.171429) \approx 0.068572$$

$$\text{and } \beta 1 = 0.3(0.171429) \approx 0.051428.$$

Similarly:

$$\frac{\alpha 4}{0.1} = \frac{\beta 2}{0.2} = \frac{0.1 \cdot 0.2}{0.1 + 0.2} = 0.066667$$

$$\text{whence } \alpha 4 = 0.1(0.066667) \approx 0.006667$$

$$\text{and } \beta 2 = 0.2(0.066667) \approx 0.013333.$$

Therefore, the indeterminate mass of  $A$ ,  $I(A)$  receives from  $0.14$  back:

$$\alpha 3 + \alpha 4 = 0.068572 + 0.006667 = 0.075239$$



and the indeterminate mass of  $B$ ,  $I(B)$ , receives from 0.14 back:

$$\beta_1 + \beta_2 = 0.051428 + 0.013333 = 0.064761.$$

c) Analogously,  $m_{12}(B \cap C) = 0.13$  is redistributed back to the indeterminate parts of the masses of  $B$  and  $C$  respectively, namely  $I(B)$  and  $I(C)$  as noted in the neutrosophic mass form, because  $B \cap C = Ind.$  also following the PCR5 style. Whence  $I(B)$  gets back 0.065 and  $I(C)$  also gets back 0.065.

Finally we sum all results obtained from firstly using the Conjunctive Rule [Table 1] and secondly redistributing the intersections masses with PCR5 [sections a), b), and c) from above]:

	T(A)	T(B)	T(C)	$T(\Theta)$	I(A)	I(B)	I(C)
$m_{12}$	.21	.17	.20	.04			
additions	.0075 .053 333		.022 5 .026 667		.068 572 .006 667	.051 428 .013 333 .02 .045	.04 .045
$m_{12PCR5}$	.270 833	.17	.249 167	.04	.075 239	.129 761	.065

Table 2

where  $\Theta = A \cup B \cup C$  is the total ignorance.

## VII. BELIEF, DISBELIEF, AND UNCERTAINTY

In classical fusion theory there exist the following functions:

**Belief in  $A$**  with respect to the bba  $m(\cdot)$  is:

$$Bel(A) = \sum_{\substack{X \in S^\Theta \setminus \{\emptyset\} \\ X \subseteq A}} m(X) \quad (15)$$

**Disbelief in  $A$**  with respect to the bba  $m(\cdot)$  is:

$$Dis(A) = \sum_{\substack{X \in S^\Theta \setminus \{\emptyset\} \\ X \cap A = \emptyset}} m(X) \quad (16)$$

**Uncertainty in  $A$**  with respect to the bba  $m(\cdot)$  is:

$$U(A) = \sum_{\substack{X \in S^\Theta \setminus \{\emptyset\} \\ X \cap A \neq \emptyset \\ X \cap C(A) \neq \emptyset}} m(X), \quad (17)$$

where  $C(A)$  is the complement of  $A$  with respect to the total ignorance  $\Theta$ .

**Plausability of  $A$**  with respect to the bba  $m(\cdot)$  is:

$$Pl(A) = \sum_{\substack{X \in S^\Theta \setminus \{\emptyset\} \\ X \cap A \neq \emptyset}} m(X) \quad (18)$$

## VIII. NEUTROSOPHIC BELIEF, NEUTROSOPHIC DISBELIEF, AND NEUTROSOPHIC UNDECIDABILITY

Let's consider a neutrosophic mass  $m_n(\cdot)$  as defined in formulas (7) and (8),  $m_n(X) = (T(X), I(X), F(X))$  for all  $X \in S^\Theta$ .

We extend formulas (15)-(18) from  $m(\cdot)$  to  $m_n(\cdot)$ :

**Neutrosophic Belief in  $A$**  with respect to the nbba  $m_n(\cdot)$  is:

$$NeutBel(A) = \sum_{\substack{X \in S^\Theta \setminus \{\emptyset\} \\ X \subseteq A}} T(X) + \sum_{\substack{X \in S^\Theta \setminus \{\emptyset\} \\ X \cap A = \emptyset}} F(X) \quad (19)$$

**Neutrosophic Disbelief in  $A$**  with respect to the nbba  $m_n(\cdot)$  is:

$$NeutDis(A) = \sum_{\substack{X \in S^\Theta \setminus \{\emptyset\} \\ X \cap A = \emptyset}} T(X) + \sum_{\substack{X \in S^\Theta \setminus \{\emptyset\} \\ X \subseteq A}} F(X) \quad (20)$$

**Neutrosophic Uncertainty in  $A$**  with respect to the nbba  $m_n(\cdot)$  is

$$\begin{aligned} NeutU(A) &= \sum_{\substack{X \in S^\Theta \setminus \{\emptyset\} \\ X \cap A \neq \emptyset \\ X \cap C(A) \neq \emptyset}} T(X) + \sum_{\substack{X \in S^\Theta \setminus \{\emptyset\} \\ X \cap A \neq \emptyset \\ X \cap C(A) \neq \emptyset}} F(X) \\ &= \sum_{\substack{X \in S^\Theta \setminus \{\emptyset\} \\ X \cap A \neq \emptyset \\ X \cap C(A) \neq \emptyset}} [T(X) + F(X)] \end{aligned} \quad (21)$$

We now introduce the **Neutrosophic Global Indeterminacy in  $A$**  with respect to the nbba  $m_n(\cdot)$  as a sum of local indeterminacies of the elements included in  $A$ :

$$NeutGlobInd(A) = \sum_{\substack{X \in S^\Theta \setminus \{\emptyset\} \\ X \subseteq A}} I(X) \quad (22)$$

And afterwards we define another function called **Neutrosophic Undecidability about  $A$**  with respect to the nbba  $m_n(\cdot)$ :

$$NeutUnd(A) = NeutU(A) + NeutGlobInd(A) \quad (23)$$

or

$$NeutUnd(A) = \sum_{\substack{X \in S^\Theta \setminus \{\emptyset\} \\ X \cap A \neq \emptyset \\ X \cap C(A) \neq \emptyset}} [T(X) + F(X)] + \sum_{\substack{X \in S^\Theta \setminus \{\emptyset\} \\ X \subseteq A}} I(X) \quad (24)$$

**Neutrosophic Plausability of  $A$**  with respect to the nbba  $m_n(\cdot)$  is:

$$NeutPl(A) = \sum_{\substack{X \in S^\Theta \setminus \{\emptyset\} \\ X \cap A \neq \emptyset}} T(X) + \sum_{\substack{Y \in S^\Theta \setminus \{\emptyset\} \\ C(Y) \cap A \neq \emptyset}} F(Y) \quad (25)$$

In the previous example let's compute  $NeutBel(\cdot)$ ,  $NeutDis(\cdot)$ , and  $NeutUnd(\cdot)$ :

	A	B	C	$A \cup B \cup C$
NeutBel	0.270833	0.17	0.249167	0.73
NeutDis	0.419167	0.52	0.440833	0
NeutGlobInd	0.115239	0.169761	0.105	0
Total	0.805239	0.859761	0.795	0.73
	$\neq$	$\neq$	$\neq$	$\neq$
	1	1	1	1

Table 3

As we see, for indeterminate model we cannot use the intuitionistic fuzzy set or intuitionistic fuzzy logic since the sum  $NeutBel(X)+NeutDis(X)+NeutGlobInd(X)$  is less than 1. In this case we use the neutrosophic set or logic which can deal with incomplete information.

The sum is less than 1 because there is missing information (we don't know if some intersections are empty or not).

For example:

$$NeutBel(A)+NeutDis(A)+NeutGlobInd(A)=0.805239 = 1-I(B)-I(C).$$

Similarly,

$$NeutBel(B)+NeutDis(B)+NeutGlobInd(B)=0.859761 = 1-I(A)-I(C).$$

$$NeutBel(C)+NeutDis(C)+NeutGlobInd(C)=0.795 = 1-I(A)-I(B)$$

and

$$NeutBel(A \cup B \cup C)+NeutDis(A \cup B \cup C) + NeutGlobInd(A \cup B \cup C)=0.73=1-I(A)-I(B)-I(C).$$

#### IX. NEUTROSOPHIC DYNAMIC FUSION

A Neutrosophic Dynamic Fusion is a dynamic fusion where some indeterminacy occurs: with respect to the mass or with respect to some elements.

The solution of the above indeterminate model which has missing information, using the neutrosophic set, is consistent in the classical dynamic fusion in the case we receive part (or total) of the missing information.

In the above example, let's say we find out later in the fusion process that  $A \cap B = \emptyset$ . That means that the mass of indeterminacy of A,  $I(A)=0.075239$ , is transferred to A, and the masses of indeterminacy of B (resulted from  $A \cap B$  only) - i.e.  $0.051428$  and  $0.133333$  - are transferred to B. We get:

	A	B	C	$\ominus$	I(A)	I(B)	I(C)	$A \oplus B$	$A \oplus C$
m	.270 833	.17 428	.249 167	.04	0	.065	.065	0	0
+	.075 239	.051 428 .013 333							
$m_N$	.346 072	.234 761	.249 167	.04	0	.065	.065	0	0

Table 4

where  $\ominus = A \cup B \cup C$  is the total ignorance.

The sum  $NeutBel(X)+NeutDis(X)+NeutBlogInd(X)$  increases towards 1, as indeterminacy  $I(X)$  decreases towards 0, and reciprocally.

When we have complete information we get  $NeutBel(X)+NeutDis(X)+NeutGlobInd(X)=1$  and in this case we have an intuitionistic fuzzy set, which is a particular case of the neutrosophic set.

Let's suppose once more, considering the neutrosophic dynamic fusion, that afterwards we find out that  $B \cap C \neq \emptyset$ . Then, from Table 4 the masses of indeterminacies of B,  $I(B)$  ( $0.065 = 0.02 + 0.045$ , resulted from  $B \cap C$  which was considered indeterminate at the beginning of the neutrosophic dynamic fusion), and that of C,  $I(C)=0.065$ , go now to  $B \cap C$ . Thus, we get:

	A	B	C	$\ominus$	I(A)	I(B)	I(C)	$A \oplus B$	$A \oplus C$	$B \oplus C$
$m_N$	.346 072	.234 761	.249 167	.04	0	.065	.065	0	0	0
-/+						-.0 65	-.0 65			+.0 65 +.0 65
$m_{NN}$	.346 072	.234 761	.249 167	.04	0	0	0	0	0	.13

Table 5

#### X. MORE REDISTRIBUTION VERSIONS FOR INDETERMINATE INTERSECTIONS OF DETERMINATE ELEMENTS

Besides PCR5, it is also possible to employ other fusion rules for the redistribution, such as follows:

- For the masses of the empty intersections we can use PCR1-PCR4, URR, PURR, Dempster's Rule, etc. (in general any fusion rule that first uses the conjunctive rule, and then a redistribution of the masses of empty intersections).
- For the masses of the indeterminate intersections we can use DSm Hybrid (DSmH) rule to transfer the mass  $m_{12}(X \cap Y = ind.)$  to  $X \cup Y$ , since  $X \cup Y$  is a kind of uncertainty related to X, Y. In our opinion, a better approach in this case would be to redistributing the empty intersection masses using the PCR5 and the indeterminate intersection masses using the DSmH, so we can combine two fusion rules into one:

Let  $m_1(.)$  and  $m_2(.)$  be two masses. Then:

$$\begin{aligned}
m_{12PCR5 / DSmH}(A) &= \sum_{\substack{X, Y \in S^\Theta \setminus \{\emptyset\} \\ X \cap Y = A}} m_1(X)m_2(Y) \\
&+ \sum_{\substack{X \in S^\Theta \setminus \{\emptyset\} \\ X \cap A = \emptyset}} \left[ \frac{m_1(A)^2 m_2(X)}{m_1(A) + m_2(X)} + \frac{m_2(A)^2 m_1(X)}{m_2(A) + m_1(X)} \right] \\
&+ \sum_{\substack{X, Y \in S^\Theta \setminus \{\emptyset\} \\ X \cap Y = ind. \\ X \cup Y = A}} m_1(X)m_2(Y) \\
&= \sum_{\substack{X, Y \in S^\Theta \setminus \{\emptyset\} \\ \{X \cap Y = A\} \vee \{(X \cap Y = ind.) \wedge (X \cup Y = A)\}}} m_1(X)m_2(Y) \\
&+ \sum_{\substack{X \in S^\Theta \setminus \{\emptyset\} \\ X \cap A = \emptyset}} \left[ \frac{m_1(A)^2 m_2(X)}{m_1(A) + m_2(X)} + \frac{m_2(A)^2 m_1(X)}{m_2(A) + m_1(X)} \right]
\end{aligned} \tag{26}$$

Yet, the best approach, for an indeterminate intersection resulted from the combination of two classical masses  $m_1(.)$  and  $m_2(.)$  defined on a determinate frame of discernment, is the first one:

- Use the *PCR5* to combine the two sources: formula (14).
- Use the *PCR5-ind* [adjusted from classical *PCR5* formula (14)] in order to compute the indeterminacies of each element involved in indeterminate intersections :

$$\forall A \in S^\Theta \setminus \emptyset,$$

$$m_{12PCR5ind}(I(A)) = \sum_{\substack{X \in S^\Theta \setminus \{\emptyset\} \\ X \cap A = ind.}} \left[ \frac{m_1(A)^2 m_2(X)}{m_1(A) + m_2(X)} + \frac{m_2(A)^2 m_1(X)}{m_2(A) + m_1(X)} \right] \tag{27}$$

- Compute *NeutBel(.)*, *NeutDis(.)*, *NeutGlobInd(.)* of each element.

#### CONCLUSION

In this paper we introduced for the first time the notions of indeterminate mass (bba), indeterminate element, indeterminate intersection, and so on. We gave an example of neutrosophic dynamic fusion using two classical masses, defined on a determinate frame of discernment, but having indeterminate intersections in the super-power set  $S^\Theta$  (the fusion space). We adjusted several classical fusion rules (*PCR5* and *DSmH*) to work for indeterminate intersections instead of empty intersections.

Then we extended the classical *Bel(.)*, *Dis(.)* {also called *Dou(.)*, i.e Dough} and the uncertainty *U(.)* functions to their respectively neutrosophic correspondent functions that use the neutrosophic masses, i.e. to the *NeutBel(.)*, *NeutDis(.)*, *NeutU(.)* and to the undecidability function *NeutUnd(.)*. We have also introduced the Neutrosophic Global Indeterminacy function, *NeutGlobInd(.)*, which together with *NeutU(.)* form the *NeutUnd(.)* function.

In our first example the mass of  $A \cap B$  is determined (it is equal to 0.14), but the element  $A \cap B$  is indeterminate (we don't know if it empty or not).

But there are cases when the element is determinate (let's say a suspect John), but its mass could be indeterminate as given by a source of information {for example  $m_n(John) = (0.4, 0.1, 0.2)$ , i.e. there is some mass indeterminacy:  $I(John) = 0.2 > 0$ }.

These are the distinctions between the indeterminacy of an element, and the indeterminacy of a mass.

#### ACKNOWLEDGMENT

The author would like to thank Dr. Jean Dezert for his comments related to the indeterminate models from our Fall 2011 email correspondence.

#### REFERENCES

- [1] F. Smarandache, *A Unifying Field in Logics: Neutrosophic Logic, Multiple Valued Logic / An International Journal*, Vol. 8, No. 3, 2002, pp. 385-438.
- [2] F. Smarandache, J. Dezert (editors), *Advances and Applications of DSmT for Information Fusion*, Am. Res. Press, Rehoboth, 2004-2009, <http://fs.gallup.unm.edu/DsmT.htm>.
- [3] F. G. Lupiáñez: *Interval neutrosophic sets and Topology*, *Kybernetes* **38** (2009), 621-624.
- [4] Andrew Schumann, *Neutrosophic logics on Non-Archimedean Structures*, Critical Review, Creighton University, USA, Vol. III, 36-58, 2009.
- [5] Fu Yuhua, Fu Anjie, Zhao Ge., *Positive, Negative and Neutral Law of Universal Gravitation*, *New Science and Technology*, 2009 (12), 30-32.
- [6] Monoranjan Bhowmik and Madhumangal Pal, *Intuitionistic Neutrosophic Set*, *Journal of Information and Computing Science*, England, Vol. 4, No. 2, 2009, pp. 142-152.
- [7] Wen Ju and H. D. Cheng, *Discrimination of Outer Membrane Proteins using Reformulated Support Vector Machine based on Neutrosophic Set*, *Proceedings of the 11th Joint Conference on Information Sciences* (2008), Published by Atlantis Press.
- [8] Goutam Bernajee, *Adaptive fuzzy cognitive maps vs neutrosophic cognitive maps: decision support tool for knowledge based institution*, *Journal of Scientific and Industrial Research*, 665-673, Vol. 67, 2008.
- [9] Smita Rajpal, M.N. Doja, Ranjit Biswas, *A Method of Imprecise Query Solving*, *International Journal of Computer Science and Network Security*, Vol. 8 No. 6, pp. 133-139, June 2008, [http://paper.ijcsns.org/07\\_book/200806/20080618.pdf](http://paper.ijcsns.org/07_book/200806/20080618.pdf)
- [10] Jose L. Salmeron, F. Smarandache, *Redesigning Decision Matrix Method with an indeterminacy-based inference process*, *Advances in Fuzzy Sets and Systems*, Vol. 1(2), 263-271, 2006.
- [11] P. Kraipeerapun, C. C. Fung, W. Brown and K. W. Wong, *Neural network ensembles using interval neutrosophic sets and bagging for mineral prospectivity prediction and quantification of uncertainty*, 2006

IEEE Conference on Cybernetics and Intelligent Systems, 7-9 June 2006, Bangkok, Thailand.

- [12] Goutam Bernajee, *Adaptive fuzzy cognitive maps vs neutrosophic cognitive maps: decision support tool for knowledge based institution*, Journal of Scientific and Industrial Research, 665-673, Vol. 67, 2008.
- [13] Anne-Laure Jousselme, Patrick Maupin, *Neutrosophy in situation analysis*, Proceedings of Fusion 2004 Int. Conf. on Information Fusion, pp. 400-406, Stockholm, Sweden, June 28-July 1, 2004.

Motto: "The science wouldn't be so good today,  
if yesterday we hadn't thought about today"

Grigore C. Moisil

## ECCENTRICITY, SPACE BENDING, DIMMENSION

Marian Nițu, Florentin Smarandache, Mircea Eugen Șelariu

### 0.1. ABSTRACT

This work's central idea is to present new transformations, previously non-existent in Ordinary mathematics, named centric mathematics (CM) but that became possible due to new born eccentric mathematics, and, implicit, to supermathematics.

As shown in this work, the new geometric transformations, named conversion or transfiguration, wipes the boundaries between discrete and continuous geometric forms, showing that the first ones are also continuous, being just apparently discontinuous.

### 0.2 ABBREVIATIONS AND ANNOTATIONS

**C** → Circular and Centric, **E** → Eccentric and Eccentrics, **F** → Function, **M** → Mathematics,  
Circular Eccentric → CE, FCE → FCE, centric M → CM, eccentric M → EM,  
Super M → SM, F CM → FCM, F EM → FEM, F SM → FSM

## 1. INTRODUCTION: CONVERSION or TRANSFIGURATION

In [linguistics](#) a **word** is the fundamental unit to communicate a meaning. It can be composed by one or more [morphemes](#). Usually, a word is composed by a basic part, named [root](#), where one can attach [affixes](#). To define some [concepts](#) and to express the domain where they are available, sometimes more words are needed; two, in our case.

### SUPERMATHEMATICAL CONVERSION

**The concept** is the easiest and methodical [idea](#) which reflect a finite of one or more/( a series)of attributes where these attributes are [essentials](#).

**The concept** is a minimal coherent and usable information, relative to an object, action, property or a defined event.

According the Explicatory Dictionary, [THE CONVERSION](#) is, among many other definitions / meanings, defined as "changing the nature of an object". Next, we will talk about this thing, about transforming / changing / converting, previously impossible in the ordinary classic mathematics, now named also **CENTRIC (CM)**, of some forms in others, and that became possible due to the new born mathematics, named **ECCENTRIC (EM)** and to the new built-in mathematical complements, named temporarily also **SUPERMATHEMATICS**

**(SM).** We talk about the conversion of a circle into a square, of a sphere into a cube, of a circle into a triangle, of a cone into a pyramid, of a cylinder into a prism, of a circular torus in section and shape into a square torus in section and/or form, etc. (**Fig. 1**).

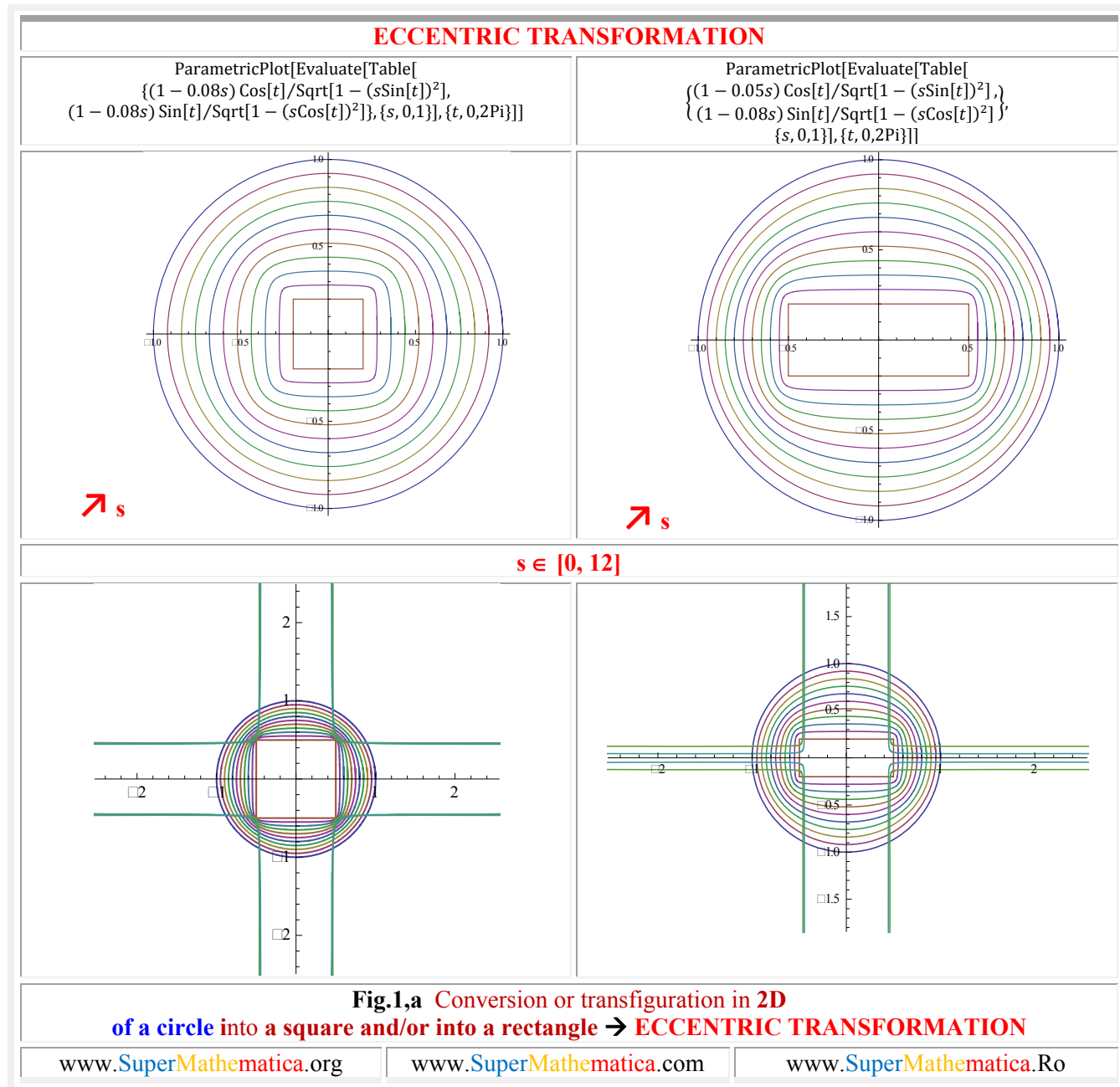

**SUPERMATHEMATICAL CONVERSION (SMC)** is an internal pry for the mathematical dictionary enrichment, which consist in building-up of a new denomination, with one or more new terms, two in our case, by assimilating some words from the current language in a specialized domain, as Mathematics, with the intention to

name, adequate, the new operations that became possible only due to the new born **eccentric mathematics**, and implicit, to **supermathematics**. Because previously mentioned conversions could not be made until today, in **MC**, but only in **SM**, we need to call them **SUPERMATHEMATICAL conversion (SMC)**

In [14] work, the continuous transformation of a circle into a square was named also **eccentric transformation**, because, in that case, the linear numeric eccentricity  $s$  varies/grows from 0 to 1, being a slide from centric mathematics domain **MC**  $\rightarrow s = 0$  to the **eccentric mathematics, ME** ( $s \neq 0$ )  $\rightarrow s \in (0, 1]$  where the circular form draws away more and more from the circular form until reach a perfect square ( $s = \pm 1$ ).

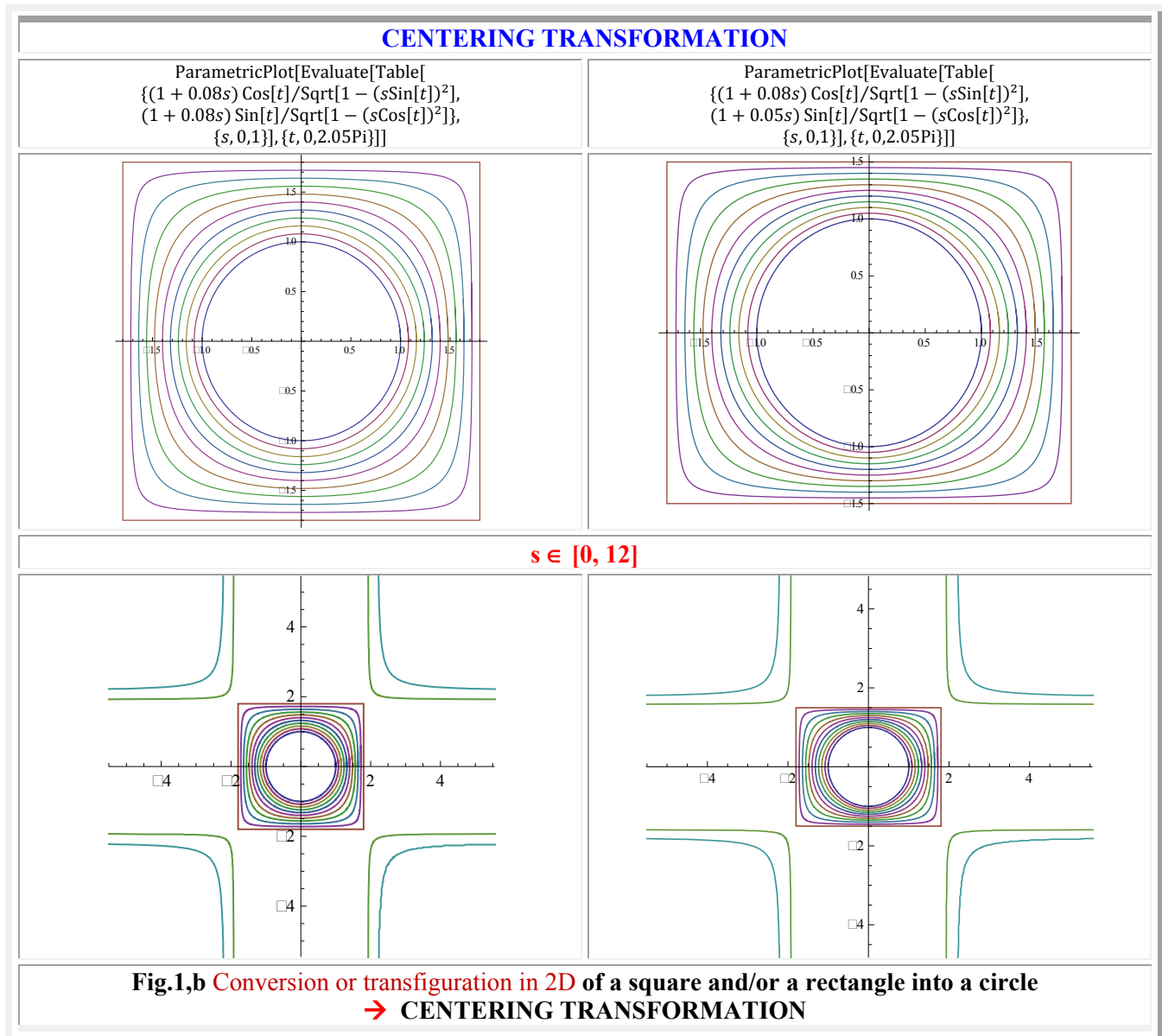

In the same work, the reverse transformation, of a square into a circle, was named as **centering transformation**, by easy to understand means. Same remarks are valid also for transforming a circle into a rectangle and a rectangle into a circle (Fig. 1).

Most modern physicists and mathematicians consider that the [numbers](#) represent the reality's language. The truth is that [the forms](#) are those who generate all physical laws.

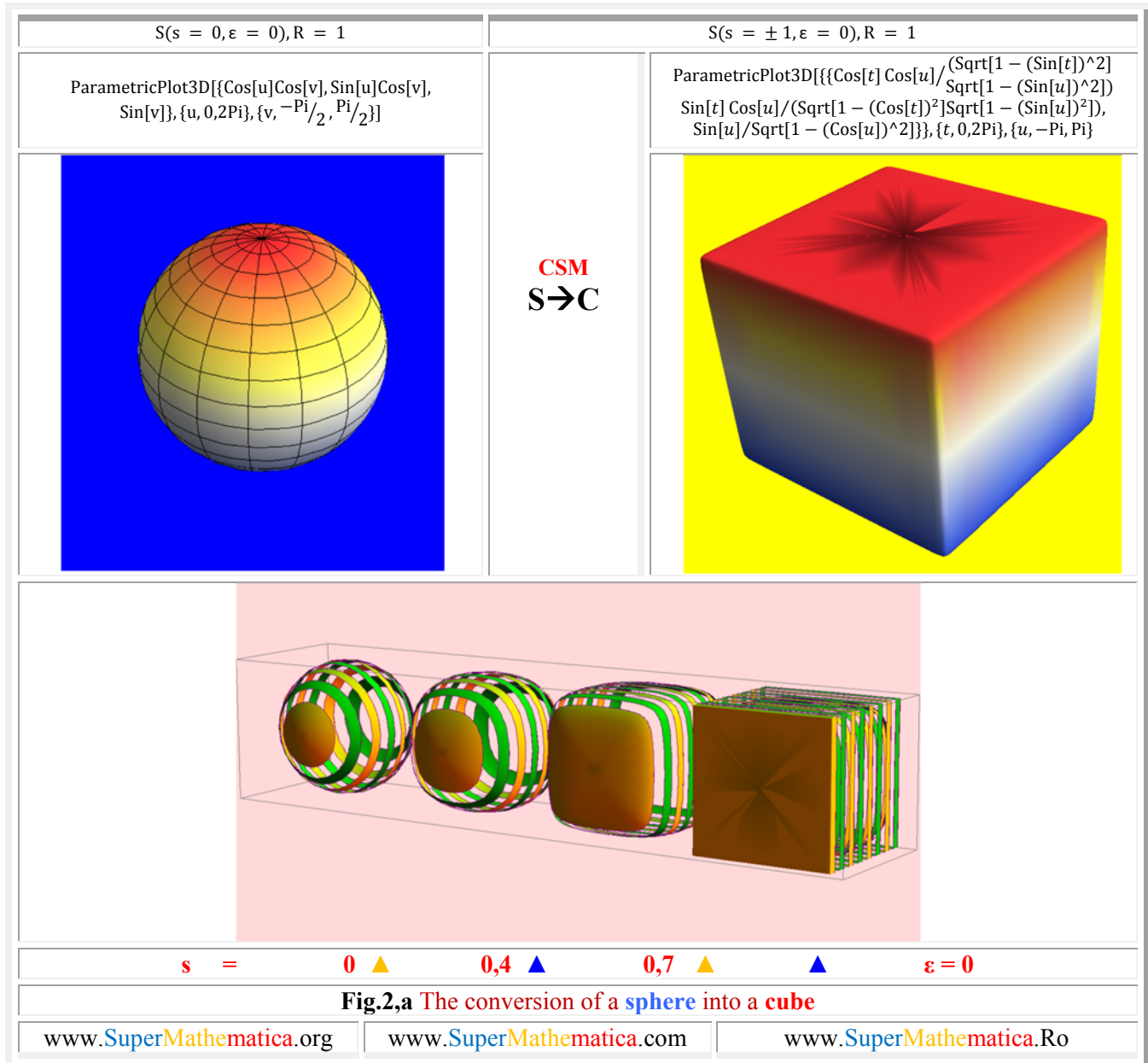



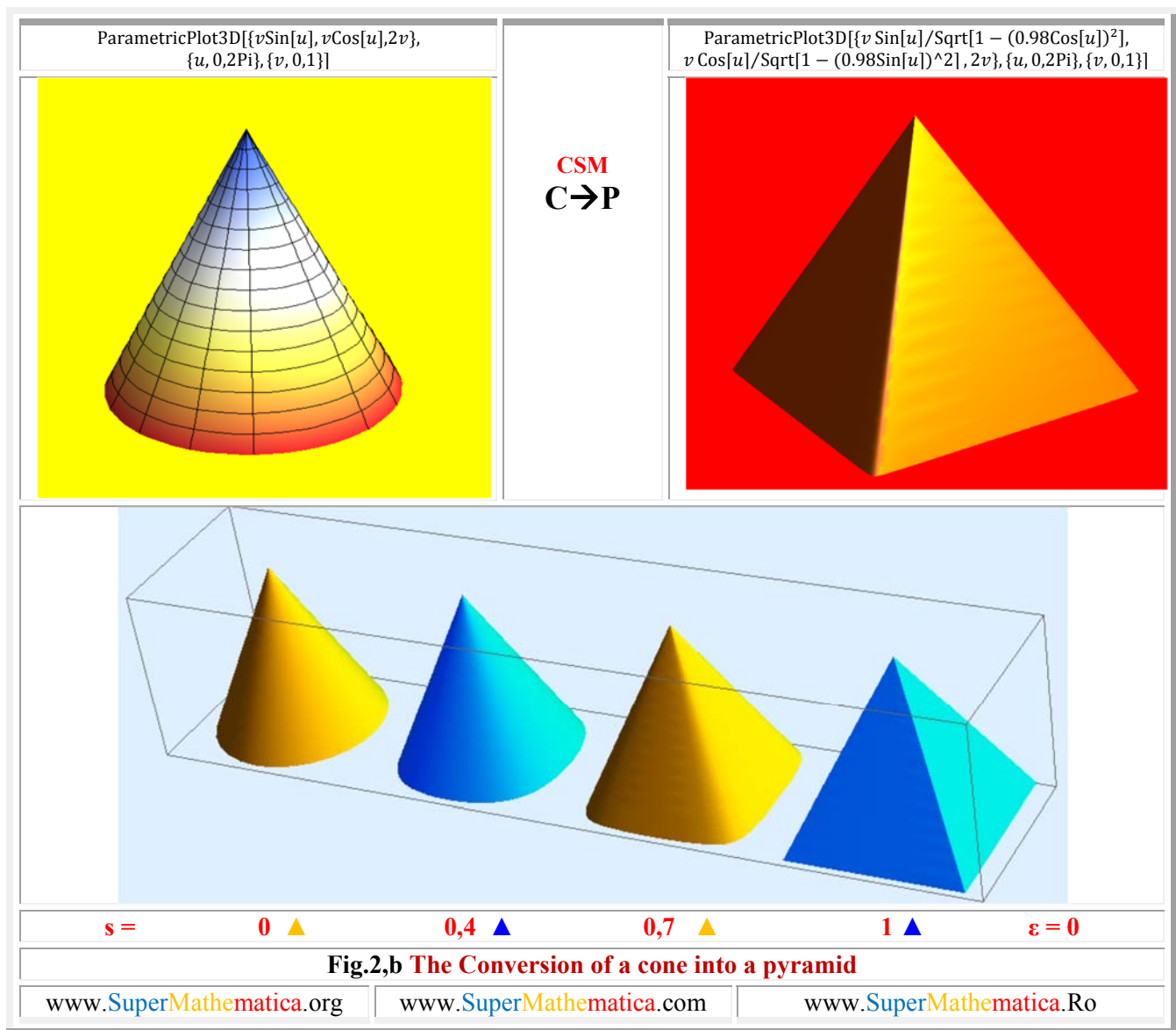

Look what the famous Romanian physicist **Prof. Dr. Fiz. Liviu Sofonea** in “**REPRESENTATIVE GEOMETRIES AND PHYSICAL THEORIES**”, Ed. Dacia, Cluj-Napoca, p. 24, in 1984, in the chapter named “**MATHEMATICAL GEOMETRY AND PHYSICAL GEOMETRY**” wrote:

“Trough *geometrization* we look for ( deliberately and by sui generis) exactly the ordering directions ( detailed, fundamentals, even the supreme, the *unique-unifier*) thinking about the pre-established ( relating to physical theory undertaking) from the “geometrical worlds” built and moved after disciplined canons in *more geometrical* style ( logical derivability and structure, geometrically proved, where it’s done), an extension with the purpose if “it works” also “*physically*”, and as we see that we have reasons to say “it really works”, we bargain on a methodological-operant gain, heuristically, but even gnoseological. But never *geometrical* pre-norming cannot be fully functional; it can be only (inherent) partial, limited, often a simple boundary marking, a

suggestion, an incitement, a scheme, sometimes too dummy, but we use it like a scaffold, to rise up, as we can, to a more adequate description or even more understanding”

In the **centric mathematical geometry** one is doing what can be done, how can be done, with what can be done, and in **supermathematical geometry** we can do what must be done, with what must be done, as we will proceed.

In the **supermathematical geometry**, between the elements of the “**CM scaffold**”, one can introduce as many other constructive elements we want, which will give an infinitely denser scaffold structure, much more durable and, consequently, higher, able to offer an unseen high level and an extremely deep description and gravity.

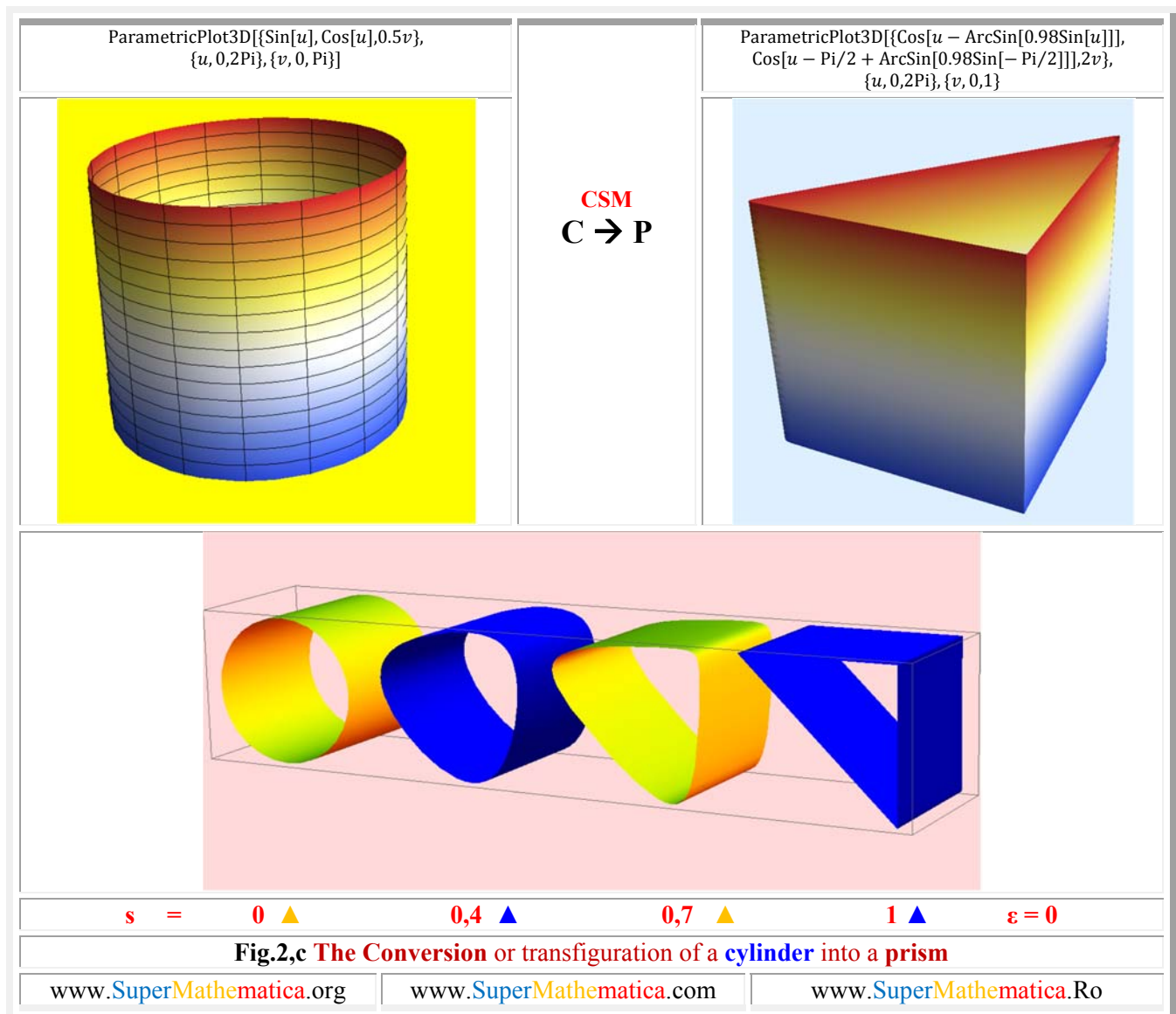

ParametricPlot3D[{(3 + Cos[v])Cos[u],  
(3 + Cos[v])Sin[u], Sin[v]}, {u, 0, 2Pi}, {v, 0, 2Pi}]

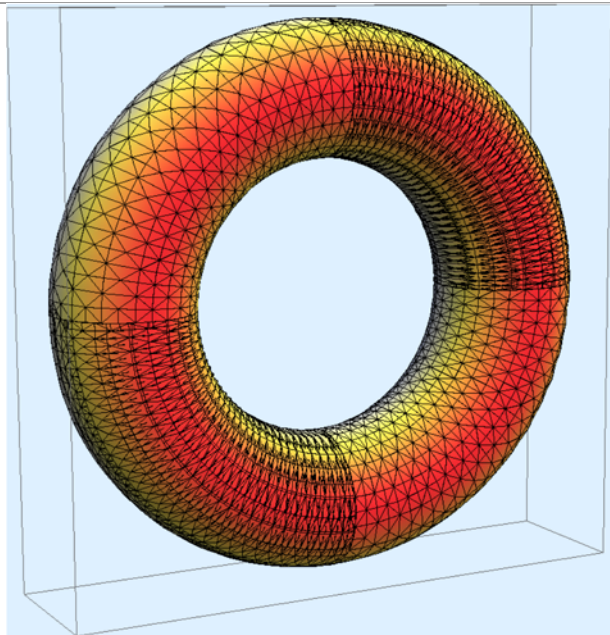

ParametricPlot3D[{  
(3 + Cos[v]/Sqrt[1 - (Sin[v])^2]) Cos[u]/Sqrt[1 - (Sin[u])^2],  
(3 + Cos[v]/Sqrt[1 - (Sin[v])^2]) Sin[u]/Sqrt[1 - (Cos[u])^2],  
Sin[v]/Sqrt[1 - (Cos[v])^2]}, {u, 0, 2Pi}, {v, 0, 2Pi}]

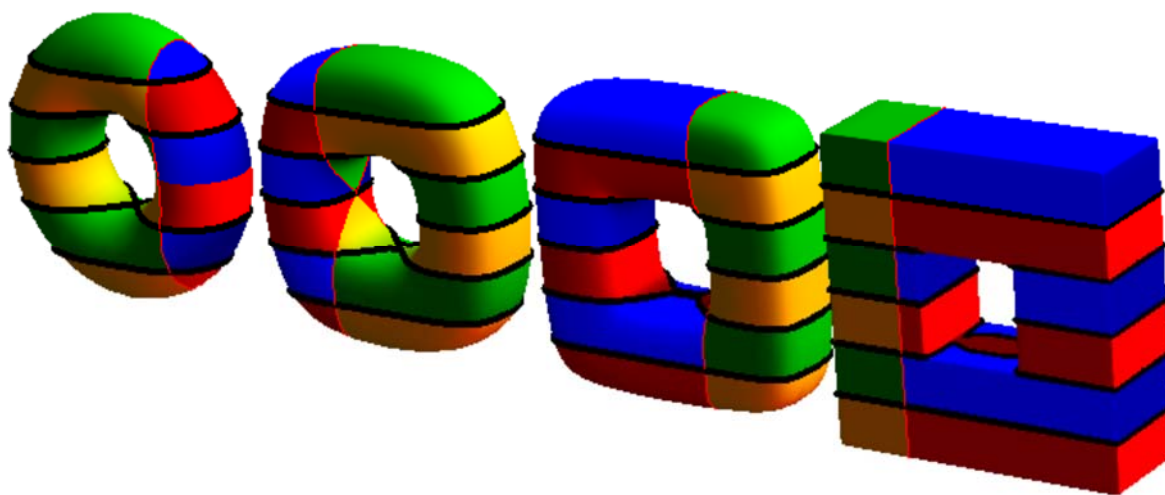
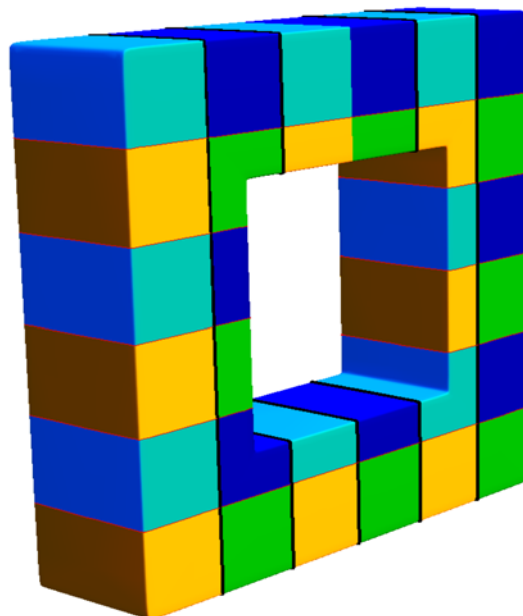

s = 0 ▲

0,4 ▲

0,7 ▲

1 ▲ ε = 0

Fig.2,d The conversion or transfiguration of the circular thorus into a square thorus, both in form and in section

The fundamental principles of the geometry are, according their topological dimensions: the **corps** (3) the **line** (2) and the **point** (0)

The elementary principles of geometry are the point, the line, the space, the curve, the plane, geometrical figures ( segment, triangle, square, rectangle, rhombus, the polygons, the polyhedrons, etc, the arcs, circle, ellipse, hyperbola, the scroll, the helix, etc.) both in 2D and in 3D spaces.

With the fundamental geometrical elements are defined and built all the forms and geometrical structures of the objects:

- Discrete forms, or discontinuous, statically, directly, starting from a finite set (discrete) of points, statically bonded with lines and planes.
- Continuous forms, or dynamical, mechanical, starting from a single point and considering its motion, therefore the **time**, and obtaining in this way continuous forms of curves, as trajectories of points or curves traces, in the plane (2D) or in the space ( 3D)

Consequently, one has considered, and still is considering, the existence of two geometries: the geometry of discontinuous, or discrete geometry, and the geometry of the continuum.

As, both the objects limited by plane surfaces ( cube, pyramid, prism), apparently discontinuous, as those limited by different kinds of continuous surfaces ( sphere, cone, cylinder) can be described with the same parametric equations, the first ones for numerical eccentricity  $s = \pm 1$  and the last ones for  $s=0$  , it results that in **SM** exists only one geometry, the geometry of the continuum.

In other words, the **SM** erases the boundaries between continueous and discontinuous, as **SM** erased the boundaries between linear and nonlinear, between centric and eccentric, between ideal/perfection and real, between circular and hyperbolic, between circular and elliptic, etc.

Between the values of numerical eccentricity of  $s=0$  and  $s = \pm 1$ , exists an infinity of values, and for each value, an infinity of geometrical objects, which, all of them, has the right to a geometrical existence.

If the geometrical mathematical objects for  $s \in [0 \vee \pm 1]$  belongs to **the centric ordinary mathematics ( CM)** (circle→ square, sphere→ cube, cylinder→ prism, etc.), those for  $s \in (0 , \pm 1)$  has forms, equations and denominations unknown in this **centric mathematics ( CM)**

They belongs to the new mathematics, the **eccentric mathematics (EM)**, and, implicit, to the **supermathematics (SM)** which is a reunion of the two mathematics: **centric** and **eccentric**, that means **SM = MC  $\cup$  ME**

By erasing the boundaries between centric and eccentric, the **SM** implicitly dissolved the boundaries between **linear** and **nonlinear**, the linear being the appanage of **CM** and the **nonlinear** of the **EM** one, and introduced a disjunction between the centric geometrical entities and the eccentric ones. By this way, all the entities of **centric mathematics** in 2 D was named **centrics** ( circular centrics, square centrics, triangular centrics, elliptical centrics, hyperbolic centrics, etc.) and those of **eccentric mathematics** was named as **eccentrics** (circular eccentrics, elliptic eccentrics, hyperbolic eccentrics, parabolic eccentrics, spiral eccentrics, cycloid eccentrics, etc.).

If the 2D **centric** entities can remain to the actual denominations (circle, square, ellipse, spiral, etc.) at the **eccentric** ones one have to specify also the teh denomination of **eccentrics**. The same thing is available for 3D entities: **the centric** ones (sphere, ellipsoid, cube, paraboloid, etc) can carry, further, the old denominations, and for the new ones, the **eccentric** ones, it is necessary to specify that they are **eccentric**. That means: eccentric sphere, eccentric ellypsoid, eccentric cube, eccentric paraboloid, etc.

With the new SM functions, like eccentric amplitude axe  $\theta$  and Axe  $\alpha$ , of eccentric variable  $\theta$  and, respectively, **centric  $\alpha$ , beta eccentric** bex  $\theta$  și Bex  $\alpha$  , radial eccentric rex and REX, eccentric derived dex  $\theta$  and Dex  $\alpha$ , etc., which having no equivalents in **centric / (CM)**, doesn't need other denominations for determining the mathematical domain where they belongs.

By way of exception are the last two **FSM-CE**,  $\text{re}\alpha$  și  $\text{dex}\alpha$ , ( $\theta = \alpha$ ), to which ones are discovered, later, equivalents in **centrics**: the **centric radial** function **rad $\alpha$** , which is the direction fazor  $\alpha$  and the **centric derived dera**, which is the direction fazor  $\alpha + \frac{\pi}{2}$ , fazors reciprocal perpendiculars.

## SUPERMATHEMATICAL HYBRIDIZATION AND METAMORPHOSIS THE CONSEQUENCES OF THE NEW SPACE DIMMENSIONS

**The space** is an abstract entity which reflects an objective form of matter's existence. It shows like a generalization and abstractization of the parameters assembly through which is achieved the **distinction between different systems** that forms a condition of the Universe.

It is an objective and universal form of matter's existency, inseparable from the matter, which has the aspect of a tri-dimensional continuum and expresses the order of the real world's objects coexistence, [their position, distance, size, form and extension](#).

In conclusion, one can say that the space appears like a synthesis, like a generalization and abstractization of the observations about a condition, in a certain moment, of the Universe. Within the classical mechanics, the notion of space is that of the tridimensional Euclidian space (E3), homogenous, isotropic, infinite.

When one discuss about the space, the first thought is directed to the **position**, that means the notion of position is directly associated with that of the notion of space. The **position** is expressed in terms of a reference system, or shortly, by a coordinate system.

A tridimensional object has in the  $E^3$  6 variances, made of the 3 translations, on **X**, **Y** and **Z** directions and of the **3 rotations**, around the axis **X**, **Y** and **Z**, noted, respectively, by  **$\theta$** ,  **$\phi$** ,  **$\psi$**  in Mathematics and in Mechanics and with **A**, **B** and **C** in technology and in robotics.

An object can be "created", or more specifically, its image can be reproduced in the virtual space, when appears in the 3D space, on the display of a computer, by using some technical programs (CAD) or commercial mathematical programs (MATHEMATICA, MATLAB, MATHCAD, MAPLE, DERIVE, etc.), or special ones, which use **Eccentric-FSM**, **Elevated** and/or **Exotic** - for objects describing, as at **SM-CAD-CAM**.

By **modifying the eccentricity**, the known and formed objects in the centric domain of the supermathematics (**SM**), that means, in centric mathematics (**MC**), can be deformed in the eccentric domain of the **SM**, therefore, in the eccentric mathematics (**ME**) and transformed, initially, in hybrid objects, proper to **ME**, and after that, to be re-transformed in other kind of objects, known in **MC**. As an example, by deforming a perfect **cone** ( $s = 0$ ) into a **cono-pyramid** [ $s \in (0, 1)$ ] with the base a perfect square and conical tip, which constitutes hybrid objects, placed between a cone and a pyramid, up to transforming it into a perfect **pyramid** ( $s = \pm 1$ ) with a perfect square base ( Fig 3). In the fact, the object can be achieved by different machine works (see **Mircea Șelariu**, Chap.17, **Dispozitive de prelucrare**, PROIECTAREA DISPOZITIVELOR, EDP, București, 1982, coordinator **Sanda-Vasii Roșculeț**], by forming, (casting, sintering), deforming (at worm and cold), dislocation (cutting, chipping, erosion, grinding) and by **aggregation** (welding and binding).

In both cases, **movements** of the tool and/or of the piece are needed, respectively, of the bright spot which delimitates a pixel on the screen and passes from a pixel to another.

The movement is strongly linked to space and time.

**The mechanical movement** can be of the:

- corps, and implicit, objects **forming** in time ;
- objects **position changing** in time, or of its parts, named corps, in relation to other corps, chosen as referentials.
- corps **form changing** in time, and implicit, of the objects form, by **deforming** them.



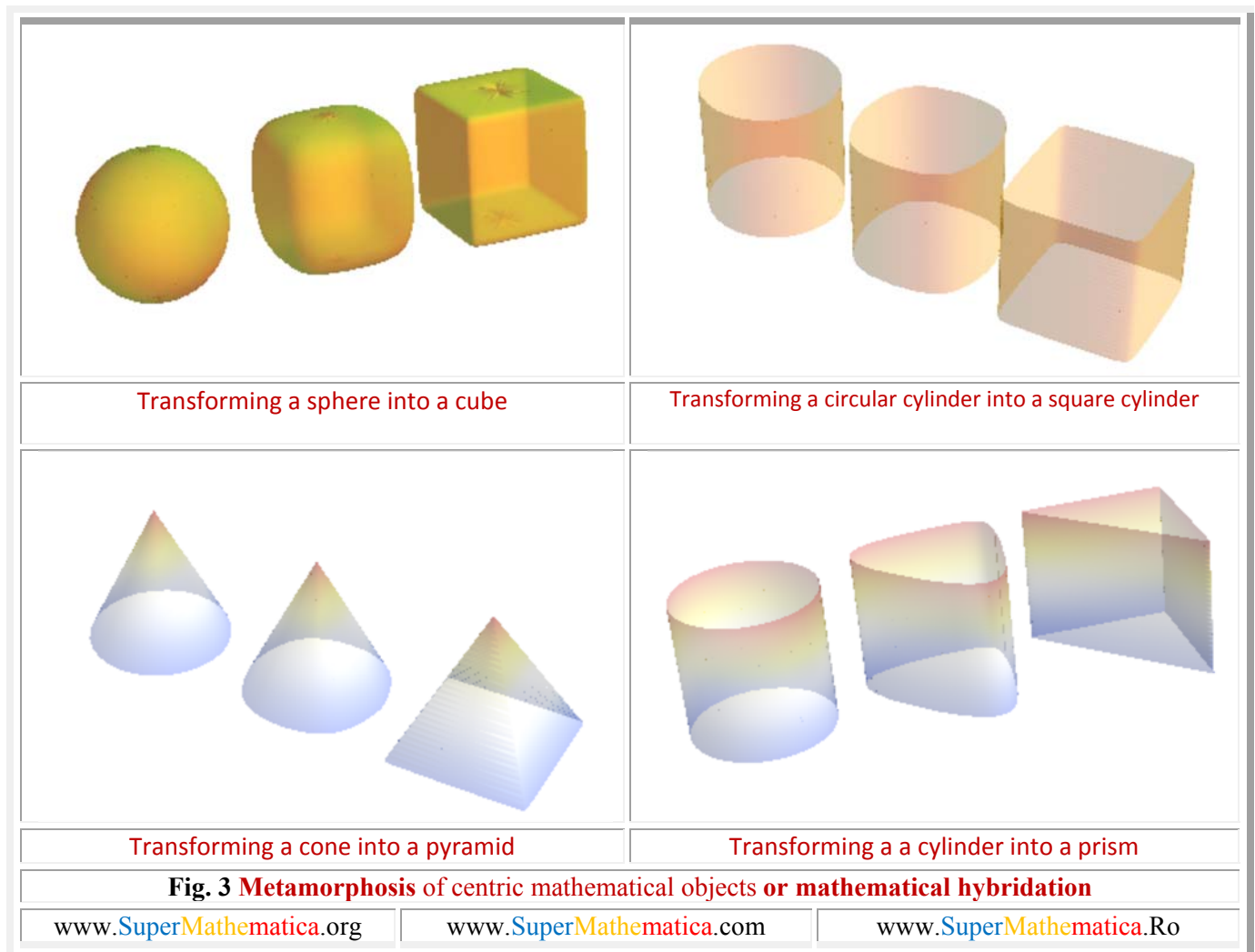

The Space reflects the coexistence relationship between objects and events, or parts of them, by indicating:

- their **expansion**/bigness, named **gage dimension**;
- the objects **position**, through **linear coordinates X, Y, Z**, in 3D space, named **localization dimensions**;
- the objects **orientation**, in 3D space, through the **angular coordinates  $\psi, \phi, \theta$** , or A, B, C, named **orientation dimensions**.
- the relative **positions** or distances between the objects, named **positioning dimensions**, if refers to the absolute and/or relative orientation and localization of the objects, and if it refers to parts of them, named corps, then they are named **coordination dimensions**;
- the form of the objects and, respectively, the phenomena evolution, named **forming dimensions**, which defines, at the same time, the objects defining equations;
- the deformation of the objects and phenomena evolution changing, named **dimensions deformation** or **eccentricities**.

- The last space dimension, **eccentricity**, by making possible the apparition of **eccentric mathematics** ( **EM** ) and by making the pass through from centric mathematics domain to the eccentric mathematics one, as well as the leap from a single mathematical entity, existent in Mathematics and in the **centric** domain, to an infinity of entities, of same kind, but more and more deformed, once the numerical eccentricity value  $s$  is growing, up to their transformation in other kind of objects, also existent in the centric domain. An example, became already classical, is the continuous deforming of a sphere until it is transformed into a cube (**Fig. 3**), by using the same **formation dimensions** ( parametric equations), both for the sphere and for the cube, by changing only the eccentricity: being  $s = e = 0$  for the sphere of radius  $R$  and  $s = \pm 1$ , or  $e = R$ , for the cube of leg  $L = 2R$ .
- For  $s \in [(-1, 1) \setminus 0]$  one obtain **hybrid objects** , proper for eccentric mathematics ( **EM** ), previously non-existent in mathematics, or, more specific, in Centric Mathematics ( **CM** )
- As shown before, the **straight line** is an unidimensional space, and, concurrently, in **Supermathematics** ( **SM** ), a **bent** of zero eccentricity [ 8 ].

By increasing the eccentricity, from zero to one, it transforms the straight line into o broken line, both existing and known in **Centric Mathematics**, but not the rest of the bents, which are proper to **Eccentric Mathematics**, being generated by **FSM-CE** eccentric amplitude. In this way, the straight line with angular coefficient  $m = \tan\alpha = \tan\frac{\pi}{4} = 1$  which pass through the point  $P(2, 3)$  has the equation

$$(1) \quad y - 3 = x - 2,$$

and the bents family, from the same family with the straight line, has the equation

$$(2) \quad y [x, S(s, \varepsilon)] - y_0 = m \{aex [\theta, S(s, \varepsilon)] - x_0\},$$

$$(3) \quad y - y_0 = m \{ \theta - \arcsin[s \cdot \sin(\theta - \varepsilon)] \} - x_0, \quad m = \tan\alpha,$$

in eccentric coordinates  $\theta$  and, in centric coordinates  $\alpha$ , the equation is

$$(4) \quad y[x, S(s, \varepsilon)] - y_0 = m (Aex [\theta, S(s, \varepsilon)] - x_0),$$

$$(5) \quad y - y_0 = m \left\{ \alpha + \arcsin \frac{s \cdot \sin(\alpha - \varepsilon)}{Rex\alpha} - x_0 \right\}, \quad m = \tan\alpha,$$

$$(6) \quad y - y_0 = m \left\{ \alpha + \arcsin \frac{s \cdot \sin(\alpha - \varepsilon)}{\sqrt{1 + s^2 - 2s \cdot \cos(\alpha - \varepsilon)}} - x_0 \right\}.$$

- The difference, for the two types of bents, of  $\theta$  and of  $\alpha$ , is that the  $\theta$  ones are continuous only for the numerical eccentricity from the domain  $s \in [-1, 1]$ , while the  $\alpha$  ones are continuous for all the values possible for  $s$ , it means  $s \in [-\infty, +\infty]$ .
- The broken line is known in Centric Mathematics ( **CM** ), but without knowing their equations! That is not the case anymore in **SM** and, obviously, in **EM** where it is obtained for the value  $s = 1$  of the **numerical eccentricity**  $s$ .
- A similar phenomenon of mathematical metamorphosis, through which from **CM** a known object pass through the eccentric mathematics ( **EM** ) taking hybrid forms and returns in the centric mathematics ( **CM** ), as another type of object (**Fig.3**), is considered to take place also in physics: from vacuum continuously appears particles and they return back into to vacuum. Are they the same or are they other ones?
- The cosmology has a theory which applies to the whole universe, enounced by Einstein in 1916: **the General Relativity**. It says that the gravitational force, which acts on the objects, acts also on the structure of space, which loses its rigid and immutable frame, becoming flexible and curved, depending of the contained matter or energy. In other words, **the space is deforming**.

The space-time continuum, of general relativity, is not conceived without a content, so it not admits the vacuum! As Einstein said to the journalists that beg him to resume his theory: "Before, **one believed** that, if all the things would disappear from the Universe, the space and time will still be here, whatever. In the

theory of general relativity, the time and space disappears, together with the disappearance of the other things from the Universe.”

- As one said before,  $\mathbf{s} = \mathbf{e} = 0$  is the world of CM, of the linearity, of perfect, ideal entities, as long as the infinite possible values referable to the eccentricities  $\mathbf{s}$  and  $\mathbf{e}$ , give birth to **EM** and, at the same time, to worlds that belongs to to the reality, to the imperfect world, which are farther of the ideal world as  $\mathbf{s}$  and  $\mathbf{e}$  are farther from zero.
- What happens if  $\mathbf{e} = \mathbf{s} \rightarrow 0$  ? The real world, as **EM** too, disappears, and because an ideal world cannot exist, everything disappears!
- As shown in the author’s theory from SUPERMATEMATICA. Fundamente, Vol. I, Editura POLITEHNICA, Timișoara, Cap. 1 INTRODUCERE [23], [24], the expansion of the Universe is a process of developing the order into absolute chaos , a progressive passing-through of the chaotic space in a more and more pronounced order.
- As a conclusion, the space, and also the time, is **forming and deforming**, it means that the space eccentricity, of a certain value, takes to a space **forming**, and then, by modifying its value, the space **deforms/modifies** itself.
- The modified form of the the space is depending on the value of the eccentricity, which becomes o new space dimension: **the deformation dimension**.

Installing an object for machining in the working space of a modern machine tool, with computer numerical control (CNC) is very similar with “installing” a mathematical object in the  $R^3$  tridimensional Euclidian space. Therefore, we will further use some notions from technological domain.

In technology, **installing** is the operation that precedes machining; only an installed object / piece can be machined. This involves the next phases or technological operations, in this sequence / order; only achieving one phase makes possible to pass to the next phase:

**1. ORIENTATION**, is the action or the operation where the object’s geometrical elements, which are **orientation technological referential bases**, shortly, orientation bases (**OB**), accept a well determined direction, regarding to the directions of a referential. In technology, this is regarding to the main and/or secondary working movements, and/or regarding the directions of dimensional arrangement movements of the technological system.

As **orientation bases (OB)** one can use:

a) A **plane** of the object, respectively a flat surface of the piece, if it exists; in that case, this surface, determined by three contact points between the object and the device, is named **emplacement of orientation technological referential base (EOB)**, or shortly, emplacement base (**EB**), being theoretically determined by the three mutual contact points of the piece with the device, which has the task to achieve the piece installing on the working machine. As **EB**, virtually, the most extended surface of the piece is chosen, if other positioning restrictions are not imposed, or that one from where the resulting surface after machining has the highest imposed precision, or parallelism constraints with **EB**.

By imposing the condition of mutual piece/device contact on **EB**, the object/piece loses 3 degrees of freedom, among them, a translation on the direction, let’s name it **Z**, perpendicular on **EB** ( a plane) and two rotations: around the **X** axis, noted in technology with **A**, and around the **Y** axis, noted in technology with **B**.

The object/piece can also be rotated around the **Z** axis, rotation noted with **C** and can be translated on **EB** on **X** and **Y** directions, by permanently keeping contact with **EB**.

From this surface is established, in technology, the **z** coordinate, by example, as a distance between **EOB** and the machining technological base (**MTB**), or shortly, machining base (**MB**), that means the plane generated on the piece by the machining tool. In a surface is totally machined ( by milling, as example, with large milling machines, for a single passage), then the other coordinates **y** and **x** can be established with a very large approximation, because they did not influence the plane surface precision achievement, at **z** distance of **EB**,



resulted after piece machining and named **MTP** or shortly, **MP**, whose technological demand is to be parallel to **EOB** and to be located at **z** distance from it.

The **z** dimension, being, in this case, a **forming dimension** of the piece, on the one hand and on the other hand also a **coordinating dimension** for tool/piece relative position, and from technological point of view, one of the **dimensional alignment dimensions** of the technological system **MDPT** (**Machine-Device-Piece-Tool**). Mathematically speaking, it's about two surfaces situated at **z** distance, it means parallel planes.

**b) A straight line** belonging to the object, if it exists, as axes on/or edges, as intersection of plane surfaces in Mathematics.

In Technology, the edges are avoided, because their irregularities, in other words because the deviations from semifabricates linear geometrical shape, and of the pieces too, after machining their semifabricates.

In Technology, this straight line is determined by the two points from a piece surface, other than **EB**, common to the piece and the device, which achieve the piece and device orientation base, as heteronymous elements, a straight line named **conducting orientation base (COB)** or shortly, **conducting base (CB)**, name derived from the fact that these two conducting elements, conducts/guides the movement of the object/piece for its localization, if the contact piece/device is permanently maintained during the movement. In this way, the **CB** takes over two degrees of freedom of the object: the translation on a direction perpendicular on the straight line determined by the two contact points between piece/device that materializes **CB**, translation on **Y** axis, as example, if **CB** is always parallel, with the **EB** from **XOY** plane, and the rotation around **Z** axis, noted in technology with **C**.

As **COB** is chosen, on principle, it's easy to understand why, by aiming the guiding precision, the longest surface of the piece, if other reasons are not imposed by the execution drawing.

From **COB** can be established/measured the level/dimension **y**, parallel to **EOB** and perpendicular on **COB**, as example, perpendicular on **z**, because **COB** is parallel with **EOB**.

Therefore, if the two points belongs to a parallelepipedical object, so bounded by plane surfaces, and **COB** is parallel with **EOB**, by maintaining the contact between piece/device on the two bases, by a translation movement, the piece can only be translated, in the device, on **X** direction, until it comes into collision with a **localization element**.

1) from this one, named localization element, namely **localization technological base (LTB)**, or shortly, **localization base (LB)** can be established the **x** coordinate/dimension perpendicular simultaneously on **y** and **z**. But without being coordinates/dimensions/concurrent segments in a common point **O(x,y,z)** as in mathematics, only if **COB** and **LTB** drops to the level **EOB**, and, in addition, **LTB** moves toward **COB** and will be contained in it, both going to be contained in **EOB**, so the point **O(x, y,z)**, as **LTB** will be a tip of the parallelepipedical piece, contained simultaneously in the **EOB** plane, the **CB** straight line in **LB** point, resulting, in this case, that  $O(x,y,z) \equiv BL$

If the localization is achieved by a translation movement, as previously assumed, it is also named **translation localization (TL)**.

If the localization is achieved through a rotational movement of the object, it is named **rotational localization (RL)**. In this case, **CB** can be, or is, usually, a symmetry plane of the piece, by example a cylindrical one, a plane named **semicentering orientation base (SCOB)**, in the case of a semicentering, or an axis of a rotational surface (cylindrical or spherical) of the object, named **Centering orientation base (COB)**, around whom the object rotates until another corps of the piece come into collision with the rotation localization element. Or, until a locator gets into a muzzle perpendicular on **COB** or into a channel parallel with **COB**.

The objects which did not bring out **elements/orientation bases**, like the sphere in mathematics or the balls for ball bearings in technology, as example, are non-orientational objects.

**1. LOCALIZATION**, is the operation or the action to establish the place, in  $E^3$  tridimensional Euclidian space, of an  $O(x,y,z)$  point, characteristic for the object, which belongs to a orientating referential element

of this one, from which one are established the coordinates/linear dimensions  $x,y,z$  regarding a given referential system, or in technology, regarding the machining tool.

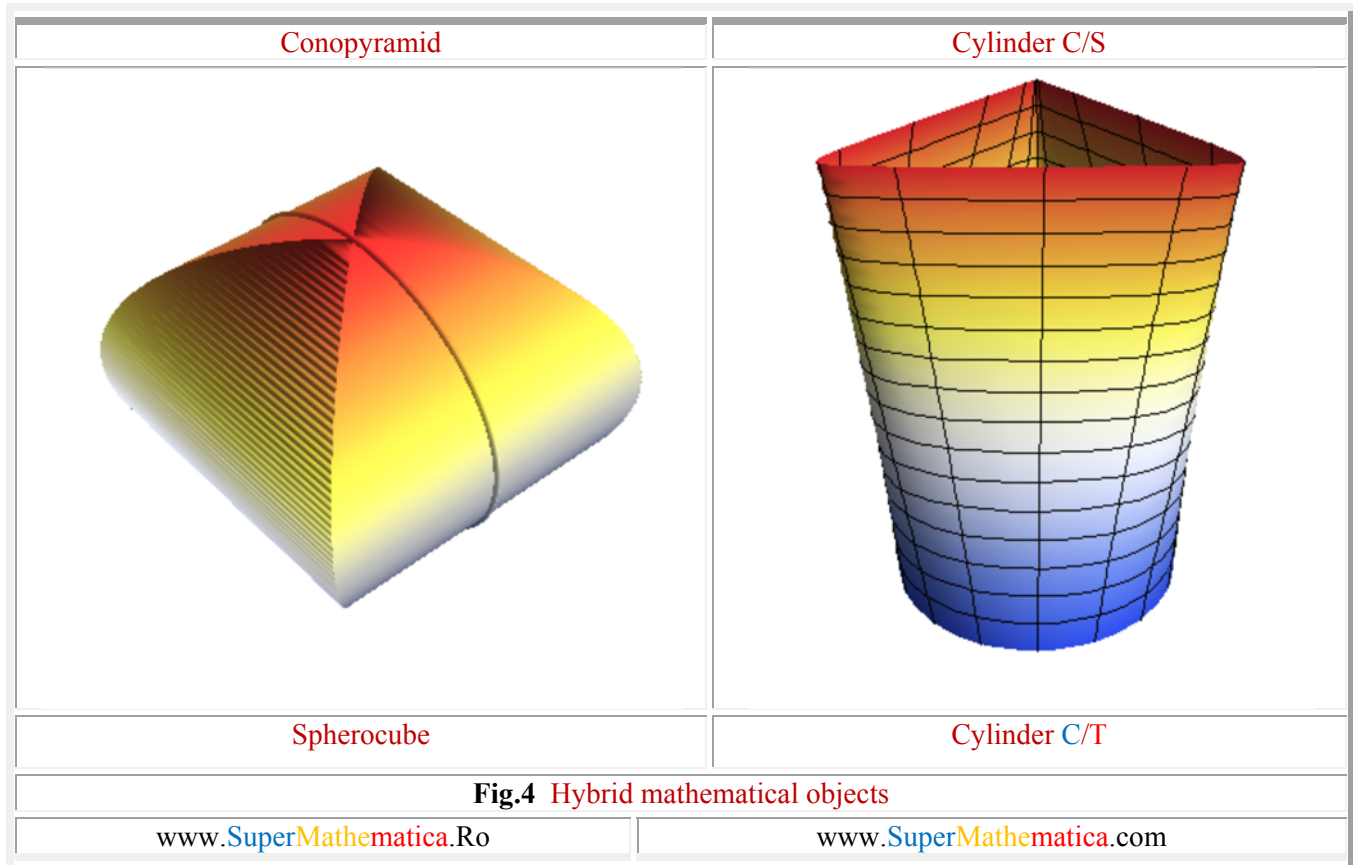

The  $O(x,y,z)$  point of the **non-orientational** objects is the symmetry center of them, and of the **orientational** objects, like the parallelipedical ones, in Technology, as example, the  $O(x,y,z)$  point is disseminated in three distinctive points, for each coordinate apart,  $O_x \subset LB$  for  $x$ ,  $O_y \subset CB$  for  $y$  și  $O_z \subset EB$  for  $z$ , as explained before.

In the Technology, the succession orientation  $\rightarrow$  localization is compulsory; only an oriented object can be then located. Beside this, as in mathematics. First, one chose a reference system unitive with the  $O(x,y,z)$  object, and after that, an invariant one ( $O, X, Y, Z$ ) which one, initially, coincide with the other one, in 3D space or in the  $E^3$  tridimensional one, and then are operated various translation and/or rotation transformations.

The union between orientation and localization represents the most important technological action/operation, named **positioning**, namely **orientation  $\cup$  localization = positioning**

If the object **positioning** is achieved/ finished/ fulfilled, then the relative position piece/device can be maintained by the operation of **anchorage** of the piece in the device.

Further, one can establish the distances/dimensions between the tool and the piece, so one can obtain the piece of dimensions and precisions imposed by the piece work drawing. This technological operation is named **dimensional adjustment**. With this, the installing process is finished, and the machining of the piece can be started

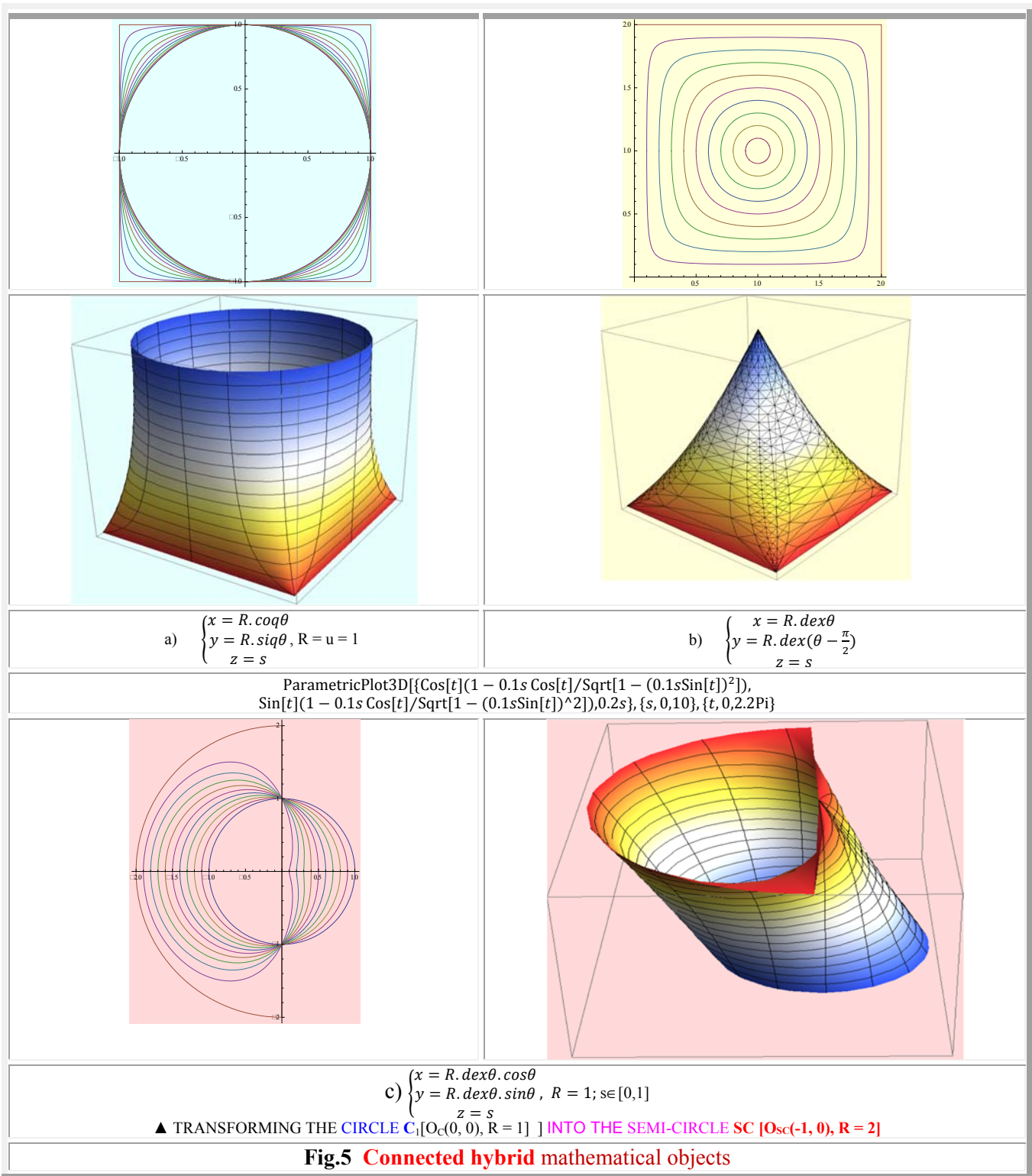

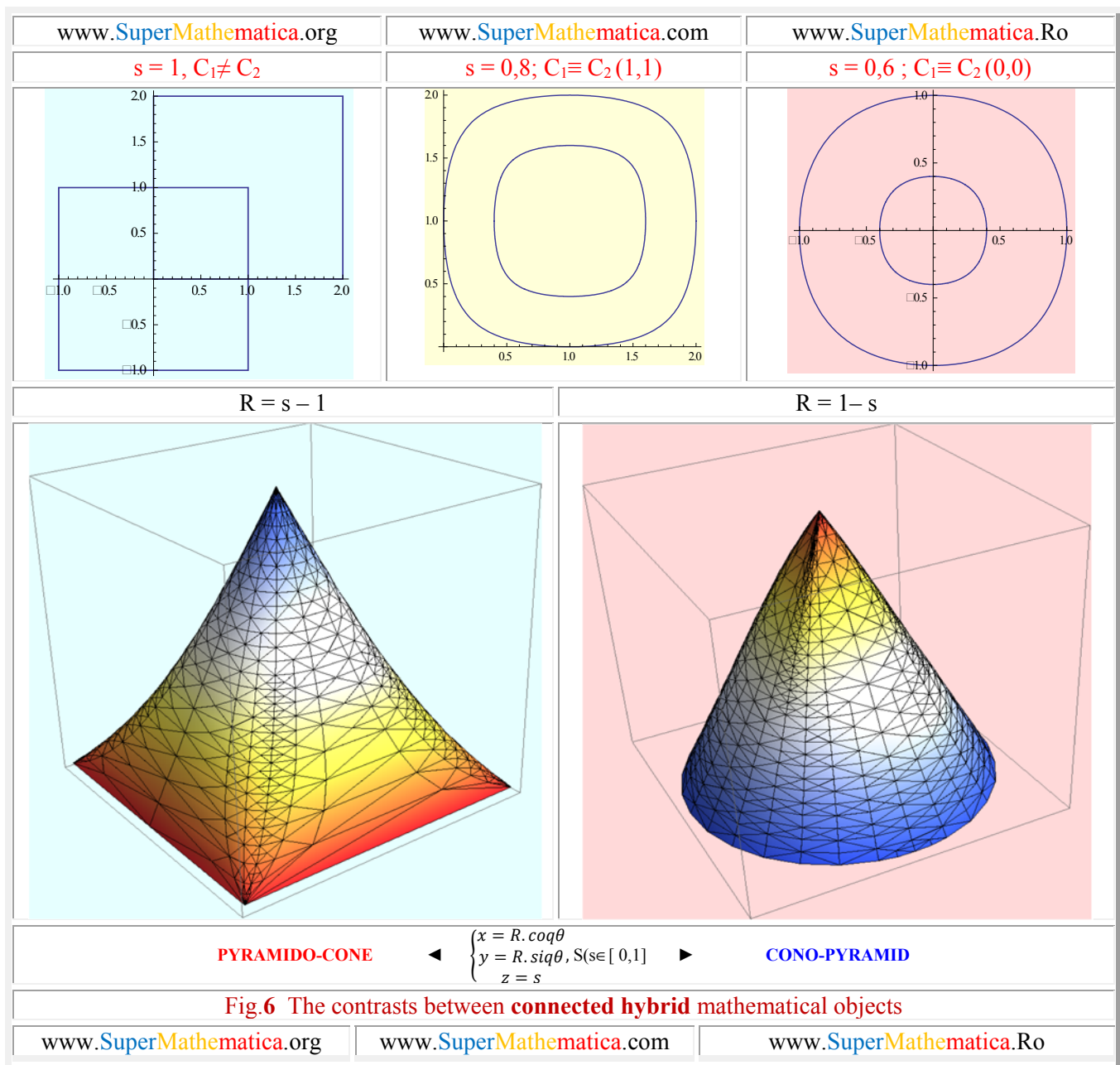

Reductively, installing an object is an union of positioning with anchorage and dimensional adjustment of the technological system, namely:

**installing = pozitioning  $\cup$  anchorage  $\cup$  adjustment (dimensional)**

In Technology, **the adjustment** can be achieved by (fixing) **force** or by **form** ( which blocks the piece displacement during the machining). In Mathematics, the anchorage is “achieved” by **convention**.

**By telling** that the **(O, x,y,z)** system is linked to the piece, it cannot move anymore relative to the piece, but only together with the object, so they are “bonded” each other. Therefore, in Mathematics, the anchorage of

the elements relative to the reference systems, is a matter of course, it doesn't exist anymore, because in mathematics doesn't exist "mathematical forces". These belonging to the Mechanics, namely it's dynamics, also in mathematics doesn't exist machining tools, neither various coordinating dimensions, dimensional adjustments, dimensional machining, etc.

Therefore, in Centric mathematics (**CM**), only 3 **x, y and z** linear dimensions exists, which are, at the same time, forming dimensions of the 3D objects, by their parametric equations, by example.

Reductively, in this Centric mathematics (**CM**), entities as straight line, the square, the circle, the sphere, the cube e.a., are unique, while in the Eccentric Mathematics (**EM**), and implicit, in Supermathematics (**SM**), they are infinitely multiplied through **hybridation**, a hybridation possible by introducing of a new space dimension, the **eccentricity**.

**The supermathematical Hybridation** can be defined as the mathematical process of "cross-breeding" of two mathematical entities from **CM** ( the circle, and the square, the sphere and the cube, the cone and the pyramid) and obtaining of a supermathematical **new entity** in **EM**, which is unknown/non-existent in **CM** ( by example: **cono-pyramid**).

Through **metamorphosis** one understand a continuous passing from a certain entity, existing in **CM**, to another entity, also existing in **CM**, through an infinity of hybrid entities, appropriates only to **EM**. In other words, transforming a centric mathematical entity into another centric mathematical entity, an action that became possible inside the **Eccentric mathematics ( EM )**, by using **supermathematical** functions.

By **metamorphosis** one obtain new entities, previously non-existent in **CM**, named **hybrid entities**, and also **eccentric** entities, or **supermathematical (SM)**, to differ the **centric** ones, also by name, because **by form**, they are essentially different.

The first object obtained through **mathematical hybridation** was the **cono-pyramid**: a supermathematical corps with the square base of a pyramid and the tip of a circular cone, resulting from the transformation of the unity square of  $L=2$  into the unity circle of  $R=1$  and/or viceversa (Fig. 4). The parametric equations of the cono-pyramid are obtained from the parametric equations of right circular cone, where the FCC are changed/converted with the corresponding quadrilobe supermathematical functions (**FSM-Q**).

$$\left\{ \begin{array}{l} x = u \cdot \text{coq}\theta = u \cdot \frac{\cos\theta}{\sqrt{1-s^2 \cdot \sin^2\theta}} \\ y = u \cdot \text{siq}\theta = u \cdot \frac{\sin\theta}{\sqrt{1-s^2 \cdot \cos^2\theta}} \\ z = u \end{array} \right. , \quad \text{for} \quad \left\{ \begin{array}{l} u = 1 - s, \quad s \in [0, 1] \blacktriangleright \text{CONO - PIRAMIDĂ} \\ u = s - 1, \quad s \in [0, 1] \blacktriangleright \text{PIRAMIDO - CON} \\ u = 1; \quad s = 1 \blacktriangleright \text{PĂTRAT}; \quad L = 2 \\ u = 1; \quad s = 0 \quad \blacktriangleright \text{CERC}; \quad R = 1 \\ u = 1; \quad s \in [0, 1] \blacktriangleright \text{CILINDRU C/P} \end{array} \right.$$

(Fig. 1, Fig. 3 și Fig. 5,a), because **FSM-Q** can achieve the contiuous transformation of the circle into a square and viceversa, also as **FSM-CE** eccentric derivate **dex<sub>1,2</sub>θ**

$$(7) \quad \left\{ \begin{array}{l} x = u \cdot \text{dex}\theta = u \left[ 1 - \frac{s \cdot \cos(\theta - \varepsilon)}{\sqrt{1 - s^2 \sin^2(\theta - \varepsilon)}} \right] \\ y = u \cdot \text{dex}\left(\theta - \frac{\pi}{2}\right) = u \left[ 1 - \frac{s \cdot \cos\left(\theta - \varepsilon - \frac{\pi}{2}\right)}{\sqrt{1 - s^2 \sin^2\left(\theta - \varepsilon - \frac{\pi}{2}\right)}} \right] \\ z = u \end{array} \right. , \text{pentru} \quad \left\{ \begin{array}{l} u = 1; \quad s = 0 \blacktriangleright \text{CON} \\ u = 1, \quad s = 1 \blacktriangleright \text{PIRAMIDĂ} \\ u = s \in [0, 1] \blacktriangleright \text{CONOPIRAMIDĂ} \\ u = 1; \quad s \in [0, 1] \blacktriangleright \text{Fig 5, c} \end{array} \right.$$

(Fig. 4 și Fig. 5,b și Fig. 5,c).

The relations (7) are expressed with the help of quadrilobes **FSM-Q**, introduced in Mathematics since 2005, in the work [19], quadrilobe cosine **coqθ** and quadrilobe sine **siqθ**.

The (7) and (8) equations express the same forms, but with following remarks:

- Of a **circle** only for an eccenter  $S(s = 0, \varepsilon = 0)$ , with the difference that the first one (7) has the radius  $R = 1$ , and the other one (8) has the radius  $R = 0$ , Fig. 6, up ▲;
- Of a **square** for an eccenter  $S(s = 1, \varepsilon = 0)$ , of the same dimensions  $L = 2R$ , as one can see in the figure 6., but centered in different points; one is centered in the origin  $O(0, 0)$ , the one expressed by the



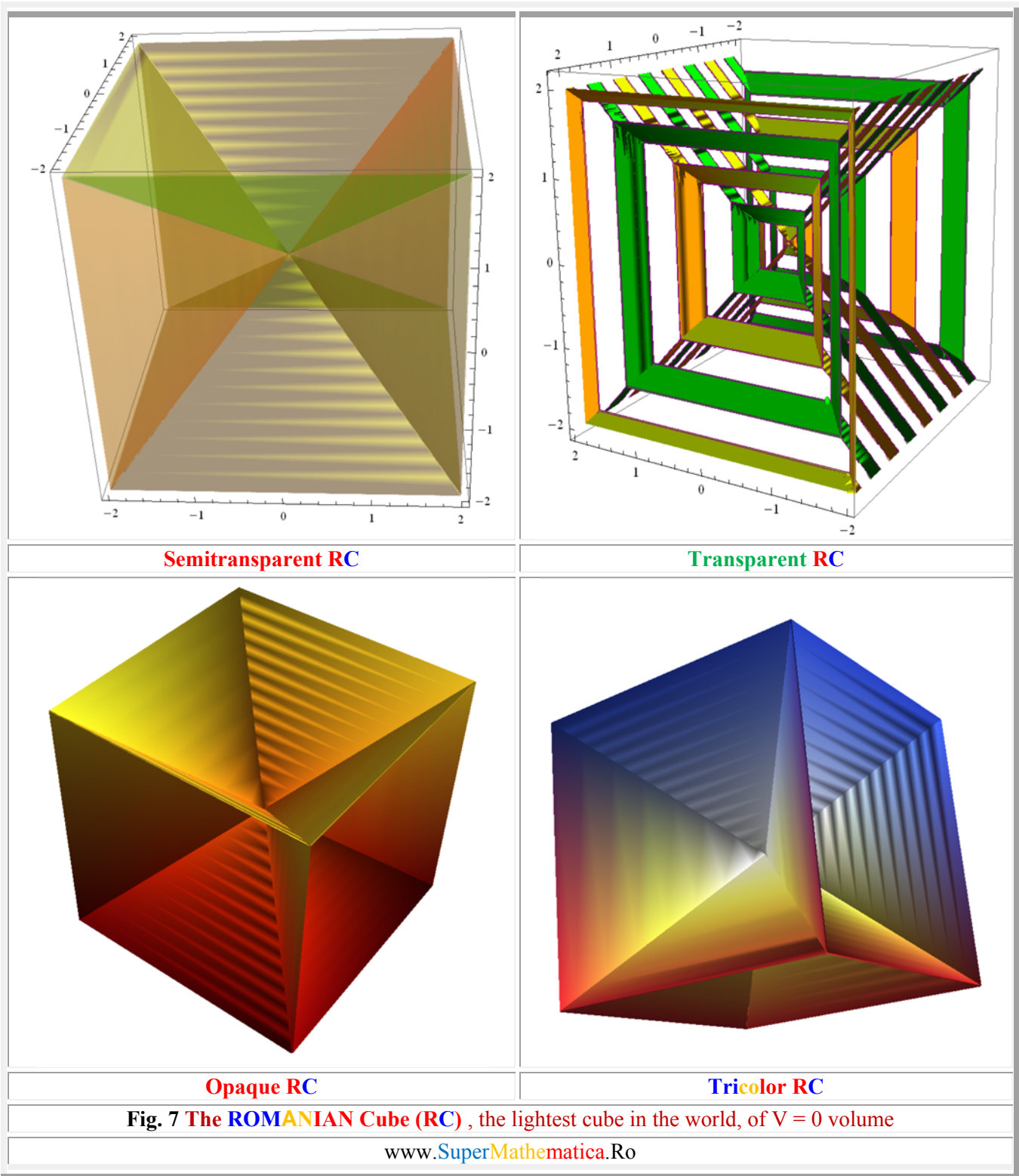

- relations (7), and the other one is ex-centered, centered eccentrical relative to the origin  $O(0, 0)$ - in the point  $C(1,1)$ ;
- Of a **quadrilobe** (neither circle and neither square, namely an infinity of hybrid forms, between circle and square). For the same numerical eccentricity  $s \in (0, 1)$ , which characterizes the **mathematical excenter (ME)** domain, they has the same forms, but are of different dimensions; the first one, having higher dimensions then those expressed with  $dex\theta$  function, what can be concluded also from the **figure 5,b** from 2D.

One can see that the dimension of the quadrilobes expressed by the relation (8) by  $dex\theta$  decrease as eccentricity increase.

The Romanian cube from the **Fig 7**, “**the lightest cube of the world**”, is the cube with zero volume, obtained from 6 pyramids, without their square base surfaces, with the common tip in the cube’s symmetry center.

In this case, the pyramid was expressed through the relations (7), by quadrilobe functions of  $s=1$ .

As a conclusion, **supermatematics** offer multiple possibilities to express different mathematical entities from **center mathematics (CM)**, and, at the same time, an infinity of hybrid entities from the **eccentric mathematics (EM)**.

### BIBLIOGRAFIE

#### IN DOMENIUL SUPERMATEMATICII

- |    |                         |  |  |
|----|-------------------------|--|--|
| 1  | Șelariu Mircea<br>Eugen | <b>FUNȚII CIRCULARE EXCENTRICE</b>   | Com. I Conferință Națională de<br>Vibrații în Construcția de Mașini ,<br>Timișoara , 1978, pag.101...108.                    |
| 2  | Șelariu Mircea<br>Eugen | <b>FUNȚII CIRCULARE EXCENTRICE<br/>ȘI EXTENSIA LOR.</b>  | Bul .Șt.și Tehn. al I.P. ”TV”<br>Timișoara, Seria Mecanică, Tomul<br>25(39), Fasc. 1-1980, pag. 189...196                    |
| 3  | Șelariu Mircea<br>Eugen | <b>STUDIUL VIBRAȚIILOR LIBERE<br/>ALE UNUI SISTEM NELINIAR, CONSERVATIV<br/>CU AJUTORUL FUNȚIILOR CIRCULARE<br/>EXCENTRICE</b> | Com. I Conf. Naț. Vibr.în C.M.<br>Timișoara,1978, pag. 95...100  |
| 4  | Șelariu Mircea<br>Eugen | <b>APLICAȚII TEHNICE ALE FUNȚIILOR<br/>CIRCULARE EXCENTRICE</b>  | Com.a IV-a Conf. PUPR, Timișoara,<br>1981, Vol.1. pag. 142...150 A V-a   |
| 5  | Șelariu Mircea<br>Eugen | <b>THE DEFINITION of the ELLIPTIC ECCENTRIC<br/>with FIXED ECCENTER</b>  | Conf. Naț. de Vibr. în Constr. de<br>Mașini, Timișoara, 1985, pag.175...182  |
| 6  | Șelariu Mircea<br>Eugen | <b>ELLIPTIC ECCENTRICS with MOBILE<br/>ECCENTER</b>  | Com.a IV-a Conf. PUPR, Timișoara,<br>1981, Vol.1. pag. 183...188   |
| 7  | Șelariu Mircea<br>Eugen | <b>CIRCULAR ECCENTRICS and HYPERBOLICS<br/>ECCENTRICS</b>  | Com. a V-a Conf. Naț. V. C. M.<br>Timișoara, 1985, pag. 189...194.   |
| 8  | Șelariu Mircea<br>Eugen | <b>ECCENTRIC LISSAJOUS FIGURES</b>   | Com.a IV-a Conf. PUPR, Timișoara,<br>1981, Vol.1. pag. 195...202   |
| 9  | Șelariu Mircea<br>Eugen | <b>FUNȚIILE SUPERMATEMATICE cex<br/>ȘI sex- SOLUȚIILE UNOR SISTEME MECANICE<br/>NELINIARE</b>                                  | Com. a VII-a Conf.Nat. V.C.M.,<br>Timișoara,1993, pag. 275...284.  |
| 10 | Șelariu Mircea<br>Eugen | <b><u>SUPERMATEMATICA</u></b>  | Com.VII Conf. Internaț. de Ing.<br>Manag. și Tehn.,TEHNO’95<br>Timișoara, 1995, Vol. 9: Matematică<br>Aplicată,, pag.41...64 |

- |    |                         |   |   |
|----|-------------------------|---|---|
| 11 | Șelariu Mircea<br>Eugen | <b>FORMA TRIGONOMETRICĂ<br/>A SUMEI SI A DIFERENȚEI<br/>NUMERELOR COMPLEXE</b>  | Com.VII Conf. Internat. de Ing.<br>Manag. și Tehn., TEHNO'95<br>Timișoara, 1995, Vol. 9: Matematică<br>Aplicată, pag. 65...72                 |
| 12 | Șelariu Mircea<br>Eugen | <b>MIȘCAREA CIRCULARĂ<br/>EXCENTRICĂ</b>  | Com.VII Conf. Internaț. de Ing.<br>Manag. și Tehn. TEHNO'95.,<br>Timișoara, 1995 Vol.7: Mecatronică,<br>Dispozitive și Rob.Ind.,pag. 85...102 |
| 13 | Șelariu Mircea<br>Eugen | <b>RIGIDITATEA DINAMICĂ<br/>EXPRIMATĂ CU FUNCȚII<br/>SUPERMATEMATICE<br/>DETERMINAREA ORICÂT DE EXACTĂ</b>                              | Com.VII Conf. Internaț. de Ing.<br>Manag. și Tehn., TEHNO'95<br>Timișoara, 1995 Vol.7: Mecatronică,<br>Dispoz. și Rob.Ind., pag. 185...194    |
| 14 | Șelariu Mircea<br>Eugen | <b>A RELAȚIEI DE CALCUL A<br/>INTEGRALEI ELIPTICE COMPLETE<br/>DE SPETA ÎNTÂIA K(k)</b>   | Bul. VIII-a Conf. de Vibr. Mec.,<br>Timișoara,1996, Vol III, pag.15 ... 24  |
| 15 | Șelariu Mircea<br>Eugen | <b>FUNCȚII SUPERMATEMATICE CIRCULARE<br/>EXCENTRICE DE VARIABILĂ CENTRICĂ</b>   | TEHNO ' 98. A VIII-a Conferință de<br>inginerie managerială și tehnologică ,<br>Timișoara 1998, pag 531..548                                  |
| 16 | Șelariu Mircea<br>Eugen | <b>FUNCȚII DE TRANZIȚIE INFORMAȚIONALĂ</b>  | TEHNO ' 98. A VIII-a Conferință de<br>inginerie managerială și tehnologică ,<br>Timișoara 1998, pag 549... 556                                |
| 17 | Șelariu Mircea<br>Eugen | <b>FUNCȚIILE SUPERMATEMATICE CIRCULARE<br/>EXCENTRICE DE VARIABILA CENTRICA CA<br/>SOLUȚII ALE UNOR SISTEME OSCILANTE<br/>NELINIARE</b> | TEHNO ' 98. A VIII-a Conferință de<br>inginerie managerială și tehnologică ,<br>Timișoara 1998, pag 557...572                                 |
| 18 | Șelariu Mircea<br>Eugen | <b>INTRODUCEREA STRÂMBEI ÎN MATEMATICĂ</b>  | Lucr. Simp. Național "Zilele<br>Universității Gh. Anghel" Ed. II-a,<br>Drobeta Turnu Severin, 16-17 mai<br>2003, pag. 171 ... 178             |
| 19 | Șelariu Mircea<br>Eugen | <b>QUADRILOBIC VIBRATION SYSTEMS</b>  | The 11 -th International Conference on<br>Vibration Engineering, Timișoara,<br>Sept. 27-30, 2005 pag. 77 ... 82                               |
| 20 | Șelariu Mircea<br>Eugen | <b>SMARANDACHE STEPPED FUNCTIONS</b>  | International Journal "Scientia<br>Magna" Vol.3, Nr.1, 2007 , ISSN<br>1556-6706   |
| 21 | Șelariu Mircea<br>Eugen | <b>TEHNO-ART OF ȘELARIU SUPERMATHEMATICS<br/>FUNCTIONS</b>  | (ISBN-10):1-59973-037-5<br>(ISBN-13):974-1-59973-037-0<br>(EAN): 9781599730370  |
| 22 | Șelariu Mircea<br>Eugen | <b>PROIECTAREA DISPOZITIVELOR DE<br/>PRELUCRARE, Cap. 17 din PROIECTAREA<br/>DISPOZITIVELOR</b>   | Editura Didactică și Pedagogică,<br>București, 1982, pag. 474 ... 543   |
| 23 | Șelariu Mircea<br>Eugen | <b><u>SUPERMATEMATICA.<br/>FUNDAMENTE</u></b>   | Coord onator Vasii Roșculeț Sanda<br>Editura "POLITEHNICA" , Timișoara,<br>2007   |
| 24 | Șelariu Mircea<br>Eugen | <b><u>SUPERMATEMATICA.<br/>FUNDAMENTE VOL.I EDITIA A II-A</u></b>   | Editura "POLITEHNICA" , Timișoara,<br>2012  |
| 25 | Șelariu Mircea<br>Eugen | <b><u>SUPERMATEMATICA.<br/>FUNDAMENTE VOL.II</u></b>  | Editura "POLITEHNICA" , Timișoara,<br>2012  |
| 26 | Șelariu Mircea<br>Eugen | <b>TRANSFORMAREA RIGUROASA IN CERC A<br/>DIAGRAMEI POLARE A COMPLIANȚEI</b>   | Buletiiul celei de a X-a Conf. de Vibr.<br>Mec.cu participare interatională, Bul.<br>Șt. al Univ. "Politehnica" din Timșoara,                 |



- 
- |    |                         |   |
|----|-------------------------|---|
|    |                         | Seria Mec. Tom 47(61), mai 2002, Vol II, pag.247...260.   |
| 27 | Șelariu Mircea<br>Eugen | <b>UN SISTEM SUPERMATEMATIC CU BAZĂ CONTINUĂ DE APROXIMARE A FUNCȚIILOR</b><br><a href="http://www.CartiAZ.ro">www.CartiAZ.ro</a>   |
| 28 | Șelariu Mircea<br>Eugen | <b>DE LA REZOLVAREA TRIUNGHIURILOR LA FUNCȚII SUPERMATEMATICE (SM)</b><br><a href="http://www.CartiAZ.ro">www.CartiAZ.ro</a>  |
| 29 | Șelariu Mircea<br>Eugen | <b>FUNCȚIILE SUPERMATEMATICE CIRCULARE COSINUS ȘI SINUS EXCENTRICE (FSM-CE <math>cex\theta</math> ȘI <math>sex\theta</math>)</b><br><b>DE VARIABILĂ EXCENTRICĂ <math>\theta</math>, DERIVATELE ȘI INTEGRALELE LOR</b><br><a href="http://www.CartiAZ.ro">www.CartiAZ.ro</a> |
| 30 | Șelariu Mircea<br>Eugen | <b>LOBE EXTERIOARE ȘI CVAZILOBE INTERIOARE CERCULUI UNITATE</b><br><a href="http://www.CartiAZ.ro">www.CartiAZ.ro</a>   |
| 31 | Șelariu Mircea<br>Eugen | <b>METODĂ DE INTEGRARE PRIN DIVIZAREA DIFERENȚIALEI</b><br><a href="http://www.CartiAZ.ro">www.CartiAZ.ro</a>   |
| 32 | Șelariu Mircea<br>Eugen | <b>FUNCȚII COMPUSE AUTOINDUSE (FAI) ȘI FUNCȚII INDUSE (FI)</b><br><a href="http://www.CartiAZ.ro">www.CartiAZ.ro</a>  |
| 33 | Șelariu Mircea<br>Eugen | <b>FUNCȚII SUPERMATEMATICE CIRCULARE EXCENTRICE INVERSE (FSM-CEI)</b><br><a href="http://www.CartiAZ.ro">www.CartiAZ.ro</a>   |
| 34 | Șelariu Mircea<br>Eugen | <b>FUNCȚII HIPERBOLICE EXCENTRICE</b><br><a href="http://www.CartiAZ.ro">www.CartiAZ.ro</a>   |
| 35 | Șelariu Mircea<br>Eugen | <b>ELEMENTE NELINIARE LEGATE ÎN SERIE</b><br><a href="http://www.CartiAZ.ro">www.CartiAZ.ro</a>   |
| 36 | Șelariu Mircea<br>Eugen | <b>INTERSECȚII ÎN PLAN</b><br><a href="http://www.CartiAZ.ro">www.CartiAZ.ro</a>  |
| 37 | Șelariu Mircea<br>Eugen | <b>LINIILE CONCURENTE ȘI PUNCTELE LOR DE INTERSECȚIE ÎNTR-UN TRIUNGHI</b><br><a href="http://www.CartiAZ.ro">www.CartiAZ.ro</a>   |
| 38 | Șelariu Mircea<br>Eugen | <b>MIȘCAREA CIRCULARĂ EXCENTRICĂ DE EXCENTRU PUNCT MOBIL</b><br><a href="http://www.CartiAZ.ro">www.CartiAZ.ro</a>  |
| 39 | Șelariu Mircea<br>Eugen | <b>TEOREMELE POLIGOANELOR PĂTRĂTE, DREPTUNGHIURI ȘI TRAPEZE ISOSCELE Ș</b><br><a href="http://www.CartiAZ.ro">www.CartiAZ.ro</a>  |
| 40 | Șelariu Mircea<br>Eugen | <b>UN SISTEM SUPERMATEMATIC CU BAZĂ CONTINUĂ DE APROXIMARE A FUNCȚIILOR</b><br><a href="http://www.CartiAZ.ro">www.CartiAZ.ro</a>   |
| 41 | Șelariu Mircea<br>Eugen | <b>FUNCȚIILE SM – CE <math>rex_{1,2}\theta</math> CA SOLUȚII ALE ECUAȚIILOR ALGEBRICE DE GRADUL AL DOILEA CU O SINGURĂ NECUNOSCUTĂ</b><br><a href="http://www.CartiAZ.ro">www.CartiAZ.ro</a>  |
| 42 | Șelariu Mircea<br>Eugen | <b>TEOREMA Ș A BISECTOARELOR UNUI PATRULATER INSCRIPTIBIL ȘI TEOREMELE Ș ALE TRIUNGHIULUI</b><br><a href="http://www.CartiAZ.ro">www.CartiAZ.ro</a>   |
| 43 | Petrișor<br>Emilia      | <b>ON THE DYNAMICS OF THE DEFORMED STANDARD MAP</b><br>Workshop Dynamicas Days'94, Budapest, și Analele Univ.din Timișoara, Vol.XXXIII, Fasc.1-1995, Seria Mat.-Inf.,pag. 91...105  |
| 44 | Petrișor<br>Emilia      | <b>SISTEME DINAMICE HAOTICE</b><br>Seria Monografii matematice, Tipografia Univ. de Vest din Timișoara, 1992  |
|    |                         | <b>RECONNECTION SCENARIOS AND THE</b>   |

- 
- |    |  |   |  |
|----|--|---|--|
| 45 | Petrișor<br>Emilia   | <b>THRESHOLD OF RECONNECTION IN THE DYNAMICS OF NONTWIST MAPS</b>   | Chaos, Solitons and Fractals, 14 (2002) 117-127  |
| 46 | Petrișor<br>Emilia   | <b>NON TWIST AREA PRESERVING MAPS WITH REVERSING SYMMETRY GROUP</b>   | International Journal of Bifurcation and Chaos, Vol.11, no 2(2001) 497-511   |
| 47 | Cioara Romeo   | <b>FORME CLASICE PENTRU FUNCȚII CIRCULARE EXCENTRICE</b>  | Proceedings of the Scientific Communications Meetings of "Aurel Vlaicu" University, Third Edition, Arad, 1996, pg.61 ...65 |
| 48 | Preda Horea  | <b>REPREZENTAREA ASISTATĂ A TRAIECTORILOR ÎN PLANUL FAZELOR A VIBRAȚIILOR NELINIARE</b>   | Com. VI-a Conf.Naț.Vibr. în C.M. Timișoara, 1993, pag.   |
| 49 | Filipescu<br>Avram   | <b>APLICAREA FUNCȚIILOR EXCENTRICE PSEUDOHIPERBOLICE ( ExPH ) ÎN TEHNICĂ</b>  | Com.VII-a Conf. Internat.de Ing. Manag. și Tehn. TEHNO'95, Timișoara, Vol. 9. Matematică aplicată, pag. 181 ... 185        |
| 50 | Dragomir<br>Lucian   | <b>UTILIZAREA FUNCȚIILOR SUPERMATEMATICE IN CAD / CAM : SM-CAD / CAM. Nota I-a: REPREZENTARE ÎN 2D</b>                              | Com.VII-a Conf. Internaț.de Ing. Manag. și Tehn. TEHNO'95, Timișoara, Vol. 9. Matematică aplicată, pag. 83 ... 90          |
| 51 | Șelariu Șerban   | <b>UTILIZAREA FUNCȚIILOR SUPERMATEMATICE IN CAD / CAM : SM-CAD / CAM. Nota II -a: REPREZENTARE ÎN 3D</b>                            | Com.VII-a Conf. Internaț.de Ing. Manag. și Tehn. TEHNO'95, Timișoara, Vol. 9. Matematică aplicată., pag. 91 ... 96         |
| 52 | Staicu<br>Florențiu  | <b>DISPOZITIVE UNIVERSALE de PRELUCRARE a SUPRAFEȚELOR COMPLEXE de TIPUL EXCENTRICELOR ELIPTICE</b>                                 | Com. Ses. anuale de com.șt. Oradea ,1994   |
| 53 | George<br>LeMac  | <b>THE ECCENTRIC TRIGONOMETRIC FUNCTIONS: AN EXTENTION OF CLASSICAL TRIGONOMETRIC FUNCTIONS.</b>                                    | The University of Western Ontario, London, Ontario, Canada<br>Department of Applied Mathematics<br>May 18, 2001            |
| 54 | Șelariu Mircea<br>Ajiduah<br>Cristoph<br>Bozântan Emil<br>Filipescu<br>Avram | <b>INTEGRALELE UNOR FUNCȚII SUPERMATEMATICE</b>   | Com. VII Conf.Internaț. de Ing.Manag. și Tehn. TEHNO'95 Timișoara. 1995,Vol.IX: Matem. Aplic. pag.73...82                  |
| 55 | Șelariu Mircea<br>Fritz Georg<br>Meszaros A.                                 | <b>ANALIZA CALITĂȚII MIȘCARILOR PROGRAMATE cu FUNCȚII SUPERMATEMATICE</b>   | IDEM, Vol.7: Mecatronică, Dispozitive și Rob.Ind., pag. 163...184  |
| 56 | Șelariu Mircea<br>Szekely Barna  | <b>ALTALANOS SIKMECHANIZMUSOK FORDULATSZAMAINAK ATVITELI FUGGVENYEI MAGASFOKU MATEMATIKAVAL A FELSOFOKU MATEMATIKA ALKALMAZASAI</b> | Bul.Șt al Lucr. Premiate, Universitatea din Budapesta, nov. 1992   |
| 57 | Șelariu Mircea<br>Popovici<br>Maria  |   | Bul.Șt al Lucr. Premiate, Universitatea din Budapesta, nov. 1994   |
| 58 | Smarandache<br>Florentin<br>Șelariu Mircea<br>Eugen                          | <b>IMMEDIATE CALCULATION OF SOME POISSON TYPE INTEGRALS USING SUPERMATHEMATICS CIRCULAR EX-CENTRIC FUNCTIONS</b>                    | arXiv:0706.4238, 2007  |

- 
- |    |  |  |  |
|----|--|--|--|
| 59 | Konig<br>Mariana<br>Șelariu Mircea                                 | <b>PROGRAMAREA MIȘCĂRII DE CONTURARE A ROBOȚILOR INDUSTRIALI cu AJUTORUL FUNCȚIILOR TRIGONOMETRICE CIRCULARE EXCENTRICE</b>                                      | MEROTEHNICA, Al V-lea Simp. Naț.de Rob.Ind.cu Part .Internaț. Bucuresti, 1985<br>pag.419...425   |
| 60 | Konig<br>Mariana<br>Șelariu Mircea                                 | <b>PROGRAMAREA MIȘCĂRII de CONTURARE ale R. I. cu AJUTORUL FUNCȚIILOR TRIGONOMETRICE CIRCULARE EXCENTRICE</b>  | Merotehnica, V-lea Simp. Naț.de RI cu participare internațională, Buc.,1985, pag. 419 ... 425.   |
| 61 | Konig<br>Mariana<br>Șelariu Mircea                                 | <b>THE STUDY OF THE UNIVERSAL PLUNGER IN CONSOLE USING THE ECCENTRIC CIRCULAR FUNCTIONS</b>  | Com. V-a Conf. PUPR, Timișoara, 1986, pag.37...42  |
| 62 | Staicu<br>Florentiu<br>Șelariu Mircea                              | <b>CICLOIDELE EXPRIMATE CU AJUTORUL FUNCȚIEI SUPERMATEMATICE <math>\text{rex}\theta</math></b>   | Com. VII Conf. Internațională de Ing.Manag. și Tehn ,Timișoara "TEHNO'95" pag.195-204  |
| 62 | Gheorghiu<br>Em. Octav<br>Șelariu Mircea<br>Bozântan Emil          | <b>FUNCȚII CIRCULARE EXCENTRICE DE SUMĂ DE ARCE</b>  | Ses.de com.șt.stud.,Secția Matematică,Timișoara, Premiul II la Secția Matematică, 1983   |
| 64 | Gheorghiu<br>Emilian Octav<br>Șelariu Mircea<br>Cojerean<br>Ovidiu | <b>FUNCȚII CIRCULARE EXCENTRICE. DEFINIȚII, PROPRIETĂȚI, APLICAȚII TEHNICE</b>   | Ses. de com. șt.stud. Secția Matematică, premiul II la Secția Matematică, pe anul 1985.  |
| 65 | Șelariu Mircea<br>Eugen,<br>Bălă Dumitru                           | <b>WAYS OF PRESENTING THE DELTA FUNCTION AND AMPLITUDE FUNCTION JACOBI</b>   | Proceedings of the2nd World Congress on Science, Economics and Culture, 25-29 August 2008 New York, paper published in Denbridge Journals, p.42 ... 55 |
| 66 | Dumitru Bălă   | <b>SUPERMATHEMATICAL – ȘELARIU FUNCTIONS BETA ECCENTRIC <math>\text{bex}\theta</math> SOLUTIONS OF SOME OSCILATORY NON-LINIAR SYSTEMS (SO<math>\beta</math>)</b> | Proceedings of the2nd World Congress on Science, Economics and Culture, 25-29 August 2008 New York, paper published in Denbridge Journals, p.27 ... 41 |
| 67 | Șelariu Mircea<br>Eugen<br>Smarandache<br>Florentin<br>Nițu Marian | <b>CARDINAL FUNCTIONS AND INTEGRAL FUNCTIONS</b>   | International Journal of Geometry Vol.1 (2012), N0. 1, 5-14  |

## **Extension Communication for Solving the Ontological Contradiction between Communication and Information**

Florentin Smarandache  
University of New Mexico  
200 College Road,  
Gallup, NM 87301, U.S.A.

Ștefan Vlăduțescu  
University of Craiova  
Romania

The study lies in the interdisciplinary area between the information theory and extenics, as the science of solving the contradictions. This space addresses the central issue of the ontology information, the contradictory relationship between communication and information. The research core is the reality that the scientific research of communication-information relationship has reached a dead end. The bivalent relationship communication-information, information-communication has come to be contradictory, and the two concepts to block each other. With the Extenics as a science of solving the conflicting issues, "extenics procedures" will be used to solve the contradiction. In this respect, considering that the matter-elements are defined, their properties will be explored ("The key to solve contradictory problems, Wen Cai argues, the founder of Extenics (1999, p 1540), is the study of properties about matter-elements"). According to „The basic method of Extenics is called extension methodology” (...), and "the application of the extension methodology in every field is the extension engineering methods" (Weihai Li, Chunyan Yang, 2008, p 34).

With linguistic, systemic, and hermeneutical methods, grafted on "extension methodology" a) are "open up the things", b) is marked "divergent nature of matter-element", c) "extensibility of matter-element" takes place and c) "extension communication" allows a new inclusion perspective to open, a sequential ranging of things to emphasize at a higher level and the contradictory elements to be solved. "Extension" is, as postulated by Wen Cai (1999, p 1538) "opening up carried out".

After the critical examination of conflicting positions expressed by many experts in the field, the extenics and inclusive hypothesis is issued that information is a form of communication. The object of communication is the sending of a message. The message may consist of thoughts, ideas, opinions, feelings, beliefs, facts, information, intelligence or other signification elements. When the message content is primarily informational, communication will become information or intelligence.

The arguments of supporting the hypothesis are linguistic (the most important being that there is "communication of information" but not "information of communication"), systemic-procedural (in the communication system is developing an information system; the informing actant is a type of communicator, the information process is a communication process), practical arguments (the delimitation eliminates the efforts of disparate and inconsistent understanding of the two concepts), epistemological arguments (the possibility of inter-subjective thinking of reality is created), linguistic arguments (it is clarified and reinforced the over situated referent, that of the communication as a process), logical and realistic arguments (it is noted the situation that allows to think coherently in a system of concepts - derivative series or integrative groups) and arguments from historical experience (the concept of communication has temporal priority, it appears 13 times with Julius Caesar). The main arguments are summarized in four axioms: three are based on the pertinent observations of Tom D. Wilson-Marcus Solomon, Magoroh Maruyama and Richard Varey, and the fourth is a relevant application of Florentin Smarandache's neutrosophic theory on communication.

Keywords: extension communication, information, extenics, ontology, neutrosophic communication, message

## **I. The information thesis as a form of communication**

The question of the relationship between communication and information as fields of existence is the fingerprint axis of communication and information ontology. The ontological format allows two formulas: the existence in the act and the virtual existence. The ontological component of the concepts integrates a presence or a potency and an existential fact or at a potential of existence.

In addition to the categorial-ontological element, in the nuclear ratio of communication-information concepts it shows comparative specificities and regarding attributes and characteristics, on three components, epistemological, methodological and hermeneutical.

In a science which would have firmly taken a strong subject, a methodology and a specific set of concepts, this ontological founding decision would be taken in an axiom. It is known that, in principle, axioms solve within the limits of that type of argument called evidence (clear and distinct situation), the relations between the systemic, structural, basic concepts. Specifically, in Extenics, scientists with an advanced vision, substantiated by professor Wen Cai, axioms govern the relationship between two matter-elements with divergent profiles. For the communication and information issues that have occurred relatively recently (about three quarters of a century) in subjects of study or areas of scientific concern not a scientific authority to settle the issue

was found. The weaknesses of these sciences of soft type are visible even today when after non accredited proposals of science ("comunicology" - comunicology Joseph De Vito, "communicatics," - "comunicatique" of Metayer G., informatology - Klaus Otten and Anthony Debon) it was resorted to the remaining in the ambiguity of validating the subject "The sciences of communication and information" or "The sciences of information and communication", enjoying the support of some courses, books, studies and dictionaries.

This generic vision of unity and cohesion wrongs both the communication and information. In practice, the apparent unjust overall, integrative, altogether treatment has not an entirely and covering confirmation. In almost all humanist universities of the world the faculties and the communication courses are prevailing, including those of Romania and China. Professor Nicolae Drăgulănescu ascertained in what Romania is concerned, that in 20 colleges communication (with various denominations) is taught and in only two the informing-information is taught.

The main perspectives from which the contradictory relationship of communication-information was approached are the ontological, the epistemological and the systemic. In most cases, opinions were incidental. When it was about the dedicated studies, the most common comparative approach was not programmatically made on one or more criteria and neither directly and applied. Jorge Reina Schement, R. Brent Ruben, Harmut B. Mokri and Magoroh Maruyama's contributions remain fundamental.

In his study "Communication and Information" (19 March 9, pp. 3-31), J. R. Schement starts from the observation that "in the rhetoric of the Information Age, the communication and information converge in synonymous meanings." On the other hand, he retains that there are specialists who declare in favor of stating a firming distinction of their meanings. To clarify exactly the relationship between the two phenomena, i.e. concepts, he examines the definitions of information and communication that have marked the evolution of the "information studies" and the "communication studies". For informing (information) three fundamental themes result: information-as-thing (M. K. Buckland), information-as-process (N.J. Belkin, R.M. Hays, Machlup & Mansfield, etc.), Information-as-product-of - manipulation (C.J. Fox, R.M. Hayes). It is also noted that these three subjects involve the assessing of their issuers, a "connection to the phenomenon of communication". In parallel, from examining the definitions of communication it is revealed that the specialists "implicitly or explicitly introduce the notion of information in defining communication". There are also three the central themes of defining communication: communication-as-transmission (W. Weaver, E. Emery, C. Cherry, B. Berelson, G. Steiner), communication-as-sharing-process (RS Gover, W. Schramm), communication-as-interaction (G. Gerbner, L. Thayer). Comparing the six thematic nodes, Schement emphasizes that the link between

information and communication is "highly complex" and dynamic "information and communication is ever present and connected" (Schement JR, 1993, p 17). In addition, in order that "information exist, the potential for communication must be present".

The result at the ontological level of these findings is that the existence of information is (strictly) conditioned by the presence of communication. That is for the information to occur communication must be present. Communication will precede and always condition the existence of information. And more detailed: communication is part of the information ontology. Ontologically, information occurs in communication also as potency of communication. J. R. Schement is focused on finding a way to census a coherent image leading to a theory of communication and information ("Toward a Theory of Communication and Information" - Schement JR, 1993, p 6). Therefore, he avoids to conclusively asserting the temporal and linguistic priority, the ontological precedence and the amplitude of communication in relation to information. The study concludes that 1. "Information and communication are social structures" ("two words are used as interchangeable, even as synonyms" – it is argued) (Schement JR, 1993, p 17), 2. "The study of information and communication share concepts in common" (in both of them communication, information, "symbol, cognition, content, structure, process, interaction, technology and system are to be found" - Schement JR, 1993, p 18), 3. "Information and communication form dual aspects of a broader phenomenon" (Schement J.R., 1993, p. 18). In other words, we understand that: a) linguistically ("words", "terms", "notions", "concepts", "idea of") communication and information are synonyms; b) as area of study the two resort the same conceptual arsenal. Situation produced by these two elements of the conclusion allows, in our opinion, a hierarchy between communication and information. If it is true that ontologically and temporally the communication precedes information, if this latter phenomenon is an extension smaller than the first, if eventual sciences having communication as object, respectively information, benefit from the one and the same conceptual vocabulary, then the information can be a form of communication. Despite this line followed coherently by the linguistic, categorical-ontological, conceptual and definitional epistemological arguments brought in the reasoning, the third part of the conclusion postulates the existence of a unique phenomenon which would include communication and information (3. "Information and communication form two aspects of the same phenomenon "- Schement JR, 1993, p 18). This phenomenon is not named. The conclusive line followed by the arguments and the previous conclusive elements enabled us to articulate information as one of the forms of communication. Confirmatively, the fact that JR Schement does not name a phenomenon situated over communication and information, gives us the possibility of attracting the argument in order to strengthen our thesis that information is a form of communication. That is because a category of

phenomena encompassing communication and information cannot be found. J. R. Schement tends towards a leveling perspective and of convergence in the communication and information ontology. Instead, M. Norton supports an emphasized differentiation between communication and information. He belongs to those who see communication as one of the processes and one of the methods "for making information available". The two phenomena "are intricately connected and have some aspects that seem similar, but they are not the same" (M. Norton, 2000, p 48 and 39). Harmut B. Mokros and Brent R. Ruben (1991) lay the foundation of a systemic vision and leveling understanding of the communication-information relationship. Taking into account the context of reporting as a core element of the internal structure of communication and information systems, they mark the information as a criterion for the radiography of relationship. The systemic-theoretical non-linear method of research founded in 1983 by B. R. Ruben is applied to the subject represented by the phenomena of communication and information. Research lays in the "Information Age" and creates an informational reporting image. The main merit of the investigation comes from the relevance given to the non-subordination between communication and information in terms of a unipolar communication that relates to leveling information. Interesting is the approach of information in three constituent aspects: "informatione" (potential information - that which exists in a particular context, but never received a significance in the system), "information" (active information in the system) and "information" (information created socially and culturally in the system). The leveling information is related to a unified communication. On each level of information there is communication. Information and communication is co-present: communication is inherent to information. Information has inherent properties of communication. Research brings a systemic-contextual elucidation to the relationship between communication and information and only subsidiarily a firm ontological positioning. In any case: in information communication never misses.

In the most important studies of the professor Stan Petrescu: "Information, the fourth weapon" (1999) and "About intelligence. Espionage-Counterespionage"(2007), information is understood as "a type of communication" (Petrescu S., 1999, p 143) and situated in the broader context of "knowledge on the internal and international information environment "(S. Petrescu, 2007, p 32).

## **II. The subject of communication: the message. The subject of informing: the information. The information thesis as species of message**

In order to finish our basic thesis that of the information as a form of communication, new arguments may be revealed which corroborate with those previously mentioned. As phenomena, processes, the communication and



information occur in a unique communication system. In communication, information has acquired a specialized profile. In the information field, the intelligence, in his turn, strengthened a specific, detectable, identifiable and discriminative profile. It is therefore acceptable under the pressure of practical argument that one may speak of a general communication system which in relation to the message sent and configured in the communication process could be imagined as information system or intelligence system. Under the influence of the systemic assumption that a (unitary) communicator transmits or customize transactionally with another (receiving) communicator a message, one may understand the communicational system as the interactional unit of the factors that exerts and fulfill the function of communicating a message.

In his books "Messages: building interpersonal communication skills" (attained in 1993 its fourth edition and in 2010 its twelfth) and "Human Communication" (2000), Joseph De Vito (the renowned specialist who has proposed the name "Communicology" for the sciences of communication - 1978), develops a concept of a simple and productive message. The message is, as content, what is communicated. As a systemic factor, it is emerging as what is communicated. To remember in this context is that the German Otto Kade insisted that what it is communicated to receive the title of "release". According to Joseph De Vito, through communication meanings are transmitted. "The communicated message" is only a part of the meanings (De Vito J., 1993, p 116). Among the shared meanings feelings and perceptions are found (De Vito J., 1993, p. 298). Likewise, information can be communicated (De Vito J., 1990, p 42), (De Vito J., 2000, p 347).

In a "message theory" called "Angelitică" (Angelitics), Rafael Capurro argues that the message and information are concepts that designate similar but not identical phenomena. In Greek "Angela" meant message; from here, "Angelitica" or theory of the message (Angelitica is different from Angeologia dealing, in the field of religion and theology, with the study of angels) (<http://www.capurro.de/angelitics.html>). R. Capurro set four criteria for assessing the relationship between message and information. The similarity of the two extends over three of them. The message, as well as the information, is characterized as follows: „is supposed to bring something new and/or relevant to the receiver; can be coded and transmitted through different media or messengers; is an utterance that gives rise to the receiver's selection through a release mechanism of interpretation". "The difference between these two is the next: „a message is sender-dependent, i.e. it is based on a heteronomic or asymmetric structure. This is not the case of information: we receive a message but we ask for information" ([http://www.capurro.de/angeletics\\_zkm.html](http://www.capurro.de/angeletics_zkm.html)). To request information is to send a message of requesting information. Therefore, the message is similar to the information in this respect too. In our opinion, the difference between them is from genus to species: information is a species of message. The message depends on the transmitter and the information, as well.

Information is still a specification of the message, is an informative message. C. Shannon asserts that the message is the defining subject of the communication. He is the stake of the communication because „the fundamental problem of communication is that of reproducing at one point either exactly or approximately a message selected at another point” (1949, p. 31).

The communication process is in fact the "communication" of a complex and multilayered message. "Thoughts, interests, talents, experiences"(Duck S., Mc Mahan D.T., 2011, p 222), "information, ideas, beliefs, feelings "(Wood J.T., 2009, p 19 and p 260) can be found in a message. G. A. Miller, T. M. Newcomb and Brent R. Ruben consider that the subject of communication is information: "Communication - Miller shows – means that information is passed from one place to another” (Miller G. A., 1951, p. 6). In his turn, T. M. Newcomb asserts: „very communication act is viewed as a transmission of information” (Newcomb T. M., 1966, p. 66) and Brent R. Ruben argues: „Human communication is the process through which individuals in relationships, groups, organizations and societies create, transmit and use information to relate to the environment and one another” (Ruben B. R., 1992, p. 18).

Professor Nicolae Drăgulănescu, member of the American Society of Information Science and Technology, is the most important of Romanian specialists in the Science of information. According to him, "communicating information" is the third of the four processes that form the "informational cycle", along with generating the information, processing/storing the information and the use of information. The process of communication, N. Dragulanescu argues, is one of the processes whose object is the information (<http://ndragulanescu.ro/publicatii/CP54.pdf>, p 8). The same line is followed by Gabriel Zamfir too; he sees the information as "what is communicated in one or other of the available languages" (Zamfir G., 1998, p. 7), as well as teacher Sultana Craia: communication is a "process of transmitting a piece of information, a message" (Crai S., 2008, p 53). In general, it is accepted that information means transmitting/receiving information. However, when speaking of transmitting information, the process is considered not to be information but communication. Therefore, it is created the appearance that the information is the product and communication would only be the transmitting process. Teodoru Ștefan, Ion Ivan și Cristian Popa assert: "Communication is the process of transmitting information, so the ratio of the two categories is from the basic product to its transmission" (Stephen T., Ivan I., Popa C., 2008, p 22). The professors Vasile Tran and Irina Stănciugelu see communication as an "exchange of information with symbolic content" (V. Tran, Stănciugelu I., 2003, p 109). The communication is an over-ranged concept and an ontological category more extended than informing or information. On the other hand, information is generated even in the global communication process. From this point of view, information (whose subject-message is information) is a regional,

sectorial communication. Information is that communication whose message consists of new, relevant, pertinent and useful significances, i.e. of information. This position is shared by Doru Enache too (2010, p 26).

The position set by Norbert Wiener, consolidated by L. Brillouin and endorsed by many others makes from the information the only content of the message. N. Wiener argues that the message "contains information" (Wiener N., 1965, p 16), L. Brillouin talks about "information contained in the message" (L. Brillouin, 2004, p 94 and p 28).

Through communication "information, concepts, emotions, beliefs are conveyed" and communication "means (and subsumes) information" (Rotaru N., 2007, p.10). Well-known teachers Marius Petrescu and Neculae Năbârjoiu consider that the distinction between communication and information must be achieved depending on the message. A communication with an informational message becomes information. As a form of communication, information is characterized by an informative message and a "message is informative as long as it contains something unknown yet" (M. Petrescu, Năbârjoiu N., 2006, p 25). One of the possible significant elements that could form the message content is thus the information as well. Other components could be thoughts, ideas, beliefs, knowledge, feelings, emotions, experiences, news facts. Communication is "communicating" a message regardless of its significant content.

### **III. Four axioms of communication-information ontology**

3.1. The message axiom. We call the ontological segregation axiom on the subject or the Tom D. Wilson-Solomon Marcus' axiom, the thesis that not any communication is information, but any information is communication. Whenever the message contains information, the communicational process will acquire an informational profile. Moreover, the communicational system becomes informational system. Derivatively, the communicator becomes the "informer" and the communicational relationship turns into informational relationship. The interactional basis of society, even in the Information Age, is the communicational interaction. Most social interactions are non-informational. In this respect, T. D. Wilson has noted: „We frequently receive communications of facts, data, news, or whatever which leave us more confused than ever. Under formal definition these communications contain no information” (Wilson T. D., 1987, p. 410). Academician Solomon Marcus takes into account the undeniable existence of a communication "without a transfer of information" (Marcus S., 2011, vol. 1. P. 220). For communications that do not contain information we do not have a separate and specific term. Communications containing information or just information are called informing.

Communication involves a kind of information, but as Jean Baudrillard

stated (Apud Dancu VS, 1999, p 39), "it is not necessarily based on information". More specifically, any communication contains cognition that can be knowledge, data or information. Therefore, in communication, information may be missing, may be adjacent, incidental or collateral. Communication can be informational in nature or its destination. That communication which by its nature and organization is communication of information is called informing.

The main process ran in Information System is informing. The function of such a system is to inform. The actants can be informants, producers-consumers of information, transmitters of information, etc. The information action takes identity by the cover enabled onto-categorial by the verb "to inform". In his turn, Petros A. Gelepithis considers the two concepts, communication and information to be crucial for "the study of information system" (Gelepithis PA, 1999, p 69).

Confirming the information axiom as post reductionist message, as reduced object of communication, Soren Brier substantiates: „communication system actually does not exchange information” (Brier S., 1999, p. 96). Sometimes, within the communication system information is no longer exchanged. However, communication remains; communication system preserves its validity, which indicates and, subsequently, proves that there can be communication that does not involve information.

Then:

a) when in the Information System functional principles such as "need to know"/"need to share" are introduced,

b) when running processes for collecting, analyzing and disseminating information,

c) when the beneficiaries are deciders, "decision maker", "ministry", "government", "policymakers" and

d) when the caginess item occurs,

this Information System will become Intelligence System (see Gill P., Marrin S., Phytian M., 2009, p. 16, p. 17, p. 112, p. 217), (Sims J.E., Gerber B., 2005, p. 46, p. 234; Gill P., Phytian S., 2006, p. 9, p. 236, p. 88; Johnson L.K. (ed.) 2010, p. 5, p. 6, p. 61, p. 392, p. 279, Maior G.-C. (ed.), 2010). "Secrecy, Peter Gill establishes, is the Key to Understanding the essence of intelligence" (Gill P., S. Marrin, Phyti of n M., 2009, p 18), and professor George Cristian Maior emphasizes: "in intelligence, collecting and processing information from secret sources remain essential" Major G.-C., 2010, p 11).

Sherman Kent, W. Laqueur, M.M. Lowenthal, G.-C. Major etc. start from a complex and multilayered concept of intelligence, understood as meaning

knowledge, activity, organization, product, process and information. Subsequently, the question of ontology, epistemology, hermeneutics and methodology of intelligence occurs. Like Peter Gill, G.-C. Major does pioneering work to separate the ontological approach of intelligence from the epistemological one and to analyze the "epistemological foundation of intelligence" (Major G.-C., 2010, p 33 and p 43).

The intelligence must be also considered in terms of ontological axiom of the object. In this regard, noticeable is that one of its meanings, perhaps the critical one, places it in some way in the information area. In our opinion, the information that has critical significance for accredited operators of the state, economic, financial and political power, and holds or acquires confidential, secret feature is or becomes intelligence. Information from intelligence systems can be by itself intelligence or end up being intelligence after some specialized processing. "Intelligence is not just information that merely exists" (Marina M., Ivan I., 2010, p 108), Mariana Marinică and Ion Ivan assert, it is acquired after a "conscious act of creation, collection, analysis, interpretation and modeling information" (Marina M., Ivan I., 2010, p 105).

**3.2. Teleological axiom.** In addition to the axiom of segregating communication, of informing in relation to the object (message), it may be stated as an axiom a Magoroh Maruyama's contribution to the demythologization of information. In the article "Information and Communication in Poly Epistemological System" in "The Myths of Information", he states: „The transmission of information is not the purpose of communication. In Danish culture, for example, the purpose of communication is frequently to perpetuate the familiar, rather than to introduce new information” (1980, p. 29).

The ontological axiom of segregation in relation to the purpose determines information as that type of communication with low emergence in which the purpose of the interaction is transmitting information.

**3.3. Linguistic axiom.** A third axiom of communication-information ontological segregation can be drawn in relation to the linguistic argument of the acceptable grammatical context. Richard Varey considers that understanding "the difference between communication and information is the central factor" and finds in the linguistic context the criterion to validate the difference: „we speak of giving information **to** while communicate **with** other” (1997, p. 220). The transmission of information takes place "to" or to someone, and communication takes place "with". Along with this variant of grammatical context it might also emerge the situation of acceptability of some statements in relation to the object of the communication process, respectively the object of the information process.

The statement "to communicate a message, information" is acceptable. Instead, the statement "to inform communication" is not. The phrase "communication of messages-information" is valid, but the phrase "informing of

communication", is not. Therefore, language bears knowledge and "lead us" (Martin Heidegger states) to note that, linguistically, communication is more ontological extensive and that information ontology is subsumed to it.

The ontical and ontological nature of language allows it to express the existence and to achieve a functional-grammatical specification. Language allows only grammatical existences. As message, the information can be "communicated" or "communicable". There is also the case in which a piece of information can not be "communicated" or "communicable". Related, communication can not be "informed". The semantic field of communication is therefore larger, richer and more versatile. Communication allows the "incommunicable".

**3.4. The neutrosophic communication axiom.** Understanding the frame set by the three axioms, we find that some communicational elements are heterogeneous and neutral in relation to the criterion of informativity. In a speech some elements can be suppressed without the message suffering informational alterations. This means that some message-discursive meanings are redundant; others are not essential in relation to the orexis-the practical course or of practical touch in the order of reasoning. Redundancies and non-nuclear significational components can be elided and informational and the message remains informationally unchanged. This proves the existence of cores with neutral, neutrosophic meanings. (In the epistemological foundations of the concept of neutrosophy we refer to Florentin Smarandache's work, *A Unifying Field in Logics, Neutrosophic Logic, Neutrosophy, Neutrosophic Set, Neutrosophic Probability and Statistics*, 1998).

On the operation of this phenomenon are based the procedures of textual contraction, of grouping, of serial registration, of associating, summarizing, synthesizing, integrating.

We propose to understand by neutrosophic communication that type of communication in which the message consists of and it is based on neutrosophic significational elements: non-informational, redundant, elidable, contradictory, incomplete, vague, imprecise, contemplative, non-practical, of relational cultivation. Informational communication is that type of communication whose purpose is sharing an informational message. The issuer's fundamental approach is, in informational communication, to inform. To inform is to transmit information or, specifically, in the professor's Ilie Rad words: "to inform, that is just send information" (Moldovan L., 2011, p 70). In general, any communication contains some or certain neutrosophic elements, suppressible, redundant, elidable, non-nuclear elements. But when neutrosophic elements are prevailing communication is no longer informational, but neutrosophic. Therefore, the neutrosophic axiom allows us to distinguish two types of communication: neutrosophic communication and informational communication. In most of the time our communication is neutrosophic. The

neutrosophic communication is the rule. The informational communication is the exception. In the ocean of the neutrosophic communication, diamantine islands of informational communication are distinguished.

## BIBLIOGRAPHY

1. Brier S., *What is a Possible Ontological and Epistemological Framework for a true Universal Information Science*, în Hofkirshner W. (ed.), *The Quest for a unified Theory of Information*, Amsterdam, Gordon and Breach Publishers, 1999.
2. Brillouin L., *Science and Information Theory*, 2<sup>nd</sup> edition, New York, Dober Publications Inc., 2004.
3. Cai Wen, *Extension Theory and its Application*, Chinese Science Bulletin, vol. 44, nr. 17, pp. 1538-1548, 1999.
4. Craia Sultana, *Dicționar de comunicare, mass-media și știința comunicării*, București, Editura Meronia, 2008.
5. Dâncu V. S., *Comunicarea simbolică*, Cluj-Napoca, Editura Dacia, 1999.
6. DeVito, J. A., *Communicology*, New-York, Harper and Row, 1982.
7. DeVito J., *Messages*, Harper Collins College Publishers, 1993.
8. DeVito J., *Human Communication*, Addison Wesley Longman Inc., 2000.
9. Dobreanu Cristinel, *Preventing surprise at the strategic level*, Buletinul Universității Naționale de Apărare „Carol I”, anul XX, nr. 1, pp. 225-233, 2010.
10. Duke S., Mc Mahan D.T., *The Basics of Communication*, London, Sage Publications Inc., 2011.
11. Enache Doru, *Informația, de la primul cal troian la cel de-al doilea cal troian*, Parașutiștii, anul XIV, nr. 27(36), pp. 25-28, 2010.
12. Gelepithis P.A., *A rudimentary theory of information* în Hofkirshner W. (ed.), *The Quest for a unified Theory of Information*, Amsterdam, Gordon and Breach Publishers, 1999.
13. Gill P., Phytian S., *Intelligence in an insecure world*, Cambridge, Polity Press, 2006.
14. Gill P., Marrin S., Phytian S., *Intelligence Theory: Key questions and debates*, Routledge, New York, 2009.
15. Li Weihua, Yang Chunyan, *Extension Information-Knowledge-Strategy System for Semantic Interoperability*, Journal of Computers, vol. 3, no. 8, pp. 32-39, 2008.
16. Marinică M., Ivan I., *Intelligence – de la teorie către știință*, Revista Română de Studii de Intelligence, nr. 3, pp. 103-114, 2010.
17. Johnson L.K. (ed.), *The Oxford of Nnational Security Intelligence*, Oxford University Press, 2010.
18. Maior George Cristian, *Un război al minții. Intelligence, servicii de informații și cunoaștere strategică în secolul XXI*, București, Editura

- RAO, 2010.
19. Marinescu Valentina, *Introducere în teoria comunicării*, București, Editura C. H. Beck, 2011.
  20. Marcus Solomon, *Întâlniri cu /meetings with Solomon Marcus*, București, Editura Spandugino, 2011, 2 volume.
  21. Maruyama M., *Information and Communication in Poly-Epistemological Systems*, în Woodward K. (ed.), *The Myths of Information*, Routledge and Kegan Paul Ltd., 1980.
  22. Métayer, G., *La Communicatigue*, Paris, Les éditions d'organisation, 1972.
  23. Miller G.A., *Language and communication*, New York, Mc-Graw-Hill, 1951.
  24. Mokros H.B. și Ruben B.D., *Understanding the Communication-Information Relationship: Levels of Information and Contexts of Availabilities*, Science Communication, June 1991, vol. 12, no. 4, pp. 373-388.
  25. Moldovan L., *Indicii jurnalistice. Interviu cu prof. univ. dr. Ilie Rad în Vatra veche*, Serie nouă, Anul III, nr. 1(25), ianuarie 2011 (ISSN2066-0962), pp. 67-71.
  26. Newcomb TM, *An Approach to the study of communicative acts*, în Smith A.G. (ed), *Communication and culture*, New York, Holt, Rinehart and Winston, 1966.
  27. Norton M., *Introductory concepts of Information Science*, Information Today, Inc., 2000.
  28. Păvăloiu Catherine, *Elemente de deontologie a evaluării în contextul creșterii calității actului educațional*, Forțele terestre, nr. 1/2010.
  29. Petrescu Marius, *Năbârjoiu Neculae Managementul informațiilor*, vol. I, Târgoviște, Editura Bibliotheca, 2006.
  30. Petrescu Stan, *Despre intelligence. Spionaj-Contraspionaj*, București, Editura Militară, 2007.
  31. Petrescu Stan, *Informațiile, a patra armă*, București, Editura Militară, 1999.
  32. Popa C., Ștefan Teodoru, Ivan Ion, *Măsuri organizatorice și structuri funcționale privind accesul la informații*, București, Editura ANI, 2008.
  33. Popescu C. F., *Manual de jurnalism*, București, Editura Tritonic, 2004, 2 volume.
  34. Rotaru Nicolae, *PSI-Comunicare*, București, Editura A.N.I., 2007.
  35. Ruben B.D., *The Communication-information relationship in System-theoretic perspective*, Journal of the American Society for Information Science, volume 43, issue 1, pp. 15-27, January 1992.
  36. Ruben B.D., *Communication and human behavior*, New York, Prentice Hall, 1992.
  37. Schement J.R., *Communication and information* în Schement J.R.,



- Ruben B.D., *Information and Behavior*, volume 4, Between Communication and Information, Transaction Publishers, New Brunswick, New Jersey, 1993.
38. Shannon C., Weaver W., *The mathematical theory of communication*, Urbana, University of Illinois Press, 1949.
39. Sims J.E., Gerber B., *Transforming US Intelligence*, Washington D.C., Georgetown University Press, 2005.
40. Smarandache F., *A Unifying Field in Logics, Neutrosophic Logic, Neutrosophy, Neutrosophic Set, Neutrosophic Probability and Statistics*, American Research Press, Rehoboth, 1998.
41. Smarandache F., *Toward Dialectic Matter Element of Extenics Model*, sursă Internet, 2005.
42. Tran V., Stănciugelu I., *Teoria comunicării*, București, comunicare.ro, 2003.
43. Vlăduțescu Ștefan, *Informația de la teorie către știință*, București, Editura Didactică și Pedagogică, 2002 (in romanian), *Information, from theory to science*.
44. Vlăduțescu Ștefan, *Comunicarea jurnalistică negativă*, București, Editura Academiei Române, 2006 (in romanian), *Negative Journalistical Communication*.
45. Wiener N., *Cybernetics*, 3<sup>th</sup> ed., Mit Press, 1965.
46. Wilson T.D., *Trends and issues in information science*, în Boyd-Barrett O., Braham P., *Media, Knowledge and Power*, London, Croom Helm, 1987.
47. Wood J.T., *Communication in Our Lives*, Wadsworth/Cengage learning, 2009.
48. Zamfir G., *Comunicarea și informația în sistemele de instruire asistată de calculator din domeniul economic*, *Informatica Economică*, nr. 7/1998, p. 7.

## The Duality and the Euler's Line

**Prof. Ion Pătrașcu – The Frații Buzești National College, Craiova - Romania**  
**Prof. Florentin Smarandache – University of New Mexico – U.S.A.**

In this article we'll discuss about a theorem which results from a duality transformation of a theorem and the configuration in relation to the Euler's line.

### Theorem

Let  $ABC$  a given random triangle,  $I$  the center of its inscribed circle, and  $A'B'C'$  its triangle of contact. The perpendiculars constructed in  $I$  on  $AI$ ,  $BI$ ,  $CI$  intersect  $BC$ ,  $CA$ ,  $AB$  respectively in the points  $A_1$ ,  $B_1$ ,  $C_1$ . The medians of the triangle of contact intersect the second time the inscribed circle in the points  $A_1'$ ,  $B_1'$ ,  $C_1'$ , and the tangents in these points to the inscribed circle intersect the lines  $BC$ ,  $CA$ ,  $AB$  in the points  $A_2$ ,  $B_2$ ,  $C_2$  respectively.

Then:

- i) The points  $A_1$ ,  $B_1$ ,  $C_1$  are collinear;
- ii) The points  $A_2$ ,  $B_2$ ,  $C_2$  are collinear;
- iii) The lines  $A_1B_1$ ,  $A_2B_2$  are parallel.

### Proof

We'll consider a triangle  $A'B'C'$  circumscribed to the circle of center  $O$ . Let  $A'A''$ ,  $B'B''$ ,  $C'C''$  its heights concurrent in a point  $H$  and  $A'M$ ,  $B'N$ ,  $C'P$  its medians concurrent in the weight center  $G$ . It is known that the points  $O$ ,  $H$ ,  $G$  are collinear; these are situated on the Euler's line of the triangle  $A'B'C'$ .

We'll transform this configuration (see the figure) through a duality in rapport to the circumscribed circle to the triangle  $A'B'C'$ .

To the points  $A'$ ,  $B'$ ,  $C'$  correspond the tangents in  $A'$ ,  $B'$ ,  $C'$  to the given circle, we'll note  $A$ ,  $B$ ,  $C$  the points of intersection of these tangents. For triangle  $ABC$  the circle  $A'B'C'$  becomes inscribed circle, and  $A'B'C'$  is the triangle of contact of  $ABC$ .

To the mediators  $A'M$ ,  $B'N$ ,  $C'P$  will correspond through the considered duality, their pols, that is the points  $A_2$ ,  $B_2$ ,  $C_2$  obtained as the intersections of the lines  $BC$ ,  $CA$ ,  $AB$  with the tangents in the points  $A_1'$ ,  $B_1'$ ,  $C_1'$  respectively to the circle  $A'B'C'$  ( $A_1'$ ,  $B_1'$ ,  $C_1'$  are the intersection points with the circle  $A'B'C'$  of the lines  $(A'M)$ ,  $(B'N)$ ,  $(C'P)$ ). To the height  $A'M$  corresponds its pole noted  $A_1$  situated on  $BC$  such that  $m(\widehat{AOA_1}) = 90^\circ$  (indeed the pole of  $B'C'$  is the point  $A$  and because  $A'M \perp B'C'$  we have  $m(\widehat{AOA_1}) = 90^\circ$ ), similarly to the height  $B'N$  we'll correspond the point  $B_1$  on  $AC$  such that  $m(\widehat{BOB_1}) = 90^\circ$ , and to the height  $C'N$  will correspond the point  $C_1$  on  $AB$  such that  $m(\widehat{COC_1}) = 90^\circ$ .

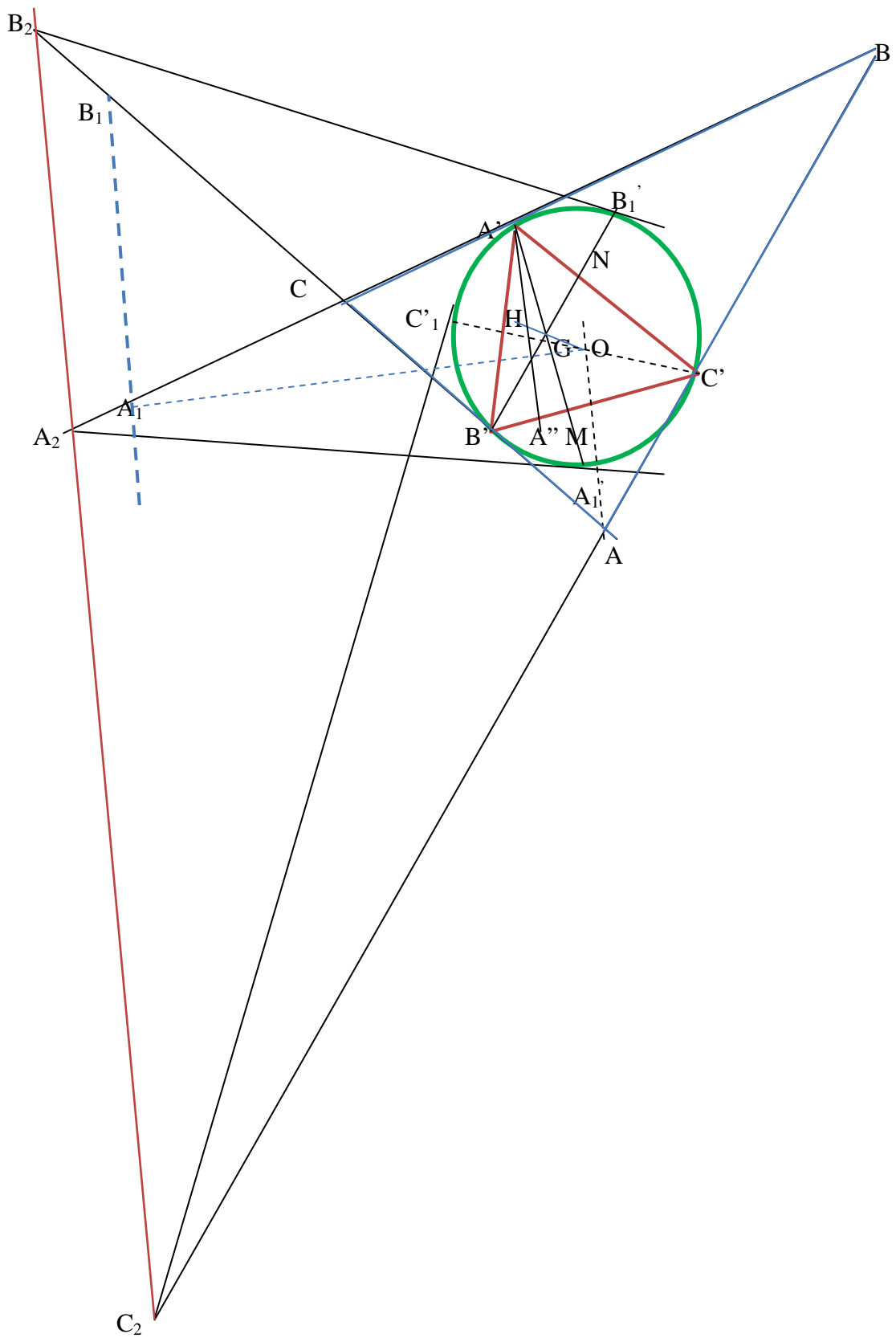

Because the heights are concurrent in  $H$  it means that their poles, that is the points  $A_1, B_1, C_1$  are collinear.

Because the medians are concurrent in the point  $G$  it means that their poles, that is the points  $A_2, B_2, C_2$  are collinear.

The lines  $A_1B_1C_1$  and  $A_2B_2C_2$  are respectively the poles of the points  $H$  and  $G$ , because  $H, G$  are collinear with the point  $O$ ; this means that these poles are perpendicular lines on  $OG$  respectively on  $OH$ ; consequently these are parallel lines.

By re-denoting the point  $O$  with  $I$  we will be in the conditions of the propose theorem and therefore the proof is completed.

**Note**

This theorem can be proven also using an elementary method. We'll leave this task for the readers.

## Parameterized Special Theory of Relativity (PSTR)

Florentin Smarandache

University of New Mexico, Gallup, NM 87301, USA

E-mail: smarand@unm.edu

We have parameterized Einstein's thought experiment with atomic clocks, supposing that we knew neither if the space and time are relative or absolute, nor if the speed of light was ultimate speed or not. We have obtained a Parameterized Special Theory of Relativity (PSTR), first introduced in 1982. Our PSTR generalized not only Einstein's Special Theory of Relativity, but also our Absolute Theory of Relativity, and introduced three more possible Relativities to be studied in the future. After the 2011 CERN's superluminal neutrino experiments, we recall our ideas and invite researchers to deepen the study of PSTR, ATR, and check the three new mathematically emerged Relativities 4.3, 4.4, and 4.5.

### 1 Einstein's thought experiment with the light clocks

There are two identical clocks, one is placed aboard of a rocket, which travels at a constant speed  $v$  with respect to the Earth, and the second one is on the Earth. In the rocket, a light pulse is emitted by a source from  $A$  to a mirror  $B$  that reflects it back to  $A$  where it is detected. The rocket's movement and the light pulse's movement are orthogonal. There is an observer in the rocket (the astronaut) and an observer on the Earth. The trajectory of light pulse (and implicitly the distance traveled by the light pulse), the elapsed time it needs to travel this distance, and the speed of the light pulse at which is travels are perceived differently by the two observers (depending on the theories used — see below in this paper).

According to the astronaut (see Fig. 1):

$$\Delta t' = \frac{2d}{c}, \tag{1}$$

where  $\Delta t'$  time interval, as measured by the astronaut, for the light to follow the path of double distance  $2d$ , while  $c$  is the speed of light.

According to the observer on the Earth (see Fig. 2):

$$\left. \begin{aligned} 2l = v \Delta t, \quad s = |AB| = |BA'| \\ d = |BB'|, \quad l = |AB'| = |b'A'| \end{aligned} \right\}, \tag{2}$$

where  $\Delta t$  is the time interval as measured by the observer on the Earth. And using the Pythagoras' Theorem in the right triangle  $\Delta ABB'$ , one has

$$2s = 2 \sqrt{d^2 + l^2} = 2 \sqrt{d^2 + \left(\frac{v \Delta t}{2}\right)^2}, \tag{3}$$

but  $2s = c \Delta t$ , whence

$$c \Delta t = 2 \sqrt{d^2 + \left(\frac{v \Delta t}{2}\right)^2}. \tag{4}$$

Squaring and computing for  $\Delta t$  one gets:

$$\Delta t = \frac{2d}{c} \frac{1}{\sqrt{1 - \frac{v^2}{c^2}}}. \tag{5} \text{ or}$$

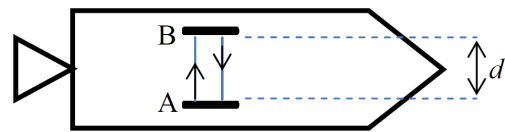

Figure 1

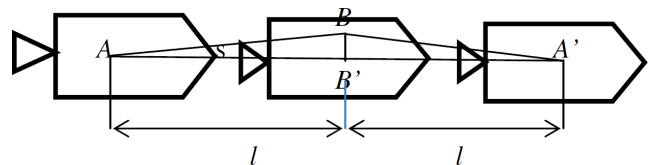

Figure 2

Whence Einstein gets the following time dilation:

$$\Delta t = \frac{\Delta t'}{\sqrt{1 - \frac{v^2}{c^2}}}. \tag{6}$$

where  $\Delta t > \Delta t'$

### 2 Parameterized Special Theory of Relativity (PSTR)

In a more general case when we don't know the speed  $x$  of the light as seen by the observer on Earth, nor the relationship between  $\Delta t'$  and  $\Delta t$ , we get:

$$x \Delta t = 2 \sqrt{d^2 + \left(\frac{v \Delta t}{2}\right)^2}. \tag{7}$$

But  $d = \frac{c \Delta t'}{2}$ , therefore:

$$x \Delta t = 2 \sqrt{\left(\frac{c \Delta t'}{2}\right)^2 + \left(\frac{v \Delta t}{2}\right)^2}, \tag{8}$$

$$x \Delta t = \sqrt{c^2(\Delta t')^2 + v^2(\Delta t)^2}. \tag{9}$$

Dividing the whole equality by  $\Delta t$  we obtain:

$$x = \sqrt{v^2 + c^2 \left( \frac{\Delta t'}{\Delta t} \right)^2}. \quad (10)$$

which is the *PSTR Equation*.

### 3 PSTR elapsed time ratio $\tau$ (parameter)

We now substitute in a general case

$$\frac{\Delta t'}{\Delta t} = \tau \in (0, +\infty), \quad (11)$$

where  $\tau$  is the PSTR elapsed time ratio. Therefore we split the Special Theory of Relativity (STR) in the below ways.

### 4 PSTR extends STR, ATR, and introduces three more Relativities

4.1 If  $\tau = \sqrt{1 - \frac{v^2}{c^2}}$  we get the STR (see [1]), since replacing  $x$  by  $c$ , one has

$$c^2 = v^2 + c^2 \left( \frac{\Delta t'}{\Delta t} \right)^2, \quad (12)$$

$$\frac{c^2}{c^2} - \frac{v^2}{c^2} = \left( \frac{\Delta t'}{\Delta t} \right)^2, \quad (13)$$

or  $\frac{\Delta t'}{\Delta t} = \sqrt{1 - \frac{v^2}{c^2}} \in [0, 1]$  as in the STR.

4.2 If  $\tau = 1$ , we get our *Absolute Theory of Relativity* (see [2]) in the particular case when the two trajectory vectors are perpendicular, i.e.

$$X = \sqrt{v^2 + c^2} = |\vec{v} + \vec{c}|. \quad (14)$$

4.3 If  $0 < \tau < \sqrt{1 - \frac{v^2}{c^2}}$ , the time dilation is increased with respect to that of the STR, therefore the speed  $x$  as seen by the observer on the Earth is decreased (becomes subluminal) while in STR it is  $c$ .

4.4 If  $\sqrt{1 - \frac{v^2}{c^2}} < \tau < 0$ , there is still time dilation, but less than STR's time dilation, yet the speed  $x$  as seen by the observer on the Earth becomes superluminal (yet less than in our Absolute Theory of Relativity). About superluminal velocities see [3] and [4].

4.5 If  $\tau > 1$ , we get an *opposite time dilation* (i.e.  $\Delta t' > \Delta t$ ) with respect to the STR (instead of  $\Delta t' < \Delta t$ ), and the speed  $x$  as seen by the observer on earth increases even more than in our ATR.

### 5 Further research

The reader might be interested in studying these new Relativities mathematically resulted from the above 4.3, 4.4, and 4.5 cases.

Submitted on February 6, 2012 / Accepted on February 12, 2012

### References

1. Einstein A. Zur Elektrodynamik bewegter Körper. *Annalen der Physik*, 1905, v. 17, 891–921.
2. Smarandache F. *Absolute Theory of Relativity and Parameterized Special Theory of Relativity and Noninertial Multirelativity*. Somipress, 1982, 92 p.
3. Smarandache F. There is No Speed Barrier in the Universe. Liceul Pedagogic Rm. Vâlcea, Physics Prof. Elena Albu, 1972.
4. Rabounski D. A blind pilot: who is a super-luminal observer? *Progress in Physics*, 2008, v. 2, 171.

# Oblique-Length Contraction Factor in the Special Theory of Relativity

Florentin Smarandache

University of New Mexico 705 Gurley Ave. Gallup, NM 87301, USA. E-mail: smarand@unm.edu

In this paper one generalizes the Lorentz Contraction Factor for the case when the lengths are moving at an oblique angle with respect to the motion direction. One shows that the angles of the moving relativistic objects are distorted.

## 1 Introduction

According to the Special Theory of Relativity, the Lorentz Contraction Factor is referred to the lengths moving along the motion direction. The lengths which are perpendicular on the direction motion do not contract at all [1].

In this paper one investigates the lengths that are oblique to the motion direction and one finds their Oblique-Length Contraction Factor [3], which is a generalization of the Lorentz Contraction Factor (for  $\theta = 0$ ) and of the perpendicular lengths (for  $\theta = \pi/2$ ). We also calculate the distorted angles of lengths of the moving object.

## 2 Length-Contraction Factor

Length-Contraction Factor  $C(v)$  is just Lorentz Factor:

$$C(v) = \sqrt{1 - \frac{v^2}{c^2}} \in [0, 1] \text{ for } v \in [0, c] \quad (1)$$

$$L = L' \cdot C(v) \quad (2)$$

where  $L$  = non-proper length (length contracted),  $L'$  = proper length.  $C(0) = 1$ , meaning no space contraction [as in Absolute Theory of Relativity (ATR)].

$C(c) = 0$ , which means according to the Special Theory of Relativity (STR) that if the rocket moves at speed 'c' then the rocket length and laying down astronaut shrink to zero! This is unrealistic.

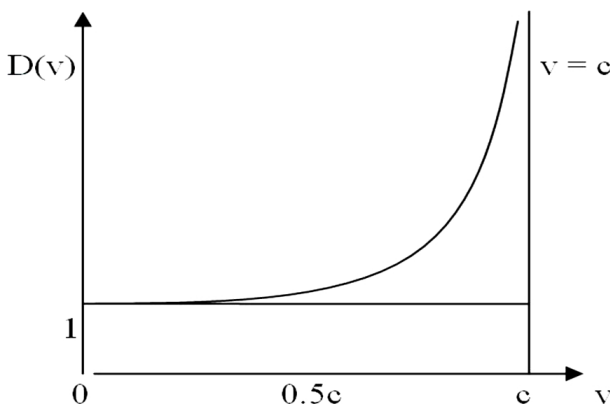

Fig. 1: The graph of the Time-Dilation Factor

## 3 Time-Dilation Factor

Time-Dilation Factor  $D(v)$  is the inverse of Lorentz Factor:

$$D(v) = \frac{1}{\sqrt{1 - \frac{v^2}{c^2}}} \in [1, +\infty] \text{ for } v \in [0, c] \quad (3)$$

$$\Delta t = \Delta t' \cdot D(v) \quad (4)$$

where  $\Delta t$  = non-proper time and,  $\Delta t'$  = proper time.  $D(0) = 1$ , meaning no time dilation [as in Absolute Theory of Relativity (ATR)];  $D(c) = \lim_{v \rightarrow c} D(v) = +\infty$ , which means according to the Special Theory of Relativity (STR) that if the rocket moves at speed 'c' then the observer on earth measures the elapsed non-proper time as infinite, which is unrealistic.  $v = c$  is the equation of the vertical asymptote to the curve of  $D(v)$ .

## 4 Oblique-Length Contraction Factor

The Special Theory of Relativity asserts that all lengths in the direction of motion are contracted, while the lengths at right angles to the motion are unaffected. But it didn't say anything about lengths at oblique angle to the motion (i.e. neither perpendicular to, nor along the motion direction), how would they behave? This is a generalization of Galilean Relativity, i.e. we consider the oblique lengths. The length contraction factor in the motion direction is:

$$C(v) = \sqrt{1 - \frac{v^2}{c^2}}. \quad (5)$$

Suppose we have a rectangular object with width  $W$  and length  $L$  that travels at a constant speed  $v$  with respect to an observer on Earth.

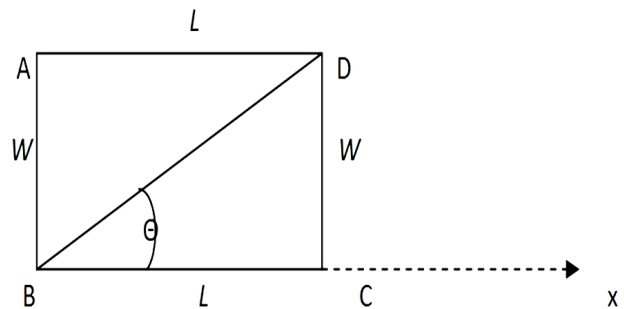

Fig. 2: A rectangular object moving along the x-axis

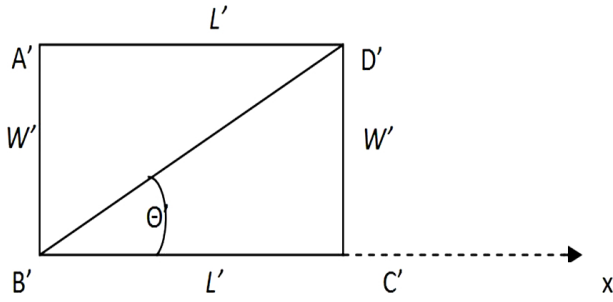

Fig. 3: Contracted lengths of the rectangular object moving along the  $x$ -axis

Then its lengths contract and its new dimensions will be  $L'$  and  $W'$ : where  $L' = L \cdot C(v)$  and  $W' = W$ . The initial diagonal of the rectangle ABCD is:

$$\begin{aligned} \delta &= |AC| = |BD| = \sqrt{L^2 + W^2} \\ &= \sqrt{L^2 + L^2 \tan^2 \theta} = L \sqrt{1 + \tan^2 \theta} \end{aligned} \quad (6)$$

while the contracted diagonal of the rectangle  $A'B'C'D'$  is:

$$\begin{aligned} \delta' &= |A'C'| = |B'D'| \\ &= \sqrt{(L')^2 + (W')^2} = \sqrt{L^2 \cdot C(v)^2 + W^2} \\ &= \sqrt{L^2 C(v)^2 + L^2 \tan^2 \theta} = L \sqrt{C(v)^2 + \tan^2 \theta}. \end{aligned} \quad (7)$$

Therefore the lengths at oblique angle to the motion are contracted with the oblique factor

$$\begin{aligned} OC(v, \theta) &= \frac{\delta'}{\delta} = \frac{L \sqrt{C(v)^2 + \tan^2 \theta}}{L \sqrt{1 + \tan^2 \theta}} \\ &= \sqrt{\frac{C(v)^2 + \tan^2 \theta}{1 + \tan^2 \theta}} = \sqrt{C(v)^2 \cos^2 \theta + \sin^2 \theta} \end{aligned} \quad (8)$$

which is different from  $C(v)$ .

$$\delta' = \delta \cdot OC(v, \theta) \quad (9)$$

where  $0 \leq OC(v, \theta) \leq 1$ .

For unchanged constant speed  $v$ , the greater is  $\theta$  in  $(0, \frac{\pi}{2})$  the larger gets the oblique-length contraction factor, and reciprocally. By oblique length contraction, the angle

$$\theta \in \left(0, \frac{\pi}{2}\right) \cup \left(\frac{\pi}{2}, \pi\right) \quad (10)$$

is not conserved.

In Fig. 4 the horizontal axis represents the angle  $\theta$ , while the vertical axis represents the values of the Oblique-Length Contraction Factor  $OC(v, \theta)$  for a fixed speed  $v$ . Hence  $C(v)$  is thus a constant in this graph. The graph, for  $v$  fixed, is

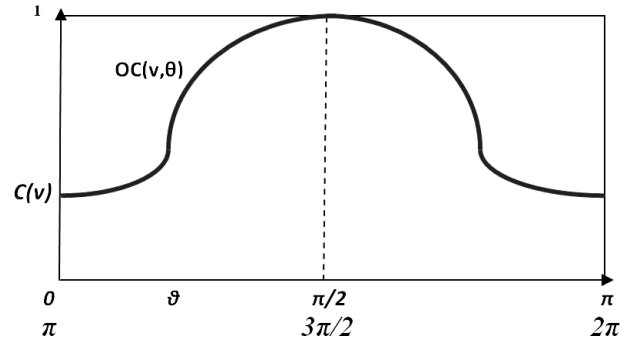

Fig. 4: The graph of the Oblique-Length Contraction Factor  $OC(v, \theta)$

periodic of period  $\pi$ , since:

$$\begin{aligned} OC(v, \pi + \theta) &= \sqrt{C(v)^2 \cos^2(\pi + \theta) + \sin^2(\pi + \theta)} \\ &= \sqrt{C(v)^2 [-\cos \theta]^2 + [-\sin \theta]^2} \\ &= \sqrt{C(v)^2 \cos^2 \theta + \sin^2 \theta} \\ &= OC(v, \theta). \end{aligned} \quad (11)$$

More exactly about the  $OC(v, \theta)$  range:

$$OC(v, \theta) \in [C(v), 1] \quad (12)$$

but since  $C(v) \in [0, 1]$ , one has:

$$OC(v, \theta) \in [0, 1]. \quad (13)$$

The Oblique-Length Contractor

$$OC(v, \theta) = \sqrt{C(v)^2 \cos^2 \theta + \sin^2 \theta} \quad (14)$$

is a generalization of Lorentz Contractor  $C(v)$ , because: when  $\theta = 0$  or the length is moving along the motion direction, then  $OC(v, 0) = C(v)$ . Similarly

$$OC(v, \pi) = OC(v, 2\pi) = C(v). \quad (15)$$

Also, if  $\theta = \frac{\pi}{2}$ , or the length is perpendicular on the motion direction, then  $OC(v, \pi/2) = 1$ , i.e. no contraction occurs. Similarly  $OC(v, \frac{3\pi}{2}) = 1$ .

### 5 Angle Distortion

Except for the right angles  $(\pi/2, 3\pi/2)$  and for the  $0, \pi$ , and  $2\pi$ , all other angles are distorted by the Lorentz transform.

Let's consider an object of triangular form moving in the direction of its bottom base (on the  $x$ -axis), with speed  $v$ , as in Fig. 5:

$$\theta \in \left(0, \frac{\pi}{2}\right) \cup \left(\frac{\pi}{2}, \pi\right) \quad (16)$$

is not conserved.



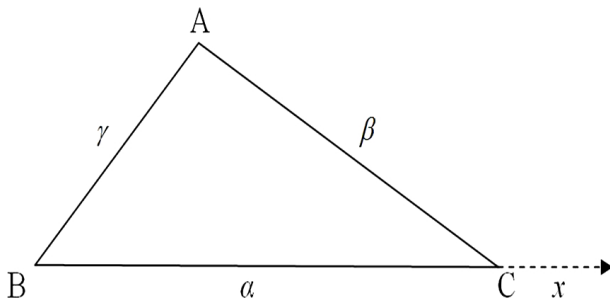

Fig. 5:

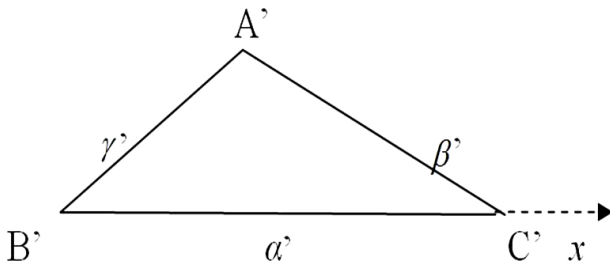

Fig. 6:

The side  $|BC| = \alpha$  is contracted with the contraction factor  $C(v)$  since  $BC$  is moving along the motion direction, therefore  $|B'C'| = \alpha \cdot C(v)$ . But the oblique sides  $AB$  and  $CA$  are contracted respectively with the oblique-contraction factors  $OC(v, \angle B)$  and  $OC(v, \angle \pi - C)$ , where  $\angle B$  means angle B:

$$|A'B'| = \gamma \cdot OC(v, \angle B) \tag{17}$$

and

$$|C'A'| = \beta \cdot OC(v, \angle \pi - C) = \beta \cdot OC(v, \angle A + B) \tag{18}$$

since

$$\angle A + \angle B + \angle C = \pi. \tag{19}$$

Triangle  $ABC$  is shrunk and distorted to  $A'B'C'$  as in Fig. 6.

Hence one gets:

$$\begin{aligned} \alpha' &= \alpha \cdot C(v) \\ \beta' &= \beta \cdot OC(v, \angle A + B) \\ \gamma' &= \gamma \cdot OC(v, \angle B) \end{aligned} \tag{20}$$

In the resulting triangle  $A'B'C'$ , since one knows all its side lengths, one applies the Law of Cosine in order to find each angle  $\angle A'$ ,  $\angle B'$ , and  $\angle C'$ . Therefore:

$$\angle A' = \arccos \frac{-\alpha^2 \cdot C(v)^2 + \beta^2 \cdot OC(v, \angle A + B)^2 + \gamma^2 \cdot OC(v, \angle B)^2}{2\beta \cdot \gamma \cdot OC(v, \angle B) \cdot OC(v, \angle A + B)}$$

$$\angle B' = \arccos \frac{\alpha^2 \cdot C(v)^2 - \beta^2 \cdot OC(v, \angle A + B)^2 + \gamma^2 \cdot OC(v, \angle B)^2}{2\alpha \cdot \gamma \cdot OC(v) \cdot OC(v, \angle B)}$$

$$\angle C' = \arccos \frac{\alpha^2 \cdot C(v)^2 + \beta^2 \cdot OC(v, \angle A + B)^2 - \gamma^2 \cdot OC(v, \angle B)^2}{2\alpha \cdot \beta \cdot OC(v) \cdot OC(v, \angle A + B)}.$$

As we can see, the angles  $\angle A'$ ,  $\angle B'$ , and  $\angle C'$  are, in general, different from the original angles  $A$ ,  $B$ , and  $C$  respectively.

The distortion of an angle is, in general, different from the distortion of another angle.

Submitted on November 12, 2012 / Accepted on November 15, 2012

**References**

1. Einstein A. On the Electrodynamics of Moving Bodies. *Annalen der Physik*, 1905, v. 17, 891–921.
2. Smarandache F. Absolute Theory of Relativity and Parameterized Special Theory of Relativity and Noninertial Multirelativity. Somipress, Fes, 1982.
3. Smarandache F. New Relativistic Paradoxes and Open Questions. Somipress, Fes, 1983.

## Relations between Distorted and Original Angles in STR

Florentin Smarandache

Arts and Science Division, University of New Mexico, 705 Gurley Ave., Gallup, NM 87301, USA. E-mail: smarand@unm.edu

Using the Oblique-Length Contraction Factor, which is a generalization of Lorentz Contraction Factor, one shows several trigonometric relations between distorted and original angles of a moving object lengths in the Special Theory of Relativity.

### 1 Introduction

The lengths at oblique angle to the motion are contracted with the Oblique-Length Contraction Factor  $OC(\nu, \theta)$ , defined as [1-2]:

$$OC(\nu, \theta) = \sqrt{C(\nu)^2 \cos^2 \theta + \sin^2 \theta} \quad (1)$$

where  $C(\nu)$  is just Lorentz Factor:

$$C(\nu) = \sqrt{1 - \frac{\nu^2}{c^2}} \in [0, 1] \text{ for } \nu \in [0, c]. \quad (2)$$

Of course

$$0 \leq OC(\nu, \theta) \leq 1. \quad (3)$$

The Oblique-Length Contraction Factor is a generalization of Lorentz Contractor  $C(\nu)$ , because: when  $\theta = 0$ , or the length is moving along the motion direction, then  $OC(\nu, 0) = C(\nu)$ . Similarly

$$OC(\nu, \pi) = OC(\nu, 2\pi) = C(\nu). \quad (4)$$

Also, if  $\theta = \pi/2$ , or the length is perpendicular on the motion direction, then  $OC(\nu, \pi/2) = 1$ , i.e. no contraction occurs. Similarly  $OC(\nu, \frac{3\pi}{2}) = 1$ .

### 2 Tangential relations between distorted acute angles vs. original acute angles of a right triangle

Let's consider a right triangle with one of its legs along the motion direction (Fig. 1).

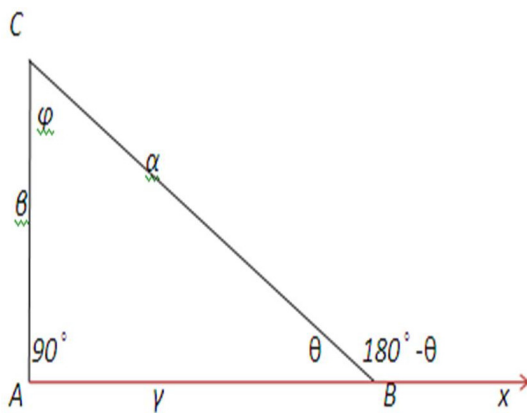

Fig. 1:

$$\tan \theta = \frac{\beta}{\gamma} \quad (5)$$

$$\tan(180^\circ - \theta) = -\tan \theta = -\frac{\beta}{\gamma} \quad (6)$$

After contraction of the side  $AB$  (and consequently contraction of the oblique side  $BC$ ) one gets (Fig. 2):

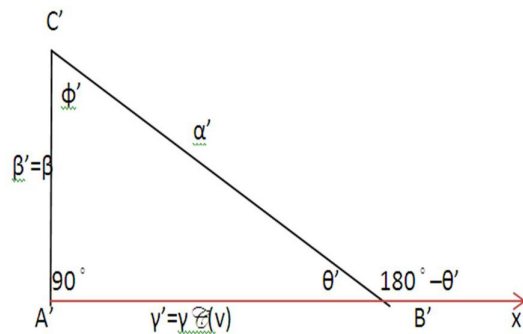

Fig. 2:

$$\tan(180^\circ - \theta') = -\tan \theta' = -\frac{\beta'}{\gamma'} = -\frac{\beta}{\gamma C(\nu)}. \quad (7)$$

Then:

$$\frac{\tan(180^\circ - \theta')}{\tan(180^\circ - \theta)} = \frac{-\frac{\beta}{\gamma C(\nu)}}{-\frac{\beta}{\gamma}} = \frac{1}{C(\nu)}. \quad (8)$$

Therefore

$$\tan(\pi - \theta') = -\frac{\tan(\pi - \theta)}{C(\nu)} \quad (9)$$

and consequently

$$\tan(\theta') = \frac{\tan(\theta)}{C(\nu)} \quad (10)$$

or

$$\tan(B') = \frac{\tan(B)}{C(\nu)} \quad (11)$$

which is the Angle Distortion Equation, where  $\theta$  is the angle formed by a side travelling along the motion direction and another side which is oblique on the motion direction.

The angle  $\theta$  is increased (i.e.  $\theta' > \theta$ ).

$$\tan \varphi = \frac{\gamma}{\beta} \quad \text{and} \quad \tan \varphi' = \frac{\gamma'}{\beta'} = \frac{\gamma C(v)}{\beta} \quad (12)$$

whence:

$$\frac{\tan \varphi'}{\tan \varphi} = \frac{\frac{\gamma C(v)}{\beta}}{\frac{\gamma}{\beta}} = C(v). \quad (13)$$

So we get the following Angle Distortion Equation:

$$\tan \varphi' = \tan \varphi \cdot C(v) \quad (14)$$

or

$$\tan C' = \tan C \cdot C(v) \quad (15)$$

where  $\varphi$  is the angle formed by one side which is perpendicular on the motion direction and the other one is oblique to the motion direction.

The angle  $\varphi$  is decreased (i.e.  $\varphi' < \varphi$ ). If the traveling right triangle is oriented the opposite way (Fig. 3)

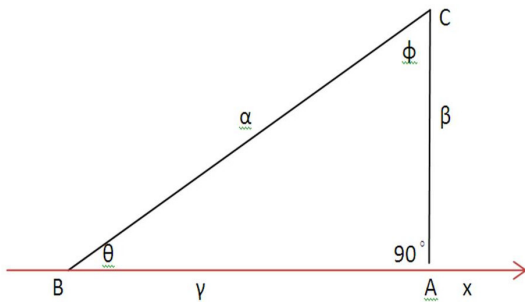

Fig. 3:

$$\tan \theta = \frac{\beta}{\gamma} \quad \text{and} \quad \tan \varphi = \frac{\gamma}{\beta}. \quad (16)$$

Similarly, after contraction of side  $AB$  (and consequently contraction of the oblique side  $BC$ ) one gets (Fig. 4)

$$\tan \theta' = \frac{\beta'}{\gamma'} = \frac{\beta}{\gamma C(v)} \quad (17)$$

and

$$\tan \varphi' = \frac{\gamma'}{\beta'} = \frac{\gamma C(v)}{\beta} \quad (18)$$

$$\frac{\tan \theta'}{\tan \theta} = \frac{\frac{\beta}{\gamma C(v)}}{\frac{\beta}{\gamma}} = \frac{1}{C(v)} \quad (19)$$

or

$$\tan \theta' = \frac{\tan \theta}{C(v)} \quad (20)$$

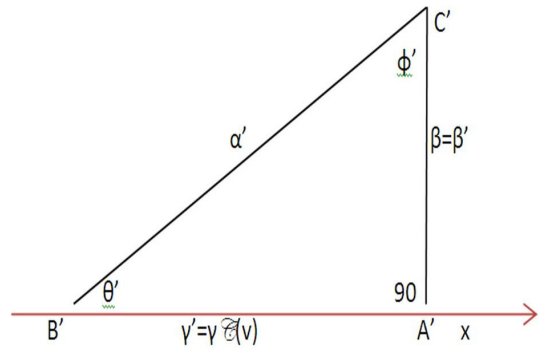

Fig. 4:

and similarly

$$\frac{\tan \varphi'}{\tan \varphi} = \frac{\frac{\gamma C(v)}{\beta}}{\frac{\gamma}{\beta}} = C(v) \quad (21)$$

or

$$\tan \varphi' = \tan \varphi \cdot C(v). \quad (22)$$

Therefore one got the same Angle Distortion Equations for a right triangle traveling with one of its legs along the motion direction.

### 3 Tangential relations between distorted angles vs. original angles of a general triangle

Let's suppose a general triangle  $\Delta ABC$  is travelling at speed  $v$  along the side  $BC$  as in Fig. 5.

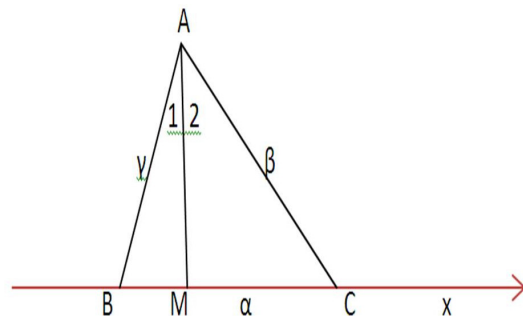

Fig. 5:

The height remains not contracted:  $AM \equiv A'M'$ . We can split this figure into two traveling right sub-triangles as in Fig. 6.

In the right triangles  $\Delta A'M'B'$  and respectively  $\Delta A'M'C'$  one has

$$\tan B' = \frac{\tan B}{C(v)} \quad \text{and} \quad \tan C' = \frac{\tan C}{C(v)}. \quad (23)$$

Also

$$\tan A'_1 = \tan A_1 C(v) \quad \text{and} \quad \tan A'_2 = \tan A_2 C(v). \quad (24)$$

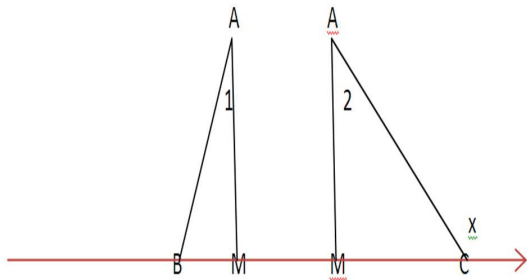

Fig. 6:

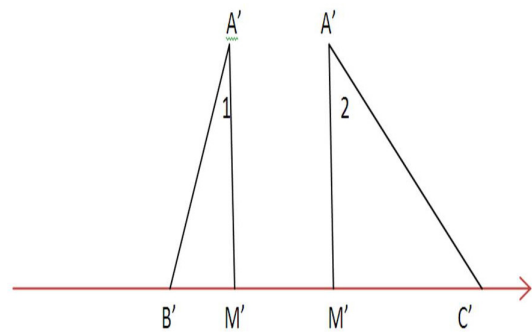

Fig. 8:

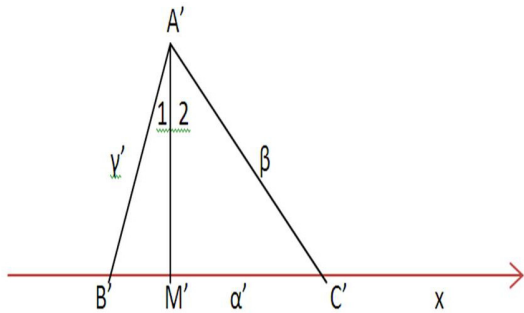

Fig. 7:

But

$$\begin{aligned}
 \tan A' &= \tan(A'_1 + A'_2) = \frac{\tan A'_1 + \tan A'_2}{1 - \tan A'_1 \tan A'_2} \\
 &= \frac{\tan A_1 C(\nu) + \tan A_2 C(\nu)}{1 - \tan A_1 C(\nu) \tan A_2 C(\nu)} \\
 &= C(\nu) \cdot \frac{\tan A_1 + \tan A_2}{1 - \tan A_1 \tan A_2 C(\nu)^2} \\
 &= C(\nu) \cdot \frac{\tan A_1 + \tan A_2}{1 - \tan A_1 \tan A_2} \cdot (1 - \tan A_1 \tan A_2) \\
 &= C(\nu) \cdot \frac{\tan(A_1 + A_2)}{1} \cdot \frac{1 - \tan A_1 \tan A_2}{1 - \tan A_1 \tan A_2 C(\nu)^2}.
 \end{aligned}$$

$$\tan A' = C(\nu) \cdot \tan(A) \cdot \frac{1 - \tan A_1 \tan A_2}{1 - \tan A_1 \tan A_2 C(\nu)^2}. \quad (25)$$

We got

$$\tan A' = \tan(A) \cdot C(\nu) \cdot \frac{1 - \tan A_1 \tan A_2}{1 - \tan A_1 \tan A_2 C(\nu)^2} \quad (26)$$

Similarly we can split this Fig. 7 into two traveling right sub-triangles as in Fig. 8.

#### 4 Other relations between the distorted angles and the original angles

1. Another relation uses the Law of Sine in the triangles  $\Delta ABC$  and respectively  $\Delta A'B'C'$ :

$$\frac{\alpha}{\sin A} = \frac{\beta}{\sin B} = \frac{\gamma}{\sin C} \quad (27)$$

$$\frac{\alpha'}{\sin A'} = \frac{\beta'}{\sin B'} = \frac{\gamma'}{\sin C'}. \quad (28)$$

After substituting

$$\alpha' = \alpha C(\nu) \quad (29)$$

$$\beta' = \beta \theta C(\nu, C) \quad (30)$$

$$\gamma' = \gamma \theta C(\nu, B) \quad (31)$$

into the second relation one gets:

$$\frac{\alpha C(\nu)}{\sin A'} = \frac{\beta \theta C(\nu, C)}{\sin B'} = \frac{\gamma \theta C(\nu, B)}{\sin C'}. \quad (32)$$

Then we divide term by term the previous equalities:

$$\frac{\frac{\alpha}{\sin A}}{\frac{\alpha C(\nu)}{\sin A'}} = \frac{\frac{\beta}{\sin B}}{\frac{\beta \theta C(\nu, C)}{\sin B'}} = \frac{\frac{\gamma}{\sin C}}{\frac{\gamma \theta C(\nu, B)}{\sin C'}} \quad (33)$$

whence one has:

$$\begin{aligned}
 \frac{\sin A'}{\sin A \cdot C(\nu)} &= \frac{\sin B'}{\sin B \cdot \theta C(\nu, C)} \\
 &= \frac{\sin C'}{\sin C \cdot \theta C(\nu, B)}.
 \end{aligned} \quad (34)$$

2. Another way:

$$A' = 180^\circ - (B' + C') \quad \text{and} \quad A = 180^\circ - (B + C) \quad (35)$$

$$\tan A' = \tan[180^\circ - (B' + C')] = -\tan(B' + C')$$

$$= -\frac{\tan B' + \tan C'}{1 - \tan B' \cdot \tan C'}$$

$$\begin{aligned}
&= -\frac{\frac{\tan B}{C(v)} + \frac{\tan C}{C(v)}}{1 - \tan B \cdot \tan C/C(v)^2} \\
&= -\frac{1}{C(v)} \cdot \frac{\tan B + \tan C}{1 - \tan B \cdot \tan C/C(v)^2} \\
&= -\frac{\tan(B+C)}{C(v)} \cdot \frac{1 - \tan B \tan C}{1 - \tan B \cdot \tan C/C(v)^2} \\
&= -\frac{-\tan[180^\circ - (B+C)]}{C(v)} \cdot \frac{1 - \tan B \cdot \tan C}{1 - \tan B \cdot \tan C/C(v)^2} \\
&= \frac{\tan A}{C(v)} \cdot \frac{1 - \tan B \cdot \tan C}{1 - \tan B \cdot \tan C/C(v)^2}.
\end{aligned}$$

We got

$$\tan A' = \frac{\tan A}{C(v)} \cdot \frac{1 - \tan B \cdot \tan C}{1 - \tan B \cdot \tan C/C(v)^2}. \quad (36)$$

Submitted on March 30, 2013 /Accepted on April 2, 2013

## References

1. Smarandache F. *New Relativistic Paradoxes and Open Questions*. Somipress, Fes, 1983.
2. Smarandache F. Oblique-Length Contraction Factor in the Special Theory of Relativity, *Progress in Physics*, 2013, v. 1, 60–62.
3. Einstein A. On the Electrodynamics of Moving Bodies. *Annalen der Physik*, 1905, v. 17, 891–921.
4. Smarandache F. *Absolute Theory of Relativity and Parameterized Special Theory of Relativity and Noninertial Multirelativity*. Somipress, Fes, 1982.

# On Gödel's incompleteness theorem(s), Artificial Intelligence/Life, and Human Mind

V. Christianto<sup>1</sup> & Florentin Smarandache<sup>2</sup>

1 – <http://www.sciprint.org>, email: victorchristianto@gmail.com

2 – Dept. Mathematics & Sciences, University of New Mexico, Gallup, NM, USA, email: smarand@unm.edu, or fsmarandache@gmail.com

## Abstract

In the present paper we have discussed concerning Gödel's incompleteness theorem(s) and plausible implications to artificial intelligence/life and human mind. Perhaps we should agree with Sullins III, that the value of this finding is not to discourage certain types of research in AL, but rather to help move us in a direction where we can more clearly define the results of that research. Gödel's incompleteness theorems have their own limitations, but so do Artificial Life (AL)/AI systems. Based on our experiences so far, human mind has incredible abilities to interact with other part of human body including heart, which makes it so difficult to simulate in AI/AL. However, it remains an open question to predict whether the future of AI including robotics science can bring this gap closer or not. In this regard, fuzzy logic and its generalization –neutrosophic logic- offer a way to improve significantly AI/AL research.[15]

## Introduction

In 1931 a German mathematician named Gödel published a paper which included a theorem which was to become known as his Incompleteness Theorem. This theorem stated that:

"To every  $w$ -consistent recursive class  $k$  of formulae there correspond recursive class-signs  $r$ , such that neither  $v \text{ Gen } r$  nor  $\text{Neg } (v \text{ Gen } r)$  belongs to  $\text{Flg}(k)$  (where  $v$  is the free variable of  $r$ )" [9].

In more common mathematical terms, this means that "all consistent axiomatic formulations of number theory include undecidable propositions." [9]

Another perspective on Gödel's incompleteness theorem can be found using polynomial equations [10]. It can be shown that Gödel's analysis does not reveal any essential incompleteness in formal reasoning systems, nor any barrier to proving the consistency of such systems by ordinary mathematical means.[10] In the mean time, Beklemishev discusses the limits of applicability of Gödel's incompleteness theorems.[11]

### **Does Gödel's incompleteness theorem limit Artificial Intelligence?**

In the 1950s and 1960s, researchers predicted that when human knowledge could be expressed using logic with mathematical notation, it would be possible to create a machine that reasons, or artificial intelligence. This turned out to be more difficult than expected because of the complexity of human reasoning.[12]

Nowadays, it is widely accepted that general purpose of artificial intelligence (AI) is to develop (1) conceptual models (2) formal rewriting processes of these models and (3) programming strategies and physical machines to reproduce as efficiently and thoroughly as possible the most authentic, cognitive, scientific and technical tasks of biological systems that we have labeled Intelligent [5, p.66].

According to Gelgi, Penrose claims that results of Gödel's theorem established that human understanding and insight cannot be reduced to any set of computational rules [1]. Gelgi goes on to say that:

"Gödel's theorem states that in any sufficiently complex formal system there exists at least one statement that cannot be proven to be true or false. Penrose believes that this would limit the ability of any AI system in its reasoning. He argues that there will always be a statement that can be constructed which is unprovable by the AI system." [1]

The above question is very interesting to ponder, considering recent achievements in modern AI research. There are ongoing debates on this subject in many online forums, see for instance [5][6][7][8][9]. Here we give a summary of those articles and papers in simple words. Hopefully this effort will shed some light on this debatable subject. Those arguments basically stand either on the optimistic side (that Gödel's theorems do not limit AI), or on the pessimistic side (that Gödel's theorems limit AI).

## **Mechanism and reductionism in biology and implications to AI/AL**

It is known that mechanistic or closely related reductionistic theories have been part of theoretical biology in one form or another at least since Descartes.[8] The various mechanistic and reductionistic theories are historically opposed to the much older and mostly debunked theories of vitalism (see Emmeche, 1991). These theories (the former more than the latter), along with formism, contextualism, organicism, and a number of other "isms" mark the major centers of thought in the modern theoretical biology debate (see Sattler, 1986).[8]

Such mechanistic and reductionistic view of the world were discussed by F. Capra in his book: *The Turning Point* [13].

According to Sullins III [8], AL (Artificial Life) falls curiously on many sides of these debates in the philosophy of biology. For instance AL uses the tools of complete mechanization, namely the computer, while at the same time it acknowledges the existence of emergent phenomena (Langton, 1987, p. 81). Neither mechanism nor reductionism is usually thought to be persuaded by arguments appealing to emergence. Facts like this should make our discussion interesting. It may turn out that AL is hopelessly contradictory on this point, or it may provide an escape route for AL if we find that Gödel's incompleteness theorems do pose a theoretical road block to the mechanistic-reductionistic theories in biology.

Sullins III also writes that most theorists have outgrown the idea that life can be explained wholly in terms of classical mechanics.[8] Instead, what is usually meant is the following (paraphrased from Sattler, 1986):

- 1) Living systems can and/or should be viewed as physico- chemical systems.
- 2) Living systems can and/or should be viewed as machines. (This kind of mechanism is also known as the machine theory of life.)
- 3) Living systems can be formally described. There are natural laws which fully describe living systems.

According to Sullins III[8], reductionism is related to mechanism in biology in that mechanists wish to reduce living systems to a mechanical description. Reductionism is also the name of a more general world view or scientific strategy. In this world view we explain phenomena around us by reducing them to their most basic and simple parts. Once we have an understanding of the components, it is then thought that we have an understanding of the whole. There are many types of reductionist strategies.[8]



According to Sullins III [8], reductionism is a tool or strategy for solving complex problems. There does not seem to be any reason that one has to be a mechanist to use these tools. For instance one could imagine a causal reductionistic vitalist who would believe that life is reducible to the elan vital or some other vital essence. And, conversely, one could imagine a mechanist who might believe that living systems can be described metaphorically as machines but that life was not reducible to being only a property of mechanics.

Sullins III [8] also asserts that the strong variety of AL does not believe that living systems should only be viewed as physico-chemical systems. AL is life-as-it-could-be, not life-as-we-know-it (Langton, 1989, p. 1), and this statement suggests that AL is not overly concerned with modeling only physico-chemical systems. Postulates 2 and 3 seem to hold, though, as strong AL theories clearly state that the machine, or formal, theory of life is valid and that simple laws underlie the complex, nonlinear behavior of living systems (Langton, 1989, p. 2).

Sullins III [8] goes on with his argument, saying that at least one of the basic qualities of our reality will always be missing from any conceivable artificial reality, namely, a complete formal system of mathematics. This argument tends to make more sense when applied to strong AI claims about intelligent systems understanding concepts (see Tieszen, 1994, for a more complete argument as it concerns AI). He also concludes that it is impossible to completely formalize an artificial reality that is equal to the one we experience, so AL systems entirely resident in a computer must remain, for anyone persuaded by the mathematical realism posited by Gödel, a science which can only be capable of potentially creating extremely robust simulations of living systems but never one that can become a complete instantiation of a living system.[8]

However, Sullins III [8] also writes that the value of this finding is not to discourage certain types of research in AL, but rather to help move us in a direction where we can more clearly define the results of that research. In fact, since one of the above arguments rests on the assumption that the universe is infinite and that some form of mathematical realism is true, if we are someday able to complete the goal advanced in strong AL it would seem to cast doubt on the validity of the assumptions made above.

For a recent debate on this issue in the context of fuzzy logic, see for instance Yalciner et al. [5]. The debates on the possibility of thinking machines, or the limitations of AI research, have never stopped. According to Yalciner et al. (2010), these debates on AI have been focused on three claims:

- An AI system is in principle an axiomatic system.
- The problem solving process of an AI system is equivalent to a Turing machine.

- An AI system is formal, and only gets meaning according to model theoretic semantic (Wang 2006).[16]

More than other new sciences, AI and philosophy have things to say to one to another: any attempt to create and understand minds must be of philosophical interest.[5]

May be we will never manage to build real artificial intelligence. The problem could be too difficult for human brain over to solve (Bostrom, 2003).

Yalciner et al. [5] also write that a fundamental problem in artificial intelligence is that nobody really knows what intelligence is. The problem is especially acute when we need to consider artificial systems which are significantly different to humans.

### **Human mind is beyond machine capabilities**

According to Gelgi [1], it follows that no machine can be a complete or adequate model of the mind, that minds are essentially different from machines. This does not mean that a machine cannot simulate any piece of mind; it only says that there is no machine that can simulate every piece of mind. Lucas says that there may be deeper objections. Gödel's theorem applies to deductive systems, and human beings are not confined to making only deductive inferences. Gödel's theorem applies only to consistent systems, and one may have doubts about how far it is permissible to assume that human beings are consistent. [1]

Therefore it appears that there are some characteristics of human mind which go beyond machine capabilities. For example there are human capabilities as follows:

- a. to synchronize with heart, i.e. to love and to comprehend love;
- b. to fear God and to acknowledge God: "The fear of the LORD is the beginning of knowledge" (Proverbs 1:7)
- c. to admit own mistakes and sins
- d. to repent and to do repentance
- e. to consider things from ethical perspectives.

All of the above capabilities are beyond the scope of present day AI machines, i.e. it seems that there is far distance between human mind capabilities and machine capabilities. However, we can predict that there will be much progress by AI research. For instance, by improving AI-based chess programs, one could see how far the machine can go.

Furthermore there are other philosophical arguments concerning the distinction between human mind and machine intelligence. Dreyfus contends that it is impossible to create intelligent computer programs analogous to the human brain because the workings of human intelligence are entirely different from that of computing machines. For Dreyfus, the human mind functions intuitively and not formally. Dreyfus's critique on AI proceeds from his critique on rationalist epistemological assumptions about human intelligence. Dreyfus's major attack targets the rationalist conception that human understanding or intelligence can be "formalized".[5, p.67]

We agree with the content related to the distinctions between Human and Computer. Yet, we think that the differences (Love, God, Own mistakes, Repentance, Ethical) between Human and Computer will be in the future little by little diminished, since it would be possible to train a computer at least for partial adjustments in each of them.

In addition to the fuzzy logic in AI, neutrosophic logic provides besides truth and falsehood a third component, called indeterminacy that can be used in AI, since many approaches of reality that AI has to model or describe involve a degree of uncertainty, unknown. Neutrosophic logic is a generalization of intuitionistic fuzzy logic.[15] We have a lot of unknown and paradoxical, contradictory information that AI has to deal with in our world.

The above argument can be seen as stronger than Penrose's.

However, one should admit the differences between human intelligence and machine intelligence. There are fundamental differences between the human intelligence and today's machine intelligence. Human intelligence is very good in identifying patterns and subjective matters. However, it is usually not very good in handling large amounts of data and doing massive computations. Nor can it process and solve complex problems with large number of constraints. This is especially true when real time processing of data and information is required. For these types of issues, machine intelligence is an excellent substitute.[5]

### **Concluding remarks**

In the present paper we have discussed concerning Gödel's incompleteness theorem(s) and plausible implications to artificial intelligence/life and human mind.

Perhaps we should agree with Sullins III, that the value of this finding is not to discourage certain types of research in AL, but rather to help move us in a direction where we can more clearly define the results of that research. Gödel's incompleteness theorems have their own limitations, but so do Artificial Life (AL)/AI systems. Based on our experiences so far, human mind has incredible abilities to interact with other part of human body

including heart, which makes it so difficult to simulate in AI/AL. However, it remains an open question to predict whether the future of AI including robotics science can bring this gap closer or not. In this regard, fuzzy logic and its generalization –neutrosophic logic- offer a way to improve significantly AI/AL research. [15]

1<sup>st</sup> version: march 8, 2013. 2<sup>nd</sup> version: march 18, 2013. 3<sup>rd</sup> version: march 30, 2013

### References:

- [1] Gelgi, F. (2004) Implications of Gödel's Incompleteness Theorem on A.I. vs. Mind, *NeuroQuantology*, Issue 3, 186-189, URL: <http://www.neuroquantology.com/index.php/journal/article/download>
- [2] Chalmers, DJ. ( ) *Minds, Machines, and Mathematics*. URL: <http://psyche.cs.monash.edu.au/v2/psyche-2-09-chalmers.html>
- [3] Gödel, K. (1931) On Formally Undecidable Propositions of Principia Mathematica and related systems I. *Monatshefte für Mathematik und Physik*, vol. 38 (1931), pp. 173-198. URL: <http://www.ddc.net/ygg/etext/godel/> or <http://courses.arch.ntua.gr/fsr/113698/Goedel-OnFormally.pdf> or <http://www.research.ibm.com/people/h/hirzel/papers/canon00-goedel.pdf>
- [4] Pelletier, F.J. (2000) Metamathematics of fuzzy logic, *The Bulletin of Symbolic Logic*, Vol. 6, No.3, 342-346, URL: <http://www.sfu.ca/~jeffpell/papers/ReviewHajek.pdf>
- [5] Yalciner, A.Y., Denizhan, B., Taskin, H. (2010) From deterministic world view to uncertainty and fuzzy logic: a critique of artificial intelligence and classical logic. *TJFS: Turkish Journal of Fuzzy Systems* Vol.1, No.1, pp. 55-79.
- [6] Karavasileiadis, C. & O'Bryan, S., (2008) Philosophy of Logic and Artificial Intelligence, <http://rudar.ruc.dk/bitstream/1800/3868/1/Group%206-Philosophy%20of%20Logic%20and%20Artificial%20Intelligence-Final%20Hand%20In%285.1.2009%29.pdf>
- [7] Collins, J.C. (2001) On the compatibility between physics and intelligent organisms, arXiv:physics/0102024

- [8] Sullins III, J.P. (1997) Gödel's Incompleteness Theorems and Artificial Life - Digital Library & archives, Society for Philosophy and Technology, URL: <http://scholar.lib.vt.edu/ejournals/SPT/v2n3n4/sullins.html>
- [9] Makey, J. (1995) Gödel's Incompleteness Theorem is Not an Obstacle to Artificial Intelligence, URL: [http://www.sdsc.edu/~jeff/Godel vs AI.html](http://www.sdsc.edu/~jeff/Godel_vs_AI.html)
- [10] Norman, J.W. (2011) Resolving Gödel's incompleteness myth: Polynomial Equations and Dynamical Systems for Algebraic Logic, arXiv:1112.2141 [math.GM]
- [11] Beklemishev, L.D. ( ) Gödel incompleteness theorems and the limits of their applicability. I, Russian Math. Surveys.
- [12] URL: <http://www.wikipedia.org/Logic>
- [13] Capra, F. (1982) *The Turning Point*. Bantam Books.
- [14] Chaitin, G.J. (1999) A century of controversy over the foundations of mathematics, arXiv: chao-dyn/9909001
- [15] Schumann, A. & Smarandache, F. (2007) *Neutrality and many-valued logics*. American Research Press. 121 p.
- [16] Wang, P. (2006) Three Fundamental Misconceptions of Artificial Intelligence, URL: [http://www.cis.temple.edu/~pwang/Publication/AI Misconceptions.pdf](http://www.cis.temple.edu/~pwang/Publication/AI_Misconceptions.pdf)
- [17] URL: [http://www.wikipedia.org/Philosophy\\_of\\_artificial\\_intelligence](http://www.wikipedia.org/Philosophy_of_artificial_intelligence)
- [18] Straccia, U. (2000) On the relationship between fuzzy logic and four-valued relevance logic, arXiv:cs/0010037
- [19] Born, R.P. (2004) Epistemological Investigations into the Foundations of Artificial Intelligence, URL: [http://www.iwp.jku.at/born/mpwfst/04/0401Turing\\_engl\\_1p.pdf](http://www.iwp.jku.at/born/mpwfst/04/0401Turing_engl_1p.pdf)
- [20] Chrisley, R. (2005 ) Simulation and Computability: Why Penrose fails to prove the impossibility of Artificial Intelligence (and why we should care), URL: <http://www.idt.mdh.se/ECAP-2005/articles/COGNITION/RonChrisley/RonChrisley.pdf>

## **Grand design, intelligent designer, or simply God:**

### **Stephen Hawking and his hoax\***

3 sep 2010

There are a number of good reasons to say that big bang support evolution theory's idea of creation by pure statistical chance alone. And that is why: some people do think that big bang can happen out of nothing. That standpoint of view, albeit not new, are reiterated by stephen hawking from Cambridge, in his latest book: the grand design.[1][2]

Another middle-point of view, if you are believer of middle-viewpoint, is that there is a substantial amount of complexity which is irreducible in nature, sufficient enough to say that there must be the Grand Intelligent Designer, according to Behe and a host of other proponents of ID.[3][4] But still they do not want to admit that there should be God who are behind those flawless creations.

Now if you are really an astronomy person, you can free your mind of those emotional baggage from philosophical school or other pseudo-teacher who do not prove anything in their life, and start to think afresh from data:

a. If big bang is true, then the universe stabilize and evolve to become more and more structured, but that is in contradiction to the basic proposition of second law of thermodynamics, that entropy is created continuously along the time. Using this argument alone, which stephen hawking should be more adept because he is famous for his black hole entropy which has never been observed, then one can argue that big bang create entropy along the course of time, and by doing so the universe is eventually getting more and more inherently chaotic. This is in contradiction with big bang proponents' own proposition.

b. Furthermore, typical of philosopher like stephen hawking (even if he said that philosophy is dead), he only wish to have his words heard, regardless without sufficient proof. For you to know, according to black hole proponents, there should be blackhole inside the galaxy center of our Milky way. But despite there is very large mass inside the Milky way center, its center remains bright,[5] that is enough disproof for all hypotheses of black hole by stephen hawking.

---

\*by V. Christianto, url: [www.sciprint.org](http://www.sciprint.org), email: [VictorChristianto@gmail.com](mailto:VictorChristianto@gmail.com)

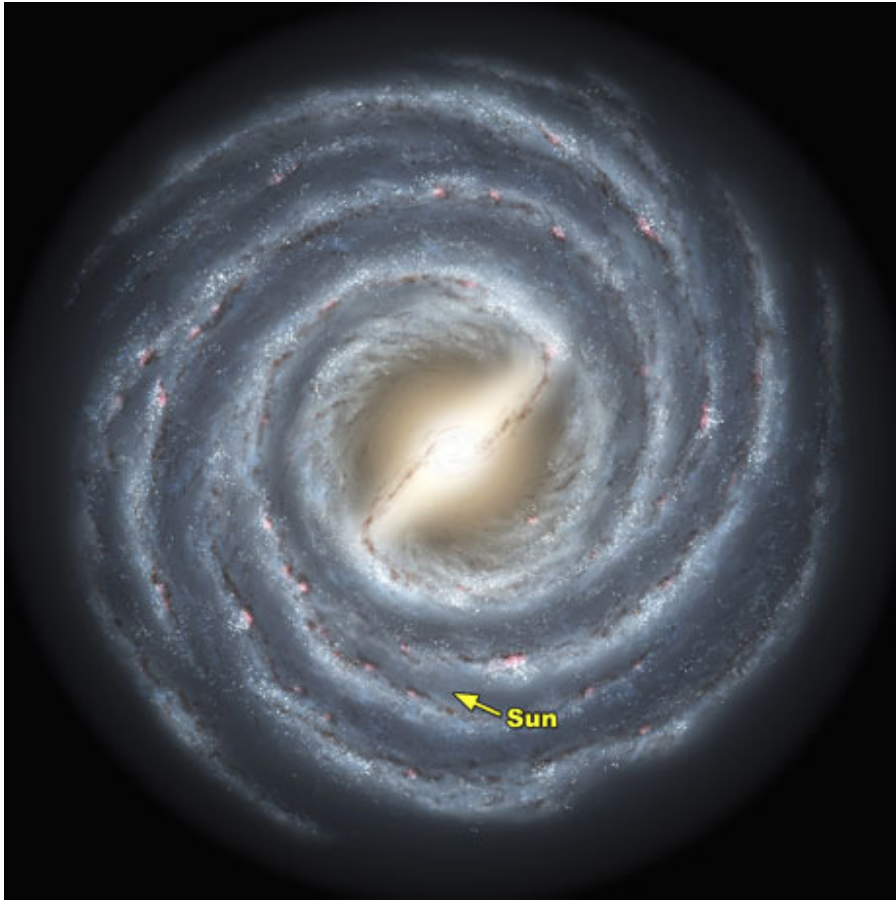

Picture. milky way center show a bar and bright center, and not a black hole. url: [http://news.nationalgeographic.com/news/2005/08/0817\\_050817\\_milkywaybar.html](http://news.nationalgeographic.com/news/2005/08/0817_050817_milkywaybar.html)

c. If you are honest astronomer, there is growing consensus of the universal law which suggest not only irreducible complexity, but also scale-organization (note that this time we do not use self-organization terminology or s.o.c.). By scale organization we mean that there is seemingly organization across different scales, which can be characterized for instance by hausdorff dimension  $\sim 2$ , for instance across different astrophysics observation.[6] There is also hint pointing toward ordering in nature, for instance quantization of planets both in solar system and beyond (exoplanets) which seem to suggest that the Grand Designer, means clearly God, do create and recreate the universe.[7]

d. Some other clever physicist like Erwin Schrodinger has suggested that there should be negative-entropy in order to resolve the contradiction of entropy in the big bang and time progress, but nobody seem to observe the negative entropy until now.

e. Similar hausdorff measure can be found in quantum mechanics. Feynman already mentioned that quantum mechanics are characterized by dimension  $\sim 2$ . See the work of Ord, Nottale, and others for they are already completing their program concerning scale relativity theory.[7]

f. Even if your calculation points to something, which this time we should verify if stephen hawking calculate his own proposition, saying that you can create something out of nothing is not only ridiculous but awkward, just the same way as you always think of black hole which do not exist.

g. Hawking apparently argue in his last book, that based on quantum theory then the universe has multiverse-history, but that is only if we accept the notion of sum-over-history and path-integral quantum mechanics. The meaning is that what he says is full of 'ifs', furthermore hawking's model is full of fine-tuning of parameters (quote: "We discuss how the laws of our particular universe are extraordinarily finely tuned so as to allow for our existence..."), just like what M-theory proponents are busy trying in order they can explain elementary particles (especially particle masses) . Do not be misguided by hawking only because he often poke you with philosophical questions, because this guy has not the same quality of Einstein to ponder things deeply even with simple thinking-experiments (hawking apparently lack this quality, he only cite and recite Einstein's questions and reinterpret that questions to what he likes to think). The result of quantization model in astrophysics, suggest that the distance between the Sun and Earth, for instance is not result of anthropic principle, but can be derived from a wave-equation model.[7] Actually, anthropic principle is another circular logic type of thinking, kind of thinking which an old guy tend to use to fool a young student.

h. Another remarkable coincidence is that the Cosmic Microwave Background Temperature, that is 2.73 degree Kelvin, are surprisingly resemble menger sponge dimension. In other words, the Cosmos may look like a big sponge just like what Zel'dovich outlined a few years ago.[8]



i. Of course, microbiologist or paleontologist or philanthropist like bill gates perhaps has their own way to say whether they prefer to be believers of God or not. And even if you are a philosophy student, then you may have risk to get your grade scaled down only because you admit that you do not swallow all evolution garbage.

Finally, to quote last comment by Paul Sheldon in [1]:

"I choose to believe in a God that is so kind as to permit me to understand without dismissing me with "Just because I said so". Such a God does do something in the universe: he is what Jaim Ginnott called a good teacher/student. My faith says I and the entire research community are manifestations of God."

What can we conclude from enormous number of astronomic observation? Apparently, if one is humble enough, then one can say along with the Psalm 19:1 : "The heavens declare the glory of God; and the firmament sheweth His handy work." And that: "God looked down from heaven upon the children of men, to see if there were any that did understand, that did seek God." (Psalm 53:2).

Sept. 3, 2010. Revised 1: sept. 4, 2010

love, Jesus Christ

references:

[1] [http://blogs.discovermagazine.com/cosmicvariance/2010/09/02/stephen-hawking-settles-the-god-question-once-and-for-all/?utm\\_source=feedburner&utm\\_medium=feed&utm\\_campaign=Feed%3A+CosmicVarianceBlog+%28Cosmic+Variance%29&utm\\_content=Twitter](http://blogs.discovermagazine.com/cosmicvariance/2010/09/02/stephen-hawking-settles-the-god-question-once-and-for-all/?utm_source=feedburner&utm_medium=feed&utm_campaign=Feed%3A+CosmicVarianceBlog+%28Cosmic+Variance%29&utm_content=Twitter)

[2] the grand design and some criticism, <http://www.amazon.com/Grand-Design-Stephen-Hawking/dp/0553805371/>

[3] comment to Behe's Darwin's Black Box: The Biochemical Challenge to Evolution, [http://www.creationismstrojanhorse.com/Gross\\_Behe\\_Review\\_10.2007.pdf](http://www.creationismstrojanhorse.com/Gross_Behe_Review_10.2007.pdf)

[4] other comment on Behe, <http://pondside.uchicago.edu/cluster/pdf/coyne/Behe, www.kean.edu/~bregal/docs/Behe.pdf>

[5] see this smitsonian picture of center of Milky Way. In other words, milky way center show a bar and bright center, and not a black hole. url:  
[http://news.nationalgeographic.com/news/2005/08/0817\\_050817\\_milkywaybar.html](http://news.nationalgeographic.com/news/2005/08/0817_050817_milkywaybar.html)

[6] there is K measure suggest a Hausdorff dimension  $\sim 2$  to large scale structures, Martinis and Sosis, arXiv:astro-ph/0708.0173 (2007). Quote: "From this point of view and together with the emersion of modern redshift surveys, the galaxy structures appear highly irregular and self-similar with fractal dimension  $D \sim 2$  up to the deepest scales probed so far..."

[7] a few years ago we wrote a book consist of documentary of quantization of astrophysics, title: Quantization in astrophysics, brownian motion, and supersymmetry. Tamil Nadu, 2007, available in amazon.com. (this book has been downloaded more than 1000 times in the first 3 days). url:  
<http://vixra.org/abs/1003.0025>

[8] for further discussion of Menger sponge and the CMBR/COBE data, see M. El Naschie, Chaos, Soliton, and Fractals 41 (2009) 2635-2646.

url:

follow **Jesus Christ** only at <http://www.twitter.com/guidetorepent>

<http://guidetorepent.uphero.com/index.html>

<http://guidetorepent.multiply.com>

<http://message.diigo.com/user/guidetorepent>

<http://Guidetorepent.blogspot.com>

<http://findtheTruthnow.blogspot.com>

<http://evangelismwithsocialmedia.blogspot.com>

<http://www.esnips.com/web/Guidetorepent>

<http://www.esnips.com/web/RepentanceGuide>

<http://www.facebook.com/guidetorepent>

<http://www.twitter.com/vChristianto>