

The Raspberry shaped Super Symmetric Multiverse without a CAT paradox.

Leo Vuyk,
Architect,
Rotterdam, the Netherlands.
LeoVuyk@Gmail.com

Abstract,

A Supersymmetric Multiverse interpretation of Quantum Mechanics with instant quantum entanglement at universal distances.

This many worlds or Supersymmetric Multiverse interpretation of quantum mechanics is the idea that NOT all possible alternate histories of the universe NEED to exist IF there is instant mirror symmetrical wavefunction collapse in at least two distant (Charge and Parity) mirror symmetric (anti)-universes. IF this is the case, then we could argue that still all alternate histories exist, but have the same anti-copy result of wavefunction collapse. Mirror symmetrical Clocks are running over there with left handed rotation, but time is running still forward.

Dual entangled Schrödinger Cats and anti-Cats in both universes, die or live instantly (superpositioned) without looking at them: they (the nuclear decay trigger) look to each other by long distant instant entanglement. Schrödinger was not aware of that possibility of course so he described the paradox, which became known as Schrödinger's cat paradox. However deep down the Planck scale at the Higgs level there seem to be TWO entangled pinball machines active between dual anti-copy universes. The oscillating Higgs energy is compared with the pinball springs and the pinballs could be compared with the Fermions and photons

Introduction.

If the process of wave function collapse of two entangled particles into mirror symmetrical states, is the basic process for all created particles, then we should live inside one part of a mirror symmetrical entangled copy MULTIVERSE with one central big bang origin.

We will give it the name: Supersymmetric Raspberry Multiverse.

Even human choice making should be subjected to this mirror symmetrical process.

Benjamin Libet described a choice experiment, which we in a different form could use to measure how many copy universes there should be.(fig 6)

The Schrödinger's cat thought experiment, is an example of how the problem of choice making at the quantum level, or wavefunction collapse in physics can be described.

According to the Copenhagen interpretation of Quantum mechanics: only by looking into the box, we seem to be able to influence the collapse of the wave function of the living cat.

Before that moment we have to accept that the cat is in two uncertain states alive and dead.

At the same time it is assumed that our conscious mind as observer, should be able to influence the wavefunction collapse as soon as the box is open.

The logic of this interpretation seems to be that we HUMANS are the unique observers of a unique universe.

However, if we live inside one of the two (or even more) mirror symmetrical entangled Copy universes, then the problem is solved, because in that case there is no uncertainty any more about the cat at the quantum level or our own choice making.

Then, at the quantum level the choice is already made about the collapse of the wavefunction between the mirror symmetric quanta by the entanglement relation between each set of quanta, even if these quanta are separated at huge distances.

If in our material universe the cat stays alive, he also will live in the mirror anti-material universe, caused by the mirror symmetry of the entanglement relation. In this way those mirror universes will always stay each others mirror copies even at the quantum level.

In addition to this interpretation of the wave function collapse, we described the possibility that the Big Bang process should be interpreted as part of a continuous process of the cyclic raspberry shaped multiverse, in (fig 10).

The Big Crunch black hole nucleus, filled with most of all the Higgs particles (fig 10) , making the universe what it was before, should be the start of a new evaporation and splitting process of matter creation and distribution in the form of the so called Lyman alpha Forest inside each egg shaped universe. (figure 1,2,3,4 and 5).

Thus the splitting of the giant Big Crunch Black Hole (= Big Bang) is assumed to be an entangled mirror symmetrical process in the Raspberry supersymmetric Multiverse and the start of all matter creation around Big Bang splitting black holes and early star (and Galaxy) formation between paired dual black holes in the form of Herbig Haro objects. (fig. 11,12)

TIME in the Multiverse, is assumed to run forward (right-handedness of clocks) because the Multiverse seems to be a huge multiple pinball machine, with for each universal bubble one pinball machine. The energetic oscillating Higgs particles (convertible rings) are in constant collision with real spinning propeller shaped Fermions.

Spinning Fermions (the pinball) are driven by the oscillating Higgs field (the electric pinball machine springs) which is also supposed to be the origin of the general increase of entropy (far away from black holes) and base of the second law of thermodynamics. (fig.15).

However dark matter in the form of black holes will eat the dark energy of the Higgs field and decrease entropy again, which is reason to postulate a pulsating and cyclic universe and an important origin of the Hubble redshift. (Ref. 2, 33).

Universal Symmetry is not broken if we accept that each material universe is entangled at a long distance with an anti-material copy universe, equipped with opposite chirality inside the 4 oscillating Higgs lattice field. As a consequence Time never runs back in anti-material entangled universes, clocks are supposed to have only left-handed rotation over there. However, as a consequence, it is a shock to realise that I am not alone inside the Multiverse, there must be at least ONE entangled COPY of ME who also tries to make decisions and is influencing me.

Benjamin Libet’s experiment on human decision making could help us understand this phenomenon. Libet measured electronic brain activity differences between Readiness Potential I and II, which he did not understand.

Future Libet-experiments focussed on the statistics of the differences between RPI and RPII will be indications of the number of entangled universes inside our Multiverse.(fig.6)

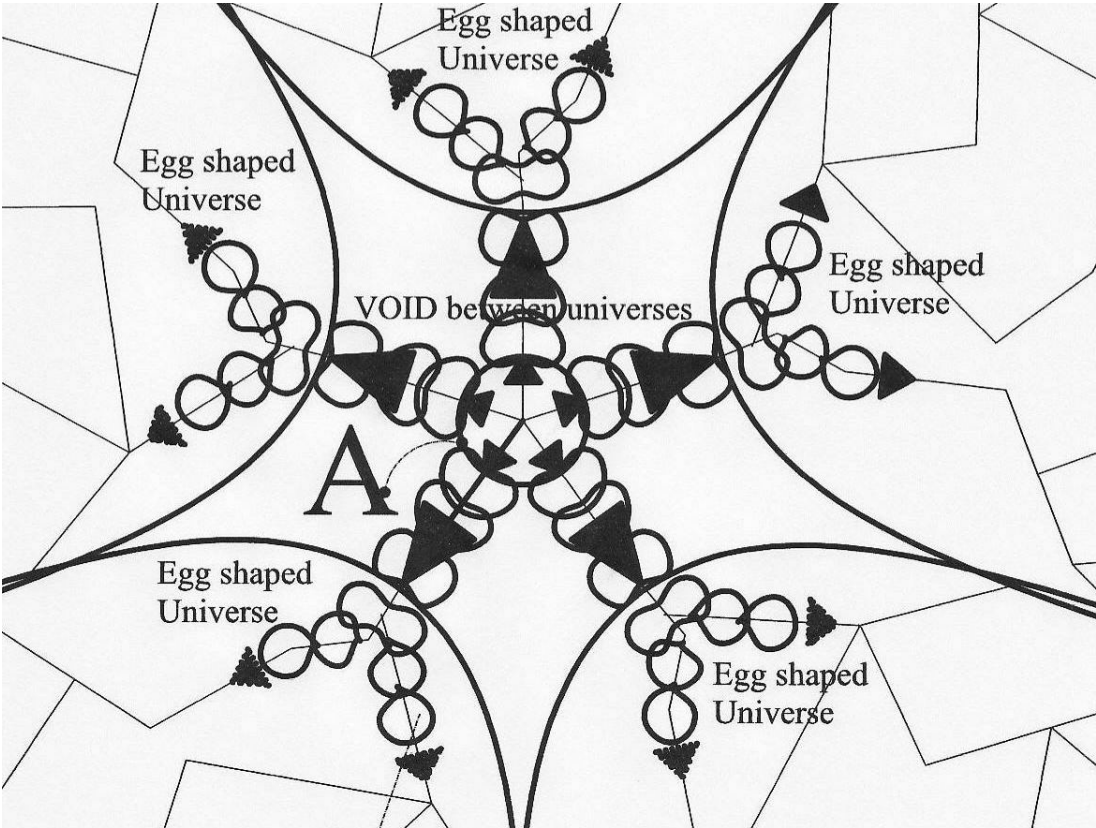

Figure 1, Cross section through the Big Crunch Black Hole splitting process starting at point A. A VOID is left behind between the EGG shaped individual universes because here no quarks of fermions will survive.

The raspberry multiverse.

The CPT symmetric raspberry universe seems to be the result of Fractal shaped evaporation, of the content of a cyclic central big crunch black hole, into egg shaped bubbles with individual Cosmic Microwave Background. (CPT= Charge Parity and Time)

3-D suggestion for the solution of the so called "MISSING GALAXY SHADOWS". All the Galaxy (clusters) located behind the WMAP CMB boundary (outside our own universe) do not create some kind of SHADOW on the 2.7 Kelvin cosmic background radiation.

2-D Section through the raspberry multiverse, with huge void in the middle. The void in the middle is supposed to be originated by the start of the Fractal process, when the vacuum density of the former cyclic multiverse was still too high for a fine grained fractal process (see my book).

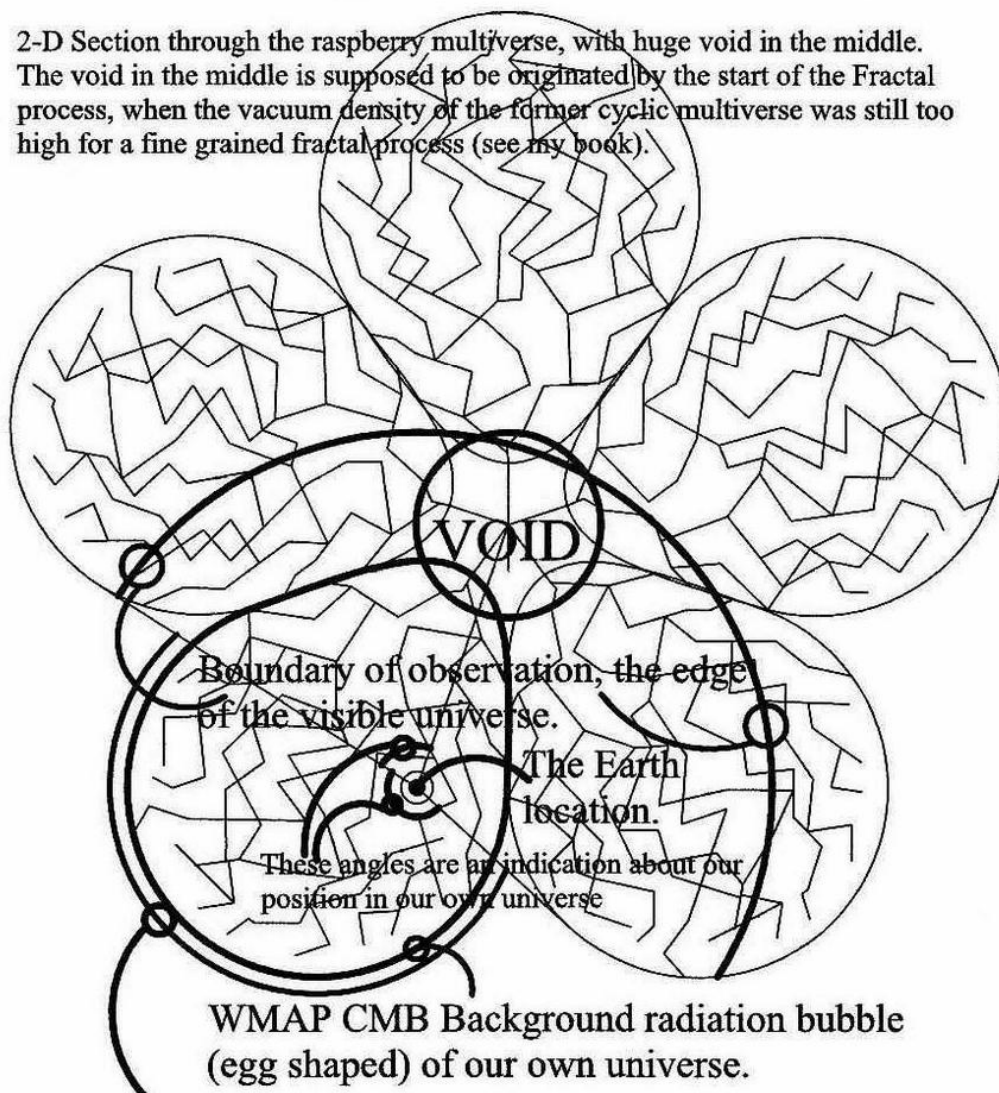

Figure 2, Cross section through a raspberry multiverse with indication for the Lyman Alpha forest inside one egg shaped universe.

The Big crunch black hole splitting and pairing process is assumed to be the origin of a BUSHY structure of the matter distribution in our visible universe, which is known as the so called Lyman Alpha forest.

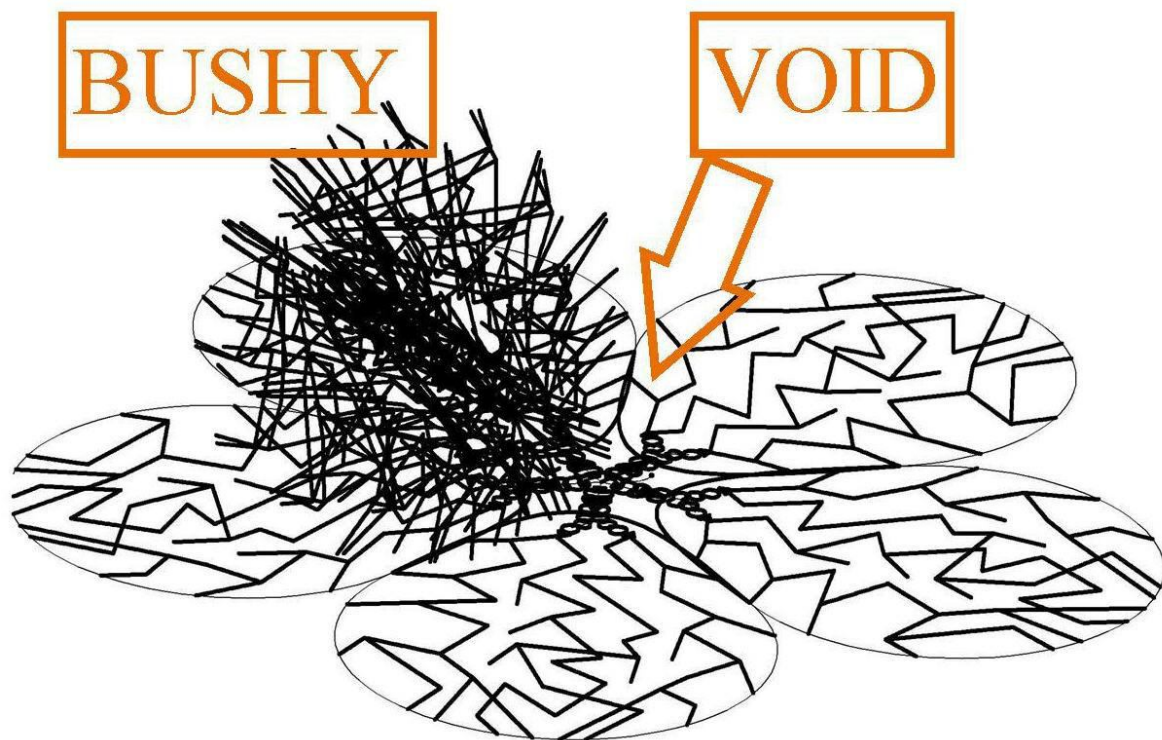

Figure 3, Cross section through a Raspberry Multiverse with 12 entangled universes in dodecahedron structure.

The absence of a Cosmic Background shadow in the WMAP is called the Sunyaev-Zel'dovich effect and found in a sample of 31 clusters. (fig 2).

Future research should provide evidence that the distribution geometry of galaxy clusters without a CMB background shadow, is found in the inner part of our egg shaped universe, due to the presence of the external Multiverse galaxies.

In the external part of the hemisphere of our egg shaped universe, all galaxy clusters should show up with a clear CMB background shadow. The angles which could be measured between the inner and outer hemisphere will be an indication of the observer location inside our own universe.

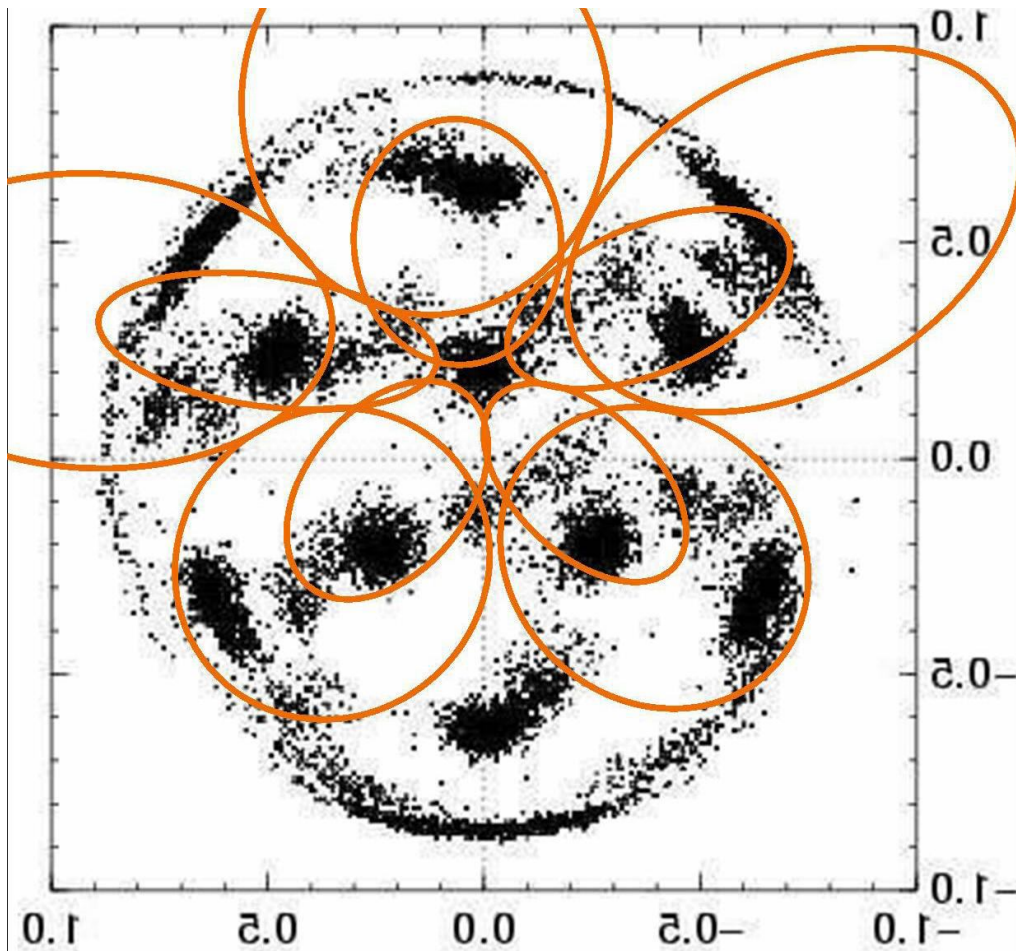

Figure 4, The Dodecahedron structure inside the WMAP sky found by F.Roukema et al. It is called: Image from: The optimal phase of generalised Poincar'e dodecahedral space hypothesis implied by the spatial cross-correlation function of the WMAP sky maps.

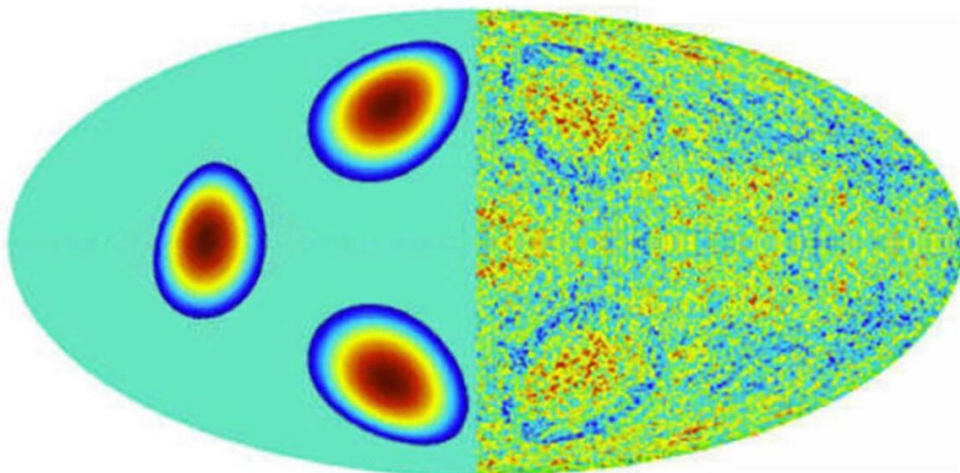
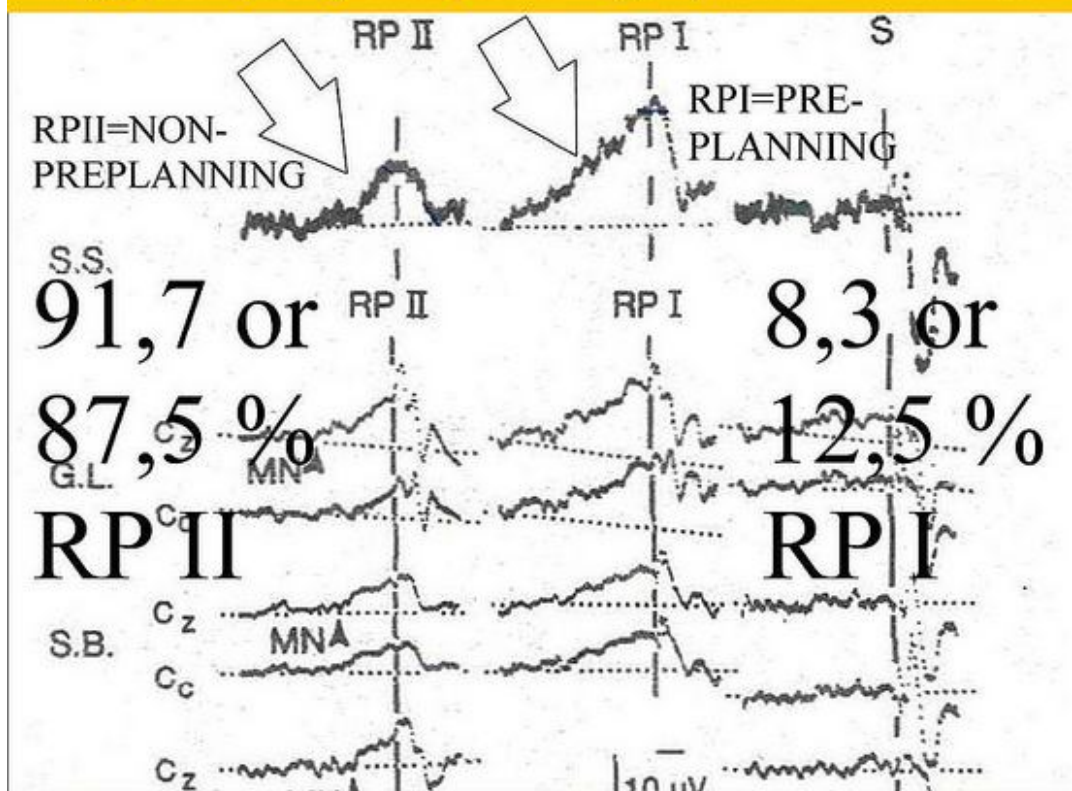

Figure 5, There are by now only four Low Variance circles found inside the WMAP sky. However we expect to find a fifth circle at equatorial position now hidden behind our own Galaxy. This would be a clear indication for a raspberry shaped Multiverse with 12 entangled universes in dodecahedral structure.

Benjamin Libet measured neural activities of test persons before and after pressing a button by “free will”. He measured differences between persons who reported pressing the button with some preplanning thoughts (RPI) and without preplanning thoughts (RPII). In Quantum FFF theory it is assumed that free will is based on quantum based wavefunction collapse by chance like dice do, spread over an even set of instant entangled (anti-)COPY multiverses, but triggered by only one Quantum jump in ONE universe.



As a consequence we should be able to use the B.Libet measurement method in more statistical detail to determine the number of entangled copy multiverses. If we measure 12.5 resp. 8.3 percent of pre-planners (RPI, then we may assume that we live inside an 8-resp 12 fold entangled multiverse.

Figure 6, The difference between RP I and RPII found by B. Libet, with off printed percentages for different numbers (8 or 12) of entangled universes to be found in future experiments. Entanglement between universes can be interpreted as a new vision on reality. (REF. 6)

Perhaps this is also the case for a new kind of entanglement between evaporated silver atoms in- and outside the oven.

This would solve the Stern Gerlach mystery described by John S. Bell.

Alternative Stern Gerlach magnet experiment to measure possible instant entanglement effects between vaporized silver atoms outside and inside the oven. (by L. Vuyk)
 This could solve John's Bell's problems with the traditional experiment, described as: no smearing of impacts on the screen between the clear up and down pattern)

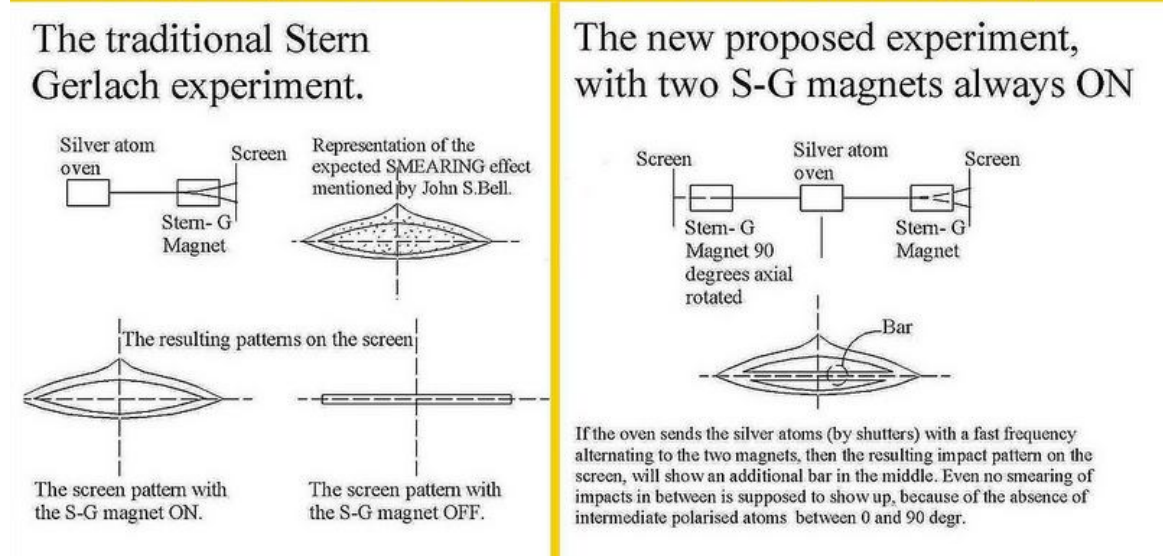

Figure 7, To solve the Q.M. problem described by J.S. Bell about the standard Stern Gerlach experiment.

Experiment proposal to support the existence of a new kind of Entanglement, which should show up inside a double Stern Gerlach experiment with two S-G magnets with different orientation.

The proposal for this experiment, is based on the hypothesis that all heated and vaporized silver atoms inside the silver oven are entangled as a whole and that magnetic measurement of one atom travelling outside the oven influences the magnetic polarity of all the other atoms in the oven.

If the oven sends the silver atoms (by shutters) alternately to the two magnets, then the resulting impact pattern on both screens will show an additional BAR in the middle of the original impact pattern. (see figure 7)

This could be the explanation for the fact that only up and down orientated atoms should enter into the S-G magnet to explain the “non smearing” effect on the screen.

John S. Bell described his doubts about the Stern Gerlach experiment interpretation in his book: “Speakable and unspeakable in Quantum Mechanics on chapter 16 page 140-141..

John Bell argued that there is no logic to be found behind the fact, that there is a so called “absence of smearing” of the particle impact pattern on the screen.



Raspberry shaped entangled oscillating Pinball Multiverse.

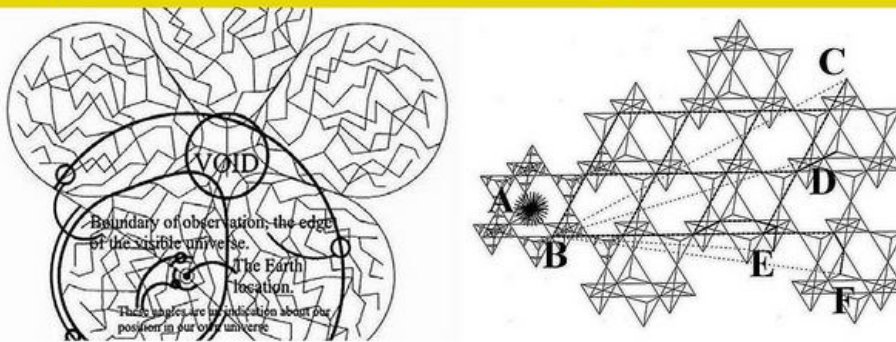

Figure 8, with the Higgs oscillating truncated tetrahedron vacuum lattice. (fig 17)

Comparison of the Final ESA CMB Planck map with a cross section through the Raspberry Multiverse according to Quantum Function Follows Form theory. Compare the Cold Spot with the Void and the Warmer and Colder Hemisphere of the Plack CMB (left) with observation boundaries (right)

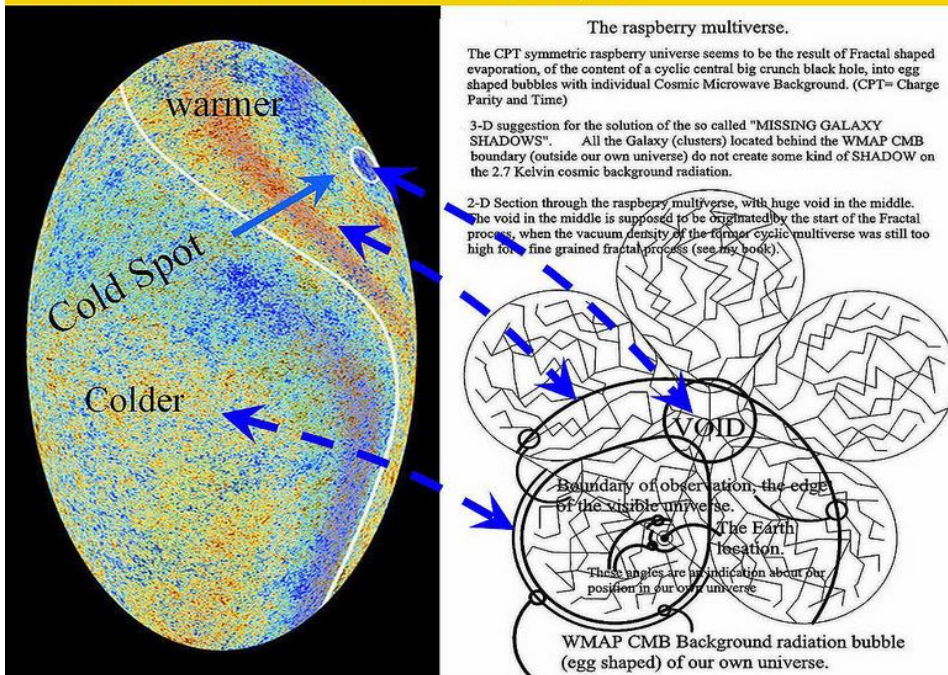
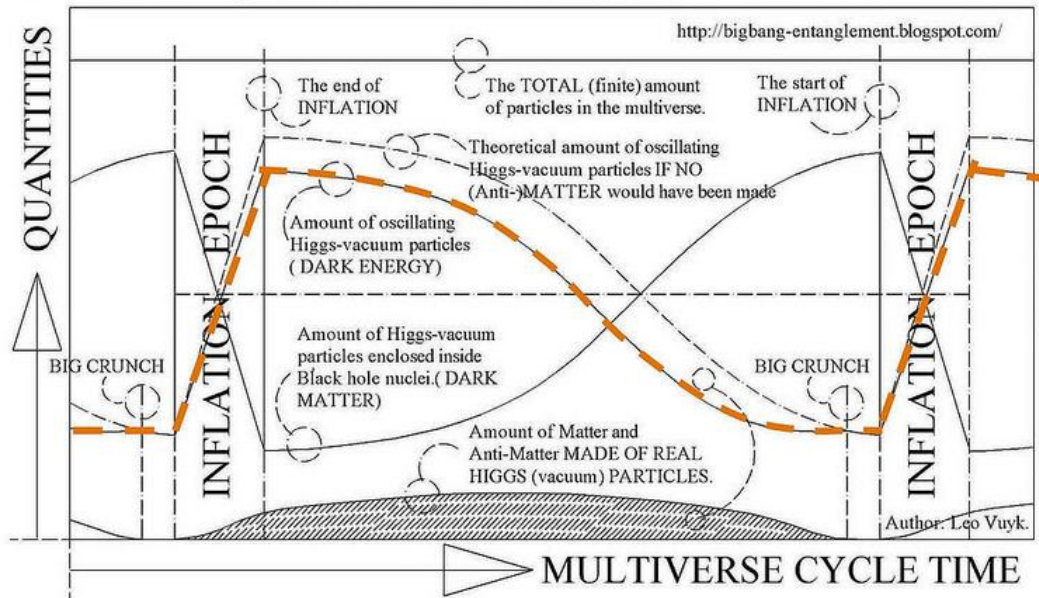

Figure 9, Comparison of the Raspberry supersymmetric multiverse with the recent CMB Planck map.

The CPT SYMMETRIC MULTIVERSE CYCLE.

The Inflation epoch starts if the decreasing vacuum pressure equals the increasing Higgs tension of the Big Crunch black hole nucleus. Inflation epoch ends if all splintered black hole nuclei are evaporated, or left behind as Galaxy Anchor Black Holes.



The Pulsating Multiverse depicted as a continuous flow of increasing and decreasing numbers free oscillating- and Black hole condensed Higgs particles and the amount of Quarks and leptons. The size of the pulsating multiverse vacuum is given in orange.

Figure 10, How the cyclic Multiverse could be made by dark matter splitting black holes and Dark energy Higgs lattices.

THE MAIN QUANTUM-FFF THEORY CHARACTERISTICS ARE:

- A: New DARK MATTER BLACK HOLE paradigm, (Fig. 11,12, Ref. 23)
- B: New DARK ENERGY HIGGS (with 126 GeV OSCILLATING energy), (Fig 16,17, Ref 23)
- C: New BIG BANG paradigm (with a symmetrical entangled raspberry shaped cyclic multiverse). (fig 10, Ref 16, 33)
- D: New SYMMETRIC WAVEFUNCTION COLLAPSE (between supersymmetric anti copy universes down to the quantum level by instant entanglement: the Raspberry shaped Supersymmetric Multiverse) (Ref. 6)
- E: New HUMAN CONSCIOUSNESS (is based on the a retarded -B.Libet: 400 m.sec-collapse principle). (fig 6, Ref. 6)
- F: New extended STANDARD MODEL . (fig 16,17, 21, Ref 4,)
- G: The LIGHTSPEED is dragged around massive objects. So a bouncing radar pulse from Venus onto Earth will show anomalies. (Ref. 3)

H: NEW HUBBLE REDSHIFT is also originated by transformation (lattice dilution) of the vacuum by Dark Matter black hole proliferation through the universe. (Ref. 29)

J: QUANTUM GRAVITY and EM forces (Ref, 7)

K: Quantum-FFF model EXPERIMENTS (Ref.32)

DESCRIPTION MORE IN DETAIL:

A: That a "black hole" create and repel propeller shaped Fermions and photons at its horizon, it has a Higgs knotty nucleus but no mass -because it does not emit gravitons-, and is the origin of all "dark matter" in the universe. The BH is supposed to exist at all scales from Quantum Knots (or Ball lightning) up to Comets, Sunspots, external Stellar- and Galaxy Anchor Black Holes, up to the Big Crunch- or Big Bang Black Hole.

B: That "dark energy" is based on microscopic massless vacuum (non SM) Higgs particles, energetic oscillating in opposing pairs (Also called "SEESAW Higgs mechanism" and able to convert into pairs of electrons and positrons, e.g. at the horizon of black holes.

That the 125 GeV mass of the Higgs particle (found by the LHC in Geneva) could be translated into 125 GeV energy of the paired vacuum particles. (alternative non SM Higgs) (And is consequently THE FIRST SIGN OF "DARK ENERGY") The LHC found a first sign of Dark Energy!!

C: That as a result, the Universe is cyclic, super symmetric and has the form of a raspberry shaped pulsating symmetric Multiverse with finite cycle time.

D: That all matter and humans have their instant entangled copy symmetric counterpart living inside the opposing super symmetric lobes of the raspberry multiverse. which is supposed to be the base for ALL WAVEFUNCTION COLLAPSES HERE on earth AND CONSCIOUSNESS.

E: That Humans and higher animals have the ability to influence conscious acts by a small retardation or lagging effect (300 m.sec) in decision making. This lagging effect phenomenon is already found and described for humans by Benjamin Libet, (fig 6) called RPI and RPII (Readiness Potential 1 and 2) see: <http://vixra.org/abs/1103.0015> called "Wavefunction Collapse and Human Choice-Making Inside an Entangled Mirror Symmetrical Multiverse."

F: That the STANDARD MODEL has to be extended with electric and magnetic monopole photons/gluons and Elementary particles are interpreted as real 3-Dimensional entities with complex convertible shapes, able to form compound quarks and two Leptons (the Muon and Tau).

G: The LIGHTSPEED is dragged around massive objects. So a bouncing radar pulse from Venus onto Earth will show anomalies. The orbital speed of Venus and the Earth will originate this anomaly. (By a LASOF: LOCAL ANTI-SYMMETRIC OSCILLATING vacuum FRAME)

Examples of Carina nebula Black hole pairing and splitting compared with Quasar Black hole pairing and splitting, both accelerated by self produced H2-ion plasma tails, according to Quantum FFF theory.

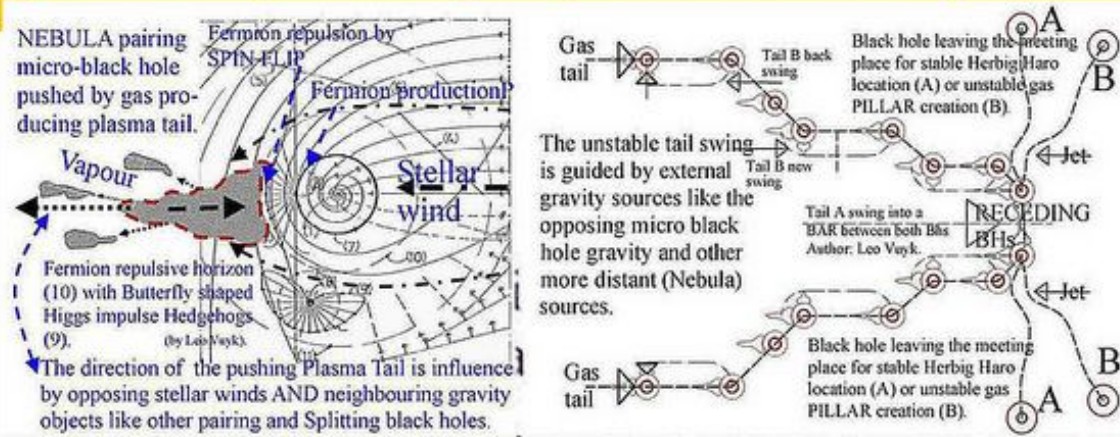

Two accelerating pairing and receding micro black holes, as the start of a HH object, in the carina nebula, with temporary meeting place (A) and ionised plasma tail. (Quantum-FFF Theory)

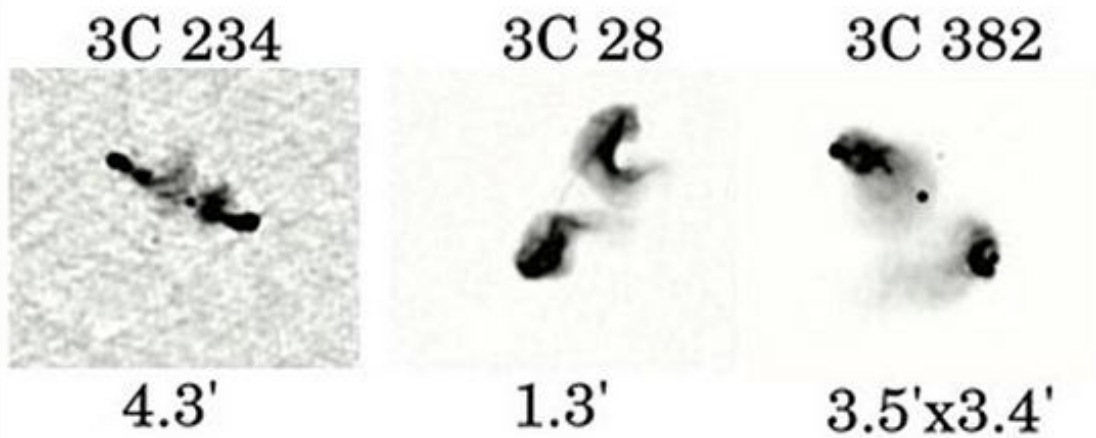
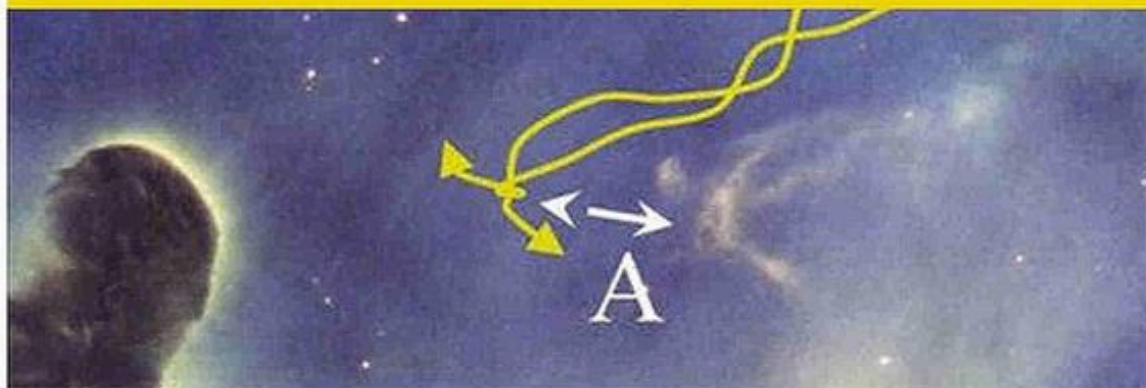

Figure 11, Several examples of pairing and splitting black hole with the principle mechanisms at the top of the image.

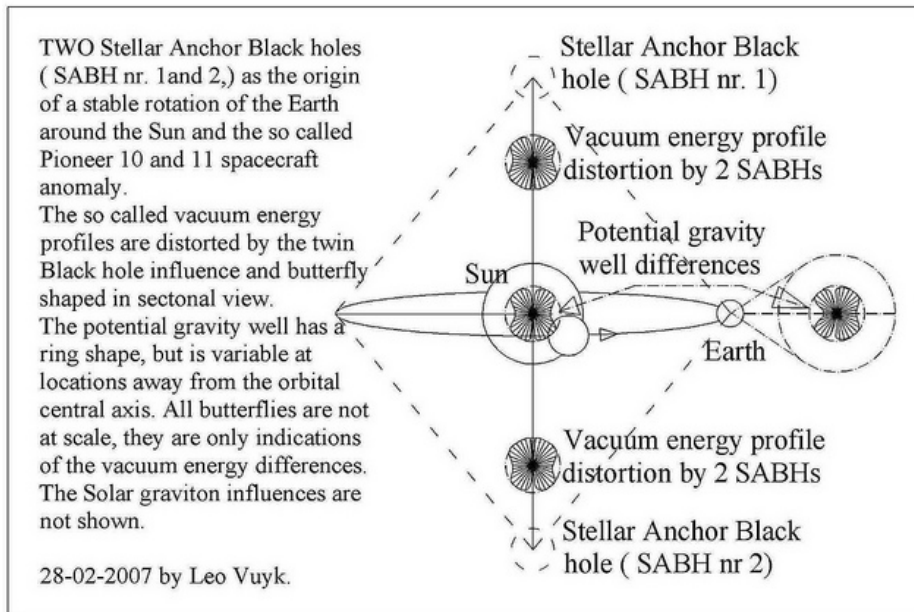
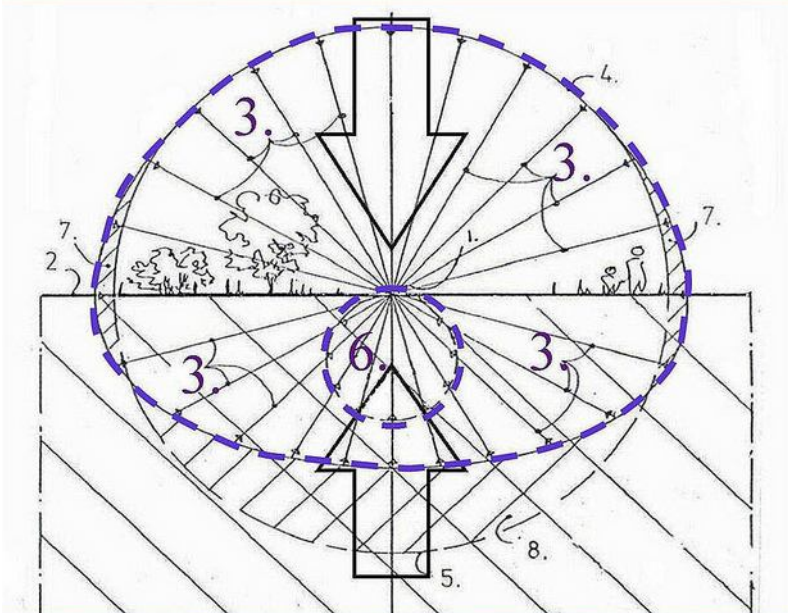

Figure 12, How the earth is assumed to be anchored between at least two dark matter black holes, responsible for anti Newtonian gravity effects like the Pioneer 10 and 11 anomaly,

Quantum Gravity as pressure distribution of the oscillating dual Higgs/Graviton vector field.



Cross section through the dual Higgs/ Graviton 3D vector field pressure distribution (or globular Hedgehog) on a point mass (1) located on earth's surface (2), according to Quantum FFF theory. 3+4= Higgs vector field. 6= Graviton vector field originated by the Higgs-graviton field transformation of the earth itself. 7+8= differences with a perfect globular vector distribution. Field variables 3+6 are rendered as inversed arrows. (see also black hole pressure distribution without gravitons)

Figure 13, The double Lesage push gravity represented by two vector arrays (blue) of push gravitons from earth and dark energy Higgs from outside and from inside the earth.

Magnetic field variations by the "Curl" of Magnetic Monopole (N and South) Radiation around a wire and the earth.

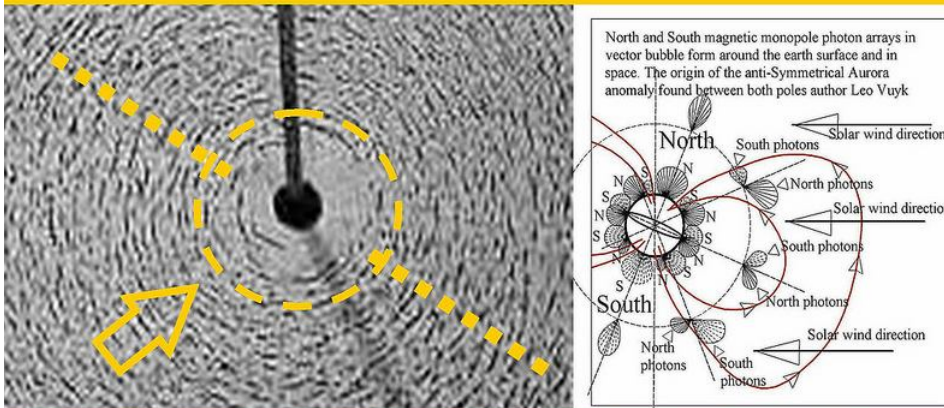

According to Quantum FFF theory, all magnetic fields can be presented as CURLED Magnetic Monopole Photon Vector Arrays. As a result, the magnetic field intensity around a wire and the a magnetic dipole is (away from linear polar positions) NOT dropping off with the cube or even the square of the distance from the source!! (See images). Also: direct around the current in a wire- equipped with iron powder on paper- the mag-

Figure 14, examples of magnetic monopole effects on anti symmetry of auroras and iron powder on paper around a current running in a wire.

Synchrotron radiation by Polarized Fermion spin combined with high speed motion through the resistive oscillating Higgs vacuum (according to Quantum FFF theory)

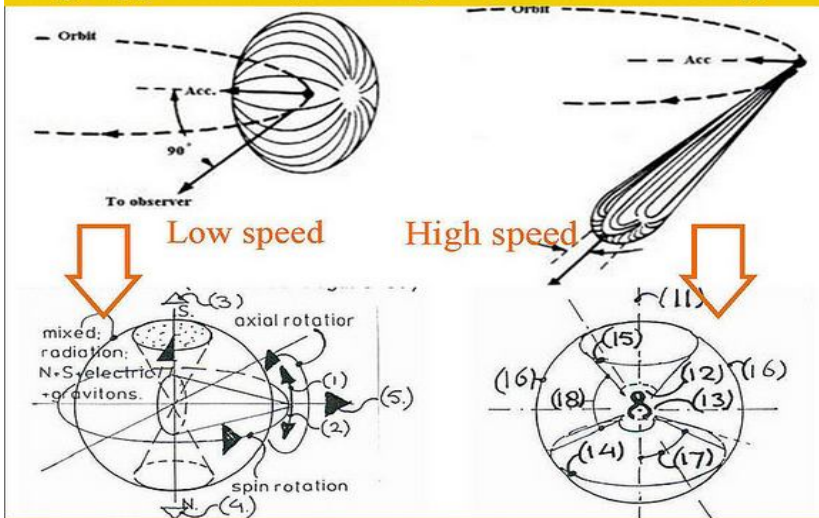

The propeller shape of Fermions is the origin of a dual spin state by collision influences of the oscillating massless Higgs vacuum at low speeds. (Spin rotation and axial rotation) At high relativistic speed the Lorentz polarization of the Fermion "propeller nose" (1 or 2) is preferently pointing into direction (11) with photon cone focussing into the opposing vacuum direction (15) and the Spin rotation has gone.

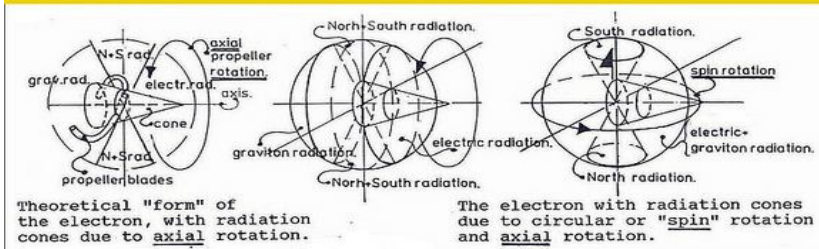

Figure 15, The propeller shape of Fermions and the dual spin

ALTERNATIVE STANDARD MODEL

of elementary (single) particles with click-on potentials to form compound Quarks- and Leptons. (author Leo Vuyk)

Explanation of the codes:

- U= Up rotation (180 degrees)
- O= Unchanged circle.
- L= Left rotation (90 degrees)
- R= Right rotation (90 degrees)

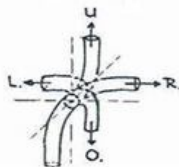

Summary with oscillation routes : (↔) or the definite Graviton decay route (→).

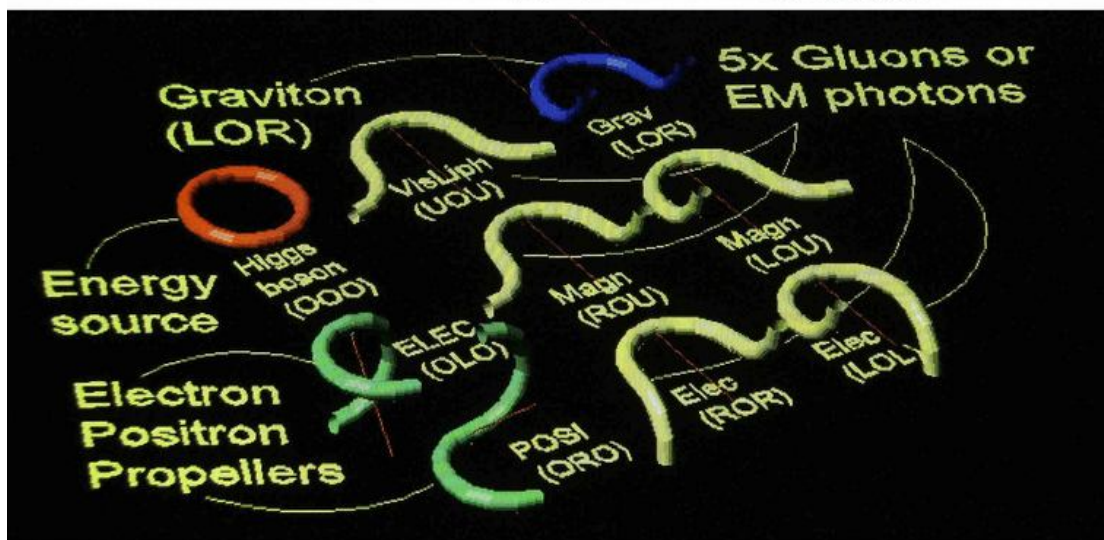
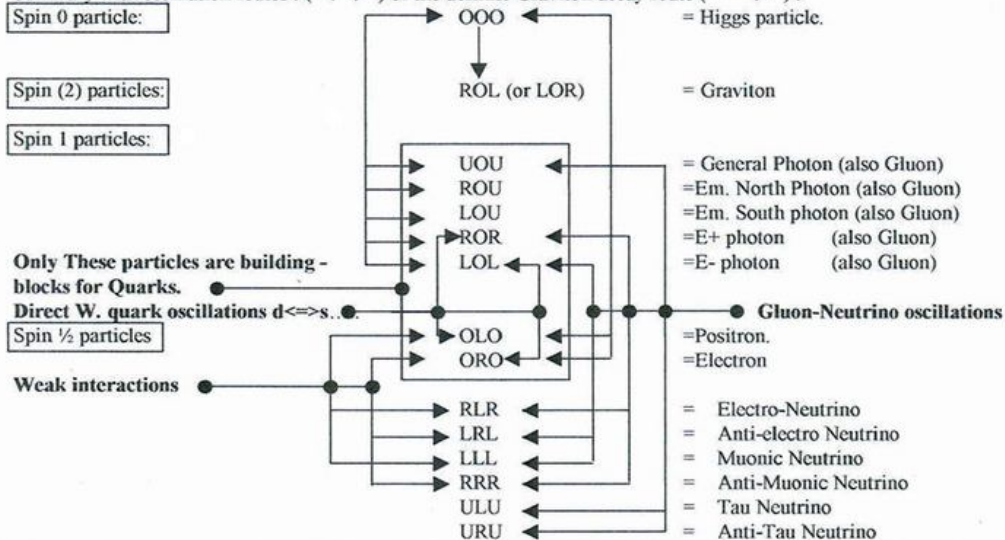

Figure 16, Convertible Higgs as the base for the extended Standard Model. (Ref 4)

Example of Tetrahedral Lattice space combined with Truncated Tetrahedral space, according to Quantum FFF Theory

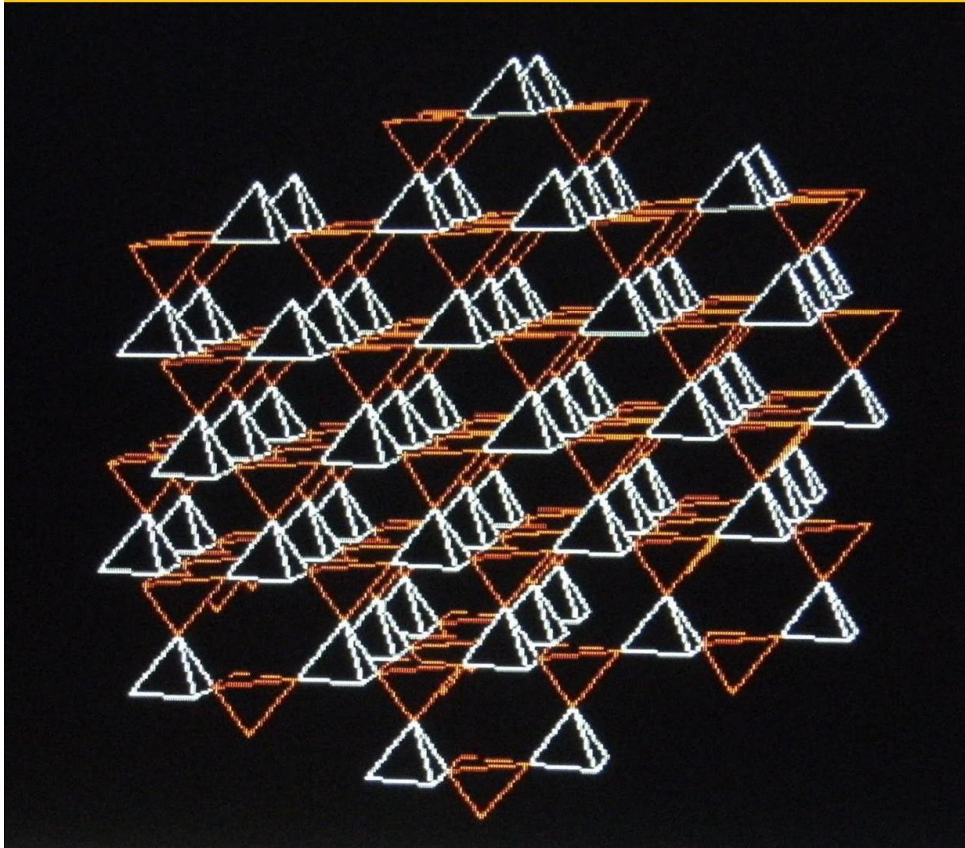
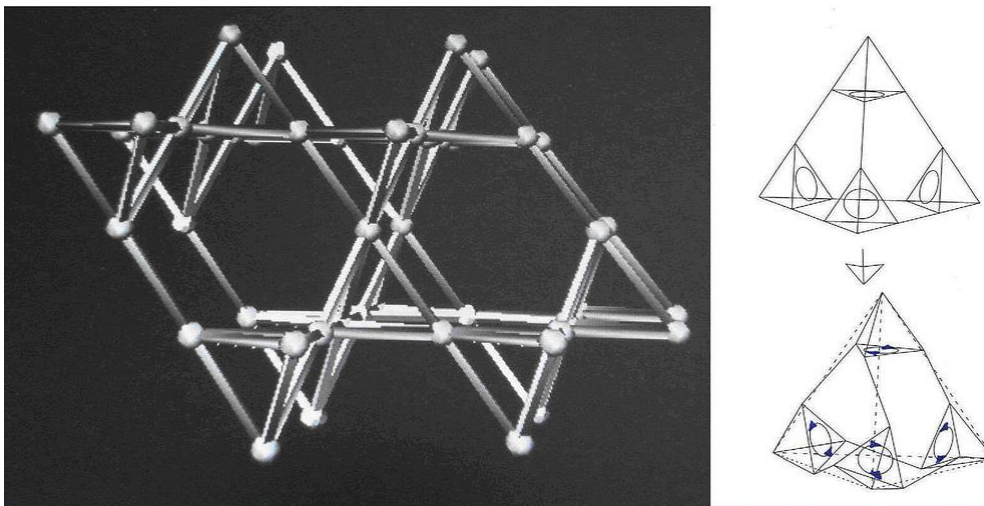
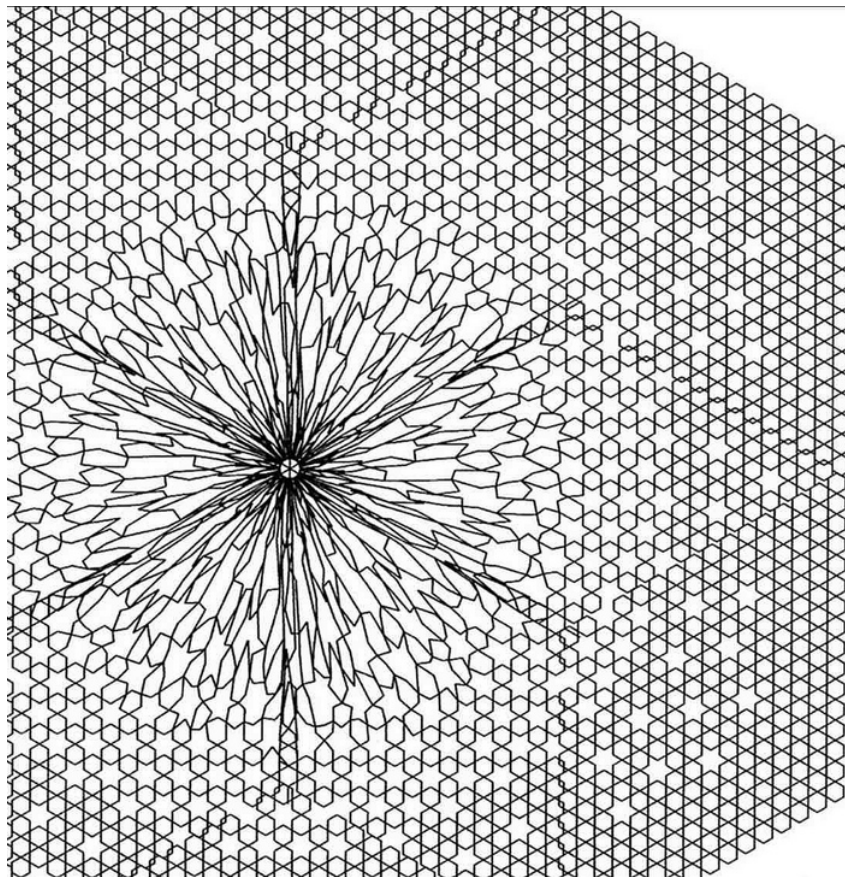

Figure 17, The truncated tetrahedron vacuum lattice. (Fig. 8, Ref. 1)



Simplified tetrahedral vacuum lattice structure (left), constructed by complex chiral tetrahedral building blocks (right). Each universe has to choose between a left- or righthanded rotation of its tetrahedral building blocks. Each chiral lattice has the Planck length and is supposed to be equipped with at least two oscillating massless new Higgs particles.

Figure 18, the chirality of the vacuum lattice for one universe. Each tetrahedron lattice is represented as a triple divided helix.



Black holes EAT the vacuum lattice with the oscillating Higgs particles, So, the vacuum lattice structure around a black hole could be represented like this.

As a result, the near vacuum is thinner or diluted, it has holes, which could be the origin of the Universal HUBBLE redshift.

By contrast, my new black hole paradigm says: the origin of universal redshift is Dark matter.

Dark matter is the proliferation of vast numbers of Black holes around Galaxies. Conclusion, based on Hubble redshift, we don't know anything about expansion or contraction of the universe.

(Author Leo Vuyk)

Figure 19, Black holes eat the vacuum lattice with a deluting effect as an extra origin of the Hubble redshift.

Why Silicon? Silicon structure (A) seems to be related to the structure of Black Hole Quantum Knots (B) proposed by the New Black Hole paradigm of Quantum FFF Theory. Basic Black Hole Quantum Knots are assumed to be formed by 3,4 or more real photon particles (B+C)

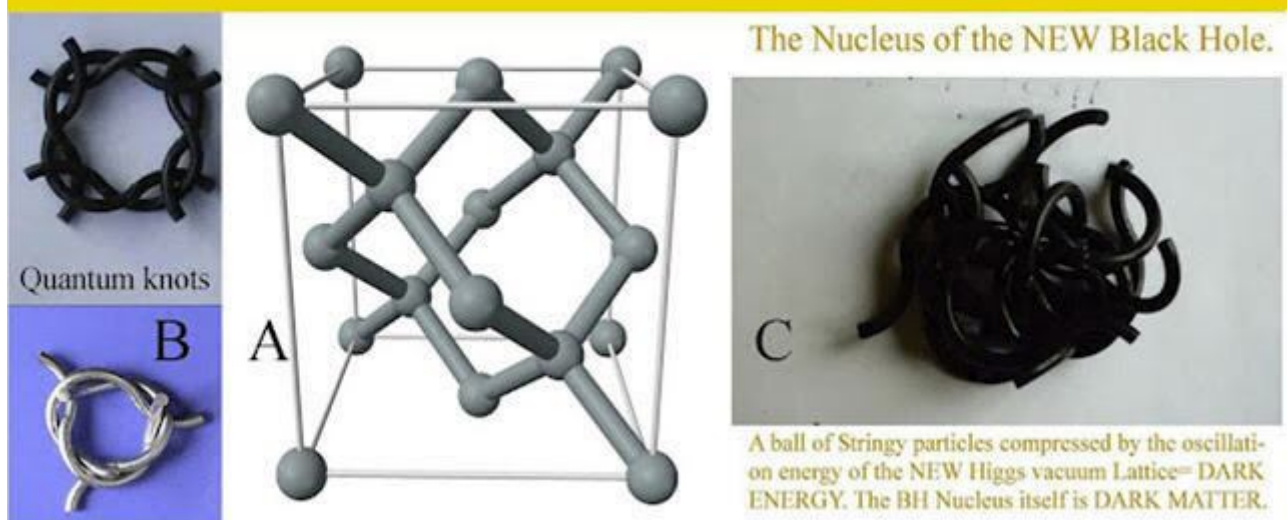

Figure 20, The nucleus of a (new paradigm) black hole represented as a very small Quantum Knot created in a silicon discharge experiment and also in the LHC UFO dust particles..(Ref. 34)

Quantum Function Follows Form Model

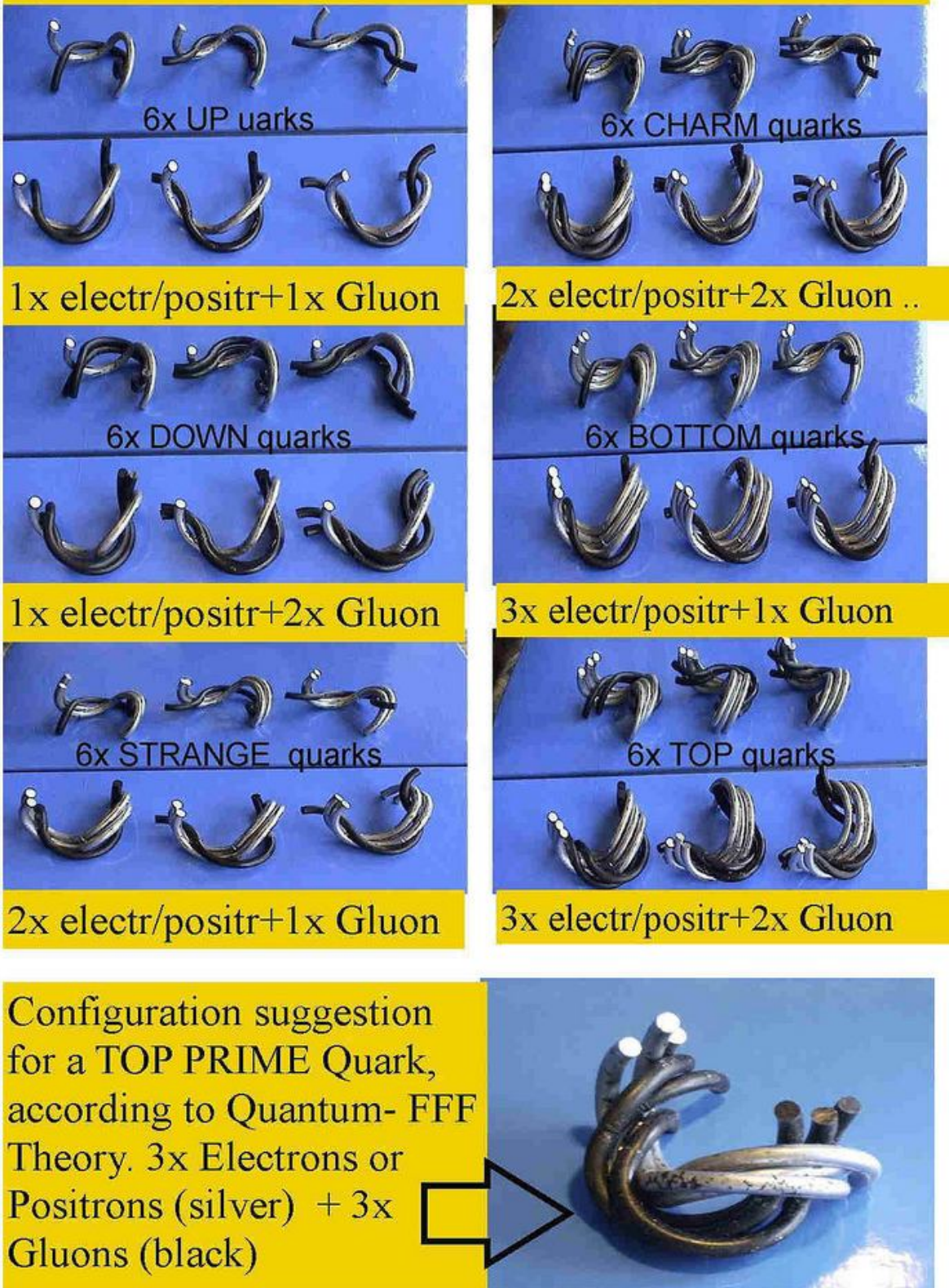

Figure 21. Quarks in the form of complex compound propeller structures with left or right handed pitch for positive or negative charge.

QUANTUM FFF THEORY

According to Quantum FFF Theory, the FORM and MICROSTRUCTURE of elementary particles, is supposed to be the origin of FUNCTIONAL differences between Higgs-Graviton- Photon- and Fermion particles. As a result, a NEW paradigm of splitting-, accelerating- and pairing Black Hole seems to be able to accelerate itself by a -Zero Point Energy driven-self created plasma tails (by a new Quantum Fluctuation process), to form dumbbell systems, of two or even more black holes. Inside Nebula these dumbbell systems are called Herbig Haro systems.

Inside the early universe however these systems are observed as dumbbell shaped radio lobes at both sides of early galaxies (Faint B3 radio galaxies). Recent cosmic observations of the infra red and x-ray background radiation of the universe by Chandra and Spitzer space telescopes (CIB and CXB), suggest that even direct after the big bang ABUNDANT black holes already existed.

This can be interpreted as a support for a Black Hole splitting Big Bang and a Black Hole pairing Big Crunch before, thus there is reason to propose a cyclic Universe.

In Quantum FFF theory, the chirality of the universal vacuum lattice is proposed to be the origin of negative- or positive charged black holes and the origin of the formation of matter over anti-matter around negative charged black holes as in our universe seems to be the case.

The chirality of the oscillating Higgs vacuum is supposed to be the origin of preferred Positron attachment with three different shaped monopole Gluon/photons for easy Quark formation without a lot of particle annihilation back into the Higgs vacuum. Quantum FFF Theory states that all quarks and two leptons (muon and Tau) are composed out of electrons or positrons as a base with one or two photons/Gluons as "click-on" elements and "click out" and transform on decay processes . So Quark compositeness is needed to be in line with the color charges of QCD model.

At the same time, the possibility of a chiral universal vacuum is reason to support the idea of a super symmetric raspberry shaped multiverse, with a limited number of dual CP(T) symmetric (anti) copy universes, instant entangled down to all quantum systems.

The Quantum FFF model seems to be a unique description of reality including multiuniversal wavefunction collapse and human consciousness. As a consequence it can be qualified as a proposal for the theory of everything.

RECENT SUPPORT FOR Q-FFF ELEMENTS

YOUNG UNSTABLE SPLITTING HULA HOOP STARS, support for SABHs (stellar Anchor Black Holes) the origin of OPEN star clusters.

Spitzer Astronomers have discovered a young stellar system known as YLW 16A containing three young stars that work together like a hula hoop.

According to Quantum FFF (Function Follows form) theory, Black Holes are equipped with three horizons by the structural differences of the quantum vacuum lattice at different distances of the BH nucleus. As a consequence, Black holes produce and repel Fermions often in the form of plasma and ionized H₂ gas. The gas has a peculiar habit, it will concentrate at the side of the black hole where it is attracted most by other gravitational influences of external objects.

As a result, the gas will form knots or tails, able to PUSH the black hole horizon into an anti symmetrical shape which forces the BH to move opposite and away from the gas tail. This process is supposed to be the base for lots of peculiar pairing and splitting dual gas knot processes observed in Nebula such as the Carina nebula.

If two black holes approach each other, there is a critical distance between the two objects originated by the mutual BH nucleus attraction force and the mutual gas tail attraction forces. As a result, at a critical distance the two gas tails will swing around the BH and form a mutual gas bar between the two BH's, pushing the two BH's away from each other.

This system is supposed the logical origin of so dual called Herbig Haro (H-H)objects, observed all around inside nebula and the origin of star forming processes in the centre of the dual H-H objects. If the two H-H lobes represent the two (Super Nova) black holes then the total nuclear content (mass) of these BH's will influence the surrounding quantum space and consequently the maximum mass of the central star of the H-H system.

It is assumed that the central star is the start of a so called open star cluster, producing multiple stars by a what I call a "Hula Hoop" instability star splitting process. This Hula Hoop process is recently observed by the Spitzer satellite, (2013) showing two "Hula Hoop" stars accelerated away from a central mother star.

If the rotating central star is growing by the gas supply and accelerated by electrical Birkeland currents, it is stabilized by these Birkeland currents and the structure of the oscillating Higgs vacuum in between the two H-H lobes or black holes..

However at some moment, the star will reach its maximum mass, as a result it will start to wobble like a rugby ball and eventual split into three stars, the start of an open star cluster, which is what the [Nasa Spitzer telescope showed us](#).

Leo Vuyk. Augustus-2- 2013.

No comparable universal models are found on the internet or in the scientific journals.

However some of them are observed aiming into parallel directions, see:

For Dark Energy Higgs oscillators:

1: BG Sidharth. (2009). Planck Oscillators in the Background Dark Energy.
<http://arxiv.org/pdf/0912.1477.pdf>

2: N. Hamein. and E.A. Rauscher, COLLECTIVE COHERENT OSCILLATION PLASMA MODES IN SURROUNDING MEDIA OF BLACK HOLES AND VACUUM STRUCTURE - QUANTUM PROCESSES WITH CONSIDERATIONS OF SPACETIME TORQUE AND CORIOLIS FORCES. <http://dimensionalchemist.com/wp-content/uploads/2011/12/Nassim-Hamein-Plasma-Paper.pdf>

3: For the 126 GeV vacuum oscillations of the (Q-FFF) Dark Energy Higgs mechanism: Kraus and Dent: "Higgs Seesaw Mechanism as a Source for Dark Energy," <http://www.sciencedaily.com/releases/2013/08/130810063645.htm> <http://scitechstory.com/2013/08/11/krauss-and-dent-a-new-theory-to-explain-dark-energy/>

For Dark Matter Black Holes:

4: For the splitting Big Bang Black Hole into primordial black holes: "The case for primordial black holes as dark matter" Author: M.R.S. Hawkins(20 Jun 2011) <http://arxiv.org/abs/1106.3875>

For a different Multiverse interpretation of Quantum Mechanics

5; "The Multiverse interpretation of Quantum Mechanics" by: Raphael Bousso and Leonard Susskind. <http://arxiv.org/pdf/1105.3796.pdf>

References:

[39] **The New God Particle and Free Will.**

Author: Leo Vuyk, LuLu publishers, 2008.

ISBN number 978-1-4092-1031-3

<http://www.lulu.com/spotlight/LeoVuyk>

[38] Quantum FFF Theory is also published in the form of POSTERS at the Flickr site:

<http://www.flickr.com/photos/93308747@N05/>

[37] Numbered listing of Vixra essays by Leo Vuyk.

http://vixra.org/author/leo_vuyk

[36] viXra:1307.0068
Quantum Function Follows Form Theory, the Small Scale, Posters part 1.
 [35] viXra:1307.0067
Quantum Function Follows Form Theory, the Large Scale, Posters part 2.
 [34] viXra:1306.0218)
Dark Matter UFO Dust Particles or Quantum Knots in the LHC at CERN ?
 33, viXra:1306.0065
The Splitting Dark Matter- Black Hole- Big Bang and the Cyclic Multiverse.
 32, viXra:1305.0140
Quantum FFF Theory Experiments, a Summary.
 31, viXra:1305.0041
The Shnoll Effect Explained by Quantum FFF Theory.
 30, viXra:1304.0022
The Self Organizing Universe in the Carina Nebula.
 29, viXra:1303.0211
Hubble Redshift Combined with Universal Contraction is Possible.
 28, viXra:1303.0053
Micro Birkeland Currents Between Two RF Generated Plasma Balls in the Laboratory.
 27, viXra:1302.0172
Silicon Based Ball Lightning Globule Structures and Signs for Accumulation and Retarded Decrease of Tunnelling Energy Bullets.
 26, viXra:1301.0088
Two or Three Large Quasar Groups (LQGs) Located at the Start of Two or Three Lyman Alpha Systems and a Part of the Raspberry Multiverse?
 25, viXra:1301.0050
Dwarf Galaxies and Their Relation with Dark Matter Based Galaxy Anchor Black Holes (Gabhs).
 24, viXra:1210.0177
Instant Broglie Bohm Pilot Waves, the Origin of All Entanglement Effects in the Lab and Wavefunction Collapses in Our Universe as Related to Our Opposing Anti-Copy Universe(s) According to Quantum FFF Theory.
 23, viXra:1209.0092
New Dark Matter Black Holes and a New Dark Energy Higgs Field, Lead to a Bouncing CP Symmetrical Multiverse, and New Experiments.
 22, viXra:1209.0061
Birkeland Currents, Sunspots, Comets and Ball Lightning Originated by New Paradigm Dark Matter Black Holes.
 21, viXra:1209.0030
Majorana and Sterile Neutrino Solutions in the Quantum-FFF Model.
 20, viXra:1208.0031
Clumpy Dark Matter Around Dwarf Galaxies a Support for an Alternative Black Hole Theory According to the Quantum Function Follows Form Model.
 19, viXra:1202.0091
Earth Magnetic Monopole Array Field Interaction with Cyclotron –Synchrotron Electrons and Muon Conversion Used for Levitation Systems.
 18, viXra:1201.0092
Earth Magnetic Monopole Array Field Interaction with Cyclotron Electrons used for Levitation Systems.

17, viXra:1112.0065

LHC Signals Between 121-130 GeV Interpreted with Quantum-FFF Theory

16, viXra:1111.0096

Reconciliation of QM and GR and the Need for a Pulsating Entangled CPT Symmetric Raspberry Shaped Multiverse.

15, viXra:1111.0061

Black Hole Horizon Curvature Dependent Balance Between Plasma Creation and e-e+ Annihilation in Quantum FFF Theory.

14, viXra:1108.0036

Artificial Ball Lightning Production and Exploitation Device for Zero Point Electric Energy Usage.

13, viXra:1108.0006

Mass in Motion in Quantum FFF Theory

12, viXra:1104.0083

Quantum FFF Theory in Posters.

11, viXra:1104.0044

Ball Lightning, Micro Comets, Sprite-Fireballs and X-Ray/gamma Flashes According to Quantum FFF Theory.

10, viXra:1104.0002

Stellar Anchor Black Holes as the Remnants of Former Herbig Haro Objects

9, viXra:1103.0097

ZPE Zero Point Energy Examples Around Black Holes.

8, viXra:1103.0068

Funktion Follows Form, at the Quantum Scale and Beyond.

7, viXra:1103.0024

Quantum Gravity and Electro Magnetic Forces in FFF Theory

6, viXra:1103.0015

Wavefunction Collapse and Human Choice-Making Inside an Entangled Mirror Symmetrical Multiverse.

5, viXra:1103.0011

An Alternative Black Hole, Provided with Entropy Decrease and Plasma Creation

4, viXra:1103.0002

3- Dimensional String Based Alternative Particles Model

3, viXra:1102.0056

Experiments to Determine the Mass Related Lightspeed Extinction Volume around massive objects.

2, viXra:1102.0054

Atomic Nuclear Geometry Based on Magic Number Logic.

1, viXra:1102.0052

Construction Principles for Chiral “atoms of Spacetime Geometry