

Dark Matter UFO Dust Particles or Quantum Knots in the LHC at CERN ?

**Leo Vuyk,
Architect,
the Netherlands.**

Abstract.

Quantum FFF (Function Follows Form) theory states, that the vacuum is seeded with fast oscillating massless dual Higgs particles, coined Dark Energy of 126 GeV. recently found by the LHC at CERN.

Now I try to describe the similarities between the characteristics of energetic Quantum Knots found inside Silicon discharge experiments in the laboratory and so called UFOs (Unidentified Falling Objects) described as “Dust particles” created “somehow” alongside the accelerated proton beam of the LHC, causing beam disruption and automatic beam dumps.

Introduction.

In a former essay called: “**The Splitting Dark Matter- Black Hole- Big Bang and the Cyclic Multiverse**”, (Ref. 33) I postulated that the 126 GeV mass of the Higgs particle (found by the LHC in Geneva) should be translated into 126 GeV energy of the paired oscillating Higgs-vacuum particles, which is consequently a first signs of "Dark Energy" in the LHC lab. as described by Quantum FFF theory. (ref: 17, LHC Signals Between 121-130 Gev Interpreted with Quantum-FFF Theory)

In this essay I try to show that micro “Electro magnetic interference Quantum Knots” coined “dark matter black holes” assumed to be the origin of molten Silicon globules (Ref, 27) have strong similarities with the origin of so called UFOs dust particles or “Unidentified Falling Objects” found in the Large Hadron Collider since 2010 mostly at two specific positions in the beam pipe.

Many of these events in the LHC, occurred at the electric arc position that produces the beam of protons. The events became more frequent as the intensity of the proton beam increased. More UFO events, and resulting beam dumps, happened at a point in the beam just past injector kicker magnets (MKIs), suggesting that these magnets are also a source of the UFO dust particles.

It is an interesting challenge to compare the molten silicon globules found in the lab, (fig, 1) and other electric discharge damage effects I found in a damage report of an exploded battery of Boeing 787 Dream liner aircraft (Jan 2013) (fig, 8) with the observational evidences of the LHC UFO dust particles. At the same time there seems to be an interesting opportunity to support the idea that interference Quantum Knots represent a micro form of Dark Matter Black Holes.

In Quantum FFF theory it is assumed that there are four kinds of dark matter black holes,
1: The Big Bang – or Big Crunch Black Hole, the origin of the cyclic multiverse.(ref. XXX)

2: Primordial Big Bang splitting Black Holes as the product of the exploding Big Bang black hole, identified after a pairing an splitting process as Galaxy Anchor Black Holes (GABHs),

3: Supernova Black Holes identified as and after a pairing and splitting process as Herbig Haro hotspots as the origin of Stellar Anchor Black Holes (SABHs).

4: Electro Magnetic Interference Black Holes, described as the origin of so called Quantum Knots found in the lab.(ref, 27) , Ball Lightning, Earth bound Micro Comets, Solar related Comets and Sunspots.

Only the last type of black hole (4, the Quantum Knotty type) is a possible candidate for the UFO phenomenon.

Quantum FFF theory.

Quantum FFF (Function Follows Form) theory states, that the vacuum is seeded with fast oscillating massless dual Higgs particles (the origin of dark energy) , oscillating along a complex chiral tetrahedral vacuum lattice, which has the ability to transfer Photon and Graviton FORM information in bunches of linear but chiral oscillations, through the chiral (helix shaped) vacuum lattice with the local speed of light.

The local speed of light is created around massive objects which seem to be able to “drag:” the Higgs vacuum oscillations into an anti-symmetrical action called “LASOF” or Local Anti Symmetrical Oscillating vacuum Frame.

There are no attraction forces in Q-FFF theory. Gravity seems to be the result of two different impulse vector arrays: the massless Higgs impulse array and the (less effective) massless Graviton impulse array, which is supposed to be based on the same massless Higgs particle transporting the “FORM information energy” of the Graviton.

As a consequence, new paradigm Dark Matter Black holes suffer only from the gravitational influence of Higgs vacuum (photon) impulses also coined Casimir push-gravity, because no gravitons can escape from the Black hole. The Black hole is supposed to be a super dense knot of Higgs particles floating inside (and compressed and attacked by) the energetic oscillating Higgs vacuum frame. (Fig. 7)

In Q-FFF theory it is postulated that only micro black hole nuclei below a certain size are able to evaporate back into the Higgs vacuum. Black hole types larger than ball lightning and small Comets are supposed to have a steady growth.

No photons like gravitons can escape from inside the Black hole. However, in Q-FFF theory, the vacuum is constantly “eaten” by these NEW Black hole nuclei and the origin of the Casimir gravity effect of Black holes..(fig 2,3,4,5,6)

In the Q-FFF model, Fermions are assumed to have a propeller shape equipped with a left- or right hand “pitch” Quarks and some leptons are compound particles (with photonic gluons) however, electrons and positrons are singular.

Only the statistical sum of the different kinds of vacuum impulses (in the form of butterfly shaped vector arrays) by real collisions from all directions on Fermions are responsible for all (energetic) phenomena in the universe. (Fig 14,15,163)

The polarisation and so called spin flip of Fermions around Black holes is the origin that Black holes are equipped with a narrow Fermion repelling globular horizon. (Fig, 9)

As a result, Black holes are Zero Point Energy driven electric generators with negative charge at the outside and positive charge at the inside.

Conclusion,

There are interesting similarities between LHC UFO dust particles and other molten globules found in the lab (fig, 1) or even at exploded batteries. (Boeing 787) (fig, 8)

However the suggestion that the automatic beam dump of the LHC is originated by these dust particles or by the postulated origin of these dust particles, the heating Quantum Knots, or micro dark matter black holes, seems to be probable but need more research.

Suggestion for the origin of UFO dust particles inside the LHC at CERN: particle based Quantum Knot heating according to Quantum FFF theory.



Comparison of UFO dust particles diam. 10 μm at CERN (left) inside ceramic tubes and on Silicon discharge globules in the lab. 100 μm (Right)

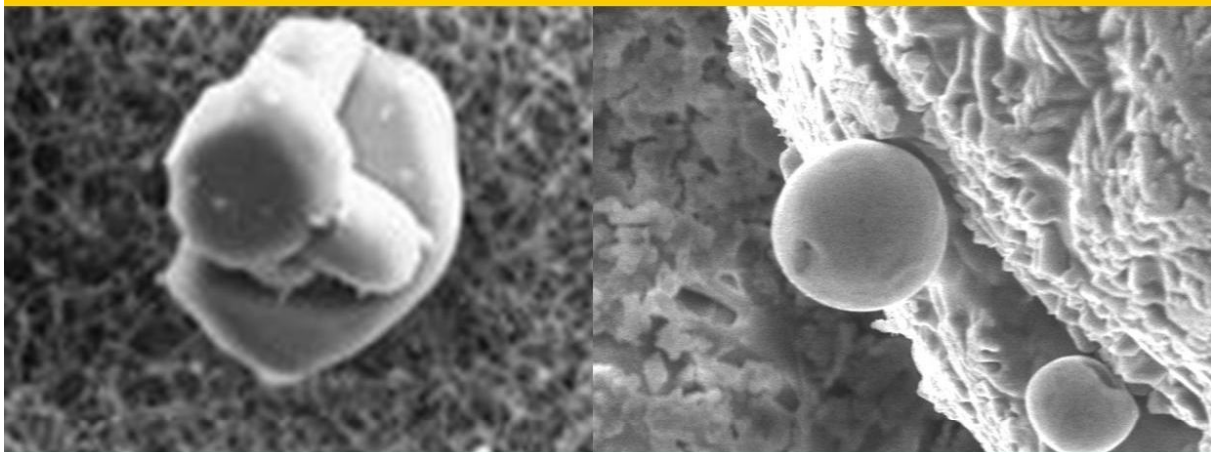

Below (in yellow) the Quantum Knot trajectory

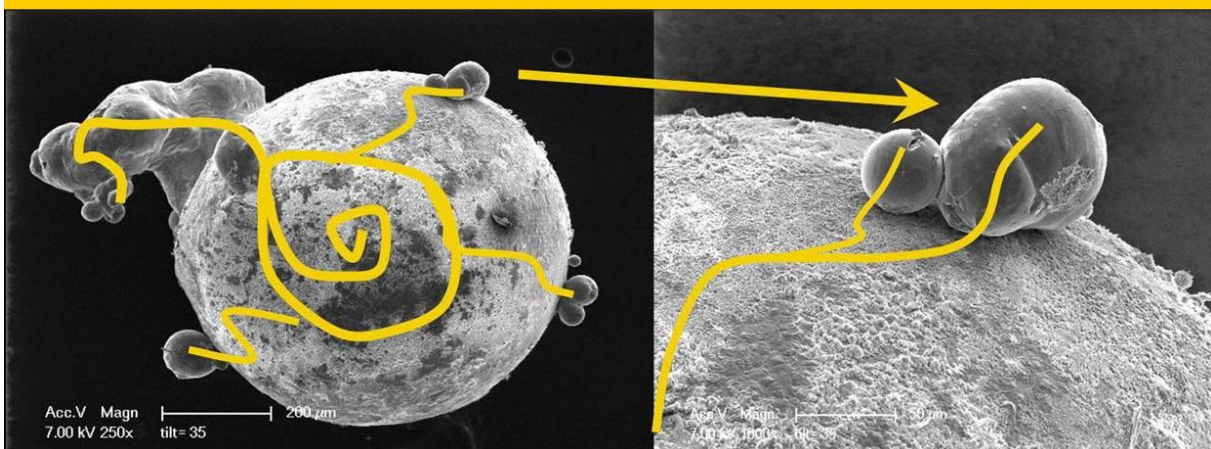
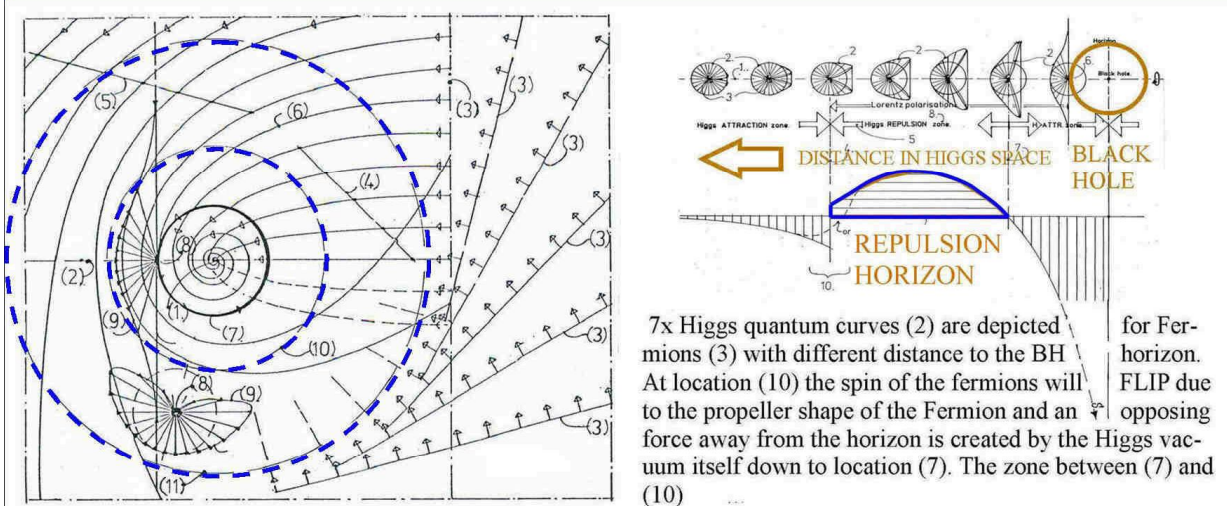

Figure 1. Comparison between LHC (CERN) UFO dust particles (10 μm) with molten Silicon globules (100 μm) originated in the lab by travelling and evaporating Interference Quantum Knots (micro dark Matter Black Holes)



Figure 2, Impression of a Quantum Knot based nucleus of the new paradigm Dark Matter Black Hole. The Quantum Knot is supposed to be compressed by the Dark Energy of the Higgs vacuum lattice.

Fermion repulsion zone 10-11 around a Black hole, with Photon and Higgs trajectories around a NEW paradigm Black Holes.(Quantum-FFF Theory)



7x Higgs quantum curves (2) are depicted for Fermions (3) with different distance to the BH horizon. At location (10) the spin of the fermions will FLIP due to the propeller shape of the Fermion and an opposing force away from the horizon is created by the Higgs vacuum itself down to location (7). The zone between (7) and (10)

- 1: Non rotating Black hole nucleus (in 2D cross section).
- 2: Reference axis for trajectories 4,5 and 6.
- 3: Other incoming photonic/Higgs fronts (without depicted trajectories)
- 7: High photon energy collider globular shell, with intense Quantum effects like pair production (e-,e+). 8: test masses.
- 9: Butterfly shaped Higgs/photon Fermion pushing curves in 2D.
- 10 and 11: Fermion repulsion zone. Due to the propeller shape of the Fermions, they will experience a so called "Spin Flip" in this zone.

Figure 3, Principle of Fermion repulsion around a new paradigm Black hole according to Quantum FFF theory..

The OLD and NEW Black Hole differences.

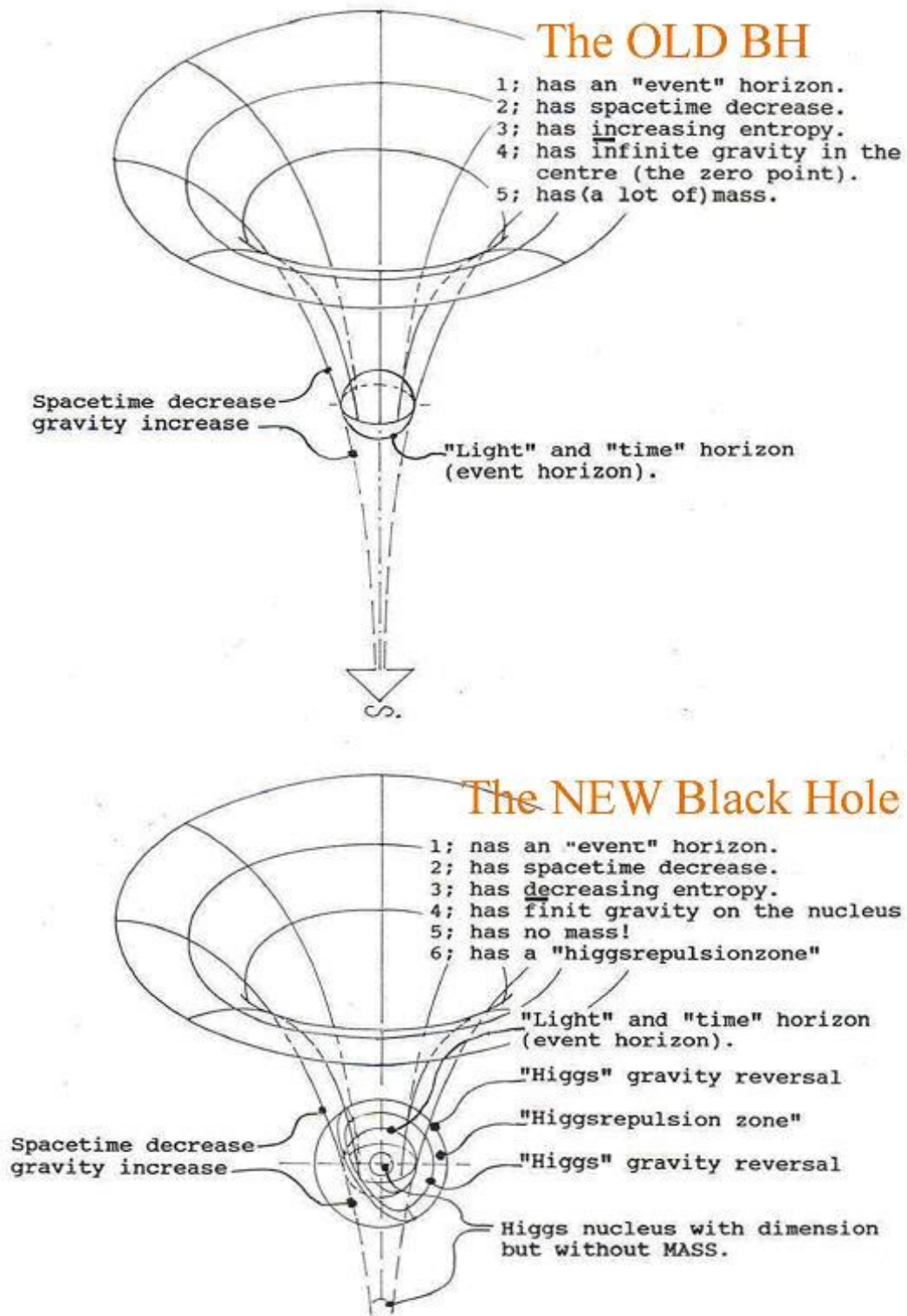
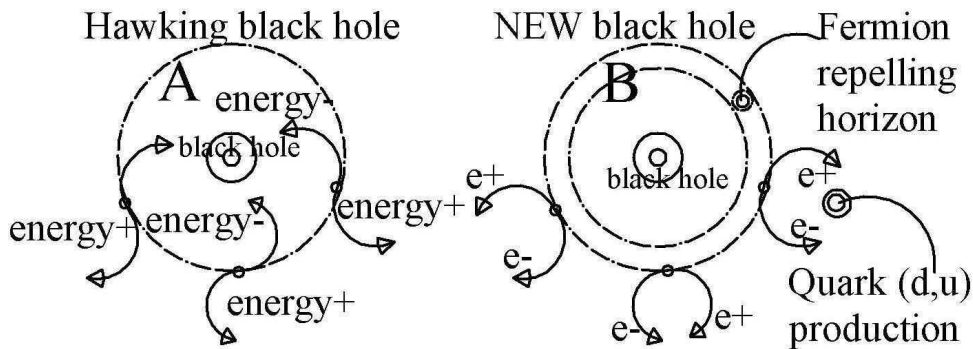

Figure 4, The difference between the old and new paradigm Black hole according to Quantum FFF Theory .

The NEW Black Hole Paradigm



The standard Hawking Radiation postulate is: that all matter (NOT all energy) is drawn into the Black hole.

My NEW postulate is that matter is created (and pushed outside) at the Black hole horizon by QUANTUM FLUTUATIONS producing electrons and positrons.

Some electrons and positrons will annihilate, but the rest will form Quarks and plasma, because the Higgs vacuum lattice is CHIRAL and prefer to link gluons to positrons. Thus more electrons will stay single and form atom shells.!

Due to the propeller shape of the particles all the plasma is repelled away from the black hole!! The black hole will not evaporate !

This is the base for NEW Physics and a support for a new explanation of Cometary X-rays, Hydrogen and AMINO ACID production. Even Gas Pillar and Herbig Haro formations inside Nebula become a logic base. Author Leo Vuyk.

Figure 5, Quantum Fluctuations as the origin of pair production and Plasma creation (Quarks) around Dark Matter Black Holes.

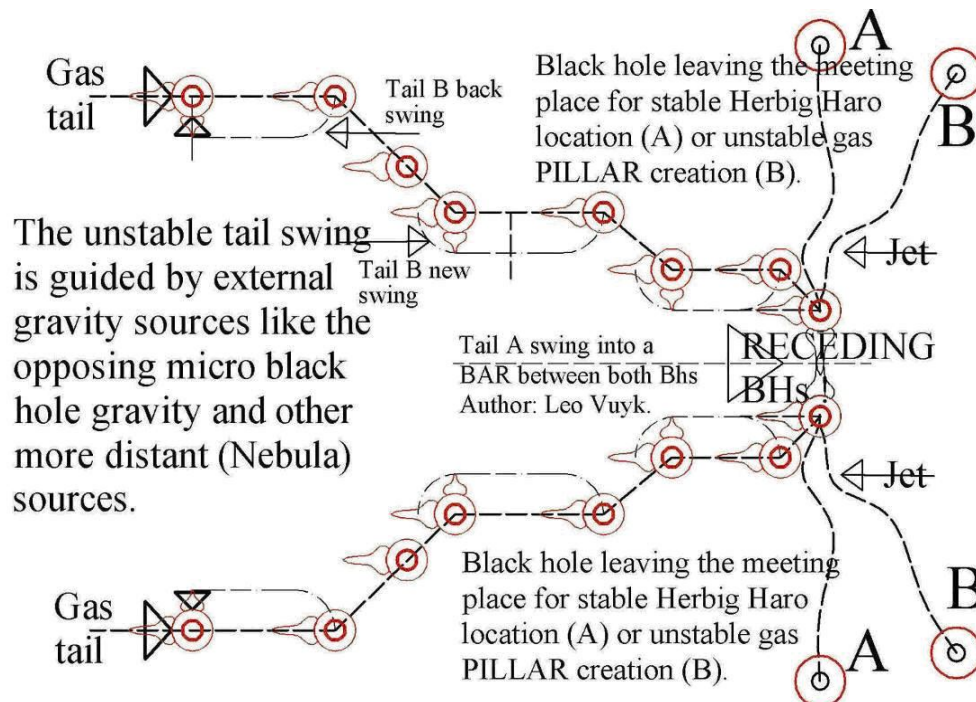
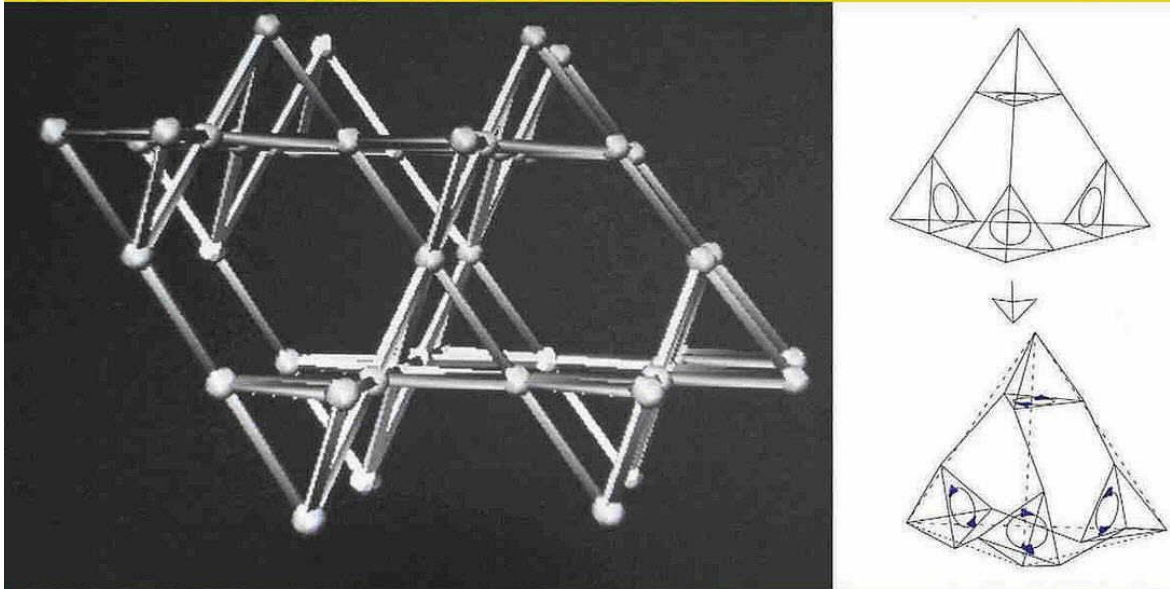
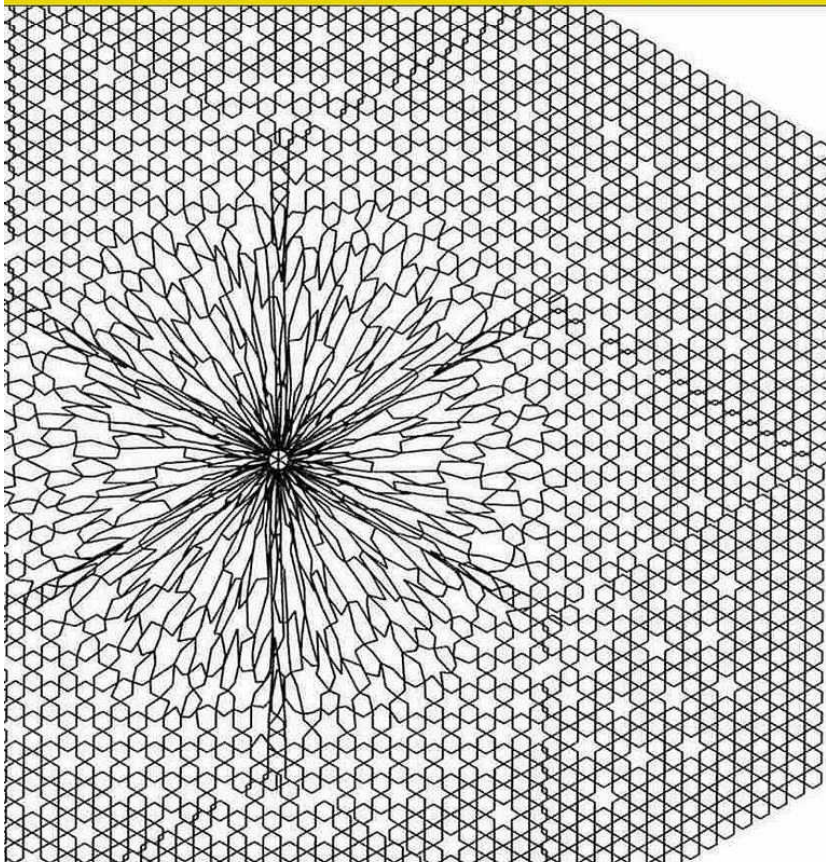

Figure 6, New Black hole propulsion principle by a self produced plasma-dust tail,. As a consequence, New black holes do not merge to form larger nuclei, they even repel negative charged metal surfaces by their own exterior electron charge.

New Dark Matter Black Hole, “Eat” the chiral oscillating Higgs vacuum.(Quantum-FFF Theory)



Symplified tetrahedral vacuum lattice structure (left), constructed by complex chiral tetrahedral building blocks (right). Each universe has to choose between a left- or righthanded rotation of its tetrahedral building blocks. Each chiral lattice has the Planck length and is supposed to be equipped with at least two oscillating massless new Higgs particles.



Black holes EAT the vacuum lattice with the oscillating Higgs particles,
 So, the vacuum lattice structure around a black hole could be represented like this.
 As a result, the near vacuum is thinner or diluted, it has holes, which could be the origin of the Universal HUBBLE redshift.
 By contrast, my new black hole paradigm says: the origin of universal redshift is Dark matter.
 Dark matter is the proliferation of vast numbers of Black holes around Galaxies.
 Conclusion, based on Hubble redshift, we don't know anything about expansion or contraction of the universe.
 (Author Leo Vuyk)

Figure 7, The Chirality and structure of the oscillating Dark Energy Higgs vacuum lattice

Suggestion for the origin of external stainless steel globules found on the Boeing 787 Dreamliner APU battery damage jan.7.2013 at Boston airport.(below)

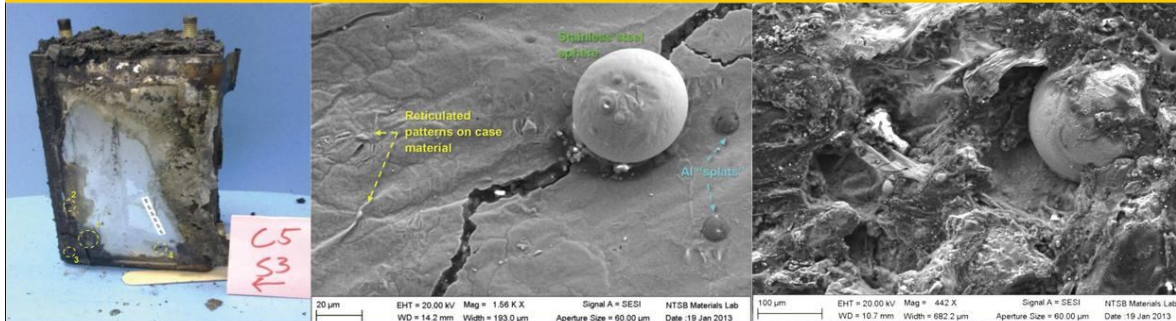

Comparison of UFO dust particles diam. 10 μ m at CERN (left) inside ceramic tubes and on Silicon discharge globules in the lab. 100 μ m (Right, below)

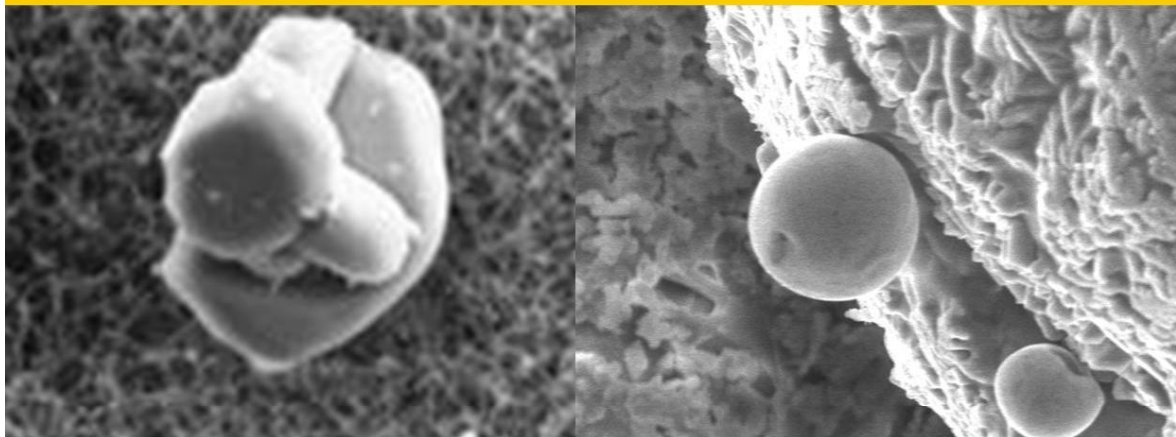

Below (in yellow) the Quantum Knot trajectory

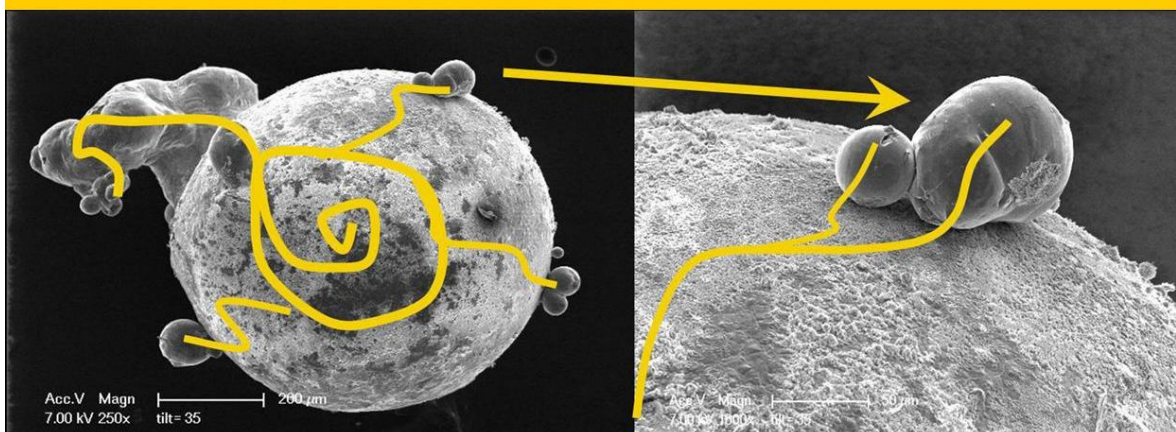

Figure 8, An other example of Quantum Knot heated globules found on an exploded battery. Suggestion for the origin of external stainless steel globules found on the Boeing 787 Dreamliner APU battery damage jan.7.2013 at Boston airport. Discharge Quantum Knot black holes seem to be able to melt stainless steel! Melting point of stainless steel is 3000 degree C! (Globule diameter 30-120 μ m.)

Addendum of some Quantum FFF theoretical principles

Characteristics of Quantum FFF Theory.

1: The clear MICROSTRUCTURE or the 3D FORM of elementary particles, (also called 3D-Preons) made out of convertible Higgs particles, is responsible for “Bound states of Fermions” and composite Quarks. (ref. 4)

2: The Higgs is supposed to be energetic oscillating, it is the origin all particle motion and spin states and Dark energy (126 GeV) inside a truncated tetrahedron shaped chiral vacuum lattice. The lattice chirality (left or right handed) is the origin of our material universe. Higgs particles are zero point “Planck Oscillators” the origin of the Casimir force, waiting to be harnessed as free energy. (ref. 17)

3: NOTHING SUCKS IN PHYSICS, Gravitons act counter intuitive with less pressure on Fermions than the Higgs vacuum (dark energy) and all particles and vacuum photonic information (radiation) is ENTANGLED by INSTANT communication between at least two anti-copy UNIVERSES or MULTIVERSE, being entangled since the big bang. (ref. 7)

4: Black holes of all sizes (down to ball lightning) do not emit gravitons, they feel only Casimir Gravity of the vacuum oscillations so they are massless but counter intuitively the origin of dark matter and producers of all Hydrogen by Electron and Positron pairs as horizon fluctuations and repel all Fermions even positrons at the double BH horizon. (ref. 9,10,11)

5: Black Holes are supposed to have a negative electron based surface charge in a material based universe and a positive charge inside an ANTI-material universe, due to the chirality (left or right handed vacuum lattice spiralling) of the oscillating dark energy Higgs vacuum. (ref. 27,28).

6: The Multiverse is Pulsating by two phenomena, A; vacuum (Higgs) eating new paradigm dark matter black holes (causing the Hubble redshift) and B: by universal expansion caused by the oscillation force (Dark energy) of the Higgs vacuum lattice. (ref: 33)

FUNCTION FOLLOWS FORM in Quantum FFF-Theory. The Microstructure of elementary particles, is supposed to be the origin of FUNCTIONAL differences between Higgs- Photon- and propeller shaped Fermion particles. Something SMALL is missing in mainstream physics: a NEW splitting and pairing MASSLESS BLACK HOLE, the origin of all dark matter, Ball Lightning Micro Comets , Comets, Sunspots up to Galaxy external Anchor Black Holes and the Big Crunch of the CP symmetric pulsating raspberry shaped multiverse.

The multiverse is a collection of huge entangled pinball machines, with dark energy in the form of linear oscillating double Higgs pins as the origin of photonic collision products with the propeller shaped Fermions running and spinning as balls.

All forces are the result of this entangled Pin-Ball interaction. The 126GeV Boson recently found in the LHC is not a single but a double massless 3rd generation Higgs boson linear oscillating in tandem as opposing boxer engine pistons in a chiral truncated tetrahedron lattice.

The 126GeV energy is the base for universal dark energy, the frequency is the base for local time and the length a base for the Planck scale. (Twin Higgs, Dual Higgs, Duplex Higgs, or Tandem Higgs).

AS A RESULT, Free energy devices and electron-muon decay levitation is proposed. An unstable Higgs vacuum seems to be present around all black hole horizons by observed H2 production and annihilation radiation created by pair production of positrons and electrons. (Instability of the Higgs field)

The main difference with mainstream physics is in short as follows:

A: That a "black hole" has no mass- it does not emit gravitons-, but is the origin of all "dark matter" in the universe and can exist at all scales from Quantum Knots (or Ball lightning) up to Comets, Sunspots, external Galaxy Anchor Black Holes, up to the Big Crunch- or Big Bang Black Hole.

B: That "dark energy" is based on microscopic massless vacuum (non SM) Higgs particles, energetic oscillating in opposing pairs and able to convert into pairs of electrons and positrons, e.g. at the horizon of black holes.

C: That the 126 GeV mass of the Higgs particle (found by the LHC in Geneva) could be translated into 126 GeV energy of the paired vacuum particles. (alternative non SM Higgs) (And is consequently THE FIRST SIGN OF "DARK ENERGY") The LHC found a first sign of Dark Energy!!

D: That as a result, the Universe is cyclic, super symmetric and has the form of a raspberry shaped pulsating symmetric Multiverse with finite cycle time.

E: That all matter and humans have their instant entangled copy symmetric counterpart living inside the opposing super symmetric lobes of the raspberry multiverse. which is supposed to be the base for consciousness.

F: That Humans have the ability to influence conscious acts by a small retardation or lagging effect (300 msec) in decision making. This lagging effect phenomenon is already found and described for humans by Benjamin Libet, called RPI and RPII (Readiness Potential 1 and 2) see: "Wavefunction Collapse and Human Choice-Making Inside an Entangled Mirror Symmetrical Multiverse." (Ref. 6)

Triple Black Hole horizons found by NASA in accordance with Quantum FFF Theory.

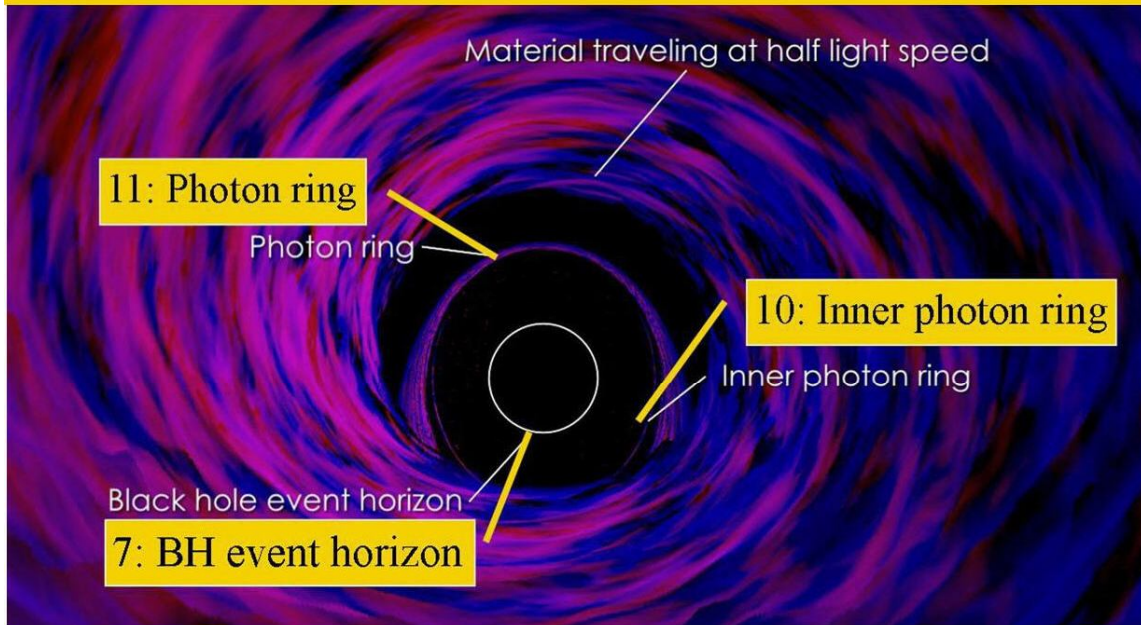

For tripple B-H horizons in Quantum FFF theory see (nrs: 7: Event horizon, 10: Inner photon ring, (10+11 =Fermion repulsion zone) 11: Photon ring)

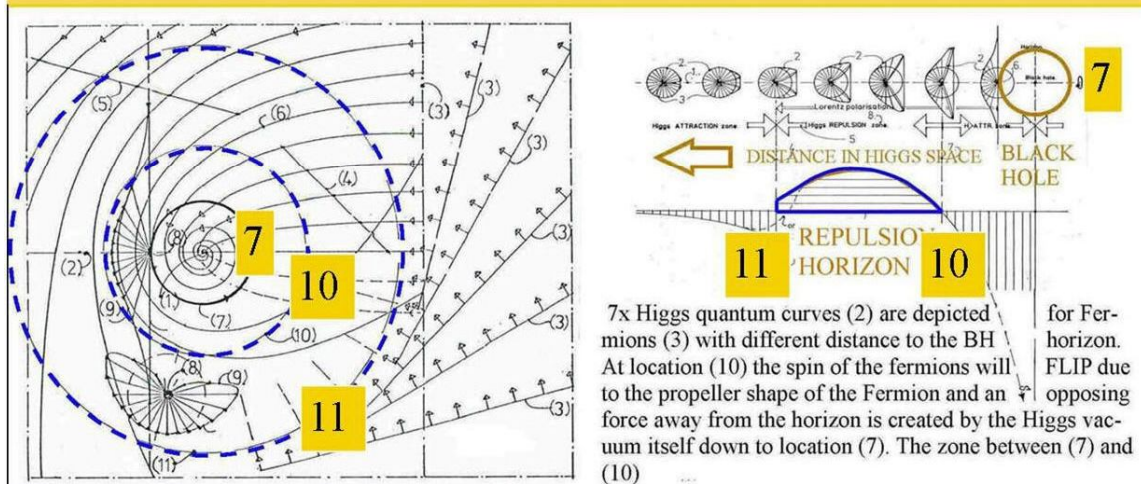

7x Higgs quantum curves (2) are depicted for Fermions (3) with different distance to the BH horizon. At location (10) the spin of the fermions will FLIP due to the propeller shape of the Fermion and an opposing force away from the horizon is created by the Higgs vacuum itself down to location (7). The zone between (7) and (10)

- 1: Non rotating Black hole nucleus (in 2D cross section).
- 2: Reference axis for trajectories 4,5 and 6.
- 3: Other incoming photonic/Higgs fronts (without depicted trajectories)
- 7: High photon energy collider globular shell, with intense Quantum effects like pair production (e-,e+). 8: test masses.
- 9: Butterfly shaped Higgs/photon Fermion pushing curves in 2D.
- 10 and 11: Fermion repulsion zone. Due to the propeller shape of the Fermions, they will experience a so called "Spin Flip" in this zone.

Figure 9, Triple Black hole horizons recently found by NASA, in accordance with Quantum FFF theory. Emergence processes like H2 production originated by pair producing of Quantum Fluctuations around the black hole in combination with the chirality of the vacuum with preference for positron mergers with photons into composite positive charged Quarks forming ions. Negative Quarks are only stable in the neighbourhood of positive Ions to form protons.

Recent observed Black Hole abundance (left) in the CIB Cosmic Infra Red Background (right) and X-ray: CXB, is a strong support for Quantum-FFF theory Black Hole splitting Big Bang- and Contracting Big Crunch cycle,

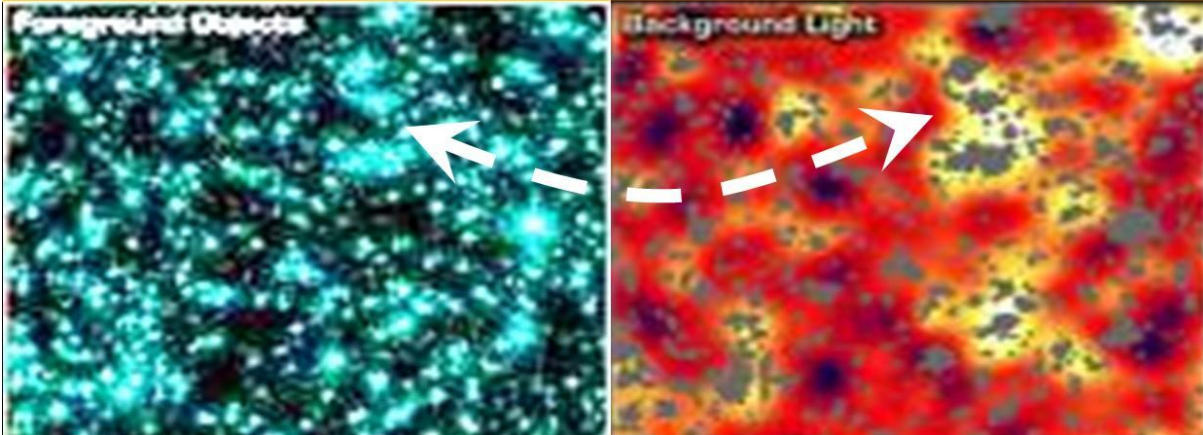

The CPT SYMMETRIC MULTIVERSE CYCLE.

The Inflation epoch starts if the decreasing vacuum pressure equals the increasing Higgs tension of the Big Crunch black hole nucleus. Inflation epoch ends if all splintered black hole nuclei are evaporated, or left behind as Galaxy Anchor Black Holes.

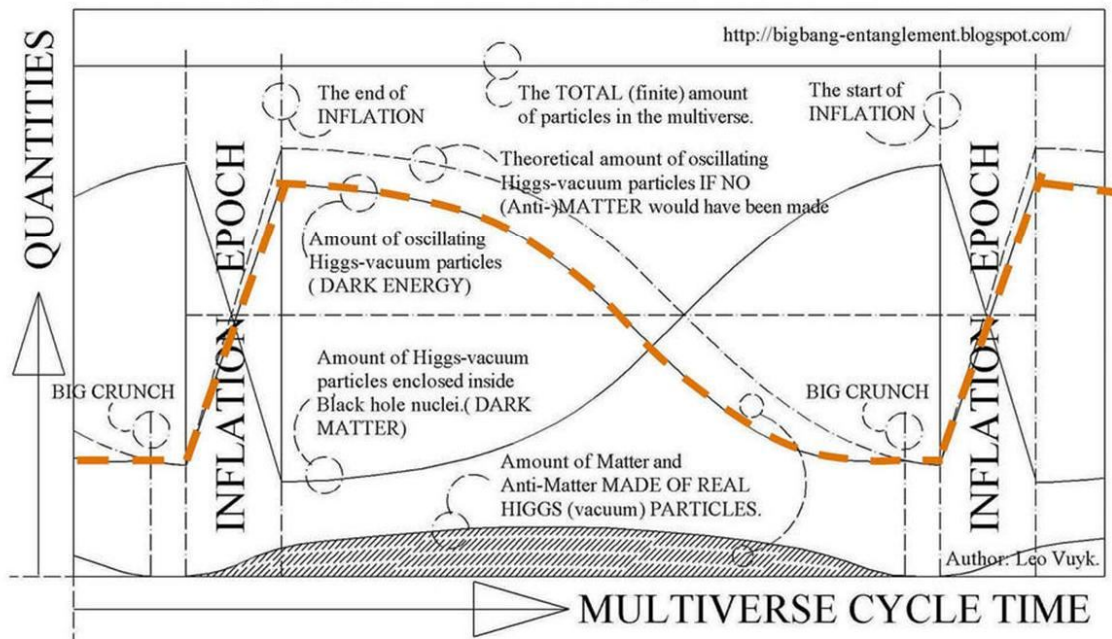

The Pulsating Multiverse depicted as a continuous flow of increasing and decreasing numbers free oscillating- and Black hole condensed Higgs particles and the amount of Quarks and leptons. The size of the pulsating multiverse vacuum is given in orange.

Figure 10, Abundant Black Holes observed in the early universe by the CIB and CXB of Chandra and Spitzer space telescopes (2013). A strong support for the Quantum FFF theory based Black Hole splitting Big Bang and contracting Big Crunch Cycle of the Multiverse.

Comparison of the Final ESA CMB Planck map with a cross section through the Raspberry Multiverse according to Quantum Function Follows Form theory. Compare the Cold Spot with the Void and the Warmer and Colder Hemisphere of the Plack CMB (left) with observation boundaries (right)

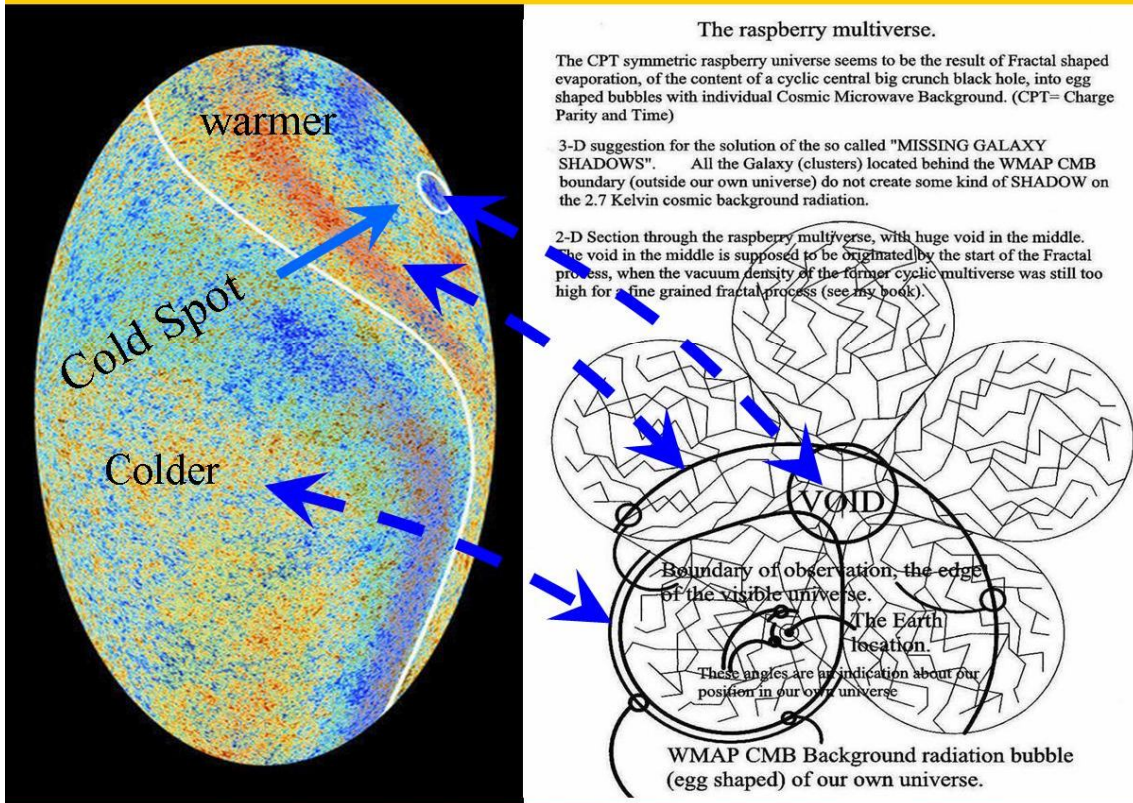

Quantum FFF theory is a combination of a holistic and a reductionist approach of nature. Holistic by the introduction of complexity into the sub quantum geometry or microstructure of elementary particles and fields and reductionist, by reducing that complexity into single elements and monopole forces.

However all these particles and fields are supposed to be connected by continuous active information fields called instant entanglement, between one or even more symmetrical anti matter universes at a long distant.

If particles combine together into simple knots they form quarks and some leptons.

If these knots become more complex (more than 6 particles) they are supposed to form ball lightning alike Casimir energy producing systems called micro black holes..

If stars explode into supernovas they for also quantum knots based on the remaining particles left over from the star's interior and form black holes.

All black hole nuclei are supposed to be based on such quantum knots.

The big bang is supposed to be the evaporation and explosion of the one and only big crunch black hole.

As a consequence we live inside a cyclic symmetric multiverse interconnected by instant entanglement between these anti-copy universe at the quantum scale.

Consciousness should also be subject of this active information system, and my thoughts are continuous competing with my brothers over there.... (Leo Vuyk)

Figure 11, The Pulsating Raspberry shaped Multiverse also to be observed from the Planck Cosmic Background Radiation image.

Synchrotron radiation by Polarized Fermion spin combined with high speed motion through the resistive oscillating Higgs vacuum (according to Quantum FFF theory)

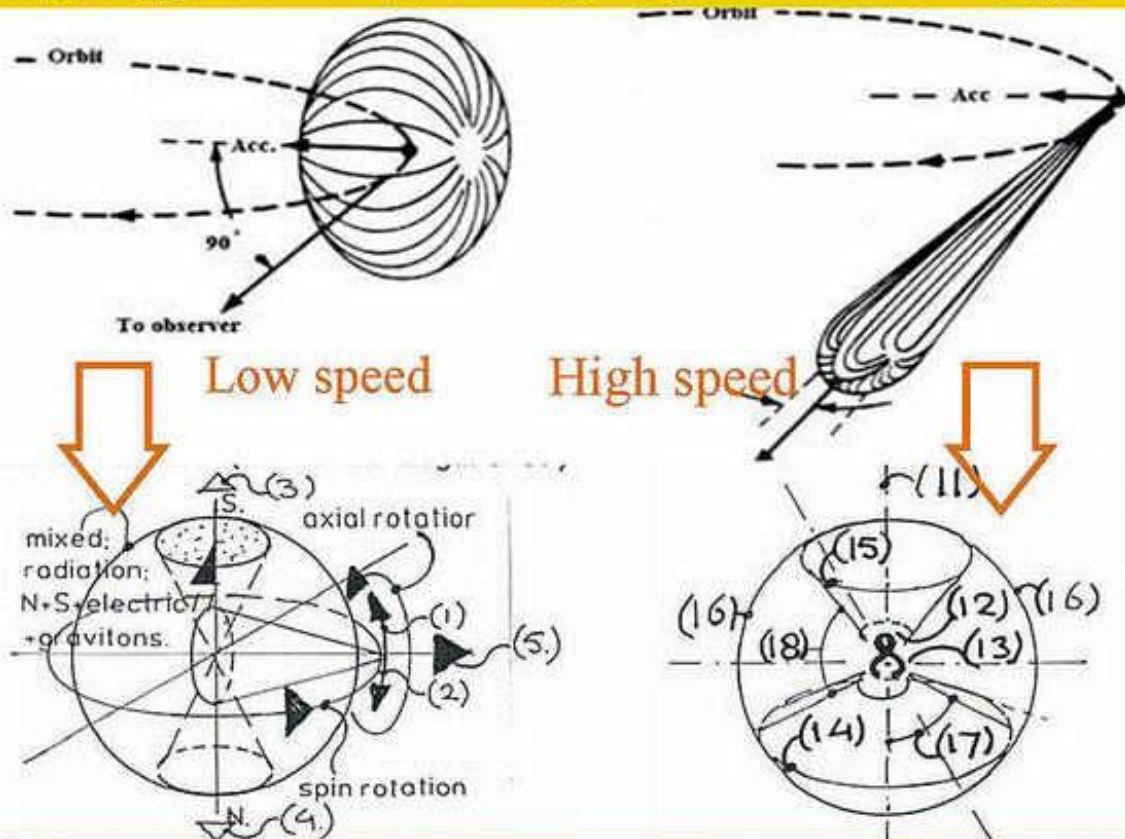

The propeller shape of Fermions is the origin of a dual spin state by collision influences of the oscillating massless Higgs vacuum at low speeds. (Spin rotation and axial rotation) At high relativistic speed the Lorentz polarization of the Fermion "propeller nose" (1 or 2) is preferentially pointing into direction (11) with photon cone focussing into the opposing vacuum direction (15) and the Spin rotation has gone.

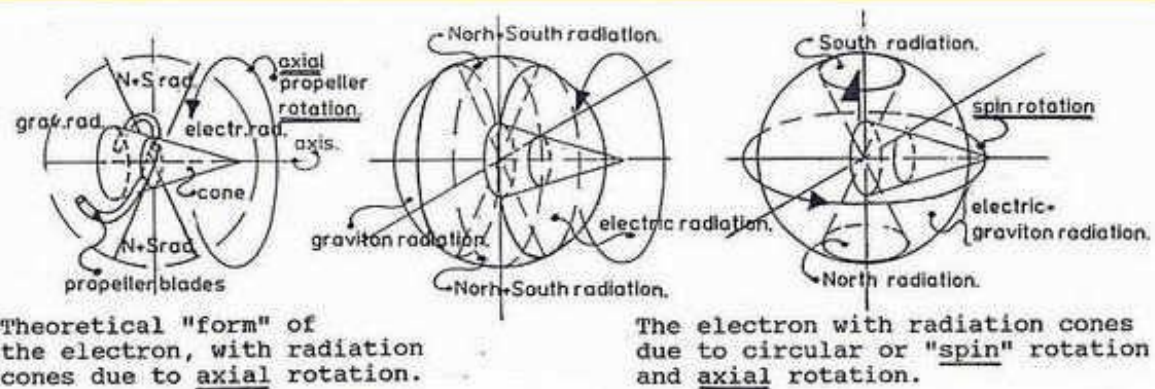
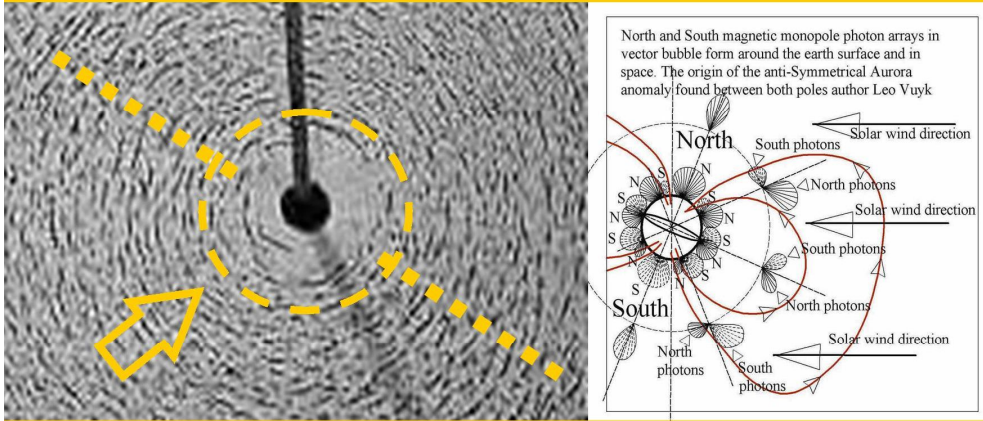

Figure 12, The polarisation of the double spinning propeller shape of Fermions is the origin of the monopole radiation differences radiated into different directions from the Fermion radiation area around the centre. It is assumed that electric and gravity radiation is not mixing with magnetic monopole radiation inside the magnetic double cone area. Consequently, the measured difference between the Equatorial gravity (9.78 m/sec²) and Polar gravity (9.83 m/sec²) should be greater without this effect.

Magnetic field variations by the “Curl” of Magnetic Monopole (N and South) Radiation around a wire and the earth.



According to Quantum FFF theory, all magnetic fields can be presented as CURLED Magnetic Monopole Photon Vector Arrays. As a result, the magnetic field intensity around a wire and the a magnetic dipole is (away from linear polar positions) NOT dropping off with the cube or even the square of the distance from the source!! (See images). Also: direct around the current in a wire- equipped with iron powder on paper- the mag-

Figure 13, Magnetic field variations originated by the curl potential of Magnetic monopole vector arrays around a wire or around the earth.

THE ARCHITECTURE OF THE QUANTUM

In Quantum FFF theory, all elementary particles are based on a 16 dimensional Torus called Higgs dark energy vacuum particle.

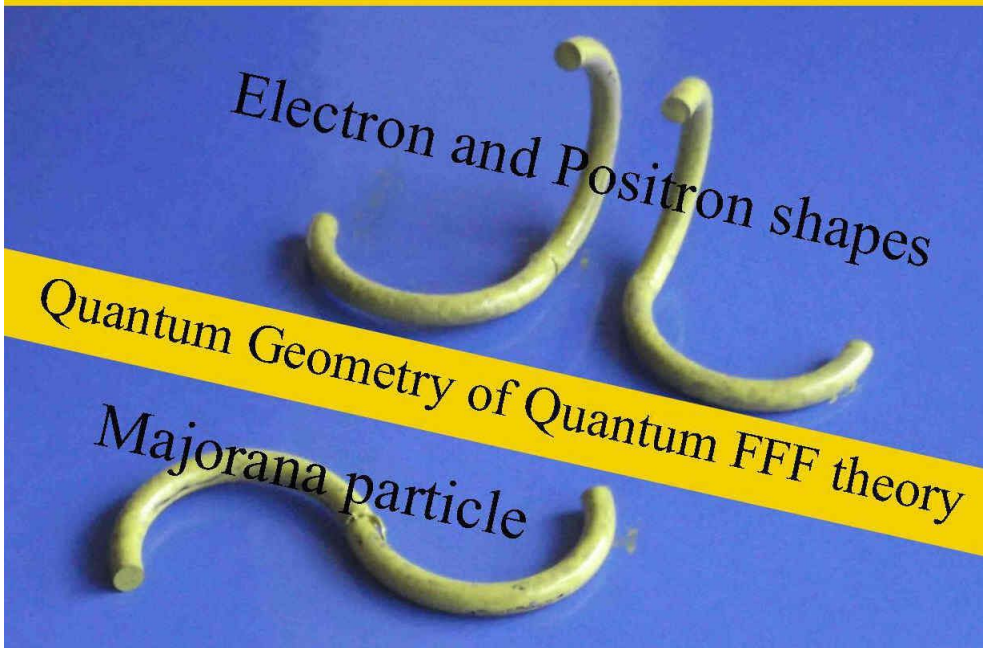

Figure 14, Three simple particle examples. The electron and Positron are each others mirror image. The Majorana particle has no mirror equivalent.

Alternative standard particle model

All SINGLE (non-compound) elementary particles suggested by Quantum FFF Theory. OLO, ORO have "click-on potential" to form compound quark particles with only 5 different shaped Gluons/Photons. In yellow colour: Quantum-FFF suggestions for NEW PHYSICS particles. The Majoranas: (OUO+ mirroring Majoranas RUR+ LUL) and 4x extra neutrinos (RLU+ RRU+ LLU and LRU) (author:Leo Vuyk)

Explanation of the codes:
 U= Up rotation (180 degrees)
 O= Unchanged circle.
 L= Left rotation (90 degrees)
 R= Right rotation (90 degrees)

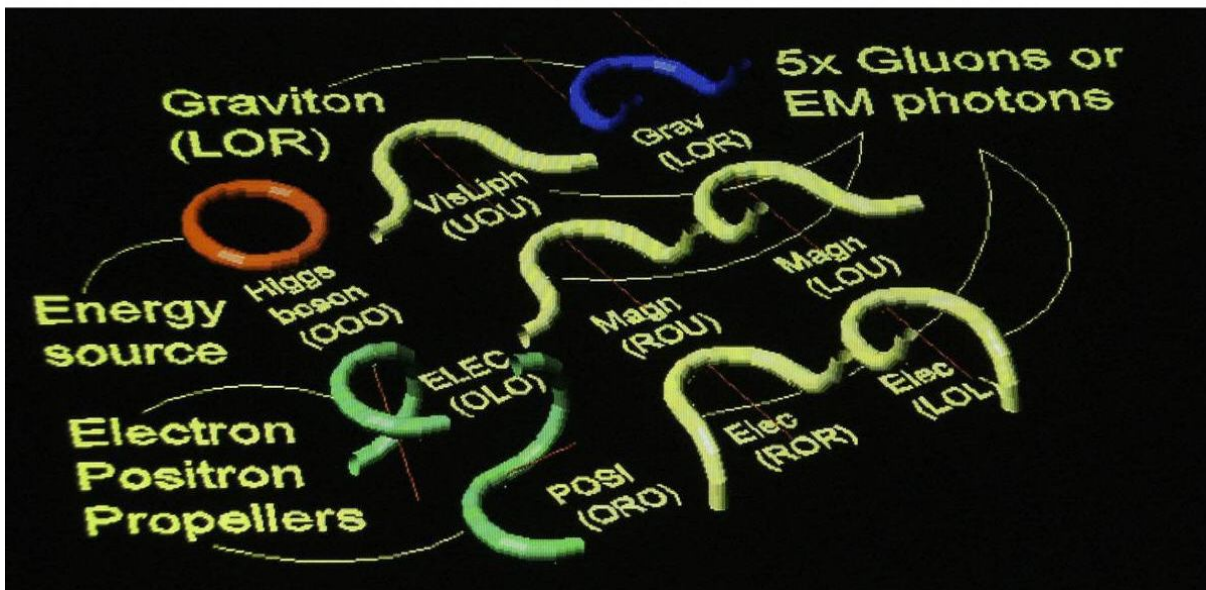
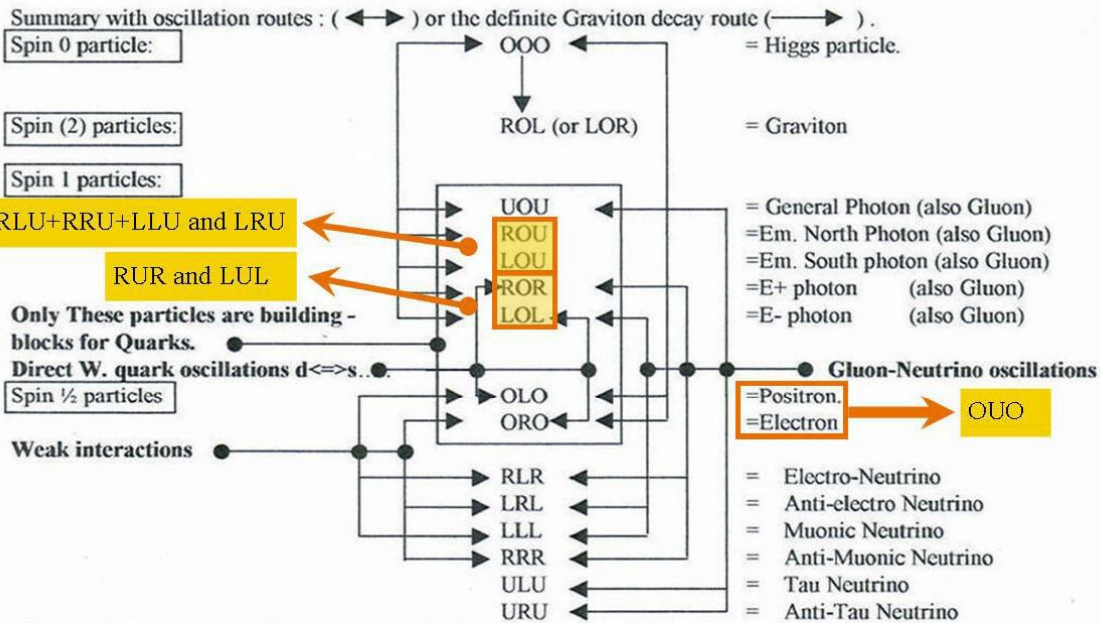
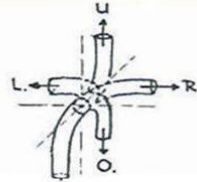

Figure 15, The particle zoo of single ELEMENTARY particles made out of ONE convertible Torus shaped Higgs particle, equipped with three hinges of 90 degree rotation.

Quantum Function Follows Form Model

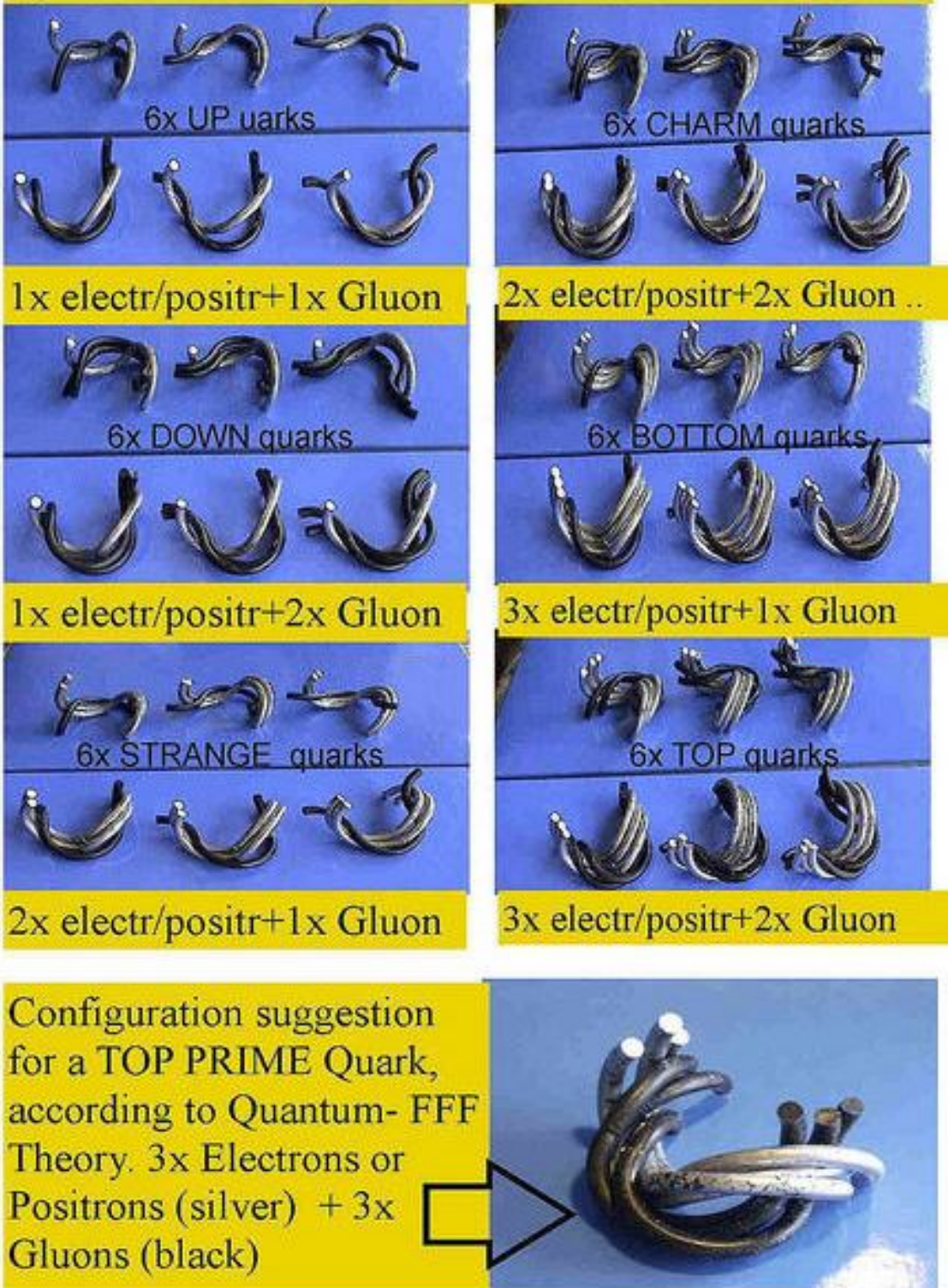
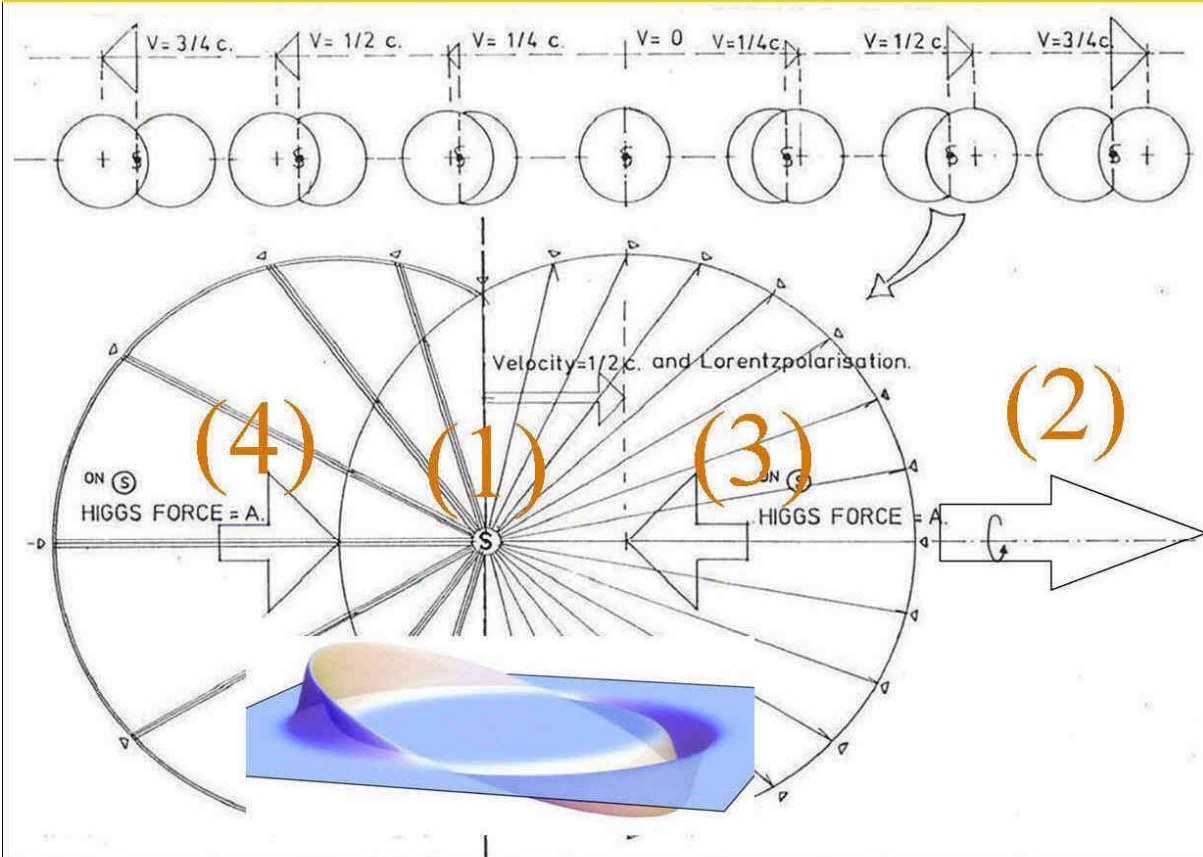

Figure 16, 5x different shaped Photon/Gluons can combine with the two propeller shapes of the Electron and Positron to form all coloured (QCD) Quarks and even a so called Top Prime Quark. The Muon and Tau particle are supposed to be the same as the Down quark, respectively the Charm quark.

Polarized Fermion Mass in motion through the resistive, but also pushing oscillating Higgs vacuum (according to Quantum FFF theory)



Cross section through the 3D vector field pressure distribution on a Fermion point mass (1). Propeller shaped spinning Fermions are supposed to be Polarized into the direction of flight through the vacuum lattice (2). As a result, the resistive vacuum Higgs force (3) is compensated by the Higgs Pushing force (4) from the “backside” of the Fermion. However every Fermion need to have polarization memory consciousness. (by a multi universal entanglement system see: Quantum-FFF theory)

Figure 17. Polarized Fermion based Mass in motion through the resistive BUT also pushing (from the back, called warp drive) oscillating Higgs vacuum lattice

References:

[36] The New God Particle and Free Will.

Author: Leo Vuyk, **LuLu publishers, 2008.**

ISBN number 978-1-4092-1031-3

<http://www.lulu.com/spotlight/LeoVuyk>

[35] Quantum FFF Theory is also published in the form of POSTERS at the Flickr site:

<http://www.flickr.com/photos/93308747@N05/>

[34] Numbered listing of Vixra essays by Leo Vuyk.

http://vixra.org/author/leo_vuyk

33, viXra:1306.0065

The Splitting Dark Matter- Black Hole- Big Bang and the Cyclic Multiverse.

32, viXra:1305.0140

Quantum FFF Theory Experiments, a Summary.

31, viXra:1305.0041

The Shnoll Effect Explained by Quantum FFF Theory.

30, viXra:1304.0022

The Self Organizing Universe in the Carina Nebula.

29, viXra:1303.0211

Hubble Redshift Combined with Universal Contraction is Possible.

28, viXra:1303.0053

Micro Birkeland Currents Between Two RF Generated Plasma Balls in the Laboratory.

27, viXra:1302.0172

Silicon Based Ball Lightning Globule Structures and Signs for Accumulation and Retarded Decrease of Tunnelling Energy Bullets.

26, viXra:1301.0088

Two or Three Large Quasar Groups (LQGs) Located at the Start of Two or Three Lyman Alpha Systems and a Part of the Raspberry Multiverse?

25, viXra:1301.0050

Dwarf Galaxies and Their Relation with Dark Matter Based Galaxy Anchor Black Holes (Gabhs).

24, viXra:1210.0177

Instant Broglie Bohm Pilot Waves, the Origin of All Entanglement Effects in the Lab and Wavefunction Collapses in Our Universe as Related to Our Opposing Anti-Copy Universe(s) According to Quantum FFF Theory.

23, viXra:1209.0092

New Dark Matter Black Holes and a New Dark Energy Higgs Field, Lead to a Bouncing CP Symmetrical Multiverse, and New Experiments.

22, viXra:1209.0061

Birkeland Currents, Sunspots, Comets and Ball Lightning Originated by New Paradigm Dark Matter Black Holes.

21, viXra:1209.0030

Majorana and Sterile Neutrino Solutions in the Quantum-FFF Model.

20, viXra:1208.0031

Clumpy Dark Matter Around Dwarf Galaxies a Support for an Alternative Black Hole Theory According to the Quantum Function Follows Form Model.

19, viXra:1202.0091
 Earth Magnetic Monopole Array Field Interaction with Cyclotron –Synchrotron Electrons and Muon Conversion Used for Levitation Systems.

18, viXra:1201.0092
 Earth Magnetic Monopole Array Field Interaction with Cyclotron Electrons used for Levitation Systems.

17, viXra:1112.0065
 LHC Signals Between 121-130 Gev Interpreted with Quantum-FFF Theory

16, viXra:1111.0096
 Reconciliation of QM and GR and the Need for a Pulsating Entangled CPT Symmetric Raspberry Shaped Multiverse.

15, viXra:1111.0061
 Black Hole Horizon Curvature Dependent Balance Between Plasma Creation and e-e+ Annihilation in Quantum FFF Theory.

14, viXra:1108.0036
 Artificial Ball Lightning Production and Exploitation Device for Zero Point Electric Energy Usage.

13, viXra:1108.0006
 Mass in Motion in Quantum FFF Theory

12, viXra:1104.0083
 Quantum FFF Theory in Posters.

11, viXra:1104.0044
 Ball Lightning, Micro Comets, Sprite-Fireballs and X-Ray/gamma Flashes According to Quantum FFF Theory.

10, viXra:1104.0002
 Stellar Anchor Black Holes as the Remnants of Former Herbig Haro Objects

9, viXra:1103.0097
 ZPE Zero Point Energy Examples Around Black Holes.

8, viXra:1103.0068
 Funktion Follows Form, at the Quantum Scale and Beyond.

7, viXra:1103.0024
 Quantum Gravity and Electro Magnetic Forces in FFF Theory

6, viXra:1103.0015
 Wavefunction Collapse and Human Choice-Making Inside an Entangled Mirror Symmetrical Multiverse.

5, viXra:1103.0011
 An Alternative Black Hole, Provided with Entropy Decrease and Plasma Creation

4, viXra:1103.0002
 3- Dimensional String Based Alternative Particles Model

3, viXra:1102.0056
 Experiments to Determine the Mass Related Lightspeed Extinction Volume

2, viXra:1102.0054
 Atomic Nuclear Geometry Based on Magic Number Logic.

1, viXra:1102.0052
 Construction Principles for Chiral “atoms of Spacetime Geometry