

FROM THE WAVEGUIDED GRAVITY TO THE PERIODIC WAVEGUIDED MULTIVERSE AS UNITED SOLUTION OF DARK ENERGY & DARK MATTER & SUSY - MYSTERIES

Iouri Gribov

Liebniz Sozietät – 10117, Berlin, Germany

Institute for the Time Nature Exploration, MSU – 119991, Moscow, Russia

igribov@aol.com

Abstract

The quasi-classical concept of Periodic Waveguided Multiverse (PWM) is proposed. This periodic 4D-hyperstructure has substantial theoretical and observational-cosmological confirmations because it unites and refines the basic physical laws (SR&GR&QM, etc), inseparably *emergent* in the waveguided dynamics and gives the multiversal explanation of dominating observational *DE&DM*-mysteries (including predicted and observed two-component *DM*) – interconnected cosmological evidences for the PWM-existence. The PWM concept can be soon tested in a laboratory: (a) it predicts antigravity in the anti-hydrogen gravity test at CERN; (b) predicts direct-atypical *DM&ANTIMATTER* annihilation with radiation of one – visible-detectable and one – dark-undetectable gamma quantum - as basis for the proposed selective direct *DM*-detection. The PWM-foundation is surprisingly compact – it is based on *two* penetrating Planckian & Einsteinian ideas: I - *photon-quanta* and II - *principle of equality* of our 3D-spatial dimensions (x,y,z) with an additional extra-dimension L , realizing so expanded - automatically Euclidean 4D-space (x,y,z,L) . We have applied these basic physical insights in frames of classical-Maxwellian-like 3D-waveguides $\mathbf{W}_n [x,y,z,nL_0 < L < (n+1)L_0]$, realizing an endless periodic chain of physically identical parallel $\mathbf{W}_{2n}/\mathbf{W}_{2n+1}$ Universes/Antiuniverses ($n = \pm 1, \pm 2, \pm 3, \dots, \pm \infty$), filling this global space (x,y,z,L) , where $L_0 = \lambda_{el.Compton} \approx 1$ picometer, determined by the lightest (electron) rest mass particle. This structure discloses the *waveguided co-emergence* of the (1) pure C_4 -dynamical quantized-gapped - “elementary” *rest mass*; (2) the SR & QM & Newtonian-like, periodic matter/antimatter antigravity; (3) the CPT_{PWM} symmetry between particles/antiparticles, with the gravity “charge” symmetry (4) the *modified* Equivalence Principle EP_{PWM} ; (5) *singularity-less* Diracian-like fermions/antifermions and GR-like black/white holes free of *singularity*; (6) opens physical possibility of the *nongravitating – chargeless*, very robust scalar (Cooper-like) *composites* - electron-positron-cells, *hidden* in their globally coherent superfluid vacuum condensate at low T – as Diracian-like, equilibrium superfluid sea/anti-sea. Common electron/positron pairs arise as elementary defects – Diracian holes/antiholes in this vacuum, disclosing the composite-SUSY nature and explaining why cosmological constant is zero; (7) the global C_3 -dynamical pseudo-Euclidean 4D-spacetime concept by Minkowski is rethought and reformulated on the 3D-waveguided, 4D-Euclidean physical basis, where global linear intervals $(\rightarrow \rightarrow \rightarrow \rightarrow \rightarrow C_3 t_{Mink.}) \rightarrow (\nearrow \searrow \nearrow \searrow \nearrow \searrow \nearrow \searrow C_4 t_{PWM})$ - waveguided-*polygonal* intervals - $C_4 t$ -parameterizations of the polygonal rest mass particle dynamics, disclosing the waveguided/wave-optical (Huygens-Fermat’s) sense of the mechanical Lagrangian and Hamilton’s principle of the least action.

TABLE OF CONTENTS

Introduction-----	3
Attempts at building the 5D-general theory of electricity and gravity-----	6
Planckian-Einsteinian roots of the periodic waveguided Multiverse-concept-----	7
Periodic 3D-waveguide's concept of the global 4D-hyperspace-----	8
The waveguided-emergent mechanism of gravity acceleration-----	13
The waveguided emergence of the quantized equivalence principle-----	14
The expanded matter/antimatter CPT-symmetry nature in the PWM -----	16
The pure relativistic waveguided nature of massive fermions in the PWM-----	18
The PWM-analogue to the Kaluza-Klein mass tower-----	22
The PWM predicts antigravity in the matter/antimatter gravity tests at CERN-----	22
The PWM-concept discloses "mystery" of the antimatter "disappearance"-----	23
Periodic-coupled matter/antimatter e-cells/e-anticells in the PWM-----	24
The space / antispacesymmetry <i>modifies</i> the equivalence principle-----	26
New relation between gravity mass and inertial mass in the PWM -----	26
The composite SUSY _{PWM} nature – the ghostly cooper-like composite vacuum-----	27
Naive unification gravitational and electrostatics forces in the PWM-----	30
<i>The ±q-Electro-Mechanical-Membrane Analogy (EMMA)-----</i>	30
<i>The ±M-Gravity-Mechanical-Membrane Analogy (GRAMMA)-----</i>	31
<i>The geometrodynamical nature of the gravity energy of electron-----</i>	32
<i>The geometrodynamical nature of the elementary electrostatic charge of electron-----</i>	35
<i>The geometrical sense of the electrostatic energy-----</i>	37
<i>Gravity potential of electron (and two-component DM&DE-phenomena in the PWM)-----</i>	42
<i>Electrostatic energy of electron-----</i>	42
The SM-analogies in crystals defects and superfluids-----	44
<i>A gauge theory of crystal dislocations-----</i>	44
<i>Condensed superfluid matter as an "empty" vacuum space-----</i>	44
<i>The "ultimate goal" is to reveal the still unknown structure of the superfluid ether-----</i>	44
<i>The paradigm of the non-gravitating superfluid vacuum-----</i>	45
Periodic massless 3D-photons / antiphotons in the PWM-----	46
Trapped antimatter as a direct DM-detectors in the PWM-----	47

The PWM-nature of unusually big excess of high energy positrons-----	47
Periodical singularityless black / white holes in the PWM-Multiverse-----	48
<i>Neutron stars with mass $1.5m_{sun} \div 3.8m_{sun}$ are “pregnant” with hidden black holes</i> -----	50
The united DE&DM cosmology with equal $\pm m_{gr}$ quantity in the PWM-----	53
<i>The large-scale cosmology with $\pm m_{gr}$ symmetry in the Multiverse</i> -----	52
<i>Periodic repulsive matter/antimatter clusters drive the Multiverse-DE expansion</i> -----	57
<i>The nature of $2L_0$-periodic dark matter in the PWM</i> -----	58
<i>The PWM-prediction of the detectable double-layered DM-structure</i> -----	60
<i>The horizon problem in the Multiverse</i> -----	61
<i>The accelerating expansion and dark energy problems in the Multiverse</i> -----	62
<i>The flatness problem in the Multiverse</i> -----	63
<i>The “bubbles structure” problem in the Multiverse</i> -----	63
<i>The problem of the decelerative phase in the universe expansion</i> -----	64
The soft superfluid, chargeless n/η Big Bang scenario in the PWM-----	66
The adjacent parallel universes, full of civilizations – Hyper-internet and informational relocation-----	69
The DE&DM nature in the $\pm m_{gr}$ concepts of Ripalda, Villata and Hajdukovic-----	71
Some notes to the book “a different universe”, by Robert Laughlin-----	74
Some comments to the “living in the Multiverse”, by Steven Weinberg-----	75
Some notes to the “Einstein and the search for unification”, by David Gross-----	75
Notes to the “viewpoints on string theory” and dark energy by Edward Witten-----	76
Notes to the Pauli’s invention of non-abelian Kaluza-Klein theory in 1953-----	83
Prediction of the picometer-limit for the singularityless Newtonian gravity law-----	83
The generic wave-optical waveguided nature of the least action principle-----	83
<i>Acknowledgement</i> -----	85
References-----	85

INTRODUCTION: The Periodic Waveguided Multiverse (PWM) concept allows physically non-contradictory and reasonable “inversions” of the basic physical paradigms of vacuum (as classically endless emptiness) and elementary matter particles (as local matter occupancy in this emptiness), (Gribov 1999, 2005, 2012, 2013a,b):

1) Vacuum is traditionally-classically perceived as a *totally empty*, free space or as almost empty space, disregarding e.g. of sporadically arising “from nothing” / annihilated virtual (e_-) and (e_+)

pairs in it. The PWM-concept of vacuum/particle totally inverts this very old dominating paradigm. The easiest illustration could be a dramatic transition from a dominating “empty darkness” on a photo of the starry night sky with tiny rare points of stars on it - to the inverted photo - from black to white (Gribov 2012, 2013a). A totally dominating white - densely filled space now arises with rare black matter points, like tiny holes on a white porcelain plate, looking as insufficient defects in the “monolithic“-white vacuum medium (Fig. 1). This is a kind of modern physical reincarnation of a miracle Aether, being proposed very long time ago, e.g. by great Renaissance thinker and cosmologist Giordano Bruno more than 400 years ago (Bruno 1588).

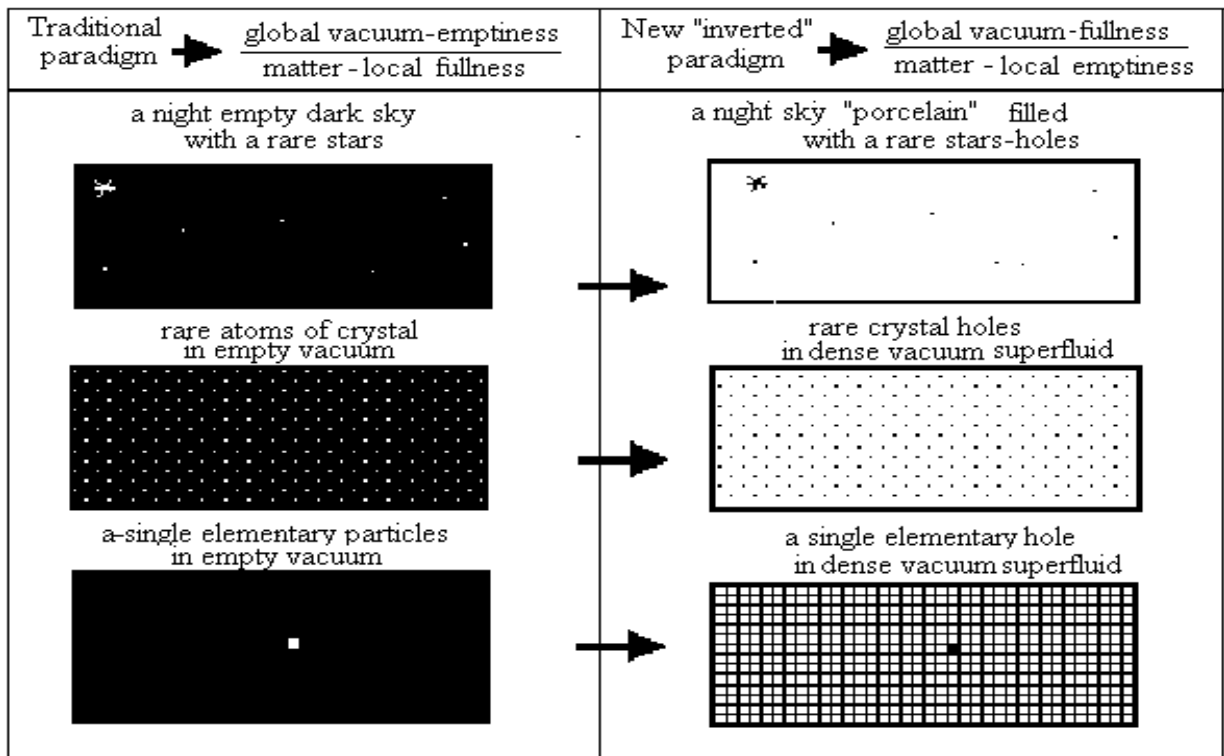

Fig. 1 shows a dramatic-inverted vacuum / particle paradigm change – from the (empty vacuum /filled matter) to the (homogenously filled vacuum medium / matter as empty holes in it). A “night sky”– is a global stars picture, above; a small piece of a crystal – in the middle; a single elementary particle – below.

2) Vacuum - looking traditionally as a continual emptiness – now has „atomistic“ – cellular levels, it is now very dense liquid-like medium but the periodic PWM-concept physically provides it’s the composite-hidden, paradoxically nongravitating *superfluid* nature.

3) Our Universe with its globally known ~3D-space dimensions now is considered as a microscopically many-dimensional and looks as a pico-tiny modular “slice” in the periodic 4D-quasi-crystalline“ structure of the proposed 4D-Multiverse, consisting of very thin periodic elastic 3D-waveguides. All these ~3D-Subuniverses have the same thickness $L_{oe} = \lambda_{el.Compton} = 2,426 \times 10^{-12} m_4$, ($L_{oe} \approx 10^{-12} m_4 \approx 1 \text{picometer}_4$). This Multiverse contains assumingly an endless number of *physically identical* periodical Universes/Antiuniverses, with enormous density $n_L \approx 10^{10} / cm_4$ Universes in the global fourth spatial dimension L .

4) The traditional-classical elementary mass particle is a „point-like“, sufficiently *localized* elementary spot, (with the controversial dimensionless point-like singularity), accumulating a huge but limited energy $E = MC_4^2$ inside. More realistic is a singularityless string-like particle paradigm; it exists in the String Theory (ST) avoiding singularity by *postulating* existence of the one-dimensional - string-like particles. Edward Witten, one of the ST founders, writes: “with our

present understanding, there would be nothing more basic than the string.” (Witten 2003b). The classical elementary mass particles (including strings) are surrounded by physical emptiness – empirically frictionless space of vacuum. But how this elementary-undivided particle can cause interference with itself on two shells, that showed famous precisions “double slit” experiments, performed by Clauss Jönsson with single electrons (Jönsson, 1961, 1974). “I think I can safely say that nobody understands quantum mechanics”, noted insightful Richard Feynman (Feynman 1985). The PWM-paradigm of elementary mass particle can solve this paradox, because now the elementary matter particle is a principally “collective” – spatially distributed medial phenomenon, it is result of a local, singularity-less „elementary confiscation“ in a huge coherent organism – via the elementary “cellular defect” (like a single atom confiscation in a regular crystal). The many-cellular vacuum medium acquires identically distributed deformations – creating identical-“elementary” physical fields around these elementary defects. The “elementary” cellular defect causes a tiny symmetry break in the multilayered equilibrium vacuum body and deforms its cellular structure. These tiny “elementary” deformations surround the elementary defect and are spatially widely *delocalized* in form of “materialized” classical *fields*. This kind of the delocalized “elementary particle” can naturally interfere with itself, in accordance with the Jönsson’s experiments! This is maybe the most surprising and the most radical “particle/vacuum paradigm“ shift in physics – the traditionally local, almost point-like elementary mass particle is result of all the endless surrounding cellular space micro-deformations, caused by the tiny (but not the point-like), symmetry breaking cellular defect (Gribov 1999, 2005, 2012, 2013a). Indeed, very deep theoretical analogy between *defects in crystals* with the Standard Model physics, or gravity, definitely supporting our atomistic vacuum concept, was discussed in many theoretical works (e.g. Kleinert 1983, 1989, Kröner 1996, Lazar 2000, 2009, 2010). But the PWM conceptual basis provides principal breakthrough in the medial concept of vacuum – it transforms these “analogies” into physically natural and non-contradictive condense matter/antimatter-composite medium, which is very stable - chargeless superfluid and has necessary nongravitating property, impossible before.

5) The second inversion-like paradigmatic shift is a shift from *the traditionally static to the pure C-dynamical elementary particle nature* and it follows intuitive insights of René Descartes. He proposed that our vacuum is not an empty space but it is filled by *dynamical vortexes* (Descartes 1644). Our *dynamically existing vacuum cell and cellular vacuum paradigm* have a quite similar (non-linear wave-dynamical nature, arising in the flat elastic $\sim 3D(x,y,z, 0 < L < L_0)$ -waveguide of our space. This crucial – dynamical shift is based on the extended 4D-concept of the 3D-photon quanta by Albert Einstein (1905) and creates the geometric-dynamical 4D-*spring*-like confined 4D-photon • 3D-mass particle structure (as a self-focused confined C_4 -quasiparticle) and so can directly explain the pure 4D *dynamical nature* of the huge Einstein's rest mass energy $E=PC_4=MC_4^2$. Indeed, Richard Feynman mentioned that contemporary physics couldn't explain where it is accumulated: “It is important to realize that in physics today, we have no knowledge of what energy is” (Feynman 1966, V1).

The physically clear explanation of the double slit experiment now arises immediately – an electron as an elementary e-cellular defect is presented (materialized) as principally *delocalized global deformation in the coherent spatial cellular architecture, caused/coupled with this elementary defect*. It is able now to interfere with itself on two spatially separated shells! This concept also explains why common quantum teleportation (mysterious quantum binding of two distant particles) is quite possible – since the condensed quantum vacuum tissue is paradoxically invisible - globally coherent medium, ultimately managing this global quantum binding. These two experimental miracles strongly support the here proposed delocalized particle paradigm, which holistically explains and demystify these mysteries of quantum mechanical behavior.

Note 1: Frank Wilczek analogically expresses this definitely arising inversion of the old matter/vacuum paradigm, asking: “What is Space? Is it an empty stage, where the physical world of matter acts out its drama -- an equal participant, like the classical Ether, that both provides background and has a life of its own - or the primary reality, of which matter is a secondary manifestation? Today, the third view is triumphant. Where our eyes see nothing our brains, pondering the revelations of sharply tuned experiments, discover the Grid that powers physical reality” (Wilczek 2008).

Note 2: What is the nature of the multi-waveguide structure? The fundamentally important periodic 3D-waveguide’s space structure seems to be also a kind of periodic collective (condensed matter-like) phenomenon, remembering some cases in a low temperature quantum liquids: Dividing strained 3D-membranes, framing 3D-waveguides in the 4D-PWM, have very-very strong surface-tension. They could arise physically, for example, as a very thin interface between two superfluid phases (e.g. like the interface between two liquid phases in a common ^3He - ^4He mixture at low T). The underlying future theory could describe a concrete nature of the proposed hyper-periodicity and may be will be able to explain empirical relation between leptons family masses from a more fundamental, yet unknown, but definitely field-theoretical - superfluid-like, supersymmetric, / *spring*-theoretical low energy limit, applicable in the PWM-concept, where all quasi-atomistic “elementary” spring-like mass particles are emergent. The further uniting theory must provide emergence of the 3D-membranes, their periodicity and of the PWM-Multiverse itself.

Note 3: David Gross analyses in his article “Einstein and the search for unification” attempts of genius in this unifying direction. Einstein “believed that the fundamental laws and principles that would embody such a theory would be simple, powerful and beautiful.” (Gross 2005, p. 2035). We will show below that some attractive theoretical features together with resulting ability to explain the *DE&DM&SUSY*-miracles arise in the proposed PWM-concept, which realizes the paradigmatic [strings/branes • photonic springs & strings/waveguides] shift on the way uniting SR&QM and elementary particles physics.

ATTEMPTS AT BUILDING THE 5D-GENERAL THEORY OF ELECTRICITY AND GRAVITY

Mathematician Theodor Kaluza, one of the first pioneers who have proposed hyperspatial physical concepts, introduced the additional *cyclical* 5th (space) dimension into the classical four-dimensional physical space (x, y, z, t) of the General Relativity (GR) by Albert Einstein, and could show emergence of Maxwell’s wave equations in the 5D-GR. (Kaluza 1921). It was impressive miracle, but the permanent conceptual problem was that the physical meaning of this 5th cyclical dimension was never clear. O. Klein and V. Fock discovered that trajectories of the charged particle in the Kaluza’s space correspond to geodesic lines with the 0-length (geometrical beam), (Klein 1926, Fock 1926). They showed that the classical *physics of relativity* is equivalent to the *geometrical optics* on a beams transmission in the 5D-space and the *quantum mechanical* movement of the charged particle is equivalent the *wave optics* on the transmission of scalar waves in 5D-space, but only if the wave function ψ has Kaluza’s *cyclical condition*:

$$\psi(x^1, x^2, x^3, t, x^5) = u(x^1, x^2, x^3, t) \exp[2\pi i(MC/h)x^5] \quad (1)$$

The well-known equation for waves of matter as the (3D+1)-wave of de Broglie also arises in this case. J. B. Rumer introduced new quantum mechanical sense in the Kaluza’s cyclical 5th -coordinate. He proposed that *all physical quantities are periodic* in the 5th coordinate of the

action and this period is the Planck constant h (Rumer 1956). But the generic *physical nature* of the so necessary, basic *cyclical condition* $\exp[2\pi i(MC/h)x^5]$ was totally hidden in all these x^5 -theories.

PLANCKIAN-EINSTEINIAN ROOTS OF THE PERIODIC WAVEGUIDED MULTIVERSE-CONCEPT

The Periodic Waveguided Multiverse (PWM) concept discloses the waveguided physical nature of the Kaluza's "cyclical condition" and also solves some other basic physical problems, including the *DE&DM* mysteries, etc (not by using of sophisticated mathematical tools in hands of a theoretician), but from a physically relevant geometrization, creating unity and physical clarity behind abstract mathematical "darkness", following Einsteinian theoretical tradition.

The PWM-theory is based on the synthesis of two genial physical proto-concepts of the 20th century:

- (1) Planckian- Einsteinian *idea of photon* - quantum of electromagnetic radiation $E=h\nu$;
- (2) Einsteinian *principle of equality* between the postulated extra spatial dimension L and our three equal spatial dimensions (x,y,z) on the way to create a physically adequate expanded space (x,y,z,L) – as the opposite to the abstract-mathematical Kaluza's 4-th cyclical spatial coordinate, mentioned above (Einstein & Grommer 1923, p. 314).

So, the additional orthogonal spatial dimension L in the PWM is defined as *physically equal to our three spatial dimensions* and provides the exactly Euclidean spatial enlargement $[x,y,z] \rightarrow [x,y,z,L]$. This constitutes the principal points in the proposed PWM-concept, postulating so at least $3D \rightarrow 4D$ enlarged dimensionality of our physical space. This principle seems to be crucially important, because it ensures possibilities of an adequate application - projection of the known conventional three-dimensional physical knowledge – physical concepts (Maxwellian-like photon, force, speed, acceleration, etc) in frames of the enlarged isotropic/Euclidean 4D-space $[x,y,z,L]$. This also ensures, that first Planckian-Einsteinian idea above – the idea of light photons - electromagnetic massless quasiparticles can be also adequately extended to the C_4 -photons ($E_3=h_3\nu=h_3C_3/\lambda=h_4C_4/\lambda$, living in this Euclidean/Einsteinian (pure 4D-spatial) isotropic hyperspace $[x,y,z,L]$. Now we can naturally apply the same fundamental constants as the C_4 -speed of light propagation $|C_4| = |C_3|$ and Planckian constant $h=h_3=h_4$ (as elementary light-dynamical action) to the so enlarged physical 4D-space. The C_4 -photon will behave like usual C_3 -massless photon - it can never stop and always moves with the same velocity – velocity of light $|C_4| = \text{const}$.

How could this C_4 -photon always belong to our $\sim 3D$ -space-crosssection in the isotropic hyperspace $[x,y,z,L]$ and also acquire the (now emergent) SR-relativistic properties? The answer is quite simple - this C_4 -photon must be captured - confined by a quasiflat $\sim 3D$ -*waveguide* $[x,y,z,0 < L < L_0]$, which is a very thin (pico-thin) L_0 -layer of the so proposed global isotropic 4D-Euclidean space $[x,y,z,L]$ (Fig. 1.1 below). The waveguide's 3D-boundaries $[x,y,z,L=0]$ and $[x,y,z,L=L_0]$, confining the C_4 -photon, must have property of two ideally reflecting surfaces & strained framing membranes (Gribov 1999, 2005, 2012).

But how could we include also fundamental Diracian matter/antimatter mass particles (C_4 -antiphotons), acquiring and preserving the (now emergent) fundamental CPT symmetry, etc in the 3D-waveguide-based $\sim 3D$ -Universe $[x,y,z,0 < L < L_0]$? The exact geometro-dynamical answer is – via the waveguides equality & L_0 -periodicity, providing common (matter/antimatter) L_0 -periodicity with the automatically arising-emergent (sufficiently expanded) CPT-like symmetry.

The proposed PWM-concept confirms a deep notion by Werner Heisenberg, that the mass particle physics and the particle masses derivation must be based on a fundamental length scale (here arising as the *hyperspatial* L_0 -period), Planck's constant h and the speed of light C (Heisenberg 1943, 1957).

PERIODIC 3D-WAVEGUIDE'S CONCEPT OF THE GLOBAL 4D-HYPERSPACE

The PWM-design consequently combines two basic mentioned above concepts with need of the consistent incorporation of Diracian matter and antimatter in the united PWM- physics. This fundamental task has the simplest solution - the *periodic* repetition of the postulated - classical (Maxwellian-like) 3D-waveguided modules \mathbf{W}_n as the multilayered-“crystallized” 4D-Multiverse structure, assumingly covering the whole global Euclidean 4D-hyperspace $[x, y, z, L]$:

$$\mathbf{W}_n[x, y, z, nL_0 < L < (n+1)L_0], \text{ where } (n = \pm 1, \pm 2, \pm 3, \dots, \pm\infty), \quad (2)$$

These periodic modules are immersed, according Einsteinian *equality-principle*, into the globally endless, isotropic Euclidean 4D-space (x,y,z,L) , mapping endless chain of physically identical, literally parallel, adjacent $\sim 3\text{D}$ -quasiflat \mathbf{W}_n -Universes – the PWM-Multiverse (Gribov 1999, 2003, 2005, 2012, 2013a,b).

Each of these identical, parallel waveguided \mathbf{W}_n -Universes has absolutely the same linear waveguided harmonic spectrum

$$E_{k(n)} = kM_0C_4^2 = khv_0 = kh(C_4/2L_0), \quad (3)$$

where h is Planck's constant, L_0 - the 3D-waveguide thickness, corresponding to the minimal elementary rest mass particle – *electron*, $L_0 = L_{0e} = \lambda_{\text{electronCompton}} \sim 10^{-10}\text{cm}_L$ expressing new fundamental waveguided length-constant, exactly determining the electron rest mass and periodicity of the PWM-structure. C_4 is four-dimensional velocity of light, where $|C_4| = |C_3|$ - and $(k=1, 2, 3, 4, 5\dots$ - positive integer. This fundamental hyperspatial PWM-length-constant $L_{0e} = \lambda_{\text{electronCompton}}$ is relatively “very large” extra-dimensional length-interval, because it is determined by the *lightest elementary spring-like* rest mass particle (as natural waveguided – start-point) – on the contrary to the String-Theoretical (ST) scale, starting from the smallest (absolutely unknown) – Planckian-length level, creating common «impenetrable forest» for the ST-implementations to the really known much lower energy physics. So, the PWM-concept starts from the opposite and more reasonable – the lowest-effective rest mass energy physics.

The first key-result of the proposed PWM-design is that the $\sim 3\text{D}$ -waveguided C_4 -photon-confinement immediately generates - like by magic – the pure C -dynamical by the nature “*rest mass*” of the C_4 -photon with corresponding – holistically and simultaneously emergent – 3D-waveguided Special Relativity (SR) & Quantum Mechanics (QM) properties of classically *quantized=identical elementary* “rest-mass”-particles. Here naturally arise traditionally impossible, but now obviously kept and simply hidden in the 3D-waveguide – the Maxwellian-like *local gauge invariance* – Maxwellian attributes of the waveguided and because “massive” C_4 -photon (realizing locally - along the hidden C_4 -polygonal-cyclical particle's 4D-trajectory of this photon in the 3D-waveguide). The 3D-waveguided – pure light dynamical nature of the “rest-mass”, which holds so trivially implanted local gauge invariance, explains the “paradoxical” bosonic masslessness in the Yang-Mills theory (as factually implicit model of the waveguided-like bosonic C_4 -photons, where the waveguided frames and the waveguided rest mass creation mechanism are totally hidden and was lost for the best theorists. This obstacle explains the corresponding paradoxical masslessness of all the Standard Model (SM) mass-

particles, because it is based on the nonabelian “massless” Yang-Mills concept (Yang & Mills 1954). Wolfgang Pauli proposed the Yang-Mills-like concept earlier in 1953; it was his promising theoretical idea to develop the *five-dimensional* theory of Kaluza-Klein (Pauli 1999), but Pauli never published his theory since “he saw no way to give masses to the gauge bosons...” (Straumann 2000).

Richard Feynman, one of the most insightful patriarchs in modern physics, mentioned in his famous lectures the remarkable property of a usual planar 2D-waveguide (whose the 3D-expansion is implemented in the PWM-concept). He noted that its electromagnetic wave dynamics has an amazing analogy with the phase waves of de Broglie, propagating along the 2D-waveguide with the corresponding super-light phase speed. Feynman also noted that the relativistic momentum-energy equation for the mass particle $U^2 = P^2 C^2 + (MC^2)^2$, being described quantum mechanically as $U = hv$, is very similar to the wave dynamics in the 2D-waveguide. “Isn’t this interesting?” exclaimed Feynman (Feynman et al, 1966, p. 230). Why being so precisely insightful, Feynman never developed so attractive waveguide’s advantages, at least for unification of the SR with the QM? Possibly, it was an influence of a widely dominating skepticism to deal with additional spatial dimensions in his times (after Kaluza’s conceptual problems, etc), or maybe he touched his amazing analogy accidentally, as a lecturer, being focused on a very narrow educational goal - to show an accidental identity of mathematical equations in physics.

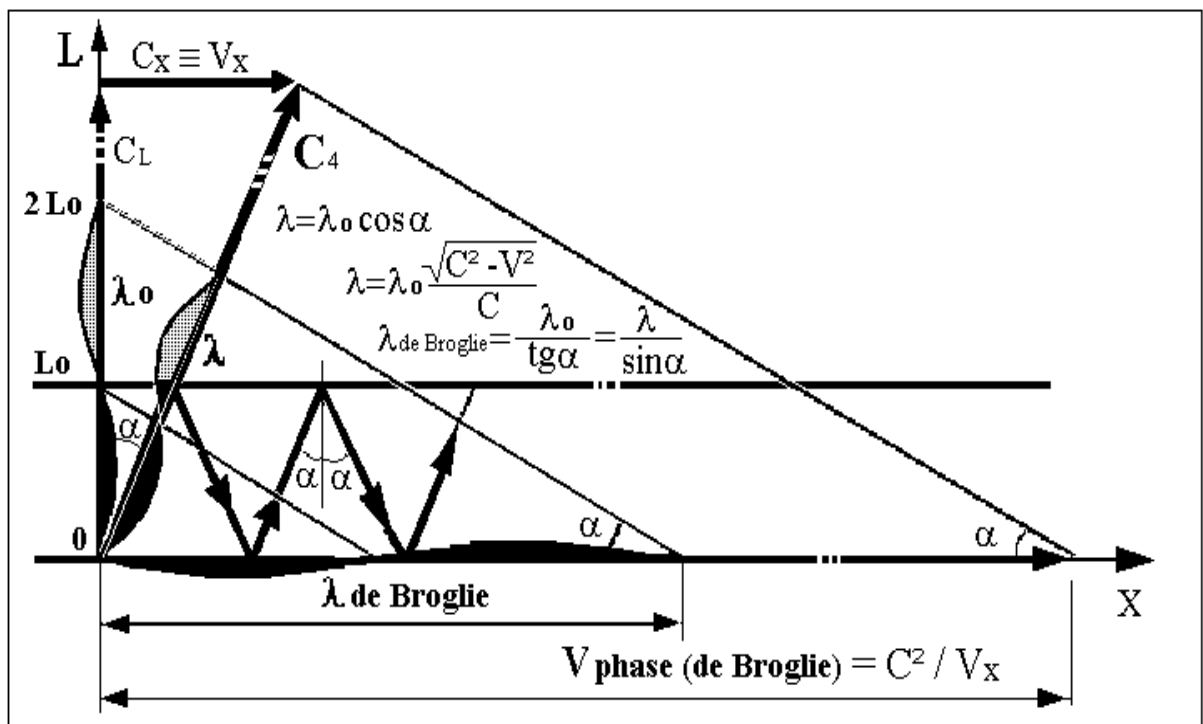

Fig. 1.1 shows three basic intersections of the C_4 -wave, propagating in the 3D-waveguide $(x, y, z, 0 < L < L_0)$. This wave propagates, being reflected along a polygonal trajectory $\uparrow \downarrow \uparrow \downarrow \uparrow \downarrow \uparrow \downarrow C_4 t$ with the corresponding co-phase waveguided conditions (see Fig 1.2a), simultaneously creating pure C_4 -dynamical “frozen” - quantized “rest mass” harmonics (OL -wave crosssection) with the waveguided-emergent SR, the wave of de Broglie (OX -wave crosssection) and physically obvious Kaluza’s “cyclical conditions”.

Albert Einstein also used the promising idea of the flat 2D-waveguide almost directly (but very differently) – in his famous “substantial” mirror clock construction. It contains two parallel 2D-mirrors with a L_0 -like macro-distance between them and a perpendicular light beam periodically

reflecting-flying-back between these mirrors. This 2D-light-clock has a timing period $T_0=2L_0/C_3$ and a corresponding clock-frequency $\nu_0=C_3/2L_0$.

Einstein “invented” this very simple „substantial“ clock, to show the essence of the SR-time delay, but even Einstein never realized that there could be a much more promising opportunity, if to reduce the light-clock’s macro-thickness L_0 to a very thin 2D-waveguide. This very simple idea could have suggested him a radically novel - the *wave-dynamical nature of the mass particle, vibrating in the 3D-waveguide* and the correspondingly arising *matter-wave – 3D-wave* of de Broglie (already in 1905). Indeed, his famous relativistic mass equation $M=M_0/\sqrt{1-V^2/C^2}$ and the frequency equation $\nu=\nu_0/\sqrt{1-V^2/C^2}$ for the 2D-waveguided wave (as necessary co-phase condition for the wave propagation along this “substantial” waveguided-clock) have identical forms (Fig. 1.2a, below). If we multiply the frequency equation by the Planck constant h , we derive equation $h\nu=h\nu_0/\sqrt{1-V^2/C^2}$ which is now directly related to the Einstein’s second great 1905- idea – the concept of the *photon*. Indeed, his basic energy-momentum equation $E_3^2=(M_0C_3)^2+(P_3C_3)^2$ for the mass particle appears very naturally as the same - pure Euclidean-Pythagorean 4D-space equation $E_4^2=(M_0C_4)^2+(P_3C_4)^2$, being simply the *common* basic wave-interference condition for the C_4 -wave, propagating along this flat 3D-waveguide with the isotropic 4D-Euclidean space inside. Finally, mathematically so necessary, but physically always unclear, the Kaluza’s cyclic condition appears in the PWM as physically transparent, accompanying cyclical C_4 -wave dynamics in the 3D-waveguide, being now organically connected – non-divisive of the united-waveguided body of basic physical laws (Fig. 1.1, 1.2, above).

1) Here we find *the purely 4D-spatial wave-dynamic nature of the huge „rest mass“ energy $E_0=M_0C^2$* of Einsteinian SR. This famous physical equation is accepted as the biggest theoretical achievement and simultaneously as the biggest physical mystery, as noted Feynman: “It is important to realize that in physics today, we have no knowledge what energy is” (Feynman 1966, V1). Now its physical nature becomes obvious - there is no literal “rest mass” in the 4D-hyperspace – the C_4 -wave-quasiparticle has non-stop C_4 -momentum $P_4=MC_4$ and its C_4 -dynamical energy E is correspondingly-directly derived as $E=P_4C_4=MC_4^2$. The waveguided elementary mass particle has classically quantized minimal-gaped dynamical energy $E_{04}=h\nu_0>0$, where $\nu_0=C_4/2L_0$. So, the “massive” 3D-particle exists as the C_4 -wave (paradoxically massive/massless – C_4 -dynamical - in the 4D-hyperspace, with its emergent - exactly the SR-rest-mass properties, emerging only because of the 3D-waveguided framing boundaries conditions. The rest mass particle has common physical 3D-velocity $V_{x,y,z}$ as a (x,y,z) -projection of the full C_4 -velocity vector $C_4=(C_x, C_y, C_z, C_L)=(V_x, V_y, V_z, C_L)$ where

$$C_4^2=V_x^2+V_y^2+V_z^2+C_L^2, \quad (\text{where } C_L^2>0) \quad (4a)$$

$$C_{x,y,z} \equiv V_{x,y,z} \equiv V \equiv \sqrt{C_4^2 - C_L^2} < C_4. \quad (4b)$$

This wave always moves with the 4D-light speed C_4 , reflecting – propagating along the *quasi-polygonal trajectory* $\hat{x}\hat{y}\hat{z}\hat{L}C_4t$, (see Fig. 1.1, above), where:

$$\sin\alpha = V/C_4 = C_{x,y,z}/C_4, \quad (4c)$$

$$\cos\alpha = [\sqrt{C_4^2 - V^2}] / C_4 = \sqrt{1 - V^2/C_4^2} \quad (4d)$$

2) *The Einstein’s relativistic mass equation, and the following relativistic energy-momentum equation disclose the pure 3D-waveguide’s wave-interference nature of the SR – with the united wave-roots, creating the wave-QM mechanics, being both emergent in the 3D-waveguide. The*

relativistic mass equation $M=M_0/\sqrt{1-V^2/C^2}$ and the corresponding waveguided energy-momentum equation appear immediately as the 4D-“self-interference effect”, the co-phase condition between two parallel wave fronts after the wave-reflection in the propagating wave-train (Fig.1.2a).

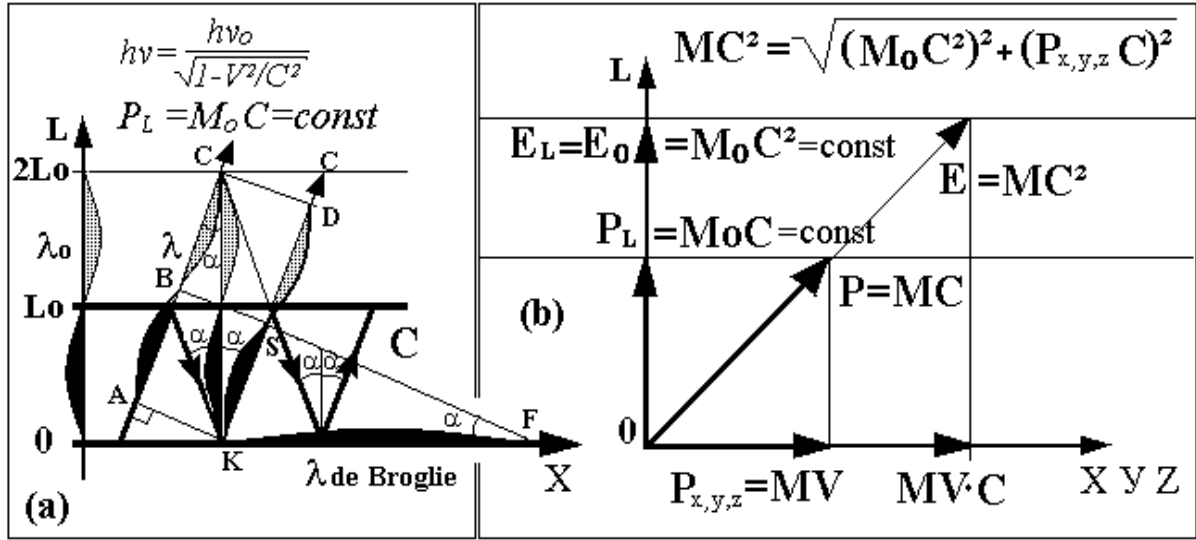

Fig. 1.2a shows how the 3D-waveguide-wave interference *creates* the exact Einstein’s relativistic mass equation for the lightest mass particle - electron, being simply the necessary condition for electron-wave propagation along the waveguide, common in the wave optics.

Fig. 1.2b shows the pure *wave nature* of the basic SR equation $E^2=[(M_0C^2)^2+P^2C^2]$. It is derived from the co-phased 3D-waveguide’s wave dynamics, which creates the “frozen“ orthogonal momentum projection $P_L=M_0C_4=const$, as result of the necessary interference condition for the wave-particle propagation alongside this 3D-waveguide.

It is quite similar to the thin 2D-oilskin in wave optics, studied at school, and visible after rain everywhere on a street. A full dynamical quasiparticle energy E in the 3D-waveguide is $E(\alpha)=h v_4=h v_0/\cos\alpha$ (where $\cos\alpha=\sqrt{1-V^2/C_4^2}$ and the corresponding relativistic mass $M(\alpha)$ is $M=M_0/\sqrt{1-V^2/C_4^2}$). The wave quanta with energy $E_4=h v_4=h/(C_4/\lambda_4)$ could pass along the 3D-waveguide L_0 , if two parallel wave-trains AC and OD have the same wave phase on the line $AK \perp AC$. Here the wave-paths difference ΔS , is $\Delta S=AB+BK$ (Fig. 1.2a). Our wave is additionally reflected two times (in the points B and K , that adds the $\pi+\pi=2\pi$ phase. The ΔS -interval must contain one integer wavelength λ_4 and is equal to the cathetus $AC=AB+BC=AB+BK=\lambda_4$ in the square triangle KAC , where $\angle KAC=90^\circ$ and its hypotenuse is $KC=\lambda_0$. From the triangle KAC we obtain the pure wave-interference source of the SR-relativism:

$$\lambda_4=\lambda_{04}\cos\alpha, \quad v_4=v=v_0/\cos\alpha, \quad \lambda_4=\lambda \tag{5a}$$

and correspondingly,

$$h v=h v_0/\cos\alpha \quad \text{and} \quad M=M_{0e}/\sqrt{1-V_x^2/C_4^2}. \tag{5b}$$

In other words, if our massless C_4 -wave freely propagates along the 3D-waveguide, it must have the “frozen” - “massive” L_0 -harmonics – that is simply the interference condition for the C_4 -wave propagation along the flat 3D-waveguide!

3) The 3D-wave of de Broglie arises here as the OX crosssection of the same wave front (and its value is clear from the corresponding triangle KSF (see Fig. 1.2a):

$$\lambda_{de\ Broglie} = \lambda_4 / \sin\alpha = \lambda / \sin\alpha, \quad (5c)$$

where the waveguide's quantum λ_4 carries its pure dynamical (electron) energy $E_{(e-)}$ as

$$E_{(e-)} = M_{in(e-)} C^2 = h\nu = hC/\lambda_4 = hC/\lambda, \quad (5d)$$

and $\lambda_4 = \lambda$ is commonly connected with the electron's dynamical-inertial mass $M_{in(e-)}$:

$$M_{in(e-)} = h/C\lambda_4 = h/C\lambda \quad \text{or} \quad \lambda = h/CM_{in(e-)}. \quad (5e)$$

So easy arise the unexpectedly very united - identical physical *wave-roots* of the SR and the QM wave of de Broglie for rest mass particle! What we can learn from the disclosed unity? It becomes obvious that the proposed pure spatial 4th dimensional 3D-waveguided hyperspace structure plays its generic, fundamental role in common classical 3D-physics, since it so deeply unifies its basic physical columns. This surprising picture shows that we definitely live in the hyperspatial physical world with more than 3 space dimensions, totally determining our basic physical laws! The periodic 3D-waveguide's architecture confirms the reasonable and insightful remark of Robert Laughlin: "Symmetries are caused by things; they are not the causes of the things" (Laughlin 2007, p.187). We see that common Lorentz symmetry and the local Yang-Mills-like gauge symmetry for the mass particle (related to the C_4 -wave propagation) arise in the 3D-waveguide simultaneously. These usually well hidden-hyperspatial "causing things" seems to be surprisingly simple spatial objects, as e.g. the quasiflat 3D-waveguide-modules, cloned periodically in the global Euclidean 4D-hyperspace.

4) Common "mystery" of the Kaluza's cyclical condition naturally arises here as the physically transparent ($L=x^5$) cyclical C_4 -wave dynamic in the 3D-waveguide, since our mass-particle (electron) is the dynamical C_4 -wave $\psi(x,y,z,0 < L < L_0)$ in the 3D-waveguide:

$$\psi = \psi_0 \cdot \exp[-2\pi i (\nu t - K_x X - K_y Y - K_z Z - K_L L)] \quad \text{or} \quad (6a)$$

$$\psi = \psi_0 \cdot \exp[(-2\pi i/h)(Et - P_x X - P_y Y - P_z Z - P_L L)], \quad (6b)$$

(where $\mathbf{K} = (K_x, K_y, K_z, K_L)$ is the wave vector \mathbf{K} , with $|\mathbf{K}| = 1/\lambda$, The full 4D-momentum $\mathbf{P}_4 = M\mathbf{C}_4 = MC$ has its P_L projection (see Fig. 1.1)

$$P_L(\alpha) = MC_4 \cos\alpha = [M_0 C_4 / \sqrt{(1 - V^2/C_4^2)}] \sqrt{(1 - V^2/C_4^2)} = M_0 C_4 = \text{const} \quad (7)$$

Here arises the so simple physical nature of the Kaluza's cyclical x^5 -condition (1).

5) The wave of de Broglie was very fundamental in modern physics, but it becomes not so fundamental any more – it becomes also emergent in the 3D-waveguide as the 3D-spatial crosssection $\psi(x,y,z,L=0)$ of the 4D-wave in the "low energy limit", keeping vacuum superfluidity and endless life of propagating inside waves-quasiparticles (see Fig.1.1). The PWM-concept discloses emergent – "machinery" of the quantum mechanical wave-particle, being now deeply united with the waveguided SR_{PWM}. Now they have the same very simple and clear 3D-waveguide-dynamical nature. The (6b) equation performs the x^5 "wave function" ψ of quantum mechanics, mimicking also the relativistic Klein-Gordon (KG) equation, which is the straight-on requirement of the Einstein's energy-momentum equation $E^2 = p^2 + m^2$, ($C_4=1$), indeed arising in the 3D-waveguide. It is common that the KG-equation can be formally reduced to the basic Schrödinger QM-equation, if $V_3 = C_{x,y,z} \ll C_4$ as it is shown in many QM-textbooks. Thus, the fundamentally important Schrödinger QM-equation, constructed-adopted a priori, now

appears as a consequence, simultaneously with the SR and the Kaluza's cyclical condition - as the ultimate consequence of the proposed 3D-waveguided PWM-structure, which has been "revived" by implantation of a precious "beating heart" of Einsteinian photon concept, with its endless the non-stop C_4 -light dynamics.

Note. Relativistic Klein-Gordon equation also keeps physical symmetry and distinction between electron and positron. Indeed, the factorization of the Klein-Gordon operator gives two multiplicands $(\square - m^2) = (P - m)(P + m)$, creating relativistic Diracian equations for fermionic electron and positron (Bogoliubov et al 1980, p. 40). Two opposite signs $-m$ and $+m$ are associated obviously with two symmetrical-adjacent 3D-waveguides $(x, y, z, -L_0 < L < 0)$, $(x, y, z, 0 < L < +L_0)$, creating two the opposite electrostatic / gravity "charges" (for electron and positron correspondingly, see below). So, the hyperspatial matter/antimatter CPT-symmetry nature and sufficiently hyperspatial *distinction* between electron and positron particles are projected into traditional - Diracian theoretical 3D-construct, providing by the miracle of Einsteinian (now rediscovered as the pure waveguided-Pythagorean) energy-momentum equation $E^2 = p^2 + m^2$, where formally $E = \pm \sqrt{p^2 + m^2}$.

THE WAVEGUIDED-EMERGENT MECHANISM OF GRAVITY ACCELERATION

Einsteinian C_4 -photon' dynamics in the 3D-waveguide reveals the completely new-emergent classical/quantum nature of gravity and gravity mass quantization, etc. We consider here non-relativistic very weak gravity and slowly processes, which don't touch limited speed of gravity force propagation.

Waveguided dynamics of the C_4 -quasiparticle creates the constant orthogonal momentum $P_L = \pm M_0 C_4$ and corresponding average orthogonal "light"-pressure $F_L = \Delta P / \Delta t \sim 2M_0 C_4 / (2L_0 / C_4)$ and $F_L = \pm M_0 C_4^2 / L_0$. This L -pressure causes tiny symmetrical L -deviations $\delta L \sim 1/r$ (and correspondingly very tiny additional stretching) of two identical very thin, very strongly stressed membranes $\mathbf{M}_0(x, y, z, L=0)$ and $\mathbf{M}_1(x, y, z, L=L_0)$ - quasiparallel 3D-boundaries of the 3D-waveguide \mathbf{W}_0 , being initially flat and parallel (see chapter "*The $\pm Q$ -Electro-Mechanical-Membrane Analogy (EMMA)*" below). The disturbed flatness creates tiny non-parallelism $\beta \approx \partial L_0 / \partial x \approx 0$ between them (Fig. 2a, below). We assume that basic physical *interactions* between 3D-waveguided particles, including gravity interaction, are realized across such deformed framing membranes $\sim \delta L_0(x, y, z)$, which are identical to the (literally materialized) classical gravity potential form $U_{gr}(x, y, z) \sim \delta L_0(x, y, z)$. The gravity acceleration g_x (as the gravity-like effect for the wave-optical waveguided approximation) was shown for very small non-parallelism - an opening angle $\beta \approx 0$ between the \mathbf{M}_0 and \mathbf{M}_1 membranes (Gribov 1999, 2013a, 2012, pp.23, 24).

A corresponding waveguided acceleration g_x is $g_x \sim \partial L_0 / \partial x \approx \beta$, where $\beta \approx 0$ is very small angle between two quasiparallel 3D-membranes \mathbf{M}_0 and \mathbf{M}_1 framing the above-mentioned 3D-waveguide \mathbf{W}_0 . The local *average* accelerating force is $f_x = \Delta P_x / \Delta t$ for the mass particle M inside this 3D-waveguide (Fig. 2a).

Here full C_4 -momentum of the waveguided rest-mass particle M in the point A on the membrane \mathbf{M}_0 is $\mathbf{P}_{1AB} = M C_4$. The particle is reflected in the point B with momentum \mathbf{P}_{2BK} on the membrane \mathbf{M}_1 and is returned back to the point K on the membrane \mathbf{M}_0 . If $\beta \approx 0$, the "tooth" ABC will be periodically repeated in the regular particle's path and we need to calculate only the average momentum change along the quasioptical part AB+BC. This calculation is very simple, because $P_{1ABC} \cos \alpha = P_{2BK} \cos \alpha = P_L = M_0 C = \text{const}$,

$$\Delta P_x \approx 2\beta P_{1AB} / \cos\alpha = 2\beta M C_4 / \cos\alpha,$$

$$\Delta t \approx (AB+BK)/C_4 \approx (2L_0/\cos\alpha)/C_4,$$

i.e. $\Delta P_x/\Delta t = f_x = M g_x = (2\beta M C_4 / \cos\alpha) / (2L_0/\cos\alpha)/C_4 = \beta M C_4^2/L_0$, so $M g_x = \beta M C_4^2/L$ and

$$g_x \approx (\partial L_0/\partial x) C_4^2/L_0 \approx \beta C_4^2/L_0, \quad (\text{for } \beta \approx 0). \quad (8)$$

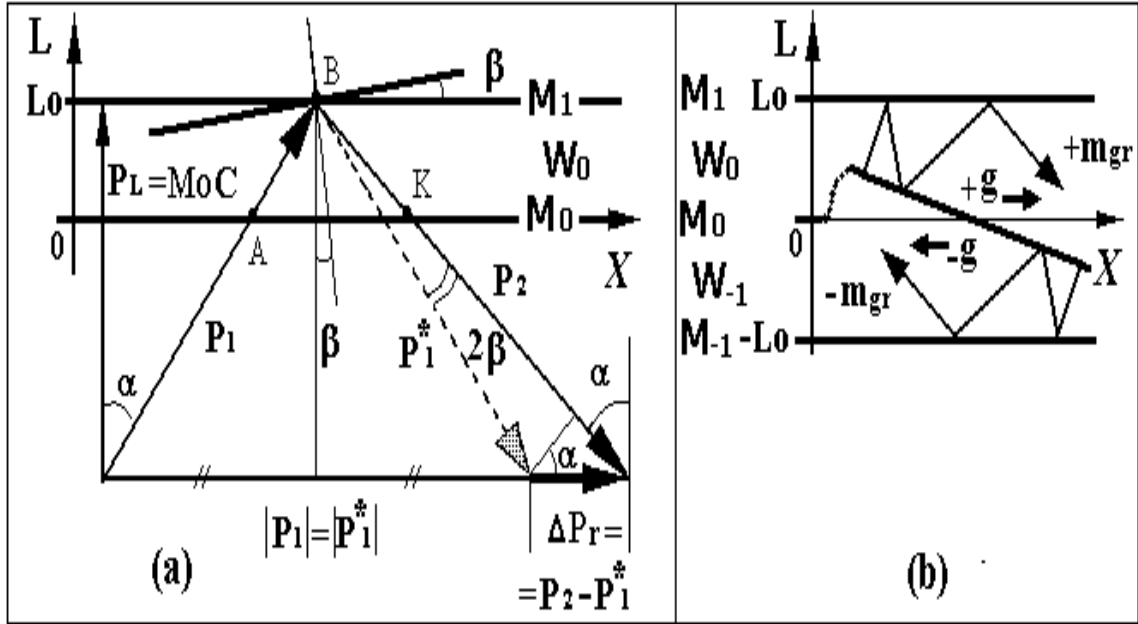

Fig. 2a shows the 3D-waveguide $(x,y,z, 0 < L < L_0)$ with a very small non-parallelism $\beta \approx 0$ between two framing membranes $M_0=(x,y,z,L=0)$ and $M_1=(x,y,z,L=L_0)$. This case creates the exact non-relativistic classical gravity acceleration along the waveguide $g_{x(gr)} = \beta_x C_4^2/L_0$.

Fig. 2b shows the gravity/antigravity mechanism as the opposite gravity acceleration directions, arising for two identical particles under the “ $\pm\beta$ ”-gravity fields”, but located in two different – the nearest adjacent waveguides $W_{-1}=(x,y,z,-L_0 < L < 0)$ and $W_0=(x,y,z,0 < L < L_0)$ with arising the opposite waveguides openings $\beta = \pm(\partial L_0/\partial x)$, that shows the so trivially emergent physical nature of the positive gravity “charge” for matter in the W_0 -Universe and correspondingly the opposite - negative gravity “charge” for antimatter in the adjacent W_{-1} -Universe.

THE WAVEGUIDED EMERGENCE OF THE QUANTIZED EQUIVALENCE PRINCIPLE

Thus, the derived quasi-optical acceleration $g_{x(gr)} = \beta_x C_4^2/L_0$ is expressed pure waveguided-geometrically. If we consider more heavy quantized mass particles in this waveguide - with the higher waveguide’s transverse harmonics $\nu_k = k \nu_0$, and correspondingly linearly quantized masses $M_k = k M_0$, ($k=1, 2, 3, \dots$) they will have the same (Fig. 2a) kinematical trains geometry for different k -harmonics and we will derive correspondingly the same acceleration $g_{x(gr)}$ for all linearly quantized waveguided rest masses $k M_0$:

$$f_{xk} = (k M_0) g_{x(gr)} = \beta_x (k M_0) C_4^2/L_0 \cdot g_{xk(gr)} \approx \beta_x C_4^2/L_0. \quad (8a)$$

So the $g_{x(gr)}$ is the same for all linearly quantized harmonics - masses $k M_0$ at the same space point and this local unparallelled deformations $\delta L_0(x,y,z)$ (creating the waveguided opening β)

can be strictly considered as a purely geometrically expressed waveguided gravity potential $U_{gr}(x,y,z)$ and corresponding gravity field in the deformed 3D-waveguide, where

$$L_0(x,y,z) = L_0 + \delta L_0(x,y,z):$$

$$U_{gr}(x,y,z) = -\delta L_0(x,y,z)C_4^2/L_0 \quad (9)$$

We obtain for a non-relativistic particle the exact classical gravitation field

$$F_{x(gr)} = -\partial U/\partial x, \text{ where } tg\beta_x(x) = \partial L(x)/\partial x \approx \beta(x) \text{ for very small } \beta(x) \approx 0,$$

$$\mathbf{g} = (\beta_x, \beta_y, \beta_z)C_4^2/L_{0e}, \quad g^2 = (\beta_x^2 + \beta_y^2 + \beta_z^2)(C_4^2/L_{0e})^2 \quad (9a)$$

Our (waveguided) gravity potential $U_{gr}(x)=0$ if $\delta L_0=0$ (very far from matter particles), where $L_{0e}(x)=L_0$.

Note 1 The classical GR was directly based on the EP postulate: “In general relativity the response of matter to gravity is independent of mass (equivalence principle)” (Wilczek 2002, p. 2). Thus, the EP – the basis point for the GR is not necessary to postulate any more – it is resulted part of the *quantized* 3D-waveguided gravity mass physics.

Note 2. Einstein could be very surprised to see arising here the pure waveguided EP_{PWM} as the source of the GR, together with so straightforward wave’s unity of the waveguided SR and gravity with QM, because he had no special liking to it for “uncertainty” and oft critiqued this theory as superficial.

Note 3. The derived gravity acceleration under the 3D-waveguide opening angle $\beta \approx 0$ is

$$g_x \approx \beta C_4^2/L_0 = 2\beta C_4(C_4/2L_0) = 2\beta C_4 v_0 = 2\beta M_0 C_4^3/h \text{ (because } C_4/2L_0 = v_0 \text{ and } h v_0 = M_0 C_4^2).$$

The pure dynamical electron-wave’s rest mass is formed in the relativistic-twisting 3D-loop (see corresponding chapter on the page 14) and it performs resting, but always twisting electron vortex, which acquires exactly doubled “rest” mass $M_{0e}=2M_0$ and the exactly twice dropped-relativistic vortex spin of *fermion*. Thus, the waveguided gravity acceleration g_x (and corresponding gravity field in the proposed waveguided PWM) is naturally determined only by the *lightest* rest mass of the waveguided - *fermionic electron*, created by the waveguided Einsteinian photon - (*bosonic*) C_4 -quasiparticle, confined in the 3D-waveguide:

$$g_x \approx \beta M_{0e} C_4^3/h \quad (9b)$$

What we can learn from this so simple way of creating “fundamental” physical basics? The “lightest electron” guideline, consequently presented here, corresponds to the well-established *paradigm of “effective theory”*, arising in the condenser matter physics – we must start from the lowest energy limit in the collective system and beautiful physical laws will arise immediately, including “the first principles” holiness inside (Hu 1996, Padmanabhan 1999, Laughlin & Pines 2000, Volovik 2003). One of the most impressive examples here is the simplest, but realistic theory of superfluidity, firstly created by legendary Lev Landau, literally “on his fingers”.

THE EXPANDED MATTER/ANTIMATTER CPT-SYMMETRY NATURE IN THE PWM

We illustrate below our PWM-hyperspace “analogy” to common “naive” Feynman’s-Stueckelberg’s CPT-symmetry interpretation (created in frames of the global Minkowski’s

spacetime concept), describing antiparticle as particle moving “backward” in time (Fig. 2c, below). Our waveguided particles and antiparticles move in a constant gravity field $\partial L(r)/\partial x \sim \beta(x) = \text{const}$ with $g_x \approx \pm \beta(x)C^2/L_0 = \text{constant}$. All framing membranes $\mathbf{M}_{-1}=(x,y,z, -L_0)$ $\mathbf{M}_0=(x,y,z,0)$ and $\mathbf{M}_1=(x,y,z,L_0)$ are *flat* – they have zero curvatures. We see usual gravity acceleration $g_x > 0$ for \mathbf{W}_0 matter particles in our matter waveguide $\mathbf{W}_0=(x,y,z,0 < L < L_0)$, but simultaneously the literally “backward” gravity acceleration $-g_x < 0$ for \mathbf{W}_{-1} antiparticles in the identical adjacent antimatter waveguide $\mathbf{W}_{-1}=(x,y,z,-L_0 < L < 0)$. The GR-like “curvatures” $+k$ (for particle) and $-k$ (for antiparticle) arise only in the *artificial* (physically non-existing), globally enrolled *polygonal* “spacetimes” of these two adjacent waveguides \mathbf{W}_{-1} and \mathbf{W}_0 . These enrolled trajectories are curved very negligibly, they are 2β -stepwise broken arks (where $\beta \sim 0$), running inside of two different adjacent 3D-waveguides, presenting the matter-waveguide \mathbf{W}_0 ($x,y,z,0 < L < L_0$) and the adjacent antimatter - “anti”-waveguide \mathbf{W}_{-1} ($x,y,z,-L_0 < L < 0$), (Fig. 2c).

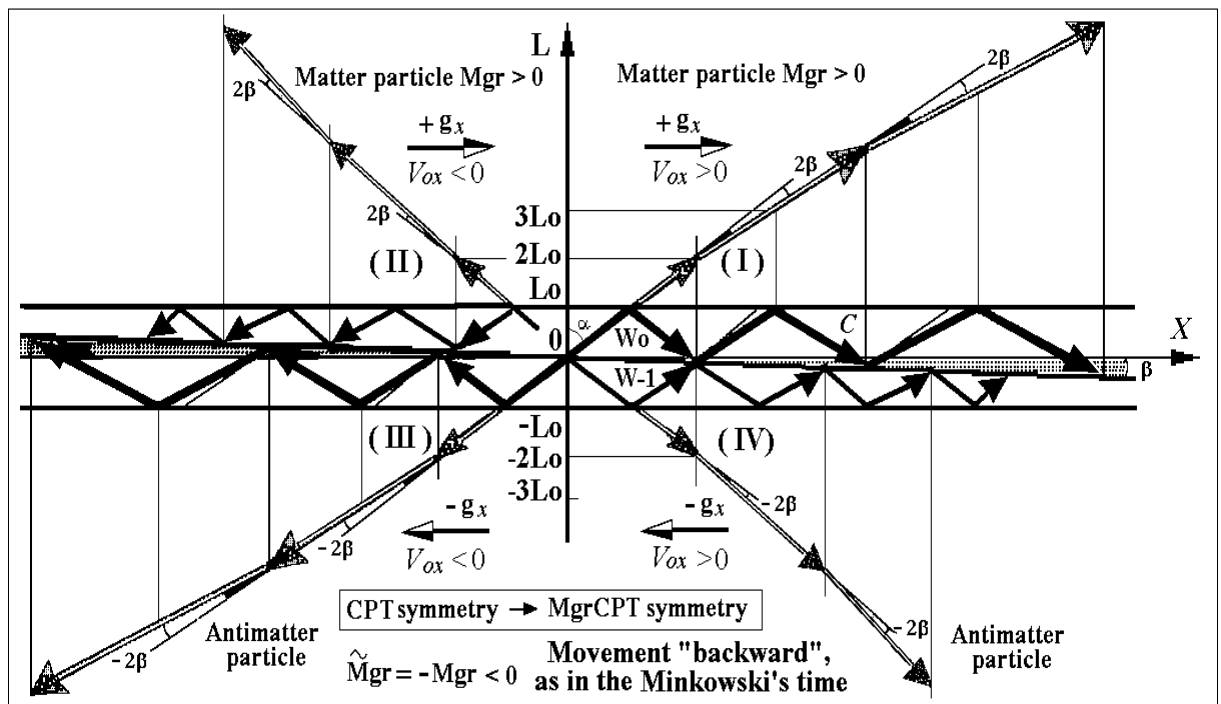

Fig. 2c shows the quasi-linear curved C_4 -sweep of the C_4 -sloping waveguide’s trajectory in the *imaginary* - *periodically unrolled* (x,L) corresponding one-layered waveguide’s spaces. We see (a) two matter particles (with initial particle velocity $V_{0x} > 0$ on the right side, and $V_{0x} < 0$ on the left side) in the above ($x,y,z,0 < L < L_0$) matter-waveguide, which has positive opening ($\beta > 0$), and correspondingly *positive gravity acceleration* $g_x = dV/dt > 0$; (b) two antimatter antiparticles are in the adjacent “antiwaveguide” ($x,y,z,-L_0 < L < 0$) with the opposite – negative opening ($\beta < 0$), and have *negative gravity acceleration* $g_x = dV/dt < 0$ (realizing by the same - middle dividing membrane non-parallelism $\beta \approx 0$).

This picture illustrates the PWM-hypersymmetric nature of common “fundamental” matter/antimatter CPT symmetry, which was not complete without the $\pm M_{gr}$ gravity mass symmetry: $C_{el}PT \rightarrow (M_{gr}C_{el}PT)_{PWM}$. The Fig 2c gives also a pure hyperspatial explanation to the mystical Feynman/Stueckelberg’s CPT-interpretation. Indeed, common global, \pm directed classical linear time coordinate (as the Ct -parameterization) *physically* does not exist as the global Minkowski’s spacetime for the mass particle – it becomes inevitably fragmental, polygonal-cyclical C_4 -particle’s 4D-spatial waveguided trajectory (Fig. 2c, above). But this quasi-optical waveguided-polygonal particle’s trajectory, measured by the Ct -parameterization, is artificially unrolled and installed into the global Minkowski spacetime construct, which does not exist as a “real” physical spacetime in the 3D-waveguided relativity, but the spacetime

formally preserves globally expressed - unrolled Ct -intervals (the Ct -parameterizations, proportional to common Lagrangians).

a) The time inversion T : Let us start from the matter particle, propagating along the matter 3D-waveguide \mathbf{W}_0 from the left to the right horizontal direction, /quadrant (I)/, (Fig. 2c). If we will try (like Feynman and Stueckelberg) associate our waveguided “cyclical” L coordinate with the Minkowski Ct time coordinate, we will have a nonsense – cyclical “forwards-backwards” “time” evolution – particle’s movements in the waveguide, mimicking a “drilled time machine”, behaving as a broken clock-pointer, shakings around the same “time” interval! Particle and its antiparticle are identical waves in the PWM, they both move identically-cyclically “forwards-backwards” in the identical - periodically placed PWM-“waveguide’s clocks”, but they exist physically as particle and antiparticle (and acquire their fundamental - mutual “charge symmetry”) only because they are placed in *different* - adjacent waveguides, like \mathbf{W}_0 , and \mathbf{W}_{-1} (Fig. 2c, above).

So, any possible vector C_4t in the 3D-waveguide does not express a “time coordinate direction” – it can have all possible pure 4D-spatial α -orientations, excluding only endless relativistic energy if $\alpha \neq \pm 90^\circ$ (Fig. 2c). If we reflect the formal Minkowski’s “time coordinate” via $(Ct \cdot -Ct)$, being interpreted by Feynman as the “backward time direction”, it will turn the mentioned above voluntary waveguided vector C_4t into the opposite vector $(C_4t \cdot -C_4t)$, realizing a trivial “backward 4D-spatial direction” of the particle movement along the same voluntary polygonal Ct -polygonal trajectory along the same waveguide \mathbf{W}_0 . This will switch the right-shifted cyclic Ct -movement /quadrant (I)/ into the left-shifted cyclic movement /quadrant (II)/, where $(x, C_x t) \rightarrow (-x, -C_x t)$ - without switching from the particle waveguide \mathbf{W}_0 to the adjacent antiparticle waveguide \mathbf{W}_{-1} – because the up-waveguide \mathbf{W}_0 is not changed onto the down-waveguide \mathbf{W}_{-1} after the “time inversion” (Fig 2c).

b) The $(x,y,z) \rightarrow (-x,-y,-z)$ inversion P : If we now add the 3D-space coordinates reflection (parity), using the inversion $(x \rightarrow -x)$, etc this will turn the $(-C_x t)$ projection of the $-C_4t$ vector of the particle movement to the opposite-initial direction, restoring the initial direction $(-C_x t \rightarrow C_x t)$ (but the particle remains in the same-up waveguide \mathbf{W}_0 , and now moves from the left to the right direction /like on the quadrant (I)/.

c) The M_{gr} Charge $\rightarrow -M_{gr}$ Charge inversion C_{gr} : This inversion arises only if we add our third inversion $L_0 \rightarrow -L_0$ to previously realized “PT”-inversion $(x, C_x t) \rightarrow (-x, -Ct)$, in the above (particle) waveguide \mathbf{W}_0 ($x,y,z, 0 < L < L_0$), we will reflex this (particle) space /quadrant (I)/ down – into the waveguided (antiparticle) space \mathbf{W}_{-1} ($x,y,z, -L_0 < L < 0$) /quadrant (IV)/. So, only the hyperspatial $L_0 \rightarrow -L_0$ inversion will create the fundamental Charge-symmetry between particle and antiparticle – now moving polygonal-symmetrically with the same 3D-velocity C_x in two adjacent waveguides \mathbf{W}_0 and \mathbf{W}_{-1} /quadrants (I) & (IV) or (II) & (III)/. This illustrates the transparent physical PWM-nature of the particles and antiparticles, including their definite *identity* and the mutual CPT-symmetry - with new gravity mass symmetry, so crucially important for the consistent PWM-cosmology (see Fig. 2b and corresponding chapters below).

Note 1: The CPT-symmetry arose historically very formally in the relativistic quantum mechanics by Paul Dirac, which is based on the SR by Einstein and the corresponding Minkowski 4D-spacetime concept. The PCT symmetry transforms the lightest elementary mass particle electron into the same mass antiparticle positron, which has (1) the opposite electrostatic charge = (C-conjugation), (2) it is spatially inversed $(x,y,z) \rightarrow (-x,-y,-z)$ = (P-inversion) and (3) it moves backwards in time $(t \rightarrow -t)$ = (T-inversion) according famous Feynman’s-Stueckelberg’s CPT-symmetry interpretation. We showed above that the common “Time inversion” couldn’t change the particle-state into the antiparticle-state in the waveguided PWM hyperspace - inverting

spatial direction of a velocity vectors - it can't switch the waveguided spaces and invert arising here "gravity charges" ($m_{\text{gr}} \rightarrow -m_{\text{gr}}$) and electrostatic charges ($q_{\text{el}} \rightarrow -q_{\text{el}}$). This is not surprising, the problem of the CPT-symmetry as an "exact symmetry of nature" was discussed and tested experimentally in many works, e.g. in the theoretical work by (Domenico 2007). He notes, that the charge inversion ($q_{\text{el}} \rightarrow -q_{\text{el}}$) cannot be achieved by the composite PT or by only the T-symmetry inversion - the additional fundamental Charge-inversion remains necessary: "An intuitive justification of this (Khriplovich et al, 1997) can be based on the fact that our space-time is four dimensional, and that for an even dimensional space, from well known geometrical arguments, reflection of all axes is equivalent to a rotation. For instance, in the case of a plane, i.e. a two dimensional space, both coordinate axes change sign under total reflection, and exactly the same happens for a 180° rotation around the origin. It would therefore be tempting to assume that PT reflection is equivalent to a rotation in four dimensional space-time. In particular, for the rotation in question, all components of any 4-vector should change signs. However it can be easily verified that this does not happen, e.g. for the four-vector current j_{μ} . The reason is that our four dimensional space-time is *pseudoeuclidean*, and the time coordinate is not exactly equivalent to a space coordinate. In order to restore the equivalence it can be shown (Khriplovich et al, 1997) that it is necessary to add C conjugation, which e.g. changes the sign of the electromagnetic four-current, to the PT operation. So, it appears that in our pseudoeuclidean spacetime, it is indeed the CPT operation, and not simply PT, which is equivalent to the reflection of all four axes." (Domenico 2007, p. 109-110). The "exact CPT invariance holds for any quantum field theory assuming (1) Lorentz invariance, (2) Locality and (3) Unitarily (i.e. conservation of probability). Testing the validity of CPT invariance therefore probes the most fundamental assumptions of our present understanding of particles and their interactions." (Domenico 2007, p. 110).

Note 2: The proposed here hypersymmetrical-waveguided nature of the charge conjugation sufficiently enlarges frames of the GR, based on the classical-global Minkowski spacetime concept. General relativity (GR) by Einstein was created before the antimatter discovery and is based on the corresponding Equivalence Principle (EP). The PWM-concept derives this (sufficiently transformed) EP_{PWM} as secondary – directly resulted of the waveguided gravity and \pm gravity "charge", described above. Some courageous physicists, including one of the so rare antigravity pioneers in cosmology Jose Maria Ripalda and Massimo Villata went in a right direction and tried to establish the \pm gravity mass existence, combining GR with the CPT-symmetry, where e.g. the time T-inversion was associated with the mass inversion $m \rightarrow -m$ (Ripalda 2010; Villata 2011a,b, 2012, 2013, Hajdukovic 2011, 2012a,b). But this classical basis is not enough here as it was shown above; the mass conjugation becomes possible (in the presented PWM concept) only for gravity "charge" $m_{\text{gr}} \rightarrow -m_{\text{gr}}$, but not for (always positive) inertial mass $m_{\text{in}} > 0 \rightarrow m_{\text{in}} > 0$; where its light-dynamical energy $E_4 = m_{\text{in}} C_4^2 > 0 \rightarrow m_{\text{in}} C_4^2 > 0$ for particle and for antiparticle. The so promising for cosmology $m_{\text{gr}} \rightarrow -m_{\text{gr}}$ conjugation arises naturally, but only after the fundamental PWM-shift into the identical adjacent anti-waveguide $\mathbf{W}_n \rightarrow \mathbf{W}_{n+1}$ or $\mathbf{W}_n \rightarrow \mathbf{W}_{n-}$ (see cosmological chapters below).

THE PURE RELATIVISTIC WAVEGUIDED NATURE OF MASSIVE FERMIONS IN THE PWM (Strings / branes \rightarrow self-focused photonic springs & strings / waveguides - approach)

The orthogonal pressure $\pm f_{\perp}$ from the waveguide \mathbf{W}_0 (Fig. 3 below) creates two local symmetrical $\sim 1/r$ singularity-less "flat-bottom" cavities (realizing the double gravity potential $-1/r = -1/2r_{(L=0)} - 1/2r_{(L=L_0)}$) and the corresponding doubled gravity "charge" $M_{e,gr} = M_{0,gr(L=0)} + M_{0,gr(L=L_0)} = 2M_{0,gr}$ in the opposite framing membranes $\mathbf{M}_1 = (x, y, z, L_0)$ and $\mathbf{M}_0 = (x, y, z, 0)$. We assume that these inevitable, local symmetrical gravitating cavities trigger a

non-linear wave-optical compaction, like (postulated for Yang-Mills fields) - self-focusing effect in the e -wave, creating identical co-phased twisting e -cells in all 3D-waveguides of the PWM.

This compaction creates the crucially important phenomenon – the self-organizing *self-focused e-wave dynamics* of the waveguided quantized quasiparticles, perpetually living as ideal frictionless loop-like co-phased excitations in the superfluid 3D-layers.

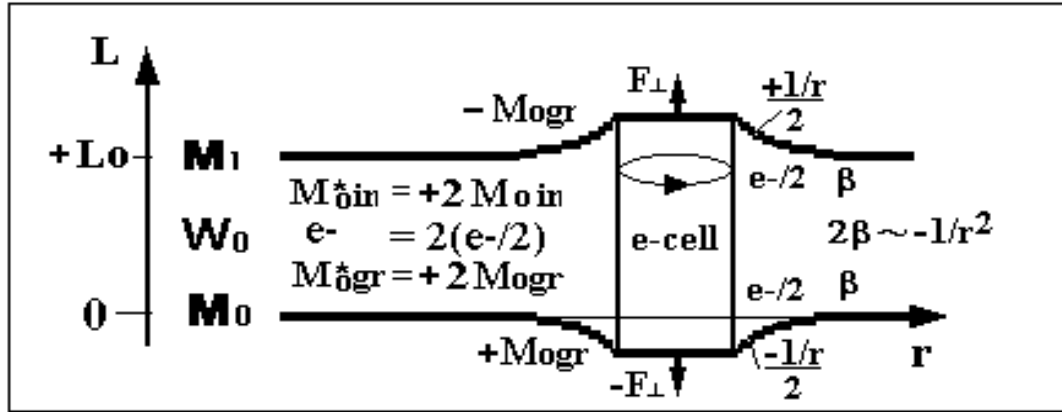

Fig. 3 shows the elementary electron 4D-vortex-quantum (topologically very thin toroidal ring) inside the 3D-waveguide $W_0=(x,y,z,0<L<L_{0e})$, built by two identical framing elastic 3D-membranes $M_0=(x,y,z,L=0)$ and $M_1=(x,y,z,L_{0e})$, whose small symmetric deformations create the exactly Newton/Coulomb double 2β -gravity potential $U\sim 1/r=2(1/2r)$ and the following double electrostatic charge potential $U\sim 1/r$.

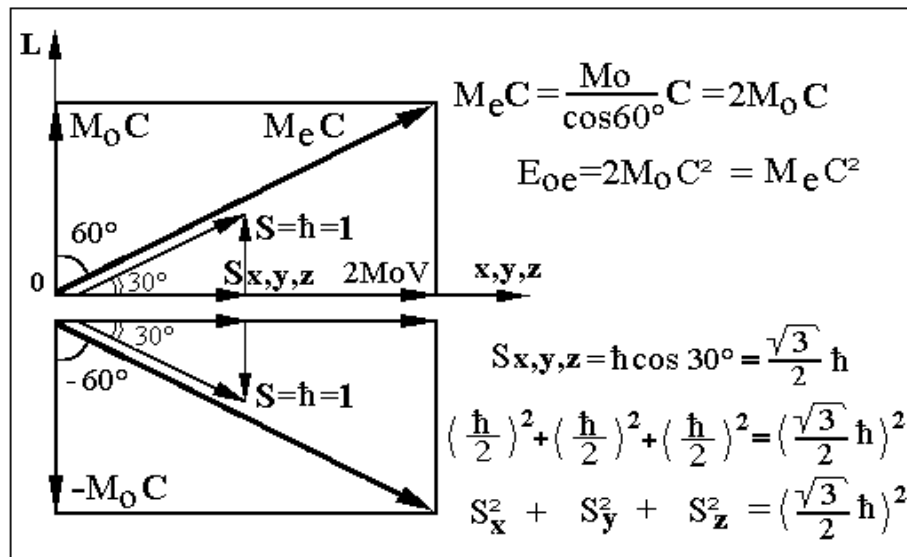

Fig. 3a shows the doubled relativistic - twisting “rest mass” momentum $P_4=M_eC=2M_0C_4$, arising in the most compact, co-phased/stable - twisting electron wave attractor, where its “resting” dynamical-relativistic “rest mass” energy is $E_{0e}=M_{in(e)}C_4^2=2M_{in(0)}C_4^2=2M_0C_4^2$ and momentum $P_L=\pm M_0C_4=const$, but common electron rest mass $M_e=2M_0$ is doubled-relativistic by the nature.

The natural minimal co-phased e -loop $2\pi R_{0e}$ must contain (in the non-relativistic frames) *only one* $\lambda_{deBroglie}$ length and according the equation (5c) $\lambda_{deBroglie}=\lambda_4/\sin\alpha$ we can write:

$$2\pi R_{0e}=\lambda_{deBroglie}=\lambda/\sin\alpha, \text{ where} \tag{10}$$

$$\sin\alpha=V/C_4=C_{||}/C_4=\sqrt{(C_x^2+C_y^2+C_z^2)}/C_4 \tag{11}$$

We could await here very small e -loop radius (as the minimal co-phased radius) $R_l \sim L_0 \sim 10^{-12}$ m. It is much smaller as, for example, the first electron orbit in the hydrogen atom - with correspondingly very small $\lambda_{deBroglie}$ and sufficiently relativistic 3D-speed-projection of e -wave rotation $V=C_{||}$, comparable to C_4 . It means that we must replace the non-relativistic $2\pi R_o$ loop length (10) using its *relativistic length-shortening* factor $\sqrt{(1-C_{||}^2/C_4^2)}$:

$$2\pi R_{oe} \sqrt{(1-C_{||}^2/C_4^2)} + \Delta l, \text{ where } \Delta l > 0. \quad (12)$$

This relativistically twisting e -wave will not be able to make closed co-phase wave of de Broglie in one (nonrelativistic) turn and *must twist two times* around the new minimal co-phased "relativistic" 2-loops-length for reaching closed, stable co-phased loop structure (12), with

$$2\pi R_{oe} \sqrt{(1-C_{||}^2/C_4^2)} + \Delta l \rightarrow 2\pi R_{oe} \sqrt{(1-C_{||}^2/C_4^2)} + 2\pi R_{oe} \sqrt{(1-C_{||}^2/C_4^2)}. \quad (13)$$

Obviously, the new minimal relativistic length $4\pi R_{oe(rel)}$ will be derived after the $360^\circ + 360^\circ$ double-loop twisting, if the $\sqrt{(1-C_{||}^2/C_4^2)} = 1/2$:

$$\sqrt{(1-C_{||}^2/C_4^2)} = \cos\alpha = 1/2 \rightarrow \sqrt{(C_4^2 - C_{||}^2)} = C_{\perp} = C_4/2, \quad (13a)$$

giving correspondingly - the double-loop with the relativistic co-phase condition (13):

$$\bullet \quad 2\pi R_{0e(rel)} + 2\pi R_{0e(rel)} = 4\pi R_{0e(rel)} = \lambda_{deBroglie} \quad \bullet \quad (14)$$

$$\bullet \quad R_{0e(rel)} = \lambda_{deBroglie} / 4\pi \quad (14a)$$

Now we derive important equation, using (5c): $\lambda_{deBroglie} = \lambda_4 / \sin\alpha$

$$R_{0e(rel)} = \lambda_4 / 4\pi \sin\alpha \quad (14b)$$

The relativistic co-phased result means that the twisting and periodically L_0 -reflecting co-phased wave vector C_4 has following twisting vector components:

$$C_4 = [C_L ; C_{||}] = [C_4/2 ; C_4(\sqrt{3}/2)] \quad (15)$$

and $\alpha = \pm 60^\circ$ in the derived *relativistic e-vortex* (Fig. 3a). The searched orthogonal spin S_{eL} of the vortex is:

$$S_{eL} = P_{e||} R_{0e(rel)} = (M_e C_{||}) R_{0e(rel)} = \pm M_e C_4 \sin 60^\circ R_{0e(rel)}, \quad (16)$$

where M_e is common relativistic "rest" mass of electron, twisting around its resting center mass and $M_e = 2M_0$. Using $R_{0e} = (h/4\pi)(2/\sqrt{3})/M_e C_4$ we derive S_{eL} being *invariant-independent* of the 3D-waveguide thickness L_0 :

$$S_{eL} = \pm M_e C_4 (\sqrt{3}/2) (h/4\pi)(2/\sqrt{3})/M_e C_4 = \pm h/4\pi. \quad (17)$$

According the Fig. 1.1 we derive the OL cross-sections of the twisting 4D-wave in the electron attractor, using corresponding relations for $\alpha = 60^\circ$:

$$\lambda_4 / 2L_0 = \lambda_4 / \lambda_0 = \cos 60^\circ = 1/2, \quad (17a)$$

$$\lambda_4 = 2L_0 \cos 60^\circ = 2L_0/2 = L_0 = \lambda_{e,Compton}, \quad (17b)$$

$$\nu = 2\nu_0 = 2(C/2L_0) = C/L_0 = C/\lambda_{e,Compton}. \quad (17c)$$

The corresponding twisting wave has frequency $\nu = 2\nu_0$ with paradoxically exactly *doubled relativistic inertial “rest” mass* $M_{in,rel} = 2M_0$, being at “rest” – as does its resting center mass, being in the center of the twisting electron attractor. The relativistic electron “rest” mass M_e is the measure of its dynamical “rest” energy $E_{in,rel} = M_{in,rel}C^2 = 2M_0C^2$ - it is exactly doubled, comparably to the vertical L -rest-mass component $M_L = M_0$ where $\alpha = 0$ and $M_{inL} = M_{oL}$;
 $E_{oL} = M_{oL}C^2$

$$M_{in(e)} = 2M_{oL} \quad (17d)$$

$$E_{oe} = 2M_{oL}C^2 = M_{in(e)}C^2 = M_eC^2 \quad (17e)$$

The 3D-radius $R_{0e(rel)}$ is derived for $\alpha = 60^\circ$ from the (14a) and $\lambda_{e,Compton} = h/M_eC$ as:

$$R_{0e(rel)} = \lambda_{deBroglie}/4\pi = \lambda_{e,Compton}/4\pi \sin 60^\circ = (2/\sqrt{3}) h/4\pi M_eC_4 \quad (18)$$

Note 1: The waveguided-emergent e -vortexes-particles physically behave exactly like contracted vibrated-dynamical *SPRINGS*, confined in the waveguide, on the contrary to the expanded - stretched *STRINGS*, postulated in the ST. Formally, the ST-string is here also “materialized” as expanded, vibrating \mathbf{W}_0 -waveguide’s thickness L_0 , looking roughly as one-dimensional-vibrating stretched ST-string! But the “truly physical sole” of the *spring*-like fermionic e -vortex is in the confined in it and forever vibrating C_4 -dynamical bosonic quasiparticle. More over, the L_0 -stretching is caused by the L -spring-pressure and resulting non-local symmetrical $\delta L_0(x,y,z) \sim 1/r$ deviations of two confining membranes \mathbf{M}_0 and \mathbf{M}_1 with the corresponding tiny, linear (x,y,z) -membranes extension, accumulating potential energy of the PWM-emergent-“materialized” gravity potential (see chapter “*The $\pm M$ -Gravito-Mechanical-Membrane Analogy*” below). So, we see that our global, very strongly tensioned, dividing 3D-membranes slightly look as very strongly tensioned ST-strings, but on the contrary, they are spatially endless objects – materialized quasiclassic potential fields - holders of non-local quasi-classical fields.

Note 2: It is common that a charged particle (electron) in the quantum field theory of Dirac experiences kind of common *Zitterbewegung* with frequency $\nu_0 = 4\pi M_e C^2/h = 1,6 \times 10^{21}$ Hz smearing out the charge over a region comparable to the Compton wavelength, as it was shown by Schrödinger (Schrödinger 1930). Now this radius gets its fundamental sense as the twisting “atomic” (near the electron Compton-length) radius in the $(e-/e+)$ cellular quantum superfluid (Gribov 1999, 2003, 2005, 2012, 2013a).

Note 3: The intrinsic magnetic moment of electron is $\mu_{Se} = -g_s \mu_{Be} S_e / (h/2\pi)$, where the $g_{s(Dirac)} = 2$, the Bohr magneton μ_B is defined in SI units as $\mu_{Be} = -eh/4\pi M_e$ and the electron spin is $S_e = h/4\pi$. Our 2 symmetrical magnetic “half-charges” realize two coaxial and symmetrical Diracian half-monopoles in the electron hole, living in the periodic Multiverse. The calculation gives the same Diracian equation for the intrinsic (here indeed $/-$ twisting by the nature) magnetic moment of electron:

$$\mu_{SL(e-holl)} \approx -2J_\perp R_{0e} = [-2(e/2)C_4(\sqrt{3}/2)][(2/\sqrt{3})h/4\pi M_eC_4] = -eh/4\pi M_e, \quad (18a)$$

where the electric loop-current $J_{(2 \text{ half-monopoles})} \approx -2(e/2)C_4(\sqrt{3}/2)$ and $R_{oe}=(2/\sqrt{3})h/4\pi M_e C$. This electron-current twists backward to the C - “mechanical” twist (electron spin) of the spinning electron attractor.

THE PWM-ANALOGUE TO THE KALUZA-KLEIN MASS TOWER

We have accounted the relativistic e-attractor radius $R_{oe(rel)}$ for the first L_0 -waveguide’s harmonics, according to common “effective theory” ideology – to the low energy limit for the electron-positron vacuum. We obtain for higher linear spectral frequencies in the L_0 -waveguide the correspondingly linear-quantized $M_k=kM_e$ mass spectrum with the same co-phase conditions, being analogue to the *Kaluza-Klein mass tower*, described below and keeping $\alpha = 60^\circ$. Here we obtain very important - the stepwise shortening of the “compactification” radius $R_{oe(rel)}$, since the new first-minimal co-phased loop condition will be derived naturally for the stepwise smaller k_e -attractor’s loops:

$$R_{k_{oe(rel)}} = R_{oe(rel)} / k \quad (19)$$

So quantized M_k mass-particles obtain very simple similar - electron-like 4D-hypercylindrical spatial structures, where the C_4 -wave $\lambda_k=\lambda_0/k$ is twisted (like a usual 3D-photon in the Maxwell electrodynamics) along the $R_{oe(rel)} / k$ curved, thin 3D-surface of these 4D-hypercylinders, arising in our 3D-e-waveguide. The M_k -attractor will have corresponding radius $R_k=R_{oe(rel)}/k$ keeping exactly the same initial fermionic spin $S_n=\pm h/4\pi$ properties! The minimal mass in this spectrum is required for the lightest elementary mass particle - electron, if $k=1$. The full electrostatic electron charge $Q_{e^*}=2Q_e$ is the e-hole charge Q_{e^*} which is $1/2$ -divided on two symmetrical M-membranes, framing this e-hole (Fig. 4.1, below). The e-hole gravity “charge” $M_{e(gr)}=2M_0$ is also $1/2$ -divided on these two symmetrical membrane’s gravity potentials, sufficiently including three surrounding waveguides bulks, constituting gravity potentials of the e-hole. The inertial (dynamical) “rest” mass $M_{e(inert)}=2M_0$ of the e-hole is sufficiently relativistic-doubled and exactly identical to the doubled gravity mass $M_{e(gr)}=2M_0$ of the hyperspatial e-hole.

We can identify some of the “mass tower” harmonics with the other elementary Standard Model particles (e.g. protons and neutrons, consisting of quarks), which *are allowed if they minimize electrostatic energy of the dominating (e-/e+) superfluid vacuum* - their electrostatic charge must be the opposite to the elementary charge of e-hole. They have assumingly similar 3D-hypertube’s form (with $\sim 1/k$ times smaller loop radiuses, $\sim k$ times bigger inertial mass, and the same fermionic spin $1/2$, described above).

THE PWM PREDICTS ANTIGRAVITY IN THE MATTER/ANTIMATTER GRAVITY TESTS AT CERN

Physicists created a real opportunity for *the first experimental, laboratory-made gravity examination*, based on the *neutral anti-hydrogen* atoms studies, being developed recently at CERN (see *ATRAP, ATHENA, AEGIS*, - research groups leading by G. Gabrielsen, R. Landua, Kellerbauer, G. Andersen, etc.), where enough cold *neutral antimatter* was created and deeply cooled (but not enough deeply yet, as it is necessary for the gravity measurements). This experiment allows “unthinkable” investigations of very tiny gravitational anti-hydrogen properties – under the tiny gravity of the Earth (AEGIS). Phillips wrote: “There has never been a direct measurement of the acceleration of antimatter in the Earth’s gravitational field. Several attempts have been made to measure g using charged antimatter, but these experiments have been stymied by the difficulty of shielding stray electric and magnetic fields to the degree required, as well as by the difficulty in obtaining an appropriate source of low-energy antimatter.

Using neutral antimatter for the measurement would vastly reduce the shielding requirements, but the problem of making and controlling the antimatter becomes more difficult” (Phillips 1997, p.357). The planned precision gravity measurement is mainly limited by enormously tiny antihydrogen temperature $T_H < 100\text{mK}$ needed, and this enormous limitation explains why it cannot be realized immediately in the AEGIS project.

Alban Kellerbauer recently wrote: “The primary scientific goal of AEGIS is the direct measurement of the Earth’s local gravitational acceleration g on anti-hydrogen. In a first phase of the experiment, a gravity measurement with 1% relative precision will be carried out by observing the vertical displacement of the shadow image produced by an anti-hydrogen beam as it traverses a Moiré deflectometer, the classical counterpart of a matter wave interferometer. In spite of its limited precision, this measurement will represent the first direct determination of the gravitational effect on antimatter.” (Kellerbauer et al. 2008, p. 351). “The principle of the equivalence of gravitational and inertial mass is one of the cornerstones of general relativity. Considerable efforts have been made and are still being made to verify its validity. A quantum-mechanical formulation of gravity allows for non-Newtonian contributions to the force which might lead to a difference in the gravitational force on matter and antimatter. Since it is widely expected that the gravitational interaction of matter and of antimatter should be identical, this assertion has *never* been tested experimentally. With the production of large amounts of cold antihydrogen at the CERN Antiproton Decelerator, such a test with neutral antimatter atoms has now become feasible” (ID, p. 351). These direct antimatter gravity investigations could (according our basic theoretical prediction) open a new - much more complete hypersymmetric page of modern physics and confirm one more time that the miracle - unpredictable Nature is always surprisingly reach and inexhaustible.

THE PWM-CONCEPT DISCLOSES “MYSTERY” OF THE ANTIMATTER “DISAPPEARANCE”

The PWM also naturally explains the mystery of the "disappearance" of antimatter - it does not disappear - the periodic waveguided antigravity between alternating (odd and even) Sub-Universes W_{2n} and W_{2n+1} has led to the large spatial cosmic separation of rare and huge - equal clusters of matter and antimatter in the process of expanding of the periodic PWM. This explains four very well verified cosmic phenomena, existing on the large scale in our Universe:

- (1) The cosmological phenomenon of DE - accelerated expansion of the Universe,
- (2) "Disappearance" of antimatter as repealing separation between symmetrically distributed matter and antimatter clusters,
- (3) Natural preservation of amazingly robust 3D-planar space geometry,
- (4) The mysterious foam-like – bubble-Universe structure of matter/antimatter distribution.

Indeed, the PWM always contains zero density of gravitational mass on the *large scale* Universe, or equal amounts of matter and antimatter in it, regularly distributed along very large quasi-spherical $\sim 2\text{D}$ -bubbles-surfaces. This equality assumption is in very good agreement with the theoretical-PWM-estimations of the ratio $DE/(DM+OM) \sim 74\%/26\%$, where the OM is the ordinary M_0 -matter of our W_0 -Universe and corresponds to the most recent observational data.

PERIODIC-COUPLED MATTER / ANTIMATTER e-CELLS / e-ANTICELLS IN THE PWM

John Wheeler and many other physicists assumed that the spacetime “continuum” must be discrete, according penetrating review of Phill Gibbs (Gibbs 1996). Indeed, the PWM-vacuum is considered as consisting of discrete, coupled electron-like “cells”, but in turn they are immersed into a more fine-grained mother-“continuum”. Wheeler also argued, the spacetime nature itself could be hidden in a more fundamental pregeometry (Wheeler 1980, 1994). Indeed, this “fundamental pregeometry” is also certainly disclosed in the presented waveguided PWM-structure. Our second *basic hypothesis* of the waveguide’s space design is the waveguide /anti-waveguide, i.e. literal physical (3D-space /3D-antispacetime) *division / adjustment*.

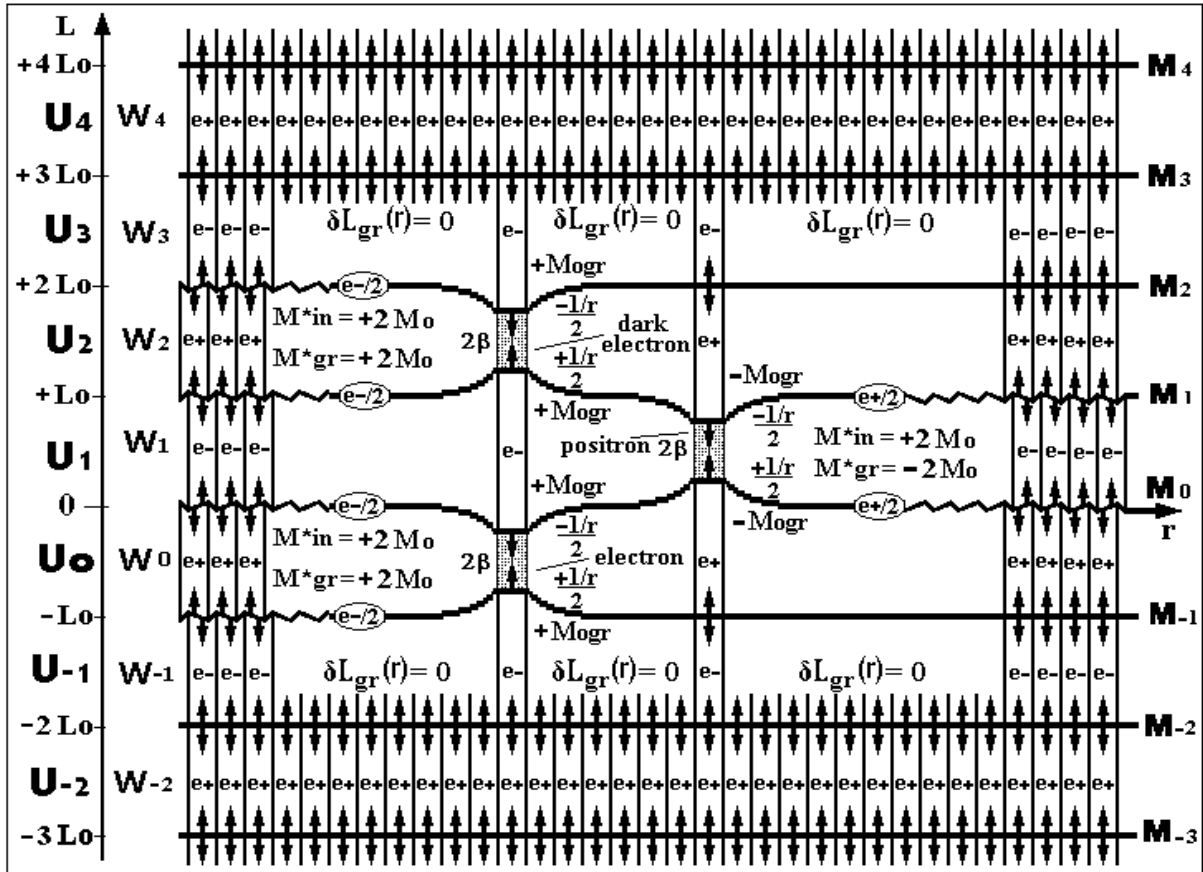

Fig. 4 shows schematically fragments of the L_{oe} -periodic 4D-space with endless number of quasiflat, adjusted and 3D-waveguides W_n , formed by the stretched quasiparallel 3D-membranes M_n ($n=0, \pm 1; \pm 2; \pm 3 \dots$). All waveguides are densely filled by intrinsically identical e -cells. Each even waveguide W_{2n} (by convention) contains monolayer of electron cells (e -cell), and each odd waveguide W_{2n+1} contains adjacent monolayer of positron cells (e -anticells), carrying the same dynamical energy $E_4 = M_e C_4^2 > 0$ and positive inertial mass $M_e > 0$. Each e -cell is coupled with its adjacent e -anticell, realizing weightless (composite-made) superfluid vacuum, built from (e^-/e^+) bosons. Adjacent monolayers W_{2n} and W_{2n+1} confine identical e -cells, which are strictly divided by the dividing joint membranes M_{2n} and cannot “annihilate” – but instead they are strongly - electrostatically pairwise coupled and build $2L_0$ -periodic coupled monolayers/anti-monolayers of scalar (e^-_{2n} / e^+_{2n+1}) bosonic “atoms” – *non-gravitating*, chargeless and spinless multilayered “grains” of the 3D-vacuum-superfluid at low T. Periodic matter and antimatter particles arise in the layered PWM-vacuum strictly symmetrically as e -holes and e -antiholes and are shown in three waveguides:

- (e_+)₀ hole (as e_0 electron - matter particle) in the W_0 waveguide of our U_0 -Universe;
- (e_+)₁ hole (as e_1 positron - antimatter) in the W_1 waveguide of the nearest W_1 -Antiuniverse U_1 ;
- (e_+)₂ hole as the nearest dark electron (as dark e_2 electron – matter particle) in the W_2 -waveguide of the Dark Matter W_2 -Universe U_2 .

It seems to be the easiest-natural way to realize (in the context of the proposed waveguided concept) the existing symmetrical properties of electron and positron and total physical equality of the matter and antimatter worlds. The potential anti-physicist will discover exactly the same physical laws as we do. The Newtonian attractive gravity force arises between mass particles in the same 3D-waveguide, but it is not possible to create exactly the opposite (the membrane-like) electrostatic electron and positron charges and gravity masses in the same waveguide, because they must have the opposite $\pm 1/r$ potentials. The proposed periodic space/antispacesymmetry with its global e -cellular structure allows not only to solve this nontrivial problem, but it opens principally new opportunities to understand the old basic physical laws and (that is much more interesting) to predict the significantly new physical reality – the Multiverse itself on its base (Fig. 4, above).

This new (periodic) space/antispacesymmetry naturally creates periodic $\pm M$ -gravity mass and \pm electrostatic charge symmetry for particle and antiparticle. The simplest - double-waveguide element of this structure is the $\pm L_{oe}$ doubled-waveguide's sandwich. It consists of two identical, symmetrical flat waveguides - $\mathbf{W}_0=(x,y,z,0<L<L_{oe})$ for *particles* and $\mathbf{W}_{-1}=(x,y,z,-L_{oe}<L<0)$ for *antiparticles* (Gribov 1999). This “minimal” $\pm M_{gr}$ hypersymmetry $|e-|e+|$ could be nearly associated with the similar symmetry, proposed by Paul Dirac in his great work, where he predicted positrons (Dirac 1930, 1931). We connect Diracian $\pm M$ symmetry for particle/antiparticle only with the common electrostatic charge $\pm Q_{el}$ & gravity “charge” symmetry $\pm M_{gr}$, depending of the waveguide's number (the \mathbf{W}_{2n} waveguides confine $+M_{gr}$ electrostatic charge of antielectron). All the opposite $\pm M_{gr}$ elementary gravity charges have the same – positive elementary inertial masses $M_{inert}=\pm M_{gr}>0$ as positive quantity of the C_4 -dynamical energy, “pumped” into these intrinsically absolutely identical (SM-like) quasiparticles, cloned in the PWM-Multiverse (Gribov 2012, 2013a). The positively signed inertial-relativistic mass $M=M_{in}$ is used, indeed in the famous Dirac's dynamical equations, describing electron and positron, where only their electrostatic charges are the opposite.

This new (periodic) space/antispacesymmetry naturally creates periodic $\pm M$ -gravity mass and \pm electrostatic charge symmetry for particle and antiparticle. The simplest - double-waveguide element of this structure is the $\pm L_{oe}$ doubled-waveguide's sandwich. It consists of two identical, symmetrical flat waveguides - $\mathbf{W}_0=(x,y,z,0<L<L_{oe})$ for *particles* and $\mathbf{W}_{-1}=(x,y,z,-L_{oe}<L<0)$ for *antiparticles* (Gribov 1999). This “minimal” $\pm M_{gr}$ hypersymmetry $|e-|e+|$ could be nearly associated with the similar symmetry, proposed by Paul Dirac in his great work, where he predicted positrons (Dirac 1930, 1931). We connect Diracian $\pm M$ symmetry for particle/antiparticle only with the common electrostatic charge $\pm Q_{el}$ & gravity “charge” symmetry $\pm M_{gr}$, depending of the waveguide's number (the \mathbf{W}_{2n} waveguides confine $+M_{gr}$ electrostatic charge of antielectron). All the opposite $\pm M_{gr}$ elementary gravity charges have the same – positive elementary inertial masses $M_{inert}=\pm M_{gr}>0$ as positive quantity of the C_4 -dynamical energy, “pumped” into these intrinsically absolutely identical (SM-like) quasiparticles, cloned in the PWM-Multiverse (Gribov 2012, 2013a). The positively signed inertial-relativistic mass $M=M_{in}$ is used, indeed in the famous Dirac's dynamical equations, describing electron and positron, where only their electrostatic charges are the opposite.

The e -holes are identical-elementary e -cellular defects (a little bit like single defects in crystals, but different, because dividing membranes are *missed* in crystals), these defects are decoupled broken ($e+/e-$)-atoms, their decoupling breaks the total ($e+/e-$) vacuum symmetry and creates simultaneously elementary gravity and electrostatic potentials/anti-potentials – global $\sim \pm 1/r$ deformations, arising around these defects and anti-defects in vacuum. The electron and the dark electron have the *half-overlapped* gravity potentials (created by the intermediate waveguide \mathbf{W}_1 , which creates layered \mathbf{W}_1 -gravity potential, mutual for the electron and for the dark electron).

But their electrostatic potentials are reciprocally totally isolated – are hyperspatially *not* “overlapped” – because they are created by (x,y,z) -polarization - reciprocal $\sim 1/r^2$ displacement of the L -coaxial $(e-/e+)$ -atoms, acting and sensible *only* in the corresponding \mathbf{W}_0 and \mathbf{W}_2 waveguides (where these e -holes are located). These electrostatic polarizations corrugate two membranes (\mathbf{M}_{-1} and \mathbf{M}_0) around e_0 -electron, accumulating its electrostatic field energy, but the dark e_2 -electron already corrugates two other membranes (\mathbf{M}_1 and \mathbf{M}_2) - these two particles are now electrostatically isolated – dark to each other! So, the electron and dark electron physically interact only half-gravitationally, but are strictly “isolated” electrostatically, as the DM indeed does. The e_1 -positron *interacts equally gravitationally and electrostatically* with the e_0 -electron and the dark e_2 -electron and can be a perfect *mediator* for the electrostatic and electro-dynamical interaction between our matter Universe \mathbf{U}_0 , and the DM-Universe \mathbf{U}_2 (Gribov 2012, 2013a).

THE SPACE / ANTISPACE SYMMETRY MODIFIES THE EQUIVALENCE PRINCIPLE

The proposed division between gravity and inertial mass of the elementary antiparticle breaks the common Einstein’s Equivalence Principle (EP): indeed, it is now possible to detect outside gravity field in the freefalling (matter) laboratory by testing the positron gravity anti-acceleration in this laboratory. The free falling positron (or antihydrogen, etc.) will be *accelerated exactly in the opposite to the electron* direction in the same gravity field and so, the freefall-acceleration of the laboratory will be easily disclosed (see Fig. 2b). We could see above that the Einstein’s EP is not the axiomatic principle anymore – it becomes the straight one consequence of our quantized waveguided gravity concept. Fundamental Einsteinian EP becomes now limited and is correct only in two symmetric cases - for matter/matter *attractive* gravity or for antimatter/antimatter *attractive* gravity, but matter/antimatter combination creates a kind of the “anti-EP principle” – assuming the opposite – *repulsive* gravity acceleration for matter and antimatter in the same gravity field (Fig. 2b).

NEW RELATION BETWEEN GRAVITY MASS AND INERTIAL MASS IN THE PWM

The initially proposed - Diracian $\pm M$ symmetry was sharply criticized and even strictly forbidden in physical community, as, for example, a “perpetual mobile” (but indeed, this critics is totally right only for the inertial mass M_{in}). The $\pm M_{gr}$ gravity “charge” symmetry for particles and antiparticles, arising in our periodic waveguided concept, has very good general cosmological *DE&DM&SUSY* supports. Till now there *was no any direct experimental confirmation* for the negative/or the positive gravity mass for the antiparticle in laboratories – it remains assumingly the biggest “open experimental questions” in physics. Why? It is extremely difficult to realize the appropriate antiparticle’s gravity test. The best opportunity is connected with the neutral antihydrogen gravity test at CERN, which uses deeply cooled neutral antihydrogen atoms.

Our principal difference with the famous Dirac’s proposal is following - we strictly distinguish gravity mass from inertial mass of the same antiparticle: Inertial (dynamical by the nature) mass M_{in} of the particle and antiparticle are the same – positive, as the absolute temperature $T > 0$, or kinetic energy. The inertial masses equality expresses their identical dynamical nature ($M_{in} > 0$). Dirac never distinguished gravity mass and inertial mass, (following the Einstein’s gravity theory). Indeed, his equations need always only inertial mass of involved particles – electrons or positrons and so have no formal discrepancy with the Einstein’s positive mass concept.

We can always keep the $M_{in} > 0$ in all dynamical equations without gravity interaction, but the sign of gravity charge depends of the “above/bottom” sides \pm pressure on the same dividing

membrane \mathbf{M}_0 , changing the pressure sign $\pm F_{\perp}$, since electron and positron press the dividing membrane from the opposite sides and create the opposite gravity potentials – the mirror-like deformations of the same dividing membrane \mathbf{M}_0 (Fig. 4).

THE COMPOSITE SUSY_{PWM} NATURE – THE GHOSTLY COOPER-LIKE COMPOSITE VACUUM

Supersymmetry (SUSY) is so promising theoretically, but is always missing experimentally. Steven Weinberg dedicated his III-th volume of “*The quantum theory of fields*” to supersymmetry and noted the supersymmetric theories of fields have unique physical properties, missing in other field theories, but “unfortunately, after a quarter century there is no direct evidence for supersymmetry, as no pair of particles related by a supersymmetry transformation has yet bin discovered. There is just one significant piece of indirect evidence for supersymmetry: the high-energy unification of the $SU(3)$, $SU(2)$, an $U(1)$ gauge couplings works better with the extra particles called for by supersymmetry than without them” and many other physicists, including Steven Weinberg “are reasonably confident that supersymmetry will be found to be relevant in the real world, and perhaps soon.” (Weinberg 2000, p. XVI). Supersymmetry could solve the fundamental problem of very small cosmological constant in the QED vacuum. Cosmologist Ta-Pei Cheng writes: „The introduction of the cosmological constant Λ in the GR field equation does not explain its physical origin.“ (Cheng 2005, p. 280). In the inflation model it represents the false vacuum energy of an inflation/Higgs field. However, the quantum vacuum “zero-point” energy density $\rho_{vac}=2 \times 10^{91} \text{g/cm}^3$ is too large ($\sim 10^{124}$) for Λ . This is the tremendous quantum vacuum problem, surprisingly deeply contrasting with the excellent - the most precious theoretical QED predictions.

The wave function of bosons/fermions is symmetric/antisymmetric and the bosonic quantum vacuum energy is positive, but the fermionic vacuum energy is negative. This fundamental theoretical fact led to common salvatory hypothesis of the “supersymmetry”, reducing the monstrous 10^{124} discrepancy, equalizing somehow the bosonic and fermionic degrees of freedom, so that resulted summary vacuum energy will vanish to the experimentally proofed zero level (Gol’fand, Likhtman 1971; Wess, Zumino 1974). All existing supersymmetric theories pair known bosons with unknown fermions and known fermions with unknown bosons. These ways were invented new necessary supersymmetric particles partners – “sparticles”: for example, for electron must exist a ”selectron” with the same electron mass but with zero spin, etc. Unfortunately, these hypothetical supersymmetric partners were never detected experimentally and this very surprising obstacle led to an additional rescue idea that the supersymmetry is yet real, but it is somehow broken at low energies and exists at higher energies - above the achieved on the best colliders. Cheng estimates these hypothetically “broken” supersymmetric corrections - they reduce the monstrous zero-vacuum energy fare not enough - from 10^{124} to about 10^{80} . “Clearly, something is missing in our understanding of the physics behind the cosmological constant.” (Cheng 2005, p.282).

We introduce this laterally “missing” physical piece”, since our hypersymmetric vacuum concept has own *supersymmetric ghosts composites* for each arising virtual electron / positron pair – existing in the form of the supersymmetric scalar ($e-/e+$) composite with exactly the same double *inertial mass* $2M_{e.in}$, as its defect - two virtual (e_-) and (e_+) fermions! The natural microscopic equilibrium between the ($e-/e+$)-coupled and virtual-decoupled (e_-); (e_+) pair states vanishes their contribution to the zero-vacuum energy to zero! We remember that the summary gravity masse of the ($e-/e+$) composite particle is zero, as it is also with the summary gravity mass of the decomposed virtual pair. Hence, our very dense quantum vacuum medium – the ($e-/e+$) superfluid is nongravitating! This way the supersymmetry is reincarnated, but absolutely

without need in exotic elementary s -particles – on the Cooper-like “composite” base, composing them from the “old” elementary particles family. We find here surprisingly simple, and at the same time basic argument, solving the monstrous “ 10^{124} ” problem, surviving the QED & SM and strongly supporting our hypersymmetrical (e^-/e^+)-atomistic, superfluid PWM-vacuum concept. For example, a decoupled virtual quark/antiquark pair, like u and \bar{u} , also could have its supersymmetric Cooper-composite – the coupled (u/\bar{u}) bosonic pair, etc. We can exchange all the s -particles by the corresponding Cooper-composites from existing fermions and antifermions! It becomes physically understandable, why super-symmetrically arranged Feynman diagrams contain many component-field diagrams, which rise to miraculous cancellations of divergences.

K. Moriyasu writes very similarly about common Higgs field: “In the Weinberg-Salam theory, the Higgs field is analogous to an old-fashioned “aether” which pervades all space-time. It acts like a continuous background medium even at very short distances. ... We saw in the case of the superconductor that the Higgs field was a composite system of electrons bound into Cooper pairs. ... Could the Higgs field for the WS theory also be a composite system of bound particles? Unfortunately, the analogy with the superconductor breaks down because there is no background atomic lattice in the WS theory to provide the binding force.” (Moriyasu 1983, p. 120). Gerard ‘t Hooft also mentioned the *composite* possibility for the other scalar particles – the Higgs bosons: “...similar to the so-called Cooper pairs of bound electrons that perform a Higgs mechanism in ultracool solid substances, leading to superconductivity. Just because such phenomena are well known in physics, this is a scenario that cannot easily be dismissed” (‘t Hooft 1999). Now we can say that this physically well thinkable (PWM-composites) scenario indeed exists and looks realizable and fruitful – as the much more robust, absolutely physically necessary *weightless* “low energy analogue” to the abstract “background atomic lattice”. It arises naturally in the proposed concept of the periodic waveguide’s hyperspace, etc. where very simple and very strong - electrostatic binding mechanism creates periodic scalar (e^-/e^+) field as the superfluid condensate, consisting of very stable “ghost” (e^-/e^+) composites, reanimating exactly the “ether-like” - atomistic vacuum (the “background atomic lattice in the Wess-Zumino theory”, now built from the well known basic particles - elementary fermions/antifermions (leptons/antileptons and quarks/antiquarks). This way is created the exactly PWM-supersymmetric QED-vacuum system, being nongravitating, with the resulting zero vacuum energy density! So, our periodic 3D-waveguide’s concept proposes clear physical base, deepening (and possibly, after some next steps of the PWM-concept development, natural exchanging) of common Higgs field theory. Indeed, the PWM-concept allows the unifying and consistent - the waveguided mass creation mechanism with Cooper-like electron/positron composites and unthinkable before summary zero gravity “charge”, electrostatic charge and spin. The first CERN-results on supersymmetry from Large Hadron Collider (LHC-2010-2011) did not find sparticles - heavy copies of the SM particles and common SUSY theory falls in deep “troubles” with less and less hopes to be through. Indeed, ATLAS and CMS independently exclude such “sparticles” with masses less than roughly 900 GeV. But on the contrary, the miracle Cooper-like composites, arising in frames of the periodic Multiverse concept, survive and reincarnate the “illusive” SUSY, and properly explain steady experimental absence of the searched elementary (now *basically ghost*) sparticles • composite scalar bosons.

Why we (made of elementary defects) cannot test them experimentally in the PWM? This is may be the trickiest story in the elementary particle physics. It looks like a joke of God, mystifying his intelligent-creative creatures, trying to understand his miracle physical world. Why we cannot find them? The answer is very easy – the “wanted” ghost’s composites are not any more independent single objects in the cellular quantum medium – they become immediately incorporated coherent parts in the restored vacuum celled body - being for us a holistic, coherent quantum “emptiness”! These coupled composites are simply *non-sensible for our physical devices* (devices being made of the cellular defects). This strange story remembers the old tale

about a “naked king” – his miracle physical clothiers look like our “ghost” (e^-/e^+) ether – as very-very light medium, so light that it becomes totally invisible! (Gribov 2005, 2012, 2013a,b).

This was may be hidden intuitive reason, why young Einstein rejected the idea of ether, reasoning that we don't need this hypothesis for the self-consistent SR. He concluded that inability to detect absolute motion relatively the hypothetical ether means that it is fundamentally undetectable and theoretically could be excluded from the theory. Later he returned back to its physical possibility and “naive” Dirac even filled our space with the hypothetical electron sea, considering positron as electron hole in it! Historically it became may be the most controversial, difficult question for its constructive physical understanding and development. The best physicists were always very near to this difficult topic (Lorentz, Einstein, Dirac, SUSY-authors, etc.), but its physical sense was always escaping, laughing as a “ghost” clown about never-ending human blindness!

Notes: 22-27, August 2011 was the Lepton-Photon Conference in Mumbai, India. Leading physicists discussed the latest results from the CERN's collider, showing a confusing lack of supersymmetric particles. Jordan Nash was disappointed, as many other physicists working on one of the LHC's experiments, about the lack of the supersymmetric (SUSY) sparticles: "The fact that we haven't seen any evidence of it (SUSY) tells us that either our understanding of it is incomplete, or it's a little different to what we thought - or maybe it doesn't exist at all,". (Nash 2011, p.1). Physicist Joseph Lykken of the Fermilab notes: the SUSY is “a beautiful idea” , "It could be that this whole framework has some fundamental flaws and we have to start over again and figure out a new direction,". (Lykken 2011, Id., p.1). George Smoot, Nobel prizewinner for his work on the cosmic microwave background says: "Supersymmetry is an extremely beautiful model", "It's got symmetry, it's super and it's been taught in Europe for decades as the correct model because it is so beautiful; but there's no experimental data to say that it is correct." (Smoot 2011, Id., p. 1).

The «playing hide-and-seeK” SUSY seems to be not only extremely beautiful “model”, it has a lot of humor – being virtuously survived and hidden by a tricky turn into the Cooper-like “ghostly” PWM-composites. This looks so simple and salvatory for the QED& QFT and the SM, but it is too difficult to grasp theoretically – being in the frames of the old physical paradigm of vacuum and particles in it. One of the deepest philosophers and historians of science - Thomas Kuhn was very right, assuming (unconscious - dictatorial collective-psychological) power of actual paradigms in science. A “*Paradigm shift*” (or revolutionary science) is, according Kuhn, a change in basic assumptions, or paradigms, within the ruling theory of science. Kuhn compares the ancient Aristotle's physics with the Newton's one and concludes that the Aristotle's physics is not a “bad Newton”, just different. (Kuhn 1962). Kuhn quotes Max Planck, who sadly noted: “A new scientific truth does not triumph by convincing its opponents and making them see the light, but rather because its opponents eventually die, and a new generation grows up that is familiar with it” (Id p. 150). But we can be much more optimistic today than as great Max Planck was, because in 2-3 years the relatively very cheap, but very difficult CERN-antihydrogen "decelerating " experiments (staying fare aside of the “accelerating” - mainstream physical interests and grandiose LEP-costs) will stress (as we have precisely predicted in the PWM-concept) the deepest paradigmatic revolution in the theory of gravity and Universe after centuries since Newton and Einstein, if the antigravity between matter and antimatter will be detected. The periodic PWM-gravity/antigravity has yet very strong observational-cosmological support - it is very well verified by the consistent explanation of the *DE&DM*-phenomena in the PWM-cosmology – where “*GRAVITY-ANTIGRAVITY TEST*” is going on billions of years “on the large-scale Universe/Multiverse, where matter and antimatter play the completely equal role.

NAIVE UNIFICATION GRAVITATIONAL AND ELECTROSTATICS FORCES IN THE PWM

The $\pm Q$ -Electro-Mechanical-Membrane Analogy (EMMA)

R. Feynman showed that surface of a thin, elastic-stretched two-dimensional flat (x,y) -membrane with very strong surface tension $\tau=const$, works as the excellent *geometrical analogy* to \pm electrostatic potential $U_{el}(x,y)$ – expressed by tiny static membrane L -deviations $\delta L(x,y) \sim U_{el}(x,y)$ from its flat state $L(x,y)=constant$ (Feynman, et al 1966, v.2/5 p. 243-246). The orthogonal mechanical force $f_{\perp}=f_L$ is the exact analog of \pm “electrical charge” (if we imagine two cylindrical pencils with radius R_o , pressing the (x,y) -membrane surface from its opposite sides with the same force $\pm f_{\perp}$). The $\pm Q$ charges (and $\pm U$ potentials) are realized by the opposite $\pm f_{\perp}$ pressure, oppositely deforming this membrane, (Fig. 5).

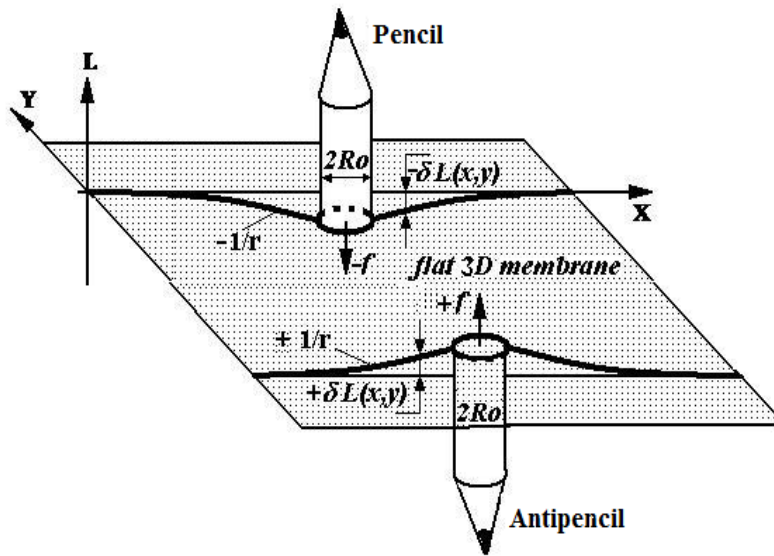

Fig. 5 shows the “electromechanical membrane analogy” with visualized charge-anticharge (as mechanical pencil - anti-pencil pressures), described by Feynman. It obtains the fundamentally important physical sense in the 3D-wavguided-membrane $\sim 1/r$ gravity, including periodic waveguide/antiwaveguide 4D-space architecture, containing periodic matter/antimatter particles.

If δL deviations are tiny, $\delta L(x,y) \approx 0$, the membrane surface tension $\tau(x,y) \approx const$ and we derive, according Feynman (Feynman et al 1966, v.2/5 p. 243-246), common physical equation

$$\nabla^2 \delta L(r) = -f_{\perp} / \tau \quad (20)$$

It is the exact analog of electrostatic potential $\pm U(r)$ for charge $\pm \rho / \epsilon_o$, in the equation

$$\nabla^2 U = -\rho / \epsilon_o, \quad (21)$$

(Id. p. 245). This deviation corresponds to the electrostatic potential $U \sim \ln(1/r)$ of a regularly charged endless cylindrical rod with the radius R_o . Feynman notes: “Distortions of a three-dimensional elastic body also are governed by similar equations, but we will stick to the two-dimensions.” (Id p. 245). Other words, the equation (20) will be the same also in the case of the 3D-membrane, realizing now deformation of the thin, tensioned-flat 3D-elastic membrane (immersed into the Euclidean 4D-space (x,y,z,L) , being now the 3D-EMMA analogy to the Newtonian 3D-potential $U \sim 1/r$ of a charged sphere with radius R_o . Feynman never developed the 3D-EMMA, what incorporates gravity into the whole physics and allows understanding of gravity and electrostatic potentials similarity (Gribov 2005). Thus, now we generalize very

important hyper-symmetrical 3D-membrane's analogy, exactly mimicking the Newtonian gravity/Coulomb-electrostatic potentials $\sim 1/r$ as tiny hyperspatial $\delta L(x,y,z)$ -deviations of the initially flat 3D-membrane:

$$\delta L(x,y,z) = \delta L(r) \sim \pm 1/r, \quad (22)$$

corresponding to the 3D-potential of a regularly charged sphere with, e.g., the form-factorized radius $R_o=R_{oe}$. Here arises the further fundamentally important feature – this visualized “gummy” potential has no classical singularities $U(r=0)=\pm\infty$ at all, since the $R_{oe}>0$: we have $\delta L(r)=\pm 1/r$ for $r\geq R_o$ and it is strictly constant in the small flat area $0\leq r\leq R_o$.

$$U(0\leq r\leq R_o) \sim \pm 1/R_o = \delta L(0\leq r\leq R_o) = constant \quad (23)$$

The $\pm M$ -Gravito-Mechanical-Membrane Analogy (GRAMMA)

The described above electro-mechanical-membrane analogy (EMMA) has the straight *geometrical* correspondence to the gravity potential, arising in our L_{oe} -waveguide, shaped by two parallel, tensioned elastic 3D-membranes (Gribov 1999, 2005). The identical 3D-waveguides in the proposed periodic waveguide's hyperspace are divided by their parallel, tensioned flat 3D-membranes $(x,y,z,nL_{oe})=\mathbf{M}_n$, where $n = 0, \pm 1, \pm 2, \pm 3\dots$ (Fig. 4.1). So, the 3D-membrane $(x,y,z,L=0)=\mathbf{M}_0$ strictly divides two adjacent \mathbf{W}_{e+} and \mathbf{W}_{e-} waveguides in our periodic waveguided hyperspace, where our Universe is mapped-centered in the \mathbf{W}_0 -waveguide. Very small L -deviations $\pm\delta L(x,y,z)\approx 0$, resulting from $f_{\perp}=\pm f_L$ acting on these 3D-membranes, create corresponding gravity/antigravity potentials $\pm U_{gr}(x,y,z)$, being now physically “materialized” as slightly \pm curved membranes surfaces, according to the equation (8):

$$U_{gr}(x,y,z) \approx \pm\delta L(x,y,z)C_4^2/L_{oe}, \quad (24)$$

This miracle GRAMMA/EMMA-correspondence allows connection the both - Coulomb-electrostatic and Newton-gravity potentials nature with the same source - the Newton-like middle 3D-membrane deviations $\pm\delta L(x,y,z) = \pm\delta L(r) \sim \pm 1/r$. The universal sense of the proposed 3D-membrane-like gravity mechanism arises in the periodic waveguided space from the linear $\pm\delta L(r)\approx 0$ GRAMMA-analogy. In the linearity of “near zero”-deviations is hidden the hyperspatial physical nature of the 3D-Poisson equation and corresponding *superposition principle* in the “Poisson” physics. Notably, the GRAMMA/EMMA open reasonable physical legitimacy for the simultaneous electrostatic charge $\pm Q$ and gravity “charge”=mass $\pm M_{gr}$ symmetry in our periodic electron/positron space/antispaces (Gribov 1999, 2005). Free electron ($e-/l\dots$) or positron ($\dots/e+$) arise in the ($e-/e+$) cell as absence of the opposite fermionic partner – as the e -hole in the opposite-adjacent anticell side, that creates a local cellular symmetry break with resulting global deformations of the whole e -cellular vacuum medium, realizing the *geometric-dynamic gravity mass = gravity charge* with its tiny gravity potential $U_{gr} \sim \pm 1/r$, applicable for very small membranes deviation ($\beta\approx 0$). This “defected”=asymmetric e -cell creates the doubled orthogonal gravitational pressure $2f_{\perp}=\pm 2(hv_{oe}/L_{oe})=\pm 2M_{oe}C^2/L_{oe}$, breaking full hypersymmetry in the e -cellular vacuum (see Fig. 4.3d,e). We remember that the *inertial mass* of identical electron or positron e -cells is at the same time always positive (independent of a 3D-waveguide's number in the periodic 4D-Multiverse) and is measure of the C_4 -dynamical energy $E_4>0$, identical in all e -cells, filling the Multiverse. But membranes deformations and corresponding gravity potentials have the opposite \pm signs, changing L_{oe} –periodically in the global 4D-Multiverse.

Note: Famous Soviet physicist Jurij Rumer, friend of Lev Landau, who spend many years in Gulag prisons, noted about the GR: “Theory of gravity could never provide a satisfactory answer to the question – how do gravitating matter bends space in which it is localized” (Rumer 1956, p. 29). The discussed above periodic, hyperspatial *waveguide’s nature* of gravity/antigravity explains this space-bending machinery and, moreover – the (quantized) equivalence principle itself naturally arises as consequence in the described above elastic 3D-membrane deformation under the L -hyperspatial (x,y,z) -orthogonal wave-particle pressure f_{\perp} .

The geometrodynamical nature of the gravity energy of electron

We can account exact geometrical characteristics of the surely $\sim 1/r$ gravity potential form if we compare our waveguide’s gravity potential of electron $U_{e(gr)} = \delta L(r)C^2/L_{oe} \sim 1/r$ with the Newton gravity potential equation, containing its empirical gravitational constant G :

$$U_{e(gr)}(r) = -GM_{oe}/r = \delta L_{e(gr)}(r)C^4/L_{oe}, \quad (25)$$

where the $\delta L_{gr}(r)$ is a tiny deviation of the waveguide thickness L_{oe} , and G is the gravitational constant, C -speed of light, $L_{oe} = \lambda_{e.Compton} = h/2M_{oe}C = h/M_e C_4$

Thus, the 3D-membrane deviation $\delta L_{gr}(r)$, corresponding to the gravity potential of electron, if we remember that $M_{oe}C^2 = hv_{oe} = hC/2L_{oe}$ and use the (25), is following:

$$\delta L_{gr}(r) \equiv U_{e(gr)}(r) = -GM_{oe}L_{oe}/C^2r = -Gh / 2C^3r. \quad (26)$$

Now it includes combination of three fundamental physical constants, gracefully unifying special relativity with the quantum physics and Newton’s gravity. We can easy derive the *finite* - minimal potential value for electron $U_{e-min} \equiv U_{oe(gr)} = U_{e(gr)}(r=R_{oe(rel)})$ which has its flat bottom potential $U_{oe(gr)}$ within the interval $0 < r < R_{oe(rel)}$ without any singularity at $r=0$:

$$U_{oe(gr)} = -2\pi GM_{oe}/C^2 = -Gh / 2C^3 R_{oe(rel)} = const, \text{ if } 0 < r < R_{oe(rel)}, \quad (27a)$$

$$U_{oe(gr)} = -2\pi G(\sqrt{3}/2) h / C^3 \lambda_{e.Compton} = -2\pi G(\sqrt{3}/2) M_e / C^2 \quad (27b)$$

thus, the $U_{oe(gr)} \approx -3,68 \times 10^{-55}$ cm for electron and *without* gravity potential singularity. This deviation $U_{oe(gr)}$ is so tiny, that the relation $\delta L_{e(gr)}(r)/L_{oe} \approx 10^{-55}/10^{-10} \approx 10^{-45}$. It is interesting also to note, that the $U_{oe(gr)}$ is very near to the GR-Schwarzschild radius of electron:

$$R_{e(Schwarzschild)} = 2GM_e/C^2 = -U_{oe(gr)} / (\pi\sqrt{3}/2), \quad (28)$$

but it is only the tiny deepness of electron “immersion” into the 4-*th* dimension! Thus, singularity-less elementary particles cannot build tiny Black Holes; physical conditions for their creation arise mostly in very dense neutron stars (see corresponding chapters below).

$$\delta r_{oe(gr)} \approx (1/2)\beta_{e(gr)}^2(r)dr \quad (29)$$

The very-very tiny maximal membrane deviation $U_{oe(gr)}$ simply does not change the basic cophased waveguide’s condition $v_{oe} = C/\lambda_{oe} = C/2L_{oe}$ and its “resting” mass $M_{oe} = h/2L_{oe}C$ is *practically the same*. The additional local 3D-membrane extensions $\delta r_{oe(gr)}$ are connected with a small membrane deviation from the parallelism on an very small angle $\beta_{e(gr)}(r) \approx dU_{e(gr)}(r)/dr \approx 0$, and is approximately, (see the corresponding triangle, Fig. 7):

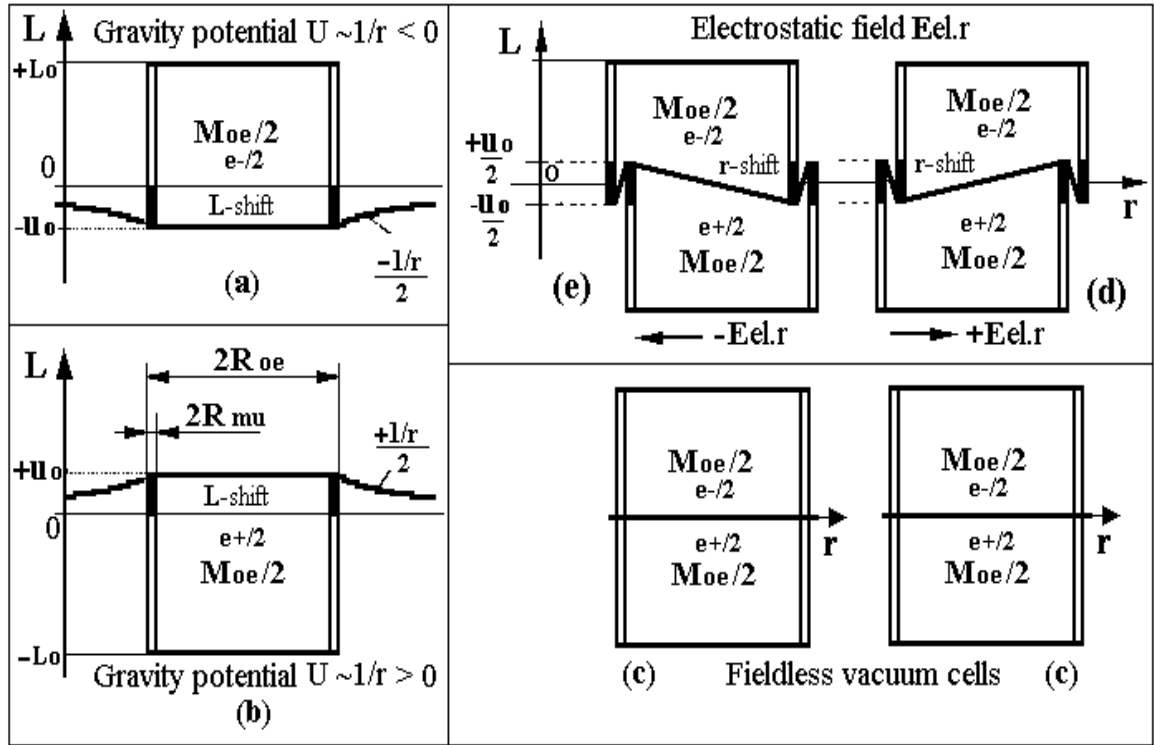

Fig. 6a shows a negative deviation of the middle membrane $L=0$ (its gravity deviations), creating the half of the gravity potential $U_{gr}(r) \sim -1/2r$ of the electron-cell, as result of a symmetry break of reciprocal L -forces, creating by the excluded positron-cell below.

Fig. 6b shows the opposite - positive deviation of the middle membrane $L=0$, creating half of the waveguide gravity potential $U_{gr}(r) \sim +1/2r$ of positron, caused by excluded e -hole above. We assume that the e -vortex has its very thin wall thickness $\sim 2R_{o\mu}$ - as the minimal granular size of the (femto-metric $\approx 10^{15}$ m) in the μ -cellular (μ^-/μ^+) vacuum structure - a kind of more fine quantum (μ^-/μ^+) femto-superfluid, filling all the periodic L_{oe} -waveguides bulks.

Fig. 6c shows zero gravity potential $U_{gr}(r)=0$ for the ideal coupled (e^-/e^+) pair.

Fig. 6d,e show r -symmetry breaking polarization ($\pm r$ -shifts) inside the (e^-/e^+) vacuum cells, causing by the gravity (L_o -membranes non-parallelism), that creates the opposite $\pm E_{el,r}$ electrostatic fields (expressing the local electrostatic L_{oe} -membrane tension).

The additional local 3D-membrane extension $\delta r_{oe(gr)}$ is connected with a small membrane deviation from the parallelism on a very small angle $\beta_{e(gr)}(r) \approx dU_{e(gr)}(r)/dr \approx 0$, and is approximately, (see triangle, Fig. 7):

$$\delta r_{oe(gr)} \approx (1/2)\beta_{e(gr)}^2(r)dr \quad (29a)$$

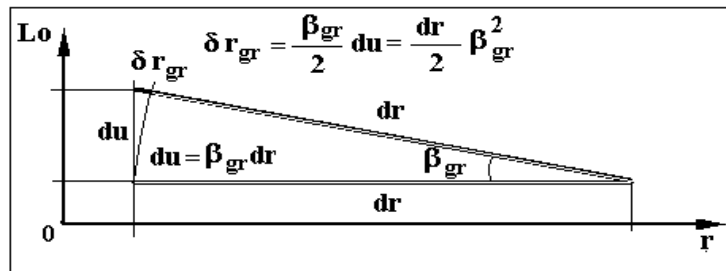

Fig. 7 shows a smooth gravitational membrane extension δr_{gr} for small $\beta \rightarrow 0$ in comparison to its flat length dr , going parallel to the coordinate axes or .

This angle $\beta_{e(gr)}(r) \approx 0$, it can be derived from the $1/r$ membrane deviation form, using corresponding empirical gravity potential value $U_{e(gr)} = -GM_{oe}/r$ for free electron and gravitational acceleration $g_{e(gr)}(r)$, arising in the created non-parallel waveguide:

$$g_{e(gr)}(r) \approx \beta_{e(gr)}(r) C^2 / L_{oe} = GM_{oe} / r^2, \text{ (if } \beta_{e(gr)} \approx 0 \text{), thus,} \quad (30)$$

$$\beta_{e(gr)}(r) = (GM_{oe} L_{oe} / C^2) / r^2 = |U_{oe(gr)}| R_{oe} / r^2, \text{ or} \quad (31)$$

$dE_{e(gr)}(r)$ – as energy of the additional 3D-membrane extension could be accounted using $\delta r_{oe(gr)}(r)$ – additional extension of a very small and initially flat interval dr within initial spherical layer $dV_{layer} = 4\pi r^2 dr$ of radius r and thickness dr around the free electron. This volume extension $\delta V_{e(gr) \text{ layer}}(r)$ could be written as

$$\delta V_{e(gr) \text{ layer}}(r) = dV_{layer} \delta r_{e(gr)} = 4\pi r^2 \delta r_{e(gr)}, \quad (32)$$

that expresses a tiny extension of the initially flat 3D-membrane volume $dV_{layer} = 4\pi r^2 dr$ around free electron. The additional - extensional 3D-membrane energy is the local gravity energy of electron. Increment of additional energy $dE_{e(gr)}(r)$ of elastic extension of the 3D-membrane (with a membrane's bulk tension $\sigma_{3D-membr}$) is

$$dE_{e(gr)}(r) \approx \sigma_{3D-membr} \delta V_{oe(gr)}(r) > 0, \quad (33)$$

in the differential form, if $\delta r_{e(gr)} \ll dr$, or $\delta V_{oe(gr)}(r) \ll 4\pi r^2 dr$ and

$$\sigma_{3D-membr}(r) = \sigma = \text{const.} \quad (34)$$

It is the central point – the nature of Einsteinian *geometrization* principle in our case – (if, for example, the $\sigma_{3D-membr} = 1$), we manipulate mathematically with the potentials as only with corresponding geometrical structures – with their tiny deviations from the flat vacuum state. All classically behaving 3D-membrane deviations and extensions must be very small, other words the *initially flat*, tensioned 3D-membrane must have enormously strong basic bulk tension σ , but it is the perfect vacuum state with the *dominating minimal tension energy density* $E_{min(membr)}$, corresponding to the strictly flat, “empty” vacuum. This minimal energy density always dominates all tiny classical physical potentials, carrying an additional (positive) extension energy δE_{membr} , so $E_{min(membr)} \gg \delta E_{membr} = \delta E_{e(gr)}$.

$$\delta E_{e(gr)} = \sigma \delta V_{oe(gr)}(r) = \sigma \delta r_{oe(gr)} 4\pi r^2 = \sigma (1/2) \beta_{e(gr)}^2(r) 4\pi r^2 dr, \quad (35)$$

and using (35), we derive

$$dE_{e(gr)} = 2\pi \sigma U_{oe(gr)}^2 R_{oe}^2 dr / r^2. \quad (36)$$

The full integral extension gravity energy of electron $E_{e(gr)}$ is the 3D-space integral across the non-flat 3D-membrane area, the $1/r$ -like deformed space volume, on the interval $R_{oe} < r < \infty$.

$$E_{e(gr)} = \int_{R_{oe}}^{\infty} dE_{e(gr)} = \int_{R_{oe}}^{\infty} 2\pi \sigma U_{oe(gr)}^2 R_{oe}^2 (1/r^2) / dr, \text{ and finally,} \quad (37)$$

$$E_{e(gr)} = 2\pi \sigma U_{oe(gr)}^2 R_{oe} = \pi \sigma G^2 h^2 / 2C^6 R_{oe}, \quad (38)$$

if we substitute the (27a), being $|U_{oe(gr)}| = Gh / 2C^3 R_{oe}$ into the (37). The derived $E_{e(gr)}$ has two impressive results:

(a) The potential gravity energy of electron contains 5 fundamental constants: σ - the new one – the bulk elasticity of our substantial spatial membranes, the Newton’s gravity constant G , the light speed $C=C_4$, the quantum Planck’s constant h and the fundamental hyper-length constant – the 3D-waveguide thickness $L_{oe}=\lambda_{e.Compton}$.

(b) Classically unavoidable physical singularities = endless gravity or electrostatic energy of electron, arising in the traditional (the point-like) elementary particle paradigm, totally disappear in our case.

Note: The basic physical gravitational parameter is the membrane deviating hyperforce, equal to the \pm gravity “hypercharges” $\pm f_{\perp oe}$ in relativistic electron and positron holes. This hyperforce could be derived using a simplified wave-reflection. The orthogonal electron momentum $P_{\perp oe}$ is constant $P_{\perp oe}=M_{oe}C_4$ and it is periodically reflected into the opposite direction (by the total periodic electron wave reflection in the same 3D-waveguide) as the $P_{\perp oe}=-M_{oe}C_4$ in the doubled-relativistic electron-loop for the doubled time period $\Delta T=2(2L_{oe}/C_4\cos 60^\circ)=8L_{oe}/C_4$. The resulting orthogonal wave pressure $\pm f_{\perp oe}$ is surprisingly enormous for the so tiny relativistic inertial rest mass of electron $M_e=2M_{oe}$:

$$f_{\perp oe}=\Delta P_{\perp oe} / \Delta T = \pm[2M_{oe}C] / [8L_{oe}/C] = M_e C^2 / \pm 8\lambda_{e.Compton}^* \approx \pm 0,8 \text{ kg (!)} \quad (39)$$

The geometrodynamical nature of the elementary electrostatic charge of electron

Now we connect very smooth gravity deformations $U(r) \sim (-1/r)$ (Fig. 6), described above, with *corresponding simultaneous polarizations* inside each ($e-/e+$) vacuum “atom” around electron (as positron-hole) under the oppositely acting gravitational/antigravitational forces

$F_{e-(gr)}(r)=+\mathbf{g}_{gr}(r)M_{e-}+=\boldsymbol{\beta}(r)C^2/L_{oe}$ for electron, and the same opposite force $F_{e+(gr)}(r)=-\mathbf{g}_{gr}(r)M_{e-}=-\boldsymbol{\beta}(r)C^2/L_{oe}$ for positron in ($e-/e+$) vacuum cells respectively (Fig. 8, below).

The e -cells, filling the assumingly endless global 4D-Multiverse, build L -endless periodical- L_{oe} -segmented ($e-/e+$) tubes – vertical hyper-“polymers” (Fig. 4). The e -cells themselves cannot be destroyed – any two L -adjusted and coupled ($e_i ; e_{i+1}$) - cells can be only decoupled via reciprocal $+\Delta r \approx 2R_{oe}$ and $-\Delta r \approx 2R_{oe}$ -displacement along their 3D-waveguide (without destroying of other existing and the decoupled vacuum e -cells), with creation of two corresponding e_- and e_+ holes, (Fig. 4). Other words – the full quantity of the e -cells in the liquid quantum vacuum is always constant. The e -hole looks as a stable elementary inter-space, arising between densely packed (but slightly shifted) e -cells, easy possible in the superfluid vacuum medium. The so created e -hole is very stable, since it realizes a bolt jamming mechanism, holding stability of the aroused e -hole and holding its non-local potentials (Fig. 8, below).

The e -hole /anti- e -hole annihilation is well possible, since the bolt jamming can be destroyed by the opposite anti-bolt jamming, relaxing the middle adjusting 3D-membrane and eliminating the vacuum polarizations and these two e -holes simultaneously. The electrostatic and gravity straining-energy of the fully flattened membranes is transformed into two gamma quanta, common after annihilation e_- and e_+ particles. It is natural to assumes that the vacuum composites ($e-/e+$) behave as common stable atoms of liquid with the composite coupling energy $E_{(e-/e+)coupling}=2M_e C^2$ where the fermionic dynamical e -cells themselves are very stable and cannot disappear, since all levels of underlying sliced vacuum mediums are “effective” – cooled and have superfluid properties at the minimal energy levels.

The hole/antihole creation needs outside decoupling energy $E_{(e-/e+)\text{decoupl}}$:

$$E_{(e-/e+)\text{decoupl}} = E_{(e-/e+)\text{coupling}} = 2M_e C^2. \quad (39.1)$$

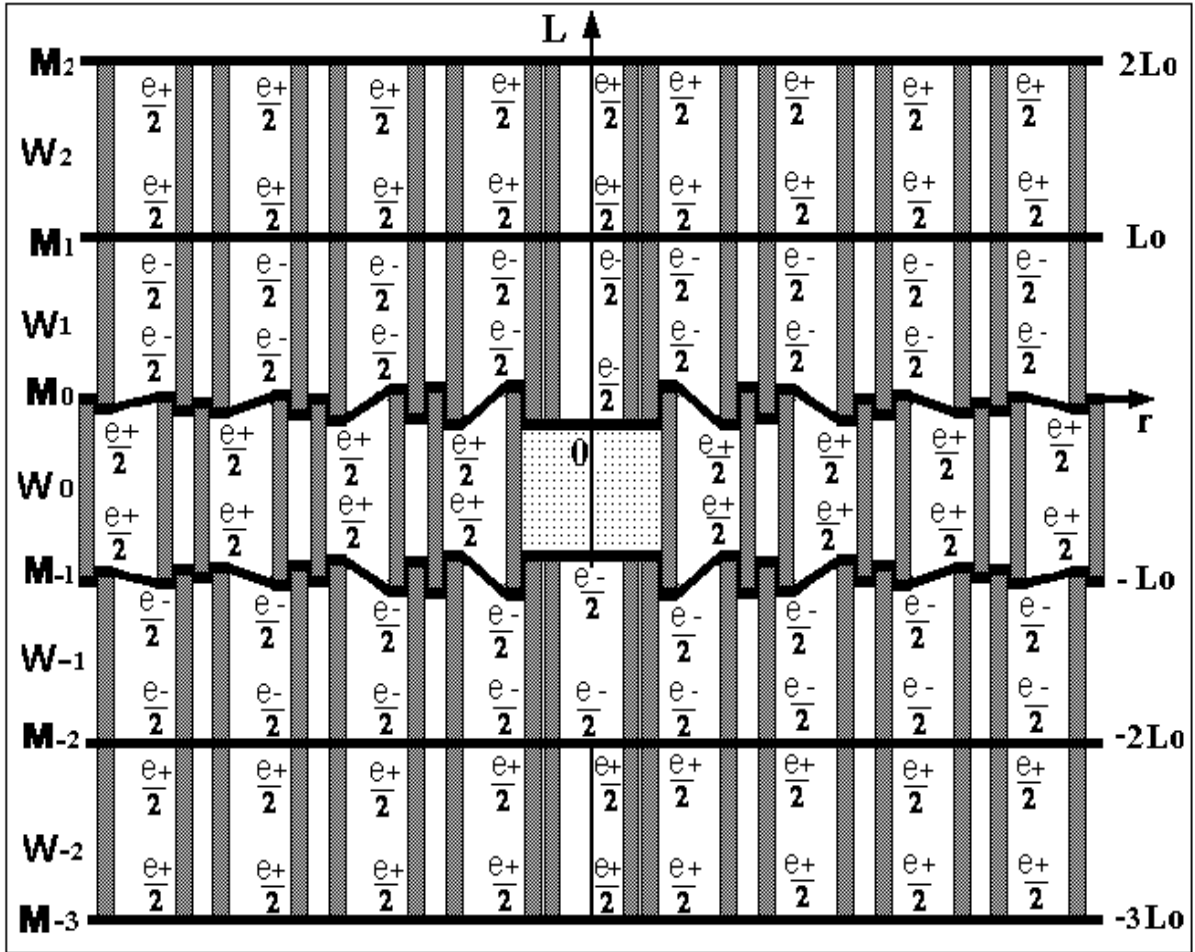

Fig. 8 shows schematically a 2D-cross-section of five coupled e -waveguides. Only the middle - W_0 -waveguide contains an elementary “positron hole”- our material *electron* particle. Coupled bosonic ($e-/e+$) pairs fill all these adjacent waveguides (containing equal e -cells) and build together sliced 3D-superfluids. The “positron hole” causes tiny non-local pressing-out (with tiny local polarization shifts) of surrounding e -cells, but only along the W_0 -waveguide – since two very strongly “horizontally” tensioned membranes M_0 and M_1 localize these shifts only along the W_0 -waveguide. This relative shifts lead to local ($e-/e+$) pairs polarizations and to resulting symmetrical, reciprocal “electrostatic-hyperspatial” L -corrugations, only along of two framing membranes M_0 and M_1 , realizing huge electrostatic potentials of electron. This means that the electrostatic extension energy is accumulated-located exclusively along of two framing e -hole membranes M_0 and M_1 . Other surrounding membranes (M_1 , M_2 , M_2 and M_3), etc. are not affected by this e -hole – are not corrugated and “don’t fill” electrostatic existence of our electron (e -hole in the W_0 -waveguide). Two symmetrical (L -coaxial) “bolt-like jamming” e -hole-locks in the middle of the picture confine and keep enormous stability of the whole e -cellular structure, surrounding this e -hole. Only the same *anti-lock* (the positron antiparticle) can effectively destroy the electron e -hole-lock. Hyperspatial contact of the lock and the anti-lock (electron and positron holes) naturally realizes a reciprocal simultaneous “knack” of these locks, as “fighting fire with anti-fire”. This “knack” eliminates both e -hole and e -antihole – they annihilate together with their tiny \pm potentials and \pm charges. This tiny polarization has spherical ($1/r$)-“electrostatic” form, and is globally distributed around the e -hole along the W_0 -waveguide, realizes very stable, quasi-classical, sufficiently non-local electrostatic potential of electron.

Our ideal - “atomistic” superfluid vacuum without defects is totally hypersymmetric and has the lowest vacuum energy state without membranes deformations above the minimal –flat state. Zero vacuum energy density has very simple-limited meaning here, since all substation membranes \mathbf{M}_n have always extremely strong constant tensions and correspondingly enormous “Zero-Zero” self-energy density, keeping their perfect flatness. But this enormous self-energy realizes and keeps the minimal – equilibrium vacuum state, free of elementary defects. It is totally out of our material physical perception and looks as a perfect “emptiness”. The e -hole / e -antihole annihilation returns back the defectless zero vacuum state to it’s the minimal = “zero energy density” state with the backward coupling - the ($e-/e+$) Cooper-like pair with liberation of the $E_{(e-/e+)\text{coupling}}=2M_eC^2 >0$ in form of two massless gamma-quanta. This means that e -cells in our e -cellular vacuum can be hypersymmetrically coupled or decoupled but they cannot disappear at all. Creation of the electron and positron pair (e -hole/ e -antihole) is creation of two the opposite non-local space-deformations - potential fields around these elementary e -holes, accumulating always the positive stretching membrane energy – always above the minimal vacuum state.

The coupling energy $E_{(e-/e+)\text{coupling}}$ consists almost of the doubled *electrostatic* energy of electron $E_{(e-/e+)\text{coupl.}}=2M_eC^2\approx 2E_{e(el)}$. Namely this electrostatic e -hole energy realizes physically the *effective dynamical energy* $E_{e\pm(\text{inertial})}=M_eC^2 >0$ and corresponding positive effective *inertial mass* $M_{e\pm(\text{inertial})}=M_e >0$ of each elementary e -hole, being the same-positive in all-parallel 3D-waveguides. This energy is practically equal to the dynamical energy, implanted into the corresponding inertial mass M_e of the e -cell. Physicist percepts only elementary, massive vacuum defects and massless C_3 -quasiparticles (photons) in different experiments, including the massive matter electrons, protons and massless photons, etc., and sporadically arising virtual fermionic pairs e_- & e_+ in the vacuum superfluid tissue, e.g. with the resulting Casimir effect.

The electrostatic e -hole has its electrostatic charge $Q=\pm e$ with the sign depending of its waveguide’s number \mathbf{W}_k : it is periodically negative for even numbers $k=2n$ (and for $n=0$) and it is positive for odd numbers $k=2n+1$; the corresponding gravity “charge” $M_{e(gr)}=\pm M_{e(in)}$ of the same e -hole also has its periodically changing signs (it is positive for $n=0$ and even natural numbers $k=2n$ and is negative for the odd $k=2n+1$). The e -hole creates its electrostatic potential $U\sim 1/r$ (plus a tiny energy part of $1/r$ gravity potential) being 3D-spatially exponentially ($\sim 1/r$) spread as additional 3D-membrane stretching from the energetically minimal-flat stat (see below). This additional stretching potential energy $E_{e(el)}\approx M_eC^2$ is liberated (as doubled) after annihilation of the e -hole (e_-) and e -antihole (e_+) as two massless γ -quanta with $\Sigma E_\gamma\approx 2M_eC^2$ with resulting substantial membranes flattening and disappearing of the previous electrostatic $\sim 1/r$ potentials. This way is realized the law of energy conservation in the system vacuum-matter-antimatter, where the superfluid vacuum tissue plays tremendously major physical-existential role. Here we have kind of a condensed matter physics analog, connected to endless quantity of identical coupled e -cells, etc., which physical behavior become unexpectedly very simple on the background of the coherent low energy physics, common in the condensed matter physics.

The geometrical sense of the electrostatic energy

The relatively enormous density of the electrostatic energy arises here as unexpectedly very strong reciprocal vertical membrane extensions like $_/_$ and like $_ \backslash _$, caused by the r -shifted coupled ($e-/e+$) pairs under the smooth gravitational $1/r$ deviance of the dividing membrane (Fig. 6e,d; 8). We associate the smooth gravitational component ($1/r$) of the middle membrane stretching-deformation with the gravity energy $E_{e(gr)}$ of the free electron. These –much more stronger reciprocal membrane tensions $_/_$, $_ \backslash _$ are caused by very small reciprocal r -shifts - polarizations inside the ($e-/e+$) cells and are associated with the arising electrostatic vacuum

energy $E_{e(el)}$ of the same free electron (e -hole), arising in all surrounding (e - e +) vacuum atoms via their positional asymmetry (polarization) – equal to the corresponding local spatial symmetry break in vacuum atoms without their decoupling!

The local membrane extension $\delta r_{e(gr)}(r)$ for free electron is connected with its deviations $\delta L(r)$ from the initial flat form. It could be consider independently for the smooth $1/r$ membrane deviation $U_{e(gr)}(r) = -(GM_{oe}L_{oe}/C^2)/r$ – for the smooth gravitational straining $\delta r_{oe(gr)}$, and for the reciprocal $\sqrt{\quad}$ deviations – the corresponding electrostatic straining $\delta r_{oe(el)}$. We can acquire the enormous relation $E_{e(el)}/E_{e(gr)}$ between these two membrane extensions, if we assume that:

- (a) The smooth gravitational potential $U_{e(gr)}(x) \sim 1/r$ of electron will provide polarizations of the (e - e +) vacuum pairs around of the e -hole for $r > R_{oe}$, that means r -reciprocal coaxial shifts between the coupled e_- and e_+ companions in each coupled pair, filling our vacuum;
- (b) It causes very strong reciprocal *radial* $\sqrt{\quad}$ membrane extensions inside each polarized (e - e +) cell around the e -hole (Fig. 6e;8);
- (c) The $2R_{oe}$ -periodical cellular $\sqrt{\quad}$ membrane extensions $\delta r_{e(el)}$ must be distantly reduced as $1/r^2$, as is reduced the polarizing reciprocal gravitational Newton-like force, described above

$$g(r) = \pm dU_{e(gr)}(r)/dr \sim \pm 1/r^2, \quad (40)$$

providing the distantly $\sim 1/r^2$ reduced r -polarization of the (e - e +) pairs (see Fig. 8).

- (d) We propose also that very narrow spherical shell between polarized electron and positron spheres in the (e - e +) pair provides physically rather unusual conditions, connected with very strong additional extension of the dividing membrane, literally being stacked in these almost coaxial hypercylindrical shells. Our naive assumption means that this extension is comparable to the maximal gravitational electron immersion $U_{oe(gr)}$, mentioned above; this maximal extension arises if the polarized (e - e +) pair is placed very near to the “free” e -hole, causing the (e - e +) “atoms” polarization and very strong local membrane’s L -extensions $\sqrt{\quad}$, $\sqrt{\quad}$. Naively thinking, the shell-stacked dividing membrane could be stepwise extended by additional fluctuating reciprocal forces to the maximal value $U_{oe(gr)}$ near $r=R_{oe}$.

The local *maximal* electrostatic extension $\delta r_{e(el)}$ near $r=R_{oe}$ around the e -hole consists of 2 identical quasi-orthogonal ΔL -intervals $u_{ab} \approx |U_{oe(gr)}|$ and $u_{cd} \approx |U_{oe(gr)}|$ for each (e - e +) pair cell (see Fig. 9b). But we must also take in account roughly the same additional straining interval $u_{da} \approx |U_{oe(gr)}|$, arising between all neighboring (e - e +) atoms, *if they are placed very closely* to each other (what is natural for the (e - e +) liquid medium) in our 3D-space along the 3D-radius r . (Fig. 9b).

We could (imaginary) unfold these *radial* $\sqrt{\quad}$ membrane ($|U_{oe(gr)}| + |U_{oe(gr)}| + |U_{oe(gr)}|$)-extensions, related to each (e - e +) pair (Fig. 10a), into the smooth elements, building now imaginary smoothed common electrostatic potential function $U_{e(el)} \sim k_{e(el)}/r$ (see Fig. 9a*). This imaginary smooth function $U_{e(el)}$ has its local (also very small) angle $\beta(r)_{e(el)} = dU_{e(el)}(r)/dr \approx 0$, and it is changed as $\beta(r)_{e(el)} \sim 1/r^2$. We have here $\beta_{max}(r=R_{oe}) \equiv \beta_{oe}$ and thus, $\beta(r)_{e(el)} = \beta_{oe} R_{oe}^2 / r^2$. The β_{oe} can be derived from similar geometrical reasons for $\beta_{oe} \approx 0$, as the derived above equation $\delta r_{e(gr)} \approx (1/2)\beta_{e(gr)}^2(r)dr$, where $\beta_{e(gr)}^2(r) \sim 1/r^2$.

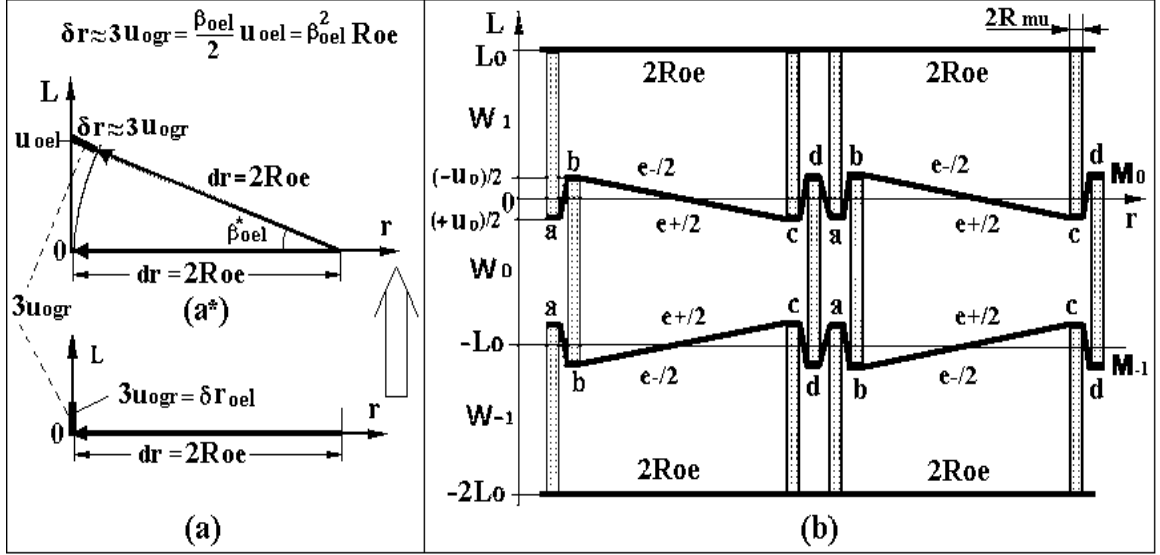

Fig. 9a shows the full vertical L -straining $\delta r_{oel} \approx 3U_{oe(gr)}$ for the $(e-/e+)$ cell, nearest to the e -hole.

Fig. 9a* shows the electrostatic membrane straining for one $(e-/e+)$ vacuum cell, for very small β_{oel}^* (since $3U_{ogr} \ll 2R_{oe}$) and correspondingly keeping $U_{el} \sim 1/r$ -like electrostatic straining electron potential, realizing in one of two symmetrically deformed membranes M_0 or M_{-1} .

Fig. 9b shows electrostatic r -polarizations for the nearest $(e-/e+)$ vacuum cells, placing along r near to the electron hole in the W_0 waveguide, creating very the strong vertical membranes straining $ab=cd=da$ for each vacuum cell, providing here enormous electrostatic-straining potential energy, comparably to the smooth gravity-straining potential energy $\sim 1/r$ of the same membranes M_0 and M_{-1} around the electron hole.

$$\delta r_{e(el)max} = 3 |u_{oe(gr)}| = (1/2) \beta_{e(el)max}^2 2R_{oe} = \beta_{e(el)max}^2 R_{oe}, \quad (41)$$

from the (43) we derive $\beta_{e(el)max}^2$

$$\beta_{e(el)max}^2 = 3 |U_{oe(gr)}| / R_{oe}, \text{ near } r=R_{oe} \text{ and} \quad (42)$$

$$\beta(r)_{e(el)} = \sqrt{[(3 |U_{e(gr)}| / R_{oe}) (R_{oe}^2 / r^2)]} \quad (43)$$

and electrostatic extension $\delta r_{e(el)}(r)$ will be here

$$\delta r_{e(el)}(r) \approx (1/2) \beta^2(r)_{e(el)} dr = (1/2) [(3 |U_{oe(gr)}| / R_{oe}) R_{oe}^4 / r^4] dr \quad (44)$$

The derived here resulting local electrostatic extension $\delta r_{e(el)}(r)$ goes in all directions around spherical layer with radius R_{oe} for each $(e-/e+)$ pair and so, we must take into account the spherical-layered forms of the corresponding membrane extensions. Walls of our (e_-) and (e_+) hyper-cylinders R_{oe} could have a minimally small thickness, it cannot be thinner as the $2R_{\mu\mu}$, since these walls are constructed from the corresponding muonic vacuum “mini-atoms”, (coming from the second leptonic generation) filling our waveguides 4D-volumes with the dense, quasi-continual fine-grained $(\mu-/ \mu+)$ quantum liquid (Gribov 2005, 2012). It is naturally to propose that the minimal (cutoff) thickness $d_{ewall}=d_{min}$ is exactly the $d_{ewall}=2R_{\mu\mu}$. Thus, the electron/positron orthogonal reciprocal extensions are distributed in each polarized $(e-/e+)$ pair along *two* thin 3D-spherical layers, each with the proximally volume $\delta V_o \approx 4\pi R_{oe}^2 2R_{\mu\mu}$ since $R_{oe} \gg R_{\mu\mu}$, with summary double volume

$$2\delta V_o \approx 2(4\pi R_{oe}^2 2R_{\mu\mu}) \quad (45)$$

The whole space “micro-box”, containing an electron-positron pair is approximately cubic $(2R_o)^3$ volume $V_{(e-/e+)}=V_{\square}$, containing the R_{oe} sphere

$$V_{(e-/e+)}V_{\square}=(2R_{oe})^3 \quad (46)$$

In the right integral account we must use the membrane extension, averaging on the full approximately cubic $(e-/e+)$ micro-volume $V_{\square}=(2R_o)^3$, containing these extended spherical layers, i.e. we must use averaging multiplicand

$$2\delta V_o / V_{\square}=2\pi R_{o\mu} / R_{oe}, \quad (47)$$

thus, the local extension $\delta r_{e(el)}(r)$ will be rewritten for the cubic $V_e=(2R_o)^3$ cell as the

$$\delta r_{e(el)}(r) \approx 2\pi(R_{o\mu}/R_{oe})(1/2)[(3 | U_{oe(gr)} | / R_{oe})R_{oe}^4 / r^4]dr, \text{ or} \quad (48)$$

$$\delta r_{e(el)}(r) \approx 3\pi (| U_{oe(gr)} | R_{o\mu} R_{oe}^2 / r^4)dr \quad (49)$$

Now we form spherical layer $4\pi r^2$ around the free charged electron and multiply with membrane bulk tension σ will derive differential form of the extension membrane energy $dE_{e(el)}(r)$:

$$dE_{e(el)} = \sigma \delta r_{e(el)}(r) 4\pi r^2 \text{ or , using (49) we derive} \quad (50)$$

$$dE_{e(el)} = 3\pi \sigma (| U_{oe(gr)} | R_{o\mu} R_{oe}^2 / r^4) 4\pi r^2 dr = 12\pi^2 \sigma (| U_{oe(gr)} | R_{o\mu} R_{oe}^2 / r^2)dr \quad (51)$$

and then it is easy to write the final integral form, also integrating, as in the case of gravity extension energy, for the interval $R_{oe} \leq r < \infty$

$$E_{e(el)} \approx \int_{R_{oe}}^{\infty} 12\pi^2 \sigma (| U_{oe(gr)} | R_{o\mu} R_{oe}^2 / r^2)dr \text{ or} \quad (52)$$

$$E_{e(el)} \approx 12\pi^2 \sigma | U_{oe(gr)} | R_{o\mu} R_{oe}^2 \int_{R_{oe}}^{\infty} (1/r^2)dr. \quad (53)$$

$$E_{e(el)} \approx 12\pi^2 \sigma | U_{oe(gr)} | R_{o\mu} R_{oe} , \quad (54)$$

Thus, according the (38): $E_{e(gr)} = 2\pi\sigma U_{oe(gr)}^2 R_{oe}$, and we derive the desired ratio $E_{e(el)}/E_{e(gr)}$,

$$E_{e(el)} / E_{e(gr)} \approx 6\pi R_{o\mu} / U_{oe(gr)} = 6\pi R_{o\mu} / (Gh/2C^3 R_{oe}) = C h / \pi M_{\mu} M_e G, \quad (55)$$

where $U_{oe(gr)} = Gh/2C^3 R_{oe}$, $R_{oe} = (2/\sqrt{3}) (h/4\pi M_e C)$ and $R_{o\mu} = (2/\sqrt{3}) (h/4\pi M_{\mu} C)$

The numerical computation gives, (with some crude approximations, as e.g. the cubic $(e-/e+)$ micro-volume $V_{\square}=(2R_{oe})^3$, etc.) this huge numerical ratio:

$$(E_{e(el)} / E_{e(gr)})_{EMMA} / (E_{e(el)} / E_{e(gr)})_{GRAMMA} = F_{e(el)} / F_{e(gr)} \approx 5,5 \times 10^{42}. \quad (56)$$

This means that we derive enough similar ratio as the empirical* ratio $E_{e(el)}^*/E_{e(gr)}^* \approx 4,169 \times 10^{42}$. We recall that electrostatic $F_{e(el)}^*$ and gravity $F_{e(gr)}^*$ interactions between two electrons have common classical relation

$$F^*_{e(el)}/F^*_{e(gr)} = (e^2/r^2 4\pi\epsilon_0)/(GM_e^2/r^2) = U_{e(el)}/U_{e(gr)} \approx hC / \pi M_\mu M_e G. \quad (57)$$

The electron charge e_{EMMA} is derived from the last equation:

$$(e^2/4\pi\epsilon_0)/(GM_e^2) \approx hC / \pi M_\mu M_e G, \quad (58)$$

$$e^2_{EMMA} \approx 4\epsilon_0 hC M_e / M_\mu \quad (59)$$

This means that electron charge (or simultaneously the opposite – positron charge) obtains now its enough clear geometric-dynamical nature, supporting our periodical Multiverse concept with the periodical foliated space-antispacesymmetry, and the following “atomistic” ($e-/e+$) quantum vacuum concept. Electrons arise as e-holes (elementary defects), the electrostatic charge and gravity mass of the e -hole arises as sufficiently collective phenomenon in superfluid vacuum medium. The electron arises via elementary microscopic, symmetry breaking defect – a lateral positron “hole”, following penetrative Diracian terminology. Our matter particles look not as a physically dominating local “quintessence in emptiness” – on the contrary – they are very rare, tiny defects in the enormously dense, dominating grandiose Superfluid Ocean – with totally “deceptive emptiness”, being an omnipresent physical incognito under the hypersymmetry cover. Behind the enough important charge nature arises something much more tempting and exiting – the Multiverse “hyper-ripples”. This Multiverse is enormously dense but coherent-invisible-weightless, Euclidean-like-flat, very stable but penetrable without friction (as realized once Galileo Galilee and Isaac Newton) – it behaves as a non-dissipative quantum superfluid, a kind of a “Heavenly Helium” at low T – as the reincarnated old-one Ether, now integrating our physical laws and myriads of physically identical worlds. Now it arises with the periodical quantum outfit, as 4D-“hyperether” of the 21 century.

Note 1: Using the cubic $V_\square=(2R_{oe})^3$ packing approximation for ($e-/e+$) “atoms” gives roughly similar numerical value for $(E_{e(el)}/E_{e(gr)})$. This relatively good numerical correspondence indicates that the ($e-/e+$) vacuum “atoms” are indeed packed not as a very dense solid crystal, but as a more flexible packed atoms of superfluid with a small flexible free space between them, that allows this liquid to stream and to fill all possible forms. This allows substation membranes to “brief” under gravity pressure, etc. This means also that this liquid has no torsion effects, common for a solid body. Transverse spin waves - quasiparticles with photonic spin $S=1$ penetrate this superfluid medium, realizing common physical principle of causality, where all Feynman’s paths and corresponding path integrals are self-calculated and selected simultaneously. This medial e -cellular vacuum works like as a parallel, hyperspatial C -speeded quantum super-computer.

Note 2. The classical electron radius $R=b=(2/3)R_e=(2/3)e^2M_eC^2$ was assumed for classical electron electrostatic charge, being distributed on the sphere $R_{eClass}=b$ with the full electromagnetic mass $M_{e(electromagn)} \approx M_eC^2$ (see Feynman, 1966, v.6, p. 306). It has its value $b=1,878 \times 10^{-15}$ m and is approximately equal to the $2R_{o\mu}=2,15 \times 10^{-15}$ m, that is the assumed muonic/anti-muonic wall thickness, building the spherical e -cell surface (see Fig. 5.3). In this case the full membrane tension energy $E_{e(el)}$ for free electron (54) and corresponding enormous membrane bulk tension $\sigma_{3D-membr}$ could be calculated from the equation below:

$$E_{e(el)} = 12\pi^2 \sigma_{3D-membr} R_{o\mu} R_{oe} \mid U_{oe(gr)} \mid \approx M_e C^2, \quad (61)$$

$$\sigma_{3D-membr} \approx M_e M_\mu C^6 / \sqrt{3\pi G h^2} \approx 2 \times 10^{72} \text{ g s}^{-2} \text{ cm}^{-1} \quad (62)$$

This enormous $\sigma_{3D-membr}$ value explains common linearity of the basic classical equations and the *superposition principle* in physics. Feynman noted, “nobody could create theory of electricity”,

in which the basic equation $\nabla^2 U = -\rho/\epsilon_0$ is understood “as a smoothed approach to a more deep mechanism”. But, on the other hand, this “leads to a wild absurd on the unlimitedly small distances, which nobody yet could avoid” $U(r=0) = -\infty$, (Id. p. 257). The waveguided GAMMA / EMMA provide the $\sim \pm 1/r$ potentials forms without classical singularities, both for gravity and electrostatic energy of electron. These potentials arise simultaneously as result of the local - elementary “normal” L -symmetry break, created by the e -hole), (see Fig. 4, Fig 8 above).

Gravity potential of electron (and two-component DM&DE-phenomena in the PWM)

It arises via non-local quasi-classical very smooth $\sim 1/r$ deviations of two symmetrical framing membranes \mathbf{M}_0 and \mathbf{M}_1 , confining $[e_0\text{-hole}]$ (our electron) in the \mathbf{W}_0 waveguide (Fig. 8). The initial-flat 3D-membranes tensions and theirs tension energies densities are enormously huge and equal in the PWM, as it was shown above. So, it is very natural to assume that all other waveguides \mathbf{W}_n in the multi-waveguided hyperspace (with natural waveguides numbers $n < -1$ and $n > 1$) are not affected (not disturb) by the e_0 -hole in the \mathbf{W}_0 -waveguide (Fig. 8).

Two strictly symmetrical $\frac{1}{2}$ gravity “charges” and corresponding smooth \mathbf{M}_0 and \mathbf{M}_1 deviations – \mathbf{W}_0 -waveguided gravity potentials of electron – arise around the $[e_0\text{-hole}]$ via 4D-“light” pressure $F_{L(+,-)} = \pm M_0 C^2 / L_0$, created by two identical symmetrical-coaxial e-cells (e_+ -cell) and (e_- -cell) living in the nearest waveguides \mathbf{W}_{-1} and \mathbf{W}_1 , surrounding this $[e_0\text{-hole}]$ (Fig. 8). They are C_4 -dynamical physical carriers-sources of $\frac{1}{2}$ gravity charges of our electron= $[e_0\text{-hole}]$ – via “locally broken symmetry” in the orthogonal reciprocal “4D-light” pressure, resulting symmetrical gravitational deviations of only *two gravitating waveguided wings* - the \mathbf{W}_{-1} thickness $\partial L_{0(-)}/\partial r$ and \mathbf{W}_1 thickness $\partial L_{0(+)}/\partial r$. The same very simple and clear picture arises for all identical e -holes/ e -antiholes arising in the PWM. This means that \mathbf{W}_{n-1} and \mathbf{W}_{n+1} *waveguide's bulks* function always as two symmetrical gravitational waveguides-wings for the $[e_n\text{-hole}]$ between them (Table 1, below).

This causes additional pairwise (DM-like) gravity attraction between our \mathbf{W}_0 -matter and identical \mathbf{W}_{-2} and \mathbf{W}_2 “dark” matter Universes in the “Hyperbook” of the PWM Universes, building mutually pairwise attractive DM L -columns of \mathbf{W}_{2n} and Dark Anti-Matter (DAM)- L -columns \mathbf{W}_{2n+1} (Table 1, below). The \mathbf{W}_{2n} and \mathbf{W}_{2n+1} anti-chains build symmetrically distributed hyperspatial galactic clusters and galactic anti-clusters, which gravitationally repulse each other. They have simply joint-superposed gravitational wings \mathbf{W}_{-1} and \mathbf{W}_1 – each of the $\mathbf{W}_{\pm 2}$ Dark Matter (DM) Universes is gravitationally overlapped with our Universe, creating $\frac{1}{2}$ -attraction between $[e_0\text{-holes}]$ and the nearest (dark) $[e_{-2}\text{-holes}]$; $[e_{+2}\text{-holes}]$ in the $\mathbf{W}_{n\pm 2}$ waveguides. So, the PWM-concept directly and obviously predicts the *MIXED-two-component DM $_{\pm 2}$* , indeed observationally verified in the recent DM-observations (see cosmological chapters below).

Similar analysis regarding antimatter e-holes e_{-1} and e_1 in the nearest odd \mathbf{W}_{-1} and \mathbf{W}_1 waveguides shows simultaneous antigravity between them and our \mathbf{W}_0 -mater holes, what predicts two-component antimatter or *two-component Dark Energy (DE $_{\pm 1}$)*, keeping total matter-antimatter equality in the DE-observations (Gribov 2012, 2013a,b).

Electrostatic energy of electron

It arises in the PWM as more complicated additional breaks arising around ordinary electron’ defect – around e -hole in the composite superfluid vacuum – as bunch of tiny symmetry breaks inside each (e^-/e^+) vacuum composites-“atoms” along the \mathbf{W}_0 -waveguide, creating relatively very big reciprocal membrane’s stretchings – accumulating local electrostatic micro-potentials of the e -hole. These regular “electrostatic energy” stretchings are located-accumulated only in two

membranes \mathbf{M}_0 and \mathbf{M}_1 , framing the “defected” \mathbf{W}_0 –waveguide, confining this e -hole (Fig. 8). Flatness of all very-very strongly strained periodical PWM-membranes \mathbf{M}_n ($n \neq 0; 1$) is not changed – they are not affected by the e -hole presence in the \mathbf{W}_0 –waveguide (in our Universe), because all membranes have so enormous rate of tension $\sigma_{3D-membr} \approx 2 \times 10^{72} \text{ g s}^{-2} \text{ cm}^{-1}$, estimated from the equation (68).

Table 1. Pico-range gravity&3D-photons interactions limits between waveguides in the PWM

Mutually-pairwise attractive \mathbf{DM}_{2n} chains	Mutually-pairwise attractive \mathbf{DAM}_{2n+1} chains
No (W_4/W_0) gravity interactions $ \mathbf{W}_4 $	W_4 joint wing Dark 3D-photons/
Dark 3D-antiphotons / joint wing W_3	$ \mathbf{W}_3 $ Dark \mathbf{AM}_3 Dark 3D-antiphotons/
Attractive dark \mathbf{DM}_2 partner $ \mathbf{W}_2 $	W_2 joint wing Dark 3D-photons/
Visible 3D-antiphotons / joint wing W_1	$ \mathbf{W}_1 $ repulsive visible \mathbf{AM}_1 antipartner
Our attractive \mathbf{OM}_0 matter $ \mathbf{W}_0 $	W_0 joint wing Visible 3D-photons/
Visible 3D-antiphotons / joint wing W_{-1}	$ \mathbf{W}_{-1} $ repulsive visible \mathbf{AM}_{-1} antipartner
Attractive dark \mathbf{DM}_{-2} partner $ \mathbf{W}_{-2} $	W_{-2} joint wing Dark 3D-photons/
Dark 3D-antiphotons / joint wing W_{-3}	$ \mathbf{W}_{-3} $ Dark \mathbf{AM}_{-3} Dark 3D-antiphotons/
No (W_{-4}/W_0) gravity interactions $ \mathbf{W}_{-4} $	W_{-4} joint wing Dark 3D-photons/

Electrostatic energy of our electron is *strictly localized-accumulated* on two the nearest framing membranes \mathbf{M}_0 and \mathbf{M}_1 framing the ordinary visible electron [e_0 -hole]. So, *only* two the nearest Antiuniverses $\mathbf{W}_{-1}[\mathbf{M}_{-1,0}]$ and $\mathbf{W}_1[\mathbf{M}_{1,2}]$ have their electrostatic membranes \mathbf{M}_0 and \mathbf{M}_1 *joint* with our visible matter Universe $\mathbf{W}_0[\mathbf{M}_{0,1}]$ via two electrostatic membranes \mathbf{M}_0 and \mathbf{M}_1 . This very simple analysis explains empirically known (but physically so miracle) *darkness* of the \mathbf{DM} , located in the $\mathbf{W}_{-2}[\mathbf{M}_{-2,-1}]$ and $\mathbf{W}_2[\mathbf{M}_{2,3}]$ “dark” matter Universes, because they *have no joint electrostatic membranes* with our Universe $\mathbf{W}_0[\mathbf{M}_{0,1}]$. This circumstance also explains presence of the electromagnetic interactions between our Universe \mathbf{W}_0 and two the nearest Antiuniverses \mathbf{W}_{-1} and \mathbf{W}_1 (very well known experimentally as successful detections of two $E=500\text{KeV}$ gamma quanta after electron/positron annihilation).

These so simple hyperspatial (electrostatic & gravity) fields-“shielding” phenomena manage electrodynamical and gravitational interactions between periodical matter / antimatter layers in physically equal \mathbf{W}_n Subuniverses, being overlapped-integrated in the proposed periodical Multiverse structure. This analysis totally explains the “dark” $\mathbf{DM\&DE}$ mysteries as now fundamentally united cooperative-Multiversal cosmological phenomena, surprisingly very easy explainable - without new elementary particles and fields (see cosmological chapters and Fig. 13a,b,c below).

THE SM-ANALOGIES IN CRYSTALS DEFECTS AND SUPERFLUIDS

A gauge theory of crystal dislocations

It is important to note that our cellular vacuum concept and its elementary matter particles as an elementary “cellular defects” in this (elastoplastic and frictionless) vacuum medium find a lot of conceptual and formal mathematical support in (a rather similar by the physical nature) gauge theory of crystal dislocations, where was discovered some basic, deep analogues with the Maxwell electromagnetic theory, the Einstein gravity theory and the SM Yang-Mills gauge field theory. The *gauge theory of crystal dislocations* was historically formulated as a *3-dimensional translation gauge theory in analogy to gravity* (e.g. Kleinert 1983, 1989, Kröner 1996). This theory was essentially developed, considering the *elastoplasticity* of crystals and could show very close analogy with the SM physics. Elasticity of the membranes in our waveguide’s vacuum and corresponding fields’ concepts are also very important conditions in our waveguided physics. Importantly that the elastoplastic material plays in the theories of defects in crystals a role of a kind of an *anisotropic “ether” for the defects* in direct analogy to our *e-cellular vacuum*. It is interesting that in the theories of defects in crystals arise the “elastoplastic” Yang-Mills type gauge field equations and Euler-Lagrange equations, which can be interpreted as equilibrium equations. Indeed, due to the nonlinear geometrical character of elastoplasticity, the field equations are nonlinear partial differential equations (Lazar 2000, 2009, 2010).

Condensed superfluid matter as an “empty” vacuum space

Here we follow Laughlin & Pines (2000), and Volovik (2003) guidelines. According to the anti-GUT analogy, (Hu 1996; Padmanabhan 1999; Laughlin & Pines 2000) “properties of our world such as gravitation, gauge fields, elementary chiral fermions, etc., all arise in the low energy corner as low energy soft modes of the underlying Planck condensed matter” (Volovik 2003 p.7). “It is assumed that the quantum vacuum of the Standard Model is also a fermionic system, since the bosonic modes are the secondary quantities, which are the collective modes of this vacuum.” (Id. p. 5). Indeed, “In the limit $T \rightarrow 0$ the superfluid $^3\text{He-A}$ gradually acquires from nothing almost all the symmetries which we know today in high energy physics: (an analogy of Lorentz invariance, local gauge invariance, elements of general covariance, etc.” “The quasiparticles and collective bosons perceive the homogeneous ground state of condensed matter as an empty space a vacuum since they do not scatter on atoms comprising this vacuum state: quasiparticles move in a quantum liquid or in a crystal without friction just as particles move in empty space”. “The dynamics of the zero modes is described within what we now call ‘the effective theory’ ”. (Id. p. 3). “This quantum field remains the effective field which is applicable only in the long wave-length limit, and does not give detailed information on the real quantum structure of the underlying crystal (except for its symmetry class). (Id. p. 7). “One of the most important consequences of such symmetry breaking is the existence of topological defects in both systems. Cosmic strings, monopoles, domain walls and solitons, etc., have their counterparts in condensed matter: namely, quantized vortices, hedgehogs, domain walls and solitons, etc.” (Id. p. 3).

The “ultimate goal” is to reveal the still unknown structure of the superfluid ether

“Its physical structure on a ‘microscopic’ trans-Planckian scale remain unknown, but from topological properties of elementary particles of the Standard Model one might suspect that the quantum vacuum belongs to the same universality class as $^3\text{He-A}$. More exactly, to reproduce *all the bosons and fermions of the Standard Model*”, “but the effective gravity still remains a caricature of the Einstein theory. (Id. pp. 5, 8). We remember that great creators of the classical gravity theory Newton and later Einstein were also uncomfortable with the notion of “action at a

distance" and practically meant kind of paradigm of continual vacuum-medium, transmitting gravity interactions (Newton 1693, Einstein 1920).

Notes. This analogue supports our superfluid frictionless vacuum architecture, consisting of the hypersymmetric-condensed electron/positron tubes composites; quark/antiquark doubled-coaxial tubes composites, etc. – the quantized periodic hypercylindrical vortexes. We even don't need to care about our quasi-particles physics – it must surely contain the SM complex with its $U(1)\times SU(2)\times SU(3)$ symmetry, being quantum Fermi-liquid on all vacuum levels! It must contain and explain also the basic leptonic families' phenomena and weak interaction, arising between these levels (being out of discussion in present work). So-called spinons "carrying electrical spin" (Id. p. 149) and holons ("slave" bosons, carrying its electrical charge) find their analogies in our mass/charge concept. Volovik (Id., p. 18) supposes that the hypothetical quantum vacuum consists "of some discrete elements – bare particles – whose number is conserved". These conserved "bare particles" are identical e -cells in our superfluid vacuum, filling the Multiverse, building very strongly coupled (e - e +) pairs, very well conserved at low temperature, that keeps global $U(1)$ gauge invariance in the (e - e +) vacuum and keeps a $U(1)$ gauge invariance together with a local $SU(2)\times SU(3)$ symmetry for all other quantum vacuum levels, based on a C_4 -quasiparticles, confined in our 3D-waveguides .

The paradigm of the non-gravitating superfluid vacuum

Einstein claimed some essential physical properties for this hypothetical ether (Einstein, 1920):

- (a) It must be a non-pondermotor = non-gravitating media;
- (b) The corresponding sound-light waves in this media must be transverse (as the transverse light waves) and, thus "must be of the nature of a solid body".

In his times Einstein could not take in consideration a new promising ether analogy with superfluid, where the "transverse light waves" are natural (Volovik 2003), as also the corresponding, now *non-gravitating*, quantum-liquid-like (e - e +) vacuum structure (Gribov 1999, 2003, 2005, 2012, 2013a). Volovik writes: "The paradigm of the non-gravitating equilibrium vacuum, which is easily derived in condensed matter when we know the microscopic trans-Planckian' physics, can be considered as one of the postulates of the effective phenomenological theory of general relativity. This principle cannot be derived within the effective theory. It can follow only from the still unknown fundamental level" (Volovik 2003, p.8). He concludes, that we need a '*perfect*' quantum liquid, "where in the low-energy corner the symmetries become exact to a very high precision as we observe today in our Universe, where " $E_{Lorentz} \gg E_{cutoff}$." (Id. p. 463), but "such quantities as atoms of the vacuum and the related chemical potential are not known by an inner observer who uses the effective theory" (Id. p. 465). He recalls that the scheme of the emergent phenomena "is not complete: quantum mechanics is still fundamental. It is the only ingredient which does not emerge in condensed matter." (Id. p. 468).

Anderson, Laughlin and Pines suppose that all "fundamental" physical laws are emergent, as it is, for example, in superconductivity and superfluidity, resulting of a many-body interaction at low temperature. These laws emerge out of a many-body interaction and will simply disappear if one tries to take it apart to a single-particle level (Anderson 1972, Laughlin & Pines 2000).

Notes. Why the fundamental microscopic level of the non-gravitating atomistic vacuum "is still unknown"? (Volovik 2003, p. 8). The answer seems to be very simple - this medium-like vacuum was practically impossible to realize all the time without the here proposed periodic 3D-waveguided particle/antiparticle concept, what allows existence of the composite scalar (e - e +) bosons with the summary zero gravity mass. All other necessary features of the realizable now

vacuum's medium – as non-dissipative foliated superfluids, etc. – are not so problematic after this basic conceptual correction (Gribov 1999, 2005, 2012, 2013a). It is clear that without the $\pm M_{gr}$ hypersymmetry there was no way to create this microscopic fundamental level, being at the same time non-gravitating & supersymmetric - with zero vacuum energy (friendly with the SM and being now organically connected to the Newton/Einstein \pm gravity). The necessary “non-pondermotor” postulate by Einstein is exactly “at home” in our multi-waveguided vacuum - it is the straight result of the underlying \pm space-symmetry and immediately arising antigravity.

Michio Kaku once noted: "Even the powerful gauge symmetries of Yang-Mills theory and the general covariance of Einstein equations are insufficient to yield a finite quantum theory of gravity" (Kaku 1999, p.4). The proposed 3D-waveguide's hyperspace creates and unifies the SR, QM and GR as *simultaneously emergent* on this level. Quantum mechanics with waves of de Broglie also is emergent. Here we find basic quasi-classical stones, unifying gravity with the (now periodic-hyperspatial) SM, where so tiny elementary particles and even so monstrous black holes have no common classical singularities (see below).

PERIODIC MASSLESS 3D-PHOTONS / ANTIPHOTONS IN THE PWM

Few months ago author of this paper spooked by phone with Sheldon Glashow and tried to explain him the negative gravity mass nature for antiparticle, so naturally arising in the PWM. Glashow asked very soon: “Have you developed any corresponding theory of photon and antiphoton”? Will they behave non-contradictable? The answer was negative, but this simple and fundamental question accelerated the answer below. Our common Planckian-Einsteinian massless 3D-photons, which were proposed in the revolutionary work by Einstein (1905), can be incorporated in the PWM-picture very simple way – via periodic correspondence to each 3D-waveguide. These massless photons remember common quasiparticles - collective quantum phenomena in the condensed matter physics – 3D spin waves in the superfluid vacuum medium. These spin waves – C_3 -quasiparticles always belong to a concrete waveguide \mathbf{W}_n . They have bosonic spin $S=1$ and move with the 3D-velocity of light $C_3(x,y,z)$ parallel to the waveguide's shell (Gribov 2005, 2012, 2013a,b). Each waveguide \mathbf{W}_n confines and holds its 3D-photons $C_{3(n)}$.

We belong (by the PWM-convention) to the matter waveguide \mathbf{W}_0 and know that two annihilating elementary particles electron e_0 and positron e_1 create two photons – two ~ 500 KeV gamma quanta $C_{3(0)}$ and $C_{3(1)}$, which have the opposite momentums and are both “visible” – equally detectable by detectors, fabricated of our ordinary matter and traditionally these two photons are described as absolutely equal – as a particle being its antiparticle. Our imaginary antimatter physicists, living in the \mathbf{W}_1 waveguide, belong to the totally symmetrical – physically equal Antiuniverse and must equally detect these two gamma quanta $C_{3(0)}$ and $C_{3(1)}$ after the electron e_0 and positron e_1 annihilation (as we do)! So, these two photons arise as two sufficiently different species in the PWM-concept – they are placed and captured symmetrically in two different - adjacent matter/antimatter waveguides \mathbf{W}_0 and \mathbf{W}_1 and have two correspondingly different waveguided numbers $n=0$ and $n=1$, similar to leptonic waveguided numbers e_n .

So, the nearest dark matter DM_2 -detector in the \mathbf{W}_2 waveguide will be also able to “see” – to detect the adjacent photon $C_{3(1)}$ from the \mathbf{W}_1 waveguide (as it is possible in our symmetrically placed – the ordinary matter waveguide \mathbf{W}_0). Our positron e_1 has the same – the positron e_1 property to the adjacent dark electron e_2 . If dark electron e_2 will annihilate with its antiparticle - positron e_1 this will create two gamma quanta – two photons $C_{3(2)}$ and $C_{3(1)}$, but our matter detectors will be able to detect only *one* - the adjacent gamma quantum $C_{3(1)}$ -photon! This way

can be constructed a Direct DM-detector, consisting of antiparticles captured in a vacuumed magnet trap (Gribov 2013b). This way could be directly tested our PWM&DM&DE concepts.

TRAPPED ANTIMATTER AS A DIRECT DM-DETECTORS IN THE PWM

We proposed usage of charged antimatter particles (positron, antiprotons), captured in a vacuumed magnet field trap, as transmitters of electromagnetic signals between our Universe and parallel dark Universes, existing according the PWM-concept (Gribov 2013a). Similar traps with the antimatter particles could be also arranged as the *antimatter detector of dark matter* particles – dark electrons or dark protons around us, because they are able to collide and annihilate only with the oppositely electrostatically charged anti-electrons or antiprotons captured in this direct DM-detector (Gribov 2013b). Annihilating antimatter particles, captured in the proposed DM detector, will “disappear” from the trap – that could be possible to detect; it is possible to detect (but only one – observable $C_{3(1)}$ -photon) of two common gamma quanta $C_{3(2)}$ and $C_{3(1)}$, created after annihilation of the dark matter particle and antiparticle in the trap. The PWM-concept could be experimentally tested this way, because it predicts that *only* this sufficiently new (antimatter) type of DM-detectors will be able to detect directly DM particles in the earth laboratory. All existing (only matter-made) detectors have showed experimentally examined failure to detect any DM particles and this failure is directly predictable by the PWM-concept, which discloses the so simple physical nature of the DM particles. For example, the W_2 -particles DM_2 can annihilate with their W_3 or W_1 antiparticles: (a) with dark antiparticles from the dark Antiuniverse W_3 with two dark - *undetectable* W_2 & W_3 gamma quanta events (b) annihilate with visible for us antiparticles from the Antiuniverse W_1 with resulting two W_2 & W_1 gamma quanta events, but *only one - visible gamma quantum* W_1 will be *detectable* in our W_0 laboratories.

Recent study by astrophysicists from Switzerland, Germany, the UK and China used a large sample of red dwarf stars to estimate the dark matter density in the solar neighborhood up to about 3000 light-years from the Sun. This gives a proximal DM density about (0.9 GeV +/- 0.5) GeV/C² per cm³ (<http://darkmatterdarkenergy.com/category/dark-matter-2/>). So, the estimated DM_{PWM} -density near our Sun system is about ~1 dark proton per cm³.

THE PWM-NATURE OF UNUSUALLY BIG EXCESS OF HIGH ENERGY POSITRONS

The Alpha Magnetic Spectrometer (AMS-02) on the International Space Station collected first precision measurements of the positron fraction in primary cosmic rays (from 0.5 to 350 GeV) based on 6.8×10^6 positron and electron events. “The positron fraction spectrum shows:

- (a) *no fine structure*;
- (b) *no observable anisotropy* for the positron to electron ratio (Aguilar et al 2013).

Young pulsars are theoretically tested as possible (very powerful primary) collective astrophysical source of the rising cosmic ray positron fraction, recently detected by the PAMELA and AMS-02 collaborations (Aguilar et al. 2013). The resulting electromagnetic cascades in these pulsars can include photons that are capable of producing a significant fraction of highly relativistic electron-positron pairs of the GeV-TeV electrons and positrons present in the cosmic ray spectrum (Hooper, et al 2009). Kelso and Hooper calculated the spectrum of synchrotron emission from high-energy electrons and positrons (~10 - 200 GeV) injected from 366 young pulsars (<10⁶ years) in the Milky Way galaxy and their calculations are qualitatively similar to that was observed (Kelso & Hooper 2010). What we know about the unexpectedly high-energy positrons excess in the latest measurements?

- 1) Astrophysicists agree that all high-energy electrons and positrons are from our galaxy sources.
- 2) One of the basic explanations is that (a) their natural sources are young pulsars or (b) hypothetical very heavy supersymmetric (*DM-like*) WIMPs particles, annihilating with each other and creating the high energy electron-positron pairs, but the WIMPs hypothesis is excluded by the PWM-concept, introducing the dark SM-particles DM_{SM} as basic DM_{SM} – spices for consideration.

The PWM concept predicts so unusual increase of the positrons via one-sided involvement of additional invisible sources – *dark pulsars* $DM_{-2,2}$ in two the nearest *DM* galaxies W_2 and W_{-2} , dominating and widely extended around our Milky Way galaxy (Fig. 13a, left). Addition of these invisible pulsars into the summary e^-/e^+ spectrum can significantly reduce its fine structure and increase its spatial isotropy. All periodic PWM-Universes W_n are intrinsically equal to our Universe W_0 and acquire the same internal physical laws and identical (visible or dark) SM-like elementary particles (dark electrons & dark protons, dark hydrogen etc), dark stars, dark galaxies and dark young pulsars. These dark W_2 and W_{-2} pulsars also create their (dark electron)/(visible positron) pairs e_{-2} & e_{-1} and e_2 & e_1 with invisible for us dark electrons e_{-2} and e_2 and visible for us positrons e_{-1} and e_1 , which live in the visible W_{-1} and W_1 antimatter waveguides around our ordinary matter waveguide W_0 . So, three different Universes with the $W_{-2,2}$ pulsars and our W_0 pulsars simultaneously participate in the summary e^-/e^+ spectra with the resulting unusual increase of the dark pulsars-made visible positrons e_{-1} and e_1 fraction. So, the so enlarged and sufficiently homogenized dark & visible pulsars density around our Milky Way galaxy could create the observed - structureless, isotropic spectral curves, where positrons number has unusually increased proportion. The PWM- cosmological scenario explains the mentioned above experimental AMS-02 data, it predicts no spectral peaks in the future AMS-02 spectral curves and excludes the supersymmetric DM_{WIMPs} hypothesis. This leading *DM*-hypothesis is excluded independently by the whole set of the biggest accelerator LHC-data at CERN, etc where SUSY-particles were never observed. More over, the reformulated - Cooper-like - composite $SUSY_{PWM}$ concept naturally arises in the PWM-physics, predicting experimentally hidden fermion/antifermion composites (see corresponding chapters below). The latest reports of a search for low-mass WIMPs with the Si detectors of the underground Cryogenic Dark Matter Search (CDMS) II showed only three events, which could correspond to the mass $m_{WIMP's} < 10$ GeV/c², but similar signals could give high-energy cosmic neutrons (Agnese et al. 2013). WIMPs at such low-masses are also theoretically disfavored in fits of some basic supersymmetry models (Baltz & Gondolo 2004).

PERIODICAL SINGULARITYLESS BLACK / WHITE HOLES IN THE PWM-MULTIVERSE

The multilayered waveguide hyperspace concept gives a novel Periodical Multilayered Waveguided Black Hole (BH_{PWM}) phenomenon, exactly free of common singularities, but with the same Schwarzschild radius as it is in the GR by Einstein. It is not so surprising, since the SR and EP are based (indirectly), as we could show above, on the thin quasiflat *3D-waveguide* in the *4D-Euclidean space* and the GR describes small deformations of its quasiflat boundaries, associated with the non-Euclidean-like geometrized gravity. Our definition of the Black Hole (BH) is very simple and natural for the Multiverse: The BH_{PWM} arises as a mono-layered quasicrystal defect – as a local “collapse” of the initial middle waveguide W_0 thickness L_{oe} to zero, consolidating two waveguide-framing membranes inside the MWBH. Roughly speaking, the W_0 .waveguide area must contain a critical quantity of elementary matter particles (elementary holes=elementary defects), (Fig. 10a), creating collapse of the L_{oe} -thickness to zero under an enormous reciprocal pressure of defectless vacuum cells, always existing around the waveguide W_0 and located in the nearest waveguides W_{-1} and W_1 , (Fig. 10b).

The *maximally possible symmetrical deviations* of the membranes \mathbf{M}_{-1} and \mathbf{M}_0 , framing the waveguide \mathbf{W}_0 , is $\delta L_{oe(gr)}(r) = -L_{oe} / 2$ for the \mathbf{M}_0 membrane and $\delta L_{oe(gr)}(r) = L_{oe}/2$ for the \mathbf{M}_{-1} membrane, correspondingly (see Fig. 10b). In this case they contact to each other and *consolidate* - build a topologically new - exactly equilibrium flat membrane-ball inside the BH_{PMW} . Our BH_{PMW} works as a restless vacuum “trash” exhauster, attracting and killing “defected” elementary matter holes around. It looks like a kind of a topological defect in the initially quasiflat periodical waveguide’s 4D-structure, acting proximally as a stable and properly $\approx 1/r$ gravitating mass M_{MWBH} . The BH_{PMW} creates a local topological “hole” in the \mathbf{W}_0 waveguide and the consolidation of the normally strictly divided framing membranes \mathbf{M}_{-1} and \mathbf{M}_0 realizes usually impossible local flat “bridge” - a direct contact between two normally strictly separated waveguides \mathbf{W}_{-1} and \mathbf{W}_1 . The BH_{PMW} looks like a stable, gravitating “scar” on the healthy body of our multilayered cellular vacuum structure.

We derive the BH_{PMW} Schwarzschild-like radius if we connect our soft waveguide’s gravity potential equation (8) and proximally the waveguide’s Newtonian gravity potential (12) arising as the deformed 3D-membranes, into the equation (30) using $\delta L_{gr}(r) = L_{oe}/2$:

$$\delta L_{oe(gr)}(r) \cdot \delta L_{oe(gr)}(R_{\text{Schw. BH}_{\text{PMW}}}) = L_{oe} / 2 \quad (63)$$

Our gravity equation, connecting deviation $\delta L_{gr}(r)$ with a Quasi-Newtonian ($\sim 1/r$) gravity potential (where G is the Newtonian gravity constant and M is spherical gravity mass), is following:

$$U_{gr}(r) = -GM/r = -\delta L_{gr}(r)C^2/L_{oe}, \quad (64)$$

and under the BH_{PMW} condition (63) it is now

$$-GM_{\text{MWBH}} / R_{\text{Schw.MWBH}} = -(L_{oe}/2) C^2/L_{oe} = -C^2/2, \quad (65)$$

$$R_{\text{Schw.MWBH}} = R_{\text{Schw.BH}} = 2GM_{\text{MWBH}}/C^2 \quad (66)$$

We have derived the same BH-Schwarzschild radius as predicted in the General Relativity (GR) by Einstein. In the GR, a black hole could exist of any mass, as it is assumed for the point-like mass particle (with practically endless point mass density – with a common classical GR-singularity in the center). Our quantized elementary mass particle concept avoids the GR-singularity – the point-like mass density and the proposed above BH_{PMW} also cannot have singularities in the quasi-crystalloid periodical waveguide’s hyperspace, since the $\delta L_{gr}(r)$ *never can be deeper than* $-L_{oe}/2$ and it is the lowest gravity potential $U(r < R_{\text{Schw.}}) = C^2/2 = \text{const}$, *ever possible* inside all possible BH_{PMW} .

We will roughly investigate this singularity-less MWBH (as a collapse of the central waveguide \mathbf{W}_0 and consolidation of its framing membranes \mathbf{M}_{-1} and \mathbf{M}_0), (like in a layered 3D-crystal defects) using a *neutron star* - the densest bulk matter known in Nature. Neutron stars have overall densities near $\rho_{\text{neutr}} \approx 10^{17} \div 10^{18} \text{ kg/m}^3$, comparable with the approximate huge density of an atomic nucleus of $3 \times 10^{17} \text{ kg/m}^3$ (North 1995, etc.). It is known that if the star accumulates matter at nuclear density and all stellar energy sources are exhausted, it would fall within its own Schwarzschild radius and would be a *stellar black hole*. The maximum mass of a neutron star is not well known, but is believed to be about 3 solar masses. There are no known processes that can produce BHs with mass less than a few times the mass of the Sun, ($M_{\text{Sun}} \approx 2 \times 10^{30} \text{ kg}$). The smallest known black hole was recently discovered by N. Shaposhnikov and L. Titarchuk at

NASA, it has the mass of 3.8 solar masses and the diameter of only $D_{BH}=2.4\times 10^4\text{m}$, i.e. $R_{BH}=D/2=1,2\times 10^4\text{m}$, (Lovett 2008). This tiny BH_{PMW} could be described naturally as a baby-MWBH, aroused from a mature neutron star with the same average density $\rho_{neutr.star}$. This proximal density could be roughly calculated, using a volume $V_{BH}=(4/3)\pi R_{BH}^3$ of this black hole, accounted for its radius $R_{BH}=1,2\times 10^4\text{m}$:

$$\rho_{neutr.star} \approx 3.8M_{sun}/V_{BH} = 3.8\times 2\times 10^{30}\text{kg} / (4/3)\pi (1.2\times 10^4\text{m})^3 \approx 10^{18}\text{kg/m}^3 \quad (67)$$

This neutron star density $\rho_{neutr.star}$ is near 10^{18}kg/m^3 and the estimated above average density of the very small BH ever found are quite the same. We derive from the (66) practically the same Schwarzschild radius, corresponding to the BH_{PMW} with 3.8 solar masses:

$$R_{Schw.MWBH} = 2GM_{MWBH}/C^2 = 2G\cdot 3.8\cdot 2\times 10^{30}\text{kg}/C^2 \approx 1.12\times 10^4\text{m} \quad (68)$$

Neutron stars with mass $1.5M_{sun} \div 3.8M_{sun}$ are “pregnant” with hidden black holes

Our simple analysis of the Newton-like gravity potential of a proximally homogenous neutron star shows gravity potentials U_{ns} as a parabolic function $U_{ns}\sim +r^2$ inside ($0<r<R_{ns}$) and it is usual Newtonian potential $U_{ns}\sim -1/r$ outside the neutron star ($r>R_{ns}$):

$$U_{ns}(0<r<R_{ns}) = GM_{ns}(r)/r + U_{ons} = G(4/3)\pi r^3\rho_{ns}/r + U_{ons} = G(4/3)\pi r^2\rho_{ns} + U_{ons} \quad (68a)$$

$$U_{ns}(r>R_{ns}) = -G(4/3)\pi R_{ns}^3\rho_{ns}/r \quad (68b)$$

These two potentials functions $\sim r^2$ and $\sim 1/r$ are equal on the star's surface $r = R_{ns}$

$$G(4/3)\pi R_{ns}^2\rho_{ns} + U_{ons} = -G(4/3)\pi R_{ns}^2\rho_{ns}, \quad \bullet \quad U_{ons} = -2G(4/3)\pi R_{ns}^2\rho_{ns} \quad (68c)$$

From the (68a) and (68c) we derive

$$U_{ns}(0<r<R_{ns}) = G(4/3)\pi r^2\rho_{ns} - 2G(4/3)\pi R_{ns}^2\rho_{ns} = \delta L_{gr}(r)C^2/L_{oe} \quad (68d)$$

The first-minimal point-like BH_{PMW} will arise inside the neutron star if $\delta L_{gr}(r) = -L_{oe}/2$ and two symmetrical potential's parabolas (Fig. 10b) will contact *pointy* with each other:

$$G(4/3)\pi r^2\rho_{ns} - 2G(4/3)\pi R_{ns}^2\rho_{ns} = \delta L_{gr}(r)C^2/L_{oe} = -C^2/2 \quad (68e)$$

This equation shows that the initial collapsing condition $\delta L_{gr}(r) = -L_{oe}/2$ is possible in the single tangent point at $r=0$ in the equation (68d). For this case we derive necessary mass of the neutron star, creating the point-like “*embryonic*” BH_{PMW} :

$$R_{ns}^2 \text{ with point } BH = C^2/[4(4/3)\pi\rho_{ns}G] = 3C^2/16\pi\rho_{ns}G \quad (68f)$$

This gives the neutron star radius $R_{ns}\approx 8.9\times 10^3\text{m}$ and the corresponding neutron star mass $M_{ns.(pointMWBH)} \approx 2.9\times 10^{30}\text{kg} \approx 1.5M_{sun}$ with the created point-like embryo- BH_{PMW} with zero $R_{Schw}=0$ and zero mass $M_{pointMWBH}=0$, (see Fig. 10b). This means that very small embryo-like BH_{PMW} are quite possible, but they arise only inside a huge & dense neutron stars centers. They cannot exist independently without a huge “pregnant mother” - the matured neutron star.

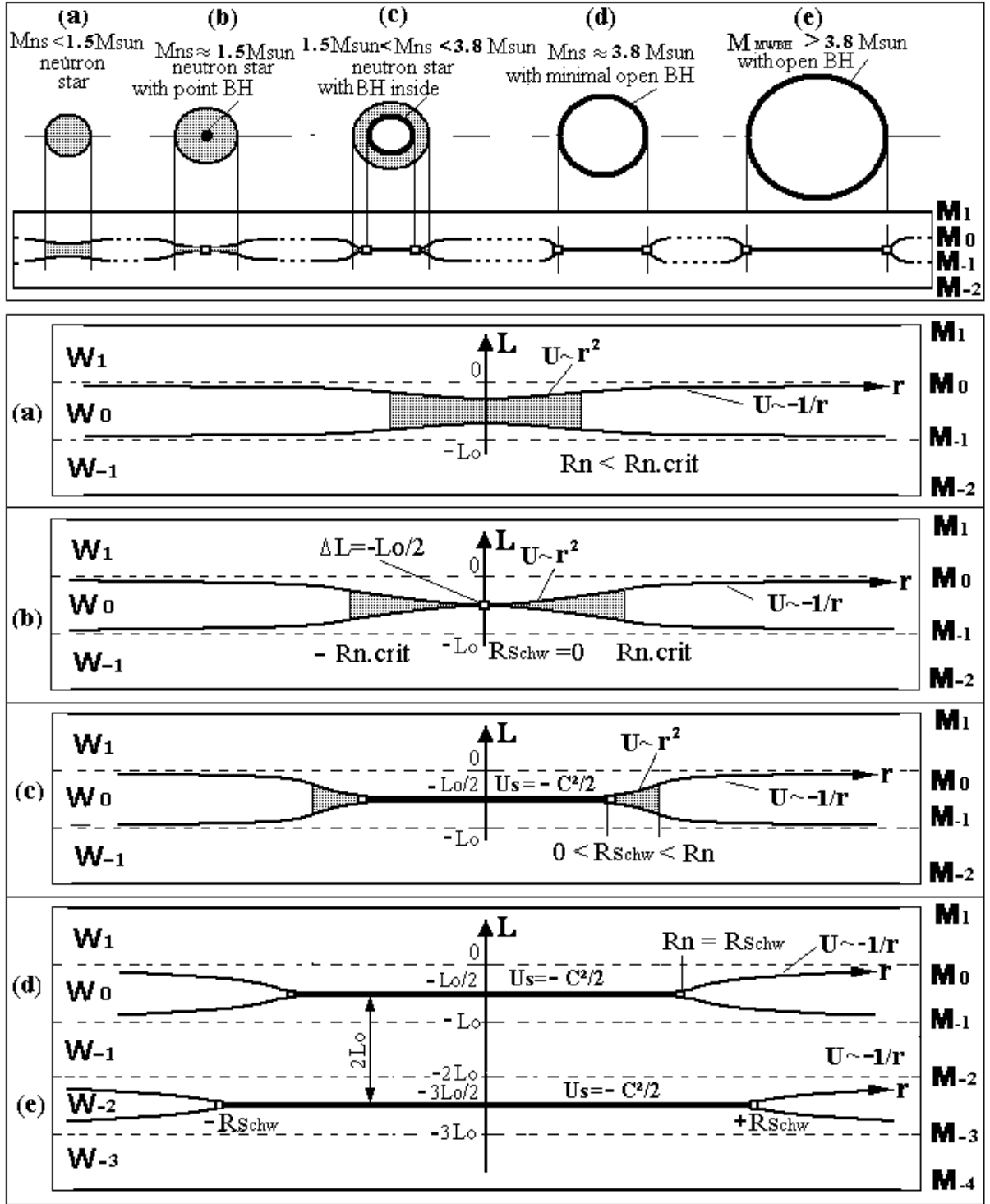

Fig. 10(a) shows small spherical neutron star with two symmetrically curved, but not contacting framing membranes M_1 and M_0 , realizing gravity $U \sim 1/r^2$ inside of the star and $U \sim -1/r$ outside the star radius, where $|\delta L_{gr}(r)| < L_{oe}/2$ (no black hole inside the neutron star);

Fig. 10(b) shows the minimal point-like hidden BH_{PMW} , if $\delta L_{gr}(r=0) = -L_{oe}/2$ creating “point-like” membranes M_1 and M_0 contact.

Fig. 10(c) shows bigger hidden BH_{PMW} inside of the neutron star with $0 < R_{Schw} < R_{ns}$, containing flat potential area $0 < r < R_{Schw}$, with the neutron matter shell $R_{Schw} < r < R_{ns}$ around it.

Fig. 10(d) shows the minimal open BH_{PMW} , when $R_{Schw} = R_{ns}$ without the neutron matter shell.

Fig. 10(e)+10(d) show two coupled open BH_{PMW} s, our (e) and “dark” BH_{PMW} (d), with the double $2L_{oe}$ waveguide thickness between them, if $r < R_{Schw}$.

We remember that ratio between the minimal *open* BH_{PMW} (Fig. 10d) and the L_{oe} -thickness is $R_{(open)Schw.min}/L_{oe} \approx 10^4 \text{m} / 10^{-12} \text{m} = 10^{16}$, so the $R_{(open)Schw.min} \gg L_{oe}/2$, and the r^2 -like or the $1/r$ membranes deformations have extremely tiny curvatures. It means that $\beta \approx 0$ is even here very good approximation and our basic equation for gravity acceleration $g = \beta C^2 / L_{oe}$ is quite correct for all BH_{PMW} regions. It is interesting that the BH_{PMW} looks gravitationally as very thin massive spherical surface, being “empty” inside - with the exactly flat inside gravity potential $U_{inside} = -C^2/2 = \text{constant}$, and it is the same for different BH_{PMWS}. They are free of singularity for all possible BH_{PMWS} masses! So, the full BH_{PMW}-mass is formally distributed on the 2D-surface of its Schwarzschild radius. This analysis, together with the derived (67) and (68) equations, shows that neutron star with the mass M_{ns} less when $1.5M_{sun}$ cannot contain hidden black hole inside (Fig. 10a).

Neutron stars with masses in the interval $1.5M_{sun} < M_{ns} < 3.8M_{sun}$ contain the *hidden* BH_{PMWS}, starting from the zero BH_{PMW} radius $R_{MWBH} \approx 0$, for correspondingly critical neutron star radius $R_{ns} \geq 8.9 \times 10^3 \text{m}$, (see Fig. 10b), growing to the *maximal hidden* BH_{PMW} radius $R_{MWBH} \approx 1.12 \times 10^4 \text{m}$, with transition to the *minimal open* BH_{PMW} with this radius (Fig. 10d).

The neutron matter (holes) totally disappear between the collapsed membranes and instead is created the minimal open BH_{PMW} without surrounding neutron shell, if $M_{MWBH} > 3.8M_{sun}$, (Fig. 10d,e). This analysis shows unexpectedly simple and rather new structural features of the neutron stars and black holes in the PWM, being fantastic singular incognito before.

Astronomers have found the most massive neutron star yet detected — one nearly twice the mass of our sun (Choi 2010). This discovery indicates that these stellar remnants really are made mostly of neutrons, but neutron stars with the masses $1.5M_{sun} < M_{ns} < 3.8M_{sun}$ contain and mask “embryonic” BH_{PMWS} inside.

It has mass $M_{ns} = 1.97M_{sun}$ and so, we can say that it must have a small “closed” BH inside. This mass value is inside the maximal possible neutron star mass $M_{ns} < 3.8M_{sun}$, since $M_{ns} = 3.8M_{sun}$ assumed to be transformed into the smallest open BH_{PMW}. Our proximal estimations are derived for $\rho_{neutr.star} \approx 10^{18} \text{kg/m}^3$ and this gives enough realistic maximal neutron star mass about $3.8M_{sun}$.

The BH_{PMWS} have surprisingly smooth gravity potentials (membranes deformations). It is easy to see that the BH_{PMWS}, placed in the “dark matter” waveguides \mathbf{W}_{-2} and \mathbf{W}_2 . the nearest to our central \mathbf{W}_0 waveguide, rapidly develop similarly centered, parallel BH_{PMWS} in these waveguides. This way could be created hyper-periodically prolonged and “darkly”-gravitationally - “one-to-one” – interacting, very long coupled dark L - <BH_{2N}-tubes. These L -axially coupled Periodical BH_{PMWS} have a sufficiently new - the doubled waveguide’s thickness $2L_{oe}$ inside $r < R_{Schw}$, where $dU/dr = 0$ and gravity field inside is zero (!), (see Fig. 10e,d). Virtual \mathbf{W}_{-1} -positron and \mathbf{W}_1 -positron inside the Periodical BH_{PMWS}-tubes behave exotically as particle and antiparticle to each other and are gravitationally confined inside these BH_{PMWS}-tubes. These periodical tubes contain a twice-lighter periodical ($e/2$)-vacuum with twice-lighter exotic electron- and positron-holes, etc.

These hyper-tubes work like a hyper-system, forming “spinal hyper-columns” what helps to explain why our \mathbf{W}_0 -Universe galaxies (with visible baryonic matter) were developed so quickly (being themselves too light for theirs formation tempo). The same \mathbf{W}_0 -BH_{SPWM}, being shifted - placed in the nearest “antimatter” waveguides \mathbf{W}_{-1} and \mathbf{W}_1 , will be repulsive for the \mathbf{W}_0 -Universe – they will repulse our \mathbf{W}_0 -matter and could be named as White Holes (WH_{PMW}). They also build the correspondingly gravitationally attractive - segment-to-segment coupled hyper-“spinal columns” of Periodical WH_{2N+1}:

...+ $\mathbf{W}_{-5\text{WH}}+\mathbf{W}_{-3\text{WH}}+\mathbf{W}_{-1\text{WH}}+\mathbf{W}_{1\text{WH}}+\mathbf{W}_{3\text{WH}}+\mathbf{W}_{5\text{WH}}+\dots$ of antimatter WHs on the contrary to the gravitationally segment-to-segment coupled hyper-“spinal columns” of the Black Holes BH_{2N} :
 ...+ $\mathbf{W}_{-6\text{BH}}+\mathbf{W}_{-4\text{BH}}+\mathbf{W}_{-2\text{BH}}+\mathbf{W}_{0\text{BH}}+\mathbf{W}_{2\text{BH}}+\mathbf{W}_{4\text{BH}}+\mathbf{W}_{6\text{BH}}+\dots$. The periodical hyper-spinal columns of the black holes BH_{2N} mutually gravitationally repeal the periodical hyper-spinal column of the white holes BH_{2N+1} .

Note: M. Begelman theoretically investigated similar possibility of “seed” black holes in super-massive stars, arising like our “closed” BH_{PMWS} inside the most compact - neutron stars. He calculated “how super-massive stars might have formed, as well as masses of their cores. These calculations allowed him to estimate their subsequent size and evolution, including how they ultimately left behind “seed” black holes (Begelman 2009).

THE UNITED $DE\&DM$ COSMOLOGY WITH EQUAL $\pm M_{gr}$ QUANTITY IN THE PWM

The large-scale cosmology with $\pm M_{gr}$ symmetry in the Multiverse

Famous cosmologist Jaan Eniasto writes: „Both Dark Matter and Dark Energy are the greatest challenges for modern physics since their nature is unknown” and the “realization that we do not know the nature of basic constituents of the Universe is a scientific revolution difficult to comprehend” (Eniasto 2010, p. 1). “We even do not know is a radical change in our understanding of the Newton and Einstein theories of gravitation needed...” (Id., p. 23). Indeed, there are tremendous cosmological discoveries of DM by Fritz Zwicky, Vera Rubin and DE-accelerating Universe expansion by Saul Perlmutter and colleagues, which vastly dominate Universe and need explanation (Perlmutter et al. 1999). Fritz Zwicky discovered the DM -phenomenon in astronomical studies of some rotating galactic groups. Later Vera Rubin and others discovered the DM in studies of stars rotation around galactic centers, (Zwicky 1933; Rubin et al 1970). The discovered DM is invisible for electromagnetic radiation, but it interacts gravitationally with the Ordinary Matter (OM) and sufficiently prevails the first one. The proposed below *holistic-Multiversal hyper-cosmology* (with the non-broken large-scale periodical matter/antimatter = gravity/antigravity symmetry and the resulting natural large-scale space flatness) solves these two problems simultaneously and shows that they are *deeply connected phenomena in our periodical Multiverse*.

The most intriguing consequence of the presented physical concept (going surprisingly far beyond the interests of physics itself) is opportunity to be surrounded by plenty of highly developed parallel civilizations, settled hyperspatially very densely ($\approx 5 C_4$ -light minutes from us in the 4D-hyperspace). Here arise fantastic possibilities to communicate with them - to become a member of their super-intelligent super-knowledgeable Hyperclub! From this point of view our dear, experienced civilization looks “hyper-historically” like a “nesting, hatching from an egg”.

Note: There are some hyperspatial physical theories along our PWM-concept, also creating some basic physical laws (the SR and gravity, CPT symmetry, etc.) using more than 3 Euclidean spatial dimensions and C -dynamical hyperspatial particles. One of them is the 6D-spatial model by Igor Urusovskii (Urusovskii 2003, 2005, 2010). This model describes a point-like dynamical 6D-particle, confined on a surface of the hypercylindrical tube by a kind of hypothetical cosmological force; the tube is placed along our 3D-space, reminding the compactified 5D-space by Theodor Kaluza (Kaluza 1921). The point particle twists around the tube with a quasi-light speed and its axial projection is its common physical velocity. This kinematical model has some definite similarities to our hyperspatial waveguided concept. The basic differences are following (1) our hypercylindrical tubes have emergent-quantized radiuses & masses, they are polygonal in the 3D-waveguide’s space and are topologically tori; (2) the confining cosmological force in the

PWM-concept is result of a quasi-optical non-linearity in the waveguide's 4D-medium, etc; (3) particles/antiparticles by Urusovskii (as also in the ST) are defined by the opposite twisting directions and charges, they live in the same hyperspace, but in the PWM-concept they live in two strictly *different-adjacent* waveguides, that creates the novel $\pm M_{gr}$ gravity charges symmetry and show sufficiently new cosmological reality, easily solving *DE&DM*-problems.

The $\pm M_{gr}$ -neutral matter-antimatter cosmological paradigm (Gribov 1999, 2005, 2012, 2013a,b; Ripalda 2010, Villata 2011, 2013) is in the total accordance with the SM and the corresponding Big Bang concepts, it provides a quite universal and simple solution for the most fundamental and mysterious cosmological problems named the *Horizon Problem*, the *Flatness Problem*, the *Repulsive Dark Energy Problem*, the *Accelerating Expansion Problem*; the large-scale *Bubble-like Structure Problem*. We can solve these problems simultaneously if we keep our fundamental background condition - the zero vacuum energy, generic for the hyper-symmetric vacuum – and suppose the full conservation of the large scale $\pm M$ baryon-antibaryons matter *symmetry*, i.e.

$$\sum(+M_{gr(\text{baryonic})} - M_{gr(\text{antibaryonic})}) = \sum M_{gr} = 0, \quad (69)$$

across the whole evolution of our matter - Universe, being an organic, indivisible part of the periodic matter-antimatter Multiverse. The repulsive - counterpart $-M_{gr(\text{antibaryonic})}$ functions quite similar to the hypothetical cosmic “quintessence” medium, proposed in (Caldwell, et al 1998), needed for the flatly Multiverse: our repulsive ($-M_{gr}$) antimatter (DE) and DM matter plus dark matter also are evolved equally-dynamically, they develop fluctuations, co-participate in the microwave background anisotropy, etc. Crucial here is that our cosmological paradigm of the hyper-periodic large-scale $\pm M_{gr}$ -neutrality is not some kind of isolated hypothesis, rescuing physics but it has fundamental generic roots in the hypersymmetric microscopic quantum vacuum structure, compatible with the periodically “cloned” hypersymmetrical SM- and underlying classical physics. The $\pm M_{gr}$ in the periodic matter/antimatter Multiverse (see Fig. 13a,b,c) is connected with significantly improved Einsteinian $+M_{gr}$ gravity concept and with arising here overall simplicity – the Cooper-composed QED-supersymmetry - zero vacuum energy density, (Gribov 2003, 2005, 2012, 2013a).

Resent, very fine astronomical observations showed strong evidences not only for very large-scale cosmic antigravity (Perlmutter et al 1999), but it was found also the astronomically short distance antigravity evidences at about 2÷5 Mps, existing around some galaxies groups (Chernin et al 2009). The “local antigravity” studies observed matter flows around galaxies clusters, starting from the centered attraction zone (flows-in) with some radiuses $R_{attractive}$ to a neutral zone $R_{neutral}$ without gravity and to the most interesting repulsive zone with $R_{repulsive} > R_{neutral}$ – with corresponding quasi-spherical outflow. The observed minimal $R_{repulsive}$ was about 2Mps from the cluster center (Chernin et al 2009). This means, accordingly our symmetric matter/antimatter Universe, it could be a proximal typical distance between matter and antimatter clusters, being today so far away from each other (2Mps $\sim 6 \times 10^6$ ly $\sim 10^{20}$ km). This is too large distance for cosmic space travels (if we want to transport the antimatter “fuel” from the unlimited antimatter sources to the Earth (Gribov 2007). This huge distance explains why the matter/antimatter symmetrical Multiverse is saved so well from their annihilation and why it is so difficult to experience and imagine the symmetrically existing matter and antimatter cosmos. They are enormously repulsed-separated now in the endless cosmic space. Indeed, the fundamentally important mentioned above global and “local antigravity” findings support the symmetrical matter/antimatter Universe concept. This concept is also in a total harmony with the universally observed today and fundamentally important - the fractal “empty bubble” Universe structure. These fundamental cosmological data can be very easily explained by the periodic matter /antimatter - gravity/antigravity effects in the periodic Multiverse (Fig. 12).

If we have only *asymmetric – the attractive matter* in our Universe and if only the constant vacuum energy density itself is a full drive of the recently observed macro-cosmic antigravity, we must observe many huge massive matter islands, locating somewhere in a middle of some existing cosmic bubbles. Why real cosmic bubbles are surprisingly *EMPTY* inside?

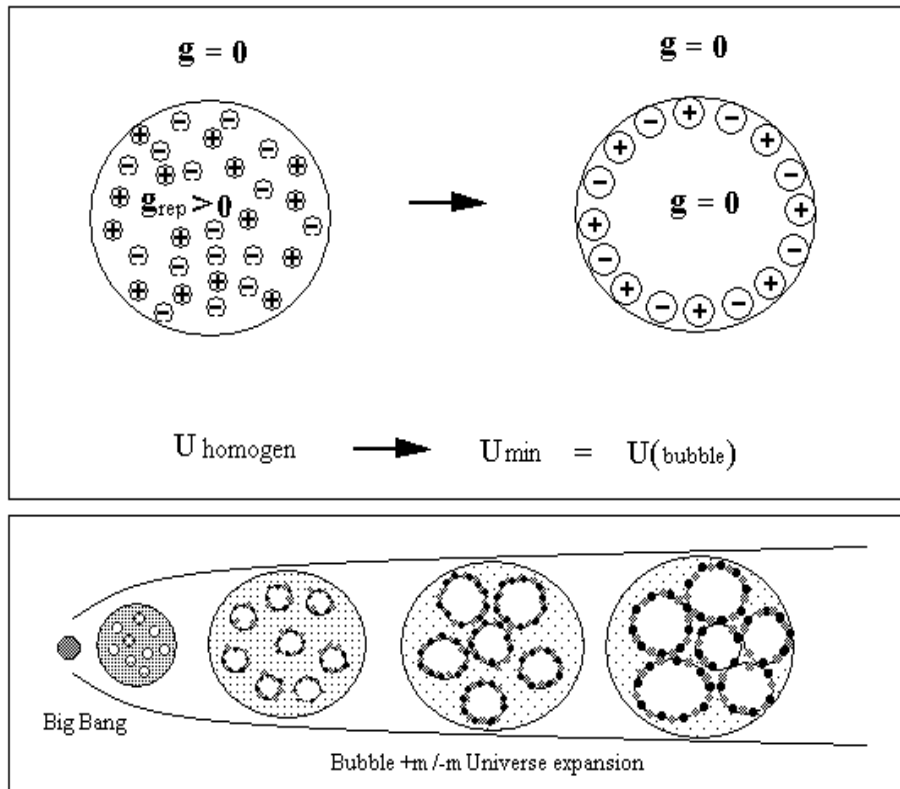

Fig. 12 (above) shows cosmic evolution, minimizing the potential gravity/antigravity energy $U_{grav/antigrav}$ (resulting in creation of empty and growing mini-bubbles) in a quasi-homogeneous *neutral* 3D-mixture of the equal $+m$ and $-m$ “powder”, consisting from matter and antimatter seeds, with arising sporadically local repulsive antigravity fields $g_{rep\ inside}$ between these seeds inside this voluntary spherical region, so $g_{rep\ inside} > 0$ in this spherical space volume. At the same time there is no antigravity fields $g=0$ outside of this sphere, producing from the same inside $+m$ and $-m$ seeds, containing the zero summary gravity mass (see the left sphere). This homogeneous state intends to be transformed into the spherical “bubble” state with a devastated inside volume with spherically symmetrical 2D-distribution of the $\pm m$ seeds on the spherical surface. In this case we have the same zero outside gravity field $g=0$, but all inside particles are devastated by the \pm repulsion (the right bubble). The both states show that the minimal potential energy $U_{min}=U_{bubble} < U_{homogen}$ and so, the homogeneous “powder” will revolute to the locally created devastated mini-bubbles everywhere, minimizing the summary potential energy.

Fig. 13 (below) shows resulting bubble Universe states (with more and more expanding bubbles radiuses), as it is indeed everywhere in our expanding Universe! The summary potential gravity/antigravity energy of the “powder” is decreased and the powder behaves as a decompressing bubbled-spring, accelerating the Universe expansion with asymptotically constant speed of ever expansion without acceleration.

The void in Böotes with a diameter of 60 Mpc was discovered some decades ago (Kirshner et al 1981). Observations have shown the existence of many similar voids and computer analysis of galaxy distribution gave evidence that voids occupy about 50% of the volume of the Universe and their “bubble” structure practically dominate everywhere (El-Ad & Piran 1997).

Several models have been proposed to explain the origin and dynamics of the bubbles “but until now, no exhaustive and fully consistent theory has been found”. (Capozziello et al 2004). Traditional theories supposed “voids are the consequence of the collapse of extremely large wavelength perturbations into low-density black holes and of the comoving expansion of matter surrounding the collapsed perturbations” (Capozziello et al 2004). The voids-theories with the exclusively attractive matter try to survive the void creation and the further voids stability by the very unlikely claim that in the center of each void must be an enormous black hole, exactly compensating its disappeared mass (Stornaiolo 2002).

The unnatural need of the super-huge “black holes” in the optically empty bubble centers is the straight result of the common asymmetric matter-dominating concept with only attractive positive matter gravity mass, filling our Universe. Antigravity was proposed later as the hypothetically *repulsive vacuum energy*, which has a constant density, independent of the Universe expansion. But the existing cosmic bubbles keep these hypothetical - super-heavy central black holes as a total incognito, on the contrary to the galactic black holes, being enough well detectable inside very dense galactic centers. Disability to explain the voids emptiness and their miracle fractal emergence everywhere seems to be for us one of the strongest - decisive cosmological contra-argument to the common asymmetric (+matter) Universe concept and to common hypothesis of the repulsive dark energy of vacuum itself.

On the contrary, the large-scale periodic matter/antimatter antigravity is the natural self-enough drive to the bubbles creation and the continual accelerating expansion of the repulsive Universe’ foam, where matter and antimatter clusters are neutrally-symmetrically distributed along these very-very huge bubble’s surfaces, so that the large scale gravity mass density on the bubbles surfaces is zero.

Very natural spherical bubbles creation alone from the always symmetrically presented repulsive matter and antimatter “powder”, initially produced via common (but never unbroken in the PWM) Big Bang matter/antimatter symmetry, strongly supports our basic concept of the matter-antimatter symmetry – decisive from the microscopic (e^-/e^+) vacuum level till to the global – large-scale level and the whole Universe & PWM hyper-complex. The antigravity of the antiparticle in the multi-waveguide hyperspace also allows physical reformulation of the microscopic vacuum supersymmetry concept, which creates corrected physically QED without common monstrous singularities - with experimentally verified ~ zero vacuum energy.

The cosmological – large-scale matter/antimatter symmetry explains simultaneously (as it is common for our wise grandmothers) (a) the “yeast dough” of the growing voids (Fig. 12, 13) the corresponding Universe repulsive expansion and (c) the mysteries nature of the here deeply related *DM* and *DE* (see the chapter below).

How could we distinguish matter clusters from antimatter clusters in our Universe? Optically it looks impossible – photons and anti-photons are well detectable, electromagnetically indistinguishable particles, but we could try to detect and distinguish neutrinos bursts of newborn matter neutron stars and correspondingly the antineutrinos bursts from new-born antineutron stars. This is the principle possibility, but we must now take in account so very big distance ($R \sim 10^{20}$ km) to the nearest antimatter clusters, creating the antineutron bursts. Who could detect such a small antineutrino-bursts till now? Indeed, as we know, nobody ever detected these events, since the antineutrinos bursts from the antimatter sources are too far away (comparably to the mentioned above neutrino bursts sources, created by the surrounding us matter cluster) and the antineutrino-antimatter signals are too small.

Periodic repulsive matter/antimatter clusters drive the Multiverse-DE expansion

The described Multiverse expansion creates huge parallel Multiverse bubbles with periodic parallel $+m$ matter and periodic $-m$ antimatter clusters, distributed on the bubbles walls. Fig. 13a,b,c show bunch of parallel Universes/Anti-Universes W_{2n} / W_{2n+1} , driving this accelerating expansion. These parallel multi-clusters/multi-anticlusters are built from aggregations of periodic dark (gravitationally attracting each other) W_{2n} galaxies and dark (the same way attracting each other) W_{2n+1} antigalaxies. This hyperspatial gravitational interaction is clearly a *very short-distance interaction via the L-dimension* in our waveguide's gravity concept (it involves directly only the nearest $n=n_0 \pm 2$ waveguides).

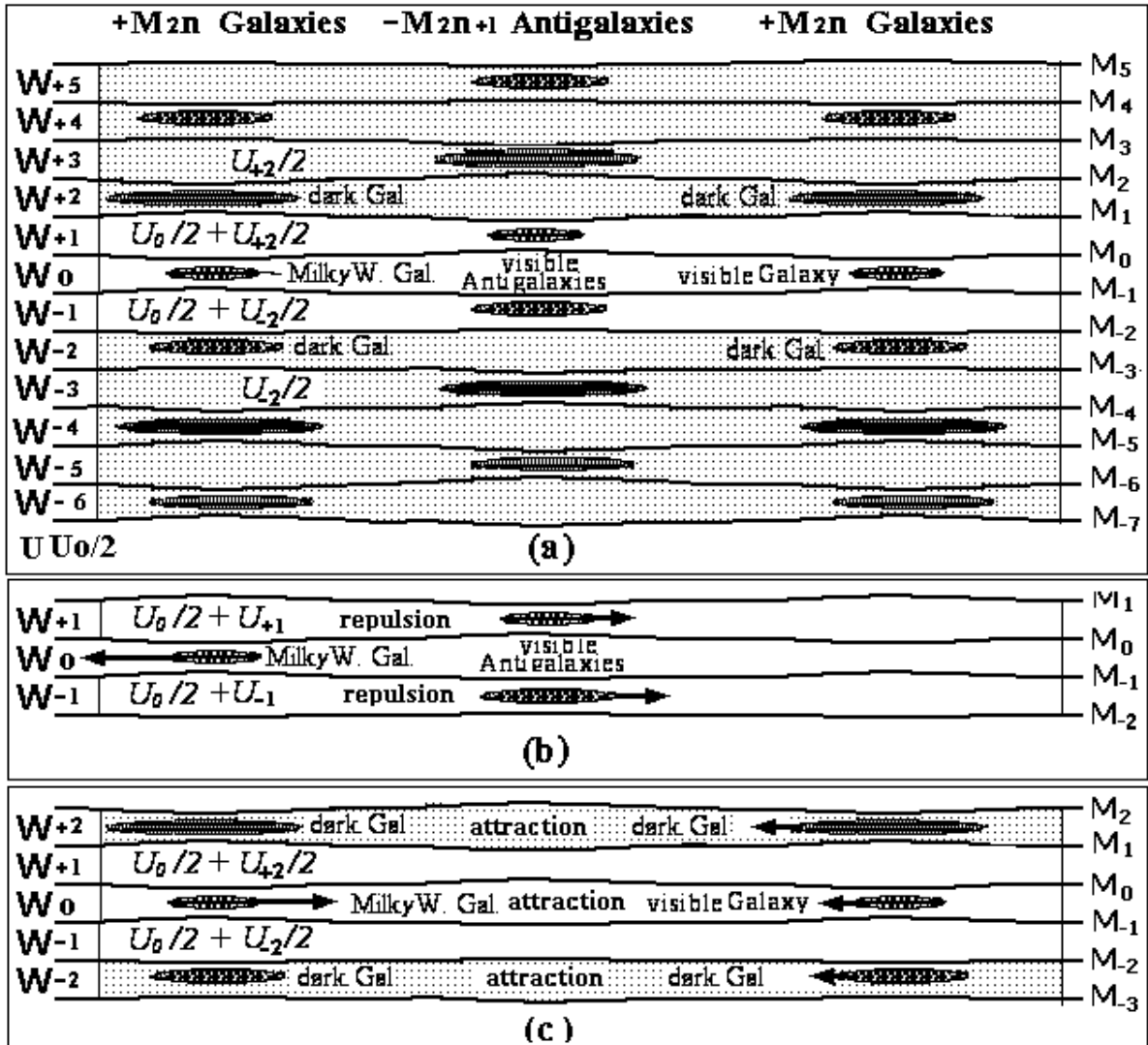

Fig. 13a shows parallel Universes/Antiuniverses W_{2n} / W_{2n+1} .
Fig. 13b shows repulsive antigravity between all the nearest matter/antimatter waveguides, e.g. between W_{-1} (antimatter), W_{+1} (antimatter) and our matter W_0 Galaxies.
Fig. 13c shows attractive gravity between the nearest “dark” waveguides (e.g. between W_{-2} Dark Matter, W_{+2} Dark Matter) and our Matter W_0 Galaxies.

Fig. 13a shows parallel Universes/Antiuniverses W_{2n} / W_{2n+1} . The visible W_{-1} (antimatter), W_{+1} (antimatter) Universes are adjacent to the W_0 (our matter)-Universe and have *two joint framing membranes* M_0 and M_{-1} , carrying two joint electrostatic potentials. Our Milky Way Galaxy is surrounded by two the nearest *DARK MATTER* Galaxies W_{-2} and W_{+2} with *two joint gravity waveguides* W_{+1} and W_{-1} and our Galaxy acquires the corresponding joint gravity potential

$U_{MWG}=U_{0MWG}+U_{+2}/2+U_{-2}/2 \approx (5\div 10)U_{0MWG}$, but the \mathbf{W}_0 has no joint chargeable membranes with the \mathbf{W}_{-2} and \mathbf{W}_{+2} Universes and is electrostatically isolated from them – resulting the absence of the electromagnetic interactions (and invisibility) between our matter and DM in the \mathbf{W}_{-2} and \mathbf{W}_{+2} Universes.

For example, our central waveguide \mathbf{W}_0 contains the visible $+M$ matter with the Milky Way galaxy, with its gravity potential $U_{VisibleMilkyWay}$. Its positive gravity mass interacts *attractively* with two the nearest dark matter galaxies (shadow-dark Milky Way galaxies), centered in the waveguides \mathbf{W}_{-2} and \mathbf{W}_{+2} . They carry two corresponding gravity potentials: $U_{+2DarkMilkyWay}$ and also $U_{-2DarkMilkyWay}$, *half-acting* from *two joint deformed waveguides* \mathbf{W}_{+1} and \mathbf{W}_{-1} above and below correspondingly. So, our visible Milky Way galaxy “gravitationally senses” only half of these “dark” gravity potentials, added to our Milky Way gravity potential $U_{VisibleMilkyWay}$ and acquires the corresponding joint gravity potential $\Sigma U_{MilkyWay}$:

$$\Sigma U_{MilkyWay}=U_{VisibleMilkyWay}+U_{+2DarkMW}/2+U_{-2DarkMW}/2 \approx (5\div 10)U_{VisibleMilkyWay} \quad (69a)$$

The nearest shadow \mathbf{W}_{-2} and \mathbf{W}_{+2} DM -galaxies contain the summary gravity potential near $2(5\div 10) U_{VisibleMilkyWay}$, empirically estimated by cosmologists. Our matter galaxies have their attractive (visible and dark, Fig 13c) matter neighbor galaxies in the *even-attractive* waveguides \mathbf{W}_{2n} and correspondingly periodic repulsive antimatter neighbor’s antigalaxies (visible and dark) in the \mathbf{W}_{2n+1} - the *odd-repulsive* waveguides (see Fig. 13b). The basic physical laws are exactly the same in the whole periodic Multiverse structure – it is assumed to be quasi-identical periodic waveguides structure and we know today a lot of these physical laws. What we yet don’t know – is their parallel existence and definitive interaction between our and theirs “cellular defects”, manifesting our matter or antimatter particles. Namely here we find the DE and the DM simultaneously! The visible \mathbf{W}_{-1} (antimatter), \mathbf{W}_{+1} (antimatter) Universes are adjacent to the \mathbf{W}_0 (our matter)-Universe and have *two joint framing membranes* ($\mathbf{M}_0, \mathbf{M}_1$) carrying two joint $\frac{1}{2}$ electrostatic potentials of our matter particles. These identical partners interact (attractively) electrostatically as electron and positron. At the same time they repulse each other gravitationally and the same symmetrical way, realizing here the “anti-equivalence” principle, transforming the Einstein’s GR.

The underlying new $\pm M$ -symmetry and corresponding multi-waveguide features with periodic atomistic (e^-/e^+) structure, realizing our nongravitating vacuum, create physical origin of two fundamental “hidden” symmetries, discovered in the 19th century (Lorentz-Einstein invariance and gauge invariance, generating Special Relativity and massless Maxwell fields in the generic quantum electrodynamics (QED) “that as we now know, literally hold the key to the secrets of our Universe”, and he ask further that may be some other symmetries are hidden and are not discovered, may be they could explain existing physical troubles (Zee 2003, p. 457). The proposed here new - fundamental periodic hypersymmetry, indeed is deeply hidden in our huge matter cluster, but it is crucial not only for the physical microcosmos – elementary particle physics free of singularities, including the Standard Model, it is crucial for understanding the large-scale (now the $\pm M_{gr}$ -neutral) Multiverse.

Note: The described above hyper-columns of parallel dark galaxies / dark antigalaxies could arise from a simultaneous hyper- (Big Bang), providing all hyper-“floors” of the Multiverse with expanding periodic defects/anti-defects.

The nature of $2L_0$ -periodic dark matter in the PWM

Some basic, necessary DM -particles properties (which are totally fulfilled in the DM_{PWM} concept), were shortly summarized by Valerii Rubakov as following: “The DM particles must be

stable during the universe history. Behind must be new conservation law, forbidding decay of these particles. *DM* particles interact extremely weakly with our matter, otherwise they would have already been found in terrestrial experiments” (Rubakov 2005).

The most realistic candidates to the cold *DM*-particles usually assumed to be the SM-connected *supersymmetric* SUSY-WIMPs, because they are heavy and dark - weakly interacting with our usual matter. The *DM*-WIMPs *must be cold*, that show simulations of a universe full of cold *DM* (Conroy et al, 2006). These particles were not yet detected in the most sensitive detectors of *DM*, e.g. at PICASSO (Aubin et al 2009). Latter observations also claimed “exclusion of canonical WIMPs by the joint analysis of Milky Way dwarfs with data from the Fermi Gamma-ray Space Telescope” (Geringer-Sameth & Koushiappas 2011). On the other hand, the underlying SUSY itself (as theoretical basis for the SUSY-WIMPs in the direct particles/sparticles_{SUSY} form) was also never supported experimentally. So, we need some other “cold & dark” alternatives to the WIMPs.

The periodic *DM_{PWM}*-candidates, presented in this paper, are exactly *the same, but dark SM-baryons* (indeed very stable protons, nucleons, etc), existing in the same form as in our Universe **W₀** and as in all other dark matter Universes **W_{2n}** including our DM-partners *DM_{2,+2}* (Gribov 2012, 2013a,b). Their baryons have the same inertial mass as our Ordinary Matter (OM) baryons, but their quantity in the most of *DM_{2,+2}*-galaxies is ~10 times bigger than in our *OM₀*-galaxies. They are electro-dynamically dark, because they are **W₋₂** and **W₊₂** shifted, but they still keep ½ gravitational interaction with our matter particles. The *DM_{PWM}*-candidates are naturally cold (as our baryonic matter now), correspondingly to the observed galactic structures. According the PWM-concept they behave cosmophysically as two cold, symmetrical, monstrously enlarged dark “mirror images” – dark gravitational galactic partners of our cold baryonic matter.

The PWM-concept postulates periodic waveguides **W_n[x,y,z,nL₀<L<(n+1)L₀]** Universes in the global 4D-space [x,y,z,L], being divided-separated by equal - very thin strained 3D-membranes **M_n[x,y,z,nL₀]**. Such 3D-membrane behaves like common thin membrane-like interface between two media (like water and oil). These membranes have a total internal reflection (complete waveguided confinement) for elementary quasiparticles living inside these waveguides. All Universes **W_n** have the same physical laws and contain the same elementary particles as our Universe. **W_n** Universes are placed periodically with period $L_0 = \lambda_{\text{electronCompton}} \sim 10^{-10} \text{cm}$. The value of this period L_0 is naturally defined as the first harmonic in the transverse 3D-waveguide, which is equal to the minimum mass particle's rest mass – rest mass of electron. Thus, our ~ 3D-Universe is only a very small part of the PWM – it is the pico-thin 3D-waveguided layer **W₀** in an infinite number of parallel waveguided Universes/Antiuniverses:

... |**W₋₄**| |**W₋₂**| |**W₀**| |**W₂**| |**W₄**|(mutually dark **W_{2n}**-Universes),
|**W₋₃**| |**W₋₁**| |**W₁**| |**W₃**| |**W₅**| ... (mutually dark **W_{2n+1}**Antiuniverses)

Any two adjacent layers **W_{2n}** и **W_{2n+1}** contain matter +*M_{2n}* and antimatter -*M_{2n+1}*, which gravitationally repel each other. Thus the giant 2*L₀*-periodical **W_{2n}**-galactic columns and **W_{2n+1}** antigalactic columns form a gravitationally repulsive Multiversal - gravitationally neutral 4D-system, creating reliable separation of matter and antimatter clusters. This united picture discloses the cooperative-hyperspatial (poly-Universal/Antiuniversal) phenomenon of *DE&DM* in the PWM (Fig. 13.1 below), (Gribov 2012, p. 72).

All *even* **W_{2n}** Universes, including our Universe **W₀**, are mutually *dark* to each other - they are electrostatically isolated from each other by the intermediate-*odd* layers of **W_{2n+1}** Antiuniverses.

The corresponding $2L_0$ -periodic $+M_{2n}$ as the DM_{2n} -layers have the same pico-short range of $2L_0$ -periodic = pairwise - gravitational attraction (I):

even $+DM_{2n}$... $[+M_{2n} | +M_{2n+2}]$... pairwise gravitational attraction (I)
 odd $-DM_{2n+1}$... $[-M_{2n+1} | -M_{2n+3}]$... pairwise gravitational attraction (II)
 even/odd $(+DM_{2n} / -DM_{2n+1})$... $[+M_{2n} | -M_{2n+1}]$... pairwise gravitational repulsion (III)

$+M_0 \leftrightarrow +M_0$ $(-e_0; -e_0);$ $(+m_0; +m_0)$ attractive gravity gravity; electrostatic repulsion	$+M_0 \leftrightarrow -AM_{.1}$ $(-e_0 / +e_1);$ $(+m_0 / -m_{.1})$ repulsive gravity antigravity; electrostatic attractions	$+M_0 \leftrightarrow +DM_{.2}$ $(-e_0 // -e_{.2});$ $(+m_0 // +m_{.2})$ dark 1/2- attractive gravity; zero electrostatic interactions	$+M_0 \leftrightarrow -DAM_{.3}$ $(-e_0 /// +e_{.3});$ $(m_0 /// -m_{.3})$ zero gravity interactions; zero electrostatic interactions.
<p>(a)</p>	<p>(b)</p>	<p>(c)</p>	<p>(d)</p>

Fig. 13.1(a,b,c,d) The corresponding gravity potentials are created by
 (a) two gravitationally $2F_{gr}$ -attracted matter electrons e_0 and e_0 in the same waveguide W_0 ;
 (b) two symmetrically $2F_{gr}$ -repulsed electrons e_0 and positrons e_{-1} (L_0 -step shifted e -holes);
 (c) two F_{gr} -attracted electrons e_0 and dark electrons e_{-2} ($2L_0$ -steps shifted e -holes);
 (d) gravitationally non-interacting electrons e_0 and dark positrons e_{-3} ($3L_0$ -steps shifted e -holes).

The attraction (I) leads to formation and growth of periodic galactic L -columns $+M_{2n}$ of the $+DM_{2n}$ in the PWM, gravitationally attracting each other.

The odd W_{2n+1} Antiuiverses behave identically – they are also dark to each other – electrostatically isolated by the intermediate layers W_{2n} . They also form $2L_0$ -periodic antigalactic L -columns $-M_{2n+1}$ of the Dark Antimatter ($-DM$), which have also $2L_0$ -periodic mutual gravitational attraction ... $[-M_{2n+1} | -M_{2n+3}]$... along each antimatter-column in the PWM. These antimatter L -columns $-M_{2n+1}$ also gravitationally attract each other.

L_0 -periodic galactic Matter-Antimatter layers ... $[+M_{2n} | -M_{2n+1}]$... have the L -pico-short range of the L_0 -periodic = pairwise-gravitational repulsion (III) and create repulsion between all $+M_{2n}$ matter of the $+DM_{2n}$ galactic L -columns and the $-M_{2n+1}$ antimatter of the $-DM_{2n+1}$ antigalactic L -columns (Fig. 13 above).

The PWM-prediction of the detectable double-layered DM-structure

The first and the most famous direct DM observation by Markevitch, Clove and coauthors was related to the Bullet Cluster, where two huge colliding-stripped DM components were discovered. They behaved unexpectedly – two colliding DM components went through each other practically without visible collisional interaction, but at the same time two comoving colliding Ordinary Matter (OM) components showed naturally expected decelerating interaction (Markevitch et al 2003; Clove et al 2006). Other direct observation by Jee and coauthors of collisional-stripped DM components in the next huge cluster A520, on the contrary, showed

definite collisional interaction between these two collisional DM partners (Jee et al 2012). The A520 direct observation showed an unexpected “counterexample to the Bullet Cluster”, where collision-stripped DM parts definitely interact with their collisional partner (Jee et al p. 1). They even wrote in this article’s title: “The mystery deepens”! Williams & Saha (2011) also claimed significant detection of light/mass offsets in the cluster A3827, which can be interpreted as evidence for collisional dark matter. These data suggest that “the a kpc-scale separation between stellar and dark matter components in the cluster A3827 may be evidence for dark matter with a non-negligible self-interaction crosssection” and “...the current improvement in precision only increases the significance of the above discrepancy.” (Jee et al, 2012, p. 7).

The two-component DM_{PWM} composition explains the mentioned above collisional discrepancy, if we remember that cosmic observations show various proportions of DM/OM in different galaxies and galactic clusters:

Bullet Cluster presents non-interacting case, because its two massive colliding DM -components are hyperspatially separated as DM_{-2} and DM_2 and are placed in two symmetrical dark Universes W_{-2} and W_{+2} . They are huge and both attractive to our OM (so, detectable), but they are out of mutual gravity interaction between each other. Indeed, they show the negligible “self-interaction”, according the nature of the DM_{PWM} -gravity:

<i>Bullet Cluster $DM_{2,-2}$ before collision</i>	<i>Bullet Cluster $DM_{2,-2}$ after collision</i>
$W_2 \quad DM_2 \rightarrow$	$W_2 \quad DM_2 \rightarrow$
$W_0 \quad OM_0 \rightarrow \leftarrow OM_0$	$W_0 \quad OM_0 \rightarrow \leftarrow OM_0$
$W_{-2} \quad \leftarrow DM_{-2}$	$W_{-2} \leftarrow DM_{-2}$

Abel 520 and A3827 present a non-negligible self-interaction cases, because the colliding DM components DM_{-2} and DM_2 are not hyperspatially separated as it is shown below:

<i>Abel 520 and A3827 before collision</i>	<i>Abel 520 and A3827 after collision</i>
$DM_2 \rightarrow \leftarrow DM_2$	$DM_2 \rightarrow \leftarrow DM_2$
$OM_0 \rightarrow \leftarrow OM_0$	$OM_0 \rightarrow \leftarrow OM_0$
$DM_2 \rightarrow \leftarrow DM_2$	$DM_2 \rightarrow \leftarrow DM_2$

The Horizon problem in the Multiverse

This problem is a conflict between causality versus the large-scale isotropy and homogeneity versus density fluctuations of the Universe. In the initially homogenous and symmetrical $\pm M_{gr}$ baryonic matter we have an average repulsive-attractive gravity that has the dominating large-scale *repulsive potential*. This negative pressure was much higher in the early Universe, being much denser initially. Namely that very high negative pressure provided a very high expansion rate $R(t) \approx t^n$ ($n > 1$) for the very early Universe. It is common that the very high (solving the Horizon Problem) expansion requires "the pressure to become negative, which makes it inadmissible in a Standard Model with positive pressure (Guidry 1991, p. 498). But we see that the $\pm M_{gr}$ antigravity Multiverse makes this quite possible and even unavoidable! In addition, we have on the smaller scale the local attractions between $+M_{gr}$ with $+M_{gr}$ matter and the same local attractions between $-M_{gr}$ with $-M_{gr}$ antimatter particles driving to their fluctuating consolidation, building growing / and simultaneously anti-gravitationally separating galaxy and anti-galaxy clusters.

The accelerating expansion and Dark Energy problems in the Multiverse

Modern fundamental physics recognizes, as writes Valerii Rubakov, “The nature of the dark energy is the main mystery of the fundamental physics of the XXI century” (Rubakov 2005). The above-mentioned repulsive $\pm M_{gr}$ gravity potential - the negative pressure - immediately explains very surprising recent observations data of the accelerating Universe expansion - the Accelerating Expansion Problem (Hinshaw 2008). This acceleration is simply impossible (and must be deceleration) from the point of view of the common asymmetrical $+M_{gr}$ physics. Our Newtonian estimations of ratio between repulsive and attractive parts of the gravity potential energies in the symmetrical $\pm M_{gr}$ distributions with different spatial configurations (but with zero average gravity mass density on the large-scale) give about 65%÷70% for the repulsive part - Dark Energy (DE) = repulsive energy between matter and antimatter) and 35%÷30% for the attractive part, correspondingly - near to the latest Planck’s satellite data. The attractive energy part means the Newtonian attractive gravitational energy of matter-matter + DM, or antimatter-antimatter + dark antimatter, including here the Dark Matter (DM) and our Ordinary Matter (OM) components.

The WMAP, measurements of cosmic microwave background (CMB) anisotropies, produced recently by spacecraft indicate that our Universe is very close to flat and correspondingly $DE:(DM+OM)\approx 74\%:26\%$, where $DM\approx 22\%$ and Ordinary Matter (OM) $\approx 4\%$, (Hinshaw 2008). We will investigate below (for a short illustration) the simplest - flat, two-dimensional galactic cluster’s-cell, built from 4 symmetrically places gravity masses $+m_{gr}; -m_{gr}; +m_{gr}; -m_{gr}$ with the summary zero gravity mass density (Fig. 14a).

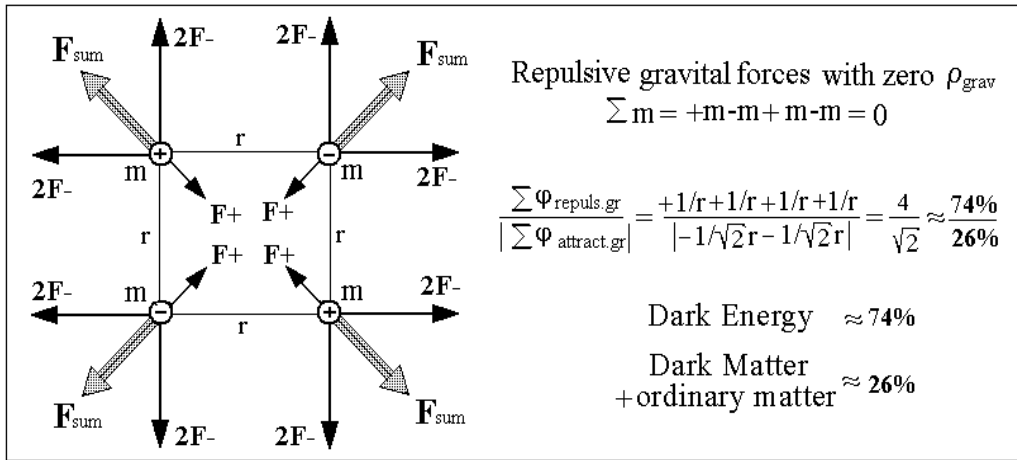

Fig. 14a shows a quasiflat, two-dimensional (here quadratic for simplicity) matter clusters/ antimatter clusters - Module from 4 symmetrically places gravity masses $+m_{gr}; -m_{gr}; +m_{gr}; -m_{gr}$ with the summary zero gravity mass.

$$|\sum U_{gr-rep.}| / |\sum U_{gr-attr.}| = |-4G(+m_{gr})(-m_{gr})/r| / |[-G(+m_{gr})(+m_{gr})/r\sqrt{2}] - G(-m_{gr})(-m_{gr})/r\sqrt{2}| = 4/\sqrt{2}$$

$$|\sum U_{gr-rep.}| / |\sum U_{gr-attr.}| \approx 74\% / 26\% \tag{70}$$

So, the simplest elementary 2D-flat zero-gravity-mass module expresses proximally the same numerical proportion $DE:(DM+OM)\approx [74\%:26\%]_{P_{WM}}$ as was measured in the recent WMAP observations, mentioned above. Why the presented 2D-module is so instructive? The enormously huge cosmic babbles have very thin bubbles walls - very thin $\sim 2D$ -monolayers – constructed

from similar neutral *2D-modules* (appearing everywhere on the large-scale Universe, carrying symmetrical quantity of matter and antimatter).

Recently was published a purely geometric, independent - the Alcock–Paczynski - test of the Universe expansion, also confirming its flatness and accelerating expansion. The *DE* - the antigravity part estimation, responsible for the accelerative expansion, is here between 60%-80% (Marinoni & Buzzi 2010) and is also near our theoretical estimations (~74%), presented above. The nature of the surprisingly decelerated expansion epoch of the Universe expansion after the BB will be proposed below (see the ‘The cosmic-attractive “dark flow” nature’).

The positive and negative mass seeds grow quicker because of an additional local outside antigravity-compression, shown below (Fig. 14b). This additional local compression and influence of the huge - the nearest to us DM-galaxies can explain why our Universe has developed first galaxies so quickly.

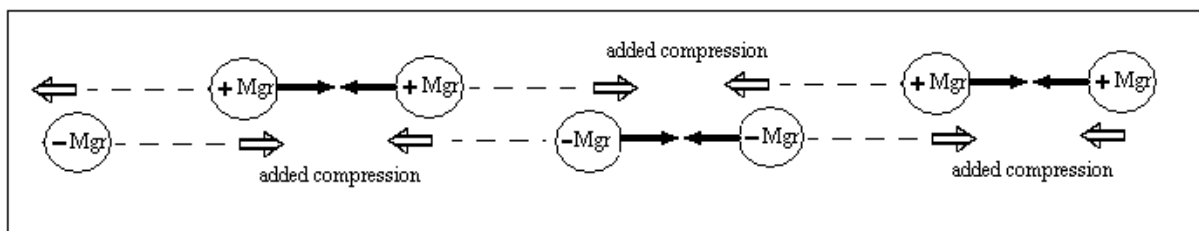

Fig. 14b shows additional outside compression, accelerating $+M$ and $-M$ seeds consolidation.

Note: A string-theoretical hope related to the nature of the *DM* was expressed by Joe Lykken, who assumes the common supersymmetry involvement: “In supersymmetric theories it is usually the case that the lightest superpartner particle has exactly the characteristics that dark matter has.” (Lykken 2003). Our periodic (gravity/antigravity) Multiverse concept excludes the rather illusive - monstrously heavy superpartners (searched at CERN now) as the *DM*-candidates and discloses much more realistic cosmologically and much more promising – the hyperspatial *DM* nature, where the SM particles, shifted in the ± 2 waveguides (the nearest dark nucleons in the mirror-“mirror sector”) behave exactly as the miracle *DM*, and, correspondingly the ± 1 waveguides (the nearest anti-nucleons in the “mirror sector”) express the *DE* repulsion.

The Flatness problem in the Multiverse

The nature of the spatial flatness - becomes trivial, because the large-scale Universe has exactly zero average gravity mass density and could be described as quasi-empty *flat* space on the large-scale Universe. The repulsive *DE* nature and the attractive *DM* nature are connected now with the fundamental $+M_{gr}/-M_{gr}$ gravity/antigravity symmetry in the Multiverse. The baryonic antimatter ($-M_{gr}$) is not always dark; it must build exactly the 1/2 of all visible galaxies clusters, distributed in the Universe! Why astronomers did not noted this for so many years? We cannot distinguish the $+M_{gr}$ or $-M_{gr}$ galaxy clusters, using observational electromagnetic radiation, since photons are "their own antiparticles" and are the same for the $+M_{gr}$ and $-M_{gr}$ radiating matter and antineutrino bursts from antineutron stars are too weak to be detected today.

The “Bubbles Structure” problem in the Multiverse

Recent observations state that the large-scale Universe structure consisting of giant and surprisingly empty "foam bubbles" (with enormous diameter about 10^8 light years!). Computer analysis of galaxies distribution gives evidence that these voids occupy about 50% of the volume of the Universe (e.g., see El-Ad & Piran 1997). Several models have been proposed to explain

the origin and dynamics of such features “but until now, no exhaustive and fully consistent theory has been found”. (Capozziello et al 2004). We must note, that all these “several models” were proposed in the frame of the traditional large-scale asymmetrical $+M_{gr}$ -Universe paradigm. But the symmetrical $\pm M_{gr}$ “gravitationally massless” Multiverse has on the large-scale its natural repulsive expansion, calculated above, where empty bubbles arise quite naturally, because of the above-mentioned repulsiveness of the large-scale $\pm M_{gr}$ matter/antimatter “powder”. Importantly, that a properly - finely mixed matter/antimatter powder (mixed assumingly in the compact Hyper-Big-Bang “mixer”) has so perfect foam quality! This local repulsive force will slowly empty arising and growing bubbles and pull out the $\pm M_{gr}$ matter powder on the local spherical surfaces of the cosmic bubbles. It is simply energetically profitable to devastate local cosmic areas being initially homogeneously filled by the $\pm M_{gr}$ neutral “powder”. The further evolution of the $\pm M_{gr}$ neutral foam is its further global repulsive expansion with simultaneously growing attractive grains of the $+M_{gr}$ and $-M_{gr}$ matter clusters that corresponds to the grandiose bubble architecture of the Universe. Astronomers found that this large-scale structure is fractal-like and is everywhere!

The problem of the decelerative phase in the universe expansion

The estimated above ratio $U_{gr-rep.}/U_{gr-attr}$ between repulsive $DE&U_{gr-rep.}$ and attractive $(DM+OM)&U_{gr-attr.}$ gravity potentials is $U_{gr-rep.}/U_{gr-attr}\sim 4/\sqrt{2}=74\%:26\%$, (Gribov 2012, 2013a). This means that *antigravity* between matter and antimatter in gravitationally neutral $\pm m_{gr}$ - “plasma” (on the large scale Universe) always provides repulsive - accelerated matter-antimatter expansion - in any era after Big Bang. This explains exactly that is going on today, but this looks as serious weakness of the PWM-concept, if we look in the past – in the decelerative expansion epoch along the first 6 milliards years after Big Bang.

It is easy to find natural additional (non-gravitational) decelerating mechanism that explains existence of the decelerating expansion era, if we take in account global decelerating contribution of residual electrostatic hydrogen plasma in earlier cosmic times, when electrostatic plasma was mixed with electrostatically neutral cosmic gas¹. Indeed, the estimated ratio between repulsive/attractive electrostatic potentials (e.g. for globally electrostatically neutral ionized hydrogen matter or antihydrogen matter, as $\pm q$ -plasma), using for comparison the same – zero-quadratic charges configuration as in the Fig. 13d, (see the quadratic $-q+q-q+q=0$ configuration on the picture below (Fig. 13e below). The neutral electrostatic plasma ratio $U_{el-rep.}/U_{el-attr}$ for the $\pm q$ -plasma is obviously the opposite of the gravitationally neutral $\pm m$ -plasma!

$$|\Sigma U_{el-rep.}| / |\Sigma U_{el-attr.}| = |[-4(+q_{el})(-q_{el})/r]| / |[-2(+q_{el})(+q_{el})/r\sqrt{2}] - 2(-q_{el})(-q_{el})/r\sqrt{2}| = \sqrt{2}/4,$$

$$\frac{|\Sigma U_{el-rep.}|}{|\Sigma U_{el-attr.}|} = \frac{|\Sigma U_{gr-attr.}|}{|\Sigma U_{gr-rep.}|} \approx 26\% / 74\% \quad (71)$$

Always *decelerative* – compressive $\pm q$ -plasma slowly goes to its inevitable relaxation (in form of neutral hydrogen and antihydrogen atoms and this means the end of its decelerative effects. Indeed, this is suitable for our resent cosmic times, why the experimentally measured ratio $DE/(DM+OM)\sim 74\%/26\%$ is caused only by gravitational $\pm m_{gr}$ - “plasma”, in accordance to the gravitational ratio $U_{gr-rep.}/U_{gr-attr} \sim 4/\sqrt{2} = 74\% / 26\%$ for it.

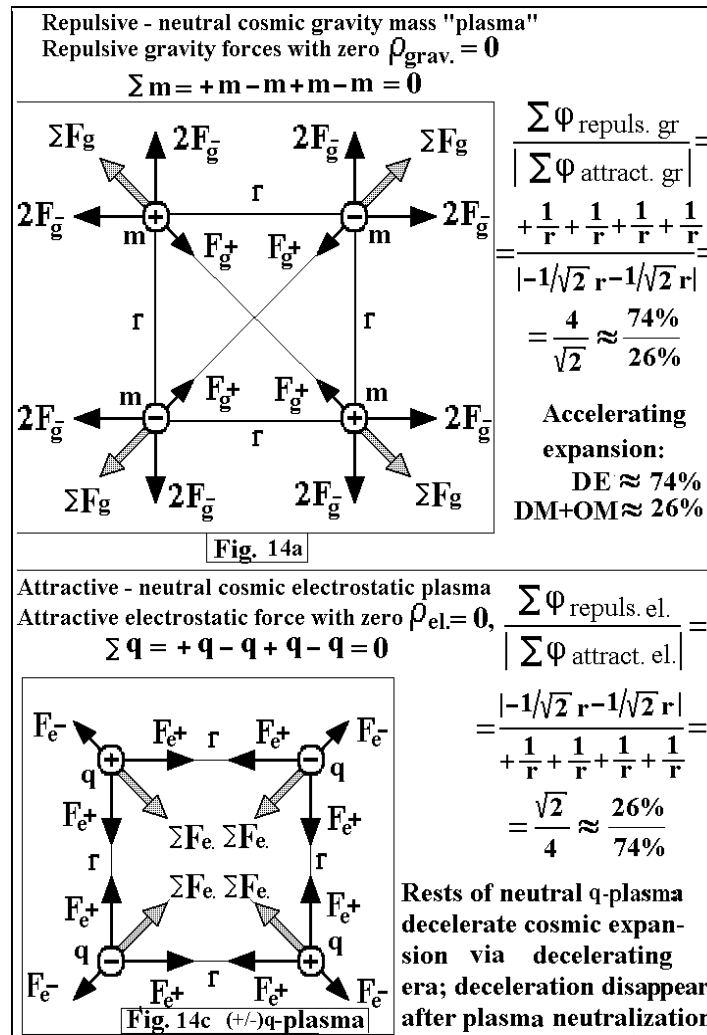

Fig. 14a,c show instructive comparison between “gravitational”-accelerative “plasma” and electrostatic-decelerating plasma, arising after the Big Bang in the PWM, creating two the opposite expansion phases:
(I) – Decelerative ($\pm q_{el}$)-electrostatic plasma dominating (past) epoch,
(II) Accelerative ($\pm m_{gr}$)-gravitational-exploding “plasma” dominating (recent) epoch. Our approximation is made for very huge cosmic bubbles-spheres, which are locally quasiflat, $\sim 2D$ -films, filled by the large-scale neutral gravity and electrostatic matter /antimatter plasmas. We considered very simple symmetric-quadratic module with zero mass/charge density. There are matter clusters/ antimatter clusters - symmetrically places gravity masses $+m_{gr}-m_{gr}+m_{gr}-m_{gr} = 0$ with the summary *zero* gravity mass (above picture, and similarly placed electrostatic charges $+q_{el}-q_{el}+q_{el}-q_{el} = 0$

Note 1: We can see now that electrostatically neutral plasma and gravitationally neutral plasma behave the opposite (attractive vs. repulsive) way. So, e.g. mutual behavior of positive and negative ions in liquids, as was proposed by Ripalda (Ripalda 2010), cannot be analogue to the matter/antimatter plasma behavior, it is exactly the contra-analogue to the *DE*-repulsiveness explanation.

Note 2: The very fruitful idea to make comparison repulsive/attractive potential energy ratios for neutral gravitational $\pm m_{gr}$ -”plasma” vs. electrostatic $\pm q$ -plasma arose during discussion with physicist S. A. Trigger, famous specialist in the plasma theory.

THE SOFT SUPERFLUID, CHARGELESS n/\bar{n} BIG BANG SCENARIO IN THE PWM

The Inflation Theory (IT), which describes initial-explosive BB-phases, proposed absolutely necessary *hypothetical negative-pressure fields*, driving the BB-explosion. It was initially created by Allan Guth and with some new variations developed by Paul Steinhardt and Andrei Linde (Guth 81, Steinhardt 1982, Linde 1982). Their descriptions of the very early universe have successfully resolved some very important problems existing in hot Big Bang cosmology, such as flatness, horizon, monopole problem and so on. However, this scenario usually starts from initial - physically non-realistic singularity (Borde & Vilenkin 1994). The original IT was established before (1998-1999) tremendous discovery of the accelerating Universe expansion. If right, the IT could describe relation between the initial BB-Inflation and the recently discovered *DE*-inflation-like accelerating expansion. But the IT theory (may be except the pure heuristic “quintessence” hypothesis by Steinhardt and colleagues (Caldwell & Dave & Steinhardt 1998) has no simultaneous solutions of the *DE&DM*-problems.

On the contrary, the proposed BB_{PWM} -scenario shows unusual integrity of the so simple PWM-approach, slightly rewriting basic physical laws, connecting elementary particles physics with gravity/antigravity and leading to the steady-inflationary Universe concept (Gribov 2012). The BB_{PWM} scenario supposes at least three natural possibilities:

(I) The so perfect 4D-Multiverse, Euclidean - flat, endless superfluid-frictionless vacuum medium, described above, existed in this perfect form *fare before* the BB and is much more fundamental proto-structure, than tiny matter/antimatter holes in it. Our matter/antimatter particles - like micro-bubbles of air in an ocean – are secondary in the totally dominating, independent of their existence ocean of the PWM. Some huge local fluctuation could create in this case locally arising thin hyperspatial column of periodical distortions – vacuum defects – being at the beginning very dense matter /antimatter - holes/antiholes with their further very simple by the nature repulsive matter/antimatter “inflation” = steady, self-regulated-stable matter/antimatter expansion. This – the 1:1 matter/antimatter – antigravitational repulsive inflation keeps *steady flatness*, even in the BB_{PWM} -starting stages & *bubble* large-scale Universe structure & the *Hubble-like distance/velocity* ratio in the matter/antimatter “yeast-doll” & the quite *correct ratio* $DE/(DM+OM) \sim 70\% / 30\%$ in the whole Multiverse, including our tiny Universe’s slice in it, as we see this today. The Multiverse-space itself is not changing at all, it stays stable as a genial Newtonian-like “absolute space” construct, being at the same time Einsteinian-Lorenz-invariant, managing all physical laws and particles, identical everywhere in this perfect multilayered “absolute”. This scenario is the opposite of the canonical today theories of inflation, almost immediately creating our huge flat Universe of nothing - our space itself from a very tiny single micro-spatial rubber-bubble (Guth 81, Linde 82). The Universe flatness performs the perfect large-scale space/antispacesymmetry in the PWM and it cannot be destroyed even along of the initial BB_{PWM} stages, keeping equal /matter/antimatter quantity in it, as it is shown in this paper. So the most basic theoretical question about the well-observed Universe’s flatness today, triggering the common canonical inflation concepts, is naturally resolved in this PWM-scenario.

(II) Second BB_{PWM} -like scenario could directly connect the matter /antimatter creation with appearance of the crystallizing-like PWM-structure itself. In this case the PWM could be somehow *globally spontaneously* crystallized in very huge chaotic 4D-volume and could be globally self-cooled, transforming its heat energy into creation of emergent electron/positron-like, layered/coupled e-cells/e-anticells & periodical flat waveguides along this global 4D-volume. It could be kinds of hyperspatial condense “proto-matter” physics, creating our vacuum-superfluid itself. This scenario follows so usual everywhere 3D-crystallization processes, self-creating regular order, being always accompanying by non-sufficient - rare crystal-defects (assumingly our matter and antimatter particles, creating their DE_{PWM} -accelerating expansion).

(III) The local $BB_{P_{WM}}$ -like scenario arises in the same crystallization if (as it is usual in oversaturated chemical solutions) it is starting from a kind of very local by the nature microcrystalline and (baby-like) center of crystallization, like in the Guth's inflation concept (Guth 1981). In this case our perfect space itself (as we know it) will be very quickly created & expanded together with simultaneously arising matter and antimatter in its growing crystallizing volume. This seems to be the "micro-crystallization" variant of the $BB_{P_{WM}}$ -inflation, but if going with many sporadically arising, spreading centers of micro-crystallization, like in the "chaotic inflation" concept by Andrei Linde.

Now we will try to analyze the simplest – the Newtonian-like "absolute space" $BB_{P_{WM}}$ -scenario (I) mentioned above, because it could be the simplest explanation to the existing $DE&DM$ phenomena, etc together with observable Universe structure and it's the large-scale dynamics. Our elementary particles (electron, etc.) and the $BH_{P_{MW}}$ - back holes are free of singularity. So, it seems to be natural if the mysterious Big Bang (BB) also started (now backward to the $BH_{P_{MW}}$ creation) from the same natural vacuum mega-state, but now free of singularity. Let us turn the neutron star story backward in the BB-times, but from an enough big "nothing" as a hyper-periodical neutron/antineutron superfluid ball state in the PWM. The soft, singularityless $BB_{P_{MW}}$ could be safely realized through shortly existing *electrostatically neutral matter/antimatter mixture* (as neutron star/antineutron star), being in a cold enough - superfluid state. This initial state seems to have the same neutron star matter density, but now accurately 0.5/0.5 mixed with the antineutrons. Will this mixing immediately annihilate? If the proposed antigravity between matter and antimatter does not exist (as it is in convenient physical theories), this strange mixing will annihilate immediately. But this nongravitating matter/antimatter plasma - nuclear-like dense neutron/antineutron proto-mixture will easily avoid this annihilation, because of the $\pm M_{P_{WM}}$ gravity repulsion in this very dense ball/antiball, since its *microscopic gravity mass density is zero*. So, we start of the neutron/antineutron *bosonic mixture of gravitationally and electrostatically neutral* superfluid megaball. Importantly, the very dense weightless and spatially flat mega-ball's state has the extremely strong - negative antigravity pressure inside, effectively and softly – from zero-velocity - separating electrostatically neutral neutrons and antineutrons. Very short-range nuclear forces in the correspondingly self-heated megaball will be very quickly switched off into a nucleonic/anti-nucleonic repulsive-separating antigravitational expansion. The Newtonian-like separating antigravity pressure dominates in this soft megaball expansion. It will cause a propriety spatial separation of free micro-droops of neutrons and antineutrons and will keep them from a total annihilation, what could be not a case in so dense but immediately annihilating proton/antiproton or quark/antiquark superfluids. Spatially separated, still shortly electrostatically neutral matter and antimatter seeds will be survived exactly symmetrically, along the initial very important for neutrons electrostatic-chargeless time-interval of the anti-gravitating repulsive "inflation", preventing self-killing them by annihilation. Indeed, the electrostatically charged/anticharged proton/antiproton mixture has too strong $p-p$ electrostatic attraction, monstrously exceeding the mentioned above antigravitational repulsion of the electrostatically neutral n/\bar{n} mixture. The neutrons/antineutrons inflation process will be accompanying with a particular $n-\bar{n}$ annihilation (realizing a heating process, also switching off a very short-range attracting nuclear force between neutrons and antineutrons). This initially *electrostatically neutral n/\bar{n}* antigravitational spatial separation seems to be much more effective for security of a full annihilation.

Neutrons and antineutrons recombine later into separated, *electrostatically neutral* hydrogen and antihydrogen seeds, creating much later survived-growing matter and antimatter macro-clusters, being steadily spatially further and further separated by the repulsive antigravity between matter and antimatter. This means:

1) The large-scale Universe (as part of the large-scale flat Multiverse) is exactly flat on the large

scale, as it was even microscopically flat also directly from the beginning of the described here antigravitational n/\bar{n} inflation.

2) This smooth antigravitational Big Bang “inflation” has a short but enough long time interval for the initial thermodynamic homogenization, because the initial neutron/antineutron star-like megaball size is relatively small - in order of about $R \approx 10^{12}$ m and it is *superfluid* in the initial super-dense n/\bar{n} state, where each n/\bar{n} couple pair is a composite Cooper-like boson, like the (e^-/e^+) coupled bosonic pair.

Indeed, if all matter mass of our visible Universe is approximately $M_{Univ.} = 8 \times 10^{52}$ kg and the mass of neutron: $m_n = 1.67 \times 10^{-27}$ kg, we can account full neutrons (nucleons) number in the Universe $N_n = M_{Univ.}/m_n = 4,8 \times 10^{79}$. Using the neutron radius $r_n = 1.25 \times 10^{-15}$ m we derive the proximal single neutron (nucleon) volume as $V_n = (4/3)\pi r_n^3 \approx 4 \times 10^{-45}$ m³. This neutron/antineutron star-like, very dense Universe has initial radius $R_{nBB} \approx 10^{12}$ m (with the initial neutron/antineutron star-like inertial mass density about 10^{18} kg/m³ in the initial inflationary Big Bang phase). It has this enough small initial size with the superfluid state – that is enough for very fast thermal homogenization. The light speed crosses the megaball in $T \approx R_{nBB}/C \approx 500$ min.

The average large-scale gravity mass density of our Universe (in frames of the Multiverse) is zero. This scenario *excludes* hypothetical repulsive vacuum energy for repulsion, hypothesized initially by Einstein and expressed in his famous cosmological constant lambda, incorporated “ad hoc” into the GR equation. Our super-dense (e^-/e^+) vacuum tissue is also frictionless ideal superfluid, consisting of the chargeless composite bosons. It is (and it must be accordingly our all-day experience) supersymmetric and nongravitating ghost medium (as common cooled superfluid - having zero energy density).

Note 1. The latest measurement of charged $Pb-Pb$ nucleons collisions at 2.76 TeV was realized at the CERN Large Hadron Collider (LHC) and was presented recently (ALICE Collaboration 2010). This collision requires the frictionless *hydrodynamic* properties inside the arising fireball (FB), related to the matter state at extremely high temperature $T_{FB} \approx 10^{13}$ K, surprisingly contrasting to the expected gas-phase. This temperature is about 1000 times more than critical destructive temperature for the (e^-/e^+) pairs $T_{couple(e/e)} = 1,2 \times 10^{10}$ K of the lightest (electron/positron) vacuum fraction. But the colliding protons mass is about 2000 times heavier than electron and corresponding p/\bar{p} or n/\bar{n} coupling energy is $E_{couple(p/\bar{p})} = 2M_p C^2$. It is at least about 2000 times more than the electron/positron coupling energy $E_{couple(e/e)} = 2M_e C^2$. If the fireball temperature T_{FB} is very high and $kT_{FB} > E_{couple(p/\bar{p})} = 2M_p C^2$, than the perfect superfluid quark/gluons/antiquark vacuum can be locally destructed (inside the fireball volume by an overheating). This critical temperature $T_{couple(p/\bar{p})}$ estimation is $T_{couple(p/\bar{p})} \approx 2000 T_{couple(e/e)}$ and thus $T_{couple(p/\bar{p})} \approx 2,2 \times 10^{13}$ K. This means the mentioned above $Pb-Pb$ collision energy is very near, but above the distortion-border for the corresponding perfect $q/gluon/q$ vacuum superfluid state and still is able to keep the liquid-like-ordered (superfluid) features of the sub-atomic $q/gluon/q$ fireball. Leading investigators at the ALICE experiment in CERN suggested, that the Universe (immediately after the Big Bang) would behave like a super-hot *ideal liquid without viscosity* (what was confirmed in the mentioned above CERN $Pb-Pb$ collision-experiment). These new experimental data correspond to our dense “superfluid hydrodynamic” BB_{PMW} scenario, described above, including very realistic - safety, flat and soft DE-inflation (flat, nongravitating, singularity-less, chargeless, etc.), effectively thermo-equalizing the initial superfluid BB_{PMW} phase.

THE ADJACENT PARALLEL UNIVERSES, FULL OF CIVILIZATIONS – HYPER-INTERNET AND INFORMATIONAL RELOCATION

Thus, it is quite possible that we live on the “few 3D-pages of a giant motherly Hyperbook”, live between myriads of parallel Sub-Universes, physically identical to each other, glued together and packed hyperspatially with enormous density $N_{1m}=1m/L_{oe}\approx 10^{12}$ Universes/m⁴, (Gribov 1999, 2005, 2012, 2013a,b). It means that we could find our intelligent “hyper-brothers” somewhere within these neighboring similar parallel Universes and (if our brothers exist) can become members of their Hyper-Intellectual Hyperinternet System. An average distance R_4 between the nearest hyper-civilization, estimated below, is amazingly small: $R_4 = \sqrt{(x^2+y^2+z^2+L^2)} \approx 10^8$ km, with corresponding timing delay of the C_4 -communication signal $\Delta T^*_{comm}\approx 10$ min. May be some of our hypersensitive brains are able to “hear” these “extrasensory” communicative noise in dreams? This future hyper-communication, possibly, could safe and amazingly develop our young and brittle civilization and survive us of ourselves wildness, and, for example, of possible social, ecological or cosmic catastrophes, etc.

Indeed, sun-like stars could account for up to half of the Milky Way's population of several hundred billion suns, and many of rocky earth-like planets might inhabit our galaxy (Farihi, et al 2010). Indeed, now astronomers rapidly discover plenty of the Earth-like planets, potentially suitable for life: "The fact that we've found so many planet candidates in such a tiny fraction of the sky suggests there are countless planets orbiting sun-like stars *in our galaxy*," said William Borucki of NASA's Ames Research Center in Moffett Field, Calif., the mission's science principal investigator. "We went from zero to 68 Earth-sized planet candidates and zero to 54 candidates in the habitable zone, some of which could have moons with liquid water." (Mewhinney & Hoover 2011).

Our Milky Way ($D\approx 100000$ ly, $h\approx 1000$ ly) has its, grubby estimated, 3D-space volume

$$V_{MW} = \pi R^2_{MilkyWay} \cdot h \approx 3,14 \cdot D^2 h \approx 10^{13} \text{ly}^3 \approx (10^4 \text{ly})^3, \quad (72.1)$$

(where one light year $1\text{ly}\approx 10^{13}$ km). Imagine that only $\sim 10^3$ planets of more than billion rocky planets in our Milky Way have a high-developed intellectual civilizations, randomly distributed in the galactic $V_{MilkyWay}$ volume. We obtain here an average 3D-space volume V_{1Civil} with 1 civilization inside:

$$V_{1Civil} = V_{MilkyWay} / 10^3 \approx (10^4 \text{ly})^3 / 10^3 \approx (10^3 \text{ly})^3 = (10^{16} \text{km})^3 \quad (72.2)$$

This single average volume V_{1Civil} is so huge, that we simply have no physical chance to communicate “in real time” with our Milky Way intelligent neighbors. Indeed, an average light signal 3D-distance between these civilizations is too long

$$\Delta T^{(3)}_{delay} \approx 10^{16} \text{km} / 10^{13} \text{km} = 1000 \text{ light years (ly)}. \quad (72.3)$$

This volume can be dramatically “compressed” if we take in account a bunch of parallel 3D-Sub-Universes around us along the L -extradimension (Fig. 13a). They contain corresponding “hyper-stockpile” of a Milky Way–like parallel hyper-galaxies around us. Let us estimate this compression in the mentioned above modest “10 C_4 -light seconds” – L -hyper-interval

$$\Delta L_{10sec} = C_4 \cdot 10 \text{sec} \approx 10^9 \text{m} = 10^6 \text{km}. \quad (72.4)$$

This ΔL -interval contains N^* parallel Hyper-Universes

$$N^*_{Univ} = \Delta L_{10sec} / L_o \approx 10^9 m / 10^{-12} m = \mathbf{10^{21}}_{Universes}. \quad (72.5)$$

The supposed periodic prolongation of the gravitationally bounded *DM* hyper-galaxies above and below of our Milky Way galaxy realizes corresponding periodic hyper-galactic (Milky Way)-“stockpile” (Fig. 13a, left). This short hyper-interval (10 light minutes) of the (Milky Way)-“stockpile” contains near 10^{24} hyper-civilizations inside the 10-seconds 4D-hyperslice:

$$N^*_{Civil} = 10^{21} \cdot N_{MWCivil} = \mathbf{10^{24}} (!) \quad (72.6)$$

A new average 4D-volume V^*_{1Civil} of assumingly randomly distributed hypercivilizations (that contains only 1 hyper-civilization) becomes here extremely compact. Thus, the hypercivilizations are distributed unexpectedly densely around us (Fig. 15). Now this proximal single average 3D-volume V^*_{1Civil} is 10^{24} times smaller:

$$V^*_{1Civil} \approx V_{1Civil} / 10^{24} = (10^{16} \text{km})^3 / 10^{24} = (10^8 \text{km})^3. \quad (72.7)$$

This gives the dramatically “compressed” average hyper-distance $R^{(4)} \approx 10^8 \text{km}$ between two the nearest hyper-civilizations C^*_i and C^*_j . This distance is shorter of the distance between the Earth and the Sun, being about $1,5 \cdot 10^8 \text{km}$. This “compression” provides correspondingly a very strong shortening of the potential average C_4 -communication time delay $\Delta T^{(4)}_{delay}$, with $\Delta T^{(3)}_{delay} / \Delta T^{(4)}_{delay} = 10^{16} \text{km} / 10^8 \text{km} = 10^8$. The average communicative $C=C_4$ -time interval $2 \cdot \Delta T^{(4)}_{delay}$ between the nearest 4D-civilizations becomes now 10^8 times shorter:

$$\Delta T^{(4)}_{delay} = 2R^{(4)}_{C^*_i C^*_j} / C \approx 11 \text{minutes!} \quad (72.8)$$

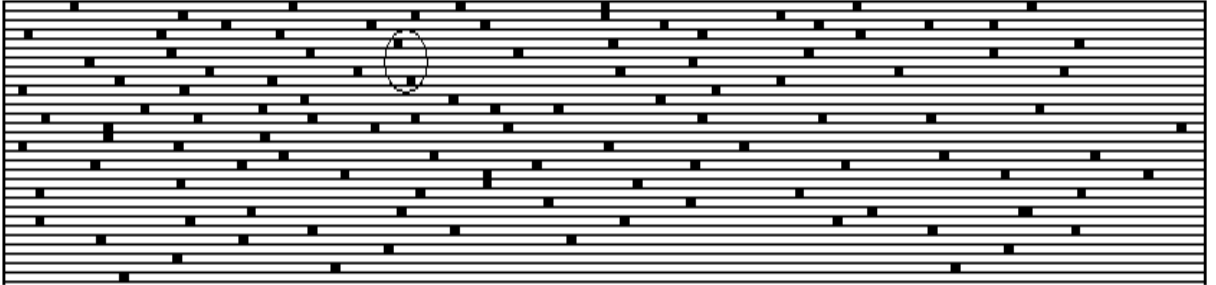

Fig. 15 shows rapidly growing 4D-density of civilizations, occupying pico-slices of the periodic 4D-Multiverse.

This could allow practically the “real time” 4D-telecommunication between the nearest hyper-civilizations. If we have only one civilization in the Milky Way (that is very-very unlikely), we have still very short average distance

$$R^{(4)}_{C1C2} \approx 10^9 \text{km} \text{ and } \Delta T^{(4)}_{delay} \approx 110 \text{min}. \quad (72.9)$$

It seems to be almost sure that we will not be able to travel (as a complex material objects) through the monstrous substantial membranes, dividing waveguides, but (very likely) we would be able to send and receive back information through the 4D-continuous hyper-vacuum *medium*. Total physical identity of these periodic dark Hyper-Universes with our Universe, including the same SM elementary particles, the same physical laws and very similar, gravitationally hyper-coupled cosmology, planetary life, etc are crucial for the further effective and fruitful communication with these hyper-civilizations. The absolute physical/chemical equality provides biological similarity or even identity. These crucial circumstances - similar forms of life in

myriads of hyper-civilizations, living in identical physically 3D-worlds - could significantly simplify and enrich inter-communication between them. From this point of view, our great (now technological) civilization looks suddenly as a kind of a newborn “hatched chick biddy” in comparison to the potentially much more matured Hyper-Club of a parallel, long-existing and enormously developed surrounding us hyper-civilizations. It could be for us a new amazing and endless knowledge, enormously fruitful for our further development.

Our biological form of life and biological human being could become indeed immortal, being simply transported from our civilization to other hyper-civilizations via a pure informational way. It could be transported rather “by wire” as joked genial father of cybernetics Norbert Wiener. Our genetic code could be enough quickly transported and reconstructed on other highly developed intelligent hyper-islands (as, for example, genetic codes of our geniuses, as dreamed at the beginning of the XX century Russian pioneer of astronautics Konstantin Tsiolkovsky). His naive interest to cosmonautic (in so terrible, wild times in the post-revolutionary Russia) was cursorily motivated by “fictional” dreams of his teachers to “animate” our geniuses, to transport them somewhere on other planets and so, to build much better civilization. If we will be able to send our genetic code literally “by wires”, with a corresponding knowledge to our hyper-brothers, they could restore and displace our human biological nature on another suitable for life hyper-planets. This hyper-exchange could involve genetic/biological/environmental information about our/their ontogenetic culture, art, etc. and realize dreams of Tsiolkovsky and Wiener. These cloned islands of our Civilization could become informationally “traveling forever” – across the PWM-hyperspace and communicating with us as co-developing part of the other parallel civilizations. It could be tested enough quickly – possibly in few decades (even if the proposed physical hyperspace structure contains quite rare density of the hyper-civilizations inside, e.g., only one civilization – our “isolated solar farmstead” along the so huge Milky Way galaxy. Great science-fiction writer and insightful futurologist Herbert Wells wrote about our future – about inevitable future contacts with much more developed extraterrestrial civilizations: “It is possible to believe that all that the human mind has ever accomplished is but the dream before the awakening . . . Out of our . . . lineage, minds will spring, that will reach back to us in our littleness to know us better than we know ourselves.” (Wells 1902). We proposed recently usage of cold charged antimatter particles (positron or antiprotons), captured in a well vacuumed magnet field trap, as transmitters of electromagnetic information between our Universe and parallel dark Universes, existing according the PWM-concept (Gribov, 2013a).

THE *DE&DM* NATURE IN THE $\pm M_{GR}$ CONCEPTS OF RIPALDA, VILLATA AND HAJDUKOVIC

Some bold physicists - pioneers of the Matter/Anti-Matter Antigravity Concept (MAMAC) in cosmology, like Ripalda (1999-2010), Gribov (1999-2013a,b), Villata (2011, 2012, 2013) and Hajdukovic (2011, 2012a,b) have implemented very similar and of cause very fruitful hypothesis about $\pm M_{GR}$ between matter and antimatter to the accelerated Universe expansion (*DE*-problem), but they have developed surprisingly different and controversial concepts of *DE* & *DM*.

Ripalda and Villata assume equal quantity of matter and antimatter in our Universe and have established the MAMAC, applying the CPT-symmetry to the GR by Einstein, with accent on the *Time inversion* in it (Ripalda 2010, Villata 2011, 2013), which was analyzed and criticized above as not enough correct and directly contradicting to the Equivalence Principle (EP) by Einstein – the basic milestone of the GR itself. We have developed sufficiently new uniting approach to the waveguided SR&QM and gravity/antigravity nature in the PWM, where the $SR_{PWM}\&EP_{PWM}\&GR_{PWM}\&QM_{PWM}$ are its simultaneous direct *consequences*, including the hyper-periodic matter / antimatter and the resulting interconnected-multiversal $DE_{PWM}\&DM_{PWM}$ nature with the correspondingly naturally arising MAMAC_{PWM} phenomena (Gribov 1999-2013).

For example, **Jose Maria Ripalda** writes about the *Time inversion* in his the latest work “Time reversal and negative energies in general relativity”: “Due to their mutual repulsion, there should be voids in the distribution of past-pointing matter around future-pointing clusters. Such voids create an effective “dark” gravitational halo around matter clusters, just like a hole creates the effect of a positive charge in a semiconductor. The concepts of “dark energy” and nonbaryonic “dark matter” are unnecessary.” (Ripalda 2010, p. 4).

It is clearly wrong to reject the so called “dark matter” concept this way, because, for example, there is ~5 times more nonbaryonic *DM* above *OM* around the most of galaxies in our Universe. Where is this asymmetry from, if matter and antimatter are in equal amount everywhere? The PWM-concept can give a reasonable answer – there are electrostatically isolated $W_{2,-2}$ *dark baryons* in two parallel - *two the nearest dark* $W_{2,-2}$ Universes, which are mutually independent parallel Universes and de facto have more mass than our Universe contains (Gribov 2012).

Massimo Villata also writes: “... as already said, antimatter would be matter traveling backwards in time” (Villata 2012, p. 5). He argued that “...antigravity appears as a prediction of general relativity, once it is assumed that this theory is CPT invariant and that, consequently, matter is transformed into antimatter by these three joint operations (charge conjugation, parity, and time reversal).” (Villata 2012, p. 2). There is an immediate discrepancy: it is well known that the “charge conjugation” in the relativistic Dirac theory of electron and positron is applicable only to the electrostatic charge – it does not change positive sign of inertial mass of electron (inertial mass also remains positive for positron), but it changes the sign of electrostatic charge only. Indeed, it is necessary to introduce sufficiently new physical category – gravity “charge” of elementary mass particle (naturally arising in the PWM). But how to do so in frames of the Diracian theory, where gravity does not presented at all. On the other hand, the EP by Einstein and GR strictly forbid the opposite signs for inertial and gravity masses of positron. This is very old theoretical dilemma, formally forbidding MAMAC-antigravity, where is no way out of troubles without new physical concept, somehow uniting QM, EP and gravity, where *gravity “charge” conjugation* finds its natural roots, like it is in the PWM-concept, described above.

The PWM-concept discloses total physical symmetry between matter W_0 and antimatter W_1 Universes and between observers W_0 and anti-observers W_1 (simultaneously observing surrounding large scale W_0/W_1 Universe/Antiuniverse structure). So, anti-telescopes must absolutely observe the same bubbles/voids large-scale cosmic realities: where must be the same shining bubbles surfaces with empty voids inside (so, obviously without matter or antimatter inside, that is against the total observational symmetry in the PWM). The total physical symmetry dictates the simplest fully symmetric large-scale picture, where mutually repulsive matter and antimatter clusters must be spread homogeneously - along the same gigantic surfaces of the same observable cosmic bubbles, keeping an average local gravity mass density $\rho_{\text{grav.mass}}=0$ on these ~2D-spheres. The so homogeneously organized cosmic bubble’s surfaces work as compressed superficial springs, where all these bubbles expand with acceleration; so, each huge bubble has ~ zero summary gravity mass and gravity fields inside these empty spherical bubbles is also ~zero. More over, a compressed static bubble-spring approximation says that bubbles are self-organized large-scale structure will permanent equalization of the bubble’s surface compression everywhere, automatically self-restoring the bubble’s sphericity.

Villata assumes (as it is emerged in the PWM) equal quantity of matter and antimatter in the Universe and the CPT-symmetry. This means a total visual Large-Scale Bubbles Symmetry (LSBS) for observers and anti-observers, mentioned above. But Villata newer uses this implicit large-scale symmetry for the babbles/voids structure analysis. He assumes the opposite – totally asymmetric view where the whole babble’s surface consists of matter, distributed on their quasi-

spherical surfaces and dark voids inside (which are indeed observationally totally empty) hide invisible antimatter in their *centers*, but it is obviously wrong from the LSBS point of view. Villata writes: "...we can try a rough estimate of the mass of antimatter, possibly located around the center of the Local Void..." (Villata 2012, p. 4).

But he states an important difficult question about visibility of photons, radiated from antimatter: "There remains the question of why antimatter in voids should not be visible. It seems that something "dark" must necessarily exist: dark matter, dark energy, and now "dark repulsors". (Villata 2012, p. 1). He predicts that voids (actually empty in the PWM) "...might be revealed by its gravitational effect on the radiation coming from background sources, in a sort of antigravitational lensing." Villata (2011, 2012 p. 3). Villata prolongs: "...there seem to be more reasons for antimatter invisibility than for visibility, so that we are not surprised not to see anything in cosmic voids." (Villata 2012, p. 5).

As we discussed above in the corresponding chapter, the question about photons visibility is resolved in the PWM concept using the same LSBS-like annihilation symmetry for observer and anti-observer. This very simple analysis have showed that there are different photons and antiphotons and dark photons spices in the PWM: (a) our usual visible photons W_0 , emitted by matter W_0 , (b) also visible W_1 or W_{-1} antiphotons, emitted by visible antimatter W_1 or W_{-1} and (c) invisible W_2 or W_{-2} dark photons. All other $W_{n<-2}$ or $W_{n>+2}$ photons W_{2k} and antiphotons W_{2k+1} are dark for us. One cosmic bubble is small comparable to so many bubbles in the large-scale Universe. Visible photons and visible antiphotons flying across these bubble's structure could be easily assumed as flying across homogonously distributed matter and antimatter clusters, so flying almost straight forwards with tiny +/- curvatures near these rare clusters/anti-clusters, confirming that matter and antimatter clusters are equally mixed in the Universe and our space is consequently so highly Euclidean on the large scale (on the contrary to the controversial Vallita's assumptions about invisibility of the antimatter within voids, mentioned above).

Dragan Hajdukovic directly uses the MAMAC-hypothesis as his primary assumption and applies it for cosmology, but (as typical elementary particles physicist at CERN) he strictly rejects the matter/antimatter equality in the Universe, mentioned above (and so naturally arising in the PWM concept). Hajdukovic assumes cosmos consisting mostly of matter and explains *DE&DM* as the pure gravitational polarization effects of the quantum vacuum, consisting of electrostatically bounded virtual electron ($M_{gr}>0$) and positron ($M_{gr}<0$) pairs, surrounding gravitating matter particles. He explains the *DM* nature as a short-scale vacuum polarizations (Hajdukovic 2011, 2012a) and the *DE* nature as a long-scale vacuum polarizations (Hajdukovic 2012b).

Even superficial analysis shows that it is wrong concerning the correct *DM*-explanation – if Hajdukovic is right, there must be strict *DM/OM* proportions in each galaxy, but there are usual broad variations - some galaxies consist totally of the *OM* and are without the *DM* or on the contrary - consist totally of the *DM*. These common observational facts and some other common - mentioned above *DM*-collisions phenomena (e.g. Bullet Cluster, etc) obviously exclude the proposed secondary-polarization's *DM*-nature. The long-scale *DE*-polarization concept seems to be even more speculative – because such tiny polarizations (of electrostatically much more strongly connected electron/positron pairs) could work as a partial gravity shielding effect, only slightly weakening always attractive gravity forces, but not switching it into the so vastly dominating repulsive *DE*-antigravity in the Universe. This Hajdukovic's-Universe will have always-decelerative expansion, which obviously contradicts the observed accelerated Universe expansion.

SOME NOTES TO THE BOOK “A DIFFERENT UNIVERSE”, BY ROBERT LAUGHLIN

All our matter particles in the PWM are elementary cellular defects in the collective coherent-superfluid world of emergent dynamical e -cells. Such single, pure dynamical cell-vortex exists in a gradually much more fine, (because dynamical = necessarily frictionless) and empirically weightless “grandmother”-medium, built on the analogue to the lightest, here presented - electron/positron vacuum-fraction (Gribov 2005, 2012). This picture corresponds to penetrating thoughts of Robert Laughlin: “I think that spacetime tissue not only creates a scene, where is played a life, but it is phenomenon of an order, behind which is something bigger”, (Laughlin 2007, p.190). This “something bigger” is the hidden cause (and not the backward) of common “first principles”, including fundamental symmetries in physics: „Symmetries are caused by things; they are not the causes of the things”; „If the relativity always true, there must be a reason” (Id p.187). He summarizes: “...science has now moved from an Age of Reductionism to an Age of Emergence, a time when the search for ultimate causes of things shifts from the behavior of parts to the behavior of the collective” and “...collective principles of organization are not just a quaint side show but everything - the true source of physical law, including perhaps the most fundamental laws we know” and the “Transition to the Age of Emergence brings to an end the myth of the absolute power of mathematics.” (Laughlin 2005). Modern physics always try to understand the structure and the nature of this “something bigger” behind old “mythological” pictures. Indeed, as it was shown about four great “hidden discoveries”, “Like Columbus or Marco Polo, we set out to explore a new country but instead discovered a new world.” (Id. 2005).

SOME COMMENTS TO THE “LIVING IN THE MULTIVERSE”, BY STEVEN WEINBERG

The hypersymmetric PWM-vacuum is globally coherent-united & *nongravitating* superfluid (like helium at low T (Volovik 2003, Gribov 2003, 2012, 2013a). This extraordinary superfluid medium creates and holds us inside, but (as biblical God) is invisible for its elementary “defects”. The SR is emergent waveguided / superfluid phenomenon, where all physical laws are invariant under the Lorentz transformation. We cannot determine our absolute movement in this medium – so, Einstein created his SR reasonably “ignoring” it. Steven Weinberg writes that Einstein „offered a symmetry principle, which stated that not just the speed of light but all the laws of nature are unaffected by a transformation to a frame of reference in uniform motion.” (Weinberg 2005, p. 1). Weinberg notes: “Our present Standard Model of elementary particle interactions can be regarded as simply the consequence of certain gauge symmetries and the associated quantum mechanical consistency conditions” and the “development of the Standard Model did not involve any changes in our conception of what was acceptable as a basis for physical theories. Indeed, the Standard Model can be regarded as just quantum electrodynamics writ large.” (Id p.2). He notes that for decades of the QED success “...there seemed to be something peculiar about the value of the vacuum energy ρ_V ” and “Quantum fluctuations in known fields at well-understood energies (say, less than 100 GeV)”, give “a value of ρ_V larger than observationally allowed by a factor 10^{56} and “no symmetry argument or adjustment mechanism could be found that would explain such a cancellation.” (Id p.3). This Weinberg’s note is crucially important – it means that common physical field theory (even if it has implanted the conveniently-broken SUSY) is not complete at all. The searched miracle “cancellation” comes from the monstrous dark PWM-Multiverse structure, immediately creating corresponding monstrous cancellations everywhere in our vacuum. We are happy stable creatures & witnesses of an endless “effective” being – arising on the lowest vacuum energy level - with enough complicated, chemically very fine forms of life, with resulting curiously “purblind” physics of Galilean Simplicio, ignoring vacuum itself. Emergent, but extremely stable elementary matter particles and following very complicated life forms could be so evolutionally slowly created only

in the cooled-superfluid vacuum state, what naturally corresponds to common “anthropic arguments”, being discussed by Lenard Susskind regarding to the string theory “landscape” (Susskind 2003).

The question about Multiverses sees to be the most difficult - dark question in modern physics. Weinberg notes that, e.g. multidimensional string theory tells about plenty of possible Multiverses with sufficiently different vacua and so called “string landscape” is estimated *to be of order 10^{100} to 10^{500}* . He assumes “at least four ways in which we might imagine the different “universes” actually exist. Various subuniverses may be simply (1) “different regions of space”; (2) “different eras of time in a single big bang”; (3) “different regions of spacetime”; (4) “different parts of quantum mechanical Hilbert space” and “These alternatives are by no means mutually exclusive. In particular, it seems to me that, whatever one concludes about alternatives 1, 2, and 3.” (Id p. 10-11). Indeed the case (1) seems to be the nearest for our periodical Multiverse picture, but the “different regions of space” are now different regions in the adjacent PWM-hyperspace, with literally parallel, physically identical quasiflat subuniverses. Interactions between these Sub-Universes work correspondingly - globally / microscopically – super symmetrically / everywhere in our space (as e.g., the monstrous *DE&DM* omnipresence in our large scale Universe).

Weinberg writes: “The test of a physical theory is not that everything in it should be observable and every prediction it makes should be testable, but rather that enough is observable and enough predictions are testable to give us confidence that the theory is right.” (Id p.12). Indeed, we cannot e.g. percept our vacuum’s medium, but we are able to build some basic physical concepts of it, that explain the illusion of its emptiness, the miracle of its weightlessness, frictionless, etc. pure physically, what we tried to show above. Quite the same ways we cannot directly percept quantum mechanical wave function, but physicists widely apply its fundamental theoretical concept for accounting promptly measurable QM-probabilities. Weinberg sorely notes: “There is also a less creditable reason for hostility to the idea of a multiverse, based on the fact that we will never be able to observe any subuniverses except our own.” (Id p.12). But the PWM-concept shows much more optimistic, surprising news - *we have observed neighbor Subuniverses* many decades via the gravitational DM/DE observations, but yet don’t understand it this way!

SOME NOTES TO THE “EINSTEIN AND THE SEARCH FOR UNIFICATION”, BY DAVID GROSS

David Gross writes that Einstein “believed that the fundamental laws and principles that would embody such a theory would be simple, powerful and beautiful.” (Gross 2005, p. 2035). These features arise repeatedly in the pure hyperspatial-waveguided interpretation of the Einstein’s SR, being hyperspatially “married” with the Einstein’s second genial creation - the quantum light photon. Albert Einstein, like biblical Moses, took people to the borders of the “holy Multiverse” - land, but did not come in himself. Indeed, very young Einstein stood alone on a threshold of this fairy-tale door 106 years ago, with almost prepared “self-made” classical/quantum equipment to open it. But the Multiverse dragon was too quiet, invisible and serene, as a miracle “Tao”, designed by genial Lao-tse long time ago: “There is a thing confusedly formed, born before Heaven and Earth, silent and void. It stands alone and does not change, goes around and does not weary. It is capable of being the mother of the world.” (Lao-tse 600 B.C.). We could wait may be some billions years, but the fantastic *DE&DM&SUSY*-manes, etc. open for us its hyperspatial ocean, where we will try to find ourselves intelligent images, waving factually from our distant future (Gribov 2012, 2013a). Einstein was always encouraged by his naïve, invincible believe in a harmony, beauty and simplicity of the existing world. He was irreparable pacifist and idealist, with undamaged morality of teenager in terrible times of wars and violence. Such paradoxical “mature” naiveté is natural for great geniuses and contains a powerful cognitive

source for their creativity. Why? They have not only usual – the adult one - aging *verbal* consciousness (placed in the left brain hemisphere), but also never-aging teenager's sub-conscious (like a speaking sub-universe), with well developed *additional speech center*, etc. living in their right brain hemisphere, which contains and manages mostly visual and emotional worlds of the human being (Gribov, 2002). Such bright personalities as Albert Einstein, Andrei Sacharov, Leonardo da Vinci and many other outstanding creators definitely had this kind of the doubled “super-brain” structure (being oft left-handers, as Einstein, Leonardo and Sacharov). This is one of the strong markers of the neuronal left-hemispherical “functional islands” shifted into the right brain hemisphere (RH), that could be shortly expressed as a “functional mixing paradigm” – describing the neuropsychological basis for human creative abilities (Gribov 2002). Indeed, Einstein was emotionally hypersensitive, musically very talented “right hemispheric” person with very powerful global - intuitive, always original - figurative vision-understanding of things, relevant to the very strong, verbally equipped RH co-involvement in attract thinking processes. These outstandingly creative persons may be also the most happy human beings, because they never become mentally old and never loose their “naiveté”, their *curiosity* and hopes, because the RH-speech centers cannot mature behind age of teenagers - they have oft extraordinary expressed global-holistic insights, realizing by very strong involvement of the global - right hemispheric functions in their thinking (Gribov 2002).

Gross notes, for example, that the GR has common conceptual problem - there is “no principle to determine the properties of mass” in it (Id p. 2036). These properties are related to the *source* of curvature-mass, arising arbitrary in the GR. The proposed PWM-waveguided gravity mass-“charge” concept presents this natural – uniting, light-dynamical hyperspatial source, caused by the orthogonal *L*-pressure of the photon-like quasiparticle, deforming 3D-membranes of the 3D-waveguide. This picture literally realizes Newtonian-Einsteinian gravity potential (by negative and positive potentials for matter and antimatter and with unavoidable involvement of the Planckian constant h and the velocity of light C and the light-photon concept by Einstein).

Gross cites Einstein: ‘That appears certain to me, however, is that, in the foundation of any consistent field theory the particle concept must not appear in addition to the field concept. The whole concept must be based on partial differential equations and their singularity-free solutions’ (Id, p. 2036). He wanted to generalize the GR including electromagnetism and to “eliminate the right-hand side of his equations and deduce the existence of matter by constructing singularity free solutions that would describe stable lumps of energy” (Id, p. 2036). Einstein also “abhorred the arbitrary nature of the quantum rules and their probabilistic interpretation, he hoped to deduce them from these non-singular solutions.” (Id p. 2037). Einstein „imagined that the demand of lack of singularities in the solutions that would describe matter would lead to over-determined equations, whose solutions only exist for some, quantized values of physical parameters, say the radii of electrons orbits. Thus he could imagine reproducing the Bohr model of the atom. The core of this program was to include electromagnetism and derive the existence of matter in form of, that we call today, solitons. As Einstein understood, nonlinear equations can possess regular solutions that describe lumps of energy that do not dissipate:” (Id p. 2037). The proposed waveguided PWM-structure allows creating these necessary identical “stable lumps of energy” – non-linearly self-focused, classically quantized waveguided *e*-vortexes, indeed “remembering the Bohr model of the atom”, now surprisingly without attracting proton in its center and much more small “proto-atoms” - building cells of the superfluid ghost vacuum.

NOTES TO THE “VIEWPOINTS ON STRING THEORY” AND DARK ENERGY BY EDWARD WITTEN

Viewpoints on string theory (Witten 2003). Edward Witten describes historical motivation to build the String Theory (ST) as “an attempt at a deeper description of nature by thinking of an

elementary particle not as a little point but as a little loop of vibrating string.” (Witten 2003b). The ST assumes a *priory* existence of plenty identical, very tiny ‘musical instruments’, expressing elementary particles in their vibrations: “All are different forms of vibration of the same basic string. In the case of string theory, with our present understanding, there would be nothing more basic than the string, and ... It's indeed surprising that replacing the elementary particle with a string leads to such a big change in things. I'm tempted to say that it has to do with the fuzziness it introduces.” (Id). So, the ST declared *a priory* (1) very tiny string-particle with (fuzziness) as basic elementary - extra tiny physical object and postulates (2) additional (being mostly compactified) space dimensions and (3) branes which can be large, even endless. The extra dimensions were not yet observed, since they assumed to be very small.

String theorist Barton Zwiebach writes with optimism about opportunity to observe existence of even enough large extra dimensions: “Surprisingly, it is possible that “large extra dimensions” exist and that we have not observed them yet.” (Zwiebach 2004, p. 61). Indeed, in concordance to the ST hypothesis, the proposed above Periodical Waveguided Multiverse (PWM) concept supposes that the fourth L -extra dimensional interval $\Delta L \sim 10^{-12}$ m is very small - it is 100 times smaller than the size of hydrogen atom (that's why it is not visible), but it is much-much bigger (10^{23} times) as common - Planckian string length $\sim 10^{-35}$ m.

Here we will try to compare the ST and the PWM-concepts, since the PWM also contains compact ST-string-like \rightarrow vibrating self-focused photonic PWM-“springs” - wave-particles/antiparticles (Table 2a,b above). It summarizes this unexpectedly fruitful transition, which might be kind of reincarnation uniting the ST with existing “low energy limit” physics. Now the PWM-quasi-strings (as so easy understandable physically elementary spines - life-full photonic spring) are sufficiently emergent, robust C_4 -vertexes *confined between two* endless quasiflat 3D-membranes framing \sim 3D-waveguides. These vortexes can freely fly along the confining 3D-waveguide, behaving mechanically as steady compressed-robust, L_0 -short hypercylinders, topologically toroidal “loops” with (1) self-focused, coherent, very strongly curved dynamical hypercylinders with 3D-surfaces –like strongly curved “branes” and (2) also robust and assumingly also C -dynamical & coherent endless 3D-membranes, framing 3D-waveguides. These membranes have assumingly physical property of the very thin membrane-like behaving surfaces, dividing two different medial 4D-bulks. They behave as very robust, very stable, very strongly mechanically stressed 3D-“solitons”, dividing periodically waveguided Multiverse.

It is easy to note, that the ST contains the same generic weaknesses as the underlying classical physics – it accepts a quasi-empty vacuum space and local by the nature mass particle, plus it has the same – formally correct but physically mistakable – the global Minkowski's 4D-spacetime platform, which is a *priory* implanted into the ST. The ST has, of cause, very useful (going to the absolutely right – the singularityless direction) non-point, dynamical physical elements – vibrating loop's with fuzziness and with necessary (as convincingly shows our present analysis) additional somehow compactified dimensions, but the mentioned above “mistakable old clothes” make the so obvious ST-innovations helpless. Indeed, Witten writes, e.g., that in the ST “we do not have the analogue of the Einstein-Hilbert action or the principle of equivalence that led Einstein to it” (Witten 2003a, p. 458).

The PWM concept, on the contrary, derives the bunch of basic physical laws as simultaneously emergent & deeply united – arising together with the emergent quantized gravity “charge” and the (hyper-symmetrically corrected) *equivalence principle* with pure classically quantized (as it is exactly also in the ST), stringy-fuzzy elementary particles. Our bosonic (massless) C_4 -quasiparticles behave as relativistic fermions and acquire their identical rest masses together with the composite supersymmetry in the modular - periodical 3D-waveguided vacuum medium of

the PWM. The same basic motivation - to create the ST-like theory - free of singularities - is also realized in the PWM-concept, but much more holistically, where the most basic physical laws and string-like photoparticles emerge simultaneously as secondary in the basic PWM-structure!

TABLE 2a STRINGS & BRANES	TABLE 2b PHOTONIC SPRINGS & WAVEGUIDES
Postulated ST-STRINGS & BRANES →	Nonlinear PHOTONIC SPRINGS & WAVEGUIDES
<u>Empirical</u> <u>Postulated</u> → Global 3D-Euclidean Compactified n-3 _{Dim.}	<u>Postulated</u> PWM-global 4D-Euclidean, [kL ₀]-3D-waveguided
(3D _{sp})-space → (nD)-space →	4D-Euclidean ≥ 4D _{sp} -3D _{sp} -waveguided L ₀ -periodic
Pseudo-Euclidean Pseudo-Euclidean SR (3D _{sp} +iCt)-spacetime → (nD+iCt)-spacetime →	≥ (4D _{sp})- bounded waveguided space with C _{3t} → \mathbb{M} C _{4t} polygonal waveguide-parameterization
<u>Empirical</u> <u>Postulated</u> Membranes → (n-1)D _{sp} global Branes →	<u>Postulated</u> / possibly emergent medial borders (n-1)D _{sp} -Waveguides & L ₀ -periodic
(n-1)D _{sp} Branes →	framing (n-1)D _{sp} -Membranes & Waveguides
Dynamic X ⁴ =C _{3t} global spacetime coordinate →	PWM-emergent polygonal C _{4t} -parameterization
Classical continuous → ST-Quantized →	PWM-emergent waveguided Quantized $M_{inert} = hkv_0/C_4^2$
Empirical rest mass M _{inert} → vibrating modes →	PWM-emergent- waveguided C ₄ -dynamical “rest mass”
Fundamental SR →	PWM-emergent SR _{PWM} – periodic waveguided
Fundamental QM →	PWM-emergent QM _{PWM} – periodic waveguided
Fundamental fermionic Spin 1/2 →	PWM-emergent periodic relativistic vortex SU(2), S=1/2
GR-empirical Equivalence Principle (EP) →	PWM- emergent-waveguided quantized ±EP
Fundamental-empirical M _{inert} =M _{grav} >0 →	PWM-emergent M _{inert} = ± M _{grav} “charge, L ₀ -periodic”
Fundamental-empirical matter / antimatter →	PWM-emergent matter / antimatter, L ₀ -periodic
Fundamental-empirical ± Q _{electr} charge →	PWM-emergent ± Q _{electr} charge, L ₀ -periodic
Fundamental-empirical CPT-theorem →	PWM-emergent L ₀ -periodic (±M _{grav})CPW _n -theorem
Hypothetical Sparticles, broken (SUSY) →	PWM-emergent-composite SUSY, hidden-unbroken
Empirical-unknown Dark Energy →	PWM-em. period. Baryonic/Antibaryonic Dark Energy
Empirical-unknown Dark Matter (WIMPs ?) →	PWM-em. period. SM -Dark Baryonic Matter
Empirical-unknown two-component Dark Matter →	PWM-emergent two-comp. Dark Baryonic Matter
Empirical-unknown matter/antimatter asymmetry →	PWM-em. large-scale matter / antimatter symmetry
Empirical-unknown large-scale Universe flatness →	PWM-emergent steady large-scale Universe flatness
Empirical-unknown bubble large-scale Universe →	PWM-emergent bubble large-scale Universe-“doll”
Empirical-unknown small cosmological constant →	PWM-emergent ZERO- cosmological constant

The rest mass in the ST “(or its rest energy) arises only because the string has a tension”. (Zwiebach 2004, p. 108). This means that the ST-string is massless if its tension is zero. It is realizable for free 3D-light photons if they are not confined and if there are no barriers on the photons way. The ST postulates string tensions for the rest mass existence. The confined C₄-quasiparticle behaves in our case as localized-confined springy C₄-wave with the enormous C_L-pressure, directed outward of the L₀-confinement, creating its C₄-dynamical rest mass and gravity charge. This stable dynamical confinement assumes the exact opposite tension, arising in the confining system, compensating the enormous outward C_L-pressure (on the contrary to the tensioned - static by the nature ST-string). Our static elements now are two endless confining – slightly deformed - membranes, creating non-local quasi-classical gravity fields. But stabilization of periodical 3D-waveguides system involves as bulk as its framing membranes - tensions, keeping integrity of the whole periodical bulk structure. We can assume that this bulk is a kind of liquid superfluid medium, which allows membrane’s deformations. This means that underlying very dense bulky-mediums must be hypersymmetric (nongravitating superfluids, as

for example, the proposed and investigated (e^-/e^+) vacuum) and the vacuum's atoms must be very well self-integrated - coupled by a kind of microscopic Van der Waals forces, common in the condensed matter (e.g. liquids) physics.

The PWM stringy states are confined excitations in this isotropic 4D-bulky superfluid medium. They are easily associated with common Yang-Mills "photons". The simplest stringy-loop state is hypercylindrical with the quantized dynamical energy $E_n = h(nv^*_{04})$ and the waveguided rest mass $M_n = hnv^*_{04}/C^2$. These quantized mass-particles are light-dynamical by the nature and have *different* stationary orbiting-twisting radii $R_n = R_0/n$, but they hold the same fermionic L_n -spin $S_n = 1/2$ corresponding to the group $SU(2)$, arising as pure relativistic abrupt effect on the level of common - "effective" - superfluid theory.

The obvious analogy to the ST-like branes are our global flat 3D-membranes, dividing two 4D-vacuum's slices), but they could be emergent and arise from conceptually deeper - condensed matter/antimatter 4D- or even more dimensional physics. The PWM-springs are not elementary and isolated entities in empty space any more. It becomes obvious that the ST must be deeply revised and developed on the PMW-like, superfluid mediums basis - on the "lowest energy" limits. Thus, the PWM enables an obvious paradigmatic deepening of existing convenient "paradigmatic landscape" in fundamental physics including the both general sides of it - classical SM-physics and ST. Stable stringy loops are not thinkable any more as basic elements without corresponding nonlinear superfluid medium *around*, holding these ideal - inevitably dynamical - springy strings "for ever". This includes superfluidity, superconductivity, etc. as basic surrounding vacuum properties, describing by common quantum field theory.

It is symptomatic that much more successful development of the ST arose after the M-theory creation and involves additional hypothetical *macroscopic* objects like *branes*. These branes have analogue to our "substantial membranes", postulated at the beginning in the PWM concept. They have enormous tension and are elastic carcasses of 3D-waveguides. But these membranes are thinkable physically in the PWM concept as very thin surfaces, dividing different vacua, L_0 -periodically placed in the hyperspace and so, they are not elementary - they are thinkable as emergent global collective (sufficiently hyperspatial) phenomena - physical macro-surfaces with natural - common properties of strained elastic 3D-membranes. We see that these membranes are sufficiently different from the postulated abstract ST-branes. Indeed, our springy particles cannot "live" on the single isolated brane (being a dividing surface) - since (a) our isolated brane is physically disappearing fiction without two surrounding vacua as bulky slices and moreover, (b) the PWM-particles (e -cells) need at least *two parallel confining* branes-membranes and (c) springy-particles live in the isotropic 3D-bulk-shell between these framing 3D-branes. Non-local electrostatic potentials "live" indeed on two reciprocally stretched 3D-membranes, but their collective sources are e -holes in the cellular-dynamical superfluid bulk-tissue. The minimal membranes quantity, containing *particles and antiparticles as elementary cellular defects and anti-defects*, now they need at least six parallel, periodically placed 3D-membranes and five 3D-waveguides. This picture naturally assumes their inevitable - further *periodical prolongation* in the global hyperspace. Our periodically placed membranes seem to be emergent 3D-surfaces, dividing periodically layered vacuum/antivacuum. Underlying future theories (describing the substantial 3D-waveguide nature, the hyperspatial periodicity nature and correspondingly different masses of leptons and quarks) could be developed in the frames of the proposed periodical hyperspatial by the nature condensed matter/antimatter physics. It is very possible that the sophisticated ST machinery plus hyperspatial condensed matter QFT, etc. contain kind of its basic geometric-topological elements. Indeed, the ST captures "so much of what we already know about physics since shedding so much light on theories that we already have" (Witten 2003b). But natural hope and test of a deeper theory is its ability to solve at least some basic unsolved theoretical problems and to predict some new, experimentally testable physical

phenomena, what was not yet the tremendous case for the ST. Indeed, Martinus Veltman wrote recently that very big hopes for modern string theory did not prove true, and the “strings and supersymmetry...explain nothing from things what we don't understand today” (Hargittai 2004, p. 107). We assume that basic obstacles for the ST unsuccessfulness can be the same old-fashioned paradigmatic physical frames of “particle” and “vacuum”, realizing in the physically blinding, non-existing Minkowski’s global spacetime, analyzed above. These frames were not changed also in the SM and now it becomes also clear, why (as Veltman notes), “the miraculous thing with the Standard Model (SM) is that originally ALL the particles in the SM have some zero mass...”. (Id p. 101). He asks, “is there a deeper layer to understanding the balancing of forces?”, ... “we don't know why, but it gives you the suspicion that in the Higgs system there is probably another layer where the idea of mass gets another interpretation” (Id p. 101). The PWM concept gives surprisingly simple, inevitably hyperspatial answers, crucial for arising picture of the Multiverse’s physics, disclosing periodic waveguided rest mass nature and corresponding *DE&DM&SUSY*- features. Here arises the Higgs-like scalar e^-/e^+ superfluid vacuum (scalar chargeless electron-positron field) without Higgs. The described here waveguided electron rest mass creation mechanism is much more simple, it holds a local gauge invariance and has an excellent synergy with the basic physical laws.

Witten, indeed was deeply right (together with Gross, Glashow and some other prominent physicists) to question, first of all, the Minkowski’s spacetime concept: “when we study it more deeply, we find that in string theory, spacetime becomes fuzzy” and “I suspect that the fuzziness of spacetime will play more of a role in the eventual answer than we understand now.” On the other hand, the classical – global Minkowski’s spacetime is, as we could show above, not more than physically wrong unrolling of the 3D-waveguide’s wave-dynamics, where some basic physical features (as the 4D-space presence, rest mass, etc.) are lost. This classical-global unrolling stops the underlying opportunities to unify the micro-sized rest mass particles physics and hides of us extradimensional Multiverse. Witten writes: “I would conclude that extra dimensions really exist. They're part of nature. We don't really know how big they are yet, but we hope to explore that in various ways. They're beyond our ordinary experience just like atomic nuclei are. On the other hand, we don't understand the theory too completely, and because of this fuzziness of spacetime, the very concept of spacetime and spacetime dimensions isn't precisely defined.” (Witten 2003b). The PWM concept shows that the electron-Compton length becomes not only analogy of the hypothetical ST-“fuzziness”, it becomes the extradimensional “fundamental” physical length constant and fundamental hyper-period in the PWM-Multiverse.

Witten writes: “That's a big problem that has to be explained. As of now, string theorists have no explanation of why there are three large dimensions as well as time, and the other dimensions are microscopic. Proposals about that have been all over the map.” (Witten 2003b). An exemplary answer could be following – only the long-range force can provide the long-range (always *C*-dynamical) coherent existence of our dividing medial 3D-membranes and provide the long-range dynamical connections in ideal mediums. Only the long-range forces (*C*-quasiparticles) provide a long-range coherence - by common 3D-Maxwell’s photons (as spin waves in the 3D-superfluid vacuum). Surface of the hypercylindrical electron’s attractor is three-dimensional (two our and one hyperspatial dimension *L*) and the 4D-wave of electron is self-focused here (one from 4 spatial dimension is “condensed”) - self-reduced into the loop-like 3D-wave. It behaves like a (locally gauge invariant) ordinary Maxwell’s *C*-photon, twisting on this, very strongly curved, 3D-surface (being at the same time the Yang-Mills-like “photon”, flying in the nonlinear 4D-medium. It is massless only in the “illusory” (waveguide-less-unrolled) Minkowski’s spacetime description. It becomes the “gapped” rest mass in the 3D-waveguide – with the minimal classical rest mass harmonics (the waveguided mass gap), common for classical 2D-waveguides. Here arises very simple sense of the *mass gap* existence in the Yang-Mills theory, being totally lost in frames of the Minkowski’ 4D-spacetime – it becomes hidden in the lost 3D-waveguide’s

hyperspace structure, which is able to create the SR, etc. as wave interference effects in the 3D-waveguide. We see now that Jaffe and Witten have challenged in the “Mass Gap” - (Millennium problem) something much bigger – the “illusory” Minkowski’s spacetime itself.

Witten notes about crucial role of the SUSY: “...many physicists do suspect that our present decade is the decade when supersymmetry will be discovered. Supersymmetry is a very big prediction; it would be interesting to delve into history and try to see any theory that ever made as big a prediction as that.” (Witten 2003b). From our point of view the so necessary but always “illusive”, *perfect supersymmetry indeed exists* and is provided by the Cooper-like fermionic/antifermionic composites in the PWM atomistic hyperspatial vacuum, but material spices/devoices (as being made of elementary vacuum “defects”) are not able to percept this coherent global vacuum tissue. If they could directly percept it, their life could be very short, but it is practically endless, as our Universe life is. This ideal-perfect tissue is absolutely necessary for their steady existence, but at the same time it looks like a perfect emptiness for them. Imagine, that a fish, living in superfluid and clean ocean, will also percept it as emptiness. So, we cannot percept directly these single supersymmetric vacuum “atoms” – directly by physical experiments – they are truly dominating physical actors, but they are simply dominating ghosts, ghostly incorporated into the global coherent orchestra of the transparent superfluid vacuum. This miracle medium is our modest motherland - our invisible Tao, according (Lao-tze 600 B.C.), giving us (sophisticated bunches of its elementary defects) a wonderful freedom to fly free, fare away across the huge cosmos – our united vacuum’s space, to arise and to exist (as could a fish in superfluid) in the confusedly illusive hyperspatial emptiness. The QED-Casimir effect is one of indirect strong evidences to the maternal superfluid existence.

Views of dark energy (Witten 2008). Witten is one of few outstanding physicists, who can honestly accept, like Feynman, “I don’t know what energy is”, or “no body knows quantum mechanics”. He writes in his presentation: “Regrettably, I don’t have any new concept of dark energy to explain today.” (Witten 2008). Witten assumes the *DE* discovery “greatly changed how we think about the laws of Nature” and it “depends crucially on whether dark energy is a “cosmological constant” or not. He mentions an old QED-problem with quantum zero-point energy, which is too big if there is no total supersymmetry where bosons and fermions cancel if they have the same masses. He concludes: “... that some very deep and unknown mechanism, maybe involving mysteries of quantum gravity, would one day make the vacuum energy vanish.” Witten accepts: “We don’t really know for sure if observed dark energy is really the energy of the *vacuum*” (Witten 2008).

Indeed the proposed hypersymmetric PWM-concept of vacuum creates this exactly zero-vanishing case – providing by the non-broken - total Cooper-like composite-hidden supersymmetry and secretiveness of the so dense PWM-vacuum. The PWM vacuum excludes the cosmological constant and there must be another source of *DE*.

Witten notes: “This is the only interpretation of dark energy that is based entirely on General Relativity with no fields beyond the gravitational field. One only needs a new constant of nature: $[R_{\mu\nu} - (1/2)g_{\mu\nu}R] / 8\pi G = \Lambda g_{\mu\nu}$.” and “Every other theory of dark energy needs new fields (or more exotic new ingredients of some kind) and a more elaborate explanation.”, “This doesn’t necessarily mean that the cosmological constant is the right theory, but it is a simple and definite one and doesn’t yet really have a compelling competitor” (Witten 2008).

The PWM-description of *DE* is also in frames of gravitational field, but it contains consequent hypersymmetric matter/antimatter concept with *negative* gravity charge for antimatter particles, that is able to transform the GR into wider concept, applicable to the whole symmetrical periodical matter/antimatter Multiverse, immediately describing *DE* and *DM* simultaneously.

Witten writes that according quantum theory “we live in shouldn’t just be taken for granted as “empty space,”” and “Before the discovery of the dark energy, quantum physicists tended to assume that the “vacuum” we live in has some very deep meaning that reflects Nature’s deepest secrets.” (Witten 2008).

Indeed, theoretically constructed weightless superfluid, very dense PWM-vacuum and the grandiose periodical Multiverse itself “reflects Nature’s deepest secrets.”, hiding behind its illusive emptiness.

Witten assumes: “cosmic acceleration” has “an obvious analogy to the inflation that may have occurred in the past.”, and if “Inflation in the past didn’t go on forever and maybe that is also the case for the present epoch of inflation” (Witten 2008).

Indeed, the PWM-accelerated expansion (as compressed mega-spring) has limited quantity of repulsive potential energy (as once compressed and then expanded), where acceleration will be relaxed asymptotically to zero, if distances between galactic clusters / anticlusters will be endless.

Witten writes crucially important things: “In the last decade or so, we’ve learned (through work of Maldacena and others) that it is definitely possible to make a stable quantum gravity vacuum of *negative* vacuum energy. Supersymmetrically, zero is also possible. But it is extremely unclear whether in the presence of quantum gravity it is possible to have a stable world of *positive* vacuum energy.” (Witten 2008).

Witten assumes: “we shouldn’t aim to explain why “the vacuum” has a very tiny energy. Rather, we should look for a theory that generates all kinds of “vacua” with different properties – with energy large or small, positive, negative, or (in the supersymmetric case) possibly zero.” (Witten 2008).

He writes: “Several distinguished physicists – among them A. Linde, A. Vilenkin, S. Weinberg, M. Rees – have proposed or advocated this picture for years. The motivations were cosmic inflation, the problem of the cosmological constant, and curiosity about whether the Universe could be like that.”, and “since the dark energy was discovered, R. Bousso, J. Polchinski, L. Susskind, M. Douglas and other prominent string theorists have advocated that this sort of picture is the correct interpretation of string theory and the Universe.” (Witten 2008).

The PWM-concept punctually excludes these variations – proposing hyperspatially very regular structure, may be too boring, comparably to e.g. chaotically exploding endless bubble Universes with plenty of fundamental physical differences between them (Linde 1990, Susskind 2003). But the so physically “boring” PWM-structure contains something brilliant - very densely packed/overlapped clones of our mother-world with the same basic physical laws and similar intelligent brothers very near around us! So, may be now even the so fantastic physics of Multiverse will be used for very practical reasons - for communication with bunch of dark civilizations around us!

Witten formulates what one needs to accomplish in the ST: “To describe particle physics via string theory, what one needs is to describe the “vacuum” of the theory – the observed particles and forces are then expected to result from small oscillations around this vacuum.” (Witten 2008). Practically, he writes about creation of the “low energy limit” ST, which will be able to solve “the most basic problem of all – vanishing of the cosmological constant after supersymmetry breaking.” (Witten 2008). He assumes: “that for the theory to be right, one day a miraculous new idea would have to solve these problems.” and “Making the cosmological constant vanish would be a key test of this new idea.” (Witten 2008).

This is the culminating point in Witten’s analysis, and the PWM-concept stands the claimed key test: (1) it even survives the fully hidden supersymmetry, free of breaking troubles, so there was no supersymmetry break before, (2) the cosmological constant is and was exactly zero in the superfluid supersymmetric, weightless vacuum, and it is not necessary to kea about its vanishing,

(3) the PWM-concept – as this “miraculous new idea” - leads to the emergent negative gravity mass for antimatter, etc solving the *DE&DM&SUSY* problems simultaneously, with the sufficient overfulfilment – it explains the not less miracle interconnected nature of *DM*. Now these three things are deeply interconnected aspects of the whole PWM-system, created by its unity and periodicity. Witten was right: “dark energy might really represent the discovery of a new elementary field or particle.” Indeed, saying globally, this is discovery of the “impossible” repulsive gravity; new Cooper-like-composite “atoms” of our vacuum medium and it is at the same time discovery and proof of something enormously bigger - the Periodic Waveguided Multiverse itself.

NOTES TO THE PAULI’S INVENTION OF NON-ABELIAN KALUZA-KLEIN THEORY IN 1953

Wolfgang Pauli developed in 1953 the first consistent generalization of the five-dimensional theory of Kaluza-Klein to a higher dimensional internal space, realizing that is known as the fundamental nonabelian Yang-Mills theory (Pauli 1999). Being too self-critical, Pauli never published his theory since “he saw no way to give masses to the gauge bosons...” (Straumann 2000). This theory was later recreated and published by more relaxed and not so self-critical Cheng Ning Yang and Robert Mills (Yang & Mills 1954). Indeed, the gauge bosons will never acquire rest mass on the base of the global (unrolled) Minkowski spacetime, incorporated into the GR and automatically incorporated into the Kaluza-Klein five-dimensional generalization of the GR, where the rest mass creation mechanism disappears together with its fundamental – the described above waveguided physical base.

PREDICTION OF THE PICOMETER-LIMIT FOR THE SINGULARITYLESS NEWTONIAN GRAVITY LAW

Three very precisions torsion-balance experiments were recently conducted to test the gravitational Newtonian inverse-square law at separations between 9.53mm and 55μm, probing distances, being less than the “dark-energy length scale” ($R \approx 85\mu\text{m}$), (Kapner et al 2006). This test confirms the Newton inverse-square law down to a *length* scale $R=56\mu\text{m}$ and if exist an extra dimension, it must have a size less than $R \leq 44\mu\text{m}$ (!). Our estimation shows that the Newtonian $F_{gr} \sim 1/r^2$ -law is singularity-less and is true proximally till very small micro-distances down to the radius of the proposed (e^-/e^+) vacuum “atom” $R_3 \leq R_{oe} \approx 10^{-10}\text{cm} = 10^{-12}\text{m}$ and is very fare ($56 \times 10^{-6}\text{cm} / 10^{-10}\text{cm} \approx 10^7$) from the proposed microscopic 4-th extradimensional size R_4 , discussed in many articles:

$$R_4 \approx L_{oe} = \lambda_{e,Compton}^* = 2,426 \times 10^{-12}\text{m}_4 = 2,426 \text{ pm}_4. \quad (73)$$

THE GENERIC WAVE-OPTICAL WAVEGUIDED NATURE OF THE LEAST ACTION PRINCIPLE

The Einstein geodesic line condition means the shortest distance S between two spatial points (a,b):

$$\delta \int_a^b dS = 0. \quad (74)$$

This simple condition gives the common Hamilton principle in mechanics and dynamics for weak fields $\delta \int_{t_1}^{t_2} (U-T) dt = 0$. We could consider the massive C_4 - e -wave trajectory in the *artificially unfolded* L -space as the same quasi-classical “light” beam, propagating with the light speed C_4 along the quasi-straight geodesic line S_4 , corresponding to geodesic lines with the 0-length (geometrical beam), (Klein 1926, Fock 1926). This unfolded - Hamiltonian-like

trajectory mimics the (same by the summary length) physically waveguided-polygonal C_4 -“beam” trajectory ($\nearrow \searrow \nearrow \searrow \nearrow \searrow \nearrow \searrow \nearrow \searrow C_4 t_{PVM}$) along the substantial 3D-waveguide (see Fig. 2c). This quasi-optical, the wave-optical situation realizes the four-dimensional “minimal time” = “minimal length” principle of Fermat, based on the theory of Huygens, i.e.

$$\delta \int_b^a dS = \delta \int_{t_2}^{t_1} (U - T) dt = 0. \quad (75)$$

The idea of geodesic C_3 -lines, proposed by Einstein has generic relation not only to classical mechanics, but also to the roots of quantum mechanics in Dirac’s and Feynman’s path integrals interpretation. It is based on the Huygens wave principle, including the common ‘path integral’ concept in the wave-optical co-phased waveguided machinery. The e -wave’s energy also naturally propagates exactly along the singled out mainstream way, where wave’s phases along it hold “fast the same” and “full amplitude has considerable quantity” (Feynman 1966, v2/6, p. 109). Thus, the minimal action principle of the classical mechanics is not heuristic anymore - it can be deduced from the uniting - 3D-waveguided physical roots, emerging the Schrödinger and Dirac equations as the following waveguided wave equations (Gribov 2012). Kaku attenuated generic role of the least action principle, which was used by Feynman to reformulate the quantum mechanics in terms of Feynman path integrals. He writes: “We can derive Newton’s laws of motion, and vice versa”, but “this equivalence, however, breaks down at the quantum level...and ... thus, the action principle is the only acceptable framework for quantum mechanics” (Kaku 1999, p.20). This position corresponds well to our cellular-condensed vacuum media concept, where energy could be transported literally through the “atomistic” bosonic superfluid medium via spin waves – photons (bosonic quasiparticles). These spin waves propagate *casually* from cell to cell - like it is along Feynman paths - where action S shows its essential wave-phase properties. Obviously, all Feynman’s paths integral accounts *###for classical cases* must be realized *simultaneously* (for all possible paths) - *parallel* in the all-surrounding cellular vacuum space and “in the real time” along acting spin-wave’s fronts, giving determined classical trajectory. But electron-hole as elementary cellular defect’s-wave will travel chaotically, probing its always individual path between endless quantity of possible paths and common QM-wavefunction describes deterministic spatial distribution of wave’s amplitudes, showing probability in each place, where this defect can arise. It becomes easy possible via our concept of the inverted-condensed (globally coherent e -cellular vacuum) - quantum superfluid, where elementary mass particles are elementary Diracian e -holes, represented as the resulting non-local - globally coherent fields around these e -holes (Gribov 2005, 2012), which explains experimentally verified interference of a propagating single electron on two shells (Jönsson, 1961, 1974).

The proposed cellular-quantized vacuum space indeed works as a natural quantum supercomputer – super-quick, coherent (playing “multi-dice”) parallel calculator (like optical calculating machines), realizing all the Feynman’s part integrals and selecting the minimal-one for a classical mass particle. But a single C_4 -photon with very small elementary rest mass realizes all possible trajectories consequently! We could accept famous phrase of Einstein, related to the full Universe: “God does not play dice with universe” (Einstein 1926). But who can forbidden God to play a miracle multi-dice with tiny elementary defects, arising in his perfect kingdom?

The same non-local concept must be applied to the common 3D-photon quanta as a collective – spin wave quasiparticle phenomena in the e -cellular superfluid medium, which also shows the same experimental non-local interference of the single photon with itself on two shells. Why we percept a 3D-photon as a point-like object? It must behave physically as a limited coherent wave path ΔS_{Cph} (because of a limited photon quantum energy and an “internal” non-locality), so this wave path has a limited “internal length” ΔS_{Cph} along the C_3 -vector. But this ultra-relativistic

wave path ΔS^*_{Cph} moves with the constant velocity C_3 of light for all possible observers and we always percept it with the inevitably *maximal* relativistic shortening, strictly hiding its internal longitudinal non-locality $\Delta S_{\text{Cph}} \rightarrow 0$:

$$\Delta S_{\text{Cph}} \rightarrow \Delta S^*_{\text{Cph}} \sqrt{(1-C^2/C^2)} \rightarrow 0 \quad (76)$$

Acknowledgment My thanks to my dear friends Vladimir Kozlovskij and Igor Urusovski for frankly interest and steady professional support. My thanks to Alban Kellerbauer, Paul Steinhardt, Andrei Linde, and Juan Maldacena for short but fruitful discussions on the subject. My thanks to Sheldon Glashow who motivated me develop the photon/antiphoton concept, which allows the direct-DM-detection - as independent experimental verification of the PWM-concept. Thanks Grigorij Volovik and Frank Wilczek for penetrating superfluidity-SM-vacuum likeness, reincarnated in the *nongravitating e-/e+* superfluid vacuum concept in the PWM. Thanks to Sergey Trigger, whose questions helped me understand the mixed decelerative & accelerative phases nature in the universe expansion and thanks Otto Rössler who motivated me develop the singularity-less black holes concept. Thanks Leo Pomirchi, Lev Khein, Dieter Herrmann, Constantine Glaum and Boris Shapiro for interest, discussions and friendly support. Of cause, also my indirect – *Internet-thanks* to Robert Laughlin, David Gross, Steven Weinberg, Edward Witten and some other not less great physicists, many times quoted in this article for their deep and fascinating ideas, mentioned / partially realized in this paper, triggering so “crazy” *inversions* of the basic physical paradigms, realizable in the presented periodic waveguided Multiverse.

References

- Aguilar, M. et al. 2013. First Result from the Alpha Magnetic Spectrometer on the International Space Station: Precision Measurement of the Positron Fraction in Primary Cosmic Rays of 0.5–350 GeV. *Phys. Rev. Lett.* **110**.
- Agnese, R. et al. 2013. Silicon Detector Results from the First Five-Tower Run of CDMS II. <http://arxiv.org/pdf/1304.3706v2.pdf>
- Albrecht, A. & Steinhardt, P. J. 1982. *Phys. Rev. Lett.* **48**, 1220
- ALICE Collaboration. 2010. Elliptic flow of charged particles in Pb-Pb collisions at 2.76 TeV. <http://arxiv.org/abs/1011.3914>.
- Anderson, P.W. 1972. More is different: broken symmetry and the nature of the hierarchical structure of science. *Science*, Vol. **177** no. 4047: 393-396.
- Aubin, F.; Auger, M.; Behnke, E.; Beltran, B.; Clark, K.; Dai, X.; Davour, A. et al. (PICASSO Collaboration). 2009. Dark Matter Spin-Dependent Limits for WIMP Interactions on ^{19}F by PICASSO". *Physics Letters B* **682** (2): 185.
- Begelman, M. (2009). First black holes may have incubated in giant, starlike cocoons, says CU-Boulder study. http://www.eurekalert.org/pub_releases/2009-11/uoca-fbh112409.php.
- Baltz, E. A. & Gondolo, P. 2004. *JHEP* 10, 052
- Borde, A., Vilenkin, A. 1994. *Phys. Rev. Lett.* 72, 3305
- Bogoliubov, N.N, Shirkov, D.V. 1980. *Quantum fields*. Moscow, Nauka.

- Bruno, G. 1588. Teofilo, in Cause, Principle, and Unity, "Fifth Dialogue," ed. and trans. by Jack Lindsay (1962).
- Caldwell, R. R., Dave, R., Steinhardt, P. J. 1998. Cosmological Imprint of an Energy Component with General Equation of State. *Physical Review Letters*, **80**/8: 1582-1585.
- Capozziello, S. Funaro, M. Stornatolo, C. 2004. Cosmological black holes as seeds of voids in the galaxy distribution. *A&A* **420**: 847-851.
- Cheng, T.P. 2005. *Relativity, gravitation and cosmology*. Oxford Univ. Press. Oxford. New York.
- Chernin, A.D., Teerikorpi, P., Valtonen, M. J., Byrd, G. G., Dolgachev, V. P., Domozhilova, L. M. 2009. Dark energy and the mass of the Local Group. ArXiv:0902.3871v1 [astro-ph.CO].
- Choi, C. Q. 2010. Most Massive Neutron Star Breaks Cosmic Record.
<http://www.space.com/scienceastronomy/most-massive-neutron-star-record-101027.html>
- Clowe, D., Bradac, M., Gonzalez, A. H., Markevitch, Randall, M., S. W., Jones, C., Zaritsky, D. 2006. A Direct Empirical Proof of the Existence of Dark Matter. *The Astrophysical Journal Letters* **648**(2): L109–L113. arXiv:astro-ph/0608407
- Conroy, C. Wechsler, R. H. Kravtsov, A. V. 2006. Modeling Luminosity-Dependent Galaxy Clustering Through Cosmic Time
- Cropper, W.H. 2001. *Great physicists*. Oxford Univ. Press. Oxford, New York.
- Descartes, R. 1644. *The Principles of Philosophy (IX)*.
- Dirac, P.A.M. 1930. *Proc. Cambr. Phil. Soc.* **26**: 376.
- Dirac, P.A.M. 1931. Quantized singularities in the quantum field. *Proc. R. Soc. London, A*.
- Dirac, P. A.M. 1948. *Phys. Rev.* **74**: 817.
- Domenico, A. 2007. Experimental Tests Of CPT Symmetry And Quantum Mechanics In The Neutral Kaon System. In: *Time And Matter 2007 Conference*.
<http://tam.ung.si/2007/papers/TAM2007-Proceedings.pdf>
- Einstein, A. 1926. Letter to Max Born (4 December 1926). In: *The Born—Einstein Letters*. (translated by Irene Born). Walker and Company, New York, 1971.
- Einstein, A. Grommer, J. 1923. Beweis der Nichtexistenz eines Ueberall Regulaeren Zentrisch Symmetrischen Feldes dach der Feld-Theorie Von Th. Kaluza. In: Wuensch, D. 2010. *Dimensionen des Universums*. Termessor. Göttingen & Stuttgart.
- Einstein, A. 1920. Ether and the theory of relativity. May 5th, University of Leiden.
- Einstein, A. 1905a. Zur Elektrodynamik bewegter Körper. *Annalen der Physik* **17**, 891.
- Einstein, A. 1905b. Über einen die Erzeugung und Verwandlung des Lichtes betreffenden heuristischen Gesichtspunkt. *Annalen der Physik* **17**, 132.

- El-Ad, H., Piran, T. 1997, Voids in the Large-Scale Structure. *Astrophysical Journal* **491**: 421.
- Farihi, J., Barstow, M.A., Redfield, S., Dufour, P., Hambly, N.C. 2010. Rocky Planetesimals as the Origin of Metals in DZ Stars. arXiv:1001.5025v1.
- Feynman, R.P. 2001. Was soll das alles? Gedanken eines Physikers. Piper Verlag GmbH, München.
- Feynman, R.P. 1985. QED: the strange theory of light and matter. Princeton University Press.
- Feynman, R.P., Leighton R B., Sands M. 1966. The Feynman lectures on physics, V. 1, 2.5, 2.6. Electricity and magnetism. MIR, Moscow.
- Fock, V. 1926. Über die invariante Form der Wellen-und der Bewegungsgleichungen für einen geladenen Massenpunkt. *Zeits. F. Phys.* **39**: 226.
- Geringer-Sameth, A., & Koushiappasy, S.M. 2011. Exclusion of canonical WIMPs by the joint analysis of Milky Way dwarfs with data from the Fermi Gamma-ray Space Telescope
- Gibbs, P. 1996. The Small Scale Structure of Space-Time: A Bibliographical Review. arXiv:hep-th/9506171v2.
- Gribov, I. 2013b. Method and device for the direct detection of dark matter via antimatter and its annihilation with the elementary particles of the dark matter in the magnetic trap. Patent application, 09 March 2013.
- Gribov, I. 2013a. Method and device for signal – information – transmission between our Universe and physically identical periodic Universes from dark matter. Patent application, 05 September 2011, DE102011112804A1.
- Gribov, I. 2012. Dark Matter as Pico-Windows to physically equal Multiverse Worlds with Myriads Civilizations Around Us (in extra dimension). Humboldt Univ., Internet-Journal of Leibniz-Sozietät, (submitted - Jun 24, 2010, reported - Colloquium 06. January, 2011, publ. 20.01.2012). http://www2.hu-berlin.de/leibniz-sozietat/journal/archive/13_12/01_gribov.pdf
- Gribov, I. 2007. Massless matter/antimatter space ship. Patent application DE202006016942U1.
- Gribov, I. 2005. How could Einstein empty vacuum become stable quantum liquid with the common Einstein-Lorentz invariance and other Standard Model features? In: *Sitzungsberichte der Leibniz-Sozietät. Anniversary collection of articles: „Albert Einstein in Berlin“* (Kolloquium 17.03. 2005). V. 78/79: 193-208. Berlin. (Engl.).
http://www2.hu-berlin.de/leibniz-sozietat/archiv%20sb/078-79/22_gribov.pdf
- Gribov I. 2003. The photostring Universe and antigravity of the antiparticle. In: *Abhandlungen der WIGB, Berlin, 3*: 37-46. (Engl.).
- Gribov, I. 2002. “Creative predisposition and creative activity in the context of brain functional asymmetry”. PhD thesis. Bremen University, Germany. (Engl.).
http://elib.suub.uni-bremen.de/publications/dissertations/E-Diss705_gribov.pdf

- Gribov, I. 1999. About the nature of wave function in quantum mechanics. In: Abhandlungen der WIGB, Berlin, v. 2: 15-28. (Engl.).
- Gol'fand J. A. & Likhtman, E. P. 1971. Расширение алгебры генераторов группы Пуанкаре и нарушение p -инвариантности. Письма в ЖЭТФ, том 13 стр. 452-455.
- Guidry, M. 1991. Gauge field theories. John Wiley & Sons, INC.NY.
- Guidry, M. 1991. Gauge field theories. John Wiley & Sons, INC.NY.
- Hargittai, M., Hargittai, I. 2004. Candid science IV. Conversations with famous physicist. Imperial College Press. London.
- Heisenberg, W. 1943. Die Beobachtbaren Grossen in der Theorie der Elementarteilchen, Z Phys. 120, 513.
- Heisenberg, W. 1957. Quantum Theory of Fields and Elementary Particles, Rev Mod Phys, 29 269.
- Hinshaw, G. F. 2008. "WMAP Cosmological Parameters Model: lcdm+sz+lens Data: wmap5". NASA. Retrieved 2009-05-24.
- Guth, A. H. 1981. The inflaionary Universe: A possible solution to the horisont and flatness problems. Pysical Review D**23**: 347.
- Hajdukovic, D. S. 2011. Is dark matter an illusion created by the gravitational polarization of the quantum vacuum. Astrophys. Space Sci., **334**, 215
- Hajdukovic, D. S. 2012a, Astrophys. Space Sci., **337**, 9
- Hajdukovic, D. S. 2012b, Astrophys. Space Sci., **339**, 1
- Hooft, G. 't. 1999. A confrontation with infinity. Nobel lecture, December 8, 1999.
- Hu, B.L. 1996. General relativity as geometro-hydrodynamics', Expanded version of an invited talk at 2nd International Sakharov Conference on Physics. Moscow 20-23 May 1996.
- Jee, M. J., Mahdavi, A. et al. 2012. A study of the dark core in A520 with Hubble space telescope: the mystery deepens. <http://arxiv.org/pdf/1202.6368.pdf>
- Jönsson, C. 1961. Zeitschrift für Physik, **161**:454–474.
- Jönsson, C. 1974. Electron diffraction at multiple slits. American Journal of Physics, **4**:4–11.
- Kaluza, T. 1921. Sitzungsberichte. d. Preuss. Akad., 966.
- Kaku, M. 1999. Introduction to Superstrings and M-Theory. Springer. New York Berlin.
- Kellerbauer, A., et al. 2008. Proposed antimatter gravity measurement with an antihydrogen beam. Nucl. Instr. and Meth. in Phys. Res. B **266**: 351–356.
- Kelso, C. M. & Hooper, D. 2010. Synchrotron emission from young and nearby pulsars. Journal

of Cosmology and Astroparticle Physics, 05 039.

Kirshner, R. P., Oemler, A., Schechter, P. L., & Shectman, S. A. 1981. A million cubic megaparsec void in Bootes. *Astrophysical Journal, Part 2 - Letters to the Editor*, **248**, Sept. 1, 1981: 57-60.

Klein, O. 1926. Quantentheorie und fünfdimensionale Relativitätstheorie. *Zeits. F. Phys.* **37**: 895.

Kleinert, H. 1983. *Phys. Lett. A* **97** 51.

Kleinert, H. 1989. Gauge fields in condensed matter. V II: Stresses and defects, WSc, Singapore.

Khriplovich, I. B., Lamoreaux, S. K. 1997. CP Violation Without Strangeness. Electric Dipole Moments of Particles, Atoms and Molecules. Springer, Berlin.

Kröner, E. 1996. Dislocation theory as a physical field theory, in: Continuum Models and Discrete Systems, Proc. 8th Int. Symp., Varna, Bulgaria, K.Z. Markov ed., World Scientific, Singapore: 522-537.

Kapner, D.J. Cook, T.S. Adelberger, E.G. Gundlach, J.H. Heckel, B.R. Hoyle, C.D. and Swanson, H.E. 2006. Tests of the Gravitational Inverse-Square Law below the Dark-Energy Length Scale. http://arxiv.org/PS_cache/hep-ph/pdf/0611/0611184v1.pdf

Kuhn, T. N. 1962. The structure of scientific revolutions. Univ. of Chicago Press. Chicago.

Laughlin, R.B., Pines D. 2000. 'The Theory of Everything', *Proc. Natl Acad.Sci. USA* **97**:28-31.

Laughlin, R. B. 2007. Abschied von der Weltformel. Piper Verlag, München.

Lazar, M. 2000. Dislocation theory as a 3-dimensional translation gauge theory. arXiv:cond-mat/0006280v1.

Lazar, M. 2009. On the Higgs mechanism and stress functions in the translational gauge theory of dislocations. arXiv:0903.0990v1.

Lazar, M. 2010. On the fundamentals of the three-dimensional translation gauge theory of dislocations. arXiv:1003.3549v1.

Lao-tse, about 600 B.C. Tao Te Ching, (China). In: Sagan, C. 1981. Cosmos. The story of cosmic evolution, science and civilisation. Macdonald & Co. London.

Linde, A. D. 1982. *Phys. Lett. B* **108**, 389.

Linde, A. D. 1990. "Extended chaotic inflation and spatial variations of the gravitational constant," *Phys. Lett. B* **238**, 160

Lykken, J. 2011. In: Lepton-Photon Conference. CERN. Mumbai.

Lykken, J. 2003. Viewpoints on String Theory. <http://www.pbs.org/wgbh/nova/elegant/view-witten.html>.

Marinoni, C., Buzzi, A. 2010. A geometric measure of dark energy with pairs of galaxies.

Nature **468**: 539-541.

Moriyasu, K. 1983. An elementary primer for gauge theory. World Scientific Publishing Co Pte Ltd. Singapore.

Markevitch, M.A., Gonzalez, H., Clowe, D., Vikhlinin, A., David, L., Forman, W., Jones, C., Murray, S., Tucker, W. 2003. Direct constraints on the dark matter self-interaction cross-section from the merging galaxy cluster 1E0657-56. *Astrophys.J.* **606**(2): 819–824. arXiv:astro-ph/0309303.

Nash J. 2011. In: Lepton-Photon Conference. CERN. Mumbai.

Newton, I. 1692. The third letter to Bentley. Trinity College Library, Cambridge, UK.

Padmanabhan, T. 1998. Conceptual issues in combining general relativity and quantum theory hep- th/9812018.

Pauli, W. 1999. *Wissenschaftlicher Briefwechsel*, Vol. IV. Part II. Springer-Verlag, edited by K.V. Meyenn.

Perlmutter, S. et al. (June 1999). "Measurements of Omega and Lambda from 42 High-Redshift Supernovae". *The Astrophysical Journal* **517** (2): 565–586.

Phillips, T.J. 1997. Antimatter gravity studies with interferometry. *Hyperfine Interactions*. **109**: 357–365.

Perlmutter, S. et al. 1999. "*Measurements of Omega and Lambda from 42 HighRedshift Supernovae*". *The Astrophysical Journal* 517 (2): 565–586.

Ripalda, J. M. 2010. Time reversal and negative energies in general relativity. <http://arxiv.org/ftp/gr-qc/papers/9906/9906012.pdf>

Rubakov, V.A. 2005. Dark matter and dark energy in the universe. <http://elementy.ru/lib/25560/25564>

Sagan, C. 1981. *Cosmos. The story of cosmic evolution, science and civilisation.* Macdonald & Co. London

Schrödinger, E. 1930. Über die kräftefreie Bewegung in der relativistischen Quantenmechanik, *Berliner Ber.* : 418-428.

Shaposhnikov N.&Titarchuk L. 2007. *NASA Scientists Identify Smallest Known Black Hole.* http://www.nasa.gov/centers/goddard/news/topstory/2008/smallest_blackhole.html

Smoot, G. 2011. In: Lepton-Photon Conference. CERN. Mumbai.

Straumann, N. 2000. On Pauli's invention of non-abelian Kaluza-Klein theory in 1953. Arxiv:/gr-qc/pdf/0012054v1.

Susskind, L. 2003. The anthropic landscape of string theory. Arxiv.org/abs/hep-th/0302219.

Stornaiolo, C. 2002. Cosmological black holes. *Gen. Relativity Gravitation* 34, **12**: 2089-2099

- Villata, M. 2013. On the nature of dark energy: the lattice Universe.
<http://arxiv.org/pdf/1302.3515.pdf>
- Villata, M. 2012. Dark energy” in the Local Void. Arxiv:1201.3810v1 [astro-ph.CO]
- Villata, M. 2011b, EPL (Europhysics Letters), 94, 20001
- Villata, M. 2011a. CPT symmetry and antimatter gravity in general relativity.
arXiv:1103.4937v1
- Volovik, G.E. 2003. The universe in a helium droplet. Clarendon press. Oxford university press.
- Weinberg, S. 2000. The quantum theory of fields. Volume III. Cambridge. Cambridge Univ. Pr.
- Weinberg, S. 2005. *Living in the Multiverse*. arXiv: hep-th/0511037v1 3 Nov 2005.
- Wells, H. G. 1902. The discovery of the future. Nature **65**: 326.
- Wess, J., Zumino, B.A. 1974. Lagrangian model invariant under super-gauge transformations, "Phys. Lett.", v. **49B**: 52.
- Wilczek, F. 2002. Four Big Questions with Pretty Good Answers. Talk given at a Symposium in Honor of Heisenberg's 100th birthday, December 6, 2001, Munich. To be published in the Festschrift. http://arxiv.org/PS_cache/hep-ph/pdf/0201/0201222v2.pdf
- Wilczek, F. 2008. The Lightness of Being: Mass, Ether, and the Unification of Forces. Basic Books.
- Williams, L. L. R., & Saha, P. 2011, MNRAS, 415, 448
- Witten, E. 2003a. The past and future of string theory. In: The future of theoretical physics and cosmology. Eds. G.W. Gibbons, E.P.S. Shellard, S.J. Rankin. Cambridge Uni. Press.
- Witten, E. 2003b. NOVA: Viewpoints on String Theory.
<http://www.pbs.org/wgbh/nova/elegant/view-witten.html>.
- Witten, E. 2008. Views of dark energy.
http://www.stsci.edu/institute/itsd/information/streaming/archive/SpringSymposium2008/EdwardWitten050508Hi_supporting/Witten.ppt
- Yang, C. N., Mills, R. 1954. Conservation of isotopic spin and isotopic gauge invariance. Physical Review **96** (1) : 191-195.
- Zee, A. 2003. Quantum field theory in a nutshell. Princeton Uni. Press. Princeton, Oxford.
- Zwiebach, B. 2004. A first course in string theory. University Press. Cambridge.