

The 3D Universe Theory

$8\pi-1$

Patrick Tonin

Website: www.3d-universe-theory.com

Email: patrick@3d-universe-theory.com

Twitter: @3DUTheory

Summary:

The 3D Universe Theory describes the Universe as a growing sphere of layered information with only three dimensions: two space dimensions and one dimension which is both space and time. The information describing our "present" moment is contained in a 2D layer of that sphere and past/present/future co-exist as concurrent layers. Each layer is scaling up with time. The Universe follows two simple ratios: **$8\pi-1$** and **Phi** (the Golden ratio)

Simple equations suggest that this model is correct, here are a few:

1) The Universe is a growing sphere of information and is fundamentally holographic:

The Universe information sphere is composed of Planck size Universal Bits (UB's), the inverse of the surface area in Planck units gives a correct value for the Dark Energy Density:

Value of Dark Energy Density (in Planck units):

$$\rho\Lambda = \frac{1}{4\pi \times R^2} = \frac{1}{8.14 \times 10^{122}} = 1.23 \times 10^{-123} \text{ (WMAP value} = 1.27 \pm 0.07 \times 10^{-123}\text{)}$$

R = age of the Universe in Planck units

2) The Universe is scaling up with time. (at our present times the scale factor is 10^{20})

We show that the proton's diameter is a scaled up version of the Planck length. Starting with the Planck Length, then using the 10^{20} scale factor and the $8\pi-1$ ratio (in this case $8\pi-1/8\pi$), we get a correct value for the proton's radius measured with a muon but more astonishingly by dividing that value again by the same expression we get the correct value for the proton's radius measured with an electron.

Proton's radius (measured with muon):

$$R_{pm} = \frac{l_p \times 10^{20}}{2 \times \left(1 - \frac{1}{8\pi}\right)} = 0.8416 \times 10^{-15} \text{ m (official value } 0.8418 \times 10^{-15} \text{ m)}$$

Proton's radius (measured with electron):

$$R_{pe} = \frac{R_{pm}}{1 - \frac{1}{8\pi}} = \frac{0.8416 \times 10^{-15}}{0.9602} = 0.8765 \times 10^{-15} \text{ m (official value } 0.8768 \times 10^{-15} \text{ m)}$$

Using the $8\pi-1$ ratio again (in this case $8\pi-1/\pi$) and a 10^{20} scale factor, we show that the proton's mass is a scaled down version of the Planck mass

Proton's mass in relation to the Planck Mass:

$$M_{pr} = m_p \times 10^{-20} \times \left(8 - \frac{1}{\pi}\right) = 1.6719 \times 10^{-27} \text{ Kg (official value } 1.6726 \times 10^{-27} \text{ Kg)}$$

Proton's mass and proton's diameter in relation to the Planck Constant and the speed of light:

$$D_{pr} \times M_{pr} = 8 \times l_p \times m_p = 8 \times \sqrt{\frac{hG}{2\pi c^3}} \times \sqrt{\frac{hc}{2\pi G}} = \frac{4h}{\pi \times c}$$

3) The $8\pi-1$ ratio is fundamental to the Universe:

Proton-to-Electron mass ratio:

$$M_{pr}/m_e = \left((8\pi - 1) + \frac{1}{(8\pi - 1)} + \frac{1}{(8\pi - 1)^2} + \frac{1}{(8\pi - 1)^3} + \dots \right)^2 \times \pi = 1836.19 \text{ (official value } 1836.15)$$

Gravitational coupling constant :

$$\alpha_G = \left(\left(8 - \frac{1}{\pi} \right) \times 10^{-20} \right)^2 = 5.900 \times 10^{-39} \text{ (official value = } 5.905 \times 10^{-39}\text{)}$$

4) The golden ratio is fundamental to the Universe:

Electron's mass: (φ has a dimension of Time in sec)

$$m_e = \frac{2h}{\varphi \times 10^{-20} \times c^2} = 9.112 \times 10^{-31} \text{ Kg (official value = } 9.109 \times 10^{-31} \text{ Kg)}$$

Electron's Compton wavelength: (φ has a dimension of Time in sec)

$$\lambda_e = \frac{\varphi \times 10^{-20} \times c}{2} = 2.4253 \times 10^{-12} \text{ m (official value = } 2.4263 \times 10^{-12} \text{ m)}$$

Electron's Compton frequency: (φ has a dimension of Time in sec)

$$\nu_e = \frac{c}{\lambda_e} = \frac{2}{\varphi \times 10^{-20}} = 1.2360 \times 10^{20} \text{ Hertz (official value = } 1.2356 \times 10^{20} \text{ Hertz)}$$

Electron's charge:

$$e = \sqrt{\frac{h \times \left(1 - \frac{1}{8\pi} \right)}{\varphi^2 \times 8\pi \times \mu_0 \times c}} = 1.60209 \times 10^{-19} \text{ C (official value = } 1.60217 \times 10^{-19} \text{ C)}$$

Fine structure constant :

$$\alpha = \left(\frac{e}{q_p} \right)^2 = \frac{h \times \left(1 - \frac{1}{8\pi} \right) \times \mu_0 \times c}{\varphi^2 \times 8\pi \times \mu_0 \times c \times 2h} = \frac{\left(1 - \frac{1}{8\pi} \right)}{\varphi^2 \times 16\pi} = 7.2966 \times 10^{-3} \text{ (official value } 7.2973 \times 10^{-3}\text{)}$$

Main features of the 3D Universe Theory

- The Universe is just pure information
- The Universe starts from just a single bit of potential information (existence/non-existence)
- The Universe is an expanding sphere of layered information
- The sphere is expanding at the speed of light
- The Universe has only got 3 dimensions: two space dimensions and one dimension which is both space and time
- The Universe is holographic
- Past, present and future co-exist as layers of coherent information
- There are as many “presents” as there are layers and they all form a coherent space-time continuum
- Each layer scales up with time
- Fundamental constants scale up with time
- The Universe is pixelated
- Time and space are quantized
- Time and space are emergent and are both expanding
- The dimensions of Time and Length are fundamentally linked ($T=L^2$)
- Matter and Energy density follows a simple ratio ($8\pi-1$) with 1 representing ordinary matter
- Matter is a temporal pattern of coherent information
- Matter is continuously created
- Matter is continuously expanding
- Gravity is a “push” effect and a consequence of the continuous matter expansion
- The electron is the possible future of the proton
- The Planck Length is linked to the golden ratio
- The proton's diameter is a scaled up version of the Planck Length
- The proton's mass is a scaled down version of the Planck Mass
- The dimension of Mass is fundamentally linked to Time and Length ($M=L^2/T$) and is effectively dimensionless
- As fundamental dimensions are linked, they cancel out and simple dimensionless equations for fundamental constants can be derived
- The Universe is holistic

The start of the Universe and its fundamental structure

At the start of the Universe there is nothing, nothing exists, not even time. The notion of existence itself has to be defined. But the notion of existence can only be defined if there is a notion of non-existence. Therefore, it all starts with two states: one existence and one non-existence.

To distinguish them we can only say that one is the opposite of the other one, or if one “is”, the other one “is not”. They are just pieces of potential information, like bits in a computer, either 0 or 1.

The notion of existence is relative. Each state is existence from its own point of view and non-existence from the other’s. The two states cannot exist without one another, but they are in two completely separate “worlds”; the existence world and the non-existence world.

From a single world’s point of view, only one state can exist at any one time, either existence or non-existence. From a single world’s point of view, we will call these two opposite states a Universal Bit (UB). Like a computer bit, a UB can be in only one state at a time, either existence or non-existence. A UB is constantly flicking between existence and non-existence (the chance of it existing is 50% and the chance of it not existing is also 50%).

The appearance of the first UB creates the notion of potential existence. The space around this first UB needs to be defined: it either exists or it does not, therefore more UBs are added all around the first UB, creating a growing sphere of UBs, a growing sphere of potential information.

There are two ways to describe our Universe:

- 1) From an external observer’s point of view: this is what we would observe if we could look at the Universe without being part of it. In this case, we would see a growing sphere of UBs.
- 2) From an internal observer’s point of view: this is what is observed by a person living in our world. In what will follow, the term “world” or “coherent world” will mean the Universe as we see/experience it.

UBs are the most basic constituents of the Universe sphere. Basic constituents are the smallest of everything and cannot be subdivided. A UB is just a bit of potential information. A UB is not material and does not have a shape as such, but its apparent size, in any directions, is one Planck Length and it flicks between existence and non-existence every Planck Time. Only UBs following certain rules can develop into a coherent world, the world as perceived by an internal observer.

Rule no 1: The Universe Sphere Rule

The formula for the surface area of a sphere is $4\pi R^2$ with R being the radius of the sphere. R being composed of UBs, the rule is: “The number of UBs on the surface of the sphere is equal to $4\pi R^2$ ”

Rule no 2: The Coherent World Rule

At the very start of the Universe, the radius of the sphere is just one basic constituent and from the above formula we can deduce the following rule: “The number of basic constituents on the surface of a sphere is equal to the square of its own value times 4π ”

In order to follow rule no 2, the basic constituents of a developing coherent world must be subdivided into smaller units. These smaller units are the UBs of the Universe sphere. We will call the basic constituents of a coherent world: Coherent Basic Units (CBUs). A CBU is made of UBs.

There are now two ways to look at the growing sphere of UBs:

- 1) From an external observer's point of view: the sphere is made of UBs
- 2) From an internal observer's point of view (living in a coherent world): the sphere is made of CBUs

In other words, UBs are the basic constituents of the Universe sphere and CBUs are the basic constituents of a coherent world. To an internal observer, a CBU is just a bit of potential information in the same way that a UB is a bit of potential information to an external observer.

We can translate the above rules into the following equations:

The total number of UBs on the surface of the sphere:

$$N = 4\pi R^2 \text{ (with R being the number of UBs composing the radius of the Universe sphere)}$$

The total number of CBUs on the surface of the sphere:

$$C = 4\pi X^2 \text{ (with X being the total number of UBs per CBU)}$$

The total number of UBs on the surface is also $N = CX$

$$\text{So we have : } 4\pi R^2 = 4\pi X^2 X = 4\pi X^3$$

We can now work out the number of UBs per CBU and the number of CBUs on the surface of the sphere in relation to the radius R of the Universe sphere:

Number of UBs per CBU:

$$X = \sqrt[3]{R^2}$$

Number of CBUs on the surface:

$$C = 4\pi \sqrt[3]{R^4}$$

From the above equations we deduct that, as the radius of the Universe sphere increases, new CBUs are inserted on the surface of the sphere and each CBU also grows in size.

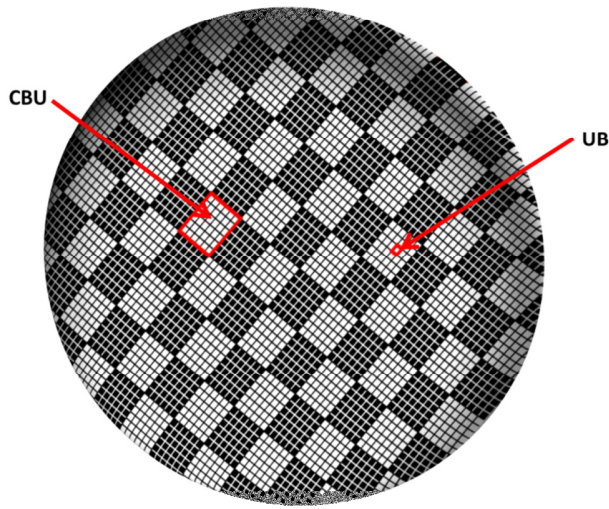

This figure shows the surface of the Universe sphere composed of CBU's which are themselves composed of UB's. At this stage, we assume that the number of "existence" and "non-existence" CBU's is equal and that they are equally spaced out.

The radius of the Universe sphere increases in increments of one UB (because a UB is the most basic constituent of the Universe). With each radius increase, the number of new UB's added to the surface of the sphere is given by the following equation:

$$\text{Nb of new UBs added} \approx (4\pi (R + 1)^2) - (4\pi R^2) \approx 8\pi R$$

The above equation, and the ones that will follow, are simplified because, as the Universe sphere expands, R rapidly becomes very large.

The number of new UB's is far too small to enable the Universe to follow the Coherent World Rule. Indeed, with each radius increase there aren't enough new UB's to equally expand each existing CBU and also to create new ones. The Universe has to go through a certain number of "radius expansions" (layers of UB's) in order to build up enough UB's to share them out equally.

To calculate the number of "radius expansions" needed, we first need to calculate the total number of new UB's needed to expand the surface in an equal manner (i.e. a certain number of new CBU's made of UB's and one new UB for all the existing CBU's)

Number of new CBU's per surface (using $C=4\pi X^2$ and $X=\sqrt[3]{R^2}$)

$$(4\pi (\sqrt[3]{R^2} + 1)^2) - (4\pi (\sqrt[3]{R^2})^2) \approx 8\pi \sqrt[3]{R^2}$$

Number of new UB's needed to create the new CBU's:

$$8\pi \sqrt[3]{R^2} \times \sqrt[3]{R^2} = 8\pi \sqrt[3]{R^4}$$

Number of new UBs needed to expand each existing CBU by one UB:

$$4\pi\sqrt[3]{R^4} + 8\pi\sqrt[3]{R^2} \approx 4\pi\sqrt[3]{R^4}$$

So the total number of new UBs needed to expand the surface of the sphere in an equal manner is:

$$8\pi\sqrt[3]{R^4} + 4\pi\sqrt[3]{R^4} = 12\pi\sqrt[3]{R^4}$$

Therefore, the number of “radius expansions” (each one UB thick) required to expand the surface in an equal manner is:

$$\frac{12\pi\sqrt[3]{R^4}}{8\pi R} = \frac{3\sqrt[3]{R}}{2}$$

This number of expansions represents the “thickness” of a CBU, measured in UBs. The Universe is expanding in layers of UBs, but a coherent world is expanding in layers of CBUs.

We will represent a CBU (as seen by an external observer) as a rectangular prism with the following dimensions (in UBs):

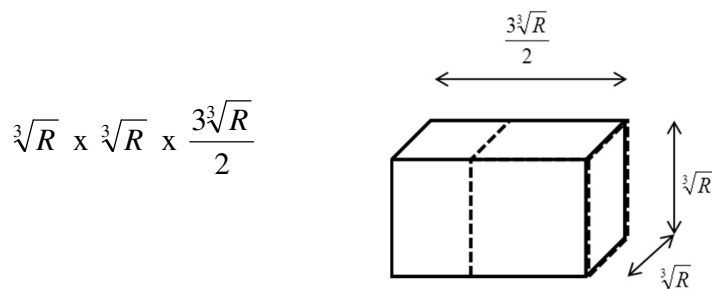

We see that as the Universe sphere of information expands, the size of a CBU also expands and we note that the 3rd dimension of the CBU is always 1.5 times its side dimension.

To summarise this chapter, the basic structure of the Universe is made up of layers of UBs (Universal Bits) and the basic structure of a coherent world is made up of layers of CBUs (Coherent Basic Units). The CBUs are growing in size and in number as the Universe sphere expands.

To an internal observer living in a coherent world, a CBU is just a bit of potential information in the same way that a UB is a bit of potential information to an external observer. We could say that a CBU is a “coherent” potential bit of information.

We could also say that the Universe is pixelated with UBs and a coherent world is pixelated with CBUs.

Existence and information

At the start of the Universe, the chance of something existing is 50% and the chance of it not existing is also 50%, therefore each layer of the growing sphere should contain the same number of existence and non-existence CBU's. If we represent the CBU's on the surface of the sphere as being either black or white, then they should form a perfect checkerboard like pattern. But for a growing sphere, this is not possible. A certain number of extra black or white CBU's have to be inserted, creating cross like patterns on the surface.

The reason for this could be explained in the following simple way.

Let's consider a circle with an infinitely small diameter, the maximum number of circles (P) of the same diameter that can be put around it to form a larger circle is:

First layer: $P = \pi \times 2 = 6.28$ so 6 circles (even number)

Second layer: $P = \pi \times 4 = 12.56$ so 12 circles (even number)

Third layer: $P = \pi \times 6 = 18.84$ so 18 circles (even number)

Fourth layer: $P = \pi \times 8 = 25.13$ so 25 circles (odd number)

The number of circles in each layer is an even number up to the 3rd layer, so we can have the same number of alternating black and white circles in layers 1 to 3, but on the 4th layer the number is odd and it is not possible to have the same number of black and white circles. One out of 8π circles ($\approx 3.97\%$) will be inserted next to a circle of the same colour and this will create a disruption in the alternating pattern.

As the surface of a growing sphere can be considered as an infinite number of infinitely small growing circles, the same principal as above applies to the CBU's on the surface of the Universe sphere and 3.97% of them will disrupt the alternating pattern and will form cross like patterns.

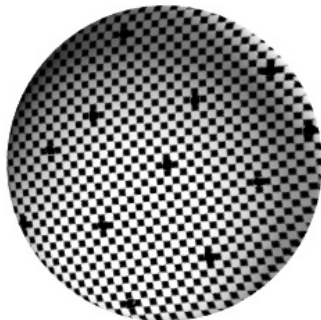

This disruption in the standard pattern causes the potential information to become real information and existence can now be defined. Existence is a disruption in the standard pattern of alternating black and white CBU's.

To an external observer, a CBU is composed of two opposite states (existence and non-existence) both being in two different worlds (the existence world and the non-existence world), if a disruption creates a black pattern in one world, the same pattern will be white in the opposite world. As the sphere develops, two opposite worlds are being created, a world where the patterns of existence are black and a world where the same patterns of existence are white, like a world and an anti-world.

The perception of existence/information

We have seen that existence/information is caused by a disruption in the standard pattern of alternating black and white CBUs. Cross like patterns of existence/information are forced to exist just by the geometrical properties of a growing sphere (a perfect checkerboard like pattern on the surface is not possible). In our world, these cross like patterns of existence/information are perceived as energy.

All the energy in our world comes from the interaction between the existence world and the non-existence world. The two opposite worlds give the energy to each other just by being the opposite of each other. No energy is actually created anywhere; it is just the result of an opposition of two worlds.

On the most basic level, energy, existence and information are the same thing. We could say that our world is just existence or just energy or just information, these are just different ways to look at it.

In all cases, there are always dualities involved: existence or non-existence, positive energy or negative energy, information or non-information, the way we see/perceive our world is all down to the way these dualities are arranged and are evolving with time.

The evolution of a 3D world

When we look around us, even though we see a 3D world, the information describing that 3D world is contained in a succession of 2D images on the surface of our retina.

This is exactly what is happening with the information describing the physical world we live in. At any one time, we only experience a “slice” of it (like a 2D image) and that slice contains all the information we need to describe our 3D world at that precise moment/instant in our life.

That precise instant is what we call our present and that “slice” is represented by a layer of CBUs, we will call it the present layer. To the internal observer, only the information in his present layer is real, the rest is virtual and is shared with the other layers. The notion of past, present and future is relative to the layer itself. There are as many presents as there are present layers around the Universe sphere. The number of layers is growing constantly.

There are two ways to represent a present layer:

- 1) As seen by an external observer: it is composed of two layers of CBUs. The thickness of the CBUs represents a spatial dimension which equals 1.5 times the side dimension of a CBU (as seen previously)
- 2) As seen/perceived by an internal observer. It is composed of one layer of CBUs. The thickness of the CBUs represents a time dimension.

The “thickness” of a UB is one Planck Length and a UB is updated every Planck Time. The information contained in a layer of UBs moves up the Universe sphere layers at the speed of light. (*The Planck length is the distance travelled by light in a Planck Time*). To an external observer, the “present” moves up the layers at the speed of light.

To an internal observer, the present information (contained in his present layer) is updated every time the “present” has travelled through two consecutive layers of CBU. The time it takes to update a present layer is called a Basic Unit of Time and, to an internal observer, it will represent the thickness of his present layer.

To an internal observer, the present layer does not seem to move, it is just updated every Basic Unit of Time. An internal observer moves up the Universe layers with his present layer.

In the following figure, the CBU are represented with black or white cubes. For simplicity, we have drawn the layers as vertical lines but in reality they are layers around a sphere.

The figure shows the evolution of a virtual 3D world as seen by an internal observer in his present layer (blue layer). The green layer represents the outer layer of the Universe sphere of potential information. The growing virtual 3D world is outlined in red and is faded out for clarity.

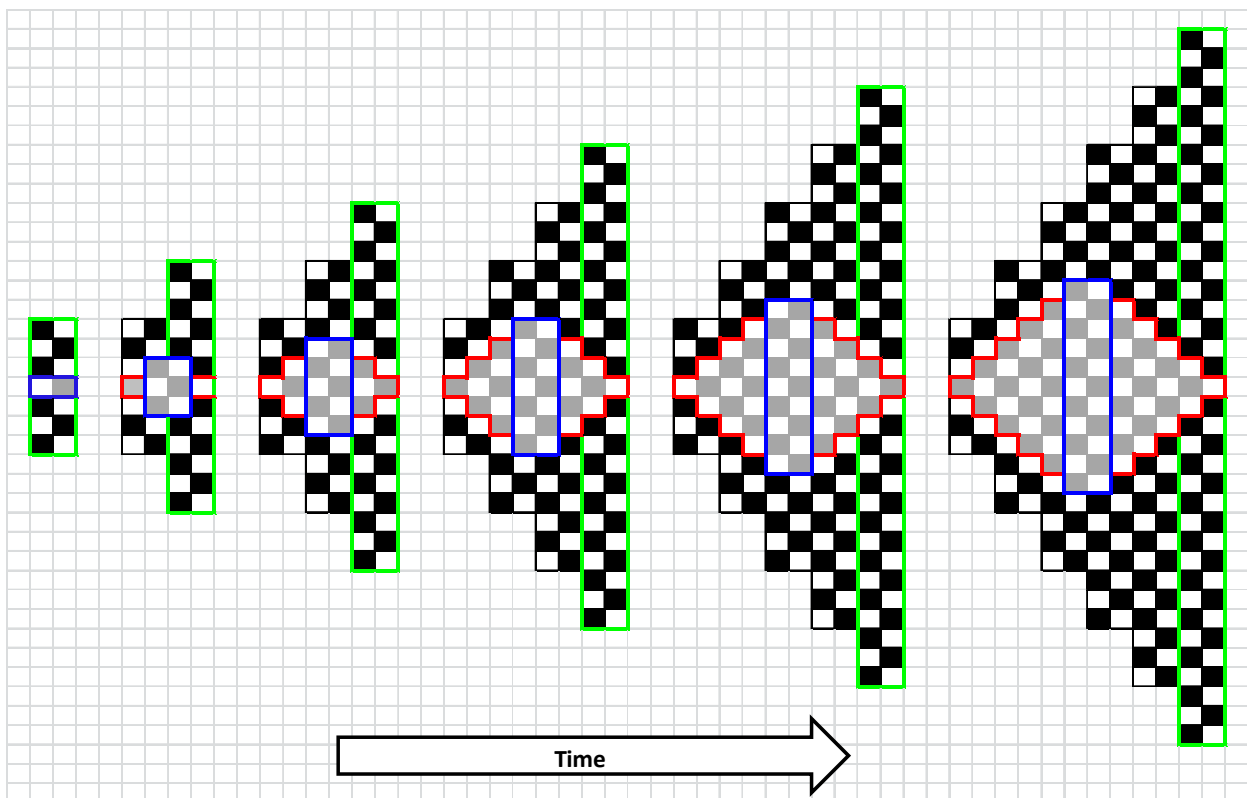

A virtual 3D world is a superposition of time and space. On the above figure, the present layer is composed of two layers of CBU's (the thickness of the CBU's representing space). To an internal observer, the information contained in the present layer is only updated once the "present" has travelled through the two consecutive layers of CBU's. As a result of this, the present layer, as experienced by an internal observer, is progressing at half the speed of the Universe outer layer.

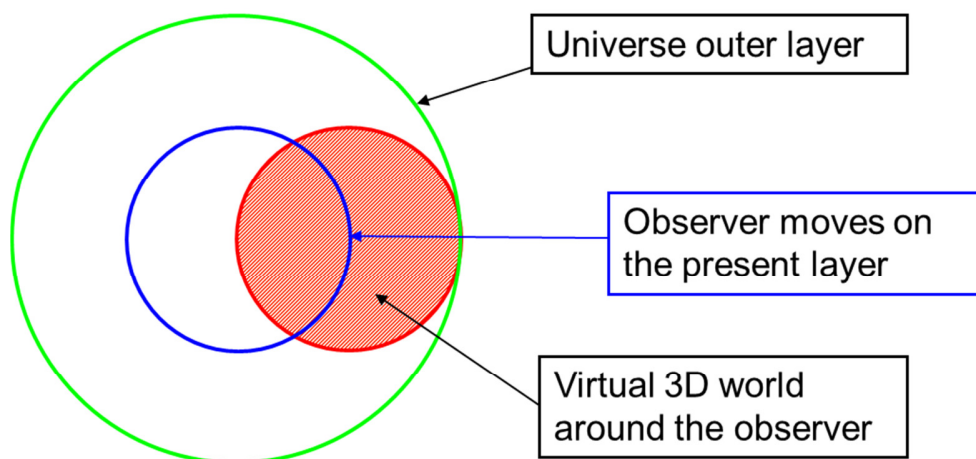

An internal observer on the present layer will always be at the centre of his own virtual 3D world. That world is constantly growing around him.

Another observer on the layer just before the present layer will see the same virtual 3D world as an observer on the present layer but just as it was a Basic Unit of Time earlier.

Although the layers are side by side (like layers around an onion), to an internal observer, the successive virtual 3D worlds are like Russian dolls, they envelope one another. The succession of the present layers (containing the real information of each successive world) form a unique "real" 3D world that keeps all virtual 3D worlds coherent.

That real 3D world could only be seen by an external observer, although it would not make much sense to that observer.

Matter particles

We have seen previously that a present layer can be represented in two different ways:

- 1) As seen by an external observer: it is composed of two consecutive layers of CBUs. The first layer represents a possible past and the second layer represents a possible future. These two layers will become an internal observer's present layer once the present has travelled through them.
- 2) As seen/perceived by an internal observer: it is composed of one layer of CBUs. This layer represents an internal observer's "real" present information.

A matter particle is a disruption in the standard pattern of alternating black and white CBUs. The particle properties are determined by the shape of the disruption pattern across two consecutive layers.

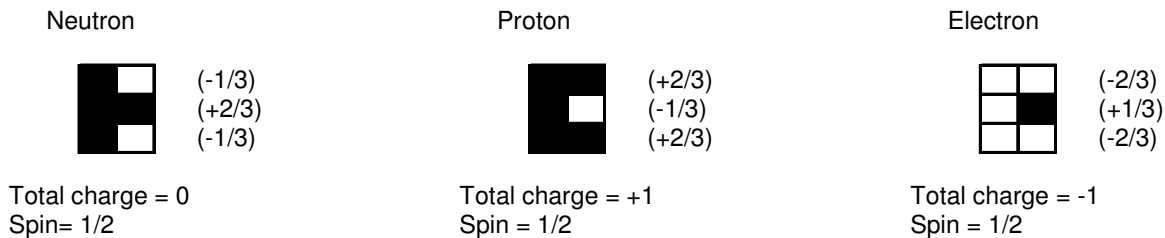

Above, we see that each particle is made up of 6 CBUs and these CBUs go in pairs. A black CBU followed by a white CBU is a Quark Down ($-1/3$ of electric charge) and a black CBU followed by a black CBU is a Quark Up ($+2/3$ of electric charge). A neutron is made up of two Quark Down and a Quark Up and a proton is made up of two Quark Up and one Quark Down. The electron is different, its possible past layer is empty (i.e.: a pattern of non-existence). In a certain way the electron is not exactly "real" matter, it is only a possible future.

When we study particles, we don't actually look at them, we study the way they behave. When we study an atom of hydrogen, both images of the proton and the electron are superimposed. In that case, we notice that the black CBU that was part of the electron's image, is now also part of the possible future of the proton (in the second layer). In a way, we could say that, when inside an atom, the electron is the possible future of the proton. This is why in quantum mechanics the electron's orbital is only probabilities, it hasn't happened yet but this is also why in a normal stable atom, the number of protons is equal to the number of electrons.

Every Basic Unit of Time, a new UB is inserted in every CBU, allowing the existing pattern of CBUs to evolve. This mechanism creates a circle of possibilities for the future position of the proton. The mass ratio between a proton and an electron is exactly that circle's area. To calculate the exact mass ratio, we also need to take into account the possibilities on the past proton/electron's position and also the one before and so on. The diameter of the possibilities circle is $8\pi-1$ (we have seen previously that matter is created at a rate of 1 out of 8π).

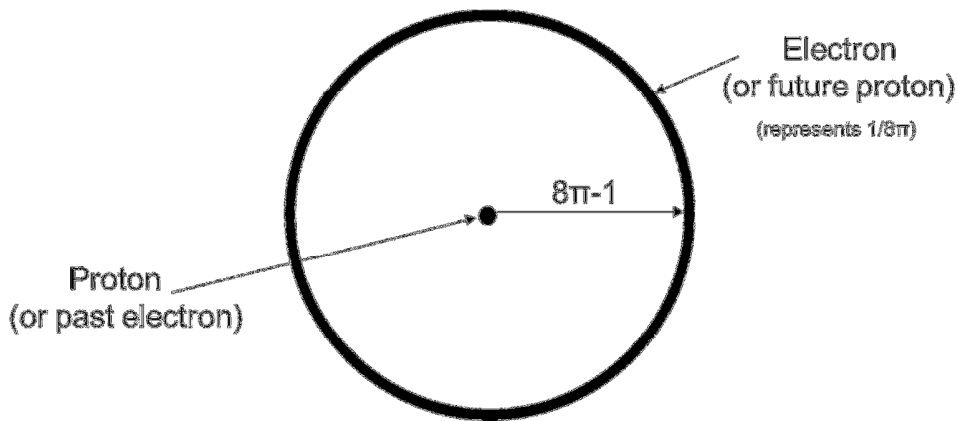

We can calculate the proton/electron mass ratio using the following formula:

$$m_p/m_e = \left((8\pi - 1) + \frac{1}{8\pi - 1} + \frac{1}{(8\pi - 1)^2} + \frac{1}{(8\pi - 1)^3} + \dots \right)^2 \times \pi = 1836.19 \text{ (official value 1836.15)}$$

This equation simplifies to:

$$m_p/m_e = \left((8\pi - 1) + \frac{1}{8\pi - 2} \right)^2 \times \pi = 1836.19 \text{ (official value 1836.15)}$$

The three generations of elementary particles are a temporal differentiation of the same particle. In a certain way, tau and muon represent the immediate past or immediate future of an electron. The rest of the particles of the standard model are just different dynamic patterns created by CBUs.

Some numbers

With the previous formulae, we can work out the different numbers of UBs and CBUs composing our present world.

If our world is 13.75 billion years old and the time dimension of a UB is one Planck Time, then we can work out the number of UBs composing the radius of our present layer:

$$R = (3600 \times 24 \times 365.25 \times 13.75 \times 10^9) / 5.39106 \times 10^{-44} = 8.0488 \times 10^{60} \text{ UBs}$$

$$\text{Number of UBs on our layer: } N = 4\pi R^2 = 4\pi \times (8.0488 \times 10^{60})^2 = 8.14 \times 10^{122}$$

(Note: this is very close to the 10^{122} we find in the cosmological constant problem)

$$\text{Number of UBs per CBU: } X = \sqrt[3]{R^2} = \sqrt[3]{(8.0488 \times 10^{60})^2} = 4.0162 \times 10^{40}$$

(Note: this is very close to the 10^{40} ratio of electric/gravitational force between a proton and an electron)

$$\text{The number of CBUs on our layer: } C = 4\pi \sqrt[3]{R^4} = 4\pi \times \sqrt[3]{(8.0488 \times 10^{60})^4} = 202.69 \times 10^{80}$$

We have seen previously that cross-like patterns made by CBUs represent 3.97% (exactly 1 on 8π) of the total sphere surface and that these patterns represent the protons in our world. We can therefore calculate the number of protons in our present world as follows:

$$\text{Nb of protons} = 4\pi \sqrt[3]{R^4} \times \frac{1}{8\pi} = \frac{\sqrt[3]{R^4}}{2} = \frac{\sqrt[3]{(8.0488 \times 10^{60})^4}}{2} = 8.06 \times 10^{80}$$

The Planck Length and proton radius

A CBU is just a scaled up version of a UB. The size of a UB is a Planck Length, therefore the size of a CBU will always have the same numeric value as the Planck Length.

This “scaling” property of the Universe means that the various formulae that we will work out on the most basic scale will remain valid for all the other scale levels, only the scale factor will vary.

The scale factor for a CBU will depend on the number of UBs composing the side length of a CBU. This number is the square root of the total number of UBs composing a CBU. The precise value does not matter here because we are looking for a scale factor.

The number of UBs in a CBU is $\sqrt[3]{R^2} = 10^{40}$

The number of UBs composing a CBU's side length is $\sqrt{10^{40}} = 10^{20}$

The size of a CBU is:

$$\ell_P \times 10^{20} = 1.6162 \times 10^{-35} \times 10^{20} = 1.6162 \times 10^{-15} \text{ meters}$$

We have seen that a disruption in the alternating pattern of CBUs represents a proton. Therefore the size of a proton should be the size of a CBU. Although a CBU has got a size, it is meaningless to give it a shape, if it had a shape, it would not be a basic unit anymore. The same applies to a proton, although it is common to give it the shape of a sphere.

The proton radius can be measured using either an electron or a muon. Experiments show that there is an unexplained discrepancy between the two measurements. The 3D Universe theory explains this discrepancy with the following figures:

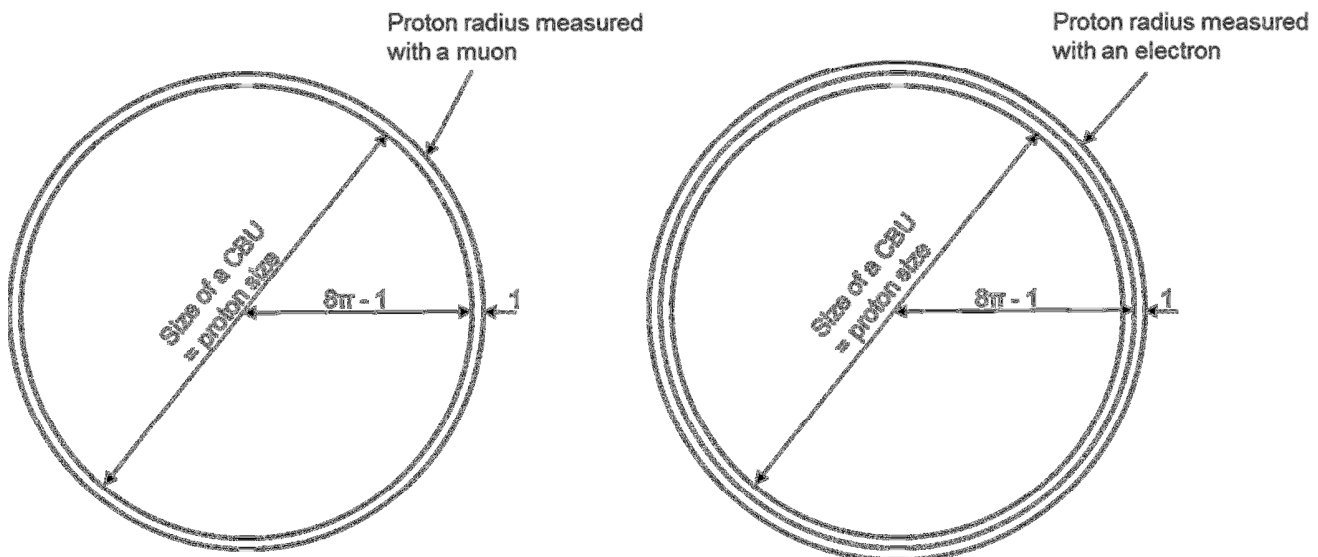

From the above figures and using the official value of the Planck Length (1.6162×10^{-35} m) we deduce the following equations:

Proton radius (radius of a CBU):

$$R_p = \frac{\ell_p \times 10^{20}}{2} = \frac{1.6162 \times 10^{-15}}{2} = 0.8081 \times 10^{-15} \text{ m}$$

Proton radius (measured with muon):

$$R_{pm} = \frac{R_p}{1 - \frac{1}{8\pi}} = \frac{0.8081 \times 10^{-15}}{0.9602} = 0.8416 \times 10^{-15} \text{ m (Official value } 0.8418 \times 10^{-15} \text{ m)}$$

Proton radius (measured with electron):

$$R_{pe} = \frac{R_{pm}}{1 - \frac{1}{8\pi}} = \frac{0.8416 \times 10^{-15}}{0.9602} = 0.8765 \times 10^{-15} \text{ m (Official value } 0.8768 \times 10^{-15} \text{ m)}$$

The numbers are very close to the official values, this gives a good indication that the size of the proton is a scaled up version of the Planck Length.

Definition of the Basic Unit of Time:

We have seen previously that we could represent a CBU (as seen by an external observer) as a rectangular prism with the following three dimensions (in UBs):

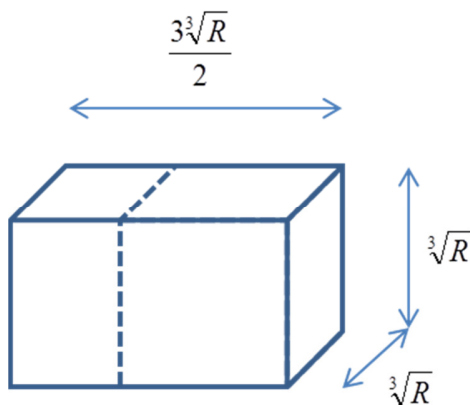

We have seen that to update a present layer, the “present” needs to travel through 2 layers of CBUs.

The distance to travel is: $D = 2 \times \frac{3^3\sqrt{R}}{2} = 3^3\sqrt{R}$

This distance represents a Basic Unit of Time.

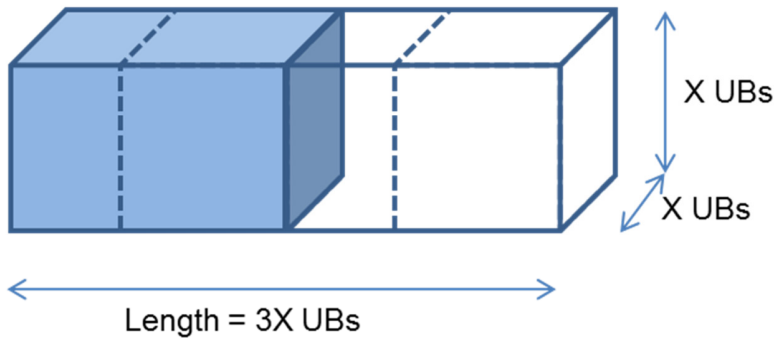

From the above figure, we deduce that the dimension of a Basic Unit of Time will be 3 times the scaled up time value of a UB. The time value of a UB is 5.391×10^{-44} sec. We have seen previously that the scaling factor for a CBU is 10^{20} , therefore:

Basic Unit of Time = $3 \times 5.391 \times 10^{-44} \times 10^{20} = 1.617 \times 10^{-23}$ sec

To summarise the above, we could represent a CBU, as seen by an internal observer, with the following dimensions:

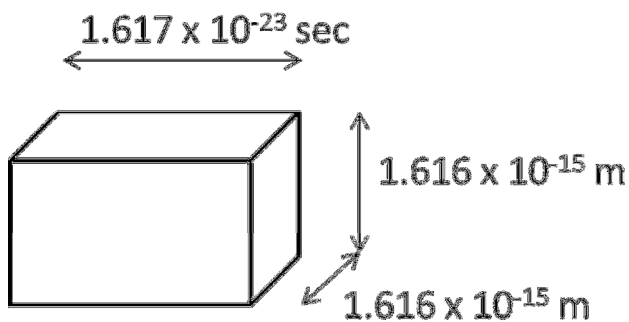

This means that a “present” layer is updated every 1.617×10^{-23} sec.

The coherent space-time continuum

We have seen that the Universe sphere is a succession of layered information, layers of CBUs. To an external observer, these layers are side by side. In relation to the present layer, the inner layers represent the past and the outer layers the future.

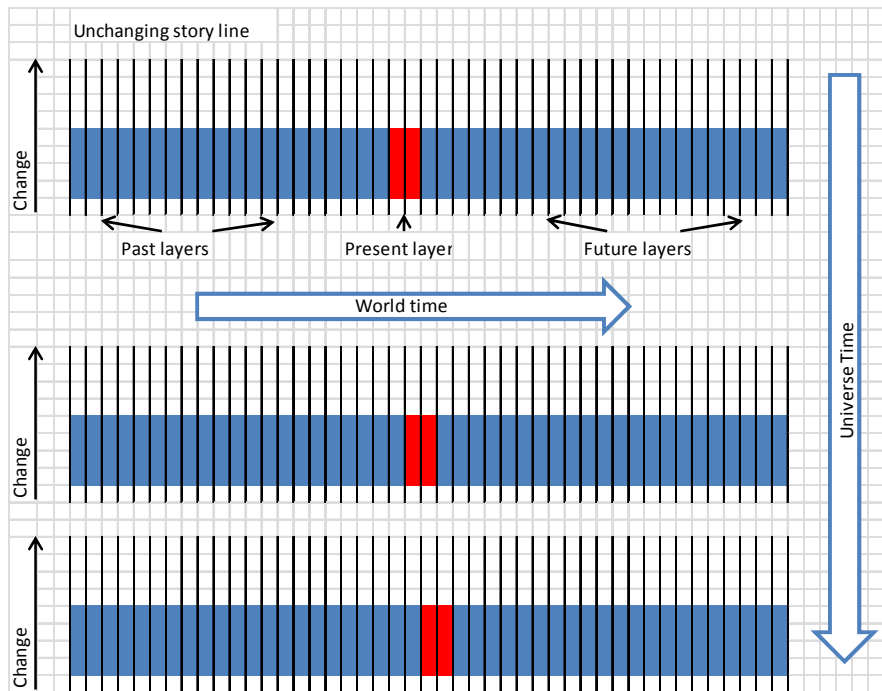

The portion in blue in each layer represents the information describing an internal observer (we can imagine it as an image of that observer). We will call the blue band made by the succession of these images, a storyline.

An internal observer, living his life, will successively go through all the layers of his storyline. During his lifetime, an internal observer can modify the storyline but so can the “copies” of himself in the past layers (himself younger) and in the future layers (himself older). Therefore all layers can evolve separately but on a different time scale than the internal observer’s time scale. An internal observer evolves in “world time” and a storyline evolves in “Universe time”.

An unchanging storyline, during a certain period of Universe time, would mean that the life lived by each successive internal observer is exactly the same over that period.

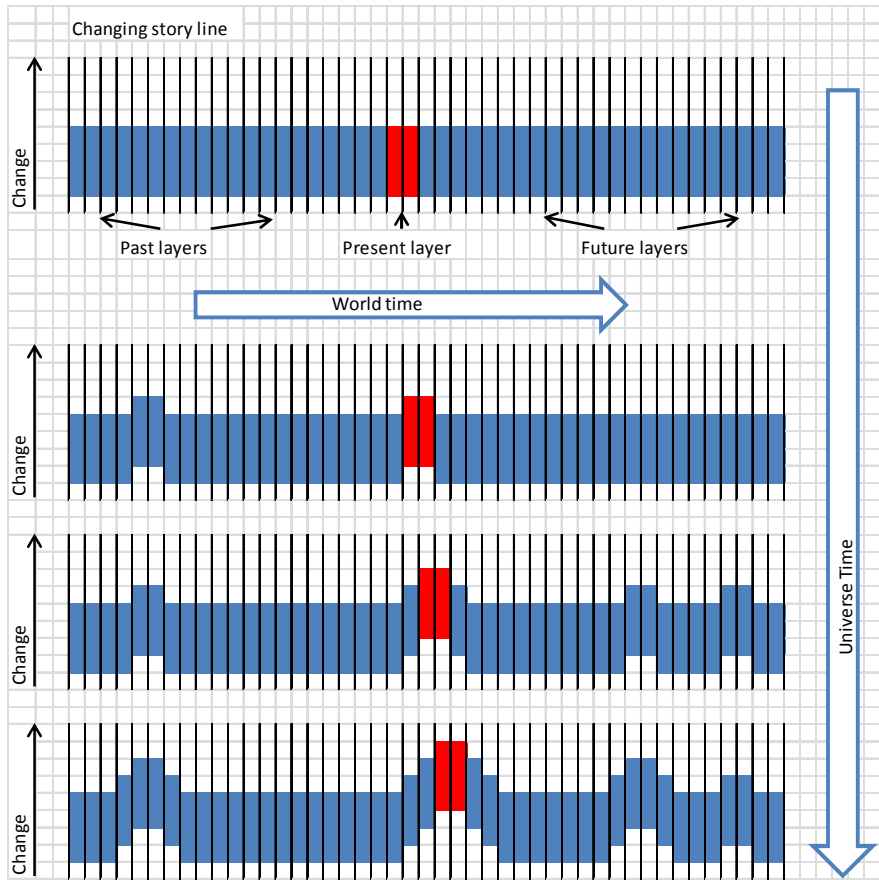

Each layer can evolve separately but they are all linked through time. A change in one present layer, in relation to the existing storyline, will affect the adjacent layers which in turn will affect their adjacent layers, therefore maintaining a coherent storyline.

From the above figures, it looks like our future already exists. This is correct but it is only a possible future as far as we are concerned; we can always change it.

The age of our world depends on our position on the Universe storyline. The real age of the Universe depends on the size of its story line.

Quick overview of different topics

1) The Cosmological constant problem:

The measured value of the cosmological constant is 122 orders of magnitude smaller than what would be expected if the Universe formed under the "standard" Big Bang theory.

We have calculated that the number of UBs on our present layer is 8.14×10^{122} , this is exactly the same order of magnitude.

In our model, the cosmological constant is represented by the UB's on our present layer. The inverse of the number of UB's on our present layer gives a correct value of the Dark Energy Density in Planck units. (see list of equations)

2) Black hole entropy:

Black hole entropy is proportional to its event horizon area ($4\pi R^2$) but divided by 4.

A black hole is in fact a circle on a 2D surface (not a sphere) and the entropy is proportional to the area of the circle. (The area of a circle is 4 times smaller than the area of a sphere)

3) Entanglement:

Two entangled particles will always be found to have the same correlated state, whatever the distance between them.

The spin of a particle (or other quantum states) is linked to the relative state of the black and white CBUs composing the particle. As the flickering rate between black and white CBUs is the same across a present layer, then whatever the particle's position in the layer, the relative state of the different CBUs composing the particle will always remain the same.

4) Quantum wave collapse:

In quantum mechanics, a particle has got the properties of a wave but as soon as we observe it, the wave collapses to a single point.

Only what we observe becomes part of our present layer, the rest remains only virtual and is shared with the other layers.

5) Gravitation:

Gravitation in the context of the 3D Universe Theory is a consequence of the continuous expansion of CBUs.

6) Time travel paradox:

If someone could travel faster than the speed of light, then we can imagine that his information would not be updated fast enough and that information would stay behind and therefore move to the previous layers. The person would effectively move to his past. Should that person modify his storyline, then that change would never catch up with the future layer the person came from (all layers are moving forward). Therefore a time traveller travelling to the past would never modify the future he actually came from.

If time travel is possible, why haven't we already seen time travellers from the future ?
 For us to see the time travellers, they would have to travel exactly to our present layer, considering that there are approximately 10^{23} present layers per second, it is very unlikely.

7) Paranormal phenomena:

Our past and future layers actually exist even though they can change with Universe time. The possibility of seeing a probable past or probable future could be envisaged if somehow we could access the information on those layers.

8) Spiritual aspect:

We could imagine that our storyline (made up by all the layers composing our entire life) is an entity with a "life" of its own, evolving in Universe time. That entity could represent our soul. We would only be a "time slice" of that entity. That entity would live much longer than our lifetime.

(In the figure below, the number of layers is not to scale, there are approximately 10^{23} layers per second)

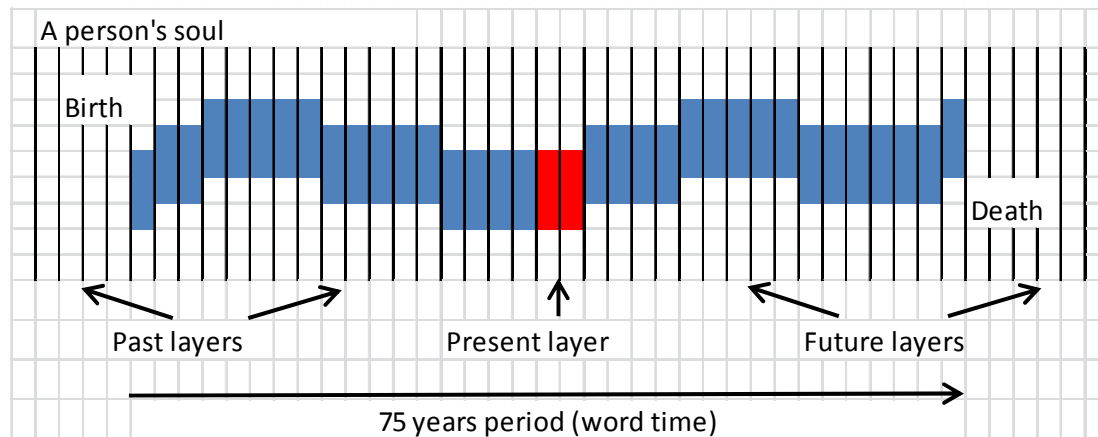

Revised fundamental dimensions:

From the 3D Universe Theory we deduce that the dimensions of time and space are fundamentally linked.

We can deduce that the Time dimension is equal to the Length dimension squared and that the Mass dimension is just the ratio of both, therefore we have:

$$T = L^2 \text{ and } M = \frac{L^2}{T} = \text{dimensionless}$$

From the above we deduce the rest:

$$\text{Speed} = \frac{1}{L}$$

$$\text{Energy} = \frac{1}{L^2}$$

$$\text{Acceleration} = \frac{1}{L^3}$$

$$\text{Force} = \frac{1}{L^3}$$

$$\text{Power} = \frac{1}{L^4}$$

$$\text{Gravitational constant: } G = \frac{1}{L}$$

Planck constant = dimensionless

We also propose the following:

$$\text{Temperature} = \frac{1}{L^2}$$

Boltzmann constant = dimensionless

$$\text{Charge} = \sqrt{L}$$

$$\text{Coulomb constant} = \frac{1}{L^2}$$

μ_0 = dimensionless

$$\epsilon_0 = L^2$$

$$\text{Current} = \frac{1}{\sqrt{L^3}}$$

$$\text{Voltage} = \frac{1}{\sqrt{L^5}}$$

$$\text{Impedance} = \frac{1}{L}$$

Equations:

Proton-to-Electron mass ratio:

$$m_p/m_e = \left((8\pi - 1) + \frac{1}{(8\pi - 1)} + \frac{1}{(8\pi - 1)^2} + \frac{1}{(8\pi - 1)^3} + \dots \right)^2 \times \pi = 1836.19 \text{ (official value 1836.15)}$$

The above equation can be rewritten as follows:

$$m_p/m_e = \left((8\pi - 1) + \frac{1}{(8\pi - 2)} \right)^2 \times \pi = 1836.19 \text{ (official value 1836.15)}$$

Electron's charge:

$$e = \sqrt{\frac{h \times \left(1 - \frac{1}{8\pi}\right)}{\varphi^2 \times 8\pi \times \mu_0 \times c}} = 1.60209 \times 10^{-19} \text{ C (official value = } 1.60217 \times 10^{-19} \text{ C)}$$

Fine structure constant :

$$\alpha = \left(\frac{e}{q_p}\right)^2 = \frac{h \times \left(1 - \frac{1}{8\pi}\right) \times \mu_0 \times c}{\varphi^2 \times 8\pi \times \mu_0 \times c \times 2h} = \frac{\left(1 - \frac{1}{8\pi}\right)}{\varphi^2 \times 16\pi} = 7.2966 \times 10^{-3} \text{ (official value } 7.2973 \times 10^{-3}\text{)}$$

Electron's mass: (φ has a dimension of Time in sec)

$$m_e = \frac{2h}{\varphi \times 10^{-20} \times c^2} = 9.112 \times 10^{-31} \text{ Kg (official value = } 9.109 \times 10^{-31} \text{ Kg)}$$

Electron's Compton wavelength: (φ has a dimension of Time in sec)

$$\lambda_e = \frac{\varphi \times 10^{-20} \times c}{2} = 2.4253 \times 10^{-12} \text{ m (official value = } 2.4263 \times 10^{-12} \text{ m)}$$

Electron's Compton frequency: (φ has a dimension of Time in sec)

$$\nu_e = \frac{c}{\lambda_e} = \frac{2}{\varphi \times 10^{-20}} = 1.2360 \times 10^{20} \text{ Hertz (official value = } 1.2356 \times 10^{20} \text{ Hertz)}$$

Electron's energy: (ϕ has a dimension of Time in sec)

$$E_e = m_e c^2 = h\nu_e = \frac{2h}{\phi \times 10^{-20}} = 8.190 \times 10^{-14} \text{ Joules (official value} = 8.186 \times 10^{-14} \text{ Joules)}$$

Proton's mass in relation to the Planck Mass:

$$M_{pr} = m_p \times 10^{-20} \times \left(8 - \frac{1}{\pi}\right) = 1.6719 \times 10^{-27} \text{ Kg (official value} = 1.6726 \times 10^{-27} \text{ Kg)}$$

Proton's diameter in relation to the Planck Length:

$$D_{pr} = \frac{l_p \times 10^{20}}{1 - \frac{1}{8\pi}} = 1.6832 \times 10^{-15} \text{ m (official value} = 1.6836 \times 10^{-15} \text{ m)}$$

Proton's mass and proton's diameter in relation to the Planck Constant and the speed of light:

$$D_{pr} \times M_{pr} = 8 \times l_p \times m_p = 8 \times \sqrt{\frac{hG}{2\pi c^3}} \times \sqrt{\frac{hc}{2\pi G}} = \frac{4h}{\pi \times c}$$

$$D_{pr} = \frac{4h}{\pi \times c \times M_{pr}} = \frac{4 \times \lambda_{pr} \times M_{pr} \times c}{\pi \times c \times M_{pr}} = \frac{4\lambda_{pr}}{\pi} = 1.6824 \times 10^{-15} \text{ m (official value} = 1.6836 \times 10^{-15} \text{ m)}$$

Proton's radius (measured with muon):

$$R_{pm} = \frac{l_p \times 10^{20}}{2 \times \left(1 - \frac{1}{8\pi}\right)} = 0.8416 \times 10^{-15} \text{ m (official value} = 0.8418 \times 10^{-15} \text{ m)}$$

Proton's radius (measured with electron):

$$R_{pe} = \frac{R_{pm}}{1 - \frac{1}{8\pi}} = \frac{0.8416 \times 10^{-15}}{0.9602} = 0.8765 \times 10^{-15} \text{ m (official value} = 0.8768 \times 10^{-15} \text{ m)}$$

Proton's mass:

$$M_{pr} = \frac{4h \times \left(1 - \frac{1}{8\pi}\right)}{t_p \times 10^{20} \times \pi \times c^2} = 1.6719 \times 10^{-27} \text{ Kg (official value } 1.6726 \times 10^{-27} \text{ Kg)}$$

Proton's Compton wavelength:

$$\lambda_{pr} = \frac{t_p \times 10^{20} \times \pi \times c}{4 \times \left(1 - \frac{1}{8\pi}\right)} = 1.3219 \times 10^{-15} \text{ m (official value } = 1.3214 \times 10^{-15} \text{ m)}$$

Proton's Compton frequency:

$$\nu_{pr} = \frac{c}{\lambda_{pr}} = \frac{4 \times \left(1 - \frac{1}{8\pi}\right)}{t_p \times 10^{20} \times \pi} = 2.2678 \times 10^{23} \text{ Hertz (official value } = 2.2687 \times 10^{23} \text{ Hertz)}$$

Proton's Energy:

$$E_{pr} = M_{pr} c^2 = h \nu_{pr} = \frac{4 \times h \times \left(1 - \frac{1}{8\pi}\right)}{t_p \times 10^{20} \times \pi} = 1.5026 \times 10^{-10} \text{ Joules}$$

(official value = 1.5032×10^{-10} Joules)

Gravitational coupling constant :

$$\alpha_G = \left(\frac{m_e}{m_p}\right)^2 = \left(\frac{m_e \times 10^{-20} \times \left(8 - \frac{1}{\pi}\right)}{M_{pr}}\right)^2 = \left(\frac{10^{-20} \times \left(8 - \frac{1}{\pi}\right)}{1836.15}\right)^2 = 1.7502 \times 10^{-45}$$

(official value = 1.7518×10^{-45})

$$\alpha_G = \left(\frac{M_{pr}}{m_p}\right)^2 = \left(\frac{M_{pr} \times 10^{-20} \times \left(8 - \frac{1}{\pi}\right)}{M_{pr}}\right)^2 = \left(\left(8 - \frac{1}{\pi}\right) \times 10^{-20}\right)^2 = 5.900 \times 10^{-39}$$

(official value = 5.905×10^{-39})

Value of Dark Energy Density (in Planck units):

$$\rho_{\Lambda} = \frac{1}{4\pi \times R^2} = \frac{1}{8.14 \times 10^{122}} = 1.23 \times 10^{-123} \text{ (WMAP value} = 1.27 \pm 0.07 \times 10^{-123}\text{)}$$

R = age of the Universe in Planck units

Number of protons in the Universe:

$$N_p = \frac{\sqrt[3]{R^4}}{2} = \frac{\sqrt[3]{(8.0488 \times 10^{60})^4}}{2} = 8.06 \times 10^{80} \text{ (Official estimate value } 10^{80}\text{)}$$

R = age of the Universe in Planck units

Ordinary matter, dark matter and dark energy ratios:

$$\text{Total matter/energy in the Universe} = 8 + (8\pi) = 8(1 + \pi)$$

$$\text{Ordinary matter/energy} = \frac{1}{\pi} + \left(\frac{1}{\pi} \times \pi\right) = \frac{1}{\pi} + 1$$

$$\text{Dark matter} = 8 - \frac{1}{\pi}$$

$$\text{Dark energy} = \left(8 - \frac{1}{\pi}\right) \times \pi = 8\pi - 1$$

$$\text{Ordinary matter \%} = \frac{\frac{1}{\pi} + 1}{8(1 + \pi)} = 3.97 \% \text{ (Official WMAP estimate value } 4\text{\%)}$$

$$\text{Dark matter \%} = \frac{8 - \frac{1}{\pi}}{8(1 + \pi)} = 23.19 \% \text{ (Official WMAP estimate value } 23\text{\%)}$$

$$\text{Dark energy \%} = \frac{8\pi - 1}{8(1 + \pi)} = 72.84 \% \text{ (Official WMAP estimate value } 73\text{\%)}$$

The following equations do not comply with conventional dimensional analysis; nevertheless we believe that they are valid if we redefine fundamental dimensions as per previous chapter:

Planck constant:

$$h = \frac{10^{-13}}{\left((8\pi - 1) + \frac{1}{(8\pi - 2)} \right)} = 4.1363 \times 10^{-15} \text{ eV.s (official value } 4.1356 \times 10^{-15} \text{ eV.s)}$$

Electron's mass:

$$m_e = \frac{2 \times 10^7}{\left((8\pi - 1) + \frac{1}{(8\pi - 2)} \right) \times \varphi} = 0.5112 \times 10^6 \text{ eV/c}^2 \text{ (official value } 0.5109 \times 10^6 \text{ eV/c}^2)$$

Proton's mass:

$$M_{pr} = \frac{2\pi \left((8\pi - 1) + \frac{1}{(8\pi - 2)} \right) \times 10^7}{\varphi} = 938,80 \times 10^6 \text{ eV/c}^2 \text{ (Official value } 938,27 \times 10^6 \text{ eV/c}^2)$$

Boltzmann constant:

$$k_B = \text{Log}(8\pi - 1) \times 10^{-23} = 1.3826 \times 10^{-23} \text{ m}^2 \text{ kg s}^{-2} \text{ K}^{-1} \text{ (official value } 1.3806 \times 10^{-23} \text{ m}^2 \text{ kg s}^{-2} \text{ K}^{-1} \text{)}$$

$$k_B = \frac{4 \times 10^{-23}}{\pi \left(1 - \frac{1}{8\pi} \right)^2} = 1.3809 \times 10^{-23} \text{ m}^2 \text{ kg s}^{-2} \text{ K}^{-1} \text{ (official value } 1.3806 \times 10^{-23} \text{ m}^2 \text{ kg s}^{-2} \text{ K}^{-1} \text{)}$$

Permittivity of free space:

$$\epsilon_0 = \left(1 - \frac{1}{8\pi} \right)^3 \times 10^{-11} = 8.8532 \times 10^{-12} \text{ F/m (official value } 8.8541 \times 10^{-12} \text{ F/m)}$$

Planck Length:

$$\ell_P = \frac{2 \times \varphi \times 10^{-35}}{g} = \frac{2 \times 1.61803398 \times 10^{-35}}{2.00231930} = 1.616159 \times 10^{-35} \text{ m (Official value } 1.616199 \times 10^{-35} \text{ m)}$$

φ = Golden ratio

g = electron's Landé factor

Temperature of Cosmic Microwave Background Radiation:

$$\text{CMBR} = \left((8\pi - 1) + \frac{1}{(8\pi - 2)} \right) \times \frac{\sqrt{2}}{4\pi} = 2.7207 \text{ K (official value 2.7254 K)}$$