

[This is a preprint of an article published in International Review of Physics, Vol. 7 No. 1, p1-6.](#)

Detection of Absolute Rest Frame by Measuring Light Wavelength of Light Source in Uniform Rectilinear Motion

Justin Lee
January 13th, 2013

Abstract

This paper introduces a new theory called, “the theory of absolutivity”, which challenges the two postulates of the special theory of relativity (special relativity). This paper analyzes how special relativity derives the time dilation, and then explains how it leads to a disagreement on the first postulate: the principle of relativity. Next, this paper continues to explain a disagreement on the second postulate: the universal speed of light. Furthermore, the paper written by Gjurchinovski on the reflection of light from a uniformly moving mirror is interpreted to give a classical explanation for the null result of Michelson-Morley experiment, by justifying Lorentz contraction of length without referring to special relativity.

Introduction

The two famous postulates of special relativity are (1) the principle of relativity: there is no absolute rest frame of reference and (2) the universal speed of light: the speed of light is constant in all inertial frames of reference (Griffiths 1989:449).

Everyone would agree that special relativity built itself on these postulates to become a well-established cornerstone in the era of modern physics. Virtually every physicists in the world have studied the theory for almost a century. And there are overwhelming experimental data that support the theory.

Nevertheless, what if the theory has an oversight that has managed to mislead people? Also, what if all the experimental data, although may agree with special relativity, could be explained by other non-relativity theories? For example, what if Lorentz contraction of length could be explained in classical manner, without referring to special relativity?

This paper intends to reveal this oversight in the principle of relativity by cross-examining the derivation of time dilation against classical electromagnetism in order to present a way to detect an absolute rest frame. Then, the existence of an absolute rest frame would support the non-universal speed of light.

Lastly, this paper will discuss the published paper by Gjurchinovski on the reflection of light from a uniformly moving mirror to justify how Lorentz contraction can occur without referring to special relativity. Lorentz contraction without special relativity is important because it can explain the null result of Michelson-Morley experiment, which gave a rise to special relativity (Serway 1990: 1109).

Electromagnetism: Review

Before we continue, let us briefly review Poynting vector and Lienard-Wiechert potentials.

Poynting vector is a cross product of electric field vector and magnetic field vector, and in the case of an electromagnetic wave, it points to the same direction as the propagation vector of the wave (Griffiths 1989:357).

$$\mathbf{S} = 1/\mu_0 (\mathbf{E} \times \mathbf{B}) \quad (\text{Griffiths 1989:323; Equation 1})$$

where

S = Poynting vector

E = electric field vector

B = magnetic field vector

μ_0 = permeability of free space

Lienard-Wiechert potentials describe a retarded electromagnetic field emitted by a moving point charge (Griffiths 1989:424). Poynting vector of radiation of a moving point charge can be derived from Lienard-Wiechert potentials as shown below.

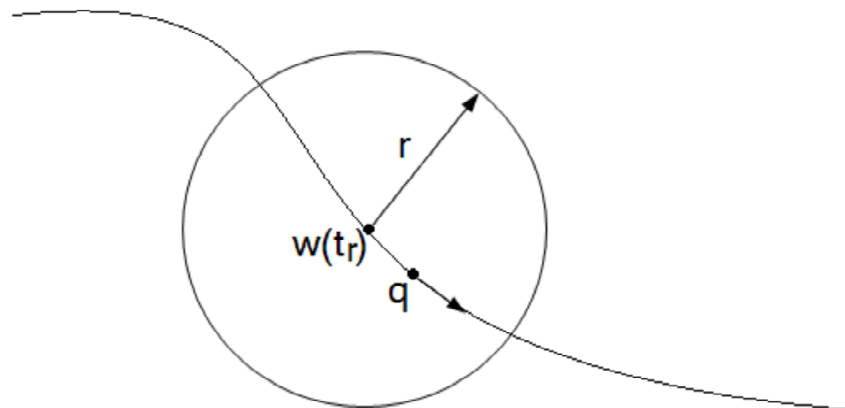

Griffiths 1989:427; Figure 1

$$\mathbf{S}_{\text{rad}} = (1/\mu_0 c) E_{\text{rad}}^2 \mathbf{r}^\wedge \quad (\text{Griffiths 1989:428; Equation 2})$$

where

t_r = a retarded time taken by the radiation field

$w(t_r)$ = a retarded position of the point charge, q , at a retarded time, t_r

\mathbf{r}^\wedge = a radial unit vector pointing from the retarded position of the charge

c = the speed of light in vacuum in which the radiation travels to the sphere

According to the Poynting vector, the light radiates pointing away from the retarded position of a moving point charge, not from the current position. In other words, once the electromagnetic radiation leaves the source, it does not move along with the source, but it continues on its original path unaffected by the motion of the source (Griffiths 1989:428).

Special Relativity: Review

Now, let us review how special relativity derives the time dilation by examining a moving train. The time dilation is derived by describing a vertically traveling light, onboard a horizontally moving train, observed by a stationary observer on the ground, as shown below (Griffiths 1989:452).

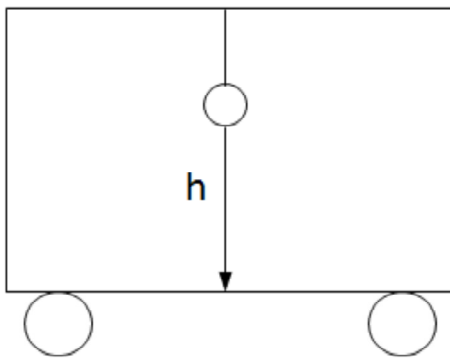
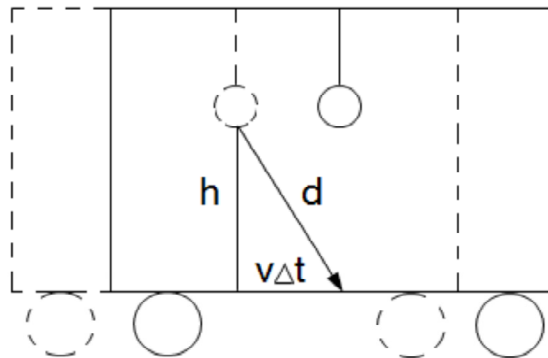

Figure 2



Griffiths 1989:452; Figure 3

Figure 2 depicts a stationary train with a light source hanging from the ceiling. The height of light source from the floor is denoted as h . For an observer on the train, the time it takes for the light to travel vertically down from the light source to the floor is:

$$\Delta t' = h / c \quad (\text{Griffiths 1989:452; Equation 3})$$

Figure 3 depicts the moving train observed by a stationary observer on the ground. For the ground observer, the train moves horizontally from left to right with a constant velocity, v . And the same light is observed to have traveled in a diagonal path, d . The time it takes for the

light to travel is:

$$\Delta t = d / c = \sqrt{h^2 + (v\Delta t)^2} / c \quad (\text{Griffiths 1989:453; Equation 4})$$

The time dilation of the moving train is calculated by solving for Δt in terms of $\Delta t'$:

$$\Delta t = \gamma \Delta t' \quad (\text{Griffiths 1989:453; Equation 5})$$

$$\text{where } \gamma = 1/\sqrt{1 - v^2/c^2} = \text{Lorentz factor}$$

Methods

Special Relativity: Analysis

Let us analyze the above derivation of the time dilation. At this point, it is important to determine how exactly the light wave propagates from the moving light source when observed by the stationary ground observer. There are two possible scenarios one can interpret what special relativity could have meant by the light propagating from the moving light source as shown below.

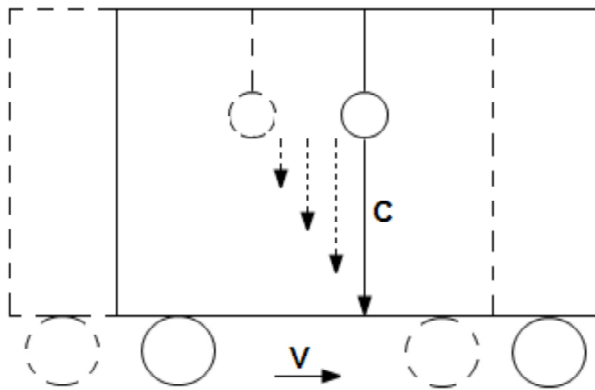

Figure 4

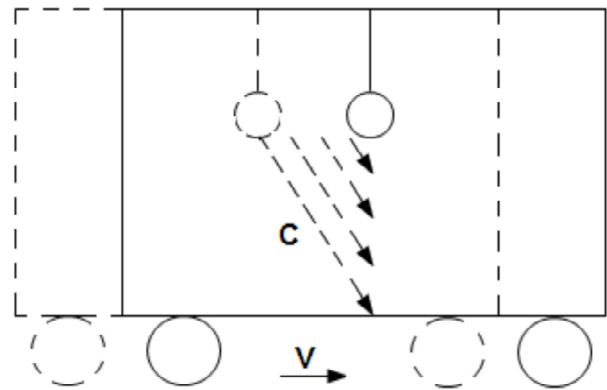
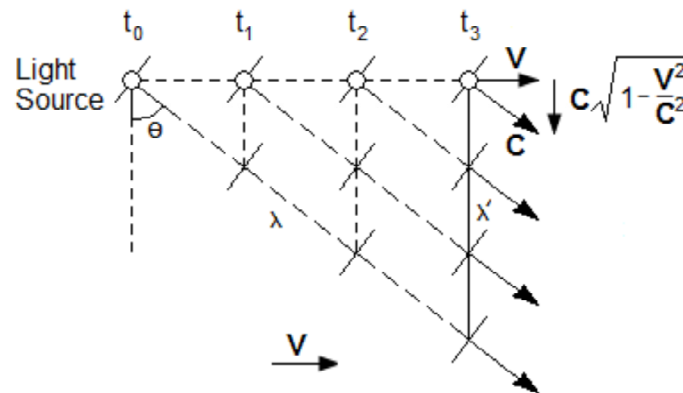

Figure 5

Figure 4 depicts a scenario where the propagation vector of the light points straight downward and the light moves along with the train horizontally, forming the diagonal path observed by the stationary ground observer. This scenario cannot be the case because of Poynting vector of radiation of a moving point charge derived from Lienard-Wiechert potentials (Equation 2). To reiterate, the electromagnetic wave radiates from the retarded position of the moving source, not from the current position. Thus the light could not have moved along with the train after it has been emitted from the moving light source.

Figure 5 depicts a scenario where the propagation vector of the light points diagonally, matching the horizontal velocity of the train. Just like a well-known phenomenon of the aberration of light, the train observer would then observe a vertical propagation of the light. This is the scenario which applies to special relativity, in how the light propagates downward from the moving light source (Gjurchinovski 2004: 1319).

The below Figure 6 depicts the detailed view of this propagation of the light from Figure 5.



Gjurchinovski 2004: 1319; Figure 6

The stationary ground observer sees horizontally moving light source, emitting consecutive light waves diagonally during different time periods. The train observer would see the wavefronts from these diagonal light waves line up vertically, thus would observe as if the light is traveling vertically down. In other words, the train observer observes the vertical propagation of the light from the light source, just like how the aberration of light is observed (Gjurchinovski 2004: 1319).

Notice though, how the wavelength of the vertical light observed by the train observer is shorter than the original wavelength observed by the stationary ground observer as shown below:

$$\lambda' = \lambda \cos\theta = \lambda \sqrt{1 - v^2/c^2} \quad (\text{Equation 6})$$

where

λ' = the observed wavelength of light in the moving inertial frame, S'

λ = the original wavelength of light in the stationary inertial frame, S

Now, let us introduce another inertial frame in between the stationary ground observer and the moving train as shown below.

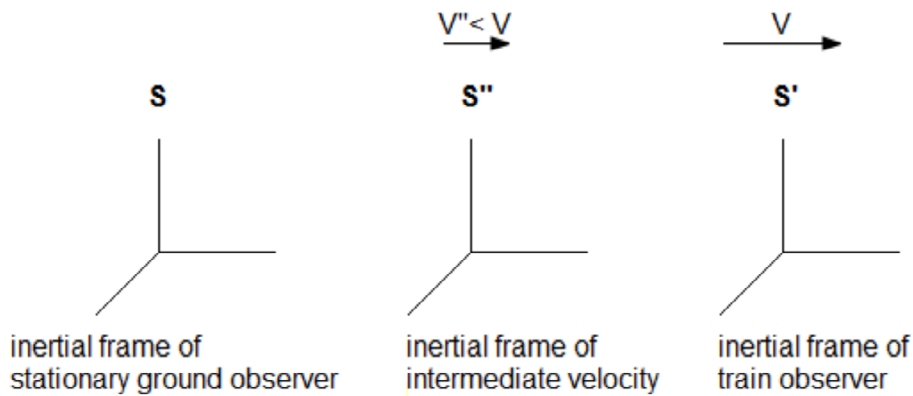

Figure 7

Figure 7 depicts three inertial frames. S is the inertial frame of the stationary ground observer. S' is the inertial frame of the train observer, moving with the velocity, v , in respect to S . S'' is an inertial frame in between S and S' . In respect to S , S'' moves in the same direction as S' , but with the slower velocity, v'' , than that of S' . In respect to S' , S'' moves away toward S .

Next, let us suppose three scenarios where the each inertial frame from the above observes the light source to be stationary in its inertial frame as shown below in Figure 8.

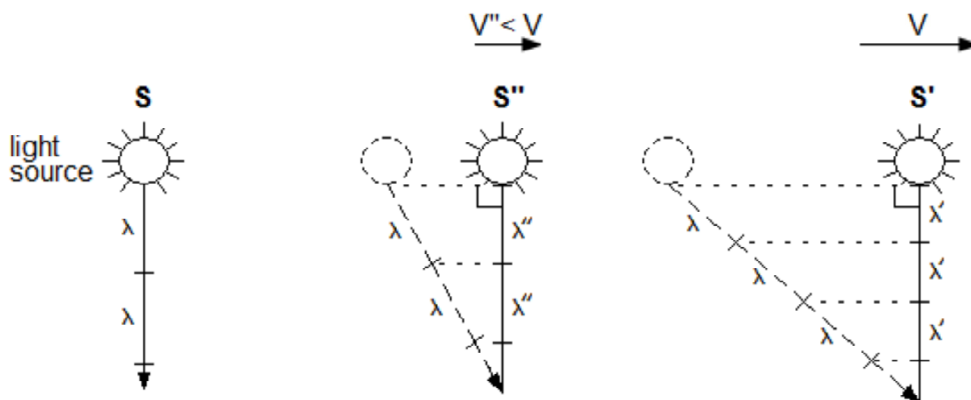

Figure 8

Figure 8 uses Equation 6 to show the wavelength of the vertical light, λ , λ' , and λ'' , observed by each inertial frame, S, S', and S'' respectively.

Notice how λ'' is longer than λ' . This contradicts the principle of relativity, because according to the principle of relativity, S' observes S'' to be moving -- and applying the same logic used in Figure 6, a moving inertial frame should have observed the shorter wavelength, not longer.

In other words, if the principle of relativity were correct, then S claiming to be at rest, it would observe λ'' to be longer than λ' , but, S' claiming to be at rest, it would observe λ'' to be shorter than λ' .

Remember: the length perpendicular to the velocity does not contract in the special relativity. So, when later λ'' measured by S'' is compared against λ' , it cannot be both longer and shorter at the same time.

Understanding this contradiction becomes clearer when we consider the following paradox. If special relativity somehow allows λ'' to be both longer and shorter than λ' depending on an inertial frame of the observer, then in general, it basically means that the vertical wavelength of a moving inertial frame becomes shorter than the wavelength of any arbitrary rest frame.

If so, then let us consider this scenario: there is a cat and a rocket on Earth. The both initially observe Sun shining visible light at 500nm wavelength. The rocket takes off and moves away from Earth with such velocity, so that their Lorentz factor, $\gamma = 50,000$. Now, from the rocket's point of view, the wavelength of Sun would have shortened by the factor of 50,000, turning the harmless visible light into deadly gamma radiation. The cat on Earth would have died, if the principle of relativity were correct.

This contradiction would not exist if there were an absolute rest frame -- in this case, S.

This change in the vertical wavelength is significant because it indicates that an observer in any inertial frame can detect if its inertial frame is in motion or not. Only in an absolute rest frame would the moving light source result in the shorter wavelength measured by the inertial frame of the light source, regardless of the direction to where the light source move; in a moving inertial frame, the moving light source would result in the longer wavelength if the light source moves either in the forward or backward direction -- if the forward results in the shorter wavelength, then the backward would result in the longer; and vice versa.

Moreover, the observer can detect which inertial frame is an absolute rest frame. In respect to a non-absolute rest frame, the absolute rest frame is located at the same direction as the moving light source resulting in the longer wavelength. As the light source moves faster, it would observe the increasing vertical wavelength up until when the inertial frame of the light

source matches an absolute rest frame. If the light source moves faster than an absolute rest frame, then the vertical wavelength would start to get shorter.

The very existence of an absolute rest frame is a direct contradiction to the first postulate of special relativity: the principle of relativity. Furthermore, the existence of an absolute rest frame entails Galilean transformation between inertial frames where the time is constant, which means the speed of light is not going to be constant between all inertial frames. Only in an absolute rest frame, the speed of light is going to be constant in all directions. In a moving inertial frame, the velocity of the inertial frame in respect to the absolute rest frame would affect the speed of light. Thus, it contradicts the second postulate of special relativity: the universal speed of light.

By the way, this change in the speed of light is exactly what people tried to detect using Michelson interferometer. The reason for the null result of Michelson-Morley experiment is explained in the following Discussion section. In short, the null result was an expected result, and thus should not have been used as an evidence against the non-universal speed of light.

Results

The analysis of the derivation of the time dilation has explained that an absolute rest frame can be detected by measuring the wavelength from light source in the uniform rectilinear motion. In addition, the existence of an absolute rest frame affects the speed of light in a moving inertial frame. These are contrary to the two postulates of the special theory of relativity: the principle of relativity and the universal speed of light, respectively.

In conclusion, this paper introduced the theory of absolutivity that states:

1. There is an absolute rest frame of reference.
2. The speed of light is not a universal constant.

Discussion

This section discusses the paper written by Gjurchinovski titled, "Reflection of light from a uniformly moving mirror". His paper derives Lorentz contraction by analyzing how an inclined, moving mirror reflects light. Although Gjurchinovski bases his findings on the two postulates of special relativity, I intend to show that his findings would be still valid if they were applied in an absolute rest frame without referencing special relativity. Then, his derivation of Lorentz contraction can be used to explain the null result of Michelson-Morley experiment.

Law of Reflection of Light from Moving Mirror

Gjurchinovski uses Huygens' construction to calculate how light would get reflected from an inclined, moving mirror with a constant linear velocity as shown below.

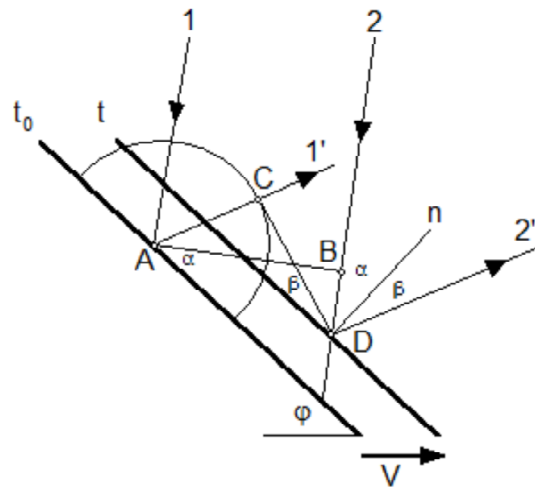

Gjurchinovski 2004: 1317; Figure 9

Figure 9 depicts the diagram of the moving mirror used by Gjurchinovski. Here are the steps of reflected light as described by Gjurchinovski: 1 and 2 are the boundaries of the incident, plane-polarized light wave. At time, t_0 , the boundary 1 of the light wavefront, AB, strikes the mirror at the point A. The boundary 2 continues to travel along its original path. At time, t , the mirror moves forward and collides with the boundary 2 at the point D. By this time, the boundary 1 at the point A has formed an expanding spherical wavelet -- the spherical wavelet travels with the speed of light in vacuum, c . Finally, the wavefront CD represents the reflected light with the boundaries 1' and 2'.

From these, Gjurchinovski derives the law of reflection of light from an inclined flat mirror in uniform rectilinear motion.

$$\sin \alpha - \sin \beta = (v/c) \sin \varphi \sin (\alpha + \beta) \quad (\text{Gjurchinovski 2004: 1318; Equation 7})$$

Here, Gjurchinovski refers to the postulate of the universal speed of light, in order to justify that the spherical expansion of the wavelet from the point A has the speed of light in vacuum, c (Gjurchinovski 2004: 1316). I contend that we do not need to refer to the universal speed of light for the above law (Equation 7) to be valid if we use an absolute rest frame.

Now, remember how the speed of radiation derived from Lienard-Wiechert potentials (Equation 2) equals the speed of light in vacuum, c . And notice how Figure 9 is from the perspective of a stationary observer. And notice in Figure 6, how although the vertical speed of light has changed, the diagonal speed of light has not changed. Put these all together, it means that if we assume the stationary observer in Figure 9 to be in an absolute rest frame, then the speed of the spherical wavelet from A would still be the speed of light in vacuum, c .

The consequence of referring to an absolute rest frame would be though that the law of reflection of light (Equation 7) is no longer going be valid in a moving inertial frame, and is only valid in an absolute rest frame. But, for our purpose, that is good enough.

Thus, in an absolute rest frame, the law of reflection of light derived by Gjurchinovski (Equation 7) would be still valid without having to refer to special relativity.

Einstein’s Cat Experiment and Lorentz Contraction

Gjurchinovski continues by discussing Einstein’s cat experiment to derive Lorentz contraction, as shown below.

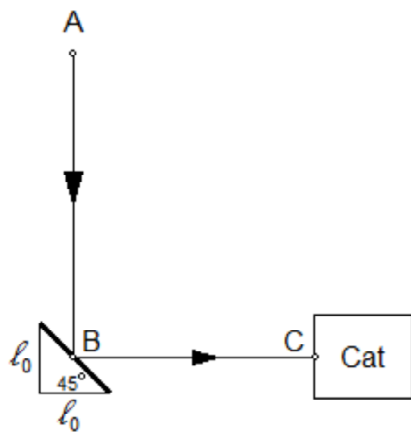

Gjurchinovski 2004: 1318; Figure 10

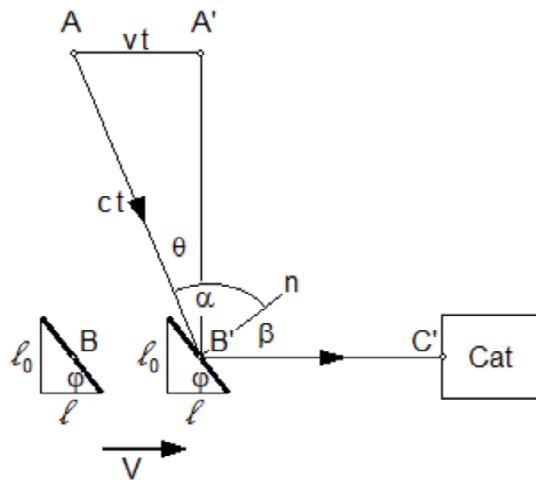

Gjurchinovski 2004: 1319; Figure 11

Figure 10 depicts a stationary setup of Einstein's cat experiment. The light beam travels from the light source A to the mirror at B. The mirror inclined at 45° angle reflects the light to the cat at C.

Figure 11 depicts this setup, moving horizontally with a constant velocity, observed by a stationary observer. The points A, B, and C moves to A', B', and C', respectively. The light travels from A to B', then gets reflected from B' to C'.

From these, Gjurchinovski derives Lorentz contraction of length using his law of reflection of light (Equation 7):

$$\tan \varphi = 1/\cos \theta = 1/(1 - v^2/c^2)^{1/2} \quad (\text{Gjurchinovski 2004: 1320; Equation 8})$$

$$l = l_0 (1 - v^2/c^2)^{1/2} \quad (\text{Gjurchinovski 2004: 1320; Equation 9})$$

Now, Gjurchinovski refers to the postulate of the principle of relativity, in order to justify that the reflected light from the moving setup would strike the cat at C' (Gjurchinovski 2004: 1319). I contend that we do not need to refer to the principle of relativity for this to be valid if we use an absolute rest frame.

In an absolute rest frame, Figure 10 would depict the setup in the moving inertial frame. Again, when we consider how the light propagates in Figure 6, the moving setup would observe the light as if it travels vertically from A to B. The difference would be though that the wavelength and the speed of the light (for both the vertical, AB and the horizontal, BC) would have changed when observed by the setup (which is stationary in the moving frame). Nonetheless, the light would travel from A to B to C because the mirror is inclined at 45° in this inertial frame.

If so, then there is no reason why a stationary observer in an absolute rest frame would not observe the same light to have traveled from A to B' to C' as in Figure 11. This does not mean that we have referenced the principle of relativity; if we had, then the wavelength and the speed of light would not have changed in the moving inertial frame -- but, in the context of an absolute rest frame, they do change.

This means, in an absolute rest frame, Lorentz contraction derived by Gjurchinovski (Equation 9) would be still valid without having to refer to the postulates of special relativity.

This interpretation of Lorentz contraction derived by Gjurchinovski without the dependencies on special relativity is important because it has long been a proposed explanation by Fitzgerald and Lorentz that the null result of Michelson-Morley experiment could have been due to

Lorentz contraction of the length in the parallel direction of the motion (Serway 1990:1109). And it is this null result that had inspired Einstein to propose the postulate of the universal speed of light for special relativity (Griffiths 1989:449).

Bibliography

Gjurchinovski, A. 2004. Reflection of light from a uniformly moving mirror. *Am J Phys.* 72(10):1316-1324.

Griffiths, D. J. 1989. *Introduction to electrodynamics*. 2nd ed. Englewood Cliffs: Prentice-Hall, Inc.

Serway, R. A. 1990. *Physics for scientists & engineers*. 3rd ed. Philadelphia: Saunders College Publishing.

Acknowledgements

I would like to thank Jesus Christ for guidance and encouragement.

I would like to thank Richard Lee and Myung Lee for helping me with the experiments and reviewing the paper.